

CATALOG CARGO

2024



WWW.UNIXAUTO.RO

TEXTAR
BRAKE TECHNOLOGY

ÎN CĂUTAREA CONTROLULUI



STIMATE PARTENER!

Avem deosebita plăcere să vă prezentăm primul catalog al diviziei UNIX Cargo. În publicația noastră, vă prezentăm peste 4.000 de produse selectate din stocul de marfă al companiei noastre, care conține mai multe milioane de produse focusate pe cele mai cunoscute mărci de vehicule utilizate în servicii de transporturi. Suntem convinși că produsele prezentate în acest catalog arată faptul că divizia UNIX Cargo în ultimii ani a trecut printr-o dezvoltare semnificativă.

Oferta noastră de produse a fost extinsă cu multe mărci noi și importante, astfel încât compania UNIX Auto și în acest segment a devenit un jucător dominant pe piață. Toți clienții noștri, inclusiv partenerii Cargo, se pot bucura de avantajele oferite de UNIX: stoc de marfă mărit, multitudine de piese cu disponibilitate imediată și livrare rapidă, precum și reducerile și promoțiile speciale oferite de programul VIP Club.

Desigur, într-o astfel de publicație nu avem posibilitatea de a prezenta toate produsele din oferta UNIX, dar echipa noastră pregătită tehnic și profesional cu bucurie stă la dispoziția tuturor partenerilor noi și existenți, și va răspunde cu plăcere la întrebări! Contactați-ne, și în același timp răsfoiți catalogul nostru cu folos, care sperăm să fie un real ajutor în munca dumneavoastră de zi cu zi!

HERMANN SÁNDOR \ Manager divizia UNIX Cargo

CUPRINS

5	PIESE CAP TRACTOR
47	CAROSERIE
77	SISTEMUL DE FRÂNARE HIDRAULIC
93	SISTEMUL DE FRÂNARE PNEUMATIC
101	SISTEMUL DE TRACȚIUNE
107	SEMIREMORCI
113	ARC PNEUMATIC
117	ILUMINARE
131	PIESE ELECTRICE
137	PIESE UTILAJE AGRICOLE ȘI DE CONSTRUCȚII
143	LUBRIFIANȚI – LICHIDE
151	ECHIPAMENTE
159	MATERIALE SERVICE
171	ECHIPAMENTE PENTRU DOTAREA ATELIERELOR ȘI GARAJELOR
181	INOVAȚIE
189	ECHIPAMENTE DE PROTECȚIA MUNCII

DATE DE CONTACT

Echipa editorială:

Bencsik Péter \ Expert Cargo
Hermann Sándor \ Manager Divizia Cargo
Püsök Beatrix Klaudia \ Expert Cargo

Vă invităm să ne contactați prin următoarele date de contact:

Ungaria
Telefon: +36 (1) 270 8721
Mobil: +36 (20) 511 8601
Mobil: +36 (20) 394 7352
Mobil: +36 (30) 539 3771
E-mail: cargo@unixauto.com

România
Telefon: +40 (377) 100 150
Mobil: +40 (749) 055 500
E-mail: cargo@unixauto.com



Testăm sistemele noastre de frânare pe șosele, peste **38.000 de ore**, în fiecare an. Produsele noastre sunt supuse în cele mai grele condiții, la cele mai mari presiuni. Sunt testate în fiecare mediu de conducere, astfel încât să putem oferi performanță garantată. Din acest motiv suntem noi experții sistemelor de frânare.

www.textar.com | | #InPursuitOfExcellence





Genuine Quality.
Durable Trust.



Tot de ce aveti nevoie



O marcă pentru toate piesele de schimb ale camioanelor.
www.dt-spareparts.com

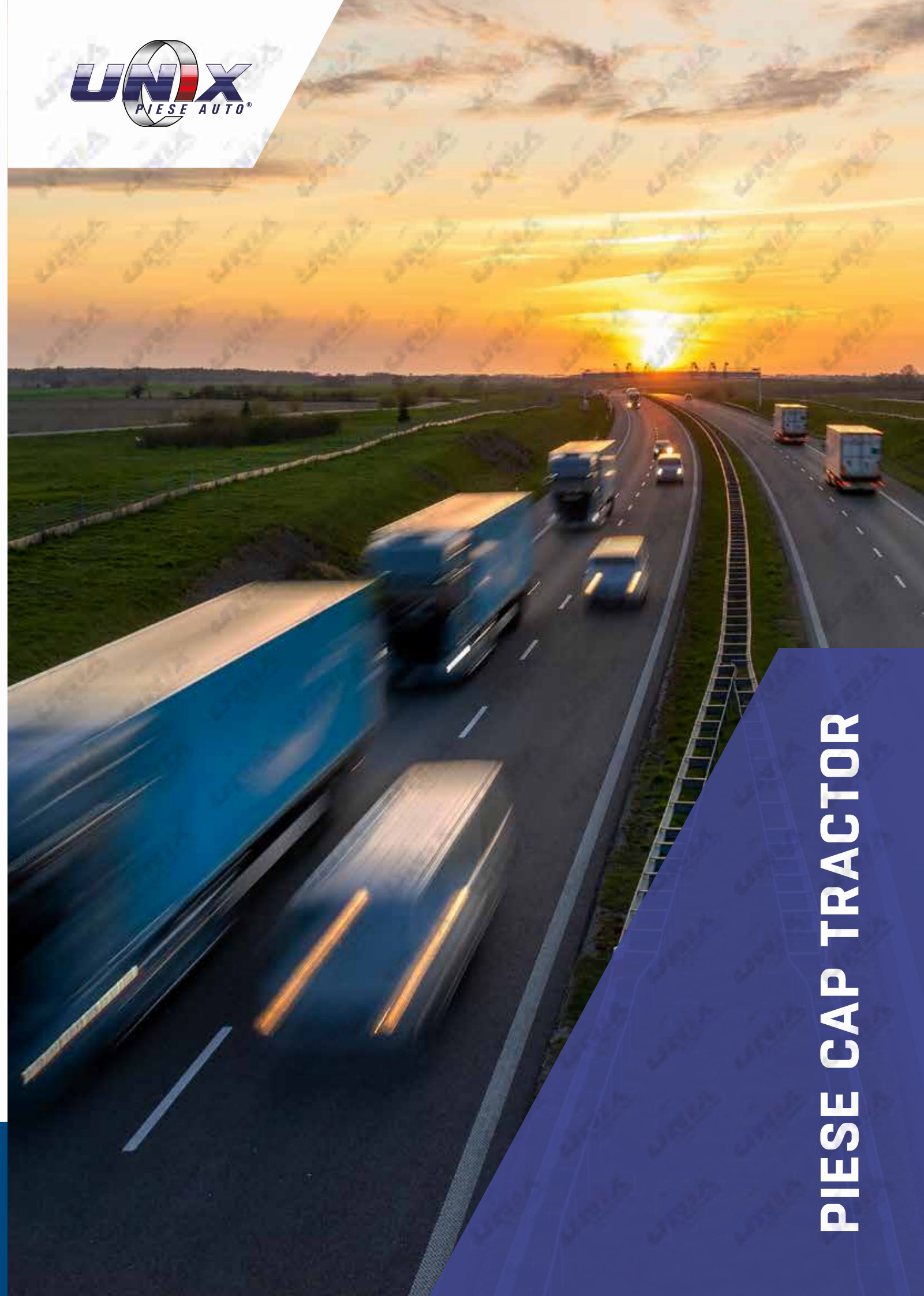

PIESE CAP TRACTOR

DAF LF

FILTRE

Filtru aer



Nr. Unix: 10365729

Filtru ulei



Nr. Unix: 346705/1

Prefiltru combustibil



Nr. Unix: 11190572

Filtru combustibil



Nr. Unix: 11190636

Filtru polen



Nr. Unix: 10370862

FRÂNĂ - FRÂNĂ PNEUMATICĂ

Plăcuțe frână la disc frână

Față/Spate
Nr. Unix: 10954012

Disc frână

Față
Nr. Unix: 10266751

Disc frână

Spate
Nr. Unix: 11363413

Set reparație etrier (PAN 17)



Nr. Unix: 11064123

SISTEMELE DE RULARE - DE DIRECȚIE -DE AMORTIZARE

Amortizor

Față
Nr. Unix 10120384

Amortizor

Spate
Nr. Unix 340955

Rulment roată

Față
Nr. Unix 11152799

Rulment roată

Spate
Nr. Unix 51674/1

Levier comandă direcție



Nr. Unix: 10354491

Bieleță direcție



Nr. Unix: 10402036

Set reparație fuzetă



Nr. Unix: 11030562

ILUMINARE

Lampă spate

Stânga
Nr. Unix 157168

Lampă spate

Dreapta
Nr. Unix 157188

Semnalizator



Nr. Unix: 157152

Lampă poziție



Nr. Unix: 157349

RĂCIRE- ÎNCĂLZIRE

Radiator climă



Nr. Unix 10396103

Compresor climă



Nr. Unix 10273323

Vas expansiune



Nr. Unix: 11262434

Motor ventilator încălzire



Nr. Unix: 11096758

Termostat



Nr. Unix 10056031

Pompă apă



Nr. Unix 11213644

Capac radiator



Nr. Unix: 10926788

Suport cauciuc radiator



Nr. Unix: 11032319

DAF CF EURO-6

FILTRE

Filtru aer



Nr. Unix: 343658/1

Filtru ulei



Nr. Unix: 11189309

Filtru combustibil



Nr. Unix: 11209965

Filtru combustibil



Nr. Unix: 11190526

Filtru polen



Nr. Unix: 11200380

Filtru uree (Adblue)



Nr. Unix: 10367221

FRÂNĂ - FRÂNĂ PNEUMATICĂ

Plăcuțe frână la disc frână

Față/Spate
Nr. Unix 10953392

Disc frână

Față/Spate
Nr. Unix 157841

Senzor uzură frână



Nr. Unix: 10944669

Compresor frână pneumatică



Nr. Unix: 11061909

SISTEMELE DE RULARE - DE DIRECȚIE -DE AMORTIZARE

Amortizor suspensie cabină

Față
Nr. Unix 11032532

Amortizor suspensie cabină

Spate
Nr. Unix 11032542

Braț oscilant



Nr. Unix 11117753

Set reparație fuzetă



Nr. Unix 11096606

Pernă de aer completă (spate/față)



Nr. Unix: 10995811

Pernă de aer completă (spate/spate)



Nr. Unix: 10995810

Amortizor (Față)



Nr. Unix: 89111

Amortizor (Spate)



Nr. Unix: 10580147

TRANSMISIE PRIN CUREA

Rulment întinz. curea cu caneluri



Nr. Unix 10225716

Curea cu caneluri

8PK2080HD
Nr. Unix 238113/2

Injector



Nr. Unix: 10267476

Unitate diuză alimentare



Nr. Unix: 10267371

GARNITURI MOTOR

Set garnituri chiulasa



Nr. Unix 11215152

Set prezoane chiulasa



Nr. Unix 854241

Simering arbore cotit

Față Nr. Unix 865502
Spate Nr. Unix 865501

Garnitură bloc motor



Nr. Unix: 11017623

CABINĂ

Pompă ridicare cabină



Nr. Unix 10538715

Cilindru de rabatare cabină



Nr. Unix 11030862

Macara geam (stânga)



Nr. Unix: 11181570

Buton geam electric (stânga)



Nr. Unix: 10316236

DAF XF105

FILTRE

Filtru aer  07/11-> Nr. Unix 10365671	Filtru ulei  Nr. Unix: 346415/1	Filtru combustibil  Nr. Unix: 83403/1	Filtru polen  Nr. Unix: 82719/1	Filtru hidraulic  Nr. Unix: 11129337	Filtru sistem răcire  Cu conector separator apă
 -> 06/11 Nr. Unix 10365593	Filtru ulei centrifugal  Nr. Unix 346189/1	Prefiltru combustibil  Nr. Unix 82601/1	Filtru carbon activ cu polifenol+cu efect antibacterian  Nr. Unix 10596261	Direcție  Nr. Unix 82994/1	Parker-Racor  Nr. Unix 346491/1

FRÂNĂ - FRÂNĂ PNEUMATICĂ

Plăcuțe frână la disc frână  Față/Spate Nr. Unix 10953392	Disc frână  Față/Spate Nr. Unix 157841	Set montare disc frână  Nr. Unix 10944257	Filtru dezumidificare  Nr. Unix 167888
--	---	--	--

SISTEMUL DE AMORTIZARE

Amortizor  Față Nr. Unix 10973600	Pernă de aer completă  Spate Nr. Unix 10541713	Amortizor suspensie cabină  Față Nr. Unix 10495820	Amortizor suspensie cabină  Spate Nr. Unix 10495943
--	---	---	--

SISTEMUL DE ILUMINARE

Far față  Dreapta Nr. Unix 394914/2	Far față  Stânga Nr. Unix 394913/2	Lampă spate  Dreapta Nr. Unix 157281 Stânga: Nr. Unix 157280	Far ceață  Dreapta Nr. Unix 576740 Stânga Nr. Unix 576741
--	---	--	--

CABINĂ

Oglinda  dreapta/stânga (cu încălzire-cu motor) Nr. Unix 10808357	Oglindă unghi mort  dreapta/stânga (cu încălzire-cu motor) Nr. Unix 1080300	Suport oglindă (dreapta)  Nr. Unix 456993	Suport oglindă (stânga)  Nr. Unix: 456997
Buton geam electric  Nr. Unix 872124	Bloc semnalizare  Nr. Unix 881416	Ștergător parbriz (550mm)  Nr. Unix: 10985360	

DAF XF105

TRANSMISIE PRIN CUREA

Rulment întinz. curea cu caneluri  Nr. Unix 11016611	Rulment întinz. curea cu caneluri  Nr. Unix: 888619	Curea cu caneluri  9PK1330HD Nr. Unix 102971 7PK1753HD Nr. Unix 102876
--	---	---

ELECTROMOTOR/ALTERNATOR

Electromotor  24V, 5,5kW Nr. Unix 10241444	Alternator  28V, 80A Nr. Unix 10241419
---	---

RĂCIRE

Radiator răcire  Nr. Unix 948430	Pompă apă  Nr. Unix 10578985	Viscocuplaj ventilator răc.  Nr. Unix 10889510	Vas expansiune  Nr. Unix 10513828
--	--	--	---

CLIMĂ

Radiator climă  Nr. Unix 315932	Compresor climă  Nr. Unix 10273091	Filtru uscător  Nr. Unix 10273510	ÎNCĂLZIRE Motor ventilator încălzire  Nr. Unix 10399063
---	--	---	---

SISTEMELE DE RULARE - DE DIRECȚIE

Bioletă direcție  Nr. Unix 10403019	Levier comandă direcție  Nr. Unix 10286436
---	--

Butuc roată (Față)  Nr. Unix 10030954	Butuc roată (Spate)  Nr. Unix 10030953	Rulment roată  Nr. Unix 10348900	Set reparație fuzetă  Nr. Unix 135495
---	--	--	---

SISTEMUL DE EVACUARE

AdBlue pompă  Nr. Unix 10177070	Senzor Nox  Nr. Unix 11066668 Nr. Unix 11066667	Filtru uree (AdBlue)  Nr. Unix 344572/1	Filtru aer (EAS)  Nr. Unix: 344501/1
---	--	---	--

TRANSMISIA PUTERII

Kit ambreiaj Ø 430

Nr. Unix 10467388

Cilindru servoambreiaj

Nr. Unix 146499

TURBOCOMPRESOR

Turbocompresor

Nr. Unix 10886599

DAF XF106

FILTRE

Filtru aer



07/11->

Nr. Unix 10365671

Filtru ulei



Nr. Unix 304577

Filtru combustibil



Nr. Unix X40313468

Filtru polen
-> 06/15

Nr. Unix 82719/1

Filtru polen
07/15 ->Filtru cu carbon activ
Nr. Unix 10370974

Filtru hidraulic

Direcție
Nr. Unix 80978/1

Filtru sistem răcire



Nr. Unix 11129337

Filtru ulei

Filtru ulei
centrifugal
Nr. Unix 343813

Filtru combustibil

Filtru primar
Nr. Unix 11190783Filtru polen
-> 06/15Filtru carbon activ
cu polifenol+cu
efect antibacterian
Nr. Unix 10596261

Filtru polen (2 buc)

Pt. vehicule
echipate cu EGR
Nr. Unix 11094298

Filtru hidraulic

Direcție
Nr. Unix 82994/1

FRÂNĂ - FRÂNĂ PNEUMATICĂ

Filtru dezumidificare



Nr. Unix 11118392

Supapă frână de mână



Nr. Unix 11168068

Modulator ax



Nr. Unix 10853875

Supapă multicircuit



Nr. Unix 11093396

Supapă releu



Nr. Unix 11179080

Supapă magnetică (ABS)



Nr. Unix 10853345

Supapă releu
(frână de servici)

Nr. Unix 11179083

Supapă ghidaj



Nr. Unix 11276372

SISTEMUL DE ILUMINARE

Far față

Dreapta
Nr. Unix 365345

Far față

Stânga
Nr. Unix 365342

Far ceață

Dreapta Nr. Unix 365189
Stânga Nr. Unix 365188

Lampă spate

Dreapta Nr. Unix 157190
Stânga Nr. Unix 157189

SISTEMUL DE AMORTIZARE

Amortizor Față (cabină)



Nr. Unix 10379046

Amortizor Spate (cabină)



Nr. Unix 10378953

Pernă de aer completă



Nr. Unix 10995811

Pernă de aer completă



Nr. Unix: 10995810

DAF XF106

TRANSMISIE PRIN CUREA

Rulment întinz. curea cu
caneluri

Nr. Unix 10225716

Curea cu caneluri

8PK2080HD
Nr. Unix 238113/2

ELECTROMOTOR/ALTERNATOR

Electromotor

24V, 6 kW
Nr. Unix 770970

Alternator

28V, 80 A
Nr. Unix 11223069

SISTEMELE DE RULARE - DE DIRECȚIE

Butuc roată (Față)



Nr. Unix 10030954

Butuc roată (Spate)



Nr. Unix 11023355

Inel ABS



Nr. Unix 621743

Șurub roată

Șurub roată Nr. Unix 10541442
Prezon roată Nr. Unix 10031119

Senzor ABS (Față)



Nr. Unix 11283094

Senzor ABS (Spate)



Nr. Unix 11178883

Set reparație fuzetă



Nr. Unix 11096606

Piuliță fuzetă

Față Nr. Unix 10170333
Spate Nr. Unix 10170332Cilindru frână pneumatic
(față)

Nr. Unix 11183563

Cilindru frână pneumatic
24/24 (Spate)Stânga Nr. Unix 10267180
Dreapta Nr. Unix 10267179

Levier comandă direcție



Nr. Unix 10997763

Vas ulei servo



Nr. Unix 10096506

EGR / SISTEMUL DE EVACUARE

Senzor presiune EGR



Nr. Unix 10316211

Senzor temperatură
emisii gaze

Nr. Unix 10926496

Senzor temperatură
emisii gaze

Nr. Unix 11298747

Senzor Nox



Nr. Unix 11103407

Diesel filtru particule



Nr. Unix 11356863

Țeavă eșapament



Nr. Unix 11357063

Senzor presiune



Nr. Unix 11357371

Garnitură galerie evacuare



Nr. Unix 857325

IVECO Daily IV-V

FILTRE

Filtru aer



Nr. Unix: 82387/1

Filtru ulei



Nr. Unix: 344466/1

Filtru combustibil



Nr. Unix: 10372005

Filtru polen (cu carbon activ)



Nr. Unix: 10370758

FRÂNĂ

Plăcuțe frână la disc frână

Față (IV-V)
Nr. Unix: 10602322

Plăcuțe frână la disc frână

Spate (IV)
Nr. Unix: 10884828

Disc frână

Față (IV-V)
Nr. Unix: 198092

Disc frână

Spate (IV)
Nr. Unix: 197963

Plăcuțe frână la disc frână

Spate (V)
Nr. Unix: 10952644

Disc frână

Spate (V)
Nr. Unix: 10965623

Cablu frână de mână

dreapta/stânga (III-VI)
Nr. Unix: 10613054

Furtun frână (cauciuc)

Spate Dreapta-Stânga (IV-VI)
Nr. Unix: 256975

Etrier (IV-VI)

Axă față stânga
Nr. Unix: 565129

Etrier (IV-VI)

Axă față dreapta
Nr. Unix: 565130

Etrier (IV-VI)

Axă spate stânga
Nr. Unix: 563906

Etrier (IV-VI)

Axă spate dreapta
Nr. Unix: 563907

AMORTIZAREA PRIN ARCURI LAMELARE

Amortizor (II-VI)

Față Nr. Unix: 10420448
Spate Nr. Unix: 10420447Bucșă foaie arc
(versiunea veche)

Nr. Unix: 10545286

Bucșă foaie arc
(versiunea nouă)

Nr. Unix: 10546340

Bucșă bară stabilizatoare
(spate)

Nr. Unix: 11067172

Bucșă bară stabilizatoare
(față)

Nr. Unix: 10198410

Casetă direcție



Nr. Unix: 11041525

IVECO Daily IV-V

TRANSMISIE PRIN CUREA

Curea cu caneluri



Nr. Unix: 10002142

Rulment întinz. curea cu
caneluri

Nr. Unix: 10897451

ELECTROMOTOR/ALTERNATOR

Alternator



Nr. Unix: 10247915

Electromotor



Nr. Unix: 10195123

SISTEMUL DE EVACUARE/ADMISIE

Catalizator



Nr. Unix: 303641

Tobă eșapament



Nr. Unix: 554622

Țeavă flexibilă eșapament



Nr. Unix: 289480

Supapă EGR



Nr. Unix: 10629499

Răcitor carcasă evacuare



Nr. Unix: 11280494

Turbocompresor



Nr. Unix: 10513985

Intercooler



Nr. Unix: 11259571

Senzor presiune (MAP)



Nr. Unix: 10131970

Sondă lambda



Nr. Unix: 737876

Supapă regularizare presiune



Nr. Unix: 11122002

Debitmetru aer



Nr. Unix: 907936

TRANSMISIA PUTERII

Kit ambreiaj



Nr. Unix: 10796120

Volantă cu masă dublă



Nr. Unix: 149824

Set ambreiaj hidraulic



Nr. Unix: 10470063

RĂCIRE

Viscocuplaj ventilator răc.



Nr. Unix: 11263308

Pompă apă



Nr. Unix: 588891

Radiator răcire



Nr. Unix: 294875

IVECO Daily VI

FILTRE

Filtru aer



Nr. Unix: 10365469

Filtru ulei



Nr. Unix: 304394/1

Filtru combustibil



Nr. Unix: 11094297

Filtru polen (polifenolic)

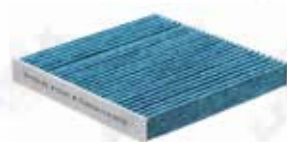

Nr. Unix: 11042982



Nr. Unix: 10365470



Nr. Unix: 344466/1



Nr. Unix: 10372005



Nr. Unix: 10515228

SISTEMUL DE ILUMINARE - OGLINDĂ

Far față

Dreapta
Nr. Unix: 838959

Far față

Stânga
Nr. Unix: 838960

Lampă spate

Stânga
Nr. Unix: 301324

Lampă spate

Dreapta
Nr. Unix: 301325

Lampă spate

Stânga
Nr. Unix: 10263969

Lampă spate

Dreapta
Nr. Unix: 10263970

Stop adițional



Nr. Unix: 11193526

Catadioptru



Nr. Unix: 461438

Lampă indicator gabarit



Nr. Unix: 10755652

Lampă poziție (Dreapta)



Nr. Unix: 11184555

Iluminare număr înmatriculare



Nr. Unix: 10325674

Lampă poziție (Stânga)



Nr. Unix: 11184556

Semnalizator (Stânga)



Nr. Unix: 10326384

Semnalizator (Dreapta)



Nr. Unix: 10326385

Oglindă (Stânga)



Nr. Unix: 11090766

Oglindă (Deapta)



Nr. Unix: 11090767

Semnalizator oglindă retrovizoare (Stânga)



Nr. Unix: 10556902

Semnalizator oglindă retrovizoare (Dreapta)



Nr. Unix: 10556906

IVECO Daily VI

TRANSMISIE PRIN CUREA

Curea cu caneluri (alternator)



Nr. Unix: 653875

Rulment întinz. curea cu caneluri



Nr. Unix: 10989426

Rulment întinz. curea cu caneluri



Nr. Unix: 10982494

Curea cu caneluri (compresor climă)



Nr. Unix: 11056099

RĂCIRE - ÎNCĂLZIRE

Viscocuplaj ventilator răc.



Nr. Unix: 11263321

Pompă apă



Nr. Unix: 588891

Radiator răcire



Nr. Unix: 10657377

Radiator climă



Nr. Unix: 11025751

Intercooler



Nr. Unix: 10400100

Radiator ulei



Nr. Unix: 10698399

Compresor climă



Nr. Unix: 11311015

Supapă expansiune



Nr. Unix: 11063747

Rezistență



Nr. Unix: 11220967

Motor ventilator încălzire



Nr. Unix: 11280417

Furtun apă radiator



Nr. Unix: 11106704

Senzor nivel apă



Nr. Unix: 11203255

Vas expansiune



Nr. Unix: 10927211

Termostat + garnitură



Nr. Unix: 11213172

Senzor temperatură apă



Nr. Unix: 861079

Furtun apă radiator (motor)



Nr. Unix: 10996650

Nr. Unix: 10996649

UȘĂ CULISANTĂ

Rolă ușă glisantă



Nr. Unix: 11023675

Rolă ușă glisantă



Nr. Unix: 11023676

Rolă ușă glisantă



Nr. Unix: 11023674

Mâner deschidere ușă



Nr. Unix: 11023688

Închizător ușă



Nr. Unix: 11023684

IVECO EuroCargo

FILTRE

Filtru aer



Nr. Unix: 11209924

Filtru ulei



Nr. Unix: 346705/1

Filtru combustibil



Nr. Unix: 11190580

Filtru combustibil



Nr. Unix: 346490/1

Filtru polen



Nr. Unix: 11209954

FRÂNĂ - FRÂNĂ PNEUMATICĂ

Plăcuțe frână la disc frână



Față/Spate Nr. Unix: 10954015

Disc frână (Față)



Nr. Unix: 10229493

Disc frână (Spate)



Nr. Unix: 11259203

Senzor uzură frână



Nr. Unix: 10963218

Supapă magnetică ECAS

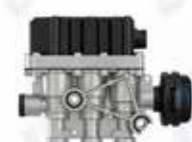

Nr. Unix: 11179030

Supapă de control nivel



Nr. Unix: 10054055

Supapă de control nivel



Nr. Unix: 10054056

Supapă frână de mână



Nr. Unix: 163015

SISTEMUL DE ILUMINARE - CABINĂ

Far față (Dreapta)



Nr. Unix: 10326381

Far față (Stânga)



Nr. Unix: 10326380

Lampă indicator gabarit

Dreapta Nr. Unix: 461394
Stânga Nr. Unix: 461395

Lampă spate (Stânga)



Nr. Unix: 157184

Lampă spate (Dreapta)



Nr. Unix: 157183

Semnalizator (dreapta/stânga)



Nr. Unix: 388014

Oglindă (Stânga)



Nr. Unix: 456779

Oglindă (Dreapta)



Nr. Unix: 456777

Pompă ridicare cabină



Nr. Unix: 872642

Închizător ușă (Stânga)



Nr. Unix: 10003594

Cilindru de rabatare cabină



Nr. Unix: 10805790

Macara geam (Stânga)



Nr. Unix: 11063368

IVECO EuroCargo

TRANSMISIE PRIN CUREA

Curea cu caneluri



Nr. Unix: 238104/2

Rulment întinz. curea cu caneluri



Nr. Unix: 10225353

Rulment întinz. curea cu caneluri



Nr. Unix: 217837

Rulment întinz. curea cu caneluri



Nr. Unix: 217730

SISTEMELE DE RULARE - DE DIRECȚIE

Butuc roată (Față)



Nr. Unix: 10515516

Rulment roată



Nr. Unix: 51331/1

Bieletă direcție



Nr. Unix: 11032446

Cap de bară bieletă direcție (M24x1,5, M30x1,5)

Cu filet pe dreapta
Nr. Unix: 10540652
Cu filet pe stânga
Nr. Unix: 10540651

Braț oscilant



Nr. Unix: 10068904

Amortizor (Față)



Nr. Unix: 10194318

Amortizor (Spate)



Nr. Unix: 10973765

TRANSMISIA PUTERII

Pompă ambreiaj



Nr. Unix: 167989

Kit ambreiaj



Nr. Unix: 11128138

Volantă



Nr. Unix: 11285634

INJEȚIE DE COMBUSTIBIL

Pompă de înaltă presiune



Nr. Unix: 10175795

Pompă combustibil



Nr. Unix: 338217

Injector



Nr. Unix: 10852858

Furtun de presiune



Nr. Unix: 10183562

Conductă combustibil (preîndoită)



Nr. Unix: 10927349

Filtru combustibil complet



Nr. Unix: 11030879

Litrometru



Nr. Unix: 10374232

Senzor apă alimentare combustibil



Nr. Unix: 10070726

IVECO Stralis

FILTRE

Filtru aer



Nr. Unix: 10365484

Filtru ulei



Nr. Unix: 10365778

Filtru ulei



Nr. Unix: 11050009

Filtru combustibil



Nr. Unix: 10367217

Filtru combustibil



Nr. Unix: 10367225

Filtru polen



Nr. Unix: 84498/1

FRÂNĂ - FRÂNĂ PNEUMATICĂ

Plăcuțe frână la disc frână



Nr. Unix: 10953392

Disc frână (Față)



Nr. Unix: 10053097

Disc frână (Spate)



Nr. Unix: 10053103

Inel ABS



Nr. Unix: 11096410

Unitate de pregătire aer



Nr. Unix: 10853295

Cilindru frână pneumatic (Față dreapta/stânga)



Nr. Unix: 10040953

Cilindru frână pneumatic (Spate Stânga)



Nr. Unix: 168023

Cilindru frână pneumatic (Spate Dreapta)



Nr. Unix: 168024

SISTEMUL DE ILUMINARE - CABINĂ

Far față (Dreapta)



Nr. Unix: 10196599

Far față (Stânga)



Nr. Unix: 10196598

Semnalizator (Stânga)



Nr. Unix: 576648

Semnalizator (Dreapta)



Nr. Unix: 576647

Lampă spate (Stânga)



Nr. Unix: 157287

Lampă spate (Dreapta)



Nr. Unix: 157288

Lampă indicator gabarit Stânga/Dreapta



Nr. Unix: 461430

Nr. Unix: 461429

Oglindă (Stânga)



Nr. Unix: 456867

Oglindă (Dreapta)



Nr. Unix: 456865

Rezervor spălător parbriz



Nr. Unix: 11031098

Motor spălător parbriz



Nr. Unix: 10627926

Senzor nivel lichid spălător parbriz



Nr. Unix: 11182025

IVECO Stralis

TRANSMISIE PRIN CUREA

Rulment întinz. curea cu caneluri



Nr. Unix: 655208

Curea cu caneluri (12PK1932HD)



Nr. Unix: 655110

Rulment întinz. curea cu caneluri



Nr. Unix: 655207

Curea cu caneluri (4PK1041EEHD)



Nr. Unix: 36599

RĂCIRE - ÎNCĂLZIRE

Radiator răcire



Nr. Unix: 948116

Pompă apă



Nr. Unix: 656734

Supapă magnetică (apă)



Nr. Unix: 10130463

Furtun apă radiator (partea superioară)



Nr. Unix: 10305035

Furtun apă radiator (partea superioară)



Nr. Unix: 10805364

Radiatoare climă



Nr. Unix: 295995

Compresor climă



Nr. Unix: 10273206

Motor ventilator încălzire



Nr. Unix: 11383689

Întreprupător presiune



Nr. Unix: 11262298

Rezistență



Nr. Unix: 11046764

SISTEMUL DE EVACUARE

Teavă eșapament



Nr. Unix: 11357140

Diesel filtru particule



Nr. Unix: 11356870

Colier eșapament



Nr. Unix: 554385

Garnitură galerie evacuare



Nr. Unix: 869895

Senzor temperatură emisii gaze



Nr. Unix: 11298734

Senzor temperatură emisii gaze



Nr. Unix: 11298735

Senzor Nox



Nr. Unix: 11298833

Senzor presiune



Nr. Unix: 10374614

SISTEMUL DE AMORTIZARE

Amortizor suspensie cabină față



Nr. Unix: 10107805

Amortizor suspensie cabină spate



Nr. Unix: 10768356

Element cauciuc pernă de aer



Nr. Unix: 10898504

Amortizor (Față)



Nr. Unix: 10973601

Amortizor (Spate)



Nr. Unix: 10973727

MAN TGL

FILTRE

Filtru aer



Nr. Unix: 11220329

Filtru ulei



Nr. Unix: 82284/1

Filtru combustibil



Nr. Unix: 81801/1

Filtru polen



Nr. Unix: 11042892

Filtru uree (Adblue)



Nr. Unix: 10367221

FRÂNĂ - FRÂNĂ PNEUMATICĂ

Plăcuțe frână la disc frână
(Față/Spate)

Nr. Unix: 10953393

Disc frână (Față)



Nr. Unix: 157887

Disc frână (Spate)



Nr. Unix: 10053119

Senzor ABS

Stânga Nr. Unix: 11031271
Dreapta Nr. Unix: 872195

Set reparație compresor



Nr. Unix: 10034554

Supapă magnetică (Față)



Nr. Unix: 10841180

Cilindru frână pneumatic
(Față)Stânga Nr. Unix: 168032
Dreapta Nr. Unix: 168033

Supapă limitare presiune

Stânga Nr. Unix: 11179052
Dreapta Nr. Unix: 11179045

SISTEMUL DE AMORTIZARE - CABINĂ

Bucșă suspensie
cabină

Nr. Unix: 11174244

Amortizor suspensie
cabină (Spate)

Nr. Unix: 10580081

Pernă de aer completă



Nr. Unix: 10001314

Supapă de control nivel



Nr. Unix: 10842000

Tijă presiune

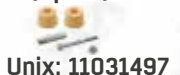

Nr. Unix: 10853451

Set rep. Suport cabină
(Spate)

Nr. Unix: 11031497

Amortizor (Față)



Nr. Unix: 10495708

Amortizor (Spate)



Nr. Unix: 11096995

Tampon arc lamerl



Nr. Unix: 10178341

Bucșă foaie arc



Nr. Unix: 10178587

Bucșă foaie arc



Nr. Unix: 10805860

SISTEMUL DE ILUMINARE

Far față (Dreapta)



Nr. Unix: 11226532

Far față (Stânga)



Nr. Unix: 11226531

Semnalizator



Nr. Unix: 10735800

Lampă spate (Stânga)



Nr. Unix: 157199

Lampă spate (Dreapta)



Nr. Unix: 157201

Sticlă lampă spate

Stânga Nr. Unix: 157043
Dreapta Nr. Unix: 157044

MAN TGL

ELECTROMOTOR/ALTERNATOR

Electromotor 24V, 5Kw

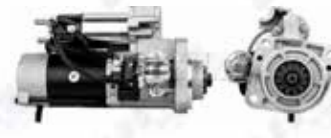

Nr. Unix: 11172594

Contact cu cheie



Nr. Unix: 11283126

Alternator 28V, 120A



Nr. Unix: 10241424

Punte diodă alternator



Nr. Unix: 339654

SISTEMELE DE RULARE - DE DIRECȚIE

Butuc roată (Față)



Nr. Unix: 51333/1

Rulment roată (Spate)



Nr. Unix: 10515514

Bieleță direcție



Nr. Unix: 943718

Levier comandă direcție



Nr. Unix: 11096642

Braț oscilant



Nr. Unix: 11030776

TRANSMISIA PUTERII

Pompă centrală ambreiaj



Nr. Unix: 77986

Cilindru servoambreiaj



Nr. Unix: 10845967

Kit ambreiaj



Nr. Unix: 10467333

RĂCIRE - ÎNCĂLZIRE

Radiator răcire



Nr. Unix: 948389

Intercooler



Nr. Unix: 922146

Viscocuplaj ventilator răc.



Nr. Unix: 11046452

Vas expansiune



Nr. Unix: 320079

Furtun apă radiator



Nr. Unix: 10805340

Furtun apă radiator



Nr. Unix: 10805341

Radiator încălzire



Nr. Unix: 10368499

Robinet încălzire



Nr. Unix: 923136

CABINĂ

Duză spălare parbriz

Nr. Unix: 10002697
Capac rezervor spălător
parbriz

Nr. Unix: 10007688

Macara geam (Stânga)



Nr. Unix: 11181561

Motoasă geam electric
(Stânga)

Nr. Unix: 11281969

Închizător ușă electric
(Stânga)

Nr. Unix: 11063356

Mâner deschidere ușă
(Stânga interior)

Nr. Unix: 11181618

Mâner deschidere ușă
(Dreapta interior)

Nr. Unix: 11181619

Mâner deschidere ușă
(Stânga exterior)

Nr. Unix: 445850

Mâner deschidere ușă
(Dreapta exterior)

Nr. Unix: 445849

MAN TGA

FILTRE

Filtru aer



Nr. Unix: 82794/1

Filtru ulei



Nr. Unix: 84510/1

Filtru combustibil



Nr. Unix: 81801/1

Filtru combustibil



Nr. Unix: 10174010

Filtru polen



Nr. Unix: 11042892

FRÂNĂ

Plăcuțe frână la disc frână
(Față/Spate)

Nr. Unix: 10953392

Disc frână (Față)



Nr. Unix: 10053114

Disc frână (Spate)



Nr. Unix: 10053115

Senzor ABS

Stânga Nr. Unix: 160377
Dreapta Nr. Unix: 160378

SISTEMUL DE AMORTIZARE

Amortizor suspensie cabină
(Față)

Nr. Unix: 301707

Amortizor suspensie cabină
(Spate)

Nr. Unix: 89046

Pernă de aer complet
(Spate)

Nr. Unix: 10769748

Pernă de aer complet
(Spate)

Nr. Unix: 10769743

Braț oscilant (Spate)



Nr. Unix: 10101222

Set reparație braț oscilant



Nr. Unix: 10423572

Amortizor (Față)



Nr. Unix: 10193685

Amortizor (Spate)



Nr. Unix: 10267144

CABINĂ

Set reparație (reglare înălțimea
scaunului)

Nr. Unix: 10903201

Amortizor scaun



Nr. Unix: 10116543

Arc pneumatic complet
scaun

Nr. Unix: 872778

Reglator scaun



Nr. Unix: 11362523

Reglator scaun



Nr. Unix: 10116527

Bloc semnalizare
(cu funcție ștergere-spălare)

Nr. Unix: 10036199

Bloc semnalizare
(cu funcție semnalizare)

Nr. Unix: 10097959

Cauciuc pedală



Nr. Unix: 10544204

Mâner deschidere ușă
(Stânga interior)

Nr. Unix: 10006246

Mâner deschidere ușă
(Dreapta interior)

Nr. Unix: 10150856

Buton geam electric
(Stânga)

Nr. Unix: 1063498

Buton geam electric
(Dreapta)

Nr. Unix: 10153209

MAN TGA

INJEȚIE DE COMBUSTIBIL

Pompă de înaltă presiune



Nr. Unix: 10175798

Furtun distribuitor de combustibil



Nr. Unix: 770733

Conductă combustibil (Preîndoită)



Nr. Unix: 11294615

Conductă combustibil
(Preîndoită)

Nr. Unix: 11294614

Conductă combustibil
(Preîndoită)

Nr. Unix: 11294613

Conductă combustibil
(Preîndoită)

Nr. Unix: 11294616

Conductă combustibil
(Preîndoită)

Nr. Unix: 11213437

Injector



Nr. Unix: 10182630

Litometru



Nr. Unix: 10996288

Senzor presiune combustibil



Nr. Unix: 334931

Sul cablu (injector)



Nr. Unix: 11161906

EGR / SISTEMUL DE EVACUARE

Supapă EGR



Nr. Unix: 11095811

Țeavă flexibilă eșapament



Nr. Unix: 10105173

Țeavă eșapament



Nr. Unix: 11182968

Supapă magnetică



Nr. Unix: 10101603

GARNITURI

Garnitură chiulasa



Nr. Unix: 859590

Garnitură capac culbutori

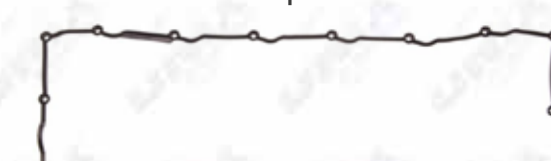

Nr. Unix: 864217

Garnitură galerie evacuare



Nr. Unix: 870084

Set garnituri sist. evacuare

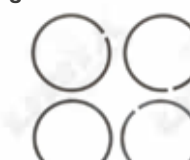

Nr. Unix: 67955

Garnitură turbocompresor



Nr. Unix: 10057088

Garnitură turbocompresor



Nr. Unix: 66208

MAN TGS

FRÂNĂ - FRÂNĂ PNEUMATICĂ

Plăcuțe frână la disc frână (Fată)



Nr. Unix: 10854517

Disc frână (Față)



Nr. Unix: 158900

Saboți frână (Spate)



Nr. Unix: 10854211

Tambur frână



Nr. Unix: 10031798

Braț frână (Stânga)



Nr. Unix: 724195

Braț frână (Dreapta)



Nr. Unix: 724196

Cheie frână (Stânga)



Nr. Unix: 10005638

Cheie frână (Dreapta)



Nr. Unix: 10005639

Supapă frână de mână



Nr. Unix: 11178905

Supapă releu



Nr. Unix: 873976

Supapă reglaj



Nr. Unix: 10848587

Arc saboți frână



Nr. Unix: 10005648

SISTEMUL DE ILUMINARE - CABINĂ

Far față (Dreapta)



Nr. Unix: 11184003

Far față (Stânga)



Nr. Unix: 11184002

Semnalizator lateral (Dreapta/Stânga)



Nr. Unix: 10749868

Semnalizator



Nr. Unix: 364875

Lampă spate (Stânga)



Nr. Unix: 157199

Lampă spate (Dreapta)



Nr. Unix: 157201

Semnalizator (Partea superioară)



Nr. Unix: 11010482

Oglindă (Stânga)



Nr. Unix: 10808597

Oglindă (Dreapta)



Nr. Unix: 10808598

Carcasă oglindă (Dreapta/Stânga)



Nr. Unix: 10057107

Oglindă unghi mort



Nr. Unix: 10060589

Carcasă oglindă (Stânga)



Nr. Unix: 10057110

MAN TGS

TRANSMISIE PRIN CUREA

Rulment întinz. curea cu caneluri



Nr. Unix: 11056284

Rulment întinz. curea cu caneluri



Nr. Unix: 217857

Curea cu caneluri



Nr. Unix: 10875449

Viscocuplaj ventilator răcire



Nr. Unix: 11046451

RĂCIRE - ÎNCĂLZIRE

Radiator răcire



Nr. Unix: 294324

Suport cauciuc radiator (Stânga)



Nr. Unix: 10902808

Suport cauciuc radiator (Dreapta)



Nr. Unix: 10902809

Termostat



Nr. Unix: 10886650

Robinet încălzire



Nr. Unix: 923136

Furtun apă radiator



Nr. Unix: 10358680



Nr. Unix: 939581



Nr. Unix: 10805254

Radiator climă



Nr. Unix: 10368499

Compresor climă



Nr. Unix: 10273092

Capac vas expansiune



Nr. Unix: 10008088

Garnitură termostat



Nr. Unix: 70707

SISTEMELE DE RULARE - DE DIRECȚIE

Bridă arc (Față) L: 210mm



Nr. Unix: 10064055

Bridă arc (Spate) L: 390 mm



Nr. Unix: 10064057

Arc parabolic (Stânga)



Nr. Unix: 10546122

Arc parabolic (Dreapta)



Nr. Unix: 10546121

Set reparație fuzetă



Nr. Unix: 10079265

Bieleță direcție

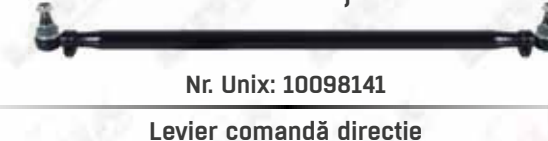

Nr. Unix: 10098141

Levier comandă direcție

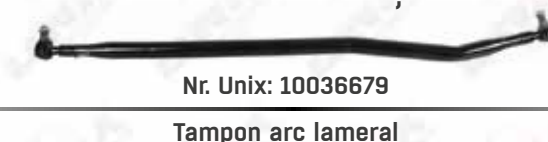

Nr. Unix: 10036679

Cap de bară bieletă direcție



Nr. Unix: 11362281

Bucșă foaie arc (Față)



Nr. Unix: 944597

Tampon arc lameral



Nr. Unix: 10544175

Rulment roată (Spate)



Nr. Unix: 10351164

MERCEDES Atego 2

FILTRE

Filtru aer



Nr. Unix: 82199/1

Filtru ulei



Nr. Unix: 11189089

Filtru combustibil



Nr. Unix: 10371605

Filtru polen



Nr. Unix: 11024115

FRÂNĂ

Plăcuțe frână la disc frână (Față/Spate)



Nr. Unix: 10954015

Disc frână (Față)



Nr. Unix: 10053068

Disc frână (Spate)



Nr. Unix: 10053069

Șurub disc frână



Nr. Unix: 10052573

SISTEMUL DE AMORTIZARE

Amortizor suspensie cabină (Față)



Nr. Unix: 301689

Amortizor suspensie cabină (Spate)



Nr. Unix: 89043

Pernă de aer completă



Nr. Unix: 10541587

Bieletă antiruliu



Nr. Unix: 10354642

Amortizor (Față)



Nr. Unix: 301714

Amortizor (Spate)



Nr. Unix: 987247

Bucșă cauciuc



Nr. Unix: 10045203

Bucșă cauciuc



Nr. Unix: 10805727

Bucșă bară stabilizatoare



Nr. Unix: 10178553

RĂCIRE - ÎNCĂLZIRE

Radiator răcire



Nr. Unix: 294677

Viscocuplaj ventilator răcire



Nr. Unix: 10692725

Ventilator răcire



Nr. Unix: 10008107

Senzor nivel apă



Nr. Unix: 10152958

Șurub golire radiator răcire



Nr. Unix: 516894

Motor ventilator încălzire



Nr. Unix: 10320585

Radiator încălzire



Nr. Unix: 10396731

Termostat



Nr. Unix: 10696032

Capac vas expansiune



Nr. Unix: 10539464

MERCEDES Atego 3

FILTRE

Filtru aer



Nr. Unix: 11200281

Filtru ulei



Nr. Unix: 11189329

Filtru combustibil



Nr. Unix: 11200399

Filtru polen



Nr. Unix: 82709/1

TRANSMISIE PRIN CUREA

Rulment întinz. curea cu caneluri



Nr. Unix: 10225723

Rulment întinz. curea cu caneluri



Nr. Unix: 10225678

Rulment întinz. curea cu caneluri



Nr. Unix: 10225692

Curea cu caneluri 8PK2320HD



Nr. Unix: 102962

ELECTROMOTOR/ALTERNATOR

Electromotor 24V, 5.5kw



Nr. Unix: 11172963

Alternator



Nr. Unix: 11120673

SISTEMUL DE RULARE

Bieletă direcție

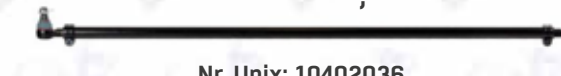

Nr. Unix: 10402036

Levier comandă direcție



Nr. Unix: 11284441

FRÂNĂ PNEUMATICĂ

Supapă frână de mână



Nr. Unix: 11118506

Supapă releu



Nr. Unix: 11179083

Supapă magnetică



Nr. Unix: 10853345

Senzor ABS

Față Nr. Unix: 11063616
Spate Nr. Unix: 11181985

CABINĂ

Buton geam electric



Nr. Unix: 10316159

Macara geam (Stânga)



Nr. Unix: 10002659

Închizător ușă (Stânga)



Nr. Unix: 445727

Bowden închidere ușă



Nr. Unix: 10003597

GARNITURI

Garnitură chiulasa



Nr. Unix: 856721

Garnitură capac culbutori

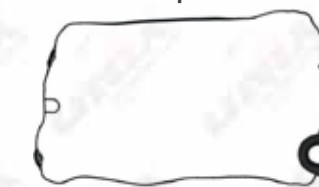

Nr. Unix: 857042

Garnitură capac culbutori

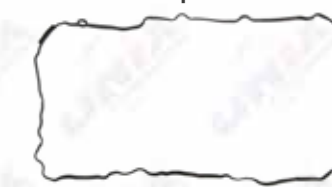

Nr. Unix: 857043

MERCEDES Actros MP3

FILTRE

Filtru aer



Nr. Unix: 11048575

Filtru aer



Nr. Unix: 82886/1

Filtru aer



Nr. Unix: 84211/1

Filtru polen



Nr. Unix: 84298/1

Filtru ulei



Nr. Unix: 84221/1

Filtru combustibil



Nr. Unix: 84315/1

Filtru combustibil



Nr. Unix: 346406/1

Filtru combustibil



Nr. Unix: 10174016

Filtru uree (AdBlue)



Nr. Unix: 11190296

FRÂNĂ

Plăcuțe frână la disc frână (Față)



Nr. Unix: 10953651

Disc frână (Față)



Nr. Unix: 157882

Plăcuțe frână la disc frână (Spate)



Nr. Unix: 10227975

Disc frână (Spate)



Nr. Unix: 157821

SISTEMUL DE ILUMINARE - CABINĂ

Far față (Dreapta)



Nr. Unix: 10887077

Far față (Stânga)



Nr. Unix: 10887076

Semnalizator (Stânga)



Nr. Unix: 10749841

Semnalizator (Dreapta)



Nr. Unix: 10749842

Lampă spate (Stânga)



Nr. Unix: 301305

Lampă spate (Dreapta)



Nr. Unix: 301306

Far ceață (Stânga)



Nr. Unix: 10885786

Far ceață (Dreapta)



Nr. Unix: 10885787

Lampă indicator gabarit



Nr. Unix: 10054044

Lampă indicator gabarit



Nr. Unix: 927292

Claxon



Nr. Unix: 10130206

Lampă ușă



Nr. Unix: 10925119

Bloc lumini (Cu funcție semnalizare + ștergere-spălare)



Nr. Unix: 10036205

Bloc semnalizare (Tempomat)



Nr. Unix: 881328

Comutator lumini



Nr. Unix: 10316145

Comutator reglare scaun (Reglare înălțimea scaunului)



Nr. Unix: 11363169

MERCEDES Actros MP3

TRANSMISIE PRIN CUREA

Rulment întinz. curea cu caneluri



Nr. Unix: 10226822

Curea cu caneluri 9PK2871



Nr. Unix: 10002580

ELECTROMOTOR/ALTERNATOR

Electromotor 24V, 7,5kw



Nr. Unix: 10241439

Alternator 28V, 80A



Nr. Unix: 10241413

RĂCIRE - ÎNCĂLZIRE

Radiator răcire



Nr. Unix: 293008

Intercooler



Nr. Unix: 297113

Radiator climă



Nr. Unix: 295363

Vas expansiune



Nr. Unix: 10513846

Viscocuplaj ventilator răcire



Nr. Unix: 10889521

Ventilator răcire



Nr. Unix: 888766

Pompă apă



Nr. Unix: 10672790

SISTEMELE DE RULARE - DE DIRECȚIE

Bieletă direcție



Nr. Unix: 10036715

Levier comandă direcție



Nr. Unix: 947387

Butuc roată (Față)



Nr. Unix: 10030947

Rulment roată (Față)



Nr. Unix: 51334/1

Set simering butuc roată



Nr. Unix: 10157241

Inel ABS



Nr. Unix: 10316126

Pompă servodirecție



Nr. Unix: 10118389

Vas ulei servo



Nr. Unix: 10096508

Capac roată (Jantă)



Nr. Unix: 10054210

Prezon roată

Dimensiune filet:
M22x1,5
Nr. Unix: 658160

Șurub roată

Dimensiune filet:
M22x1,5/43x68
Nr. Unix: 10071082

MERCEDES Actros MP4

FILTRE

Filtru aer (M: 210mm)



Nr. Unix: 10365456

Filtru aer (M: 247mm)



Nr. Unix: 10365458

Filtru aer (M: 295mm)



Nr. Unix: 10365457

Filtru polen



Nr. Unix: 10370816

Filtru ulei



Nr. Unix: 304578

Filtru ulei



Nr. Unix: 304587

Filtru combustibil



Nr. Unix: 10341265

Filtru combustibil



Nr. Unix: 10371586

Filtru uree (AdBlue)



Nr. Unix: 10367222

FRÂNĂ

Plăcuțe frână la disc frână (Față)



Nr. Unix: 10953651

Disc frână (Față)



Nr. Unix: 10672662

Plăcuțe frână la disc frână (Spate)



Nr. Unix: 10227975

Disc frână (Spate)



Nr. Unix: 157821

SISTEMUL DE ILUMINARE - CABINĂ

Far față (Dreapta)



Nr. Unix: 10197223

Far față (Stânga)



Nr. Unix: 10197222

Semnalizator (Stânga)



Nr. Unix: 10325725

Semnalizator (Dreapta)



Nr. Unix: 10325726

Lampă spate (Stânga)



Nr. Unix: 10995215

Lampă spate (Dreapta)



Nr. Unix: 10995217

Lampă indicator gabarit (Stânga)



Nr. Unix: 11362720

Lampă indicator gabarit (Dreapta)



Nr. Unix: 11362721

Far ceață (Stânga)



Nr. Unix: 10757657

Far ceață (Dreapta)



Nr. Unix: 10757658

Lampă poziție de zi (Stânga)



Nr. Unix: 10047429

Lampă poziție de zi (Dreapta)



Nr. Unix: 10047430

Pedală accelerație



Nr. Unix: 10150163

Mecanică ștergător parbriz cu motor



Nr. Unix: 11362652

Întreprupător ușă



Nr. Unix: 10415946

MERCEDES Actros MP4

TRANSMISIA PUTERII

Kit ambreiaj



Nr. Unix: 635618

Volantă



Nr. Unix: 10174998

Coroană dințată



Nr. Unix: 11161781

Rulment ax came



Nr. Unix: 95837

Furcă ambreiaj



Nr. Unix: 568967

Rulment presiune ambreiaj



Nr. Unix: 11279664

Set reparație volantă



Nr. Unix: 10463918

TRANSMISIE PRIN CUREA

Rulment întinz. curea cu caneluri



Nr. Unix: 11230012

Rulment întinz. curea cu caneluri



Nr. Unix: 217798

Curea cu caneluri 8PK2630HD



Nr. Unix: 102969

Viscocuplaj ventilator răcire



Nr. Unix: 10889584

SISTEMUL DE EVACUARE/ADMISIE

Senzor Nox (înainte de catalizator)



Nr. Unix: 11298806

Senzor Nox (după catalizator)



Nr. Unix: 11298804

Senzor temperatură emisii gaze



Nr. Unix: 11151594

Senzor presiune



Nr. Unix: 11299172

Diesel filtru particule



Nr. Unix: 11356881

Turbocompresor



Nr. Unix: 10886438

Set garnituri turbocompresor



Nr. Unix: 11148113

Garnitură galerie evacuare

1-3 cilindru Nr. Unix: 11017573
4-6 cilindru Nr. Unix: 11017574

SISTEMUL DE EVACUARE/ADMISIE

Pompă de înalta presiune



Nr. Unix: 736652

Injector



Nr. Unix: 448788

Furtun distribuitor de combustibil



Nr. Unix: 770749

Bușon rezervor



Nr. Unix: 10157507

RENAULT Premium

FILTRE

Filtru aer



Nr. Unix: 304387/1

Filtru ulei (LONG LIFE)



Nr. Unix: 84764/1

Filtru ulei (BY-PASS)



Nr. Unix: 81691/1

Filtru combustibil



Nr. Unix: 81886/1

Filtru combustibil



Nr. Unix: 10371555

Filtru polen



Nr. Unix: 346670/1

SISTEMUL DE ILUMINARE - CABINĂ

Far față (Dreapta)



Nr. Unix: 364407

Far față (Stânga)



Nr. Unix: 364406

Lampă indicator gabarit



Nr. Unix: 157333

Lampă indicator gabarit



Nr. Unix: 157330

Lampă spate (Stânga)



Nr. Unix: 157228

Lampă spate (Dreapta)



Nr. Unix: 157230

Semnalizator



Nr. Unix: 157151

Lampă poziție



Nr. Unix: 157349

Macara geam



Nr. Unix: 10584361

Bloc semnalizare (Cu funcție semnalizare)



Nr. Unix: 375722

Bloc semnalizare (Cu funcție de ștergere-spălare)



Nr. Unix: 375724

Claxon



Nr. Unix: 11181830

SISTEMUL DE AMORTIZARE

Amortizor suspensie cabină



Nr. Unix: 10043985

Amortizor suspensie cabină



Nr. Unix: 10646921

Bucșă suspensie cabină



Nr. Unix: 10107711

Bucșă suspensie cabină



Nr. Unix: 10927138

Bucșă suspensie cabină



Nr. Unix: 10048801

Amortizor (Față)



Nr. Unix: 340983

Amortizor (Spate)



Nr. Unix: 10541813

Pernă de aer completă (Spate)



Nr. Unix: 10541670

Arc pneumatic complet



Nr. Unix: 10768367

Bară stabilizatoare



Nr. Unix: 10320316

Bucșă bară stabilizatoare



Nr. Unix: 10053407

Bucșă bară stabilizatoare



Nr. Unix: 10053408

RENAULT Premium

TRANSMISIE PRIN CUREA

Rulment întinz. curea cu caneluri



Nr. Unix: 10225725

Curea cu caneluri 8PK1525HD



Nr. Unix: 102951

Curea cu caneluri 10PK1340HD



Nr. Unix: 102834

Viscocuplaj ventilator răcire



Nr. Unix: 297723

ELECTROMOTOR/ALTERNATOR

Electromotor 24V, 5.5kw



Nr. Unix: 10241454

Alternator 28V, 110A



Nr. Unix: 11171849

Releu



Nr. Unix: 10926771

Comutator magnetic electromotor



Nr. Unix: 10926770

RĂCIRE - ÎNCĂLZIRE

Radiator răcire



Nr. Unix: 948855

Intercooler



Nr. Unix: 516802

Pompă apă



Nr. Unix: 10726514

Vas expansiune



Nr. Unix: 10542564

Capac radiator



Nr. Unix: 10926788

Senzor nivel apă



Nr. Unix: 11262344

Furtun apă radiator



Nr. Unix: 11055742

Furtun apă radiator



Nr. Unix: 11055738

MOTOR

Pompă ulei



Nr. Unix: 10523670

Indicator nivel ulei



Nr. Unix: 10047612

Radiator ulei



Nr. Unix: 11284986

Supapă siguranță (presiune ulei)



Nr. Unix: 11063433

Garnitură baie ulei



Nr. Unix: 871777

Bușon golire baie ulei



Nr. Unix: 11151942

Joiă ulei



Nr. Unix: 10101783

RENAULT T-model

FILTRE

Filtru aer



Nr. Unix: 11191000

Filtru ulei (LONG LIFE)



Nr. Unix: 84764/1

Filtru ulei (BY-PASS)



Nr. Unix: 81691/1

Filtru combustibil



Nr. Unix: 11056752

Filtru combustibil



Nr. Unix: 10372036

SISTEMELE DE RULARE - DE DIRECȚIE

Set reparație fuzetă



Nr. Unix: 135731

Bieletă direcție



Nr. Unix: 10402708

Levier comandă direcție



Nr. Unix: 10997748

Bieletă antiruliu (Față)



10266841

Butuc roată (Față)



Nr. Unix: 10030639

Butuc roată (Spate)



Nr. Unix: 11091317

Piuliță fuzetă (Spate)



Nr. Unix: 10004198

Piuliță fuzetă (Față)



Nr. Unix: 872682

Supapă de control nivel



Nr. Unix: 10543690

FRÂNĂ PNEUMATICĂ

Compresor frână pneumatică



Nr. Unix: 11078160

Unitate de pregătire aer



Nr. Unix: 11118507

Rezervor aer comprimat



Nr. Unix: 10901087

Modulator EBS (Față)



Nr. Unix: 190832

Modulator EBS (Spate)



Nr. Unix: 190833

Modulator EBS remorcă



Nr. Unix: 168397

RENAULT T-model

SISTEMUL DE ILUMINARE - CABINĂ

Far față (Dreapta)



Nr. Unix: 10592668

Far față (Stânga)



Nr. Unix: 11065651

Lampă poziție (Stânga)



Nr. Unix: 157133

Lampă poziție (Dreapta)



Nr. Unix: 157134

Far ceață (Dreapta)



Nr. Unix: 911415

Far ceață (Stânga)



Nr. Unix: 911414

Lampă ușă



Nr. Unix: 157128

GARNITURI

Garnitură chiulasa



Nr. Unix: 859947

Garnitură baie ulei

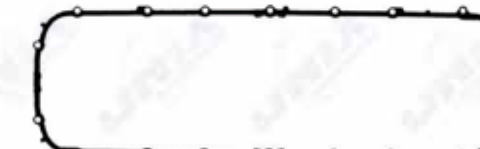

Nr. Unix: 856524

Garnitură turbocompresor



Nr. Unix: 901686

Garnitură galerie evacuare



Nr. Unix: 68128

Garnitură coloană admisie



Nr. Unix: 68165

Garnitură termostat



Nr. Unix: 68206

Garnitură pompă apă



Nr. Unix: 10062216

Inel etanșare (Pompă apă)



Nr. Unix: 10115073

Inel etanșare (Pompă apă)



Nr. Unix: 10062215

Garnitură termostat



Nr. Unix: 10113203

RĂCIRE - ÎNCĂLZIRE

Radiator răcire



Nr. Unix: 10371938

Intercooler



Nr. Unix: 11046394

Radiator climă



Nr. Unix: 228387

Compresor climă



Nr. Unix: 10273194

SCANIA S-seria

SISTEMUL DE EVACUARE/ADMISIE

Tobă eșapament



Nr. Unix: 521442

Țeavă flexibilă eșapament



Nr. Unix: 468934

Țeavă flexibilă eșapament



Nr. Unix: 517168

Tobă eșapament



Nr. Unix: 10080209

Garnitură galerie evacuare



Nr. Unix: 870871

Garnitură admisie



Nr. Unix: 836394

Garnitură capac culbutori



Nr. Unix: 10107448

Garnitură capac culbutori



Nr. Unix: 10107447

Garnitură chiulasa



Nr. Unix: 10437662

Garnitură turbocompresor



Nr. Unix: 66570

Șurub eșapament



Nr. Unix: 10096539

Răcitor, recirculare gaze de eșapament



Nr. Unix: 11061679

SISTEMUL DE AMORTIZARE

Amortizor suspensie cabină (Față)



Nr. Unix: 11097000

Amortizor suspensie cabină (Spate)



Nr. Unix: 11097010

Bucșă suspensie cabină



Nr. Unix: 10544397

Set reparație suport cabină



Nr. Unix: 11062979

Bucșă suspensie cabină



Nr. Unix: 947591

Tampon cauciu



Nr. Unix: 10900300

Bucșă suspensie cabină



Nr. Unix: 10055820

Încuietoare ușă, cabina șoferului



Nr. Unix: 10003100

Încuietoare ușă, cabina șoferului (hidraulic)



Nr. Unix: 10900311

Suport arc



Nr. Unix: 10104311

Bridă arc L: 202mm



Nr. Unix: 10004377

Bucșă arc foi



Nr. Unix: 10048978

Bolt arc



Nr. Unix: 10048974

Set reparație bolt arc



Nr. Unix: 10104402

Pernă de aer spate/față



Nr. Unix: 10769807

Pernă de aer completă spate/spate



Nr. Unix: 10769804

Supapă de control nivel



Nr. Unix: 11179115

SCANIA S-seria

SISTEMUL DE ILUMINARE

Far față (Dreapta)



Nr. Unix: 10325876

Far față (Stânga)



Nr. Unix: 10325880

Lampă poziție



Nr. Unix: 10081209

Far ceață (Dreapta)



Nr. Unix: 10037294

Far ceață (Stânga)



Nr. Unix: 10037293

Semnalizator



Nr. Unix: 10325689

Lampă indicator gabarit



Nr. Unix: 10167889

Lampă spate (Stânga)



Nr. Unix: 10885758

Lampă spate (Dreapta)



Nr. Unix: 10885757

Sticlă lampă spate (Dreapta/Stânga)



Nr. Unix: 10098888

SISTEMELE DE RULARE - DE DIRECȚIE

Bieletă direcție



Nr. Unix: 10545340

Levier comandă direcție

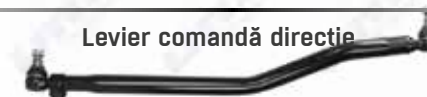

Nr. Unix: 10069605

Casetă direcție



Nr. Unix: 10868865

Pompă servodirecție



Nr. Unix: 10054061

Vas ulei servo



Nr. Unix: 11201460

Set reparație casetă direcție



Nr. Unix: 872364

MOTOR

Pompă ulei



Nr. Unix: 11230892

Radiator ulei



Nr. Unix: 10371768

Conductă, ștuț umplere ulei



Nr. Unix: 10314307

Bușon ulei



Nr. Unix: 10047481

Jojă ulei



Nr. Unix: 10900388

Set garnituri radiator ulei



Nr. Unix: 11033172

Garnitură carcasă filtru ulei



Nr. Unix: 68954

SCANIA R-seria 2016-

FILTRE

Filtru aer



Nr. Unix: 11190998

Filtru ulei



Nr. Unix: 11189089

Filtru combustibil



Nr. Unix: 11190298

Filtru polen

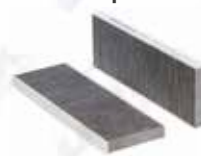

Nr. Unix: 11200382

FRÂNĂ

Plăcuțe frână la disc frână
(Față/Spate)

Nr. Unix: 10718719

Disc frână (Față/Spate)



Nr. Unix: 10053156

ELECTROMOTOR/ALTERNATOR

Electromotor 24V, 5.5kw



Nr. Unix: 10241443

Alternator 28V, 100A



Nr. Unix: 11171862

SISTEMUL DE ILUMINARE - CABINĂ

Far față (Dreapta)



Nr. Unix: 11175369

Far față (Stânga)



Nr. Unix: 11175368

Semnalizator (Stânga)



Nr. Unix: 11066461

Semnalizator (Dreapta)



Nr. Unix: 11066465

Far ceață (Dreapta)



Nr. Unix: 11057955

Far ceață (Stânga)



Nr. Unix: 11057954

Lampă indicator gabarit



Nr. Unix: 10167889

Lampă spate (Stânga)



Nr. Unix: 157212

Lampă spate (Dreapta)



Nr. Unix: 157213

Claxon 24V



Nr. Unix: 10039588

Macara geam (Stânga)



Nr. Unix: 11063358

Macara geam (Dreapta)



Nr. Unix: 11063359

Motoras geam electric
(Stânga)

Nr. Unix: 11063470

Motoras geam electric
(Dreapta)

Nr. Unix: 11063471

Ștergător parbriz 700mm



Nr. Unix: 11011433

SCANIA R-seria 2016-

TRANSMISIA PUTERII

Kit ambreiaj



Nr. Unix: 10462878

Volantă



Nr. Unix: 568978

Coroană dințată



Nr. Unix: 10078967

Rulment presiune ambreiaj



Nr. Unix: 95965

Furcă ambreiaj



Nr. Unix: 10039226

Rulment furcă ambreiaj



Nr. Unix: 10541183

Cilindru servoambreiaj



Nr. Unix: 10752046

SISTEMELE DE RULARE - DE DIRECȚIE

Rulment roată (Față)



Nr. Unix: 51190/1

Butuc roată (Spate)



Nr. Unix: 11285454

Rulment roată (Spate)



Nr. Unix: 10173945

Inel ABS



Nr. Unix: 879552

Set reparație fuzetă



Nr. Unix: 135471

Bucșă foaie arc



Nr. Unix: 11287858

Bucșă bară stabilizatoare



Nr. Unix: 11061245

Pernă de aer completă
(Spate)

Nr. Unix: 10541658

Bridă arc L: 308mm



Nr. Unix: 10064004

Bridă arc L: 215mm



Nr. Unix: 10004378

Bucșă arc lameral

Nr. Unix: 949742
Tampon cauciuc cabină

Nr. Unix: 11174255

RĂCIRE - ÎNCĂLZIRE

Radiator răcire



Nr. Unix: 11103682

Vas expansiune



Nr. Unix: 11262479

Senzor nivel apă



Nr. Unix: 11181920

Carcasă termostat



Nr. Unix: 11183740

Capac vas expansiune



Nr. Unix: 10896805

Termostat



Nr. Unix: 10896808

VOLVO FL

FILTRE

Filtru aer



Nr. Unix: 304387/1

Filtru ulei



Nr. Unix: 346519/1

Filtru combustibil



Nr. Unix: 81936/1

Filtru combustibil



Nr. Unix: 81889/1

Filtru polen



Nr. Unix: 346670/1

FRÂNĂ - FRÂNĂ PNEUMATICĂ

Plăcuțe frână la disc frână
(Față/Spate)

Nr. Unix: 10953412

Disc frână (Față)



Nr. Unix: 10106176

Disc frână (Spate)



Nr. Unix: 838491

Set reparație etrier
(Față/Spate)

Nr. Unix: 11063807

Rezervor aer
comprimat

Nr. Unix: 11162916

Unitate de pregătire
aer

Nr. Unix: 168158

Modulator EBS (Față)



Nr. Unix: 160498

Modulator EBS (Spate)



Nr. Unix: 168142

Supapă releu



Nr. Unix: 11179087

SISTEMUL DE AMORTIZARE

Amortizor (Față)



Nr. Unix: 11033684

Amortizor (Spate)



Nr. Unix: 10100976

Bucșă suspensie cabină



Nr. Unix: 11361847

Închizător ușă (Cabină)



Nr. Unix: 10901682

SISTEMUL DE ILUMINARE - CABINĂ

Far față (Dreapta)



Nr. Unix: 10749369

Far față (Stânga)



Nr. Unix: 10749368

Lampă indicator gabarit



Nr. Unix: 10887617

Lampă poziție



Nr. Unix: 157349

Far ceață



Nr. Unix: 10750061

Lampă spate cu iluminare număr
înmatriculare (Stânga)

Nr. Unix: 157170

Lampă spate (Dreapta)



Nr. Unix: 157171

Sticlă lampă spate



Nr. Unix: 157038

VOLVO FL

TRANSMISIE PRIN CUREA

Rulment întinz. curea cu
caneluri

Nr. Unix: 217761

Curea cu caneluri
8PK1705HD

Nr. Unix: 10873036

Electromotor 24V, 5,5kw



Nr. Unix: 11172944

Alternator 28V, 100A



Nr. Unix: 10018914

TRANSMISIA PUTERII

Kit ambreiaj



Nr. Unix: 781463

Cilindru servoambreiaj



Nr. Unix: 10847555

Set reparație cilindru servoambreiaj



Nr. Unix: 10845867

Volantă



Nr. Unix: 568990

Cruce cardan



Nr. Unix: 568938

Suport ax cardanic



Nr. Unix: 137273

Pompă centrală ambreiaj



Nr. Unix: 10037587

RĂCIRE - ÎNCĂLZIRE

Radiator răcire



Nr. Unix: 948649

Intercooler



Nr. Unix: 922176

Radiator climă



Nr. Unix: 315957

Pompă apă



Nr. Unix: 10170279

Termostat



Nr. Unix: 11097622

Vas expansiune



Nr. Unix: 11262461

Furtun apă radiator
(Superior)

Nr. Unix: 939970

Furtun apă radiator
(Inferior)

Nr. Unix: 939972

SCR / SISTEMUL DE EVACUARE

Senzor AdBlue



Nr. Unix: 10063296

Filtru uree (Adblue)



Nr. Unix: 11271381

Capac AdBlue



Nr. Unix: 10549520

Pompă AdBlue



Nr. Unix: 10175711

Sistem oprire (AdBlue)



Nr. Unix: 10900929

VOLVO FH Euro5

FILTRE

Filtru aer



Nr. Unix: 344570/1

Filtru ulei (LONG LIFE)



Nr. Unix: 84764/1

Filtru ulei (BY-PASS)



Nr. Unix: 81691/1

Filtru combustibil



Nr. Unix: 81886/1

Filtru combustibil



Nr. Unix: 10371555

Filtru polen



Nr. Unix: 82255/1

FRÂNĂ - FRÂNĂ PNEUMATICĂ

Plăcuțe frână la disc frână (Față)



Nr. Unix: 10953409

Disc frână (Față)



Nr. Unix: 10266756

Plăcuțe frână la disc frână (Spate)



Nr. Unix: 10953413

Disc frână (Spate)



Nr. Unix: 10266758

Cilindru frână pneumatic



Nr. Unix: 11178968

Supapă frână



Nr. Unix: 10016486

Compresor frână pneumatică



Nr. Unix: 10847589

Uscător aer



Nr. Unix: 10843654

SISTEMUL DE ILUMINARE - CABINĂ

Far față (Dreapta)



Nr. Unix: 363438

Far față (Stânga)



Nr. Unix: 363437

Lampă spate (Stânga)



Nr. Unix: 10754366

Lampă spate (Dreapta)



Nr. Unix: 11226555

Far ceață (Dreapta)



Nr. Unix: 10735208

Far ceață (Stânga)



Nr. Unix: 10735207

Semnalizator (Stânga)



Nr. Unix: 157103

Semnalizator (Dreapta)



Nr. Unix: 157104

Limitator ușă



Nr. Unix: 11161565

Închizător ușă (Stânga)



Nr. Unix: 10003580

Bowden închidere ușă



Nr. Unix: 10003596

Mâner deschidere ușă (Stânga exterior)



Nr. Unix: 10693764

VOLVO FH Euro5

SISTEMUL DE EVACUARE

Tobă eșapament



Nr. Unix: 10080311

Cot eșapament



Nr. Unix: 541090

Țeavă eșapament



Nr. Unix: 541087

Țeavă flexibilă eșapament



Nr. Unix: 10105715

Colier eșapament



Nr. Unix: 504708

Colier eșapament



Nr. Unix: 10032160

Țeavă eșapament



Nr. Unix: 10105734

Țeavă flexibilă eșapament



Nr. Unix: 541358

Tobă eșapament EURO 5 (Spate)



Nr. Unix: 566820

Suport tobă eșapament



Nr. Unix: 515885

RĂCIRE - ÎNCĂLZIRE

Radiator răcire



Nr. Unix: 294161

Intercooler



Nr. Unix: 297102

Radiator climă



Nr. Unix: 296392

Locaș termostat



Nr. Unix: 11061800

Termostat



Nr. Unix: 10547698

Pompă apă



Nr. Unix: 10518864

Furtun apă radiator



Nr. Unix: 10006574

Suport cauciuc radiator



Nr. Unix: 10998969

Vas expansiune



Nr. Unix: 10513827

Motor ventilator încălzire



Nr. Unix: 10399049

Rezistență



Nr. Unix: 11261054

Filtru uscător



Nr. Unix: 295821

Supapă expansiune



Nr. Unix: 11063746

Compresor climă



Nr. Unix: 10273194

VOLVO FH Euro6

SISTEMUL DE AMORTIZARE

Amortizor suspensie cabină



Nr. Unix: 10379030

Amortizor suspensie cabină



Nr. Unix: 986470

Pernă de aer completă (Față)



Nr. Unix: 10995812

Pernă de aer completă (Spate)



Nr. Unix: 872805

Amortizor (Față)



Nr. Unix: 11286030

Amortizor (Spate)



Nr. Unix: 340967

Bieleță antiruliu (Față)



Nr. Unix: 10403100

Bucșă bară stabilizatoare



Nr. Unix: 10544193

Bară stabilizatoare (Spate)



Nr. Unix: 10683453

Bucșă bară stabilizatoare



Nr. Unix: 10546070

Supapă de control nivel



Nr. Unix: 10543690

Supapă magnetică (Față)



Nr. Unix: 11032230

Supapă magnetică (Spate)



Nr. Unix: 168125

Braț oscilant



Nr. Unix: 10402330

Set reparație braț oscilant



Nr. Unix: 10178605

Set reparație braț oscilant



Nr. Unix: 10354666

SISTEMELE DE RULARE - DE DIRECȚIE

Bieleță direcție



Nr. Unix: 11228647

Cap de bară bieletă direcție



Nr. Unix: 11284426

Set reparație fuzetă



Nr. Unix: 10018544

Levier comandă direcție



Nr. Unix: 10230294

Cap de bară levier împingere



Nr. Unix: 11096610

TRANSMISIA PUTERII

Kit ambreiaj



Nr. Unix: 10464809

Volantă



Nr. Unix: 10463917

Rulment presiune ambreiaj



Nr. Unix: 11245724

Filtru ulei (Cutie de viteze)



Nr. Unix: 346687/1

Rulment ax came



Nr. Unix: 95843

Comutator viteză



Nr. Unix: 11162748

Supapă magnetică (Ambreiaj)



Nr. Unix: 11118063

VOLVO FH Euro6

SISTEMUL DE ILUMINARE - CABINĂ

Far față (Dreapta)



Nr. Unix: 11024051

Far față (Stânga)



Nr. Unix: 11024052

Lampă indicator gabarit (Stânga)



Nr. Unix: 157121

Lampă indicator gabarit (Dreapta)



Nr. Unix: 157120

Semnalizator (Stânga)



Nr. Unix: 157116

Semnalizator (Dreapta)



Nr. Unix: 157117

Lampă spate (Stânga)



Nr. Unix: 157225

Lampă spate (Dreapta)



Nr. Unix: 157227

Lampă lucru



Nr. Unix: 157532

Oglindă (Stânga)



Nr. Unix: 11000614

Oglindă (Dreapta)



Nr. Unix: 11000615

Oglindă unghi mort



Nr. Unix: 10901798

SENZORI - COMUTATORI DE PRESIUNE

Senzor Nox



Nr. Unix: 11298828

Senzor Nox



Nr. Unix: 11298826

Senzor temperatură emisii gaze



Nr. Unix: 10316022

Senzor temperatură emisii gaze T2



Nr. Unix: 10315990

Senzor turație cutie de viteze



Nr. Unix: 10006865

Litrometru



Nr. Unix: 10116586

Comutator presiune (Aer condiționat)



Nr. Unix: 11283150

Senzor arbore cotit/ ax cu came



Nr. Unix: 10131415

Senzor temperatură apă



Nr. Unix: 10690659

Bulb ulei



Nr. Unix: 10047550

Senzor presiune gaze evacuare



Nr. Unix: 11299176

Senzor temperatură habitacul



Nr. Unix: 621951

Senzor temperatură (Externă)



Nr. Unix: 10900980

Senzor aer comprimat



Nr. Unix: 11181958

Senzor nivel apă



Nr. Unix: 11063198

COVIND

unlimited quality

BUN VENIT ÎN LUMEA
excelenței

GHIDAȚI DE PUTEREA COLABORĂRII, NE MIȘCĂM
CU DETERMINARE PENTRU A OFERI O CALITATE
SUPERIOARĂ, RAPIDĂ ȘI LA NIVEL GLOBAL.



PIESE DE SCHIMB
PENTRU CAMIOANE
ȘI VEHICULE COMERCIALE



UNIX
PIESE AUTO®

CAROSERIE

Suitable to DAFLF55

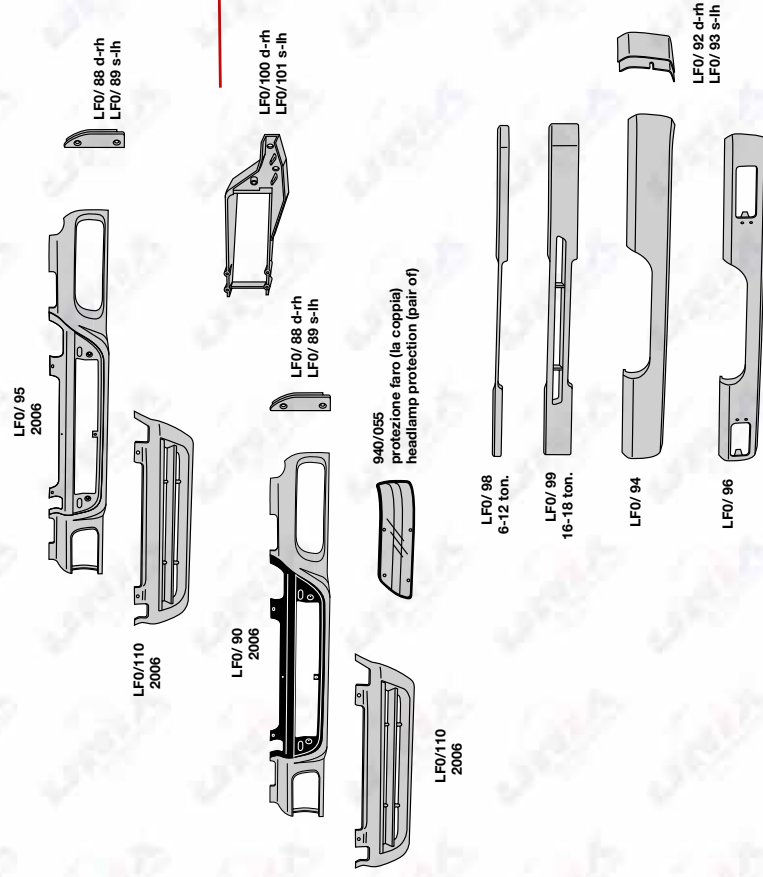
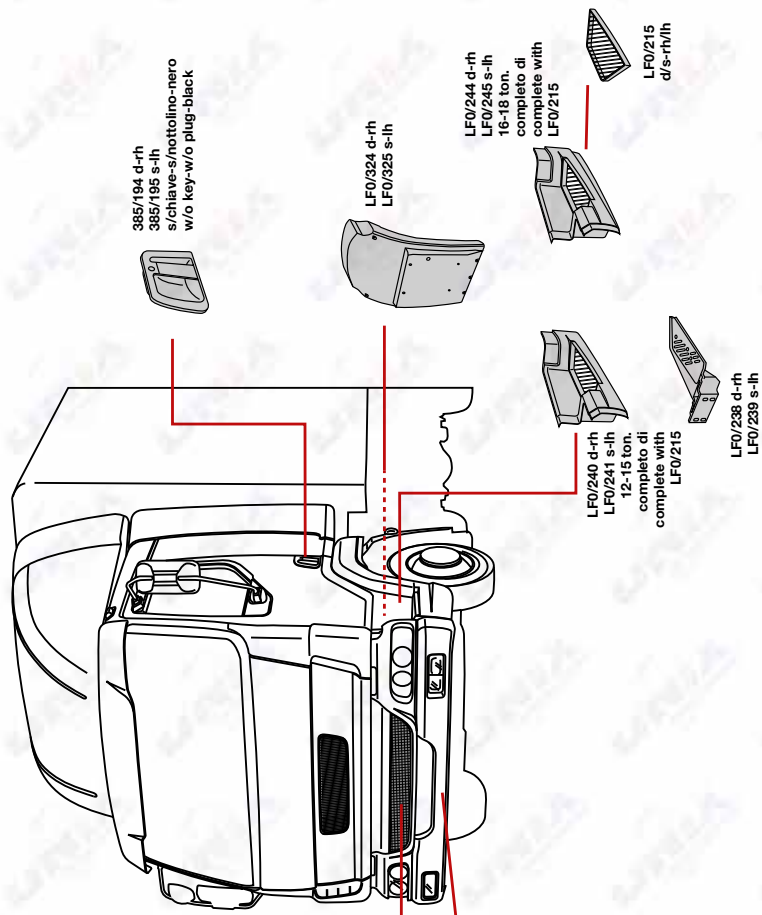

Suitable to DAFCF6

Euro 6

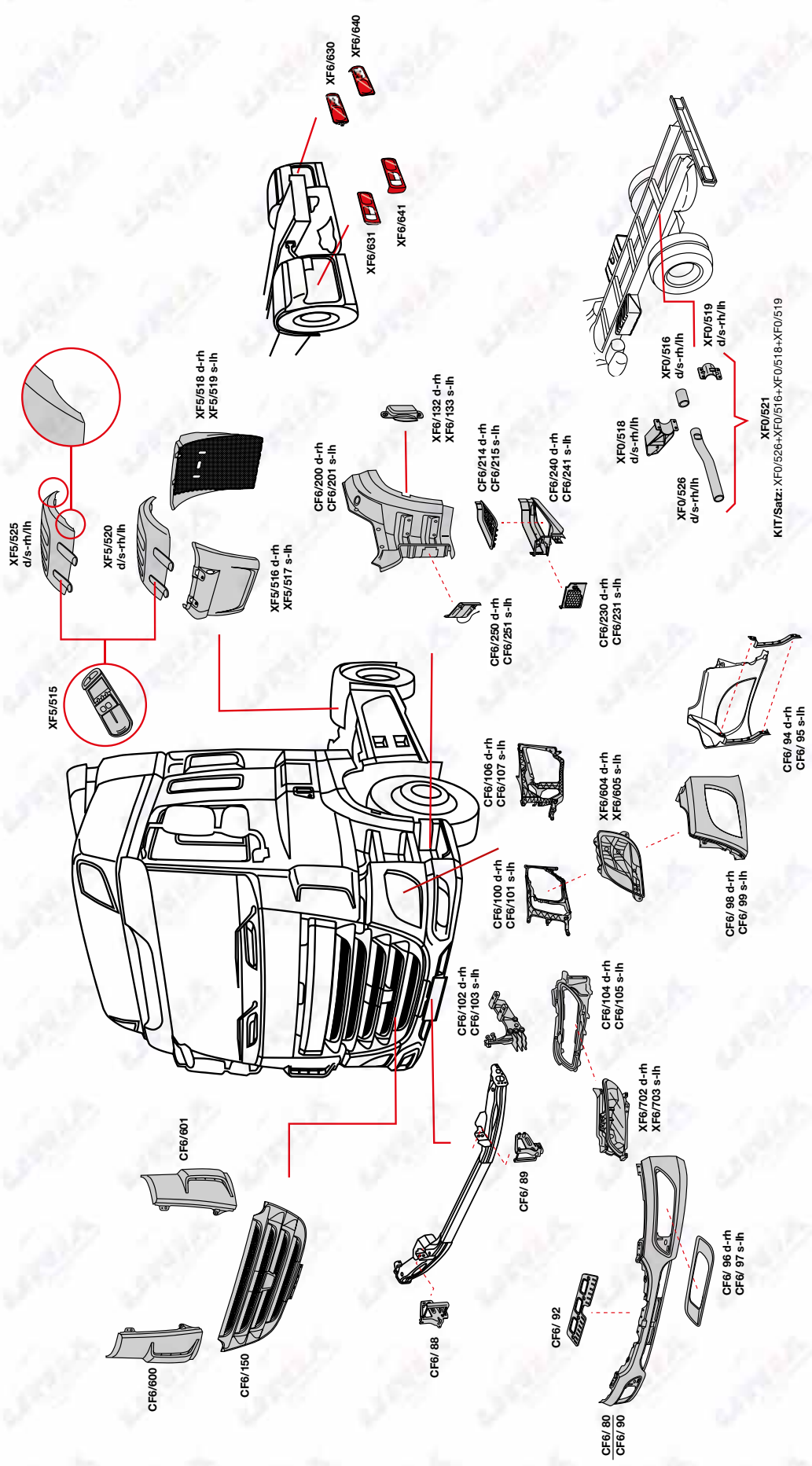



(*) verniciato - painted
 (°) grezzo - unprocessed
 (†) predisposto per Active Cruise Control - Active Cruise Control suitable

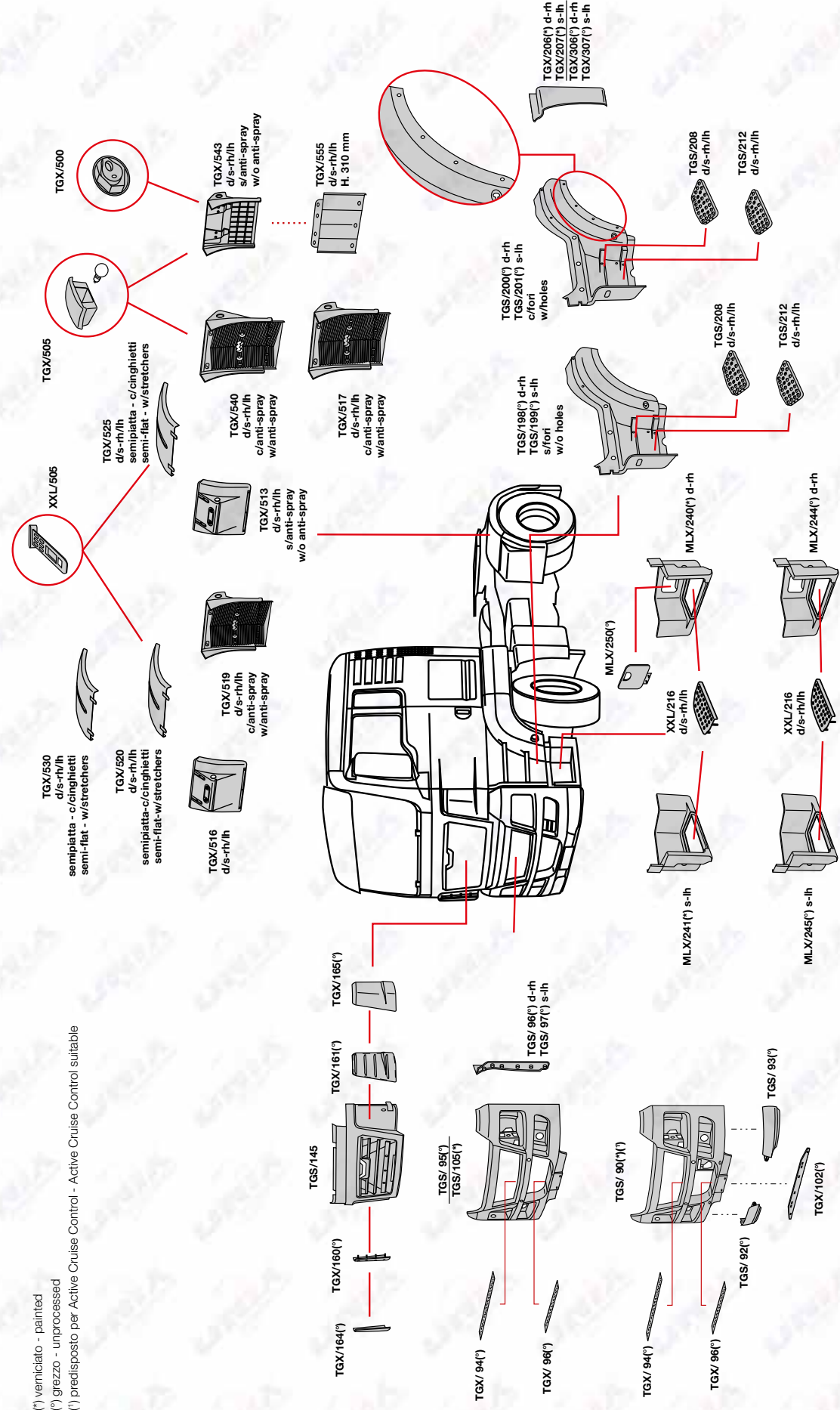

(*) verniciato - painted
 (°) grezzo - unprocessed
 (†) predisposto per Active Cruise Control - Active Cruise Control suitable
 (‡) Veicoli per Trasporti Eccezionali e Cava/Cantiere
 Exceptional transport vehicles and Yard&Quary

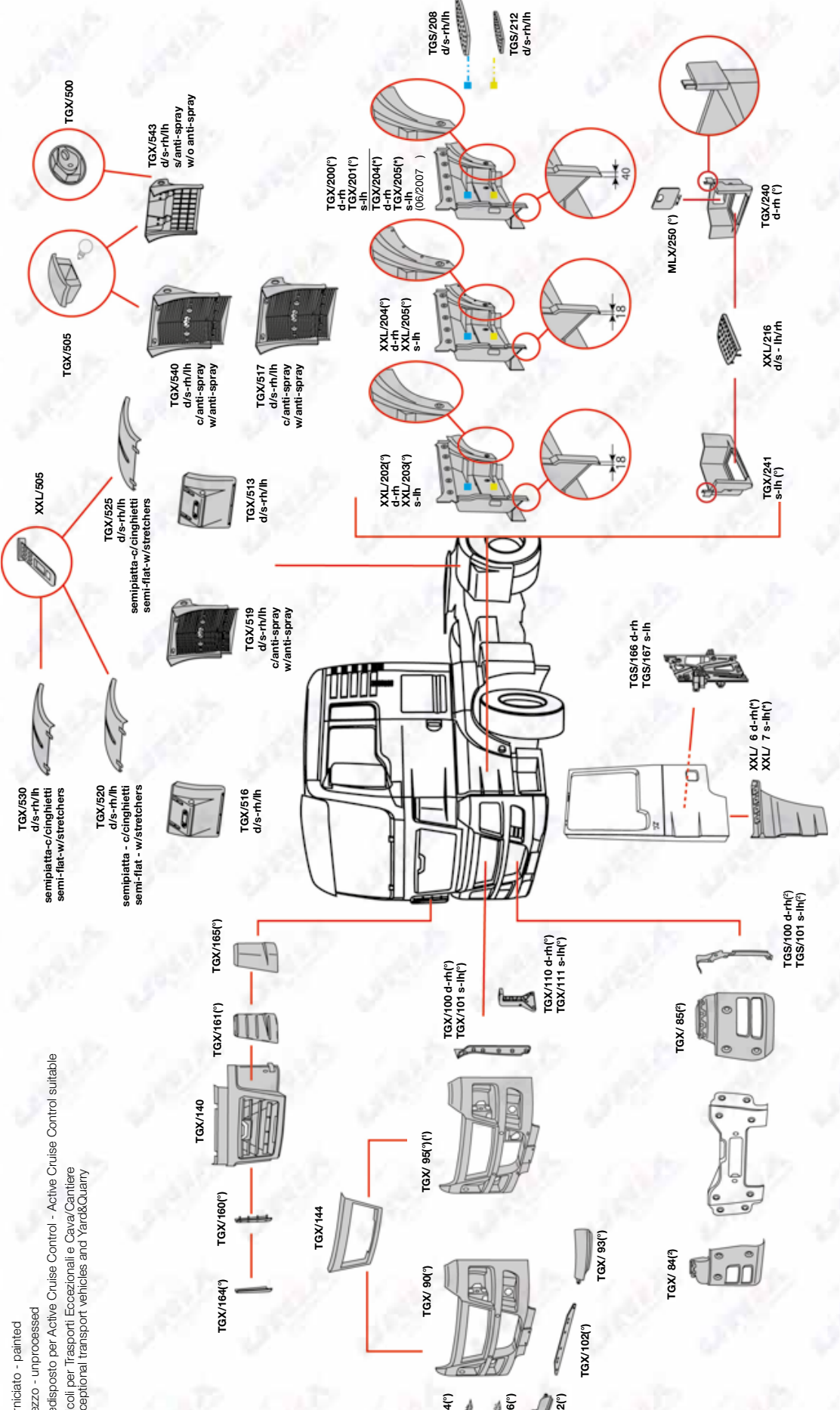

Suitable to MERCEDES-BENZACTROS4

Classic Space 2

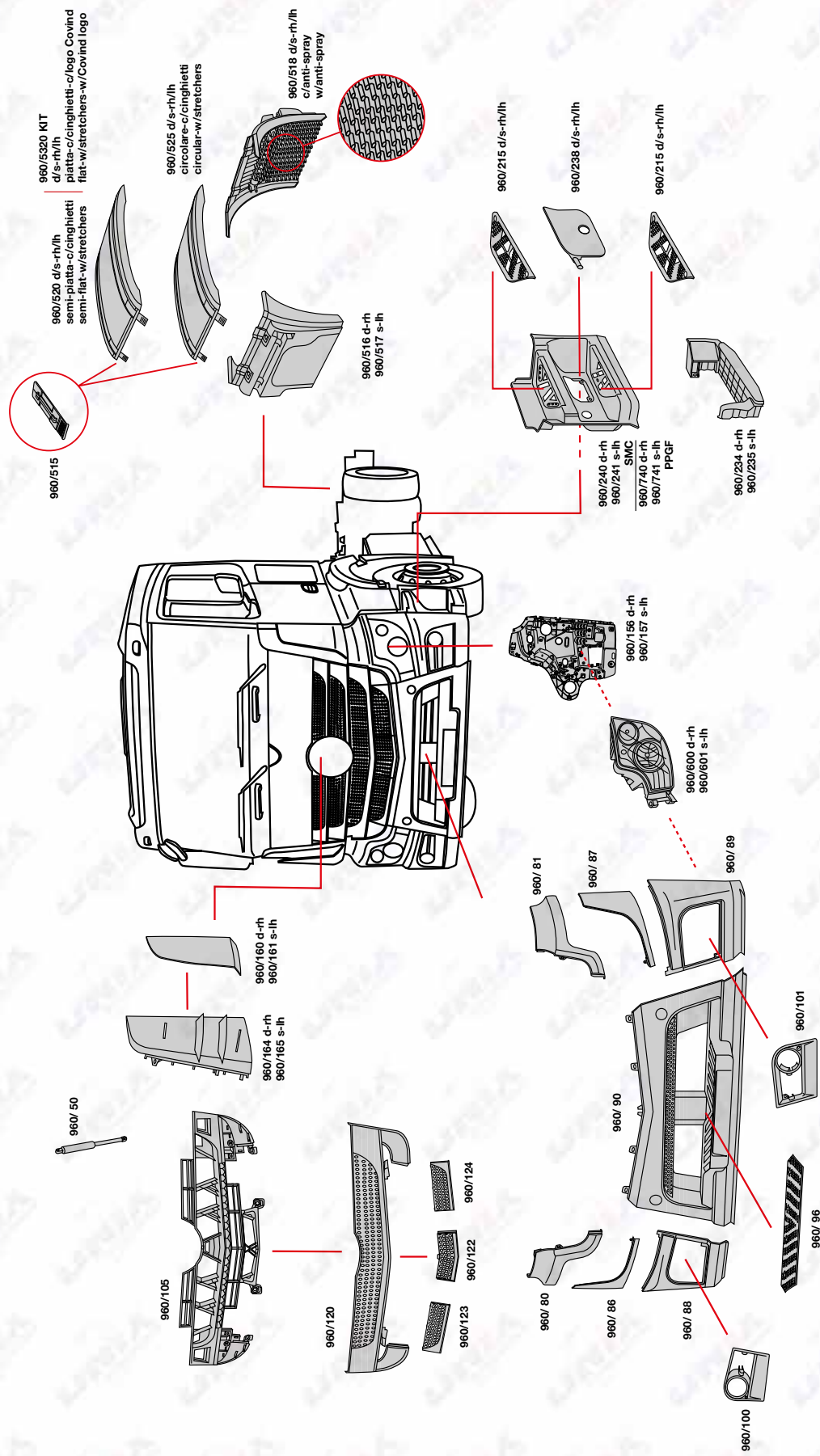

Suitable to MERCEDES-BENZACTROS4

Giga Space

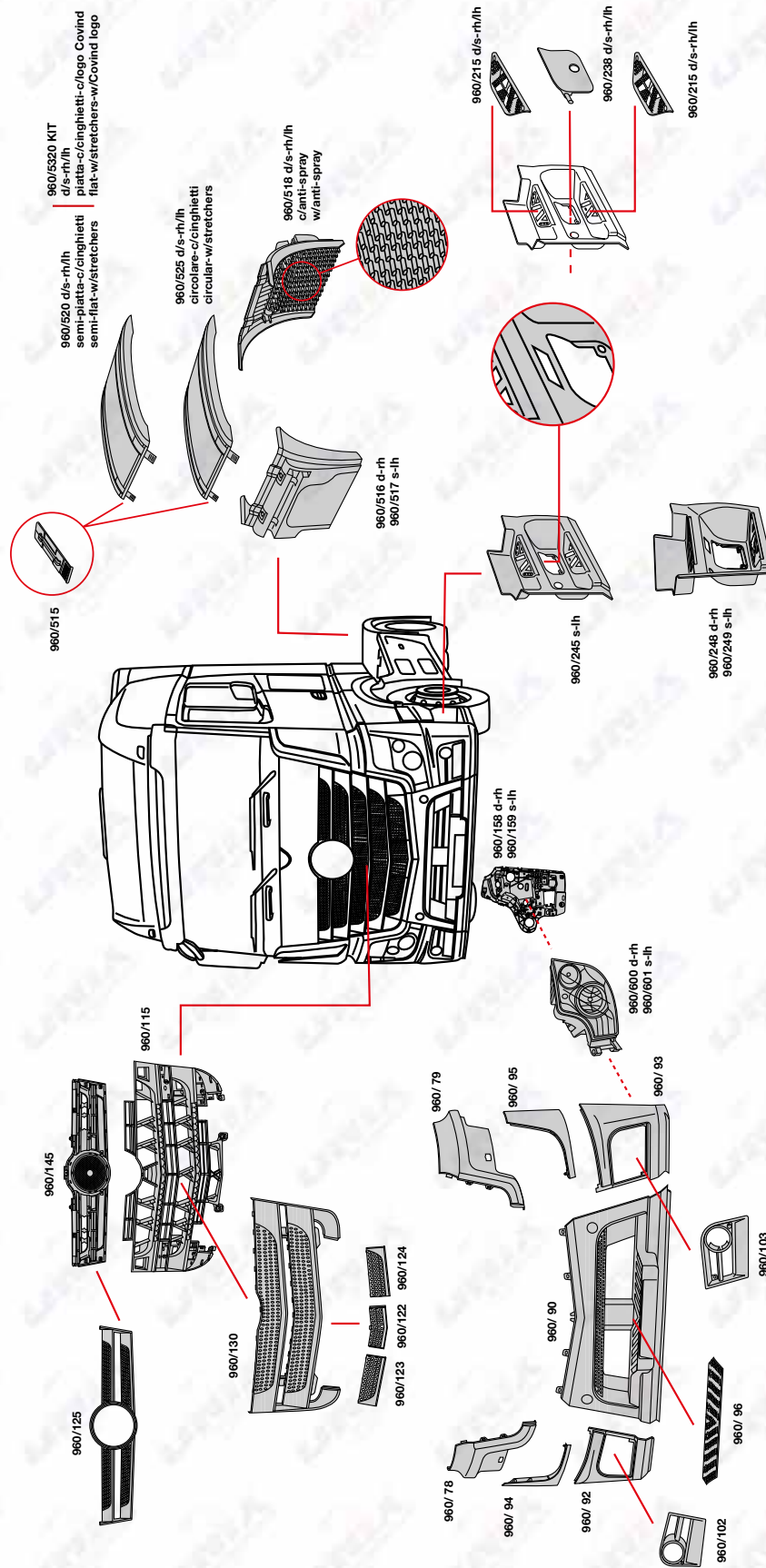



Suitable to RENAULT PREMIUM

(**) s/fori fendinebbia-c/spoiler - w/o foglamp holes-w/spoiler
 (*) c/fori fendinebbia-c/spoiler - w/foglamp holes-w/spoiler
 (**) s/fori fendinebbia-s/spoiler - w/o foglamp holes-w/o spoiler
 (†) c/fori fendinebbia-s/spoiler - w/foglamp holes-w/o spoiler

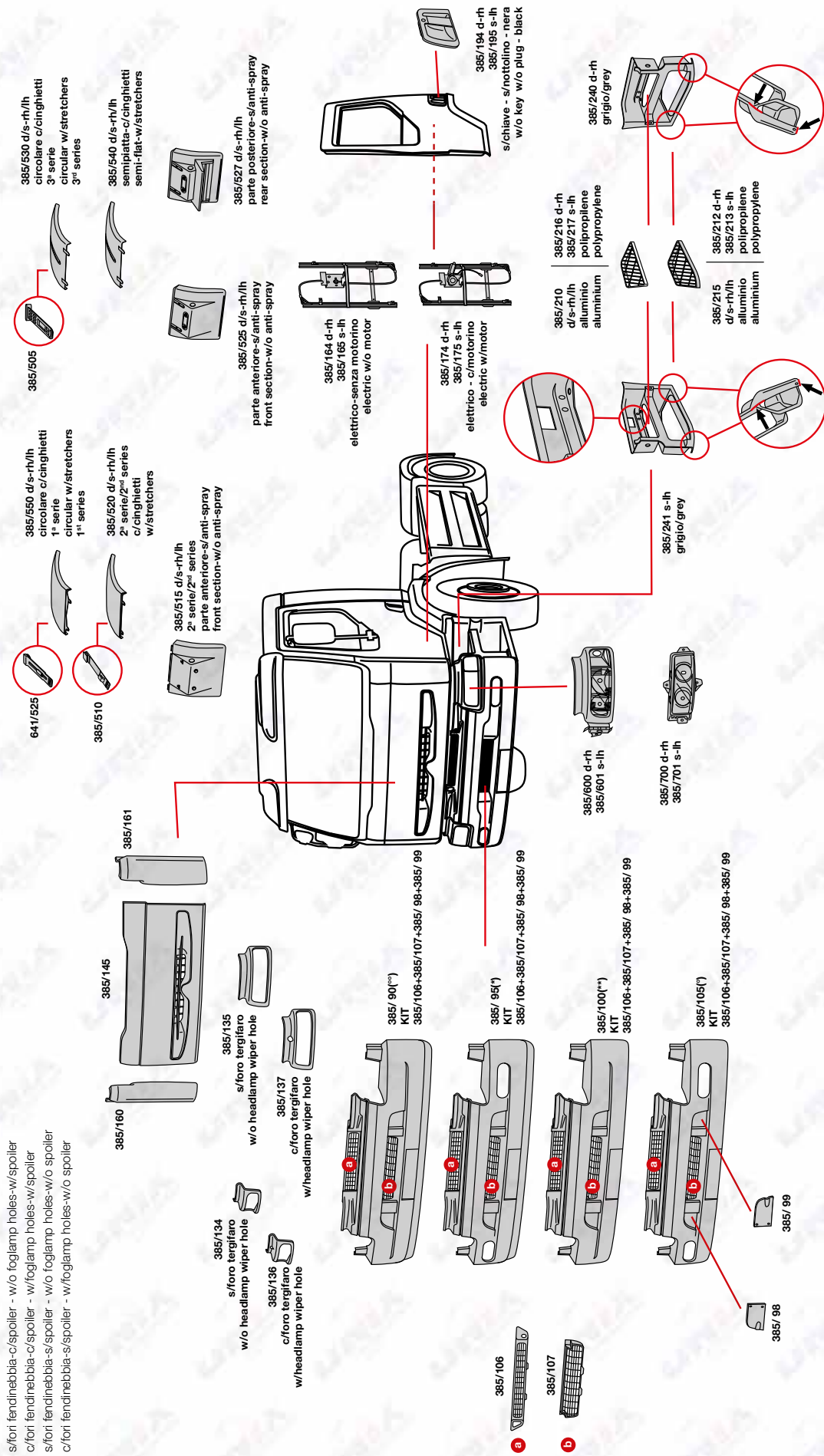

Suitable to RENAULT TRANGET Euro 6

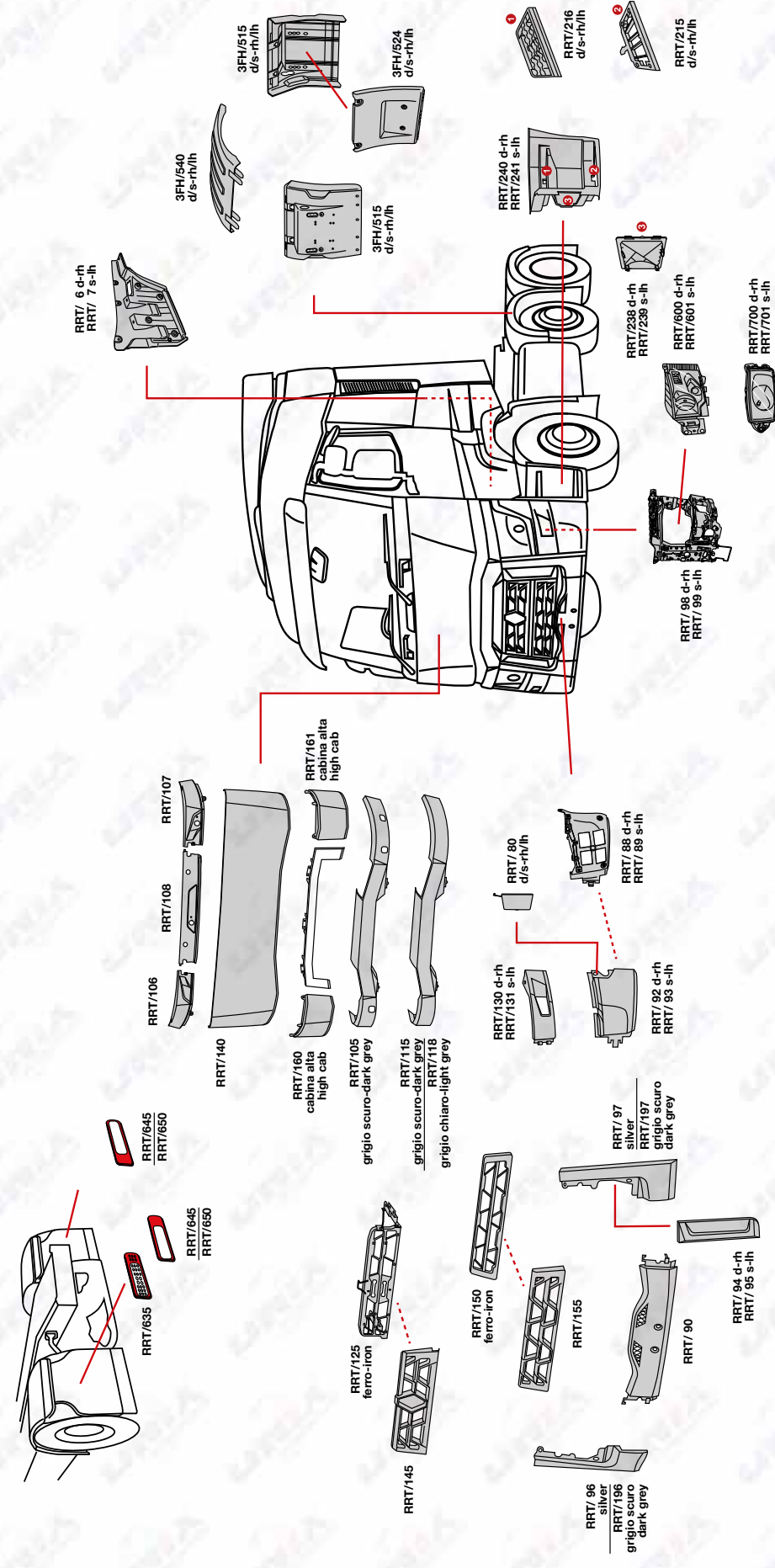

APĂRĂTOARE NOROI (CAMION) UNIVERSALE

SPECIFICAȚII

Lungime (mm)	Lățime (mm)	Înălțime (mm)	Lungime arc (mm)	Nr. Unix
840	270	400	1290	456553
860	440	425	1350	456555
1280	420	690	2120	456557
1270	440	580	1900	456559
1010	500	510	1620	456561
1140	540	560	1780	456563
1180	590	580	1840	456565
1360	660	670	2130	456571

SPECIFICAȚII

Lungime (mm)	Lățime (mm)	Înălțime (mm)	Lungime arc (mm)	Nr. Unix
675	660	150	715	456575
745	420	170	800	456577
755	655	170	790	456579

SPECIFICAȚII

Lungime (mm)	Lățime (mm)	Înălțime (mm)	Lungime arc (mm)	Nr. Unix
860	400	415	1350	456269
950	440	475	1500	456327
965	485	556	1665	456329

APĂRĂTORARE NOROI CAMION PUNTE SPATE (drept)



Lățime (mm): 450
Înălțime (mm): 640
Nr. Unix: 456585



Lățime (mm): 490
Înălțime (mm): 412
Nr. Unix: 456593



Lățime (mm): 490
Înălțime (mm): 608
Nr. Unix: 456601

APĂRĂTOARE NOROI CAMION PUNTE SPATE (curbat)



Lungime (mm): 680
Lățime (mm): 400
Înălțime (mm): 220
Lungime arc (mm): 705
Nr. Unix: 456585



Lungime (mm): 670
Lățime (mm): 450
Înălțime (mm): 700
Lungime arc (mm): 700
Nr. Unix: 456637



Lungime (mm): 600
Lățime (mm): 595
Înălțime (mm): 180
Lungime arc (mm): 620
Nr. Unix: 11184664



Lungime (mm): 670
Lățime (mm): 650
Înălțime (mm): 760
Lungime arc (mm): 760
Nr. Unix: 456639

APĂRĂTOARE NOROI (CAMION) UNIVERSALE

SPECIFICAȚII

Lungime (mm)	Lățime (mm)	Înălțime (mm)	Lungime arc (mm)	Nr. Unix
1315	395	640	2010	11184659
1315	400	610	1940	11184660
900	450	570	1880	456619

SPECIFICAȚII

Lungime (mm)	Lățime (mm)	Înălțime (mm)	Lungime arc (mm)	Nr. Unix
1100	600	520	1750	456629
1235	650	580	1810	11184661
1300	650	580	1900	456633
1350	650	670	2100	11184662
1380	670	655	2100	456635

SPECIFICAȚII

Lungime (mm)	Lățime (mm)	Înălțime (mm)	Lungime arc (mm)	Nr. Unix
2640	600	650	3400	456371
2635	640	700	3400	456375

SPECIFICAȚII

Lungime (mm)	Lățime (mm)	Înălțime (mm)	Lungime arc (mm)	Nr. Unix
930	280	470	1495	11184656
1025	450	560	1750	11184657
1025	510	560	1750	11184658

SET APĂRĂTOARE NOROI CAMION



Dimensiune (mm) Nr. Unix
350x300 578185
400x300 578181
400x620 578197
530x370 578193



Dimensiune (mm) Nr. Unix
350x300 578201
350x450 578202
600x400 578231

ȘTIATI CĂ...



**... CU UNA DINTRE
FRÂNELE NOASTRE
PUTEM DA COMANDĂ
DE OPRIRE PÂNĂ LA
10 ELEFANȚI ADULȚI?**























Etrierele EconX® sunt la fel de puternice ca și noile noastre produse service, făcându-le ideale pentru provocările vieții de zi cu zi. La frânare, acestea absorb până la 27 de tone de forță de strângere, ceea ce este echivalent cu greutatea a 10 elefanți adulți.

















Mai multe informații:
truckservices.knorr-bremse.com/econxadb



ETRIER FRÂNĂ

ETRIER FRÂNĂ

NISSAN CABSTAR  Partea de montare: stânga față Sistem frânare: BENDIX Nr. Unix 10603668	NISSAN CABSTAR  Partea de montare: dreapta față Sistem frânare: BENDIX Nr. Unix 10603669	NISSAN CABSTAR  Partea de montare: stânga spate Sistem frânare: BREMBO Nr. Unix 10390445	NISSAN CABSTAR  Partea de montare: dreapta spate Sistem frânare: BREMBO Nr. Unix 10391022
IVECO Daily III-VI  Partea de montare: stânga spate Sistem frânare: BREMBO Unix N 10390119	IVECO Daily III-VI  Partea de montare: dreapta spate Sistem frânare: BREMBO Nr. Unix 10390696	Iveco EuroCargo  Partea de montare: stânga Sistem frânare: Knorr SB6 Nr. Unix 10227985	Iveco EuroCargo  Partea de montare: dreapta Sistem frânare: Knorr SB6 Unix N 10227986
EOBUS, IVECO, MB  Partea de montare: stânga Sistem frânare: Knorr SB7/SN7 Nr. Unix10227991	EOBUS, IVECO, MB  Partea de montare: dreapta Sistem frânare: Knorr SB7/SN7 Nr. Unix 10227992	Iveco, MB  Partea de montare: stânga Sistem frânare: Knorr SB6/SN6 Nr. Unix 10229343	Iveco, MB  Partea de montare: dreapta Sistem frânare: Knorr SB6/SN6 Nr. Unix 10229344
MERCEDES  Partea de montare: stânga Sistem frânare: Knorr SB6/SN6 Nr. Unix 10227987	MERCEDES  Partea de montare: dreapta Sistem frânare: Knorr SB6/SN6 Nr. Unix 10227988	IVECO, MB  Partea de montare: Sistem frânare: Knorr SB7 Nr. Unix 10227996	Iveco, MB  Sistem frânare: Knorr SB6/SN6 Nr. Unix 10229343
SCANIA  Sistem frânare: Knorr SN7 Nr. Unix 10229347	SCANIA  Sistem frânare: Knorr SN7 Nr. Unix 10229348	SAF  Partea de montare: stânga Sistem frânare: ModulT, DBT22LT Nr. Unix 138321	SAF  Partea de montare: dreapta Sistem frânare: ModulT, DBT22LT Nr. Unix 138322

MERCEDES  Partea de montare: stânga Sistem frânare: Knorr SB5/SN5 Nr. Unix 10227999	MERCEDES  Partea de montare: dreapta Sistem frânare: Knorr SB5/SN5 Nr. Unix 10229340	BPW, SAF  Partea de montare: stânga Sistem frânare: Knorr SK7 Nr. Unix 10229341	BPW, SAF  Partea de montare: dreapta Sistem frânare: Knorr SK7 Nr. Unix 10229342
DAF  Partea de montare: stânga Sistem frânare: Knorr SN7 Nr. Unix 10229345	DAF  Partea de montare: dreapta Sistem frânare: Knorr SN7 Nr. Unix 10229346	RENAULT  Partea de montare: stânga Sistem frânare: ROR/Meritor Nr. Unix 838375	RENAULT  Partea de montare: dreapta Sistem frânare: ROR/Meritor Nr. Unix 838376
Suport etrier WABCO PAN22-1  Nr. Unix 11064079	Suport etrier WABCO PAN17  Nr. Unix 11064108	Suport etrier WABCO PAN22-1  Nr. Unix 11064082	
Suport etrier KNORR SB7/SN7  Nr. Unix 11063852	Suport etrier KNORR SB6/SN6  Nr. Unix 11063850	Suport etrier KNORR SN6  Nr. Unix 11063819	
Suport etrier KNORR SK7  Nr. Unix 11063828	Suport etrier KNORR SK7  Nr. Unix 11063829	Suport etrier KNORR SN5  Nr. Unix 11063847	
Suport etrier HALDEX ModulT, SAF  Nr. Unix 11063799	Suport etrier MERITOR ELSA 195  Nr. Unix 11063932	Suport etrier MERITOR D DUCO  Nr. Unix 11063944	

SET REPARAȚIE ETRIER KNORR-BREMSE

KNORR SB5/SN5

SB5



Nr. Unix 11063918

SB6



Nr. Unix 11064215

KNORR SB6/SB7

SB6/SB7



Nr. Unix 11064210

SN5



Nr. Unix 11063909

SB6/SB7



Nr. Unix 11064206

SB6/SB7



Nr. Unix 11064211

SB5



Nr. Unix 11063923

SB6/SB7



Nr. Unix 11064207

SB6/SB7



Nr. Unix 11063882

SN5



Nr. Unix 11064237

SB6/SB7



Nr. Unix 11064219

SB6/SB7



Nr. Unix 11064212

SN5



Nr. Unix 11064241

SB6/SB7



Nr. Unix 11064208

SB5



Nr. Unix 11064206

SB6/SB7



Nr. Unix 11064208

SB5/SN5



Nr. Unix 11064208

SB6/SB7



Nr. Unix 11064209

SB6/SB7



Nr. Unix 11108816

SET REPARAȚIE ETRIER KNORR-BREMSE

KNORR SB6/SB7

SB6/SB7/SB7 Radial



Nr. Unix 11063918

SB6/SB7



Nr. Unix 11063895

SB6/SB7



Nr. Unix 111063892

SB6/SB7



Nr. Unix 11063909

SB6/SB7



Nr. Unix 11064206

SB6/SB7



Nr. Unix 11064211

SB5



Nr. Unix 11063923

SB6/SB7



Nr. Unix 11064207

SB6/SB7



Nr. Unix 11063882

SN5



Nr. Unix 11064237

SB6/SB7



Nr. Unix 11064219

SB6/SB7



Nr. Unix 11064212

SN5



Nr. Unix 11064241

SB6/SB7



Nr. Unix 11064208

SB5



Nr. Unix 11064206

SB6/SB7



Nr. Unix 11064208

SB5/SN5



Nr. Unix 11064208

SB6/SB7



Nr. Unix 11064209

SB6/SB7



Nr. Unix 11108816

SB6/SB7/SB7 Radial



Nr. Unix 11063918

SB6/SB7



Nr. Unix 11063895

SB6/SB7



Nr. Unix 111063892

SB6/SB7



Nr. Unix 11063909

SB6/SB7



Nr. Unix 11064206

SB6/SB7



Nr. Unix 11064211

SB5



Nr. Unix 11063923

SB6/SB7



Nr. Unix 11064207

SB6/SB7



Nr. Unix 11063882

SN5



Nr. Unix 11064237

SB6/SB7



Nr. Unix 11064219

SB6/SB7



Nr. Unix 11064212

SN5



Nr. Unix 11064241

SB6/SB7



Nr. Unix 11064208

SB5



Nr. Unix 11064206

SB6/SB7



Nr. Unix 11064208

SB5/SN5



Nr. Unix 11064208

SB6/SB7



Nr. Unix 11064209

SB6/SB7



Nr. Unix 11108816

SB6/SB7/SB7 Radial



Nr. Unix 11063918

SB6/SB7



Nr. Unix 11063895

SB6/SB7



Nr. Unix 111063892

SB6/SB7



Nr. Unix 11063909

SB6/SB7



Nr. Unix 11064206

SB6/SB7



Nr. Unix 11064211

SB5



Nr. Unix 11063923

SB6/SB7



Nr. Unix 11064207

SB6/SB7



Nr. Unix 11063882

SN5



Nr. Unix 11064237

SB6/SB7



Nr. Unix 11064219

SB6/SB7



Nr. Unix 11064212

SN5



Nr. Unix 11064241

SB6/SB7



Nr. Unix 11064208

SB5



Nr. Unix 11064206

SB6/SB7



Nr. Unix 11064208

SB5/SN5



Nr. Unix 11064208

SB6/SB7



Nr. Unix 11064209

SB6/SB7



Nr. Unix 11108816

SB6/SB7/SB7 Radial



Nr. Unix 11063918

SB6/SB7



Nr. Unix 11063895

SB6/SB7



Nr. Unix 111063892

SB6/SB7



Nr. Unix 11063909

SB6/SB7



Nr. Unix 11064206

SB6/SB7



Nr. Unix 11064211

SB5



Nr. Unix 11063923

SB6/SB7



Nr. Unix 11064207

SB6/SB7



Nr. Unix 11063882

SN5



Nr. Unix 11064237

SB6/SB7



Nr. Unix 11064219

SB6/SB7



Nr. Unix 11064212

SN5



Nr. Unix 11064241

SB6/SB7



Nr. Unix 11064208

SB5



Nr. Unix 11064206

SB6/SB7



Nr. Unix 11064208

SB5/SN5



Nr. Unix 11064208

SB6/SB7



SET REPARAȚIE ETRIER

KNORR-BREMSE

KNORR SN6/SN7/SK7



SN6/SN7/SK7

Nr. Unix 11063924



SN6/SN7/SK7

Nr. Unix 11063834



SN6/SK7

Nr. Unix 11064224



SN6

Nr. Unix 11064225



SN6/SN7/SK7

Nr. Unix 11064206



SN6/SN7/SK7

Nr. Unix 11064207



SN7/SK7

Nr. Unix 11064221



SN6/SN7/SK7

Nr. Unix 11064208

SN6/SN7/SK7



Nr. Unix 11064209

SN6/SN7/SK7



Nr. Unix 11064210

SN6/SN7/SK7



Nr. Unix 11064211

SN6/SN7/SK7



Nr. Unix 11063882

SN6/SN7/SK7



Nr. Unix 11064212

SN6/SN7/SK7



Nr. Unix 11108815



SN6/SN7/SK7

Nr. Unix 11234610



SN6/SN7/SK7

Nr. Unix 11213741



SN6/SN7



Nr. Unix 11184065



SN7



Nr. Unix 11063906

SN6/SN7/SK7



Nr. Unix 11063907



Nr. Unix 11063905

SET REPARAȚIE ETRIER

KNORR-BREMSE

KNORR SN6/SN7/SK7



SN6/SN7/SK7

Nr. Unix 11063902



SN6/SN7/SK7



Nr. Unix 11063900



SN6



Nr. Unix 11063895



SN6/SN7/SK7



Nr. Unix 11063905



Nr. Unix 11063905



SN6

Nr. Unix 11063857

SB6/SB7



Nr. Unix 11063904



SN7



Nr. Unix 11063868



SN7



Nr. Unix 11063866

SN6/SK7



Nr. Unix 11108819



SN6/SK7

Nr. Unix 11108820

SN7



Nr. Unix 11063888

SN6/SK7



Nr. Unix 11108835

SN7



Nr. Unix 11063881

SN6/SN7/SK7



Nr. Unix 11063880

SN6/SN7/SK7



Nr. Unix 11108825

SISTEMUL DE FRÂNARE HIDRAULIC

SISTEMUL DE FRÂNARE HIDRAULIC

SET REPARAȚIE ETRIER

KNORR-BREMSE

KNORR SL7/SM7/ST7

SL7/SM7/ST7



Nr. Unix 11063920

SL7/SM7/ST7



Nr. Unix 11063831

SL7/SL7 NEW



Nr. Unix 11064223

SL7/SM7



Nr. Unix 11064228

ST7



Nr. Unix 11064229

SL7/SM7/ST7



Nr. Unix 11064230

SL7/SM7/ST7



Nr. Unix 11064221

SL7/SM7/ST7



Nr. Unix 11064231

SL7/SM7/ST7



Nr. Unix 11064209

SL7/SM7/ST7



Nr. Unix 11064210

SL7/SM7/ST7



Nr. Unix 11064232

SL7/SM7/ST7



Nr. Unix 11063882

SL7/SM7/ST7



Nr. Unix 11064212

SL7/SM7



Nr. Unix 11108815

SL7/SM7



Nr. Unix 11234610

SL7/SM7



Nr. Unix 11213741

SL7/SM7



Nr. Unix 11213742

SL7/SM7



Nr. Unix 11063895

SL7/SM7/ST7



Nr. Unix 11063880

SET REPARAȚIE ETRIER

KNORR-BREMSE

KNORR BENDIX ADB22X ADB22XL

ADB22X



Nr. Unix 11064224

ADB22XL



Nr. Unix 11064229

ADB22X



Nr. Unix 11064227

ADB22X



Nr. Unix 11064209

ADB22X



Nr. Unix 11064210

ADB22X



Nr. Unix 11064211

ADB22X



Nr. Unix 11108814

ADB22X (Mercedes)



Nr. Unix 11213741

ADB22X (Mercedes) New version



Nr. Unix 11213742

ADB22X



Nr. Unix 11108817

ADB22X



Nr. Unix 11063836

ADB22X



Nr. Unix 11063861

ADB22X



Nr. Unix 11063905

ADB22X



Nr. Unix 11063862

ADB22XL



Nr. Unix 11063830

ADB22X



Nr. Unix 11063873

ADB22X



Nr. Unix 11063884

SISTEMUL DE FRÂNARE HIDRAULIC

SISTEMUL DE FRÂNARE HIDRAULIC

SET REPARAȚIE ETRIER

MERITOR

SET REPARAȚIE ETRIER

MERITOR

<p>ELSA 2</p> <p>Nr. Unix 11064233</p>	<p>ELSA 2</p> <p>Nr. Unix 11064027</p>	<p>ELSA 2</p> <p>Nr. Unix 11064014</p>
<p>ELSA 2 Radial</p> <p>Nr. Unix 11064015</p>	<p>ELSA 2</p> <p>Nr. Unix 11064015</p>	<p>ELSA 2</p> <p>Nr. Unix 11063961</p>
<p>ELSA 2</p> <p>Nr. Unix 11064037</p>	<p>ELSA 2</p> <p>Nr. Unix 11063976</p>	<p>ELSA 2</p> <p>Nr. Unix 11063954</p>
<p>ELSA 2</p> <p>Nr. Unix 11064036</p>	<p>ELSA 2</p> <p>Nr. Unix 11108839</p>	<p>ELSA 2</p> <p>Nr. Unix 11063983</p>
<p>ELSA 2</p> <p>Nr. Unix 11063972</p>	<p>ELSA 2</p> <p>Nr. Unix 11108838</p>	<p>ELSA 2</p> <p>Nr. Unix 11108840</p>
<p>ELSA 2</p> <p>Nr. Unix 11064030</p>	<p>ELSA 2</p> <p>Nr. Unix 11108838</p>	<p>ELSA 2</p> <p>Nr. Unix 11108840</p>

<p>EX225</p> <p>Nr. Unix 11246900</p>	<p>ELSA 195, ELSA 225, EX 225</p> <p>Nr. Unix 11063972</p>	<p>ELSA 2 195-225</p> <p>Nr. Unix 10882204</p>
<p>ELSA 195, ELSA 225, EX 225</p> <p>Nr. Unix 11108837</p>	<p>ELSA 195, ELSA 225, EX 225</p> <p>Nr. Unix 11064030</p>	<p>ELSA 2 195-225</p> <p>Nr. Unix 141588</p>
<p>ELSA 195, ELSA 225, EX 225 H2</p> <p>Nr. Unix 11064022</p>	<p>ELSA 225 Radial</p> <p>Nr. Unix 141600</p>	<p>ELSA 225</p> <p>Nr. Unix 10882423</p>
<p>ELSA 195, ELSA 225, EX 225</p> <p>Nr. Unix 11064234</p>	<p>ELSA 225 Axial</p> <p>Nr. Unix 141600</p>	<p>ELSA 225</p> <p>Nr. Unix 10882423</p>
<p>ELSA 195, ELSA 225, EX 225</p> <p>Nr. Unix 11064020</p>	<p>ELSA 225</p> <p>Nr. Unix 10882421</p>	<p>ELSA 225</p> <p>Nr. Unix 10882421</p>
<p>ELSA 195, ELSA 225, EX 225</p> <p>Nr. Unix 11063977</p>	<p>ELSA 225</p> <p>Nr. Unix 11063946</p>	<p>ELSA 225</p> <p>Nr. Unix 11063946</p>

SISTEMUL DE FRÂNARE HIDRAULIC

SISTEMUL DE FRÂNARE HIDRAULIC















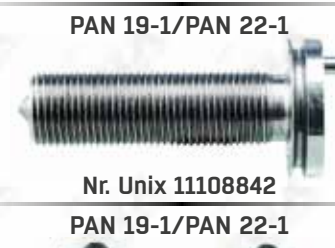

SET REPARAȚIE ETRIER

WABCO

SET REPARAȚIE ETRIER

WABCO

 Nr. Unix 11108843	 Nr. Unix 11064121	 Nr. Unix 11064112
 Nr. Unix 11108849	 Nr. Unix 11108845	 Nr. Unix 11064111
 Nr. Unix 11108844	 Nr. Unix 11108846	 Nr. Unix 11064111
 Nr. Unix 11034123	 Nr. Unix 11064093	 Nr. Unix 11064099
 Nr. Unix 11064122	 Nr. Unix 11064119	 Nr. Unix 141607
 Nr. Unix 11064120	 Nr. Unix 11064114	 Nr. Unix 141614
	 Nr. Unix 11064113	 Nr. Unix 10882276
		 Nr. Unix 10882449

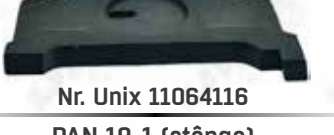
 Nr. Unix 11108841	 Nr. Unix 11108844	 Nr. Unix 11064125
 Nr. Unix 11108847	 Nr. Unix 11064128	 Nr. Unix 11108845
 Nr. Unix 11108848	 Nr. Unix 11064127	 Nr. Unix 11108846
 Nr. Unix 11108842	 Nr. Unix 11064127	 Nr. Unix 11108858
 Nr. Unix 11108843	 Nr. Unix 11064126	 Nr. Unix 11064116
 Nr. Unix 11108849	 Nr. Unix 11064093	 Nr. Unix 11064115
		 Nr. Unix 11064119

SISTEMUL DE FRÂNARE HIDRAULIC

SISTEMUL DE FRÂNARE HIDRAULIC

SET REPARAȚIE ETRIER

WABCO

SET REPARAȚIE ETRIER

BPW ECODISC

MAXX 22 MAN

MAXX 22 MAN

MAXX 22 MAN

ECODISC

TSB 3709/4309/4312

TSB 4309/4312

TSB 3709/4309/4312



Nr. Unix 11108851

MAXX 22 MAN



Nr. Unix 11064105

MAXX 22 MAN



Nr. Unix 11064095

MAXX 22 MAN



Nr. Unix 11108866

TSB 3709/4309/4312



Nr. Unix 11108870

TSB 3709/4309/4312



Nr. Unix 11108860

TSB 3709/4309/4312



Nr. Unix 11108861

TSB 3709/4309/4312



Nr. Unix 11108862

TSB 3709/4309/4312



Nr. Unix 11108863

TSB 3709/4309/4312



Nr. Unix 11108864

TSB 3709/4309/4312



Nr. Unix 11063786



Nr. Unix 11108856

MAXX 22 MAN



Nr. Unix 11064104

MAXX 22 MAN



Nr. Unix 11108855

MAXX 22 MAN



Nr. Unix 11108867

TSB 3709/4309/4312



Nr. Unix 11108859

TSB 3709/4309/4312



Nr. Unix 11108857

MAXX 22 MAN



Nr. Unix 11064096

MAXX 22 MAN



Nr. Unix 11064103

MAXX 22 MAN



Nr. Unix 11108867

TSB 3709/4309/4312



Nr. Unix 11063789

TSB 3709/4309/4312



Nr. Unix 11108852

MAXX 22 MAN



Nr. Unix 11220816

MAXX 22 MAN (dreapta)



Nr. Unix 11064103

MAXX 22 MAN



Nr. Unix 11108869

TSB 3709/4309/4312



Nr. Unix 11063788



Nr. Unix 11108854

MAXX 22 MAN



Nr. Unix 11064098

MAXX 22 MAN (stânga)



Nr. Unix 11064092



Nr. Unix 11108853



Nr. Unix 11064097

VANSTAR®

Producătorul sistemelor de evacuare

UNIX
PIESE AUTO®

FURTUN APĂ
SISTEM RĂCIRE

SUPORT SUSȚINERE
ARIPĂ UNIVERSAL

REZERVOR AER

TOBĂ EȘAPAMENT (SCR)

ȚEAVĂ EȘAPAMENT

COLIER EȘAPAMENT

ȚEAVĂ FINALĂ EȘAPAMENT

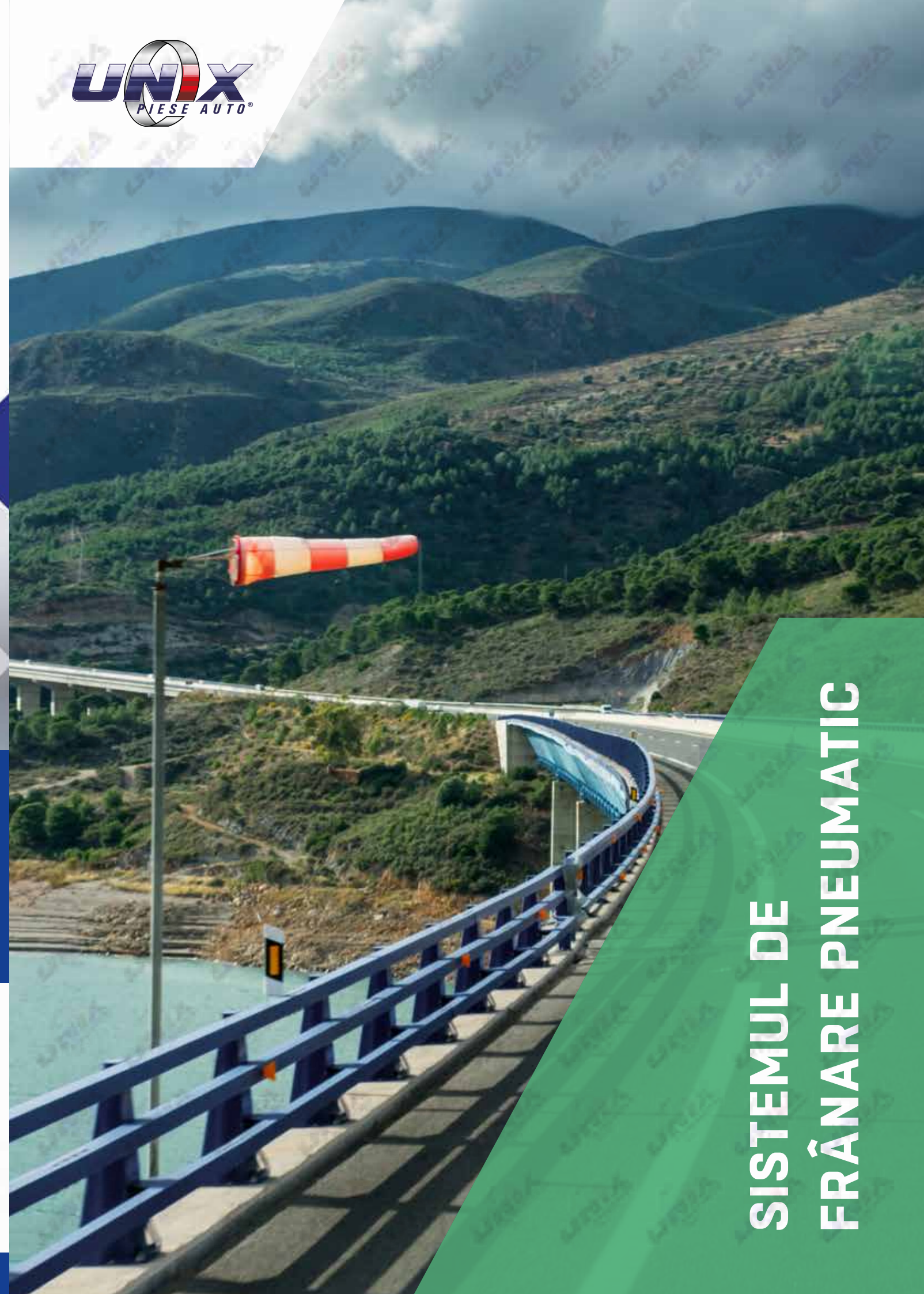

SISTEMUL DE
FRÂNARE PNEUMATIC

VANSTAR®

Suntem producătorul
pieselor OEM și AEM
de cea mai înaltă calitate

www.vanstar.pl
info@vanstar.pl

TIP PREMIUM

TIP ECONOMIC



SISTEMUL DE FRÂNARE PNEUMATIC

FURTUN AER SPIRALAT

GALBEN



Lungime (mm)	Dimensiune conector	Nr Unix
3000-5000	M16x1,5/M16x1,5	10155099
4000-6400	M16x1,5/M16x1,5	10155102
4000-6400	M16x1,5/M18x1,5	10155107
3000-5000	M22x1,5/M22x1,5	10155091

Lungime (mm)	Dimensiune conector	Nr Unix
3000-5000	M16x1,5/M16x1,5	10155100
4000-6400	M16x1,5/M16x1,5	10155104
4000-6400	M16x1,5/M18x1,5	10155108
3000-5000	M22x1,5/M22x1,5	10155092

Roșu



DISTRIBUITOR AER

Cu supapă automată (Remorcă)



Dimensiuni racord	Nr Unix
M6x1,5	10153433
M22x1,5	10153429

Cu supapă automată (Remorcă)



Dimensiuni racord	Nr Unix
M16x1,5	10153431
M22x1,5	10153427

Fără supapă (Remorcă)



Dimensiuni racord	Nr Unix
M16x1,5	10153421
M22x1,5	10153419

Fără supapă (Remorcă)



Dimensiuni racord	Nr Unix
M16x1,5	10153417
M22x1,5	10153415

CAP DE CUPLARE (DUOMATIC)

Autocamion



Nr Unix 10848735

Semiremorcă



Nr Unix 10848742

SISTEMUL DE FRÂNARE PNEUMATIC

DISTRIBUITOR AER

Fără supapă (Remorcă) cu filtru integrat



Dimensiuni racord	Nr Unix
M16x1,5	10851151

Fără supapă (Remorcă) cu filtru integrat



Dimensiuni racord	Nr Unix
M16x1,5	10851150

Support racord aer



Nr Unix 10117077

Set reparație cap de cuplare



Nr Unix 10995905

Racord pneumatic (SCANIA)



Dimensiuni M18x1,5x12/
M18x1,5x34
Nr Unix 10152414

FURTUN AER, PRESIUNE MARE

25m/rolă (DIN 74324)



Dimensiuni (mm)	Nr Unix
4x1,0	10003289
5x1,0	10003282
6x1,0	10003245
8x1,0	10003252
9x1,5	10003251
10x1,0	10003263
12x1,5	10003271
15x1,5	10003280

20m/rolă (DIN 74310)



Dimensiuni (mm)	Nr Unix
18x11x3,5	10842700
25x13x6	10842701

Colier 18x12



Nr Unix 10003114

Colier 25x15



Nr Unix 10003115

SISTEMUL DE FRÂNARE PNEUMATIC

RACORD FURTUN, AER COMPRIMAT (CONECTOR RAPID)

Conector rapid (10buc/set)	Dimensiune	Nr Unix	Conector rapid (10buc/set)	Dimensiune	Nr Unix
	4 mm	226929		6-4 mm	226921
	6 mm	226930		8-6 mm	226922
	8 mm	226931		10-8 mm	226923
	9 mm	226932		12-10 mm	226924
	10 mm	226933			
	12 mm	226935			
	14 mm	226936			
	15 mm	226937			
	16 mm	226938			

Conector rapid (metal)	Dimensiune	Nr Unix	Conector rapid	Dimensiune	Nr Unix
	4 mm	10152764		4 mm	10152303
	6 mm	10152767		5 mm	10152304
	8 mm	10152769		6 mm	10152305
	10 mm	10152771		8 mm	10152306
	11 mm	10152799		10 mm	10152307
	12 mm	10152773		12 mm	10152308
	15 mm	10153303			
	16 mm	10153304			

Conector rapid cu cot	Dimensiune	Nr Unix	Conector rapid în formă de T	Dimensiune	Nr Unix
	6 mm	226905		6 mm	226939
	8 mm	226906		8 mm	226940
	10 mm	226907		10 mm	226941
	12 mm	226908		12 mm	226942

RACORD FURTUN, AER COMPRIMAT (HOLENDER)

Racord pneumatic (holender)	Dimensiune	Nr Unix	Racord pneumatic cu cot (holender)	Dimensiune	Nr Unix
	4 mm	10152348		6/6 x 27/27 mm	10152453
	6 mm	10152347		8/8 x 31/31 mm	10152454
	8 mm	10152351		10/10 x 30/30 mm	10152455
	10 mm	10152355		12/12 x 32/32 mm	10152456
	12 mm	10152360			



Racord pneumatic cu cot	Dimensiune	Nr Unix	Racord pneumatic în formă de T	Dimensiune	Nr Unix
	6/6 x 44/27 mm	10152479		6/6/6 x 53 mm	10152519
	8/8 x 52/31 mm	10152480		6/8/6 x 57 mm	10152520
	10/10 x 61/30 mm	10152481		8/8/8 x 57 mm	10152521
	12/12 x 64/32 mm	10152482		8/6/8 x 57 mm	10152522
	15/15 x 74/55 mm	10152483		10/10/10 x 59 mm	10152523
				10/6/10 x 59 mm	10152524
				10/8/10 x 59 mm	10152525
				12/12/12 x 63 mm	10152526
				12/6/12 x 63 mm	10152527
				12/8/12 x 64 mm	10152528
				12/10/12 x 63 mm	10152529

Racord pneumatic drept	Dimensiune	Nr Unix	Racord pneumatic în formă de T	Dimensiune	Nr Unix
	6/M12 x 37	10152381		M12/12/12	10003239
	6/M16 x 36	10152382		M14/14/14	10003240
	8/M10 x 33	10152386		M18/18/18	10003242
	8/M16 x 36	10152387		M22/22/22	10003243
	8/M22 x 40	10152389			
	10/M14 x 39	10152391			
	10/M16 x 37	10152394			
	12/M12 x 34	10152397			
	12/M16 x 37	10152399			
	12/M18 x 38	10152400			

SISTEMUL DE FRÂNARE PNEUMATIC

RACORD FURTUN, AER COMPRIMAT (HOLENDER)

Racord pneumatic drept	Dimensiune	Nr Unix	Racord conexiune	Dimensiune	Nr Unix
	6/6/M12 x 64	10152368		M12 x 30	10152564
	10/10/M16 x 75	10152374		M12 x 35	10152563
	12/12/M18 x 69	10152375		M14 x 25	10152565
	15/15/M22 x 94	10152376		M16 x 25	10152566
				M18 x 26	10152568
				M22 x 38	10152567

Racord conexiune (cu filet exterior/interior)	Dimensiune	Nr Unix	Îmbinare, tubulatură aer comprimat	Dimensiune	Nr Unix
	M12/M22 x 27	10152578		M22/M12	10152572
	M16/M22 x 30	10152580		M22/M14	10152574
	M22/M22 x 44	10152581			

Racord pneumatic drept	Dimensiune	Nr Unix	Racord pneumatic cu cot	Dimensiune	Nr Unix
	6/8 x M12	10152742		M12	10152751
	6/12 x M12	10152743		M14	10152752
	6/15 x M12	10152744		M16	10152753
	8/10 x M14	10152745		M18	10152754
	8/12 x M14	10152746		M22	10152755
	8/15 x M14	10152747			
	10/12 x M16	10152748			
	10/15 x M16	10152749			
	12/15 x M18	10152750			

RACORD FURTUN, AER COMPRIMAT (FILET)

Racord pneumatic cu cot (filet exterior)	Dimensiune	Nr Unix	Racord pneumatic în formă de T (cu filet interior)	Dimensiune	Nr Unix
	M22 x 33/45	10152484		M12	10153379
	M22 x 33/54	10152485		M16	10153380
	M22 x 45/45	10152486			

RACORD FURTUN, AER COMPRIMAT (RACORD MĂSURARE)

Drept	Dimensiune	Nr Unix
	M12	10167372
	M14	10167387
	M16	10167388
	M18	10167389
	M22	10167371

RACORD FURTUN, AER COMPRIMAT (DREPT)

NEW LINE	Dimensiune	Nr Unix
	6/M10 x 33,5	10153354
	6/M12 x 32	10153313
	6/M16 x 21,5	10153350
	8/M12 x 34	10153318
	8/M16 x 26	10153321
	12/M16 x 39	10153333
	15/M22 x 40,5	10153338
	16/M16 x 42	10153353

ȘURUB RACORDARE (VOSS)

Șurub olandez	Dimensiune	Nr Unix	Set reparatie cuplaj sistem aer	Dimensiune	Nr Unix
	M10	10152269		NG 8	10152240
	M16	10152081		NG 12	10152241
	M16	10152267			
	M22	10152268			

SISTEMUL DE FRÂNARE PNEUMATIC

REZERVOR AER COMPRIMAT



Volum (litri)	Dimensiuni (mm)	Nr Unix
37	246 x 862	10152689
40	246 x 927	10152690
40	276 x 758	10152692
60	246 x 1365	10152694
60	276 x 1108	10152693
60	310 x 880	10152695
60	396 x 580	10152696
80	396 x 750	10152697
100	396 x 915	10152699



Volum (litri)	Dimensiuni (mm)	Nr Unix
10	206 x 368	10152685
20	206 x 691	10152684
20	246 x 495	10053777

SCHMITZ (80 litri, 400 x 750)

KÖGEL (60 litri, 310 x 888)

SCHMITZ (80 litri, 310 x 1157)



Nr Unix 10667088



Nr Unix 10667019



Nr Unix 10153625

KRONE (40 litri, 276 x 762)

SCHMITZ (80 litri, 396 x 743)

Supapă admisie



Nr Unix 11162875



Nr Unix 10153626



Nr Unix 10152619

Bandă susținere rezervor aer comprimat



Dimensiuni (mm)	Nr Unix
206 x 125	10156349
246 x 165	10156350
276 x 195	10156352
310 x 230	10156353
396 x 315	10156354

Nr Unix
10156349
10156350
10156352
10156353
10156354

SISTEMUL DE FRÂNARE PNEUMATIC

FILTRU DESICATOR SISTEM FRÂNĂV

CARACTERISTICI TEHNICE

M39x1.5
Filet dreapta
Presiune maximă: 14 bar
Aplicații:
DAF, RENAULT
IVECO, MERCEDES
MAN, EVOBUS

M39x1.5
Filet dreapta
Presiune maximă: 14 bar
Aplicații:
DAF, RENAULT
IVECO, MERCEDES
MAN, EVOBUS

M39x1.5
Filet stânga
Presiune maximă: 14 bar
Aplicații:
RENAULT, VOLVO

M41x1.5
Filet dreapta
Presiune maximă: 14 bar
Aplicații:
DAF

G1 1/4"
Presiune maximă: 14 bar
Aplicații:
SCANIA

M39x1.5
Filet dreapta
Presiune maximă: 14 bar
Aplicații:
DAF

EAC pregătire aer
Aplicații:
VOLVO

M41x2
Presiune maximă: 14 bar
Aplicații:
MERCEDES Actros MP4
MERCEDES Actros MP5



TRUCKSERVICES



WABCO

ProVia

FILTRU DESICATOR SISTEM FRÂNĂ



Nr Unix 166960 (II40100F)

FILTRU DESICATOR SISTEM FRÂNĂ CU FUNCȚIE SEPARARE ULEI



Nr Unix: 169042 (K039454X00)

FILTRU DESICATOR SISTEM FRÂNĂ



Nr Unix: 909100 (432 410 222 7)

FILTRU DESICATOR SISTEM FRÂNĂ CU FUNCȚIE SEPARARE ULEI



Nr Unix: 10853306 (432 901 223 2)



Nr Unix: 10853175 (432 410 244 2)



Nr Unix: 11179008 (PRO0102002)



Nr Unix: 11179010 (PRO1247012)



Nr Unix: 169034 (K039453X00)



Nr Unix: 10853309 (432 901 245 2)



Nr Unix: 169045 (K039455X00)



Nr Unix: 10853310 (432 901 246 2)



Nr Unix: 190794 (K087957)



Nr Unix: 10853303 (432 410 927 2)



Nr Unix: 10853308 (432 901 228 2)

Soluție dezghețat frână pneumatică 1l WABCOTHYL



Nr Unix: 10853602 (830 702 087 4)



Nr Unix: 190862 (K096383)



Nr Unix: 190863 (K096837K50)



Nr Unix: 190896 (K163455)

M41x2
Presiune maximă: 13 bar
Aplicații:
MERCEDES Actros MP4
MERCEDES Actros MP5



HFC
Nr Unix: 724362 (031005509)



MTC+
Nr Unix: 724368 (950310040)



**SISTEMUL DE
TRACȚIUNE**

RINGFEDER

PIESE PENTRU CUPLA TRACTARE

Sferă de cuplare



Tip: RF40G150A
Nr. Unix: 11255467

Robinet sferă de cuplare



Tip: RF40/RF45 A,B
Nr. Unix: 11255514

Unitate de siguranță cuplă tractare



Tip: 20/40/50 Serie
Nr. Unix: 11255493

Set reparație braț siguranță



Tip: RF40/FR45 A,AM
Nr. Unix: 11255425

Ax cuplă tractare



Tip: 4040/4045 ax, cu braț blocare
Nr. Unix: 11255665

Ax cuplă tractare



Tip: RF40/RF45 ax, cu braț blocare
Nr. Unix: 11255668

Set reparație cuplă tractare



Tip: 86/95/645
Nr. Unix: 11255572

Set reparație cuplă tractare



Tip: 4040/4045 A,B
Nr. Unix: 11255577

Set reparație cuplă tractare



Tip: 5050 A,B,AM
Nr. Unix: 11255578

Set reparație cuplă tractare



Tip: RF40/RF45 A,B
Nr. Unix: 11255582

Bucșă ochet tractare



Nr. Unix Dimensiuni
11255673 40mm/48mm
11255675 40mm/48,5mm
11255676 40mm/49,5mm
11255677 40mm/49mm
11255681 50mm/60,3mm

Manetă siguranță



Tip: 4040/4045/5050 B
Nr. Unix: 11255407

JOST

PIESE PENTRU ROATA A CINCEA

Știft cuplaj semiremorcă



Tip: 2"
Nr. Unix: 154836

Set reparație cuplaj semiremorcă



Tip: JSK 42
Nr. Unix: 156878

Set reparație cuplaj semiremorcă (2 buc)



Tip: JSK 40, 42
Nr. Unix: 156852

Set reparație cuplaj semiremorcă



Nr. Unix: 156767

Set reparație cuplaj semiremorcă



Tip: JSK 37
Nr. Unix: 156779

Set reparație cuplaj semiremorcă



Tip: JSK 37CW/EAW
Nr. Unix: 156792

Set reparație cuplaj semiremorcă



Tip: JSK 42MK
Nr. Unix: 156851

Set reparație cuplaj semiremorcă



Tip: JSK 37
Nr. Unix: 154951

Set reparație cuplaj semiremorcă



Tip: JSK 42
Nr. Unix: 156889

Set reparație cuplaj semiremorcă



Tip: JSK 37
Nr. Unix: 156799

Inel de uzură cuplaj semiremorcă



Nr. Unix: 156764

Inel de uzură cuplaj semiremorcă



Tip: JSK 37
Nr. Unix: 156764

Inel de uzură cuplaj semiremorcă



Tip: JSK 42/42MK
Nr. Unix: 156880

Inel de uzură cuplaj semiremorcă



Tip: JSK 36, 37
Nr. Unix: 154920

Cârlig închidere cap tracțiune



Nr. Unix: 154899

ROCKINGER

PIESE PENTRU CUPLA TRACTARE/ OCHI TRACTARE

Sferă de cuplare



Tip: RO*50-50mm
Nr. Unix: 152669

Sferă tractare la cârlig



Diametru: 50mm
Nr. Unix: 154346

Sferă de cuplare



Tip: RO*400-1 -40mm
Nr. Unix: 152621

Ochi tractare complet



Diametru: 40mm
Nr. Unix: 153415

Ochi tractare complet



Diametru: 50mm
Nr. Unix: 153416

Ochi tractare complet



Diametru: 40mm
Nr. Unix: 153421

Ochi tractare complet



Diametru: 50mm
Nr. Unix: 153422

Bucșă ochet tractare



Nr. Unix: 153310

Carcasă cuplă tractare



Nr. Unix: 153170

Carcasă cuplă tractare



Nr. Unix: 153180

Robinet sferă de tractare



Nr. Unix: 153201

Kit fixare



Nr. Unix: 153638

Carcasă robinet sferă de cuplare



Nr. Unix: 154056

ROCKINGER

SETURI DE REPARAȚII

Set reînnoire



Tip: 400S5100C
Nr. Unix: 154134

Set reînnoire



Tip: 500A6600
Nr. Unix: 154154

Set reînnoire



Tip: RO 500
Nr. Unix: 153993

Set reînnoire



Tip: RO 400
Nr. Unix: 153992

Set reînnoire



Tip: RO 260
Nr. Unix: 153991

Bucșă robinet sferă de cuplare



Tip: RO 400/430/460
Nr. Unix: 153319

Bucșă robinet sferă de cuplare



Tip: RO 400-1
Nr. Unix: 154133

Bucșă robinet sferă de cuplare



Tip: RO 400/430/460
Nr. Unix: 153320

Bucșă robinet sferă de cuplare



Tip: 500A6600
Nr. Unix: 153342

Bucșă robinet sferă de cuplare



Tip: R500
Nr. Unix: 153318

Bucșă robinet sferă de cuplare



Tip: 500A6600
Nr. Unix: 153336

Bucșă robinet sferă de cuplare



Tip: 260G150
Nr. Unix: 153669

Carcasă cuplă tractare



Nr. Unix: 154030

Telecomandă mecanică



Nr. Unix: 154121

Indicator rotație



Nr. Unix: 154117

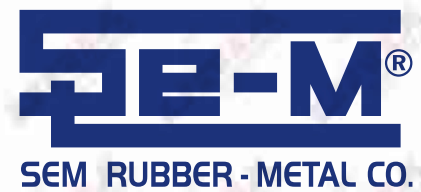

Suntem mai puternici
prin legăturile noastre.

Înaltă calitate și performanță

Piese de schimb premium pentru camioane, remorci și autobuze



www.semlastik.com



SEMIREMORCI



BPW

FRÂNĂ

Plăcuțe frână la disc frână

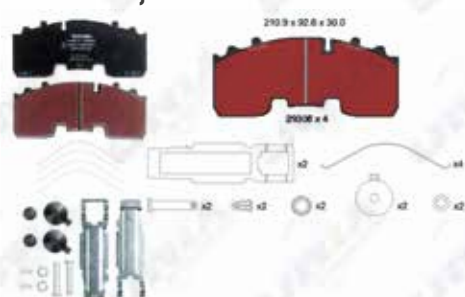

Nr. Unix: 10854519

Plăcuțe frână la disc frână



Nr. Unix: 10854521

Plăcuțe frână la disc frână

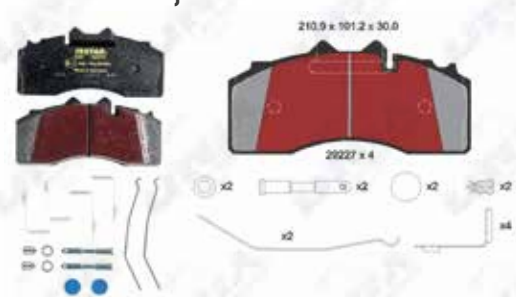

Nr. Unix: 10854513

Plăcuțe frână la disc frână



Nr. Unix: 10854514

Disc frână (Diametru: 430mm)



Nr. Unix: 10053132

Disc frână (Diametru: 377mm)



Nr. Unix: 10053131

Inel ABS



Nr. Unix: 10002754

Saboți frână (WWA 19032)



Nr. Unix: 10854081

Saboți frână (WWA 19574)



Nr. Unix: 10854253

Nit sabot frână (8x15mm, 100buc/pachet)



Nr. Unix: 10052590

Tambur frână (ECO diametru: 420mm)



Nr. Unix: 10031834

Tambur frână (ECO - Maxx Diametru: 300mm)



Nr. Unix: 10031812

Placă protecție praf (tambur frână)



Nr. Unix: 947595

BPW

FRÂNĂ

Braț frână



Nr. Unix: 10358297

Arc saboți frână



Nr. Unix: 10102653

Set reparație ax frână cu tambur



Nr. Unix: 10005741

Inel de siguranță



Nr. Unix: 939985

Cilindru frână pneumatic (16/24")



Nr. Unix: 11129558

Cilindru frână pneumatic 24



Nr. Unix: 10152661

Cilindru frână pneumatic (24/30")



Nr. Unix: 10152664

Cilindru frână pneumatic 24



Nr. Unix: 10152632

SISTEMUL DE AMORTIZARE

Arc lamelar



Nr. Unix: 150109

Arc lamelar



Nr. Unix: 150115

Bucșă foaie arc



Nr. Unix: 944405

Bucșă foaie arc



Nr. Unix: 943844

Suport arc (Stânga)



Nr. Unix: 947537

Suport arc (Dreapta)



Nr. Unix: 947538

Set reparație bolt arc



Nr. Unix: 10178529

Piuliță



Nr. Unix: 10354320

Amortizor



Nr. Unix: 85746

Șurub arc M30x170



Nr. Unix: 10178511

Șurub arc M30x210/45



Nr. Unix: 10071593

Șurub roată M22x1,5



Nr. Unix: 872744

Prezon roată M22x1,5



Nr. Unix: 10071247

Rulment roată



Nr. Unix: 10519010

FRÂNĂ PNEUMATICĂ

Cilindru frână pneumatic axă portantă



Nr. Unix: 10995765

Senzor ABS



Nr. Unix: 10841955

Nr. Unix: 10841972

Rezervor aer comprimat (60l)



Nr. Unix: 10152693

Valvă scurgere apă



Nr. Unix: 10152619

SAF

FRÂNĂ

Plăcuțe frână la disc frână



Nr. Unix: 138294

Plăcuțe frână la disc frână



Nr. Unix: 138293

Plăcuțe frână la disc frână



Nr. Unix: 138290

Plăcuțe frână la disc frână



Nr. Unix: 138292

Disc frână



Nr. Unix: 138447

Disc frână



Nr. Unix: 138443

Disc frână



Nr. Unix: 138448

Disc frână



Nr. Unix: 138446

Cilindru frână pneumatic
20/24

Nr. Unix: 138471

Cilindru frână pneumatic
16/24

Nr. Unix: 138470

Set șurub disc frână M12



Nr. Unix: 138389

Set șurub disc frână M14



Nr. Unix: 138390

Saboți frână 300x200



Nr. Unix: 138288

Saboți frână 420x180



Nr. Unix: 138287

Saboți frână (frână cu
tambur) 300mm

Nr. Unix: 138301

Saboți frână (frână cu
tambur) 420mm

Nr. Unix: 138304

Tambur frână



Nr. Unix: 138256

Cheie frână



Nr. Unix: 138265

Cheie frână



Nr. Unix: 138266

Placă protecție praf
(tambur frână)

Nr. Unix: 138282

Braț frână



Nr. Unix: 910576

Set reparație ax frână cu tambur



Nr. Unix: 10355182

Element de racordare



Nr. Unix: 10844630

SAF

SISTEMUL DE AMORTIZARE

Amortizor



Nr. Unix: 138274

Amortizor



Nr. Unix: 138276

Amortizor



Nr. Unix: 138277

Pernă de aer completă



Nr. Unix: 138333

Set șuruburi sistem direcție



Nr. Unix: 138386

Set șurub roată



Nr. Unix: 138340

Set șurub roată



Nr. Unix: 138341

Set șurub roată



Nr. Unix: 138339

Butuc roată



Nr. Unix: 138352

Butuc roată



Nr. Unix: 138351

Butuc roată



Nr. Unix: 138349

Butuc roată



Nr. Unix: 138258

Bucșă arc foi



Nr. Unix: 10805706

Set reparație bolt arc



Nr. Unix: 10358412

Set rulment roată



Nr. Unix: 138384

Capac rulment roată



Nr. Unix: 10096399

Bucșă arc foi



Nr. Unix: 10805707

Set reparație bolt arc



Nr. Unix: 10358414

Șurub arc



Nr. Unix: 10178519

Bucșă foaie arc



Nr. Unix: 10156305

Piuliță fuzetă (cu filet pe
stânga)

Nr. Unix: 10170328

Piuliță fuzetă (cu filet pe
dreapta)

Nr. Unix: 10170327

Bridă arc



Nr. Unix: 872459

Șurub arc



Nr. Unix: 138354



CEA MAI ÎNALTĂ CALITATE CARE POATE FI ATINSĂ
NOI ARCURI PNEUMATICE PENTRU CAMIOANE EURO 6



**GAMĂ NOUĂ DE PRODUSE
PENTRU CAMIOANELE EURO 6**

VOLVO FH4 / FM4 | MERCEDES BENZ ACTROS MP4 | DAF CF/XF

Firestone

ARC PNEUMATIC

ARC PNEUMATIC

BPW

BPW 30 (piston din plastic) BPW 30 (piston din metal) BPW 30 K (piston din plastic) BPW 30 K (piston din metal)



Nr Unix 10769607



Nr Unix 10898512



Nr Unix 10769606



Nr Unix 10898502

BPW 30 K (piston din plastic) BPW 30 K (piston din metal) BPW 36 (piston din plastic) BPW 36 (piston din metal)



Nr Unix 10769671



Nr Unix 10769670



Nr Unix 10769889



Nr Unix 10898517

BPW 36 K (piston din plastic) BPW 36 K (piston din metal)



Nr Unix 10769742



Nr Unix 10898531



Nr Unix 10898540



Nr Unix 11096980

SCHMITZ



Nr Unix 912342/2



Nr Unix 10769621



Nr Unix 10898520



Nr Unix 10769685



Nr Unix 10769786



Nr Unix 10898524



Nr Unix 10898563



Nr Unix 10323137

ARC PNEUMATIC

SAF

SAF 2618V SAF 2619V SAF 2918V SAF 2919V



Nr Unix 10769682



Nr Unix 10898534



Nr Unix 10898519



Nr Unix 11148755

SAF 2923V



Nr Unix 10898527

SAF 2922V



Nr Unix 10541681

SAF 2621V



Nr Unix 10541712

SAF 2626V



Nr Unix 10541695

SAF 2926V



Nr Unix 10769597

SAF 2927V



Nr Unix 11148764

Axă remorcată



Nr Unix 10898578

Axă remorcată



Nr Unix 10898567

FRUEHAUF, SMB, ROR, GIGANT, MB

FRUEHAUF



Nr Unix 10769697

FRUEHAUF



Nr Unix 10769717

FRUEHAUF



Nr Unix 10266544

GIGANT



Nr Unix 10769798

MB



Nr Unix 10117383

MB



Nr Unix 10117568

MB



Nr Unix 10117673

GIGANT



Nr Unix 10769627



ARTA ILUMINĂRII

FABRILcar
Partenerul dumneavoastră pentru piese alternative
powered by ASPÖCK



CAMIOANE ȘI REMORCI



ECOLED II
Lampă spate

ECOLED III
Lampă spate

WORKPOINT II
Lampă de lucru
și marșarier

FLEXLED
Iluminare număr
înmatriculare

LĂMPI DE LUCRU

WORKPOINT II

WORKFAB II



10-32V | 40-50 | LED | High Power | 5000K | ADI | CE | E118 | IP6K9K

1000lm | 2000lm | 2500lm | 3000lm | 3500lm | 4500lm | 10-32V | 40-50 | LED | CE | ADI | E118 | IP6K9K



ILUMINARE

LAMPĂ SPATE

SEMIREMORCĂ

EUROPOINT 1



Tip conexiune: ASS2 7PIN
Nr. Unix 300593

EUROPOINT 1



Tip conexiune: ASS2 7PIN
Nr. Unix 300600

EUROPOINT 1



Tip conexiune: fără mufă
Nr. Unix 300598

EUROPOINT 1



Tip conexiune: fără mufă
Nr. Unix 300605

EUROPOINT 2



Tip conexiune: ASS2 7PIN
Nr. Unix 300624

EUROPOINT 2



Tip conexiune: ASS2 7PIN
Nr. Unix 300607

EUROPOINT 2 (cu semnalizator lățime)



Tip conexiune: ASS2 7PIN EOML
Nr. Unix 300619

EUROPOINT 2 (cu semnalizator lățime)



Tip conexiune: ASS2 7PIN EOML
Nr. Unix 300636

EUROPOINT 3



Tip conexiune: ASS2 7PIN
Nr. Unix 300643

EUROPOINT 3



Tip conexiune: ASS2 7PIN
Nr. Unix 300656

EUROPOINT 3 (cu semnalizator lățime)



Tip conexiune: ASS2 1 7PIN EOML SP IV
Nr. Unix 300650

EUROPOINT 3 (cu semnalizator lățime)



Tip conexiune: ASS2 1 7PIN EOML SP IV
Nr. Unix 300661

LAMPĂ SPATE

SEMIREMORCĂ

ECOPOINT 1 (SCHMITZ)



Tip conexiune: ASS2 7PIN
Nr. Unix 300526

ECOPOINT 1 (SCHMITZ)



Tip conexiune: ASS2 7PIN
Nr. Unix 300547

ECOPOINT 2



Tip conexiune: ASS2 7PIN
Nr. Unix 300573

ECOPOINT 2



Tip conexiune: ASS2 7PIN
Nr. Unix 300575

ECOPOINT 2 (cu semnalizator lățime)



Tip conexiune: ASS2 7PIN
Nr. Unix 300568

ECOPOINT 2 (cu semnalizator lățime)



Tip conexiune: ASS2 7PIN
Nr. Unix 300579

ECOPOINT 2 (cu semnalizator lățime) KÖGEL



Tip conexiune: ASS2 7PIN + 2x2 PIN ASS 2
Nr. Unix 300572

ECOPOINT 2 (cu semnalizator lățime) KÖGEL



Tip conexiune: ASS2 7PIN + 2x2 PIN ASS 2
Nr. Unix 300583

ECOLED



Tip conexiune: ASS2 7PIN
Nr. Unix 300586

ECOLED



Tip conexiune: ASS2 7PIN
Nr. Unix 300590

ECOLED 2



Tip conexiune: ASS2 7PIN
Nr. Unix 11049578

ECOLED 2

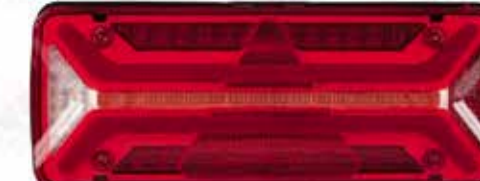

Tip conexiune: ASS2 7PIN
Nr. Unix 11049576

LAMPĂ SPATE

SEMIREMORCĂ

ECOLED 2 (cu semnalizator lățime)



Tip conexiune: ASS2 7PIN + 2x2 PIN ASS 2
Nr. Unix 11049579

ECOLED 2 (cu semnalizator lățime)



Tip conexiune: ASS2 7PIN + 2x2 PIN ASS 2
Nr. Unix 11049577

MULTIPOINT



Tip conexiune: 5 PIN RFS
(cu faruri ceață + cu iluminare număr înmatriculare)
Nr. Unix 300506

MULTIPOINT



Tip conexiune: 5 PIN RFS (cu iluminare număr înmatriculare)
Nr. Unix 300515

LC5T



Tip conexiune: AMP 1.5
Nr. Unix 157174

LC5T



Tip conexiune: AMP 1.5
Nr. Unix 157175

LC7 T4C (cu iluminare număr înmatriculare)



Tip conexiune: PG
Nr. Unix 157271

LC7 T4C



Tip conexiune: PG
Nr. Unix 157272

LC12T SCHMITZ



Tip conexiune: AMP 1.5 LED
Nr. Unix 461743

LC12T SCHMITZ



Tip conexiune: AMP 1.5 LED
Nr. Unix 461742

LC8T



Tip conexiune: AMP 1.5
Nr. Unix 157195

LC8T



Tip conexiune: AMP 1.5
Nr. Unix 157196

LAMPĂ SPATE

SEMIREMORCĂ (UNIVERSALĂ)

6 funcții de iluminare



Tip conexiune: ieșire cablu
Nr. Unix 11049832

6 funcții de iluminare



Tip conexiune: ieșire cablu
Nr. Unix 11049831

6 funcții de iluminare



Tip conexiune: ieșire cablu
Nr. Unix 11049693

6 funcții de iluminare



Tip conexiune: ieșire cablu
Nr. Unix 11049692

6 funcții de iluminare cu LED



Tip conexiune: ieșire cablu
Nr. Unix 11049677

6 funcții de iluminare cu LED



Tip conexiune: ieșire cablu
Nr. Unix 11049676

7 funcții de iluminare cu LED



Tip conexiune: PG Plug
Nr. Unix 11049707

7 funcții de iluminare cu LED



Tip conexiune: PG Plug
Nr. Unix 11049706

7 funcții de iluminare cu LED



Tip conexiune: AMP 7PIN
Nr. Unix 11049710

7 funcții de iluminare cu LED



Tip conexiune: AMP 7PIN
Nr. Unix 11049711

LAMPĂ SPATE

SEMIREMORCĂ (UNIVERSALĂ)

6 funcții de iluminare



Tip conexiune: AMP
Nr. Unix 11049827

6 funcții de iluminare



Tip conexiune: AMP
Nr. Unix 11049826

7 funcții de iluminare



Tip conexiune: AMP
Nr. Unix 11230796

7 funcții de iluminare



Tip conexiune: AMP
Nr. Unix 11230795

6 funcții de iluminare cu LED



Tip conexiune: ieșire cablu
Nr. Unix 11049673

6 funcții de iluminare cu LED



Tip conexiune: ieșire cablu
Nr. Unix 11049672

6 funcții de iluminare cu LED



Tip conexiune: ieșire cablu
Nr. Unix 11049681

6 funcții de iluminare cu LED



Tip conexiune: ieșire cablu
Nr. Unix 11049680

7 funcții de iluminare



Tip conexiune: cu cablu (50 cm)
Nr. Unix 11049713

7 funcții de iluminare



Tip conexiune: cu cablu (50 cm)
Nr. Unix 11049712

7 funcții de iluminare (cu iluminare plăcuța de înmatriculare)



Tip conexiune: cu cablu (50 cm)
Nr. Unix 11049717

7 funcții de iluminare



Tip conexiune: cu cablu (50 cm)
Nr. Unix 11049715

LAMPĂ SPATE

SEMIREMORCĂ (UNIVERSALĂ)

7 funcții de iluminare



Tip conexiune: cu cablu (50 cm)
Nr. Unix 11049719

7 funcții de iluminare



Tip conexiune: cu cablu (50 cm)
Nr. Unix 11049718

7 funcții de iluminare (cu iluminare plăcuța de înmatriculare)



Tip conexiune: ieșire cablu
Nr. Unix 11049737

7 funcții de iluminare



Tip conexiune: ieșire cablu
Nr. Unix 11049738

5 funcții de iluminare



Tip conexiune: 5 PIN
Nr. Unix 11049847

5 funcții de iluminare



Tip conexiune: 5 PIN
Nr. Unix 11049846

5 funcții de iluminare (cu bec)



Nr. Unix 11049873

5 funcții de iluminare (cu bec)



Nr. Unix 11049872

3 funcții de iluminare (cu bec)



Nr. Unix 11049883

3 funcții de iluminare (cu bec)



Nr. Unix 11049882

3 funcții de iluminare (cu LED)



Nr. Unix 11049868

3 funcții de iluminare (cu LED)



Nr. Unix 11049869

3 funcții de iluminare (cu bec)



Nr. Unix 11049898

LAMPĂ INDICATOR GABARIT

SEMIREMORCĂ (UNIVERSALĂ)

Superpoint 2 (roșu/alb)

Lungime cablu: 860mm
Nr. Unix 300897

Superpoint 2 (roșu/alb)

Lungime cablu: 860mm
Nr. Unix 300896

Superpoint 2 (roșu/alb)

ECOPOINT lampă spate
Nr. Unix 300914

Superpoint 2 (roșu/alb)

ECOPOINT lampă spate
Nr. Unix 300913

Superpoint 2 (roșu/alb, galben) cu LED

Lungime cablu: 250mm
Nr. Unix 300856

Superpoint 2 (roșu/alb, galben) cu LED

Lungime cablu: 1m
Nr. Unix 300857

Superpoint 3 (roșu/alb, galben) cu LED

Lungime cablu: 1,25m
Nr. Unix 300830

Superpoint 3 (roșu/alb, galben) cu LED

Lungime cablu: 1,25m
Nr. Unix 300832

Superpoint 3 (roșu/alb, galben) cu LED

Lungime cablu: 4m
Nr. Unix 300877

Superpoint 3 (roșu/alb, galben) cu LED

Lungime cablu: 4m
Nr. Unix 300879

Superpoint 3 (roșu/alb, galben) cu LED



Nr. Unix 300837

Superpoint 3 (roșu/alb, galben) cu LED

Lungime cablu:
1,25m AMP 2 PIN
Nr. Unix 300835

Superpoint 3 (roșu/alb, galben) cu LED KÖGEL



Nr. Unix 300824

Superpoint 3 (roșu/alb, galben) cu LED KÖGEL



Nr. Unix 300816

Superpoint 4 (roșu/alb, galben) cu LED

Lungime cablu: 2m
Nr. Unix 300806

Superpoint 4 (roșu/alb, galben) cu LED

Lungime cablu: 2m
Nr. Unix 300807

UNIPOINT (cu LED)

Lungime cablu: 0,5m
Nr. Unix 300727

UNIPOINT (cu LED)



Nr. Unix 300341

UNIPOINT (cu LED)

Lungime cablu: 0,5m
Nr. Unix 300720

UNIPOINT 2 (cu LED)

Tip conexiune: SCHMITZ
Nr. Unix 300785

FLATPOINT (cu LED)

Lungime cablu: 0,5m
Nr. Unix 300749

FLATPOINT (cu LED)



Nr. Unix 300345

FLATPOINT 2 (cu LED)

Lungime cablu: 0,5m
Nr. Unix 300763

FLATPOINT 2 (cu LED) KÖGEL

Lungime cablu: 1,5m
Nr. Unix 300763

LAMPĂ INDICATOR GABARIT

SEMIREMORCĂ (UNIVERSALĂ)

DX (cu bec)



Nr. Unix 157485

DX (cu bec)



Nr. Unix 157484

Roșu/alb (cu bec)



Nr. Unix 157487

Roșu/alb/galben (cu LED)



Nr. Unix 157626

Roșu/alb cu LED

Lungime cablu: 1m
Nr. Unix 157123

Roșu/alb cu LED

Lungime cablu: 1m
Nr. Unix 157122

Roșu/alb (cu bec)



Nr. Unix 157323

Roșu/alb (cu bec)



Nr. Unix 157306

Roșu/alb cu LED



Nr. Unix 367702

Roșu/alb cu LED



Nr. Unix 367703

Roșu/alb cu LED



Nr. Unix 367698

Roșu/alb cu LED



Nr. Unix 367699

Roșu/alb/galben LED ADR



Nr. Unix 364891

Roșu/alb/galben LED ADR



Nr. Unix 364892

Roșu/alb (cu bec)



Nr. Unix 395323

Roșu/alb (cu bec)



Nr. Unix 395322

Roșu/alb (cu LED)



Nr. Unix 11049911

Roșu/alb (cu LED)



Nr. Unix 11049910

Roșu/alb (cu LED)



Nr. Unix 11049909

Galben (cu LED)



Nr. Unix 11049955

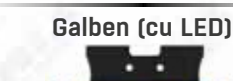

Nr. Unix 11049963

Roșu/alb/galben (cu LED)



Nr. Unix 11049906

Roșu/alb/galben (cu LED)



Nr. Unix 11049907

Galben (cu LED)



Nr. Unix 11049931



Nr. Unix 11049964

Galben (cu LED)



Nr. Unix 11049931



Nr. Unix 11049924

LAMPĂ POZIȚIE

SEMIREMORCĂ (UNIVERSALĂ)

Flexipoint (cu bec)



Nr. Unix 300369

Flexipoint (cu LED)



Nr. Unix 300964

Unipoint (cu LED)

Lungime cablu: 0,5m
Nr. Unix 301068

Unipoint (cu LED)

Lungime cablu: 1,5m
Nr. Unix 301069

Flatpoint 2 (cu LED)

Lungime cablu: 0,5m
Nr. Unix 301034

Flatpoint 2 (cu LED)

Lungime cablu: 1,5m
Nr. Unix 301035

Flatpoint 1 (cu LED)

Lungime cablu: 0,5m
Nr. Unix 301008

Posipoint 2 (cu LED)

Lungime cablu: 0,5m
Nr. Unix 301049

Posipoint 2 (cu LED)

Lungime cablu: 0,5m
Nr. Unix 301057

Unipoint (cu LED)

Lungime cablu: 0,5m
Nr. Unix 301078

Position (cu LED)

Lungime cablu: 1,5m
Nr. Unix 11248982

Position (cu LED)

Lungime cablu: 5m
Nr. Unix 11248983

cu LED (4buc/set)



Nr. Unix 11049975

cu LED (4buc/set)



Nr. Unix 11049974

cu LED

Lungime cablu: 1m
Nr. Unix 11049960

cu LED

Lungime cablu: 1m
Nr. Unix 11049961

cu LED



Nr. Unix 11049971

cu LED



Nr. Unix 11049959

Cu bec 12/24V (2buc/set)



Nr. Unix 11049981

Cu bec 12/24V (2buc/set)



Nr. Unix 11049967

cu LED



Nr. Unix 11049970

cu LED



Nr. Unix 11049958

cu LED 24V



Nr. Unix 11049976

cu LED 24V



Nr. Unix 11049962

Cu bec 12/24V (2buc/set)



Nr. Unix 11049965

Cu bec 12/24V (2buc/set)



Nr. Unix 11049968

cu LED 24V



Nr. Unix 11049973

cu LED 24V



Nr. Unix 11049957

LAMPĂ GIROFAR (UNIVERSALĂ)

LAMPĂ GIROFAR - PUNTE DE LUMINI

Mod de fixare magnetic (12V)



Nr. Unix 397570/2

Mod de fixare pe suport (12V)



Nr. Unix 397572/2

Mod de fixare înșurubat (12V)



Nr. Unix 397575/2

Mod de fixare magnetic (24V)



Nr. Unix 397571/2

Mod de fixare pe suport (24V)



Nr. Unix 397727/2

Mod de fixare înșurubat (24V)



Nr. Unix 397576/2

Mod de fixare magnetic (10-30V, LED)



Nr. Unix 11002040

Mod de fixare magnetic (10-30V, LED)



Nr. Unix 11002052

Mod de fixare magnetic (12/24, H1)



Nr. Unix 463981

Mod de fixare magnetic (12/24V, LED)



Nr. Unix 11248726

Mod de fixare pe suport (12/24V, LED)



Nr. Unix 11248737

Mod de fixare magnetic (12/24V, LED)



Nr. Unix 10677847

LED Punte de lumini LED (12/24V, 4100lm, 6000K)



Nr. Unix 11056742

LED Punte de lumini LED (12/24V, 1500lm, 6000K)



Nr. Unix 11056739

LAMPĂ LUCRU

UNIVERSALĂ

cu LED (5 buc) 10-30V, 800lm



Nr. Unix 680732

cu LED (5 buc) 10-30V, 800lm



Nr. Unix 680731

cu LED (9 buc) 10-30V, 1800lm



Nr. Unix 680735

cu LED (8 buc) 10-30V, 1800lm



Nr. Unix 301352

cu LED (9 buc) 9-59V, 1500lm



Nr. Unix 11249129

cu LED (6 buc) 9-59V, 3500lm



Nr. Unix 11248048

cu LED 10-30V



Nr. Unix 465436

cu LED (6 buc) 12/24V, 1000lm



Nr. Unix 11103699

cu LED (6 buc) 12/24V, 1000lm



Nr. Unix 11103700

cu LED (6 buc) 12/24V, 1500lm



Nr. Unix 11103701

cu LED (6 buc) 12/24V, 2000lm



Nr. Unix 11103702

cu bec H3 (cu întrerupător)



Nr. Unix 157651

LAMPĂ LUCRU

UNIVERSALĂ

cu LED (36 buc) 12/24V, 5400lm



Nr. Unix 11049557

cu LED (4 buc) 12V, 500lm



Nr. Unix 363812

cu LED (set) 12/24V, 1300lm



Nr. Unix 11210444

ILUMINARE NUMĂR ÎNMATRICULARE (UNIVERSAL)

12/24 (cu bec)



Nr. Unix 300670

12/24 (cu bec)

Lungime cablu: fără
Nr. Unix 300671

cu LED 12/24V

Lungime cablu: 1m
Nr. Unix 301185

cu LED 12/24V

Lungime cablu: 3,5m
Nr. Unix 301187

12/24 (cu bec)



Nr. Unix 157407

cu LED 12/24V

Lungime cablu: 0,3m
Nr. Unix 157638

cu LED 24V

Lungime cablu: AP 1,5m
Nr. Unix 157593

cu LED 12/24V



Nr. Unix 11255828

12/24 (cu bec)



Nr. Unix 314988

12/24 (cu bec)



Nr. Unix 376087/2

cu LED 10-30V



Nr. Unix 314987

cu LED 24V



Nr. Unix 11129550

LAMPĂ MARȘALIER (UNIVERSALĂ)

Cu bec 12/24V



Nr. Unix 371055/2

cu LED 24V



Nr. Unix 371938

Cu bec 12/24V



Nr. Unix 371052/2

cu LED 12/24V



Nr. Unix 371933

A.L. 
Meisterteile®

Până la infinit...și mai departe!

Acumulatori A.Z. Meisterteile
pentru autoturisme nu lasă pe
nimeni la rece.



The power of quality 

PIESE AUTO®

PIESE AUTO®



PIESE ELECTRIC

PIESE ELECTRICE

RACORD ELECTRIC REMORCĂ

7 POLI



Nr. Unix 157493



Nr. Unix 157421



Nr. Unix 157494



Nr. Unix 157423



Nr. Unix 157418



Nr. Unix 157426



Nr. Unix 157419



Nr. Unix 157427



Nr. Unix 157420



Nr. Unix 157422



Nr. Unix 157415



Nr. Unix 157416



Nr. Unix 157409



Nr. Unix 157415

15 POLI



Nr. Unix 157450



Nr. Unix 157451



Nr. Unix 157515



Nr. Unix 157453

7P-15P (Cablu-Y)



Nr. Unix 157514



Nr. Unix 11002121

ABS/EBS



Nr. Unix 157424



Nr. Unix 157452



Nr. Unix 157454



Nr. Unix 157455



Nr. Unix 157675



Nr. Unix 157483



Nr. Unix 465446



Nr. Unix 157425

CUTIE CONECTARE CABLURI

6 + 2 P6R



Nr. Unix 305137

KÖGEL



Nr. Unix 305181

ASS3 +2xASS2



Nr. Unix 305144

PIESE ELECTRICE

KIT REPARARE CONECTOR ELECTRIC

2 POLI



Nr. Unix 305276



Nr. Unix 305347



Nr. Unix 305343



Nr. Unix 305305



Nr. Unix 305312



Nr. Unix 300029



Nr. Unix 305345



Nr. Unix 305275



Nr. Unix 305348



Nr. Unix 300028



Nr. Unix 305307



Nr. Unix 305316



Nr. Unix 305344



Nr. Unix 305273



Nr. Unix 305329



Nr. Unix 305309



Nr. Unix 305317



Nr. Unix 305318

3 POLI



Nr. Unix 305349



Nr. Unix 305278



Nr. Unix 305323



Nr. Unix 305321



Nr. Unix 305357



Nr. Unix 305355

4 POLI



Nr. Unix 305279



Nr. Unix 305338



Nr. Unix 305341



Nr. Unix 157528



Nr. Unix 157386



Nr. Unix 301482

5 POLI



Nr. Unix 305281



Nr. Unix 305282



Nr. Unix 305292



Nr. Unix 157662



Nr. Unix 157022



Nr. Unix 10047916

6 POLI

CUTIE CONECTARE CABLURI

Conexiune 8/32



Nr. Unix 924035

Conexiune 12/56



Nr. Unix 924036

Conexiune 4/12



Nr. Unix 924037

14 PG



Nr. Unix 305133

Conexiune 16/80



Nr. Unix 157289

12V, cu garnituri



Nr. Unix 11249041

PIESE ELECTRICE

ACUMULATOR (BATERIE)



Capacitate (Ah)	Pornire la rece (A)	Nr. Unix
100	830	11045007



Capacitate (Ah)	Pornire la rece (A)	Nr. Unix
150	950	10838514



Capacitate (Ah)	Pornire la rece (A)	Nr. Unix
180	1050	10583117



Capacitate (Ah)	Pornire la rece (A)	Nr. Unix
225	1150	10583119

PIESE ELECTRICE

ACUMULATOR (BATERIE)



Capacitate (Ah)	Pornire la rece (A)	Nr. Unix
140	800	129463



Capacitate (Ah)	Pornire la rece (A)	Nr. Unix
170	1000	129465



Capacitate (Ah)	Pornire la rece (A)	Nr. Unix
180	1000	129460



Capacitate (Ah)	Pornire la rece (A)	Nr. Unix
225	1150	129461



Capacitate (Ah)	Pornire la rece (A)	Nr. Unix
210	1200	11052923

De ce Fleetguard?



Acoperire produs: peste 8 000 produse de filtrare disponibile care pot acoperi majoritatea aplicațiilor



Fiabilitate: peste 50 de ani de experiență în în producția sistemelor de filtrare în cooperare cu o companie de fabricație motoare



Specificații OEM: toate produsele Fleetguard îndeplinesc sau depășesc specificațiile OEM



Muncă de inginer: resurse vizate și dezvoltare pentru produse de filtrare avansate și inovatoare



Garanție: unic în industrie și nu invalidează garanția OEM

Nu există o
protecție mai
bună decât

Fleetguard®



PIESE UTILAJE AGRICOLE
ȘI DE CONSTRUCȚII

PIESE UTILAJE AGRICOLE ȘI DE CONSTRUCȚII

ILUMINARE

Lampă spate
(MINIPOINT 12V)



Nr Unix. 300388
Nr Unix. 300389
Nr Unix. 300284
(sticlă lampă)

Lampă spate
(MULTIPOINT 12V)



Nr Unix. 300365
Nr Unix. 300470
Nr Unix. 300309
(sticlă lampă)

Lampă spate
(AGRIPOINT 12V)



Nr Unix. 300395
(lungime cablu 0,5m)
Nr Unix. 300396
(conexiune: baionetă 5p)

Lampă spate
(AGRILED)



Nr Unix. 11248759
(stânga/dreapta)
Nr Unix. 11248761

Lampă spate (MULTIPOINT 12V)



Nr Unix. 300506 (stânga)
Nr Unix. 300515 (dreapta)
Nr Unix. 300312 (sticlă lampă)

Lampă spate (AGRILED)



Nr Unix. 11248754
(stânga/dreapta)
Nr Unix. 11248756
(cu iluminare număr de
înmatriculare)

Lampă indicator gabarit
(FLATPOINT)



Nr Unix. 300782 (galben)
Nr Unix. 301043 (alb)

Lampă indicator gabarit
(FLEXIPOINT)



Nr Unix. 300984 (alb)
Nr Unix. 300964 (alb, LED)
Nr Unix. 300987 (galben)
Nr Unix. 11249272
(galben, LED)

Set lămpi (MULTIPOINT)



Nr Unix 11249057

Set lămpi (AGRILED 1)



Nr Unix 11249058

Set lămpi (AGRILED 2)



Nr Unix 11249059

Cablu de legătură



Nr Unix. 301417 (4 m)
Nr Unix. 301419 (7 m)

Adaptor priză remorcă
(7p-13p)



Nr Unix 300069

Adaptor priză remorcă
(13p-7p)



Nr Unix 301385

Adaptor priză remorcă
(7-pin, 12V)



Nr Unix. 300048
Nr Unix. 300049 (aluminiu)

ȘTERGĂTOR PARBRIZ



Lungime (mm):
400
450
500
550
600

Nr Unix
909062
909063
909064
909065
909066

PIESE UTILAJE AGRICOLE ȘI DE CONSTRUCȚII

RĂCIRE

Compresor climă NEW HOLLAND



Nr Unix 11260149

Compresor climă JOHN DEERE



Nr Unix 11260099

Compresor climă JOHN DEERE 2000



Nr Unix 11260315

Compresor climă JOHN DEERE 3400



Nr Unix 11260317

Compresor climă CASE IH Magnum



Nr Unix 11260446

Compresor climă MASSEY FERGUSON



Nr Unix 11260385

Radiator răcire NEW HOLLAND



Nr Unix 11264424

Radiator răcire FENDT



Nr Unix 11263493

Radiator răcire MASSEY FERGUSON



Nr Unix 11264421

Radiator răcire CASE IH



Nr Unix 11264423

Radiator răcire JOHN DEERE



Nr Unix 11264708

Radiator răcire JOHN DEERE



Nr Unix 11263563

Viscocuplaj ventilator răcire
(CASE IH, NEW HOLLAND)



Nr Unix 11394844

Viscocuplaj ventilator răcire
(CASE IH, NEW HOLLAND)



Nr Unix 11394845

Viscocuplaj ventilator răcire
(JOHN DEERE)



Nr Unix 11263201

PIESE UTILAJE AGRICOLE ȘI DE CONSTRUCȚII

FENDT

Filtru polen



Nr Unix. 11189505

Filtru polen



Nr Unix. 11189528

Filtru polen

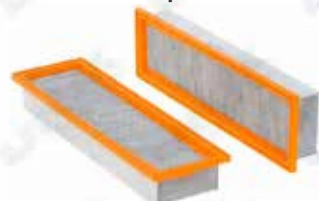

Nr Unix. 11200358

Filtru aerisire rezervor
hidraulic

Nr Unix. 11187164

Filtru hidraulic (cutie viteze)



Nr Unix. 11187349

Filtru combustibil



Nr Unix. 11190855

Filtru combustibil



Nr Unix. 11190793

Filtru hidraulic



Nr Unix. 11187407

Filtru aer



Nr Unix. 11186441

Filtru aer



Nr Unix. 11186770

Filtru aer (interior)



Nr Unix. 10365254

Filtru ulei



Nr Unix. 11187148

MASSEY FERGUSON

Rotor centrifugal filtru ulei



Nr Unix. 11189371

Filtru polen



Nr Unix. 11189618

Filtru ulei



Nr Unix. 11189073

Filtru ulei



Nr Unix. 11189148

Filtru ulei



Nr Unix. 11189087

Filtru ulei



Nr Unix. 10189218

Filtru combustibil



Nr Unix. 11190950

Filtru combustibil



Nr Unix. 10444607

Filtru combustibil



Nr Unix. 11190745

Filtru combustibil



Nr Unix. 11190811

Filtru aer



Nr Unix. 11186696

Filtru aer



Nr Unix. 11186640

PIESE UTILAJE AGRICOLE ȘI DE CONSTRUCȚII

JOHN DEERE

Filtru combustibil

6000
Nr Unix 11190569

Filtru combustibil

6320/6420
Nr Unix 11190796

Filtru combustibil

WTS
Nr Unix 11190807

Filtru combustibil

8000/9000
Nr Unix 11190759

Filtru combustibil

6030/7030
Nr Unix 344560/1

Filtru combustibil

3000/5000/6000/z2000
Nr Unix 11190753

Filtru combustibil

8000/STS/CTS
Nr Unix 11190690

Filtru combustibil

2000/WTS
Nr Unix 11190922

Filtru ulei



Nr Unix. 11187640

Filtru ulei



Nr Unix. 11188409

Filtru ulei



Nr Unix. 11187210

Filtru ulei

8020
Nr Unix 11189047

Filtru ulei

6000/WTS/CWS
Nr Unix 11189045

Filtru ulei



Nr Unix. 11189033

Filtru ulei



Nr Unix. 11189278

Filtru ulei



Nr Unix. 11189136

Filtru aer (exterior)

3400
Nr Unix 11186770

Filtru aer (interior)

3400
Nr Unix 11186771

Filtru aer



Nr Unix. 11186421

Filtru aer



Nr Unix. 11186411

Filtru aer

7000
Nr Unix 10429160

Filtru aer

7000
Nr Unix 10429155

Filtru aer



Nr Unix. 11186010

Filtru aer



Nr Unix. 11186397

A.L. 
Meisterteile®

Nu ne oprim privind calitatea!

Soluție de curățat frâna
A.Z. Meistererteile cu
cap de pulverizare special.

Supapa și capul
de pulverizare special
permit o pulverizare
la presiune mare.



The power of quality 

UNIX
PIESE AUTO

UNIX
PIESE AUTO

LUBRIFIANȚI - LICHIDE

LUBRIFIANT

ULEI MOTOR

Nr Unix®	Ambalare [l]	Viscozitate	Clasificare
10928939	10	20W-50	API SF/CF
10928940	55	20W-50	API SF/CF
10928941	200	20W-50	API SF/CF
10928948	10	15W-40	ACEA E7, ACEA E9, API CI-4, CATERPILLAR ECF-3, MAN 3275, MERCEDES 228.31, RENAULT RLD-3, VOLVO VDS-4
10928949	56	15W-40	ACEA E7, ACEA E9, API CI-4, CATERPILLAR ECF-3, MAN 3275, MERCEDES 228.31, RENAULT RLD-3, VOLVO VDS-4
10928950	200	15W-40	ACEA E7, ACEA E9, API CI-4, CATERPILLAR ECF-3, MAN 3275, MERCEDES 228.31, RENAULT RLD-3, VOLVO VDS-4
10928909	10	15W-40	ACEA E7, API CI-4, GLOStanga DHD-1, CATERPILLAR ECF-2, DEUTZ DQC III-10, MAN 3275, RENAULT RLD-2, VOLVO VDS-3
10928910	56	15W-40	ACEA E7, API CI-4, GLOStanga DHD-1, CATERPILLAR ECF-2, DEUTZ DQC III-10, MAN 3275, RENAULT RLD-2, VOLVO VDS-3
10928911	200	15W-40	ACEA E7, API CI-4, GLOStanga DHD-1, CATERPILLAR ECF-2, DEUTZ DQC III-10, MAN 3275, RENAULT RLD-2, VOLVO VDS-3
10928935	57	15W-40	ACEA E9, API CI-4, API CJ-4, GLOStanga DH-2, ALLISON C-4, CATERPILLAR ECF-2, CUMMINS CES 20077, CUMMINS CES 20078, CUMMINS CES 20081, DDC 93K218, DEUTZ DQC III-10LA, MAN 3275, MERCEDES 228.31, RENAULT RLD-2, SCANIA Low Ash, VOLVO VDS-4
10928906	10	15W-40	API SF/CD
10928907	56	15W-40	API SF/CD
10928908	200	15W-40	API SF/CD
10928912	10	10W-40	ACEA E4, ACEA E6, ACEA E7, DEUTZ DQC III-10, MAN 3477, RENAULT RLD-2, VOLVO VDS-3
10928913	54	10W-40	ACEA E4, ACEA E6, ACEA E7, DEUTZ DQC III-10, MAN 3477, RENAULT RLD-2, VOLVO VDS-3
10928914	197	10W-40	ACEA E4, ACEA E6, ACEA E7, DEUTZ DQC III-10, MAN 3477, RENAULT RLD-2, VOLVO VDS-3
10928945	10	10W-40	ACEA E7, API CI-4, CUMMINS CES 20078, Mack EO-N, MAN 3277, RENAULT RLD-2, VOLVO VDS-3
10928946	57	10W-40	ACEA E7, API CI-4, CUMMINS CES 20078, Mack EO-N, MAN 3277, RENAULT RLD-2, VOLVO VDS-3
10583054	195	10W-40	ACEA E7, API CI-4, CUMMINS CES 20078, Mack EO-N, MAN 3277, RENAULT RLD-2, VOLVO VDS-3
10928900	10	10W-40	ACEA E7, API CI-4, GLOStanga DH-1, GLOStanga DHD-1, CUMMINS CES 20078, MAN 3275, RENAULT RLD-2, VOLVO VDS-3
10928901	57	10W-40	ACEA E7, API CI-4, GLOStanga DH-1, GLOStanga DHD-1, CUMMINS CES 20078, MAN 3275, RENAULT RLD-2, VOLVO VDS-3
10928902	205	10W-40	ACEA E7, API CI-4, GLOStanga DH-1, GLOStanga DHD-1, CUMMINS CES 20078, MAN 3275, RENAULT RLD-2, VOLVO VDS-3
10928942	10	10W-40	ACEA E9, API CI-4, API CJ-4/SM, API CK-4, API SN, CUMMINS CES 20.081, CUMMINS CES 20.086, DDC 93K218, DFS 93K222, FORD WSS-M2C171-F1, MACK EO-S 4.5, MAN M 3575, RENAULT RLD-3/RLD-4, VOLVO VDS-4, VOLVO VDS-4.5
10583052	55	10W-40	ACEA E9, API CI-4, API CJ-4/SM, API CK-4, API SN, CUMMINS CES 20.081, CUMMINS CES 20.086, DDC 93K218, DFS 93K222, FORD WSS-M2C171-F1, MACK EO-S 4.5, MAN M 3575, RENAULT RLD-3/RLD-4, VOLVO VDS-4, VOLVO VDS-4.5
10583053	198	10W-40	ACEA E9, API CI-4, API CJ-4/SM, API CK-4, API SN, CUMMINS CES 20.081, CUMMINS CES 20.086, DDC 93K218, DFS 93K222, FORD WSS-M2C171-F1, MACK EO-S 4.5, MAN M 3575, RENAULT RLD-3/RLD-4, VOLVO VDS-4, VOLVO VDS-4.5
10583265	10	5W-30	ACEA E6, ACEA E7, ACEA E9, API CK-4, JASO DH-2, CATERPILLAR ECF-3, CUMMINS CES 20086, DDC 93K222, DEUTZ DQC IV-10LA, MAN 3677, MAN 3777, MTU Type 3.1, RENAULT RLD-3, RENAULT RLD-4, SCANIA Low Ash, VOLVO VDS-4
10583266	55	5W-30	ACEA E6, ACEA E7, ACEA E9, API CK-4, JASO DH-2, CATERPILLAR ECF-3, CUMMINS CES 20086, DDC 93K222, DEUTZ DQC IV-10LA, MAN 3677, MAN 3777, MTU Type 3.1, RENAULT RLD-3, RENAULT RLD-4, SCANIA Low Ash, VOLVO VDS-4
10583267	198	5W-30	ACEA E6, ACEA E7, ACEA E9, API CK-4, JASO DH-2, CATERPILLAR ECF-3, CUMMINS CES 20086, DDC 93K222, DEUTZ DQC IV-10LA, MAN 3677, MAN 3777, MTU Type 3.1, RENAULT RLD-3, RENAULT RLD-4, SCANIA Low Ash, VOLVO VDS-4



LUBRIFIANT

ULEI PT. UTILAJE AGRICOLE

Nr Unix®	Ambalare [l]	Viscozitate	Clasificare
10928958	10	10W-40	ACEA E3, API CG-4, API GL-4, HLP, ALLISON C-4, CATERPILLAR TO-2, EATON (VICKERS) I-280-S, Eaton (Vickers) M-2950-S, Ford New Holland ESN M2C 159-B, Ford New Holland ESN M2C 159-C, John Deere JDM J-20C, John Deere JDM J27, Massey-Ferguson M1139, Massey-Ferguson M1143, Massey-Ferguson M1144, Massey-Ferguson M1145, ZF TE-ML 06B, ZF TE-ML 06C, ZF TE-ML 07B
10928959	57	10W-40	ACEA E3, API CG-4, API GL-4, HLP, ALLISON C-4, CATERPILLAR TO-2, EATON (VICKERS) I-280-S, Eaton (Vickers) M-2950-S, Ford New Holland ESN M2C 159-B, Ford New Holland ESN M2C 159-C, John Deere JDM J-20C, John Deere JDM J27, Massey-Ferguson M1139, Massey-Ferguson M1143, Massey-Ferguson M1144, Massey-Ferguson M1145, ZF TE-ML 06B, ZF TE-ML 06C, ZF TE-ML 07B
10583055	195	10W-40	ACEA E3, API CG-4, API GL-4, HLP, ALLISON C-4, CATERPILLAR TO-2, EATON (VICKERS) I-280-S, Eaton (Vickers) M-2950-S, Ford New Holland ESN M2C 159-B, Ford New Holland ESN M2C 159-C, John Deere JDM J-20C, John Deere JDM J27, Massey-Ferguson M1139, Massey-Ferguson M1143, Massey-Ferguson M1144, Massey-Ferguson M1145, ZF TE-ML 06B, ZF TE-ML 06C, ZF TE-ML 07B
10583072	10	80W	API GL-4, ALLISON C-4, Case New Holland MAT 3525, CATERPILLAR TO-2, Deutz-Allis PF821, Eaton (Vickers) M-2950-S, EATON (VICKERS) I-280-S, Ford ESN-M2C134-D, Ford ESN-M2C86-C, Ford New Holland FNHA-2-C-201.00, JI Case MS 1204, JI CASE MS 1207, JI CASE MS 1209, John Deere JDM J-20C, Kubota UDT Fluid, Massey-Ferguson M1127B, Massey-Ferguson M1135, Massey-Ferguson M1143, Massey-Ferguson M1145, NH 410B, Valtra G2-08, Volvo WB101, ZETOR
10583073	57	80W	API GL-4, ALLISON C-4, Case New Holland MAT 3525, CATERPILLAR TO-2, Deutz-Allis PF821, Eaton (Vickers) M-2950-S, EATON (VICKERS) I-280-S, Ford ESN-M2C134-D, Ford ESN-M2C86-C, Ford New Holland FNHA-2-C-201.00, JI Case MS 1204, JI CASE MS 1207, JI CASE MS 1209, John Deere JDM J-20C, Kubota UDT Fluid, Massey-Ferguson M1127B, Massey-Ferguson M1135, Massey-Ferguson M1143, Massey-Ferguson M1145, NH 410B, Valtra G2-08, Volvo WB101, ZETOR
10583074	205	80W	API GL-4, ALLISON C-4, Case New Holland MAT 3525, CATERPILLAR TO-2, Deutz-Allis PF821, Eaton (Vickers) M-2950-S, EATON (VICKERS) I-280-S, Ford ESN-M2C134-D, Ford ESN-M2C86-C, Ford New Holland FNHA-2-C-201.00, JI Case MS 1204, JI CASE MS 1207, JI CASE MS 1209, John Deere JDM J-20C, Kubota UDT Fluid, Massey-Ferguson M1127B, Massey-Ferguson M1135, Massey-Ferguson M1143, Massey-Ferguson M1145, NH 410B, Valtra G2-08, Volvo WB101, ZETOR
10583015	10	80W	API GL-4, HLP, HVLP, JI Case MS 1204, Deutz-Allis PF821, EATON (VICKERS) I-280-S, Eaton (Vickers) M-2950-S, Ford New Holland ESN-M2C 86-B, John Deere JDM J-20A, John Deere JDM J-20C, Massey-Ferguson M1127B, Massey-Ferguson M1129A, Massey-Ferguson M1141, Volvo WB101
10583016	56	80W	API GL-4, HLP, HVLP, JI Case MS 1204, Deutz-Allis PF821, EATON (VICKERS) I-280-S, Eaton (Vickers) M-2950-S, Ford New Holland ESN-M2C 86-B, John Deere JDM J-20A, John Deere JDM J-20C, Massey-Ferguson M1127B, Massey-Ferguson M1129A, Massey-Ferguson M1141, Volvo WB101
10583017	200	80W	API GL-4, HLP, HVLP, JI Case MS 1204, Deutz-Allis PF821, EATON (VICKERS) I-280-S, Eaton (Vickers) M-2950-S, Ford New Holland ESN-M2C 86-B, John Deere JDM J-20A, John Deere JDM J-20C, Massey-Ferguson M1127B, Massey-Ferguson M1129A, Massey-Ferguson M1141, Volvo WB101



LUBRIFIANT

ULEI HIDRAULIC

Nr Unix®	Ambalare [l]	Nivel de putere	Clasificare
10583028	200	HLP 32	DIN 51 524-3 (HVLP), ISO 11158 HV, ISO VG 32, Bosch Rexroth RE 90220, Bosch Rexroth RE 07075, Denison HF0/HF-1/HF-2, ZF TE-ML 21M
10928953	10	HVLP 32	DIN 51 524-3 (HVLP), ISO 11158 HV, ISO VG 32, Bosch Rexroth RE 90220, Bosch Rexroth RE 07075, Denison HF0/HF-1/HF-2, ZF TE-ML 21M
10583056	55	HVLP 32	DIN 51 524-3 (HVLP), ISO 11158 HV, ISO VG 32, Bosch Rexroth RE 90220, Bosch Rexroth RE 07075, Denison HF0/HF-1/HF-2, ZF TE-ML 21M
10583057	197	HVLP 32	DIN 51 524-3 (HVLP), ISO 11158 HV, ISO VG 32, Bosch Rexroth RE 90220, Bosch Rexroth RE 07075, Denison HF0/HF-1/HF-2, ZF TE-ML 21M
10583030	10	HLP 46	DIN 51 524-2 (HLP), ISO 11158 HM, ISO VG 46, ZF TE-ML 21M
10583031	56	HLP 46	DIN 51 524-2 (HLP), ISO 11158 HM, ISO VG 46, ZF TE-ML 21M
10583032	200	HLP 46	DIN 51 524-2 (HLP), ISO 11158 HM, ISO VG 46, ZF TE-ML 21M
10583024	10	HVLP 46	DIN 51 524-3 (HVLP), ISO 11158 HV, ISO VG 46, Bosch Rexroth RE 90220, ZF TE-ML 21M
10928952	57	HVLP 46	DIN 51 524-3 (HVLP), ISO 11158 HV, ISO VG 46, Bosch Rexroth RE 90220, ZF TE-ML 21M
10583058	197	HVLP 46	DIN 51 524-3 (HVLP), ISO 11158 HV, ISO VG 46, Bosch Rexroth RE 90220, ZF TE-ML 21M
10583026	10	HLP 68	DIN 51 524-2 (HLP), ISO 11158 HM, ISO VG 68, ZF TE-ML 21M
10583027	56	HLP 68	DIN 51 524-2 (HLP), ISO 11158 HM, ISO VG 68, ZF TE-ML 21M



ULEI TRANSMISIE

Nr Unix®	Ambalare [l]	Viscozitate	Aprobare
10583063	1	75W-80	API GL-4; MAN 341 TYP Z4, VOLVO 97305, ZF O2L, ZF 16K
10583064	10	75W-80	API GL-4; MAN 341 TYP Z4, VOLVO 97305, ZF O2L, ZF 16K



LUBRIFIANT

VASELINĂ

Nr Unix®	Ambalare [kg]	Aprobare, descriere
10583300	5	MT-00, gresor central NLGI 00
10583302	0,4	EP2, vaselină pe bază de litiu, NLGI 2
10583303	5	EP2, vaselină pe bază de litiu, NLGI 2
10583304	50	EP2, vaselină pe bază de litiu, NLGI 2
10583315	0,4	K2K vaselină pe bază de litiu, NLGI 2, DIN 51502, K2K-25, ISO 6743-9, L-XBCEA 2
10583316	5	K2K vaselină pe bază de litiu, NLGI 2, DIN 51502, K2K-25, ISO 6743-9, L-XBCEA 2
10583317	50	K2K vaselină pe bază de litiu, NLGI 2, DIN 51502, K2K-25, ISO 6743-9, L-XBCEA 2
10583312	0,4	LIX Blue vaselină cu uz general și viață lungă, complex de litiu; NLGI 2, DIN 51502, KP2N-30, ISO 6743-9, L-XCDEB 2
10583313	5	LIX Blue vaselină cu uz general și viață lungă, complex de litiu; NLGI 2, DIN 51502, KP2N-30, ISO 6743-9, L-XCDEB 2
10583314	50	LIX Blue vaselină cu uz general și viață lungă, complex de litiu; NLGI 2, DIN 51502, KP2N-30, ISO 6743-9, L-XCDEB 2
10583301	50	Schmierfett LiCa00, gresor central NLGI 00
10583075	0,4	Schmierfett Graphit vaselină cu grafit, NLGI: NLGI 2, DIN 51502: KPF2K-20, ISO 6743-9: L-XBCEB 2
10583076	5	Schmierfett Graphit vaselină cu grafit, NLGI: NLGI 2, DIN 51502: KPF2K-20, ISO 6743-9: L-XBCEB 2
10583077	50	Schmierfett Graphit vaselină cu grafit, NLGI: NLGI 2, DIN 51502: KPF2K-20, ISO 6743-9: L-XBCEB 2



ANTIGEL

ANTIGEL



Nr Unix®	Marca	Cod OE	Ambalare [kg]	Temperatură îngheț [°C]
71667	UNIX	ALU G11 -70C 1kg	1	-70
71668	UNIX	ALU G11 -70C 5kg	5	-70
71921	UNIX	ALU G11 -70C 60kg	60	-70
71922	UNIX	ALU G11 -70C 220kg	220	-70
71648	UNIX	ALU G12 -70C 1kg	1	-70
71649	UNIX	ALU G12 -70C 5kg	5	-70
71923	UNIX	ALU G12 -70C 60kg	60	-70
71924	UNIX	ALU G12 -70C 220kg	220	-70
71647	UNIX	ALU G12 -72C 1kg	1	-72
71925	UNIX	ALU G12 -72C 60kg	60	-72
71926	UNIX	ALU G12 -72C 220kg	220	-72



Nr Unix®	Cod OE	Ambalare [l]	Temperatură îngheț [°C]
11195253	KFS 11-35 1L	1	-35
11195254	KFS 11-35 4L	4	-35
11298053	KFS 12-35 1L	1	-35
11298054	KFS 12-35 4L	4	-72
11195251	KFS 11-72 1L	1	-72
11195252	KFS 11-72 4L	4	-72
11298049	KFS 12-72 1L	1	-72
11298050	KFS 12-72 4L	4	-72
11298051	KFS 12-72 65kg	58	-72
11298052	KFS 12-72 220kg	197	-72



APĂ DISTILATĂ (APĂ PENTRU ACUMULATOR)



Nr Unix®	Marca	Ambalare [l]
680562	UNIX	2
680563	UNIX	5
71927	UNIX	10
71968	UNIX	20
71969	UNIX	60

SOLUȚII DE CURĂȚARE

LICHID SPĂLAT PARBRIZ DE VARĂ

Nr Unix®	Marca	Ambalare [l]	Parfum
10985193	A.Z. Meisterteile	4	Coacăze
10985197	A.Z. Meisterteile	4	Lămâie
10985195	A.Z. Meisterteile	4	Exotic
10985199	A.Z. Meisterteile	4	Portocală

LICHID SPĂLAT PARBRIZ DE IARNĂ

Nr Unix®	Marca	Ambalare [l]	Parfum	Temperatură îngheț [°C]
10986956	A.Z. Meisterteile	4	Coacăze	-23
10986960	A.Z. Meisterteile	4	Lămâie	-23
10986958	A.Z. Meisterteile	4	Exotic	-23
10986962	A.Z. Meisterteile	4	Portocală	-23



LICHID SPĂLAT PARBRIZ DE VARĂ

Nr Unix®	Marca	Ambalare [l]	Parfum
71690	UNIX	2	Lămâie
71691	UNIX	5	Lămâie
11034504	UNIX	10	Lămâie
11034505	UNIX	20	Lămâie
11034506	UNIX	60	Lămâie

LICHID SPĂLAT PARBRIZ DE IARNĂ

Nr Unix®	Marca	Ambalare [l]	Parfum	Temperatură îngheț [°C]
71695	UNIX	2	Lămâie	-20
71696	UNIX	5	Lămâie	-20
71970	UNIX	10	Lămâie	-20
71964	UNIX	20	Lămâie	-20
71965	UNIX	60	Lămâie	-20
71697	UNIX	2	Lămâie	-20
71657	UNIX	5	Lămâie	-20
71971	UNIX	10	Lămâie	-20
71966	UNIX	20	Lămâie	-20
71967	UNIX	60	Lămâie	-20



ADITIV ADBLUE

Nr Unix®	Marca	Ambalare [l]
11027180	A.Z. Meisterteile	10
11027181	A.Z. Meisterteile	20
11027182	A.Z. Meisterteile	200



A.Z. 
Meisterteile®

UNIX
PIESE AUTO®



**Cu scaunul și patul pentru
mecanici A.Z. Meister
reparațiile merg ca unse cu ulei!**

The power of quality 

UNIX
PIESE AUTO®

ECHIPAMENTE



ECHIPAMENTE

MASĂ BORD



Aplicații	Nr. Unix
DAF XF106	580634
IVECO Stralis	580637
MAN TGX	580640
MERCEDES Actros MP4	580642
MERCEDES Actros MP4	580643
RENAULT T	580647
SCANIA R	580652
VOLVO FH serie 3	580655
VOLVO FH serie 4	580656

PERDEA CABINĂ



Specificații	Nr. Unix
Albastru	581806
Gri	581807
Negru	581808
Roșu	581809
Bej	581810
Crem	581612

PERDEA CABINĂ + HUSĂ SCAUN



Specificații	Nr. Unix
Albastru	581817
Gri	581818
Negru	581819
Bej	581820

HUSĂ PROTECȚIE VOLAN Club Premium



Dimensiuni	Nr. Unix
S 42/44 cm	582133
M 44/46 cm	582134
L 46/48 cm	582135
XL 49/51 cm	582136

HUSĂ PROTECȚIE VOLAN Club Premium



Dimensiuni	Nr. Unix
S 42/44 cm	581976
M 44/46 cm	581977
L 46/48 cm	581978
XL 49/51 cm	581979

HUSĂ PROTECȚIE VOLAN Club Premium



Dimensiuni	Nr. Unix
S 42/44 cm	582141
M 44/46 cm	582142
L 46/48 cm	582143
XL 49/51 cm	582144

HUSĂ PROTECȚIE VOLAN Radica



Dimensiuni	Nr. Unix
M 44/46 cm	581892
L 46/48 cm	581893

HUSĂ PROTECȚIE VOLAN Crome Strip



Dimensiuni	Nr. Unix
M 44/46 cm	582150

HUSĂ PROTECȚIE VOLAN Club Premium Classic



Dimensiuni	Nr. Unix
S 42/44 cm	582129
M 44/46 cm	582130
L 46/48 cm	582131
XL 49/51 cm	582132

HUSĂ PROTECȚIE VOLAN PREMIUM 44-46 cm



Culoare șnur	Dimensiuni	Nr. Unix
Negru	44-46 cm	581980

ASPIRATOR DE MÂNĂ



Specificații	Nr. Unix
24V, 160W cu conector brichetă	580184

YALĂ UȘĂ SUPLIMENTARĂ (parbriz)



Aplicații	Nr. Unix
DAF XF105, XF106	581623
IVECO Eurocargo, Stralis	581622
MAN TGX	581597
MERCEDES Actros MP4	581596
RENAULT T	581598
SCANIA R Seria 5-6	581628
SCANIA R Seria 7	581595
VOLVO FH, FM	581627

ECHIPAMENTE

TRANSFORMATOR DE TENSIUNE

24V/DC - 220V/AC, 500/1000W



Nr. Unix 581721

BUTON PRINCIPAL

12-50V (max. 200A)



Nr. Unix 578839

CHEIE ROATĂ

Model multiplicator cuplu 1:58,
32-33 mm

Nr. Unix 581670

CLAXON

Claxon electric/aer, două tonuri,
24V, 15A

Nr. Unix 581826

Claxon aer, două tonuri,
24V, 5A, 125dB

Nr. Unix 581827

12V, 30, 118 dB



Nr. Unix 579041

BUTON VOLAN



Nr. Unix 576765



Nr. Unix 576767



Nr. Unix 581792



Nr. Unix 576766

SOLUȚIE REPARAT PRELATĂ



Specificații	Nr. Unix
Alb (4 db)	581852
Negru (4 db)	581853
Albastru (4 db)	581854

BRIDĂ FIXARE PRELATĂ



Specificații	Nr. Unix
2db/set	11077561
2db/set	11077562
capacitate încărcare: 200kg	11077563

BOWDEN ÎNCHIDERE SECURIZARE VAMĂ



Specificații	Nr. Unix
24 m	11077564
34 m	11077565
37 m	581599

SISTEM ANTIFURT REMORCĂ



Specificații	Nr. Unix
Diametru pivot principal: 74 mm	581838

ELEMENT TENSIONARE PRELATĂ



Specificații	Nr. Unix
290x50 mm	11111305

ELEMENT TENSIONARE PRELATĂ



Specificații	Nr. Unix
370x30 mm	11111306

ECHIPAMENTE

BENZI REFLECTORIZANTE - PLĂCUȚE AVERTIZARE

Bandă reflectorizantă
(565x130 mm)

Nr. Unix 11002012

Bandă reflectorizantă
(565x192 mm)

Nr. Unix 11002013

Tablă atenționare aluminiu
(565x135mm)

Nr. Unix 157495

Tablă atenționare aluminiu
(565x195mm)

Nr. Unix 11002021

Bandă reflectorizantă (50mx50,8mm)

Roșu Nr. Unix 157566
Alb Nr. Unix 157567
Galben Nr. Unix 157565

Bandă reflectorizantă (100x5cm)

Roșu Nr. Unix 582116
Alb Nr. Unix 582118
Galben Nr. Unix 582117

Bandă reflectorizantă (roată)

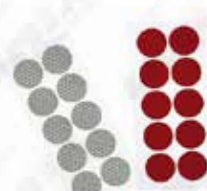
Alb Nr. Unix 581681
Roșu Nr. Unix 581682Tablă atenționare cu senzor punct
mort

Nr. Unix 11103683

Tablă atenționare cu senzor punct
mort (AUTOBUZ)

Nr. Unix 11103684

Tablă atenționare pentru vehicule cu
rampă încărcare 250x400mm

Nr. Unix 10167820

Tablă ADR pliabilă 400x300



Nr. Unix 10927843

Tablă atenționare din oțel
423x423mm

Nr. Unix 10927856

Tablă atenționare cu balama pliabilă
400x250mm

Nr. Unix 10995337

Etichetă atenționare viteză



Nr. Unix 10927873

Etichetă atenționare viteză



Nr. Unix 10927875

Etichetă atenționare viteză



Nr. Unix 581762

Etichetă atenționare viteză



Nr. Unix 581763

Etichetă atenționare viteză



Nr. Unix 581764

Etichetă atenționare viteză



Nr. Unix 581765

Etichetă atenționare viteză



Nr. Unix 581766

CHINGĂ FIXARE ÎNCĂRCĂTURĂ

ECLISĂ FIXARE ÎNCĂRCĂTURĂ (CHINGĂ)

0,5 t

NrUnix®	Forță de strângere	Execuție	Lățime (mm)	Lungime totală(m)
11051052	500 daN	dintr-o bucată	25mm	4m
11051053	500 daN	dintr-o bucată	25mm	6m
11051054	500 daN	din două piese	25mm	4m
11051055	500 daN	din două piese	25mm	6m

Dintr-o bucată



1 t

NrUnix®	Forță de strângere	Execuție	Lățime (mm)	Lungime totală(m)
11051056	1000 daN	dintr-o bucată	25mm	4m
11051057	1000 daN	dintr-o bucată	25mm	6m
11051058	1000 daN	din două piese	25mm	4m
11051059	1000 daN	din două piese	25mm	6m

Din două piese



2 t

NrUnix®	Forță de strângere	Execuție	Lățime (mm)	Lungime totală(m)
11051060	2000 daN	din două piese	35mm	4m
11051061	2000 daN	din două piese	35mm	6m

5 t

NrUnix®	Forță de strângere	Execuție	Lățime (mm)	Lungime totală(m)
11051062	5000 daN	din două piese	50mm	8m
11051063	5000 daN	din două piese	50mm	10m
11051064	5000 daN	din două piese	50mm	12m

ERGO (întărit)

5 t
ERGO

NrUnix®	Forță de strângere	Execuție	Lățime (mm)	Lungime totală(m)
11051065	5000 daN	din două piese	50mm	6m
11051066	5000 daN	din două piese	50mm	8m
11051067	5000 daN	din două piese	50mm	10m
11051068	5000 daN	din două piese	50mm	12m



5 t

NrUnix®	Forță de strângere	Execuție	Lățime (mm)	Lungime totală(m)
11051071	5000 daN	din două piese	50mm	16m

COLȚAR PROTECȚIE ÎNCĂRCĂTURĂ

NrUnix®	Lățime (mm)	Material	Ambalare
11051666	134 mm	plastic	5buc/pachet
11051667	132 mm	plastic	5buc/pachet
11051668	132 mm	plastic	5buc/pachet
11051669	137 mm	plastic	5buc/pachet
11051670	290 mm	plastic	5buc/pachet
11051671	590 mm	plastic	5buc/pachet
11051672	880 mm	plastic	5buc/pachet
11051673	1180 mm	plastic	5buc/pachet
11051674	158 mm	oțel	5buc/pachet



GRINDĂ FIXARE ÎNCĂRCĂTURĂ

Lungime: 1880-2852 mm, sarcină maximă: 230kg



Nr. Unix 1111300

Lungime: 2350-2720 mm, sarcină maximă: 180kg



Nr. Unix 1111299

ROLE CULISAR PRELATĂ

SCHMITZ/TSE 30x9,5x18



Nr. Unix 11054286

SCHMITZ 608-ST 26x9x17



Nr. Unix 11054294

UNIVERSAL 24x7x16



Nr. Unix 11054304

UNIVERSAL 24x7x21,5



Nr. Unix 11054312

SCHMITZ/TSE 30x9,5x17,75

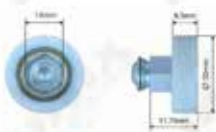

Nr. Unix 11054287

UNIVERSAL 24x7x30



Nr. Unix 11054295

KÖGEL 24x8,9x17,5



Nr. Unix 11054305

UNIVERSAL 24x7x17,5



Nr. Unix 11054313

EDSCHA 609-E 24x7x9



Nr. Unix 11054288

SESAM 609-S 24x7x22,5



Nr. Unix 11054296

VERSUS 24x8,9x14,5



Nr. Unix 11054306

UNIVERSAL 24x14x27



Nr. Unix 11054314

TSE 609-ELP 24x7x15,3



Nr. Unix 11054289

KÖGEL 628-B 24x8x20



Nr. Unix 11054297

KÖGEL 24x7x14



Nr. Unix 11054307

SAMRO 30,5x10x14,7



Nr. Unix 11054315

KÖGEL 629-K 26x8x18



Nr. Unix 11054290

KÖGEL 629-B 26x8x20



Nr. Unix 11054298

KÖGEL 24x7x15,5



Nr. Unix 11054308

UNIVERSAL 24x7x16



Nr. Unix 11054316

CSMAX 609 24x7x22,5



Nr. Unix 11054291

VERSUS 26x9x17



Nr. Unix 11054301

VERSUS 24x8,9x20



Nr. Unix 11054309

VERSUS 26x8x17,5



Nr. Unix 11054317

SESAM 24x14x35



Nr. Unix 11054292

UNIVERSAL 24x7x16



Nr. Unix 11054302

VERSUS 26x9x17,3



Nr. Unix 11054310

KÖGEL 24x7x18



Nr. Unix 11054318

KÖGEL 628-K 24x8x15



Nr. Unix 11054293

VERSUS 26x9x17,5



Nr. Unix 11054303

VERSUS 24x8,9x28



Nr. Unix 11054311

SAMRO 30,5x10x23,5



Nr. Unix 11054319

UNIVERSAL 38x28x62



Nr. Unix 11054354

UNIVERSAL 31,5x17x66



Nr. Unix 11054355

EDSCHA 31,5x12



Nr. Unix 11054342

UNIVERSAL 20x7x24



Nr. Unix 11054373

ROLE CULISARE PRELATĂ

SAMRO 30x9,5x17,3



Nr. Unix 11054320

SCHMITZ 30,5x27x110,2



Nr. Unix 11054328

UNIVERSAL 19x17x70

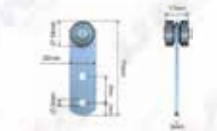

Nr. Unix 11054336

FRUEHAUF 43x34x125,5

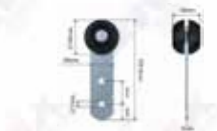

Nr. Unix 11054345

UNIVERSAL 26x9x17,3



Nr. Unix 11054321

SCHMITZ 37,5x29,5x62



Nr. Unix 11054329

UNIVERSAL 22x21x72,5



Nr. Unix 11054337

KÖGEL 31,5x17x75



Nr. Unix 11054346

SCHMITZ 24x7x27



Nr. Unix 11054322

EDSCHA 35,2x29x127



Nr. Unix 11054330

UNIVERSAL 22x21x78



Nr. Unix 11054338

SCHMITZ 30,5x27x96



Nr. Unix 11054347

UNIVERSAL 26x8x17,5



Nr. Unix 11054323

SESAM 24x21x121



Nr. Unix 11054331

EDSCHA 35,2x29x124,5

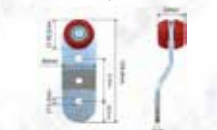

Nr. Unix 11054339

KÖGEL 22x21,5x175



Nr. Unix 11054348

UNIVERSAL 24x7x19,5



Nr. Unix 11054324

EDSCHA 35,2x29x104,7

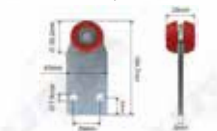

Nr. Unix 11054332

EDSCHA 35,2x29x82,3

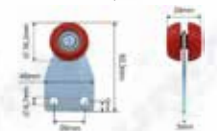

Nr. Unix 11054340

KÖGEL/HESTAL 35,2x30x96,5



Nr. Unix 11054350

UNIVERSAL 24x7x20,5



Nr. Unix 11054325

SCHMITZ 35,2x29x61



Nr. Unix 11054333

EDSCHA 31,5x17x75



Nr. Unix 11054341

HESTAL 24x21,5x97



Nr. Unix 11054351

SCHMITZ 37,5x29x128

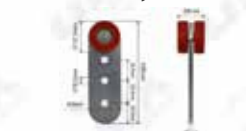

Nr. Unix 11054326

EDSCHA 35,2x29x81,5

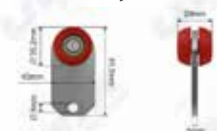

Nr. Unix 11054334

UNIVERSAL 38x38x120,5



Nr. Unix 11054343

UNIVERSAL 38x28x103,5

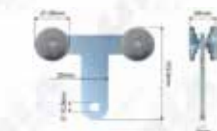

Nr. Unix 11054352

KRONE/EDSCHA 24x21,5x96,5



Nr. Unix 11054327

SCHMITZ 30,5x26x160



Nr. Unix 11054335

SCHMITZ 31x25x66



Nr. Unix 11054344

UNIVERSAL 31x23,8x115,7



Nr. Unix 11054353

SCHMITZ 85x50x230



Nr. Unix 11054357

EDSCHA 84x50x275



Nr. Unix 11054358

VERSUS 80x52x288



Nr. Unix 11054371

PWP 27 adapter 27x25x51,5



Nr. Unix 11054372

SPRAY

Spray A.Z.Meisterteile

Soluție antifonare cu bitom



Cantitate 1000 ml
Nr Unix. 11200532

Soluție antifonare cu bitom



Cantitate 500 ml
Nr Unix. 11200531

Soluție protecție cabluri
împotriva rozătoarelor



Cantitate 400 ml
Nr Unix. 11200537

Șampon auto



Cantitate 1 l
Nr Unix. 11200533

Zinc spray



Cantitate 400 ml
Nr Unix. 11200534

Vopsea termorezistentă
RAL 9004



Cantitate 400 ml
Nr Unix. 11200535

Vopsea termorezistentă
argintiu



Cantitate 400 ml
Nr Unix. 11200536

Vopsea acril negru mat



Cantitate 600 ml
Nr Unix. 11200529

Vopsea acril negru RAL 9005



Cantitate 600 ml
Nr Unix. 11200530

Spray degripant șuruburi



Cantitate 500 ml
Nr Unix. 11039948

Spray curățat frână



Cantitate 500 ml
Nr Unix. 11039949

Spray curățat frână



Cantitate 12*500ml
Nr Unix. 11039950

Soluție dezghețat



Cantitate 500 ml
Nr Unix. 11039951

SPRAY

Spray A.Z.Meisterteile

Soluție curățat climă



Cantitate 100 ml
Nr Unix. 11039952

Soluție curățat climă



Cantitate 500 ml
Nr Unix. 11039953

Spray lanț



Cantitate 500 ml
Nr Unix. 11039954

Soluție întreținere bord



Cantitate 500 ml
Nr Unix. 11039955

Soluție antiinsecte



Cantitate 500 ml
Nr Unix. 11039956

Spray silicon



Cantitate 500 ml
Nr Unix. 11039957

Spray ulei ungere



Cantitate 500 ml
Nr Unix. 11039958

Spray universal



Cantitate 500 ml
Nr Unix. 11039959

Soluție dezghețat yale



Cantitate 500 ml
Nr Unix. 11039960

Soluție curățat jantă



Cantitate 500 ml
Nr Unix. 11058298

Întreținere cauciuc



Cantitate 500 ml
Nr Unix. 11058299

Spray de pornire la rece



Cantitate 500 ml
Nr Unix. 11058300

Spray curățat tapițerie



Cantitate 500 ml
Nr Unix. 11058301

PRODUSE DE CURĂȚENIE

Produse de curățenie A.Z.Meisterteile

Soluție întreținere bord



Cantitate 500 ml
Nr Unix. 11058302

Soluție curățat motor



Cantitate 500 ml
Nr Unix. 11058303

Spray vaselină



Cantitate 500 ml
Nr Unix. 11058304

Spray cupru



Cantitate 500 ml
Nr Unix. 11179848

Spray antipatinare curea



Cantitate 500 ml
Nr Unix. 11200521

Soluție dezaburire



Cantitate 500 ml
Nr Unix. 11200522

Soluție protejat contacte



Spray, 500 ml
Nr Unix. 11200523

Spray tăiat găurit



Cantitate 500 ml
Nr Unix. 11200524

Spray verificat scurgeri gaze



Cantitate 500 ml
Nr Unix. 11200525

Soluție curățat geamuri



Cantitate 1 l
Nr Unix. 11200528

Soluție întreținere bord



Lavetă de curățat bordul
- 20 lavete
Nr Unix. 1184407

Soluție întreținere bord



Mat - 20 lavete
Nr Unix. 11184408

Dezinfectant mâini



40 șervețele/pachet,
10 pachete/cutie
Nr Unix. 11184414

PRODUSE DE CURĂȚENIE

Produse de curățenie A.Z.Meisterteile

Soluție întreținere bord



Lavetă - strălucitoare, 30
lavete
Nr Unix. 11184411

Soluție întreținere bord



Lavetă - mată, 30 lavete
Nr Unix. 11184412

Soluție protecție și
întreținere piele



Lavetă de curățat - 30 lavete
Nr Unix. 11184413

Soluție curățat geamuri



Lavetă de curățat - 30 lavete
Nr Unix. 11184410

Soluție curățat geamuri



Lavetă, în pungă din plastic,
20 lavete
Nr Unix. 11184406

Soluție protecție și
întreținere piele



Lavetă, în pungă din plastic,
20 lavete
Nr Unix. 11184409

Dezinfectant mâini



Cu alcool 70%, 1L
Nr Unix. 11057411

Dozator curățare mâini cu
pompa dozare



Flacon 500 ml, cu dozator
Nr Unix. 10986954

Rezervă soluție curățat mâini



Flacon 4 litri
Nr Unix. 10986953

Pompă dozator la soluția
lichidă de spălat mâini



Pompă dozator 4 litri
Nr Unix. 10583492

Suport perete dozator
curățat mâini



Suport perete, 4 litri
Nr Unix. 10583491

Gel curățat mâini



Cantitate: 400 g
Nr Unix. 10986952

Gel curățat mâini



Cantitate: găleată 5 kg
Nr Unix. 10986951

Gel curățat mâini



Cantitate: găleată 10 litri
Nr Unix. 10986950

REPARAȚIE PANĂ ANVELOPE

REPARAȚIE PANĂ ANVELOPE

Petec pt. reparare pană

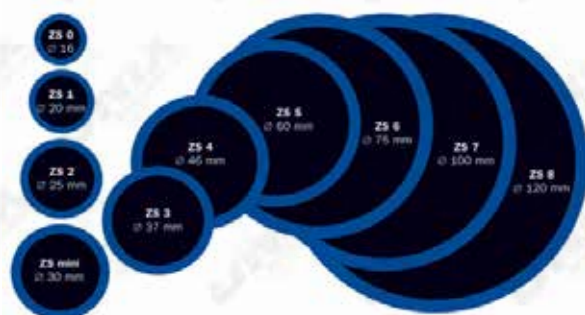

Cantitate de ambalare	Diametru (mm)	Nr Unix
100	30	11201135
100	37	11201136
50	46	11201137
50	60	11201138
25	75	11201139
10	100	11201140
10	120	11201145

Petec pt. reparare pană

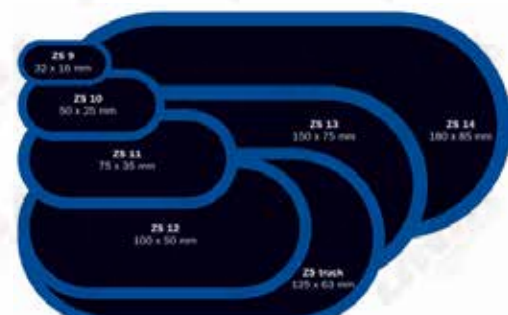

Cantitate de ambalare	Dimensiuni (mm)	Nr Unix
50	75x35	11201141
25	100x50	11201142
10	150x75	11201143
10	180x85	11201144
10	125x63 (Camioane)	11201146

Petec pt. reparare pană (RADIAL)



Cantitate de ambalare	Dimensiuni (mm)	Nr Unix
10	185x220 (Camioane)	11201155
10	75x260 (Camioane)	11201156
10	75x330 (Camioane)	11201157

Petec pt. reparare pană (RADIAL)



Cantitate de ambalare	Dimensiuni (mm)	Nr Unix
20	55x75 (Autoturisme)	11201147
10	70x120 (Autoturisme/Camioane)	11201148
10	80x125 (Camioane/Stivuitor)	11201149
5	95x175 (Camioane/Stivuitor)	11201150
5	105x200 (Camioane/Stivuitor)	11201151
5	130x260 (Camioane/Stivuitor)	11201152
2	135x335 (Camioane)	11201153
2	180x400 (Autoturisme)	11201154

Petec pt. reparare pană (RADIAL)



Cantitate de ambalare	Dimensiuni (mm)	Nr Unix
3	150x190 (Tractor)	11201160
2	180x230 (Tractor)	11201161
2	215x295 (Tractor)	11201162
2	245x340 (Tractor)	11201163
20	55x75 (Autoturisme)	11201164
20	60x90 (Autoturisme)	11201165
10	70x120 (Autoturisme/Camioane)	11201166
10	80x125 (Camioane/Stivuitor)	11201167
10	90x145 (Camioane)	11201168
5	95x175 (Camioane/Stivuitor)	11201169
5	105x200 (Camioane/Stivuitor)	11201170
5	130x260 (Camioane/Stivuitor)	11201171
3	135x335 (Camioane)	11201172
2	180x400 (Camioane)	11201173

REPARAȚIE PANĂ ANVELOPE

REPARAȚIE PANĂ ANVELOPE

Petec pt. reparare pană UNIVERSAL RADIAL/DIAGONAL (Autoturisme, Motociclete, Biciclete)



Cantitate de ambalare	Dimensiuni (mm)	Nr Unix
50	32	11201174
50	37	11201175
50	45	11201176
50	60	11201177
50	27	11201178
50	24	11201179
50	24x37	11201180
10	80 (Camioane)	11201181

Pin de reparare pană



Cantitate de ambalare	Dimensiuni (mm)	Nr Unix
10	4/35	11201216
10	6/45	11201217
10	8/50	11201218
10	16/130x130	11201219
10	12/90	11201220
10	10/50	11201221
10	6/45 (cu tijă din sârmă)	11201222
10	8/55 (cu tijă din sârmă)	11201223
10	10/65 (cu tijă din sârmă)	11201224
10	12/90 (cu tijă din sârmă)	11201225
10	4/35 (cu tijă metalică)	11201226
10	6/45 (cu tijă metalică)	11201227
10	8/50 (cu tijă metalică)	11201228

Șnur vulcanizare



Cantitate de ambalare	Dimensiuni (mm)	Nr Unix
5	100 (Autoturisme)	11201238
5	200 (Camioane/Tractor)	11201237
30	140 (Camioane)	11201236
30	200 (Camioane/Tractor)	11201235
50	100 (Autoturisme)	11256182
50	100 (Autoturisme/Motociclete)	11256183

Kit reparare anvelope cu compresor (DUNLOP)



Nr Unix 11201130

REPARAȚIE PANĂ ANVELOPE

REPARAȚIE PANĂ ANVELOPE

Lichid vulcanizare pentru anvelopă



Tip petece	Tip fir	Ambalare	Nr Unix
universal	universal	250ml + pensulă	11201286
universal	universal	400ml	11201287
universal	universal	800ml	11201285

Lichid vulcanizare pentru anvelopă



Tip petece	Tip fir	Ambalare	Nr Unix
PS, VS	ON12, ON16	250ml + pensulă	11201280
PS, VS	ON12, ON16	400ml	11201282
PS, VS	ON12, ON16	800ml	11201283

Lichid vulcanizare pt. anvelopă (400ml)



Tip petece	Tip fir	Ambalare	Nr Unix
ZS, universal	ON, OK	250ml + pensulă	11201288
ZS, universal	ON, OK	400ml	11201281
ZS, universal	ON, OK	800ml	11201284

Lichid curățare vulcanizare anvelopă



Ambalare	Nr Unix
400ml (spray)	11201275
800ml	11201276

Diluant pentru lichid vulcanizare anvelopă



Ambalare	Nr Unix
800ml	11201289

Soluție etanșare flanșă anvelopă



Ambalare	Nr Unix
400ml	11201249
800ml	11201250

REPARAȚIE PANĂ ANVELOPE

ACCESORII PT. REPARAȚIE PANĂ ANVELOPE

Supapă anvelopă (TUBELESS)



Diametru (mm)	Lungime (mm)	Ambalare	Aplicații	Nr Unix
11,3	48,5	100 buc/pachet	Autoturisme	11201262
11,5	33	100 buc/pachet	Autoturisme/Motociclete	11201263
16	61,5	100 buc/pachet	Camioane	11201264
11,5	61,5	100 buc/pachet	Autoturisme	11201265
11,5	42,5	100 buc/pachet	Autoturisme	11201266
17	61,5	50 buc/pachet	Camioane	11201260

Supapă anvelopă (TUBELESS) presiune ridicată



Diametru (mm)	Lungime (mm)	Ambalare	Nr Unix
11,5	33	100 buc/pachet	11248661
11,5	42,5	100 buc/pachet	11248662
11,5	48,5	100 buc/pachet	11248663
11,5	61,5	100 buc/pachet	11248664

Unealtă pt. aplicare șnur vulcanizare



Nr Unix 11201239

Clește supapă anvelopă



Nr Unix 11201268

Clește echilibrat roți



Nr Unix 11201445

Clește demontare contragreutate roată



Nr Unix 11201440

Dispozitiv retractare supapă



Nr Unix 11201448

Cretă



Nr Unix 11201322

Cilindru de presare petec



Nr Unix 11201320

Racletă anvelopă



Nr Unix 11201248

Leră adâncime profil anvelopă (digital)



Nr Unix 11201290

Trusă reparație pană cauciuc



Nr Unix 11201215

REPARAȚIE PANĂ ANVELOPE

REPARAȚIE PANĂ ANVELOPE



Greutate roată TRUCK		
Ambalare	Greutate (g)	Nr Unix
50 buc/pachet	50	11201380
50 buc/pachet	75	11201381
25 buc/pachet	100	11201382
20 buc/pachet	150	11201383
20 buc/pachet	200	11201384
10 buc/pachet	250	11201385
10 buc/pachet	300	11201386



Greutate roată TRUCK (pt. jante din oțel)		
Ambalare	Greutate (g)	Nr Unix
50 buc/pachet	25	11201372
50 buc/pachet	50	11201373
50 buc/pachet	75	11201374
25 buc/pachet	100	11201375
20 buc/pachet	150	11201376
10 buc/pachet	200	11201377
10 buc/pachet	250	11201378
10 buc/pachet	300	11201379

Plumbi autoadezivi TRUCK (jante din oțel, acoperiți cu plastic)



Ambalare	Greutate (g)	Nr Unix
20 buc/pachet	4x25	11201410
25 buc/pachet	4x50	11201411

Plumbi autoadezivi TRUCK (jante din oțel, formatat)



Ambalare	Greutate (g)	Nr Unix
25 buc/pachet	50	11201434
25 buc/pachet	75	11201435
25 buc/pachet	100	11201436
10 buc/pachet	150	11201437
10 buc/pachet	200	11201438

Pastă montare anvelopă MONTI



Ambalare	Culoare	Nr Unix
1 L	alb	11201300
3 L	alb	11201301
5 L	alb	11201302

Pastă montare anvelopă MONTI SEAL



Ambalare	Culoare	Nr Unix
1 L	Negru	11201303
3 L	Negru	11201304
5 L	Negru	11201305

Pastă montare anvelopă FERMENT BLUE



Ambalare	Culoare	Nr Unix
1 L	albastru	11201308
3 L	albastru	11201309
5 L	albastru	11201310

Pastă montare anvelopă FERMENT RED



Ambalare	Culoare	Nr Unix
1 L	Roșu	11201311
3 L	Roșu	11201312
5 L	Roșu	11201313

Gel montare anvelopă



Ambalare	Nr Unix
1 L	11201295
5 L	11201296

Gel montare anvelopă



Ambalare	Nr Unix
0,25 L	11201297
0,5 L	11201298

Talc montare anvelopă (pudră TALC)



Ambalare	Nr Unix
0,5 kg	11201317
2,5 kg	11201318

Pensulă pastă montare anvelopă



Nr Unix 11201314



Nr Unix 11201315

MATERIALE SERVICE AUTO

ALTE MATERIALE PUBLICITARE SPECIFICE PENTRU SERVICE

Folie protecție scaun (UNIX Design)



Nr Unix 10574976

Folie protecție scaun (AZ-MT Design)



Nr Unix 11583407

Folie protecție volan



Nr Unix 10574977

Set șaibe (cupru, 250 buc)



Nr Unix 11025780

Set șaibe (metric, 240 buc)



Nr Unix 11025781

Set șaibe (cupru, 200 buc)



Nr Unix 11025779

Set O-ring (Diametru: 3-50mm)



Nr Unix 11025886

Set O-ring (Diametru: 3-12mm, 225 buc) Set O-ring (Diametru: 3,5-21mm, 225 buc)



Nr Unix 11025885



Nr Unix 11025884

Set colier (100 buc)



Nr Unix 11025783

Granule absorbție ulei (10 kg/găleată)



Nr Unix 10376644

Granule absorbție ulei (10 kg/sac)



Nr Unix 10376643



**ECHIPAMENTE PENTRU DOTAREA
ATELIERELOR ȘI GARAJELOR**

ECHIPAMENTE PENTRU DOTAREA ATELIERELOR ȘI GARAJELOR

TESTER DIAGNOZĂ - TEXA

TEXA TXT MULTIHUB



Set cabluri



Nr Unix	Descriere
11056708	Navigator TXT MULTIHUB - O interfață de diagnosticare de nouă generație care poate fi utilizată pt. toate categoriile de vehicule
10172945	Licență software IDC5 PLUS TRUCK - Tester diagnoză pt. camioane (autobuze, semiremorci și vehicule utilitar ușor)
10172953	Licență software IDC5 PLUS OHW - Tester diagnoză pt. utilaje agricole și de construcții
11056703	Kit cablu adaptor TRUCK și OHW pentru Navigator TXT MULTIHUB
10172779	Set cabluri diagnoză (camioane)
10172778	Set cabluri diagnoză (autobuze)
10172498	Set cabluri diagnoză (semiremorcă)

TESTER DIAGNOZĂ - BOSCH

BOSCH KTS TRUCK



Set cabluri



Nr Unix	Descriere
10129822	KTS TRUCK - Interfață de diagnosticare pentru camioane, utilaje agricole și de construcții
11391077	Software ES[tronic] Truck cu taxă de abonament de 12 luni - Tester diagnosticare pt. camioane (autobuze, semiremorci)
10129823	Set cabluri diagnoză (camioane)
10486107	Set cabluri diagnoză (autobuze)
10486108	Set cabluri diagnoză (semiremorcă)

ECHIPAMENTE PENTRU DOTAREA ATELIERELOR ȘI GARAJELOR

TESTER DIAGNOZĂ - LAUNCH

Tester diagnoză X-431 EURO TURBO II



Set tester diagnoză HD BOKSZ 3



Nr Unix	Descriere
11288950	X-431 EURO TURBO II - Pachet complet de diagnosticare pt. autoturisme
11033817	HD Box 3 - Pachet suplimentar de diagnosticare a camioanelor

TESTER DIAGNOZĂ - DELPHI



Nr Unix	Descriere
11168113	BLUETECH DS180E - Interfață de diagnosticare de nouă generație
11168118	Software BLUETECH HD - actualizare pe 1 an
11168119	Software BLUETECH HD - actualizare pe 2 ani
11168120	Software BLUETECH HD - actualizare pe 3 ani
11168121	Software BLUETECH HD - actualizare pe 5 ani
10137859	Set cablu OBD, Camion, Set cabluri camion și semiremorcă - 11 cabluri

ECHIPAMENTE PENTRU DOTAREA ATELIERELOR ȘI GARAJELOR

REPARAȚIE ANVELOPE

Aparat de echilibrat roți BIG RED (Diametru roată: 13-24") Aparat de echilibrat roți SPACE (Diametru roată: 10-30")



Nr Unix 11049516



Nr Unix 11046188

Aparat de montat roată BIG RED
(Diametru roată: 14-26", greutate maximă 500kg)



Nr Unix 11254568

Aparat de montat roată BIG RED
(Diametru roată: 14-56", greutate maximă 2000 kg)



Nr Unix 11049515

Aparat de montat roată SPACE
(Diametru roată: 14-56", greutate maximă 2000 kg)



Nr Unix 348002

Cric schimbat roată SEALEY



Nr Unix 11036088

ECHIPAMENTE PENTRU DOTAREA ATELIERELOR ȘI GARAJELOR

CLIMĂ

Stație climă SPIN - CLEVER MIURA



Nr Unix 11207053

Specificații:

Rezervor de 18 kg, pentru agent frigorific R134a, cu imprimantă. Pompă vacuum 170 litri/min. Compresor 400 gr/min. Display grafic. Baza de date încorporată pentru vehicule.

Aparat de spălat instalații AC SPIN - EASY FLUSH



Nr Unix 348051

Specificații:

Rezervor de 20 litri. Racord extern la rezervor de nitrogen. 3 metri, furtun racord 1/4 SAE, 3/8 SAE și 1/2 SAE. Set racorduri de conectare 1/4 SAE, 3/8 SAE și 1/2 SAE. Set racorduri conic.

Generator ozon A.Z MEISTERTEILE



Nr Unix 11099514

Specificații:

Emisie ozon: 10 g/hr, Putere: 100 W, debit maxim de aer: 100 CFM (2,8 m3/min)

ECHIPAMENTE PENTRU DOTAREA ATELIERELOR ȘI GARAJELOR

ÎNCĂRCAREA ȘI ÎNTREȚINEREA BATERIILOR

Redresor acumulator (încărcător)



Nr Unix
333011

Specificații:
TELWIN 807545 - Alpine 18 Boost
Redresor acumulator 230 V, 200 W, 12/24 V, curent de încărcare 14/8 A, pentru acumulatori 14/6-185/90 Ah

Redresor acumulator (încărcător)



Nr Unix
333021

Specificații:
TELWIN 807579 - Alaska 200 Start
Redresor acumulator 230 V, 1 kW, 12/24 V, curent încărcare 45A , pentru acumulatori 20-700 Ah

Redresor acumulator (încărcător)



Nr Unix
333036

Specificații:
TELWIN 829490 - Sprinter 3000 Star
Redresor acumulator 230 V, 1 kW, 12/24 V, curent încărcare 45A, pentru acumulatori 20-700 Ah

Redresor acumulator (încărcător)



Nr Unix
646704

Specificații:
TELWIN 829342 - Doctor Start 630
Redresor acumulator 230 V, 2 kW, 12/24 V, curent încărcare 90A , pentru acumulator 10-1050 Ah

ECHIPAMENTE PENTRU DOTAREA ATELIERELOR ȘI GARAJELOR

ÎNCĂRCAREA ȘI ÎNTREȚINEREA BATERIILOR

Redresor acumulator (încărcător)



Nr Unix
333026

Specificații:
TELWIN 807599 - Doctor charge 130
Redresor acumulator 230 V, 1.8 kW, 12/24 V, curent de încărcare 140/170 A, pentru acumulatori 20-1200 Ah

Unitate pornire



Nr Unix
11094920

Specificații:
TELWIN STĂRTZILLA 9024 XT - Unitate pornire 12/24 V, curent pornire: 1000 A/600 A (max. 9000 A)

Tester acumulator (12V, 20-200Ah)



Nr Unix 333001

Protecție supratensiune



Nr Unix 333106

Densimetru acumulator



Nr Unix 580310

Extractor bornă acumulator



Nr Unix 348732

Perie curățat bornă baterie



Nr Unix 579957

Cablu pornire 1500A, 6 m



Nr Unix 11007811

ECHIPAMENTE PENTRU DOTAREA ATELIERELOR ȘI GARAJELOR

RIDICARE

Cric de canal



Specificații:
Echipament ridicare la margine canal GRA-12 hidropneumatic, rezistență la greutate de 12 tone, înălțime de ridicare : 790 mm.

Nr Unix 10867024

Elevator mobil cu două coloane



Specificații:
Elevator mobil cu două coloane SPACE SM2304
Electro-mecanic, elevator cu 4 coloane ptr. camioane. Sarcină pe coloană 5 500 kg, înălțime de ridicare 1 800 mm.

Nr Unix 10867024

Cric tip crocodil



Nr Unix 11025862
Specificații:
Cric tip crocodil SEALEY 4040AG Rocket Lift Green, Sarcină: 4 t, Înălțime: 100-533 mm, înălțime minimă șa

Cric



Nr Unix 331881
Specificații:
Cric SEALEY YA10-40LELR Hidropneumatic, telescopic. Sarcină maximă: 40 t. Înălțime ridicare: 130-307 mm/40 t, 356 mm/20 t, 409 mm/10 t. Adaptor detașabil: 45/75 mm. Piston distanță cursă: 177 mm. Presiune de lucru: 8-10 bar

ECHIPAMENTE PENTRU DOTAREA ATELIERELOR ȘI GARAJELOR

RIDICARE

Girafă de ridicat motor



Specificații:
Girafă de ridicat motor BIG RED T32002CX-GS sarcină maximă 2 tone, 25-2445 interval de ridicare. Pliabilă.

Nr Unix 10472673

Cric hidraulic



Specificații:
Cric hidraulic SEALEY SJ10 Sarcină maximă: 10 t, Înălțime ridicare: 260-460 mm, Adaptor înșurubabil: 80 mm, Ridicare hidraulică: 150 mm

Nr Unix 331741

Cric hidraulic



Specificații:
Cric hidraulic BIG RED TQ20002 Acționare pneumatică. Sarcină maximă 20 tone. Înălțime minimă : 267 mm. Înălțime de ridicare: 165 mm. Reglare: 82 mm.

Nr Unix 10472666

Cric hidraulic



Specificații:
Cric hidraulic LAMPA 71556 Sarcină: 30 t, GS-TÜV, Înălțime ridicare: 255-405 mm

Nr Unix 11025601

Cric hidraulic



Specificații:
Cric hidraulic BIG RED TQ35001 Acționare pneumatică. Sarcină 35 tona. Înălțime minimă: 245 mm. Înălțime de ridicare: 130 mm. Reglare: 115 mm.

Nr Unix 10472667

Elevator ridicare cutie de viteză



Specificații:
Elevator ridicare cutie de viteză BIG RED TEL15011 Sarcină 1,5 tone. Înălțime de ridicare: 1130-1915 mm

Nr Unix 10472696

Element ridicare pneumatic



Specificații:
Element ridicare pneumatic BIG RED TRA1813 Sarcină : 2 tone. Înălțime de ridicare: 200-560mm

Nr Unix 10472707

A.L. Meisterteile®



The power of quality 

Căutare piese în baza seriei de șasiu

În sistemul UNIX TradeLine®

Ce avantaje prezintă utilizarea noului modul de căutare, identificare piese în baza seriei de șasiu?

• Principalul avantaj al utilizării noului modul este: identificarea ușoară și exactă a pieselor căutate, atât cele originale cât și aftermarket, pe baza seriei de șasiu. Acest lucru simplifică procesul de căutare, identificare pro-

duse, accelerează și ușurează munca Partenerilor noștri. Putem căuta în mod evident piese auto de la furnizori de top, pentru autoturisme sau vehicule comerciale.

• Intrând în programul TradeLine, prin modulul de identificare VIN, fără clicuri suplimentare, programul este disponibil direct în pagina principală, și vă oferă acces direct la cataloagele pro-

ducătorilor de autovehicule.

- Programul funcționează printr-o interfață prietenoasă cu care v-ați obișnuit deja în programul nostru TradeLine.
- Căutările sunt salvate de sistemul nostru, astfel oricând puteți reveni cu ușurință la vehiculele căutate anterior.
- Oferim Partenerilor noștri acces gratuit la modulul de căutare pe baza seriei de șasiu.

Vă prezentăm pas cu pas cum funcționează noul modul!

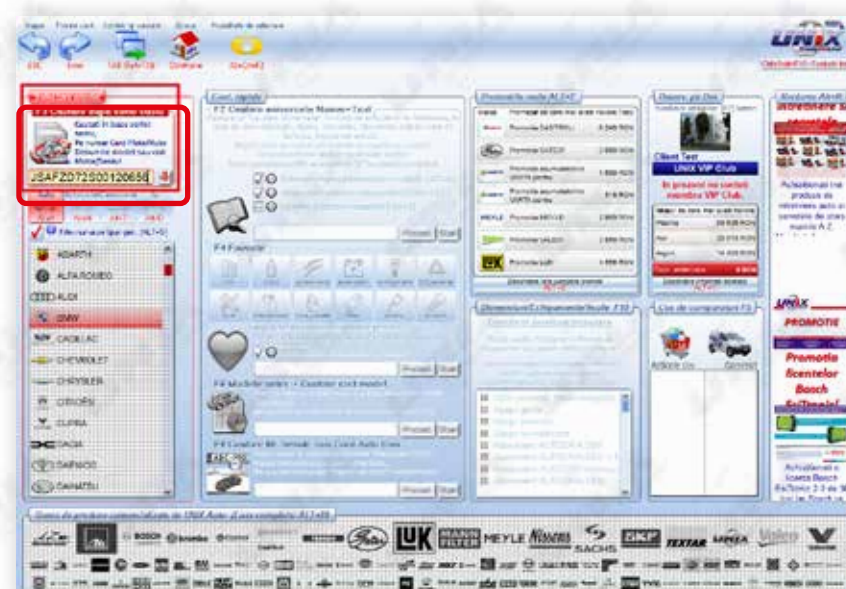

1 Introduceți seria de șasiu în câmpul de căutare, după care apăsați tasta Enter.

2 Odată identificat, devin vizibile informațiile principale ale autovehiculului.

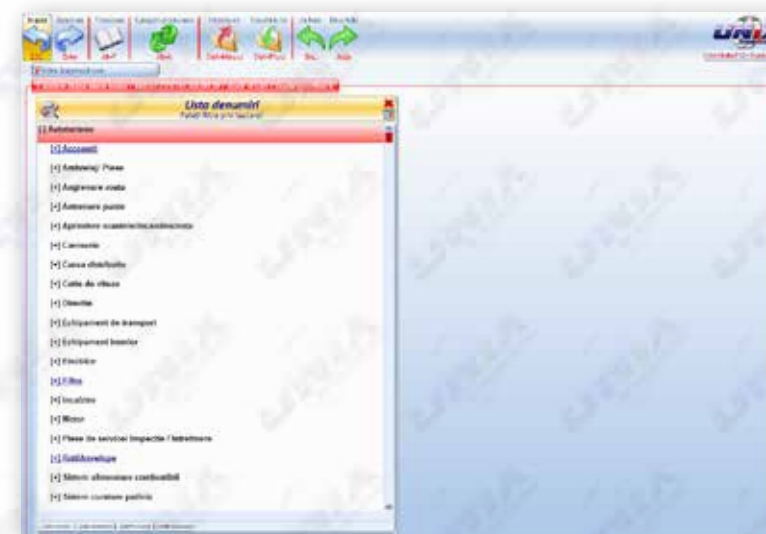
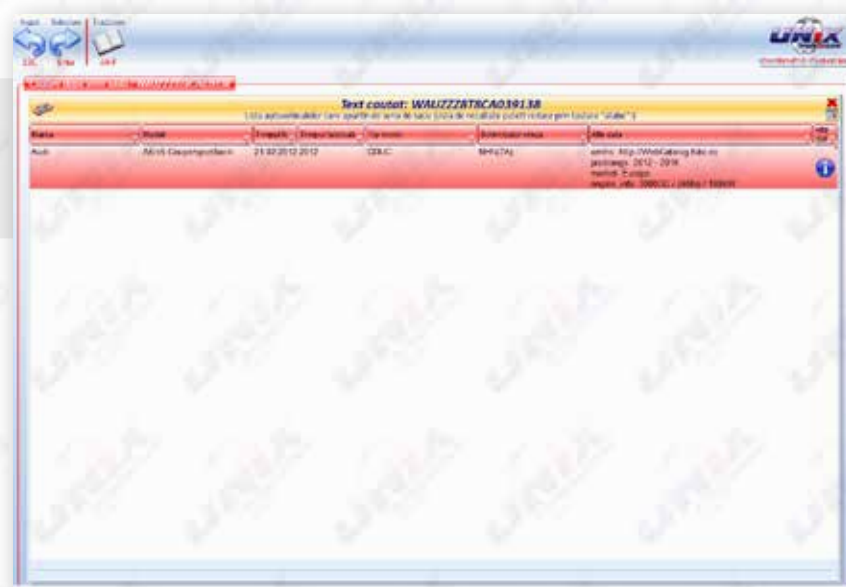

3 După selectarea autovehiculului apar principalele categorii de piese.

4 După selectarea categoriei principale de piese ajungem la subcategoriile prezentate prin imagini.



5 După selectarea imaginii dorite, devine disponibilă lista de piese. În cazul în care ca rezultat al căutării apar piese auto de la mai mulți producători, alegeți piesa dorită. Aici puteți utiliza atât lista din partea stângă sau clic pe numărul elementului din imaginea explodată și la fel ca și în cazul anterior puteți alege piesa dorită.

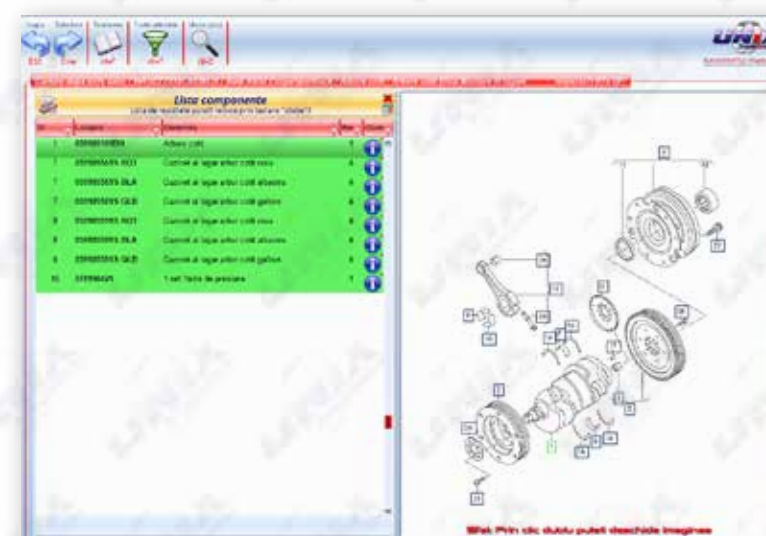

6 După ce alegeți produsul pe care îl căutați, veți găsi în oferta noastră atât piese originale cât și piese aftermarket. Prin modulul nostru de căutare după serie de șasiu aveți posibilitatea de a identifica piesele de care aveți nevoie mai rapid, mai corect și mai fiabil!

Modulul de identificare piese ax remorcă

În acest nou modul de căutare axuri, putem identifica cu ușurință piese de schimb pentru sistemele de rulare ale remorcilor și autobuzelor. Pentru acest lucru, este suficient să cunoașteți producătorul și tipul axului, precum și anul de fabricație.

Gama pieselor care pot fi identificate prin acest modul este una foarte largă cum ar fi de exemplu: piese pentru sistemul de frânare (plăcuțe de frână, cheie de frână, manetă de frână, etc.), arcuri pentru sistemul de suspensie, rulmenți ax sau multe alte piese de fixare.

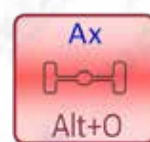

1. În modulul de căutare după tip, alegeți opțiunea Ax, după care selectați producătorul.

2. Alegeți tipul sistemului de rulare (ax) remorcă, după care dacă cunoașteți exact anul fabricației, îl selectați din lista care apare, iar dacă nu atunci alegeți opțiunea ...Toate....

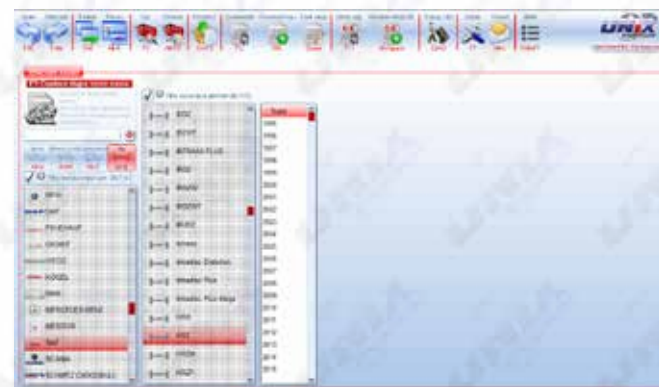

3. Dintre tipurile de axuri care apar alegeți cel corespunzător.

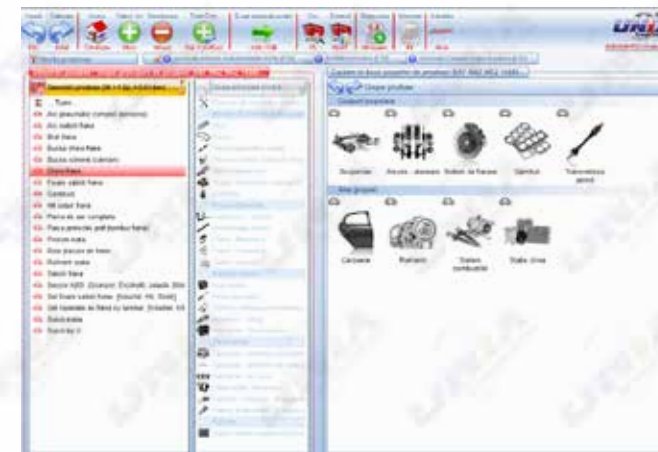

4. Restrângeți lista cu rezultate, așa cum apare în imagine, sau pur și simplu începeți să tastați denumirea piesei pe care o căutați (De ex.: Cheie frână).

5. Alegeți marca dorită și introduceți produsul în Coșul de cumpărături.

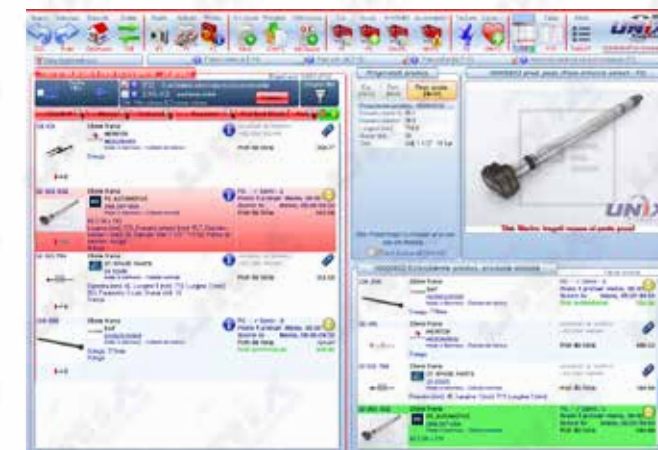

Noul modul de căutare piese pentru axuri este disponibil și în Webshop UNIX.



A.Z. 
Meisterteile®

UNIX
PIESE AUTO®



Siguranță și sport!

Pantofi de protecție A.Z. Meisterteile

STRUCTURA INTERIOARĂ A PANTOFILOR:



ECHIPAMENTE DE
PROTECȚIA MUNCII

The power of quality 

UNIX
PIESE AUTO®

Echipamente de protecția muncii

A.Z. MEISTERTEILE Echipament de lucru - Set complet



Marca	Denimre produs	Mărime	Nr. Unix
A.Z. MEISTERTEILE	Echipament de lucru- Set complet - AZ-MT Design	S	909997
		M	909998
		L	909999
		XL	910044
		XXL	910045
		XXXL	910046
		XXXXL	910047

Echipamente de protecția muncii

Echipament de lucru - Geacă



Marca	Denimre produs	Mărime	Nr. Unix
A.Z. MEISTERTEILE	Geacă - Echipament de lucru AZ-MT Design	S	10987806

Echipament de lucru - Geacă



Marca	Denimre produs	Mărime	Nr. Unix
UNIX	Echipament de lucru - geacă-UNIX Design	S	4585
		M	4586

Echipament de lucru - Geacă



Marca	Denimre produs	Mărime	Nr. Unix
UNIX	Echipament de lucru - geacă-UNIX Design	L	4625

UNIX Echipament de lucru - Set complet



Marca	Denimre produs	Mărime	Nr. Unix
UNIX	Echipament de lucru - Set complet - UNIX Design	S	4579
		M	4580
		L	4581
		XL	4582
		XXL	4583
		XXXL	4584
		XXXXL	4662

A.Z. MEISTERTEILE Pantofi de protecție



Marca	Denimre produs	Mărime	Nr. Unix
A.Z. MEISTERTEILE	Pantofi de protecție - design sportiv - AZ-MT Design	35	11249299
		36	11249300
		37	11249301
		38	11045117
		39	11045118
		40	11045119
		41	11045120
		42	11045121
		43	11045122
		44	11045123
		45	11045124
		46	11045125
		47	11249302

Pantofi de protecție

A.Z. MEISTERTEILE Pantofi de protecție



Marca	Denumire produs	Observații	Mărime	Nr. Unix
A.Z. MEISTERTEILE	Pantofi de protecție - design sportiv - AZ-MT Design	Gri-negru-roșu, Partea superioară din țesătură funcțională, bombeu din oțel, talpă intermediară din oțel, Brant din spumă cu memorie AZMT	37	11276373
			38	11276374
			39	11276375
			40	11276376
			41	11276377
			42	11276378
			43	11276379
			44	11276380
			45	11276381
			46	11276382

A.Z. MEISTERTEILE Pantofi de protecție



Marca	Denumire produs	Observații	Mărime	Nr. Unix
A.Z. MEISTERTEILE	Pantofi de protecție - design sportiv - AZ-MT Design	Roșu-negru, Partea superioară din piele întoarsă, bombeu din oțel, talpă intermediară din oțel, Brant din spumă cu memorie AZMT	37	11276383
			38	11276384
			39	11276385
			40	11276386
			41	11276387
			42	11276388
			43	11276389
			44	11276390
			45	11276391
			46	11276392

Mănușă de protecție

A.Z. MEISTERTEILE Mănușă de protecție



Marca	Denumire produs	Observații	Mărime	Nr. Unix
A.Z. MEISTERTEILE	Mănușă de protecție - AZ-MT Design	Mănușă cu înveliș de poliuretan, EN388: 3121X	7	10266221
			8	10266222
			9	10266223
			10	10266224
			11	10266225

A.Z. MEISTERTEILE Mănușă de protecție



Marca	Denumire produs	Observații	Mărime	Nr. Unix
A.Z. MEISTERTEILE	Mănușă de protecție - AZ-MT Design	Mănușă cu înveliș de poliuretan, EN388: 4543D	7	10266226
			8	10266227
			9	10266228
			10	10266229
			11	10266230

A.Z. MEISTERTEILE Mănușă de protecție



Marca	Denumire produs	Observații	Mărime	Nr. Unix
A.Z. MEISTERTEILE	Mănușă de protecție - AZ-MT Design	Mănușă cu înveliș de poliuretan, EN388: 4542D	7	10266231
			8	10266232
			9	10266233
			10	10266234
			11	10266235

A.Z. MEISTERTEILE Mănușă de protecție



Marca	Denumire produs	Observații	Mărime	Nr. Unix
A.Z. MEISTERTEILE	Mănușă de protecție (Piele) - AZ-MT Design	Alb	7	10308689
			8	10308690
			9	10308691
			10	10308692
			11	10308693

A.Z. MEISTERTEILE Mănușă de protecție



Marca	Denumire produs	Observații	Mărime	Nr. Unix
A.Z. MEISTERTEILE	Mănușă de protecție (Piele) - AZ-MT Design	Negru	7	10308694
			8	10308695
			9	10308696
			10	10308697
			11	10308698

A.Z. MEISTERTEILE Mănușă de protecție



Mărkanév	Marca	Observații	Mărime	Nr. Unix
A.Z. MEISTERTEILE	Mănușă de protecție (Piele) - AZ-MT Design	Roșu	7	10308699
			8	10308717
			9	10308718
			10	10308719
			11	10308720

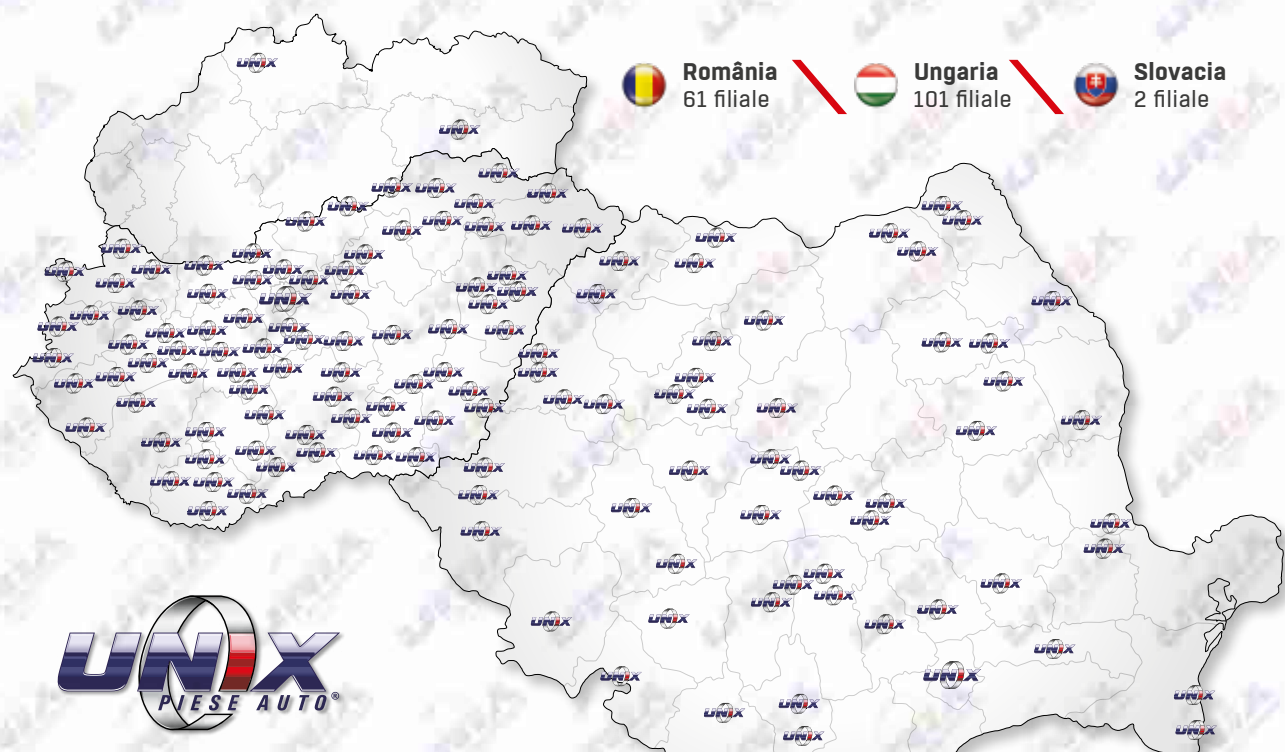

România
61 filiale

Ungaria
101 filiale

Slovacia
2 filiale



Sediul Central din România:

RO-400632 Cluj-Napoca

Str. Fabricii Nr. 118

Tel.: +40 264 501 899 | Fax: +40 264 441 422

Internet: www.unixauto.ro

E-mail: info@unixauto.ro | Webshop: www.unixauto.ro

Filiale din România

Alba Iulia 510193 Str. Alexandru I. Cuza Nr. 24 C Tel.: +40 377 100 165
 Arad 310318 Calea Radnei Nr. 288 A Tel.: +40 257 271 010
 Bacău 600169 Str. Milcov Nr. 3-5 Tel.: +40 234 522 074
 Baia Mare 430264 Bld. Republicii Nr. 2 Tel.: +40 262 216 637
 Bărlad 731149 Str. Nicolae Bălcescu Nr. 1-3 Tel.: +40 377 100 153
 Beiuș 415200 Str. Lucian Blaga Nr. 4 Tel.: +40 377 100 144
 Bistrița 420006 Str. Libertății Nr. 41-43 Tel.: +40 374 285 544
 Botoșani 710002 Calea Națională Nr. 21 Tel.: +40 374 285 549
 Brașov 500010 Str. Nicolae Titulescu Nr. 2 Tel.: +40 268 476 692
 Brașov II 500222 Str. Hărmanului Nr. 49 Z Tel.: +40 377 100 161
 Brăila 610521 Str. Ștefan cel Mare Nr. 218 Tel.: +40 377 100 157
 București 050156 Sect. 5 Șos. Vilor Nr. 14 Tel.: +40 213 189 890
 București Crângași 060339 Str. Mehadiel Nr. 41 Tel.: +40 377 100 162
 București I 012381 Sect. 5 Șos. Chitiei Nr. 12 Tel.: +40 374 207 700
 București II 022523 Sect. 2 Șos. Andronache Nr. 157 Tel.: +40 212 404 205
 București III 031504 Sect. 3 Intrarea Lobodei Nr. 2 Tel.: +40 374 206 696
 București IV 041719 Sect. 4 Str. Aurel Părușu Nr. 2-10 Tel.: +40 377 100 120
 București VI 061971 Sect. 6 Str. Valea Otlului Nr. 199-201
 Tel.: +40 217 777 077
 Buzău 120226 Șos. Spătarului Nr. 26 Tel.: +40 377 100 163
 Câmpulung 115100 Str. Pictor Grigorescu Nr. 1 Tel.: +40 377 100 129
 Caracal 235200 Str. Vornicu Ureche Nr. 2 Tel.: +40 377 100 143
 Cluj-Napoca 400632 Str. Fabricii Nr. 118 Tel.: +40 264 441 444
 Cluj-Napoca II 407280 Com. Florești Str. Avram Iancu Nr. 419
 Tel.: +40 377 100 155
 Constanța 900301 Str. Dreptății Nr. 24 Tel.: +40 241 552 226
 Craiova 200501 Calea Severinului Nr. 39 Tel.: +40 251 426 444
 Curtea de Argeș 115300 Str. I. Mai Nr. 5 Tel.: +40 377 100 121
 Dej 405200 Str. I. Mai Nr. 97 A Tel.: +40 377 100 166
 Deva 330158 Str. Dorobanților Nr. 34 Tel.: +40 374 290 290
 Drobeta 715200 Str. Scaililor Nr. 40 Tel.: +40 377 100 122
 Drobeta-Turnu Severin 220139 Str. Traian Nr. 159 A Tel.: +40 377 100 160
 Făgăraș 505200 Str. Unirii Nr. 7 Tel.: +40 377 100 138
 Galați 600396 Str. Brăilei Nr. 272 Tel.: +40 236 425 255
 Iași 700382 Str. Aurel Vlaicu Nr. 78 Tel.: +40 232 262 660
 Lugoj 305500 Str. Timișorii Nr. 113 Tel.: +40 377 100 124
 Mangalia 905500 Str. M. I. Dobrogeanu Nr. 20 B Tel.: +40 377 100 159
 Marghita 415300 Str. Pop Mircea Nr. 17 Tel.: +40 377 100 128
 Medias 551010 Str. Gării Nr. 2 Tel.: +40 377 100 126
 Onești 601115 Str. Redului Nr. 8 Tel.: +40 377 100 156
 Oradea 410266 Str. Barcăului Nr. 33 Tel.: +40 259 475 453
 Oradea II 410060 Calea Clujului Nr. 144-148 Tel.: +40 377 100 127
 Petroșani 332071 Str. Livezeni Nr. 7 Tel.: +40 377 100 125
 Piatra Neamț 617185 Str. Dumbravei Nr. 12 Tel.: +40 374 204 604
 Pitești 117045 Str. Mierlusești (Com. Bascov) Nr. 19 Tel.: +40 248 224 261
 Pitești II 100070 Cartier Albert (Blajii) Nr. 94 A Tel.: +40 244 542 055
 Rădăuți 725400 Calea Corniștii Nr. 42 P Tel.: +40 377 100 169
 Râmnicu Vâlcea 240300 Str. Horia Nr. 1-3 Tel.: +40 374 207 702
 Reșița 320210 Str. Făgărașului Nr. 18 C Tel.: +40 377 100 151
 Roman 611052 Str. Nicolae Bălcescu Nr. 28 Tel.: +40 377 100 152
 Satu Mare 440101 Str. Botizului Nr. 24 Tel.: +40 261 770 360
 Sibiu 550024 Bld. Victoriei Nr. 42 Tel.: +40 269 221 262
 Sighetua Marmăției 435500 Str. Avram Iancu Nr. 233 A Tel.: +40 377 100 148
 Sighisara 545400 Str. Mihai Viteazul Nr. 2 A Tel.: +40 377 100 123
 Slatina 230048 Str. Pitești FN Tel.: +40 377 100 158
 Slobozia 920095 Șos. Brăilei Nr. 1 Tel.: +40 377 100 168

Suceava 727525 Com. Scheia, Str. Humorului Nr. 39 Tel.: +40 230 533 310
 Târgoviște 130093 Str. Tudor Vladimirescu Nr. 65 Tel.: +40 374 279 517
 Târgu Jiu 210177 Str. Gen. Titus I. Gârbea Nr. 3 Tel.: +40 374 203 102
 Târgu Mureș 540210 Str. Gheorghe Doja Nr. 197 Tel.: +40 265 314 010
 Timișoara 300642 Str. Mișesei Nr. 1 Tel.: +40 258 474 701
 Turda 401096 Str. Avram Iancu Nr. 1-3 Tel.: +40 374 282 680
 Zalău 450090 Bld. Mihai Viteazul Nr. 58 C Tel.: +40 374 203 780

Filiale din Ungaria

Alja 8400 Hárfa u. 1/B Tel.: +36 88 200 025
 Baja 6500 Szegedi út 64. Tel.: +36 79 522 991
 Siíngassagyarmat 2680 Kóvári út 4/A Tel.: +36 35 886 809
 Siíngaatónfűrdő 8230 Arácsi út 16. Tel.: +36 87 888 690
 Békéscsaba 5600 Barényi út 47. Tel.: +36 66 445 297
 Berettyóújfalu 4100 Kossuth út 82. Tel.: +36 54 889 101
 Bp. III. ker. 1039 Szentendrei út 255. Tel.: +36 1 439 1592
 Bp. IV. ker. 1044 Váci út 83. Tel.: +36 1 245 4552
 Bp. IX. ker. 1097 Gubacsi út 95/C Tel.: +36 1 347 0938
 Bp. X. ker. 1107 Száva u. 8. Tel.: +36 1 211 1508
 Bp. XI. ker. 1116 Kondorosi út 3. Tel.: +36 1 803 6204
 Bp. XIII. ker. 1139 Frangepán u. 55-57. Tel.: +36 1 270 8700
 Bp. XV. ker. 1152 Rákosi út 59. Tel.: +36 1 803 8598
 Bp. XVI. ker. 1161 Csömöri út 93-101. Tel.: +36 1 403 9564
 Bp. XVI. ker. II. 1163 Veres Péter út 1-3. Tel.: +36 1 211 1589
 Bp. XVII. ker. 1173 Pesti út 237/L Tel.: +36 1 258 5370
 Bp. XIX. ker. 1195 Üllői út 280. Tel.: +36 1 454 3352
 Bp. XXI. ker. 1214 Kossuth Lajos u. 160-164. Tel.: +36 1 803 6889
 Bp. XXII. ker. 1222 Háros utca 11/A Tel.: +36 1 424 8104
 Budaörs 2040 Kintizi út 4-6. Tel.: +36 23 428 080
 Cegléd 2700 Külső-Kátai út 1. Tel.: +36 53 886 360
 Csorna 9300 Soproni út 23/B Tel.: +36 96 887 544
 Dabas 2373, Kossuth Lajos utca 1. Tel.: +36 29 889 236
 Debrecen 4030 Mikepércsi út 79. Tel.: +36 52 500 280
 Debrecen II. 4027 Fűredi u. 76. Tel.: +36 52 887 813
 Dombóvár 7200 Kőztársaság utca 31. Tel.: +36 74 888 690
 Dunakeszi 2120 Fő út 24. Tel.: +36 27 887 311
 Dunaújváros 2400 Magyar út 108-1. Tel.: +36 25 286 002
 Eger 3300 Mátyás király út 4-6. Tel.: +36 36 515 702
 Érd 2030 Velencei út 33. Tel.: +36 23 520 926
 Érd II. 2030 Bem tér 1. Tel.: +36 23 806 390
 Esztergom 2500 Kertész u. 5. Tel.: +36 33 889 108
 Gödöllő 2100 Dózsa György út 88-90. Tel.: +36 28 412 808
 Gyomaendrőd 5500 Bajcsy-Zsilinszky u. 53. Tel.: +36 66 280 288
 Gyöngyös 3200 Vásár út 1. Tel.: +36 37 304 249
 Győr 9024 Mécs László út 5. Tel.: +36 96 518 280
 Győr II. 9027 Puskás Tivadar u. 8. Tel.: +36 96 887 948
 Gyula 5700 Csabai út 9. Tel.: +36 66 889 147
 Hajdúszoboszló 4220 Dorogi út 25. Tel.: +36 52 887 081
 Hajdúszoboszló 4200 Dózsa György u. 19. Tel.: +36 52 888 674
 Hatvan 3000 Horváth Mihály út 69. Tel.: +36 37 345 640
 Hódmezővásárhely 6800 Szántó Kovács János u. 108. Tel.: +36 62 221 399
 Jászberény 5100 Vásár tér 1. Tel.: +36 57 505 800
 Kaposvár 7400 Gyár utca 64. Tel.: +36 82 510 290
 Karcag 5300 Kisdíszállási út 110. Tel.: +36 59 889 101
 Kazincbarcika 3700 Bercsényi u. 2. Tel.: +36 48 704 020
 Kecskemét 6000 Szent László krt. 29. Tel.: +36 76 505 279
 Keszthely 8360 Csapás út 10. Tel.: +36 83 312 321

Kiskunfélegyháza 6100 Szegedi út 54. Tel.: +36 76 887 274
 Kiskunhalas 6400 Átiós út 35-37. Tel.: +36 77 997 001
 Kisvárd 4600 Mátyás király u. 116. Tel.: +36 45 889 100
 Komárom 2900 Bálhory út 1. Tel.: +36 34 880 554
 Komló 7300 Bem József utca 4. Tel.: +36 72 887 654
 Kőrmend 8900 Rákóczi u. 57/A Tel.: +36 94 887 008
 Makó 6900 Deák Ferenc u. 61. Tel.: +36 62 209 500
 Marcali 8700 Nosszoply G. u. 12. Tel.: +36 85 889 114
 Mátészalka 4700 Jármi út 51/A Tel.: +36 44 500 423
 Miskolc 3527 József Attila u. 74. Tel.: +36 46 506 857
 Mohács 7700 Pécsi út 43. Tel.: +36 69 889 103
 Mór 8060 Mikes Kelemen u. 6. Tel.: +36 22 880 557
 Mosonmagyaróvár 9200 Gabonarakpart 18. Tel.: +36 96 889 871
 Nagyatád 7500 Plac tér 1345/6 hrsz. Tel.: +36 82 801 002
 Nagykanizsa 8800 Siíngaatóni út 33. Tel.: +36 93 536 230
 Nyíregyháza 4400 Pazonyi u. 15. Tel.: +36 42 400 872
 Nyíregyháza II. 4400 Debreceni út 228. Tel.: +36 42 886 899
 Orosháza 5900 Október u. 6. Tel.: +36 68 512 510
 Ózd 3600 Malom u. 1. Tel.: +36 48 889 106
 Pécs 7030 Nyárfa utca 1. Tel.: +36 75 889 110
 Pécs 8500 Külső-Veszprémi út 57. Tel.: +36 89 311 992
 Pécs 7622 Légszuszgúr u. 36. Tel.: +36 72 333 296
 Salgótarján 3100 Rákóczi út 135/A Tel.: +36 32 513 410
 Sárospatak 7000 Ady Endre út 210. Tel.: +36 25 889 101
 Sárospatak 3950 Wesselényi u. 20/A Tel.: +36 47 887 014
 Sárvár 9600 Szombathelyi út 52. Tel.: +36 95 887 014
 Siklós 7800 Felszabadulási utca 94. Tel.: +36 73 889 105
 Siófok 8600 Ipar utca 4. Tel.: +36 84 510 030
 Solvadtartó 6230 Kossuth u. 110. Tel.: +36 78 886 610
 Solymár 2083 Bécsi út 17/C Tel.: +36 26 560 263
 Sopron 9400 Győri út 50/A Tel.: +36 99 505 917
 Szarvas 5540 Vasút u. 31. Tel.: +36 66 510 694
 Szeged 6724 Bakay Nándor út 29. Tel.: +36 62 550 490
 Székesalvár 8000 Zámolyi út Tel.: +36 22 500 260
 Szekszárd 7100 Rákóczi út 134/A Tel.: +36 74 511 313
 Szentendre 2000 Dózsa György út 87. Tel.: +36 26 889 100
 Szentos 6600 Alsórád 250/A Tel.: +36 63 311 218
 Szerencs 3900 Gyár út 61. Tel.: +36 47 887 301
 Szilgentszentmiklós 2310 Gyári út 88. Tel.: +36 24 887 316
 Szivátvár 7900 József Attila u. 83/2. Tel.: +36 72 889 142
 Szolnok 5000 Mozdony u. 4. Tel.: +36 56 513 931
 Szombathely 9700 Zanati u. 50. Tel.: +36 94 510 400
 Tamási 7090 Rákóczi Ferenc út 87. Tel.: +36 74 887 599
 Tapolca 8300 Dózsa György út 34. Tel.: +36 87 887 650
 Tatabánya 2800 Szent Borbála út 22. Tel.: +36 34 511 530
 Tiszaújváros 3580 Debreceni út 3. Tel.: +36 49 886 399
 Vác 2600 Szent László út 11. Tel.: +36 27 311 290
 Várpalota 8100 Szent Imre u. 15. Tel.: +36 88 889 129
 Vecsés 2220 Fő út 187. Tel.: +36 29 889 148
 Veszprém 2112 Szadai út 18/C Tel.: +36 28 500 143
 Veszprém 8200 Veszprém, Mártírok útja 13. Tel.: +36 88 580 640
 Zalaegerszeg 8900 Siíngaatóni út 6/A Tel.: +36 92 510 280
 Zirc 8420 Kossuth Lajos utca 72. Tel.: +36 88 889 128

Filiale din Slovacia

Košice 040 01 Rosnák 7 Tel.: +421 55 699 8551
 Žilina 010 01 Bytčická 2 Tel.: +421 41 548 8146



COMPUS DIN INGREDIENTE SPECIALE. MATURAT ÎN BUTOAI DE METAL.
 LUBRIFIANT DE CALITATE SUPERIOARĂ.





WWW.UNIXAUTO.RO