

# VIGOR EQUIPMENT®

TOOL CATALOGUE  
WERKZEUG-KATALOG

2015

K15-EN/DE



[www.vigor-equipment.com](http://www.vigor-equipment.com)

Valid until December 2015 / Gültig bis 31.12.2015



Content	Inhalt	from page ab Seite
Tool Trolley and Work Bench with Assortment	Werkstattwagen und Werkbank inkl. Sortiment	14
Tool Trolleys and Work Bench	Werkstattwagen und Werkbank, einzeln	24
Tool Trolley Accessories	Werkstattwagen-Zubehör	27
Work Bench / Tool Cabinet	Werkbank / Werkzeugschrank	31
Soft Foam Inserts	Weichschaum-Einlagen	33
Tool cases	Werkzeugkoffer	41
Socket Systems	Steckschlüssel-Systeme	42
Wrenches	Schraubenschlüssel	71
Screwdrivers and Bits	Schraubendreher und Bits	78
Pliers	Zangen	84
Hand Tools	Handwerkzeuge	94
Measuring Tools	Mess-Werkzeuge	101
Cutting and Sawing	Schneiden / Sägen / Zerspanen	102
Lights	Lampen / Leuchten	108
Torque Tools	Drehmoment-Werkzeuge	111
Pneumatic Tools	Druckluft	114
Carriers / Diagnostics / Battery	Tragehilfen / Diagnose / Batterie	116
Electrical System	Elektrik	117
Engine / Radiator / A/C	Motor / Kühlung / Klima	118
Oil service	Öldienst	126
SAC Clutch	SAC-Kupplung	131
Brakes	Bremsen	132
Wheels/Tyres	Räder / Reifen	138
Motor Vehicles – Chassis	KFZ-Fahrwerk	148
Commercial Vehicles – Chassis	NFZ-Fahrwerk	151
Car body	Karosserie	152

## Description of icons / Erklärung der Piktogramme

	Tools for motor vehicles	KFZ Werkzeug
	Tools for trucks	LKW Werkzeug
	Operating instructions / Application note	Betriebsanleitung / Anwendungshinweis
	Central locking	Zentralverriegelung
	Weight of Tool Trolley	Gewicht Werkstattwagen
	Loading capacity of Tool Trolley	Traglast Werkstattwagen
	Number of pieces	Teiligkeit
	Teeth (of wrenches)	Zähne (bei Schlüsseln)
	Rotation angle	Drehwinkel
	Bore holes	Bohrungen
	Shafts	Wellen
	Magnet	Magnet
	Operating time	Leuchtdauer
	Charging time	Ladezeit
	Weight	Gewicht
	Battery type	Batterietyp
	Audible signal	Akkustisches Signal
	Working pressure	Betriebsdruck
	Vibration	Vibration
	rpm	U/min
	Sound level	Lautstärke
	Max. loosening torque	Max. Lösemoment
	Twin hammer mechanism	Doppelhammerschlagwerk
	Coupler plug, nominal size	Kupplungsstecker-Nennweite
	Battery type	Batterietyp
	Test Equipment	Prüfgeräte
	SUV/Van	SUV/Van
	Agricultural Machinery	Landmaschinen
	Industry	Industrie
	QR Code	QR-Code
	Application video	Anwendungsvideo
	Hose length	Schlauchlänge
	Oil capacity	Ölinhalt
	Hydraulic working	Hydraulische Nutzung
	Mechanical working	Mechanische Nutzung

## Description of drive symbols / Erklärung Antriebssymbole

	For slotted screws	Für Schlitz-Schrauben
	For Phillips-Recess screws (PH)	Für Kreuzschlitz-Schrauben (PH)
	For Pozidriv screws (PZ)	Für Pozidriv-Schrauben (PZ)
	For inside hexagon screws	Für Innensechskant-Schrauben
	For outside hexagon screws	Für Außensechskant-Schrauben
	For inside TORX® screws	Für Innen TORX® Schrauben
	For tamper-resistant TORX® screws (Inside TORX® screws with pin)	Für Tamper Resistant TORX® Schrauben (Innen TORX® Schrauben mit Zapfenführung)
	For outside TORX® screws	Für Außen TORX® Schrauben
	For screws with internal serration XZN	Für Innenvielzahn-Schrauben (XZN)
	For spline socket screws RIBE CV	Für Innenkeilprofil-Schrauben
	For Polydrive screws	Für Polydrive-Schrauben
	For inside -5-star screws with centre pin	Für Innen-5-Stern-Schrauben mit Zapfen
	For Tri-Wing® screws	Für Tri-Wing® Schrauben
	Nominal size 6.3	Nenngröße 6,3
	Nominal size 10	Nenngröße 10
	Nominal size 12.5	Nenngröße 12,5
	Nominal size 20	Nenngröße 20
	Nominal size 25	Nenngröße 25
	Inside square	Innen-Vierkant
	Outside square	Außen-Vierkant
	Inside hexagon	Innen-Sechskant
	Outside hexagon	Außen-Sechskant
	EN/IEC 60900:2004	EN/IEC 60900:2004

## A

ABS reamer set .....	132
Accessories for ViGOR 500, 600, 700, 800.....	27
Accessories for ViGOR 1000.....	30
Adapter.....	46, 50, 59, 63
Adapter insert.....	33
Adapter set.....	70
Adapter Set for V1293 .....	130
Air blow gun.....	115
Anti-freeze tester .....	121
Anti-slipping mat .....	27
Auto-impact centre punch .....	95
Axle oil drain pan for trucks.....	128

## B

Balance weight pliers .....	144
Balance weight remover .....	144
Ball joint puller, hydraulic .....	149
Battery and charging system tester with thermal printer .....	117
Battery carrier.....	116
Battery cell tester .....	116
Bit adapter .....	46, 50, 59
Bit box .....	83
Bit box with finger ratchet .....	83
Blind rivet pliers .....	92
Bottle jack .....	139
Brake and fuel line inspection tool.....	134
Brake calliper file .....	134
Brake line wrench set.....	135
Brake piston readjusting tool set .....	137
Brass brake calliper brush.....	134
Brass wire brush.....	105
Brush set.....	98

## C

Camshaft holding tool.....	119
Can holder.....	27, 30
Car light tester .....	117
Carrier.....	116
Centre punch.....	95
Chain brush for motorcycle, bicycle and drive chain cleaning.....	98
Charging Cable for LED Folding Light .....	109
Chisel.....	95
Clamping screw disassembly tool set for four-link axle VAG .....	150
Club hammer .....	94
Combination pliers.....	84
Combination pliers with double joint.....	88
Combination wrench .....	72
Combination wrench set .....	35, 72
Cooling system diagnosis set .....	120
Cordless mini grinder .....	100
Crimping pliers set.....	91
Cutter.....	104
Cutter, scraper and tweezers set .....	36

## D

Diagonal cutters.....	84
Digital vernier calliper.....	101
Document holder.....	27
Double box-end wrench.....	72
Double box-end wrench and double open-end wrench set .....	38
Double box-end wrench, double open-end wrench, combination wrench set.....	41

## D

Double flexible head wrench.....	71
Double joint pliers set.....	35
Double open-end wrench .....	35, 71
Double open-end, double box-end and combination wrench set .....	38
Double ratcheting box-end wrench.....	76-77
Drift punch .....	95

## E

Electronic screwdriver set .....	80
Extension .....	46, 50, 59, 63, 65
Extractor socket with spiral profile.....	54, 60

## F

Feeler gauge set .....	101
File set .....	36
Fine-tooth reversible ratchet.....	45, 49, 56, 70
Finger ratchet .....	45
Fixed torque wrench.....	111
Flat chisel.....	95
Flat hand file .....	105
Flexible extension .....	46
Four-way rim wrench .....	138

## G

Generator socket set.....	123
Glow plug socket set .....	47
Grip pliers .....	36, 90
Guide bolts repair set .....	150

## H

Half-round file .....	105
Hammer, chisel and drift punch set.....	36
Hammer, pliers and screwdriver set.....	40
Hammers, pliers and chisels set .....	37
Hand pump with manometer .....	120
Hand riveting tool for blind rivets and rivet nuts..	92
Headlamp.....	110
Hex-nut driver .....	80
Hexagon T-handle screwdriver.....	82
Holder for paper reel .....	30
Hook and scraper set .....	96
Hook and scraper set with car light tester .....	36
Hose clamp set.....	118
HSS step drill set .....	106
Hydraulic aluminium service jack 1.35 t .....	140
Hydraulic service jack.....	141

## I

Impact socket set .....	146
Impact wrench.....	114
Indexable ratcheting pry bar set .....	97
Induction heater .....	152
Injector sealing seat cleaning set .....	122
Inside hexagon tool set .....	34

## J

Jack stands .....	142
Japanese pull-stroke saw.....	103

## K

Kneeling mat .....	100
--------------------	-----

## L

LED extension.....	59
LED light .....	108-110
Lever removing set.....	96
Line wrench set .....	136
Lockring pliers .....	86-87

## M

Machinist's hammer .....	94
Magnetic pick-up tool.....	99
Manometer for turbo system pressure tester kit .....	124-125
MasterKey construction and electronics .....	95
Measuring and cutting tools and pliers set .....	39
Metal tightening strap set .....	151
Mini LED flash light.....	110
Mobile tensioning block.....	102
Multi-tool 14 in 1.....	89
Multifunctional drain pan.....	128

## O

Offset screwdriver .....	81
Oil dipstick.....	126
Oil drain hose.....	129
Oil filling device with adapter set .....	130
Oil filter tool .....	127

## P

Pair of holding plates for the under-bench cabinet ViGOR 1000 .....	31
Panel partition/separation sheet assortment .....	30
Phillips-Recess screwdriver .....	78
Pick-up tool with claws .....	99
Pipe locking tool set.....	118
Plastic cover .....	30
Plastic hammer.....	94
Plastic hand riveting tool.....	93
Pliers set .....	35, 39
Pliers, hammer and chisel set .....	41
Pneumatic brake piston readjusting tool set .....	137
Precision oiler .....	99
Pry bar set .....	97

## R

Radiator tester set for commercial vehicles .....	121
Ratcheting box-end wrench .....	77
Ratcheting combination wrench and 15° offset combination wrench set .....	38
Ratcheting combination wrench set.....	35, 73-75
Ratcheting exhaust pipe cutter .....	107
Ratcheting tube cutter.....	107
Refractometer.....	121
Repair set .....	45, 49, 56
Repair set for plastic parts.....	154
Replacement container for oil filling device.....	130
Reversible ratchet.....	63, 65
Reversible ratchet with T-handle.....	45
RIBE screwdriver socket .....	37, 53, 58
Rotation angle tester.....	113
Round file .....	105
Rubber hammer.....	147

## S

SAC clutch alignment tool set.....	131
------------------------------------	-----

## S

Saw frame.....	103
Scraper and screwdriver set.....	40
Scraper set.....	96
Scrapers.....	95
Screw extractor set.....	60
Screw sleeve.....	106
Screwdriver.....	35–37, 39–40, 78–82
Screwdriver for slotted screws.....	78
Screwdriver set.....	35, 37, 40, 78
Screwdriver set with impact cap.....	35, 78
Screwdriver socket.....	44–45, 49
Screwdriver socket set.....	34, 37, 52–54, 57
Separation sheet set.....	27, 30
Shock absorber assembly tool set.....	149
Sliding head/adaptor.....	50
Sliding piece.....	59, 65
Sliding T-handle.....	46, 59, 63, 65
Small hack saw.....	103
Snipe nose pliers.....	84
Snipe nose pliers with double joint.....	88
12-point socket.....	65
Socket.....	44, 48, 56, 63
Socket set.....	34, 40, 42–43, 47, 51, 62, 64, 66–68
Socket set with multi-purpose profile.....	43, 51
Socket tool set.....	34, 37–38, 40
Socket with multi-purpose profile.....	44, 56
Soft foam insert, empty.....	34–41
Soldering iron.....	100
Spare blades.....	95, 104, 107
Spare heads (pair).....	94
Spare parts for ViGOR 500, 600, 700 and 800.....	27
Spare Thermal Paper Rolls.....	117
Spare Tightening Strap for Oil Filter Wrench V2511.....	127
Spark plug socket.....	48, 56
Special twist sockets.....	145
Spin type speeder.....	45
Spirit level.....	101
Spreading pad.....	156
Square file.....	105
Stainless steel wire brush.....	105
Steel brake calliper brush.....	134
Steel wire brush.....	105
Steering tie rod joint tool.....	148
Steering wheel level.....	147
Strip LED-Lampe, 2er Set.....	108
Sub Maker Quadro 10-in-1.....	94

## T

Tap set.....	106
Tape measure.....	101
Tensioning ratchet.....	151
Thread repair set.....	106
Three square file.....	105
Tool bin.....	27
Tool cabinet.....	31
Tool case.....	41
Tool chest / Under-bench cabinet.....	28
Tool hook sets for tool cabinet.....	31
Tool trolley with assortment.....	14–16, 18–23
Tool trolley, empty.....	24–25, 28–29
Torch light, 1 watt.....	110
Torque wrench.....	111–112
TORX® and 6-point T-handle screwdriver set.....	39–40
TORX® and socket assortment for screws with internal serration (XZN).....	34

## T

TORX® screwdriver.....	35, 79
TORX® screwdriver socket.....	37, 45, 49, 52, 58–59
TORX® socket.....	44, 48, 56, 69
TORX® T-handle screwdriver.....	82
TORX® tool set.....	34
Tube bending tool.....	135
Tube cutter.....	107
Tube flaring tool set.....	133
Turbo system pressure tester.....	124, 125
Tweezers set.....	99
Twist drill and scraper set.....	34
Twist drill set.....	106
Tyre lever.....	143
Tyre pressure gauge.....	145
Tyre tread depth gauge.....	145

## U

Universal clamping piece with plastic protective jaws.....	149
Universal joint.....	46, 50, 59
Universal knife.....	104
Universal pliers.....	89
Universal shear.....	104
Universal tool case.....	41

## V

V-ribbed belt tool assortment.....	119
Vacuum filling unit.....	120
Vacuum pump.....	129
VDE combination pliers.....	85
VDE diagonal cutter.....	85
VDE extension.....	61
VDE Phillips-Recess screwdriver.....	79
VDE pliers set.....	36
VDE reversible ratchet.....	61
VDE round nose pliers.....	84
VDE screwdriver.....	36, 79
VDE Screwdriver socket.....	61
VDE snipe nose pliers.....	85
VDE socket.....	36, 55, 61
VDE wire stripper.....	85
Voltmeters.....	80

## W

Window pane holders.....	156
Window scraper.....	95
Wiper arm extractor set.....	155
Wire brush with scraper.....	105
Work bench.....	17, 26, 31, 32
Wrench assortment.....	38
Wrenching bar 70 cm.....	97

## A

ABS-Reibahlen-Satz..... 132  
 Adapter..... 46, 50, 59, 63  
 Adapter-Einlage..... 33  
 Adapter-Satz..... 70  
 Akku-Schleifer..... 100  
 Aluminium-Ratschen-Ringschlüssel..... 77  
 Aluminium-Ratschen-Ringschlüssel-Satz..... 77  
 Anhängerkästen, groß..... 27  
 2 Anhängerkästen, klein..... 27  
 Anti-Rutschmatte..... 27  
 Aufsatzkoffer für Werkstattwagen V1901 /  
 Unterschrank für Werkbank V2531, leer..... 28  
 Ausblas-Pistole..... 115  
 Ausblas-Pistole, ausziehbar..... 115  
 Auspuff-Ratschenrohrschneider..... 107  
 Auswuchtgewicht-Zange..... 144  
 Autolichtprüfer..... 117

## B

Bandmaß..... 101  
 Batterie-Tragegriff..... 116  
 Batterietester..... 116  
 Batterietester und Ladesystem-Prüfgerät  
 mit Thermodrucker..... 117  
 Bit Box..... 83  
 Bit-Adapter..... 46, 50, 59  
 Bit-Box mit Fingerratsche..... 83  
 Blindniet-Zange..... 92  
 Bördelgerät-Satz..... 133  
 Brecheisen 70 cm..... 97  
 Bremskolben-Rückstell Werkzeug-Satz..... 137  
 Bremsleitungs-Schlüssel-Satz..... 135  
 Bremssattel-Bürste, Messing..... 134  
 Bremssattel-Bürste, Stahl..... 134  
 Bremssattel-Feile..... 134  
 Bürsten-Satz..... 98

## C

Crimpzangen-Satz..... 91  
 Cutter-Messer..... 104

## D

Digitaler Messschieber..... 101  
 Dokumentenhalter..... 27  
 Doppel-Gelenkschlüssel..... 71  
 Doppel-Gelenkschlüssel-Satz..... 71  
 Doppel-Maulschlüssel..... 71  
 Doppel-Maul-, Doppel-Ring-und  
 Ring-Maulschlüssel-Satz..... 38  
 Doppel-Maulschlüssel-Satz..... 35, 71  
 Doppel-Ratschen-Ringschlüssel..... 76-77  
 Doppel-Ratschen-Ringschlüssel-Satz..... 77  
 Doppel-Ringschlüssel..... 72  
 Doppel-Ringschlüssel-,  
 Doppel-Maulschlüssel-,  
 Ring-Maulschlüssel-Satz..... 41  
 Doppel-Ringschlüssel-Sortiment..... 72  
 Doppel-Ringschlüssel-und  
 Doppel-Maulschlüssel-Satz..... 38  
 Doppel-Sechskant  
 Steckschlüssel-Einsatz..... 65  
 Doppelgelenk-Zangen-Satz..... 35  
 Dosenhalter..... 27, 30  
 Drahtbürste mit Schaber..... 105  
 Drehmoment-Schlüssel..... 111-112  
 Drehwinkel-Messgerät..... 113

## E

Edelstahl-Drahtbürste..... 105  
 Einhand-Universalzange..... 89  
 Einteilungs- / Trennblech-Sortiment..... 30  
 Elektronik-Schraubendreher-Satz  
 in Kunststoff-Box..... 80  
 Ersatzbehälter für Öl-Einfüllgerät..... 130  
 Ersatzkopf (Paar)..... 94  
 Ersatzteile für  
 VIGOR 500, 600, 700 and 800..... 27  
 Erweiterung-Sortiment  
 für SAC-Kupplungswerkzeug..... 131

## F

Fäustel..... 94  
 Feilen-Satz..... 36  
 Feinzahn-Umschaltknarre..... 45, 49, 56  
 Feinzahn-Umschaltknarren-Satz..... 70  
 Fingerratsche..... 45  
 Flachmeißel..... 95  
 Flachrund-Zange..... 84  
 Flachrundzange mit Doppelgelenk..... 88  
 Flaschenwagenheber 2 t..... 139  
 Flaschenwagenheber 6 t..... 139  
 Flexible Verlängerung..... 46  
 Frostschutz-Prüfer..... 121  
 Fühlerlehren-Satz..... 101  
 Führungsbolzen-Reparatur-Satz..... 150

## G

Gelenk-Ratschen-Ring-Maulschlüssel..... 75  
 Gelenk-Ratschen-Ring-Maulschlüssel-Satz..... 75  
 Gewinde-Reparatur-Satz..... 106  
 Gewindebohrer-Satz..... 106  
 Gleitgriff..... 46, 59, 63, 65  
 Gleitstück..... 59, 65  
 Glühkerzen-Steckschlüssel-Satz..... 47  
 Grip-Zangen-Satz..... 36  
 Grip-Zangen-Satz in Rolltasche..... 90  
 Gummihammer 2,5 kg..... 147  
 Gummihammer 5 kg..... 147

## H

Haken-und Schaber-Satz..... 96  
 Halteblech-Paar für Unterschrank VIGOR 1000... 31  
 Hammer-, Meißel-und Durchtreiber-Satz..... 36  
 Hammer-, Zangen-, Schraubendreher-Satz..... 40  
 Hammer-, Zangen-und Meißel-Satz..... 37  
 Handpumpe mit Manometer..... 120  
 Hebeleisen-Satz..... 97  
 HSS Stufenbohrer-Satz..... 106  
 Hydraulik Alu-Rangier-Wagenheber 1,35 t..... 140  
 Hydraulik-Rangier-Wagenheber 2 t..... 141  
 Hydraulik-Rangier-Wagenheber 3 t..... 141

## I

Induktionsheizgerät mit  
 Kunststoffreparatur-Funktion..... 152  
 Injektorschacht-Reinigungs-Satz..... 122  
 Innensechskant Schraubendreher-Einsatz..... 57  
 Innensechskant Schraubendreher-  
 Einsatz-Sortiment..... 37, 53  
 Innensechskant-Werkzeug-Satz..... 34  
 Innenvielzahn Schraubendreher-Einsatz (XZN) .... 57  
 Innenvielzahn Schraubendreher-Einsatz (XZN)  
 Sortiment..... 37

## J

Innenvielzahn Schraubendreher-  
 Einsatz-Sortiment (XZN)..... 52  
 Innenvielzahn-Einsätze (XZN) und  
 Spiralbohrer-Satz..... 34  
 Inspektions-Werkzeug für  
 Brems-und Kraftstoffleitungen..... 134

## K

Japanische Zugsäge..... 103

**K**

Keilrippenriemen Werkzeug-Sortiment..... 119  
 360°-Kettenbürste zur Reinigung von  
 Motorrad-/ Fahrrad-/ Antriebsketten..... 98  
 Klebegewicht-Entferner..... 144  
 Klebegewicht-Entferner-Satz..... 144  
 Kleine Handbügel-Säge..... 103  
 Klemmschrauben-DEMONTAGE-Werkzeug-Satz  
 für Vierlenker-Achse VAG..... 150  
 Kniekissen..... 100  
 Kombizange..... 84  
 Kombizange mit Doppelgelenk..... 88  
 Körner..... 95  
 Krallengreifer..... 99  
 Kreuzmeißel..... 95  
 Kreuzschlitz-Schraubendreher..... 78  
 Kreuzschlüssel..... 138  
 Kugelgelenk-Abzieher, hydraulisch..... 149  
 Kühlersystem-Diagnose-Satz..... 120  
 Kühlsystem-Diagnosekoffer Nfz..... 121  
 Kunststoff-Haube..... 30  
 Kunststoff-Nietzange..... 93  
 Kunststoff-Reparatur-Satz..... 154  
 Kunststoff-Schonhammer..... 94

## L

12 V Ladegerät für LED-Knicklampe V2316..... 109  
 LED-Knicklampe..... 109  
 LED-Lampe..... 108  
 LED-Lampe 3 Watt..... 109  
 LED-Verlängerung..... 59  
 Leitungsschlüssel-Satz..... 136  
 Lenkrad-Einstellwaage..... 147  
 Lichtmaschinen Steckschlüssel-Satz..... 123  
 Lkw-Achsölwanne..... 128  
 Lösehebel-Satz..... 96  
 LötKolben..... 100

## M

Magnetheber..... 99  
 Manometer für  
 Turbosystem-Abdrücker-Satz..... 124-125  
 MasterKey Bau..... 95  
 MasterKey Elektro..... 95  
 Maul-Gripzange..... 90  
 30 l Mehrzweckwanne mit Rollen, extraflach.... 128  
 Mess-, Schneidewerkzeuge, Zangen-Satz..... 39  
 Messer-, Schaber-und Pinzetten-Satz..... 36  
 Messing-Drahtbürste..... 105  
 Metall-Spannband-Satz..... 151  
 Mini LED-Stableuchte..... 110  
 Mobiler Spannbock..... 102  
 Multi-Tool 14-in-1..... 89  
 Multiprofil Steckschlüssel-Satz..... 43, 51  
 Multiprofil-Steckschlüssel Einsatz..... 44, 56

## N

Nockenwellen-Arretierwerkzeug ..... 119

## O

Öl-Einfüllgerät mit Adapter-Satz ..... 130  
 Ölablass-Schlauch ..... 129  
 Ölfilterbandschlüssel für den Pkw-Bereich ..... 127  
 Ölfilterkralle für Pkw ..... 127  
 Ölfilterschlüssel-Satz ..... 127  
 Ölmesststab AUDI ..... 126  
 Ölmesststäbe-Satz MERCEDES-BENZ ..... 126

## P

Papierrollenhalter ..... 30  
 Pinzetten-Satz ..... 99  
 Pneumatischer Bremskolben-  
 Rückstellwerkzeug-Satz ..... 137  
 Präzisions-Ölspritze ..... 99  
 Profiltiefenmesser ..... 145

## R

Ratschen-Ring-Maulschlüssel und 15° gekröpfte  
 Ring-Maulschlüssel-Satz ..... 38  
 Ratschen-Ring-Maulschlüssel ..... 35, 73–74  
 Ratschen-Rohrschneider ..... 107  
 Refraktometer ..... 121  
 Reifen- und Montagehebel ..... 143  
 Reifen- und Montagehebel  
 mit Kunststoff-Belag ..... 143  
 Reifendrucktester ..... 145  
 RIBE Schraubendreher-Einsatz ..... 58  
 RIBE Schraubendreher-Einsatz-Sortiment ..... 37, 53  
 Ring-Maulschlüssel ..... 72  
 Ring-Maulschlüssel-Satz ..... 35, 72  
 Rohrbieger ..... 135  
 Rohrleitungsstopper-Satz ..... 118  
 Rohrschneider ..... 107

## S

SAC-Kupplungswerkzeug-Satz ..... 131  
 Sägebogen ..... 103  
 Saugheber ..... 156  
 Schaber ..... 95  
 Schaber für Glasoberflächen ..... 95  
 Schaber-Satz ..... 96  
 Schaber-und Hakensatz  
 inkl. Autolichtprüfer ..... 36  
 Scheibenwischerarm-Abzieher-Satz ..... 155  
 Schiebestück/Adapter ..... 50  
 Schlagschrauber ..... 114  
 Schlagschrauber-Steckschlüssel-Satz ..... 146  
 Schlauchklemmen-Satz ..... 118  
 Schlitz-Schraubendreher ..... 78  
 Schlosser-Hammer ..... 94  
 Schraubenausdreher-Satz ..... 60  
 Schraubendreher, kurz ..... 81  
 Schraubendreher-Einsatz ..... 44–45, 49  
 Schraubendreher-Einsatz-Sortiment ..... 37, 54  
 Schraubendreher-Satz ..... 35, 40, 78  
 Schraubendreher-Satz mit Bit-Box ..... 37  
 Schraubendreher-Satz mit Schlagkappe ..... 35, 78  
 Schraubendreher-und Schaber-Satz ..... 40  
 Schraubendreher-und Zangen-Satz ..... 39  
 Schraubenschlüssel-Sortiment ..... 38  
 Sechskant T-Griff Schraubendreher ..... 82  
 Sechskant-Steckschlüssel-Schraubendreher ..... 80

## S

Sechskant-Steckschlüssel-  
 Schraubendreher-Satz ..... 80  
 Sechskant-T-Griff Schraubendreher-Satz ..... 82  
 Seitenschneider ..... 84  
 Selbstschlagender Körner ..... 95  
 Spannratsche ..... 151  
 Spannungsprüfer ..... 80  
 Spezial-Ausdreh-Steckschlüssel-Einsätze ..... 145  
 Spiralbohrer-Satz ..... 106  
 Spiralbohrer-und Schaber-Satz ..... 34  
 Spiralnutenausdreher-Einsatz ..... 60  
 Spiralnutenausdreher-Einsatz-Sortiment ..... 54  
 Splint-Austreiber ..... 95  
 Spurstangen-Gelenk-Werkzeug ..... 148  
 Stahl-Drahtbürste ..... 105  
 Steckgriff ..... 45  
 Steckschlüssel-Einsatz ..... 44, 48, 56, 63  
 Steckschlüssel-Einsatz, lang ..... 44, 48, 56  
 Steckschlüssel-Einsatz-Sortiment ..... 40  
 Steckschlüssel-Einsatz-Sortiment, lang ..... 34  
 Steckschlüssel-Satz ..... 42, 47, 51, 62, 64, 66–68  
 Steckschlüssel-Werkzeug-Satz ..... 34, 37–38, 40  
 Stirnlampe ..... 110  
 Stoßdämpfer-Montagewerkzeug-Satz ..... 149  
 Strip LED-Lampe ..... 108  
 Strip LED-Lampe, 2er Set ..... 108

## T

T-Griff-Umschaltknarre ..... 45  
 Taschenlampe, 1 Watt ..... 110  
 TORX® Schraubendreher ..... 79  
 TORX® Schraubendreher-Einsatz ..... 45, 49, 58–59  
 TORX® Schraubendreher-  
 Einsatz-Sortiment ..... 37, 52  
 TORX® Schraubendreher-Satz ..... 35, 79  
 TORX® Steckschlüssel-Einsatz ..... 44, 48, 56  
 TORX® Steckschlüssel-Satz ..... 69  
 TORX® T-Griff Schraubendreher ..... 82  
 TORX® T-Griff Schraubendreher-Satz ..... 82  
 TORX® und Innenvielzahn-Einsatz-  
 Sortiment (XZN) ..... 34  
 TORX® und Sechskant T-Griff-  
 Schraubendreher-Satz ..... 39–40  
 TORX® Werkzeug-Satz ..... 34  
 Tragehilfe ..... 116  
 Trennblech-Satz ..... 27  
 Trennblech-Sortiment ..... 30  
 Turbosystem-Abdrücker-Satz ..... 124  
 Turbosystem-Abdrücker-Satz  
 für Klicksysteme ..... 125  
 Türöffner-Spreizkissen ..... 156

## U

Umschaltknarre ..... 63, 65  
 Universal-Messer ..... 104  
 Universal-Nietzange für  
 Blindnieten und Nietmutter ..... 92  
 Universal-Schere ..... 104  
 Universal-Werkzeugkoffer ..... 41  
 Universalgelenk ..... 46, 50, 59  
 Universalzange ..... 89  
 Unterstellbock-Satz 6t ..... 142  
 Unterstellböcke 3t ..... 142

## V

Vakuum-Befüllleinheit ..... 120

## V

Vakuumpumpe ..... 129  
 VDE Rundzange ..... 84  
 VDE-Abisolierzange ..... 85  
 VDE-Flachrund-Zange ..... 85  
 VDE-Kombizange ..... 85  
 VDE-Kreuzschlitz-Schraubendreher ..... 79  
 VDE-Schlitz-Schraubendreher ..... 79  
 VDE-Schraubendreher-Einsatz ..... 61  
 VDE-Schraubendreher-Satz ..... 36, 79  
 VDE-Seitenschneider ..... 85  
 VDE-Steckschlüssel-Einsatz ..... 61  
 VDE-Steckschlüssel-Satz ..... 36, 55  
 VDE-Umschaltknarre ..... 61  
 VDE-Verlängerung ..... 61  
 VDE-Zangen-Satz ..... 36  
 Verlängerung ..... 46, 50, 59, 63, 65  
 Verstellbarer Hebeleisen-Satz ..... 97  
 ViGOR 1000 Aufsatzschrank für Werkbank, mit 2  
 Roll-Jalousien, leer ..... 31  
 ViGOR 1000 Werkbank, leer ..... 31  
 ViGOR 1000 Werkbank-System, komplett ..... 32  
 Voreingestellter Drehmomentschlüssel ..... 111

## W

Wasserwaage ..... 101  
 2K-Weichschaum-Einlage, mit Leerfach ..... 36  
 Weichschaum-Einlage, leer ..... 34–41  
 Werkbank mit Sortiment ..... 17  
 Werkbank, leer ..... 26  
 Werkstattwagen inkl. Aufsatzkoffer, leer ..... 29  
 Werkstattwagen inklusive  
 Aufsatzkoffer und Sortiment ..... 14  
 Werkstattwagen mit Sortiment ..... 15–16, 18–23  
 Werkstattwagen, leer ..... 24–25, 28  
 Werkzeughaken-Sätze für Aufsatzschrank ..... 31  
 Werkzeugkoffer ..... 41  
 Winkelschraubendreher ..... 81  
 Winkelschraubendreher-Satz im Clip ..... 81

## Z

Zange für Sicherungsringe ..... 86–87  
 Zangen-, Hammer-und Meißel-Satz ..... 41  
 Zangen-Satz ..... 35, 39  
 Zubehör für ViGOR 500, 600, 700, 800 ..... 27  
 Zubehör für ViGOR 1000 ..... 30  
 Zündkerzen-Einsatz ..... 48, 56

### Numerical Index / Nummernverzeichnis

VIGOR-No.	Page Seite	VIGOR-No.	Page Seite	VIGOR-No.	Page Seite	VIGOR-No.	Page Seite	VIGOR-No.	Page Seite	VIGOR-No.	Page Seite	VIGOR-No.	Page Seite	VIGOR-No.	Page Seite
V1008	74	V1222	95	V1442	77	V1579	27	V1672	71	V1746	36	V1908	30	V2009	14-15, 41
V1009	74	V1251	25	V1443	77	V1581	25	V1673	72	V1747	38	V1909	30	V2014	50
V1010	74	V1252	24	V1444	77	V1582	20	V1674	72	V1748	17-18, 39	V1911	110	V2015	36
V1020	56	V1281	127	V1445	77	V1584	145	V1676	72			V1749	17	V1915	98
V1021	74	V1282	127	V1446	104	V1586	121	V1677	72	V1750	27	V1917	52	V2017	48
V1022	74	V1283	96	V1461	71	V1610	27	V1678	72	V1751	27	V1918	52	V2018	48
V1023	74	V1293	70	V1463	108	V1614	138	V1679	72	V1752	27	V1919	53	V2019	48
V1025	74	V1301	97	V1471	71	V1616	84	V1680	72	V1754	27	V1921	98	V2020	48
V1026	74	V1303	80	V1472	71	V1617	84	V1682	34	V1755	27	V1923	117	V2021	37
V1027	74	V1304	104	V1473	71	V1620	21	V1683	17-18, 35	V1756	27	V1923	117	V2022	17-18, 37
V1028	74	V1333	111	V1474	71	V1622	27			V1757	116	V1923	117	V1963	120
V1029	74	V1345	104	V1475	71	V1625	27	V1684	72	V1764	99	V1970	29	V2028	79
V1030	74	V1364	77	V1476	71	V1626	27	V1685	72	V1781	69	V1972	40	V2029	79
V1031	74	V1367	100	V1477	71	V1627	25	V1686	72	V1782	133, 135	V1973	40	V2030	79
V1032	45	V1368	95	V1478	71	V1628	25	V1687	72	V1783	95	V1974	41	V2032	17-18, 37
V1038	45	V1369	96	V1479	71	V1629	27	V1688	72	V1784	156	V1975	41	V2033	17-18, 37
V1039	70	V1372	95	V1480	71	V1630	27	V1689	72	V1785	89	V1976	44	V2059	57
V1040	72	V1378	145	V1481	71	V1631	27	V1690	72	V1787	105	V1977	44	V2060	57
V1041	72	V1382	24	V1482	71	V1632	27	V1691	72	V1788	105	V1978	44	V2061	79
V1042	72	V1386	27	V1483	20	V1633	27	V1692	72	V1789	105	V1979	44	V2062	79
V1043	72	V1387	27	V1487	19	V1634	27	V1693	72	V1790	105	V1980	44	V2063	79
V1044	72	V1389	27	V1506	38	V1635	27	V1694	72	V1801	105	V1981	44	V2064	79
V1045	72	V1390	27	V1507	37	V1636	27	V1695	72	V1802	90	V1982	44	V2065	57
V1047	72	V1391	27	V1509	34	V1637	78	V1698	78	V1803	90	V1983	44	V2066	57
V1048	72	V1396	24	V1510	39	V1644	27	V1699	78	V1804	90	V1984	44	V2067	57
V1049	72	V1397	24	V1511	37	V1645	27	V1700	78	V1805	135	V1985	44	V2068	57
V1050	72	V1398	24	V1512	34	V1646	27	V1701	78	V1806	36	V1986	44	V2069	57
V1051	72	V1399	24	V1513	38	V1649	35	V1702	78	V1807	36	V1987	44	V2070	57
V1052	72	V1400	77	V1514	36	V1651	35	V1703	78	V1808	90	V1988	56	V2071	46
V1053	72	V1409	82	V1517	19-21, 38	V1652	34	V1704	78	V1809	103	V1989	56	V2072	57
V1054	72	V1410	82			V1653	34	V1705	26	V1811	36	V1990	56	V1990	56
V1097	83	V1411	77	V1518	19, 37	V1654	34	V1706	68	V1841	135	V1991	56	V2074	57
V1131	59	V1412	77	V1519	21, 34	V1655	35	V1707	106	V1842	135	V1992	56	V2075	57
V1135	94	V1414	77	V1520	20, 39	V1656	37	V1711	137	V1843	135	V1993	56	V2076	57
V1138	80	V1415	77	V1521	19-21, 37	V1657	144	V1713	101	V1844	135	V1994	56	V2077	57
V1139	81	V1416	77			V1658	34	V1714	101	V1715	103	V1871	39	V1995	56
V1181	81	V1417	77	V1522	17, 19-21, 34	V1660	21, 34	V1716	86	V1893	99	V1996	56	V2079	57
V1203	106	V1418	77			V1661	34	V1662	17-18, 35	V1717	86	V1894	15	V1997	56
V1208	81	V1419	77	V1523	17, 19, 36	V1663	17-18, 35	V1718	86	V1895	14	V1998	56	V2081	57
V1209	81	V1420	77	V1524	72			V1719	86	V1720	100	V1897	43	V1999	56
V1212	94	V1423	145	V1525	19, 38	V1664	17-18, 20-21, 35	V1721	117	V1898	51	V2000	56	V2083	57
V1213	95	V1424	77	V1527	25			V1722	96	V1723	96	V1899	37	V2001	56
V1214	95	V1425	41	V1542	27	V1665	37	V1724	101	V1900	37	V2002	56	V2085	57
V1215	95	V1426	89	V1547	27	V1667	34	V1728	133	V1901	28	V2003	56	V2086	57
V1216	95	V1429	97	V1549	27	V1668	35	V1729	36	V1902	28	V2004	56	V2087	57
V1217	95	V1430	77	V1550	27	V1669	71	V1741	99	V1903	30	V2006	40	V2088	57
V1218	95	V1435	116	V1552	27	V1671	71	V1743	38	V1904	30	V2007	14-15, 40	V2007	14-15, 40
V1219	95	V1437	97	V1571	147	V1672	71	V1745	36	V1905	30			V2008	14-16, 41
V1220	95	V1438	99	V1578	25	V1673	72	V1746	36	V1906	30	V2009	14-15, 41	V2009	14-15, 41
V1221	95	V1441	77	V1442	77	V1674	72	V1747	38	V1907	30	V2010	30	V2010	30



# Numerical Index

## Nummern-/Seiten-Verzeichnis



### Numerical Index / Nummernverzeichnis

VIGOR- No.	Page Seite	VIGOR- No.	Page Seite	VIGOR- No.	Page Seite	VIGOR- No.	Page Seite	VIGOR- No.	Page Seite	VIGOR- No.	Page Seite	VIGOR- No.	Page Seite	VIGOR- No.	Page Seite
V2089	57	V2144	48	V2204	58	V2267	48	V2320	63	V2409	60	V2459	121	V2514	144
V2090	57	V2145	48	V2205	58	V2268	48	V2321	63	V2410	60	V2460	51	V2515	144
V2091	57	V2146	48	V2206	58	V2269	48	V2322	63	V2411	134	V2461	67	V2516	144
V2092	57	V2149	49	V2207	58	V2270	48	V2323	63	V2412	84	V2462	30	V2517	31
V2094	57	V2151	58	V2208	58	V2271	48	V2324	63	V2413	44	V2463	31	V2518	31
V2095	57	V2152	58	V2209	58	V2272	48	V2325	63	V2414	42	V2464	41	V2519	31
V2096	57	V2153	58	V2210	58	V2273	48	V2326	63	V2415	44	V2465	56	V2520	31
V2097	57	V2154	58	V2211	58	V2274	48	V2327	63	V2416	44	V2466	133	V2521	127
V2098	57	V2155	58	V2212	58	V2275	48	V2328	63	V2417	44	V2467	133	V2522	146
V2099	57	V2156	58	V2213	58	V2276	48	V2329	63	V2418	44	V2471	146	V2523	155
V2100	57	V2157	58	V2214	58	V2277	48	V2330	63	V2419	44	V2472	146	V2531	31
V2101	57	V2158	58	V2215	58	V2278	48	V2331	63	V2420	44	V2473	146	V2532	31
V2102	57	V2159	58	V2216	58	V2279	49	V2332	63	V2421	44	V2474	146	V2533	44
V2103	57	V2160	58	V2217	58	V2280	49	V2333	63	V2422	44	V2475	146	V2534	44
V2104	57	V2161	58	V2218	58	V2281	49	V2334	63	V2423	44	V2477	142	V2535	44
V2105	57	V2162	58	V2219	58	V2282	49	V2335	63	V2424	44	V2478	139	V2536	44
V2106	57	V2163	58	V2220	58	V2283	49	V2336	63	V2425	44	V2479	139	V2537	44
V2107	57	V2165	58	V2221	58	V2284	49	V2337	63	V2426	44	V2480	141	V2538	44
V2108	50	V2167	58	V2222	58	V2285	49	V2338	100	V2427	44	V2481	140	V2539	44
V2109	59	V2168	58	V2223	58	V2286	49	V2347	109	V2428	44	V2482	82	V2540	133
V2110	59	V2169	58	V2224	58	V2287	49	V2363	38	V2429	44	V2483	82	V2542	41
V2111	63	V2170	58	V2225	58	V2288	49	V2364	38	V2430	44	V2484	82	V2551	133
V2112	126	V2171	58	V2226	58	V2289	49	V2373	38	V2431	44	V2485	82	V2552	133
V2113	57	V2172	58	V2227	58	V2290	49	V2374	38	V2432	44	V2486	82	V2553	133
V2114	50	V2173	58	V2228	58	V2291	49	V2375	22-23, 38	V2433	44	V2487	96	V2554	133
V2115	50	V2174	58	V2229	58	V2292	49	V2376	22-23, 39	V2434	44	V2488	96	V2555	133
V2116	50	V2175	58	V2230	58	V2293	49	V2377	39	V2435	44	V2489	82	V2556	133
V2117	50	V2176	58	V2231	58	V2294	49	V2378	20-23, 38	V2436	44	V2490	82	V2558	133
V2118	50	V2177	58	V2232	58	V2295	49	V2379	23	V2437	44	V2491	96	V2559	133
V2119	48	V2178	58	V2233	58	V2296	49	V2391	151	V2438	44	V2492	96	V2560	34
V2120	48	V2179	58	V2234	147	V2297	49	V2392	151	V2439	45	V2493	96	V2561	56
V2121	57	V2180	58	V2235	147	V2298	49	V2393	30	V2440	45	V2494	96	V2562	56
V2122	57	V2181	58	V2236	151	V2299	49	V2394	106	V2441	45	V2495	96	V2563	56
V2123	57	V2182	58	V2237	33	V2300	49	V2395	106	V2442	45	V2496	54	V2564	56
V2124	57	V2183	58	V2238	33	V2301	49	V2396	106	V2443	45	V2497	82	V2565	56
V2126	57	V2184	58	V2239	22, 36	V2302	49	V2397	30	V2444	45	V2498	82	V2566	56
V2128	57	V2185	44	V2240	36	V2303	49	V2398	30	V2445	45	V2499	91	V2567	56
V2129	57	V2186	44	V2249	134	V2304	49	V2399	30	V2446	45	V2501	82	V2568	56
V2132	57	V2187	44	V2250	134	V2305	47	V2400	41	V2447	45	V2502	82	V2569	56
V2133	57	V2188	44	V2253	106	V2306	131	V2401	60	V2448	81	V2503	82	V2570	56
V2134	57	V2189	44	V2256	63	V2308	131	V2402	60	V2449	81	V2504	82	V2571	56
V2135	57	V2193	49	V2257	146	V2311	48	V2403	60	V2450	81	V2505	82	V2572	56
V2136	45	V2194	49	V2258	37	V2312	48	V2404	60	V2451	81	V2506	82	V2573	59
V2137	57	V2195	49	V2259	37	V2313	48	V2405	60	V2452	46	V2507	82	V2574	56
V2138	45	V2196	56	V2261	48	V2314	48	V2406	60	V2453	46	V2508	96	V2575	59
V2139	45	V2197	56	V2262	48	V2315	48	V2407	60	V2454	46	V2509	96	V2576	59
V2140	45	V2200	59	V2263	48	V2316	109	V2408	60	V2455	46	V2510	118	V2577	59
V2141	45	V2201	53	V2264	48	V2317	63	V2409	60	V2456	46	V2511	127	V2578	56
V2142	45	V2202	58	V2265	48	V2318	62	V2410	60	V2457	46	V2512	144	V2579	56
V2143	48	V2203	58	V2266	48	V2319	63	V2411	60	V2458	45	V2513	144	V2580	56

### Numerical Index / Nummernverzeichnis

VIGOR- No.	Page Seite	VIGOR- No.	Page Seite	VIGOR- No.	Page Seite	VIGOR- No.	Page Seite	VIGOR- No.	Page Seite	VIGOR- No.	Page Seite	VIGOR- No.	Page Seite	VIGOR- No.	Page Seite
V2581	56	V2639	140	V2733	56	V2830	73	V3382	17-18, 35	V3607	76	V3703	136	V4164	155
V2582	56	V2640	140	V2734	56	V2831	73			V3608	76	V3704	136	V4165	155
V2584	56	V2641	84	V2735	56	V2832	73	V3383	17-18, 36	V3609	78	V3705	136	V4188	14-16, 40
V2585	56	V2643	85	V2737	47	V2833	73			V3610	78	V3706	136		
V2586	56	V2644	89	V2738	48	V2834	83	V3384	35	V3613	78	V3729	120	V4192	125
V2587	56	V2645	126	V2739	48	V2835	123	V3385	36	V3615	143	V3730	136	V4194	71
V2588	56	V2647	59	V2740	108			V3387	18	V3616	17, 35	V3734	42	V4195	138
V2589	56	V2648	142	V2741	48	V2837	14-15, 40	V3391	79	V3621	35	V3735	92	V4196	93
V2590	56	V2649	141	V2742	48	V2838	40	V3392	79	V3635	74	V3737	60	V4197	72
V2591	56	V2651	105	V2743	48	V2941	45	V3393	79	V3636	74	V3738	90	V4198	72
V2592	56	V2652	105	V2744	48	V3081	70	V3394	35	V3637	141	V3739	90	V4199	80
V2593	44	V2653	105	V2751	108	V3228	132	V3395	35	V3638	141	V3741	54	V4200	80
V2594	45	V2654	105	V2761	142	V3277	66	V3396	35	V3639	141	V3742	60	V4201	129
V2595	45	V2655	115	V2762	142	V3278	64	V3397	35	V3640	141	V3743	60	V4202	120
V2596	45	V2662	94	V2781	88	V3280	65	V3441	112	V3643	36	V3744	60	V4203	71
V2597	44	V2663	94	V2782	88	V3306	128	V3451	107	V3644	36	V3745	60	V4204	71
V2598	56	V2664	94	V2783	88	V3308	149	V3541	94	V3645	35	V3746	60	V4205	71
V2599	56	V2665	94	V2788	92	V3309	107	V3550	130	V3646	19, 35	V3747	60	V4206	71
V2600	56	V2666	115	V2789	134	V3330	61	V3551	154	V3647	36	V3748	117	V4207	71
V2602	41	V2667	59	V2790	103	V3331	61	V3562	78	V3648	36	V3760	137	V4208	71
V2603	56	V2668	109	V2791	87	V3332	61	V3563	143	V3651	46	V3771	119	V4209	71
V2604	32	V2669	110	V2792	87	V3333	61	V3564	143	V3652	50	V3813	152	V4212	45
V2605	17-19, 34	V2670	130	V2793	87	V3334	61	V3571	119	V3653	114	V3863	149	V4213	106
V2606	17-19, 34	V2671	37	V2794	87	V3335	61	V3572	122	V3661	149	V3864	106	V4214	106
V2607	17-19, 34	V2672	19-20, 22, 37	V2795	113	V3336	61	V3573	122	V3671	153-154	V3898	111	V4215	106
V2611	34	V2681	128	V2804	75	V3337	61	V3574	122	V3672	153-154	V3899	112	V4217	43
V2612	34	V2682	116	V2805	75	V3338	61	V3575	122	V3673	153-154	V4005	153	V4219	16
V2613	48	V2683	148	V2806	75	V3339	61	V3576	122	V3674	153-154	V4006	153	V4221	80
V2614	48	V2684	148	V2807	75	V3340	61	V3577	122	V3675	153-154	V4007	153	V4222	80
V2615	48	V2685	156	V2808	75	V3341	61	V3578	122	V3676	153-154	V4008	153	V4223	80
V2616	50	V2687	69	V2809	75	V3342	61	V3579	122	V3677	153-154	V4009	153	V4224	80
V2621	101	V2699	44	V2810	75	V3343	55	V3580	122	V3679	130	V4010	153	V4225	80
V2622	101	V2700	44	V2811	75	V3344	61	V3584	49	V3681	130	V4113	130	V4226	102
V2623	101	V2701	44	V2812	75	V3346	79	V3585	45	V3682	130	V4114	130	V4227	95
V2624	107	V2702	129	V2813	75	V3367	79	V3587	56	V3683	130	V4115	130	V4228	95
V2625	107	V2704	122	V2814	75	V3368	79	V3591	122	V3684	130	V4121	153	V4230	40
V2626	107, 133	V2705	76	V2815	73	V3369	79	V3592	122	V3685	130	V4126	150	V4231	40
V2627	104	V2707	22	V2817	75	V3370	79	V3593	122	V3686	130	V4127	150	V4233	124-125
V2628	85	V2712	22	V2818	75	V3371	65	V3594	122	V3687	130	V4130	40	V4234	94
V2629	85	V2722	44	V2819	75	V3372	65	V3595	124	V3688	130	V4153	155	V4235	94
V2630	85	V2723	44	V2820	74	V3373	65	V3596	121	V3689	130	V4154	155	V4236	94
V2631	140	V2724	48	V2821	73	V3374	65	V3597	78	V3690	130	V4155	155	V4239	16, 40
V2632	140	V2725	48	V2822	73	V3375	65	V3598	78	V3691	130	V4156	155	V4240	40
V2633	141	V2726	48	V2823	73	V3376	65	V3599	78	V3693	132	V4157	155	V4241	94
V2634	141	V2727	48	V2824	73	V3377	65	V3600	78	V3694	132	V4158	155	V4248	150
V2637	141	V2728	48	V2825	73	V3378	65	V3601	78	V3695	132	V4159	155	V4249	150
V2638	141	V2729	48	V2826	73	V3379	65	V3602	78	V3696	132	V4160	155	V4250	150
		V2730	56	V2827	73	V3380	65	V3604	122	V3697	132	V4161	155	V4262	150
		V2731	56	V2828	73	V3381	118	V3605	39	V3698	132	V4162	155		
		V2732	56	V2829	73			V3606	39	V3699	132	V4163	155		

# Overview of New Products Neuheiten-Übersicht



**VIGOR 1000**  
Tool trolley with assortment  
Werkstattswagen mit Sortiment  
**V4219**, EAN 4047728042192

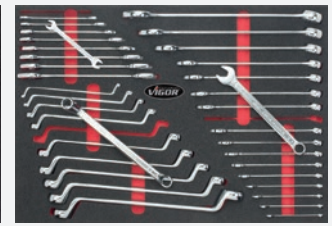

16

**6.3 1/4 10 3/8 12.9 1/2** Socket tool set  
**6.3 1/4 10 3/8 12.9 1/2** Steckschlüssel-Werkzeug-Satz  
**V4188**, EAN 4047728041881



40

**Screwdriver set**  
**Schraubendreher-Satz**  
**V4230**, EAN 4047728042307



40

**Hammer, pliers and screwdriver set**  
**Hammer-, Zangen-, Schraubendreher-Satz**  
**V4239**, EAN 4047728042390



40

**6.3 1/4** Socket set  
**6.3 1/4** Steckschlüssel-Satz  
**V3734**, EAN 4047728037341



42

**6.3 1/4** Socket set with multi-purpose profile  
**6.3 1/4** Multiprofil Steckschlüssel-Satz  
**V4217**, EAN 4047728042178



43

**6.3 1/4** Fine-tooth reversible ratchet  
**6.3 1/4** Feinzahn-Umschaltknarre  
**V4212**, EAN 4047728042123



45

**Screw extractor set**  
**Schraubenausdreher-Satz**  
**V3737**, EAN 4047728037372



60

**Double flexible head wrench set**  
**Doppel-Gelenkschlüssel-Satz**  
**V4194**, EAN 4047728041942



71

**Hex nut-driver set**  
**Sechskant-Steckschlüssel-Schraubendreher-Satz**  
**V4199**, EAN 4047728041997



80

Grip pliers with curved jaws  
Maul-Gripzange

V3738, EAN 4047728037389  
V3739, EAN 4047728037396



90

Universal hand riveting tool for blind rivets and rivet nuts  
Universal-Nietzange für Blindnieten und Nietmuttern

V3735, EAN 4047728037358



92

Plastic hand riveting tool  
Kunststoff-Nietzange

V4196, EAN 4047728041966



93

Club hammer  
Fäustel

V4234, EAN 4047728042345



94

Sub Maker Quadro 10 in 1  
Sub Maker Quadro 10-in-1

V4241, EAN 4047728042413



94

MasterKey electronics  
MasterKey Elektro

V4227, EAN 4047728042277



95

MasterKey construction  
MasterKey Bau

V4228, EAN 4047728042284



95

Mobile tensioning block  
Mobiler Spannbock

V4226, EAN 4047728042260



102

Thread repair set  
Gewinde-Reparatur-Satz

V3864, EAN 4047728038645



106

Torque wrench  $\frac{1}{2}$ "  
Drehmoment-Schlüssel  $\frac{1}{2}$ "

V3898, EAN 4047728038980  
V3899, EAN 4047728038997



112

Impact wrench  $\frac{1}{2}$ "  
Schlagschrauber  $\frac{1}{2}$ "

V3653, EAN 4047728036535



114

Battery and charging system tester with thermal printer  
Batterietester und Ladesystem-Prüfgerät mit Thermodrucker

V3748, EAN 4047728037488



117

# Overview of New Products Neuheiten-Übersicht



Camshaft holding tool  
Nockenwellen-Arretierwerkzeug  
V3771, EAN 4047728037716



119

Turbo system pressure tester  
set for click systems  
Turbosystem-Abdrücker-  
Satz für Klicksysteme  
V4192, EAN 4047728041928



125

Vacuum pump  
Vakuumpumpe  
V4201, EAN 4047728042017



129

Line wrench set  
Leitungsschlüssel-Satz  
V3730, EAN 4047728037303



136

Brake piston readjusting tool set  
Bremskolben-Rückstell Werkzeug-Satz  
V3760, EAN 4047728037600



137

Four-way rim wrench  
Kreuzschlüssel  
V4195, EAN 4047728041959



138

Shock absorber assembly tool set  
Stoßdämpfer-Montagewerkzeug-Satz  
V3863, EAN 4047728038638

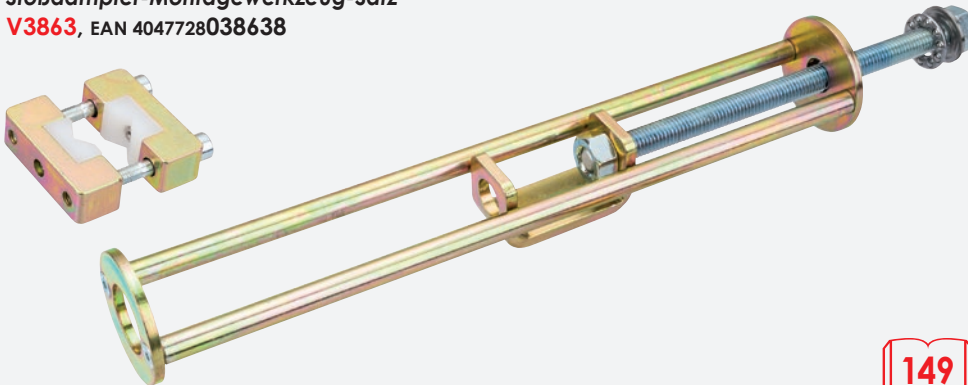

149

Clamping screw disassembly  
tool set for four-link axle VAG  
Klemmschrauben-Demontage-  
Werkzeug-Satz für Vierlenker-Achse VAG  
V4126, EAN 4047728041263



150

Guide bolts repair set  
Führungsbolzen-Reparatur-Satz  
V4127, EAN 4047728041270



150

Induction heater with function  
for plastic repairs  
Induktionsheizgerät mit  
Kunststoffreparatur-Funktion  
V3813, EAN 4047728038133



152

Repair set for plastic parts  
Kunststoff-Reparatur-Satz  
V3551, EAN 4047728035514



154



# ViGOR 1000



Tool trolley with tool chest  
and assortment  
**V1895**, EAN 4047728018951

Werkstattwagen inklusive  
Aufsatzkoffer und Sortiment  
**V1895**, EAN 4047728018951

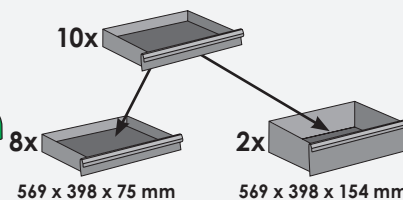
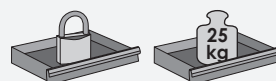

**New assortment!**  
**Neues Sortiment!**

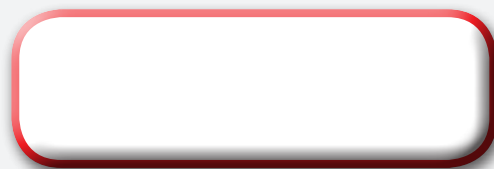

V4188

V2837

V2007

Drawer 1 / Schublade 1



Drawer 2 / Schublade 2



Drawer 3 / Schublade 3



V2008

V2009

Drawer 4 / Schublade 4

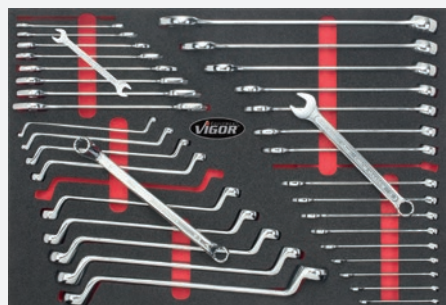

Drawer 5 / Schublade 5



**Tool Trolley ViGOR 1000 with assortment  
Werkstattswagen ViGOR 1000 inkl. Sortiment**



**ViGOR 1000**



Tool trolley with assortment  
**V1894**, EAN 4047728018944

Werkstattwagen mit Sortiment  
**V1894**, EAN 4047728018944

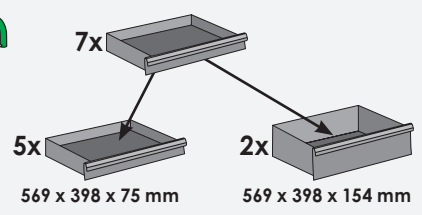
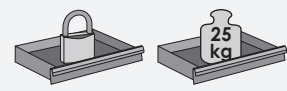

RAL 9005  
H 1000 x W 723 x D 459 mm  
H 1000 x B 723 x T 459 mm



**New assortment!  
Neues Sortiment!**

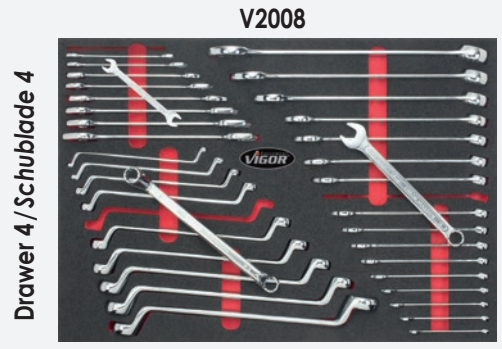

**NEW  
NEU  
NEU  
NEU  
NEU**

# ViGOR 1000



Tool trolley with assortment  
**V4219**, EAN 4047728042192

Werkstattwagen mit Sortiment  
**V4219**, EAN 4047728042192

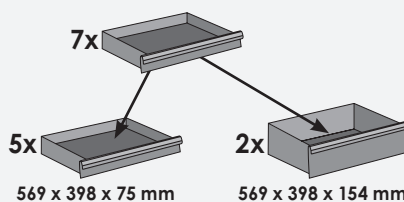
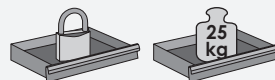

RAL 9005

H 1000 x W 723 x D 459 mm  
H 1000 x B 723 x T 459 mm

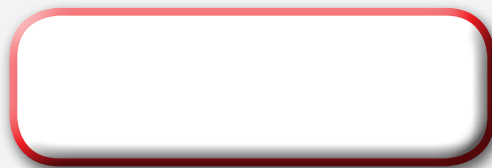

V4188

V4239

V2008

Drawer 1 / Schublade 1



Drawer 2 / Schublade 2



Drawer 3 / Schublade 3



**STURDY  
STRONG  
GOOD**

**ROBUST  
STARK  
GUT**



Work Bench ViGOR 800 with assortment  
 Werkbank ViGOR 800 inkl. Sortiment



**ViGOR 800**

Work bench with assortment  
**V1749**, EAN 4047728017497

Werkbank mit Sortiment  
**V1749**, EAN 4047728017497

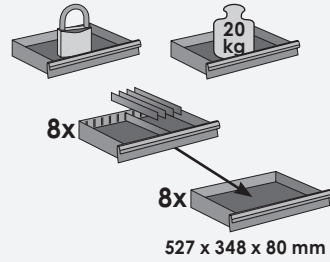
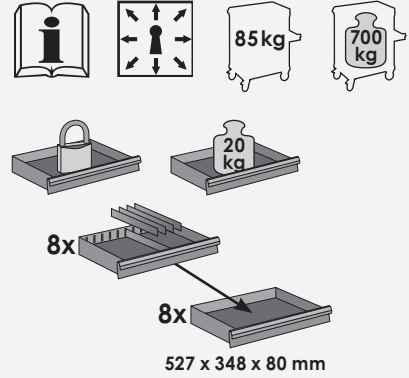

**Work bench  
 Werkbank  
 Made in Germany!**

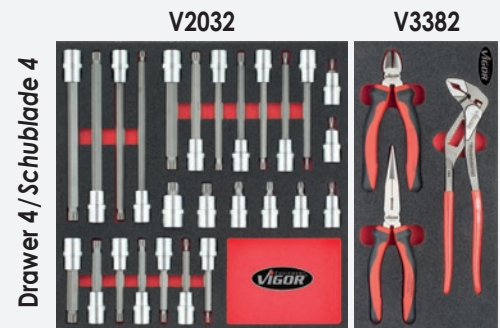
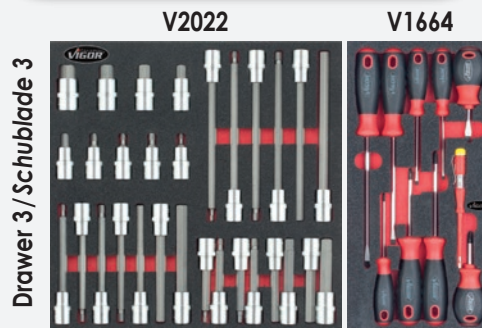
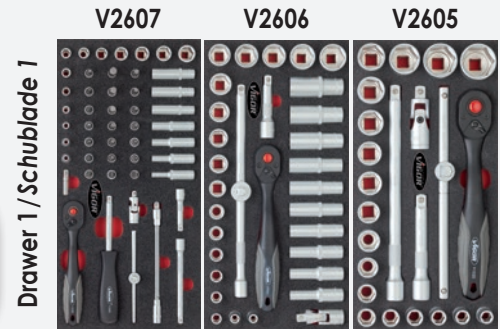



# ViGOR 700

Tool trolley with assortment  
**V3387**, EAN 4047728033879

Werkstattswagen mit Sortiment  
**V3387**, EAN 4047728033879

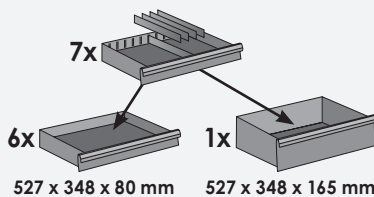
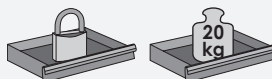

**Tool trolley**  
**Werkstattswagen**  
**Made in Germany!**

100% sliding-out  
100% Auszug

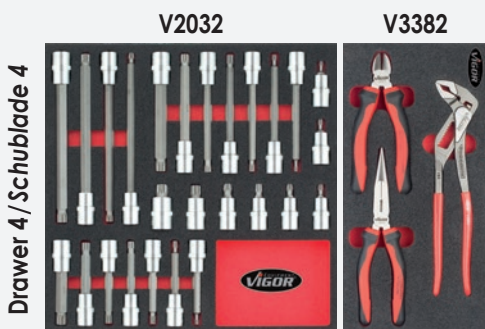
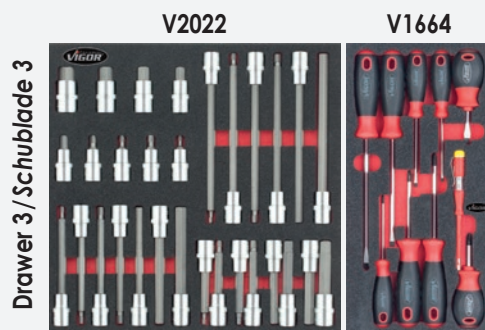
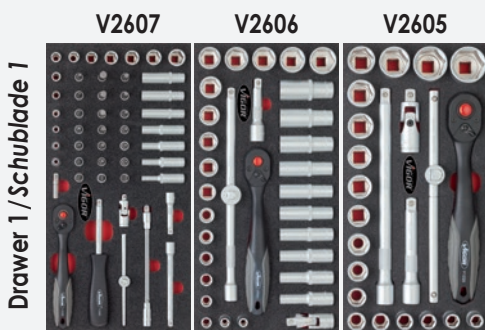
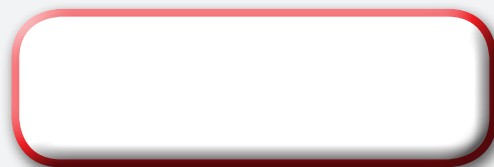

**Tool Trolley ViGOR 700 with assortment  
Werkstattswagen ViGOR 700 inkl. Sortiment**



**ViGOR 700**

Tool trolley with assortment  
**V1487**, EAN 4047728014878

Werkstattswagen mit Sortiment  
**V1487**, EAN 4047728014878

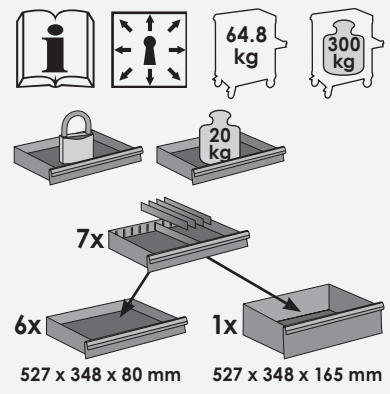

**Tool trolley  
Werkstattswagen  
Made in Germany!**

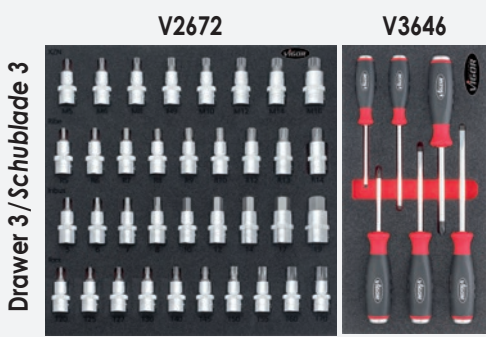
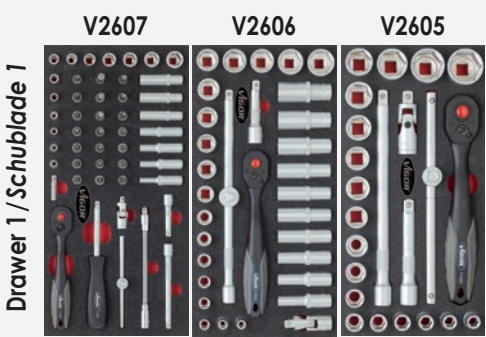

# Tool Trolley ViGOR 700 with assortment Werkstattswagen ViGOR 700 inkl. Sortiment



## ViGOR 700

Tool trolley with assortment  
**V1483**, EAN 4047728014830

Werkstattswagen mit Sortiment  
**V1483**, EAN 4047728014830



ViGOR No.	RAL	Colour Farbe	EAN 4047728+
V1483	3000		014830
V1582	7004		015820

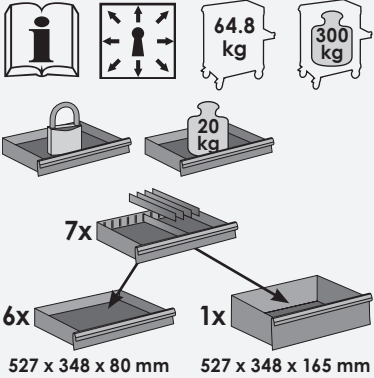

**Tool trolley  
Werkstattswagen  
Made in Germany!**



Drawer 1 / Schublade 1



Drawer 2 / Schublade 2



Drawer 3 / Schublade 3

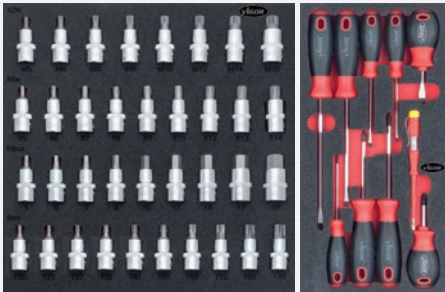

Drawer 4 / Schublade 4



Drawer 5 / Schublade 5



**Tool Trolley ViGOR 600 with assortment**  
**Werkstattswagen ViGOR 600 inkl. Sortiment**



**ViGOR 600**

Tool trolley with assortment  
**V1620**, EAN 4047728016209

Werkstattwagen mit Sortiment  
**V1620**, EAN 4047728016209

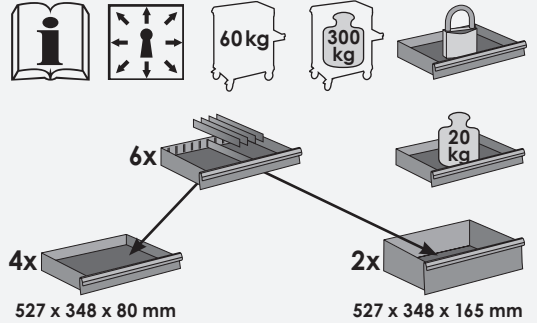

**Tool trolley**  
**Werkstattwagen**  
**Made in Germany!**



**Tool Trolley ViGOR 600 with assortment**  
*Werkstattswagen ViGOR 600 inkl. Sortiment*



**ViGOR 600**

Tool trolley with assortment  
**V2712**, EAN 4047728027120

Werkstattswagen mit Sortiment  
**V2712**, EAN 4047728027120

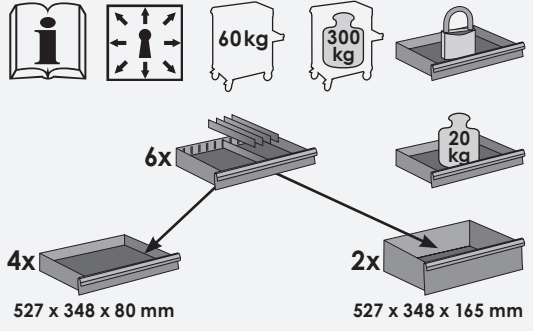

RAL 9005

H 913 x W 778 x D 496 mm  
H 913 x B 778 x T 496 mm

100% sliding-out  
100% Auszug

**Tool trolley**  
**Werkstattswagen**  
**Made in Germany!**

**Black Edition II**

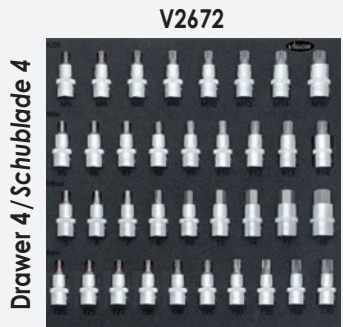

**Tool Trolley ViGOR 500 with assortment  
Werkstattswagen ViGOR 500 inkl. Sortiment**



**ViGOR 500**

Tool trolley with assortment  
**V2379**, EAN 4047728023795

Werkstattswagen mit Sortiment  
**V2379**, EAN 4047728023795

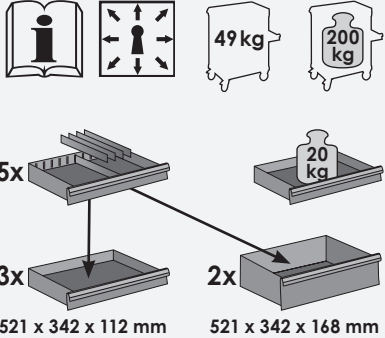

H 930 x W 700 x D 400 mm  
H 930 x B 700 x T 400 mm

**Black Edition**

**Tool trolley  
Werkstattwagen  
Made in Germany!**



Drawer 1 / Schublade 1

V2378



Drawer 2 / Schublade 2

V2375

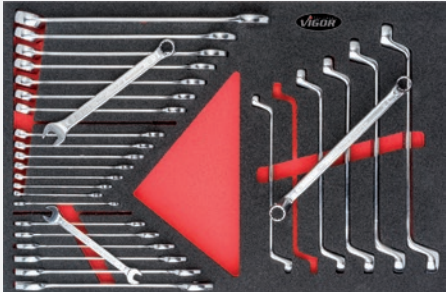

Drawer 3 / Schublade 3

V2376





### ViGOR 500

Tool trolley, empty  
**V1252**, EAN 4047728012522

Werkstattwagen, leer  
**V1252**, EAN 4047728012522

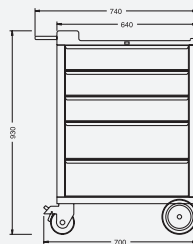
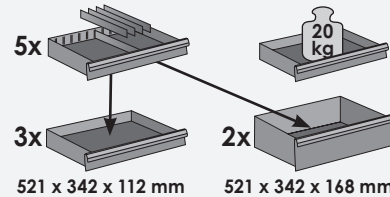

VIGOR No.	RAL	Colour Farbe	EAN 4047728+
V1252	7004		012522
V1382	3000		013826
V1396	5007		013963



### ViGOR 500

Tool trolley, empty  
**V1399**, EAN 4047728013994

Werkstattwagen, leer  
**V1399**, EAN 4047728013994

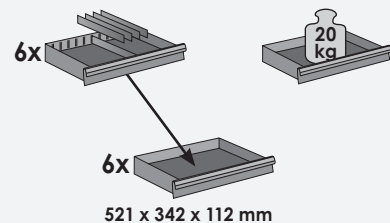

VIGOR No.	RAL	Colour Farbe	EAN 4047728+
V1399	7004		013994
V1397	5007		013970
V1398	3000		013987

- Delivery without tools and accessories (available on request) -  
 - Lieferung ohne abgebildetes Werkzeug und Zubehör (auf Anfrage erhältlich) -



**Tool Trolley ViGOR 600 / 700**  
**Werkstattwagen ViGOR 600 / 700**



**ViGOR 600**

Tool trolley, empty  
**V1627**, EAN 4047728016278

Werkstattwagen, leer  
**1627**, EAN 4047728016278

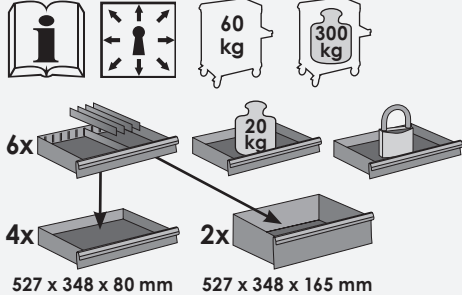

VIGOR No.	RAL	Colour Farbe	EAN 4047728+
V1251	7004		012515
V1627	3000		016278
V1628	5007		016285



**ViGOR 700**

Tool trolley, empty  
**V1581**, EAN 4047728015813

Werkstattwagen, leer  
**V1581**, EAN 4047728015813

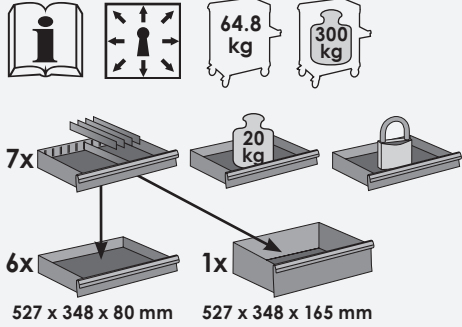

VIGOR No.	RAL	Colour Farbe	EAN 4047728+
V1581	7004		015813
V1578	5007		015783
V1527	3000		015271

- Delivery without tools and accessories (available on request) -  
 - Lieferung ohne abgebildetes Werkzeug und Zubehör (auf Anfrage erhältlich) -



# Work Bench VIGOR 800 Werkbank VIGOR 800

## VIGOR 800

Work bench, empty  
**V1705**, EAN 4047728017053

Werkbank, leer  
**V1705**, EAN 4047728017053

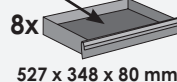
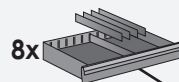

527 x 348 x 80 mm



At over 20  
Trade fairs  
in Germany  
and Abroad!

Auf über  
20 Messen  
im In- und  
Ausland!



- Delivery without tools and accessories (available on request) -  
- Lieferung ohne abgebildetes Werkzeug und Zubehör (auf Anfrage erhältlich) -

# Accessories for ViGOR 500, 600, 700 and 800 Zubehör für ViGOR 500, 600, 700 und 800

For / Für ViGOR 500

2 tool bins,  
small  
• 2 pieces per pack

2 Anhängerkästen,  
klein  
• Verpackt zu je 2 Stück



V1386,  
EAN 4047728013864



Tool bin, large  
Anhängerkasten, groß



V1387,  
EAN 4047728013871



For / Für ViGOR 600, 700, 800

Can holder  
• For 3 cans  
Dosenhalter  
• Für 3 Dosen

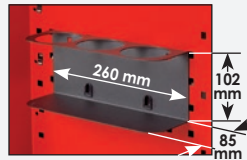

V1644,  
EAN 4047728016445



Document holder  
Dokumentenhalter

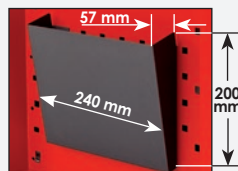

V1645,  
EAN 4047728016452



Tool bin, large  
Anhängerkasten, groß

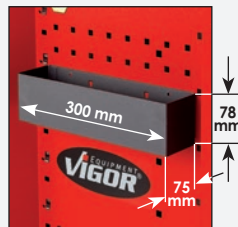

V1646,  
EAN 4047728016469



For / Für ViGOR 500, 600, 700, 800

Anti-slipping mat  
Anti-Rutschmatte

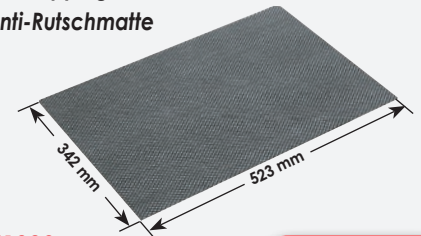

V1389,  
EAN 4047728013895



Separation sheet set Trennblech-Satz  
• 5 pieces per pack • Verpackt zu je 5 Stück

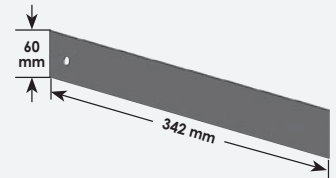

V1390,  
EAN 4047728013901



Separation sheet set Trennblech-Satz  
• 5 pieces per pack • Verpackt zu je 5 Stück

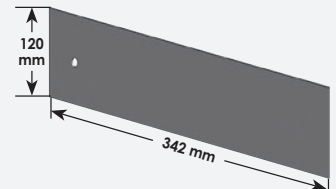

V1391,  
EAN 4047728013918



# Spare parts for ViGOR 500, 600, 700 and 800 Ersatzteile für ViGOR 500, 600, 700 und 800

ViGOR No.	Designation	Bezeichnung	Suitable for ViGOR Passend für ViGOR	EAN 4047728+
V1625	Plastic cover	Kunststoff-Haube	500	016254
V1626	Pull-handle	Fahrgriff	500	016261
V1552	Drawer slides (pair)	Führungsschiene (Paar)	500	015523
V1542	Drawer, flat	Schublade, flach	500	015424
V1547	Drawer, big	Schublade, hoch	500	015479
V1550	Swivel castor without brake	Lenkrolle ohne Feststeller	500	015509
V1549	Swivel castor with brake	Lenkrolle mit Feststeller	500	015493
V1610	Fixed castor	Scheibenrad	500	016100
V1622	Crossbar	Traverse	500	016223
V1635	Plastic cover	Kunststoff-Haube	600, 700	016353
V1634	Pull-handle	Fahrgriff	600, 700	016346
V1632	Drawer, big	Schublade, hoch	600, 700	016322
V1630	Swivel castor without brake	Lenkrolle ohne Feststeller	600, 700	016308

ViGOR No.	Designation	Bezeichnung	Suitable for ViGOR Passend für ViGOR	EAN 4047728+
V1629	Swivel castor with brake	Lenkrolle mit Feststeller	600, 700	016292
V1636	Individual drawer locking	Schubladen-Einzelverriegelung	600, 700	016360
V1756	Separation sheet for high drawer	Einteilblech-Schublade, hoch	600, 700	017565
V1750	Swivel castor	Lenkrolle	800	017503
V1751	Fixed castor	Bockrolle	800	017510
V1752	Worktop	Arbeitsplatte	800	017527
V1579	Ball-bearing drawer slides, pair	Rollenführungs-Paar	600, 700, 800	015790
V1631	Drawer, flat	Schublade, flach	600, 700, 800	016315
V1633	Padlock with 2 keys	Schloss inkl. 2 Schlüssel	600, 700, 800	016339
V1754	Separation sheet for flat drawer	Einteilblech-Schublade, flach	600, 700, 800	017541

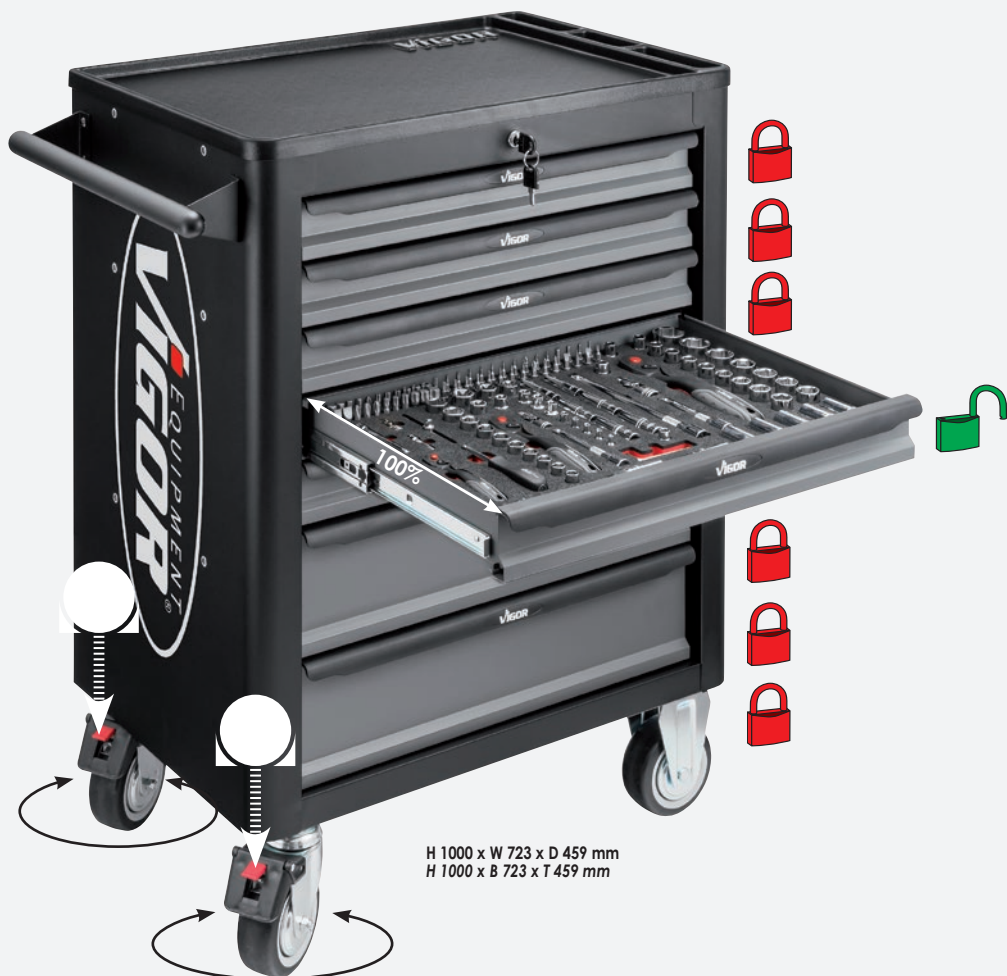

H 1000 x W 723 x D 459 mm  
 H 1000 x B 723 x T 459 mm

## VIGOR 1000

Tool trolley, empty  
**V1901**, EAN 4047728019019

Werkstattwagen, leer  
**V1901**, EAN 4047728019019

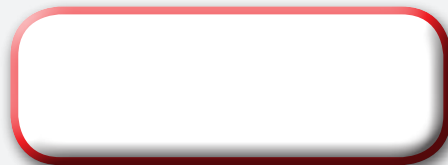
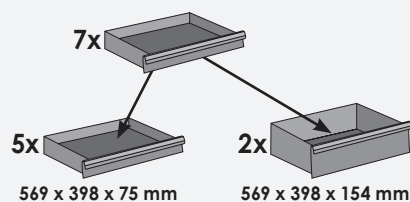
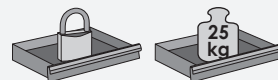
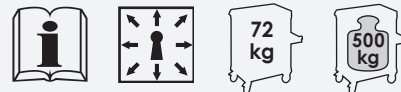

## VIGOR 1000

Tool chest for tool trolley V1901 / Under-bench cabinet for work bench V2531, empty  
**V1902**, EAN 4047728019026

Aufsatzkoffer für Werkstattwagen V1901 /  
 Unterschrank für Werkbank V2531, leer  
**V1902**, EAN 4047728019026



H 375 x W 723 x D 459 mm  
 H 375 x B 723 x T 459 mm

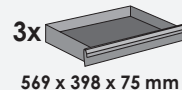
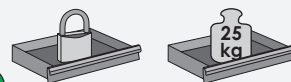

- Delivery without plastic worktop, see V1909 p. 30 -
- Lieferung ohne Kunststoffhaube, siehe V1909 S. 30 -

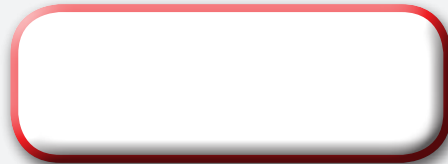

**Tool Trolley/Tool Chest ViGOR 1000**  
**Werkstattwagen / Aufsatzkoffer ViGOR 1000**



# ViGOR 1000

Tool trolley with tool chest, empty  
**V1970**, EAN 4047728019705

Werkstattwagen inkl.  
 Aufsatzkoffer, leer  
**V1970**, EAN 4047728019705



10x

8x

569 x 398 x 75 mm

2x

569 x 398 x 154 mm



H 1375 x W 723 x D 459 mm  
 H 1375 x B 723 x T 459 mm

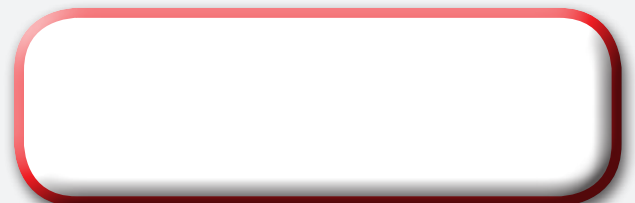

- Delivery without tools and accessories (available on request) -  
 - Lieferung ohne abgebildetes Werkzeug und Zubehör (auf Anfrage erhältlich) -

# Accessories for ViGOR 1000 / Zubehör für ViGOR 1000

**Plastic cover**  
**V1909**, EAN 4047728019095  
 • For tool trolley and tool chest

**Kunststoff-Haube**  
**V1909**, EAN 4047728019095  
 • Für Werkstattwagen und Aufsatzkoffer



**Separation sheet assortment**  
**V2398**, EAN 4047728023986  
 • 5 pieces per pack

**Trennblech-Sortiment**  
**V2398**, EAN 4047728023986  
 • Verpackt zu je 5 Stück

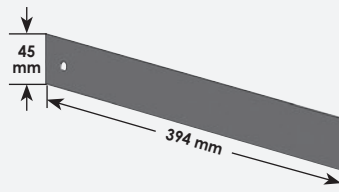

**Panel partition / separation sheet assortment**

**V2399**, EAN 4047728023993  
 • Pack of 2 panel partitions and 3 separation sheets

**Einteilungs- / Trennblech-Sortiment**  
**V2399**, EAN 4047728023993

• Verpackt zu 2 Einteilungsblechen und 3 Trennblechen

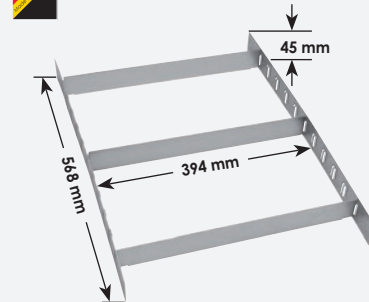

**Can holder**  
**V2393**, EAN 4047728023931

• For 5 cans

**Dosenhalter**

**V2393**, EAN 4047728023931

• Für 5 Dosen



**Holder for paper reel**  
**V2397**, EAN 4047728023979

(without paper reel)

**Papierrollenhalter**

**V2397**, EAN 4047728023979

(ohne Papierrolle)



## Spare parts for ViGOR 1000

### Ersatzteile für ViGOR 1000

VIGOR No.	Designation	Bezeichnung	Suitable for ViGOR Passend für ViGOR	EAN 4047728+
V1903	Drawer slides (pair)	Führungsschiene (Paar)	1000	019033
V1904	Locking system	Verriegelungs-system	1000	019040
V1905	Drawer, flat	Schublade, flach	1000	019057
V1906	Drawer, big	Schublade, hoch	1000	019064
V1907	Fixed castor	Bockrolle	1000	019071
V1908	Swivel castor	Lenkrolle	1000	019088
V2462	Padlock with 2 keys	Schloß, inkl. 2 Schlüsseln	1000	024624



- Delivery without tools and accessories (available on request) -  
 - Lieferung ohne abgebildetes Werkzeug und Zubehör (auf Anfrage erhältlich) -

# ViGOR 1000

ViGOR 1000 tool cabinet for work bench with 2 shutters, empty

**V2532**, EAN 4047728025324

• Supplied without pictured tools

ViGOR 1000 Aufsatzschrank für Werkbank, mit 2 Roll-Jalousien, leer

**V2532**, EAN 4047728025324

• ohne abgebildetes Werkzeug



H 603 x W 1565 x T 203 mm  
 H 603 x B 1565 x T 203 mm

# ViGOR 1000

ViGOR 1000 work bench, empty  
**V2531**, EAN 4047728025317

ViGOR 1000 Werkbank, leer  
**V2531**, EAN 4047728025317

max.  
1000  
kg



H 800 x W 1565 x D 766 mm  
 adjustable height  
 H 800 x B 1565 x T 766 mm  
 Höhenverstellbar

800 – 890 mm

# Accessories / Zubehör

Pair of holding plates for the under-bench cabinet ViGOR 1000

**V2463**, EAN 4047728024631

• For fitting the under-bench cabinet V1902 to the work bench V2531

Halblech-Paar für Unterschrank ViGOR 1000

**V2463**, EAN 4047728024631

• Zur Befestigung vom Unterschrank V1902 an der Werkbank V2531



Tool hook sets for tool cabinet

Werkzeughaken-Sätze für Aufsatzschrank



VIGOR No.	mm	EAN
V2518	100	4047728+025188

VIGOR No.	mm	EAN
V2517	25	4047728+025171

VIGOR No.	mm	EAN
V2520	100	4047728+025201

VIGOR No.	mm	EAN
V2519	25	4047728+025195



# ViGOR 1000 Work Bench System, complete Werkbanks-System ViGOR 1000, komplett

## ViGOR 1000

ViGOR 1000 work bench system, complete  
**V2604**, EAN 4047728026048

ViGOR 1000 Werkbank-System, komplett  
**V2604**, EAN 4047728026048



max.  
1000  
kg

H 1403 x W 1565 x D 766 mm  
H 1403 x B 1565 x T 766 mm

1400 – 1490 mm

- Delivery without tools and accessories (available on request) / Tool Hook Sets for Tool Cabinet V2532 see page 31 -  
- Lieferung ohne abgebildetes Werkzeug und Zubehör (auf Anfrage erhältlich) / Werkzeughaken-Sätze für Aufsatzschrank V2532 siehe S. 31 -



## ViGOR 500-800 1/3 module / 1/3 Modul

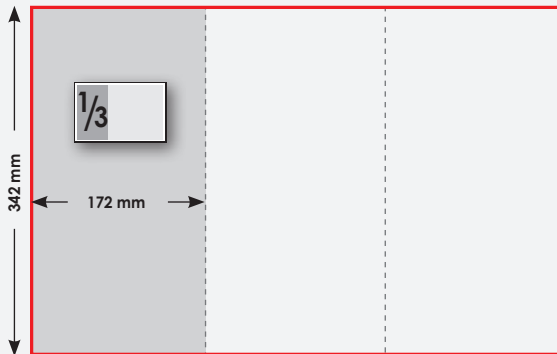

## 2/3 module / 2/3 Modul

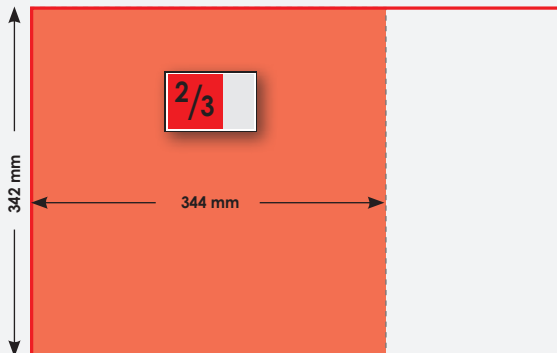

## 3/3 module / 3/3 Modul

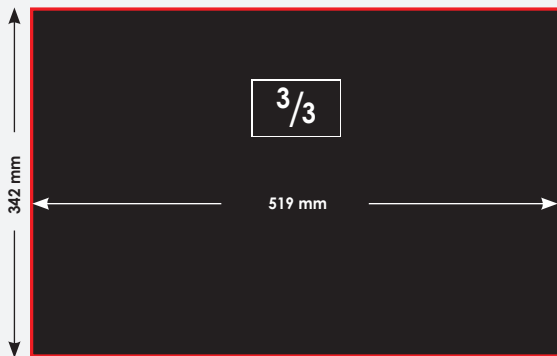

## ViGOR 1000

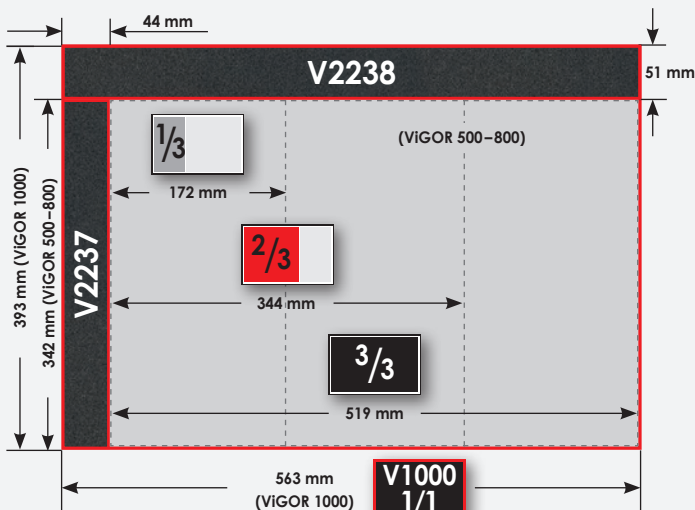

### 2-component soft foam insert

- Easy to clean: clean and dry under running water
- Missing tools are immediately noticeable through the red trough
- Everything in its place – perfect order!
- Protects the tools as they are embedded without risk of slipping
- Each tool has its own pre-defined place
- Resistant to oils and fats

### 2-Komponenten-Weichschaumeinlage

- Leicht zu reinigen: unter fließendem Wasser säubern und trocknen
- Fehlende Werkzeuge fallen sofort durch die rote Mulde auf
- Alles liegt an seinem Platz; die perfekte Ordnung
- Schützt die Werkzeuge, da diese verrutschsicher eingebettet werden
- Jedes Werkzeug hat seinen vordefinierten Platz
- Resistent gegen Öle und Fette



### Adapter insert

**V2237**, EAN 4047728022378  
and graphic illustration with dimensions 44 x 342 mm

### Adapter-Einlage

**V2237**, EAN 4047728022378  
und Darstellung der Einlagengrößen 44 x 342 mm

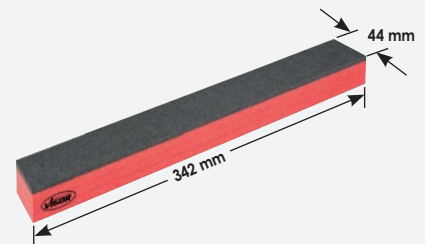

### Adapter insert

**V2238**, EAN 4047728022385  
and graphic illustration with dimensions 44 x 342 mm

### Adapter-Einlage

**V2238**, EAN 4047728022385  
und Darstellung der Einlagengrößen 44 x 342 mm

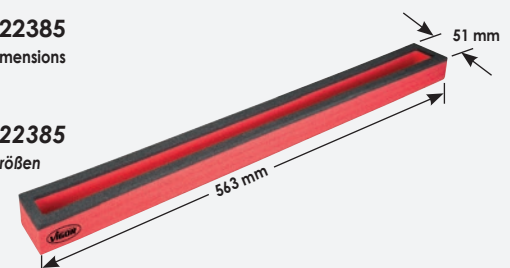

6.3 1/4 Socket tool set  
 6.3 1/4 Steckschlüssel-Werkzeug-Satz  
**V2607**, EAN 4047728026079



6.3 1/4 4 · 4.5 · 5 · 5.5 · 6 · 7 · 8 · 9  
 10 · 11 · 12 · 13 · 14 mm

6.3 1/4 4 · 5 · 6 · 7 · 8 · 9 · 10 mm

6.3 1/4 T 10 · T 15 · T 20 · T 25 · T 30 · T 40

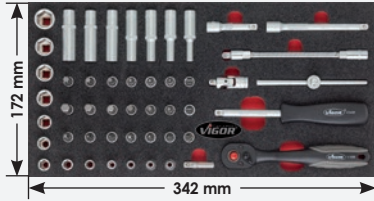

PH 1 · PH 2 · PH 3  
 PZ 1 · PZ 2 · PZ 3  
 4 · 5.5 · 7 mm  
 3 · 4 · 5 · 6 · 7 · 8 mm

Soft foam insert, empty  
 Weichschaum-Einlage, leer  
**V2612**, EAN 4047728026123

10 3/8 Socket tool set  
 10 3/8 Steckschlüssel-Werkzeug-Satz  
**V2606**, EAN 4047728026062



10 3/8 6 · 7 · 8 · 9 · 10 · 11 · 12 · 13 · 14 · 15  
 16 · 17 · 18 · 19 · 20 · 21 · 22 · 24 mm

10 3/8 8 · 9 · 10 · 11 · 12 · 13 · 14 · 15 · 17 · 19 mm

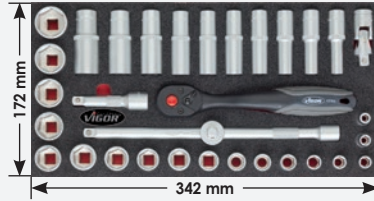

Soft foam insert, empty  
 Weichschaum-Einlage, leer  
**V2560**, EAN 4047728025607

129 1/2 Socket tool set  
 129 1/2 Steckschlüssel-Werkzeug-Satz  
**V2605**, EAN 4047728026055



129 1/2 10 · 11 · 12 · 13 · 14 · 15 · 16 · 17  
 18 · 19 · 20 · 21 · 22 · 23 · 24 · 27 · 32 mm



Soft foam insert, empty  
 Weichschaum-Einlage, leer  
**V2611**, EAN 4047728026116

129 1/2 Socket assortment, long  
 129 1/2 Steckschlüssel-Ein-  
 satz-Sortiment, lang  
**V1658**, EAN 4047728016582

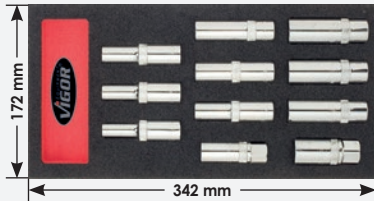

10 · 11 · 12 · 13 · 14  
 15 · 17 · 18 · 19 mm  
 16 · 21 mm

Soft foam insert, empty  
 Weichschaum-Einlage, leer  
**V1652**, EAN 4047728016520

6.3 1/4 and 129 1/2 TORX®  
 and socket assortment for screws  
 with internal serration (XZN)  
 6.3 1/4 und 129 1/2 TORX® und  
 Innenvielzahn-Einsatz-Sortiment (XZN)  
**V1519**, EAN 4047728015196

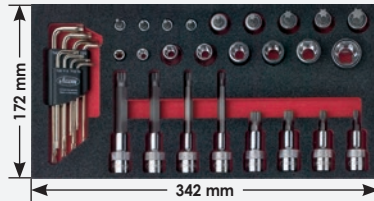

T 9 · T 10 · T 15 · T 20 · T 25 · T 27  
 T 30 · T 40 · T 45 · T 50 · T 55  
 E 8 · E 10 · E 12 · E 14  
 E 16 · E 18 · E 20 · E 24  
 M 6 · M 8 · M 10 · M 12

Soft foam insert, empty  
 Weichschaum-Einlage, leer  
**V1509**, EAN 4047728015097

6.3 1/4 and 129 1/2 TORX® tool set  
 6.3 1/4 und 129 1/2 TORX®  
 Werkzeug-Satz  
**V1661**, EAN 4047728016612

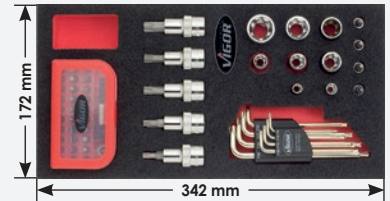

T 9 · T 10 · T 15 · T 20 · T 25 · T 27  
 T 30 · T 40 · T 45 · T 50 · T 55  
 E 8 · E 10 · E 12 · E 14 · E 16  
 E 18 · E 20 · E 24  
 M 6 · M 8 · M 10 · M 12

Soft foam insert, empty  
 Weichschaum-Einlage, leer  
**V1654**, EAN 4047728016544

129 1/2 Screwdriver sockets with internal  
 serration (XZN) and twist drill set  
 129 1/2 Innenvielzahn-Einsätze (XZN)  
 und Spiralbohrer-Satz  
**V1682**, EAN 4047728016827

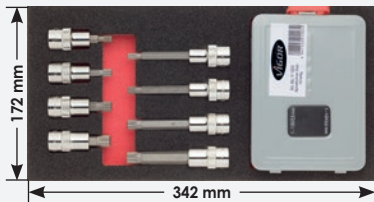

M 6 · M 8 · M 10  
 M 12  
 M 6 · M 8 · M 10  
 M 12  
 1-10 mm

Soft foam insert, empty  
 Weichschaum-Einlage, leer  
**V1667**, EAN 4047728016674

129 1/2 Inside hexagon tool set  
 129 1/2 Innensechskant-  
 Werkzeug-Satz  
**V1660**, EAN 4047728016605



5 · 6 · 7 · 8 · 10 mm  
 5 · 6 · 7  
 8 · 10 mm  
 1.5 · 2 · 2.5  
 3 · 4 · 5 · 6  
 8 · 10 mm

Soft foam insert, empty  
 Weichschaum-Einlage, leer  
**V1653**, EAN 4047728016537

Twist drill and scraper set  
 Spiralbohrer- und Schaber-Satz  
**V1522**, EAN 4047728015226



1-10 mm

Soft foam insert, empty  
 Weichschaum-Einlage, leer  
**V1512**, EAN 4047728015127

# 1/3 Soft Foam Inserts for VIGOR 500 - 800

## 1/3 Weichschaum-Einlagen für VIGOR 500 - 800



Double open-end wrench set  
Doppel-Maulschlüssel-Satz

V1683, EAN 4047728016834

• DIN 3113

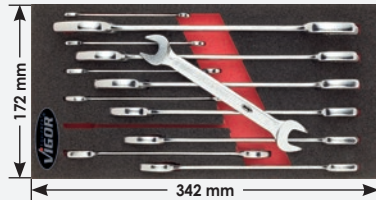

6 x 7 · 8 x 9 · 10 x 11 · 12 x 13  
14 x 15 · 16 x 17 · 18 x 19  
20 x 22 · 21 x 23 · 24 x 27  
25 x 28 · 30 x 32 mm



Soft foam insert, empty  
Weichschaum-Einlage, leer

V1668, EAN 4047728016681



Combination wrench set  
Ring-Maulschlüssel-Satz

V1662, EAN 4047728016629

• DIN 3113 / ISO 7738



**New: now with size 16 + 18**  
**Neu: Jetzt mit 5W 16 + 18**

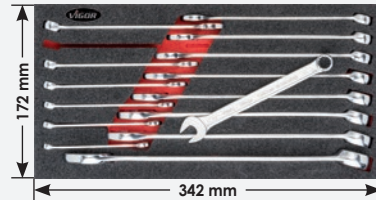

6 · 7 · 8 · 9 · 10 · 11  
12 · 13 · 14 · 15 · 16  
17 · 18 · 19 · 22 mm



Soft foam insert, empty  
Weichschaum-Einlage, leer

V1649, EAN 4047728016490



Ratcheting combination  
wrench set  
Ratschen-Ring-  
Maulschlüssel-Satz

V1663, EAN 4047728016636

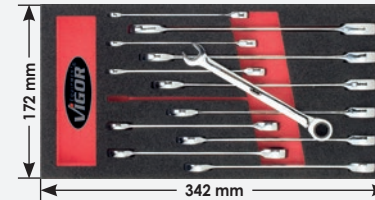

8 · 9 · 10 · 11 · 12 · 13 · 14  
15 · 16 · 17 · 18 · 19 mm



Soft foam insert, empty  
Weichschaum-Einlage, leer

V1651, EAN 4047728016513



Screwdriver set  
Schraubendreher-Satz

V1664, EAN 4047728016643

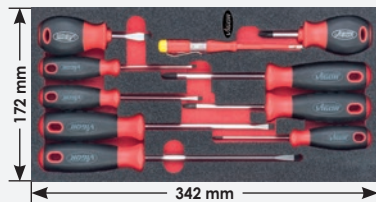

● 3 · 4 · 5.5 · 6.5 mm  
⊕ PH 0 · PH 1 · PH 2



Soft foam insert, empty  
Weichschaum-Einlage, leer

V1655, EAN 4047728016551



Screwdriver set with impact cap  
Schraubendreher-Satz mit  
Schlagkappe

V3646, EAN 4047728036467

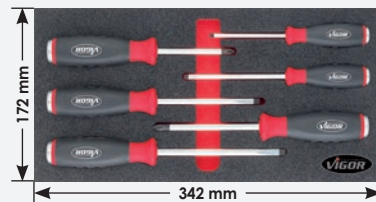

● 3.5 · 4.5 · 5.5 · 6.5 mm  
⊕ PH 1 · PH 2



Soft foam insert, empty  
Weichschaum-Einlage, leer

V3645, EAN 4047728036450



TORX® screwdriver set  
TORX® Schraubendreher-Satz

V3616, EAN 4047728036160

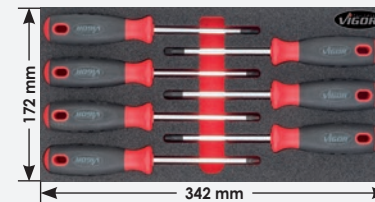

⊕ T10 · T15 · T20 · T25  
T27 · T30 · T40



Soft foam insert, empty  
Weichschaum-Einlage, leer

V3621, EAN 4047728036214



Pliers set  
Zangen-Satz

V3382, EAN 4047728033824



250 mm  
200 mm  
160 mm



Soft foam insert, empty  
Weichschaum-Einlage, leer

V3384, EAN 4047728033848



Pliers set  
Zangen-Satz

V3394, EAN 4047728033947



250 mm  
200 mm  
160 mm



Soft foam insert, empty  
Weichschaum-Einlage, leer

V3395, EAN 4047728033954



Double joint pliers set  
Doppelgelenk-Zangen-Satz

V3396, EAN 4047728033961

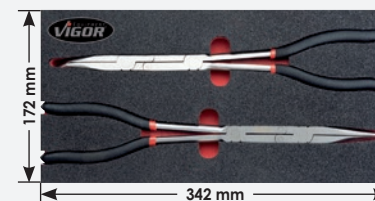

Soft foam insert, empty  
Weichschaum-Einlage, leer

V3397, EAN 4047728033978



**Grip pliers set**  
**Grip-Zangen-Satz**  
**V1729**, EAN 4047728017299

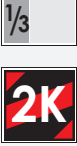
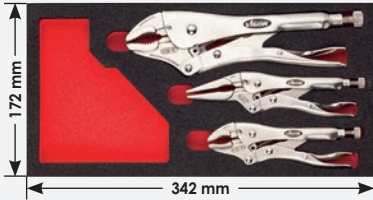

Soft foam insert, empty  
 Weichschaum-Einlage, leer  
**V1807**, EAN 4047728018074



**Hook and scraper set**  
**with car light tester**  
**Schaber- und Hakensatz**  
**inkl. Autolichtprüfer**  
**V1746**, EAN 4047728017466



Soft foam insert, empty  
 Weichschaum-Einlage, leer  
**V1745**, EAN 4047728017459



**File set**  
**Feilen-Satz**  
**V1811**, EAN 4047728018111

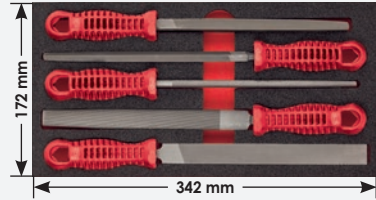

Soft foam insert, empty  
 Weichschaum-Einlage, leer  
**V1806**, EAN 4047728018067



**Hammer, chisel and drift punch set**  
**Hammer-, Meißel- und**  
**Durchtreiber-Satz**  
**V3383**, EAN 4047728033831



Soft foam insert, empty  
 Weichschaum-Einlage, leer  
**V3385**, EAN 4047728033855



**Cutter, scraper and tweezers set**  
**Messer-, Schaber- und Pinzetten-Satz**  
**V1523**, EAN 4047728015233

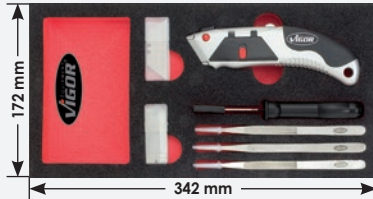

Soft foam insert, empty  
 Weichschaum-Einlage, leer  
**V1514**, EAN 4047728015141



**2-component soft foam insert,**  
**with empty compartment**  
**2K-Weichschaum-Einlage, mit Leerfach**  
**V2239**, EAN 4047728022392

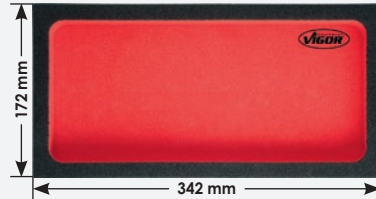

**VDE socket set**  
**VDE-Steckschlüssel-Satz**  
**V3644**, EAN 4047728036443

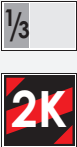

● 8 · 10 · 12 · 13 · 14  
 17 · 19 · 22 · 24 mm  
 ○ 5 · 6 · 8 mm  
 12<sup>5</sup> 1/2 125 mm  
 12<sup>5</sup> 1/2 255 mm

Soft foam insert, empty  
 Weichschaum-Einlage, leer  
**V3643**, EAN 4047728036436



**VDE screwdriver set**  
**VDE-Schraubendreher-Satz**  
**V2015**, EAN 4047728020152

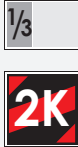
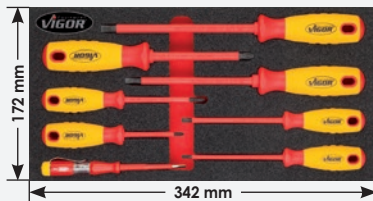

● 3 · 4 · 5.5 · 6.5 mm  
 ⊕ PH 0 · PH 1 · PH 2

Soft foam insert, empty  
 Weichschaum-Einlage, leer  
**V2240**, EAN 4047728022408



**VDE pliers set**  
**VDE-Zangen-Satz**  
**V3648**, EAN 4047728036481

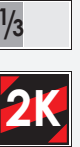
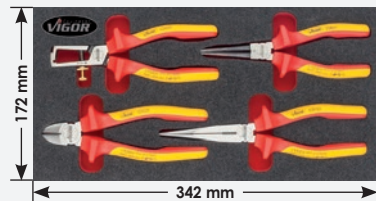

Soft foam insert, empty  
 Weichschaum-Einlage, leer  
**V3647**, EAN 4047728036474



# 2/3 Soft Foam Inserts for VIGOR 500 - 800 2/3 Weichschaum-Einlagen für VIGOR 500 - 800



6.3 1/4 and 12.9 1/2 socket tool set  
6.3 1/4 und 12.9 1/2 Steckschlüssel-  
Werkzeug-Satz  
V1665, EAN 4047728016650



2/3 2K

- 6.3 1/4
- 4 · 5 · 5.5 · 6 · 7
- 8 · 9 · 10 · 11 · 12
- 13 · 14 mm
- 12.9 1/2
- 10 · 11 · 12 · 13
- 14 · 15 · 16 · 17
- 18 · 19 · 20 · 21
- 22 · 24 · 27 · 30
- 32 mm

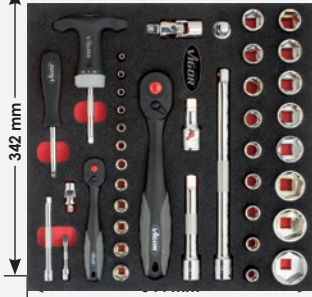

Soft foam insert, empty  
Weichschaum-Einlage, leer  
V1656, EAN 4047728016568



Hammers, pliers and chisels set  
Hämmer-, Zangen- und Meißel-Satz  
V1521, EAN 4047728015219



2/3 2K



Soft foam insert, empty  
Weichschaum-Einlage, leer  
V1511, EAN 4047728015110



Screwdriver set with bit box  
Schraubendreher-Satz mit Bit-Box  
V1518, EAN 4047728015189



2/3 2K

- 1.6-8 mm
- PH 00-PH 3
- PZ 1-PZ 3
- 3-6 mm
- T 15-T 70
- E 8-E 24



Soft foam insert, empty  
Weichschaum-Einlage, leer  
V1507, EAN 4047728015073



12.9 1/2 TORX® screwdriver socket set  
12.9 1/2 TORX® Schraubendre-  
her-Einsatz-Sortiment  
V2033, EAN 4047728020336



2/3 2K

- 12.9 1/2
- T 20 · T 25 · T 27
- T 30 · T 40 · T 45
- T 50 · T 55 · T 60
- T 70
- 12.9 1/2
- E 8 · E 10 · E 12
- E 14 · E 16 · E 18
- E 20 · E 24

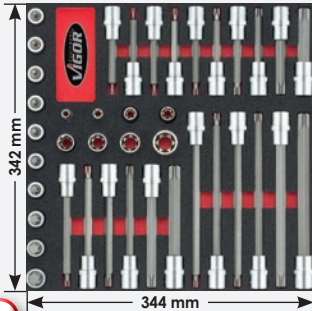

Soft foam insert, empty  
Weichschaum-Einlage, leer  
V2021, EAN 4047728020213



12.9 1/2 Screwdriver socket set for screws  
with internal serration (XZN)  
12.9 1/2 Innenvielzahn Schraubendre-  
her-Einsatz (XZN) Sortiment  
V2032, EAN 4047728020329



2/3 2K

- 12.9 1/2
- M 5 · M 6 · M 8
- M 9 · M 10 · M 12
- M 14 · M 16

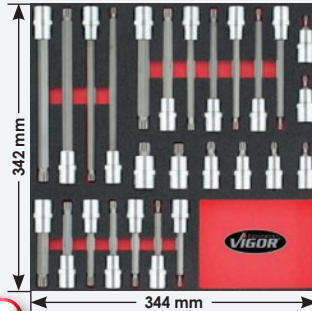

Soft foam insert, empty  
Weichschaum-Einlage, leer  
V1900, EAN 4047728019002



12.9 1/2 Screwdriver socket set  
for inside hexagon screws  
12.9 1/2 Innensechskant Schrau-  
bendreher-Einsatz-Sortiment  
V2022, EAN 4047728020220



2/3 2K

- 12.9 1/2
- 5 · 6 · 7 · 8 · 10 · 11
- 12 · 13 · 14 · 17
- 19 mm

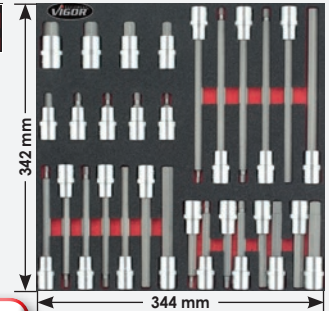

Soft foam insert, empty  
Weichschaum-Einlage, leer  
V1899, EAN 4047728018999



12.9 1/2 RIBE screwdriver socket set  
12.9 1/2 RIBE Schraubendre-  
her-Einsatz-Sortiment  
V2258, EAN 4047728022583



2/3 2K

- 12.9 1/2
- M 5 · M 6 · M 7
- M 8 · M 9 · M 10
- M 10.3 · M 12
- M 13 · M 14

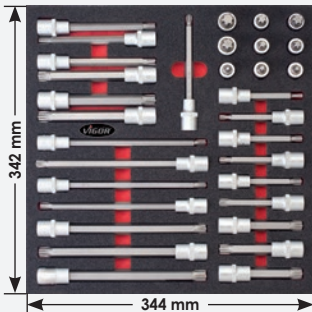

Soft foam insert, empty  
Weichschaum-Einlage, leer  
V2259, EAN 4047728022590

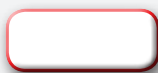

12.9 1/2 Screwdriver socket set  
12.9 1/2 Schraubendre-  
her-Einsatz-Sortiment  
V2672, EAN 4047728026727



2/3 2K

- M 5-M 16
- Sizes/SW 5-19 mm
- M 5-M 14
- T 20-T 70

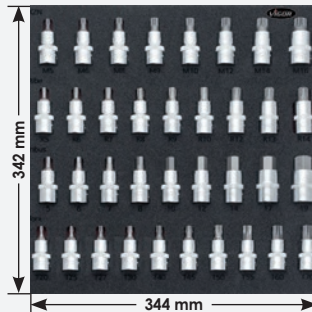

Soft foam insert, empty  
Weichschaum-Einlage, leer  
V2671, EAN 4047728026710

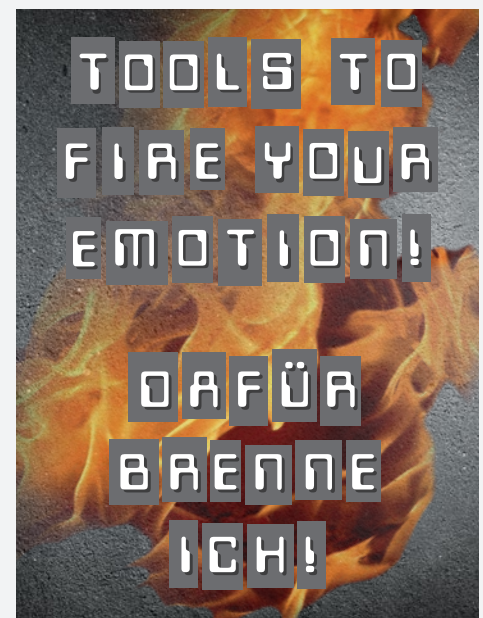

6.3 1/4 12.3 1/2 Socket tool set ●  
 6.3 1/4 12.3 1/2 Steckschlüssel-Werkzeug-Satz ●  
**V2378**, EAN 4047728023788



3/3 2K

6.3 1/4 ●  
 Sizes / SW  
 4-14 mm  
 12.3 1/2 ●  
 Sizes / SW  
 10-32 mm



Soft foam insert, empty  
 Weichschaum-Einlage, leer  
**V2373**, EAN 4047728023733



20 3/4 Socket tool set ●  
 20 3/4 Steckschlüssel-Werkzeug-Satz ●  
**V2364**, EAN 4047728023641



3/3 2K

20 3/4 ●  
 19 · 21 · 22 · 23 · 24 · 26 · 27  
 28 · 30 · 32 · 34 · 36 · 38 · 41  
 46 · 50 mm  
 20 3/4 100, 200, 400 mm  
 20 3/4 450 mm

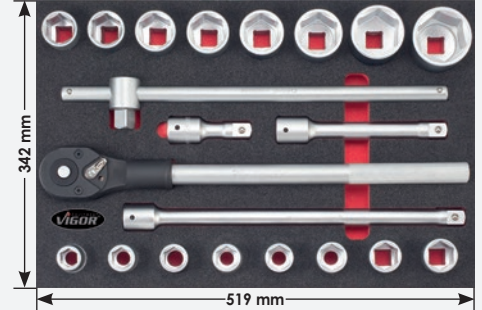

Soft foam insert, empty  
 Weichschaum-Einlage, leer  
**V2363**, EAN 4047728023634



Double open-end, double box-end  
 and combination wrench set  
 Doppel-Maul-, Doppel-Ring- und Ring-Maulschlüssel-Satz  
**V2375**, EAN 4047728023757



3/3 2K  
 New: now with  
 size 16 + 18  
 Neu: Jetzt mit  
 SW 16 + 18

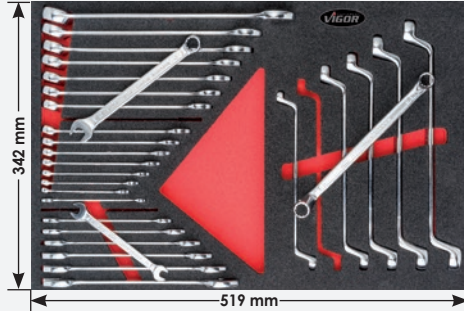

6 x 7 · 8 x 9 · 10 x 11 · 12 x 13 · 14 x 15 · 16 x 17 · 18 x 19 · 20 x 22 mm  
 6 · 7 · 8 · 9 · 10 · 11 · 12 · 13 · 14 · 15 · 16 · 17 · 18 · 19 · 22 mm  
 10 x 11 · 12 x 13 · 14 x 15 · 16 x 17 · 18 x 19 · 20 x 22 mm

Soft foam insert, empty  
 Weichschaum-Einlage, leer  
**V2374**, EAN 4047728023740



Ratcheting combination wrench and  
 15° offset combination wrench set  
 Ratschen-Ring-Maulschlüssel und  
 15° gekröpfte Ring-Maulschlüssel-Satz  
**V1517**, EAN 4047728015172



3/3 2K  
 New: now with  
 size 16 + 18  
 Neu: Jetzt mit  
 SW 16 + 18

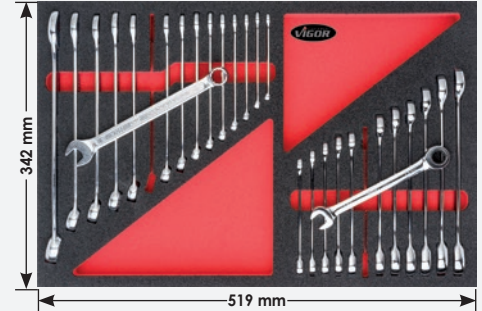

8 · 9 · 10 · 11 · 12 · 13 · 14 · 15 · 16 · 17 · 18 · 19 mm  
 6 · 7 · 8 · 9 · 10 · 11 · 12 · 13 · 14 · 15 · 16 · 17 · 18 · 19 · 22 mm

Soft foam insert, empty  
 Weichschaum-Einlage, leer  
**V1506**, EAN 4047728015066



Double box-end wrench and double open-end wrench set  
 Doppel-Ringschlüssel- und Doppel-Maulschlüssel-Satz  
**V1525**, EAN 4047728015257



3/3 2K



6 x 7 · 8 x 9 · 10 x 11 · 12 x 13 · 14 x 15 · 16 x 17 · 18 x 19  
 20 x 22 · 21 x 23 · 24 x 27 · 25 x 28 · 30 x 32 mm  
 6 x 7 · 8 x 9 · 10 x 11 · 12 x 13 · 14 x 15 · 16 x 17 · 18 x 19  
 20 x 22 · 21 x 23 · 24 x 27 · 25 x 28 · 30 x 32 mm

Soft foam insert, empty  
 Weichschaum-Einlage, leer  
**V1513**, EAN 4047728015134



Wrench assortment  
 Schraubenschlüssel-Sortiment  
**V1747**, EAN 4047728017473



3/3 2K

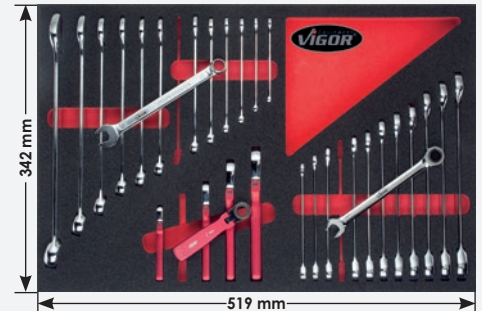

8 · 9 · 10 · 11 · 12 · 13 · 14 · 15 · 16 · 17 · 18 · 19 mm  
 6 · 7 · 8 · 9 · 10 · 11 · 12 · 13 · 14 · 15 · 17 · 19 · 22 mm  
 8 · 10 · 13 · 16 · 19 mm

Soft foam insert, empty  
 Weichschaum-Einlage, leer  
**V1743**, EAN 4047728017435



# 3/3 Soft Foam Inserts for VIGOR 500 - 800 3/3 Weichschaum-Einlagen für VIGOR 500 - 800



TORX® and 6-point T-handle screwdriver set  
TORX® und Sechskant-T-Griff-Schraubendreher-Satz  
**V1520**, EAN 4047728015202



3/3 2K

- ⊕ T9 · T10 · T15 · T20  
T25 · T27 · T30 · T40
- ⊖ 2 · 2.5 · 3 · 4 ·  
5 · 6 · 8 · 10 mm

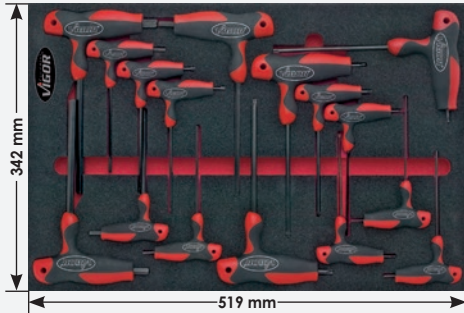

Soft foam insert, empty  
Weichschaum-Einlage, leer  
**V1510**, EAN 4047728015103



Screwdriver and pliers set  
Schraubendreher- und Zangen-Satz  
**V2376**, EAN 4047728023764



3/3 2K

- ⊖ 3 · 4 · 5.5 · 6.5
- ⊕ PH0 · PH1 · PH2



Soft foam insert, empty  
Weichschaum-Einlage, leer  
**V2377**, EAN 4047728023771



Pliers set  
Zangen-Satz  
**V3606**, EAN 4047728036061



3/3 2K

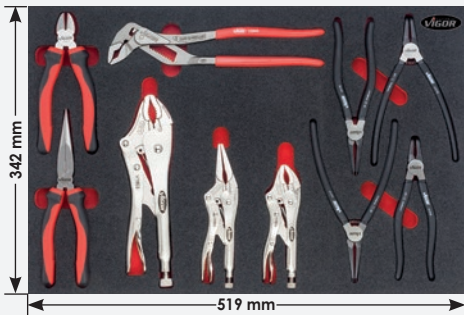

Soft foam insert, empty  
Weichschaum-Einlage, leer  
**V3605**, EAN 4047728036054



Measuring and cutting tools and pliers set  
Mess-, Schneidewerkzeuge, Zangen-Satz  
**V1748**, EAN 4047728017480



3/3 2K

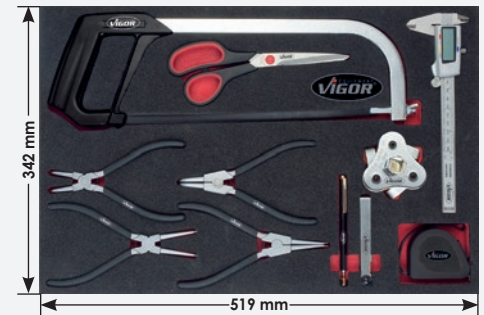

Soft foam insert, empty  
Weichschaum-Einlage, leer  
**V1871**, EAN 4047728018715



TOOLS TO  
FIRE YOUR  
EMOTION!

DAFÜR  
BRENNE  
ICH!

6.3 1/4 10 3/8 12.9 1/2 Socket tool set  
 6.3 1/4 10 3/8 12.9 1/2 Steckschlüssel-Werkzeug-Satz  
**V4188**, EAN 4047728041881



V1000 1/1 2K

- 4-32 mm
- E 4-E 22
- 3-19 mm
- 4-12 mm
- PH 0-PH 4
- PZ 0-PZ 4
- T 5-T 70
- T 7 H-T 70 H
- M 5-M 8
- M 5-R 9

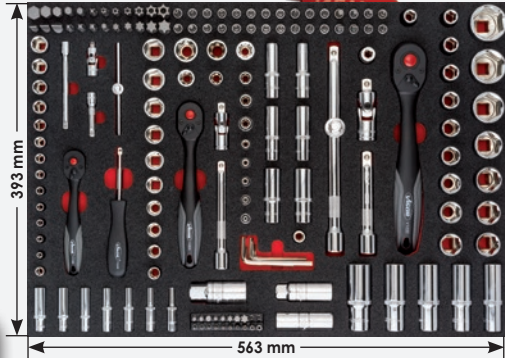

Soft foam insert, empty  
 Weichschaum-Einlage, leer  
**V4130**, EAN 4047728041300



6.3 1/4 10 3/8 12.9 1/2 Socket assortment ⊕ ⊙ ⊗ ⊛ ⊜  
 6.3 1/4 10 3/8 12.9 1/2 Steckschlüssel-Einsatz-Sortiment ⊙ ⊙ ⊙ ⊙ ⊕



V1000 1/1 2K

- 12.9 1/2 ⊙ M 5-M 16
- 12.9 1/2 ⊙ 5-19 mm
- 12.9 1/2 ⊙ M 5-M 14
- 12.9 1/2 ⊕ T 20-T 70
- 6.3 1/4 ⊙ E 4-E 11
- 10 3/8 ⊙ E 4-E 20
- 12.9 1/2 ⊕ E 10-E 24

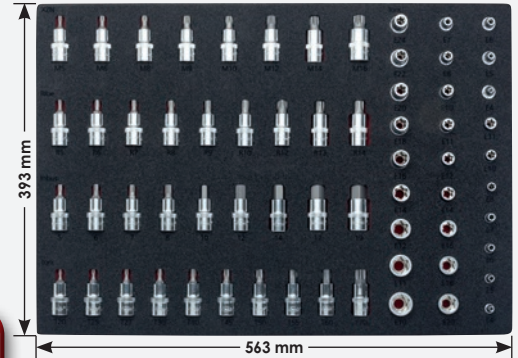

Soft foam insert, empty  
 Weichschaum-Einlage, leer  
**V2837**, EAN 4047728028370



Scraper and screwdriver set  
 Schraubendreher- und Schaber-Satz  
**V2007**, EAN 4047728020077



V1000 1/1 2K

- 3 · 4 · 5.5 · 6.5 mm
- ⊕ PH 0 · PH 1 · PH 2



Soft foam insert, empty  
 Weichschaum-Einlage, leer  
**V1973**, EAN 4047728019736



Screwdriver set  
 Schraubendreher-Satz  
**V4230**, EAN 4047728042307



V1000 1/1 2K

- 3 · 3.5 · 4 · 4.5 · 5.5 · 6.5 · 8 · 10 mm
- ⊕ PH 0 · PH 1 · PH 2 · PH 3
- ⊕ T 10 · T 15 · T 20 · T 25 · T 27 · T 30 · T 40
- 6 · 7 · 8 · 10 · 12 · 13 mm

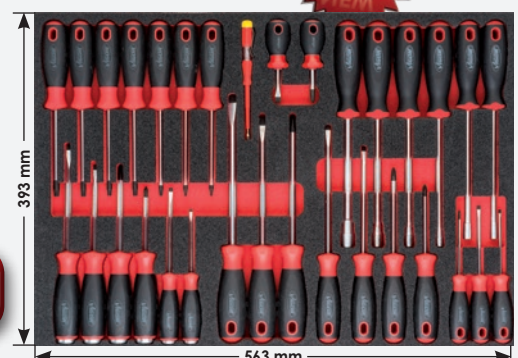

Soft foam insert, empty  
 Weichschaum-Einlage, leer  
**V4231**, EAN 4047728042314



Hammer, pliers and screwdriver set  
 Hammer-, Zangen-, Schraubendreher-Satz  
**V4239**, EAN 4047728042390



V1000 1/1 2K

- 3 · 4 · 5.5 · 6.5 mm
- ⊕ PH 0 · PH 1 · PH 2



Soft foam insert, empty  
 Weichschaum-Einlage, leer  
**V4240**, EAN 4047728042406



TORX® and 6-point T-handle screwdriver set ⊙ ⊗ ⊛ ⊜  
 TORX® und Sechskant T-Griff-Schraubendreher-Satz ⊙ ⊙



V1000 1/1 2K

- ⊕ T 9 · T 10 · T 15 · T 20 · T 25 · T 27 · T 30 · T 40
- 2 · 2.5 · 3 · 4 · 5 · 6 · 8 · 10 mm



Soft foam insert, empty  
 Weichschaum-Einlage, leer  
**V1972**, EAN 4047728019729





**1/1 Soft Foam Inserts *only* for VIGOR 1000**  
**1/1 Weichschaum-Einlagen *nur* für VIGOR 1000**



Double box-end wrench, double open-end wrench, combination wrench set  
 Doppel-Ringschlüssel-, Doppel-Maulschlüssel-, Ring-Maulschlüssel-Satz  
**V2008**, EAN 4047728020084



**V1000**  
1/1 **2K**

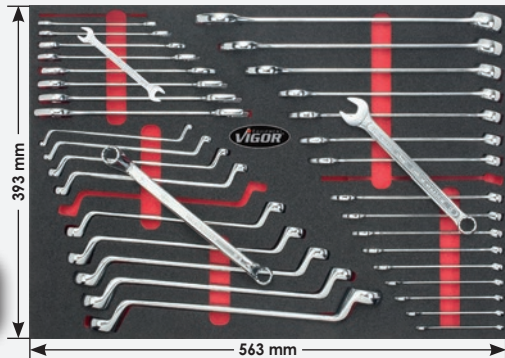

- 6 x 7 · 8 x 9 · 10 x 11 · 12 x 13 · 14 x 15 · 16 x 17 · 18 x 19 · 20 x 22 · 21 x 23 mm
- 6 · 7 · 8 · 9 · 10 · 11 · 12 · 13 · 14 · 15 · 16 · 17 · 18 · 19 · 22 · 24 · 27 mm
- 6 x 7 · 8 x 9 · 10 x 11 · 12 x 13 · 14 x 15 · 16 x 17 · 18 x 19 · 20 x 22 · 21 x 23 · 24 x 27 mm

Soft foam insert, empty  
 Weichschaum-Einlage, leer  
**V1974**, EAN 4047728019743

Pliers, hammer and chisel set  
 Zangen-, Hammer- und Meißel-Satz  
**V2009**, EAN 4047728020091



**V1000**  
1/1 **2K**



Soft foam insert, empty  
 Weichschaum-Einlage, leer  
**V1975**, EAN 4047728019750

Universal tool case  
**V2542**, EAN 4047728025423

• Universal tool case with assortment

Universal-Werkzeugkoffer

**V2542**, EAN 4047728025423

• Werkzeug-Koffer inkl. Sortiment



V2602



Tool case  
**V1425**, EAN 4047728014250

• Internal handle tray with bit holder and measuring scale (cm/inch)

Werkzeugkoffer

**V1425**, EAN 4047728014250

• Trageinsatz mit Bithalter und Maßeinteilung (cm/inch)

Integrated assortment boxes  
 Integrierte Sortimentskästen



VIGOR No.	Designation	Bezeichnung	EAN
V2400	Case, empty, w/o soft foam insert	Koffer, leer, ohne Weichschaum-Einlage	024006
V2464	Soft foam insert, universal tool case	Weichschaumeinlage Universal-Werkzeugkoffer	024648

**6.3 1/4" Socket set**  
**V3734**, EAN 4047728037341

**6.3 1/4" Steckschlüssel-Satz**  
**V3734**, EAN 4047728037341



X	Design Ausführung	SW (mm)	Sizes (mm) / mm
12 x		6.3 1/4"	4 · 4.5 · 5 · 5.5 · 6 · 7 · 8 · 9 10 · 11 · 12 · 13 mm
2 x		6.3 1/4"	PH 1 · PH 2
2 x		6.3 1/4"	PZ 1 · PZ 2
4 x		6.3 1/4"	T 15 · T 20 · T 25 · T 30
1 x		6.3 1/4"	100 mm
1 x		6.3 1/4"	25 mm
1 x		6.3 1/4"	150 mm

Single parts from page 44 on  
 Einzelteilaufistung ab Seite 44

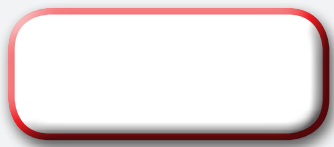

**6.3 1/4" Socket set**  
**V2414**, EAN 4047728024143

**6.3 1/4" Steckschlüssel-Satz**  
**V2414**, EAN 4047728024143



X	Design Ausführung	SW (mm)	Sizes (mm) / mm
13 x		6.3 1/4"	4 · 4.5 · 5 · 5.5 · 6 · 7 · 8 · 9 10 · 11 · 12 · 13 · 14 mm
3 x		6.3 1/4"	0.8 x 4 · 1 x 5.5 · 1.2 x 7 mm
6 x		6.3 1/4"	3 · 4 · 5 · 6 · 7 · 8 mm
3 x		6.3 1/4"	PH 1 · PH 2 · PH 3
3 x		6.3 1/4"	PZ 1 · PZ 2 · PZ 3
6 x		6.3 1/4"	T 10 · T 15 · T 20 · T 25 · T 30 · T 40
4 x		6.3 1/4"	1.27 · 1.5 · 2 · 2.5 mm
1 x		6.3 1/4"	145 mm
1 x		6.3 1/4"	110 mm
1 x		6.3 1/4"	50 mm
2 x		6.3 1/4"	100 · 145 mm
1 x		6.3 1/4"	40 mm
1 x		6.3 1/4"	150 mm
1 x		6.3 1/4"	150 mm

Single parts from page 44 on  
 Einzelteilaufistung ab Seite 44



Socket Systems **6.3 1/4"**  
 Steckschlüssel-Systeme **6.3 1/4"**



**6.3 1/4"** Socket set with multi-purpose profile  
**V4217**, EAN 4047728042178

**6.3 1/4"** Multiprofil Steckschlüssel-Satz  
**V4217**, EAN 4047728042178



Available in February  
 Erhältlich ab Februar



**6.3 1/4"**



<b>X</b>	Design Ausführung	<b>6.3 1/4"</b>	Sizes (mm) / SW (mm) / mm
13 x		<b>6.3 1/4"</b>	4 · 4.5 · 5 · 5.5 · 6 · 7 · 8 · 9 10 · 11 · 12 · 13 · 14 mm
6 x		<b>6.3 1/4"</b>	3 · 4 · 5 · 6 · 7 · 8 mm
2 x		<b>6.3 1/4"</b>	PH 1 · PH 2
2 x		<b>6.3 1/4"</b>	PZ 1 · PZ 2
6 x		<b>6.3 1/4"</b>	T 10 · T 15 · T 20 · T 25 · T 27 · T 30 · T 40
5 x		<b>6.3 1/4"</b>	M4 · M5 · M5 · M8 · M10
1 x		<b>6.3 1/4"</b>	—
1 x		<b>6.3 1/4"</b>	100
1 x		<b>6.3 1/4"</b>	40 mm
1 x		<b>6.3 1/4"</b>	150 mm
1 x		<b>6.3 1/4"</b>	152 mm

Single parts from page 44 on  
 Einzelteillaufistung ab Seite 44



**6.3 1/4"** Socket set with multi-purpose profile  
**V1897**, EAN 4047728018975

**6.3 1/4"** Multiprofil Steckschlüssel-Satz  
**V1897**, EAN 4047728018975



**6.3 1/4"**



Multi-purpose screw profiles / Multiprofile

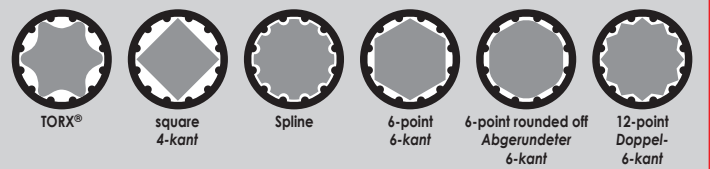

All sockets suitable for  
 6 different profiles!  
 Alle Einsätze für  
 6 Profile geeignet!



<b>X</b>	Design Ausführung	Sizes (mm) SW (mm)
12 x		4 · 5 · 5.5 · 6 · 7 · 8 · 9 · 10 · 11 · 12 · 13 · 14 mm

Single parts see page 44  
 Einzelteillaufistung Seite 44



$\frac{1}{4}$ " Socket

$\frac{1}{4}$ " Steckschlüssel-Einsatz



VIGOR No.	Sizes (mm) SW (mm)	mm	EAN 4047728+
V2413	4	25	024136
V2415	4.5	25	024150
V2416	5	25	024167
V2417	5.5	25	024174
V2418	6	25	024181
V2419	7	25	024198
V2420	8	25	024204
V2421	9	25	024211
V2422	10	25	024228
V2423	11	25	024235
V2424	12	25	024242
V2425	13	25	024259
V2426	14	25	024266

$\frac{1}{4}$ " Socket, long

$\frac{1}{4}$ " Steckschlüssel-Einsatz, lang



VIGOR No.	Sizes (mm) SW (mm)	mm	EAN 4047728+
V2533	4	50	025331
V2534	5	50	025348
V2535	6	50	025355
V2536	7	50	025362
V2537	8	50	025379
V2538	9	50	025386
V2539	10	50	025393
V2699	11	50	026994
V2700	12	50	027007
V2701	13	50	027014

$\frac{1}{4}$ " TORX® socket

$\frac{1}{4}$ " TORX® Steckschlüssel-Einsatz



VIGOR No.	Sizes (mm) SW (mm)	mm	EAN 4047728+
V2185	E 4	24.8	021852
V2186	E 5	24.8	021869
V2187	E 6	24.8	021876
V2188	E 7	24.8	021883
V2189	E 8	24.8	021890
V2722	E 10	24.8	027229
V2723	E 11	24.8	027236

$\frac{1}{4}$ " Socket with multi-purpose profile

$\frac{1}{4}$ " Multiprofil-Steckschlüssel-Einsatz



VIGOR No.	Sizes (mm) SW (mm)	mm	EAN 4047728+
V1976	4	25	019767
V1977	5	25	019774
V1978	5.5	25	019781
V1979	6	25	019798
V1980	7	25	019804
V1981	8	25	019811
V1982	9	25	019828
V1983	10	25	019835
V1984	11	25	019842
V1985	12	25	019859
V1986	13	25	019866
V1987	14	25	019873

$\frac{1}{4}$ " Screwdriver socket

$\frac{1}{4}$ " Schraubendreher-Einsatz



VIGOR No.	Sizes (mm) SW (mm)	mm	EAN 4047728+
V2430	3	38	024303
V2431	4	38	024310
V2432	5	38	024327
V2433	6	38	024334
V2434	7	38	024341
V2435	8	38	024358

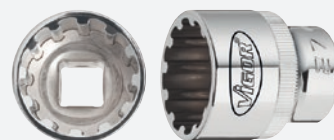

**Multi-purpose screw profiles / Multiprofile**

$\frac{1}{4}$ " Screwdriver socket

$\frac{1}{4}$ " Schraubendreher-Einsatz



VIGOR No.	Sizes (mm) SW (mm)	mm	EAN 4047728+
V2427	0.8 x 4	38	024273
V2428	1 x 5.5	38	024280
V2597	1.2 x 6.5	38	025973
V2429	1.2 x 7	38	024297

$\frac{1}{4}$ " Screwdriver socket

$\frac{1}{4}$ " Schraubendreher-Einsatz



VIGOR No.	Sizes (mm) SW (mm)	mm	EAN 4047728+
V2593	PH 0	38	025935
V2436	PH 1	38	024365
V2437	PH 2	38	024372
V2438	PH 3	38	024389

# Socket Systems 6.3 1/4" Steckschlüssel-Systeme 6.3 1/4"



## 6.3 1/4" Screwdriver socket

### 6.3 1/4" Schraubendreher-Einsatz



VIGOR No.	Sizes (mm) SW (mm)	mm	EAN 4047728+
V2594	PZ 0	38	025942
V2439	PZ 1	38	024396
V2440	PZ 2	38	024402
V2441	PZ 3	38	024419



## 6.3 1/4" TORX® screwdriver socket

### 6.3 1/4" TORX® Schraubendreher-Einsatz



VIGOR No.	Sizes (mm) SW (mm)	mm	EAN 4047728+
V2595	T 9	38	025959
V2442	T 10	38	024426
V2443	T 15	38	024433
V2444	T 20	38	024440
V2445	T 25	38	024457
V2446	T 30	38	024464
V2447	T 40	38	024471



## 6.3 1/4" Screwdriver socket

### 6.3 1/4" Schraubendreher-Einsatz



VIGOR No.	Sizes (mm) SW (mm)	mm	EAN 4047728+
V2596	T 9 H	38	025966
V2136	T 10 H	37	021364
V2138	T 15 H	37	021388
V2139	T 20 H	37	021395
V2140	T 25 H	37	021401
V2141	T 27 H	37	021418
V2142	T 30 H	37	021425



## 6.3 1/4" Spin type speeder

### 6.3 1/4" Steckgriff



VIGOR No.	mm	EAN 4047728+
V2458	150	024587



## 6.3 1/4" Fine-tooth reversible ratchet

### 6.3 1/4" Feinzahn-Umschaltknarre



VIGOR No.	mm	EAN 4047728+
V1038	150	010382



Repair set  
Reparatur-Satz  
V3585, EAN 4047728035859

## 6.3 1/4" Reversible ratchet with T-handle

### 6.3 1/4" T-Griff-Umschaltknarre



VIGOR No.	mm	EAN 4047728+
V1032	150	010320



## 6.3 1/4" Finger ratchet

### 6.3 1/4" Fingerratsche



VIGOR No.	EAN 4047728+
V2941	029414

## 6.3 1/4" Fine-tooth reversible ratchet

### 6.3 1/4" Feinzahn-Umschaltknarre

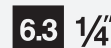

VIGOR No.	mm	EAN 4047728+
V4212	150	042123

**6.3 1/4" Sliding T-handle**

**6.3 1/4" Gleitgriff**

**6.3 1/4"**

VIGOR No.	mm	EAN
<b>V2453</b>	110	024532



**6.3 1/4" 6.3 1/4" Universal joint**

**6.3 1/4" 6.3 1/4" Universalgelenk**

**6.3 1/4" 6.3 1/4"**

VIGOR No.	mm	EAN
<b>V2454</b>	40	024549



**6.3 1/4" 6.3 1/4" Flexible extension**

**6.3 1/4" 6.3 1/4" Flexible Verlängerung**

**6.3 1/4" 6.3 1/4"**

VIGOR No.	mm	EAN
<b>V2457</b>	145	024570

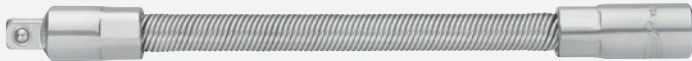

**6.3 1/4" 6.3 1/4" Extension**

**6.3 1/4" 6.3 1/4" Verlängerung**

**6.3 1/4" 6.3 1/4"**

VIGOR No.	mm	EAN
<b>V2455</b>	50	024556
<b>V2456</b>	100	024563



**6.3 1/4" 6.3 1/4" Adapter**

**6.3 1/4" 6.3 1/4" Adapter**

**6.3 1/4" 6.3 1/4"**

VIGOR No.	mm	EAN
<b>V2452</b>	30	024525



**10 3/8" 6.3 1/4" Adapter**

**10 3/8" 6.3 1/4" Adapter**

**10 3/8" 6.3 1/4"**

VIGOR No.	mm	EAN
<b>V2071</b>	27	020718



**6.3 1/4" 6.3 1/4" Bit adapter**

**6.3 1/4" 6.3 1/4" Bit-Adapter**

**6.3 1/4" 6.3 1/4"**

VIGOR No.	mm	EAN
<b>V3651</b>	25	036511



# Socket Systems $10 \frac{3}{8}$ Steckschlüssel-Systeme $10 \frac{3}{8}$



$10 \frac{3}{8}$  Socket set  
**V2305**, EAN 4047728023054



$10 \frac{3}{8}$  Steckschlüssel-Satz  
**V2305**, EAN 4047728023054



X	Design Ausführung	Sizes (mm) / SW (mm) / mm
18 x		6 · 7 · 8 · 9 · 10 · 11 · 12 · 13 · 14 · 15 · 16 · 17 · 18 · 19 · 20 · 21 · 22 · 24 mm
10 x		8 · 9 · 10 · 11 · 12 · 13 · 14 · 15 · 17 · 19 mm
2 x		16 · 21 mm
7 x		3 · 4 · 5 · 6 · 7 · 8 · 10 mm
3 x		0.8 x 5.5 · 1 x 7 · 1.2 x 8 mm
3 x		PH 1 · PH 2 · PH 3
3 x		PZ 1 · PZ 2 · PZ 3
9 x		T 15 · T 20 · T 25 · T 27 · T 30 · T 40 · T 45 · T 50 · T 55
1 x		-
1 x		40 mm
1 x		75 mm
1 x		250 mm
1 x		50 mm
1 x		198 mm

Single parts from page 48 on  
Einzelteilaufistung ab Seite 48

$10 \frac{3}{8}$  Glow plug socket set  
**V2737**, EAN 4047728027373



$10 \frac{3}{8}$  Glühkerzen-Steckschlüssel-Satz  
**V2737**, EAN 4047728027373

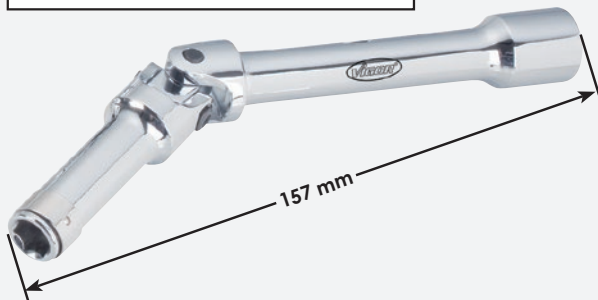
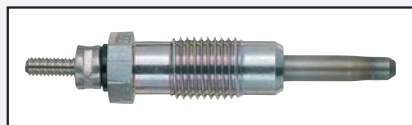

X	Sizes (mm) / SW (mm)
6 x	8 · 9 · 10 · 12 · 14 · 16 mm

Single parts see page 48  
Einzelteilaufistung Seite 48

$10 \frac{3}{8}$  Socket

$10 \frac{3}{8}$  Steckschlüssel-Einsatz



VIGOR No.	Sizes (mm) SW (mm)	mm	EAN 4047728+
V2278	6	28	022781
V2277	7	28	022774
V2276	8	28	022767
V2275	9	28	022750
V2274	10	28	022743
V2273	11	28	022736
V2272	12	28	022729
V2271	13	28	022712
V2270	14	28	022705
V2269	15	28	022699
V2268	16	28	022682
V2267	17	30	022675
V2266	18	30	022668
V2265	19	30	022651
V2264	20	30	022644
V2263	21	30	022637
V2262	22	30	022620
V2261	24	30	022613

$10 \frac{3}{8}$  Socket, long

$10 \frac{3}{8}$  Steckschlüssel-Einsatz, lang



VIGOR No.	Sizes (mm) SW (mm)	mm	EAN 4047728+
V2016	8	63	020169
V2017	9	63	020176
V2018	10	63	020183
V2019	11	63	020190
V2020	12	63	020206
V2311	13	63	023115
V2312	14	63	023122
V2313	15	63	023139
V2314	17	63	023146
V2315	19	63	023153

$10 \frac{3}{8}$  Spark plug socket

$10 \frac{3}{8}$  Zündkerzen-Einsatz

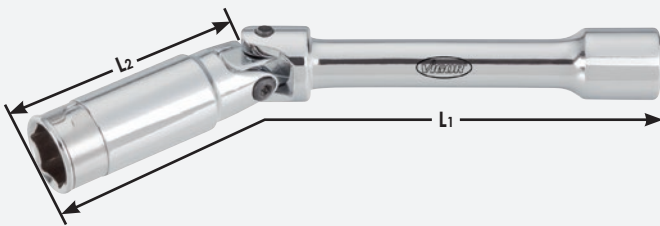

VIGOR No.	Sizes (mm) SW (mm)	Total Gesamt mm	Blade Klinge mm	EAN 4047728+
V2738	8	157	45	027380
V2741	9	157	45	027410
V2742	10	157	45	027427
V2743	12	157	45	027434
V2744	14	157	45	027441
V2739	16	157	45	027397

$10 \frac{3}{8}$  Spark plug socket

$10 \frac{3}{8}$  Zündkerzen-Einsatz



VIGOR No.	Sizes (mm) SW (mm)	mm	EAN 4047728+
V2119	16	66	021197
V2613	18	66	026130
V2120	21	66	021203



$10 \frac{3}{8}$  TORX® socket

$10 \frac{3}{8}$  TORX® Steckschlüssel-Einsatz



VIGOR No.	Sizes (mm) SW (mm)	mm	EAN 4047728+
V2724	E 4	28	027243
V2725	E 5	28	027250
V2726	E 6	28	027267
V2727	E 7	28	027274
V2728	E 8	28	027281
V2143	E 10	28	021432
V2614	E 11	28	026147
V2144	E 12	28	021449
V2145	E 14	28	021456
V2146	E 16	28	021463
V2615	E 18	28	026154
V2729	E 20	28	027298



# Socket Systems $10 \frac{3}{8}$ Steckschlüssel-Systeme $10 \frac{3}{8}$



$10 \frac{3}{8}$  Screwdriver socket  $\odot$

$10 \frac{3}{8}$  Schraubendreher-Einsatz  $\odot$



VIGOR No.	Sizes (mm) SW (mm)	mm	EAN 4047728+
V2285	3	49	022859
V2284	4	49	022842
V2283	5	49	022835
V2282	6	49	022828
V2281	7	49	022811
V2280	8	49	022804
V2279	10	49	022798

$10 \frac{3}{8}$  Screwdriver socket  $\ominus$

$10 \frac{3}{8}$  Schraubendreher-Einsatz  $\ominus$



VIGOR No.	Sizes (mm) SW (mm)	mm	EAN 4047728+
V2288	0.8 x 5.5	49	022880
V2287	1 x 7	49	022873
V2286	1.2 x 8	49	022866

$10 \frac{3}{8}$  Screwdriver socket  $\oplus$

$10 \frac{3}{8}$  Schraubendreher-Einsatz  $\oplus$



VIGOR No.	Sizes (mm) SW (mm)	mm	EAN 4047728+
V2294	PH 1	49	022941
V2293	PH 2	49	022934
V2292	PH 3	49	022927

$10 \frac{3}{8}$  Screwdriver socket  $\odot$

$10 \frac{3}{8}$  Schraubendreher-Einsatz  $\odot$



VIGOR No.	Sizes (mm) SW (mm)	mm	EAN 4047728+
V2291	PZ 1	49	022910
V2290	PZ 2	49	022903
V2289	PZ 3	49	022897

$10 \frac{3}{8}$  TORX® screwdriver socket  $\odot$

$10 \frac{3}{8}$  TORX® Schraubendreher-Einsatz  $\odot$



VIGOR No.	Sizes (mm) SW (mm)	mm	EAN 4047728+
V2303	T 15	49	023030
V2302	T 20	49	023023
V2301	T 25	49	023016
V2300	T 27	49	023009
V2299	T 30	49	022996
V2298	T 40	49	022989
V2297	T 45	49	022972
V2149	T 47	49	021494
V2296	T 50	49	022965
V2295	T 55	49	022958

$10 \frac{3}{8}$  TORX® screwdriver socket  $\odot$

$10 \frac{3}{8}$  TORX® Schraubendreher-Einsatz  $\odot$



VIGOR No.	Sizes (mm) SW (mm)	mm	EAN 4047728+
V2193	T 40 H	48	021937
V2194	T 45 H	48	021944
V2195	T 50 H	48	021951

$10 \frac{3}{8}$  Fine-tooth reversible ratchet

$10 \frac{3}{8}$  Feinzahn-Umschaltknarre

$10 \frac{3}{8}$



2K System

VIGOR No.	mm	EAN 4047728+
V2304	198	023047

Repair set  
Reparatur-Satz  
V3584, EAN 4047728035842

10 3/8 125 1/2 Sliding head/adaptor  
 10 3/8 125 1/2 Schiebestück/Adapter

10 3/8 125 1/2

VIGOR No.	mm	EAN 4047728+
V2116	40	021166



10 3/8 10 3/8 Universal joint  
 10 3/8 10 3/8 Universalgelenk

10 3/8 10 3/8

VIGOR No.	mm	EAN 4047728+
V2118	50	021180



8 5/16 10 3/8 Bit adapter  
 8 5/16 10 3/8 Bit-Adapter

8 5/16 10 3/8

VIGOR No.	mm	EAN 4047728+
V2114	28	021142



6.3 1/4 10 3/8 Adapter  
 6.3 1/4 10 3/8 Adapter

6.3 1/4 10 3/8

VIGOR No.	mm	EAN 4047728+
V2014	26	020145



125 1/2 10 3/8 Adapter  
 125 1/2 10 3/8 Adapter

125 1/2 10 3/8

VIGOR No.	mm	EAN 4047728+
V2108	36	021081



10 3/8 10 3/8 Bit adapter  
 10 3/8 10 3/8 Bit-Adapter

10 3/8 10 3/8

VIGOR No.	mm	EAN 4047728+
V3652	30	036528



10 3/8 10 3/8 Extension  
 10 3/8 10 3/8 Verlängerung

10 3/8 10 3/8



VIGOR No.	mm	EAN 4047728+
V2115	75	021159
V2616	125	026161
V2117	250	021173

# Socket Systems $\frac{12.5}{16}$ 1/2"

## Steckschlüssel-Systeme $\frac{12.5}{16}$ 1/2"



$\frac{12.5}{16}$  Socket set  
V2460, EAN 4047728024600



$\frac{12.5}{16}$  Steckschlüssel-Satz  
V2460, EAN 4047728024600

$\frac{12.5}{16}$  1/2"

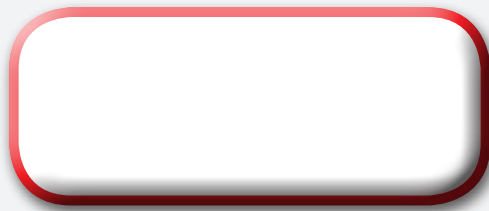

	Design Ausführung	Sizes (mm) SW (mm) / mm
18 x		10 · 11 · 12 · 13 · 14 · 15 · 16 · 17 · 18 · 19 20 · 21 · 22 · 23 · 24 · 27 · 30 · 32 mm
2 x		16 · 21 mm
1 x		250 mm
1 x		125 mm
1 x		250 mm
1 x		75 mm
1 x		250 mm

Single parts from page 56 on  
Einzelteilaufistung ab Seite 56

$\frac{12.5}{16}$  Socket set with multi-purpose profile  
V1898, EAN 4047728018982



$\frac{12.5}{16}$  Multiprofil Steckschlüssel-Satz  
V1898, EAN 4047728018982

$\frac{12.5}{16}$  1/2"



### Multi-purpose screw profiles / Multiprofile

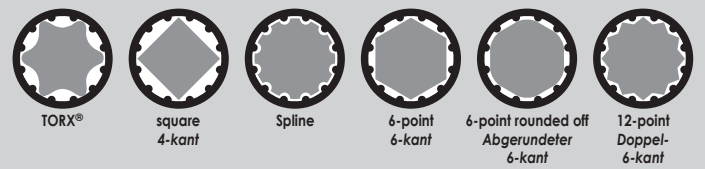

All sockets suitable for  
6 different profiles!  
Alle Einsätze für  
6 Profile geeignet!



	Design Ausführung	Sizes (mm) SW (mm)
17 x		10 · 11 · 12 · 13 · 14 · 15 · 16 · 17 · 18 · 19 20 · 21 · 22 · 24 · 27 · 30 · 32 mm

Single parts see page 56  
Einzelteilaufistung Seite 56



$12\frac{5}{16}$ " TORX® screwdriver socket set  
V1917, EAN 4047728019170

$12\frac{5}{16}$ " TORX® Schraubendreher-  
Einsatz-Sortiment  
V1917, EAN 4047728019170



$12\frac{5}{16}$ "



	Design Ausführung	Sizes (mm) SW (mm)
10 x		T 20 · T 25 · T 27 · T 30 · T 40 · T 45 · T 50 · T 55 · T 60 · T 70
10 x		T 20 · T 25 · T 27 · T 30 · T 40 · T 45 · T 50 · T 55 · T 60 · T 70
6 x		T 40 · T 45 · T 50 · T 55 · T 60 · T 70
6 x		T 40 · T 45 · T 50 · T 55 · T 60 · T 70

Single parts see page 58  
Einzelteilaufistung Seite 58

$12\frac{5}{16}$ " Screwdriver socket set for screws  
with internal serration (XZIN)  
V1918, EAN 4047728019187

$12\frac{5}{16}$ " Innenvielzahn Schraubendreher-  
Einsatz-Sortiment (XZIN)  
V1918, EAN 4047728019187



$12\frac{5}{16}$ "



	Design Ausführung	Sizes (mm) SW (mm)
8 x		M 5 · M 6 · M 8 · M 9 · M 10 · M 12 · M 14 · M 16
7 x		M 5 · M 6 · M 8 · M 9 · M 10 · M 12 · M 14
7 x		M 5 · M 6 · M 8 · M 9 · M 10 · M 12 · M 14
4 x		M 8 · M 10 · M 12 · M 14

Single parts see page 57  
Einzelteilaufistung Seite 57

# Socket Systems $12\frac{5}{8}$ 1/2"

## Steckschlüssel-Systeme $12\frac{5}{8}$ 1/2"



$12\frac{5}{8}$  1/2" Screwdriver socket set  
for inside hexagon  
**V1919**, EAN 4047728019194



$12\frac{5}{8}$  1/2" Innensechskant Schraubendreher-  
Einsatz-Sortiment  
**V1919**, EAN 4047728019194

$12\frac{5}{8}$  1/2"



	Design Ausführung	Sizes (mm) SW (mm)
9 x		5 · 6 · 7 · 8 · 10 · 12 · 14 · 17 · 19 mm
8 x		5 · 6 · 7 · 8 · 10 · 11 · 12 · 13 mm
7 x		5 · 6 · 7 · 8 · 10 · 12 · 14 mm
6 x		5 · 6 · 7 · 8 · 10 · 12 mm

Single parts see page 57  
*Einzelteilaufistung Seite 57*



$12\frac{5}{8}$  1/2" RIBE Screwdriver socket set  
**V2201**, EAN 4047728022019



$12\frac{5}{8}$  1/2" RIBE Schraubendreher-  
Einsatz-Sortiment  
**V2201**, EAN 4047728022019

$12\frac{5}{8}$  1/2"



	Design Ausführung	Sizes (mm) SW (mm)
9 x		M 5 · M 6 · M 7 · M 8 · M 9 · M 10 · M 12 · M 13 · M 14
9 x		M 5 · M 6 · M 7 · M 8 · M 9 · M 10 · M 12 · M 13 · M 14
7 x		M 8 · M 9 · M 10 · M 10.3 · M 12 · M 13 · M 14
7 x		M 8 · M 9 · M 10 · M 10.3 · M 12 · M 13 · M 14

Single parts see page 58  
*Einzelteilaufistung Seite 58*



$12\frac{5}{8}$  1/2 Screwdriver socket set  
V2496, EAN 4047728024969



$12\frac{5}{8}$  1/2 Schraubendreher-Einsatz-Sortiment  
V2496, EAN 4047728024969



X	Design Ausführung	Sizes (mm) SW (mm)
8 x		M 5 · M 6 · M 8 · M 9 · M 10 · M 12 · M 14 · M 16
9 x		5 · 6 · 7 · 8 · 10 · 12 · 14 · 17 · 19 mm
9 x		M 5 · M 6 · M 7 · M 8 · M 9 · M 10 · M 12 · M 13 · M 14
10 x		T 20 · T 25 · T 27 · T 30 · T 40 · T 45 · T 50 · T 55 · T 60 · T 70

Single parts from page 57 on  
Einzelteilaufistung ab Seite 57

$12\frac{5}{8}$  1/2 Extractor socket set with spiral profile

• Special profile sockets for releasing defective nuts and bolt heads

$12\frac{5}{8}$  1/2 Spiralnutenausdreher-Einsatz-Sortiment

• Spezialprofil zum Lösen von Muttern mit rundgedrehten Köpfen



$12\frac{5}{8}$  1/2



V2404, EAN 4047728024044

X	Design Ausführung	Sizes (mm) SW (mm)
9 x		10 · 11 · 12 · 13 · 14 · 15 16 · 17 · 19 mm



Single parts see page 60  
Einzelteilaufistung Seite 60



$12\frac{5}{8}$  1/2



V3741, EAN 4047728037419

X	Design Ausführung	Sizes (mm) SW (mm)
6 x		21 · 22 · 24 · 27 · 30 · 32 mm



Single parts see page 60  
Einzelteilaufistung Seite 60

# Socket Systems $12\frac{5}{8}$ 1/2

## Steckschlüssel-Systeme $12\frac{5}{8}$ 1/2



VDE socket set

**V3343**, EAN 4047728033435





• VDE insulated up to 1000 V according to DIN EN 60900

VDE-Steckschlüssel-Satz

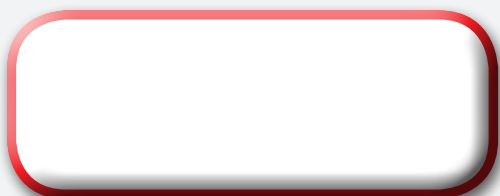
**V3343**, EAN 4047728033435

• VDE isoliert bis 1000 V nach DIN EN 60900

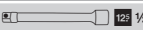

	Design Ausführung	Sizes (mm) SW (mm) / mm
9 x		8 · 10 · 12 · 13 · 14 · 17 · 19 · 22 · 24 mm
3 x		5 · 6 · 8 mm
1 x	 $12\frac{5}{8}$ 1/2	125 mm
1 x	 $12\frac{5}{8}$ 1/2	255 mm

Single parts see page 61  
Einzelteilaufistung Seite 61

$12\frac{5}{16}$  1/2" Socket ●

$12\frac{5}{16}$  1/2" Steckschlüssel-Einsatz ●



VIGOR No.	Sizes (mm) SW (mm)	mm	EAN 4047728+
V2465	10	38	024655
V2598	11	38	025980
V2603	12	38	026031
V2599	13	38	025997
V2600	14	38	026000
V2561	15	38	025614
V2562	16	38	025621
V2563	17	38	025638
V2564	18	38	025645
V2565	19	38	025652
V2566	20	38	025669
V2567	21	38	025676
V2568	22	38	025683
V2569	23	38	025690
V2570	24	38	025706
V2571	27	42	025713
V2572	30	44	025720
V2574	32	44	025744

$12\frac{5}{16}$  1/2" Socket, long ●

$12\frac{5}{16}$  1/2" Steckschlüssel-Einsatz, lang ●



VIGOR No.	Sizes (mm) SW (mm)	mm	EAN 4047728+
V2579	10	77	025799
V2580	11	77	025805
V2581	12	77	025812
V2584	13	77	025843
V2585	14	77	025850
V2586	15	77	025867
V2587	16	77	025874
V2588	17	77	025881
V2589	18	77	025898
V2590	19	77	025904
V2591	22	77	025911

$12\frac{5}{16}$  1/2" TORX® socket ●

$12\frac{5}{16}$  1/2" TORX® Steckschlüssel-Einsatz ●



VIGOR No.	Sizes (mm) SW (mm)	mm	EAN 4047728+
V2730	E 10	38	027304
V2731	E 11	38	027311
V2732	E 12	38	027328
V2733	E 14	38	027335
V2734	E 16	38	027342
V2196	E 18	38.2	021968
V2197	E 20	38.2	021975
V2735	E 22	38	027359
V2592	E 24	38	025928

$12\frac{5}{16}$  1/2" Spark plug socket ●

$12\frac{5}{16}$  1/2" Zündkerzen-Einsatz ●



VIGOR No.	Sizes (mm) SW (mm)	mm	EAN 4047728+
V2578	16	66	025782
V2582	21	66	025829

$12\frac{5}{16}$  1/2" Fine-tooth reversible ratchet

$12\frac{5}{16}$  1/2" Feinzahn-Umschaltknarre



VIGOR No.	mm	EAN 4047728+
V1020	250	010207



Socket with multi-purpose profile ○

Multiprofil-Steckschlüssel Einsatz ○



VIGOR No.	Sizes (mm) SW (mm)	mm	EAN 4047728+
V1988	10	38	019880
V1989	11	38	019897
V1990	12	38	019903
V1991	13	38	019910
V1992	14	38	019927
V1993	15	38	019934
V1994	16	38	019941
V1995	17	38	019958
V1996	18	38	019965
V1997	19	38	019972
V1998	20	38	019989
V1999	21	38	019996
V2000	22	38	020008
V2001	24	40	020015
V2002	27	42	020022
V2003	30	45	020039
V2004	32	45	020046

Repair set  
Reparatur-Satz  
V3587, EAN 4047728035873



**Multi-purpose screw profiles Multiprofile**

- TORX®
- square 4-kant
- Spline
- 6-point 6-kant
- 6-point rounded off Abgerundeter 6-kant
- 12-point Doppel-6-kant



# Socket Systems $12\frac{5}{16}$ 1/2"

## Steckschlüssel-Systeme $12\frac{5}{16}$ 1/2"



$12\frac{5}{16}$  1/2" Screwdriver socket for inside hexagon  $\odot$

$12\frac{5}{16}$  1/2" Innensechskant Schraubendreher-Einsatz  $\odot$



$12\frac{5}{16}$  1/2"



VIGOR No.	Sizes (mm) SW (mm)	mm	EAN 4047728+
V2101	5	55	021012
V2102	6	55	021029
V2103	7	55	021036
V2104	8	55	021043
V2105	10	55	021050
V2106	12	55	021067
V2107	14	55	021074
V2069	17	55	020695
V2070	19	55	020701

$12\frac{5}{16}$  1/2" Screwdriver socket for inside hexagon  $\odot$

$12\frac{5}{16}$  1/2" Innensechskant Schraubendreher-Einsatz  $\odot$



$12\frac{5}{16}$  1/2"



VIGOR No.	Sizes (mm) SW (mm)	mm	EAN 4047728+
V2072	5	100	020725
V2073	6	100	020732
V2074	7	100	020749
V2075	8	100	020756
V2076	10	100	020763
V2077	11	100	020770
V2078	12	100	020787
V2079	13	100	020794

$12\frac{5}{16}$  1/2" Screwdriver socket for inside hexagon  $\odot$

$12\frac{5}{16}$  1/2" Innensechskant Schraubendreher-Einsatz  $\odot$



$12\frac{5}{16}$  1/2"



VIGOR No.	Sizes (mm) SW (mm)	mm	EAN 4047728+
V2080	5	140	020800
V2081	6	140	020817
V2082	7	140	020824
V2083	8	140	020831
V2084	10	140	020848
V2085	12	140	020855
V2086	14	140	020862

$12\frac{5}{16}$  1/2" Screwdriver socket for inside hexagon  $\odot$

$12\frac{5}{16}$  1/2" Innensechskant Schraubendreher-Einsatz  $\odot$



$12\frac{5}{16}$  1/2"



VIGOR No.	Sizes (mm) SW (mm)	mm	EAN 4047728+
V2087	5	200	020879
V2088	6	200	020886
V2089	7	200	020893
V2090	8	200	020909
V2091	10	200	020916
V2092	12	200	020923

$12\frac{5}{16}$  1/2" Screwdriver socket for screws with internal serration (XZN)  $\odot$

$12\frac{5}{16}$  1/2" Innenvielzahn Schraubendreher-Einsatz (XZN)  $\odot$



$12\frac{5}{16}$  1/2"



VIGOR No.	Sizes (mm) SW (mm)	mm	EAN 4047728+
V2094	M5	55	020947
V2095	M6	55	020954
V2096	M8	55	020961
V2097	M9	55	020978
V2098	M10	55	020985
V2099	M12	55	020992
V2065	M14	55	020657
V2100	M16	55	021005

$12\frac{5}{16}$  1/2" Screwdriver socket for screws with internal serration (XZN)  $\odot$

$12\frac{5}{16}$  1/2" Innenvielzahn Schraubendreher-Einsatz (XZN)  $\odot$



$12\frac{5}{16}$  1/2"



VIGOR No.	Sizes (mm) SW (mm)	mm	EAN 4047728+
V2066	M5	100	020664
V2068	M6	100	020688
V2067	M8	100	020671
V2113	M9	100	021135
V2059	M10	100	020596
V2060	M12	100	020602
V2121	M14	100	021210

$12\frac{5}{16}$  1/2" Screwdriver socket for screws with internal serration (XZN)  $\odot$

$12\frac{5}{16}$  1/2" Innenvielzahn Schraubendreher-Einsatz (XZN)  $\odot$



$12\frac{5}{16}$  1/2"



VIGOR No.	Sizes (mm) SW (mm)	mm	EAN 4047728+
V2122	M5	140	021227
V2124	M6	140	021241
V2123	M8	140	021234
V2126	M9	140	021265
V2128	M10	140	021289
V2129	M12	140	021296
V2132	M14	140	021326

$12\frac{5}{16}$  1/2" Screwdriver socket for screws with internal serration (XZN)  $\odot$

$12\frac{5}{16}$  1/2" Innenvielzahn Schraubendreher-Einsatz (XZN)  $\odot$



$12\frac{5}{16}$  1/2"



VIGOR No.	Sizes (mm) SW (mm)	mm	EAN 4047728+
V2133	M8	200	021333
V2134	M10	200	021340
V2135	M12	200	021357
V2137	M14	200	021371

$12\frac{5}{16}$  TORX® screwdriver socket

$12\frac{5}{16}$  TORX® Schraubendreher-Einsatz



VIGOR No.	Sizes (mm) SW (mm)	mm	EAN 4047728+
V2151	T 20	55	021517
V2152	T 25	55	021524
V2153	T 27	55	021531
V2154	T 30	55	021548
V2155	T 40	55	021555
V2156	T 45	55	021562
V2157	T 50	55	021579
V2158	T 55	55	021586
V2159	T 60	55	021593
V2160	T 70	55	021609

$12\frac{5}{16}$  TORX® screwdriver socket

$12\frac{5}{16}$  TORX® Schraubendreher-Einsatz



VIGOR No.	Sizes (mm) SW (mm)	mm	EAN 4047728+
V2161	T 20	100	021616
V2162	T 25	100	021623
V2163	T 27	100	021630
V2165	T 30	100	021654
V2167	T 40	100	021678
V2168	T 45	100	021685
V2169	T 50	100	021692
V2170	T 55	100	021708
V2171	T 60	100	021715
V2172	T 70	100	021722

$12\frac{5}{16}$  TORX® screwdriver socket

$12\frac{5}{16}$  TORX® Schraubendreher-Einsatz



VIGOR No.	Sizes (mm) SW (mm)	mm	EAN 4047728+
V2173	T 40	140	021739
V2174	T 45	140	021746
V2175	T 50	140	021753
V2176	T 55	140	021760
V2177	T 60	140	021777
V2178	T 70	140	021784

$12\frac{5}{16}$  TORX® screwdriver socket

$12\frac{5}{16}$  TORX® Schraubendreher-Einsatz



VIGOR No.	Sizes (mm) SW (mm)	mm	EAN 4047728+
V2179	T 40	200	021791
V2180	T 45	200	021807
V2181	T 50	200	021814
V2182	T 55	200	021821
V2183	T 60	200	021838
V2184	T 70	200	021845

$12\frac{5}{16}$  RIBE screwdriver socket

$12\frac{5}{16}$  RIBE Schraubendreher-Einsatz



VIGOR No.	Sizes (mm) SW (mm)	mm	EAN 4047728+
V2202	M5	55	022026
V2203	M6	55	022033
V2204	M7	55	022040
V2205	M8	55	022057
V2206	M9	55	022064
V2207	M10	55	022071
V2208	M12	55	022088
V2209	M13	55	022095
V2210	M14	55	022101

$12\frac{5}{16}$  RIBE screwdriver socket

$12\frac{5}{16}$  RIBE Schraubendreher-Einsatz



VIGOR No.	Sizes (mm) SW (mm)	mm	EAN 4047728+
V2211	M5	100	022118
V2212	M6	100	022125
V2213	M7	100	022132
V2214	M8	100	022149
V2215	M9	100	022156
V2216	M10	100	022163
V2217	M12	100	022170
V2218	M13	100	022187
V2219	M14	100	022194

$12\frac{5}{16}$  RIBE screwdriver socket

$12\frac{5}{16}$  RIBE Schraubendreher-Einsatz



VIGOR No.	Sizes (mm) SW (mm)	mm	EAN 4047728+
V2220	M8	140	022200
V2221	M9	140	022217
V2222	M10	140	022224
V2223	M10.3	140	022231
V2224	M12	140	022248
V2225	M13	140	022255
V2226	M14	140	022262

$12\frac{5}{16}$  RIBE screwdriver socket

$12\frac{5}{16}$  RIBE Schraubendreher-Einsatz



VIGOR No.	Sizes (mm) SW (mm)	mm	EAN 4047728+
V2227	M8	200	022279
V2228	M9	200	022286
V2229	M10	200	022293
V2230	M10.3	200	022309
V2231	M12	200	022316
V2232	M13	200	022323
V2233	M14	200	022330

# Socket Systems $12\frac{5}{16}$ 1/2"

## Steckschlüssel-Systeme $12\frac{5}{16}$ 1/2"



$12\frac{5}{16}$  1/2 TORX® screwdriver socket

$12\frac{5}{16}$  1/2 TORX® Schraubendreher-Einsatz



VIGOR No.	Sizes (mm) SW (mm)	mm	EAN 4047728+
V2200	T 55 H	55	022002



$12\frac{5}{16}$  1/2 Sliding T-handle

$12\frac{5}{16}$  1/2 Gleitgriff



VIGOR No.	mm	EAN 4047728+
V2573	250	025737

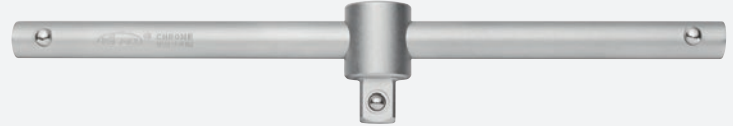

$12\frac{5}{16}$  1/2  $10$  3/8 Sliding piece

$12\frac{5}{16}$  1/2  $10$  3/8 Gleitstück

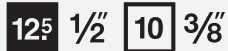

VIGOR No.	mm	EAN 4047728+
V2667	43.7	026673



$12\frac{5}{16}$  1/2  $12\frac{5}{16}$  1/2 Universal joint

$12\frac{5}{16}$  1/2  $12\frac{5}{16}$  1/2 Universalgelenk



VIGOR No.	mm	EAN 4047728+
V2575	75	025751



$12\frac{5}{16}$  1/2  $12\frac{5}{16}$  1/2 Extension

$12\frac{5}{16}$  1/2  $12\frac{5}{16}$  1/2 Verlängerung



VIGOR No.	mm	EAN 4047728+
V2576	125	025768
V2577	250	025775



$12\frac{5}{16}$  1/2 LED extension

$12\frac{5}{16}$  1/2 LED-Verlängerung



VIGOR No.	mm	EAN 4047728+
V1131	60	011310



Incl.  $\square\square\square$  1.5 V (LR 44) – 180 mAh  
Inkl.  $\square\square\square$  1.5 V (LR 44) – 180 mAh

$10$  3/8  $12\frac{5}{16}$  1/2 Adapter

$10$  3/8  $12\frac{5}{16}$  1/2 Adapter

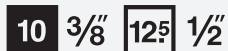

VIGOR No.	mm	EAN 4047728+
V2109	36	021098



$20$  3/4  $12\frac{5}{16}$  1/2 Adapter

$20$  3/4  $12\frac{5}{16}$  1/2 Adapter

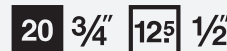

VIGOR No.	mm	EAN 4047728+
V2110	45.5	021104



$12\frac{5}{16}$  1/2 Bit adapter to  $\textcircled{8}$  5/16

$12\frac{5}{16}$  1/2 Bit-Adapter auf  $\textcircled{8}$  5/16

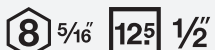

VIGOR No.	mm	EAN 4047728+
V2647	37	026475



$12\frac{5}{8}$  1/2 Extractor socket with spiral profile  
 $12\frac{5}{8}$  1/2 Spiralnutenausdreher-Einsatz

$12\frac{5}{8}$  1/2



VIGOR No.	Sizes (mm) SW (mm)	mm	EAN 4047728+
V2405	10	34	024051
V2402	11	34	024020
V2406	12	34	024068
V2407	13	34	024075
V2401	14	34	024013
V2408	15	34	024082
V2403	16	34	024037
V2409	17	34	024099
V2410	19	34	024105
V3742	21	34	037426
V3743	22	34	037433
V3744	24	34	037440
V3745	27	34	037457
V3746	30	34	037464
V3747	32	34	037471

**Screw extractor set**  
**V3737**, EAN 4047728037372

- With hexagon drive size 13 mm
- Slightly tapered spiral
- Suitable for torn off screws and stud bolts
- Collar guarantees locking effect and spreading limit
- Special steel
- In sturdy plastic box

Contents:  
• Extractors 3.2 mm = 1/8" 4.8 mm = 3/16" 6.3 mm = 1/4"  
10 mm = 3/8" 12.5 mm = 1/2"  
• Extractors 3 · 4 · 5 · 5.5 · 6 · 8 · 10 · 11 · 12 · 14 mm

**Schraubenausdreher-Satz**  
**V3737**, EAN 4047728037372

- Mit 6-kant-Antrieb SW 13 mm
- Leicht konisch zulaufende Spirale
- Gut geeignet für abgerissene Schrauben und Stehbolzen
- Kontereffekt und Aufspreizbegrenzung durch Bund gewährleistet
- Spezialstahl
- Im stabilen Kunststoffkasten

Inhalt:  
• Ausdreher 3.2 mm = 1/8" 4.8 mm = 3/16" 6.3 mm = 1/4"  
10 mm = 3/8" 12.5 mm = 1/2"  
• Ausdreher 3 · 4 · 5 · 5.5 · 6 · 8 · 10 · 11 · 12 · 14 mm



**Extra short style**  
**Extra kurze Ausführung**



# Socket Systems $12\frac{5}{8}$ 1/2"

## Steckschlüssel-Systeme $12\frac{5}{8}$ 1/2"



$12\frac{5}{8}$  1/2 VDE reversible ratchet  
 $12\frac{5}{8}$  1/2 VDE-Umschaltknarre



VIGOR No.	mm	EAN 4047728+
V3342	255	033428

$12\frac{5}{8}$  1/2"



$12\frac{5}{8}$  1/2 VDE socket ●  
 $12\frac{5}{8}$  1/2 VDE-Steckschlüssel-Einsatz ●



VIGOR No.	Sizes (mm) SW (mm)	mm	EAN 4047728+
V3330	8	55	033305
V3331	10	55	033312
V3332	12	55	033329
V3333	13	55	033336
V3334	14	55	033343
V3335	17	55	033350
V3336	19	55	033367
V3337	22	55	033374
V3338	24	55	033381



$12\frac{5}{8}$  1/2 VDE Screwdriver socket ○  
 $12\frac{5}{8}$  1/2 VDE-Schraubendreher-Einsatz ○



VIGOR No.	Sizes (mm) SW (mm)	mm	EAN 4047728+
V3339	5	78	033398
V3344	6	78	033442
V3340	8	78	033404



$12\frac{5}{8}$  1/2  $12\frac{5}{8}$  1/2 VDE extension  
 $12\frac{5}{8}$  1/2  $12\frac{5}{8}$  1/2 VDE-Verlängerung

$12\frac{5}{8}$  1/2"  $12\frac{5}{8}$  1/2"

VIGOR No.	mm	EAN 4047728+
V3341	125	033411

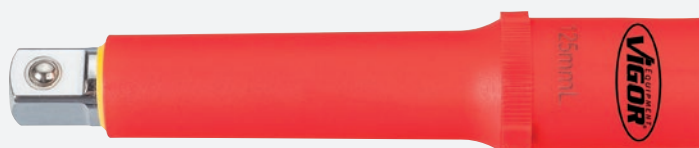



$20 \frac{3}{4}$  Socket set  
**V2318**, EAN 4047728023184

$20 \frac{3}{4}$  Steckschlüssel-Satz  
**V2318**, EAN 4047728023184



Single parts see page 63  
 Einzelteilaufistung Seite 63

	Design Ausführung	Sizes (mm) / $\frac{1}{16}$ " SW (mm) / mm
16 x		19 · 21 · 22 · 23 · 24 · 26 · 27 · 28 · 30 32 · 34 · 36 · 38 · 41 · 46 · 50 mm
1 x		100 mm
1 x		100 mm
2 x		200 · 400 mm
1 x		450 mm

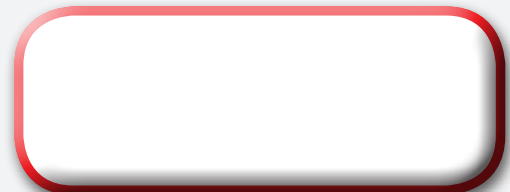

# Socket Systems $20 \frac{3}{4}$ "

## Steckschlüssel-Systeme $20 \frac{3}{4}$ "



### $20 \frac{3}{4}$ " Socket $\circ$

### $20 \frac{3}{4}$ " Steckschlüssel-Einsatz $\circ$



VIGOR No.	Sizes (mm) SW (mm)	mm	EAN 4047728+
V2323	19	50	023238
V2324	21	50	023245
V2325	22	50	023252
V2326	23	50	023269
V2327	24	50	023276
V2328	26	50	023283
V2329	27	52	023290
V2256	28	52	022569
V2330	30	54	023306
V2331	32	56	023313
V2332	34	58	023320
V2333	36	58	023337
V2334	38	60	023344
V2337	41	64	023375
V2336	46	68	023368
V2335	50	68	023351

### $12^5 \frac{1}{2}$ $20 \frac{3}{4}$ " Adapter

### $12^5 \frac{1}{2}$ $20 \frac{3}{4}$ " Adapter

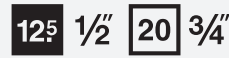

VIGOR No.	mm	EAN 4047728+
V2111	21	021111



### $20 \frac{3}{4}$ " $20 \frac{3}{4}$ " Extension

### $20 \frac{3}{4}$ " $20 \frac{3}{4}$ " Verlängerung

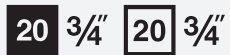

VIGOR No.	mm	EAN 4047728+
V2320	100	023207
V2321	200	023214
V2317	400	023177



### $20 \frac{3}{4}$ " Sliding T-handle

### $20 \frac{3}{4}$ " Gleitgriff



VIGOR No.	mm	EAN 4047728+
V2322	450	023221



### $20 \frac{3}{4}$ " Reversible ratchet

### $20 \frac{3}{4}$ " Umschaltknarre



VIGOR No.	mm	EAN 4047728+
V2319	100	023191

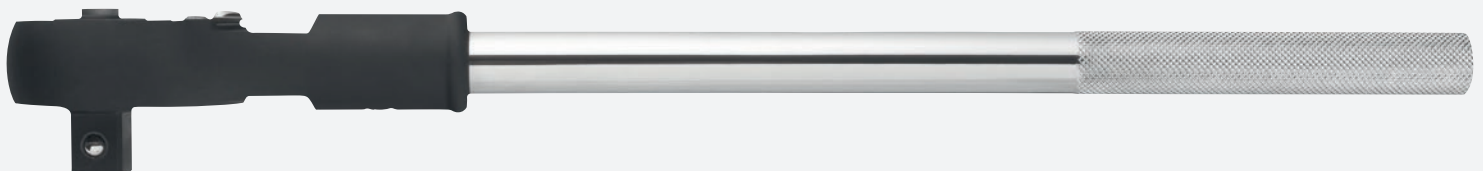

**25 T** Socket set **V3278**, EAN 4047728032780



**25 T** Steckschlüssel-Satz **V3278**, EAN 4047728032780

**25 1"**



	Design Ausführung		Sizes (mm) / SW (mm) / mm
6 x		<b>25 T</b>	50 · 55 · 60 · 65 · 70 · 80 mm
2 x		<b>25 T</b>	200 · 400 mm
1 x		<b>25 T</b>	170 mm
1 x		<b>25 T</b>	500 mm
1 x		<b>25 T</b>	—

Single parts see page 65  
Einzelteilaufistung Seite 65





# Socket Systems 25 1"

## Steckschlüssel-Systeme 25 1"



25 1" 12-point socket

25 1" Doppel-Sechskant Steckschlüssel-Einsatz



VIGOR No.	Sizes (mm) SW (mm)	mm	EAN 4047728+
V3375	50	75	033756
V3376	55	80	033763
V3377	60	85	033770
V3378	65	87	033787
V3379	70	93	033794
V3380	80	103	033800

25 1" Sliding piece

25 1" Gleitstück

25 1"



VIGOR No.	EAN 4047728+
V3373	033732

25 1" 25 1" Extension

25 1" 25 1" Verlängerung

25 1" 25 1"

VIGOR No.	mm	EAN 4047728+
V3280	200	032803
V3371	400	033718



25 1" Sliding T-handle

25 1" Gleitgriff

25 1"

VIGOR No.	mm	EAN 4047728+
V3374	500	033749



25 1" Reversible ratchet

25 1" Umschaltknarre

25 1"

VIGOR No.	mm	EAN 4047728+
V3372	170	033725





6.3 1/4 10 3/8 125 1/2 Socket set  
**V3277**, EAN 4047728032773

6.3 1/4 10 3/8 125 1/2 Steckschlüssel-Satz  
**V3277**, EAN 4047728032773



6.3 1/4 10 3/8 125 1/2

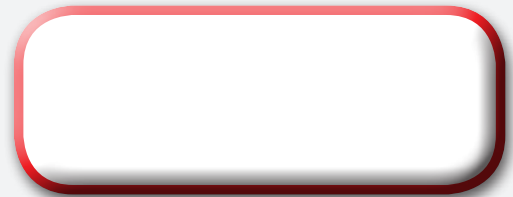
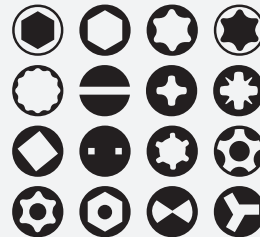

X	Design Ausführung	■	Sizes (mm) / SW (mm) / mm
12 x		—	8 · 9 · 10 · 11 · 12 · 13 · 14 · 15 17 · 19 · 22 · 24 mm
13 x		6.3 1/4	4 · 4.5 · 5 · 5.5 · 6 · 7 · 8 · 9 · 10 11 · 12 · 13 · 14 mm
7 x		6.3 1/4	4 · 5 · 6 · 7 · 8 · 9 · 10 mm
5 x		6.3 1/4	E 4 · E 5 · E 6 · E 7 · E 8
4 x		6.3 1/4	3 · 4 · 5 · 6 mm
4 x		6.3 1/4	0.8 x 4 · 1 x 5.5 · 1.2 x 6.5 · 1.2 x 7 mm
3 x		6.3 1/4	PH 0 · PH 1 · PH 2
3 x		6.3 1/4	PZ 0 · PZ 1 · PZ 2
8 x		6.3 1/4	T 8 · T 9 · T 10 · T 15 · T 20 · T 25 · T 27 · T 30
8 x		6.3 1/4	T 8 H · T 9 H · T 10 H · T 15 H · T 20 H T 25 H · T 27 H · T 30 H
2 x		6.3 1/4	50 100 mm
1 x		6.3 1/4	150 mm
1 x		6.3 1/4	205 mm
1 x		6.3 1/4	150 mm
1 x		6.3 1/4	110 mm
1 x		6.3 1/4	40 mm
1 x		6.3 1/4	30 mm
7 x		6.3 1/4	1.27 · 1.5 · 2 · 2.5 · 3 · 4 · 5 mm
1 x		10 3/8	18 mm
1 x		10 3/8	198 mm
2 x		10 3/8	30 · 56 mm
1 x		10 3/8	30 mm
6 x		10 3/8	E 10 · E 11 · E 12 · E 14 · E 16 · E 18
10 x		10 3/8	10 · 11 · 12 · 13 · 14 · 15 · 16 · 17 · 18 · 19 mm
6 x		10 3/8	10 · 11 · 12 · 13 · 14 · 15 mm
1 x		10 3/8	125 mm
1 x		10 3/8	—
14 x		125 1/2	13 · 14 · 15 · 16 · 17 · 18 · 19 · 20 · 21 · 22 · 24 · 27 · 30 · 32 mm

X	Design Ausführung	■	Sizes (mm) / SW (mm) / mm
5 x		125 1/2	16 · 17 · 18 · 19 · 22 mm
3 x		125 1/2	E 20 · E 22 · E 24
1 x		125 1/2	T 70
1 x		125 1/2	14 mm
2 x		125 1/2	16 · 21 mm
1 x		125 1/2	75 mm
2 x		125 1/2	125 · 250 mm
1 x		125 1/2	— 250 mm
1 x		125 1/2	—
3 x		6.3 1/4	M 5 · M 6 · M 8
6 x		6.3 1/4	2 · 2.5 · 3 · 4 · 5 · 6 mm
3 x		6.3 1/4	T 5 · T 6 · T 7
1 x		6.3 1/4	T 7 H
5 x		6.3 1/4	M 5 · M 6 · M 7 · M 8 · M 9
8 x		6.3 1/4	T 10 H · T 15 H · T 20 H · T 25 H T 27 H · T 30 H · T 40 H · T 45 H
4 x		6.3 1/4	0 · 1 · 2 · 3 mm
3 x		6.3 1/4	6 · 8 · 10 mm
4 x		6.3 1/4	1 · 2 · 3 · 4 mm
3 x		6.3 1/4	1 · 2 · 3 mm
4 x		6.3 1/4	4 · 6 · 8 · 10 mm
4 x		8 9/16	7 · 8 · 10 · 12 mm
3 x		8 9/16	8 · 10 · 12 mm
3 x		8 9/16	PH 2 · PH 3 · PH 4
3 x		8 9/16	PZ 2 · PZ 3 · PZ 4
5 x		8 9/16	T 40 · T 45 · T 50 · T 55 · T 60
5 x		8 9/16	T 40 H · T 45 H · T 50 H · T 55 H · T 60 H
4 x		8 9/16	M 10 · M 11 · M 12 · M 13
2 x		8 9/16	M 10 · M 12
1 x		8 9/16	50 mm

Single parts from page 44 on  
 Einzelteillaufistung ab Seite 44

# Socket Systems Steckschlüssel-Systeme



6.3 1/4 10 3/8 125 1/2 Socket set  
V2461, EAN 4047728024617

6.3 1/4 10 3/8 125 1/2 Steckschlüssel-Satz  
V2461, EAN 4047728024617



6.3 1/4 10 3/8 125 1/2

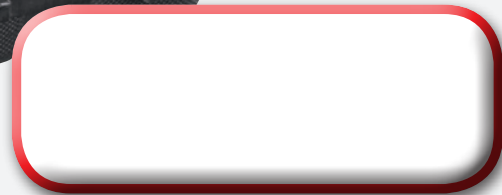

	Design Ausführung		Sizes (mm) / SW (mm) / mm
13 x		6.3 1/4	4 · 4.5 · 5 · 5.5 · 6 · 7 · 8 · 9 · 10 11 · 12 · 13 · 14 mm
7 x		6.3 1/4	4 · 5 · 6 · 7 · 8 · 9 · 10 mm
5 x		6.3 1/4	E 4 · E 5 · E 6 · E 7 · E 8
4 x		6.3 1/4	3 · 4 · 5 · 6 mm
4 x		6.3 1/4	0.8 x 4 · 1 x 5 · 1.2 x 6.5 · 1.2 x 7 mm
3 x		6.3 1/4	PH 0 · PH 1 · PH 2
3 x		6.3 1/4	PZ 0 · PZ 1 · PZ 2
8 x		6.3 1/4	T 8 · T 9 · T 10 · T 15 · T 20 · T 25 · T 27 · T 30
8 x		6.3 1/4	T 8 H · T 9 H · T 10 H · T 15 H · T 20 H T 25 H · T 27 H · T 30 H
1 x		6.3 1/4	50 mm
1 x		6.3 1/4	100 mm
1 x		6.3 1/4	150 mm
1 x		6.3 1/4	150 mm
1 x		6.3 1/4	110 mm
1 x		6.3 1/4	38 mm
1 x		6.3 1/4	30 mm
3 x		6.3 1/4	5 · 6 · 8 mm
5 x		6.3 1/4	5 · 6 · 7 · 8 · 9 mm
3 x		6.3 1/4	T 5 · T 6 · T 7
9 x		6.3 1/4	T 7 H · T 10 H · T 15 H · T 20 H · T 25 H T 27 H · T 30 H · T 40 H · T 45 H
10 x		10 3/8	10 · 11 · 12 · 13 · 14 · 15 · 16 · 17 · 18 · 19 mm
6 x		10 3/8	10 · 11 · 12 · 13 · 14 · 15 mm

	Design Ausführung		Sizes (mm) / SW (mm) / mm
1 x		10 3/8	18 mm
6 x		10 3/8	E 10 · E 11 · E 12 · E 14 · E 16 · E 18
1 x		10 3/8	198 mm
1 x		10 3/8	56 mm
1 x		10 3/8	30 mm
3 x		8 9/16	8 · 10 · 12 mm
5 x		8 9/16	7 · 8 · 10 · 12 · 14 mm
2 x		8 9/16	PH 3 · PH 4
2 x		8 9/16	PZ 3 · PZ 4
6 x		8 9/16	T 40 · T 45 · T 50 · T 55 · T 60 · T 70
6 x		8 9/16	T 40 H · T 45 H · T 50 H · T 55 H · T 60 H · T 70 H
1 x		10 3/8	125 mm
17 x		125 1/2	10 · 11 · 12 · 13 · 14 · 15 · 16 · 17 · 18 19 · 20 · 21 · 22 · 24 · 27 · 30 · 32 mm
5 x		125 1/2	16 · 17 · 18 · 19 · 22 mm
2 x		125 1/2	E 20 · E 22
2 x		125 1/2	16 · 21 mm
1 x		125 1/2	75 mm
2 x		125 1/2	125 · 250 mm
1 x		10 3/8	—
1 x		125 1/2	—
1 x		125 1/2	258 mm
7 x		125 1/2	1.27 · 1.5 · 2 · 2.5 · 3 · 4 · 5 mm

Single parts from page 44 on  
Einzelteilaufistung ab Seite 44



Socket set  
**V1706**, EAN 4047728017060

Steckschlüssel-Satz  
**V1706**, EAN 4047728017060



6.3 1/4 125 1/2 8 5/16



	Design Ausführung		Sizes (mm) / SW (mm) / mm
13 x		6.3 1/4	4 · 4.5 · 5 · 5.5 · 6 · 7 · 8 · 9 · 10 · 11 · 12 · 13 · 14 mm
8 x		6.3 1/4	6 · 7 · 8 · 9 · 10 · 11 · 12 · 13 mm
4 x		6.3 1/4	3 · 4 · 5 · 6 mm
3 x		6.3 1/4	0.8 x 4 · 1 x 5.5 · 1.2 x 7 mm
2 x		6.3 1/4	PH 1 · PH 2
2 x		6.3 1/4	PZ 1 · PZ 2
6 x		6.3 1/4	T 8 · T 10 · T 15 · T 20 · T 25 · T 30
1 x		6.3 1/4	50 mm
2 x		6.3 1/4	100 · 145 mm
1 x		—	150 mm
1 x		—	150 mm
1 x		—	110 mm
1 x		6.3 1/4	38 mm
1 x		6.3 1/4	30 mm

	Design Ausführung		Sizes (mm) / SW (mm) / mm
18 x		125 1/2	10 · 11 · 12 · 13 · 14 · 15 · 16 · 17 · 18 · 19 · 20 · 21 · 22 · 23 · 24 · 27 · 30 · 32 mm
4 x		125 1/2	14 · 15 · 17 · 19 mm
2 x		125 1/2	16 · 21 mm
1 x		125 1/2	75 mm
2 x		125 1/2	125 · 250 mm
1 x		10 3/8	—
1 x		125 1/2	—
1 x		125 1/2	258 mm
3 x		8 9/16	8 · 10 · 12 mm
4 x		8 9/16	8 · 10 · 12 · 14 mm
2 x		8 9/16	PH 3 · PH 4
2 x		8 9/16	PZ 3 · PZ 4
4 x		8 9/16	T 40 · T 45 · T 50 · T 55
3 x		—	1.5 ,5 mm

Single parts from page 44 on  
Einzelteilaufistung ab Seite 44

# Socket Systems Steckschlüssel-Systeme



TORX® socket set  
**V2687**, EAN 4047728026871

TORX® Steckschlüssel-Satz  
**V2687**, EAN 4047728026871



6.3 1/4 10 3/8 12<sup>5</sup> 1/2



X	Design Ausführung	■	Sizes (mm) SW (mm)
7 x		6.3 1/4	E 4 · E 5 · E 6 · E 7 · E 8 · E 10 · E 11
12 x		10 3/8	E 4 · E 5 · E 6 · E 7 · E 8 · E 10 · E 11 E 12 · E 14 · E 16 · E 18 · E 20

X	Design Ausführung	■	Sizes (mm) SW (mm)
9 x		12 <sup>5</sup> 1/2	E 10 · E 11 · E 12 · E 14 · E 16 · E 18 · E 20 · E 22 · E 24

Single parts from page 44 on  
Einzelteilaufistung ab Seite 44

TORX® socket set  
**V1781**, EAN 4047728017817

TORX® Steckschlüssel-Satz  
**V1781**, EAN 4047728017817



6.3 1/4 10 3/8 12<sup>5</sup> 1/2



X	Design Ausführung	■	Sizes (mm) SW (mm)
5 x		6.3 1/4	E 4 · E 5 · E 6 · E 7 · E 8
7 x		6.3 1/4	T 8 · T 10 · T 15 · T 20 · T 25 · T 27 · T 30
6 x		6.3 1/4	T 10 H · T 15 H · T 20 H · T 25 H · T 30 H
4 x		10 3/8	E 10 · E 12 · E 14 · E 16
4 x		10 3/8	T 40 · T 45 · T 47 · T 50
3 x		10 3/8	T 40 H · T 45 H · T 50 H

X	Design Ausführung	■	Sizes (mm) SW (mm)
2 x		12 <sup>5</sup> 1/2	E 18 · E 20
2 x		12 <sup>5</sup> 1/2	T 55 · T 60
1 x		12 <sup>5</sup> 1/2	T 55 H

Single parts from page 44 on  
Einzelteilaufistung ab Seite 44

Fine-tooth reversible ratchet set  
**V1039**, EAN 4047728010399  
• DIN 3122 / ISO 3315

Feinzahn-Umschaltknarren-Satz  
**V1039**, EAN 4047728010399  
• DIN 3122 / ISO 3315



**6.3** 1/4" **12<sup>5</sup>** 1/2"

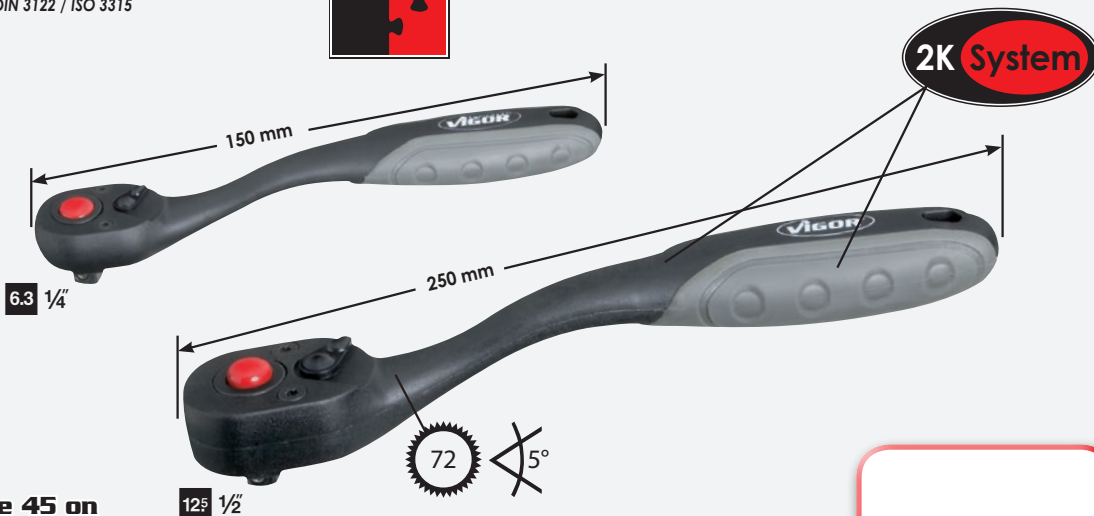

Single parts from page 45 on  
Einzelteilaufistung ab Seite 45



Fine-tooth reversible ratchet set  
**V3081**, EAN 4047728030816  
• DIN 3122 / ISO 3315

Feinzahn-Umschaltknarren-Satz  
**V3081**, EAN 4047728030816  
• DIN 3122 / ISO 3315



**6.3** 1/4" **10** 3/8" **12<sup>5</sup>** 1/2"



Single parts from page 45 on  
Einzelteilaufistung ab Seite 45



Adapter set  
**V1293**, EAN 4047728012935  
Adapter-Satz  
**V1293**, EAN 4047728012935



Design Ausführung					
6 x		6.3 1/4" - 10 3/8"	10 3/8" - 6.3 1/4"	10 3/8" - 12 5/8"	12 5/8" - 10 3/8"
		12 5/8" - 10 3/8"	12 5/8" - 20 3/4"	20 3/4" - 12 5/8"	

Single parts from page 46 on  
Einzelteilaufistung ab Seite 46



# Wrenches Schraubenschlüssel



Double flexible head wrench set  
**V4194**, EAN 4047728041942

• Can be used in areas with restricted access

Doppel-Gelenkschlüssel-Satz

**V4194**, EAN 4047728041942

• Anwendbar unter beengten Platzverhältnissen



With hinge  
Mit Gelenk



X	Design Ausführung	Sizes (mm) SW (mm)
7 x		8 x 9 · 10 x 11 · 12 x 13 · 14 x 15 · 16 x 17 · 18 x 19 21 x 22 mm

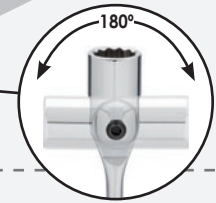

Double flexible head wrench  
Doppel-Gelenkschlüssel

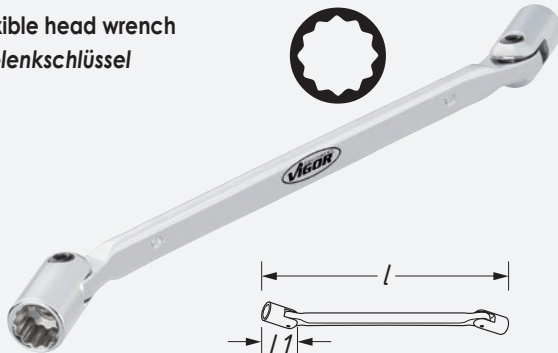

VIGOR No.	Sizes (mm) SW (mm)	L mm	L1 mm	EAN 4047728+
V4204	8 x 9	183	27	042048
V4203	10 x 11	200	28	042031
V4205	12 x 13	216	34	042055
V4206	14 x 15	240	38	042062
V4207	16 x 17	257	42	042079
V4208	18 x 19	271	44	042086
V4209	21 x 22	304	59	042093

Double open-end wrench set  
**V1461**, EAN 4047728014618

• DIN 3110

Doppel-Maulschlüssel-Satz

**V1461**, EAN 4047728014618

• DIN 3110



X	Design Ausführung	Sizes (mm) SW (mm)
12 x		6 x 7 · 8 x 9 · 10 x 11 · 12 x 13 · 14 x 15 · 16 x 17 · 18 x 19 20 x 22 · 21 x 23 · 24 x 27 · 25 x 28 · 30 x 32 mm

Double open-end wrench  
• DIN 3110

Doppel-Maulschlüssel  
• DIN 3110

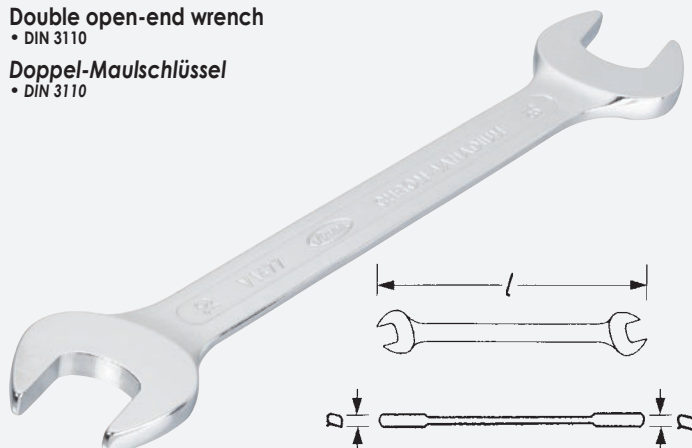

VIGOR No.	SW mm	L mm	a mm	EAN 4047728+
V1471	6 x 7	105	3.4	014717
V1472	8 x 9	115	3.8	014724
V1473	10 x 11	130	4.4	014731
V1474	12 x 13	142	5.0	014748
V1475	14 x 15	152	5.6	014755
V1476	16 x 17	165	6.2	014762
V1669	16 x 18	205	6.2	016698
V1671	17 x 19	220	6.8	016711
V1477	18 x 19	175	6.8	014779
V1478	20 x 22	190	7.2	014786
V1479	21 x 23	205	7.8	014793
V1672	22 x 24	248	7.8	016728
V1480	24 x 27	215	8.4	014809
V1481	25 x 28	240	9.0	014816
V1482	30 x 32	260	9.6	014823

## Combination wrench set V1054, EAN 4047728010542

• DIN 3113 / ISO 7738

### Ring-Maulschlüssel-Satz

V1054, EAN 4047728010542

• DIN 3113 / ISO 7738



Design Ausführung	Sizes (mm) SW (mm)
13 x	6 · 7 · 8 · 9 · 10 · 11 · 12 · 13 · 14 · 15 · 17 · 19 · 22 mm

## Combination wrench

• DIN 3113 / ISO 7738

### Ring-Maulschlüssel

• DIN 3113 / ISO 7738

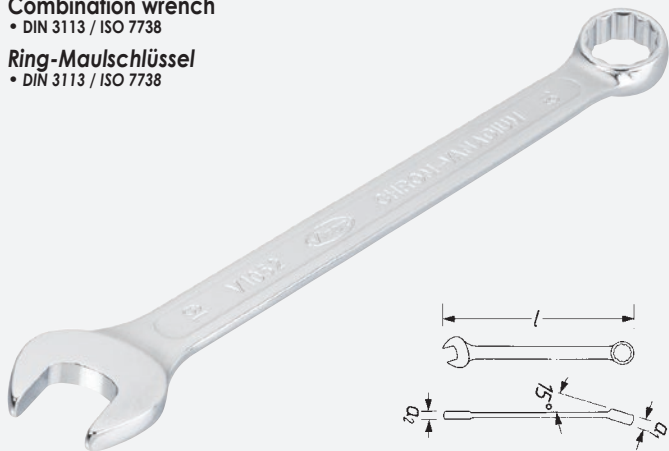

VIGOR No.	Sizes (mm) SW (mm)	mm	a1 mm	a2 mm	EAN 4047728+
V1040	6	105	5.2	3.5	010405
V1041	7	115	6.2	3.8	010412
V1042	8	130	6.6	4.3	010429

VIGOR No.	Sizes (mm) SW (mm)	mm	a1 mm	a2 mm	EAN 4047728+
V1043	9	142	7.0	4.3	010436
V1044	10	152	7.8	4.6	010443
V1045	11	165	8.1	4.8	010450
V1047	12	175	9.1	5.3	010474
V1048	13	190	9.6	5.6	010481
V1049	14	205	10.2	5.9	010498
V1050	15	215	10.9	6.3	010504
V1680	16	227	10.6	6.5	016803
V1051	17	240	11.7	6.9	010511
V1673	18	250	11.4	7.2	016735
V1052	19	260	12.3	8.0	010528
V4197	20	275	13.2	7.7	041973
V4198	21	288	13.3	8.1	041980
V1053	22	295	14.8	9.0	010535
V1674	24	330	15.8	9.6	016742
V1676	27	360	17.1	10.0	016766
V1677	30	390	18.5	11.0	016773
V1678	32	420	20.1	12.0	016780
V1679	36	450	21.5	13.0	016797

## Double box-end wrench assortment

V1524, EAN 4047728015240

• DIN 838 / ISO 10104

### Doppel-Ringschlüssel-Sortiment

V1524, EAN 4047728015240

• DIN 838 / ISO 10104



Design Ausführung	Sizes (mm) SW (mm)
12 x	6 x 7 · 8 x 9 · 10 x 11 · 12 x 13 · 14 x 15 · 16 x 17 · 18 x 19 · 20 x 22 · 21 x 23 · 24 x 27 · 25 x 28 · 30 x 32 mm

## Double box-end wrench

• DIN 838 / ISO 10104

### Doppel-Ringschlüssel

• DIN 838 / ISO 10104

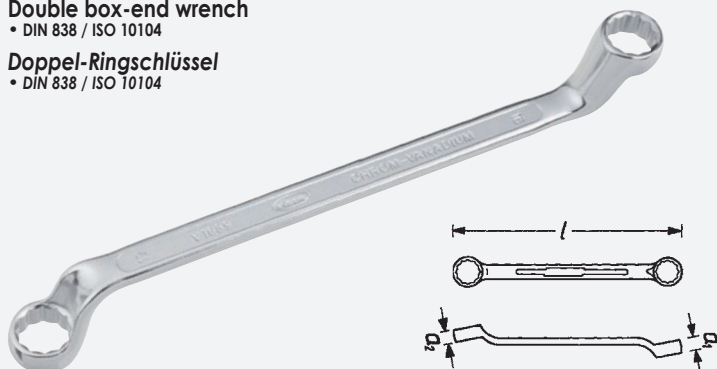

VIGOR No.	Sizes (mm) SW (mm)	mm	a1 mm	a2 mm	EAN 4047728+
V1684	6 x 7	176.0	6.3	5.7	016841
V1685	8 x 9	190.5	7.7	6.7	016858
V1686	10 x 11	205.0	9.2	8.6	016865
V1687	12 x 13	220.5	9.9	9.5	016872
V1688	14 x 15	236.0	10.8	10.2	016889
V1689	16 x 17	250.0	12.0	11.4	016896
V1690	18 x 19	271.0	12.8	12.4	016902
V1691	20 x 22	291.0	14	13.2	016919
V1692	21 x 23	310.5	14.2	13.6	016926
V1693	24 x 27	331.0	15.6	14.4	016933
V1694	25 x 28	350.0	15.6	14.6	016940
V1695	30 x 32	371.0	16.9	16.4	016957



# Wrenches Schraubenschlüssel



Ratcheting combination wrench set,  
short style

**V2815**, EAN 4047728028158

• In tool roll

Ratschen-Ring-Maulschlüssel-Satz,  
kurze Ausführung

**V2815**, EAN 4047728028158

• Mit Rolltasche

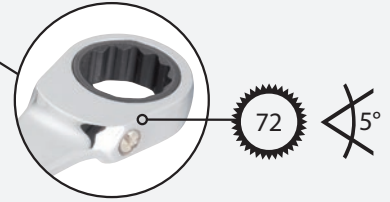

	Design Ausführung	Sizes (mm) SW (mm)
5 x		8 · 10 · 13 · 17 · 19 mm

Ratcheting combination wrench set, short style

**V2821**, EAN 4047728028219

• In tool roll

Ratschen-Ring-Maulschlüssel-Satz, kurze Ausführung

**V2821**, EAN 4047728028219

• Mit Rolltasche

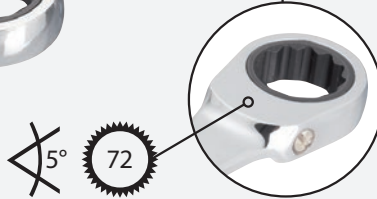

	Design Ausführung	Sizes (mm) SW (mm)
12 x		8 · 9 · 10 · 11 · 12 · 13 · 14 · 15 · 16 · 17 · 18 · 19 mm

Ratcheting combination wrench, short style

Ratschen-Ring-Maulschlüssel, kurze Ausführung



VIGOR No.	Sizes (mm) SW (mm)	mm	a1 mm	a2 mm	EAN 4047728+
V2822	8	89	7.4	4.9	028226
V2823	9	93	7.5	5.2	028233
V2824	10	97	8.5	5.5	028240
V2825	11	102	8.4	6.1	028257
V2826	12	106	8.5	6.3	028264
V2827	13	110	8.4	6.7	028271
V2828	14	114	8.4	7.0	028288
V2829	15	120	8.4	7.4	028295
V2830	16	122	10	7.7	028301
V2831	17	126	10	7.7	028318
V2832	18	131	11.5	8.4	028325
V2833	19	136	11.5	8.6	028332

Ratcheting combination wrench set, long style

**V2820**, EAN 4047728028202

• In tool roll

Ratschen-Ring-Maulschlüssel-Satz, lange Ausführung

**V2820**, EAN 4047728028202

• Mit Rolltasche



	Design Ausführung	Sizes (mm) SW (mm)
5 x		8 · 10 · 13 · 17 · 19 mm



Ratcheting combination wrench set, long style

**V1031**, EAN 4047728010313

• In tool roll

Ratschen-Ring-Maulschlüssel-Satz, lange Ausführung

**V1031**, EAN 4047728010313

• Mit Rolltasche



	Design Ausführung	Sizes (mm) SW (mm)
12 x		8 · 9 · 10 · 11 · 12 · 13 · 14 · 15 · 16 · 17 · 18 · 19 mm



Ratcheting combination wrench, long style

Ratschen-Ring-Maulschlüssel, lange Ausführung

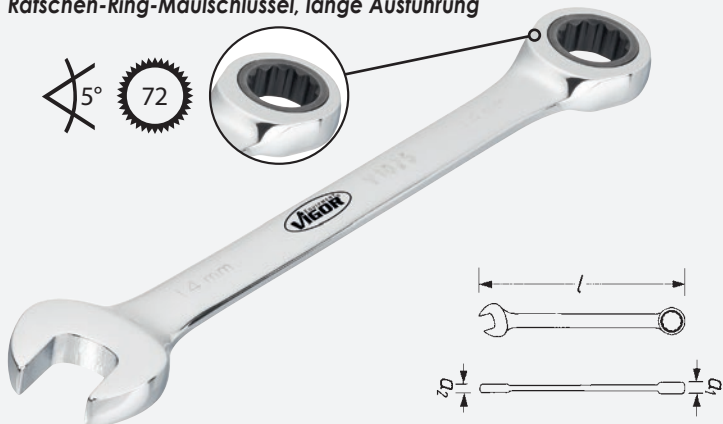

VIGOR No.	Sizes (mm) SW (mm)	L mm	a1 mm	a2 mm	EAN 4047728+
V3635	6	135	4.6	7.4	036351
V3636	7	144	4.7	7.4	036368
V1008	8	140	4.7	7.4	010085
V1009	9	151	5.3	7.4	010092
V1010	10	160	5.7	8.4	010108
V1021	11	165	6.1	8.4	010214
V1022	12	170	6.4	8.4	010221
V1023	13	177	6.6	8.4	010238
V1025	14	192	7.3	8.4	010252
V1026	15	200	7.5	8.4	010269
V1027	16	210	7.7	10.0	010276
V1028	17	225	7.9	10.0	010283
V1029	18	235	8.4	11.5	010290
V1030	19	245	8.7	11.5	010306

# Wrenches Schraubenschlüssel



## Ratcheting combination wrench set

**V2819**, EAN 4047728028196

- In tool roll

## Gelenk-Ratschen-Ring-Maulschlüssel-Satz

**V2819**, EAN 4047728028196

- Mit Rolltasche



Design Ausführung	Sizes (mm) SW (mm)
5 x	8 · 10 · 13 · 17 · 19 mm

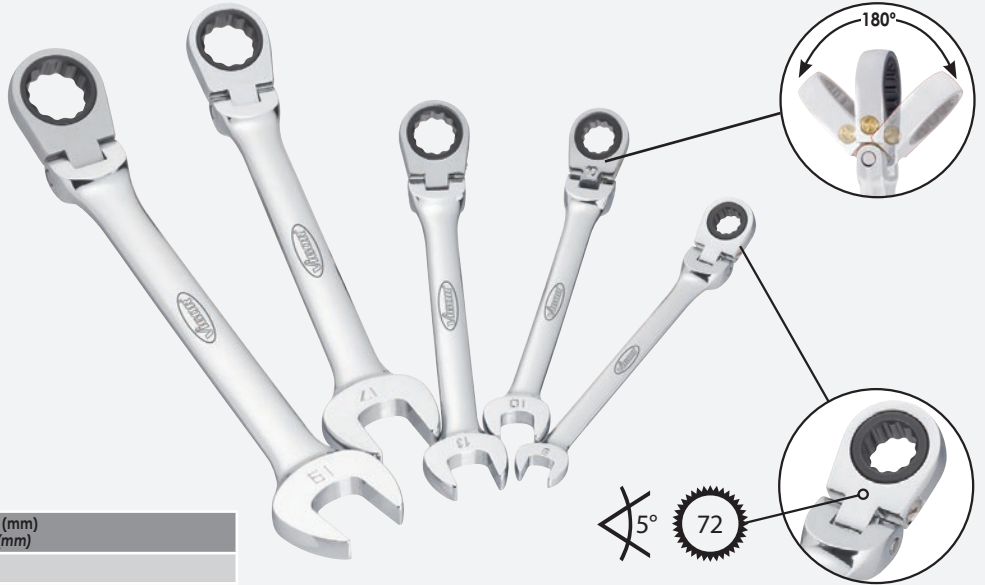

## Ratcheting combination wrench set

**V2818**, EAN 4047728028189

- In tool roll

## Gelenk-Ratschen-Ring-Maulschlüssel-Satz

**V2818**, EAN 4047728028189

- Mit Rolltasche

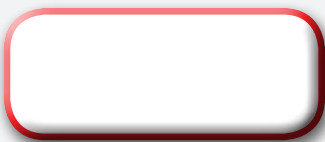

Design Ausführung	Sizes (mm) SW (mm)
12 x	8 · 9 · 10 · 11 · 12 · 13 · 14 · 15 · 16 · 17 · 18 · 19 mm

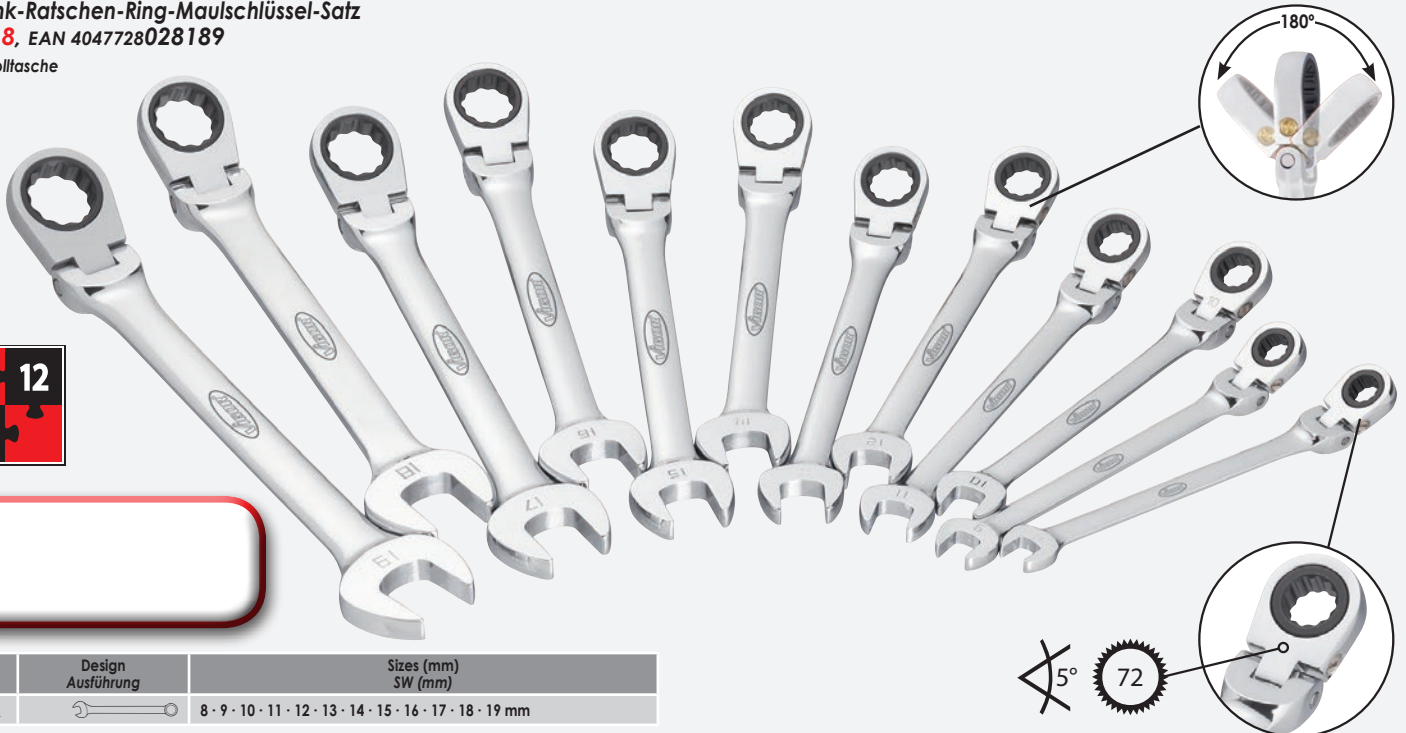

## Ratcheting combination wrench,

- 72 teeth = 5° actuation angle
- 180° ratchet head, swivelling

## Gelenk-Ratschen-Ring-Maulschlüssel,

- 72 Zähne = 5° Drehwinkel
- Ratschenkopf 180°, schwenkbar

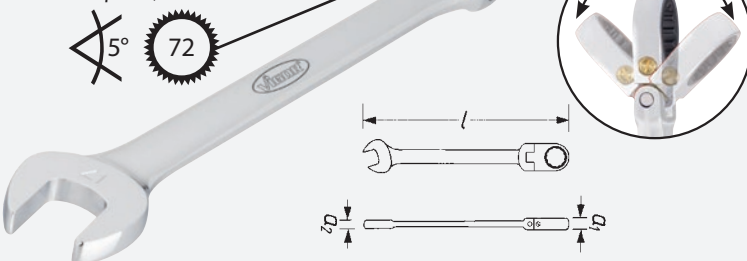

VIGOR No.	Sizes (mm) SW (mm)	L mm	a1 mm	a2 mm	EAN 4047728+
V2804	8	143	7.4	5.0	028042
V2805	9	150	7.4	5.3	028059
V2806	10	158	8.4	5.9	028066
V2807	11	165	8.4	6.1	028073
V2808	12	170	8.4	6.4	028080
V2809	13	182	8.4	6.7	028097
V2810	14	190	8.4	7.4	028103
V2811	15	200	8.5	7.6	028110
V2812	16	215	9.9	7.6	028127
V2813	17	228	10.0	8.0	028134
V2814	18	241	11.1	8.2	028141
V2817	19	250	11.5	8.7	028172

# Multi-Purpose Profile Wrench Schraubenschlüssel Multiprofil

Double ratcheting box-end wrench  
**V3607**, EAN 4047728036078

Doppel-Ratschen-Ringschlüssel  
**V3607**, EAN 4047728036078

**4 in 1**

Multi-purpose profile  
Multiprofil

VIGOR No.	Sizes (mm) SW (mm)	L mm	a1 mm	a2 mm	EAN 4047728+
<b>V3607</b>	8 x 12 10 x 13	220	12.5	14.5	036078

Double ratcheting box-end wrench  
**V3608**, EAN 4047728036085

Doppel-Ratschen-Ringschlüssel  
**V3608**, EAN 4047728036085

**4 in 1**

Multi-purpose profile  
Multiprofil

VIGOR No.	Sizes (mm) SW (mm)	L mm	a1 mm	a2 mm	EAN 4047728+
<b>V3608</b>	9 x 11 15 x 16	220	14	16.5	036085

Double ratcheting box-end wrench  
**V2705**, EAN 4047728027052

Doppel-Ratschen-Ringschlüssel  
**V2705**, EAN 4047728027052

**4 in 1**

12-point  
Doppel-Sechskant

VIGOR No.	Sizes (mm) SW (mm)	L mm	a1 mm	a2 mm	EAN 4047728+
<b>V2705</b>	10 x 17 13 x 19	220	20	17	027052

# Multi-Purpose Profile Wrench Schraubenschlüssel Multiprofil



Double ratcheting  
box-end wrench set  
**V1424**, EAN 4047728014243

Doppel-Ratschen-  
Ringschlüssel-Satz  
**V1424**, EAN 4047728014243



**1 wrench for  
6 profiles  
1 Schlüssel für  
6 Profile!**

**Extra long!  
Extra lang!**

Design Ausführung	Sizes (mm) SW (mm)
6 x	8 x 9 · 10 x 11 · 12 x 13 · 14 x 15 · 16 x 18 · 17 x 19 mm

Double ratcheting box-end wrench  
Doppel-Ratschen-Ringschlüssel

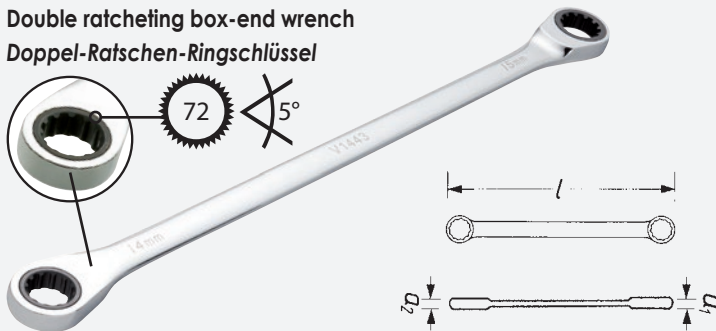

VIGOR No.	Sizes (mm) SW (mm)	L mm	a1 mm	a2 mm	EAN 4047728+
V1430	8 x 9	235	7.4	7.4	014304
V1441	10 x 11	270	8.4	8.4	014410
V1442	12 x 13	300	8.4	8.4	014427
V1443	14 x 15	330	8.4	8.4	014434
V1444	16 x 18	375	10	11.5	014441
V1445	17 x 19	405	10	11.5	014458

Ratcheting aluminium  
box-end wrench set  
**V1364**, EAN 4047728013642  
• In tool roll

Aluminium-Ratschen-  
Ringschlüssel-Satz  
**V1364**, EAN 4047728013642  
• Mit Rolltasche



## Multi-purpose screw profiles / Multiprofile (V1424/V1364)

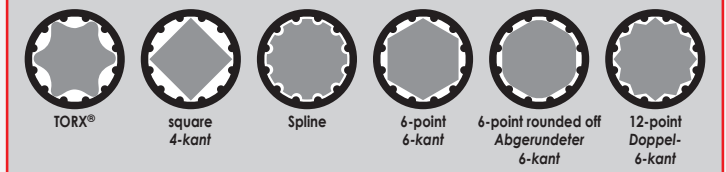

Design Ausführung	Sizes (mm) SW (mm)
4 x	10 · 13 · 17 · 19 mm



Ratcheting aluminium box-end wrench  
Aluminium-Ratschen-Ringschlüssel



VIGOR No.	Sizes (mm) SW (mm)	L mm	a1 mm	EAN 4047728+
V1400	8	89.8	7.4	014007
V1411	10	103.3	8.4	014113
V1412	12	116.2	8.4	014120
V1414	13	117.0	8.4	014144
V1415	14	129.7	8.4	014151
V1416	15	131.4	8.4	014168
V1417	16	142.5	8.4	014175
V1418	17	144	10.0	014182
V1419	18	156.2	11.4	014199
V1420	19	158.8	11.4	014205

## Screwdriver set

**V1637**, EAN 4047728016377

• Manufactured according to DIN/ISO

## Schraubendreher-Satz

**V1637**, EAN 4047728016377

• Nach DIN/ISO gefertigt



Design Ausführung	Sizes (mm) Größe (mm)
4 x	3 · 4 · 5.5 · 6.5 mm
3 x	PH 0 · PH 1 · PH 2



## Screwdriver for slotted screws

### Schlitz-Schraubendreher



VIGOR No.	Design Ausführung	Sizes (mm) SW (mm)	L mm	EAN 4047728+
V1698		0.5 x 3	75	016988
V1699		0.8 x 4	80	016995
V1700		1.0 x 5.5	125	017008
V1701		1.2 x 6.5	150	017015
V3613		1.2 x 8	150	036139
V3609		1.6 x 10	175	036092

## Phillips-Recess screwdriver

### Kreuzschlitz-Schraubendreher



VIGOR No.	Design Ausführung	Sizes (mm) SW (mm)	L mm	EAN 4047728+
V1702		PH 0	75	017022
V1703		PH 1	80	017039
V1704		PH 2	100	017046
V3610		PH 3	150	036108

## Screwdriver set with impact cap

**V3562**, EAN 4047728035620

• Manufactured according to DIN/ISO

## Schraubendreher-Satz mit Schlagkappe

**V3562**, EAN 4047728035620

• Nach DIN/ISO gefertigt



With hexagonal blade passing through the handle  
Mit durchgehender 6-kant-Klinge



Design Ausführung	Sizes (mm) Größe (mm)
4 x	3.5 · 4.5 · 5.5 · 6.5 mm
2 x	PH 1 · PH 2



## Screwdriver for slotted screws

### Schlitz-Schraubendreher



VIGOR No.	Design Ausführung	Sizes (mm) SW (mm)	L mm	EAN 4047728+
V3597		0.6 x 3.5	75	035972
V3598		0.8 x 4.5	100	035989
V3599		1 x 5.5	100	035996
V3600		1.2 x 6.5	125	036009

## Phillips-Recess screwdriver

### Kreuzschlitz-Schraubendreher



VIGOR No.	Design Ausführung	Sizes (mm) SW (mm)	L mm	EAN 4047728+
V3601		PH 1	75	036016
V3602		PH 2	100	036023

# Screwdrivers / Bits Schraubendreher / Bits



TORX® screwdriver set  
**V3366**, EAN 4047728033664

• Manufactured according to DIN/ISO

TORX® Schraubendreher-Satz  
**V3366**, EAN 4047728033664

• Nach DIN/ISO gefertigt



X	Design Ausführung	Sizes (mm) Größe (mm)
7 x		T 10 · T 15 · T 20 · T 25 · T 27 · T 30 · T 40

TORX® screwdriver  
TORX® Schraubendreher

VIGOR No.	Design Ausführung	Sizes (mm) SW (mm)	mm	EAN 4047728+
V3367		T 10	100	033671
V3368		T 15	100	033688
V3369		T 20	100	033695
V3370		T 25	100	033701
V3391		T 27	100	033916
V3392		T 30	100	033923
V3393		T 40	100	033930

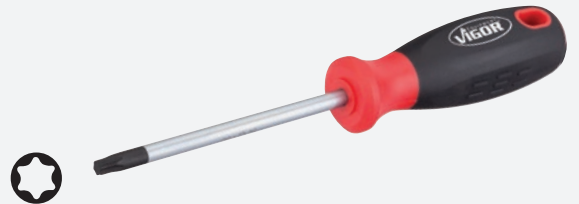

VDE screwdriver set  
**V2027**, EAN 4047728020275

• Manufactured according to DIN/ISO

VDE-Schraubendreher-Satz  
**V2027**, EAN 4047728020275

• Nach DIN/ISO gefertigt



X	Design Ausführung	Sizes (mm) Größe (mm)
4 x		3 · 4 · 5.5 · 6.5 mm
3 x		PH 0 · PH 1 · PH 2

VDE screwdriver for slotted screws  
VDE-Schlitz-Schraubendreher



VDE Phillips-Recess screwdriver  
VDE-Kreuzschlitz-Schraubendreher



VIGOR No.	Design Ausführung	Sizes (mm) SW (mm)	mm	EAN 4047728+
V2028		0.5 x 3	100	020282
V2029		0.8 x 4	100	020299
V2030		1 x 5.5	125	020305
V2061		1.2 x 6.5	150	020619

VIGOR No.	Design Ausführung	Sizes (mm) SW (mm)	mm	EAN 4047728+
V2062		PH 0	60	020626
V2063		PH 1	80	020633
V2064		PH 2	100	020640

Hex nut-driver set  
**V4199**, EAN 4047728041997

Sechskant-Steckschlüssel-  
Schraubendreher-Satz  
**V4199**, EAN 4047728041997



Design Ausführung	Sizes (mm) Größe (mm)
6 x	6 · 7 · 8 · 10 · 12 · 13 mm

Hex-nut driver  
Sechskant-Steckschlüssel-Schraubendreher

VIGOR No.	Design Ausführung	Sizes (mm) SW (mm)	EAN 4047728+
<b>V4200</b>		6	042000
<b>V4221</b>		7	042215
<b>V4222</b>		8	042222
<b>V4223</b>		10	042239
<b>V4224</b>		12	042246
<b>V4225</b>		13	042253



Electronic screwdriver set  
in plastic case  
**V1303**, EAN 4047728013031

Elektronik-Schraubendreher-Satz  
in Kunststoff-Box  
**V1303**, EAN 4047728013031

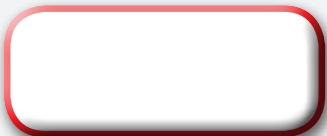

Design Ausführung	Sizes (mm) Größe (mm)
4 x	1.6 · 2 · 2.4 · 3 mm
3 x	PH 00 · PH 0

Voltmeter  
**V1138**, EAN 4047728011389

- 150 up to 250 V, VDE-tested
- 220 up to 250 V according to VDE 0680
- 3 x 0.5 x 140 mm

Spannungsprüfer  
**V1138**, EAN 4047728011389

- 150 bis 250 V, VDE geprüft
- 220 bis 250 V nach VDE 0680
- 3 x 0,5 x 140 mm

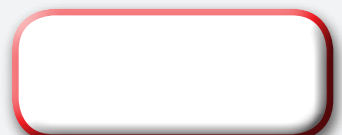



# Screwdrivers / Bits Schraubendreher / Bits



Screwdriver, short  
**V1208**, EAN 4047728012089  
⌀ 5.5 x 38 mm  
Schraubendreher, kurz  
**V1208**, EAN 4047728012089  
⌀ 5.5 x 38 mm



Screwdriver, short  
**V1209**, EAN 4047728012096  
⊕ PH 2 x 38 mm  
Schraubendreher, kurz  
**V1209**, EAN 4047728012096  
⊕ PH 2 x 38 mm



Offset screwdriver set in clip  
Winkelschraubendreher-Satz im Clip  
**V1139**, EAN 4047728011396

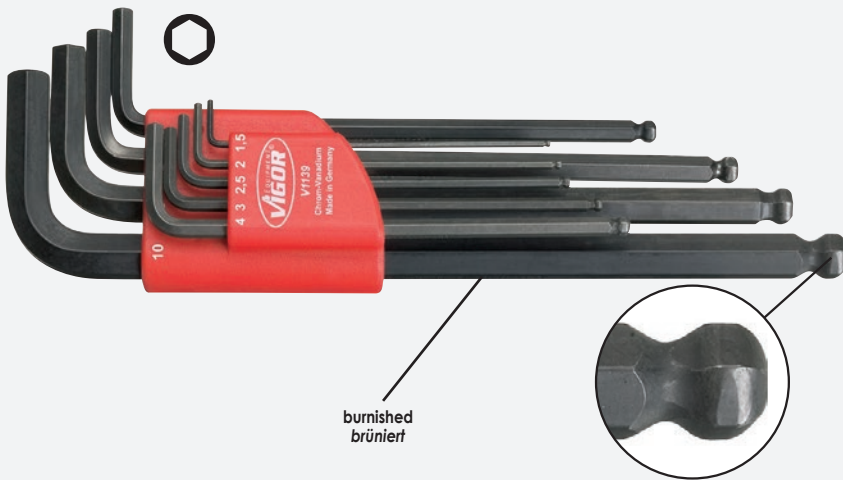

Design Ausführung	Sizes (mm) SW (mm)
9 x	1.5 · 2 · 2.5 · 3 · 4 · 5 · 6 · 8 · 10

**V1181**, EAN 4047728011815

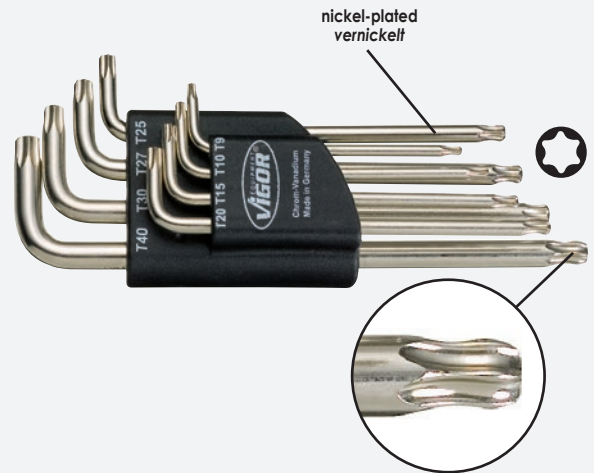

Design Ausführung	Sizes (mm) SW (mm)
8 x	T 9 · T 10 · T 15 · T 20 · T 25 · T 27 · T 30 · T 40

Offset screwdriver  
**V2448**, EAN 4047728024488  
Winkelschraubendreher  
**V2448**, EAN 4047728024488



VIGOR No.	Design Ausführung	Sizes (mm) SW (mm)	mm	EAN 4047728+
<b>V2448</b>		1.0	40.0	024488
<b>V2449</b>		1.5	45.5	024495
<b>V2450</b>		2.0	48.0	024501
<b>V2451</b>		2.5	51.0	024518

Hexagon-T-handle screwdriver set  
**V1409**, EAN 4047728014090

Sechskant-T-Griff Schraubendreher-Satz  
**V1409**, EAN 4047728014090



	Design Ausführung	Sizes (mm) SW (mm)
8 x		2 · 2.5 · 3 · 4 · 5 · 6 · 8 · 10 mm

Hexagon T-handle screwdriver  
Sechskant T-Griff Schraubendreher



VIGOR No.	Sizes (mm) SW (mm)	L mm	EAN 4047728+
V2489	2	156	024891
V2486	2.5	156	024860
V2507	3	156	025072
V2506	4	156	025065
V2505	5	156	025058
V2504	6	216	025041
V2503	8	216	025034
V2502	10	216	025027

TORX® T-handle screwdriver set  
**V1410**, EAN 4047728014106

TORX® T-Griff Schraubendreher-Satz  
**V1410**, EAN 4047728014106

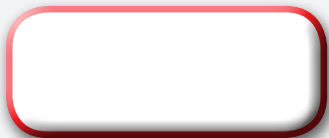

	Design Ausführung	Sizes (mm) SW (mm)
8 x		T 9 · T 10 · T 15 · T 20 · T 25 · T 27 · T 30 · T 40

TORX® T-handle screwdriver  
TORX® T-Griff Schraubendreher



VIGOR No.	Sizes (mm) SW (mm)	L mm	EAN 4047728+
V2498	T 9	156	024983
V2497	T 10	156	024976
V2501	T 15	156	025010
V2490	T 20	156	024907
V2485	T 25	156	024853
V2484	T 27	216	024846
V2483	T 30	216	024839
V2482	T 40	216	024822



# Screwdrivers / Bits Schraubendreher / Bits



Bit box with finger ratchet  
V2834, EAN 4047728028349

Bit-Box mit Fingerratsche  
V2834, EAN 4047728028349



6.3 1/4"



X	Design Ausführung	■	Sizes (mm) SW (mm)
5 x		6.3 1/4"	5 · 6 · 8 · 10 · 12 · 13 mm
3 x		6.3 1/4"	4 · 5 · 6 mm
3 x		6.3 1/4"	PH 1 · PH 2 · PH 3
3 x		6.3 1/4"	PZ 1 · PZ 2 · PZ 3
7 x		6.3 1/4"	T 10 · T 15 · T 20 · T 25 · T 27 · T 30 · T 40
1 x		6.3 1/4"	50 mm
1 x		6.3 1/4"	60 mm
1 x		6.3 1/4"	—

Single parts from page 44 on  
Einzelteilaufistung ab Seite 44

Bit box  
V1097, EAN 4047728010979  
• ~ DIN / ISO

Bit Box  
V1097, EAN 4047728010979  
• ~ DIN / ISO



With belt clip  
Inkl. Gürtelclip



6.3 1/4"



X	Design Ausführung	■	Sizes (mm) SW (mm)
5 x		6.3 1/4"	PH 1 (2x) · PH 2 (2x) · PH 3
5 x		6.3 1/4"	PZ 1 (2x) · PZ 2 (2x) · PZ 3
4 x		6.3 1/4"	4 x 0.8 · 5 x 1 · 6.5 x 1.2 · 8 x 1.6 mm
4 x		6.3 1/4"	3 · 4 · 5 · 6 mm
6 x		6.3 1/4"	T 15 · T 20 · T 25 · T 27 · T 30 · T 40
6 x		6.3 1/4"	T 10 H · T 15 H · T 20 H · T 25 H · T 27 H · T 30 H
1 x		6.3 1/4"	—
1 x		6.3 1/4"	—

Combination pliers  
**V1616**, EAN 4047728016162

Kombizange  
**V1616**, EAN 4047728016162

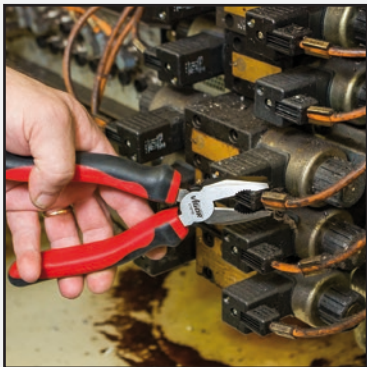

Diagonal cutters  
**V1617**, EAN 4047728016179

Seitenschneider  
**V1617**, EAN 4047728016179



Snipe nose pliers  
**V2412**, EAN 4047728024129

Flachrund-Zange  
**V2412**, EAN 4047728024129



VDE round nose pliers  
**V2641**, EAN 4047728026413

VDE Rundzange  
**V2641**, EAN 4047728026413

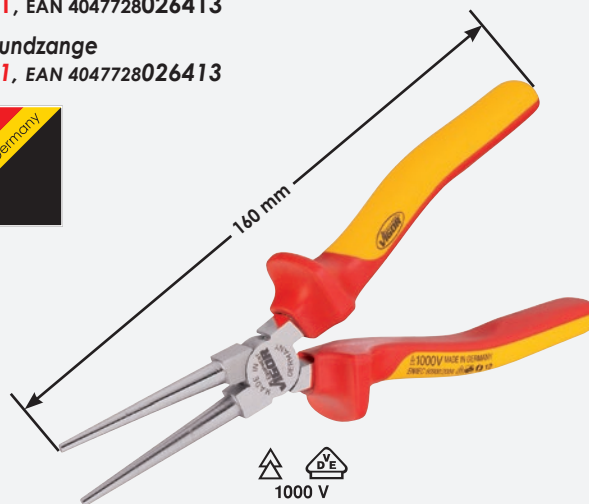

VDE combination pliers  
**V2628**, EAN 4047728026284

VDE-Kombizange  
**V2628**, EAN 4047728026284



VDE diagonal cutter  
**V2629**, EAN 4047728026291

VDE-Seitenschneider  
**V2629**, EAN 4047728026291



VDE snipe nose pliers  
**V2630**, EAN 4047728026307

VDE-Flachrund-Zange  
**V2630**, EAN 4047728026307

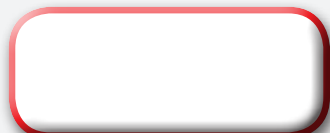
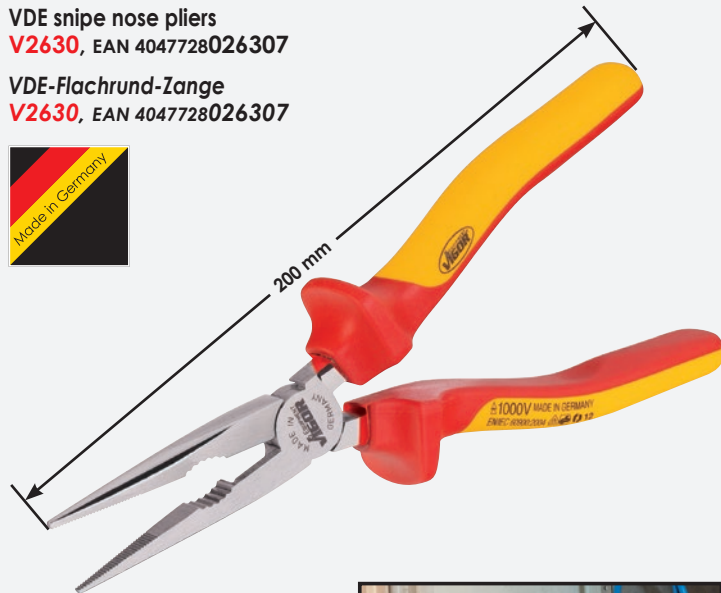

VDE wire stripper  
**V2643**, EAN 4047728026437

VDE-Abisolierzange  
**V2643**, EAN 4047728026437

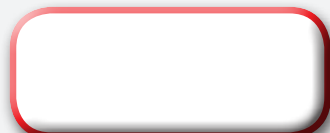

Lockring pliers

**V1716**, EAN 4047728017169

- For bore holes from 19 to 60 mm

Zange für Sicherungsringe

**V1716**, EAN 4047728017169

- Für Bohrungen von 19–60 mm



Lockring pliers

**V1717**, EAN 4047728017176

- For shafts from 19 to 60 mm

Zange für Sicherungsringe

**V1717**, EAN 4047728017176

- Für Wellen von 19–60 mm



Lockring pliers

**V1718**, EAN 4047728017183

- For bore holes from 19 to 60 mm

Zange für Sicherungsringe

**V1718**, EAN 4047728017183

- Für Bohrungen von 19–60 mm

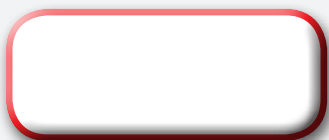

Lockring pliers

**V1719**, EAN 4047728017190

- For shafts from 19 to 60 mm

Zange für Sicherungsringe

**V1719**, EAN 4047728017190

- Für Wellen von 19–60 mm



Lockring pliers

**V2794**, EAN 4047728027946

- For bore holes from 40 to 100 mm

Zange für Sicherungsringe

**V2794**, EAN 4047728027946

- Für Bohrungen von 40–100 mm

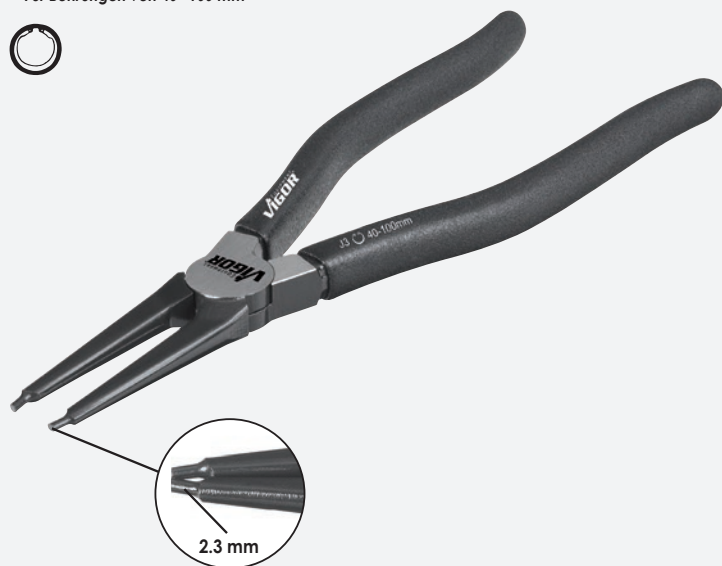

Lockring pliers

**V2792**, EAN 4047728027922

- For shafts from 40 to 100 mm

Zange für Sicherungsringe

**V2792**, EAN 4047728027922

- Für Wellen von 40–100 mm

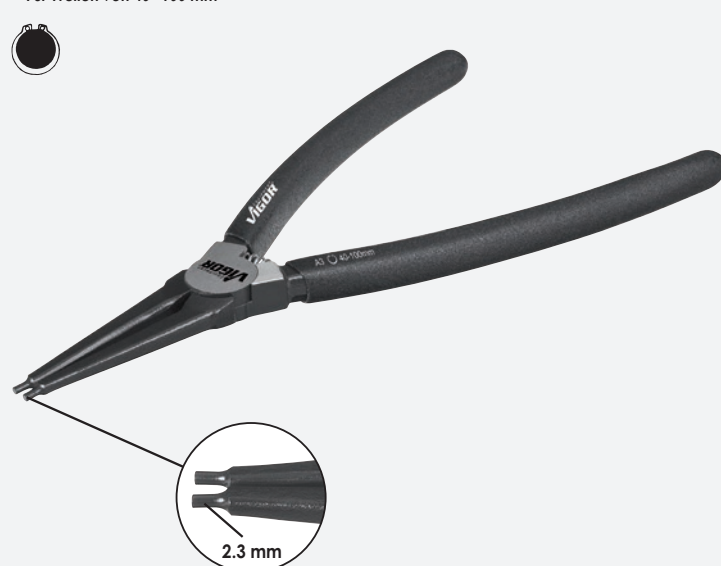

Lockring pliers

**V2793**, EAN 4047728027939

- For bore holes from 40 to 100 mm

Zange für Sicherungsringe

**V2793**, EAN 4047728027939

- Für Bohrungen von 40–100 mm



Lockring pliers

**V2791**, EAN 4047728027915

- For shafts from 40 to 100 mm

Zange für Sicherungsringe

**V2791**, EAN 4047728027915

- Für Wellen von 40–100 mm

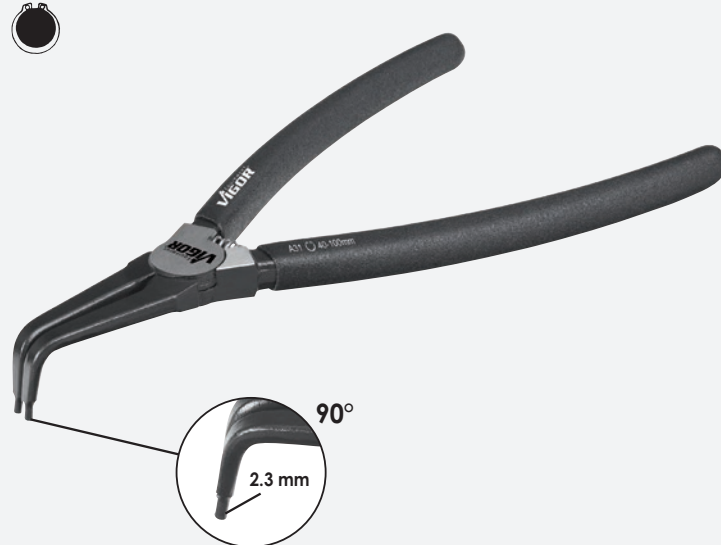

Combination pliers with double joint  
**V2781**, EAN 4047728027816

- Toothed, extremely slim design
- For working in areas with restricted access

Kombizange mit Doppelgelenk  
**V2781**, EAN 4047728027816

- Gezähnte, extrem schmale Ausführung
- Für schwer zugängliche Bereiche

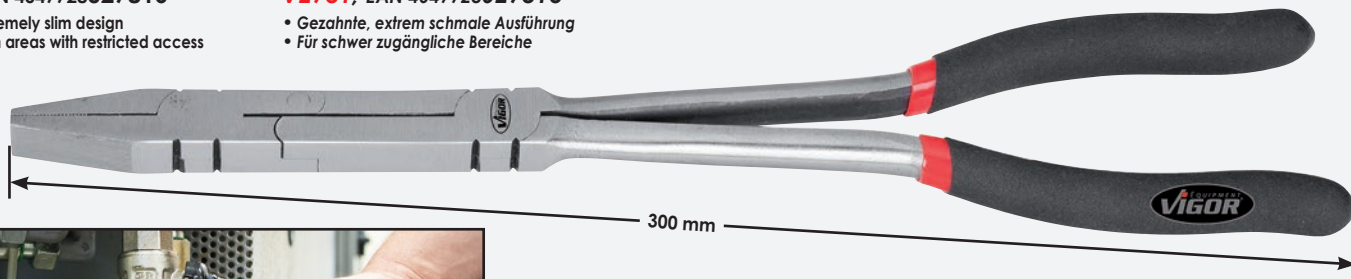

Snipe nose pliers with double joint  
**V2782**, EAN 4047728027823

- Toothed, extremely slim design
- For working in areas with restricted access

Flachrundzange mit Doppelgelenk  
**V2782**, EAN 4047728027823

- Gezähnte, extrem schmale Ausführung
- Für schwer zugängliche Bereiche

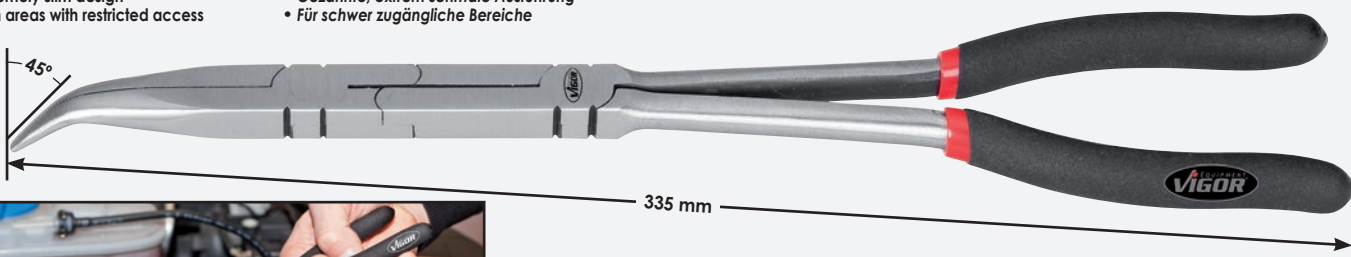

Snipe nose pliers with double joint  
**V2783**, EAN 4047728027830

- Toothed, extremely slim design
- For working in areas with restricted access

Flachrundzange mit Doppelgelenk  
**V2783**, EAN 4047728027830

- Gezähnte, extrem schmale Ausführung
- Für schwer zugängliche Bereiche

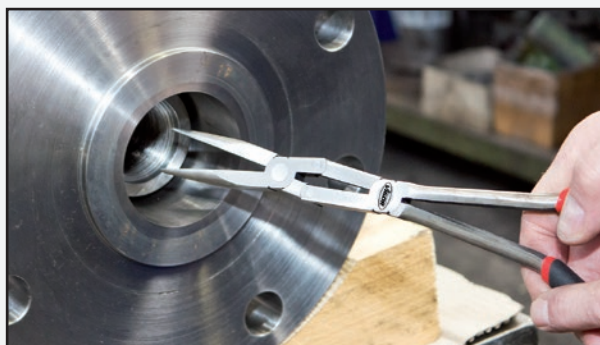
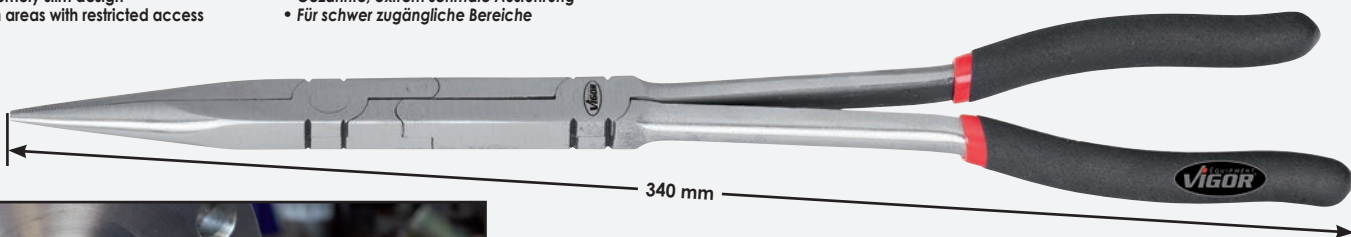



Pliers  
Zangen



Single-hand universal pliers  
**V2644**, EAN 4047728026444

Einhand-Universalzange  
**V2644**, EAN 4047728026444

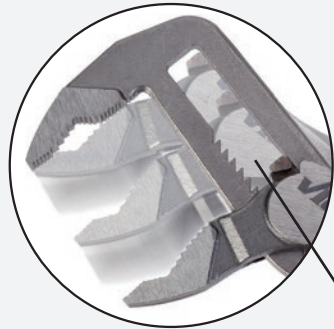

Quick adjustment  
Schnellverstellung



Universal pliers  
**V1426**, EAN 4047728014267  
• DIN ISO 8976

Universalzange  
**V1426**, EAN 4047728014267  
• DIN ISO 8976

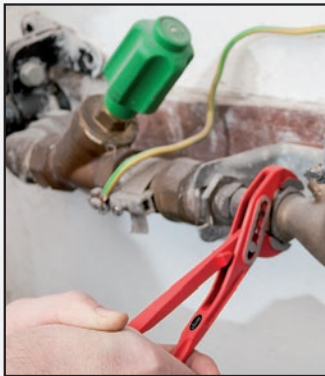

Multi-tool 14 in 1  
**V1785**, EAN 4047728017855

Multi-Tool 14-in-1  
**V1785**, EAN 4047728017855



Grip pliers with curved jaws  
**V3738**, EAN 4047728037389

Maul-Gripzange  
**V3738**, EAN 4047728037389



Size 11-19 mm  
SW 11-19 mm

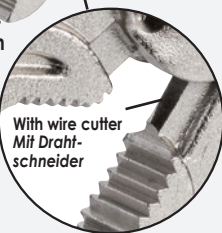

With wire cutter  
Mit Draht-  
schneider



Grip pliers with curved jaws  
**V3739**, EAN 4047728037396

Maul-Gripzange  
**V3739**, EAN 4047728037396



Size 16-27 mm  
SW 16-27 mm

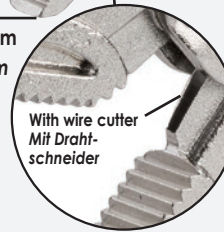

With wire cutter  
Mit Draht-  
schneider



Grip pliers set in tool roll  
**V1808**, EAN 4047728018081

Grip-Zangen-Satz in Rolltasche  
**V1808**, EAN 4047728018081



VIGOR No.	Design Ausführung	mm	EAN 4047728+
<b>V1802</b>		150	018029
<b>V1803</b>		250	018036
<b>V1804</b>		125	018043



**Crimping pliers set**

**V2499**, EAN 4047728024990

- With 5 replaceable crimping jaws:
- Crimping jaw A: for insulated cable lugs from 0.5–6.0 mm<sup>2</sup> (red, blue, yellow)
- Crimping jaw B: for closed, non-insulated cable lugs from 0.5–10.0 mm<sup>2</sup>
- Crimping jaw C: for open, non-insulated cable lugs from 0.5–6.0 mm<sup>2</sup> (up to 6.3 mm)
- Crimping jaw D: for wire end sleeves with or without collar from 0.5–4.0 mm<sup>2</sup>
- Crimping jaw F: for wire end sleeves above 4.0 mm<sup>2</sup>



**Crimpzangen-Satz**

**V2499**, EAN 4047728024990

- Mit 5 austauschbaren Crimp-Einsätzen:
- Crimp-Einsatz A: für isolierte Kabelschuhe von 0,5–6,0 mm<sup>2</sup> (rot, blau, gelb)
- Crimp-Einsatz B: für geschlossene, unisolierte Kabelschuhe von 0,5–10,0 mm<sup>2</sup>
- Crimp-Einsatz C: für offene, unisolierte Kabelschuhe von 0,5–6,0 mm<sup>2</sup> (Breite bis 6,3 mm)
- Crimp-Einsatz D: für Aderendhülsen mit und ohne Kragen von 0,5–4,0 mm<sup>2</sup>
- Crimp-Einsatz F: für Aderendhülsen über 4,0 mm<sup>2</sup>



With locking lever  
Mit Zwangssperre

**2K System**

Universal hand riveting tool for blind rivets and rivet nuts

**V3735**, EAN 4047728037358

- Rivet nuts: M5 M6 M8 M10 for rivets made of copper, brass, steel and stainless steel
- Blind rivets: 3.2 4.0 4.8 6.4 mm for rivets made of copper, brass, steel and stainless steel

Universal-Nietzange für Blindnieten und Nietmuttern

**V3735**, EAN 4047728037358

- Nietmuttern: M5 M6 M8 M10 für Kupfer-, Messing-, Stahl- und Edelstahlnieten
- Blindnieten: 3.2 4.0 4.8 6.4 mm für Kupfer-, Messing-, Stahl- und Edelstahlnieten



For: / Für:

Blind rivets  
Blindniete

Rivet nuts  
Nietmutter

(not included in set)  
(nicht im Satz enthalten)



Blind rivet pliers

**V2788**, EAN 4047728027885

- For blind rivets: 3.2 · 4.0 · 4.8 · 6.4 mm
- For rivets made of copper, brass, steel and stainless steel
- Very low power required, extra short design

Blindniet-Zange

**V2788**, EAN 4047728027885

- Für Blindnieten: 3.2 · 4.0 · 4.8 · 6.4 mm
- Für Kupfer-, Messing-, Stahl- und Edelstahlnieten
- Sehr geringer Kraftaufwand bei extrem kurzer Bauform

For: / Für:

Blind rivets  
Blindniete

(not included in set)  
(nicht im Satz enthalten)



Plastic hand riveting tool  
V4196, EAN 4047728041966

Kunststoff-Nietzange  
V4196, EAN 4047728041966



Body made from metal die casting  
Körper aus Metalldruckguss

With rubber handle  
Mit Gummigriff

Narrow  
pliers head  
Schmaler  
Zangenkopf

Rivet head angled at  
90 degrees  
90 Grad abgewinkelter  
Nietkopf

Locking element  
Arretierung

**Incl. 40 plastic rivets**  
**Inkl. 40 Kunststoffnieten**



10 pieces: 15.8 x 5 mm  
10 Stück: 15,8 x 5 mm



10 pieces: 17.2 x 5 mm  
10 Stück: 17,2 x 5 mm



10 pieces: 17.2 x 6.6 mm  
10 Stück: 17,2 x 6,6 mm



10 piece: 25.2 x 6.3 mm  
10 Stück: 25,2 x 6,3 mm

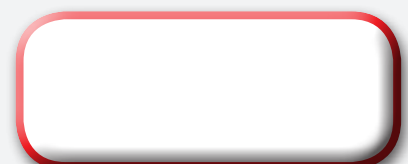

**Club hammer**  
**V4234**, EAN 4047728042345

**Fäustel**  
**V4234**, EAN 4047728042345



VIGOR No.	♁ g	— L — mm	EAN 4047728+
V4234	1000	260	042345
V4235	1500	280	042352
V4236	2000	300	042369



**Machinist's hammer**  
**Schlosser-Hammer**



VIGOR No.	— L — mm	♁ g	EAN 4047728+
V1135	300	300	011358
V2662	320	500	026628
V2665	350	800	026659
V2664	360	1000	026642
V2663	400	2000	026635



**Plastic hammer**  
**V1212**, EAN 4047728012126

**Kunststoff-Schonhammer**  
**V1212**, EAN 4047728012126



**Spare heads (pair)**  
**Ersatzkopf (Paar)**  
**V3541**, EAN 4047728035415



**Sub Maker Quadro 10-in-1**  
**V4241**, EAN 4047728042413

**Sub Maker Quadro 10-in-1**  
**V4241**, EAN 4047728042413

- 5 mm
- 6-7 mm
- 8-9 mm
- 5-6 mm
- 6-7 mm
- 8-9 mm
- 2 x 1/4" Bit
- 3-5 mm
- 1/4"



## MasterKey electronics V4227, EAN 4047728042277

- For almost all standard locking systems in plumbing, electronics, heating, ventilation, air conditioning etc.
- Material: zinc pressure casting

## MasterKey Elektro V4227, EAN 4047728042277

- Für fast alle gängigen Schließungen in Sanitär, Elektro, Heizung, Lüftung, Klima etc.
- Material: Zinkdruckguss

- 5 mm
- 6 mm
- 8 mm
- 9 mm
- 3-5 mm



## MasterKey construction V4228, EAN 4047728042284

- For almost all standard locking systems in plumbing, heating, construction, ventilation, air conditioning etc.
- Square mandrel allows the lock follower to be operated without a door handle or square pin
- Material: zinc pressure casting

## MasterKey Bau V4228, EAN 4047728042284

- Für fast alle gängigen Schließungen in Sanitär, Heizung, Bau, Lüftung, Klima etc.
- Vierkant-Dorn ermöglicht Betätigen der Schloßnuss ohne Türdrücker und Vierkantstift
- Material: Zinkdruckguss

- 3 mm
- 5 mm
- 6 mm
- 8 mm
- 9 mm
- 6-10 mm



## Flat chisel V1221, EAN 4047728012218

## Flachmeißel V1221, EAN 4047728012218



## Cape chisel V1222, EAN 4047728012225

## Kreuzmeißel V1222, EAN 4047728012225



## Centre punch V1220, EAN 4047728012201

## Körner V1220, EAN 4047728012201



## Drift punch Splint-Austreiber



VIGOR No.	Design Ausführung	Ø mm	L mm	EAN 4047728+
V1214	—	2	150	012140
V1215	—	3	150	012157
V1216	—	4	150	012164
V1217	—	5	150	012171
V1218	—	6	150	012188
V1219	—	8	150	012195

## Auto-impact centre punch V1783, EAN 4047728017831

## Selbstschlagender Körner V1783, EAN 4047728017831

Progressively adjustable  
Stufenlos einstellbar



## Window scraper V1368, EAN 4047728013680

- Changeable blade
- To remove badges, stickers, vignettes etc.
- For e.g. windscreens, ceramic hobs etc.

## Schaber für Glasoberflächen V1368, EAN 4047728013680

- Auswechselbare Klinge
- Zum Entfernen von Plaketten, Aufklebern, Vignetten etc.
- Für z.B. Windschutzscheiben, Ceranfelder etc.



## Spare blades Ersatzklingen V1372, EAN 4047728013727



## Scrapers V1213, EAN 4047728012133

## Schaber V1213, EAN 4047728012133



Scraper set  
**V1283**, EAN 4047728012836



Schaber-Satz  
**V1283**, EAN 4047728012836

VIGOR No.	Total Gesamtlänge mm	Blade Klinge mm	Width Breite mm	Thickness Dicke mm	EAN 4047728+
V2487	230	105	32	1.2	024877
V2488	230	105	32	2.5	024884
V2509	175	55	20	1.2	025096
V2508	175	55	20	2.5	025089



Lever removing set  
**V1369**, EAN 4047728013697



Lösehebel-Satz  
**V1369**, EAN 4047728013697

VIGOR No.	Contents Inhalt	Length mm	Width Breite mm	EAN 4047728+
V2491		160	60	024914
V2492		180	30	024921
V2493		180	20	024938
V2494		200	30	024945
V2495		210	20	024952



Hook and scraper set  
**V1723**, EAN 4047728017237

Haken- und Schaber-Satz  
**V1723**, EAN 4047728017237





Pry bar set

**V1301**, EAN 4047728013017

- Shock-resistant handle

Hebeleisen-Satz

**V1301**, EAN 4047728013017

- Schlagfestes Heft

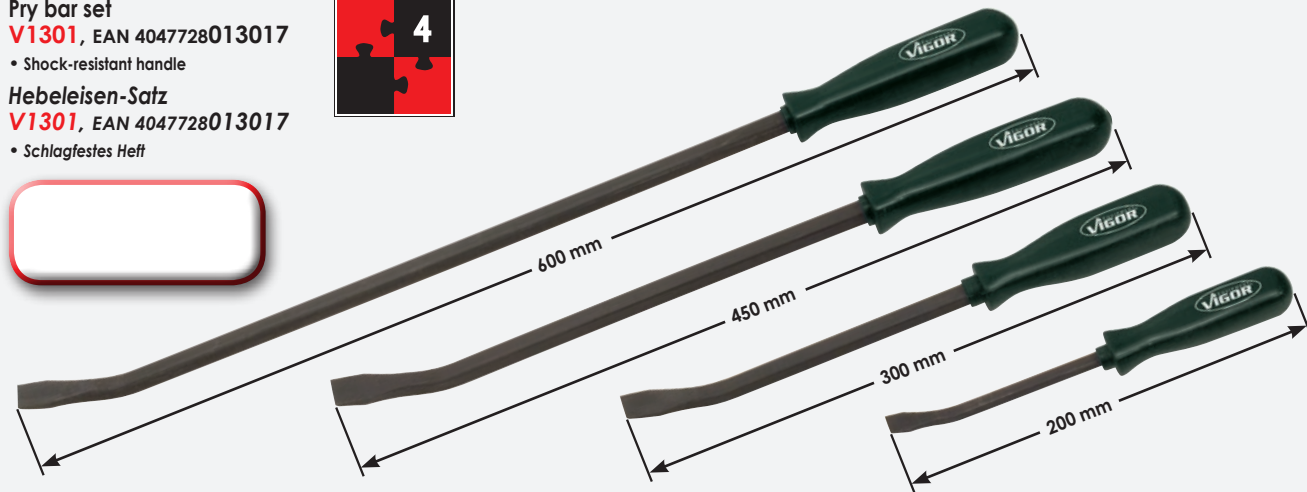

Wrenching bar 70 cm

**V1429**, EAN 4047728014298

Brecheisen 70 cm

**V1429**, EAN 4047728014298



Indexable ratcheting pry bar set

**V1437**, EAN 4047728014373

- Indexable ratcheting pry bar allows easy access into areas which are difficult to reach
- Auto forward locking ratchet design mechanism



Verstellbarer Hebeleisen-Satz

**V1437**, EAN 4047728014373

- Verstellbare Hebeleisen für den Einsatz an schwer zugänglichen Stellen
- Automatische Verriegelung über Ratschen-Mechanismus

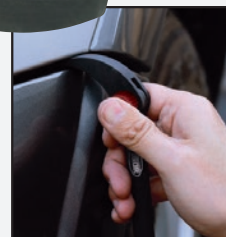
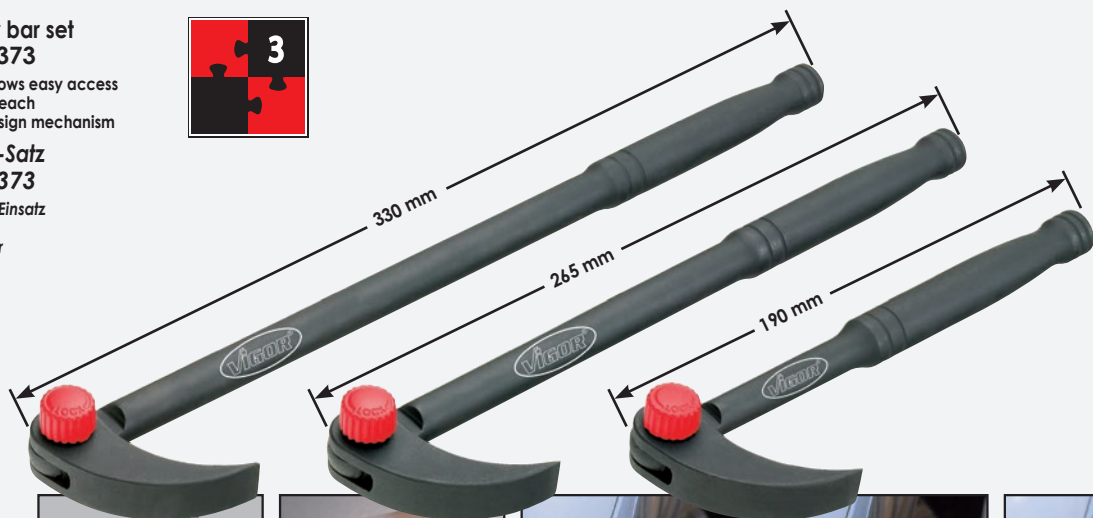



6.3 1/4"



**Brush set  
V1921, EAN 4047728019217**

- For professional cleaning and deburring of cylinders, tubes, bushings, etc.
- Suitable for drilling machines and pneumatic drills
- Contents:
  - 12 nylon brushes: Ø 8 9 10 11 12 13 14 15 16 17 18 19 mm
  - 12 steel brushes: Ø 8 9 10 11 12 13 14 15 16 17 18 19 mm
  - 12 brushes with brass coating: Ø 8 9 10 11 12 13 14 15 16 17 18 19 mm
  - 1 handle with adapter and quick lock
  - 1 extension 150 mm

**Bürsten-Satz  
V1921, EAN 4047728019217**

- Zum professionellen Reinigen und Entgraten von Zylindern, Rohren, Buchsen usw.
- Für Betrieb mit Bohrmaschinen und Druckluftbohrern geeignet
- Inhalt:
  - 12 Nylonbürsten: Ø 8 9 10 11 12 13 14 15 16 17 18 19 mm
  - 12 Stahlbürsten: Ø 8 9 10 11 12 13 14 15 16 17 18 19 mm
  - 12 Bürsten mit Messingbeschichtung: Ø 8 9 10 11 12 13 14 15 16 17 18 19 mm
  - 1 Handgriff mit Aufnahme und Schnellverriegelung
  - 1 Verlängerung 150 mm



**Note:**  
When operating with power tools only use the brushes rotating to the right!



**Hinweis:**  
Bei Maschinenverwendung nur rechtslaufend einsetzen!

Brass brushes  
Messingbürsten



Steel brushes  
Stahlbürsten



Nylon brushes  
Nylonbürsten



**360° chain brush for motorcycle, bicycle and drive chain cleaning  
V1915, EAN 4047728019156**

- For the 360° cleaning of 400, 500 and 600 series drive chains on ATV (Quads), motorcycles, bicycles and for industrial applications
- Gentle cleaning of chains with O, X and Z rings

**360°-Kettenbürste zur Reinigung von Motorrad-/ Fahrrad-/ Antriebsketten  
V1915, EAN 4047728019156**

- Kettenbürste zur 360° Reinigung von Antriebsketten der Größen 400, 500 und 600 für ATV (Quads), Motorrad, Fahrrad und Industrie
- Zur Reinigung von Ketten mit O-, X- oder Z-Ringsystem

360° cleaning  
~1000 bristles  
360° Reinigung  
~1000 Einzelborsten

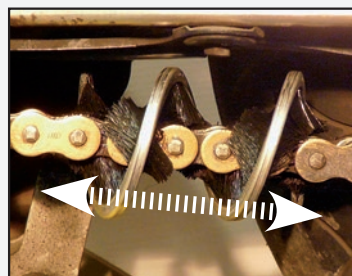
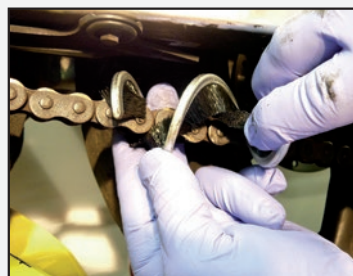
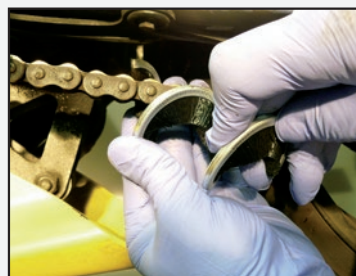
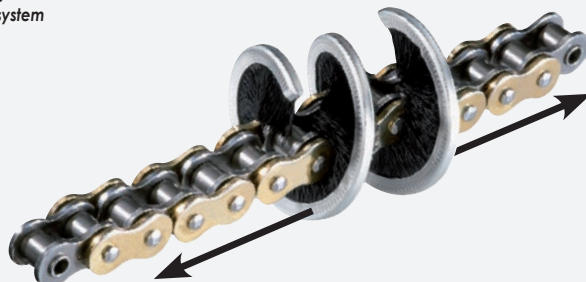
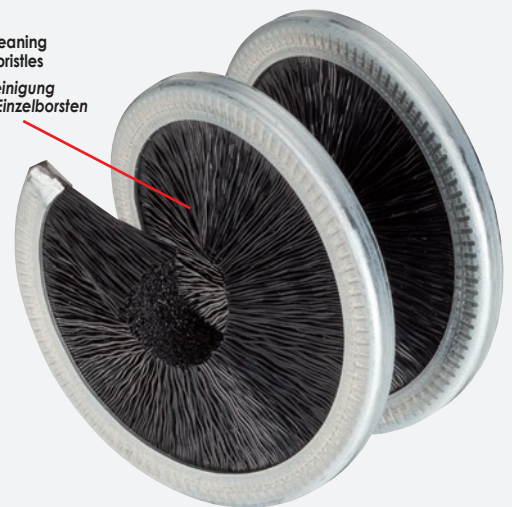

Tweezers set  
**V1438**, EAN 4047728014380

Pinzetten-Satz  
**V1438**, EAN 4047728014380



Magnetic pick-up tool  
**V1741**, EAN 4047728017411

Magnetheber  
**V1741**, EAN 4047728017411



Pick-up tool with claws  
**V1764**, EAN 4047728017640

Krallengreifer  
**V1764**, EAN 4047728017640

700 mm



Precision oiler  
**V1893**, EAN 4047728018937

Präzisions-Ölspritze  
**V1893**, EAN 4047728018937

With screw cap  
Verschraubbar

Aluminium housing  
Aluminium-Gehäuse

Ø 2.6 mm  
Ø 2.6 mm

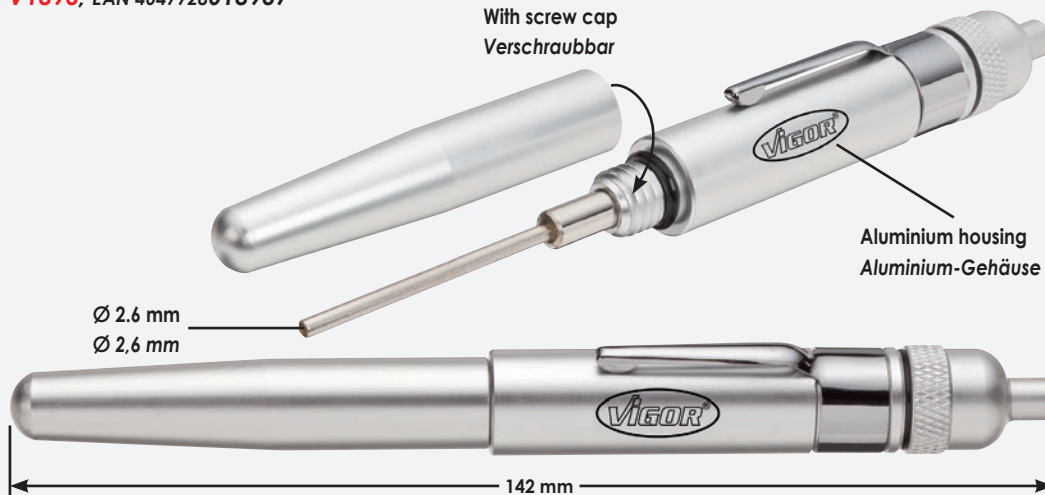

**Cordless mini grinder**  
**V1720**, EAN 4047728017206

For precise drilling, polishing, grinding, etc.  
□ 7.2 V – 1000 mA

**Akku-Schleifer**  
**V1720**, EAN 4047728017206

Zum Fräsen, Polieren, Schleifen uvm.  
□ 7,2 V – 1000 mA

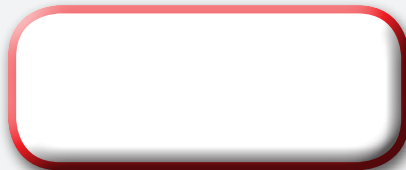
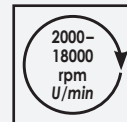
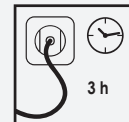

**Soldering iron**  
**V1367**, EAN 4047728013673

□ 3x AA 1.5 V  
Max. 480° C  
Max. 480° C



**Lötkolben**  
**V1367**, EAN 4047728013673

□ 3x AA 1,5 V



**Kneeling mat**  
**V2338**, EAN 4047728023382

**Kniekissen**  
**V2338**, EAN 4047728023382



### Spirit level

- 1.3 mm aluminium frame
- Surface ground
- Accuracy: 0.5 mm/m

### Wasserwaage

- 1,3 mm starker Aluminium-Rahmen
- Geschliffene Oberfläche
- Genauigkeit: 0,5 mm/m

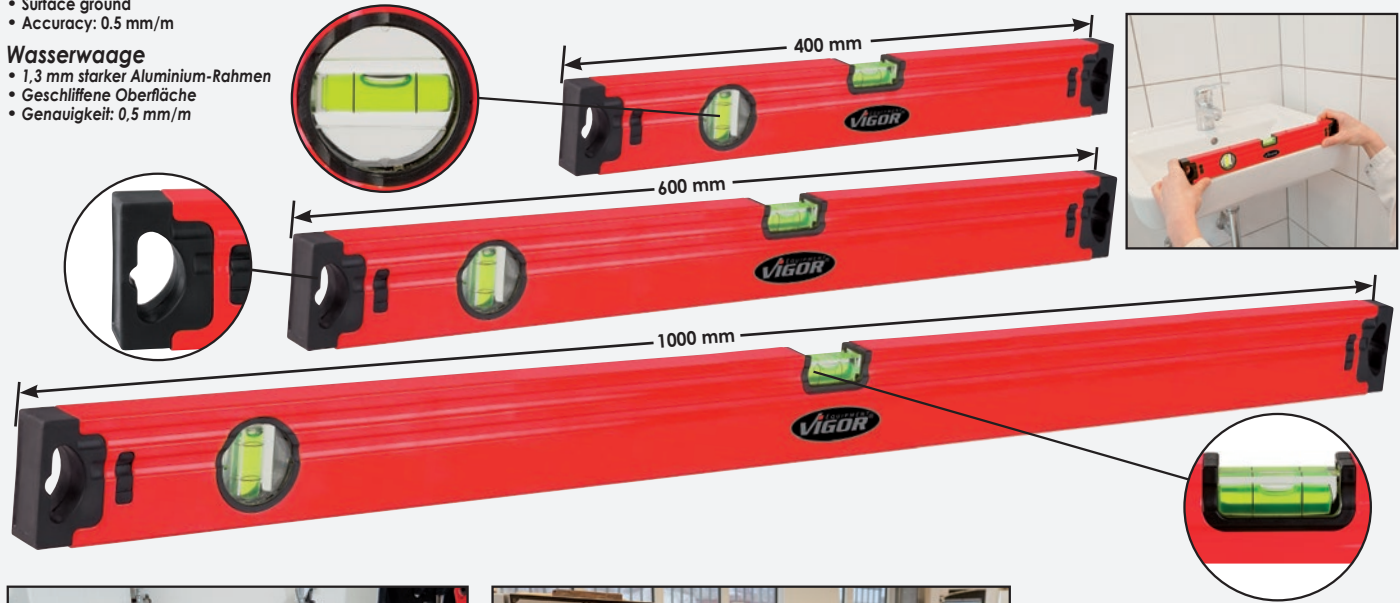

VIGOR No.	mm	EAN 4047728+
V2623	400	026239
V2622	600	026222
V2621	1000	026215

### Digital vernier calliper

V1713, EAN 4047728017138

□ 1.5 V (LR 44) – 180 mAh

### Digitaler Messschieber

V1713, EAN 4047728017138

□ 1,5 V (LR 44) – 180 mAh

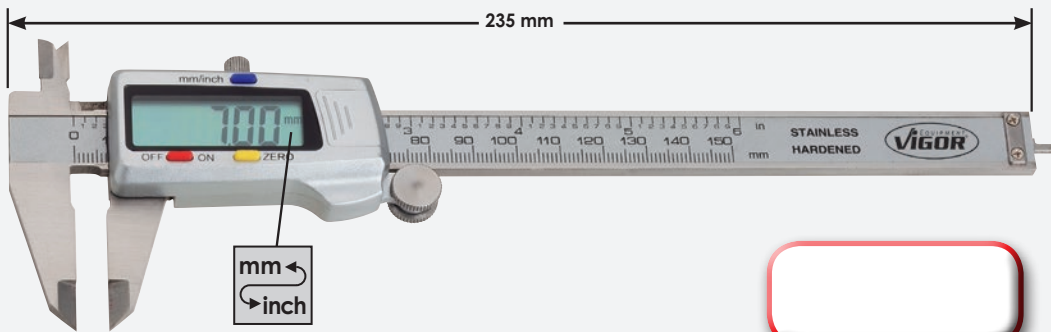

### Tape measure

V1724, EAN 4047728017244

### Bandmaß

V1724, EAN 4047728017244



### Feeler gauge set

V1714, EAN 4047728017145

### Fühlerlehren-Satz

V1714, EAN 4047728017145



### Mobile tensioning block V4226, EAN 4047728042260

- Easy to use in a few steps
- Can clamp workpieces (e.g. logs, bicycles, doors, fence posts, steel struts etc.) through its clamping force of 1,000 kg (per foot pedal).
- "Tripod principle" and robust processing: objects can be held securely and reliably
- Uses:
  - Planing, milling, drilling, sanding, sawing and assembly works
  - Finishing workpieces
  - Painting/varnishing/oiling
  - Wood, metal and plastics processing
  - Bicycle repairs
  - Cementing in fence posts
  - Dry and indoor construction
- Foldable legs

### Mobiler Spannbock V4226, EAN 4047728042260

- In wenigen Schritten unkompliziert einsetzbar
- Kann Werkstücke (z.B. Baumstämme, Fahrräder, Türen, Zaunpfosten, Stahlstreben uvm.) mittels seiner Einspannkraft von 1.000 kg (per Fußpedal) einspannen
- „Dreibein-Prinzip“ und robuste Verarbeitung: Gegenstände können sicher und zuverlässig getragen werden
- Einsatzgebiete:
  - Hobel-, Fräs-, Schweiß-, Bohr-, Schleif-, Säge- und Montagearbeiten
  - Veredelung von Werkstücken
  - Streichen/Lackieren/Ölen
  - Holz-, Metall- und Kunststoffverarbeitung
  - Fahrradinstanzsetzung
  - Zaunpfähle einbetonieren
  - Trocken- und Innenausbau
- Beine einklappbar



Clamping area: 0-913 mm  
Einspannbereich: 0-913 mm

Max. clamping pressure:  
1000 kg  
Max. Einspanndruck:  
1000 kg

Max. loading capacity: 300 kg  
Max. Traglast:  
300 kg

"Tripod principle" and robust processing: objects can be held securely and reliably  
„Dreibein-Prinzip“ und robuste Verarbeitung: Gegenstände können sicher und zuverlässig getragen werden

Clamping method: foot pedal  
Einspannmethode: Fußpedal

Foldable legs  
Beine einklappbar

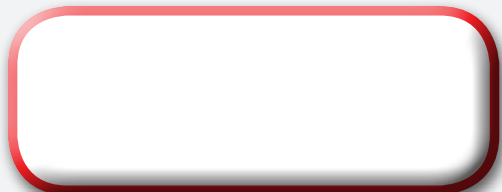
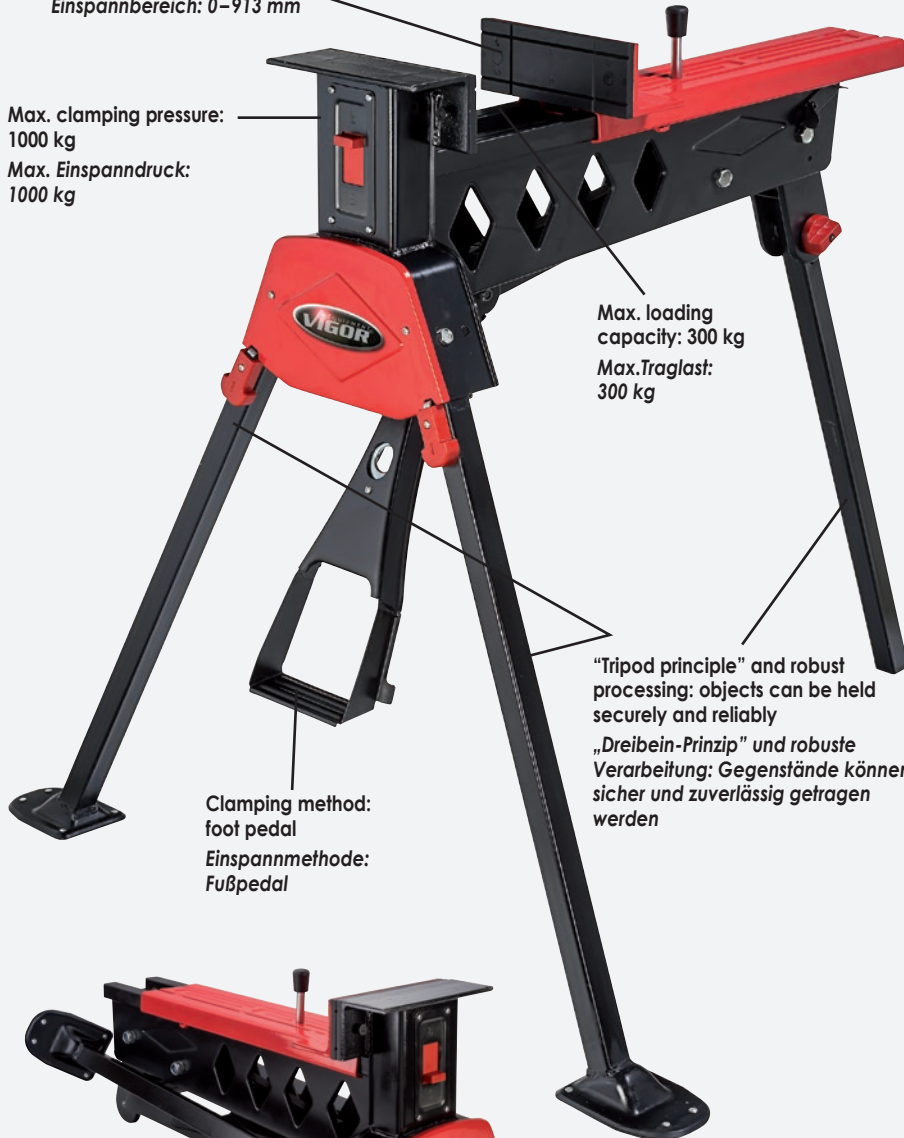

**Cutting and Sawing**  
*Schneiden / Sägen / Zerspanen*



Small hack saw

**V2790**, EAN 4047728027908

- Standard saw blades

*Kleine Handbügel-Säge*

**V2790**, EAN 4047728027908

- Handelsübliche Sägeblätter

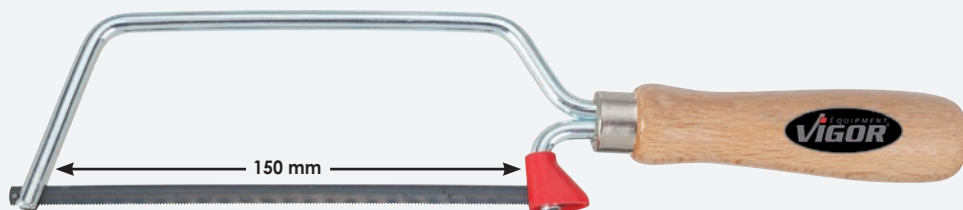

Saw frame

**V1715**, EAN 4047728017152

- Standard saw blades

*Sägebogen*

**V1715**, EAN 4047728017152

- Handelsübliche Sägeblätter

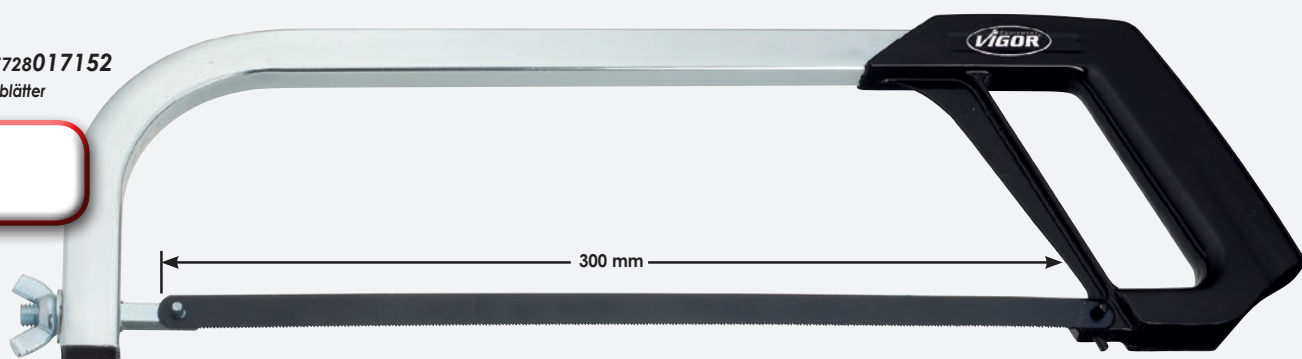

Japanese pull-stroke saw

**V1809**, EAN 4047728018098

*Japanische Zugsäge*

**V1809**, EAN 4047728018098

*„Made in Japan“  
 „Made in Japan“*



Universal knife  
**V1345**, EAN 4047728013451

Universal-Messer  
**V1345**, EAN 4047728013451



Quick change blade  
*Mit Schnellwechselfunktion*

Aluminium  
Aluminium



10x Incl.  
10x Incl.



Spare blades  
Ersatzklingen  
**V1446**, EAN 4047728014465

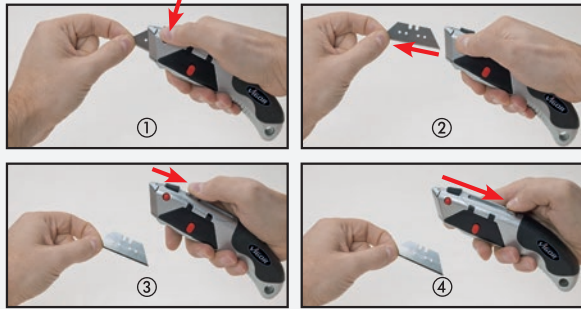

Cutter  
**V2627**, EAN 4047728026277

Cutter-Messer  
**V2627**, EAN 4047728026277

Snap-off blade:  
9 mm  
Abbrechklinge:  
9 mm



Housing made of stainless steel  
*Gehäuse aus Edelstahl*

With clip  
*Mit Clip*

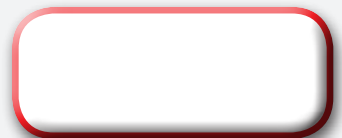

Universal shear  
**V1304**, EAN 4047728013048

Universal-Schere  
**V1304**, EAN 4047728013048

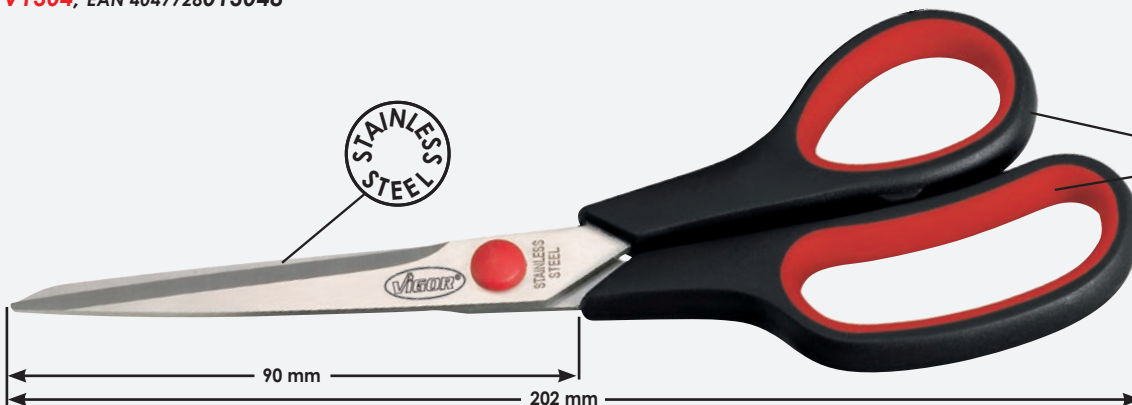



# Files

# Feilen

• Teeth (cut): 2 = medium  
 • DIN 7261

• Zahnung (Hieb): 2 = mittel  
 • DIN 7261

Flat hand file  
 Flachstumpf-Feile

**V1787**, EAN 4047728017879

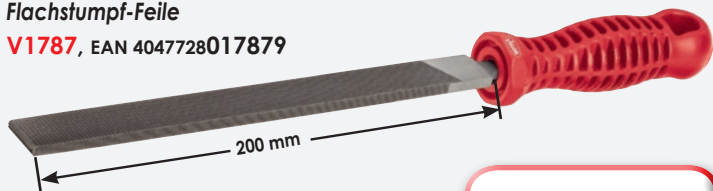

Three square file  
 Dreikant-Feile

**V1788**, EAN 4047728017886

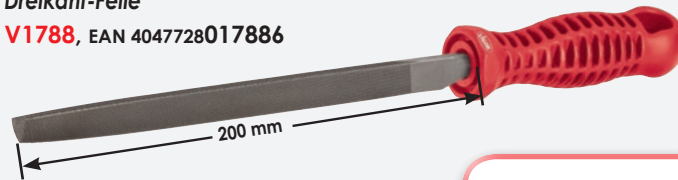

Square file  
 Vierkant-Feile

**V1789**, EAN 4047728017893

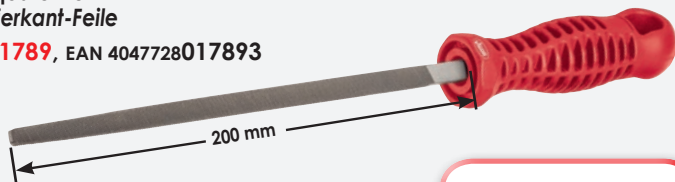

Half-round file  
 Halbrund-Feile

**V1790**, EAN 4047728017909

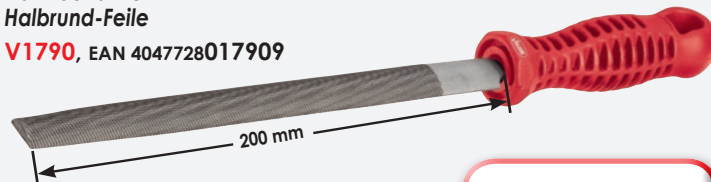

Round file  
 Rund-Feile

**V1801**, EAN 4047728018012

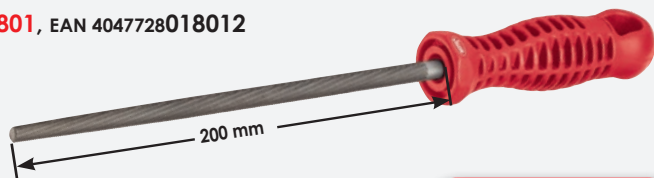

Steel wire brush

**V2651**, EAN 4047728026512



Stahl-Drahtbürste

**V2651**, EAN 4047728026512

Stainless steel wire brush

**V2654**, EAN 4047728026543



Edelstahl-Drahtbürste

**V2654**, EAN 4047728026543

Wire brush with scraper

**V2653**, EAN 4047728026536



Drahtbürste mit Schaber

**V2653**, EAN 4047728026536

Brass wire brush

**V2652**, EAN 4047728026529



Messing-Drahtbürste

**V2652**, EAN 4047728026529

### Thread repair set

**V3864**, EAN 4047728038645

- For threads M6 M8 M10
- For the repair of damaged or worn-out threads
- Due to a one-piece and extremely thin-walled design the threaded repair inserts are heat and torsion resistant
- Contents:
  - 3 x Twist drills made of HSSE high-alloy steel with 8% cobalt
  - 3 x HSS-G precision screw taps
  - 5 x Threaded repair inserts M6 x 1.00 x 12 mm
  - 5 x Threaded repair inserts M8 x 1.25 x 16 mm
  - 5 x Threaded repair inserts M10 x 1.50 x 20 mm
  - 3 x Assembly tools, sizes: M6 M8 M10



### Gewinde-Reparatur-Satz

**V3864**, EAN 4047728038645

- Für Gewinde M6 M8 M10
- Zur Gewinde-Reparatur beschädigter oder abgenutzter Gewinde
- Aufgrund extremer Dünnwandigkeit sowie einfelliger Bauform sind Reparaturhülsen temperaturbeständig und drehen nicht aus
- Inhalt:
  - 3 Stück hochlegierte HSSE Spiralbohrer mit 8% Kobalt
  - 3 Stück HSSG Präzisions-Gewindebohrer
  - 5 Stück Reparaturhülsen M6 X 1,00 X 12 mm
  - 5 Stück Reparaturhülsen M8 X 1,25 X 16 mm
  - 5 Stück Reparaturhülsen M10 X 1,50 X 20 mm
  - 3 Stück Eindreh-Werkzeuge, Größe: M6 M8 M10

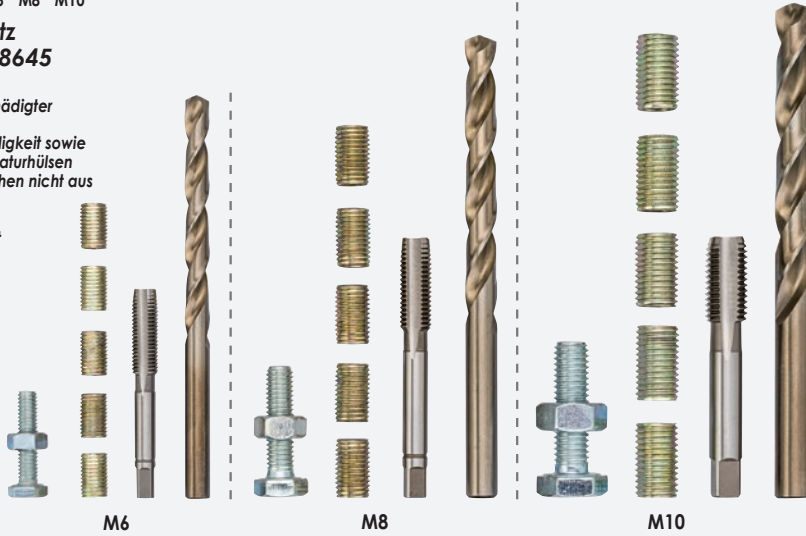

### Screw sleeve Reparatur-Gewindehülse

VIGOR No.	Size	Sizes (mm) Größe (mm)	EAN 4047728+
V4213	5	M6	042130
V4214	5	M8	042147
V4215	5	M10	042154

### Tap set

**V2253**, EAN 4047728022538

- DIN EN 22568
- HSS material, ground
- Contents:
  - 7 hand tap sets (consisting of taper tap, regroover and second tap) M 3 · M 4 · M 5 · M 6 · M 8 · M 10 · M 12
  - 7 round dies M 3 · M 4 · M 5 · M 6 · M 8 · M 10 · M 12
  - 1 tap wrench
  - 1 die stock
  - 1 thread gauge
  - 1 screwdriver

### Gewindebohrer-Satz

**V2253**, EAN 4047728022538

- DIN EN 22568
- HSS Material, geschliffen
- Inhalt:
  - 7 Handgewindebohrersätze (bestehend aus Vor-, Nach- und Fertigschneider) M 3 · M 4 · M 5 · M 6 · M 8 · M 10 · M 12
  - 7 runde Schneideisen M 3 · M 4 · M 5 · M 6 · M 8 · M 10 · M 12
  - 1 Windeisen
  - 1 Schneideisenhalter
  - 1 Gewindelehre
  - 1 Schraubendreher



### Twist drill set

**V1203**, EAN 4047728012034

- DIN 338 - for metal
- Twist drills 1-10 mm rising by 0.5 mm

### Spiralbohrer-Satz

**V1203**, EAN 4047728012034

- DIN 338 für Metall
- Spiralbohrer 1-10 mm, 0,5 mm steigend



### HSS step drill set

**V1707**, EAN 4047728017077

### HSS Stufenbohrer-Satz

**V1707**, EAN 4047728017077

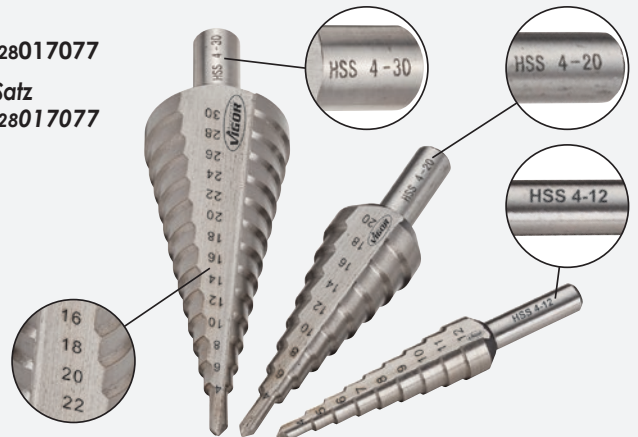

VIGOR No.	mm	Ø mm	EAN 4047728+
V2394	65	4-12	023948
V2395	75	4-20	023955
V2396	100	4-30	023962

# Cutting and Sawing Schneiden / Sägen / Zerspanen



## Tube cutter

**V2626**, EAN 4047728026260

- For tubes made of copper, brass, light metal and PVC rigid

## Rohrschneider

**V2626**, EAN 4047728026260

- Für Rohre aus Kupfer, Messing, Leichtmetall und PVC-Hartkunststoff



3–22 mm Ø



## Tube cutter

**V2625**, EAN 4047728026253

- For tubes made of copper, brass, light metal and PVC rigid

## Rohrschneider

**V2625**, EAN 4047728026253

- Für Rohre aus Kupfer, Messing, Leichtmetall und PVC-Hartkunststoff



3–35 mm Ø

With removable internal deburrer  
Mit herausnehmbarem Innen-Entgrater



## Ratcheting tube cutter

**V2624**, EAN 4047728026246

- For tubes made of stainless steel, copper, brass, light metal and PVC rigid

## Ratschen-Rohrschneider

**V2624**, EAN 4047728026246

- Für Rohre aus VA-Stahl, Kupfer, Messing, Leichtmetall und PVC-Hartkunststoff



8–29 mm Ø

Ratcheting  
Mit Ratschenfunktion

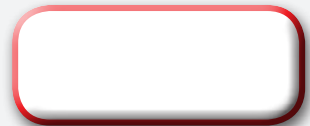

## Ratcheting exhaust pipe cutter

**V3309**, EAN 4047728033091

- Ratchet function allows you to work in areas with restricted access
- For cutting stainless steel, steel, copper and aluminium
- Working range: 32–67 mm
- Cutting depth: 3 mm

## Auspuff-

## Ratschenrohrschneider

**V3309**, EAN 4047728033091

- Ratschenfunktion erlaubt Arbeiten auch an schwer zugänglichen Stellen
- Schneidet Edelstahl, Stahl, Kupfer, Aluminium
- Arbeitsbereich: 32–67 mm
- Schnitttiefe: 3 mm



Ø 32–67 mm

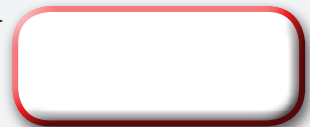

Spare blades  
Ersatzklingen

**V3451**, EAN 4047728034517



LED light  
**V1463**, EAN 4047728014632  
 Rechargeable NiMH battery ⊕ 3 h

LED-Lampe  
**V1463**, EAN 4047728014632  
 NiMH Akku ⊕ 3 h

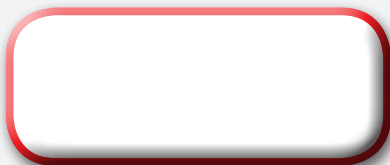

LED work light  
**V2740**, EAN 4047728027403  
 Li-Ion battery ⊕ 3 h

Strip LED-Lampe  
**V2740**, EAN 4047728027403  
 Li-Ion Akku ⊕ 3 h

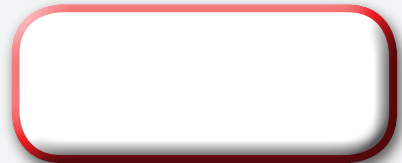

LED work light set, 2 pieces  
**V2751**, EAN 4047728027519  
 Li-Ion battery ⊕ 3 h  
 Strip LED-Lampe, 2er Set  
**V2751**, EAN 4047728027519  
 Li-Ion Akku ⊕ 3 h



LED light, 3 watt

**V2668**, EAN 4047728026680

- 3 x 1 watt high performance LED
- 3.7 V, 2200 mAh (rechargeable Li-Ion battery)
- 1200 Lux = 90 cm

LED-Lampe 3 Watt

**V2668**, EAN 4047728026680

- 3 x 1 Watt Hochleistungs-LED
- 3,7 V, 2200 mAh (Li-Ion Akku)
- 1200 Lux = 90 cm



With fold-away hook  
Mit ausklappbarem Haken

With rubberised housing  
Gummiertes Gehäuse



3 LED = 4 h  
3 LED = 4 h

With battery charger 3 h  
Mit Ladestation 3 h



LED folding light

**V2316**, EAN 4047728023160

- ☐ Rechargeable li-ion battery; 3.6 V
- ⊙ 3.5 - 4 h
- 5 LED = 300 Lux at a distance of 60 cm
- 18 LED = 800 Lux at a distance of 60 cm
- ⚖ approx. 200 g

LED-Knicklampe

**V2316**, EAN 4047728023160

- ☐ Li-Ion Akku 3.6 V ⊙ 3.5 - 4 h
- 5 LEDs = 300 Lux bei 60 cm
- 18 LEDs = 800 Lux bei 60 cm
- ⚖ ca. 200 g



Detachable  
Abnehmbar



220 mm



5 LED = 5 h  
5 LED = 5 h

18 LED = 1.5 h  
18 LED = 1.5 h

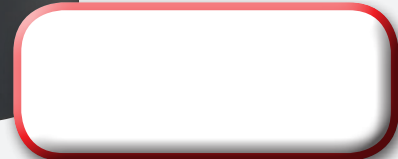

12V Charging Cable for  
LED Folding Light

**V2347**, EAN 4047728023474

- For cigarette lighter

12 V Ladegerät für  
LED-Knicklampe V2316

**V2347**, EAN 4047728023474

- Für Zigarettenzünder



**Mini LED flash light**  
**V1914**, EAN 4047728019149

- 6 bright LED
- Incl. 3 x AAA (Micro)
- Approx. 24 h



**Mini LED-Stableuchte**  
**V1914**, EAN 4047728019149

- 6 superhelle LED
- Inkl. 3 x AAA (Micro)
- ca. 24 h



With clip  
Inkl. Clip

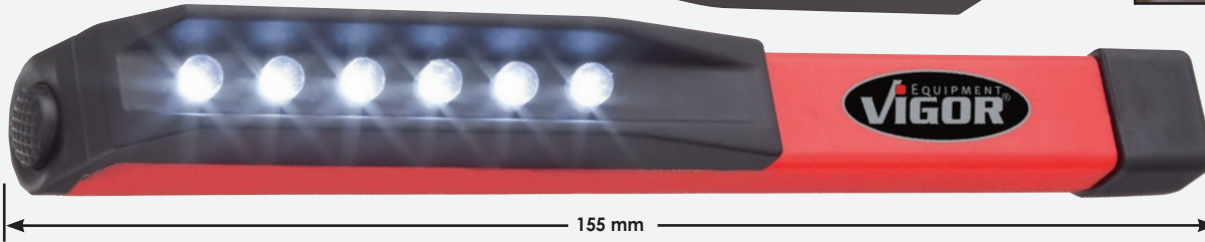
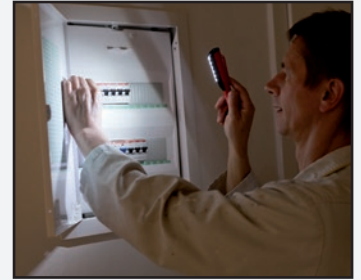

**Torch light, 1 watt**  
**V2669**, EAN 4047728026697

- 1 watt LED
- Luminous power: 90 lumen
- With 1 x AA battery

**Taschenlampe, 1 Watt**  
**V2669**, EAN 4047728026697

- 1 Watt LED
- Leistungsstärke: 90 Lumen
- Inkl. 1 x AA Batterie



Incl. clip  
inkl. Clip

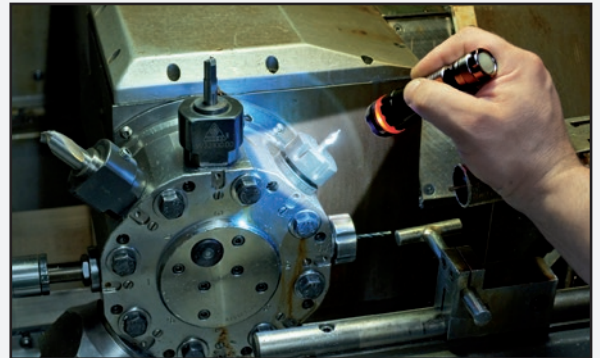

5 h

With focusing function  
Mit Fokussierungsfunktion

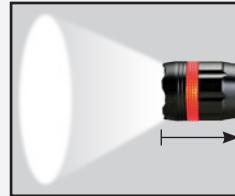
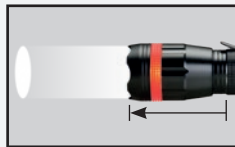

**Headlamp**  
**V1911**, EAN 4047728019118

- Luminous power: 100 lumen
- Incl. 3 x AAA (Micro)
- approx. 3 h
- 80 g

**Stirnlampe**  
**V1911**, EAN 4047728019118

- Leistungsstärke: 100 Lumen
- Inkl. 3 x AAA (Micro)
- ca. 3 h
- 80 g



- Standard light / normales Licht
- Bright light / helles Licht
- Flashing light / Blinklicht

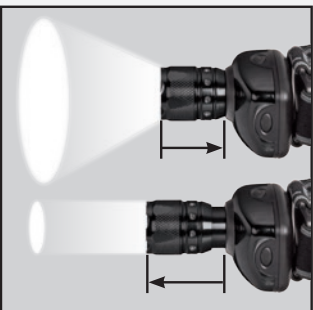

Can be adjusted into 5 positions  
Verstellbar in 5 Positionen





## Torque wrench V3441, EAN 4047728034418

- Torque release: palpable and audible
- DIN EN ISO 6789:2003 (D), square according to DIN 3120 A, ISO 1174-1A

## Drehmoment-Schlüssel V3441, EAN 4047728034418

- Drehmoment-Auslösung: Haptisch und akustisch
- DIN EN ISO 6789:2003 (D), Vierkant nach DIN 3120 A, ISO 1174-1A

Qualitätsprüf-Zertifikat Certificate of Examination																			
Prüfobjekt / Object	Series No. / Serial No.																		
Art/Nr. / Article No.	Einheitsbereich / Setting range																		
Profession / Profession																			
Produktion / Production																			
Meßmittel / Measuring Device																			
Hersteller / Manufacturer																			
<table border="1"> <thead> <tr> <th>Prüfdruck nach / Test value according to</th> <th>DIN EN ISO 6789:2003</th> </tr> </thead> <tbody> <tr> <td>40,0 Nm (Genauigkeit / Accuracy ±0,8 Nm / ±1,4 lbf.ft.)</td> <td>40,0 Nm</td> </tr> <tr> <td>50,0 Nm (Genauigkeit / Accuracy ±1,0 Nm / ±1,7 lbf.ft.)</td> <td>50,0 Nm</td> </tr> <tr> <td>60,0 Nm (Genauigkeit / Accuracy ±1,2 Nm / ±2,1 lbf.ft.)</td> <td>60,0 Nm</td> </tr> <tr> <td>80,0 Nm (Genauigkeit / Accuracy ±1,6 Nm / ±2,8 lbf.ft.)</td> <td>80,0 Nm</td> </tr> <tr> <td>100,0 Nm (Genauigkeit / Accuracy ±2,0 Nm / ±3,5 lbf.ft.)</td> <td>100,0 Nm</td> </tr> <tr> <td>120,0 Nm (Genauigkeit / Accuracy ±2,4 Nm / ±4,2 lbf.ft.)</td> <td>120,0 Nm</td> </tr> <tr> <td>150,0 Nm (Genauigkeit / Accuracy ±3,0 Nm / ±5,3 lbf.ft.)</td> <td>150,0 Nm</td> </tr> <tr> <td>200,0 Nm (Genauigkeit / Accuracy ±4,0 Nm / ±7,1 lbf.ft.)</td> <td>200,0 Nm</td> </tr> </tbody> </table>		Prüfdruck nach / Test value according to	DIN EN ISO 6789:2003	40,0 Nm (Genauigkeit / Accuracy ±0,8 Nm / ±1,4 lbf.ft.)	40,0 Nm	50,0 Nm (Genauigkeit / Accuracy ±1,0 Nm / ±1,7 lbf.ft.)	50,0 Nm	60,0 Nm (Genauigkeit / Accuracy ±1,2 Nm / ±2,1 lbf.ft.)	60,0 Nm	80,0 Nm (Genauigkeit / Accuracy ±1,6 Nm / ±2,8 lbf.ft.)	80,0 Nm	100,0 Nm (Genauigkeit / Accuracy ±2,0 Nm / ±3,5 lbf.ft.)	100,0 Nm	120,0 Nm (Genauigkeit / Accuracy ±2,4 Nm / ±4,2 lbf.ft.)	120,0 Nm	150,0 Nm (Genauigkeit / Accuracy ±3,0 Nm / ±5,3 lbf.ft.)	150,0 Nm	200,0 Nm (Genauigkeit / Accuracy ±4,0 Nm / ±7,1 lbf.ft.)	200,0 Nm
Prüfdruck nach / Test value according to	DIN EN ISO 6789:2003																		
40,0 Nm (Genauigkeit / Accuracy ±0,8 Nm / ±1,4 lbf.ft.)	40,0 Nm																		
50,0 Nm (Genauigkeit / Accuracy ±1,0 Nm / ±1,7 lbf.ft.)	50,0 Nm																		
60,0 Nm (Genauigkeit / Accuracy ±1,2 Nm / ±2,1 lbf.ft.)	60,0 Nm																		
80,0 Nm (Genauigkeit / Accuracy ±1,6 Nm / ±2,8 lbf.ft.)	80,0 Nm																		
100,0 Nm (Genauigkeit / Accuracy ±2,0 Nm / ±3,5 lbf.ft.)	100,0 Nm																		
120,0 Nm (Genauigkeit / Accuracy ±2,4 Nm / ±4,2 lbf.ft.)	120,0 Nm																		
150,0 Nm (Genauigkeit / Accuracy ±3,0 Nm / ±5,3 lbf.ft.)	150,0 Nm																		
200,0 Nm (Genauigkeit / Accuracy ±4,0 Nm / ±7,1 lbf.ft.)	200,0 Nm																		
Prüfung / Test Date	04.11.2013																		
Prüfer / Inspector	HABSA																		

### 40-200 Nm



**Torque technology  
Drehmoment-Technik  
Made in Germany**

## Torque wrench V3899, EAN 4047728038997

- Torque release: palpable and audible
- DIN EN ISO 6789:2003 (D), square according to DIN 3120 A, ISO 1174-1A

## Drehmoment-Schlüssel V3899, EAN 4047728038997

- Drehmoment-Auslösung: Haptisch und akustisch
- DIN EN ISO 6789:2003 (D), Vierkant nach DIN 3120 A, ISO 1174-1A

Qualitätsprüf-Zertifikat Certificate of Examination															
Prüfobjekt / Object	Series No. / Serial No.														
Art/Nr. / Article No.	Einheitsbereich / Setting range														
Profession / Profession															
Produktion / Production															
Meßmittel / Measuring Device															
Hersteller / Manufacturer															
<table border="1"> <thead> <tr> <th>Prüfdruck nach / Test value according to</th> <th>DIN EN ISO 6789:2003</th> </tr> </thead> <tbody> <tr> <td>60,0 Nm (Genauigkeit / Accuracy ±1,2 Nm / ±2,1 lbf.ft.)</td> <td>60,0 Nm</td> </tr> <tr> <td>80,0 Nm (Genauigkeit / Accuracy ±1,6 Nm / ±2,8 lbf.ft.)</td> <td>80,0 Nm</td> </tr> <tr> <td>100,0 Nm (Genauigkeit / Accuracy ±2,0 Nm / ±3,5 lbf.ft.)</td> <td>100,0 Nm</td> </tr> <tr> <td>120,0 Nm (Genauigkeit / Accuracy ±2,4 Nm / ±4,2 lbf.ft.)</td> <td>120,0 Nm</td> </tr> <tr> <td>150,0 Nm (Genauigkeit / Accuracy ±3,0 Nm / ±5,3 lbf.ft.)</td> <td>150,0 Nm</td> </tr> <tr> <td>200,0 Nm (Genauigkeit / Accuracy ±4,0 Nm / ±7,1 lbf.ft.)</td> <td>200,0 Nm</td> </tr> </tbody> </table>		Prüfdruck nach / Test value according to	DIN EN ISO 6789:2003	60,0 Nm (Genauigkeit / Accuracy ±1,2 Nm / ±2,1 lbf.ft.)	60,0 Nm	80,0 Nm (Genauigkeit / Accuracy ±1,6 Nm / ±2,8 lbf.ft.)	80,0 Nm	100,0 Nm (Genauigkeit / Accuracy ±2,0 Nm / ±3,5 lbf.ft.)	100,0 Nm	120,0 Nm (Genauigkeit / Accuracy ±2,4 Nm / ±4,2 lbf.ft.)	120,0 Nm	150,0 Nm (Genauigkeit / Accuracy ±3,0 Nm / ±5,3 lbf.ft.)	150,0 Nm	200,0 Nm (Genauigkeit / Accuracy ±4,0 Nm / ±7,1 lbf.ft.)	200,0 Nm
Prüfdruck nach / Test value according to	DIN EN ISO 6789:2003														
60,0 Nm (Genauigkeit / Accuracy ±1,2 Nm / ±2,1 lbf.ft.)	60,0 Nm														
80,0 Nm (Genauigkeit / Accuracy ±1,6 Nm / ±2,8 lbf.ft.)	80,0 Nm														
100,0 Nm (Genauigkeit / Accuracy ±2,0 Nm / ±3,5 lbf.ft.)	100,0 Nm														
120,0 Nm (Genauigkeit / Accuracy ±2,4 Nm / ±4,2 lbf.ft.)	120,0 Nm														
150,0 Nm (Genauigkeit / Accuracy ±3,0 Nm / ±5,3 lbf.ft.)	150,0 Nm														
200,0 Nm (Genauigkeit / Accuracy ±4,0 Nm / ±7,1 lbf.ft.)	200,0 Nm														
Prüfung / Test Date	04.11.2013														
Prüfer / Inspector	HABSA														

### 60-320 Nm



**Torque technology  
Drehmoment-Technik  
Made in Germany**



## Rotation angle tester

**V2795**, EAN 4047728027953

- Release accuracy tolerance  $\pm 2\%$
- Fine resolution (0.1°)
- Rotation angle range up to 999° (adding)
- Angle measurement in clockwise and anti-clockwise direction
- Memory capacity up to 99 readings
- Indication of battery charge
- LED alarm indication (flashing)
- Buzzer alarm indication
- Audible alarm signal
- Auto power off

## Drehwinkel-Messgerät

**V2795**, EAN 4047728027953

- $\pm 2\%$  Auslöse-Genauigkeit
- Feinauflösung (0,1°)
- Drehwinkelbereich bis 999° (addierend)
- Winkelmessungen gegen und im Uhrzeigersinn
- 99 Speicherplätze
- Anzeige für Batterieladezustand
- LED-Alarmanzeige (blinkend)
- Summeralarm-Anzeige
- Akustischer Warnton
- Automatische Selbstabschaltung

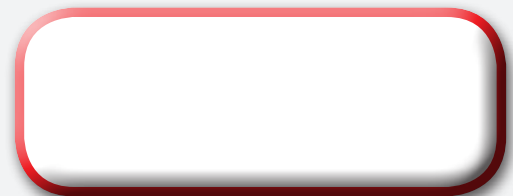

Impact wrench  
**V3653**, EAN 4047728036535

Schlagschrauber  
**V3653**, EAN 4047728036535



Powerful twin hammer mechanism  
Hochleistungs-Doppelhammer-Schlagwerk

**Max. loosening torque**  
**Max. Lösemoment:**  
**1890 Nm**



Multiple power settings in forward and reverse with one-hand reversing switch  
Mehrstufiger Rechts-/Linkslauf mit Einhand-Umschalfunktion



					Coupler plug nominal size Kupplungsstecker Nennweite	Air consumption l/min. Luftverbrauch l/min.		
	6.3 bar	12.92 m/s <sup>2</sup>	8.500	96 dBA	7.2	113	max. 1.890 Nm	1.95 kg



Exhaust air is guided downwards through the handle  
Abluffführung durch Handgriff nach unten

Coupler plug included  
Inklusive Kupplungsstecker

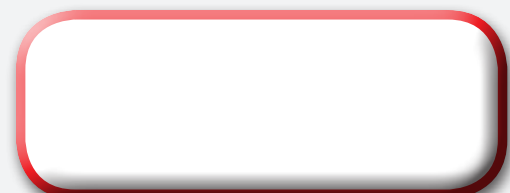

Air blow gun  
**V2655**, EAN 4047728026550

Ausblas-Pistole  
**V2655**, EAN 4047728026550

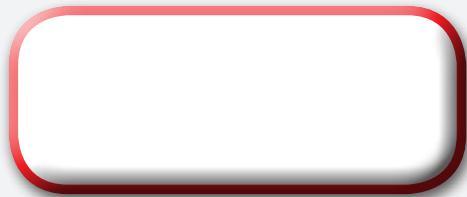

Air blow gun, telescopic  
**V2666**, EAN 4047728026666

Ausblas-Pistole, ausziehbar  
**V2666**, EAN 4047728026666

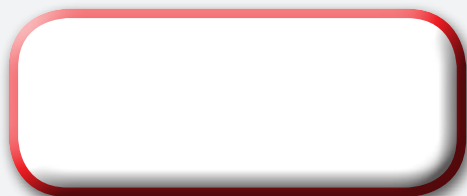
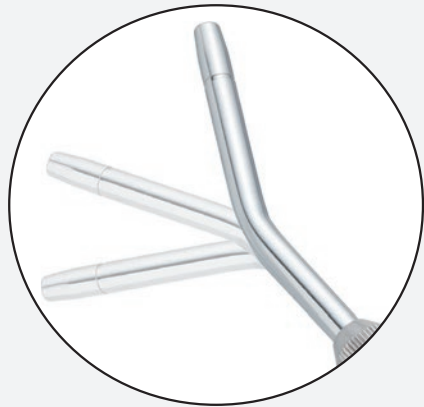
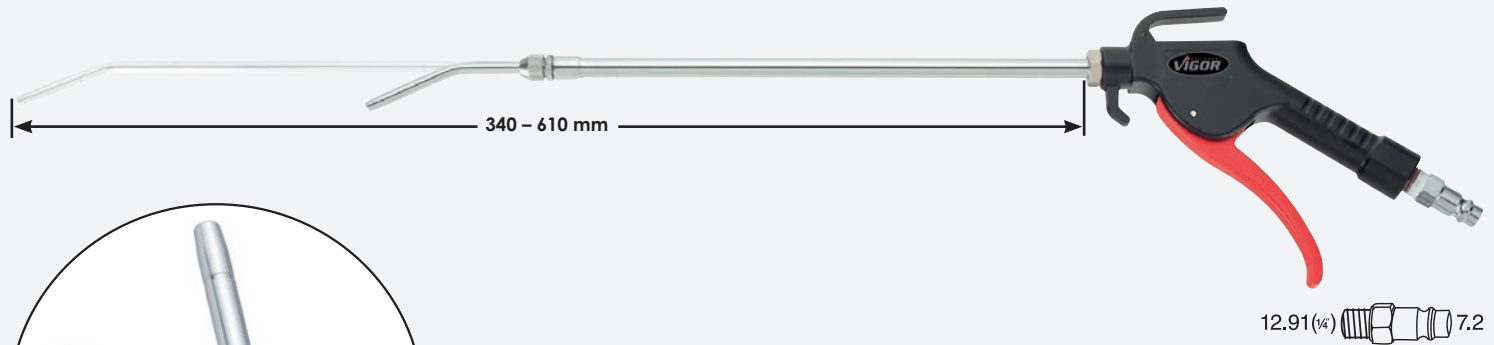

**Carrier**  
**V2682**, EAN 4047728026826

- For carrying unwieldy objects

**Tragehilfe**  
**V2682**, EAN 4047728026826

- Zum Tragen von unhandlichen Gegenständen



**Max. loading capacity: 120 kg**  
**Max. Traglast: 120 kg**

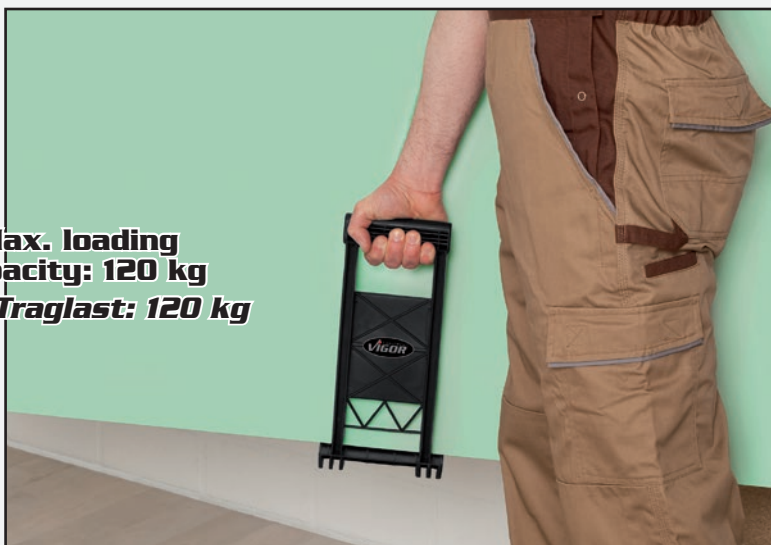

**Battery carrier**  
**V1435**, EAN 4047728014359

**Batterie-Tragegriff**  
**V1435**, EAN 4047728014359

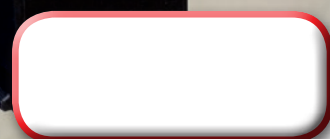
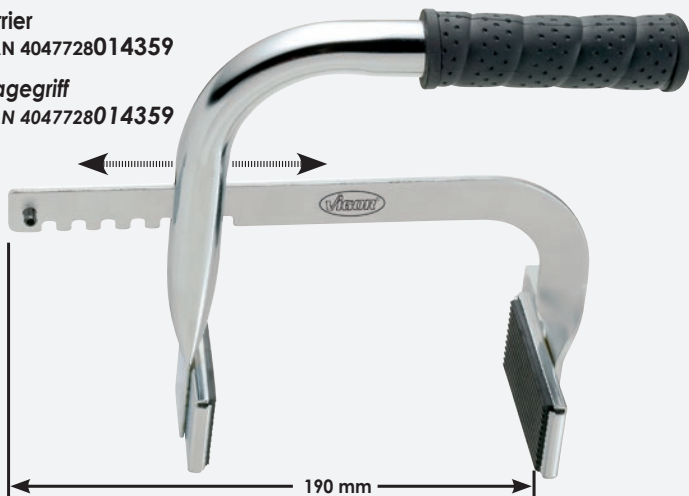

**Battery cell tester**  
**V1757**, EAN 4047728017572

- For testing the battery voltage of the generator and starter motor

**Batterietester**  
**V1757**, EAN 4047728017572

- Zur Prüfung der Batteriespannung der Lichtmaschine und des Anlasses

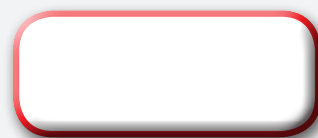
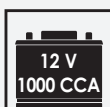
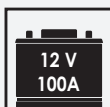
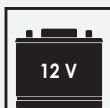

Battery and charging system tester with thermal printer

**V3748**, EAN 4047728037488

- Used for testing built-in batteries
- New: suitable for testing start-stop batteries
- With starter system and charging system test
- LCD display: voltage, battery capacity and battery capacity available in temperature measurements
- Operating range: 40 - 2000 A SAE 40 - 2000 A EN2 50 - 2500 A EN1 25 - 1300 A DIN 30 - 1500 A IEC

Batterietester und Ladesystem-Prüfgerät mit Thermodrucker

**V3748**, EAN 4047728037488

- Prüfung der Batterie im eingebauten Zustand
- Neu: Geeignet zum Testen von Start/Stop-Batterien
- Inkl. Anlasser- und Ladesystemtest
- LCD-Anzeige: Spannung, Batteriezustand sowie verfügbare Batteriekapazität unter Temperaturkompensation
- Arbeitsbereiche: 40 - 2000 A SAE 40 - 2000 A EN2 50 - 2500 A EN1 25 - 1300 A DIN 30 - 1500 A IEC



**New: suitable for testing start-stop batteries**  
**Neu: Geeignet zum Testen von Start/Stop-Batterien**



Spare Thermal Paper Rolls  
 Ersatz-Thermorollen-Paar  
**V1923**, EAN 4047728019231



Car light tester

**V1722**, EAN 4047728017220

⚡ 6-24 V

Autolichtprüfer

**V1722**, EAN 4047728017220

⚡ 6-24 V

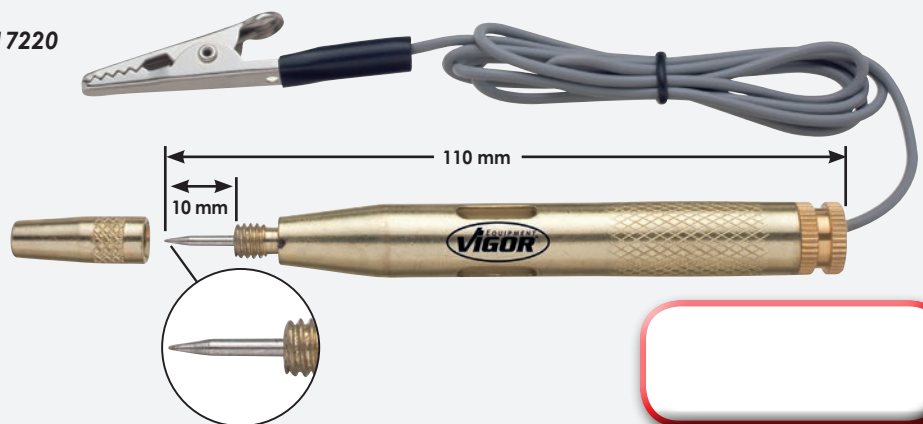

Hose clamp set

**V3381**, EAN 4047728033817

- For hoses with diameters up to 45 mm

Schlauchklemmen-Satz

**V3381**, EAN 4047728033817

- Für Schläuche mit Durchmesser bis 45 mm



Pipe locking tool set

**V2510**, EAN 4047728025102

- Pipe clamps and pipe stopping plugs for the locking of fuel lines, brake pipes, A/C pipes and power steering pipes

Rohrleitungsstopper-Satz

**V2510**, EAN 4047728025102

- Abklemmzangen und Stopfen zum Verschließen von Rohrleitungen für Kraftstoffsystem, Bremse, Klimaanlage und Servolenkung



**Camshaft holding tool**

**V3771**, EAN 4047728037716

- For safely fixing the camshaft sprocket
- Allows camshaft drive gears to be turned without disassembly
- Fibre-glass reinforced polyamide
- Very thin tool for optimal access in tight spaces

**Nockenwellen-Arretierwerkzeug**

**V3771**, EAN 4047728037716

- Zur sicheren Fixierung des Nockenwellenrades
- Ermöglicht das Drehen der Nockenwellen-Antriebsräder ohne Demontage
- Aus extrem starkem glasfaserverstärktem Polymer
- Sehr dünnes Werkzeug für optimalen Zugang bei engen Platzverhältnissen



**V-ribbed belt tool assortment**

**V3571**, EAN 4047728035712

- Made of glass reinforced nylon
- Most easy-to-use tool on the market
- No adjustment necessary
- Suitable for all kinds of flexible belts: air conditioning systems, generators as well as single and double groove belt pulleys



**Keilrippenriemen Werkzeug-Sortiment**

**V3571**, EAN 4047728035712

- Aus glasverstärktem Nylon
- Mit einfachster Handhabung auf dem Markt
- Keine Anpassung notwendig
- Passend für alle elastischen Riemenarten: Klimaanlage, Lichtmaschinen sowie einfache und doppelte Riemenscheiben

Assembly  
Montage



Disassembly  
Demontage



Assembly  
Montage



Disassembly  
Demontage



**New design  
Neue Ausführung**



## Cooling system diagnosis set V1963, EAN 4047728019637

- Complete set for service work on radiator and heating system
- Comprehensive range of adapters suitable for all common vehicles with water-cooled engines
- 3 features: pressure test (check for leaks in radiator system), refilling and cleaning
- Control of pressure loss via gauge
- Vacuum is generated in the radiator system. Advantage: coolant is sucked in without air bubbles
- Enables refilling of even large engines without thermal influences
- Universal usage due to conical rubber radiator adapter
- Measuring range: 0 up to 2.5 bar

- Contents:
  - 1 hand pump with gauge · hose · pressure release valve
  - 1 adapter, black, R123 · R124
  - 1 adapter, blue, R123 · R125
  - 1 cooling system bayonet adapter No. 3, large
  - 1 cooling system bayonet adapter No. 4, medium
  - 1 cooling system bayonet adapter No. 5, small
  - 13 cooling system screw adapters with inside threads M42 x 2.5 · M42 x 3.0 · M45 x 3.0 hollow M46 x 3.0 · M48 x 2.5 · M48 x 4.0 · M50 x 2.5 · M50 x 2.5 hollow · M50 x 3.0 · M52 x 3.0 · M60 x 4.0 mm
  - 3 cooling system screw adapters with outside threads M34 x 3.0 · M58 x 3.0 · M62 x 3.0 mm
  - 1 vacuum filling unit with gauge up to 76 cm HG = 1 bar
  - 1 rubber cone adapter, 45–14 mm, length: 75 mm
  - 1 thermometer, 0–220° C · 0–400° F

## Kühlersystem-Diagnose-Satz V1963, EAN 4047728019637

- Kompletter Satz für Servicearbeiten am Kühlsystem und an der Heizung
- Umfangreiche Adapterauswahl passend für alle gängigen Fahrzeuge mit wassergekühlten Motoren
- 3 Funktionen: Kühler abdrücken (Kontrolle auf Undichtigkeiten), befüllen und reinigen
- Druckverlustkontrolle über Manometer
- Befüllen erzeugt Vakuum im Kühlkreislauf. Vorteil: Blasenfreies Einsaugen der Flüssigkeit
- Problemlose Befüllung auch größerer Motoren ohne thermische Schwachpunkte
- Füllsystem universell adaptierbar durch konischen Gummianschluss-Stutzen
- Messbereich: 0 bis 2,5 bar

- Inhalt:
  - 1 Handpumpe mit Manometer · Schlauch · Druckablass-Ventil
  - 1 Deckel-Prüfadapter, schwarz, R123 · R124
  - 1 Deckel-Prüfadapter, blau, R123 · R125
  - 1 Kühlsystem-Bajonettadapter Nr. 3, groß
  - 1 Kühlsystem-Bajonettadapter Nr. 4, mittel
  - 1 Kühlsystem-Bajonettadapter Nr. 5, klein
  - 13 Kühlsystem-Schraubadapter mit Innengewinde M42 x 2,5 · M42 x 3,0 · M45 x 3,0 hohl · M46 x 3,0 · M48 x 2,5 · M48 x 4,0 · M50 x 2,5 · M50 x 2,5 hohl · M50 x 3,0 · M52 x 3,0 · M60 x 4,0 mm
  - 3 Kühlsystem-Schraubadapter mit Außengewinde M34 x 3,0 · M58 x 3,0 · M62 x 3,0 mm
  - 1 Vakuum-Füllereinheit mit Manometer bis 76 cm HG = 1 bar
  - 1 Gummikonus-Adapter, 45–14 mm, Länge: 75 mm
  - 1 Thermometer, 0–220° C · 0–400° F

**+ 2 adapters  
2 Adapter**

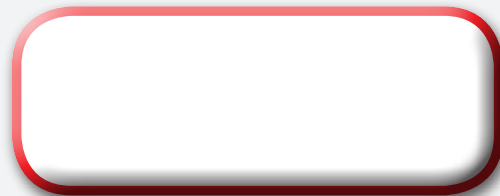

## Vacuum filling unit V4202, EAN 4047728042024

Vakuum-Befüllereinheit  
V4202, EAN 4047728042024



## Hand pump with manometer V3729, EAN 4047728037297

Handpumpe mit Manometer  
V3729, EAN 4047728037297





**Radiator tester set for commercial vehicles**

**V3596**, EAN 4047728035965

- Assortment with pump and 7 radiator adapters
- Suitable for common heavy goods vehicles from DAF, IVECO, MERCEDES-BENZ, MAN, SCANIA, RENAULT and Volvo
- Measuring range: 0–2.5 bar
- Control of pressure loss via gauge
- Test options for locking caps
- Pressure test of the radiator
- Contents:
  - 1 pump
  - 1 hose
  - 7 adapters



**Kühlsystem-Diagnosekoffer Nfz**

**V3596**, EAN 4047728035965

- Sortiment mit Pumpe und 7 Kühleradaptoren
- Geeignet für gängige Lkw von DAF, IVECO, MERCEDES-BENZ, MAN, SCANIA, RENAULT und Volvo
- Messbereich: 0–2,5 bar
- Druckverlustkontrolle über Manometer
- Prüfmöglichkeit von Verschlusskappen
- Druckprüfung des Kühlsystems
- Inhalt:
  - 1 Pumpe
  - 1 Schlauch
  - 7 Adapter



M42 x 3.0



M45 x 3.0



M52 x 3.0



M45 x 4.0



M62 x 4.0



M72 x 4.0

**Anti-freeze tester**

**V1586**, EAN 4047728015868

- For testing ethylene glycol coolant (anti-freeze) density in passenger cars, trucks, etc.

**Frostschutz-Prüfer**

**V1586**, EAN 4047728015868

- Für Ethylenglykol-Wassermischungen an Kühlkreisläufen in Pkw, Lkw usw.



**Refractometer**

**V2459**, EAN 4047728024594

- Quickly and accurately measures the anti-freeze concentration
- Application e.g. for coolant, screenwash, battery fluid and AdBlue
- Eyepiece with adjustable focus, equipped with rubber cup
- Left scale: control of the battery acid density measuring range 1100 up to 1300 sg / resolution 0.01 sg
- Middle scale: antifreeze based on propylene glycol G 13, measuring range -25 °C to -50 °C / resolution 5 °C, and antifreeze based on ethylene glycol G 11/G 12, measuring range -25 °C to -50 °C / resolution 5 °C
- Upper right scale: AdBlue (VRA) urea concentration, measuring range 30 % to 35 % / resolution 0.1 %
- Lower right scale: screenwash antifreeze SRF 1, measuring range -10 °C to -40 °C / resolution 1 °C
- In plastic case with soft foam insert
- Contents:
  - 1 x refractometer / 1 x calibration screwdriver / 1 x pipette

**Refraktometer**

**V2459**, EAN 4047728024594

- Zur schnellen und präzisen Überprüfung des Frostschutzgehaltes
- Anwendbar u.a. für Kühl- und Scheibenwasser, Batteriesäure und AdBlue
- Einstellbares Okular mit Gummi-Augenaufgabe
- Linke Skala: Kontrolle der Batteriesäuredichte Messbereich 1100 bis 1300 sg / Auflösung 0,01 sg
- Mittlere Skala: Frostschutz auf Basis Propylenglykol G 13 Messbereich -25° C bis -50° C / Auflösung 5° C sowie Frostschutz auf Basis Ethylenglykol G 11/ G 12 Messbereich -25° C bis -50° C / Auflösung 5° C
- Rechte Skala oben: AdBlue (VRA) Harnstoffgehalt Messbereich 30 % bis 35 % / Auflösung 0,1 %
- Rechte Skala unten: Frostschutz-Scheibenwaschflüssigkeit SRF 1 Messbereich -10° C bis -40° C / Auflösung 1° C
- In Kunststoffbox mit Weichschaum-Einlage
- Inhalt:
  - 1 x Refraktometer / 1 x Kalibrier-Schraubendreher / 1 x Pipette



**Injector sealing seat cleaning set  
V2704, EAN 4047728027045**

- Universal injector seat sealing and milling set
- For HDi engines, diesel direct injection and common rail engines with Bosch and Delphi injectors
- Shaft cleaning with wire brushes, machine operation



**Injektorschacht-Reinigungs-Satz  
V2704, EAN 4047728027045**

- Universal Injektor-Dichtsitz-Reinigung- und Fräsen-Satz
- Zur Verwendung an HDI-, Diesel-Direkteinspritzung und Common-Rail-Motoren mit Bosch- und Delphi-Injektoren
- Schaffreinigung durch Bürsten mit Maschinenantrieb



No. Nr.	VIGOR No.	X	Designation	Bezeichnung	← L → mm	EAN 4047728+
①	V3604	1	Basic unit	Grundgerät	267	036047
②	V3572	1	Sealing ring for distance plates	Unterlegscheiben-Dichtungsring	230	035729
③	V3573	1	Adapter	Adapter	294	035736
④	V3574	1	Brush	Bürste	300	035743
⑤	V3575	1	Brush	Bürste	85	035750
⑥	V3576	1	Threaded rod	Gewindestange	200	035767
⑦	V3577	1	Drive	Antriebsstück	107	035774

No. Nr.	VIGOR No.	X	Designation	Bezeichnung	← L → mm	EAN 4047728+
⑧	V3578	6	Threaded coil M5x0.8 mm	Gewindespule M5 x 0,8 mm	15.2	035781
⑨	V3579	1	Adapter Ø 20.6 mm	Adapter Ø 20,6 mm	32	035798
⑩	V3580	1	Adapter Ø 22 mm	Adapter Ø 22 mm	32	035804
⑪	V3591	1	Adapter Ø 24.5 mm	Adapter Ø 24,5 mm	32	035910
⑫	V3592	1	Cutter Ø 15/17 mm	Fräser Ø 15/17 mm	39	035927
⑬	V3593	1	Cutter Ø 19/17 mm	Fräser Ø 19/17 mm	39	035934
⑭	V3594	1	Cutter Ø 17 mm	Fräser Ø 17 mm	39	035941

**Generator socket set**

**V2835**, EAN 4047728028356

- For working on the generator when fitted or removed
- E.g.: VW, AUDI, SEAT, SKODA, PORSCHE, MERCEDES-BENZ, FORD, RENAULT, Volvo, etc.
- For installing and removing the belt pulley on generators
- TORX® and XZN screwdriver sockets for different inside profiles
- The generator is locked using the respective socket and the belt pulley is bolted using the adapter with internal serration



**Lichtmaschinen  
Steckschlüssel-Satz**

**V2835**, EAN 4047728028356

- Für Arbeiten an Lichtmaschine im ein- und ausgebauten Zustand
- Z.B.: VW, AUDI, SEAT, SKODA, PORSCHE, MERCEDES-BENZ, FORD, RENAULT, Volvo usw.
- Zur Demontage und Montage der Freilauf-Riemenscheibe an Lichtmaschinen
- TORX®- und XZN-Einsätze für unterschiedliche Innenprofile
- Zur Arretierung der Lichtmaschine über jeweiligen Einsatz und Verschraubung der Riemenscheibe über Vielzahnadapter

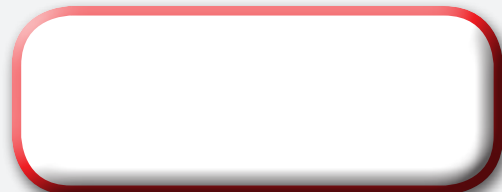
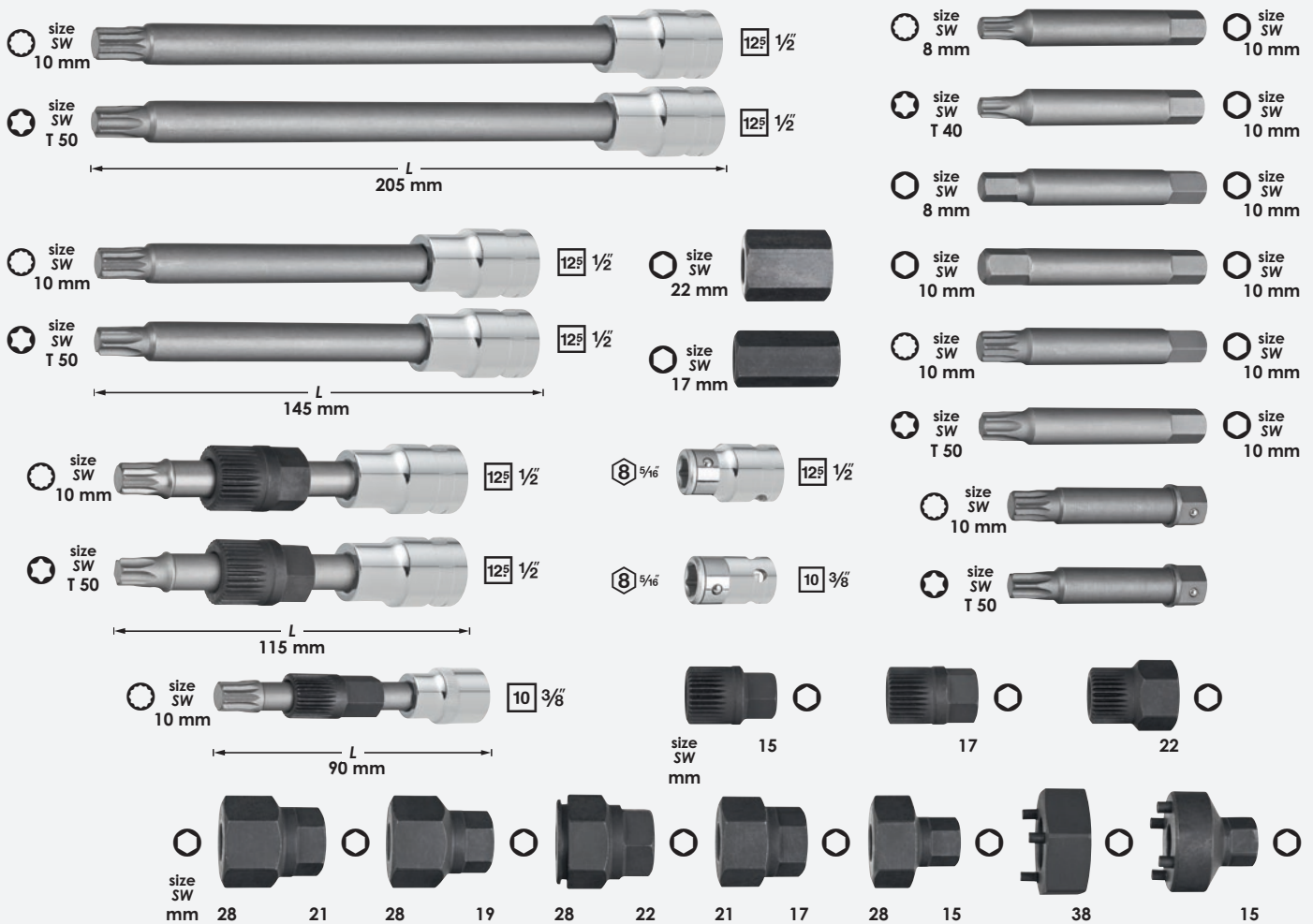

**Turbo system pressure tester kit**  
**V3595**, EAN 4047728035958

- For fast diagnostics of the charging air system
- Enables time saving and appropriate determination of leaky intercoolers and invisible cracks in charging air hoses

• Contents:  
1 manometer  
Four pairs of stepped adapters  
85-90, 75-80, 65-70, 55-60 mm

**Turbosystem-Abdrücker-Satz**  
**V3595**, EAN 4047728035958

- Zur schnellen Diagnose des Ladeluftsystems
- Ermöglicht zeitsparende und fachgerechte Ermittlung von undichten Ladeluftkühlern und nicht sichtbaren Rissen in Ladeluftschläuchen

• Inhalt:  
1 Manometer  
Vier Paar abgestufte Adapter  
85-90, 75-80, 65-70, 55-60 mm



Incl. manometer  
Inkl. Manometer



85 - 90 mm



75 - 80 mm



65 - 70 mm



55 - 60 mm



**Manometer for turbo system pressure tester kit**

**V4233**, EAN 4047728042338

- Suitable for V3595 and V4192

**Manometer für Turbosystem-Abdrücker-Satz**

**V4233**, EAN 4047728042338

- Geeignet für V3595 und V4192



**Turbo system pressure tester set for click systems**

**V4192**, EAN 4047728041928

- For the quick diagnosis of charging air systems in new generations of vehicles in which air pipes are connected with click systems
- Enables time saving and appropriate determination of leaking charging air hoses
- For performing leak tests using noise generation, leak detector spray or pressure drop
- Contents:
- 6 plug pairs 31 / 38 / 46 / 51 / 56 / 61 mm



**Turbosystem-Abdrücker-Satz für Klicksysteme**

**V4192**, EAN 4047728041928

- Zur schnellen Diagnose der Ladeluft-Systeme in neuen Fahrzeuggenerationen, bei denen Luftröhre mit Klicksystem verbunden werden
- Ermöglicht zeitsparende und fachgerechte Ermittlung von undichten Ladeluftschläuchen
- Zur Durchführung der Dichtheitsprüfung anhand von Geräuschentwicklung, Lecksuchspray oder Druckabfall
- Inhalt:
- 6 Stopfen-Paare 31 / 38 / 46 / 51 / 56 / 61 mm



Without manometer  
Ohne Manometer

**Available in February**  
**Erhältlich ab Februar**



31 mm



38 mm



46 mm



51 mm



56 mm



61 mm



**Manometer for turbo system pressure tester kit**

**V4233**, EAN 4047728042338

- Suitable for V3595 and V4192

**Manometer für Turbosystem-Abdrücker-Satz**

**V4233**, EAN 4047728042338

- Geeignet für V3595 und V4192



**Oil dipstick set MERCEDES-BENZ**  
**V2112, EAN 4047728021128**



- For measuring the level of engine and automatic gearbox oil
- Essential after each oil change (vehicle provided by the manufacturer without dipstick, only with sealing plug)

**Ölmesststäbe-Satz MERCEDES-BENZ**

**V2112, EAN 4047728021128**

- Zum Messen des Motor- und Automatikgetriebe-Ölstandes
- Unverzichtbar nach Ölwechsel (Fahrzeugauslieferung werksseitig ohne Messstäbe, sondern nur mit Verschlussstopfen)

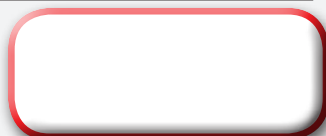
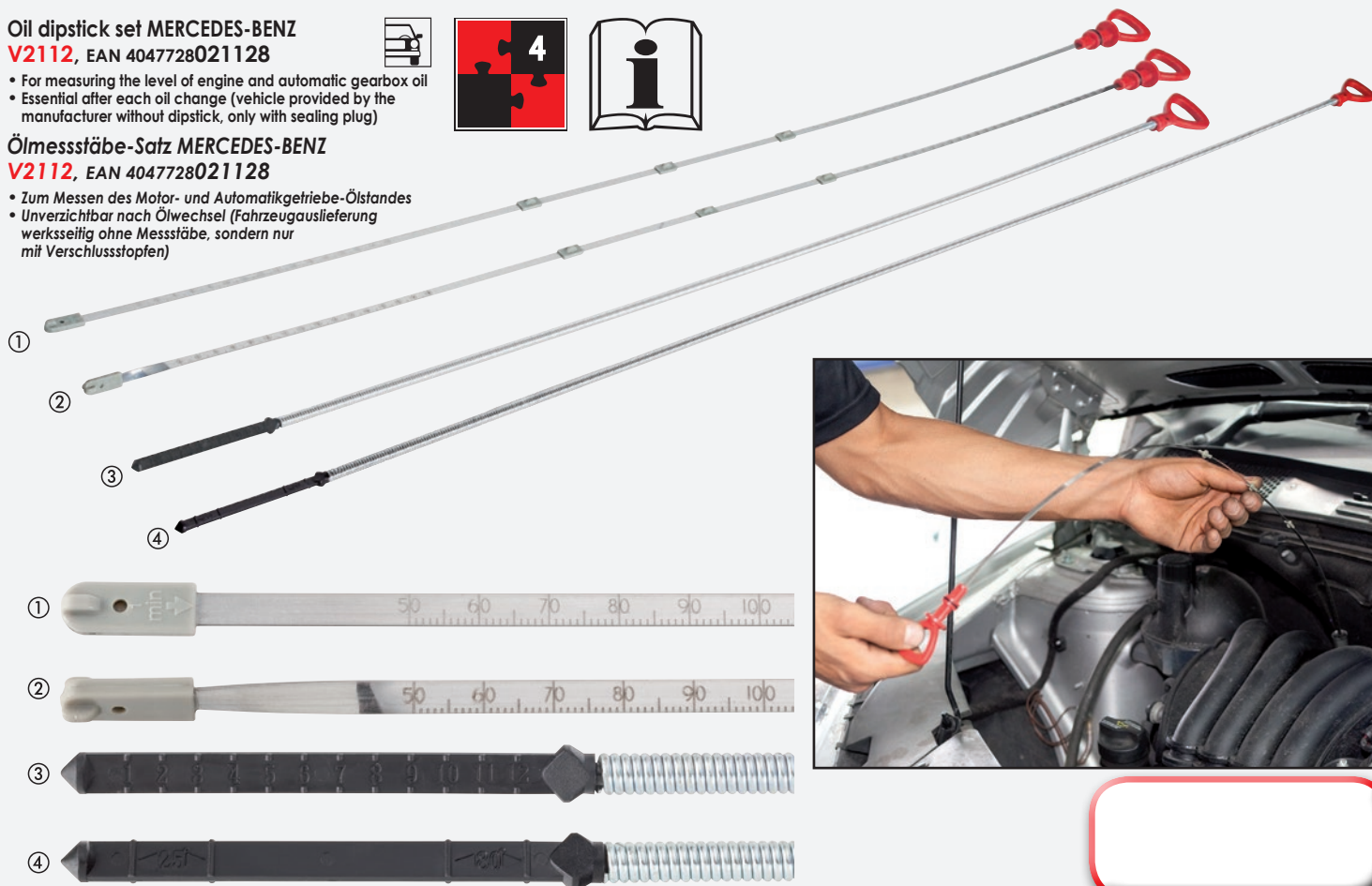

**Oil dipstick AUDI**

**V2645, EAN 4047728026451**



- For models with oil level indicator on the display (no dipstick in the engine)
- For checking the level after oil change and subsequent comparison with the display
- Helpful after replacing the oil sensor or calibrating the indicator in the driver's display (comparable to T40178)
- Application: for AUDI A4 / A5 / A6 with engines 1.8, 2.0 TFSI / 3.0, 3.2 FSI / 2.0, 2.7, 3.0 TDI, among others

**Ölmesststab AUDI**

**V2645, EAN 4047728026451**

- Für Modelle mit Ölstandsanzeige im Display (kein Peilstab am Motor)
- Zum Kontrollieren des Füllstands nach Ölwechsel und anschließendem Vergleich mit Displayanzeige
- Hilfreich nach Tausch des Ölsensors oder Kalibrierung der Anzeige im Fahrerdisplay (vergleichbar T40178)
- Anwendung: u.a für AUDI A4 / A5 / A6 mit Motoren 1.8, 2.0 TFSI / 3.0, 3.2 FSI / 2.0, 2.7, 3.0 TDI

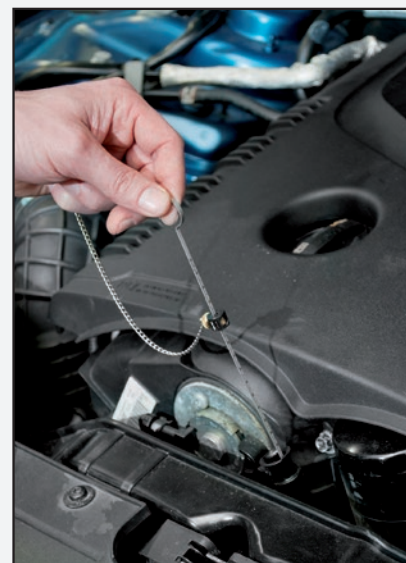
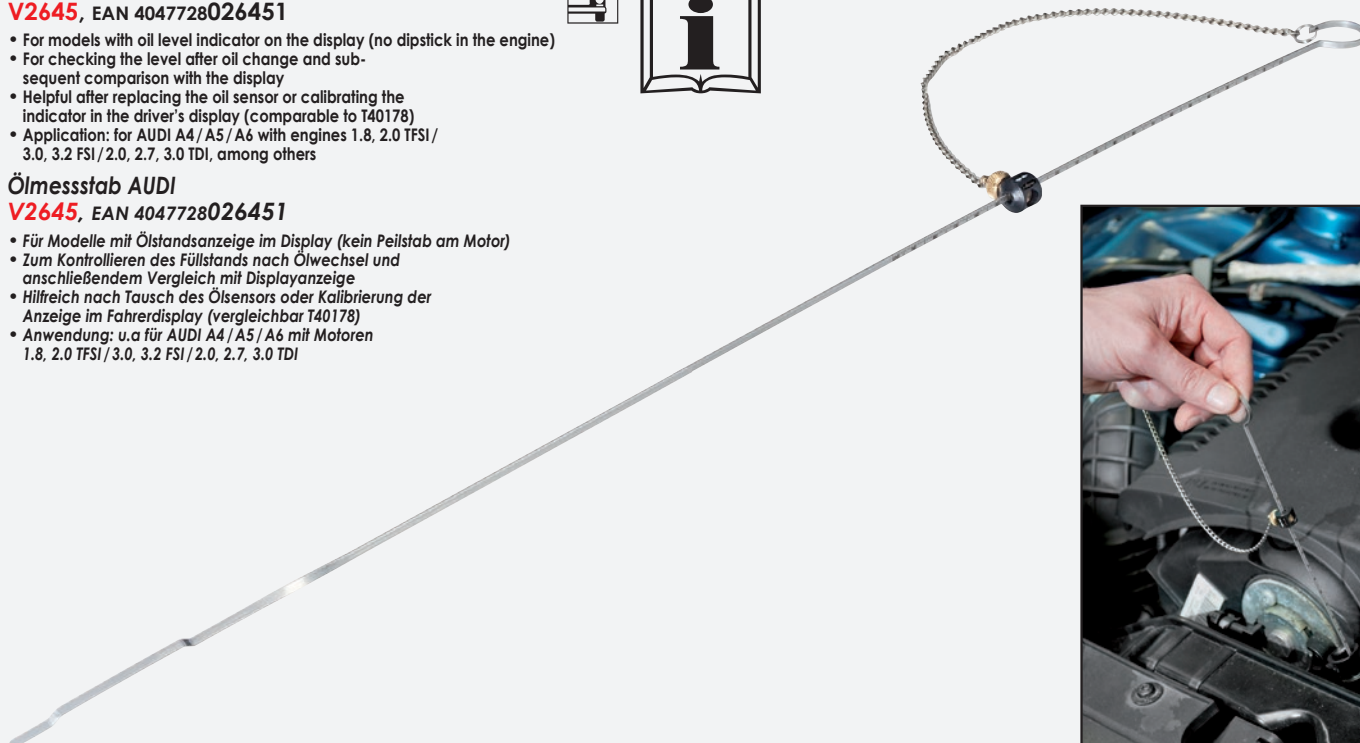

**Oil filter wrench set**

**V1282**, EAN 4047728012829

- 14 Oil filter wrenches
- 1 adapter  $\frac{1}{2}$  outside square /  $\frac{1}{2}$  inside square, with outside hexagon size 21 mm



**Ölfilterschlüssel-Satz**

**V1282**, EAN 4047728012829

- 14 Ölfilterschlüssel
- 1 Adapter  $\frac{1}{2}$  Außenvierkant /  $\frac{1}{2}$  Innenvierkant, mit Außensechskant SW 21 mm

Ø mm	Step Stufe	Grooves Rillen	Surface Fläche	Vehicles Fahrzeuge
65	1	-	14	DAIHATSU, TOYOTA, NISSAN, FIAT
65-67	1	-	14	DAIHATSU, TOYOTA
68	1	-	14	MAZDA, FORD, SUBARU
73	1	-	14	TOYOTA, LEXUS
74-76	2	-	15	FORD, OPEL, VW, AUDI, MERCEDES-BENZ
75-77	2	-	15	VW, AUDI, ISUZU, MERCEDES-BENZ
76	-	-	14	VW, PORSCHE, MERCEDES-BENZ, BMW, AUDI, OPEL
76	1	30	-	FORD
80	1	-	15	NISSAN, HONDA, OPEL, MAZDA
80-82	2	-	15	SUBARU, TOYOTA, HONDA, NISSAN
90	1	-	15	HONDA, MITSUBISHI, ISUZU
93	1	-	15	MAZDA, Volvo, MITSUBISHI, NISSAN, HONDA
93	1	36	-	FORD
100	1	-	15	ISUZU, MITSUBISHI



**Oil filter strap wrench for passenger cars**

**V2511**, EAN 4047728025119



**Ölfilerbandschlüssel für den Pkw-Bereich**

**V2511**, EAN 4047728025119



Spare strap  
Ersatz-Spannband

**V2521**, EAN 4047728025218



**Oil filter claw wrench for passenger cars**

**V1281**, EAN 4047728012812



- Drive optionally:
- $\frac{1}{2}$  Inside square
- $\frac{1}{2}$  inside square or size 21 mm outside hexagon
- 1 adapter  $\frac{1}{2}$  outside square,  $\frac{1}{2}$  inside square, with outside hexagon size 21 mm

**Ölfilerkralle für Pkw**

**V1281**, EAN 4047728012812

- Antrieb wahlweise:
- $\frac{1}{2}$  Innenvierkant,
- $\frac{1}{2}$  Innenvierkant oder SW 21 mm Außensechskant
- 1 Adapter  $\frac{1}{2}$  Außenvierkant,  $\frac{1}{2}$  Innenvierkant, mit Außensechskant SW 21 mm

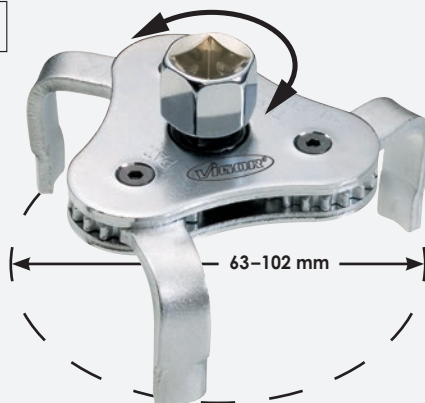

Multifunctional drain pan with castors, 30 litres, extra flat

**V2681**, EAN 4047728026819

- Suitable for oil, cooling fluid etc.

30 l Mehrzweckwanne mit Rollen, extraflach

**V2681**, EAN 4047728026819

- Geeignet für Öl, Kühlfüssigkeit etc.

Incl. anti-splash grille  
Inkl. Sieb



Extra flat  
Extra flach

Incl. 4 castors  
Inkl. 4 Rollen



Axle oil drain pan for trucks

**V3306**, EAN 4047728033060

- For clean removal of the drive shaft
- Suitable for different wheel rim diameters
- Special-plastic material
- Dimensions: H 160 x W 310 x D 240 mm

Lkw-Achsölwanne

**V3306**, EAN 4047728033060

- Zur sauberen Demontage der Antriebswelle
- Passend für unterschiedliche Felgendurchmesser
- Spezial-Kunststoff
- Maße: H 160 x B 310 x T 240 mm





**Vacuum pump**

**V4201**, EAN 4047728042017

- Manual vacuum pump for extracting and filling vehicle fluids.
- Capacity: 1.5 l
- Suitable for the following fluids:
  - Diesel
  - Petrol
  - Brake fluid
  - Antifreeze
  - Engine oil
  - Gear oil
  - Power steering oil



**Vakuumpumpe**

**V4201**, EAN 4047728042017

- Manuelle Vakuumpumpe zum Absaugen und Einfüllen von Fahrzeugflüssigkeiten
- Kapazität: 1,5 l
- Geeignet für folgende Flüssigkeiten:
  - Dieselmotoren
  - Benzin
  - Bremsflüssigkeit
  - Frostschutz
  - Motoröl
  - Getriebeöl
  - Servolenkungöl



Suitable for all fuel types  
Geeignet für alle Kraftstoffe

Hose length: 450 m  
Schlauchlänge: 450 mm



Incl.  
**5 adapters**  
Inkl.  
**5 Adapter**



**Oil drain hose**

**V2702**, EAN 4047728027021

- When the adapter is screwed into the oil filter housing it opens a valve to allow controlled draining of oil from the oil filter housing
- No further customer complaints due to oily engines
- For VAG 1.8 l and 2.0 l petrol engines with engine codes AXW / BLX / BLR / BLY / BVX / BVY BVZ on:
  - AUDI A3 (8P1 / 8PA), A4 (8EC / 8ED / 8H7 / 8HE), A6 (4F2 / 4F5), TT (8J3 / 8J9),
  - SEAT Altea (5P1 / 5P5), Leon (1P1), Toledo 3 (5P2),
  - SKODA Octavia (1Z3 / 1Z5)
  - VW Jetta 3 (1K2), New Beetle (9C1 / 1C1 / 1Y7), Golf 5 and Eos (1K1 / 5M1), Passat (3C2 / 3C5), Touran (1T1 / 1T2)

**Ölablass-Schlauch**

**V2702**, EAN 4047728027021

- Adapter öffnet beim Einschrauben in das Ölfiltergehäuse ein Ventil und gewährleistet dadurch kontrolliertes Abfließen des Öls aus Ölfiltergehäuse
- Nie mehr Kundenreklamationen auf Grund verölter Motoren
- Für VAG 1,8 l und 2,0 l Benzinmotoren mit Motorkennbuchstaben AXW / BLX / BLR / BLY / BVX / BVY BVZ bei:
  - AUDI A3 (8P1 / 8PA), A4 (8EC / 8ED / 8H7 / 8HE), A6 (4F2 / 4F5), TT (8J3 / 8J9),
  - SEAT Altea (5P1 / 5P5), Leon (1P1), Toledo 3 (5P2),
  - SKODA Octavia (1Z3 / 1Z5)
  - VW Jetta 3 (1K2), New Beetle (9C1 / 1C1 / 1Y7), Golf 5 und Eos (1K1 / 5M1), Passat (3C2 / 3C5), Touran (1T1 / 1T2)



Length: 1000 mm  
Länge: 1000 mm

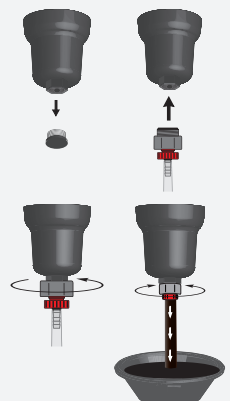

Oil filling device with adapter set  
**V2670**, EAN 4047728026703

- For filling gearboxes and differentials with oil
- Incl. oil pan and 14 adapters for vehicles with extremely restricted installation spaces

Öl-Einfüllgerät mit Adapter-Satz  
**V2670**, EAN 4047728026703

- Zum Befüllen von Getrieben und Differentialen mit Öl
- Inkl. Ölwanne und 14 Adapter für Fahrzeuge mit extrem beengten Bauräumen



No. Nr.	VIGOR No.	Designation	Bezeichnung	EAN 4047728+
①	V3681	Adapter FORD with threaded connection	Adapter FORD mit Gewindeanschluss	036818
②	V3682	Adapter BMW bent	Adapter BMW abgelenkt	036825
③	V3683	Adapter VAG short bent	Adapter VAG kurz abgelenkt	036832
④	V3684	Adapter VAG long bent	Adapter VAG lang abgelenkt	036849
⑤	V3685	Adapter VAG straight with threaded connection	Adapter VAG gerade mit Gewindeanschluss	036856
⑥	V3686	Adapter MERCEDES-BENZ 7-speed automatic gearbox	Adapter MERCEDES-BENZ 7-Gang Automatik	036863
⑦	V3687	Adapter VAG DSG direct shift gearbox	Adapter VAG DSG Direktschaltgetriebe	036870
⑧	V3688	Adapter VAG CVT continuously variable transmission	Adapter VAG CVT stufenlose Automatik	036887
⑨	V3689	Adapter Volvo straight	Adapter Volvo gerade	036894
⑩	V3690	Adapter SKODA M 18 x 1.5 mm	Adapter SKODA M 18 x 1,5 mm	036900
⑪	V3691	Adapter VW Passat from model year 2007	Adapter VW Passat ab Bj. 2007	036917
⑫	V4113	Adapter TOYOTA, LEXUS 18 x 1.5 mm	Adapter TOYOTA, LEXUS 18 x 1,5 mm	041133
⑬	V4114	Adapter Infiniti 7 Speed M8 x 1.0 for V2670	Adapter Infiniti 7 Speed M8 x 1,0 für V2670	041140
⑭	V4115	Multifunction adapter	Multifunktions-Adapter	041157



with 14 adapters  
inkl. 14 Adapter



can also be ordered as spare part  
auch als Ersatzteil bestellbar

Adapter Set for V2670  
Adapter-Satz zu V2670  
**V3679**, EAN 4047728036795



Viscosity up to SAE 140  
Viskosität bis SAE 140

With return function  
Mit Rücklauf-funktion

Hose length: 1600 mm  
Schlauchlänge: 1600 mm

Contents: 7.5 l  
Inhalt: 7,5 l



Incl. oil pan  
Inkl. Ölwanne

Replacement container for oil filling device  
**V3550**, EAN 4047728035507

Ersatzbehälter für Öl-Einfüllgerät  
**V3550**, EAN 4047728035507



# SAC Clutch SAC-Kupplung



## SAC clutch alignment tool set V2306, EAN 4047728023061

- For almost all SAC (self-adjusting) clutches with 3 hole division
- For the fast and professional removal and installation of SAC clutches
- Without this tool set, correct installation is almost impossible
- With centring option of the clutch and resetting of the adjusting ring
- Prevents distortion of the adjusting ring in the clutch pressure plate
- For damage-free working on the pressure plate
- Avoids malfunctions (bad separating, slipping or judder)



## SAC-Kupplungswerkzeug-Satz V2306, EAN 4047728023061

- Für nahezu alle selbstnachstellenden SAC-Kupplungen mit 3-Loch-Teilung
- Zur schnellen und fachgerechten Demontage und Montage der SAC-Kupplungen
- Korrekter Einbau nahezu unmöglich ohne diesen Werkzeugsatz
- Mit Zentriermöglichkeit der Kupplung und Rückstellen des Nachstellrings
- Verhindert das Verdrehen des Nachstellrings in der Kupplungsdruckplatte
- Ideal für beschädigungsfreies Arbeiten an der Druckplatte
- Funktionsstörungen (schlechtes Trennen, Rutschen oder Rupten) werden vermieden

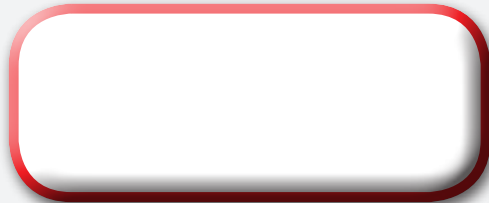
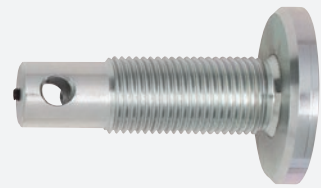

## Expansion assortment for SAC clutch alignment tool V2308, EAN 4047728023085

- For example, for MERCEDES-BENZ A-Class



## Erweiterung-Sortiment für SAC- Kupplungswerkzeug V2308, EAN 4047728023085

- Zum Beispiel für MERCEDES-BENZ A-Klasse

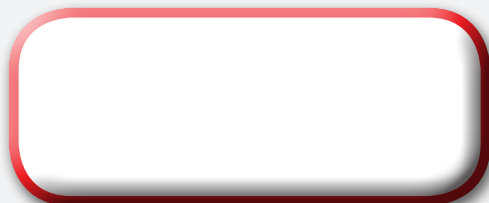

**ABS reamer set**

**V3228**, EAN 4047728032285

- Consisting of: fine-tooth reversible ratchet with hinge joint and quick-change function, for clockwise operation only, 5 reamers as well as one twist drill 10 mm Ø x 133 mm for reaming corroded and stuck sensors
- Note: when defective ABS sensors are replaced, residues of torn-off sensors may remain which are difficult to remove. For correct installation of new sensors, the seats of the sensors in the wheel bearing housing must be cleaned with the appropriate reamers



**ABS-Reibahlen-Satz**

**V3228**, EAN 4047728032285

- Bestehend aus ausschließlich nach rechts drehender, feinverzahnter Gelenkknarre mit Schnellwechselfunktion, 5 Reibahlen sowie Spiralbohrer 10 mm Ø x 133 mm zum Ausbohren von korrodierten und somit feststehenden Sensoren
- Hinweis: Beim Austauschen fehlerhafter ABS-Sensoren bleiben oft schwer zu entfernende Reste aufgrund abgerissener Sensoren zurück. Für ordnungsgemäßen Einbau neuer Sensoren, müssen die Sitze der Sensoren im Radlagergehäuse mit entsprechenden Reibahlen gereinigt werden



**5 reamers:**

- V3695** reamer Ø 10 mm x 150 mm:  
VW Golf 5, Polo 9N, T5, SKODA Fabia, SEAT Ibiza, OPEL Insignia
- V3694** reamer Ø 14 mm x 32 mm:  
BMW E38, E39, E52, E60, E61, E63, E64, E65, E66, E70, E71
- V3699** reamer Ø 15 mm x 23 mm:  
MERCEDES-BENZ A class, MAZDA, FORD
- V3698** reamer Ø 18 mm x 23 mm:  
AUDI, VW, BMW E36, E46, SEAT, SKODA
- V3697** reamer Ø 18 mm x 34 mm:  
AUDI, VW, SEAT, SKODA, commercial vehicles

**5 Reibahlen:**

- V3695** Reibahle Ø 10 mm x 150 mm:  
VW Golf 5, Polo 9N, T5, SKODA Fabia, SEAT Ibiza, OPEL Insignia
- V3694** Reibahle Ø 14 mm x 32 mm:  
BMW E38, E39, E52, E60, E61, E63, E64, E65, E66, E70, E71
- V3699** Reibahle Ø 15 mm x 23 mm:  
MERCEDES-BENZ A-Klasse, MAZDA, FORD
- V3698** Reibahle Ø 18 mm x 23 mm:  
AUDI, VW, BMW E36, E46, SEAT, SKODA
- V3697** Reibahle Ø 18 mm x 34 mm:  
AUDI, VW, SEAT, SKODA, Nutzfahrzeuge

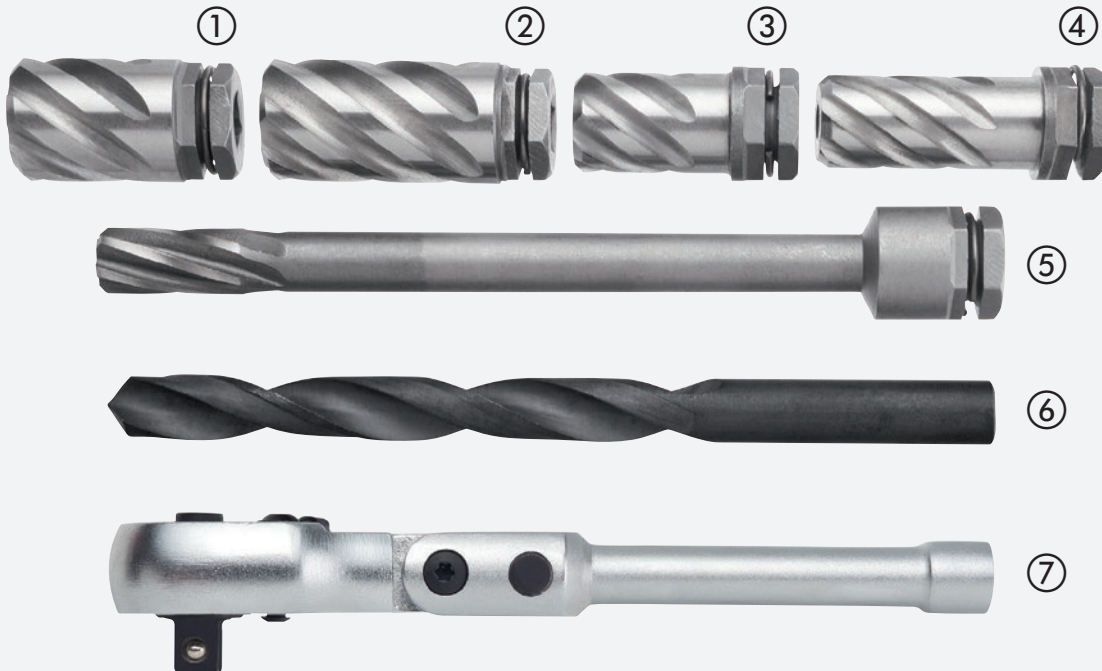

No. Nr.	VIGOR No.	Designation	Bezeichnung	EAN 4047728+
①	V3698	Reamer Ø 18 x 23 mm	Reibahle Ø 18 x 23 mm	036986
②	V3697	Reamer Ø 18 x 34 mm	Reibahle Ø 18 x 34 mm	036979
③	V3699	Reamer Ø 15 x 23 mm	Reibahle Ø 15 x 23 mm	036993
④	V3694	Reamer Ø 14 x 32 mm	Reibahle Ø 14 x 32 mm	036948
⑤	V3695	Drill (reamer) Ø 10 x 133 mm	Bohrer (Reibahle) Ø 10 x 133 mm	036955
⑥	V3696	Drill (reamer) Ø 10 x 133 mm	Bohrer (Reibahle) Ø 10 x 133 mm	036962
⑦	V3693	Reversible ratchet with hinge joint $\frac{33}{16}$	Gelenk-Umschaltknarre $\frac{33}{16}$	036931

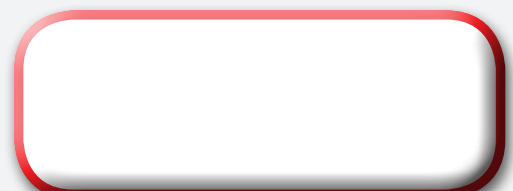

## Tube flaring tool set

**V1728**, EAN 4047728017282

- Lightweight and easy to handle
- Especially suited for direct application on brake and hydraulic lines on vehicles
- For thin-walled pipes made of steel, aluminium and copper, metric/inch
- For convex and double flares (DIN/SAE-standards)
- No damage to coated lines



## Bördelgerät-Satz

**V1728**, EAN 4047728017282

- Leicht und handlich
- Besonders für den direkten Einsatz an Brems- bzw. Hydraulikleitungen am Fahrzeug geeignet
- Für dünnwandige Stahl-, Aluminium- und Kupferleitungen Metrisch/Zoll
- Zur Anfertigung von Konvex und Doppelbördelungen (DIN/SAE-Standards)
- Keine Beschädigung beschichteter Leitungen



No. Nr.	VIGOR No.	Designation	Bezeichnung	∅ mm	EAN 4047728+
①	V2466	Quick-change holder	Schnellwechsel-Halterung	—	024662
②	V2559	Basic unit	Grundgerät	—	025591
③	V2467	Hydraulic spindle	Hydraulik-Spindel	—	024679
④	V2558	Thrust block 90° DIN / SAE	Druckstück 90° DIN / SAE	4.75–6	025584
⑤	V2553	Thrust block DIN / SAE	Druckstück DIN / SAE	5	025539
⑥	V2554	Thrust block DIN / SAE	Druckstück DIN / SAE	4.75	025546
⑦	V2556	Thrust block DIN / SAE	Druckstück DIN / SAE	6	025560
⑧	V2555	Thrust block DIN / SAE	Druckstück DIN / SAE	6	025553
⑨	V2626	Tube cutter, 3–22 mm	Rohrschneider, 3–22 mm	3–16	026260
⑩	V2551	Pair of gripping jaws	Spannbacken-Paar	5	025515
⑪	V2552	Pair of gripping jaws	Spannbacken-Paar	6	025522
⑫	V2540	Pair of gripping jaws	Spannbacken-Paar	4.75	025409
⑬	V1782	Tube bending tool	Rohrbieger	—	017824

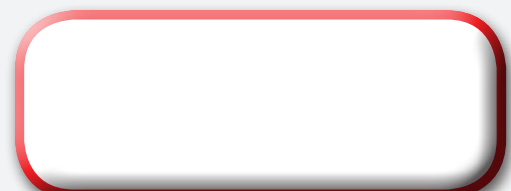

**Brake and fuel line inspection tool**

**V2789**, EAN 4047728027892

- With 12 cleaning edges for removal of dirt and rust from various lines
- Curved cleaning edges for working in areas with restricted access
- For the detection of hidden corrosion during general inspection
- 0.1 kg

**Inspektions-Werkzeug für Brems- und Kraftstoffleitungen**

**V2789**, EAN 4047728027892

- Mit 12 Abstreifflächen zur Beseitigung von Schmutz und Korrosion verschiedener Leitungen
- Scharf gebogene Abstreifflächen ermöglichen Zugriff an schwer erreichbaren Stellen
- Zum Aufspüren verborgener Korrosionsstellen bei Hauptuntersuchung (HU)
- 0.1 kg



200 mm



**Brake calliper file**

**V2411**, EAN 4047728024112

**Bremssattel-Feile**

**V2411**, EAN 4047728024112

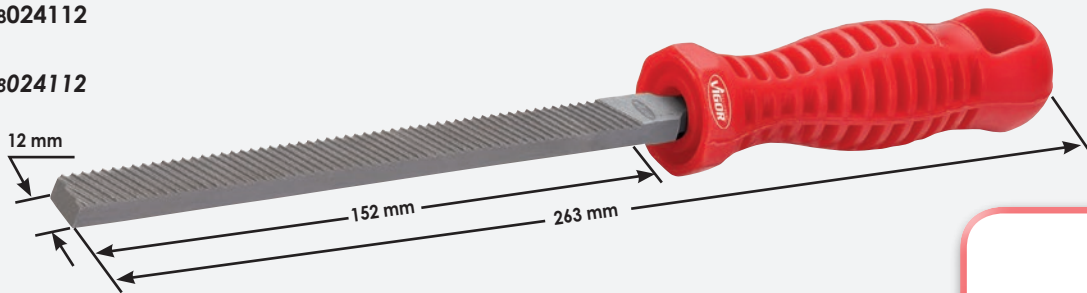

**Steel brake calliper brush**

**V2250**, EAN 4047728022507

- For removal of stubborn brake dust
- Allows access into small brake callipers

**Bremssattel-Bürste, Stahl**

**V2250**, EAN 4047728022507

- Zum Entfernen von hartnäckigem Bremsstaub
- Für enge Bremssattelschächte



With hanging hole  
Mit Aufhängeloch

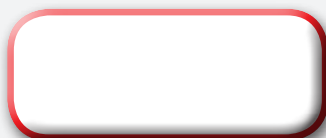

**Brass brake calliper brush**

**V2249**, EAN 4047728022491

- For cleaning aluminium brake callipers
- For removal of stubborn brake dust
- Allows access into small brake callipers

**Bremssattel-Bürste, Messing**

**V2249**, EAN 4047728022491

- Zum Reinigen von Aluminium-Bremssätteln
- Zum Entfernen von hartnäckigem Bremsstaub
- Für enge Bremssattelschächte



With hanging hole  
Mit Aufhängeloch

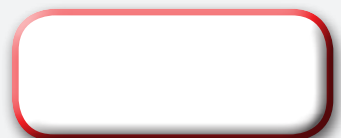

Brake line wrench set

**V1805**, EAN 4047728018050

- With hinge joint for working in areas with restricted access
- Especially suitable for application in areas with restricted and difficult access such as brake lines, air conditioning lines, power steering lines, vacuum lines, compressed air and fuel lines



Bremsleitungs-Schlüssel-Satz

**V1805**, EAN 4047728018050

- Mit Gelenk zur Anwendung an schwer zugänglichen Leitungsver schraubungen
- Besonders geeignet für den Einsatz unter beengten und schwierigen Platzverhältnissen wie z.B. an Brems-, Klima-, Servo-, Vakuum-, Druckluft- und Kraftstoffleitungen



VIGOR No.	Sizes (mm) SW (mm)	mm	EAN 4047728+
V1841	8 x 9	120	018418
V1842	10 x 11	160	018425
V1843	12 x 13	180	018432
V1844	14 x 15	210	018449



Special wave profile  
Spezielles Wellenprofil

2 sizes per wrench  
2 Größen pro Schlüssel

Tube bending tool

**V1782**, EAN 4047728017824

- For tubes made of copper, brass, aluminium and soft steel

Rohrbieger

**V1782**, EAN 4047728017824

- Für Kupfer-, Messing-, Alu- und Weichstahlrohre

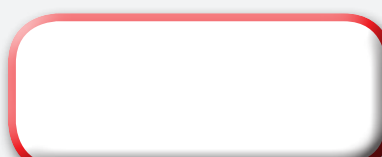
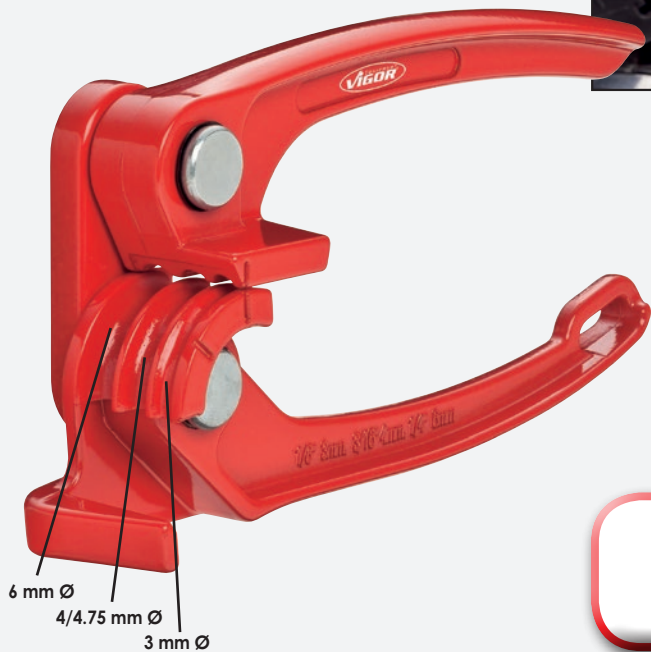

**Line wrench set**

**V3730**, EAN 4047728037303

- For screw connections on brake, fuel, hydraulic and air-conditioning lines
- Wrench heads work like spring hinges
- Worn, damaged or too small screw connections are firmly enclosed
- Clamping mechanism depending on torque:
- The higher the torque the more powerful the clamping
- Adapts to metric as well as inch sizes
- Drive 10 = 3/8" for extra leverage

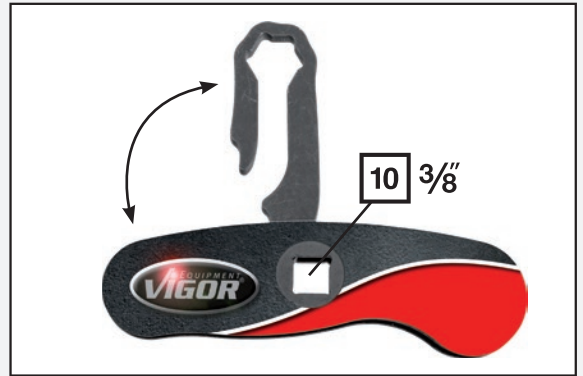

**Leitungsschlüssel-Satz**

**V3730**, EAN 4047728037303

- Für Verschraubungen an Brems-, Kraftstoff-, Hydraulik- und Klimaleitungen
- Schlüsselkopfen arbeiten wie Federscharniere
- Abgenutzte, beschädigte oder zu kleine Verschraubungen werden fest umschlossen
- Drehmomentabhängiger Klemm-Mechanismus:
- Je höher das Drehmoment, desto besser die Klemmung
- Passt sich sowohl metrischen als auch Zollgrößen an
- Antrieb 10 = 3/8" für extra Hebelwirkung



Size 14 mm  
SW 14 mm  
(9/16")

Size 12/13 mm  
SW 12/13 mm  
(1/2")

Size 11 mm  
SW 11 mm  
(7/16")

Size 10 mm  
SW 10 mm  
(3/8")

VIGOR No.	Sizes (mm) SW (mm)	EAN 4047728+
V3703	10	037037
V3704	11	037044
V3705	12/13	037051
V3706	14	037068







**Brake piston readjusting tool set  
V3760, EAN 4047728037600**

- New system suitable for push-back and wind-back brake pistons
- Adapters enable use even on very worn brake linings and assembly of the back plate in the break calliper
- Contents:
  - 2 Thrust bolt assemblies (left-handed and right-handed)
  - 2 Allen keys (6 and 7 mm)
  - 2 Drift Pins
  - 3 Exchangeable reaction plates
  - 31 Reaction plates and adapters
  - 1 Lubricating oil



**Bremskolben-Rückstell Werkzeug-Satz  
V3760, EAN 4047728037600**

- Neues System für links- und rechtsdrehende Kolben
- Adapter ermöglichen Einsatz auch bei stark abgefahrenen Belägen sowie den Zusammenbau der Rücksteller im Bremsattel
- Inhalt:
  - 2 Spindeln (links- und rechtsdrehend)
  - 2 Winkelschlüssel (6 und 7 mm)
  - 2 Splinttreiber
  - 3 austauschbare Rückhalteplatten
  - 31 Rückhalteplatten und Adapter
  - 1 Gewindeölf flasche

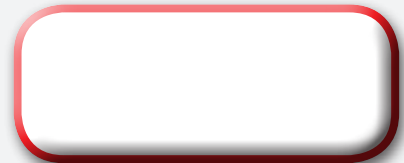

**Pneumatic brake piston readjusting tool set  
V1711, EAN 4047728017114**

- Universal set for pushing and turning brake pistons on nearly all passenger cars
- Rotation possible to left and right
- Set with 16 pieces consisting of:
  - 1 pneumatic spindle and 15 adapter plates

**Pneumatischer Bremskolben-Rückstellwerkzeug-Satz  
V1711, EAN 4047728017114**

- Universeller Satz zum Drehen und Drücken von Bremskolben an nahezu allen Pkw
- Drehbewegung rechts und links möglich
- 16-teiliger Satz bestehend aus:
  - 1 Druckluftspindel und 15 Adapterplatten

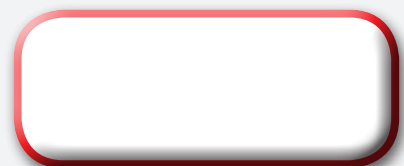

Four-way rim wrench  
**V1614**, EAN 4047728016148

12<sup>5</sup> 1/2" 

Kreuzschlüssel  
**V1614**, EAN 4047728016148



Size / SW 17 mm  
Size / SW 19 mm  
Size / SW 21 mm  
Size / SW 23 mm

To be used on both sides  
Beidseitig einsetzbar



Four-way rim wrench  
**V4195**, EAN 4047728041959

Kreuzschlüssel  
**V4195**, EAN 4047728041959

12<sup>5</sup> 1/2" 

Size 19 mm  
SW 19 mm

- For passenger cars and vans
- Sizes: 17 x 19 x 21 mm x 1/2"
- Surface: chrome-plated
- DIN 3119

- Für Pkw und Transporter
- Größen: 17 x 19 x 21 mm x 1/2"
- Oberfläche: verchromt
- DIN 3119

12<sup>5</sup> 1/2"



Size 17 mm  
SW 17 mm



Size 21 mm  
SW 21 mm

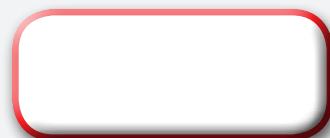

**Bottle jack 2 t**

**V2479**, EAN 4047728024792

- Suitable for vertical and horizontal applications

⚖️ 2,3 kg



**Flaschenwagenheber 2 t**

**V2479**, EAN 4047728024792

- Horizontaler und vertikaler Einsatz möglich

⚖️ 2,3 kg

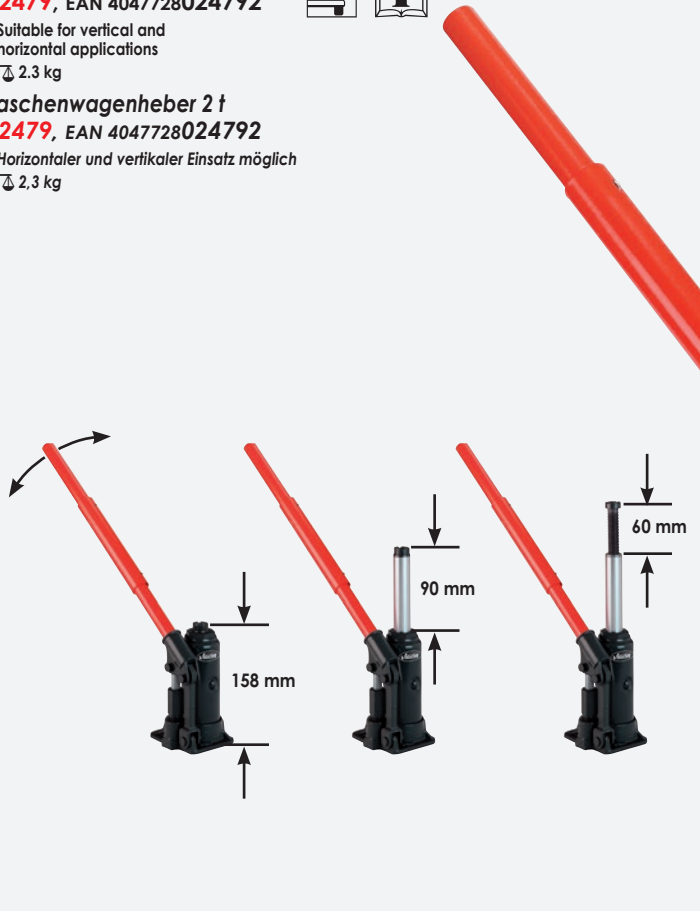

**Bottle jack 6 t**

**V2478**, EAN 4047728024785

- Suitable for vertical and horizontal applications

⚖️ 4,4 kg



**Flaschenwagenheber 6 t**

**V2478**, EAN 4047728024785

- Horizontaler und vertikaler Einsatz möglich

⚖️ 4,4 kg

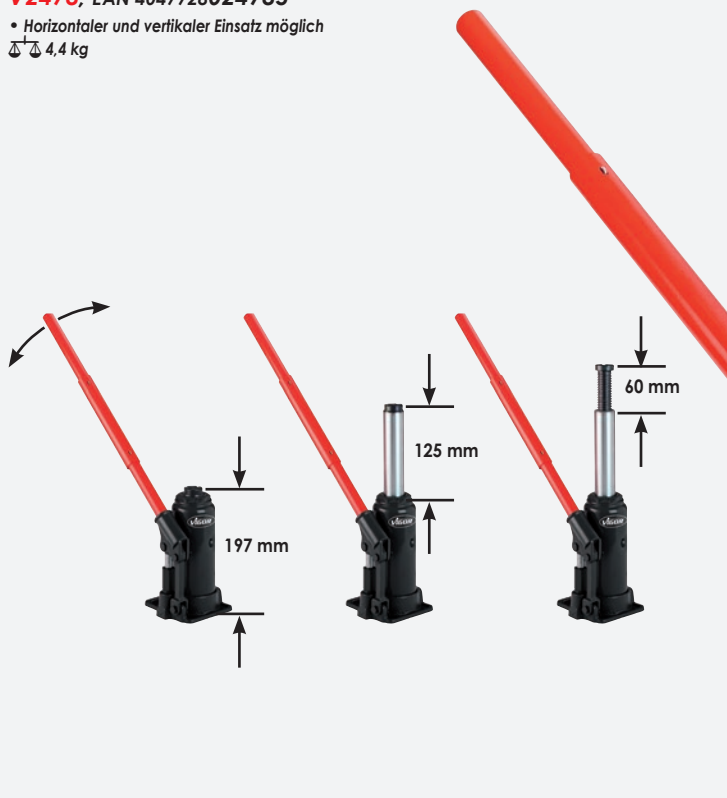



Hydraulic aluminium service jack 1.35 t  
**V2481**, EAN 4047728024815

⚖️ 10 kg

Hydraulik Alu-Rangier-Wagenheber 1,35 t  
**V2481**, EAN 4047728024815

⚖️ 10 kg

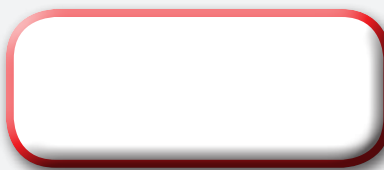

**Aluminium -  
only 10 kg  
Alu -  
nur 10 kg**

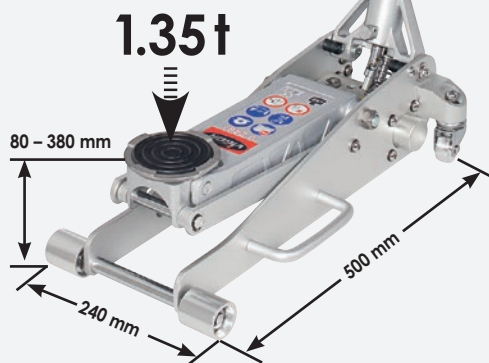

VIGOR No.	Designation	Bezeichnung	EAN 4047728+
<b>V2640</b>	Rubber pad	Gummi-Auflage	026406
<b>V2632</b>	Pair of swivel castors	Lenkrollen-Paar	026321
<b>V2631</b>	Pair of fixed castors	Bockrollen-Paar	026314
<b>V2639</b>	Hydraulic unit	Hydraulik-Einheit	026390

Hydraulic service jack 2 t  
**V2649**, EAN 4047728026499



⚖️ 38 kg

Hydraulik-Rangier-Wagenheber 2 t  
**V2649**, EAN 4047728026499

⚖️ 38 kg



Hydraulic service jack 3 t  
**V2480**, EAN 4047728024808



⚖️ 42.0 kg

Hydraulik-Rangier-Wagenheber 3 t  
**V2480**, EAN 4047728024808

⚖️ 42.0 kg



VIGOR No.	Designation	Bezeichnung	EAN
<b>V3639</b>	Rubber pad	Gummi-Auflage	036399
<b>V3638</b>	Pair of swivel castors	Lenkrollen-Paar	036382
<b>V3637</b>	Pair of fixed castors	Bockrollen-Paar	036375
<b>V3640</b>	Hydraulic unit	Hydraulik-Einheit	036405

VIGOR No.	Designation	Bezeichnung	EAN
<b>V2637</b>	Rubber pad	Gummi-Auflage	026376
<b>V2633</b>	Pair of swivel castors	Lenkrollen-Paar	026338
<b>V2634</b>	Pair of fixed castors	Bockrollen-Paar	026345
<b>V2638</b>	Hydraulic unit	Hydraulik-Einheit	026383

Jack stands 3 t  
**V2477**, EAN 4047728024778

5.2 kg per pair

Unterstellböcke 3 t

**V2477**, EAN 4047728024778

5.2 kg pro Paar



3t

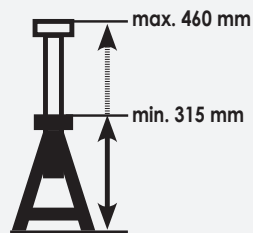

VIGOR No.	Designation	Bezeichnung	EAN
<b>V2762</b>	Rubber pad	Gummi-Auflage	027625

Jack stand set 6 t

**V2648**, EAN 4047728026482

11 kg per pair

Unterstellbock-Satz 6 t

**V2648**, EAN 4047728026482

11 kg pro Paar



6t

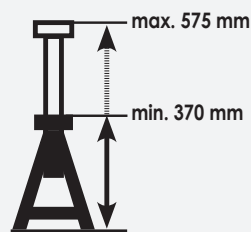

VIGOR No.	Designation	Bezeichnung	EAN
<b>V2761</b>	Rubber pad	Gummi-Auflage	027618



**Tyre lever**

**V3564**, EAN 4047728035644

- For passenger cars and vans
- Double-T profile ensures high stability
- Surface: chrome-plated
- Length: 500 mm

**Reifen- und Montagehebel**

**V3564**, EAN 4047728035644

- Für Pkw und Transporter
- Doppel-T-Profil für hohe Stabilität
- Oberfläche: verchromt
- Länge: 500 mm



**Tyre lever with plastic coating**

**V3563**, EAN 4047728035637

- For installing and removing tyres on steel and esp. on aluminium rims

**Reifen- und Montagehebel**

**mit Kunststoff-Belag**

**V3563**, EAN 4047728035637

- Zum Auf- und Abziehen der Reifen an Stahl- und insbesondere Alu-Felgen

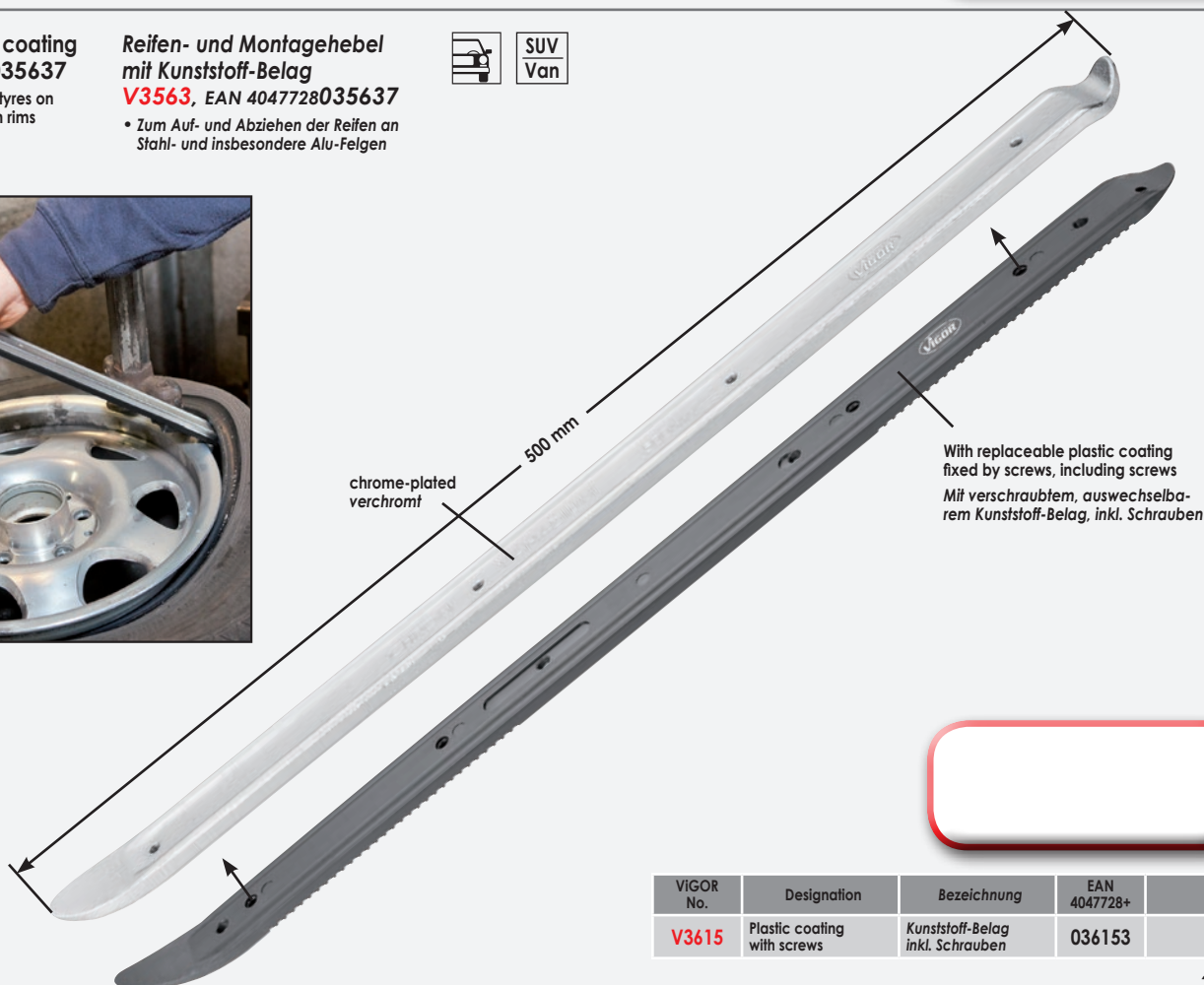

VIGOR No.	Designation	Bezeichnung	EAN 4047728+
<b>V3615</b>	Plastic coating with screws	Kunststoff-Belag inkl. Schrauben	<b>036153</b>

Balance weight remover set  
**V2512**, EAN 4047728025126



- Solvent resistant
- Blunt edges may be sharpened with a file
- No damage to surfaces
- Ideal for removing balance weights from light-alloy rims on motorcycles and passenger cars
- Also suitable for removing labels and stickers

Klebegewicht-Entferner-Satz  
**V2512**, EAN 4047728025126

- Lösemittelbeständig
- Mittels Feile nachschleifbar
- Oberflächen werden nicht beschädigt
- Ideal zur Demontage von Klebegehalten auf Alufelgen bei Pkw und Motorrad
- Auch zum Ablösen von Etiketten, Klebe- und Typenschildern

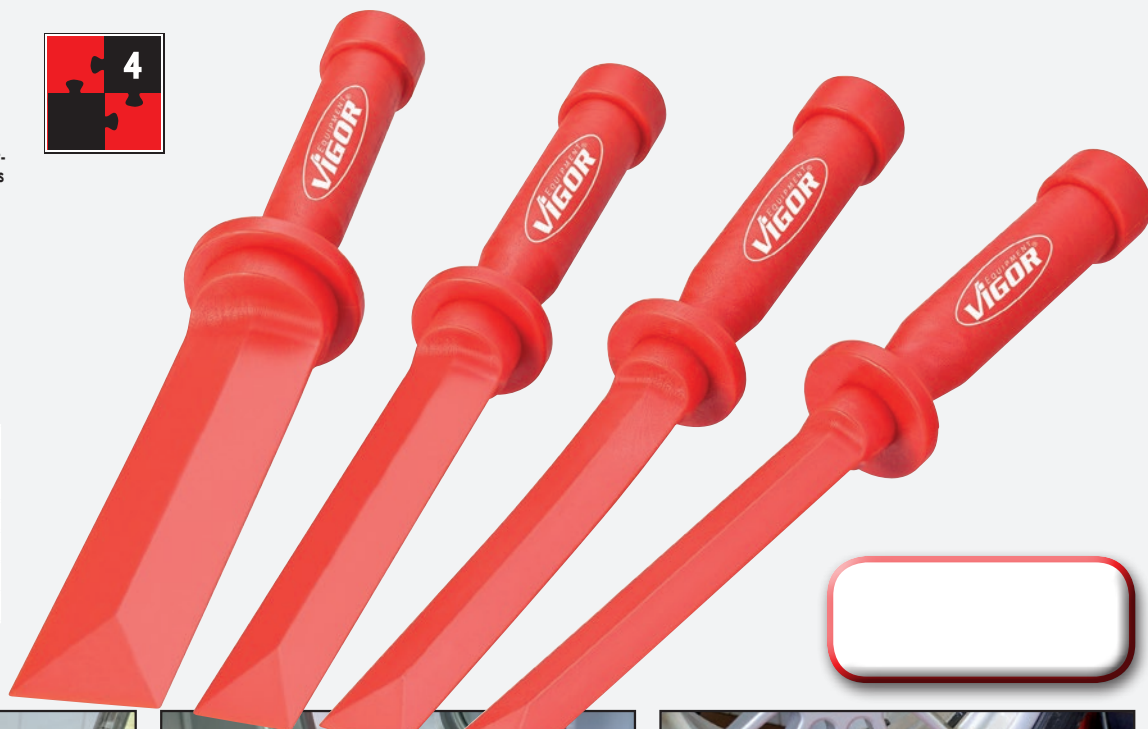

VIGOR No.	Width mm Breite mm	EAN 4047728+
V2513	19	025133
V2514	22	025140
V2515	25	025157
V2516	38	025164



Balance weight remover  
**V2514**, EAN 4047728025140

Klebegewicht-Entferner  
**V2514**, EAN 4047728025140



Top seller!  
Topseller!

Balance weight pliers  
**V1657**, EAN 4047728016575

Auswuchtgewicht-Zange  
**V1657**, EAN 4047728016575





**Tyre tread depth gauge**

**V1584**, EAN 4047728015844

- Zero-setting possible in any position
- Suitable for detecting wear patterns on tyres, brake shoes and brake linings
- $\square$  3 V (CR 2032) – 240 mAh

**Profiltiefenmesser**

**V1584**, EAN 4047728015844

- Nullstellung in jeder Position möglich
- Verwendbar zur Messung von Profiltiefen, Bremsklötzen und Bremsbelägen
- $\square$  3 V (CR 2032) – 240 mAh

max. 27 mm  $\rightarrow$



**Tyre pressure gauge**

**V1423**, EAN 4047728014236

- Measuring ranges:
- 0,15–7 bar
- 2–99,5 PSI
- 15–70 KPA
- $\square$  3 V (CR 2032) – 240 mAh

**Reifendrucktester**

**V1423**, EAN 4047728014236

- Messbereiche:
- 0,15–7 bar
- 2–99,5 PSI
- 15–70 KPA
- $\square$  3 V (CR 2032) – 240 mAh



**Special twist sockets**

**V1378**, EAN 4047728013789

- Special profile for loosening aluminium rim locks, unscrewing tight wheel nuts and bolts with damaged heads
- Sockets usable on both sides:
- 1. As normal socket /
- 2. As special cutting thread
- Set consisting of:
  - $\square$   $\frac{1}{2}$  size 17 mm
  - $\square$   $\frac{1}{2}$  size 19 mm
  - $\square$   $\frac{1}{2}$  extension 60 mm



**Spezial-Ausdreh-Steckschlüssel-Einsätze**

**V1378**, EAN 4047728013789

- Spezialprofil zum Lösen von Felgenschlössern, feststehenden Radbolzen und Muttern mit rundgedrehten Köpfen
- Steckschlüssel-Einsätze zweiseitig verwendbar:
- 1. Als normaler Steckschlüsseleinsatz /
- 2. Als Spezial-Schneidgewinde
- Satz bestehend aus:
  - $\square$   $\frac{1}{2}$  SW 17 mm
  - $\square$   $\frac{1}{2}$  SW 19 mm
  - $\square$  Verlängerung 60 mm



**12<sup>5</sup>/<sub>16</sub>"** Impact socket set  
**V2257**, EAN 4047728022576

**12<sup>5</sup>/<sub>16</sub>"**



**12<sup>5</sup>/<sub>16</sub>"** Schlagschrauber-Steckschlüssel-Satz  
**V2257**, EAN 4047728022576

VIGOR No.	Sizes (mm) SW (mm)	mm	EAN 4047728+
V2471	15	85	024716
V2472	17	85	024723
V2473	19	85	024730
V2474	21	85	024747
V2475	22	85	024754



Incl. plastic sleeve  
Inkl. Kunststoffhülse

**Impact wrenches  
see page p. 114  
Schlagschrauber  
siehe S. 114**



**12<sup>5</sup>/<sub>16</sub>"** Impact socket set  
**V2522**, EAN 4047728025225

**12<sup>5</sup>/<sub>16</sub>"**



**12<sup>5</sup>/<sub>16</sub>"** Schlagschrauber-Steckschlüssel-Satz  
**V2522**, EAN 4047728025225

VIGOR No.	Sizes (mm) SW (mm)	mm	EAN 4047728+
V2472	17	85	024723
V2473	19	85	024730
V2474	21	85	024747



Incl. plastic sleeve  
Inkl. Kunststoffhülse

Size 17 mm  
SW 17 mm

Size 19 mm  
SW 19 mm

Size 21 mm  
SW 21 mm

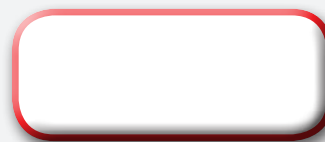

**2.5 kg rubber hammer**  
**V2235**, EAN 4047728022354

- Especially for loosening rusted rims during a tyre change

**Gummihammer 2,5 kg**  
**V2235**, EAN 4047728022354

- Speziell zum Lösen festgerosteter Felgen beim Reifenwechsel



**5 kg rubber hammer**  
**V2234**, EAN 4047728022347

- Extra heavy design, especially suitable for commercial vehicles
- Especially for loosening rusted rims during a tyre change

**Gummihammer 5 kg**  
**V2234**, EAN 4047728022347

- Extra schwere Ausführung, besonders geeignet für Nfz
- Speziell zum Lösen festgerosteter Felgen beim Reifenwechsel

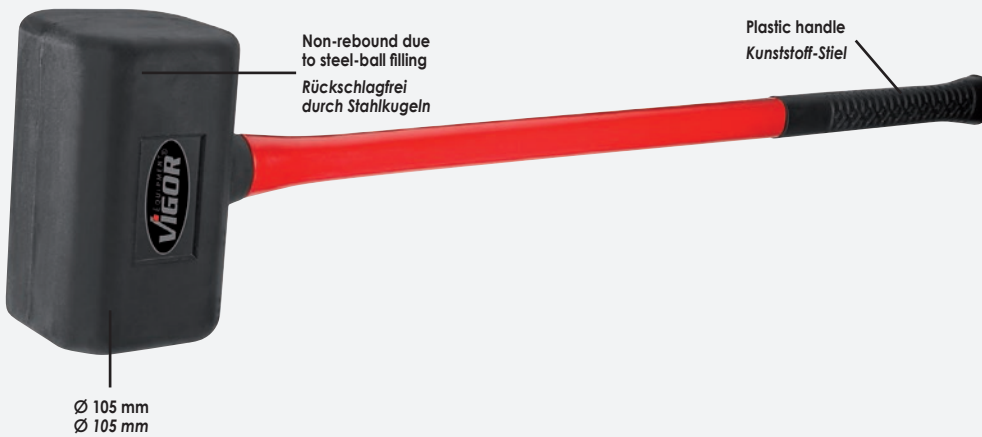

**Steering wheel level**  
**V1571**, EAN 4047728015714



**Lenkrad-Einstellwaage**  
**V1571**, EAN 4047728015714

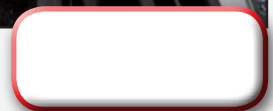
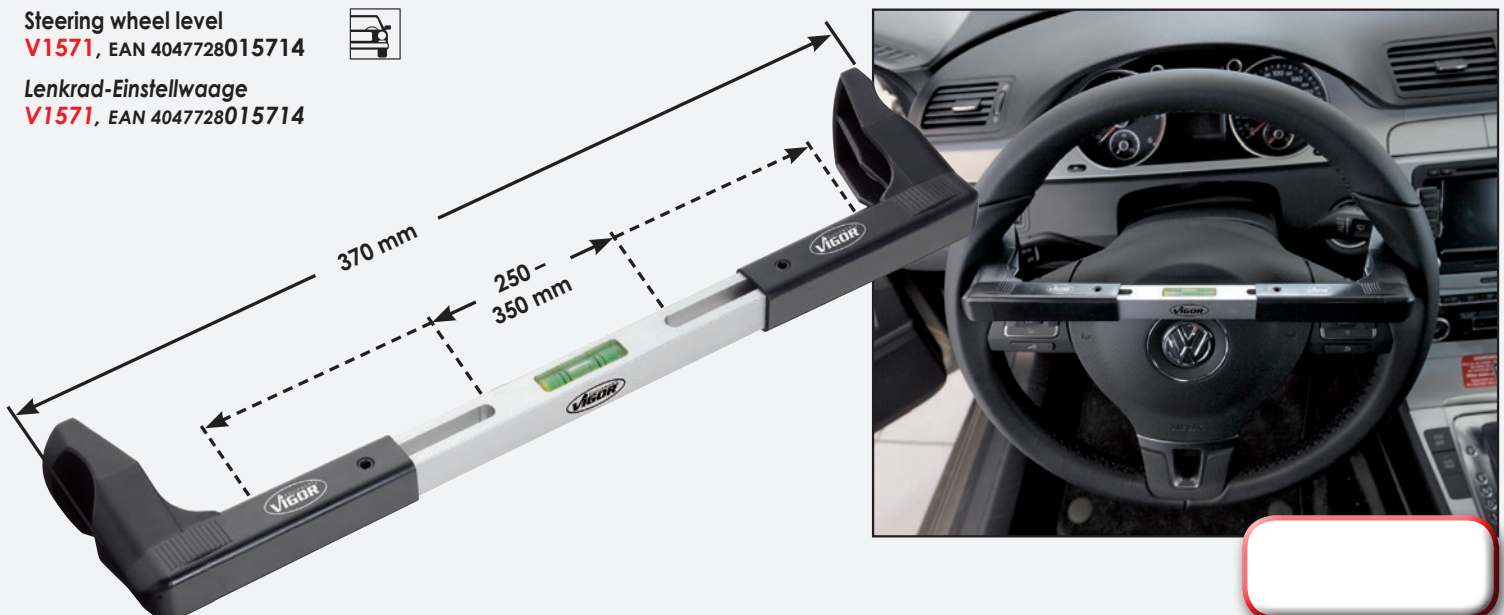

**Steering tie rod joint tool**

- For fast and professional replacement of axial joints on steering tie rods on passenger cars and small commercial vehicles
- Easy installation of longer steering tie rods due to open construction

**Spurstangen-Gelenk-Werkzeug**

- Zum fachgerechten und schnellen Austausch von Spurstangen-Axialgelenken an Pkw und leichten Nfz
- Problemlose Montage längerer Spurstangen durch offene Bauweise

Size 27 mm  
SW 27 mm

12<sup>5</sup> 1/2"

**V2684**, EAN 4047728026840

For steering tie rod ends 28–35 mm Ø



**V2684**, EAN 4047728026840

Für Spurstangenköpfe 28–35 mm Ø

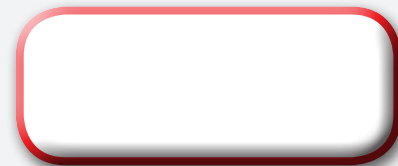

Size 27 mm  
SW 27 mm

12<sup>5</sup> 1/2"

**V2683**, EAN 4047728026833

For steering tie rod ends 35–45 mm Ø



**V2683**, EAN 4047728026833

• Für Spurstangenköpfe 35–45 mm Ø

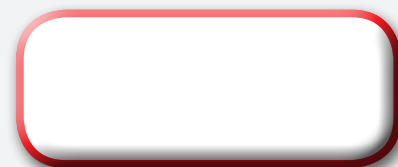



# Motor Vehicle - Chassis Ball Joint / Shock Absorber Hfa-Fahrwerk - Kugelgelenk / Stoßdämpfer



## Shock absorber assembly tool set V3863, EAN 4047728038638

- Suitable for installation and removal of shock absorbers with rebound spring
- Special construction enables appropriate lifting of the piston rod without tilting
- Clamping piece with V-formed plastic inserts enables fixation in final stop position without causing any damage
- For: BMW, FIAT, FORD, MERCEDES-BENZ, NISSAN, PEUGEOT, TOYOTA
- Contents:  
Special base component  
Sturdy threaded spindle M12 with special receptacle  
Universal clamping piece with V-formed plastic inserts

## Stoßdämpfer-Montagewerkzeug-Satz V3863, EAN 4047728038638

- Zur Demontage und Montage an Stoßdämpfern mit Zuganschlagfeder
- Spezielle Konstruktion ermöglicht fachgerechtes Hochziehen der Kolbenstange ohne Verkranten
- Fixierung mittels Klemmstücke mit V-Form Kunststoffeinsätzen in Endanschlagposition ohne Beschädigung
- Für: BMW, FIAT, FORD, MERCEDES-BENZ, NISSAN, PEUGOT, TOYOTA
- Inhalt:  
Spezial-Grundkörper  
Robuste M12 Gewindespindel mit Spezialaufnahme  
Universal-Klemmstück mit V-Form-Kunststoffeinsätzen

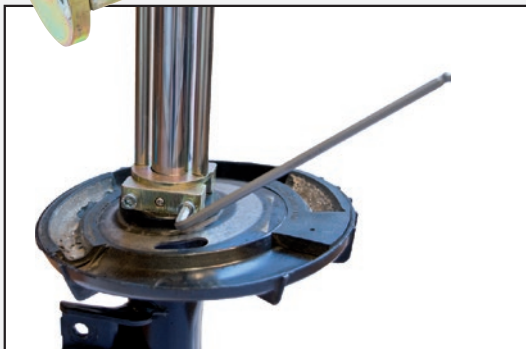
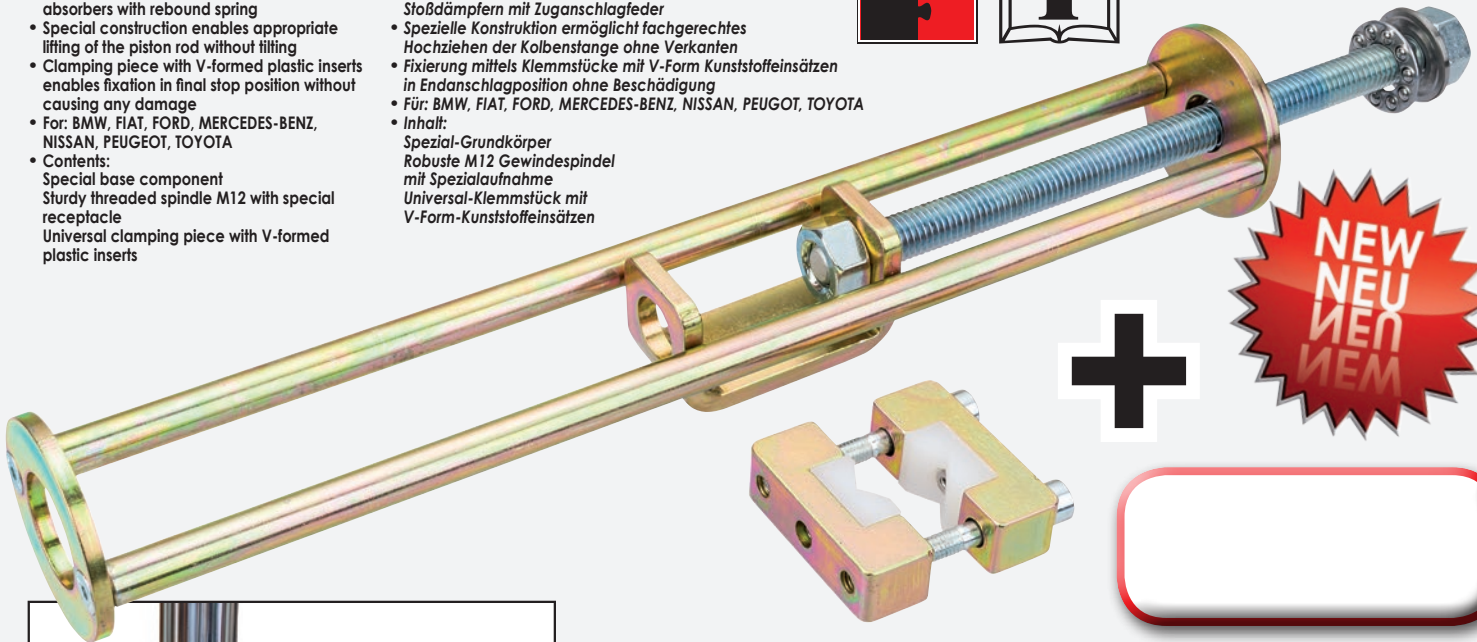

Universal clamping piece  
with plastic protective jaws  
Universal-Klemmstück  
mit Kunststoff-Schonbacken  
V3661, EAN 4047728036610

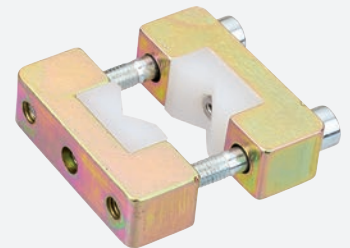
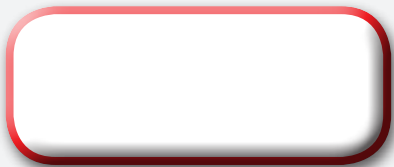

## Ball joint puller, hydraulic V3308, EAN 4047728033084

- For removing the ball joint pivots of steering tie rods, stabilizers, etc. on the most common vehicles

## Kugelgelenk-Abzieher, hydraulisch V3308, EAN 4047728033084

- Zum Abdrückenn der Kugelgelenkzapfen an Spurstangen, Stabilisatoren usw. für die gängigsten Fahrzeugmarken



Hydraulic spindle,  
capacity: 8 tons  
Hydraulikspindel,  
Kraft: 8 t

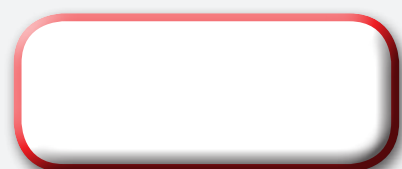

## Guide bolts repair set V4127, EAN 4047728041270

- Fast and inexpensive repair of the inside thread (M9 x 1.25 mm) on the wheel bearing housing / calliper anchor bracket
- Use of threaded sleeves or similar repairs are not needed, no new brake guide bolts need to be purchased
- Extend the available thread to M10 x 1.25 mm and screw in guide bolts provided
- Suitable for the following vehicles:
  - VW Sharan, Touareg, Phaeton, transporter Synchro, transporter 1999-2010
  - SEAT Alhambra
  - AUDI A6, A8 (also Quattro)

## Führungsbolzen-Reparatur-Satz V4127, EAN 4047728041270

- Schnelle und kostengünstige Reparatur des Innengewindes (M9 x 1,25 mm) am Radlagergehäuse / Bremsattelträger
- Einsatz von Gewindehülsen oder ähnlichen Reparaturen entfällt, es muss kein neuer Bremsführungsbolzen gekauft werden
- Erweitern des vorhandenen Gewindes auf M10 x 1,25 mm und mitgelieferten Führungsbolzen eindrehen
- Geeignet für folgende Fahrzeuge:
  - VW Sharan, Touareg, Phaeton, Transporter Synchro, Transporter 1999-2010
  - SEAT Alhambra
  - AUDI A6, A8 (auch Quattro)



VIGOR No.	Designation	Bezeichnung	EAN 4047728+
V4262	Brake guide bolts M10 x 1.25	Bremsführungsbolzen M10 x 1,25	042628



## Clamping screw disassembly tool set for four-link axle VAG V4126, EAN 4047728041263

- Special tool for loosening the clamp screw on the four-link axle in VAG vehicles e.g. AUDI A4, A6 etc.
- Can also be used in aluminium axle knuckles
- Contents:
  - 3 high-performance drills (HSS cobalt), size: 6 8.5 10 mm
  - 1 pressure clamp
  - 1 ejector drift

## Klemmschrauben-Demontage-Werkzeug-Satz für Vierlenker-Achse VAG V4126, EAN 4047728041263

- Spezialwerkzeug zum Lösen der Klemmschraube an der Vierlenkerachse bei VAG-Fahrzeugen, z. B. AUDI A4, A6 etc.
- Einsetzbar auch bei Aluminium-Achsschenkeln
- Inhalt:
  - 3 Hochleistungsbohrer (HSS Cobalt), Größe: 6 8,5 10 mm
  - 1 Andrückbügel
  - 1 Ausschlag-Werkzeug

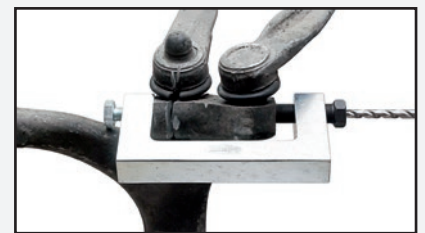

No. Nr.	VIGOR No.	Designation	Bezeichnung	EAN 4047728+
①	V4248	HSS drill 6 mm	HSS-Bohrer 6 mm	042482
②	V4249	HSS drill 8,5 mm	HSS-Bohrer 8,5 mm	042499
③	V4250	HSS drill 10 mm	HSS-Bohrer 10 mm	042505



**Tensioning ratchet**

**V2236**, EAN 4047728022361

- For easy installation of clips and hose clamps (free-end), as well as prefabricated clamps
- For clips 6 mm to 10 mm wide



**Spannratsche**

**V2236**, EAN 4047728022361

- Zur einfachen Montage für Band- und Schlaufen- (Free-end) Schellen oder auch vorgefertigten Schellen
- Für Bandschellen mit einer Breite von 6–10 mm

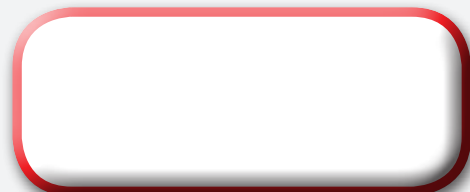

**Metal tightening strap set**

**V2391**, EAN 4047728023917

- 20 pieces / set
- To be used with tensioning ratchet V2236



**Metall-Spannband-Satz**

**V2391**, EAN 4047728023917

- 20 Stück / Satz
- In Verbindung mit Spannratsche V2236

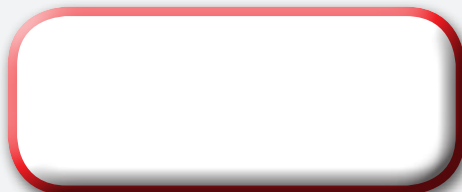
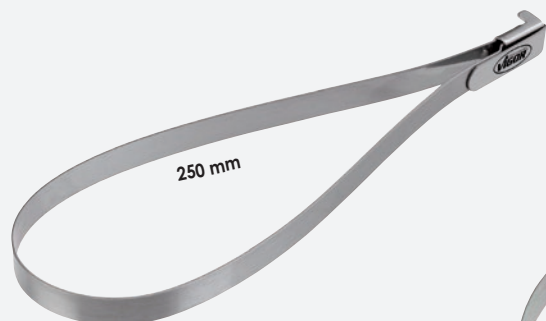

**Metal tightening strap set**

**V2392**, EAN 4047728023924

- 20 pieces / set
- To be used with tensioning ratchet V2236



**Metall-Spannband-Satz**

**V2392**, EAN 4047728023924

- 20 Stück / Satz
- In Verbindung mit Spannratsche V2236

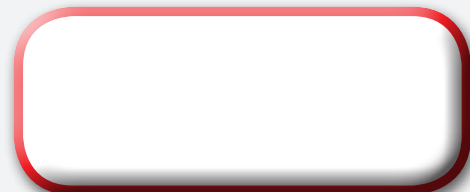

Induction heater with function for plastic repairs

**V3813**, EAN 4047728038133

- For the quick and exact heating of rusted or hard to loosen nuts and bolts or micro-encapsulated connections
- Including 5 heating coils and 6 types of clamp (100 pieces of each) for repairing plastic



Induktionsheizgerät mit Kunststoffreparatur-Funktion

**V3813**, EAN 4047728038133

- Zur schnellen und punktgenauen Erhitzung von festgerosteten bzw. schwer lösbaren Schrauben und Muttern oder mikroverkapselten Verbindungen
- Inkl. 5 Heizspulen und 6 Klammerntypen (je 100 Stück) zur Kunststoffreparatur

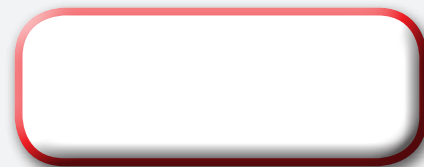

Induction application / Induktions-Anwendung

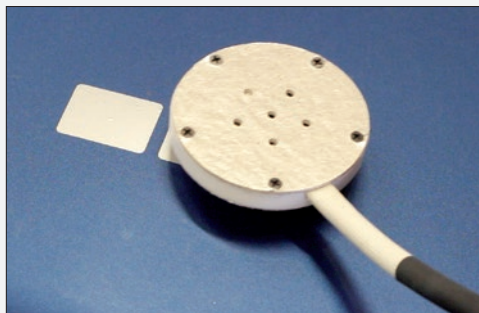



**Contents: / Im Satz enthalten:**

**Induction accessories  
Induktions-Zubehör**



**Induction function  
Induktionsfunktion**

VIGOR No.	X	Designation	Bezeichnung	EAN 4047728+
V4005	1	Moulding iron	Modellereinsatz	040051
V4006	1	Adapter	Adapter	040068
V4007	1	Induction loop	Runder Induktionsstrahler	040075
V4008	3	Induction coil set, U-shaped	U-Induktionsspulen-Set	040082
V4009	3	Flexible induction coil set	Flexible Induktionsspulen-Set	040099
V4010	3	Induction coil set 32 mm	Induktionsspulen-Set 32 mm	040105
V4121	3	Induction coil set 19 mm	Induktionsspulen-Set 19 mm	041218

**Accessories for synthetic repairs  
Zubehör für die Kunststoffreparatur**

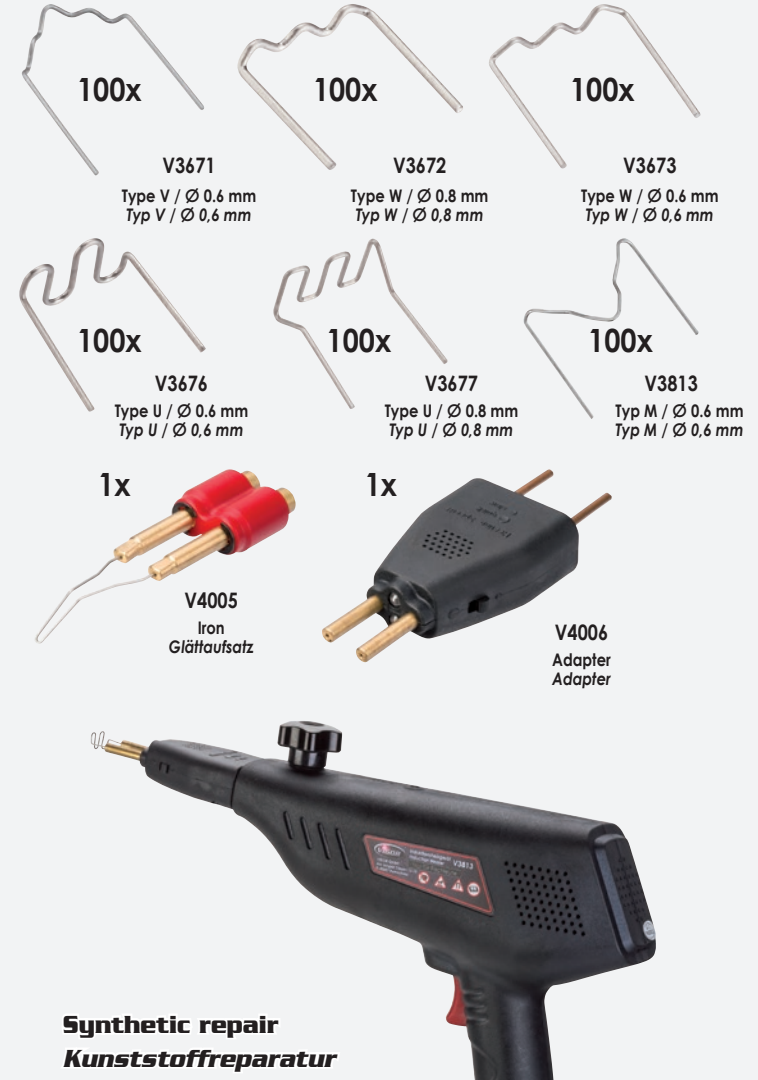

**Synthetic repair  
Kunststoffreparatur**

VIGOR No.	X	Designation	Bezeichnung	EAN 4047728+
V3671	100	Staples, V-shape 0.6 mm	Klammern, V-Format 0,6 mm	036719
V3672	100	Staples, W-shape 0.8 mm	Klammern, W-Format 0,8 mm	036726
V3673	100	Staples, W-shape 0.6 mm	Klammern, W-Format 0,6 mm	036733
V3674	100	Staples, F-shape 0.8 mm	Klammern, F-Format 0,8 mm	036740
V3675	100	Staples, S-shape 0.8 mm	Klammern, S-Format 0,8 mm	036757
V3676	100	Staples, U-shape 0.6 mm	Klammern, U-Format 0,6 mm	036764
V3677	100	Staples, U-shape 0.8 mm	Klammern, U-Format 0,8 mm	036771

**Synthetic repair / Kunststoffreparatur**

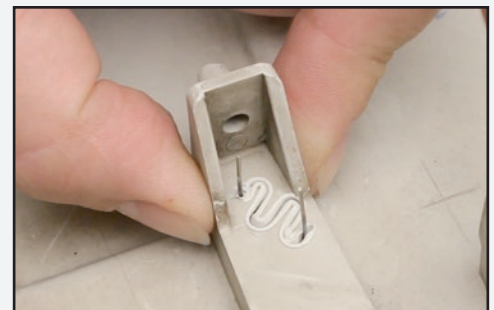

Repair set for plastic parts

**V3551**, EAN 4047728035514

- For the repair and reinforcement of plastic parts, such as cracked light bars and housing parts
- Suitable for repairing plastic components within a few minutes, the kit ensures dimensional stability and prepares the work-piece for subsequent treatments such as painting or filling.
- Electrical output: 100-240 V -50/60Hz
- Max: up to 20W
- Contents: 100 clips type V / Ø 0.6 mm  
100 clips type W / Ø 0.6 mm  
100 clips type W / Ø 0.8 mm



Kunststoff-Reparatur-Satz

**V3551**, EAN 4047728035514

- Zur Reparatur und Verstärkung von Kunststoffteilen wie z.B. gerissene Lampenbügel und Gehäuseteile
- In wenigen Minuten ist ein Bauteil formstabil repariert und für eine mögliche Weiterverarbeitung wie z. B. Lackierung oder Spachteln vorbereitet.
- Elektrische Leistung: 100-240 V - 50 / 60 Hz
- Max: Bis zu 20 W
- Inhalt: 100 Klammern Typ V / Ø 0,6 mm  
100 Klammern Typ W / Ø 0,6 mm  
100 Klammern Typ W / Ø 0,8 mm

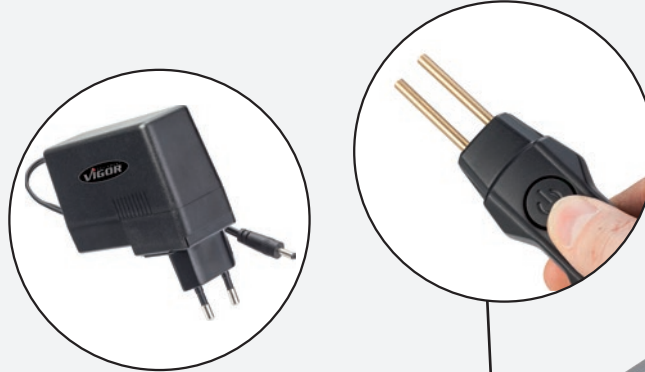

Included in the set: / Im Satz enthalten:

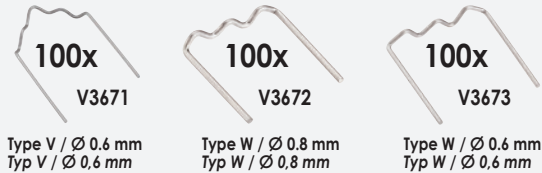

Also available: / Zusätzlich erhältlich:

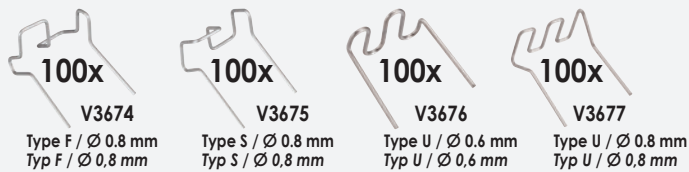

VIGOR No.	X	Designation	Bezeichnung	EAN 4047728+
V3671	100	Staples, V-shape 0.6 mm	Klammern, V-Format 0,6 mm	036719
V3672	100	Staples, W-shape 0.8 mm	Klammern, W-Format 0,8 mm	036726
V3673	100	Staples, W-shape 0.6 mm	Klammern, W-Format 0,6 mm	036733
V3674	100	Staples, F-shape 0.8 mm	Klammern, F-Format 0,8 mm	036740
V3675	100	Staples, S-shape 0.8 mm	Klammern, S-Format 0,8 mm	036757
V3676	100	Staples, U-shape 0.6 mm	Klammern, U-Format 0,6 mm	036764
V3677	100	Staples, U-shape 0.8 mm	Klammern, U-Format 0,8 mm	036771

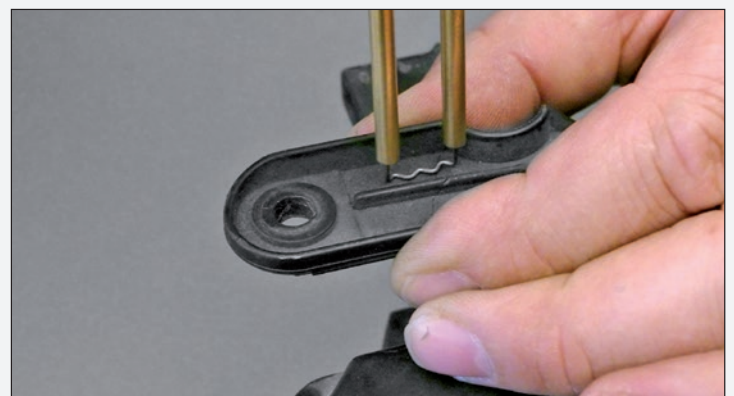
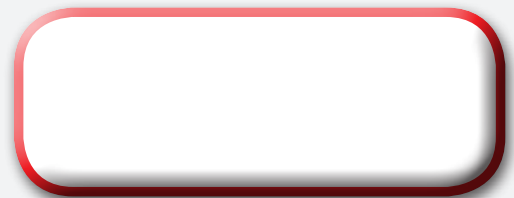

Wiper arm extractor set  
**V2523**, EAN 4047728025232

- Universally usable
- Allows easy disassembly of all common wiper arms
- Optimum usability options with rusted and stuck wiper arms
- Best possible protection for integrated wiper nozzles when used with a sliding hammer

Scheibenwischerarm-Abzieher-Satz  
**V2523**, EAN 4047728025232

- Universell verwendbar
- Ermöglicht einen problemlosen Ausbau aller gängigen Wischerarme
- Optimale Einsatzmöglichkeiten bei gerosteten und feststehenden Wischerarmen
- Größtmöglicher Schutz für integrierte Wischerdüsen bei Anwendung mit Schlagauszieher



5



9

10

11

12

13



No. Nr.	VIGOR No.	Designation	Bezeichnung	EAN 4047728+
①	V4153	Universal puller	Universalsabzieher	041539
②	V4154	Sliding hammer	Schlagauszieher	041546
③	V4155	Pressure spindle	Druckspindel	041553
④	V4156	Spindle extension	Spindelverlängerung	041560
⑤	V4157	Spindle attachment	Spindelvorsatz	041577
⑥	V4159	Gripper 1	Zugglocke 1	041591
⑦	V4160	Gripper 2	Zugglocke 2	041607
⑧	V4161	Gripper 3	Zugglocke 3	041614
⑨	V4162	Gripper 4	Zugglocke 4	041621
⑩	V4163	Gripper 5	Zugglocke 5	041638
⑪	V4164	Gripper 6	Zugglocke 6	041645
⑫	V4165	Gripper 7	Zugglocke 7	041652
⑬	V4158	Gripper 8	Zugglocke 8	041584

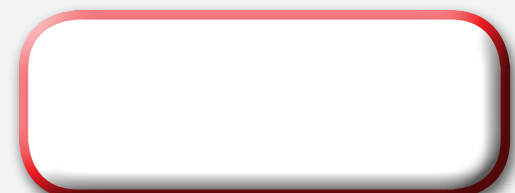

Window pane holders

**V2685**, EAN 4047728026857

Saugheber

**V2685**, EAN 4047728026857



Spreading pad

**V1784**, EAN 4047728017848

- For universal use e.g. door opening, positioning, fixing and pushing away car body parts, inner linings etc.

Türöffner-Spreizkissen

**V1784**, EAN 4047728017848

- Universell einsetzbar zum Positionieren, Fixieren und Abdrücken von Karosserieteilen, Innenverkleidungen etc.



















**VIGOR** EQUIPMENT®

TOOLS TO FIRE YOUR EMOTION!  
DAFÜR BRENNNE ICH!

Please contact us: / Sprechen Sie uns an: