

Green Valley[®]
S m a r t m o b i l i t y



2014



Barre portatutto per autovetture
da pag. 4 a pag. 15



Barre portatutto per furgoni
da pag. 17 a pag. 20



Porta-biciclette
da pag. 22 a pag. 29



Box contenitore-baule da tetto
da pag. 31 a pag. 34



Portasci da tetto
da pag. 36 a pag. 37



Cinghie - Funi
da pag. 38 a pag. 40

STUDIO - PROGETTO - FABBRICAZIONE



I prodotti **Green Valley** sono studiati e sviluppati all'interno del nostro ufficio tecnico.

I nostri prodotti sono sottoposti sia a Test interni, statici e dinamici, sia a Test di Enti Certificatori esterni, a garanzia di qualità e sicurezza.

Lo sviluppo di nuovi prodotti avanza di anno in anno con particolare attenzione alle richieste del mercato e all'uscita dei nuovi veicoli delle più importanti case automobilistiche.

La progettazione ha un occhio di riguardo per il Design dei prodotti per rendere l'accessorio un componente piacevole oltre che utile.



La **Aurilis Group Italia** fornisce assistenza telefonica e via web a privati e aziende.

La collaborazione con fornitori di qualità ed esperienza fa sì che disponga dei migliori materiali presenti sul mercato.



CITY CRASH TEST





SISTEMA MODULARE GREEN VALLEY ORIGINAL

Questo sistema è stato progettato per soddisfare qualsiasi esigenza di trasporto sul tetto con la massima considerazione per qualità, design e sicurezza. Questo sistema componibile è stato studiato per ridurre il numero di referenze nel punto vendita e con 3 componenti offre una maggiore adattabilità e flessibilità di utilizzo da parte del cliente.



Traversa in profilo di ALLUMINIO



Individuare la misura adeguata alla vettura
(consultare la guida applicazione)



Individuare il tipo di piede adeguato alla vettura
(consultare la guida applicazione)



Individuare il kit di attacchi specifico per la vettura
(consultare la guida applicazione)



SISTEMA MODULARE GREEN VALLEY ORIGINAL

Questo sistema è stato progettato per soddisfare qualsiasi esigenza di trasporto sul tetto con la massima considerazione per qualità, design e sicurezza. Questo sistema componibile è stato studiato per ridurre il numero di referenze nel punto vendita e con 3 componenti offre una maggiore adattabilità e flessibilità di utilizzo da parte del cliente con 3 componenti offre una maggiore adattabilità e flessibilità di utilizzo da parte del cliente.



Traversa in profilo
di ACCIAIO



Individuare la misura adeguata alla vettura
(consultare la guida applicazione)



Individuare il tipo di piede adeguato alla vettura
(consultare la guida applicazione)



Individuare il kit di attacchi specifico per la vettura
(consultare la guida applicazione)



Original

KIT PIEDE ORIGINAL

Set di 4 piedi in copolimero

Compatibili con le traverse Green Valley in Alluminio o acciaio

Elegante design e di facile fissaggio alle traverse

Cod 156 500

Unix cikkszám: 774773



CITY CRASH TEST



ISO/PAS 11154



KIT KEY

Cod 156 002 OPTIONAL

Unix cikkszám: 774572

TRAVERSE PER SISTEMA MODULARE GREEN VALLEY



Coppia di traverse in profilo di Alluminio
A sezione asimmetrica " Aerodinamica "
Tappo con apertura parziale per utilizzare il binario a "T"
(montaggio rapido degli accessori)
Base di appoggio del carico in EPDM
Scala graduata per il posizionamento dei piedi
Profilo in gomma antisibilo

Unix cikksz.:

774781

774782

774783

774784

774785

TRAVERSE IN ALLUMINIO

Cod 156 607 = cm. 107

Cod 156 613 = cm. 113

Cod 156 620 = cm. 120

Cod 156 626 = cm. 126

Cod 156 642 = cm. 142



Coppia di traverse in acciaio
con rivestimento in plastica nera antiscivolo
Scala graduata per il posizionamento dei piedi
Profilo in gomma antisibilo

Unix cikksz.:

774774

774775

774776

774777

774778

TRAVERSE IN ACCIAIO

Cod 156 507 = cm. 107

Cod 156 513 = cm. 113

Cod 156 520 = cm. 120

Cod 156 526 = cm. 126

Cod 156 542 = cm. 142



CITY CRASH TEST



ISO/PAS 11154



ADAPTER

Cod 156 000

Set di 4 bulloni a (T)

Accessorio non compreso

OPTIONAL

Unix cikkszám: 774584



SISTEMA MODULARE GREEN VALLEY TREK CC

Questo sistema è stato progettato per soddisfare qualsiasi esigenza di trasporto sul tetto con la massima considerazione per qualità, design e sicurezza. Questo sistema componibile è stato studiato per ridurre il numero di referenze nel punto vendita e con 3 componenti offre una maggiore adattabilità e flessibilità di utilizzo da parte del cliente con 3 componenti offre una maggiore adattabilità e flessibilità di utilizzo da parte del cliente.



Traversa in profilo
di ALLUMINIO



Individuare la misura adeguata alla vettura
(consultare la guida applicazione)



Cod 156 600

Unix cikkszám: 774780



Individuare il tipo di piede adeguato alla vettura
(consultare la guida applicazione)



SISTEMA MODULARE GREEN VALLEY TREK CC

Questo sistema è stato progettato per soddisfare qualsiasi esigenza di trasporto sul tetto con la massima considerazione per qualità, design e sicurezza. Questo sistema componibile è stato studiato per ridurre il numero di referenze nel punto vendita e con 3 componenti offre una maggiore adattabilità e flessibilità di utilizzo da parte del cliente con 3 componenti offre una maggiore adattabilità e flessibilità di utilizzo da parte del cliente.



Traversa in profilo
di ACCIAIO



Individuare la misura adeguata alla vettura
(consultare la guida applicazione)



Cod 156 600

Unix cikkszám: 774780



Individuare il tipo di piede adeguato alla vettura
(consultare la guida applicazione)



KIT Original

Per veicoli
con o senza
punti di fissaggio



CITY CRASH TEST



ISO/PAS 11154

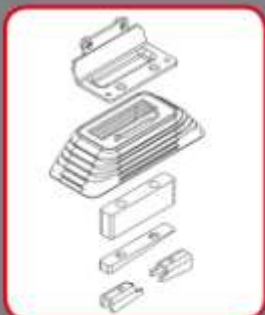

NUOVO KIT CON TAMPONE E STAFFA

comunemente utilizzato per vetture con tetto "normale" senza punti fissi di aggancio.

Esempio: Fiat Grande Punto, Lancia Ypsilon, etc...



NUOVO KIT CON SOFFIETTO

utilizzato per vetture con predisposizione per il fissaggio "fix point"

Esempio: BMW serie 3, Lancia Musa, ecc...



NUOVO KIT CON SOFFIETTO

utilizzato per vetture con predisposizione per il fissaggio sotto la portiera.

Esempio : Dacia Sandero, Renault Clio III



KIT

KIT Trek

Per veicoli con barre
longitudinali tipo S.W.
«Integrate»



Differenti tipologie di kit si adattano alla sezione della barra longitudinale di tipo "integrato".



ISO/PAS 11154



Esempio : Fiat Panda III



Esempio: Opel Astra s.w.

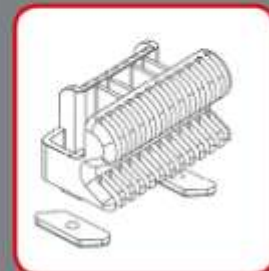
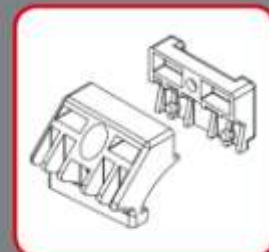

KIT

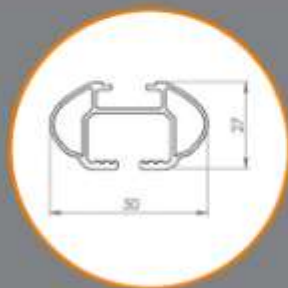

CITY CRASH TEST



ISO/PA5 11154

OK
X4

Easy One S.W.

Barre da tetto in profilo di Alluminio complete di piedi premontati e pronte all'utilizzo su autovetture con barre longitudinali di tipo standard. Con l'abbinamento del Kit Trek, è consentito il montaggio su nuove tipologie di barre longitudinali di tipo "integrato" (consultare la guida applicazione). Fornite di antifurto con 4 serrature a chiave. Disponibili in 2 lunghezze cm. 120 - cm. 135

Unix cikksz:

774788

774789

Cod 156 915 = cm 120 Alluminio

Cod 156 930 = cm 135 Alluminio



KIT Trek

Per veicoli con barre longitudinali tipo S.W. «Integrate»

La barra Easy One S.W. può essere montata su barre longitudinali di ultima generazione "integrate", utilizzando lo specifico Kit Trek (consultare la guida applicazione)



Easy One S.W.



Barre da tetto in tubolare di acciaio complete di piedi premontati e pronte all'utilizzo su autovetture con barre longitudinali di tipo standard. Con l'abbinamento del Kit Trek, è consentito il montaggio su nuove tipologie di barre longitudinali di tipo "Integrato" (consultare la guida applicazione) Fornite di antifurto con 2 serrature a chiave. Disponibili in 2 lunghezze cm. 120 - cm. 135

Cod. 156 815 = cm 120 Acciaio
Cod. 156 830 = cm 135 Acciaio

Unix cikksz:
774786
774787

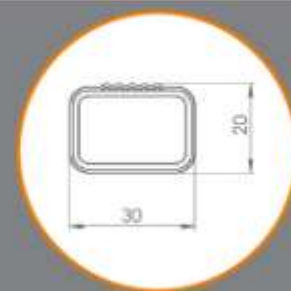

CITY CRASH TEST



ISO/PAS 11154



OK
X2



KIT Trek

Per veicoli con barre longitudinali tipo S.W. «Integrate»

La barra Easy One S.W. può essere montata su barre longitudinali di ultima generazione "Integrate", utilizzando lo specifico Kit Trek (consultare la guida applicazione)

Easy One

Barre da tetto in tubolare di acciaio complete di piedi premontati e pronte all'utilizzo
Il kit di fissaggio, incluso nella confezione, è completo per il montaggio su veicoli con tetto normale
o con predisposizioni tipo Fix Point
(consultare la guida applicazione)



Profilo a sezione ovale



DIN 75302



Kit di fissaggio incluso



Initial

Barre da tetto complete di fissaggi per l'applicazione su veicoli equipaggiati di barre longitudinali di tipo standard.
(consultare la guida applicazioni)

Cod 156 596 = cm 132 Alluminio

Cod 156 597 = cm 132 Acciaio

Unix cikksz:

774779

774649

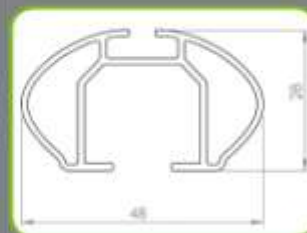

Alluminio



Acciaio





Original PRO

Barre da tetto in acciaio specificatamente studiate per il trasporto di carichi pesanti su veicoli commerciali.

Proposte in 2 versioni : per equipaggiare il veicolo con 2 o 3 barre.

Speciale profilo in acciaio a forma di "H" = maggiore resistenza per i carichi pesanti!

Cod 156 535 = N° 1 traversa da cm 135

Cod 156 550 = N° 1 traversa da cm 150

Cod 156 570 = N° 1 traversa da cm 170

Unix cikksz:

774618

774619

774620

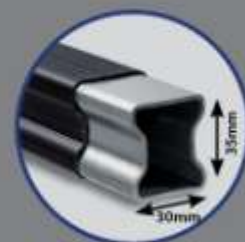

Profilo ad alta resistenza.



CITY CRASH TEST

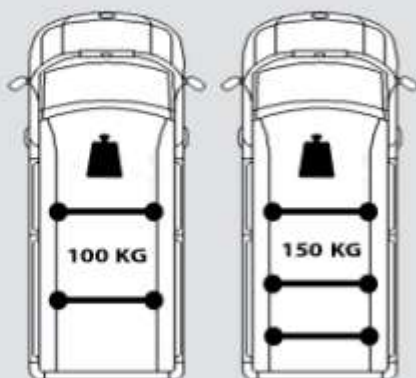



Disponibili in versione 2 barre
o 3 barre per rispondere
a tutte le necessità.



CITY CRASH TEST

Original PRO

Specifico Kit di fissaggio in copolimero.
I kit Green Valley sono studiati per essere montati solo sulle predisposizioni originali
consigliate dalla casa costruttrice del veicolo.
(consultare la guida applicazione)

KIT



Montaggio rapido



Accessori adattabili al bisogno dei professionisti





Per veicoli commerciali



Lista applicazione sui 2 lati



CITY CRASH TEST

Consultare la Guida Applicazioni per conoscere il N° del Kit corrispondente al Vs/veicolo



Original PRO



Cod 156 790

Rullo carica scale completo di supporto per il fissaggio sulle barre Pro

Unix cikkszám: 774811



Cod 156 700

Set di 2 fermi per barre da tetto Pro

Unix cikkszám: 774621





Fix & Slide

Nuovo accessorio da applicare su barre porta tutto.

In Alluminio con meccanismo di scorrimento all'esterno del tetto per facilitare il carico o scarico

A questo accessorio è possibile montare n° 2 portabiciclette, per il trasporto di n° 2 bici oppure il porta Kayak , etc...

Cod.150 028

Unix cikkszám: 774808

NEW



Prodotto
Brevettato/Patent



Fix & Slide



Adventure 635

Portabicicletta per barre porta tutto
Struttura semplice e professionale per il trasporto della bicicletta sulla forcella.

Adatto anche alle biciclette con freno a disco

Adattatori a "T" per barre in alluminio, inclusi

La speciale culla in plastica garantisce un buon fissaggio dei pneumatici

La cinghia a rilascio rapido, regolabile per adattarsi a pneumatici di qualsiasi misura, mantiene saldamente in posizione la ruota.

Cod 160 635

Unix cikkszám: 774792



INCLUSO



Adventure 634

Green Valley
SPORTS

Portabicicletta per barre portatutto
Consente il trasporto di biciclette anche con telaio ovale da 30 a 80 mm
Interamente in Alluminio
Speciali culle in plastica garantiscono un buon fissaggio dei pneumatici
Le cinghie a rilascio rapido, regolabili per adattarsi a pneumatici di qualsiasi misura, mantengono saldamente in posizione le ruote.
Con antifurto a chiave, è dotato di una pinza con camma.
Adattatori a "T" per barre in alluminio, inclusi

Cod 160 634

Unix cikkszám: 774791



Adventure 630

Portabicicletta per barre portatutto
Consente il trasporto di biciclette con telaio con sezione da 20 mm a 55 mm.
Realizzato in acciaio ad alto spessore e verniciato con trattamento anticorrosione.
Cod 160 633

Unix cikkszám: 774815



Adventure 621



Portabicicletta per portellone posteriore
 Confezionato assemblato e pronto all'utilizzo
 Dotato di pinze blocca telaio per un fissaggio ottimale di ogni bicicletta durante il trasporto.
 Portata = 3 biciclette (max 45 kg)
 (consultare la guida applicazione per trovare l'applicazione sul veicolo)

Cod 160 621

Unix cikkszám: 774626

**COMPLETAMENTE
 PREMONTATO**



Confezionato assemblato e pronto all'utilizzo per un tempo minimo di montaggio sul veicolo.



Dotato di pinze bloccatelaio per un fissaggio ottimale di ogni bicicletta durante il trasporto.



Adventure 620

Portabicicletta per portellone posteriore o baule
 Confezionato assemblato e pronto all'utilizzo
 Dotato di pinze blocca telaio per un fissaggio ottimale di ogni bicicletta durante il trasporto.
 Portata = 3 biciclette (max 45 kg)
 (consultare la guida applicazione per trovare l'applicazione sul veicolo)

Cod 160 620

Unix cikkszám: 774625



Confezionato assemblato e pronto all'utilizzo per un tempo minimo di montaggio sul veicolo.



Dotato di pinze bloccatelaio per un fissaggio ottimale di ogni bicicletta durante il trasporto.



**COMPLETAMENTE
PREMONTATO**



Adventure 636



Portabicicletta per gancio di traino. Si monta e si smonta facilmente.
 Specifiche culle per fissare i pneumatici della bicicletta. Braccio centrale per fissare saldamente il telaio delle biciclette.
 Portata N° 2 biciclette (max 30 kg). Completo di porta targa e luci con connettore a 7 punti.

Cod 160 636

Unix cikkszám: 774816



Adventure 610

5'
Montaggio rapido



COMPLETAMENTE PREMONTATO

PORTABICICLETTA PER GANCIO DI TRAINO
La semplice struttura garantisce un montaggio semplice e veloce senza l'utilizzo di utensili
Portata = 2 biciclette (max 30 kg)

Cod 160 610

Unix cikkszám: 774624

ADATTATORE PER TELAIO
Traversa di collegamento per ciclo con telaio speciale.
Da utilizzarsi per un corretto posizionamento del ciclo
nei bracci del portabici posteriore.

Cod 160 641

Unix cikkszám: 774817

PORTA TARGA
Supporto di luci per seconda targa.
Si applica al portabicicletta posteriore nel caso
le luci del veicolo non rimangono visibili.
Completo di fari e spina a 7 poli.

Cod 2919

Unix cikkszám: 774650



CINGHIETTI
Parti di ricambio: Set di 6 cinghie per
il fissaggio delle biciclette al portabicicletta
Adventure 610/620/621.

Cod 160 651

Unix cikkszám: 774818



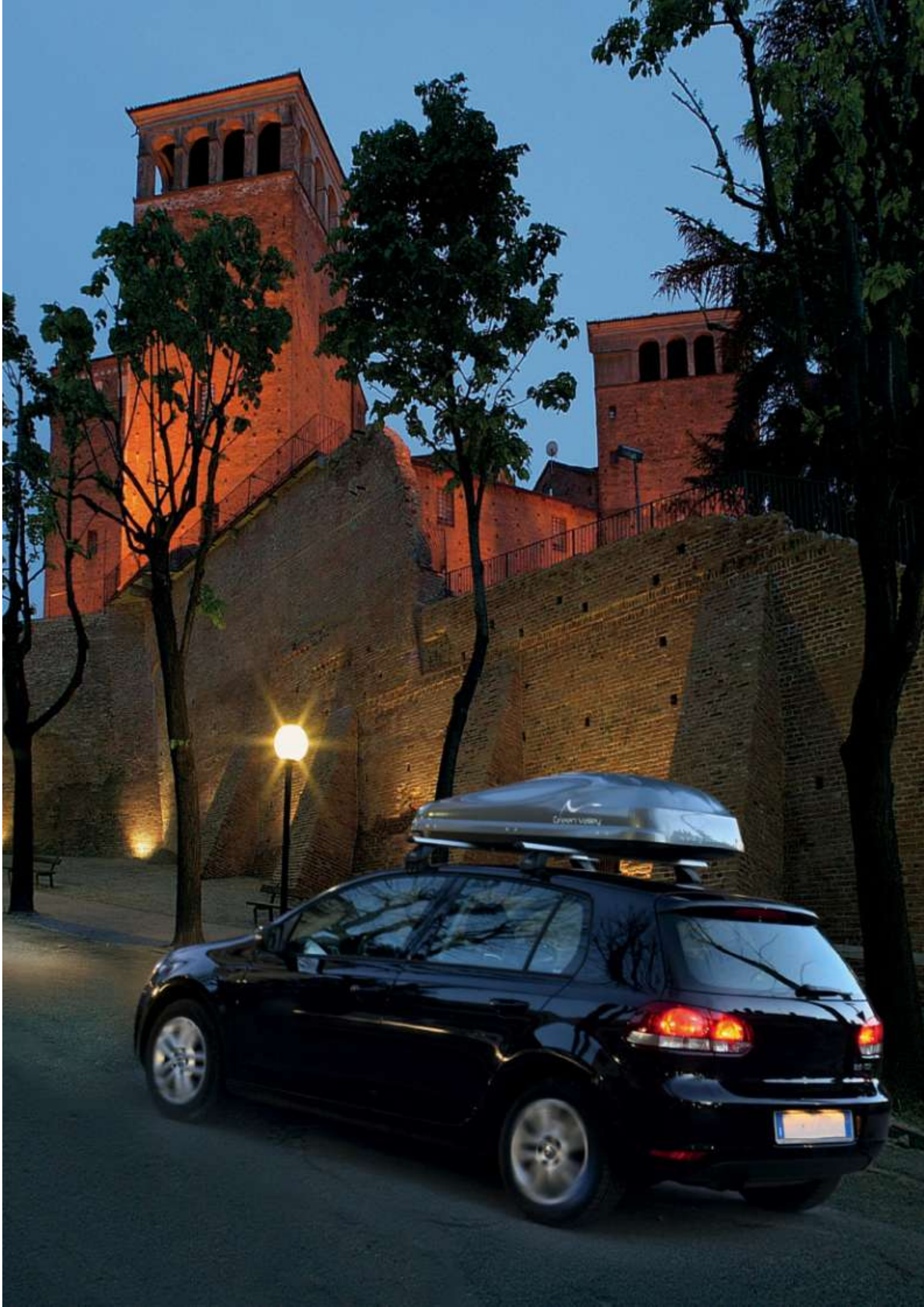

Connemara 500

Contenitore portatutto dalla forma particolarmente aerodinamica

Sistema di chiusura centralizzata

Apertura su due lati "Dual Side"

Sistema di fissaggio alle barre Ultrarapido

Dimensioni: cm 200x90x41

Volume: Litri 500

Cod 158 501

Unix cikkszám: 774814



Sistema di fissaggio rapido

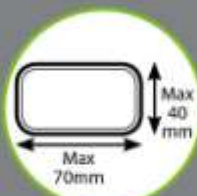

Per barre



Chiusura centralizzata

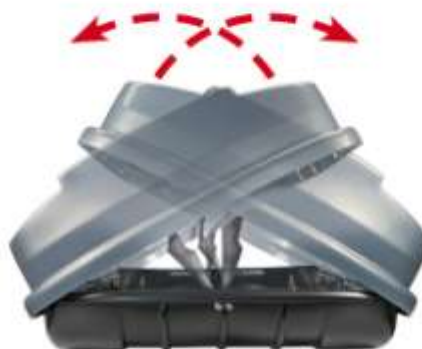

Connemara 460



Contenitore portatutto dalla forma particolarmente aerodinamica

Sistema di chiusura centralizzata

Apertura su due lati "Dual Side"

Sistema di fissaggio alle barre Ultrarapido

Dimensioni: cm 185x80x41

Volume: Litri 460

Cod 158 463

Unix cikkszám: 774813



Sistema di fissaggio rapido

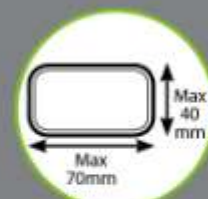

Per barre



Chiusura centralizzata



Unico 420

Contenitore portatutto dalla forma particolarmente aerodinamica

Sistema di chiusura centralizzata

Sistema di fissaggio alle barre di tipo standard

Dimensioni: cm 145x94x90

Volume: Litri 420

Cod 170 420

Unix cikkszám: 774819



Sistema di fissaggio a «U»



Per barre



Sherpack 100 270L

BOX RIPIEGABILE PER LA MASSIMA PRATICITÀ

Ripiegabile per un agevole trasporto.

Sistema di fissaggio alle barre senza bisogno di utensili

Realizzato in materiale impermeabile

Cod 158 002

Unix cikkszám: 774812



20x100x10cm - 3Kg

In dotazione la speciale custodia
per riporre il box arrotolato



Stoccaggio facilitato!

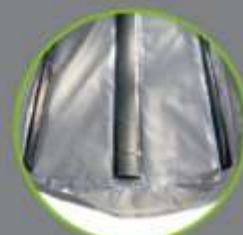

Rinforzi in metallo





Slide RIDER



SLIDE RIDER

Portasci per barre porta tutto

Interamente in profilo di Alluminio

Lo scorrimento laterale consente un più facile

posizionamento degli sci

Dotato di chiusura antifurto a chiave

Cod 160 502

Unix cikkszám: 774790

Consente il trasporto di:

- 6 paia di sci tipo normale

Oppure

5 paia di sci tipo Carving

Oppure

8 paia di sci tipo Fondo

Oppure 4 Snow Board

Adattatori a "T" per barre in alluminio, inclusi



Aluminium
Aluminio
Alluminio



RIDER 5

RIDER 5

Portasci per barre porta tutto
Dotato di chiusura antifurto a chiave
Consente il trasporto di:
- 6 paia di sci tipo normale
Oppure
5 paia di sci tipo Carving
Oppure
8 paia di sci tipo Fondo
Oppure 4 Snow Board
Adattatori a "T" per barre
in alluminio, inclusi



Cod 160 506

Portasci in acciaio per 5 paia

Unix cikkszám: 774686



Cod 160 509

Accessorio optional per tutti i portasci Green Valley
Set di 4 fissaggi per traverse
con sezione sino a 80 mm

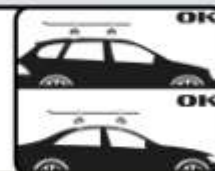
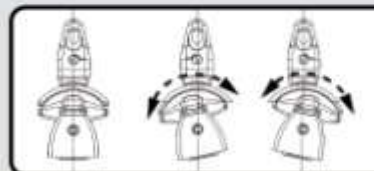

Unix cikkszám: 774688

CINGHIE PER IL FISSAGGIO



2 cinghie ad anello + ganci

3m x 25mm

Cod 240 001

x2



3m

2 cinghie ad anello + ganci

25mm

2m x 50mm

Cod 240 002

x2



2m

50mm

Cinghia con cricchetto + ganci

Cod 240 003

x2

25mm

3.5m x 25mm



Cinghia con cricchetto + ganci

3.5m

Cod 240 006

x1

35mm

5m x 35mm



Cinghia con cricchetto + ganci

5m

Cod 240 004

x1

50mm

5m x 50mm

Cinghia con cricchetto + ganci



5m

40

Green Valley
EQUIPMENT

Cinghie Pro

20mm

30 à 100cm

Regolabile

Cod 240 016

Cinghia elastica regolabile



x1



9m maxi
5T

Cod 810 069

Cinghia con ganci tondino



x1



9m maxi
5T

Cod 810 659

Cinghia con ganci sponda



x1



12m maxi
5T

Cod 810 652

Cinghia con ganci sponda



x1



17m maxi
5T

Cod 810 657

Cinghia con ganci sponda



x1



6m maxi
2T

Cod 240 827

Cinghia con ganci tondino



x1





2.5m x 25mm

Cod 240 821

2 cinghie a fibbia



x2



3.5m x 25mm

Cod 240 822

2 cinghie a fibbia



5m x 25mm

Cod 240 824B

Cinghie a fibbia



x2



5m x 25mm

Cod 240 826

Cinghia con cricchetto 2 ganci



x1



5m x 25mm

Cod 240 832

Cinghia con cricchetto



x1



x1



Cod 240 897
(fornito vuoto)



xx cm

xx cm

xx cm



TABELLA PESI E DIMENSIONI IMBALLI

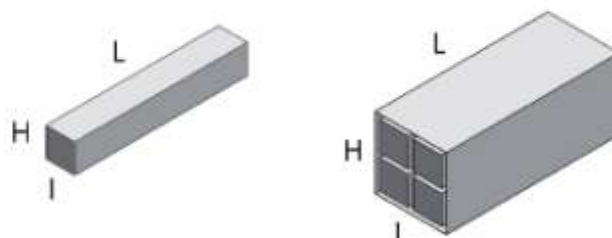

cod.	I cm.	H cm.	L cm.	Kg.	Qty	I cm.	H cm.	L cm.	Kg.	Qty
156 607	7	6,7	118	2,3	1	33	17	120	19,42	6
156 613	7	6,7	118	2,39	1	33	17	120	20,13	6
156 620	7	6,7	131	2,57	1	33	17	133	21,56	6
156 626	7	6,7	131	2,66	1	33	17	133	22,27	6
156 642	7	6,7	147	2,98	1	33	17	149	24,85	6
156 507	3,8	6	117	2,89	1	15,5	15	119	18,32	6
156 513	3,8	6	117	3,03	1	15,5	15	119	19,18	6
156 520	3,8	6	130	3,23	1	15,5	15	132	20,37	6
156 526	3,8	6	130	3,38	1	15,5	15	132	21,27	6
156 542	3,8	6	146	3,8	1	15,5	15	148	23,82	6
156 500	10	25	26,5	1	1	21	50,5	27	4,1	4
156 600	16,5	16	17	1,4	1	36,5	35,5	37,5	12,25	8
156 915	10	15	135	3,4	1	21	30,5	136	14,1	4
156 930	10	15	135	3,7	1	21	30,5	136	15,3	4
156 815	10	15	135	2,8	1	21	30,5	136	11,7	4
156 830	10	15	135	3	1	21	30,5	136	12,6	4
156 597	7	3,5	135	3,5	1	21	28	135	42,5	12
156 596	9	4,5	135	2,5	1	21	28	135	30,5	12
156 535	3	3,5	135	2,25	1	10	12,5	140	14,0	6
156 550	3	3,5	150	2,42	1	10	12,5	155	15,1	6
156 570	3	3,5	170	2,8	1	10	12,5	175	17,7	6
156 790	8	9	71	1,5	1	x	x	x	x	x
156 700	8	10	20	0,5	1	18	31	22	3,2	6
160 610	8	26	78	5,4	1	x	x	x	x	x
160 620	13	50	72	7,0	1	51	55	73	28,5	4
160 621	18	63	106	8,0	1	37	64	107	16,5	2
160 630-1	6	20	75	2,5	1	23,5	34	78	15,8	6
160 634	10	25	130	2,5	1	22	26,5	135	5,5	2
160 635	13	18	112	2	1	26	36	115	8,5	4
160 502	14	15	79	4,0	1	28,5	30,5	80	16,5	4
160 506	13	14	79	4,0	1	26,5	28,5	80	16,5	4
160 507	13	14	79	3,8	1	26,5	28,5	80	15,7	4
160 509	21	7	23	0,3	1	x	x	x	x	x
kit Original	20	8	20	1	1	22	18	43	4,2	4
kit Trek	8	10	20	0,5	1	18	31	22	3,2	6
kit Pro x 4	9	22	25	1,5	1	x	x	x	x	x
Kit Pro x 6	10	23	34	2,5	1	x	x	x	x	x
Easy One	15	11	127	3,5	1	30	25,5	130	14,5	4



Aurilis[®]
Group-Italia srl



Aurilis Group Italia S.R.L.
Via Torino , 101
12045 Fossano (Cn) Italy
Tel. : +39 0172 694 590
Fax : +39 0172 657 553
info@aurilisitalia.com
www.aurilisitalia.com