

# Car Racing Pads Products Range

Part Number	DS2500	4300	DS3000	DS 1.11	DSUNO
	H	C	R	W	Z
FCP2	✓	✘	✓		✘
FCP3	✓		✓	✘	
FCP9	✓		✓		
FCP11	✓		✓	✘	✓
FCP22	✓				
FCP29	✓		✓		
FCP39		✘			
FCP72	✓		✓		
FCP93	✓		✓		
FCP96	✓		✓		
FCP105			✘		
FCP116	✓		✓		
FCP167	✓	✓	✓	✘	✓
FCP170		✓			
FCP173	✓		✓		
FCP206	✓		✓		✘
FCP253	✘				
FCP256	✓		✓		
FCP276	✓		✓		
FCP296	✓		✓	✘	
FCP308	✓		✓		
FCP342	✓	✓	✓	✘	✘
FCP351	✓		✓		✓
FCP360	✓				
FCP370	✓	✘	✓	✘	✘
FCP372	✓		✘	✘	✘
FCP385	✘				
FCP392	✓		✓	✘	
FCP393	✓		✓		
FCP399	✓		✓		
FCP406	✓		✓		
FCP408	✓		✓		✘
FCP409	✓		✓		
FCP415	✓		✓		
FCP419	✓		✓		
FCP434	✓		✘		
FCP441		✘	✓		
FCP448	✓		✓		
FCP451	✓		✓	✘	✓
FCP461	✓		✓		
FCP472	✓		✓		
FCP483	✓		✓		✘
FCP484	✓	✘	✘		
FCP487	✓		✘		
FCP519				✘	✘
FCP524			✓		
FCP527	✓		✓		
FCP535	✓	✘	✓		
FCP541	✓	✓	✓	✘	✘
FCP546	✓		✓		
FCP558	✓	✘	✓		
FCP560	✓		✓	✘	
FCP565	✓		✓	✓	
FCP578	✓		✓	✘	
FCP584	✓		✓		
FCP586	✓		✓		
FCP590	✓		✓	✘	
FCP596	✓		✓		
FCP598	✓		✓		
FCP600	✓		✘		
FCP602	✓		✘		
FCP613	✓		✓		
FCP617	✓				
FCP638	✓				
FCP646	✓			✘	
FCP647	✘				
FCP660	✓		✓	✘	
FCP685	✓		✓		

Part Number	DS2500	4300	DS3000	DS 1.11	DSUNO
	H	C	R	W	Z
FCP691	✓				
FCP721	✓		✓	✘	
FCP725	✓		✓	✓	
FCP726	✓		✓		
FCP732	✓		✓		
FCP748	✓				
FCP761	✘				
FCP765	✓		✓	✓	✓
FCP766	✘		✘		
FCP767			✘		
FCP774	✓		✓		
FCP775	✓		✓		
FCP776	✓		✓		✘
FCP777	✓				
FCP779	✓		✓	✘	
FCP789	✓		✓		
FCP790	✓		✓		
FCP809	✓	✓	✓	✘	✓
FCP810	✓	✘	✓	✘	✘
FCP815	✓	✘	✓	✘	
FCP817	✓		✓		
FCP823			✘		
FCP825	✓	✓	✓	✓	✓
FCP832	✘		✓		
FCP840		✘	✓		
FCP845	✓	✓	✓	✘	
FCP850	✓		✓	✓	✓
FCP856	✓		✘		
FCP857	✓		✓		
FCP859	✘		✓		
FCP867	✓				
FCP876	✓		✓		
FCP878	✓		✓		
FCP881	✘				
FCP891	✓		✓	✘	
FCP904	✓				
FCP905	✓		✓		
FCP925	✓		✓		
FCP948	✓		✓		
FCP956	✓		✓	✘	
FCP986	✓		✓	✘	✓
FCP995	✓				
FCP997			✘		
FCP1001	✓				✓
FCP1011	✓		✘		
FCP1012	✓				
FCP1049	✓				
FCP1050	✓				
FCP1052			✓		
FCP1054	✓				
FCP1056	✓				
FCP1063	✓		✓		
FCP1068	✓				
FCP1073	✓			✘	✘
FCP1081	✓		✓		
FCP1082	✓		✘		
FCP1093	✓		✘		
FCP1094	✓		✘		✘
FCP1101	✘		✘		
FCP1112	✓				
FCP1113	✓		✓		
FCP1133	✓		✓		
FCP1134	✓				
FCP1160	✓				
FCP1162	✓				
FCP1213	✘				
FCP1224			✘		
FCP1280	✓		✓	✘	

Part Number	DS2500	4300	DS3000	DS 1.11	DSUNO
	H	C	R	W	Z
FCP1281	✓		✓	✓	
FCP1283			✓		
FCP1285	✓		✓		
FCP1288	✘				
FCP1289	✘				
FCP1293	✓				
FCP1294	✘				
FCP1295	✓				
FCP1298	✓		✓	✘	✓
FCP1300	✓				
FCP1301	✓		✘		
FCP1307	✓		✓	✓	
FCP1308	✓		✘	✓	
FCP1312	✓				✘
FCP1318	✓		✘		
FCP1319	✓				
FCP1323	✓				
FCP1324	✓				
FCP1327	✓		✘		
FCP1333	✓		✓		
FCP1334	✓		✓	✓	✓
FCP1348	✓		✓	✓	✘
FCP1349	✓		✘		
FCP1368	✓		✘		
FCP1370	✓		✓		
FCP1372	✓		✓		
FCP1376	✓		✓		
FCP1378	✓		✓		
FCP1382	✘				
FCP1392	✓				
FCP1394	✓		✓		
FCP1399	✓		✓		
FCP1419	✓		✓		
FCP1424	✓				
FCP1430	✓				
FCP1436	✘				
FCP1437	✘				
FCP1441	✓				
FCP1444	✓		✓	✓	
FCP1459			✘		
FCP1466	✓		✘		✘
FCP1467	✓		✓		✓
FCP1468	✓		✓		
FCP1469	✓		✓		
FCP1483	✓		✘	✘	✘
FCP1491	✓			✓	
FCP1499	✓		✓	✘	
FCP1501			✘		
FCP1520	✓				
FCP1528	✓		✓		
FCP1540	✓				
FCP1543	✘		✓		
FCP1553	✓		✘	✘	✘
FCP1560	✓		✘	✓	
FCP1561	✓		✓	✓	✓
FCP1562	✓		✓	✓	✓
FCP1563	✘			✘	✘
FCP1568	✓		✓		
FCP1573	✓				
FCP1617			✓	✘	✘
FCP1625	✓				
FCP1626	✓				
FCP1628	✓		✘	✓	✓
FCP1629	✓				
FCP1631	✘				
FCP1636	✓				
FCP1639	✓			✘	
FCP1641	✓		✘	✓	✓

# Car Racing Pads Products Range

Part Number	DS2500	4300	DS3000	DS 1.11	DSUNO
	H	C	R	W	Z
FCP1655	✓				
FCP1661	✓				
FCP1664	✓				
FCP1667	✓		✓	✓	✓
FCP1672	✓			✓	✓
FCP1676	✓				
FCP1690	✓				
FCP1693	✓				
FCP1706	✓			✓	
FCP1725	✓		✓	✓	
FCP1747	✓				
FCP1751	✓		✓		
FCP1765	✓			✓	✓
FCP1773	✓				
FCP1783	✓		✓		
FCP1786	✓				
FCP1790	✓				
FCP1805	✓				
FCP1806	✓				
FCP1807	✓				
FCP1808	✓				
FCP1858	✓				
FCP1859	✓				
FCP1862	✓				
FCP1917	✓				
FCP1954	✓				
FCP1975	✓				
FCP4044	✓				
FCP4045	✓				
FCP4050	✓				
FCP4064	✓				
FCP4080	✓			✓	
FCP4168	✓		✓	✓	
FCP4172	✓				
FCP4173	✓				
FCP4187	✓			✓	
FCP4191	✓				
FCP4217	✓		✓		
FCP4218	✓		✓		
FCP4316	✓				
FCP4353	✓				
FCP4416	✓				
FCP4426	✓		✓		✓
FCP4430	✓				
FCP4433	✓				
FCP4612	✓				
FRP101			✓		
FRP201	✓	✓	✓	✓	✓
FRP202	✓	✓	✓		
FRP203	✓		✓		✓
FRP212	✓		✓	✓	✓
FRP216	✓	✓	✓	✓	✓
FRP217			✓	✓	✓
FRP218	✓	✓	✓	✓	
FRP219	✓	✓	✓	✓	✓
FRP302	✓		✓	✓	✓
FRP308	✓	✓	✓	✓	✓
FRP501	✓		✓	✓	✓
FRP502	✓	✓	✓	✓	
FRP503	⚠		✓	✓	
FRP504	✓		✓	✓	✓
FRP506	✓	✓	✓	✓	
FRP1058			✓	✓	
FRP1059			⚠		
FRP1060			✓		✓
FRP1061			✓		
FRP1064			✓		
FRP1077	✓		✓	✓	✓

Part Number	DS2500	4300	DS3000	DS 1.11	DSUNO
	H	C	R	W	Z
FRP1078			✓	✓	✓
FRP1079	✓	✓	✓		
FRP3000	✓		✓	✓	
FRP3001	⚠	⚠	⚠		
FRP3003	✓	⚠	✓	✓	✓
FRP3004			✓		
FRP3006	✓				
FRP3007	✓		✓		✓
FRP3009			✓		
FRP3012			✓	✓	
FRP3014			✓	✓	✓
FRP3015				✓	
FRP3018	✓		✓	✓	
FRP3020			✓		
FRP3021		✓			
FRP3022			✓	✓	
FRP3023			✓		
FRP3024			✓	✓	✓
FRP3025			✓		
FRP3026			✓		
FRP3027	✓				
FRP3028	✓		✓	✓	
FRP3029	✓		✓	✓	✓
FRP3030			✓	✓	✓
FRP3031			✓	✓	✓
FRP3032			✓		
FRP3033					
FRP3034			✓		
FRP3035			✓		
FRP3037				✓	
FRP3039			✓	✓	
FRP3040					✓
FRP3042			✓	✓	
FRP3043			✓		✓
FRP3044			✓		
FRP3045			✓		
FRP3046				✓	
FRP3050	✓		✓	✓	
FRP3051	✓		✓	✓	
FRP3053			✓	✓	
FRP3054	✓		✓	✓	✓
FRP3055			✓	✓	✓
FRP3056	✓	✓	✓		
FRP3057	✓		✓	✓	✓
FRP3058	✗		✓	⚠	✓
FRP3059			✓	✗	
FRP3060			✗	✓	
FRP3061			✓	✓	✓
FRP3062			✓	✓	
FRP3067	✓		✓	✓	
FRP3069	✓		✓	✓	✓
FRP3070			✓	✓	
FRP3071	✓	✓	✓	✓	✓
FRP3073			✓		
FRP3074			✓		
FRP3075	✓		✓	✓	
FRP3076	✓		✓		✓
FRP3077	✓		✓	✓	✓
FRP3078	✓		✓		
FRP3080			✓	✓	✓
FRP3081	✓		✓	✓	✓
FRP3082	✓		✓	✓	✓
FRP3083	✓		✓	✓	✓
FRP3084	✓		✓	✓	✓
FRP3085	✓		✓	✓	✓
FRP3086			✓		
FRP3087			✓	✓	✓
FRP3088			✓	✗	✓

Part Number	DS2500	4300	DS3000	DS 1.11	DSUNO
	H	C	R	W	Z
FRP3091			✓		
FRP3092				✓	✓
FRP3094	✓			✓	✓
FRP3095	✓			✓	✓
FRP3096	✓			✓	✓
FRP3097	✓		✓	✓	✓
FRP3098	✓		✓	✓	✓
FRP3099	✓		✓	✓	✓
FRP3100	✓		✓		
FRP3101					✓
FRP3102				✓	✓
FRP3103				✓	✓
FRP3104		✓	✓		
FRP3105			✓		
FRP3106	✓		✓	✓	✓
FRP3107	✓		✓		
FRP3108	✓				✓
FRP3109	✓				
FRP3110			✓	✓	✓
FRP3112					✓
FRP3113	✓		✓		
FRP3114	✓		✓	✓	
FRP3115	✓		✓	✓	
FRP3116	✓		✓	✓	✓
FRP3117			✓		
FRP3118				✓	
FRP3119					✓
FRP3120	✓				
FRP3121	✓				✓
FRP3122				✓	
FRP3123					✓
FRP3126	✓				
FRP3127	✓				
FRP3128					✓
FRP3129	✓				
FRP3130	✓			✓	
FRP3133	✓				
FRP3134	✓		✓		✓
FRP3135	✓		✓		✓
FRP3136	✓				
FRP3137	✓				
FRP5001			✓	✓	
FRP5002			✓	✓	

- ✓ Available
- ✗ Not Available
- ⚠ In Introduction
- ⚠ Exhausting
- ✉ Make to order

# Equivalent Ferodo Pad Shapes

Part Number	DIMENSIONS	ALSO AVAILABLE				
	Length x Height x Thickness (mm)	Shape	Th. mm	Shape	Th. mm	Notes
FCP22	109.0 x 36.0 x 10.0 mm	FCP29	17.5			
FCP29	108.9 x 37.0 x 17.3 mm	FCP22	10			
FCP116	76.7 x 50.1 x 16.5 mm	FCP1562	14.6			
FCP351	108.9 x 42.4 x 18.0 mm	FCP360	12			
FCP360	108.9 x 42.4 x 12.0 mm	FCP351	18			
FCP392	140.0 x 46.0 x 15.3 mm	FCP419	19.7			
FCP419	138.0 x 45.3 x 19.7 mm	FCP392	15.3			
FCP451	97.9 x 50.8 x 18.0 mm	FRP3069	16			
FCP541	87.0 x 41.0 x 15.0 mm	FCP1491	16			
FCP558	105.2 x 42.0 x 11.0 mm	FCP881	15			
FCP721	109.8 x 51.3 x 17.3 mm	FCP1348	15	FRP3109	12.5	
FCP774	119.0 x 47.5 x 16.2 mm	FCP775	19.6			
FCP775	119.0 x 47.5 x 19.6 mm	FCP774	16.2			
FCP857	123.2 x 54.8 x 17.0 mm	FCP1483	17.2			
FCP881	105.2 x 42.0 x 15.0 mm	FCP558	11			
FCP891	131.8 x 66.0 x 17.5 mm	FRP3042	26.5			
FCP905	148.8 x 50.5 x 18.5 mm	FRP3062	19.5			
FCP1054	141.8 x 45.0 x 19.3 mm	FCP1101	17.3	FCP1288	15.3	
FCP1101	142.0 x 45.0 x 17.3 mm	FCP1054	19.3	FCP1288	15.3	
FCP1281	131.8 x 51.5 x 18.2 mm	FRP3028	16			
FCP1288	141.8 x 45.0 x 15.3 mm	FCP1054	19.3	FCP1101	17.3	
FCP1289	119.0 x 47.5 x 19.9 mm	FCP1312	16			
FCP1312	119.0 x 47.2 x 16.0 mm	FCP1289	19.9			
FCP1334	131.8 x 62.0 x 16.0 mm	FRP3067	14.7			
FCP1348	109.8 x 51.3 x 15.0 mm	FCP721	17.3	FRP3109	12.5	
FCP1483	123.0 x 59.4 x 17.2 mm	FCP857	17			
FCP1491	87.4 x 40.5 x 16.0 mm	FCP541	15			
FCP1560	126.0 x 41.0 x 12.9 mm	FCP878	14.6			
FCP1562	76.8 x 45.0 x 14.6 mm	FCP116	16.5			
FRP212	132.4 x 50.3 x 20.3 mm	FRP216	17			
FRP216	132.4 x 50.3 x 17.0 mm	FRP212	20.3			
FRP302	131.8 x 49.0 x 20.0 mm	FRP1077	16	FRP3007	18	
FRP308	99.8 x 43.6 x 20.0 mm	FRP1079	16			
FRP501	133.0 x 43.0 x 20.0 mm	FRP3097				
FRP1058	79.8 x 45.5 x 18.0 mm	FRP1064	20			
FRP1059	84.8 x 51.5 x 22.0 mm	FRP3004	20	FRP3045	18	
FRP1060	152.0 x 45.0 x 25.0 mm	FRP3000	18			
FRP1064	79.8 x 45.5 x 20.0 mm	FRP1058	18			
FRP1077	131.8 x 49.0 x 16.0 mm	FRP302	20	FRP3007	18	
FRP1078	131.8 x 49.0 x 25.0 mm	FRP302	20	FRP3007	18	
FRP1079	99.8 x 43.6 x 16.0 mm	FRP308	20			
FRP3000	152.0 x 45.0 x 18.0 mm	FRP1060	25			
FRP3003	152.1 x 54.0 x 18.0 mm	FRP3014	25	FRP3077	17	
FRP3004	84.8 x 51.5 x 20.0 mm	FRP1059	22	FRP3045	18	
FRP3007	131.8 x 49.0 x 18.0 mm	FRP302	20	FRP1078	25	
FRP3009	131.7 x 59.0 x 16.0 mm	FRP3012	20			
FRP3012	131.7 x 59.0 x 20.0 mm	FRP3009	16			
FRP3014	152.1 x 54.0 x 25.0 mm	FRP3003	18	FRP3077	17	
FRP3015	152.1 x 54.0 x 28.5 mm	FRP3003	18	FRP3077	17	
FRP3018	132.4 x 42.0 x 16.7 mm	FRP3073	20.3			
FRP3020	86.2 x 46.0 x 15.0 mm	FRP3086	18			
FRP3022	79.8 x 50.5 x 20.0 mm	FRP3023	17.5	FRP3033	21	
FRP3023	79.8 x 50.5 x 17.5 mm	FRP3022	20	FRP3033	21	
FRP3024	139.8 x 48.0 x 20.0 mm	FRP3029	26	FRP3087	17.5	
FRP3028	131.8 x 51.5 x 16.0 mm	FCP1281	18.2			
FRP3029	139.8 x 48.0 x 26.0 mm	FRP3024	20	FRP3087	17.5	

## Equivalent Ferodo Pad Shapes

Part Number	DIMENSIONS	ALSO AVAILABLE				
	Length x Height x Thickness (mm)	Shape	Th. mm	Shape	Th. mm	Notes
FRP3030	139.8 x 48.0 x 28.0 mm	FRP3024	20	FRP3087	17.5	
FRP3031	163.8 x 52.5 x 29.0 mm	FRP3110	25	FRP3123	21.5	
FRP3032	131.8 x 42.5 x 16.0 mm	FRP3070	18			
FRP3033	79.8 x 50.5 x 21.0 mm	FRP3022	20	FRP3023	17.5	
FRP3034	84.8 x 51.5 x 21.0 mm	FRP1059	22	FRP3045	18	
FRP3037	163.1 x 54.0 x 28.0 mm	FRP3039	25	FRP3055	30	
FRP3039	163.1 x 54.0 x 25.0 mm	FRP3037	28	FRP3055	30	
FRP3040	163.9 x 62.0 x 30.0 mm	FRP3047	22			
FRP3042	131.8 x 66.0 x 26.5 mm	FCP891	17.5			
FRP3045	84.8 x 51.5 x 18.0 mm	FRP1059	22	FRP3034	21	
FRP3047	163.9 x 62.0 x 22.0 mm	FRP3040	30			
FRP3054	152.0 x 51.0 x 18.0 mm	FRP3061	25	FRP3076	17	
FRP3055	163.1 x 54.0 x 30.0 mm	FRP3037	28	FRP3039	25	
FRP3061	152.0 x 51.0 x 25.0 mm	FRP3054	18	FRP3076	17	
FRP3062	148.8 x 50.5 x 19.5 mm	FCP905	18.5			
FRP3067	131.8 x 62.0 x 14.7 mm	FCP1334	16			
FRP3069	97.9 x 50.8 x 16.0 mm	FCP451	18			
FRP3070	132.0 x 42.5 x 18.0 mm	FRP3032	16			
FRP3073	132.4 x 42.0 x 20.3 mm	FRP3018	16.7			
FRP3075	190.4 x 65.8 x 17.5 mm	FRP3096	19			
FRP3076	152.0 x 50.0 x 17.0 mm	FRP3054	18	FRP3061	25	
FRP3077	152.0 x 54.0 x 17.0 mm	FRP3003	18	FRP3015	28.5	
FRP3083	130.3 x 55.0 x 16.9 mm	FRP3107				
FRP3086	86.2 x 46.0 x 18.0 mm	FRP3020	15			
FRP3087	139.8 x 48.4 x 17.5 mm	FRP3024	20	FRP3030	28	
FRP3096	190.4 x 63.5 x 19.0 mm	FRP3075	17.5			
FRP3097	133.2 x 43.0 x 20.4 mm	FRP501				
FRP3107	130.3 x 50.0 x 16.9 mm	FRP3083				
FRP3109	109.8 x 51.3 x 12.5 mm	FCP721	17.3	FCP1348	15	
FRP3110	163.8 x 52.5 x 25.0 mm	FRP3031	29	FRP3123	21.5	
FRP3123	163.8 x 52.5 x 21.5 mm	FRP3031	29	FRP3110	25	





kW

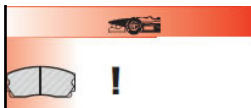

**AC**

**428**

			COMPOUND AVAILABILITY					COMPOUND AVAILABILITY						
			H	C	R	W	Z							
4.1	01/67 → 12/74	FCP9 LUC	✓		✓			FCP815 LUC	✓	✉	✓	✉		

**Ace**

5.0	01/93 →	FCP276 LUC	✓		✓									
-----	---------	------------	---	--	---	--	--	--	--	--	--	--	--	--

**Cobra**

7.0	01/63 → 12/75	FCP9 LUC	✓		✓			FCP815 LUC	✓	✉	✓	✉		
-----	---------------	----------	---	--	---	--	--	------------	---	---	---	---	--	--

**ME 3000**

3.0 E,M	101	01/75 → 12/81	FCP167 LUC	✓	✓	✓	✉	✓	FCP815 LUC	✓	✉	✓	✉	
---------	-----	---------------	------------	---	---	---	---	---	------------	---	---	---	---	--

**Superblower**

4.9	01/97 →	FRP216	✓	✉	✓	✓	✓							
-----	---------	--------	---	---	---	---	---	--	--	--	--	--	--	--

**ACURA**

**CL 4 cylinder**

2.2-2.3 L	01/97 → 12/99	FCP761	✉											
-----------	---------------	--------	---	--	--	--	--	--	--	--	--	--	--	--

**CL 6 cylinder**

3.0 L	01/97 → 12/99	FCP905	✓		✓									
-------	---------------	--------	---	--	---	--	--	--	--	--	--	--	--	--

**Integra**

1.6-1.7-1.8 L	01/90 → 12/93	FCP748	✓											
---------------	---------------	--------	---	--	--	--	--	--	--	--	--	--	--	--

1.6-1.8 L	01/94 → 12/01	FCP1436	✉											
-----------	---------------	---------	---	--	--	--	--	--	--	--	--	--	--	--

**Legend**

3.2 L	01/91 → 12/95	FCP905	✓		✓									
-------	---------------	--------	---	--	---	--	--	--	--	--	--	--	--	--

**Vigor**

2.0-2.5 L	01/94 →	FCP905	✓		✓									
-----------	---------	--------	---	--	---	--	--	--	--	--	--	--	--	--

**ALFA ROMEO**

**145**

1.3 i	66	09/94 → 09/96	FCP370 LUC	✓	✉	✓	✉	✉	FCP1113 LUC	✓		✓		
-------	----	---------------	------------	---	---	---	---	---	-------------	---	--	---	--	--

1.4	66	09/94 → 09/96	FCP370 LUC	✓	✉	✓	✉	✉	FCP409 LUC	✓		✓		
-----	----	---------------	------------	---	---	---	---	---	------------	---	--	---	--	--

1.4 Twin Spark 16V	76	10/96 → 02/99	FCP1056 ATE	✓		✓			FCP409 LUC	✓		✓		
--------------------	----	---------------	-------------	---	--	---	--	--	------------	---	--	---	--	--

1.6	76	09/94 → 11/96	FCP370 LUC	✓	✉	✓	✉	✉	FCP409 LUC	✓		✓		
-----	----	---------------	------------	---	---	---	---	---	------------	---	--	---	--	--

1.6 Twin Spark 16V	88	01/97 → 02/99	FCP1056 ATE	✓		✓			FCP409 LUC	✓		✓		
--------------------	----	---------------	-------------	---	--	---	--	--	------------	---	--	---	--	--

1.7 16V	95	01/97 → 09/00	FCP370 LUC	✓	✉	✓	✉	✉	FCP409 LUC	✓		✓		
---------	----	---------------	------------	---	---	---	---	---	------------	---	--	---	--	--

1.7 16V	95	09/94 → 12/97	FCP370 LUC	✓	✉	✓	✉	✉	FCP409 LUC	✓		✓		
---------	----	---------------	------------	---	---	---	---	---	------------	---	--	---	--	--

1.8 Twin Spark 16V	103	01/95 → 02/99	FCP1056 ATE	✓		✓			FCP409 LUC	✓		✓		
--------------------	-----	---------------	-------------	---	--	---	--	--	------------	---	--	---	--	--

1.9 JTD	77	01/99 → 09/00	FCP1056 ATE	✓		✓			FCP409 LUC	✓		✓		
---------	----	---------------	-------------	---	--	---	--	--	------------	---	--	---	--	--

1.9 TD	68	09/94 → 11/96	FCP370 LUC	✓	✉	✓	✉	✉	FCP409 LUC	✓		✓		
--------	----	---------------	------------	---	---	---	---	---	------------	---	--	---	--	--

1.9 TD	68	12/96 → 12/99	FCP1056 ATE	✓		✓			FCP409 LUC	✓		✓		
--------	----	---------------	-------------	---	--	---	--	--	------------	---	--	---	--	--

2.0 Twin Spark 16V	110	01/96 → 02/99	FCP1052 ATE	✓		✓			FCP409 LUC	✓		✓		
--------------------	-----	---------------	-------------	---	--	---	--	--	------------	---	--	---	--	--

**146**

1.3 i	66	09/94 → 09/96	FCP370 LUC	✓	✉	✓	✉	✉	FCP1113 LUC	✓		✓		
-------	----	---------------	------------	---	---	---	---	---	-------------	---	--	---	--	--

1.4	66	09/94 → 09/96	FCP370 LUC	✓	✉	✓	✉	✉	FCP409 LUC	✓		✓		
-----	----	---------------	------------	---	---	---	---	---	------------	---	--	---	--	--

1.4 Twin Spark 16V	76	01/96 → 02/99	FCP1056 ATE	✓		✓			FCP409 LUC	✓		✓		
--------------------	----	---------------	-------------	---	--	---	--	--	------------	---	--	---	--	--

1.6	76	09/94 → 12/97	FCP370 LUC	✓	✉	✓	✉	✉	FCP409 LUC	✓		✓		
-----	----	---------------	------------	---	---	---	---	---	------------	---	--	---	--	--

1.6 Twin Spark 16V	88	01/97 → 02/99	FCP1056 ATE	✓		✓			FCP409 LUC	✓		✓		
--------------------	----	---------------	-------------	---	--	---	--	--	------------	---	--	---	--	--

1.7 16V	95	01/97 → 09/00	FCP370 LUC	✓	✉	✓	✉	✉	FCP409 LUC	✓		✓		
---------	----	---------------	------------	---	---	---	---	---	------------	---	--	---	--	--

1.7 16V	95	09/94 → 12/97	FCP370 LUC	✓	✉	✓	✉	✉	FCP409 LUC	✓		✓		
---------	----	---------------	------------	---	---	---	---	---	------------	---	--	---	--	--

1.8 Twin Spark 16V	103	01/95 → 02/99	FCP1056 ATE	✓		✓			FCP409 LUC	✓		✓		
--------------------	-----	---------------	-------------	---	--	---	--	--	------------	---	--	---	--	--

1.9 JTD	77	01/99 → 09/00	FCP1056 ATE	✓		✓			FCP409 LUC	✓		✓		
---------	----	---------------	-------------	---	--	---	--	--	------------	---	--	---	--	--

1.9 TD	68	01/96 → 12/99	FCP1056 ATE	✓		✓			FCP409 LUC	✓		✓		
--------	----	---------------	-------------	---	--	---	--	--	------------	---	--	---	--	--

1.9 TD	68	09/94 → 12/96	FCP370 LUC	✓	✉	✓	✉	✉	FCP409 LUC	✓		✓		
--------	----	---------------	------------	---	---	---	---	---	------------	---	--	---	--	--

2.0 Twin Spark 16V	110	01/96 → 02/99	FCP1052 ATE	✓		✓			FCP409 LUC	✓		✓		
--------------------	-----	---------------	-------------	---	--	---	--	--	------------	---	--	---	--	--

**147**

1.6 16V	76, 88	10/00 →	FCP1134	✓					FCP1349 LUC	✓		✉		
---------	--------	---------	---------	---	--	--	--	--	-------------	---	--	---	--	--

1.9 JTD	81	10/00 →	FCP1052 ATE	✓		✓			FCP1349 LUC	✓		✉		
---------	----	---------	-------------	---	--	---	--	--	-------------	---	--	---	--	--

2.0 16V	110	10/00 →	FCP1052 ATE	✓		✓			FCP1349 LUC	✓		✉		
---------	-----	---------	-------------	---	--	---	--	--	-------------	---	--	---	--	--

3.2 GTA	184	09/03 →	FCP1334 BRM	✓		✓	✓	✓						
---------	-----	---------	-------------	---	--	---	---	---	--	--	--	--	--	--

AC









kW

**...ALFA ROMEO****Alfasud**

1.2	50	01/86 → 12/89
1.3		01/86 → 12/87
1.3		01/88 → 12/89
1.4	57	01/86 → 12/89
1.5		01/86 → 12/87
1.5		01/88 → 12/89

		COMPOUND AVAILABILITY				
		H	C	R	W	Z
FCP546	ATE	✓		✓		
FCP546	ATE	✓		✓		
FCP546	ATE	✓		✓		
FCP546	ATE	✓		✓		
FCP546	ATE	✓		✓		
FCP546	ATE	✓		✓		

		COMPOUND AVAILABILITY				
		H	C	R	W	Z

**Alfetta**

1.6	80	01/79 → 12/82
1.6	80	01/83 → 12/85
1.6	80	07/72 → 12/78
1.8	90	01/79 → 12/82
1.8	90	01/83 → 12/85
1.8	90	07/72 → 12/78
2.0		01/79 → 12/82
2.0	96	01/83 → 12/85
2.0		07/72 → 12/78
2.0 TD	60	01/80 → 12/83
2.0 TD	60	01/83 → 12/85
2.4 TD	81	01/80 → 12/85
2.5 GTV6	116	01/80 → 12/83
2.5 GTV6	116	01/84 → 12/87

		H	C	R	W	Z
FCP2	ATE	✓	☒	✓		☒
FCP2	ATE	✓	☒	✓		☒
FCP2	ATE	✓	☒	✓		☒
FCP2	ATE	✓	☒	✓		☒
FCP2	ATE	✓	☒	✓		☒
FCP2	ATE	✓	☒	✓		☒
FCP2	ATE	✓	☒	✓		☒
FCP2	ATE	✓	☒	✓		☒
FCP2	ATE	✓	☒	✓		☒
FCP2	ATE	✓	☒	✓		☒
FCP2	ATE	✓	☒	✓		☒
FCP2	ATE	✓	☒	✓		☒
FCP116	ATE	✓		✓		
FCP2	ATE	✓	☒	✓		☒

		H	C	R	W	Z
FCP93	ATE	✓		✓		
FCP3	ATE	✓		✓		☒
FCP93	ATE	✓		✓		
FCP93	ATE	✓		✓		
FCP3	ATE	✓		✓		☒
FCP93	ATE	✓		✓		
FCP93	ATE	✓		✓		
FCP3	ATE	✓		✓		☒
FCP93	ATE	✓		✓		
FCP3	ATE	✓		✓		☒
FCP93	ATE	✓		✓		
FCP3	ATE	✓		✓		☒
FCP93	ATE	✓		✓		
FCP3	ATE	✓		✓		☒

**Arna**

1.2	46	01/83 → 08/85
1.2	46	01/83 → 08/85
1.2	46	08/85 → 12/87
1.3	57	01/83 → 08/85
1.3	57	01/83 → 08/85
1.3	57	08/85 → 12/87
1.5	77	01/83 → 08/85
1.5	77	01/83 → 08/85
1.5	77	08/85 → 12/87

		H	C	R	W	Z
FCP441	ATE		✗	✓		
FCP72	BDX	✓		✓		
FCP441	ATE		✗	✓		
FCP441	ATE		✗	✓		
FCP72	BDX	✓		✓		
FCP441	ATE		✗	✓		
FCP441	ATE		✗	✓		
FCP72	BDX	✓		✓		
FCP441	ATE		✗	✓		

**Brera**

2.2 2.2 JTS	185	01/06 →
-------------	-----	---------

		H	C	R	W	Z
FCP1805	ATE	✓				

--	--	--	--	--	--	--

**Giulia**

1.3	64	01/66 → 12/85
1.6	75	01/66 → 12/85
2.0 D		01/76 → 12/78

		H	C	R	W	Z
FCP2	ATE	✓	☒	✓		☒
FCP2	ATE	✓	☒	✓		☒
FCP2	ATE	✓	☒	✓		☒

		H	C	R	W	Z
FCP3	ATE	✓		✓		☒
FCP3	ATE	✓		✓		☒
FCP3	ATE	✓		✓		☒

**Giulietta**

1.3	70	01/83 → 03/86
1.3	70	11/77 → 12/82
1.6	80	01/83 → 03/86
1.6	80	11/77 → 12/82
1.8	88	01/83 → 03/86
1.8	88	11/77 → 12/82
2.0	96	01/83 → 03/86
2.0	96	11/77 → 12/82
2.0 TD	125	01/83 → 12/85

		H	C	R	W	Z
FCP2	ATE	✓	☒	✓		☒
FCP2	ATE	✓	☒	✓		☒
FCP2	ATE	✓	☒	✓		☒
FCP2	ATE	✓	☒	✓		☒
FCP2	ATE	✓	☒	✓		☒
FCP2	ATE	✓	☒	✓		☒
FCP2	ATE	✓	☒	✓		☒
FCP2	ATE	✓	☒	✓		☒
FCP2	ATE	✓	☒	✓		☒

		H	C	R	W	Z
FCP3	ATE	✓		✓		☒
FCP93	ATE	✓		✓		
FCP3	ATE	✓		✓		☒
FCP93	ATE	✓		✓		
FCP3	ATE	✓		✓		☒
FCP93	ATE	✓		✓		
FCP3	ATE	✓		✓		☒
FCP93	ATE	✓		✓		
FCP93	ATE	✓		✓		
FCP3	ATE	✓		✓		☒

**Giulietta (940)**

1.4 TB	77	04/11 →
1.4 TB	120,125	05/10 →
1.8 TBi	173	05/10 →
2.0 JTDM	103,120,125	05/10 →

		H	C	R	W	Z
FCP1805	ATE	✓				
FCP1805	ATE	✓				
FCP1334	BRM	✓		✓	✓	✓
FCP1805	ATE	✓				

**GT**

1.9 JTD Multijet		01/04 →
3.2 GTA	176	11/03 →

		H	C	R	W	Z
FCP1052	ATE	✓		✓		
FCP1334	BRM	✓		✓	✓	✓

		H	C	R	W	Z
FCP1349	LUC	✓				☒
FCP1349	LUC	✓				☒

**GTV**

2.0		01/76 → 02/86
2.0		03/86 → 12/87
2.0 (Turbo)	147	05/95 →
2.0 (Turbo)	147	05/95 →
2.0 16V	110	05/95 →
2.0 16V	110	05/95 →
2.5	110, 114	10/79 → 12/87
3.0 24V	162	12/96 →
3.0 24V	162	12/96 →

		H	C	R	W	Z
FCP2	ATE	✓	☒	✓		☒
FCP2	ATE	✓	☒	✓		☒
FCP565	LUC	✓		✓	✓	
FCP1052	ATE	✓		✓		
FCP565	LUC	✓		✓	✓	
FCP1052	ATE	✓		✓		
FCP116	ATE	✓		✓		
FCP565	LUC	✓		✓	✓	
FCP721	BRM	✓		✓	☒	

		H	C	R	W	Z
FCP93	ATE	✓		✓		
FCP3	ATE	✓		✓		☒
FCP409	LUC	✓		✓	✓	
FCP409	LUC	✓		✓	✓	
FCP409	LUC	✓		✓	✓	
FCP409	LUC	✓		✓	✓	
FCP93	ATE	✓		✓		
FCP409	LUC	✓		✓	✓	
FCP1113	LUC	✓		✓		

Available    Exhausting  
 Not Available    Make to order  
 In Introduction



Updated on 30th Jan 2014



KW

**...ALFA ROMEO****MiTo**

				COMPOUND AVAILABILITY					COMPOUND AVAILABILITY								
				H	C	R	W	Z									
0.9	63	07/11 →	FCP1466	Bosch	✓		☒		☒	FCP1349	Lucas	✓		☒			
1.3 JTDm	62,66	09/08 → 07/10	FCP1468	Bosch- until chassis n° 1096215	✓		✓			FCP1469	Bosch	✓		✓			
1.3 JTDm	70	09/08 → 07/10	FCP1468	Bosch- until chassis n° 1096215	✓		✓			FCP1469	Bosch	✓		✓			
1.4	57	03/11 →	FCP1466	Bosch	✓		☒		☒	FCP1349	Lucas	✓		☒			
1.4	51	05/11 →	FCP1466	Bosch	✓		☒		☒	FCP1349	Lucas	✓		☒			
1.4	77	08/10 →	FCP1466	Bosch	✓		☒		☒	FCP1469	Bosch	✓		✓			
1.4	58	09/08 →	FCP1466	Bosch	✓		☒		☒	FCP1469	Bosch	✓		✓			
1.4	70	09/08 →	FCP1466	Bosch	✓		☒		☒	FCP1469	Bosch	✓		✓			
1.4	88	09/08 → 07/10	FCP1468	Bosch- until chassis n° 1096215	✓		✓			FCP1469	Bosch	✓		✓			
1.4 Bifuel	88	07/11 →	FCP1468	Bosch	✓		✓			FCP1349	Lucas	✓		☒			
1.4 TB	114	09/08 →	FCP1466	Bosch	✓		☒		☒	FCP1469	Bosch	✓		✓			
1.4 TB	114	09/08 →	FCP1667	BRE	✓		✓	✓	☒	FCP1469	Bosch	✓		✓			
1.4 TB	99	10/09 → 07/10	FCP1468	Bosch- until chassis n° 1096215	✓		✓			FCP1469	Bosch	✓		✓			
1.4 TB	120	10/09 →	FCP1466	Bosch	✓		☒		☒	FCP1469	Bosch	✓		✓			
1.4 TB	120	10/09 →	FCP1667	BRE	✓		✓	✓	✓	FCP1469	Bosch	✓		✓			
1.4 TB	125	10/09 →	FCP1468	Bosch	✓		✓			FCP1469	Bosch	✓		✓			
1.4 TB	125	10/09 →	FCP1667	BRE	✓		✓	✓	✓	FCP1469	Bosch	✓		✓			
1.6 JTDm	85,88	09/08 → 07/10	FCP1468	Bosch- until chassis n° 1096215	✓		✓			FCP1469	Bosch	✓		✓			

**Montreal**

1.8		01/66 → 12/76	FCP11	ATE	✓		✓	☒	✓	FCP3	ATE	✓		✓		☒	
2.0		01/66 → 12/76	FCP11	ATE	✓		✓	☒	✓	FCP3	ATE	✓		✓		☒	
2.6 16V	148	01/66 → 12/76	FCP11	ATE	✓		✓	☒	✓	FCP3	ATE	✓		✓		☒	

**Spider**

1.3		01/74 → 12/82	FCP2	ATE	✓	☒	✓		☒	FCP3	ATE	✓		✓		☒	
1.6		01/74 → 12/78	FCP2	ATE	✓	☒	✓		☒	FCP3	ATE	✓		✓		☒	
1.6	75, 76	01/79 → 12/91	FCP2	ATE	✓	☒	✓		☒	FCP93	ATE	✓		✓			
1.8 i 16V	103	09/97 →	FCP1056	ATE	✓					FCP409	LUC	✓		✓			
1.8 i 16V	103	09/97 →	FCP565	LUC	✓		✓	✓		FCP409	LUC	✓		✓			
2.0	86, 92	08/90 → 12/93	FCP11	ATE	✓		✓	☒	✓	FCP3	ATE	✓		✓		☒	
2.0 i		01/83 → 07/90	FCP11	ATE	✓		✓	☒	✓	FCP3	ATE	✓		✓		☒	
2.0 V6 Turbo	148	05/98 →	FCP1052	ATE	✓		✓			FCP1113	LUC	✓		✓			
2.0 Twin Spark 16V	110	05/95 →	FCP565	LUC	✓		✓	✓		FCP409	LUC	✓		✓			
3.0 V6	141	06/95 →	FCP565	LUC	✓		✓	✓		FCP409	LUC	✓		✓			

**Sprint**

1.7	77, 87	03/87 → 12/89	FCP546	ATE	✓		✓										
-----	--------	---------------	--------	-----	---	--	---	--	--	--	--	--	--	--	--	--	--

**SZ**

3.0 24V	152, 188	09/89 → 12/96	FCP448	ATE	✓		✓			FCP3	ATE	✓		✓		☒	
---------	----------	---------------	--------	-----	---	--	---	--	--	------	-----	---	--	---	--	---	--

**ALPINA****B10 (E39) 96->**

4.6 V8 B10 (E39) 96->	255	10/98 → 08/00	FCP997	ATE	✓		☒										
4.6 V8 B10 (E39) 96->	250	12/96 → 10/98	FCP997	ATE	✓		☒										
4.8 V8 B10 (E39) 96->	276	04/02 →	FCP997	ATE	✓		☒										

**B10 Touring (E39) 97->**

4.6 V8 B10 Touring (E39) 97->	250	08/97 → 10/98	FCP997	ATE	✓		☒										
4.6 V8 B10 Touring (E39) 97->	255	10/98 → 07/00	FCP997	ATE	✓		☒										
4.8 V8 B10 Touring (E39) 97->	276	04/02 →	FCP997	ATE	✓		☒										

**ASIA MOTORS****Rocsta**

1.8 i	57	02/92 → 06/98	FCP170	SUM		✓											
2.2 i	45	02/92 → 12/98	FCP170	SUM		✓											



kw



# ASTON MARTIN

## DB5

4.0 01/63 → 12/65

FCP9 LUC ✓

FCP815 LUC ✓

## DB6

5.3 01/66 → 12/71

FCP9 LUC ✓

FCP815 LUC ✓

## DB7

3.2 01/93 → 12/97

FCP817 LUC ✓

FCP815 LUC ✓

3.2 01/97 →

FCP817 LUC ✓

FCP732 LUC ✓

5.9 01/99 →

FRP3028 BRE ✓

FRP3109 BRE ✓

## DB9

5.9 01/03 →

FRP3067 BRE ✓

FRP3109 BRE ✓

## DBS

5.3 Not V8 01/67 → 12/75

FCP9 LUC ✓

FCP815 LUC ✓

5.3 V8 01/70 → 12/74

FCP9 LUC ✓

FCP815 LUC ✓

## Lagonda

5.3 258, 260, 262 01/76 → 12/78

FCP817 LUC ✓

FCP815 LUC ✓

5.3 258, 260, 262 01/79 → 12/90

FCP817 LUC ✓

FCP815 LUC ✓

## Lagonda Rapide

4.0 258, 260, 262 01/61 → 12/65

FCP817 LUC ✓

FCP815 LUC ✓

## V8

5.3 01/73 → 00/00

FCP817 LUC ✓

FCP815 BRE ✓

## Vanquish

5.9 (AP Caliper) 01/01 → 12/04

FRP3084 BRE ✓

FRP3109 BRE ✓

5.9 (Brembo Caliper) 01/01 → 12/04

FRP3028 BRE ✓

FRP3109 BRE ✓

## Vanquish S

5.9 01/04 →

FRP3084 BRE ✓

FRP3109 BRE ✓

## Vantage

4.3 01/04 → 12/08

FRP3067 BRE ✓

FRP3109 BRE ✓

4.3 01/04 → 12/08

FRP3067 BRE ✓

FRP3109 BRE ✓

4.7 01/08 →

FRP3067 BRE ✓

FRP3109 BRE ✓

4.7 01/08 →

FRP3067 BRE ✓

FRP3109 BRE ✓

5.3 (Solid rear disc) 01/93 → 12/97

FRP216 BRE ✓

FRP3109 BRE ✓

5.3 (Solid rear disc) 01/93 → 12/97

FRP217 BRE ✓

FRP3109 BRE ✓

5.3 (Vented rear disc) 01/93 → 12/97

FRP217 BRE ✓

FRP3109 BRE ✓

5.3 (Vented rear disc) 01/93 → 12/97

FRP216 BRE ✓

FRP3109 BRE ✓

5.3 i V8 01/96 → 12/97

FCP1224 LUC ✓

FCP815 LUC ✓

5.3 i V8 Volante 262 01/87 → 12/93

FCP9 LUC ✓

FCP815 LUC ✓

5.3 i V8 Volante 262 08/93 →

FCP9 LUC ✓

FCP815 LUC ✓

## Virage

5.3 32V 242 01/89 → 12/93

FCP817 LUC ✓

FCP815 LUC ✓

5.3 32V (Solid rear disc) 242 01/93 →

FRP216 BRE ✓

FRP3109 BRE ✓

## Virage Contd.

5.3 242 01/96 →

FCP1224 LUC ✓

FCP815 LUC ✓

5.3 (Solid rear disc) 242 01/93 →

FRP217 BRE ✓

FRP3109 BRE ✓

5.3 (Vented rear disc) 242 01/93 →

FRP216 BRE ✓

FRP3109 BRE ✓

5.3 (Vented rear disc) 242 01/93 →

FRP217 BRE ✓

FRP3109 BRE ✓

## Volante

5.3 01/76 → 12/93

FCP817 LUC ✓

FCP815 LUC ✓

5.3 01/93 →

FRP216 BRE ✓

FRP3109 BRE ✓

5.3 01/94 →

FRP217 BRE ✓

FRP3109 BRE ✓

5.3 01/96 →

FCP1224 LUC ✓

FRP3109 BRE ✓

## ZAGATO

5.3 01/85 → 12/88

FCP817 LUC ✓

FCP815 BRE ✓

✓ Available    ⚠ Exhausting  
 ✗ Not Available    📧 Make to order  
 📦 In Introduction



Updated on 30th Jan 2014



KW

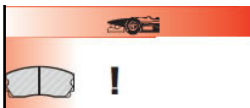

**AUDI**

**100**

				COMPOUND AVAILABILITY					COMPOUND AVAILABILITY				
				H	C	R	W	Z					
				H	C	R	W	Z	H	C	R	W	Z
1.6	63	08/81 → 09/82	FCP370 LUC	✓	✗	✓	✗	✗					
1.8	66	09/82 → 09/88	FCP775 LUC	✓	✗	✓	✗	✗					
1.8	66	10/88 → 12/90	FCP775 LUC	✓	✗	✓	✗	✗					
1.8 100 Quattro	66	01/84 → 08/86	FCP775 LUC	✓	✗	✓	✗	✗	FCP596 LUC	✓		✓	
1.8 100 Quattro Avant	66	01/85 → 08/88	FCP775 LUC	✓	✗	✓	✗	✗	FCP596 LUC	✓		✓	
1.8 Avant	66	01/76 → 12/82	FCP775 LUC	✓	✗	✓	✗	✗					
1.8 Avant	66	01/82 → 01/85	FCP775 LUC	✓	✗	✓	✗	✗	FCP596 LUC	✓		✓	
1.9	74	09/81 → 07/82	FCP370 LUC	✓	✗	✓	✗	✗					
1.9	74	09/82 → 12/90	FCP775 LUC	✓	✗	✓	✗	✗	FCP596 LUC	✓		✓	
1.9 Avant	74	01/76 → 12/82	FCP775 LUC	✓	✗	✓	✗	✗					
1.9 Avant	74	01/82 → 01/85	FCP775 LUC	✓	✗	✓	✗	✗	FCP596 LUC	✓		✓	
2.0	51, 66	09/82 → 09/88	FCP775 LUC	✓	✗	✓	✗	✗					
2.0	51, 66	10/88 → 12/90	FCP775 LUC	✓	✗	✓	✗	✗	FCP596 LUC	✓		✓	
2.0	74	12/90 → 06/94	FCP590 ATE	✓	✗	✓	✗	✗	FCP596 LUC	✓		✓	
2.0 100 Quattro	85, 98	12/90 → 12/94	FCP590 ATE	✓	✗	✓	✗	✗	FCP596 LUC	✓		✓	
2.0 100 Quattro Avant	85, 103	12/90 → 12/94	FCP590 ATE	✓	✗	✓	✗	✗	FCP596 LUC	✓		✓	
2.0 100 Quattro E 16V	103	01/93 → 12/94	FCP590 ATE	✓	✗	✓	✗	✗	FCP596 LUC	✓		✓	
2.0 Avant	51	01/76 → 12/82	FCP775 LUC	✓	✗	✓	✗	✗					
2.0 Avant	51	01/82 → 01/85	FCP775 LUC	✓	✗	✓	✗	✗	FCP596 LUC	✓		✓	
2.0 Avant E	85	01/85 → 11/90	FCP775 LUC	✓	✗	✓	✗	✗	FCP596 LUC	✓		✓	
2.0 Avant Not S4	85	01/91 → 12/94	FCP590 ATE	✓	✗	✓	✗	✗	FCP596 LUC	✓		✓	
2.0 D	51	08/78 → 07/82	FCP370 LUC	✓	✗	✓	✗	✗					
2.0 D	51	08/82 → 07/84	FCP775 LUC	✓	✗	✓	✗	✗	FCP596 LUC	✓		✓	
2.0 D	51	08/84 → 07/88	FCP775 LUC	✓	✗	✓	✗	✗	FCP596 LUC	✓		✓	
2.0 D Avant	51	03/83 → 08/88	FCP775 LUC	✓	✗	✓	✗	✗	FCP596 LUC	✓		✓	
2.0 D Avant	51	08/78 → 02/83	FCP370 LUC	✓	✗	✓	✗	✗					
2.0 D Avant	51	09/88 → 11/90	FCP775 LUC	✓	✗	✓	✗	✗	FCP596 LUC	✓		✓	
2.0 TD	51, 66	08/82 → 07/84	FCP775 LUC	✓	✗	✓	✗	✗	FCP596 LUC	✓		✓	
2.0 TD	51, 66	08/84 → 11/90	FCP775 LUC	✓	✗	✓	✗	✗	FCP596 LUC	✓		✓	
2.1	95, 96	09/82 → 12/90	FCP775 LUC	✓	✗	✓	✗	✗	FCP596 LUC	✓		✓	
2.1 Avant	95	01/76 → 12/82	FCP775 LUC	✓	✗	✓	✗	✗					
2.1 Avant	95, 96	01/82 → 01/85	FCP775 LUC	✓	✗	✓	✗	✗	FCP596 LUC	✓		✓	
2.1 E 10V	85, 95	07/80 → 09/82	FCP775 LUC	✓	✗	✓	✗	✗					
2.1 S	85	01/78 → 09/82	FCP370 LUC	✓	✗	✓	✗	✗					
2.2	85	09/78 → 07/82	FCP370 LUC	✓	✗	✓	✗	✗					
2.2	100	09/80 → 07/82	FCP775 LUC	✓	✗	✓	✗	✗					
2.2	85	10/77 → 08/78	FCP370 LUC	✓	✗	✓	✗	✗					
2.2 100 Quattro	101	01/84 → 08/86	FCP775 LUC	✓	✗	✓	✗	✗	FCP596 LUC	✓		✓	
2.2 100 Quattro 20V	169	12/90 → 12/94	FCP590 ATE	✓	✗	✓	✗	✗	FCP596 LUC	✓		✓	
2.2 100 Quattro Avant	101	01/84 → 08/86	FCP775 LUC	✓	✗	✓	✗	✗	FCP596 LUC	✓		✓	
2.2 100 Quattro Avant	101, 103, 121, 169	01/85 → 08/88	FCP775 LUC	✓	✗	✓	✗	✗	FCP596 LUC	✓		✓	
2.2 100 Quattro Avant 20V	101, 103, 121, 169	12/90 → 12/94	FCP590 ATE	✓	✗	✓	✗	✗	FCP596 LUC	✓		✓	
2.2 10V	85, 101, 103, 121	09/82 → 09/88	FCP775 LUC	✓	✗	✓	✗	✗	FCP596 LUC	✓		✓	
2.2 10V	85, 101, 103, 121	10/88 → 12/90	FCP775 LUC	✓	✗	✓	✗	✗	FCP596 LUC	✓		✓	
2.2 Avant	85	01/76 → 12/82	FCP775 LUC	✓	✗	✓	✗	✗					
2.2 Avant	100	01/76 → 12/82	FCP775 LUC	✓	✗	✓	✗	✗					
2.2 Avant	85, 100, 101	01/82 → 01/85	FCP775 LUC	✓	✗	✓	✗	✗	FCP596 LUC	✓		✓	
2.2 S4 + SW Estate	169	12/90 → 12/94	FCP590 ATE	✓	✗	✓	✗	✗	FCP596 LUC	✓		✓	
2.3 100 Quattro	98, 100	12/90 → 12/94	FCP590 ATE	✓	✗	✓	✗	✗	FCP596 LUC	✓		✓	
2.3 100 Quattro Avant	100	01/85 → 08/88	FCP775 LUC	✓	✗	✓	✗	✗	FCP596 LUC	✓		✓	
2.3 100 Quattro Avant	98, 100	12/90 → 12/94	FCP590 ATE	✓	✗	✓	✗	✗	FCP596 LUC	✓		✓	
2.3 10V	100	09/82 → 09/88	FCP775 LUC	✓	✗	✓	✗	✗	FCP596 LUC	✓		✓	
2.3 10V	100	10/88 → 12/90	FCP775 LUC	✓	✗	✓	✗	✗	FCP596 LUC	✓		✓	
2.3 Avant		01/76 → 12/82	FCP775 LUC	✓	✗	✓	✗	✗					
2.3 Avant	98	01/91 → 12/94	FCP590 ATE	✓	✗	✓	✗	✗	FCP596 LUC	✓		✓	
2.3 E	98	12/90 → 12/94	FCP590 ATE	✓	✗	✓	✗	✗	FCP596 LUC	✓		✓	
2.4 D	60	08/89 → 07/91	FCP775 LUC	✓	✗	✓	✗	✗	FCP596 LUC	✓		✓	
2.4 D	60	08/91 → 12/94	FCP590 ATE	✓	✗	✓	✗	✗	FCP596 LUC	✓		✓	
2.4 D Avant	60	01/76 → 12/82	FCP775 LUC	✓	✗	✓	✗	✗					
2.4 D Avant	60	01/91 → 12/94	FCP590 ATE	✓	✗	✓	✗	✗	FCP596 LUC	✓		✓	
2.5 TD	60	12/90 → 12/94	FCP590 ATE	✓	✗	✓	✗	✗	FCP596 LUC	✓		✓	
2.5 TD 10V	88	09/82 → 12/90	FCP775 LUC	✓	✗	✓	✗	✗	FCP596 LUC	✓		✓	
2.5 TD Avant	85	01/76 → 12/82	FCP775 LUC	✓	✗	✓	✗	✗					
2.5 TD Avant	85	01/91 → 12/94	FCP590 ATE	✓	✗	✓	✗	✗	FCP596 LUC	✓		✓	
2.5 TDi	88	01/90 → 11/90	FCP775 LUC	✓	✗	✓	✗	✗	FCP596 LUC	✓		✓	
2.5 TDi	85	12/90 → 12/94	FCP590 ATE	✓	✗	✓	✗	✗	FCP596 LUC	✓		✓	
2.6 100 Quattro Avant	110	12/90 → 12/94	FCP590 ATE	✓	✗	✓	✗	✗	FCP596 LUC	✓		✓	
2.6 E	110	12/90 → 12/94	FCP590 ATE	✓	✗	✓	✗	✗	FCP596 LUC	✓		✓	
2.8 100 Quattro Avant	128	12/90 → 12/94	FCP590 ATE	✓	✗	✓	✗	✗	FCP596 LUC	✓		✓	
2.8 E	128	12/90 → 12/94	FCP590 ATE	✓	✗	✓	✗	✗	FCP596 LUC	✓		✓	
4.2 100 Quattro 32V	206	12/90 → 12/94	FCP590 ATE	✓	✗	✓	✗	✗	FCP596 LUC	✓		✓	



KW

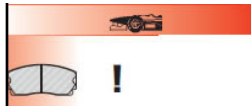

**...AUDI**

**200**

					COMPOUND AVAILABILITY						COMPOUND AVAILABILITY					
					H	C	R	W	Z		H	C	R	W	Z	
2.0		09/83 → 11/90	FCP775	LUC	✓		✓				FCP596	LUC	✓		✓	
2.0 TD	55	09/83 → 11/90	FCP775	LUC	✓		✓				FCP596	LUC	✓		✓	
2.1	100, 125	01/79 → 07/83	FCP775	LUC	✓		✓				FCP596	LUC	✓		✓	
2.1	85, 100, 134	07/83 → 01/86	FCP775	LUC	✓		✓				FCP596	LUC	✓		✓	
2.2	103	07/83 → 01/86	FCP775	LUC	✓		✓				FCP596	LUC	✓		✓	
2.2	100	10/79 → 09/82	FCP775	LUC	✓		✓				FCP596	LUC	✓		✓	
2.3	100	07/83 → 01/86	FCP775	LUC	✓		✓				FCP596	LUC	✓		✓	

**50**

1.1	37, 38, 44	01/74 → 12/80	FCP105	ATE												
1.3	44	01/74 → 12/80	FCP105	ATE												

**80**

1.3	44	10/79 → 08/86	FCP370	LUC, Solid	✓		✓									
1.3	44	10/79 → 08/86	FCP774	LUC, Vented	✓		✓									
1.3	40, 44	12/74 → 09/79	FCP105	ATE												
1.3 Auto	40, 44	01/72 → 11/74	FCP105	ATE												
1.3 Manual	40, 44	01/72 → 11/74	FCP105	ATE												
1.3 Variant	40, 44	01/66 → 12/72	FCP2	ATE	✓		✓									
1.4		09/86 → 06/91	FCP775	LUC	✓		✓									
1.5 Auto	55	01/72 → 11/74	FCP105	ATE												
1.5 Auto	55	08/76 → 07/81	FCP105	ATE												
1.5 Auto	55	12/74 → 07/76	FCP105	ATE												
1.5 Manual	55	01/72 → 11/74	FCP105	ATE												
1.5 Manual	55	08/76 → 07/81	FCP105	ATE												
1.5 Manual	55	12/74 → 07/76	FCP105	ATE												
1.5 Variant	55	01/66 → 12/72	FCP2	ATE	✓		✓									
1.6	52, 75	07/91 → 01/96	FCP775	LUC	✓		✓				FCP596	LUC	✓		✓	
1.6	40, 51, 55, 59	09/86 → 06/91	FCP775	LUC	✓		✓									
1.6	51, 53, 55	10/79 → 08/86	FCP370	LUC, Solid	✓		✓									
1.6 Auto		01/72 → 11/74	FCP105	ATE												
1.6 Auto		12/74 → 09/79	FCP105	ATE												
1.6 Manual		01/72 → 11/74	FCP105	ATE												
1.6 Manual		12/74 → 09/79	FCP105	ATE												
1.6 Variant		01/66 → 12/72	FCP2	ATE	✓		✓									
1.8	65, 66, 68	10/79 → 08/86	FCP370	LUC, Solid	✓		✓									
1.8 80 Quattro	66, 68, 82	01/83 → 09/86	FCP774	LUC	✓		✓				FCP596	LUC	✓		✓	
1.8 80 Quattro	66	09/86 → 08/88	FCP775	LUC	✓		✓				FCP596	LUC	✓		✓	
1.8 E	55, 64, 66, 82	09/86 → 06/91	FCP775	LUC	✓		✓				FCP596	LUC	✓		✓	
1.8 Std, S	83	09/86 → 06/91	FCP775	LUC	✓		✓									
1.9	85	10/79 → 08/86	FCP370	LUC, Solid	✓		✓									
1.9	85	10/79 → 08/86	FCP774	LUC, Vented	✓		✓									
1.9 80 Quattro	83	09/86 → 08/88	FCP775	LUC	✓		✓				FCP596	LUC	✓		✓	
1.9 Automatic	85	08/81 → 07/83	FCP370	LUC, Solid	✓		✓									
1.9 D	48	07/91 → 09/95	FCP775	LUC	✓		✓									
1.9 D	48	09/86 → 06/91	FCP775	LUC	✓		✓									
1.9 E	83	09/86 → 06/91	FCP775	LUC	✓		✓				FCP596	LUC	✓		✓	
1.9 TD		07/91 → 08/92	FCP775	LUC	✓		✓				FCP596	LUC	✓		✓	
1.9 TD		09/92 → 12/94	FCP775	LUC	✓		✓				FCP596	LUC	✓		✓	
1.9 TDi	66	07/92 → 01/96	FCP775	LUC	✓		✓				FCP596	LUC	✓		✓	
1.9 TDi	66	07/92 → 01/96	FCP775	LUC	✓		✓				FCP409	LUC	✓		✓	
2.0	85	10/79 → 08/86	FCP370	LUC, Solid	✓		✓									
2.0	85	10/79 → 08/86	FCP774	LUC, Vented	✓		✓									
2.0 80 Quattro	85	01/85 → 09/86	FCP774	LUC	✓		✓				FCP596	LUC	✓		✓	
2.0 80 Quattro	82, 85	06/91 → 07/92	FCP775	LUC	✓		✓				FCP596	LUC	✓		✓	
2.0 80 Quattro	85	08/82 → 12/84	FCP774	LUC	✓		✓				FCP596	LUC	✓		✓	
2.0 80 Quattro	82, 85	08/92 → 12/96	FCP775	LUC	✓		✓				FCP596	LUC	✓		✓	
2.0 Automatic	85	09/83 →	FCP370	LUC, Solid	✓		✓									
2.0 Avant	106	07/92 → 01/96	FCP775	LUC	✓		✓				FCP596	LUC	✓		✓	
2.0 E 16V	103	07/91 → 12/94	FCP775	LUC	✓		✓				FCP596	LUC	✓		✓	
2.0 Not Sport 16V	101	09/86 → 06/91	FCP775	LUC	✓		✓				FCP596	LUC	✓		✓	
2.1	85	10/79 → 08/86	FCP370	LUC, Solid	✓		✓									
2.1	85	10/79 → 08/86	FCP774	LUC, Vented	✓		✓									
2.1 80 Quattro	96, 100	01/83 → 09/86	FCP775	LUC	✓		✓				FCP596	LUC	✓		✓	
2.2 80 Quattro 20V	169	01/83 → 05/87	FCP774	LUC	✓		✓				FCP596	LUC	✓		✓	
2.2 80 Quattro Avant RS2 Turbo 20V	232	03/94 → 05/95	FCP560	ATE							FCP541	LUC	✓		✓	
2.2 80 Quattro Saloon 20V	169	06/91 → 07/96	FCP775	LUC	✓		✓				FCP596	LUC	✓		✓	
2.2 E		09/86 → 06/91	FCP775	LUC	✓		✓				FCP596	LUC	✓		✓	
2.3 80 Quattro Saloon	98	06/91 → 07/92	FCP775	LUC	✓		✓				FCP596	LUC	✓		✓	
2.3 E	98	07/91 → 07/92	FCP775	LUC	✓		✓				FCP596	LUC	✓		✓	
2.3 E	98	08/92 → 12/96	FCP775	LUC	✓		✓				FCP596	LUC	✓		✓	
2.3 I E		09/86 → 06/91	FCP775	LUC	✓		✓									
2.6	110	07/92 → 12/96	FCP775	LUC	✓		✓				FCP596	LUC	✓		✓	
2.6 80 Quattro Saloon	110	06/91 → 07/96	FCP775	LUC	✓		✓				FCP596	LUC	✓		✓	
2.6 80 Quattro V6 Avant	110	07/92 → 12/96	FCP775	LUC	✓		✓				FCP596	LUC	✓		✓	
2.8 80 Quattro Saloon	128	06/91 → 12/94	FCP775	LUC	✓		✓				FCP596	LUC	✓		✓	

✓ Available    ⚠ Exhausting  
 ✗ Not Available    📧 Make to order  
 📧 In Introduction



Updated on 30th Jan 2014



kw



...AUDI

90

Table with columns for engine type, power, torque, dates, part numbers, and availability (H, C, R, W, Z). Includes models like 1.4, 1.6 TD, 1.8, 1.9 TD, 2.0, 2.0 90 Quattro, 2.2, 2.3, 2.3 90 Quattro, 2.3 E.

A1 (8X1)

Table with columns for engine type, power, torque, dates, part numbers, and availability. Includes models like 1.2 TFSI, 1.4 TFSI, 1.6 TDI, 2.0 TDI.

A1 Sportback (8XA)

Table with columns for engine type, power, torque, dates, part numbers, and availability. Includes models like 1.2 TFSI, 1.4 TFSI, 1.6 TDI, 2.0 TDI.

A2

Table with columns for engine type, power, torque, dates, part numbers, and availability. Includes models like 1.4 i, 1.4 TDi, 1.6 FSi.

A3 (8V1)

Table with columns for engine type, power, torque, dates, part numbers, and availability. Includes models like 1.2 TFSI, 1.4 TFSI, 1.6 TDI.

A3 (8V1)

Table with columns for engine type, power, torque, dates, part numbers, and availability. Includes models like 1.8 TFSI, 1.8 TFSI quattro.



# ...AUDI

## A3 (8V1)

				COMPOUND AVAILABILITY					COMPOUND AVAILABILITY				
				H	C	R	W	Z	H	C	R	W	Z
2.0 TDI	81	01/13 →	FCP4433 LUC	✓									
2.0 TDI	110	04/12 →	FCP4433 LUC	✓									
2.0 TDI	105	09/12 →	FCP4433 LUC	✓									
2.0 TDI	135	12/12 →	FCP4433 LUC	✓									
2.0 TDI quattro	110	10/12 →	FCP4433 LUC	✓									
2.0 TDI quattro	135	12/12 →	FCP4433 LUC	✓									

## A3 Cabrio (8P7)

1.2 TFSi 8v	77	03/10 → 00/00	FCP1094 ATE, PR 1ZF	✓					FCP4316 BOSCH	✓			
1.2 TFSi 8v	77	03/10 → 00/00	FCP1641 ATE, PR 1ZE/1LJ	✓			✓	✓	FCP4316 BOSCH	✓			
1.4 TFSi 16v	92	02/11 → 00/00	FCP1641 ATE, PR 1ZE/1LJ	✓			✓	✓	FCP4316 BOSCH	✓			
1.4 TFSi 16v	92	02/11 → 00/00	FCP1094 ATE, PR 1ZF	✓					FCP4316 BOSCH	✓			
1.6 8v	75	09/08 → 05/10	FCP1094 ATE, PR 1ZF	✓					FCP4316 BOSCH	✓			
1.6 8v	75	09/08 → 05/10	FCP1641 ATE, PR 1ZE/1LJ	✓			✓	✓	FCP4316 BOSCH	✓			
1.6 TDi 16v	77	05/09 → 00/00	FCP1094 ATE, PR 1ZF	✓					FCP4316 BOSCH	✓			
1.6 TDi 16v	77	05/09 → 00/00	FCP1641 ATE, PR 1ZE/1LJ	✓			✓	✓	FCP4316 BOSCH	✓			
1.8 FSi/TFSi 16v	118	04/08 → 00/00	FCP1094 ATE, PR 1ZF	✓					FCP4316 BOSCH	✓			
1.8 FSi/TFSi 16v	118	04/08 → 00/00	FCP1641 ATE, PR 1ZE/1LJ	✓			✓	✓	FCP4316 BOSCH	✓			
1.9 TDi 8v	77	04/08 → 10/09	FCP1094 ATE, PR 1ZF	✓					FCP4316 BOSCH	✓			
1.9 TDi 8v	77	04/08 → 10/09	FCP1641 ATE, PR 1ZE/1LJ	✓			✓	✓	FCP4316 BOSCH	✓			
2.0 FSi/TFSi 16v	147	04/08 → 00/00	FCP1094 ATE, PR 1ZF	✓					FCP4316 BOSCH	✓			
2.0 FSi/TFSi 16v	147	04/08 → 00/00	FCP1641 ATE, PR 1ZE/1LJ	✓			✓	✓	FCP4316 BOSCH	✓			
2.0 TDi 16v	100	04/08 → 05/13	FCP1094 ATE, PR 1ZF	✓					FCP4316 BOSCH	✓			
2.0 TDi 16v	100	04/08 → 05/13	FCP1641 ATE, PR 1ZE/1LJ	✓			✓	✓	FCP4316 BOSCH	✓			
2.0 TDi 16v	103	04/08 → 00/00	FCP1094 ATE, PR 1ZF	✓					FCP4316 BOSCH	✓			
2.0 TDi 16v	103	04/08 → 00/00	FCP1641 ATE, PR 1ZE/1LJ	✓			✓	✓	FCP4316 BOSCH	✓			

## A3 I (8L1)

1.6 i		01/00 → 03/03	FCP1094 ATE	✓					FCP541 LUC	✓	✓	✓	✓
1.6 i		10/96 → 12/00	FCP1094 ATE	✓					FCP541 LUC	✓	✓	✓	✓
1.8 20V		01/00 → 03/03	FCP1094 ATE	✓					FCP541 LUC	✓	✓	✓	✓
1.8 20V		10/96 → 12/00	FCP1094 ATE	✓					FCP541 LUC	✓	✓	✓	✓
1.8 Quattro	92	08/98 →	FCP1094 ATE	✓					FCP1491 TRW	✓		✓	
1.8 T Sport 20V		10/96 → 12/00	FCP590 ATE	✓		✓			FCP541 LUC	✓	✓	✓	✓
1.8 T Sport, Quattro 20V		01/00 → 03/03	FCP590 ATE	✓		✓			FCP541 LUC	✓	✓	✓	✓
1.9 TDi		01/00 → 03/03	FCP1094 ATE	✓					FCP541 LUC	✓	✓	✓	✓
1.9 TDi		10/96 → 12/00	FCP1094 ATE	✓					FCP541 LUC	✓	✓	✓	✓
1.9 TDi	96	08/00 →	FCP590 ATE	✓		✓			FCP1491 TRW	✓		✓	✓
1.9 TDi Quattro	96	08/00 →	FCP590 ATE	✓		✓			FCP1491 TRW	✓		✓	✓
S3 Quattro	154, 165	01/99 → 00/00	FCP590 ATE	✓		✓			FCP1491 TRW	✓		✓	✓

## A3 II (8P1)

1.6 FSi	85	03/03 →	FCP1094 ATE	✓									
1.6 i	75	10/03 →	FCP1094 ATE	✓									
1.9 TDi		03/03 →							FCP1636		✓		
1.9 TDi	77	03/03 →	FCP1094 ATE	✓					FCP1636 TRW		✓		
2.0 FSi		03/03 →	FCP1641 ATE	✓		✓	✓	✓	FCP1636		✓		
2.0 S3 Quattro	188,195	11/06 →	FCP1765 ATE	✓			✓	✓	FCP1636 TRW		✓		
2.0 S3 Quattro	188,195	11/06 →	FCP1765 ATE	✓			✓	✓	FCP4316 Bosch		✓		
2.0 TDi	103	03/03 →	FCP1641 ATE	✓		✓	✓	✓					
2.0 TFSi 16V	147	09/04 →	FCP1641 ATE	✓		✓	✓	✓	FCP1636		✓		
3.2 V6 quattro	250	07/03 →	FCP1765 ATE	✓			✓	✓					

## A3 Sportback

1.6 FSi	85	09/04 →	FCP1094 ATE	✓					FCP1636		✓		
1.9 TDi	77	09/04 →	FCP1094 ATE	✓					FCP1636		✓		
2.0 FSi	110	09/04 →	FCP1641 ATE	✓		✓	✓	✓	FCP1636		✓		
2.0 FSi T, T Quattro	147	09/04 →	FCP1641 ATE	✓		✓	✓	✓	FCP1636		✓		
2.0 TDi	103	09/04 →	FCP1641 ATE	✓		✓	✓	✓	FCP1636 TRW, PR-1KF, 1KJ, 1KZ (255mm disc)		✓		
2.0 TDi	103	09/04 →	FCP1641 ATE, PR-1ZE, 1ZP, 1ZD, 1LI	✓		✓	✓	✓	FCP541 TRW (260mm disc)		✓	✓	✓

## A3 Sportback (8PA)

3.2 V6 quattro	250	09/04 →	FCP1765 ATE	✓				✓					
----------------	-----	---------	-------------	---	--	--	--	---	--	--	--	--	--

## A3 Sportback (8VA)

1.4 TFSi	90	09/12 →	FCP4433 LUC	✓									
1.6 TDI	77	10/12 →	FCP4433 LUC	✓									
1.8 TFSi	132	09/12 →	FCP4433 LUC	✓									
2.0 TDI	105	03/13 →	FCP4433 LUC	✓									
2.0 TDI	110	09/12 →	FCP4433 LUC	✓									
2.0 TDI quattro	135	11/12 →	FCP4433 LUC	✓									

- ✓ Available
- ✗ Not Available
- ⚡ Exhausting
- 📦 Make to order
- 👤 In Introduction



Updated on 30th Jan 2014



kW



...AUDI

COMPOUND AVAILABILITY

COMPOUND AVAILABILITY

H C R W Z

H C R W Z

Table with columns for model, power, date, FCP code, location, and availability (H, C, R, W, Z) for various Audi models like A4, A4 Allroad, A4 Avant/Estate IV, etc.

A4 Allroad (8KH)

Table for A4 Allroad (8KH) models: 2.0 TDI Quattro, 2.0 TFSI Quattro, 3.0 TDI Quattro.

A4 Avant/Estate IV (8K5)

Table for A4 Avant/Estate IV (8K5) models: 2.0 TDI Quattro, 2.0 TFSI Quattro, 2.7 TDI, 3.0 TDI Quattro, 3.2 FSI, FSI Quattro.

A4 Avant/Estate Mk2 (8E5, B6)

Table for A4 Avant/Estate Mk2 (8E5, B6) models: All S4 quattro, S4 4.2 40v Quattro.

A4 Avant/Estate Mk3 (8ED)

Table for A4 Avant/Estate Mk3 (8ED) models: 1.6, 1.8 T, 1.8 T quattro, 1.9 TDI, 2.0 TDI, 2.0 TFSi 16v, 2.0, 2.0 TFSI, 2.0 TFSI quattro, 2.5 TDI, 3.0 TDI quattro, 3.2 FSI, 3.2 FSI quattro.

A4 Cabriolet

Table for A4 Cabriolet models: 1.8 i Turbo, 1.9 TDi, 2.0 FSi, 2.0 i, 2.4 i, 2.5 TDi, 3.0 i V6.

A4 Cabriolet (8H7,8HE)

Table for A4 Cabriolet (8H7,8HE) models: 3.2 FSi 24v, 4.2 40v Quattro, S4 4.2 40v Quattro.

A4 IV (8K2)

Table for A4 IV (8K2) models: 1.8 TFSI, 2.0 TDi, 2.0 Tdi Quattro, 2.0 TFSI, 2.0 TFSI Quattro, 2.7 TDi, 3.0 TDi Quattro, 3.2 TFSI Quattro.

AUDI





kW



kW



**...AUDI**

**...A4 IV (8K2)**

					COMPOUND AVAILABILITY							COMPOUND AVAILABILITY				
					H	C	R	W	Z			H	C	R	W	Z
S4 Quattro	245	11/01 →	FCP4044	TRW	✓						FCP4050	TRW	✓			

**A4 Quattro, A4 Quattro Avant (I)**

1.8 i 20V	85, 132	10/97 → 09/01	FCP775	LUC	✓		✓									
1.8 i 20V	85, 132	10/97 → 09/01	FCP1289	LUC	✗											
1.8 i 20V	110	11/94 → 09/97	FCP775	LUC	✓		✓									
1.9 TDi	66, 81	10/97 → 09/01	FCP775	LUC	✓		✓									
1.9 TDi	66, 81	10/97 → 09/01	FCP1323	ATE	✓											
1.9 TDi	66, 81	10/97 → 09/01	FCP1289	LUC	✗											
1.9 TDi	66, 81	11/94 → 09/97	FCP775	LUC	✓		✓									
2.4 i 30V	121	11/94 → 09/01	FCP590	ATE	✓		✓				FCP541	LUC	✓		✓	
2.5 TDi ,Avant 24V	110	01/97 → 09/01	FCP590	ATE	✓		✓				FCP541	LUC	✓		✓	
2.6 i	110	11/94 → 09/01	FCP590	ATE	✓		✓				FCP596	LUC	✓		✓	
2.8 30V	128, 142	11/94 → 09/01	FCP590	ATE	✓		✓				FCP596	LUC	✓		✓	
S4 quattro	195	09/97 → 09/01	FCP1629	ATE	✓						FCP1491	TRW	✓			✓

**A4 Quattro, A4 Quattro Avant (II)**

1.8 i Turbo	110, 120, 140	09/01 →	FCP1323	ATE	✓											
1.9 TDi	96	09/01 →	FCP1323	ATE	✓											
2.0 FSi	110	07/02 →	FCP1323	ATE	✓											
2.0 i	96	09/01 →	FCP1323	ATE	✓											
2.4 i	125	09/01 →	FCP1323	ATE	✓											
2.5 TDi	114, 120, 132	09/01 →	FCP1323	ATE	✓											
3.0 i V6	162	09/01 →	FCP1323	ATE	✓											

**A4 Saloon Mk3 (8EC)**

1.6	102	11/04 →	FCP1629	ATE, PR-1LA, 1LC	✓						FCP1636	TRW	✓			
1.8 T, 1.8 T quattro	163	11/04 →	FCP1629	ATE, PR-1LA, 1LC	✓						FCP1636	TRW	✓			
1.9 TDi	116	11/04 →	FCP1629	ATE, PR-1LA, 1LC	✓						FCP1636	TRW	✓			
2.0	130	11/04 →	FCP1629	ATE, PR-1LA, 1LC	✓						FCP1636	TRW	✓			
2.0 TDi	136	11/04 →	FCP1629	ATE, PR-1LA, 1LC	✓						FCP1636	TRW	✓			
2.0 TDi	140	11/04 →	FCP1629	ATE, PR-1LA, 1LC	✓						FCP1636	TRW	✓			
2.0 TFSi 16v	162	06/05 → 10/07	FCP1629	ATE, PR 1LJ/ 1LA/1LC	✓						FCP1655	TRW, PR 1KE	✓			
2.0 TFSi, 2.0 TFSi quattro	200,220	11/04 →	FCP1629	ATE, PR-1LA, 1LC	✓						FCP1636	TRW	✓			
2.5 TDi	163	11/04 →	FCP1629	ATE, PR-1LA, 1LC	✓						FCP1636	TRW	✓			
3.0 TDi quattro	204	11/04 →	FCP1629	ATE, PR-1LA, 1LC	✓						FCP1636	TRW	✓			
3.2 FSi, 3.2 FSi quattro	255	01/05 →	FCP1629	ATE, PR-1LA, 1LC	✓						FCP1636	TRW	✓			
S4 4.2 40v Quattro	253	03/03 → 06/08	FCP1629	ATE, PR 1LJ	✓						FCP1655	TRW	✓			

**A4, A4 Avant (II)**

1.9 TDi	96	11/00 → 10/04	FCP1323	ATE	✓											
2.0 FSi	110	07/02 → 10/04	FCP1323	ATE	✓											
2.0 i	96	11/00 → 10/04	FCP1323	ATE	✓											
2.4 i	125	09/01 → 10/04	FCP1323	ATE	✓											
2.5 TDi	114, 120, 132	11/00 → 10/04	FCP1323	ATE	✓											
3.0 i V6	162	11/00 → 10/04	FCP1323	ATE	✓											

**A5**

1.8 TFSi	125	10/07 →	FCP4045	TEVES	✓						FCP4050	TRW	✓			
----------	-----	---------	---------	-------	---	--	--	--	--	--	---------	-----	---	--	--	--

**A5 (8T)**

2.0TFSi, 2.0 TFSi Quattro	132,16	06/08 →	FCP4044	TRW	✓						FCP4050	TRW	✓			
2.7 TDi	140	06/07 →	FCP4044	TRW	✓						FCP4050	TRW	✓			
3.0 TDi Quattro	176	06/07 →	FCP4044	TRW	✓						FCP4050	TRW	✓			
3.2 FSi	195	06/07 →	FCP4044	TRW	✓						FCP4050	TRW	✓			
3.2 FSi Quattro	195	06/07 →	FCP4044	TRW	✓						FCP4050	TRW	✓			
S5 4.2 Quattro	260	06/07 →	FCP4044	LUC 320mm	✓						FCP4050	TRW	✓			

**A6**

1.8 20V	92	12/95 → 02/97	FCP590	ATE	✓		✓				FCP596	LUC	✓		✓	
1.8 Avant 20V	92, 110	12/95 → 07/96	FCP590	ATE	✓		✓				FCP596	LUC	✓		✓	
1.9 TDi	66	06/94 → 02/97	FCP590	ATE	✓		✓				FCP596	LUC	✓		✓	
1.9 TDi Avant	66, 81, 85	06/95 → 07/96	FCP590	ATE	✓		✓				FCP596	LUC	✓		✓	
2.0 16V	103	06/94 → 02/97	FCP590	ATE	✓		✓				FCP596	LUC	✓		✓	
2.0 Avant 16V	103	06/94 → 02/97	FCP590	ATE	✓		✓				FCP596	LUC	✓		✓	
2.3 ,Avant	98	06/94 → 12/95	FCP590	ATE	✓		✓				FCP596	LUC	✓		✓	
2.5 TDi Avant	103	06/94 → 02/97	FCP590	ATE	✓		✓				FCP596	LUC	✓		✓	
2.5 TDi Avant	85	06/94 → 03/97	FCP590	ATE	✓		✓				FCP596	LUC	✓		✓	
2.6 ,Avant	102, 110	06/94 → 02/97	FCP590	ATE	✓		✓				FCP596	LUC	✓		✓	
2.8 ,Avant 30V	142	06/94 → 02/97	FCP590	ATE	✓		✓				FCP596	LUC	✓		✓	

✓ Available    ⚠ Exhausting  
 ✗ Not Available    📦 Make to order  
 🚧 In Introduction



Updated on 30th Jan 2014







KW



**...AUDI**

**Coupe Quattro**

			COMPOUND AVAILABILITY					COMPOUND AVAILABILITY					
			H	C	R	W	Z	H	C	R	W	Z	
1.8		11/84 → 08/87	FCP774	LUC	✓		✓		FCP596	LUC	✓		✓
2.0 10V	118	09/80 → 10/84	FCP370	LUC	✓	⚠	⚠	⚠	FCP596	LUC	✓		✓
2.0 10V	118	11/84 → 09/88	FCP774	LUC	✓		✓		FCP596	LUC	✓		✓
2.2	89, 100	01/85 → 09/88	FCP774	LUC	✓		✓		FCP596	LUC	✓		✓
2.3	98	01/85 → 09/88	FCP774	LUC	✓		✓		FCP596	LUC	✓		✓

**Q5**

2.0 TDi	125	11/08 →	FCP4044	TRW	✓				FCP4050	TRW	✓		
2.0 TFSI	155	11/08 →	FCP4044	TRW	✓				FCP4050	TRW	✓		
3.0 TDi	176	11/08 →	FCP4044	TRW	✓				FCP4050	TRW	✓		
3.2 FSI	199	11/08 →	FCP4044	TRW	✓				FCP4050	TRW	✓		

**Q7**

3.0 TDi	155	03/06 → 05/10	FCP4064	BRE, PR 1LT	✓								
3.0 TDi	171	03/06 → 05/08	FCP4064	BRE, PR 1LT	✓								
3.0 TDi Quattro	171	03/06 →	FCP1626	BRE	✓								
3.6 FSI	206	08/06 → 05/10	FCP4064	BRE, PR 1LT	✓								
3.6 FSI Quattro	206	08/06 →	FCP1626	BRE	✓								
4.2 FSI	257	03/06 → 05/10	FCP4064	BRE, PR 1LT	✓								
4.2 FSI Quattro	257	03/06 →	FCP1626	BRE	✓								
4.2 TDi	240	03/07 → 06/09	FCP4064	BRE, PR 1LT	✓								
4.2 TDi Quattro	240	03/07 →	FCP1626	BRE	✓								

**R8**

R8		→	FCP1664	BRM	✓		✓	✓	FCP1281	BRM	✓		✓	✓
----	--	---	---------	-----	---	--	---	---	---------	-----	---	--	---	---

**RS4 (8EC)**

4.2 32v Quattro	309	04/05 → 12/08	FCP1664	Bre, PR 1LP	✓		✓	✓	FCP1655	TRW	✓			
-----------------	-----	---------------	---------	-------------	---	--	---	---	---------	-----	---	--	--	--

**RS4 (8ED)**

4.2 32v Quattro	309	04/05 → 12/08	FCP1664	Bre, PR 1LP	✓		✓	✓	FCP1655	TRW	✓			
-----------------	-----	---------------	---------	-------------	---	--	---	---	---------	-----	---	--	--	--

**RS4 (8H7,8HE)**

4.2 32v Cabriolet	309	02/06 → 12/08	FCP1664	Bre, PR 1LP	✓		✓	✓	FCP1655	TRW	✓			
-------------------	-----	---------------	---------	-------------	---	--	---	---	---------	-----	---	--	--	--

**RS4 Quattro (8D5)**

2.7 Bi Turbo 30v	280	04/00 → 09/01	FCP1001	ATE	✓			✓	FCP1491	TRW	✓		✓
2.8 30v	280	10/00 → 10/01	FCP1001	ATE	✓			✓	FCP1491	TRW	✓		✓

**RS5 (8T3)**

4.2 32v Quattro	331	03/10 →	FCP1664	Bre, PR 1LM	✓		✓	✓	FCP1655	TRW	✓			
-----------------	-----	---------	---------	-------------	---	--	---	---	---------	-----	---	--	--	--

**RS6 (4B,C5)**

4.2 40v Quattro	331, 353	04/04 → 12/04	FCP1664	Bre	✓		✓	✓	FCP1655	TRW	✓			
-----------------	----------	---------------	---------	-----	---	--	---	---	---------	-----	---	--	--	--

**RS6 (4F2,4F5)**

5.0 40v Quattro	426	04/08 → 00/00	FRP3133	BRE	✓				FCP1655	TRW, PR 1KJ	✓			
-----------------	-----	---------------	---------	-----	---	--	--	--	---------	-------------	---	--	--	--

**S6 Quattro**

4.2 32V	213, 240	06/94 →	FCP590	ATE	✓		✓	⚠	FCP596	LUC	✓		✓
4.2 Avant 32V	240	06/94 →							FCP596	LUC	✓		✓

**S8 Quattro**

4.2 32V	250	07/96 → 09/98	FCP590	ATE	✓		✓	⚠	FCP596	LUC	✓		✓
4.2 40V	265	06/99 →	FCP891		✓		✓	⚠					

**Sport Quattro**

2.1	225	01/80 → 07/86	FCP775	LUC	✓		✓		FCP596	LUC	✓		✓
2.2		01/80 → 07/86	FCP775	LUC	✓		✓		FCP596	LUC	✓		✓

**TT**

1.8 20V	132	04/99 →	FCP590	ATE	✓		✓	⚠						
1.8 20V, Coupe Roadster	132	04/99 →	FCP590	ATE	✓		✓	⚠	FCP541	LUC	✓		✓	⚠

**TT (8J3)**

2.5 TFSI Quattro	265	05/11 →	FCP1334	BRM	✓		✓	✓	FCP1636	TRW	✓		
2.5 TFSI Quattro	250	07/09 →	FCP1334	BRM	✓		✓	✓	FCP1636	TRW	✓		

**TT Mk2**

2.0 TFSI	200	02/07 →	FCP1765	ATE	✓			⚠	FCP1636	TRW	✓		
2.0 TFSI	147	02/07 →	FCP1641	ATE	✓		⚠	⚠	FCP1636	TRW	✓		
3.2 V6 Quattro	250	02/07 →	FCP1765	ATE	✓		⚠	⚠	FCP1636	TRW	✓		
3.2 V6 Quattro	184	02/07 →	FCP1641	ATE	✓		⚠	⚠	FCP1636	TRW	✓		



kW

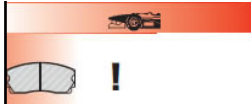

**...AUDI**

**TT Quattro**

			COMPOUND AVAILABILITY					COMPOUND AVAILABILITY								
			H	C	R	W	Z									
1.8 20V		04/99 →	FCP590	ATE	✓		✓	☒		FCP541	LUC	✓		✓	☒	☒

**TT Quattro (8N9-8N3)**

3.2 24v	184	07/03 → 12/06	FCP1001	For PR 1ZT	✓			✓		FCP1491	TRW	✓			✓	
---------	-----	---------------	---------	------------	---	--	--	---	--	---------	-----	---	--	--	---	--

**TT Roadster (8J9)**

2.5 TFSI Quattro	265	03/12 →	FCP1334	BRM	✓		✓	✓	✓	FCP1636	TRW	✓				
2.5 TFSI Quattro	250	07/09 →	FCP1334	BRM	✓		✓	✓	✓	FCP1636	TRW	✓				

**TT Roadster Mk2 (8J9)**

2.0 TFSI	200	02/07 →	FCP1765		✓			☒	✓	FCP1636	TRW	✓				
3.2 V6 quattro	250	02/07 →	FCP1765		✓			☒	✓	FCP1636	TRW	✓				

**AUTOBIANCHI**

**A111**

1.4 Berlina	54	04/69 → 10/73	FCP29	BDX	✓		✓									
-------------	----	---------------	-------	-----	---	--	---	--	--	--	--	--	--	--	--	--

**A112**

0.9	35, 37	06/71 → 10/82	FCP29	BDX	✓		✓									
0.9	35, 37	11/82 → 12/86	FCP29	BDX	✓		✓									
1.0	35, 37	06/71 → 10/82	FCP29	BDX	✓		✓									
1.0	35, 37	11/82 → 12/86	FCP29	BDX	✓		✓									

**Y10**

1.0		01/90 → 12/96	FCP351	BDX	✓		✓		✓							
1.0 (Fire/Touring/4WD)	33	01/89 → 12/92	FCP351	BDX	✓		✓		✓							
1.0 (Fire/Touring/4WD)	33	01/93 → 12/96	FCP351	BDX	✓		✓		✓							
1.0 (Fire/Touring/4WD)	33	02/85 → 12/89	FCP351	BDX	✓		✓		✓							
1.0 (Turbo)	33	01/89 → 12/92	FCP351	BDX	✓		✓		✓							
1.0 (Turbo)	33	01/93 → 12/96	FCP351	BDX	✓		✓		✓							
1.0 (Turbo)		02/85 → 12/89	FCP370	LUC	✓	☒	✓	☒	☒							
1.1		01/85 → 12/89	FCP370	LUC	✓	☒	✓	☒	☒							
1.1		01/90 → 12/96	FCP351	BDX	✓		✓		✓							
1.1 (Fire/Touring/4WD)	37	01/93 → 12/96	FCP351	BDX	✓		✓		✓							
1.1 (Fire/Touring/4WD)	37	06/86 → 12/92	FCP351	BDX	✓		✓		✓							
1.3		01/90 → 12/96	FCP370	LUC	✓	☒	✓	☒	☒							
1.3 ie GT	57	01/89 → 12/94	FCP370	LUC	✓	☒	✓	☒	☒							
1.3 ie GT	57	01/94 → 12/96	FCP370	LUC	✓	☒	✓	☒	☒							
1.3 ie GT	57	02/85 → 12/88	FCP370	LUC	✓	☒	✓	☒	☒							
1.3 Not ie GT		01/93 → 12/96	FCP351	BDX	✓		✓		✓							
1.3 Not ie GT		02/85 → 12/92	FCP351	BDX	✓		✓		✓							

**BMW**

**02 (E10)**

1502 1.6	55	01/75 → 12/77	FCP2	ATE	✓	☒	✓		☒							
1600Ti 1.6	63	01/64 → 12/66	FCP2	ATE	✓	☒	✓		☒							

**1 (E87/E81)**

All 116 d	85	03/09 →	FCP1747	TRW	✓					FCP1806	TRW	✓				
All 116 i	115	09/04 →	FCP1747	TRW	✓					FCP1806	TRW	✓				
All 118 d	122	09/04 →	FCP1747	TRW	✓					FCP1806	TRW	✓				
All 118i	129	09/04 →	FCP1747	TRW	✓					FCP1806	TRW	✓				
All 120 d	163	09/04 →	FCP1751	ATE	☒		☒			FCP1806	TRW	✓				
All 120 i	150	09/04 →	FCP1751	ATE	☒		☒			FCP1807	ATE	✓				
All 123 d	150	10/07 →	FCP1773	ATE	✓					FCP1807	ATE	✓				
All 130 i	265	09/05 →	FCP1773	ATE	✓					FCP1807	ATE	✓				

**1 Cabriolet (E88)**

135i	225	01/08 →	FCP4218	BRM	✓		☒			FCP4217	BRM	✓		☒		
------	-----	---------	---------	-----	---	--	---	--	--	---------	-----	---	--	---	--	--

**1 Coupè (E82)**

120d	130	10/07 →	FCP1773	ATE	✓					FCP1807	ATE	✓				
123d	150	10/07 →	FCP1773	ATE	✓					FCP1807	ATE	✓				
125i	160	10/07 →	FCP1773	ATE	✓					FCP1807	ATE	✓				
135i	225	10/07 →	FCP4218	BRM	✓		☒			FCP4217	BRM	✓		☒		

✓ Available    ⚠ Exhausting  
 ✗ Not Available    ☒ Make to order  
 ☒ In Introduction



Updated on 30th Jan 2014





kW



## ...BMW

				COMPOUND AVAILABILITY					COMPOUND AVAILABILITY				
				H	C	R	W	Z	H	C	R	W	Z
<b>3 (E91)</b>													
318d Touring 2.0	105	06/07	→	FCP4191	ATE					FCP1807	ATE	✓	
318d Touring 2.0	100	09/07	→	FCP4191	ATE					FCP1807	ATE	✓	
320i Touring 2.0	120	06/07	→ 12/11	FCP4191	ATE					FCP1807	ATE	✓	
320i Touring 2.0	125	06/07	→	FCP4191	ATE					FCP1807	ATE	✓	
320i Touring 2.0	115	06/07	→	FCP4191	ATE					FCP1807	ATE	✓	
320i Touring 2.0	110	07/07	→	FCP4191	ATE					FCP1807	ATE	✓	
323i Touring 2.5	130	04/06	→ 06/07	FCP4191	ATE					FCP1807	ATE	✓	
325d Touring 3.0 (E91)	150	04/10	→ 00/00	FCP1773	ATE	✓				FCP1808	ATE	✓	
325d Touring 3.0 (E91)	145	09/06	→ 00/00	FCP1773	ATE	✓				FCP1808	ATE	✓	
325i Touring 2.5	160	11/05	→ 06/07	FCP4191	ATE					FCP1807	ATE	✓	
325i Touring 2.5 Xi	160	10/05	→ 06/07	FCP4191	ATE					FCP1807	ATE	✓	
325i Touring 3.0	160	06/07	→	FCP4191	ATE					FCP1807	ATE	✓	
325i Touring 3.0	155	06/07	→	FCP4191	ATE					FCP1807	ATE	✓	
325i Touring 3.0 (E91)	160	01/06	→ 08/08	FCP1773	ATE	✓				FCP1808	ATE	✓	
325i xDrive Touring 2.5	160	09/08	→	FCP4191	ATE					FCP1807	ATE	✓	
325i xDrive Touring 3.0 (E91)	160	09/08	→ 00/00	FCP1773	ATE	✓				FCP1808	ATE	✓	
330d Touring 3.0 (E91)	180	09/09	→ 00/00	FCP1773	ATE	✓				FCP1808	ATE	✓	
330d Touring 3.0 Xd (E91)	170	06/05	→ 09/07	FCP1773	ATE	✓				FCP1808	ATE	✓	
330d xDrive Touring 3.0 (E91)	180	09/08	→ 00/00	FCP1773	ATE	✓				FCP1808	ATE	✓	
330i Touring 3.0 (E91)	190	11/05	→ 00/00	FCP1773	ATE	✓				FCP1808	ATE	✓	
330i Touring 3.0 Sport (E91)	200	09/09	→ 00/00	FCP1773	ATE	✓				FCP1808	ATE	✓	
330i Touring 3.0 Xi (E91)	190	10/05	→ 08/07	FCP1773	ATE	✓				FCP1808	ATE	✓	
330i xDrive Touring 3.0 (E91)	200	09/08	→ 00/00	FCP1773	ATE	✓				FCP1808	ATE	✓	
<b>3 (E92)</b>													
320d Coupe 2.0	130	02/07	→ 12/11	FCP4191	ATE					FCP1807	ATE	✓	
320d Coupe 2.0	120	03/07	→	FCP4191	ATE					FCP1807	ATE	✓	
320d Coupe 2.0	135	03/10	→	FCP4191	ATE					FCP1807	ATE	✓	
320d Coupe 2.0 Xd	130	03/07	→ 08/08	FCP4191	ATE					FCP1807	ATE	✓	
320d xDrive Coupe 2.0	135	03/10	→	FCP4191	ATE					FCP1807	ATE	✓	
320d xDrive Coupe 2.0	120	09/08	→	FCP4191	ATE					FCP1807	ATE	✓	
320d xDrive Coupe 2.0	130	09/08	→ 07/11	FCP4191	ATE					FCP1807	ATE	✓	
323i Coupe 2.5	130	10/07	→ 08/08	FCP4191	ATE					FCP1807	ATE	✓	
325d Coupe 3.0 (E92)	150	04/10	→ 00/00	FCP1773	ATE	✓				FCP1808	ATE	✓	
325d Coupe 3.0 (E92)	145	09/06	→ 03/10	FCP1773	ATE	✓				FCP1808	ATE	✓	
325d Coupe 3.0 (E92) - sports package	150	04/10	→ 00/00	FCP4218	BREMBO	✓		☒		FCP1808	ATE	✓	
325i Coupe 2.5 Xi	160	10/07	→ 09/08	FCP4191	ATE					FCP1807	ATE	✓	
325i xDrive Coupe 2.5	160	03/10	→	FCP4191	ATE					FCP1807	ATE	✓	
330d Coupe 3.0 (E92)	180	09/08	→ 00/00	FCP1773	ATE	✓				FCP1808	ATE	✓	
330d xDrive Coupe 3.0 (E92)	180	09/08	→ 00/00	FCP1773	ATE	✓				FCP1808	ATE	✓	
330i Coupe 3.0 (E92)	190	08/06	→ 00/00	FCP1773	ATE	✓				FCP1808	ATE	✓	
330i Coupe 3.0 (E92)	200	10/09	→ 00/00	FCP1773	ATE	✓				FCP1808	ATE	✓	
330i Coupe 3.0 (E92) - sports package	200	03/07	→ 00/00	FCP4218	BREMBO	✓		☒		FCP1808	ATE	✓	
330i Coupe 3.0 Xi (E92)	200	03/07	→ 08/09	FCP1773	ATE	✓				FCP1808	ATE	✓	
330i Coupe 3.0 Xi (E92)	190	08/06	→ 09/08	FCP1773	ATE	✓				FCP1808	ATE	✓	
330i xDrive Coupe 3.0 (E92)	200	09/08	→ 00/00	FCP1773	ATE	✓				FCP1808	ATE	✓	
335d Coupe 3.0 (E92)	210	09/06	→							FCP1808	ATE	✓	
<b>3 (E93)</b>													
320d Cabrio 2.0	120	01/08	→ 02/10	FCP4191	ATE					FCP1807	ATE	✓	
320d Cabrio 2.0	135	03/10	→	FCP4191	ATE					FCP1807	ATE	✓	
320d Cabrio 2.0	130	08/06	→ 12/11	FCP4191	ATE					FCP1807	ATE	✓	
320i Cabrio 2.0	125	03/07	→	FCP4191	ATE					FCP1807	ATE	✓	
320i Cabrio 2.0	115	07/07	→	FCP4191	ATE					FCP1807	ATE	✓	
320i Cabrio 2.0	120	07/07	→ 03/10	FCP4191	ATE					FCP1807	ATE	✓	
320i Cabrio 2.0	110	08/06	→ 08/07	FCP4191	ATE					FCP1807	ATE	✓	
325d Cabrio 3.0 (E93)	145	07/07	→ 02/10	FCP1773	ATE	✓				FCP1808	ATE	✓	
325d Cabrio 3.0 (E93) - sports package	145	07/07	→ 02/10	FCP4218	BREMBO	✓		☒		FCP1808	ATE	✓	
325i Cabrio 2.5	160	08/06	→	FCP4191	ATE					FCP1807	ATE	✓	
330d Cabrio 3.0 (E93)	180	01/09	→ 00/00	FCP1773	ATE	✓				FCP1808	ATE	✓	
330i Cabrio 3.0 (E93)	200	10/09	→ 00/00	FCP1773	ATE	✓				FCP1808	ATE	✓	
<b>3 Compact (E36)</b>													
318Ti (E36)	103	11/94	→ 08/00	FCP725	ATE	✓		✓	✓	FCP850	ATE	✓	✓
323Ti (E36)	125	05/97	→ 08/00	FCP725	ATE	✓		✓	✓	FCP850	ATE	✓	✓
<b>3 Compact (E46)</b>													
318Ti (E46)	105	03/93	→ 02/05	FCP725	ATE	✓		✓	✓	FCP1301	ATE	✓	☒
<b>3 Coupè (E46)</b>													
318Ci (E46)	87, 105	11/99	→	FCP1300	ATE	✓				FCP1301	ATE	✓	☒
320Ci /323Ci (E46)	110, 125	04/99	→	FCP1300	ATE	✓				FCP1301	ATE	✓	☒
325Ti (E46)	141	06/01	→ 02/05	FCP1300	ATE	✓				FCP1301	ATE	✓	☒
328i Coupè (E46)	142	04/98	→ 06/00	FCP1300	ATE	✓				FCP1301	ATE	✓	☒
330Cd E46)	150	03/03	→	FCP1073	ATE	✓		☒	☒	FCP1483	ATE	✓	☒
330Ci (E46)	170	06/00	→	FCP1073	ATE	✓		☒	☒	FCP1483	ATE	✓	☒

✓ Available    ⚠ Exhausting  
 ✗ Not Available    ☒ Make to order  
 ⚡ In Introduction



Updated on 30th Jan 2014







kw

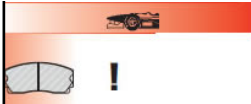

**...BMW**

**...5 (E34)**

			COMPOUND AVAILABILITY					COMPOUND AVAILABILITY						
			H	C	R	W	Z	H	C	R	W	Z		
535i (E34)	155	06/88 → 09/95	FCP779	ATE	✓		✓	✗						
540i V8 32V (E34)	210	01/92 → 09/95	FCP779	ATE	✓		✓	✗						

**5 (E39)**

520i (E39)	100, 110, 125	12/95 → 06/03	FCP1073	ATE	✓			✗	✗					
523i / 525i (E39)	125, 141	09/95 → 06/03	FCP1073	ATE	✓			✗	✗					
525d (E39)	105	09/95 →	FCP1073	ATE	✓			✗	✗					
525d Touring (E39)	105	09/95 →	FCP1073	ATE	✓			✗	✗					
525td (E39)	105	09/95 → 06/03	FCP1073	ATE	✓			✗	✗					
525td Touring (E39)	105	02/97 →	FCP1073	ATE	✓			✗	✗					
528i (E39)	142	09/95 → 09/00	FCP1073	ATE	✓			✗	✗					
530d (E39)	135	08/98 → 09/00	FCP1073	ATE	✓			✗	✗					
530d (E39)	142	09/00 → 06/03	FCP997	ATE	✓			✗	✗					
530d V8 24V (E39)	142	09/00 → 06/03	FCP997	ATE	✓			✗	✗					
530i (E39)	170	09/00 → 06/03	FCP997	ATE	✓			✗	✗					
535i (E39)	173	04/96 → 03/99	FCP1073	ATE	✓			✗	✗					
535i (E39)	180	04/99 → 06/03	FCP997	ATE	✓			✗	✗					
540i (E39)	210	04/96 → 06/03	FCP997	ATE	✓			✗	✗					

**5 Saloon (E60)**

535d	200, 210	09/04 →												
All 520d	163	07/05 →	FCP1773	ATE, Auto	✓								✗	✓
All 520d	150,163	12/04 →	FCP1773	ATE, Auto	✓									
All 520i	170	07/03 →	FCP1628	ATE, Auto	✓			✗	✓	✓				
All 520i	170	07/03 →	FCP1773	ATE, Auto	✓									
All 523i	177	07/05 →	FCP1628	ATE, Auto	✓			✗	✓	✓				
All 523i	177	07/05 →	FCP1773	ATE, Auto	✓									
All 525d	163,177	06/04 →	FCP1628	ATE, Auto	✓			✗	✓	✓				
All 525d	163,177	06/04 →	FCP1773	ATE, Auto	✓									
All 525i	218	07/05 →	FCP1628	ATE, Auto	✓			✗	✓	✓				
All 525i	218	07/05 →	FCP1773	ATE, Auto	✓									
All 525i	192	09/03 →	FCP1628	ATE, Auto	✓			✗	✓	✓				
All 525i	192	09/03 →	FCP1773	ATE, Auto	✓									
All 525xi	218	07/05 →	FCP1628	ATE, Auto	✓			✗	✓	✓				
All 530d	218,231	07/03 →	FCP1628	ATE, ->06/05	✓			✗	✓	✓				
All 530i	231	07/03 →	FCP1628	ATE, ->06/05	✓			✗	✓	✓				
All 530i	258	07/05 →	FCP1628	ATE	✓			✗	✓	✓				
All 530xd	231	07/05 →	FCP1628	ATE	✓			✗	✓	✓				
All 530xi	258	07/05 →	FCP1628	ATE	✓			✗	✓	✓				
All 540i	306	07/05 →	FCP1628	ATE	✓			✗	✓	✓				
All 545i	333	09/03 →	FCP1628	ATE, ->06/05	✓			✗	✓	✓				

**5 Touring (E39)**

520i Touring (E39)	100, 110, 125	12/95 → 06/00	FCP1073	ATE	✓			✗	✗					
523i / 525i Touring (E39)	125, 141	09/95 → 05/04	FCP1073	ATE	✓			✗	✗					
528i Touring 24V (E39)	142	09/95 → 09/00	FCP1073	ATE	✓			✗	✗					
530d Touring (E39)	135	08/98 → 09/00	FCP1073	ATE	✓			✗	✗					
530d Touring (E39)	142	09/00 → 05/04	FCP997	ATE	✓			✗	✗					
530i Touring (E39)	170	09/00 → 05/04	FCP997	ATE	✓			✗	✗					
535i Touring (E39)	173	04/96 → 03/99	FCP1073	ATE	✓			✗	✗					
540i Touring (E39)	210	01/97 → 05/04	FCP997	ATE	✓			✗	✗					

**5 Touring/Estate (E61)**

All 520d	163	07/05 →	FCP1628	ATE	✓			✗	✓	✓				
All 520d	163	07/05 →	FCP1773	ATE, (+) government vehicles	✓									
All 520d	150,163	12/04 →	FCP1773	ATE, (+) government vehicles	✓									
All 520i	170	06/04 →	FCP1628	ATE, Auto	✓			✗	✓	✓				
All 520i	170	06/04 →	FCP1773	ATE, Auto	✓									
All 523i	177	07/05 →	FCP1628	ATE, Auto	✓			✗	✓	✓				
All 523i	177	07/05 →	FCP1773	ATE, Auto	✓									
All 525d	163,177	06/04 →	FCP1628	ATE	✓			✗	✓	✓				
All 525d	163,177	06/04 →	FCP1773	ATE, (+) government vehicles	✓			✗	✓	✓				
All 525i	192	06/04 →	FCP1628	ATE, Auto	✓			✗	✓	✓				
All 525i	192	06/04 →	FCP1773	ATE, Auto	✓									
All 525i	218	07/05 →	FCP1628	ATE, Auto	✓			✗	✓	✓				
All 525i	218	07/05 →	FCP1773	ATE, Auto	✓									
All 525xi	218	07/05 →	FCP1628	ATE, ->06/05	✓			✗	✓	✓				
All 530d	218	06/04 →	FCP1628	ATE, ->06/05	✓			✗	✓	✓				
All 530i	231	06/04 →	FCP1628	ATE, ->06/05	✓			✗	✓	✓				
All 530i	258	07/05 →	FCP1628	ATE, ->06/05	✓			✗	✓	✓				
All 530xd	231	07/05 →	FCP1628	ATE, ->06/05	✓			✗	✓	✓				
All 530xi	258	07/05 →	FCP1628	ATE, ->06/05	✓			✗	✓	✓				
All 545i	333	06/04 →	FCP1628	ATE, ->06/05	✓			✗	✓	✓				

✓ Available    ⚠ Exhausting  
 ✗ Not Available    📦 Make to order  
 🚚 In Introduction



Updated on 30th Jan 2014

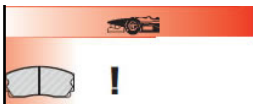

...BMW			COMPOUND AVAILABILITY					COMPOUND AVAILABILITY								
			H	C	R	W	Z	H	C	R	W	Z				
<b>6 (E24)</b>																
525 (E24)		01/76 → 06/82	FCP399	ATE	✓		✓				FCP3	ATE	✓		✓	✉
530 (E24)	135	01/76 → 12/80	FCP399	ATE	✓		✓				FCP3	ATE	✓		✓	✉
530 (E24)	135	01/81 → 08/82	FCP399	ATE	✓		✓				FCP3	ATE	✓		✓	✉
628Csi (E24)	135	09/79 → 08/87	FCP256	ATE, 07/82 ->	✓		✓				FCP296	ATE, 07/82 ->	✓		✓	✉
628Csi (E24)	135	09/79 → 08/87	FCP399	ATE, ->06/82	✓		✓				FCP3	ATE, -> 06/82	✓		✓	✉
630 (E24)	135	01/81 → 08/82	FCP256	ATE	✓		✓				FCP296	ATE	✓		✓	✉
633Csi	145	04/76 → 08/84	FCP399	ATE	✓		✓				FCP3	ATE	✓		✓	✉
635Csi	160	06/78 → 06/82	FCP399	ATE, ->06/82	✓		✓				FCP3	ATE, ->06/82	✓		✓	✉
635i (E24)	160	07/82 → 12/89	FCP256	ATE, 06/82 ->	✓		✓				FCP296	ATE, 06/82 ->	✓		✓	✉
M 635Csi	211	03/84 → 05/89	FCP256	ATE	✓		✓				FCP296	ATE	✓		✓	✉
<b>6 (E63)</b>																
All 630i	258	09/04 →	FCP1628	ATE	✓		✉	✓	✓		FCP1672	ATE	✓		✉	✓
All 645Ci	333	01/04 →	FCP1628	ATE	✓		✉	✓	✓		FCP1672	ATE	✓		✉	✓
All 650i	367	07/05 →									FCP1672	ATE	✓		✉	✓
<b>6 Convertible (E64)</b>																
All 630i	258	09/04 →	FCP1628	ATE	✓		✉	✓	✓		FCP1672	ATE	✓		✉	✓
All 645Ci	333	04/04 →	FCP1628	ATE	✓		✉	✓	✓		FCP1672	ATE	✓		✉	✓
All 650i	367	07/05 →									FCP1672	ATE	✓		✉	✓
<b>7 (E23)</b>																
725 (E23)		01/77 → 12/79	FCP399	ATE	✓		✓				FCP2	ATE	✓	✉	✓	✉
725 (E23)	110	08/81 → 08/86	FCP399	ATE	✓		✓				FCP296	ATE	✓		✓	✉
728 (E23)	125	01/77 → 08/79	FCP399	ATE	✓		✓				FCP2	ATE	✓	✉	✓	✉
728 (E23)	125	01/77 → 07/81	FCP399	ATE	✓		✓				FCP2	ATE	✓	✉	✓	✉
728i (E23)	135	07/78 → 08/86	FCP399	ATE	✓		✓				FCP296	ATE, 08/81 ->	✓		✓	✉
730	135	05/77 → 08/79	FCP399	ATE	✓		✓				FCP2	ATE	✓	✉	✓	✉
730 (E23)	135	01/77 → 12/79	FCP399	ATE	✓		✓				FCP2	ATE	✓	✉	✓	✉
730 (E23)	135	01/80 → 08/81	FCP399	ATE	✓		✓				FCP2	ATE	✓	✉	✓	✉
732i / 733i (E23)	145	05/77 → 08/86	FCP399	ATE	✓		✓				FCP296	ATE, 08/81->	✓		✓	✉
732i / 733i (E23)	145	05/77 → 08/86	FCP399	ATE	✓		✓				FCP2	ATE, ->08/81	✓	✉	✓	✉
735i / 745i (E23)	136, 141, 185	05/83 → 08/86	FCP399	ATE	✓		✓				FCP296	ATE	✓		✓	✉
745i (E23)	220	08/81 → 04/83	FCP399	ATE	✓		✓				FCP2	ATE, -> 08/81	✓	✉	✓	✉
745i (E23)	185	08/81 → 04/83	FCP399	ATE	✓		✓				FCP296	ATE, 09/81->	✓		✓	✉
<b>7 (E32)</b>																
730i / iL (E32)	138, 145	01/85 → 09/94	FCP779	ATE	✓		✓	✉			FCP578	ATE	✓		✓	✉
730i / iL V8	160	01/92 → 06/94	FCP779	ATE	✓		✓	✉			FCP578	ATE	✓		✓	✉
735i, iL (E32)	155, 160	09/86 → 09/92	FCP779	ATE	✓		✓	✉			FCP578	ATE	✓		✓	✉
740i / iL V12	220	09/87 → 09/94	FCP779	ATE	✓		✓	✉			FCP578	ATE	✓		✓	✉
740i / iL V8 (E32)	210	04/92 → 09/94	FCP779	ATE	✓		✓	✉			FCP578	ATE	✓		✓	✉
<b>7 (E38)</b>																
740 d (E38)	180	05/99 → 11/01									FCP1483	ATE	✓		✉	✉
740 i, iL (E38)	210	10/94 → 11/01	FCP997	ATE	✓						FCP1483	ATE	✓		✉	✉
750 i, iL (E38)	240	12/94 → 11/01									FCP1483	ATE	✓		✉	✉
<b>7 (E65, E66)</b>																
All 730 d, 730 Ld	218,231	10/02 →	FCP1628	ATE	✓		✉	✓	✓		FCP1672	ATE	✓		✉	✓
All 730 i,Li	231,258	03/03 →	FCP1628	ATE	✓		✉	✓	✓		FCP1672	ATE	✓		✉	✓
All 735 i,Li	272	11/01 →	FCP1628	ATE	✓		✉	✓	✓		FCP1672	ATE	✓		✉	✓
All 740 d	258	10/02 →	FCP1628	ATE	✓		✉	✓	✓		FCP1672	ATE	✓		✉	✓
All 740 i,Li	306	07/05 →	FCP1628	ATE	✓		✉	✓	✓		FCP1672	ATE	✓		✉	✓
All 745 d	329	07/05 →	FCP1628	ATE	✓		✉	✓	✓		FCP1672	ATE	✓		✉	✓
All 745 i,Li	333	11/01 →	FCP1628	ATE	✓		✉	✓	✓		FCP1672	ATE	✓		✉	✓
<b>8 (E31)</b>																
840i (E31)	210	02/93 → 02/96	FCP856	ATE, ->03/94	✓		✉				FCP857	ATE	✓		✓	✉
850Csi	280	04/93 → 12/96	FCP856	ATE, -> 03/94	✓		✉				FCP857	ATE	✓		✓	✉
850i /850Ci (E31)	220	04/90 → 10/94	FCP856	ATE, -> 03/94	✓		✉				FCP857	ATE	✓		✓	✉
<b>M3</b>																
1.8 16V	100	01/86 → 12/93	FCP256	ATE	✓		✓				FCP578	ATE	✓		✓	✉
2.3 16V	143, 147, 158	01/86 → 12/93	FCP256	ATE	✓		✓				FCP578	ATE	✓		✓	✉
3.0 E36 3/C 24V	210, 286	09/90 → 03/95	FCP779	ATE	✓		✓	✉			FCP578	ATE	✓		✓	✉
3.2 E36 3/C 24V	236	09/90 → 03/95	FCP779	ATE	✓		✓	✉			FCP578	ATE	✓		✓	✉
3.2 i E36 3/C 24V	236	04/95 → 04/99	FCP779	ATE	✓		✓	✉			FCP578	ATE	✓		✓	✉
3.2 i E40	236	04/95 → 04/99	FCP779	ATE	✓		✓	✉			FCP857	ATE	✓		✓	✉
All 3 Coupe M3 (E92)	309	03/07 →	FCP1628	ATE	✓		✉	✓	✓		FCP1672	ATE	✓		✉	✓
M3 3.2 Coupe (E46)	252	06/00 →	FCP1073	ATE	✓		✉	✉			FCP1483	ATE	✓		✉	✉
M3 CSL Coupe (E46)	265	06/03 →	FCP1073	ATE	✓		✉	✉			FCP1483	ATE	✓		✉	✉



KW



**...BMW**

**M5**

3.5 24V (E28)	211	01/85 → 12/87
3.5 24V (E28)	210	01/86 → 05/88
3.5 24V (E34)	232	06/88 → 12/91
3.8 i 24V (E34)	250	06/88 → 09/95
4.9 32V (E39)	294	10/98 → 06/03
5.0 40V (E60)	373	09/04 → 03/10
5.0 40V Touring (E61)	373	02/07 →

**COMPOUND AVAILABILITY**

H	C	R	W	Z

**COMPOUND AVAILABILITY**

H	C	R	W	Z

**X1 (E84)**

sDrive 16d 2.0	85	07/12 →
sDrive 18d 2.0	105	12/09 →
sDrive 18d 2.0	100	12/09 →
sDrive 18i 2.0	100	01/10 → 10/12
sDrive 18i 2.0	110	01/10 →
sDrive 20d 2.0	135	08/12 →
sDrive 20d 2.0	130	10/09 →
sDrive 20d 2.0 - Efficient Dynamics	120	03/10 →
sDrive 20i 2.0	135	09/11 →
xDrive 18d 2.0	105	12/09 →
xDrive 18d 2.0	100	12/09 →
xDrive 20d 2.0	120	03/10 →
xDrive 20d 2.0	135	08/12 →
xDrive 20d 2.0	130	10/09 →
xDrive 20i 2.0	135	09/11 →
xDrive 25d 2.0 - Twin Turbo	160	07/12 →

H	C	R	W	Z

H	C	R	W	Z

**X3 (E83)**

2.0 d X3 (E83)	110	10/04 →
2.0 i X3 (E83)	110	07/05 →
2.5 i X3 (E83)	141	01/04 →
3.0 d X3 (E83)	150, 160	01/04 →
3.0 i X3 (E83)	170	01/04 →
3.0 sd X3 (E83)	210	09/06 →

H	C	R	W	Z

H	C	R	W	Z

**X5 (E53)**

3.0 d X5 (E53)	135, 160	05/01 →
3.0 i X5 (E53)	163, 170	05/00 →
4.4 i X5 (E53)	210, 235	05/00 →
4.6 is X5 (E53)	255	02/02 →
4.8 is X5 (E53)	265	04/04 →

H	C	R	W	Z

H	C	R	W	Z

**Z1**

2.5	125	01/88 → 12/91
-----	-----	---------------

H	C	R	W	Z

H	C	R	W	Z

**Z3**

1.8	85	10/95 → 10/98
1.9	85, 87, 103	10/95 →
2.0	110	04/99 →
2.2	125	08/00 → 00/00
2.8	141	04/97 → 06/00
M 3.2	236,239	03/97 →
Z3	170	06/00 →

H	C	R	W	Z

H	C	R	W	Z

**Z3 Coupè**

2.8	141	07/97 → 06/00
3.0	170	06/00 →

H	C	R	W	Z

H	C	R	W	Z

**Z3 Coupe**

M 3.2	236, 239	07/97 →
-------	----------	---------

H	C	R	W	Z

H	C	R	W	Z

**Z4 (E85)**

2.0 i	110	05/04 →
2.2 i	125	10/03 →
2.5 i, 2.5 si (E85)	130, 141, 160	02/03 →
3.0 i (E85)	170	02/03 →
3.0 si	195	01/06 →

H	C	R	W	Z

H	C	R	W	Z

**Z4 Coupè**

3.0 si	195	01/06 →
--------	-----	---------

H	C	R	W	Z

H	C	R	W	Z

Available  
 Exhausting  
 Not Available  
 Make to order  
 In Introduction



Updated on 30th Jan 2014



kW



**...BMW**

				COMPOUND AVAILABILITY					COMPOUND AVAILABILITY					
				H	C	R	W	Z						
				H	C	R	W	Z	H	C	R	W	Z	
<b>Z8</b>														
4.9 Z8	294	06/00 → 06/03	FCP997 ATE	✓		☒			FCP1483 ATE	✓		☒	☒	☒
<b>Z8 Cabrio (E52)</b>														
4.9 32v	294	01/00 → 12/03	FCP1001 ATE	✓				✓	FCP1483 ATE	✓		☒	☒	☒

**BRISTOL**

<b>Beaufighter</b>														
5.9 (Turbo) 16V	162	01/74 → 12/82	FCP9 LUC	✓		✓			FCP815 LUC	✓	☒	✓	☒	
<b>Brigand</b>														
5.9 16V	162	01/74 → 12/82	FCP9 LUC	✓		✓			FCP815 LUC	✓	☒	✓	☒	
<b>Britannia</b>														
5.9 16V		01/74 → 12/82	FCP9 LUC	✓		✓			FCP815 LUC	✓	☒	✓	☒	

**BUICK**

<b>Century</b>														
5.7 16V	114	01/73 → 12/76	FRP3057 KEL	✓		☒	✓	✓						
<b>Electra</b>														
2.8	86	01/72 → 12/84	FRP3057 KEL	✓		☒	✓	✓						
5.0 16V	100, 123	01/72 → 12/84	FRP3057 KEL	✓		☒	✓	✓						
5.7 16V	114, 125, 127	01/72 → 12/84	FRP3057 KEL	✓		☒	✓	✓						
<b>Estate Wagon</b>														
5.7 16V	112, 125	01/72 → 12/90	FRP3057 KEL	✓		☒	✓	✓						
<b>Le Sabre</b>														
5.0 16V	123	01/72 → 12/85	FRP3057 KEL	✓		☒	✓	✓						
5.7 16V	93, 114, 125	01/72 → 12/85	FRP3057 KEL	✓		☒	✓	✓						
6.6 16V	138	01/72 → 12/85	FRP3057 KEL	✓		☒	✓	✓						
<b>Riviera</b>														
5.7 16V	118	01/72 → 12/78	FRP3057 KEL	✓		☒	✓	✓	FRP3057 KEL	✓		☒	✓	✓
6.6 16V	105	01/72 → 12/78	FRP3057 KEL	✓		☒	✓	✓	FRP3057 KEL	✓		☒	✓	✓
7.5 16V	140	01/72 → 12/78	FRP3057 KEL	✓		☒	✓	✓	FRP3057 KEL	✓		☒	✓	✓
<b>Roadmaster</b>														
5.0 16V	154	01/91 → 12/96	FRP3057 KEL	✓		☒	✓	✓						
5.7 16V	191	01/91 → 12/96	FRP3057 KEL	✓		☒	✓	✓						
<b>Royal</b>														
5.7 16V		01/73 → 12/76	FRP3057 KEL	✓		☒	✓	✓						
<b>Skylark</b>														
2.8	86	01/76 → 12/79	FRP3057 KEL	✓		☒	✓	✓						

**CADILLAC**

<b>Brougham</b>														
4.1		01/72 → 12/95	FRP3057 KEL	✓		☒	✓	✓						
5.0		01/72 → 12/95	FRP3057 KEL	✓		☒	✓	✓						
7.0 16V		01/72 → 12/95	FRP3057 KEL	✓		☒	✓	✓						
8.2		01/72 → 12/95	FRP3057 KEL	✓		☒	✓	✓						
<b>Commercial</b>														
		01/75 → 12/84	FRP3057 KEL	✓		☒	✓	✓						
<b>Deville</b>														
Heavy duty drum brake		01/90 → 12/98	FCP1213 KEL	☒										
4.1 16V	92	01/72 → 12/84	FRP3057 KEL	✓		☒	✓	✓						
6.0 16V	108	01/72 → 12/84	FRP3057 KEL	✓		☒	✓	✓						
7.0 16V	133	01/72 → 12/84	FRP3057 KEL	✓		☒	✓	✓						

BMW



KW



## ...CADILLAC

### Eldorado

5.7 16V	130, 136	01/69 → 12/78	FRP3057	KEL	✓									
6.0 16V	115	01/69 → 12/78	FRP3057	KEL	✓									
7.0 16V	133	01/69 → 12/78	FRP3057	KEL	✓									
8.2 16V	140	01/69 → 12/78	FRP3057	KEL	✓									

### Escalade

01/99 → 12/00

FCP1213 KEL

☒

### Fleetwood

5.7 16V	194	01/96 → 12/96	FRP3057	KEL	✓									
---------	-----	---------------	---------	-----	---	--	--	--	--	--	--	--	--	--

### Fleetwood Brougham

All models		01/90 → 12/93	FCP1213	KEL	☒									
4.5 16V		01/85 → 12/90	FRP3057	KEL	✓									
5.7 16V	175, 194	01/85 → 12/90	FRP3057	KEL	✓									
6.0 16V		01/85 → 12/90	FRP3057	KEL	✓									

### Seville

5.7 16V	66, 136	01/76 → 12/79	FRP3057	KEL	✓									
6.0 16V	108	01/76 → 12/79	FRP3057	KEL	✓									

## CATERHAM

### 21 models

Convertible 1.6 i, 1.6 i Supersport, 1.8 i	86,103,140	10/94 →	FCP167	LUC	✓	✓	✓	☒	✓	FCP408	LUC	✓		✓	☒
--	------------	---------	--------	-----	---	---	---	---	---	--------	-----	---	--	---	---

### stock AP up-grade

01/97 →

FRP201

✓ ☒ ✓ ✓ ☒

FCP825 ✓ ✓ ✓ ✓ ✓

### Super Seven

Convertible 1.8 i	112	01/98 → 12/01	FCP167	LUC	✓	✓	✓	☒	✓	FCP408	LUC	✓		✓	☒
Convertible 1.8 i 16v	171	01/99 →	FCP167	LUC	✓	✓	✓	☒	✓	FCP408	LUC	✓		✓	☒

### Super Seven models

Convertible 1.4 i, 1.6, 1.6 i,1.6 Turbo, 1.7, 2.0i 97, 74, 103, 110, 99, 121		01/90 → 12/96	FCP167	LUC	✓	✓	✓	☒	✓	FCP408	LUC	✓		✓	☒
Convertible 1.4 i, 1.6, 1.6 i,1.6 Turbo, 1.7, 2.0i 97, 74, 103, 110, 99, 121		01/97 →	FCP809	LUC	✓	✓	✓	☒	✓	FCP408	LUC	✓		✓	☒

## CHEVROLET

### Astro Van

4.3 Astra & M Van		01/91 → 12/94	FRP3057	KEL	✓										
4.3 not 4WD		01/85 → 12/90	FRP3057	KEL	✓										

### Belair

01/69 → 12/72

FRP3057 KEL

✓ ☒ ✓ ✓

### Camaro

Coupe (1SS & 2SS)		01/10 →	FCP1334	BRM	✓					FCP721		✓		✓	☒
-------------------	--	---------	---------	-----	---	--	--	--	--	--------	--	---	--	---	---

### Camaro,berlinetta,Iroc,Z28

		01/69 → 12/81	FRP3057	KEL	✓										
		01/82 → 12/88	FRP3058	KEL	✗					FRP3058		✗		✓	⚠
		01/88 → 12/89	FRP3058	KEL	✗										
		01/89 → 12/92	FCP1224	KEL	☒										
		01/89 → 12/92	FRP3058	KEL	✗										

### Caprice

112 01/77 → 12/96

FRP3057 KEL

✓ ☒ ✓ ✓

### Chevy 2, nova

01/79 → 12/84

FRP3057 KEL

✓ ☒ ✓ ✓

01/85 → 12/88

FCP308 KEL

✓ ☒

### Corvette

C4		01/88 → 12/96	FCP1224	KEL	☒										
C5		01/97 → 12/01	FCP1553	KEL	✓					FCP1563	KEL	☒		☒	☒
C6		01/04 →	FRP3094	PBR	☒				✓	FRP3094	PBR	☒		✓	

✓ Available    ⚠ Exhausting  
 ✗ Not Available    ☒ Make to order  
 ☒ In Introduction



Updated on 30th Jan 2014



kw

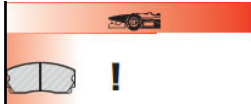

## ...CHEVROLET

### CORVETTE

				COMPOUND AVAILABILITY					COMPOUND AVAILABILITY							
				H	C	R	W	Z	H	C	R	W	Z			
C6 R FIA GT3			→	FRP3014	BRM		✓	✓	✓	FRP212	BRM	✓		✓	✓	✓
<b>Corvette</b>																
C7 Stingray (17" & 18" versions)		01/13	→	FCP1334	BRM	✓		✓	✓	✓	FRP3137	BRE	☒			
<b>Discayne</b>																
		01/69	→ 12/92	FRP3057	KEL	✓		☒	✓	✓						
<b>Impala</b>																
		01/69	→ 12/92	FRP3057	KEL	✓		☒	✓	✓						
<b>IROC</b>																
		01/69	→ 12/81	FRP3057	KEL	✓		☒	✓	✓						
<b>Monte Carlo, Malibu</b>																
		01/69	→ 12/77	FRP3057	KEL	✓		☒	✓	✓						
		01/78	→ 12/88	FRP3058	KEL	✗		✓	⚠	☒						
<b>Vectra (F19)</b>																
3.2	155	09/01	→ 03/02	FCP1520	ATE	✓					FCP1540	ATE	✓			
<b>Z28</b>																
		01/70	→ 12/81	FRP3057	KEL	✓		☒	✓	✓						
<b>Z28 single piston</b>																
		01/89	→ 12/92	FRP3058	KEL	✗		✓	⚠	☒						

## CHRYSLER

### 300C

Car 2.7	142	09/04	→	FCP1954		☒										
Car 3.0 CRD	160	06/05	→	FCP1954		☒										
Car 3.5	183	09/04	→	FCP1954		☒										
Car 5.7	250	09/04	→	FCP1954		☒										

### 300C Touring

Car 2.7	142	09/04	→	FCP1954		☒										
Car 3.0 CRD	160	09/05	→	FCP1954		☒										
Car 3.5	183	09/04	→	FCP1954		☒										
Car 3.5 AWD	183	09/04	→	FCP1954		☒										
Car 5.7	250	09/04	→	FCP1954		☒										
Car 5.7 AWD	250	04/05	→	FCP1954		☒										

### Crossfire

3.2 i	160	07/03	→	FCP1050	ATE	✓										
3.2 i SRT-6	246	09/04	→	FCP1050		✓										

### Crossfire (ZH)

3.2 18v	243	01/05	→ 08/06	FCP1001	ATE	✓				✓						
---------	-----	-------	---------	---------	-----	---	--	--	--	---	--	--	--	--	--	--

## CITROEN

### AX

1.0 10	30, 33	10/86	→ 12/98	FCP535	ATE	✓	⚠	✓								
1.1 11	40, 44	10/86	→ 12/98	FCP535	ATE	✓	⚠	✓								
1.1 GT	40, 44	01/89	→ 04/91	FCP535	ATE	✓	⚠	✓								
1.1 Sport	40, 44	01/88	→ 12/91	FCP535	ATE	✓	⚠	✓								
1.3 Sport	69	01/88	→ 12/91	FCP535	ATE	✓	⚠	✓								
1.4 14	55	04/91	→ 07/92	FCP393	BDX	✓		✓								
1.4 14	48	10/86	→ 03/91	FCP535	ATE	✓	⚠	✓								
1.4 D	39	01/88	→ 04/91	FCP535	ATE	✓	⚠	✓								
1.4 D	53	04/91	→ 12/97	FCP393	BDX	✓		✓								
1.4 GT		09/86	→ 10/88	FCP535	ATE	✓	⚠	✓								
1.4 GT		11/88	→ 04/91	FCP535	ATE	✓	⚠	✓								
1.4 i GTi	66, 69	04/91	→ 04/97	FCP434	LUC	✓		☒								
1.5 D	42	01/93	→ 12/97	FCP393	BDX	✓		✓								









# ...CITROEN

## Visa Cabriolet

11 RE 37 03/83 → 10/88



### COMPOUND AVAILABILITY

H C R W Z

✓



### COMPOUND AVAILABILITY

H C R W Z

✓

## Xsara

VTR →

1.4 i Saloon 55 09/00 →

1.4 i Saloon 55 09/97 → 09/00

1.4 i Saloon 55 09/97 → 09/00

1.4 i SW Estate 55 09/97 →

1.5 D 42 05/98 → 09/00

1.5 D Break 42 10/97 → 09/00

1.5 D SW Estate 42 05/98 → 09/00

1.5 D SW Estate 42 05/98 → 09/00

1.6 Break 65 10/97 → 09/00

1.6 i 66 05/98 → 08/00

1.6 i Saloon 80 09/00 →

1.6 i SW Estate 66 05/98 →

1.8 i Saloon 44 05/98 →

1.8 i Saloon 16V 82 01/98 →

1.8 i SW Estate 44 05/98 →

1.9 D Saloon 51 09/00 →

1.9 D SW Estate 51 09/00 →

1.9 D SW Estate 51 09/00 →

1.9 D Saloon 51 01/98 → 09/00

1.9 TD Saloon 51 01/98 →

1.9 TD SW Estate 51 02/98 →

2.0 HDi Saloon 66 09/00 →

2.0 HDi Saloon, SW Estate 66 01/99 → 09/00

2.0 HDi Saloon, SW Estate 66 01/99 → 09/00

2.0 i 16V 09/97 →

## Xsara Picasso

1.6 HDi 05/04 →

1.6 HDi 66 10/01 →

1.6 i 66 06/00 →

1.6 i 65/70 10/01 →

1.8 i 16V 82 10/01 →

1.8 i 16V 82 02/00 →

2.0 HDi 66 04/00 →

2.0 HDi 66 10/01 →

2.0 i 16V 01/03 →

## ZX

1.1 40, 44 03/91 → 06/92

1.1 40, 44 03/91 → 06/92

1.1 40, 44 07/92 → 10/97

1.1 40, 44 07/92 → 10/97

1.4 37, 55 03/91 → 06/92

1.4 37, 55 03/91 → 06/92

1.4 37, 55 07/92 → 10/97

1.4 37, 55 07/92 → 10/97

1.4 37, 55 07/92 → 10/97

1.6 65, 66 03/91 → 06/92

1.6 65, 66 03/91 → 06/92

1.6 65, 66 07/92 → 10/97

1.6 65, 66 07/92 → 10/97

1.8 76, 82 10/92 → 10/97

1.8 76, 82 10/92 → 10/97

1.8 D 44 10/92 → 10/97

1.8 D 44 10/92 → 10/97

1.9 D 47 07/92 → 06/94

1.9 D 47 07/92 → 06/94

1.9 D 47 10/91 → 06/92

1.9 D 47 10/91 → 06/92

1.9 D SW Estate 47 01/94 → 10/97

1.9 D SW Estate 47 01/94 → 10/97

1.9 TD Volcane 03/91 → 06/92

1.9 TD Volcane 03/91 → 06/92

1.9 TD Volcane 07/92 → 06/94

1.9 TD Volcane 07/92 → 06/94

1.9 Volcane 03/91 → 06/92

1.9 Volcane 03/91 → 06/92

1.9 Volcane 07/92 → 06/94

1.9 Volcane 07/92 → 06/94

2.0 Volcane 89 01/92 → 10/97

2.0 Volcane 110, 112, 120 07/92 → 10/97

✓ Available    ⚠ Exhausting  
 ✗ Not Available    📧 Make to order  
 📦 In Introduction



Updated on 30th Jan 2014



kw

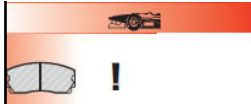

DACIA

## DACIA

### Denem

					COMPOUND AVAILABILITY					COMPOUND AVAILABILITY										
					H	C	R	W	Z	H	C	R	W	Z						
1.3	40	10/82 → 12/85	FCP72	BDX	✓		✓													

### Duster

1.4	48	04/84 → 08/88	FCP72	BDX	✓		✓													
1.4	48	09/88 →	FCP72	BDX	✓		✓													
1.6		12/88 →	FCP72	BDX	✓		✓													

### Logan

1.2 16v (LS1N)	55	06/09 →	FCP845	TRW	✓	✓	✓	☒												
1.4 8v (LS0A/LS0C/LS0E/LS0G)	53,55	08/04 →	FCP845	TRW	✓	✓	✓	☒												
1.5 dCi 8v (LS0J,LS0K,LS0W)	48,50,63	08/05 →	FCP845	TRW	✓	✓	✓	☒												
1.6 16v (LS0L/LS0M)	77	01/06 →	FCP845	TRW	✓	✓	✓	☒												
1.6 8v (LS0B/LS0D/LS0F/LS0H)	64	08/04 →	FCP845	TRW	✓	✓	✓	☒												

### Nova

1.6		01/96 →	FCP72	BDX	✓		✓													
-----	--	---------	-------	-----	---	--	---	--	--	--	--	--	--	--	--	--	--	--	--	--

### Sandero

1.2 16v (BS1N)	55	11/08 →	FCP845	TRW	✓	✓	✓	☒												
1.4 8v (BS0A/BS0C/BS0E/BS0G/BS1F)	53, 55	12/07 →	FCP845	TRW	✓	✓	✓	☒												
1.5 dCi 8v (BS00/BS0J/BS0Y/BS1E/BS0K)	48, 50	06/08 →	FCP845	TRW	✓	✓	✓	☒												
1.6 8v (BS0B/BS0D/BS0F/BS0H)	64	12/07 →	FCP845	TRW	✓	✓	✓	☒												
1.6 FlexiFuel 8v (BS1H)	64	12/07 →	FCP845	TRW	✓	✓	✓	☒												

### Super Nova

1.4		01/00 →	FCP72	BDX	✓		✓													
-----	--	---------	-------	-----	---	--	---	--	--	--	--	--	--	--	--	--	--	--	--	--

## DAEWOO

### Espero

1.5 i GLXi 16V		04/95 →	FCP584	ATE	✓		✓													
1.8 i CDi		04/95 →	FCP584	ATE	✓		✓													
2.0 i CDXi		04/95 →	FCP584	ATE	✓		✓													

### Korando

2.3	103	01/99 →	FCP600		✓		✗													
-----	-----	---------	--------	--	---	--	---	--	--	--	--	--	--	--	--	--	--	--	--	--

### Lanos

1.5 SOHC		09/97 →	FCP732	ATE, 13" Wheel	✓		✓													
1.6 DOHC 16V		09/97 →	FCP584	ATE, 14" Wheel	✓		✓													

### Nexia

1.5 i GLi	55	04/95 → 08/97	FCP732	ATE	✓		✓													
1.5 i GLi	55	04/95 → 08/97	FCP173	GM, Far East	✓		✓													
1.5 i GLXi 16V	66	04/95 → 08/97	FCP732	ATE	✓		✓													
1.5 i GLXi 16V	66	04/95 → 08/97	FCP584	ATE	✓		✓													
1.5 i GLXi 16V	66	04/95 → 08/97	FCP173	GM, Far East	✓		✓													
1.8 i		10/95 → 08/97	FCP732	ATE	✓		✓													

## DAF

### 55

1.1	34	01/68 → 12/75	FCP3	ATE	✓		✓	☒												
-----	----	---------------	------	-----	---	--	---	---	--	--	--	--	--	--	--	--	--	--	--	--

### 66

1.1	34	01/72 → 12/75	FCP3	ATE	✓		✓	☒												
1.3	42	01/72 → 12/75	FCP3	ATE	✓		✓	☒												



kW

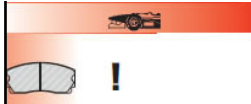

## DAIHATSU

### Sirion

1.0 , 4WD	40	04/98 →	FCP1501																
1.3	75	09/00 →	FCP1501																

### YRV

1.3 i , 4WD	64	02/01 →	FCP1501																
-------------	----	---------	---------	--	--	--	--	--	--	--	--	--	--	--	--	--	--	--	--

## DODGE

### Avenger

All (US)		01/95 →	FCP765																
----------	--	---------	--------	--	--	--	--	--	--	--	--	--	--	--	--	--	--	--	--

### Light Van

1.1 (UK)		01/76 → 12/83	FCP3	ATE															
----------	--	---------------	------	-----	--	--	--	--	--	--	--	--	--	--	--	--	--	--	--

### Stealth

		01/91 → 12/96	FCP765																
--	--	---------------	--------	--	--	--	--	--	--	--	--	--	--	--	--	--	--	--	--

### Viper

8.0 (US)		01/92 → 12/99	FCP721	BRM															
----------	--	---------------	--------	-----	--	--	--	--	--	--	--	--	--	--	--	--	--	--	--

## FERRARI

### 208

2.0 (Turbo) GTB, GTS 16V	162	01/82 → 12/88	FCP256	ATE															
2.0 GTB, GTS 16V	114	04/75 → 07/85	FCP256	ATE															

### 246

2.4 GT		01/71 → 12/75	FCP11	ATE															
--------	--	---------------	-------	-----	--	--	--	--	--	--	--	--	--	--	--	--	--	--	--

### 308

2.9 GT4, GTB		01/74 → 12/77	FCP11	ATE															
--------------	--	---------------	-------	-----	--	--	--	--	--	--	--	--	--	--	--	--	--	--	--

### 328

3.2 GTB, GTS 16V	198	01/86 → 12/89	FCP256	ATE															
------------------	-----	---------------	--------	-----	--	--	--	--	--	--	--	--	--	--	--	--	--	--	--

### 348

3.4 TB, TS 32V	221	01/90 → 09/94	FCP451	ATE															
----------------	-----	---------------	--------	-----	--	--	--	--	--	--	--	--	--	--	--	--	--	--	--

### 360 Modena

3.6 8 cyl.	294	01/99 →	FCP1348	BRM															
3.6 Challenge	294	01/99 →	FRP3024	BRM															

### 365

4.4 GTC, GTS	259	01/68 → 12/77	FCP11	ATE															
--------------	-----	---------------	-------	-----	--	--	--	--	--	--	--	--	--	--	--	--	--	--	--

### 456 GT/GTA

5.5 (F116)	325	01/93 → 06/04	FCP451	ATE															
------------	-----	---------------	--------	-----	--	--	--	--	--	--	--	--	--	--	--	--	--	--	--

### 512

4.9 Boxer B512 i 24V	250	05/86 → 12/87																	
5.0 24V	250	04/78 → 08/84																	
5.0 Boxer B512i 24V	250	04/78 → 04/86																	

### Dino

2.4 Spider, Coupe 18V	152	01/67 → 12/70	FCP9	LUC															
-----------------------	-----	---------------	------	-----	--	--	--	--	--	--	--	--	--	--	--	--	--	--	--

### F355

3.5 Berlinetta, GTS, Spider 40V	280	01/96 →	FCP451	ATE															
3.5 Berlinetta, GTS, Spider 40V	280	09/94 → 12/96	FCP451	ATE															
3.5 Challenge	280	01/96 →	FRP1078	BRM															

### F430

(Cast Iron disc)	360	01/04 →	FCP1348	BRM															
------------------	-----	---------	---------	-----	--	--	--	--	--	--	--	--	--	--	--	--	--	--	--

### F512M

4.9 i 48V	324	06/94 → 12/95																	
-----------	-----	---------------	--	--	--	--	--	--	--	--	--	--	--	--	--	--	--	--	--

#### COMPOUND AVAILABILITY

H C R W Z

#### COMPOUND AVAILABILITY

H C R W Z

- ✓ Available
- ✗ Not Available
- ⚠ Exhausting
- 📧 Make to order
- 📦 In Introduction



Updated on 30th Jan 2014



KW

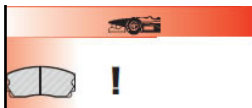

**...FERRARI**

**GTB**

2.0 i (Turbo) 16V 187 08/85 → 12/89

**COMPOUND AVAILABILITY**

H C R W Z

**COMPOUND AVAILABILITY**

H C R W Z

FCP256 ATE ✓ ✓

FCP206 ATE ✓ ✓

**GTS**

2.0 i (Turbo) 16V 187 08/85 → 12/89

FCP256 ATE ✓ ✓

FCP206 ATE ✓ ✓

**Mondial**

2.9 i 16V 158 06/82 → 09/87

FCP256 ATE ✓ ✓

FCP206 ATE ✓ ✓

3.2 01/80 → 09/85

FCP256 ATE ✓ ✓

FCP206 ATE ✓ ✓

3.2 i 16V 10/85 → 11/89

FCP256 ATE ✓ ✓

FCP206 ATE ✓ ✓

3.4 i 32V 10/89 → 12/93

FCP256 ATE ✓ ✓

FCP206 ATE ✓ ✓

**FIAT**

**124**

1.2 48 01/66 → 12/77

FCP29 BDX ✓ ✓

1.4 55 01/66 → 12/77

FCP29 BDX ✓ ✓

1.6 72, 74, 81 01/66 → 12/77

FCP29 BDX ✓ ✓

1.6 Spider 77, 99 01/82 → 12/86

FCP370 LUC ✓ ✓

1.8 87, 94 01/66 → 12/79

FCP29 BDX ✓ ✓

1.8 Spider 77, 99 01/82 → 12/86

FCP370 LUC ✓ ✓

2.0 01/66 → 12/82

FCP29 BDX ✓ ✓

2.0 Spider 77, 99 01/82 → 12/86

FCP370 LUC ✓ ✓

**125**

1.6 74, 76 01/67 → 12/75

FCP29 BDX ✓ ✓

**127**

0.9 33 01/71 → 12/83

FCP29 BDX ✓ ✓

1.0 37 01/71 → 12/83

FCP29 BDX ✓ ✓

1.3 01/71 → 12/83

FCP29 BDX ✓ ✓

1.3 01/71 → 12/83

FCP29 BDX ✓ ✓

1.3 D 33 01/83 → 12/86

FCP29 BDX ✓ ✓

**128**

1.1 40 01/68 → 12/81

FCP29 BDX ✓ ✓

1.3 54 01/68 → 12/81

FCP29 BDX ✓ ✓

**131**

1.3 40, 57 01/74 → 02/84

FCP29 BDX ✓ ✓

1.4 51 09/81 → 12/84

FCP29 BDX ✓ ✓

1.6 55, 63, 72 09/82 → 12/84

FCP351 BDX ✓ ✓

1.6 55, 63, 72 10/77 → 08/82

FCP29 BDX ✓ ✓

2.0 83, 85 10/77 → 08/85

FCP29 BDX ✓ ✓

2.4 06/79 → 10/84

FCP29 BDX ✓ ✓

2.5 D 53 03/79 → 09/82

FCP29 BDX ✓ ✓

2.5 D 53 09/82 → 03/87

FCP351 BDX ✓ ✓

**131 Mirafiori**

1.3 131 Mirafiori 49 06/74 → 12/81

FCP29 BDX ✓ ✓

1.4 131 Mirafiori 52 01/82 → 12/83

FCP29 BDX ✓ ✓

1.4 131 Mirafiori 54 01/83 → 09/85

FCP351 BDX ✓ ✓

1.6 131 Mirafiori 73 01/83 → 09/85

FCP351 BDX ✓ ✓

1.6 131 Mirafiori 73 06/74 → 12/81

FCP29 BDX ✓ ✓

2.0 131 Mirafiori 44, 84 01/83 → 09/85

FCP351 BDX ✓ ✓

2.0 131 Mirafiori 44, 84 06/74 → 12/82

FCP29 BDX ✓ ✓

2.4 131 Mirafiori 54 01/82 → 12/83

FCP29 BDX ✓ ✓

2.4 131 Mirafiori 54 01/83 → 09/85

FCP351 BDX ✓ ✓

2.4 131 Mirafiori 66 06/74 → 12/81

FCP29 BDX ✓ ✓

2.5 131 Mirafiori 53 06/78 → 09/82

FCP29 BDX ✓ ✓

2.5 131 Mirafiori 53 09/82 → 12/86

FCP351 BDX ✓ ✓

**132**

1.6 72 01/68 → 12/77

FCP29 BDX ✓ ✓

1.6 72 01/77 → 08/81

FCP29 BDX ✓ ✓

1.6 72 09/81 → 09/82

FCP370 LUC ✓ ✓

1.7 82 06/77 → 01/79

FCP29 BDX ✓ ✓

1.7 82 11/75 → 05/77

FCP29 BDX ✓ ✓

1.8 81 01/68 → 12/77

FCP29 BDX ✓ ✓

1.8 81 01/77 → 12/81

FCP29 BDX ✓ ✓

2.0 88 01/68 → 12/77

FCP29 BDX ✓ ✓

2.0 82 01/77 → 12/81

FCP29 BDX ✓ ✓

2.4 66 01/77 → 12/81

FCP29 BDX ✓ ✓



kW

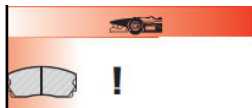

**...FIAT**

				COMPOUND AVAILABILITY					COMPOUND AVAILABILITY					
				H	C	R	W	Z						
				H	C	R	W	Z	H	C	R	W	Z	
<b>1500</b>														
1.5	55	01/62 → 12/69	FCP9 LUC	✓		✓								
<b>1600</b>														
1.6		01/62 → 12/65	FCP9 LUC	✓		✓								
<b>1800</b>														
1.8		07/62 → 12/69	FCP9 LUC	✓		✓								
<b>2300</b>														
2.3		01/62 → 12/68	FCP9 LUC	✓		✓								
<b>500</b>														
1.4 16V	74	01/07 →	FCP1466 BOS	✓		✉		✉	FCP1324 LUC	✓				
1.4 Abarth	99	03/08 →	FCP1467 BOS	✓		✓		✓	FCP1324 LUC	✓				
1.4 Turbo Abarth 695 Tributo Ferrari	132	09/09 →	FCP1667 BRE	✓		✓	✓	✓	FCP1324 LUC	✓				
Abarth 1.4 Turbo (USA)		→	FCP4353	✉					FCP1324 LUC	✓				
<b>850</b>														
0.9 Coupe/Spider/SportSpecial/Super		01/68 → 12/72	FCP29 BDX	✓		✓								
<b>900</b>														
0.9 E	33	01/82 →	FCP351 BDX	✓		✓		✓						
0.9 T,E	33	01/79 → 12/81	FCP29 BDX	✓		✓								
<b>Argenta</b>														
1.6	72	01/81 → 04/83	FCP370 LUC	✓	✉	✓	✉	✉	FCP360 BDX	✓				
1.6	72	05/83 → 12/86	FCP370 LUC	✓	✉	✓	✉	✉	FCP360 BDX	✓				
2.0	83	05/83 → 12/85	FCP29 BDX	✓		✓			FCP360 BDX	✓				
2.0	83	05/83 → 12/85	FCP370 LUC	✓	✉	✓	✉	✉	FCP360 BDX	✓				
2.0	83	06/78 → 04/83	FCP29 BDX	✓		✓			FCP360 BDX	✓				
2.0	83	06/78 → 04/83	FCP370 LUC	✓	✉	✓	✉	✉	FCP360 BDX	✓				
2.4	53	01/81 → 04/83	FCP370 LUC	✓	✉	✓	✉	✉	FCP360 BDX	✓				
2.4	53	05/83 → 12/86	FCP370 LUC	✓	✉	✓	✉	✉	FCP360 BDX	✓				
2.4 TD Volumex	66	01/83 → 12/86	FCP370 LUC	✓	✉	✓	✉	✉	FCP360 BDX	✓				
<b>Barchetta</b>														
1.8 Coupe 16V	96	03/95 → 06/95	FCP370 LUC	✓	✉	✓	✉	✉	FCP409 LUC	✓		✓		
1.8 Coupe 16V	96	06/95 →	FCP1056 ATE	✓					FCP409 LUC	✓		✓		
<b>Brava</b>														
1.6 100 16V	76	09/98 → 12/01	FCP1056 ATE, Automatic	✓										
1.8 115 16V	83	09/98 → 12/01	FCP1056 ATE	✓										
1.8 16V	83	09/95 → 08/98	FCP1056 ATE	✓										
1.9 JTD 100,105	74	09/98 → 12/01	FCP1056 ATE	✓										
1.9 TD 100	74	09/95 → 08/96	FCP1056 ATE	✓										
1.9 TD 100	74	09/96 → 08/98	FCP1056 ATE	✓										
<b>Bravo</b>														
1.6 100 16V	76	09/98 → 12/01	FCP1056 ATE, Automatic	✓										
1.8 115 16V	83	09/98 → 12/01	FCP1056 ATE	✓										
1.8 16V	83	09/95 → 08/96	FCP1056 ATE	✓										
1.8 16V	83	09/96 → 08/98	FCP1056 ATE	✓										
1.9 JTD 100,105	74	09/98 → 12/01	FCP1056 ATE	✓										
1.9 TD 100	74	09/95 → 08/98	FCP1056 ATE	✓										
1.9 TD 100	74	09/98 → 12/00	FCP1056 ATE	✓										
2.0 HGT 155 20V	113	09/98 → 12/01	FCP1052 ATE	✓		✓								
2.0 HGT 20V	108	04/97 → 08/98	FCP1052 ATE	✓		✓			FCP1113	✓		✓		
2.0 HGT 20V	108	04/97 → 08/98	FCP1052 ATE	✓		✓			FCP409 LUC	✓		✓		
2.0 HGT 20V	108	09/95 → 04/97	FCP1052 ATE	✓		✓			FCP409 LUC	✓		✓		
<b>Bravo II (198)</b>														
1.4 T-Jet	110	09/07 →	FCP1468 Bosch	✓		✓			FCP1469 Bosch	✓		✓		
<b>Cinquecento</b>														
0.7	22	03/92 → 09/94	FCP925 BDX	✓		✓								
0.9	29	03/92 → 02/98	FCP925 BDX	✓		✓								
1.1	40	03/92 → 02/98	FCP925 BDX	✓		✓								
<b>Cityvan</b>														
1.1	42	01/89 →	FCP519 ATE			✉	✉							
1.7	44	01/89 →	FCP519 ATE			✉	✉							

FIAT

✓ Available    ⚠ Exhausting  
 ✗ Not Available    ✉ Make to order  
 ⚡ In Introduction



Updated on 30th Jan 2014



kW



## ...FIAT

## Coupe

				COMPOUND AVAILABILITY					COMPOUND AVAILABILITY					
				H	C	R	W	Z	H	C	R	W	Z	
1.8 16V	96	03/96	→	FCP565	LUC	✓				FCP409	LUC	✓		
1.8 16V	96	03/96	→	FCP1052	ATE	✓				FCP409	LUC	✓		
2.0 (Turbo) 16V	143	03/95	→	FCP1052	ATE	✓				FCP409	LUC	✓		
2.0 (Turbo) 16V	143	11/93	→ 02/95	FCP565	LUC	✓				FCP596	LUC	✓		
2.0 (Turbo) 16V	143	11/93	→ 02/95	FCP565	LUC	✓				FCP409	LUC, Opt	✓		
2.0 (Turbo) 20V	162	01/97	→	FCP721	BRM	✓		✉		FCP409	LUC	✓		
2.0 (Turbo) 20V	162	01/97	→	FCP1052	ATE	✓								
2.0 16V	102	03/94	→	FCP565	LUC	✓				FCP409	LUC	✓		
2.0 16V	102	03/94	→	FCP1052	ATE	✓				FCP409	LUC	✓		
2.0 20V	108	08/96	→	FCP1052	ATE	✓				FCP409	LUC	✓		

## Croma

1.6	62	10/85	→ 09/88							FCP360	BDX	✓		
1.9 D	66	10/85	→ 09/88							FCP596	LUC	✓		
1.9 D	66	10/85	→ 09/88							FCP360	BDX	✓		
1.9 TD		10/85	→ 09/88							FCP596	LUC	✓		
1.9 TD		10/85	→ 09/88							FCP360	BDX	✓		
2.0 (Turbo)	114	10/85	→ 09/88							FCP596	LUC	✓		
2.0 (Turbo)	114	10/85	→ 09/88							FCP360	BDX	✓		
2.0 16V	103	01/93	→ 03/95	FCP565	LUC	✓				FCP596	LUC	✓		
2.0 CHT/i.e.	66, 88	10/85	→ 09/88							FCP596	LUC	✓		
2.0 CHT/i.e.	66, 88	10/85	→ 09/88							FCP360	BDX	✓		
2.5 D	85	10/85	→ 09/88							FCP360	BDX	✓		
2.5 D, TD	85	10/85	→ 09/88							FCP596	LUC	✓		
2.5 TD	117	10/85	→ 09/88							FCP596	LUC	✓		
2.5 TD	117	10/85	→ 09/88							FCP360	BDX	✓		
2.5 V6 (Turbo)	118	01/93	→ 12/96	FCP565	LUC	✓				FCP596	LUC	✓		

## Croma (194AXA12/194AXA1A)

2.2	108	06/05	→	FCP1520	ATE	✓								
-----	-----	-------	---	---------	-----	---	--	--	--	--	--	--	--	--

## Croma (194AXB1B)

1.9	88	04/06	→	FCP1520	ATE	✓								
1.9	88	06/05	→	FCP1520	ATE	✓								
1.9	85	06/05	→	FCP1520	ATE	✓								

## Croma (194AXC12/194AXC1B) from Chassis:2060169

1.9	100	10/05	→ 10/07	FCP1520	ATE	✓								
-----	-----	-------	---------	---------	-----	---	--	--	--	--	--	--	--	--

## Croma (194AXG1A)

1.8	103	11/05	→	FCP1520	ATE	✓								
-----	-----	-------	---	---------	-----	---	--	--	--	--	--	--	--	--

## Doblo

1.2	47	09/00	→	FCP1376	ATE	✓								
1.6 i	76	10/01	→	FCP1376	ATE	✓								
1.6 i	76	10/01	→	FCP1376	ATE	✓								
1.9 D	46	09/00	→	FCP1376	ATE	✓								
1.9 JTD		07/01	→	FCP1376	ATE	✓								

## Duna

1.1	43	01/87	→ 12/91	FCP519	ATE			✉	✉					
1.3	52	01/87	→ 12/91	FCP519	ATE			✉	✉					
1.7 D	42	01/87	→ 12/89	FCP519	ATE			✉	✉					
1.7 D	42	01/87	→ 12/89	FCP519	ATE			✉	✉					
1.9		01/87	→	FCP519	ATE			✉	✉					

## Fiorino

1.0	40	01/78	→ 12/81	FCP29	BDX	✓								
1.0	41	09/88	→ 08/93	FCP519	ATE			✉	✉					
1.0	41	12/87	→ 08/88	FCP29	BDX	✓								
1.1	42	01/88	→ 12/92	FCP519	ATE			✉	✉					
1.3	48	01/88	→ 12/92	FCP519	ATE			✉	✉					
1.3 D	38	01/78	→ 12/81	FCP29	BDX	✓								
1.4	49	01/88	→ 12/92	FCP519	ATE			✉	✉					
1.5	50	01/88	→ 12/92	FCP519	ATE			✉	✉					
1.6	55	01/88	→ 12/92	FCP519	ATE			✉	✉					
1.7 D	42	01/88	→ 12/92	FCP519	ATE			✉	✉					

## Grande Punto

1.2	48	09/05	→	FCP1466	Bosch	✓								
1.3 Multijet	55	09/05	→	FCP1466	Bosch	✓								
1.3 Multijet	66	09/05	→	FCP1467	Bosch	✓								
1.4 Turbo Abarth	113	09/07	→	FCP1667	BRE	✓							✓	
1.9 Multijet	88	09/05	→	FCP1467	Bosch	✓							✓	
1.9 Multijet	96	09/05	→	FCP1467	Bosch	✓							✓	



KW



...FIAT

Idea

			COMPOUND AVAILABILITY					COMPOUND AVAILABILITY				
			H	C	R	W	Z	H	C	R	W	Z
1.9 i Multijet 16V	74	01/04 →	FCP1467	Bosch	✓		✓			✓		

Marea

1.8 115 Berlina 16V	83	01/96 →	FCP1056	ATE	✓							
1.8 i 115 Berlina 16V	83	02/97 →	FCP1056	ATE	✓							
1.9 JTD 105-110	74	01/99 →	FCP1056	ATE	✓							
1.9 TD 100	74	02/97 → 12/99	FCP1056	ATE	✓							
1.9 TD 100	74	02/97 → 12/99	FCP1056	ATE	✓							
1.9 TD 100	74	01/96 → 12/99	FCP1056	ATE	✓							
2.0 150 20V	108	01/96 →	FCP1052	ATE	✓		✓			FCP409	LUC	✓
2.0 150 20V	108	01/96 →	FCP1052	ATE	✓		✓			FCP1113		✓
2.0 i 150 20V	108	09/96 → 04/99	FCP1052	ATE	✓		✓			FCP1113	LUC	✓
2.4 JTD 130	100	01/99 → 12/00	FCP1052	ATE	✓		✓			FCP1113		✓
2.4 TD 125	91	01/96 → 04/97	FCP1052	ATE	✓		✓			FCP409	LUC	✓
2.4 TD 125	91	04/97 → 12/99	FCP1052	ATE	✓		✓			FCP1113		✓
2.4 TD 125	91	04/97 → 12/99	FCP1052	ATE	✓		✓			FCP409	LUC	✓

Marea Weekend

1.6 100 16V	76	01/96 →	FCP1056	ATE	✓							
1.6 i 100 16V	76	09/96 →	FCP1056	ATE	✓							
1.8 115 16V	83	01/96 →	FCP1056	ATE	✓							
1.8 i 115 16V	83	09/96 →	FCP1056	ATE	✓							
1.9 JTD 105/110	74	04/99 →	FCP1056	ATE	✓							
1.9 TD 100	74	02/97 → 12/99	FCP1056	ATE	✓							
1.9 TD 100	74	01/96 → 12/99	FCP1056	ATE	✓							
2.0 150 20V	108, 113	01/96 →	FCP1052	ATE	✓		✓			FCP409	LUC	✓

Marengo

1.9 D		01/97 →	FCP1056	ATE	✓							
-------	--	---------	---------	-----	---	--	--	--	--	--	--	--

Multipia

1.6 i 16V	71, 76	03/02 →	FCP1052	ATE	✓		✓			FCP1469	Bosch	✓
1.6 i Bipower 16V	76	04/99 →	FCP1052	ATE	✓		✓			FCP1469	Bosch	✓
1.6 i 16V	71, 76	08/98 →	FCP1052	ATE	✓		✓			FCP1469	Bosch	✓
1.9 JTD	76	07/02 →	FCP1052	ATE	✓		✓			FCP1469	Bosch	✓
1.9 JTD	76	08/98 →	FCP1052	ATE	✓		✓			FCP1469	Bosch	✓

Palio

1.2	55	04/96 →	FCP519	ATE								
1.4	52	07/97 →	FCP519	ATE								
1.6	74	04/96 →	FCP519	ATE								
1.7 TD	51	04/96 →	FCP519	ATE								

Palio Weekend

1.2 i	55	07/97 →	FCP519									
1.6 i 16V	74	07/97 →	FCP519									
1.7 TD	51	07/97 →	FCP519									

Panda

0.7	18, 22	01/80 → 09/82	FCP29	BDX	✓		✓					
0.7	18, 22, 25	07/84 → 12/94	FCP351	BDX	✓		✓		✓			
0.7	18, 22	10/82 → 06/84	FCP351	BDX	✓		✓		✓			
0.8	26	01/80 → 09/82	FCP29	BDX	✓		✓					
0.8	25, 26	07/84 → 12/94	FCP351	BDX	✓		✓		✓			
0.8	25, 26	10/82 → 06/84	FCP351	BDX	✓		✓		✓			
0.9	33	01/80 → 09/82	FCP29	BDX	✓		✓					
0.9	29, 33	03/93 → 12/95	FCP351	BDX	✓		✓		✓			
0.9	29, 33	07/84 → 02/93	FCP351	BDX	✓		✓		✓			
0.9	29, 33	10/82 → 06/84	FCP351	BDX	✓		✓		✓			
1.0	32, 33, 35, 37	07/84 → 12/95	FCP351	BDX	✓		✓		✓			
1.0	32, 33, 35, 37	10/82 → 06/84	FCP351	BDX	✓		✓		✓			
1.0 i	32, 33, 35, 37	01/85 → 12/93	FCP351	BDX	✓		✓		✓			
1.1	37, 40	01/91 → 02/93	FCP370	LUC	✓		✓					
1.1	37, 40	03/93 → 08/99	FCP370	LUC	✓		✓					
1.1	33	04/93 →	FCP351	BDX	✓		✓		✓			
1.1	32, 33, 35, 37	07/84 → 03/93	FCP351	BDX	✓		✓		✓			
1.1	32, 33, 35, 37	10/82 → 06/84	FCP351	BDX	✓		✓		✓			
1.3		01/80 → 04/86	FCP351	BDX	✓		✓		✓			
1.3 D	27	05/86 → 04/91	FCP351	BDX	✓		✓		✓			

Panda (169)

1.2 4x4	44	10/04 →								FCP1324	LUC	✓
1.2 4x4	51	11/09 →								FCP1324	LUC	✓

✓ Available    ⚠ Exhausting  
 ✗ Not Available    📦 Make to order  
 ⚡ In Introduction



Updated on 30th Jan 2014







KW



!



!

**...FIAT****Regata**

1.3 70, 75	49	11/83	→	09/90
1.5 85	60	11/83	→	04/90
1.5 85	60	11/83	→	04/90
1.6 85, 100	60, 74	11/83	→	09/90
1.7 D	43, 44	11/83	→	04/90
1.9 D	48	11/83	→	09/90
1.9 TD	59	11/83	→	09/90
2.0 TD	59	05/86	→	07/89

		COMPOUND AVAILABILITY					COMPOUND AVAILABILITY						
		H	C	R	W	Z			H	C	R	W	Z
FCP351	BDX	✓		✓		✓							
FCP351	BDX	✓		✓		✓							
FCP370	LUC	✓	📧	✓	📧	📧							
FCP370	LUC	✓	📧	✓	📧	📧							
FCP370	LUC	✓	📧	✓	📧	📧							
FCP370	LUC	✓	📧	✓	📧	📧							
FCP370	LUC	✓	📧	✓	📧	📧							

**Ritmo**

1.0 60	44	09/78	→	09/82
1.1 60	44	09/78	→	08/82
1.1 60	42, 44	09/82	→	12/88
1.3 65, 70	48, 50	09/78	→	08/82
1.3 65, 70	48, 50	09/82	→	12/88
1.5 75, 85	55, 63	01/80	→	08/82
1.5 75, 85		09/78	→	12/79
1.5 75, 85	55, 63	09/82	→	12/88
1.6 90, 105	77	03/83	→	06/88
1.6 90, 105	77	03/83	→	06/88
1.6 90, 105	77	09/78	→	02/83
1.6 90, 105	77	09/78	→	02/83
1.7 D	41	01/81	→	08/82
1.7 D	41	03/83	→	06/88
1.7 D	41	09/82	→	02/83
1.7 TD	44	01/81	→	08/82
1.7 TD	44	03/83	→	06/88
1.7 TD	44	09/82	→	02/83
1.9 D	41	01/84	→	06/88
1.9 TD	44	01/84	→	06/88
2.0 125, 130	81, 96	03/83	→	06/88
2.0 125, 130	81, 96	03/83	→	06/88
2.0 125, 130	81, 96	09/78	→	02/83
2.0 125, 130	81, 96	09/78	→	02/83

FCP29	BDX	✓		✓									
FCP29	BDX	✓		✓									
FCP351	BDX	✓		✓		✓							
FCP29	BDX	✓		✓									
FCP351	BDX	✓		✓		✓							
FCP29	BDX	✓		✓									
FCP29	BDX	✓		✓									
FCP351	BDX	✓		✓		✓							
FCP351	BDX	✓		✓		✓							
FCP370	LUC	✓	📧	✓	📧	📧							
FCP29	BDX	✓		✓									
FCP351	BDX	✓		✓		✓							
FCP351	BDX	✓		✓		✓							
FCP370	LUC	✓	📧	✓	📧	📧							
FCP370	LUC	✓	📧	✓	📧	📧							
FCP72	BDX	✓		✓									
FCP370	LUC	✓	📧	✓	📧	📧							
FCP72	BDX	✓		✓									
FCP370	LUC	✓	📧	✓	📧	📧							

**Scudo**

1.9 JTD	81	01/00	→	
---------	----	-------	---	--

FCP565	LUC	✓		✓	✓			FCP850	ATE	✓		✓	✓	✓
--------	-----	---	--	---	---	--	--	--------	-----	---	--	---	---	---

**Seicento**

0.9	29	03/98	→	
1.1	40	03/98	→	

FCP925	BDX	✓		✓										
FCP925	BDX	✓		✓										

**Siena**

1.2	55	04/96	→	
1.4	52	07/97	→	
1.6 16V	74	04/96	→	

FCP519	ATE			📧	📧									
FCP519	ATE			📧	📧									
FCP519	ATE			📧	📧									

**Stilo**

1.2 i 16V		09/01	→	
1.6 i 16V		09/01	→	
1.8 16V	96	09/01	→	
1.9 JTD 115	156	09/01	→	
1.9 JTD 80	59	09/01	→	
1.9 JTD Multijet 140 cv	1190	01/05	→	
2.4 20V	170	09/01	→	

FCP1466		✓		📧	📧			FCP1469		✓		✓		
FCP1466		✓		📧	📧			FCP1469		✓		✓		
FCP1467	Bosch	✓		✓	✓	✓		FCP1469	Bosch	✓		✓		
FCP1467	Bosch	✓		✓	✓	✓		FCP1469	Bosch	✓		✓		
FCP1467	Bosch	✓		✓	✓	✓		FCP1469	Bosch	✓		✓		
FCP1467	Bosch	✓		✓	✓	✓		FCP1469	Bosch	✓		✓		
FCP1467	Bosch	✓		✓	✓	✓		FCP1469	Bosch	✓		✓		
FCP1468	Bosch	✓		✓	✓			FCP1469	Bosch	✓		✓		

**Stilo Multi Wagon**

1.6 i	76	11/02	→	
1.8 i	96	11/02	→	
1.9 JTD	59, 85	11/02	→	

FCP1467	Bosch	✓		✓		✓		FCP1469	Bosch	✓		✓		
FCP1467	Bosch	✓		✓		✓		FCP1469	Bosch	✓		✓		
FCP1467	Bosch	✓		✓		✓		FCP1469	Bosch	✓		✓		

**Strada**

1.1 60	40	05/83	→	12/87
1.3 65, 70	48, 50	01/78	→	12/81
1.3 65, 70	48, 50	01/83	→	01/88
1.5 85, Super	63	01/80	→	12/82
1.5 85, Super	63	05/83	→	01/88
1.6 105	77	09/81	→	07/85
2.0 130 Abarth	96	06/84	→	06/87
2.0 130 Abarth	96	06/84	→	06/87

FCP351	BDX	✓		✓		✓								
FCP29	BDX	✓		✓										
FCP351	BDX	✓		✓		✓								
FCP29	BDX	✓		✓										
FCP370	LUC	✓	📧	✓	📧	📧								
FCP370	LUC	✓	📧	✓	📧	📧								
FCP370	LUC	✓	📧	✓	📧	📧								
FCP72	BDX	✓		✓										

✓ Available    ⚠ Exhausting  
 ✗ Not Available    📧 Make to order  
 🔵 In Introduction

**FERODO**  
RACING

Updated on 30th Jan 2014

1035

FIAT





kW

**...FIAT****...Uno**

1.5 75	55	10/85 → 12/94
1.5 i	55	06/91 → 12/94
1.7 D	42	01/93 → 12/94
1.7 D	42	01/93 → 12/94
1.7 D	43	06/91 → 12/94
1.7 D, TD	42	04/86 → 12/94
1.7 D, TD	42	04/86 → 12/94
1.9 D, TD	59	01/85 → 12/94
All CS (Brazil)		01/88 → 12/91

**X1/9**

1.3	54, 55	10/72 → 12/81
1.5	56, 63	01/77 → 03/89

**FIAT AUTO POLAND****Cinquecento**

0.7		03/92 →
0.9		03/92 →
1.1		03/92 →

**Palio**

1.2 i	54	04/96 →
1.6 i	78	04/96 →

**Palio Weekend**

1.2 i		07/97 →
1.6 i 16V		07/97 →

**Seicento**

0.9		03/98 →
1.1		03/98 →

**Siena**

1.2		04/96 →
1.6		04/96 →

**FORD****B-Max**

1.0 EcoBoost	74	10/12 →
1.0 EcoBoost	88	10/12 →
1.0 EcoBoost	92	12/12 →
1.4	66	10/12 →
1.5 TDCi	55	10/12 →
1.6 TDCi	70	10/12 →
1.6 Ti	77	10/12 →

**Capri**

1.3	37	01/69 → 05/73
1.3	42	01/76 → 12/83
1.3		05/73 → 12/75
1.3 GT	37, 44	01/69 → 12/71
1.3 GT	44	01/72 → 05/73
1.5		01/68 → 12/72
1.6	56	01/69 → 12/71
1.6	51, 56	01/72 → 12/75
1.6	66	01/76 → 12/83
1.6	66	01/84 → 12/88
1.7		01/68 → 08/69
2.0	66	01/69 → 12/71
2.0	74	01/72 → 12/75
2.0	74	01/76 → 12/83
2.0	74	01/84 → 12/88
2.3	79	01/74 → 12/77
2.3		01/78 → 12/85
2.8	118	01/78 → 12/81
2.8	118	01/82 → 12/88
3.0	102, 125	01/72 → 12/75
3.0	102	01/76 → 12/83

**COMPOUND AVAILABILITY**

H C R W Z

FCP351	BDX	✓		✓		✓
FCP351	BDX	✓		✓		✓
FCP370	LUC	✓	☒	✓	☒	☒
FCP351	BDX	✓		✓		✓
FCP351	BDX	✓		✓		✓
FCP370	LUC	✓	☒	✓	☒	☒
FCP351	BDX	✓		✓		✓
FCP370	LUC	✓	☒	✓	☒	☒
FCP519	ATE			☒	☒	

**COMPOUND AVAILABILITY**

H C R W Z

✓ Available    ⚠ Exhausting  
 ✗ Not Available    ☒ Make to order  
 🚚 In Introduction

**FERODO**  
RACING

Updated on 30th Jan 2014

1037

FORD



kw



## ...FORD

## Consul

2.0 V4	74	01/72 → 12/75	FCP167	LUC	✓	✓	✓	☒	✓
2.5 V6	92	01/72 → 12/75	FCP167	LUC	✓	✓	✓	☒	✓

## Cortina

1.2	38	01/65 → 07/65	FCP809	LUC	✓	✓	✓	☒	✓
1.2	38	07/65 → 12/66	FCP810	LUC	✓	☒	✓	☒	✓
1.3	46	01/63 → 12/70	FCP810	LUC	✓	☒	✓	☒	✓
1.3	41	01/71 → 05/74	FCP167	LUC	✓	✓	✓	☒	✓
1.3	41, 42, 44	06/74 → 12/82	FCP167	LUC	✓	✓	✓	☒	✓
1.5	47	01/63 → 12/64	FCP167	LUC	✓	✓	✓	☒	✓
1.5	47	01/65 → 07/65	FCP809	LUC	✓	✓	✓	☒	✓
1.5	47	01/67 → 12/70	FCP810	LUC	✓	☒	✓	☒	✓
1.5	47	07/65 → 12/66	FCP810	LUC	✓	☒	✓	☒	✓
1.6	66	01/67 → 12/70	FCP810	LUC	✓	☒	✓	☒	✓
1.6		01/71 → 05/74	FCP167	LUC	✓	✓	✓	☒	✓
1.6	55	01/80 → 12/82	FCP167	LUC	✓	✓	✓	☒	✓
1.6	53, 66	06/74 → 12/79	FCP167	LUC	✓	✓	✓	☒	✓
1.6 E, GT	66	01/66 → 12/70	FCP810	LUC	✓	☒	✓	☒	✓
1.6 GT, SW Estate	53	01/71 → 05/74	FCP167	LUC	✓	✓	✓	☒	✓
2.0	73, 74	01/71 → 12/79	FCP167	LUC	✓	✓	✓	☒	✓
2.0	74	01/80 → 12/82	FCP167	LUC	✓	✓	✓	☒	✓
2.3	79	01/76 → 12/79	FCP167	LUC	✓	✓	✓	☒	✓
2.3	84	01/80 → 12/82	FCP167	LUC	✓	✓	✓	☒	✓

## Cougar

2.0 16V	96	08/98 → 12/01	FCP766	ATE	⚠		☒		
2.5 V6 24V	125	08/98 → 12/01	FCP766	ATE	⚠		☒		

## Courier

1.3 50		01/96 → 01/00	FCP1081	ATE	✓		✓		
1.3 50	37, 44	10/91 → 01/96	FCP206	ATE	✓			☒	
1.3 i	50	02/00 →	FCP1394		✓		✓		
1.3 i	50	02/00 →	FCP1394		✓		✓		
1.4 16V	65	05/96 →	FCP1081	ATE	✓		✓		
1.8 D	50	02/00 →	FCP1394		✓		✓		
1.8 D	50	02/00 →	FCP1394		✓		✓		
1.8 D 50		02/96 → 01/00	FCP1081	ATE	✓		✓		
1.8 D 50	44, 55	10/91 → 01/96	FCP206	ATE	✓			☒	
1.8 TDi	50	02/00 →	FCP1394		✓		✓		
1.8 TDi	50	02/00 →	FCP1394		✓		✓		

## Escort (1)

1.1 SW Estate	33	01/69 → 12/70	FCP809	LUC	✓	✓	✓	☒	✓
1.1 SW Estate	33	01/71 → 12/74	FCP809	LUC	✓	✓	✓	☒	✓
1.3		01/69 → 12/70	FCP809	LUC	✓	✓	✓	☒	✓
1.3		01/71 → 12/74	FCP809	LUC	✓	✓	✓	☒	✓
1.3 GT, SW Estate	42, 44	01/69 → 12/70	FCP809	LUC	✓	✓	✓	☒	✓
1.3 GT, SW Estate	42, 44	01/71 → 12/74	FCP809	LUC	✓	✓	✓	☒	✓
1.6 TC, Mexico, RS		01/72 → 12/74	FCP167	LUC	✓	✓	✓	☒	✓
2.0 RS	81	01/72 → 05/73	FCP167	LUC	✓	✓	✓	☒	✓
2.0 RS	81	06/73 → 12/74	FCP167	LUC	✓	✓	✓	☒	✓

## Escort (2)

1.1	33	01/75 → 12/80	FCP167	LUC	✓	✓	✓	☒	✓
1.3	40, 42	01/75 → 08/80	FCP167	LUC	✓	✓	✓	☒	✓
1.3 Sport, Ghia	51	01/75 → 08/80	FCP167	LUC	✓	✓	✓	☒	✓
1.6		01/75 → 08/80	FCP167	LUC	✓	✓	✓	☒	✓
1.8 RS1800 16V	115	01/75 → 08/80	FCP167	LUC	✓	✓	✓	☒	✓
2.0 RS2000 16V	110	01/75 → 12/80	FCP276	ATE	✓		✓		

## Escort (3)

1.1	40	01/86 → 08/90	FCP206	ATE	✓		✓	☒	
1.1	37	03/83 → 12/85	FCP206	ATE	✓		✓	☒	
1.1	37	07/80 → 02/83	FCP206	ATE	✓		✓	☒	
1.3	44	01/86 → 08/90	FCP206	ATE	✓		✓	☒	
1.3	51	03/83 → 12/85	FCP206	ATE	✓		✓	☒	
1.3	51	09/80 → 02/83	FCP206	ATE	✓		✓	☒	
1.4	55	01/86 → 12/90	FCP206	ATE	✓		✓	☒	
1.4	55	08/80 → 12/85	FCP206	ATE	✓		✓	☒	
1.6		01/86 → 10/90	FCP206	ATE	✓		✓	☒	
1.6	58, 71	03/83 → 12/86	FCP206	ATE	✓		✓	☒	
1.6	58, 71	09/80 → 02/83	FCP206	ATE	✓		✓	☒	
1.6 D	40	01/86 → 03/89	FCP206	ATE	✓		✓	☒	
1.6 D	40	08/80 → 11/85	FCP206	ATE	✓		✓	☒	
1.6 i XR3i, Cabrio	77	01/80 → 09/82	FCP206	ATE	✓		✓	☒	
1.6 i XR3i, Cabrio	77, 80	02/85 → 09/90	FCP206	ATE	✓		✓	☒	
1.6 i XR3i, Cabrio	77	10/82 → 01/85	FCP206	ATE	✓		✓	☒	
1.6 RS Turbo	97	01/87 → 08/90	FCP276	ATE	✓		✓		
1.6 RS Turbo	97	02/85 → 12/86	FCP276	ATE	✓		✓		

## COMPOUND AVAILABILITY

H C R W Z

## COMPOUND AVAILABILITY

H C R W Z



KW



**...FORD**

**...Escort (3)**

1.6 RS1600 (Turbo)	77	11/82 → 12/86	FCP206	ATE	✓				☒			
1.8 D		09/88 → 10/90	FCP206	ATE	✓				☒			

**Escort (4)**

1.3 i	44	01/95 → 08/97	FCP617	BDX	✓								
1.3 i	44	01/95 → 08/97	FCP617	BDX	✓								
1.3 i	44	04/93 → 12/94	FCP617	BDX	✓								
1.3 i	44	11/90 → 03/93	FCP617	BDX	✓								
1.3 i SW Estate	44	01/94 → 08/97	FCP617	BDX	✓								
1.3 i SW Estate	44	01/94 → 08/97	FCP617	BDX	✓								
1.3 i SW Estate	44	01/94 → 08/97	FCP617	BDX	✓								
1.3 Sedan/SW Estate	44	01/90 → 08/97	FCP617	BDX	✓								
1.4 i	54	01/95 → 08/97	FCP617	BDX	✓								
1.4 i	54	01/95 → 08/97	FCP617	BDX	✓								
1.4 i	54	01/95 → 08/97	FCP617	BDX	✓								
1.4 i	54	01/95 → 08/97	FCP617	BDX	✓								
1.4 i	54	01/95 → 08/97	FCP617	BDX	✓								
1.4 i	54	04/93 → 12/94	FCP617	BDX	✓								
1.4 i	54	04/93 → 12/94	FCP617	BDX	✓								
1.4 i	54	04/93 → 12/94	FCP617	BDX	✓								
1.4 i	54	10/90 → 03/93	FCP617	BDX	✓								
1.4 i	54	10/90 → 03/93	FCP617	BDX	✓								
1.4 i	54	10/90 → 03/93	FCP617	BDX	✓								
1.4 i	54	10/90 → 03/93	FCP617	BDX	✓								
1.4 i	54	10/90 → 03/93	FCP617	BDX	✓								
1.4 i SW Estate	54	01/94 → 08/97	FCP617	BDX	✓								
1.4 i SW Estate	54	01/94 → 08/97	FCP617	BDX	✓								
1.4 Sedan/SW Estate	54	01/90 → 08/97	FCP617	BDX	✓								
1.6 16V	66	01/92 → 08/97	FCP617	BDX	✓								
1.6 i	63, 66, 77	10/90 → 08/97	FCP617	BDX	✓								
1.6 i	63, 66, 77	10/90 → 08/97	FCP617	BDX	✓								
1.6 i	63, 66, 77	10/90 → 08/97	FCP617	BDX	✓								
1.6 i	63, 66, 77	10/90 → 08/97	FCP617	BDX	✓								
1.6 Sedan/SW Estate	63, 66, 77	01/90 → 08/97	FCP617	BDX	✓								
1.8 i	44	01/95 → 08/97	FCP617	BDX	✓								
1.8 i	44	01/95 → 08/97	FCP617	BDX	✓								
1.8 i	44	01/95 → 08/97	FCP617	BDX	✓								
1.8 i	44	01/95 → 08/97	FCP617	BDX	✓								
1.8 i 16V		01/96 → 08/97	FCP276	ATE	✓								
1.8 i XR3i 16V	77	01/91 → 12/94	FCP617	BDX	✓								
1.8 i XR3i 16V	96	01/91 → 12/94	FCP276	ATE	✓								
1.8 Sedan/SW Estate	44	10/90 → 08/97	FCP617	BDX	✓								
1.8 TD	44	10/90 → 08/97	FCP617	BDX	✓								
2.0 RS Cosworth 16V + 4x4	162	09/91 → 08/97	FCP685	ATE	✓				FCP408	LUC	✓		☒
2.0 RS2000 16V	110	09/91 → 08/97	FCP276	ATE	✓								

**Escort (5)**

1.4	55	08/97 → 12/99	FCP617		✓							
1.6 16V	66	08/97 →	FCP617		✓							
1.8	77, 85, 96	08/97 → 12/99	FCP617		✓							
1.8 i 16V		08/97 → 12/99	FCP276	ATE	✓							
1.8 TD		08/97 →	FCP617		✓							

**Escort Van**

1.1	30, 35	01/75 → 12/77	FCP167	LUC	✓	✓	✓	☒	✓			
1.1	33	09/76 → 08/80	FCP167	LUC	✓	✓	✓	☒	✓			
1.1	40	09/80 → 12/90	FCP206	ATE	✓	✓	✓	☒	✓			
1.3	44	09/76 → 08/80	FCP167	LUC	✓	✓	✓	☒	✓			
1.3	44	09/80 → 12/90	FCP206	ATE	✓	✓	✓	☒	✓			
1.4	40	09/80 → 12/90	FCP206	ATE	✓		✓	☒				
1.4 40, 60		01/91 → 08/97	FCP617	BDX	✓							
1.4 40, 60		09/97 →	FCP617	BDX	✓							
1.4 55, 75	55	01/95 →	FCP617	BDX	✓							
1.4 i 40, 60		04/93 → 08/97	FCP617	BDX	✓							
1.4 i 40, 60		04/93 → 08/97	FCP617	BDX	✓							
1.4 i 40, 60		04/93 → 08/97	FCP617	BDX	✓							
1.4 i 55, 75	55	04/93 → 08/97	FCP617	BDX	✓							
1.6		09/80 → 12/90	FCP206	ATE	✓							
1.6 40, 60		01/91 → 08/97	FCP617	BDX	✓							
1.6 40, 60		09/97 →	FCP617	BDX	✓							
1.6 i 55, 75		01/95 → 08/97	FCP617	BDX	✓							
1.8 D		09/80 → 12/90	FCP206	ATE	✓							
1.8 D 40, 60		04/93 → 08/97	FCP617	BDX	✓							
1.8 D 40, 60		04/93 → 08/97	FCP617	BDX	✓							
1.8 D 40, 60		04/93 → 08/97	FCP617	BDX	✓							
1.8 D 40, 60		01/91 → 12/99	FCP617	BDX	✓							
1.8 D 55		01/95 → 08/97	FCP617	BDX	✓							

- ✓ Available
- ✗ Not Available
- ☒ In Introduction
- ⚠ Exhausting
- ☒ Make to order



KW

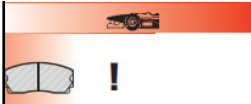

**...FORD**

**...Escort Van**

				COMPOUND AVAILABILITY					COMPOUND AVAILABILITY				
				H	C	R	W	Z	H	C	R	W	Z
1.8 TD 75	09/97 → 12/99	FCP617	BDX	✓									

**Fiesta (1)**

1.6 XR2	71	12/81 → 09/83	FCP206	ATE	✓		✓	☒					
---------	----	---------------	--------	-----	---	--	---	---	--	--	--	--	--

**Fiesta (2)**

1.6 XR2	71	10/83 → 01/89	FCP206	ATE	✓		✓	☒					
---------	----	---------------	--------	-----	---	--	---	---	--	--	--	--	--

**Fiesta (3)**

0.9		03/89 → 12/96	FCP1082	ATE	✓			☒					
1.0		03/89 → 12/95	FCP206	ATE	✓			☒					
1.1	50	04/89 → 12/96	FCP1082	ATE	✓			☒					
1.1	50	04/89 → 12/96	FCP206	ATE, ALB	✓			☒					
1.3	44	08/91 → 12/95	FCP1082	ATE	✓			☒					
1.3	44	08/91 → 12/95	FCP206	ATE, ALB	✓			☒					
1.4	54, 55	04/89 → 10/95	FCP1082	ATE	✓			☒					
1.4	54, 55	04/89 → 10/95	FCP206	ATE, ALB	✓			☒					
1.6 i	131	04/89 → 12/95	FCP206	ATE	✓			☒					
1.6 i 16V	131	01/93 → 12/95	FCP206	ATE	✓			☒					
1.6 i XR2i, 1.6S, RS (Turbo)	77, 96	04/89 → 03/92	FCP206	ATE	✓			☒					
1.8 16V	96	04/89 → 12/95	FCP206	ATE	✓			☒					
1.8 D	44	04/89 → 12/95	FCP1082	ATE, Solid	✓			☒					
1.8 D (+ SCS)	44	04/89 → 12/95	FCP206	ATE, Vented	✓			☒					
1.8 Si 16V	77	01/92 → 12/95	FCP206	ATE	✓			☒					
1.8 XR2, RS Turbo 16V	96	04/89 → 12/95	FCP206	ATE	✓			☒					

**Fiesta (4)**

1.2 16V	55	01/96 → 01/00	FCP1082	ATE, Solid	✓			☒					
1.2 16V	55	01/96 → 01/00	FCP1081	ATE, Vented	✓			☒					
1.2 i 16V		02/00 → 10/01	FCP1394		✓			☒					
1.25 i 16V	55	01/96 → 01/00	FCP1082	ATE	✓			☒					
1.25 i 16V	55	01/96 → 01/00	FCP1081	ATE	✓			☒					
1.25 i 16V	75	02/00 → 10/01	FCP1394	ATE	✓			☒					
1.3	44	01/96 → 01/00	FCP1082	ATE, Solid	✓			☒					
1.3	44	01/96 → 01/00	FCP1081	ATE, Vented	✓			☒					
1.3 i		02/00 → 10/01	FCP1394		✓			☒					
1.4 16V	65	01/96 → 01/00	FCP1082	ATE, Solid	✓			☒					
1.4 16V	65	01/96 → 01/00	FCP1081	ATE, Vented	✓			☒					
1.4 i 16V		02/00 →	FCP1394		✓			☒					
1.6 i 16V		02/00 → 10/01	FCP1394		✓			☒					
1.8 D	44	01/96 → 01/00	FCP1082	ATE, Solid	✓			☒					
1.8 D	44	01/96 → 01/00	FCP1081	ATE, Vented	✓			☒					
1.8 TDi		02/00 → 10/01	FCP1394		✓			☒					

**Fiesta (5)**

1.3 i		11/01 →	FCP1394		✓								
1.4 i 16V		11/01 →	FCP1394		✓								
1.4 TDCi		11/01 →	FCP1394		✓								
1.6 i 16V		11/01 →	FCP1394		✓								
2.0 ST150		01/05 →	FCP1568		✓					FCP1319			
R2 (Asphalt)	120	10/09 →	FRP3116	AP Racing (Asphalt)	✓		✓	✓	✓	FCP1540	AP Racing	✓	
R2 (Gravel)	120	10/09 →	FRP3097	AP Racing (285mm disc)	✓		✓	✓	✓	FCP1540	AP Racing	✓	

**Fiesta (6)**

1.0	48	01/13 →	FCP4612	TRW	☒								
1.0	59	10/12 →	FCP4612	TRW	☒								
1.0 EcoBoost	74	01/13 →	FCP4612	TRW	☒								
1.0 EcoBoost	92	09/12 →	FCP4612	TRW	☒								
1.2 16V	44	08/08 → 00/00	FCP4426	TRW, LUC	✓								
1.2 16V	60	08/08 → 00/00	FCP4426	TRW, LUC	✓								
1.4 16V	68	01/09 → 00/00	FCP4426	TRW, LUC	✓								
1.4 16V	71	10/08 → 00/00	FCP4426	TRW, LUC	✓								
1.4 TDCi 16V	50	08/08 → 00/00	FCP4426	TRW, LUC	✓								
1.5 TDCi	55	09/12 →	FCP4612	TRW	☒								
1.6 16V	88	10/08 → 00/00	FCP4426	TRW, LUC	✓								
1.6 ST	134	03/13 →	FCP4612	TRW	☒								
1.6 TDCi 16V	55	02/09 → 00/00	FCP4426	TRW, LUC	✓								
1.6 TDCi 16V	66	08/08 → 00/00	FCP4426	TRW, LUC	✓								
1.6 TDCi 8V	70	03/10 → 00/00	FCP4426	TRW, LUC	✓								
1.6 Ti	77	09/12 →	FCP4612	TRW	☒								

FORD



kW

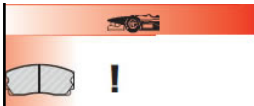

## ...FORD

## Fiesta Van

				COMPOUND AVAILABILITY					COMPOUND AVAILABILITY					
				H	C	R	W	Z	H	C	R	W	Z	
1.1	37	04/89 → 01/96	FCP1082 ATE	✓		☒								
1.1	37	04/89 → 01/96	FCP206 ATE	✓		☒								
1.3	44	04/89 → 01/96	FCP1082 ATE	✓		☒								
1.3	44	04/89 → 01/96	FCP206 ATE	✓		☒								
1.3 i 35	44	01/96 →	FCP1081 ATE	✓		☒								
1.3 i 35	44	01/96 →	FCP1082 ATE	✓		☒								
1.4 i	66	01/96 → 10/99	FCP1081 ATE	✓		☒								
1.4 i	66	01/96 → 10/99	FCP1082 ATE	✓		☒								
1.8 D	44	04/89 → 01/96	FCP1082 ATE	✓		☒								
1.8 D	44	04/89 → 01/96	FCP206 ATE	✓		☒								
1.8 D 35	44	01/96 →	FCP1081 ATE	✓		☒								
1.8 D 35	44	01/96 →	FCP1082 ATE	✓		☒								

## Fiesta Van (6)

1.2 16V	60	08/08 → 00/00	FCP4426 TRW, LUC	✓		☒		☒						
1.4 TDCi 16V	50	08/08 → 00/00	FCP4426 TRW, LUC	✓		☒		☒						
1.5 TDCi	55	10/12 →	FCP4612 TRW	☒										
1.6 TDCi 16V	66	08/08 → 00/00	FCP4426 TRW, LUC	✓		☒		☒						
1.6 TDCi 8V	70	02/10 → 00/00	FCP4426 TRW, LUC	✓		☒		☒						

## Focus I

1.4 16V	55	08/98 → 11/04	FCP1318 ATE	✓		☒								
1.6 16V	74	08/98 → 11/04	FCP1318 ATE	✓		☒								
1.8 16V	85	08/98 → 11/04	FCP1318 ATE	✓		☒				FCP541 LUC	✓	☒	☒	☒
1.8 TDCi	85	03/01 → 11/04	FCP1318 ATE	✓		☒				FCP1319 TRW	✓			
1.8 TDDi	66	08/98 → 11/04	FCP1318 ATE	✓		☒								
2.0 16V	96	08/98 → 11/04	FCP1318 ATE	✓		☒				FCP541 LUC	✓	☒	☒	☒
2.0 RS	158	10/02 → 11/04	FCP1348 BRE	✓		☒	☒	☒		FCP1319 TRW	✓			
2.0 ST170	127	03/02 → 10/04	FCP1568 ATE	✓		☒				FCP1319 TRW	✓			
WRC Tarmac		→	FRP3113 BRE 8-pot	☒		☒		☒						

## Focus II

2.5 RS	224	01/09 →	FCP4044 TRW	✓						FCP1917 TRW	✓			
2.5 ST	166	10/05 →	FCP1706 ATE	✓			☒							

## Focus III

2.0 ST	184	07/12 →	FCP4416 ATE	☒										
--------	-----	---------	-------------	---	--	--	--	--	--	--	--	--	--	--

## Fusion

1.4 i		08/02 →	FCP1394	✓		☒								
1.4 TDCi		08/02 →	FCP1394	✓		☒								
1.6 i		08/02 →	FCP1394	✓		☒								

## Galaxy

1.9 TDi	66, 81	06/95 → 04/00	FCP590 ATE	✓		☒				FCP541 LUC	✓	☒	☒	☒
2.0	85	06/95 → 04/00	FCP590 ATE	✓		☒				FCP541 LUC	✓	☒	☒	☒
2.3 16V	107	06/95 → 04/00	FCP590 ATE	✓		☒				FCP541 LUC	✓	☒	☒	☒
2.8	128	06/95 → 04/00	FCP590 ATE	✓		☒				FCP541 LUC	✓	☒	☒	☒

## Galaxy III

1.8 TDCi	74, 92	05/06 →								FCP1917 TRW, Without EPB	✓			
2.0	107	05/06 →								FCP1917 TRW, Without EPB	✓			
2.0 TDCi	96, 103	05/06 →								FCP1917 TRW, Without EPB	✓			
2.0 TDCi	85	11/07 →								FCP1917 TRW, Without EPB	✓			
2.2 TDCi	129	03/08 →								FCP1917 TRW, Without EPB	✓			
2.3	118	07/07 →								FCP1917 TRW, Without EPB	✓			

## Granada

1.6		01/77 → 06/79	FCP167 LUC	✓	☒	☒	☒	☒						
1.6	55	07/79 → 07/81	FCP167 LUC	✓	☒	☒	☒	☒						
1.6	55	08/81 → 08/82	FCP167 LUC	✓	☒	☒	☒	☒						
1.6	55	09/82 → 12/85	FCP167 LUC	✓	☒	☒	☒	☒						
1.7 Saloon	51	01/77 → 08/81	FCP167 LUC	✓	☒	☒	☒	☒						
1.7 Saloon	51	09/81 → 04/85	FCP167 LUC	✓	☒	☒	☒	☒						
1.8	66	05/85 → 07/87	FCP276 ATE	✓		☒				FCP408 LUC	✓	☒		☒
1.9		03/78 → 08/82	FCP167 LUC	✓	☒	☒	☒	☒						
2.0	66	01/75 → 04/79	FCP167 LUC	✓	☒	☒	☒	☒						
2.0	74, 77	05/79 → 02/85	FCP167 LUC	✓	☒	☒	☒	☒						
2.0	80, 85, 92	05/85 → 11/86	FCP276 ATE	✓		☒				FCP408 LUC	✓	☒		☒
2.0	80, 85, 92	12/86 → 04/92	FCP276 ATE	✓		☒				FCP408 LUC	✓	☒		☒
2.0 Ghia	85	05/92 → 10/94	FCP766 ATE	☒		☒				FCP408 LUC	✓	☒		☒
2.1 D	46	09/79 → 06/82	FCP167 LUC	✓	☒	☒	☒	☒						
2.3	79	05/79 → 02/85	FCP167 LUC	✓	☒	☒	☒	☒						
2.3 SW Estate/Saloon	79	09/77 → 04/79	FCP167 LUC	✓	☒	☒	☒	☒						
2.4	96	01/87 → 08/89	FCP276 ATE	✓		☒				FCP408 LUC	✓	☒		☒
2.5 D/TD		08/86 → 01/92	FCP276 ATE	✓		☒				FCP408 LUC	✓	☒		☒
2.5 Saloon		01/76 → 08/77	FCP167 LUC	✓	☒	☒	☒	☒						
2.8	110	05/85 → 01/87	FCP276 ATE	✓		☒				FCP408 LUC	✓	☒		☒

✓ Available    ⚠ Exhausting  
 ✗ Not Available    ☒ Make to order  
 ☒ In Introduction

**FERODO**  
RACING

Updated on 30th Jan 2014

1041



KW

**...FORD****...Granada**

				COMPOUND AVAILABILITY					COMPOUND AVAILABILITY				
				H	C	R	W	Z	H	C	R	W	Z
2.9		01/87 → 03/92	FCP276 ATE	✓		✓			FCP408 LUC	✓	✓		✉
2.9 24V	143	03/92 → 10/94	FCP276 ATE	✓		✓			FCP408 LUC	✓	✓		✉
2.9 Cosworth 24V		08/92 → 12/95	FCP767 ATE	✓		✗			FCP408 LUC	✓	✓		✉
2.9 Ghia/Saloon/SW Estate		05/92 → 10/94	FCP766 ATE	⚠		✉			FCP408 LUC	✓	✓		✉
3.0 Saloon	101	01/76 → 08/77	FCP167 LUC	✓	✓	✓	✉	✓					

**Ka**

1.3	37, 44	10/96 → 01/00	FCP1081 ATE, Vented	✓		✓							
1.3	37, 44	10/96 → 01/00	FCP1082 ATE, Solid	✓		✉							

**Kuga I**

2.0 TDCi	100	03/08 →							FCP1917 TRW	✓			
2.0 TDCi	103	03/10 →							FCP1917 TRW	✓			
2.0 TDCi 4x4	100	03/08 →							FCP1917 TRW	✓			
2.0 TDCi 4x4	103	03/10 →							FCP1917 TRW	✓			
2.0 TDCi 4x4	120	03/10 →							FCP1917 TRW	✓			
2.5	147	03/09 →							FCP1917 TRW	✓			
2.5 4x4	147	03/09 →							FCP1917 TRW	✓			

**Kuga II**

1.6 EcoBoost	110	03/13 →	FCP4416 ATE	✉									
1.6 EcoBoost 4x4	134	03/13 →	FCP4416 ATE	✉									
2.0 TDCi	103	03/13 →	FCP4416 ATE	✉									
2.0 TDCi 4x4	103	03/13 →	FCP4416 ATE	✉									
2.0 TDCi 4x4	120	03/13 →	FCP4416 ATE	✉									

**Mondeo**

1.6 16V	66	03/93 → 12/00	FCP766 ATE	⚠		✉							
1.8 16V	85	03/93 → 12/00	FCP766 ATE	⚠		✉							
1.8 TD		03/93 → 12/00	FCP766 ATE	⚠		✉							
2.0 16V	100	03/93 → 12/00	FCP766 ATE	⚠		✉							
2.0 16V	100	08/96 → 12/00	FCP767 ATE, 15" wheel	✓		✗							
2.0 i Si, Ghia, 4x4 16V	100	03/93 → 12/00	FCP766 ATE, 14" wheel	⚠		✉							
2.0 i Si, Ghia, 4x4 16V	100	03/93 → 12/00	FCP767 ATE, 15" wheel	✓		✗							
2.5 24V	125	10/94 → 12/00	FCP767 ATE	✓		✗							

**Mondeo (II)**

1.6 i 16V	66	08/96 → 12/00	FCP766 ATE	⚠		✉							
1.8 i 16V	85	08/96 → 12/00	FCP766 ATE	⚠		✉							
1.8 TD	66	08/96 → 12/00	FCP766 ATE	⚠		✉							
2.0 i 16V	100	08/96 → 12/00	FCP766 ATE	⚠		✉							
2.0 i 16V	100	08/96 → 12/00	FCP767 ATE	✓		✗							
2.5 i 24V	125	10/94 → 12/00	FCP767 ATE	✓		✗							

**Mondeo IV**

1.6 Ti	81, 92	03/07 →							FCP1917 TRW, Without EPB	✓			
1.8 TDCi	74	03/07 →							FCP1917 TRW, Without EPB	✓			
2.0	107	03/07 →							FCP1917 TRW, Without EPB	✓			
2.0 TDCi	96, 103	03/07 →							FCP1917 TRW, Without EPB	✓			
2.0 TDCi	85	11/07 →							FCP1917 TRW, Without EPB	✓			
2.2 TDCi	129	03/08 →							FCP1917 TRW, Without EPB	✓			
2.3	118	07/07 →							FCP1917 TRW, Without EPB	✓			
2.5	162	03/07 →							FCP1917 TRW, Without EPB	✓			

**Mondeo SW IV**

1.6 Ti	81, 92	03/07 →							FCP1917 TRW, Without EPB	✓			
1.8 TDCi	74	03/07 →							FCP1917 TRW, Without EPB	✓			
2.0	107	03/07 →							FCP1917 TRW, Without EPB	✓			
2.0 TDCi	96, 103	03/07 →							FCP1917 TRW, Without EPB	✓			
2.0 TDCi	85	11/07 →							FCP1917 TRW, Without EPB	✓			
2.2 TDCi	129	03/08 →							FCP1917 TRW, Without EPB	✓			
2.3	118	07/07 →							FCP1917 TRW, Without EPB	✓			
2.5	162	03/07 →							FCP1917 TRW, Without EPB	✓			

**Mustang**

5.0		01/11 → 12/11	FRP3129	✓					FRP3130	✓			✉
5.0L Performance		01/11 → 12/11							FRP3130	✓			✉
Bullit 4.6		01/08 → 12/09	FRP3129	✓					FRP3130	✓			✉
GT 4.6		01/05 → 12/10	FRP3129	✓					FRP3130	✓			✉
Shelby GT 4.6		01/07 → 12/08	FRP3129	✓					FRP3130	✓			✉
Shelby GT500		01/07 → 12/11							FRP3130	✓			✉
V6		01/05 → 12/10	FRP3129	✓					FRP3130	✓			✉
V6 3.7		01/11 →	FRP3129	✓					FRP3130	✓			✉







kW



**...FORD**

**...Sierra**

			COMPOUND AVAILABILITY					COMPOUND AVAILABILITY				
			H	C	R	W	Z	H	C	R	W	Z
2.0 SW Estate	01/82 → 12/86	FCP276 ATE, ABS	✓		✓							
2.0 SW Estate	01/87 → 02/93	FCP206 ATE	✓		✓		✉	FCP408 LUC, ABS	✓		✓	✉
2.0 SW Estate	01/87 → 02/93	FCP276 ATE, ABS	✓		✓							
2.3 D	49 02/87 → 02/90	FCP206 ATE	✓		✓		✉	FCP408 LUC, ABS	✓		✓	✉
2.3 D	49 02/87 → 02/90	FCP276 ATE, ABS	✓		✓							
2.3 D	49 10/82 → 02/87	FCP206 ATE	✓		✓		✉					
2.3 D SW Estate	49 01/82 → 12/90	FCP206 ATE	✓		✓		✉	FCP408 LUC, ABS	✓		✓	✉
2.3 D SW Estate	49 01/82 → 12/90	FCP276 ATE, ABS	✓		✓							
2.3 D SW Estate	49 01/91 → 02/93	FCP206 ATE	✓		✓		✉	FCP408 LUC, ABS	✓		✓	✉
2.3 D SW Estate	49 01/91 → 02/93	FCP276 ATE, ABS	✓		✓							
2.3 SW Estate	84 01/82 → 12/87	FCP206 ATE	✓		✓		✉	FCP408 LUC, ABS	✓		✓	✉
2.3 SW Estate	84 01/82 → 12/87	FCP276 ATE, ABS	✓		✓							
2.3 SW Estate	84 01/87 → 02/93	FCP206 ATE	✓		✓		✉	FCP408 LUC, ABS	✓		✓	✉
2.3 SW Estate	84 01/87 → 02/93	FCP276 ATE, ABS	✓		✓							
2.8 4x4	110 06/85 → 01/93	FCP276 ATE	✓		✓			FCP408 LUC	✓		✓	✉
2.8 4x4 SW Estate	110 01/82 → 02/93	FCP276 ATE	✓		✓			FCP408 LUC	✓		✓	✉
2.8 XR4i	01/83 → 12/85	FCP276 ATE	✓		✓							
2.9	107, 110 05/89 → 12/95	FCP276 ATE	✓		✓			FCP408 LUC	✓		✓	✉
2.9 V6 4x4 SW Estate	110 01/82 → 02/93	FCP276 ATE	✓		✓			FCP408 LUC	✓		✓	✉

**Sierra Cosworth**

2.0 4x4 16V	162 01/89 → 02/93	FCP685 ATE	✓		✓			FCP408 LUC	✓		✓	✉
2.0 RS 16V	150, 162 07/86 → 02/93	FCP399 LUC	✓		✓			FCP408 LUC	✓		✓	✉

**Sierra Sapphire**

1.6	55, 59 03/87 → 02/95	FCP206 ATE	✓		✓		✉	FCP408 LUC, ABS	✓		✓	✉
1.6	55, 59 03/87 → 02/95	FCP276 ATE, ABS	✓		✓							
1.8	64, 66 03/87 → 02/95	FCP206 ATE	✓		✓		✉	FCP408 LUC, ABS	✓		✓	✉
1.8	64, 66 03/87 → 02/95	FCP276 ATE, ABS	✓		✓							
2.0	77, 85, 92 03/87 → 02/93	FCP206 ATE	✓		✓		✉	FCP408 LUC, ABS	✓		✓	✉
2.0	77, 85, 92 03/87 → 02/93	FCP276 ATE, ABS	✓		✓							
2.0 RS Cosworth 2WD	02/88 → 02/93	FCP399 LUC	✓		✓			FCP408 LUC	✓		✓	✉
2.0 RS Cosworth 4x4	02/88 → 02/93	FCP685 ATE	✓		✓			FCP408 LUC	✓		✓	✉
2.3 D	49 01/87 → 12/90	FCP206 ATE	✓		✓		✉	FCP408 LUC	✓		✓	✉
2.3 D	49 01/87 → 12/90	FCP276 ATE, ABS	✓		✓							
2.3 D	49 01/91 → 02/93	FCP206 ATE	✓		✓		✉	FCP408 LUC	✓		✓	✉
2.3 D	49 01/91 → 02/93	FCP276 ATE, ABS	✓		✓							

**Street Ka**

1.6 i	02/03 →	FCP1394	✓		✓							
-------	---------	---------	---	--	---	--	--	--	--	--	--	--

**Taurus**

1.3	41, 44 01/70 → 12/92	FCP167 LUC	✓	✓	✓	✓	✉	✓				
1.3 i	41, 44 01/74 → 12/79	FCP167 LUC	✓	✓	✓	✓	✉	✓				
1.3 i	01/79 → 12/82	FCP167 LUC	✓	✓	✓	✓	✉	✓				
1.3 i	01/79 → 12/82	FCP167 LUC	✓	✓	✓	✓	✉	✓				
1.3 i	01/83 → 12/92	FCP167 LUC	✓	✓	✓	✓	✉	✓				
1.6	53, 66 01/70 → 12/92	FCP167 LUC	✓	✓	✓	✓	✉	✓				
1.6 i	53, 66 01/75 → 12/79	FCP167 LUC	✓	✓	✓	✓	✉	✓				
1.6 i	53, 66 01/80 → 12/82	FCP167 LUC	✓	✓	✓	✓	✉	✓				
1.6 i	53, 66 01/83 → 12/92	FCP167 LUC	✓	✓	✓	✓	✉	✓				
2.0 Sedan/SW Estate	66 01/76 → 12/82	FCP167 LUC	✓	✓	✓	✓	✉	✓				
2.3	79 07/79 → 07/82	FCP167 LUC	✓	✓	✓	✓	✉	✓				

**FORD USA**

**Focus I**

	01/98 → 12/01	FCP1318 KEL	✓		✉							
--	---------------	-------------	---	--	---	--	--	--	--	--	--	--

**Mustang , Cobra**

	01/94 → 12/00	FCP1224 KEL	✉		✉							
--	---------------	-------------	---	--	---	--	--	--	--	--	--	--

FORD

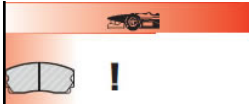

KW

**FSO****125**

1.3 01/76 → 06/90

FCP29 BDX ✓ ✓

**Polonez**

1.5 11/78 →

FCP29 BDX ✓ ✓

1.6 11/78 →

FCP29 BDX ✓ ✓

**Prima**

1.5 55 09/88 → 09/95

FCP29 BDX ✓ ✓

1.6 60 09/94 →

FCP29 BDX ✓ ✓

1.9 51 09/91 →

FCP29 BDX ✓ ✓

**GEO****Prism**

01/89 → 12/92

FCP308 ✓ ✓

**HOLDEN****Commodore**

VX,VU,VY,VZ 01/00 →

FCP1553 ✓ ☒ ☒ ☒

**HONDA****Accord**

1.8 i CE7 02/96 → 10/98

FCP904 AKE ✓ FCP956 NIS ✓ ✓ ☒

1.8 i CE7 02/96 → 10/98

FCP905 LUC ✓ ✓ FCP956 NIS ✓ ✓ ☒

2.0 CA 75, 76, 78, 85, 101 01/87 → 12/90

FCP748 AKE ✓ FCP472 ✓ ✓

2.0 CB 16V 66, 81, 98 09/89 → 12/93

FCP761 AKE ☒ FCP956 NIS ✓ ✓ ☒

2.0 CC 16V 85, 96, 116 01/93 → 09/98

FCP904 AKE, 14" wheel ✓ FCP956 NIS ✓ ✓ ☒

2.0 CC 16V 85, 96, 116 01/93 → 09/98

FCP905 LUC, 15" wheel ✓ ✓ FCP956 NIS ✓ ✓ ☒

2.0 CC 16V 85, 96, 116 01/98 →

FCP761 AKE, 14" wheel ☒ FCP956 NIS ✓ ✓ ☒

2.2 16V 09/89 → 12/91

FCP598 AKE ✓ ✓ FCP472 ✓ ✓

2.2 4 wheel drive 16V 01/91 →

FCP598 AKE ✓ ✓ FCP956 NIS ✓ ✓ ☒

2.2 i CE9 VTEC 16V 110 02/96 → 10/98

FCP905 LUC ✓ ✓ FCP956 NIS ✓ ✓ ☒

2.3 16V 05/93 → 02/96

FCP904 AKE, 14" wheel ✓ FCP956 NIS ✓ ✓ ☒

2.3 16V 05/93 → 02/96

FCP905 LUC, 15" wheel ✓ ✓ FCP956 NIS ✓ ✓ ☒

2.3 16V 05/96 →

FCP761 AKE, 14" wheel ☒ FCP956 NIS ✓ ✓ ☒

2.3 i CC7 16V 116 01/93 → 02/96

FCP905 LUC ✓ ✓ FCP956 NIS ✓ ✓ ☒

**Accord Aerodeck**

2.0 CC 16V 98 01/91 → 12/92

FCP905 LUC, 15" wheel ✓ ✓ FCP956 NIS ✓ ✓ ☒

2.0 CC 16V 98 01/92 → 12/94

FCP904 AKE, 14" wheel ✓ ✓ FCP956 NIS ✓ ✓ ☒

2.0 CC 16V 98 01/95 →

FCP761 AKE, 14" wheel ☒ FCP956 NIS ✓ ✓ ☒

2.0 i CE2/CE1 16V 136 01/94 → 12/97

FCP905 LUC ✓ ✓ FCP956 NIS ✓ ✓ ☒

2.2 CC 16V 108, 110 01/91 → 12/92

FCP905 LUC, 15" wheel ✓ ✓ FCP956 NIS ✓ ✓ ☒

2.2 CC 16V 108, 110 01/92 → 12/94

FCP904 AKE, 14" wheel ✓ ✓ FCP956 NIS ✓ ✓ ☒

2.2 CC 16V 108, 110 01/95 →

FCP761 AKE, 14" wheel ☒ FCP956 NIS ✓ ✓ ☒

2.2 i CE2/CE1 16V 150 01/94 → 12/97

FCP905 LUC ✓ ✓ FCP956 NIS ✓ ✓ ☒

2.2 i CB8/9 16V 01/91 → 12/94

FCP905 LUC ✓ ✓

**Accord Coupe**

2.0 16V 98 01/92 → 12/94

FCP904 AKE ✓ FCP956 NIS ✓ ✓ ☒

2.0 16V 98 01/95 →

FCP761 AKE ☒ FCP956 NIS ✓ ✓ ☒

2.0 i CG4 16V 147 02/98 → 12/02

FCP905 LUC ✓ ✓ FCP956 NIS ✓ ✓ ☒

2.2 110 01/98 →

FCP761 AKE ☒

2.2 110 09/93 → 12/97

FCP904 AKE ✓

3.0 i CG2 V6 200 02/98 → 12/02

FCP905 LUC ✓ ✓ FCP956 NIS ✓ ✓ ☒

**Accord VI**

2.2 Type R 156 01/99 → 12/02

FCP905 AKE ✓ ✓ FCP541 LUC-TRW ✓ ✓ ☒ ☒

**Civic**

Si with ABS 01/94 → 12/95

FCP1436 ☒

1.2 77 01/73 → 12/75

FCP39 TOK ✓ ☒

1.4 i EJ9 16V 66 01/98 → 02/01

FCP776 AKE ✓ ✓ ☒

1.5 i 16V 84 10/95 → 02/01

FCP776 AKE ✓ ✓ ☒ FCP472 AKE ✓

1.6 ED4-ED7 16V 81, 96 01/87 → 10/91

FCP598 AKE ✓ ✓ FCP472 ✓

1.6 EE9 16V 81, 96 01/90 → 10/91

FCP613 AKE ✓ ✓ FCP472 ✓

1.6 EK1, EK4 Vti 16V 10/95 → 02/01

FCP776 AKE ✓ ✓ ☒ FCP472 ✓

1.6 i 16V 83 09/94 → 01/97

FCP613 LUC ✓ ✓

1.6 i EG VTEC Esi 16V 69, 92, 118 11/91 → 12/95

FCP777 AKE ✓ ✓

1.6 i EG9 VTEC Vti 16V 69, 92, 118 11/91 → 12/95

FCP776 AKE ✓ ✓ ☒ FCP472 ✓

1.6 i MB1 VTEC 16V 93 01/95 → 12/97

FCP613 LUC ✓ ✓ FCP472 ✓

Available    Exhausting  
 Not Available    Make to order  
 In Introduction



Updated on 30th Jan 2014

1045

HONDA



kW



**...HONDA**

**...Civic**

			COMPOUND AVAILABILITY					COMPOUND AVAILABILITY						
			H	C	R	W	Z	H	C	R	W	Z		
1.8 MB6 16V	124	01/97 → 02/01	FCP905	AKE	✓					FCP472	✓			
2.0 TDi MB7	63	01/97 → 02/01	FCP613	LUC	✓					FCP472	✓			

**Civic Aerodeck**

1.6 16V	85	02/98 → 02/01	FCP613	LUC	✓					FCP472	✓			
1.8 16V	124	02/98 → 02/01	FCP613	LUC	✓					FCP472	✓			

**Civic Coupe**

1.5 i EJ2 16V	69, 74	01/94 → 11/95	FCP777	AKE	✓									
1.5 EJ2 16V	69, 74	01/94 → 11/95	FCP777	AKE	✓									
1.6 i EJ1 16V	92	01/94 → 11/95	FCP776	AKE	✓									
1.6 i EJ6 16V		03/96 → 03/00	FCP777	AKE	✓									
1.6 i EJ8 VTEC 16V		03/96 → 03/00	FCP776	AKE	✓									
1.6 i EJ1 16V	92	01/94 → 11/95	FCP776	AKE	✓									
1.6 i VTEC VTi 16V		01/92 →	FCP776	AKE	✓					FCP472	✓			

**Civic CRX**

1.5 ED	91, 96, 110	01/88 → 05/92	FCP598	AKE	✓					FCP472	✓			
1.6 ED 16V	91, 96, 110	01/87 → 12/91	FCP598	AKE	✓					FCP472	✓			
1.6 EE VTEC 16V	110	01/89 → 12/91	FCP613	AKE	✓									
1.6 i EG VTEC Vti 16V	92, 118	01/92 → 12/93	FCP776	AKE	✓									
1.6 i EH VTEC Esi 16V	92, 118	01/92 → 12/93	FCP777	AKE	✓									

**Civic I**

1.5 i	52	01/76 → 12/77	FCP39	TOK										
-------	----	---------------	-------	-----	--	--	--	--	--	--	--	--	--	--

**Civic IV**

1.3 EG 16V	55	11/91 → 12/95	FCP776	AKE	✓									
1.4 16V		11/91 → 12/94	FCP777	AKE	✓									
1.4 16V		11/91 → 12/94	FCP776	AKE	✓					FCP472	✓			
1.4 i EJ9 16V	66	01/96 → 01/98	FCP777	AKE	✓									
1.4 i MA8 16V		09/94 → 01/97	FCP613	LUC	✓									
1.4 i MA8 16V		09/94 → 01/97	FCP613	LUC	✓									
1.4 i MB2 16V		01/97 → 12/98	FCP613	LUC	✓									
1.4 MA 16V	55, 66	01/94 → 12/96	FCP613	LUC	✓									
1.5 16V	61	11/91 → 12/92	FCP777	AKE	✓									
1.5 16V	61	11/91 → 12/92	FCP776	AKE	✓					FCP472	✓			
1.5 16V	66	11/91 → 12/95	FCP777	AKE	✓									
1.5 16V	66	11/91 → 12/95	FCP776	AKE	✓					FCP472	✓			
1.5 i 16V	66	12/94 → 12/95	FCP777	AKE	✓									
1.5 i 16V	66	12/94 → 12/95	FCP777	AKE	✓									
1.5 i EG4 16V		01/92 → 12/95	FCP777	AKE	✓									
1.5 i EG4 16V		01/92 → 12/95	FCP777	AKE	✓									
1.5 i MA9 VTEC-E 16V		09/94 → 01/97	FCP613	LUC	✓									
1.5 i MA9 VTEC-E 16V		09/94 → 01/97	FCP613	LUC	✓									

**Civic Shuttle**

1.5 EE1/2 16V	66	01/88 → 12/91	FCP598	AKE	✓									
1.6 EE 16V	80, 81	04/88 → 12/92	FCP598	AKE	✓									

**Civic V**

1.3 i EG 16V	55	01/94 → 02/01	FCP776	AKE	✓									
1.4 i MB2 16V		01/99 → 02/01	FCP613	LUC	✓									
1.5 16V	84	01/96 →	FCP777	AKE	✓									
1.5 i 16V	84	10/95 → 02/01	FCP777	AKE	✓									
1.5 i 16V	84	10/95 → 02/01	FCP777	AKE	✓									
1.5 i 16V	66	12/94 → 12/95	FCP776	AKE	✓					FCP472	AKE	✓		
1.5 i EK3 16V		11/95 → 02/01	FCP776	AKE	✓									
1.5 i MB3 16V		01/97 → 02/01	FCP613	LUC	✓									
1.5 i MB3 16V		01/97 → 02/01	FCP613	LUC	✓									

**Civic V Fastback**

1.8 VTi		01/97 →	FCP905		✓									
---------	--	---------	--------	--	---	--	--	--	--	--	--	--	--	--

**Civic VII**

1.4	83	01/06 →	FCP1859		✓					FCP1862	✓			
1.7 CTDi	118	01/02 → 09/05	FCP1444	SUM	✓			✓		FCP956	NIS	✓		✗
1.8	140	01/06 →	FCP1859		✓					FCP1862	✓			
2.0		01/06 →	FCP1859		✓					FCP1862	✓			
2.0 i Sport	118	01/04 → 09/05	FCP1444	SUM	✓			✓		FCP956	NIS	✓		✗
2.0 Type R	147	09/01 → 09/05	FCP1444	SUM	✓			✓		FCP956	NIS	✓		✗
2.0 Type R 16V - Jas Motorsport		01/07 →	FRP3105	Gravel Rally R3				✗		FCP1862	✓			
2.2 CTDi	140	01/06 →	FCP1859		✓					FCP1862	✓			

HONDA



KW



**...HONDA**

**Civic VIII**

2.0 Type R 148 09/06 →

FCP1444 SUM

COMPOUND AVAILABILITY				
H	C	R	W	Z
✓		✓	✓	

FCP1862 TRW

COMPOUND AVAILABILITY				
H	C	R	W	Z
✓				

**Concerto**

1.4 16V 61 10/89 → 08/91  
 1.5 16V 66 10/91 → 05/95  
 1.6 16V 82, 90 10/89 → 10/92

FCP613 LUC, ABS  
 FCP613 LUC, ABS  
 FCP613 LUC

✓		✓		
✓		✓		
✓		✓		

FCP472  
 FCP472  
 FCP472

✓				
✓				
✓				

**Coupe**

1.6 16V 02/88 → 12/91  
 1.6 i VTEC ESi 16V 92 01/92 →  
 1.6 i VTEC VTi 16V 92 01/92 →  
 1.6 VTEC 16V 01/90 → 12/91

FCP598 AKE  
 FCP776 AKE  
 FCP776 AKE  
 FCP748 AKE

✓		✓		
✓		✓		✉
✓		✓		✉
✓		✓		

FCP472  
 FCP472  
 FCP472

✓				
✓				
✓				
✓				

**CR-V**

2.0 i RD1 16V 94 01/99 →  
 2.0 i RD1 16V 94 06/97 → 12/98

FCP1436  
 FCP905 LUC

✉				
✓		✓		

FCP905

**HR-V**

1.6 16V 77 02/99 →

FCP905 LUC

✓		✓		
---	--	---	--	--

FCP905

--	--	--	--	--

**Integra**

2.0 16V type-R 02/02 →

FCP905

✓		✓		
---	--	---	--	--

FCP956

✓		✓		✉
---	--	---	--	---

**Integra (DC2)**

1.8 Type R 16V 140 11/97 →

FCP905 LUC

✓		✓		
---	--	---	--	--

FCP956 NIS

✓		✓		✉
---	--	---	--	---

**Jazz**

1.2 i 57 03/02 →  
 1.4 i 61 03/02 →

FCP777 AKE  
 FCP777 AKE

✓				
✓				

FCP777

**Legend**

2.5 UK Man. 24V 127 10/86 → 04/91  
 2.7 Jap. Man. 24V 124 01/85 → 12/91  
 2.7 UK Man. 24V 124 10/86 → 04/91  
 3.2 UK Man. 24V 151 04/91 → 12/95  
 3.5 24V 151 01/96 →

FCP748 AKE  
 FCP748 AKE  
 FCP748 AKE  
 FCP905 LUC  
 FCP905 LUC

✓				
✓				
✓				
✓		✓		
✓		✓		

FCP956 NIS

✓		✓		✉
---	--	---	--	---

**Logo**

1.3 i GA3 48 03/99 → 03/02

FCP777 AKE

✓				
---	--	--	--	--

FCP777

--	--	--	--	--

**NSX**

3.0 24V 201 09/90 → 12/96

FCP905 LUC

✓		✓		
---	--	---	--	--

FCP905

--	--	--	--	--

**Prelude**

2.0 98 04/92 →  
 2.0 84, 98, 101, 103 10/87 → 04/92  
 2.0 BA 101 11/85 → 07/87  
 2.0 BA4 80 10/87 → 04/92  
 2.0 BA4 16V 110 10/87 → 12/91  
 2.2 16V 136 01/93 →  
 2.3 BB 16V 118 04/92 →

FCP905 LUC  
 FCP598 AKE  
 FCP905 AKE  
 FCP748 AKE  
 FCP905 LUC  
 FCP905 LUC

✓		✓		
✓		✓		
✓				
✓		✓		
✓		✓		
✓		✓		
✓		✓		

FCP956 NIS  
 FCP472  
 FCP472 AKE  
 FCP472  
 FCP472  
 FCP956 NIS  
 FCP956 NIS

✓		✓		✉
✓		✓		✉
✓		✓		
✓		✓		
✓		✓		✉
✓		✓		✉
✓		✓		✉

**S2000**

2.0 16V 178 06/99 →

FCP1444 SUM

✓		✓	✓	
---	--	---	---	--

FCP956 NIS

✓		✓		✉
---	--	---	--	---

**Shuttle**

2.2 ES 16V 110 01/94 → 12/97

FCP905 LUC

✓		✓		
---	--	---	--	--

FCP956 NIS

✓		✓		✉
---	--	---	--	---

**HUMBER**

**Sceptre**

01/63 → 12/67

FCP823 LKD

		✉		
--	--	---	--	--

FCP823

--	--	--	--	--

✓ Available    ⚠ Exhausting  
 ✗ Not Available    ✉ Make to order  
 ⚡ In Introduction



Updated on 30th Jan 2014

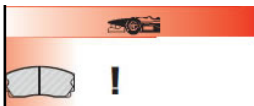

HYUNDAI

HYUNDAI				COMPOUND AVAILABILITY					COMPOUND AVAILABILITY						
				H	C	R	W	Z	H	C	R	W	Z		
<b>Coupe</b>															
1.6 KG 16V	84	01/96 →	FCP600	✓		✗				FCP638	SUM	✓			
2.0 16V	101	07/96 →	FCP600	✓		✗				FCP638	SUM	✓			
<b>Lantra</b>															
1.6 16V	84	01/91 →	FCP600	✓		✗									
1.8 16V	93	01/91 → 05/95	FCP600	✓		✗									
<b>Matrix</b>															
1.5 CRDi		10/01 →	FCP600	✓		✗									
1.6		06/01 →	FCP600	✓		✗									
1.8		06/01 →	FCP600	✓		✗									
<b>Pony</b>															
1.2 Pick-up MkII	41	02/82 → 07/85	FCP810	LUC	✓		✓	✓	✓						
1.4 II (B Series)	50	01/79 → 10/85	FCP810	LUC	✓	✗	✓	✓	✓						
1.6 Pick-up MkII		02/82 → 07/85	FCP810	LUC	✓	✗	✓	✓	✓						
<b>Sonata</b>															
1.8	63, 70, 73	10/88 → 08/89	FCP600		✓		✗								
2.0	77, 80, 96, 102	10/88 → 08/89	FCP600		✓		✗								
2.4	84	10/88 → 08/94	FCP600		✓		✗								
2.5 24V	118	06/98 →	FCP600		✓		✗								
3.0	107	08/89 → 06/96	FCP600		✓		✗								
<b>Stellar</b>															
1.6	54, 55	09/83 → 12/86	FCP167	LUC, Solid	✓	✓	✓	✗	✓						
<b>Tiburon</b>															
1.6 i 16V	84	01/96 →	FCP600		✓		✗			FCP638	SUM	✓			
1.6 i 16V	84	01/96 →	FCP600		✓		✗			FCP638	SUM	✓			
2.0 i 16V	101	07/96 →	FCP600		✓		✗			FCP638	SUM	✓			
<b>INFINITI</b>															
<b>FX35</b>															
	206	01/03 → 12/05	FCP1786	TOK	✓					FCP1693	AKE	✓			
	206	01/05 → 10/05	FCP1786	TOK	✓					FCP1693	AKE	✓			
	206	01/07 → 12/08	FCP1690		✓					FCP1693	AKE	✓			
	206	11/05 → 12/06	FCP1690		✓					FCP1693	AKE	✓			
<b>FX45</b>															
	232	01/03 → 12/05	FCP1786	TOK	✓					FCP1693	AKE	✓			
	232	01/05 → 10/05	FCP1786	TOK	✓					FCP1693	AKE	✓			
	232	01/07 → 12/08	FCP1690		✓					FCP1693	AKE	✓			
	232	11/05 → 12/06	FCP1690		✓					FCP1693	AKE	✓			
<b>FX50</b>															
FX50		01/08 →	FCP4172		✓					FCP4173		✓			
<b>G20</b>															
G20		01/91 → 12/97	FCP600		✓		✗								
G20		01/98 → 12/00	FCP691		✓										
<b>G35</b>															
RWD		01/05 → 12/06	FCP1690		✓					FCP1693	AKE	✓			
<b>G37</b>															
G37		01/08 →	FCP4172		✓					FCP4173		✓			
<b>I-30</b>															
I-30		01/96 → 12/98	FCP1430		✓										
<b>M35</b>															
M35 / M35 X		01/06 → 12/08	FCP1690		✓					FCP1693	AKE	✓			
<b>M45</b>															
M45 / M45 Sport		01/06 → 12/08	FCP1690		✓					FCP1693	AKE	✓			



kw



## INNOCENTI

### Elba

1.3	48	01/91 → 12/92	FCP519	ATE										
1.4	51	01/91 → 10/97	FCP519	ATE										
1.5	56	01/91 → 08/94	FCP519	ATE										
1.6	59	01/91 → 10/97	FCP519	ATE										
1.7	52	01/91 → 03/93	FCP519	ATE										

### Koral

0.9	33	01/89 → 12/92	FCP29	BDX	✓									
1.1	42	01/89 → 12/92	FCP29	BDX	✓									

### Mille

1.0	35	01/94 → 12/95	FCP519	ATE										
1.0	35	01/95 →	FCP351	BDX	✓									
1.4	51	01/95 →	FCP351	BDX	✓									
1.7	42	01/94 → 12/97	FCP370	LUC	✓									

### Regent

All models		01/73 → 12/80	FCP809	LUC	✓									
All i		01/73 →	FCP809	LUC	✓									

## JAGUAR

### 420

4.2		01/67 → 12/68	FCP9	LUC	✓									
-----	--	---------------	------	-----	---	--	--	--	--	--	--	--	--	--

### Daimler Double Six

5.3 Series II		09/73 → 12/78	FCP817	LUC	✓									
5.3 V12 Series III		01/79 → 09/86	FCP817	LUC	✓									

### E-Type

5.3 24V		01/68 → 12/74	FCP9	LUC	✓									
---------	--	---------------	------	-----	---	--	--	--	--	--	--	--	--	--

### Sovereign

2.9	110, 123	09/90 → 09/97	FCP685	ATE	✓									
3.2 24V	149, 160	09/90 → 09/97	FCP685	ATE	✓									
3.4 Series I (Daimler)	119	01/67 → 12/73	FCP9	LUC	✓									
3.4 Series II (Daimler)	119	01/73 → 12/78	FCP817	LUC	✓									
3.6 (Daimler) 24V	165	09/90 → 09/97	FCP685	ATE	✓									
4.0 (Daimler) 24V	166, 175, 183	09/90 → 09/97	FCP685	ATE	✓									
4.2 Series I (Daimler)	114, 124	01/67 → 12/73	FCP9	LUC	✓									
4.2 Series II (Daimler)	124	01/73 → 12/78	FCP817	LUC	✓									
4.2 Series III (Daimler)	124	01/79 → 09/86	FCP817	LUC	✓									
5.3 24V	196	01/93 → 09/97	FCP685	ATE	✓									
5.3 24V	196	09/90 → 12/92	FCP685	ATE	✓									
6.0		01/94 → 09/97	FCP685	ATE	✓									

### Vanden Plas

4.2 Series III (Daimler)	124	01/79 → 09/86	FCP817	LUC	✓									
5.3 V12 Series III (Daimler)	219	01/79 → 09/86	FCP817	LUC	✓									

### XJ12

5.3 24V	211	01/69 → 08/73	FCP9	LUC	✓									
5.3 24V	211	09/73 → 09/86	FCP817	LUC	✓									
5.3 24V	209, 227	09/90 → 12/92	FCP685	ATE	✓									
6.0 24V	227	09/90 → 09/94	FCP685	ATE	✓									

### XJ6

2.8	96	09/73 → 09/86	FCP817	LUC	✓									
2.9	123	09/73 → 09/86	FCP817	LUC	✓									
2.9	108, 117, 123	09/90 →	FCP685	ATE	✓									
3.2 24V	146	09/90 → 12/94	FCP685	ATE	✓									
3.2 24V	146	10/94 → 09/97	FCP685	ATE	✓									
3.4	119	09/73 → 09/86	FCP817	LUC	✓									
3.6 24V	149, 165	09/90 → 09/97	FCP685	ATE	✓									
4.0 24V	163, 229	09/90 → 09/97	FCP685	ATE	✓									
4.2	130	09/73 → 09/86	FCP817	LUC	✓									
6.0 i	229	09/90 → 09/94	FCP685	ATE	✓									

✓ Available    ⚠ Exhausting  
 ✗ Not Available    📧 Make to order  
 📦 In Introduction



Updated on 30th Jan 2014



KW

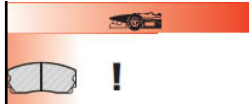

**...JAGUAR**

**XJR**

4.0 i 24V 240 09/94 →

FCP817 LUC FCP815 LUC

**XJR-S**

5.3 08/88 → 09/89  
5.3 Le Mans Ltd Edn 09/90 → 04/91  
6.0 09/89 → 05/93

FCP817 LUC FCP815 LUC   
FCP685 ATE FCP578 ATE   
FCP685 ATE FCP578 ATE

**XJS**

3.6 24V 136, 146, 156, 162 01/75 → 12/89  
3.6 24V 146 01/90 → 05/91  
4.0 24V 163, 171 01/87 → 09/96  
5.3 24V 194, 197, 202, 211, 213, 217 01/75 → 12/89  
5.3 i 24V 202, 207 01/90 → 12/93  
6.0 i 24V 227 05/93 → 05/95

FCP817 LUC FCP815 LUC   
FCP685 ATE FCP578 ATE   
FCP817 LUC FCP815 LUC   
FCP685 ATE FCP578 ATE   
FCP685 ATE FCP578 ATE

**XK8**

4.0 V8 32V 216 10/96 →

FCP685 ATE FCP578 ATE

**JEEP**

**Cherokee**

2.5 78 01/77 → 12/83  
2.8 83 01/77 → 12/83  
4.2 81 01/77 → 12/83  
5.9 16V 128 01/77 → 12/83

FRP3057 KEL   
FRP3057 KEL   
FRP3057 KEL   
FRP3057 KEL

**Comanche**

01/86 → 12/89

FRP3057 KEL

**Grand Wrangler**

2.5 01/84 → 12/91  
4.0 01/84 → 12/91  
4.2 01/84 → 12/91  
5.2 01/84 → 12/91

FRP3057 KEL   
FRP3057 KEL   
FRP3057 KEL   
FRP3057 KEL

**J10**

4.2 81 01/74 → 12/87  
5.9 16V 108, 128 01/74 → 12/87

FRP3057 KEL   
FRP3057 KEL

**J20**

4.2 81 01/74 → 12/87  
5.9 16V 108, 128 01/74 → 12/87

FRP3057 KEL   
FRP3057 KEL

**Wagoneer**

2.5 76 01/77 → 12/83  
4.2 81 01/77 → 12/83  
5.9 16V 120, 128 01/77 → 12/83

FRP3057 KEL   
FRP3057 KEL   
FRP3057 KEL

**JENSEN**

**FF**

6.3 16V 89 01/68 → 12/71

FCP9 LUC FCP815 LUC

**Healey**

2.0 88 01/72 → 12/76

FCP810 LUC

**Interceptor**

7.2 16V 01/68 → 12/71

FCP9 LUC FCP815 LUC

**SP V8**

283 01/71 → 12/72

FCP9 LUC FCP815 LUC





kW

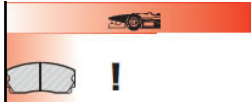

**KIA**

**Picanto**

01/05 →

FCP1783

COMPOUND AVAILABILITY

H C R W Z

COMPOUND AVAILABILITY

H C R W Z

**Sephia**

1.5 16V	59	02/96 → 12/98	FCP206	ATE	✓													
1.5 i 16V	59	02/96 → 12/98	FCP206	ATE	✓													

**Venga**

1.6		→	FRP3084		✓													
-----	--	---	---------	--	---	--	--	--	--	--	--	--	--	--	--	--	--	--

**LADA**

**1200**

1.2	46	06/72 → 09/86	FCP96	BDX	✓													
-----	----	---------------	-------	-----	---	--	--	--	--	--	--	--	--	--	--	--	--	--

**1300**

1.3	49	08/74 → 05/83	FCP96	BDX	✓													
-----	----	---------------	-------	-----	---	--	--	--	--	--	--	--	--	--	--	--	--	--

**1500**

1.5	55	11/72 → 07/85	FCP96	BDX	✓													
-----	----	---------------	-------	-----	---	--	--	--	--	--	--	--	--	--	--	--	--	--

**1600**

1.6	57	01/75 → 07/92	FCP96	BDX	✓													
-----	----	---------------	-------	-----	---	--	--	--	--	--	--	--	--	--	--	--	--	--

**Forma**

1.1		07/91 →	FCP527		✓													
1.3		03/92 → 05/95	FCP527		✓													
1.5		03/92 → 05/95	FCP527		✓													

**Nova**

1.2	46	01/70 → 10/90	FCP96	BDX	✓													
1.3	49	01/75 → 05/91	FCP96	BDX	✓													
1.5	52, 55	01/75 → 05/91	FCP96	BDX	✓													
1.6	57	01/75 → 05/91	FCP96	BDX	✓													
1.7	62	06/94 → 10/98	FCP96	BDX	✓													

**Priora**

1.6	73	02/08 →	FCP527		✓													
1.6	60	12/08 →	FCP527		✓													
1.6 LPG	71	03/09 →	FCP527		✓													

**Riva**

All Models		11/72 → 07/85	FCP96	BDX	✓													
------------	--	---------------	-------	-----	---	--	--	--	--	--	--	--	--	--	--	--	--	--

**Samara**

1.1		07/90 → 10/92	FCP527		✓													
1.3		03/85 → 10/92	FCP527		✓													
1.5		03/85 → 05/95	FCP527		✓													

**Toscana**

1.3	48	12/85 →	FCP96	BDX	✓													
1.5	55	09/83 → 02/93	FCP96	BDX	✓													

**LAMBORGHINI**

**Contach**

LP400	283	01/74 → 12/82	FCP399	ATE	✓													
LP500	324	01/74 → 12/74	FCP399	ATE	✓													
LP500 S	276	01/82 → 12/85	FCP399	ATE	✓													
S Quattrovalvole	313	01/85 → 12/91	FCP399	ATE	✓													

**Diablo**

SE	386	01/94 → 12/96	FCP399	ATE	✓													
VT	361	01/90 → 08/98	FCP399	ATE	✓													

**Jalpa**

P350	188	01/82 → 12/87	FCP399	BRE	✓													
------	-----	---------------	--------	-----	---	--	--	--	--	--	--	--	--	--	--	--	--	--

✓ Available    ⚠ Exhausting  
 ✗ Not Available    📧 Make to order  
 🚧 In Introduction



Updated on 30th Jan 2014





KW

**...LANCIA****...Delta**

				COMPOUND AVAILABILITY					COMPOUND AVAILABILITY								
				H	C	R	W	Z									
2.0 Integrale 4x4 (Turbo) 16V	155, 158, 186	03/89	→ 12/93	FCP565	LUC	✓		✓	✓		FCP360	BDX	✓				
2.0 Integrale 4x4 (Turbo) 16V	155, 158	03/91	→ 04/96	FCP565	LUC	✓		✓	✓		FCP409	LUC	✓			✓	
2.0 Integrale Turbo	130, 133	05/87	→ 03/89	FCP565	LUC	✓		✓	✓		FCP360	BDX	✓				
2.0 Integrale/Evoluzione HF		01/92	→ 12/95	FCP721	BRM	✓		✓	✓	✉	FCP726	LUC	✓			✓	
2.0 Turbo 4WD HF		01/86	→ 10/87	FCP370	LUC	✓	✉	✓	✓	✉	FCP360	BDX	✓				
2.0 Turbo HF		06/86	→ 05/93	FCP370	LUC	✓	✉	✓	✓	✉	FCP360	BDX	✓				

**Delta III**

1.4	110	09/08	→	FCP1468		✓		✓			FCP1469		✓			✓	
-----	-----	-------	---	---------	--	---	--	---	--	--	---------	--	---	--	--	---	--

**Flavia**

2.0 i	77	01/71	→ 12/74								FCP809	LUC	✓	✓	✓	✉	✓
-------	----	-------	---------	--	--	--	--	--	--	--	--------	-----	---	---	---	---	---

**Kappa**

2.0 20V	107, 114	01/94	→ 08/96	FCP565	LUC	✓		✓	✓		FCP995	LUC	✓				
2.0 i SW 20V	114	01/96	→ 12/98								FCP995	LUC	✓				
2.0 i Turbo 20V	162	05/98	→	FCP1334	BRM	✓		✓	✓	✓							
2.0 Turbo 16V	151	01/94	→ 08/96	FCP565	LUC	✓		✓	✓		FCP995	LUC	✓				
2.0 Turbo 20V	162	10/98	→ 10/01	FCP565	LUC	✓		✓	✓								
2.0 Turbo 20V	162	10/98	→ 10/01	FCP1334	BRM	✓		✓	✓	✓							
2.4 JTD	100	05/98	→								FCP995	LUC	✓				
2.4 TD	91	01/94	→ 10/01	FCP565	LUC	✓		✓	✓		FCP995	LUC	✓				
3.0 24V	150	01/94	→ 09/98	FCP565	LUC	✓		✓	✓		FCP995	LUC	✓				
3.0 24V	150	10/98	→ 10/01	FCP565	LUC	✓		✓	✓		FCP995	LUC	✓				
3.0 24V	150	10/98	→ 10/01	FCP1334	BRM	✓		✓	✓	✓							
3.0 i 24V	150	05/98	→ 10/01	FCP1334	BRM	✓		✓	✓	✓	FCP995	LUC	✓				

**Lybra**

1.6 16V	76	07/99	→								FCP1349	LUC	✓			✉	
1.7 16V	96	07/99	→								FCP1349	LUC	✓			✉	
1.8 16V	96	07/99	→								FCP1349	LUC	✓			✉	
1.9 JTD	77	07/99	→								FCP1349	LUC	✓			✉	
2.0 20V	114	07/99	→								FCP1349	LUC	✓			✉	
2.4 JTD	100	07/99	→								FCP1349	LUC	✓			✉	

**Musa**

1.9 i Multijet	74	09/04	→	FCP1467	Bosch	✓		✓		✓							
----------------	----	-------	---	---------	-------	---	--	---	--	---	--	--	--	--	--	--	--

**Prisma**

1.6	66, 73, 77, 80	01/84	→ 09/91	FCP370	LUC	✓	✉	✓	✉	✉	FCP360	BDX	✓				
1.6 4WD	66, 73, 80	01/86	→ 12/89								FCP360	BDX	✓				
1.6 i	77	01/83	→ 12/84								FCP360	BDX	✓				
1.9 TD	59	01/85	→ 12/89	FCP370	LUC	✓	✉	✓	✉	✉							
2.0 4WD	85	04/86	→ 12/89								FCP360	BDX	✓				

**Stratos**

All Models		01/73	→	FCP11	ATE	✓		✓	✉	✓							
All i		01/73	→	FCP11	ATE	✓		✓	✉	✓							

**Thema**

2.0	83, 85, 88, 122	01/84	→ 12/87								FCP596	LUC	✓			✓	
2.0 (Turbo) 16V	148	10/92	→ 05/95	FCP565	LUC	✓		✓	✓		FCP596	LUC	✓			✓	
2.0 (Turbo) 16V	148	10/92	→ 05/95	FCP565	LUC	✓		✓	✓		FCP360	BDX	✓				
2.0 16V	112	08/92	→ 12/93	FCP565	LUC	✓		✓	✓		FCP596	LUC	✓			✓	
2.4 TD	74	01/84	→ 09/88								FCP360	BDX	✓				
2.4 TD SW Estate	74	01/86	→ 09/88								FCP360	BDX	✓				
2.5 TD	87	01/84	→ 12/87								FCP596	LUC	✓			✓	
2.5 TD SW Estate	87	01/88	→ 12/94	FCP565	LUC	✓		✓	✓		FCP596	LUC	✓			✓	
2.8 V6	108	10/85	→ 12/87								FCP596	LUC	✓			✓	
2.9 8.32 32V	158	01/86	→ 09/88	FCP565	LUC	✓		✓	✓		FCP596	LUC	✓			✓	
2.9 8.32 32V	158	09/88	→ 12/94	FCP565	LUC	✓		✓	✓		FCP596	LUC	✓			✓	
3.0 V6	126	01/91	→ 12/94	FCP565	LUC	✓		✓	✓		FCP596	LUC	✓			✓	
3.0 V6	126	01/91	→ 12/94	FCP565	LUC	✓		✓	✓		FCP360	BDX	✓				

**Y**

1.1 i		01/97	→ 05/03	FCP1160		✓											
1.2 16V	63	01/97	→ 05/03	FCP1160		✓											
1.2 LE, LS	44	02/96	→ 07/97	FCP925	BDX	✓		✓									
1.4 LS, LX	55	02/96	→ 02/98	FCP925	BDX	✓		✓									

✓ Available     ✎ Exhausting  
 ✗ Not Available     ✉ Make to order  
 ✎ In Introduction

**FERODO**  
RACING

Updated on 30th Jan 2014

1053

LANCIA



kW

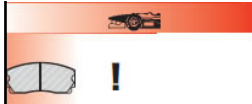

## ...LANCIA

### Y (I)

1.1 i	40	01/97 → 05/03
1.1 i	40	01/97 → 05/03
1.2 i 16V	63	01/97 → 05/03
1.2 i 16V	63	01/97 → 05/03
1.2 i LE, LS	44	02/96 → 07/97
1.2 i LE, LS	44	02/96 → 07/97
1.4 i LS, LX	55	02/96 → 02/98
1.4 i LS, LX	55	02/96 → 02/98

FCP	ATE	COMPOUND AVAILABILITY				
		H	C	R	W	Z
FCP1160	ATE	✓				
FCP925	BDX	✓		✓		
FCP1160	ATE	✓				
FCP1160	ATE	✓				
FCP925	BDX	✓		✓		
FCP925	BDX	✓		✓		
FCP370	LUC	✓	☒	✓	☒	☒
FCP1160	ATE	✓				

FCP	ATE	COMPOUND AVAILABILITY				
		H	C	R	W	Z

### Y10

1.0	32, 33	06/85 → 06/91
1.0	32, 33	06/85 → 06/91
1.0 (Turbo)	62	03/85 → 02/89
1.0 Selectronic		01/90 → 12/96
1.1	37	05/89 → 12/96
1.1 i		11/92 → 12/96
1.2	44	11/95 → 12/99
1.3	54, 57	07/89 → 10/91
1.3 GT		06/93 → 12/96
1.3 GT	53	11/87 → 05/93
1.4	55, 59	01/96 → 05/03

FCP351	BDX	✓		✓		✓
FCP370	LUC	✓	☒	✓	☒	☒
FCP370	LUC	✓	☒	✓	☒	☒
FCP351	BDX	✓		✓		✓
FCP351	BDX	✓		✓		✓
FCP351	BDX	✓		✓		✓
FCP925	BDX	✓		✓		✓
FCP351	BDX	✓		✓		✓
FCP351	BDX	✓		✓		✓
FCP370	LUC	✓	☒	✓	☒	☒
FCP370	LUC	✓	☒	✓	☒	☒

### Zeta

1.9		10/95 → 09/02
2.0	108	10/95 → 09/02
2.0 (Turbo)	108	10/95 → 09/02
2.0 JTD		06/99 → 09/02
2.1 TD	80	07/94 → 09/02

FCP565	LUC	✓		✓	✓	
FCP565	LUC	✓		✓	✓	
FCP565	LUC	✓		✓	✓	
FCP565	LUC	✓		✓	✓	
FCP565	LUC	✓		✓	✓	

FCP850	ATE	✓		✓	✓	✓
FCP850	ATE	✓		✓	✓	✓
FCP850	ATE	✓		✓	✓	✓

## LAND ROVER

### Freelander

1.8 16V	88	01/98 → 10/00
2.0 TDi	72	01/98 → 10/00

FCP613		✓		✓		
FCP613		✓		✓		

### Range Rover III (LM)

4.2 Supercharged	291	05/05 →
------------------	-----	---------

FCP1334	BRM	✓		✓	✓	✓
---------	-----	---	--	---	---	---

--	--	--	--	--	--	--

### RANGE ROVER III (LM)

5.0 V8	375	09/09 →
--------	-----	---------

FRP3133	BRE	✓				
---------	-----	---	--	--	--	--

--	--	--	--	--	--	--

### Range Rover III (LM) 02->

3.0 Td 6 Range Rover III (LM) 02->	130	03/02 →
4.4 Range Rover III (LM) 02->	210	03/02 →

FCP1483	ATE	✓		☒	☒	☒
FCP1483	ATE	✓		☒	☒	☒

### RANGE ROVER SPORT (LS)

5.0	372	01/10 →
5.0 V8	375	09/09 →

FRP3133	BRE	✓				
FRP3133	BRE	✓				

### Range Rover Sport III

4.2 Supercharged	291	02/05 →
------------------	-----	---------

FCP1334	BRM	✓		✓	✓	✓
---------	-----	---	--	---	---	---

--	--	--	--	--	--	--

## LEXUS

### ES 300

3.0		01/98 → 12/00
-----	--	---------------

FCP1437	AIS	⚠				
---------	-----	---	--	--	--	--

--	--	--	--	--	--	--

### RX 300

3.0		01/98 → 12/01
-----	--	---------------

FCP1437	AIS	⚠				
---------	-----	---	--	--	--	--

--	--	--	--	--	--	--



kW

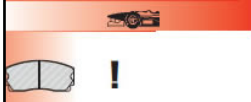

**LOTUS**

**Eclat**

2.2 520,521,522,523 16V 118 01/75 → 12/82

FCP167 LUC

COMPOUND AVAILABILITY

H C R W Z

✓ ✓ ✓ ☒ ✓

COMPOUND AVAILABILITY

H C R W Z

**Elan**

1.6 S2, 3, 4 16V 01/66 → 12/70  
1.6 Sprint 16V 01/71 → 12/74  
1.6 SS, 130 16V 01/72 → 12/75

FCP809 LUC, Servo  
FCP809 LUC  
FCP167 LUC

✓ ✓ ✓ ☒ ✓  
✓ ✓ ✓ ☒ ✓  
✓ ✓ ✓ ☒ ✓

**Elise**

1,8 01/96 →  
1,8 VVC 01/99 →

FCP1562  
FCP1562

✓ ✓ ✓ ✓ ✓  
✓ ✓ ✓ ✓ ✓

FCP1560  
FCP1560

✓ ☒ ✓ ✓

**Elite**

2.2 16V 118 01/73 → 12/82

FCP9 LUC

✓ ✓

**Esprit**

2.2 S1, S2, S3 (Turbo) 16V 01/75 → 12/86

FCP116 ATE

✓ ✓

**Evora**

3.5 206 05/09 →  
3.5S 257 12/10 →

FRP3083 AP RACING  
FRP3083 AP RACING

✓ ✓ ✓ ✓ ✓  
✓ ✓ ✓ ✓ ✓

**Excel**

2.2 16V 118, 135 01/83 → 12/87

FCP9 LUC

✓ ✓

**MASERATI**

**222**

2.8 01/88 → 12/89  
2.8 01/89 → 10/90

FCP399 ATE  
FCP256 ATE

✓ ✓ ✓ ✓

FCP2 ATE  
FCP2 ATE

✓ ☒ ✓ ✓

**228**

2.8 01/82 → 12/89  
2.8 18V 165 01/89 → 06/93

FCP399 ATE  
FCP256 ATE

✓ ✓ ✓ ✓

FCP2 ATE  
FCP2 ATE

✓ ☒ ✓ ✓

**3200 GT**

3.2 369 10/98 → 03/02

FCP1298 BRE

✓ ✓ ☒ ✓

FCP451 ATE

✓ ☒ ✓ ✓ ✓

**420**

2.0 165 01/85 → 12/89

FCP399 ATE

✓ ✓

FCP2 ATE

✓ ☒ ✓ ✓

**422**

2.2 165 01/85 → 12/89  
2.2 01/89 →

FCP399 ATE  
FCP256 ATE

✓ ✓ ✓ ✓

FCP2 ATE  
FCP2 ATE

✓ ☒ ✓ ✓

**425**

2.5 01/85 → 12/89

FCP399 ATE

✓ ✓

FCP2 ATE

✓ ☒ ✓ ✓

**430**

2.8 01/89 → 12/94  
2.8 18V 185 01/82 → 12/89

FCP256 ATE  
FCP399 ATE

✓ ✓ ✓ ✓

FCP2 ATE  
FCP2 ATE

✓ ☒ ✓ ✓

**Biturbo**

2.0 161 01/82 → 12/88  
2.0 01/94 →  
2.5 130, 147 01/82 → 12/88  
2.5 01/94 →  
2.8 185 01/82 → 12/88  
2.8 165 01/94 → 12/96

FCP399 ATE  
FCP856 ATE  
FCP399 ATE  
FCP856 ATE  
FCP399 ATE  
FCP856 ATE

✓ ✓ ✓ ✓ ✓ ✓  
✓ ✓ ✓ ✓ ✓

FCP2 ATE  
FCP857 ATE  
FCP2 ATE  
FCP857 ATE  
FCP2 ATE  
FCP857 ATE

✓ ☒ ✓ ✓  
✓ ✓ ✓ ✓  
✓ ✓ ✓ ✓  
✓ ✓ ✓ ✓  
✓ ✓ ✓ ✓  
✓ ✓ ✓ ✓

**Ghibli**

2.0 24V 225 01/89 →  
2.8 24V 209 01/89 →

FCP256 ATE  
FCP256 ATE

✓ ✓ ✓ ✓

FCP2 ATE  
FCP2 ATE

✓ ☒ ✓ ✓  
✓ ✓ ✓ ✓

**Gran Turismo**

4.2 298 08/08 →  
4.7 S 323 08/08 →

FRP3100 BRE  
FRP3100 BRE

✓ ✓ ☒

FCP1348 BRE  
FCP1348 BRE

✓ ✓ ✓ ✓

✓ Available    ⚠ Exhausting  
✗ Not Available    ☒ Make to order  
☒ In Introduction



Updated on 30th Jan 2014



KW

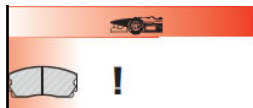

## ...MASERATI

### Karif

			COMPOUND AVAILABILITY					COMPOUND AVAILABILITY										
			H	C	R	W	Z											
2.8 18V	165	01/89 →	FCP256	ATE	✓		✓					FCP2	ATE	✓	☒	✓		☒

### Quattroporte III

4.2 (armoured opt.)	295	03/04 →	FCP1334	BRM	✓		✓	✓	✓									
---------------------	-----	---------	---------	-----	---	--	---	---	---	--	--	--	--	--	--	--	--	--

### Quattroporte V

4.2 V8	294	01/08 →	FRP3100	BRE	✓		☒					FCP1348	BRE	✓		✓	✓	☒
4.7 V8	317	01/08 →	FRP3100	BRE	✓		☒					FCP1348	BRE	✓		✓	✓	☒

### Spyder

2.8 18V	165	01/89 →	FCP256	ATE	✓		✓					FCP2	ATE	✓	☒	✓		☒
---------	-----	---------	--------	-----	---	--	---	--	--	--	--	------	-----	---	---	---	--	---

### Spyder Coupè

4.2	287	03/02 →	FCP1298	BRE	✓		✓	☒	✓			FCP451		✓		✓	☒	✓
-----	-----	---------	---------	-----	---	--	---	---	---	--	--	--------	--	---	--	---	---	---

## MATRA

### Bagheera

All Models		01/73 → 09/78	FCP2	ATE	✓	☒	✓		☒			FCP72	BDX	✓		✓		
------------	--	---------------	------	-----	---	---	---	--	---	--	--	-------	-----	---	--	---	--	--

## MAZDA

### 121

1.25 i 16V	55	01/96 →	FCP1082	ATE, Solid	✓		☒											
1.25 i 16V	55	01/96 →	FCP1081	ATE, Vented	✓		✓											
1.3 (DB) 16V	39, 54	04/93 → 10/95	FCP487	SUM	✓		☒											
1.3 DB B3	40	02/91 → 01/93	FCP487	SUM	✓		☒											
1.3 i	37, 44	01/96 →	FCP1082	ATE, Solid	✓		☒											
1.3 i	37, 44	01/96 →	FCP1081	ATE, Vented	✓		✓											
1.8 D (BAJ) (EU)	44	01/96 →	FCP1082	ATE, Solid	✓		☒											
1.8 D (BAJ) (EU)	44	01/96 →	FCP1081	ATE, Vented	✓		✓											

### 2

1.3 16V	55	06/09 → 00/00	FCP4426	TRW, LUC	✓		✓		✓									
1.3 16V	55	07/07 → 00/00	FCP4426	TRW, LUC	✓		✓		✓									
1.3 16V	63	07/07 → 00/00	FCP4426	TRW, LUC	✓		✓		✓									
1.4 8V	50	10/07 → 00/00	FCP4426	TRW, LUC	✓		✓		✓									
1.4 i 16V		04/03 →	FCP1394		✓		✓											
1.5 16V	76	07/07 → 00/00	FCP4426	TRW, LUC	✓		✓		✓									
1.5 16V	83	07/07 → 00/00	FCP4426	TRW, LUC	✓		✓		✓									
1.6 16V	70	08/10 → 00/00	FCP4426	TRW, LUC	✓		✓		✓									
1.6 16V	66	10/08 → 00/00	FCP4426	TRW, LUC	✓		✓		✓									
1.6 i 16V		04/03 →	FCP1394		✓		✓											

### 323

1.1		01/89 →	FCP487	SUM	✓		☒											
1.1 BF1 E1		07/87 → 08/89	FCP487	SUM	✓		☒											
1.3 BA1 16V	55	05/94 → 08/98	FCP487	SUM	✓		☒											
1.3 BF B3		01/87 → 01/90	FCP487	SUM	✓		☒											
1.3 BG B3	49	10/89 → 04/91	FCP487	SUM	✓		☒											
1.3 BG B3 16V	49	05/91 → 01/93	FCP487	SUM	✓		☒											
1.3 SW Estate	54	01/86 → 06/87	FCP487	SUM	✓		☒											
1.5 BA 16V	65	01/94 → 08/98	FCP487	SUM	✓		☒											
1.5 BG SW Estate		01/90 → 05/91	FCP487	SUM	✓		☒											
1.5 BW E5, BW B5 + SW Estate	54, 55	01/85 → 04/91	FCP487	SUM	✓		☒											
1.6 BF B6	63, 77	01/83 → 09/89	FCP487	SUM	✓		☒											
1.6 BG B6		10/89 → 12/91	FCP487	SUM	✓		☒											
1.6 BG B6 16V		05/91 → 10/94	FCP487	SUM	✓		☒											
1.7 D BF	40, 43	07/87 → 08/90	FCP487	SUM	✓		☒											
1.7 D BF SW Estate L		01/86 → 07/91	FCP487	SUM	✓		☒											
1.7 D BF SW Estate LX, GLX		01/87 → 08/91	FCP487	SUM	✓		☒											
1.7 D BF, BG		01/86 → 08/89	FCP487	SUM	✓		☒											
1.7 D BF, BG		09/89 → 03/91	FCP487	SUM	✓		☒											
1.8 BG 16V		10/89 → 10/94	FCP487	SUM	✓		☒											
1.8 BG GT, 4WD, Turbo 16V		10/89 → 10/94	FCP487	SUM	✓		☒											
1.8 Turbo 4WD 16V	122	10/89 → 12/92	FCP487	SUM	✓		☒											



KW

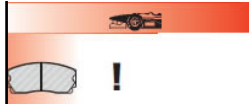

**...MAZDA**

**E1300**

1.3 i 01/81 → 08/83

FCP	SUM	COMPOUND AVAILABILITY					FCP	COMPOUND AVAILABILITY						
		H	C	R	W	Z		H	C	R	W	Z		
FCP170	SUM		✓											

**E1400**

1.4 i 01/81 → 08/83

FCP	SUM	H	C	R	W	Z	FCP	H	C	R	W	Z
FCP170	SUM		✓									

**E1600**

1.6 52, 54 01/83 → 12/84

FCP	SUM	H	C	R	W	Z	FCP	H	C	R	W	Z
FCP170	SUM		✓									

1.6 i BA2N9 01/81 → 08/83

FCP	SUM	H	C	R	W	Z	FCP	H	C	R	W	Z
FCP170	SUM		✓									

**Miata**

1.8 01/94 → 01/03

FCP	SUM	H	C	R	W	Z	FCP	H	C	R	W	Z
FCP1012	SUM						FCP1012	✓				

**MX-3**

1.6 Coupe (EC13) 16V 66, 81 09/91 → 10/93

FCP	SUM	H	C	R	W	Z	FCP	H	C	R	W	Z
FCP487	SUM	✓										

1.6 Coupe V6 (EC13) 16V 65 09/91 → 10/93

FCP	SUM	H	C	R	W	Z	FCP	H	C	R	W	Z
FCP487	SUM	✓										

**MX-5**

1.6 i NB1 16V 81 05/98 → 12/00

FCP	SUM	H	C	R	W	Z	FCP	H	C	R	W	Z
FCP1011	SUM	✓					FCP1012	✓				

1.6 i Miata (USA) 16V 01/94 → 12/98

FCP	SUM	H	C	R	W	Z	FCP	H	C	R	W	Z
FCP1011	SUM	✓										

1.8 i NB1 16V 103 05/98 → 12/00

FCP	SUM	H	C	R	W	Z	FCP	H	C	R	W	Z
FCP1011	SUM	✓					FCP1012	✓				

1.8 i Coupe (NA) (NB1) 16V 96 01/94 → 04/98

FCP	SUM	H	C	R	W	Z	FCP	SUM	H	C	R	W	Z
FCP1011	SUM	✓					FCP1012	SUM	✓				

**RX-7**

2.3 Coupe 77, 83, 85, 110 10/85 → 12/96

FCP	SUM	H	C	R	W	Z	FCP	SUM	H	C	R	W	Z
FCP483	SUM	✓					FCP372	SUM	✓				

2.3 i 01/84 → 12/86

FCP	SUM	H	C	R	W	Z	FCP	SUM	H	C	R	W	Z
FCP483	SUM	✓					FCP372	SUM	✓				

2.4 Coupe 110, 133, 147, 176 01/86 → 06/92

FCP	SUM	H	C	R	W	Z	FCP	SUM	H	C	R	W	Z
FCP483	SUM	✓					FCP372	SUM	✓				

2.4 i 01/86 → 12/92

FCP	SUM	H	C	R	W	Z	FCP	SUM	H	C	R	W	Z
FCP483	SUM	✓					FCP372	SUM	✓				

2.6 Coupe (Turbo) 177 01/93 → 12/96

FCP	SUM	H	C	R	W	Z	FCP	SUM	H	C	R	W	Z
FCP483	SUM	✓					FCP372	SUM	✓				

2.6 i 01/93 → 12/96

FCP	SUM	H	C	R	W	Z	FCP	SUM	H	C	R	W	Z
FCP483	SUM	✓					FCP372	SUM	✓				

**MERCEDES**

**190**

1.8 (W201) 81 09/86 → 12/94

FCP	SUM	H	C	R	W	Z	FCP	SUM	H	C	R	W	Z
FCP660	LUC	✓											

2.0 (W201) 01/82 → 12/94

FCP	SUM	H	C	R	W	Z	FCP	SUM	H	C	R	W	Z
FCP660	LUC	✓											

2.0 D (W201) 01/82 → 12/94

FCP	SUM	H	C	R	W	Z	FCP	SUM	H	C	R	W	Z
FCP660	LUC	✓											

2.3 (W201) Not 16V 97 01/82 → 12/94

FCP	SUM	H	C	R	W	Z	FCP	SUM	H	C	R	W	Z
FCP660	LUC	✓											

2.3 E (W201) 16V 130, 143 01/82 → 12/94

FCP	SUM	H	C	R	W	Z	FCP	SUM	H	C	R	W	Z
FCP415	BDX	✓											

2.5 D (W201) 69 01/82 → 12/94

FCP	SUM	H	C	R	W	Z	FCP	SUM	H	C	R	W	Z
FCP660	LUC	✓											

2.5 E (W201) 16V 130, 143 01/82 → 12/94

FCP	SUM	H	C	R	W	Z	FCP	SUM	H	C	R	W	Z
FCP415	BDX	✓											

2.5 E (W201) 16V 130, 143 01/82 → 12/94

FCP	SUM	H	C	R	W	Z	FCP	SUM	H	C	R	W	Z
FCP646	ATE	✓											

2.5 TD (W201) 93 11/87 → 12/94

FCP	SUM	H	C	R	W	Z	FCP	SUM	H	C	R	W	Z
FCP660	LUC	✓											

2.6 (W201) 118 01/82 → 12/94

FCP	SUM	H	C	R	W	Z	FCP	SUM	H	C	R	W	Z
FCP660	LUC	✓											

**200**

2.0 D W124 Saloon 55 03/90 → 05/95

FCP	SUM	H	C	R	W	Z	FCP	SUM	H	C	R	W	Z
FCP415	BDX	✓											

2.0 D W124 SW Estate 03/90 → 05/95

FCP	SUM	H	C	R	W	Z	FCP	SUM	H	C	R	W	Z
FCP415	BDX	✓											

2.0 D (W110) 01/71 → 07/73

FCP	SUM	H	C	R	W	Z	FCP	SUM	H	C	R	W	Z
FCP11	ATE	✓											

2.0 D W114, 115 01/68 → 12/76

FCP	SUM	H	C	R	W	Z	FCP	SUM	H	C	R	W	Z
FCP11	ATE	✓					FCP2	ATE	✓				

2.0 D W124 Saloon/SW Estate 55 01/85 → 05/95

FCP	SUM	H	C	R	W	Z	FCP	SUM	H	C	R	W	Z
FCP415	BDX	✓											

2.0 E W124 Saloon/SW Estate 77, 80, 87 01/85 → 05/95

FCP	SUM	H	C	R	W	Z	FCP	SUM	H	C	R	W	Z
FCP415	BDX	✓											

2.0 i W124 E Saloon 77, 87 03/90 → 05/95

FCP	SUM	H	C	R	W	Z	FCP	SUM	H	C	R	W	Z
FCP415	BDX	✓											

2.0 i W124 E SW Estate 03/90 → 05/95

FCP	SUM	H	C	R	W	Z	FCP	SUM	H	C	R	W	Z
FCP415	BDX	✓											

2.0 i W124 Saloon 77, 80, 87 03/90 → 05/95

FCP	SUM	H	C	R	W	Z	FCP	SUM	H	C	R	W	Z
FCP415	BDX	✓											

2.0 i W124 SW Estate 03/90 → 05/95

FCP	SUM	H	C	R	W	Z	FCP	SUM	H	C	R	W	Z
FCP415	BDX	✓											

2.0 W114, 115 63 01/68 → 12/76

FCP	SUM	H	C	R	W	Z	FCP	SUM	H	C	R	W	Z
FCP11	ATE	✓					FCP2	ATE	✓				

2.0 W124 Saloon/SW Estate 77, 80, 87 01/85 → 05/95



kw

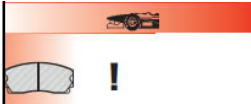

### ...MERCEDES

#### 230

2.3 C W124 Coupe		01/87 → 08/88
2.3 C W124 Saloon/SW Estate		01/85 → 06/93
2.3 E W124 Coupe		01/87 → 08/89
2.3 E W124 Saloon/SW Estate	97	01/85 → 06/93
2.3 W114, 115		01/68 → 12/73

		COMPOUND AVAILABILITY							COMPOUND AVAILABILITY				
		H	C	R	W	Z			H	C	R	W	Z
FCP415	BDX	✓		✓									
FCP415	BDX	✓		✓									
FCP415	BDX	✓		✓									
FCP415	BDX	✓		✓									
FCP11	ATE	✓		✓	✉	✓	FCP2	ATE	✓	✉	✓		✉

#### 234

W114, 115		01/68 → 12/73
All i W114, 115		01/68 → 12/73

FCP11	ATE	✓		✓	✉	✓	FCP2	ATE	✓	✉	✓		✉
FCP11	ATE	✓		✓	✉	✓	FCP2	ATE	✓	✉	✓		✉

#### 250

2.5 D W124 Saloon	66	03/90 → 05/95
2.5 D W124 SW Estate		03/90 → 05/95
2.5 D W124 Saloon/SW Estate	66	01/85 → 05/95
2.5 TD W124 Saloon	93	01/85 → 02/90

FCP415	BDX	✓		✓									
FCP415	BDX	✓		✓									
FCP415	BDX	✓		✓									
FCP415	BDX	✓		✓									

#### 260

2.6 E W124 Saloon/SW Estate	118	01/85 → 06/93
-----------------------------	-----	---------------

FCP415	BDX	✓		✓									
--------	-----	---	--	---	--	--	--	--	--	--	--	--	--

#### 280

2.8 E W124 Saloon/SW Estate	125	01/85 → 05/95
2.8 i W124 E Saloon		03/90 → 05/95
2.8 i W124 E SW Estate		03/90 → 05/95

FCP415	BDX	✓		✓									
FCP415	BDX	✓		✓									
FCP415	BDX	✓		✓									

#### 300

3.0 C W124 Coupe	132	01/87 → 08/88
3.0 C W124 Coupe 24V	162	01/89 → 12/93
3.0 C W124 Saloon 24V	162	01/89 → 06/93
3.0 C W124 Saloon/SW Estate	132	01/85 → 05/95
3.0 D W124 Saloon	80	03/90 → 05/95
3.0 D W124 SW Estate		03/90 → 05/95
3.0 D W124 Coupe	80	01/87 → 08/88
3.0 D W124 Coupe 24V		01/89 → 12/93
3.0 D W124 Saloon/SW Estate	80	01/85 → 05/95
3.0 E W124 Coupe	132	01/87 → 08/88
3.0 E W124 Coupe 24V	162	01/89 → 12/93
3.0 E W124 Saloon 24V	162	01/89 → 06/93
3.0 E W124 Saloon/SW Estate	132	01/85 → 05/95
3.0 i W124 C Saloon		03/90 → 05/95
3.0 i W124 C Saloon		03/90 → 05/95
3.0 i W124 C SW Estate		03/90 → 05/95
3.0 i W124 E Saloon	132	03/90 → 05/95
3.0 i W124 E SW Estate		03/90 → 05/95

FCP415	BDX	✓		✓									
FCP646	ATE	✓			✉								
FCP646	ATE	✓			✉								
FCP415	BDX	✓		✓									
FCP415	BDX	✓		✓									
FCP415	BDX	✓		✓									
FCP415	BDX	✓		✓									
FCP415	BDX	✓		✓									
FCP415	BDX	✓		✓									
FCP415	BDX	✓		✓									
FCP415	BDX	✓		✓									
FCP415	BDX	✓		✓									
FCP415	BDX	✓		✓									
FCP415	BDX	✓		✓									
FCP415	BDX	✓		✓									
FCP415	BDX	✓		✓									
FCP415	BDX	✓		✓									

#### 320

3.2 E W124 Coupe		01/89 →
3.2 E W124 Saloon, SW Estate		01/91 → 05/95
3.2 i W124 E Coupe		10/92 → 05/93

FCP646	ATE	✓			✉								
FCP646	ATE	✓			✉								
FCP646	ATE	✓			✉								

#### 400

4.2 E W124 Saloon 32V	205	01/91 → 06/93
-----------------------	-----	---------------

FCP646	ATE	✓			✉								
--------	-----	---	--	--	---	--	--	--	--	--	--	--	--

#### 420

4.2 E W124 Saloon		07/93 → 05/95
-------------------	--	---------------

FCP646	ATE	✓			✉								
--------	-----	---	--	--	---	--	--	--	--	--	--	--	--

#### 500

5.0 E W124 Saloon		07/93 → 05/95
5.0 E W124 Saloon 32V	235	01/91 → 06/93

FCP646	ATE	✓			✉								
FCP646	ATE	✓			✉								

#### A190

1.9 (W168)	92	11/97 → 02/99
------------	----	---------------

FCP541	LUC	✓		✓	✉	✉							
--------	-----	---	--	---	---	---	--	--	--	--	--	--	--

#### C180

1.8 16v (S203 ) For vehicles with sports package	105	05/02 → 04/04
1.8 16v (W203 ) For vehicles with sports package	105	05/02 → 04/04

FCP1661	BRE	✓											
FCP1661	BRE	✓											

#### C200

1.8 16v (S203 ) For vehicles with sports package	120	05/02 → 04/04
1.8 16v (W203 ) For vehicles with sports package	120	05/02 → 04/04
1.8 CGI 16v (S203 ) For vehicles with sports package	125	07/03 → 07/04
1.8 CGI 16v (W203 ) For vehicles with sports package	125	07/03 → 04/04
2.0 i T202 SW Estate Kompressor 16V	100, 141	11/96 → 03/01
2.0 i W202 Kompressor 16V	100, 141	10/95 → 05/00
2.2 CDI 16v (S203 ) For vehicles with sports package	75	03/01 → 03/03
2.2 CDI 16v (S203 ) For vehicles with sports package	90	04/03 → 04/04
2.2 CDI 16v (S203 ) For vehicles with sports package	85	11/00 → 07/03
2.2 CDI 16v (W203 ) For vehicles with sports package	75	02/01 → 03/04

FCP1661	BRE	✓											
FCP1661	BRE	✓											
FCP1661	BRE	✓											
FCP1661	BRE	✓											
FCP1049	ATE	✓											
FCP1049	ATE	✓											
FCP1661	BRE	✓											
FCP1661	BRE	✓											
FCP1661	BRE	✓											
FCP1661	BRE	✓											

MERCEDES





KW

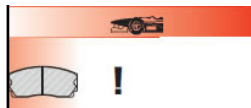

**...MERCEDES**

**...C200**

2.2 CDI 16v (W203 ) For vehicles with sports package90	04/03 → 04/04	FCP1661	BRE	✓
2.2 CDI 16v (W203 ) For vehicles with sports package85	06/00 → 03/04	FCP1661	BRE	✓

**C220**

2.2 CDI 16v (S203 ) For vehicles with sports package 110	08/03 → 04/04	FCP1661	BRE	✓
2.2 CDI 16v (S203 ) For vehicles with sports package 105	11/00 → 07/03	FCP1661	BRE	✓
2.2 CDI 16v (W203 ) For vehicles with sports package110	04/03 → 04/04	FCP1661	BRE	✓
2.2 CDI 16v (W203 ) For vehicles with sports package105	06/00 → 12/04	FCP1661	BRE	✓

**C230**

1.8 16v (S203 ) For vehicles with sports package	141	11/03 → 04/04	FCP1661	BRE	✓
1.8 16v (W203 ) For vehicles with sports package	141	11/03 → 04/04	FCP1661	BRE	✓
2.3 (W202) Kompressor 16V	142	10/95 → 05/00	FCP1049	ATE	✓

**C240**

2.4 (W202) 18V	125	06/97 → 05/00	FCP1049	ATE	✓
2.6 18v (S203 ) For vehicles with sports package	125	11/00 → 04/04	FCP1661	BRE	✓
2.6 18v (W203 ) For vehicles with sports package	125	06/00 → 04/04	FCP1661	BRE	✓

**C250**

2.5 TD T202 SW Estate 20V	110	06/96 → 03/01	FCP1049	ATE	✓
2.5 TD W202 20V	110	10/95 → 05/00	FCP1049	ATE	✓

**C270**

2.7 CDI 20v (S203 ) For vehicles with sports package 125	11/00 → 04/04	FCP1661	BRE	✓
2.7 CDI 20v (W203 ) For vehicles with sports package125	06/00 → 04/04	FCP1661	BRE	✓

**C280**

2.8 (W202)	145	06/97 → 05/00	FCP1049	ATE	✓
------------	-----	---------------	---------	-----	---

**C30CDi AMG**

3.0 20v (C203 )	170	08/02 → 01/08	FCP1661	BRE	✓
3.0 20v (S203 )	170	08/02 → 12/04	FCP1661	BRE	✓
3.0 20v (W203 )	170	08/02 → 12/04	FCP1661	BRE	✓

**C32 AMG**

3.2 18v (S203 )	260	11/00 → 12/04	FCP1661	BRE	✓
3.2 18v (W203 )	260	11/00 → 12/04	FCP1661	BRE	✓

**C320**

3.0 CDi 24v (S203 ) For vehicles with sports package 165	165	01/05 → 11/07	FCP1661	BRE	✓
3.0 CDi 24v (W203 ) For vehicles with sports package165	165	01/05 → 02/07	FCP1661	BRE	✓
3.2 18v (C203 )	160	06/02 → 08/05	FCP1661	BRE	✓
3.2 18v (S203 ) For vehicles with sports package	160	11/00 → 04/04	FCP1661	BRE	✓
3.2 18v (W203 ) For vehicles with sports package	160	06/00 → 04/04	FCP1661	BRE	✓

**C350**

3.5 24v (S203 )	200	04/05 → 11/07	FCP1661	BRE	✓
3.5 24v (S203 ) For vehicles with sports package	200	01/05 → 11/07	FCP1661	BRE	✓
3.5 24v (W203 )	200	03/05 → 02/07	FCP1661	BRE	✓
3.5 24v (W203 ) For vehicles with sports package	200	01/05 → 02/07	FCP1661	BRE	✓

**C36 AMG**

3.6 24V	206	01/95 → 03/97	FCP1049	ATE	✓
3.6 i 24V (W202)	206	07/94 → 05/00	FCP646	ATE	✓

**C43 AMG**

4.3 24v (S202)	225	04/97 → 05/00	FCP1001	ATE	✓
----------------	-----	---------------	---------	-----	---

**C55 AMG**

5.4 24v (S203 )	270	08/03 → 11/07	FCP1661	BRE	✓
5.4 24v (W203 )	270	08/03 → 02/07	FCP1661	BRE	✓

**C63 AMG**

6.2 32v (S204)	336	02/08 → 00/00	FRP3133	Brembo	✓
6.2 32v (S204)	386	05/08 → 00/00	FRP3133	Brembo	✓
6.2 32v (W204)	336	02/08 → 00/00	FRP3133	Brembo	✓
6.2 Black Series 32v (C204)	380	01/12 → 00/00	FRP3133	Brembo	✓
6.2 Performance 32v (C204)	358	01/11 → 00/00	FRP3133	Brembo	✓
6.2 Performance 32v (S204)	358	01/11 → 00/00	FRP3133	Brembo	✓
6.2 Performance 32v (W204)	358	01/11 → 00/00	FRP3133	Brembo	✓

COMPOUND AVAILABILITY

H C R W Z

COMPOUND AVAILABILITY

H C R W Z

- ✓ Available
- ✗ Not Available
- ⚡ Exhausting
- ✉ Make to order
- 🚚 In Introduction



Updated on 30th Jan 2014



KW

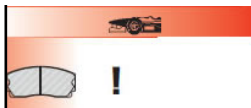

MERCEDES

**...MERCEDES**

				COMPOUND AVAILABILITY					COMPOUND AVAILABILITY				
				H	C	R	W	Z	H	C	R	W	Z
<b>CL500</b>													
5.0 24v (C215)	225	09/99 → 12/06	FCP1661 BRE	✓									
<b>CL55 AMG</b>													
5.4 24v (C215)	265	04/00 → 07/02	FCP1661 BRE	✓									
<b>CL600</b>													
5.8 36v (C215)	270	09/99 → 07/02	FCP1661 BRE	✓									
<b>CLK 55 AMG</b>													
5.5 (C209)		09/02 →	FRP3100 BRM	✓		✉							
<b>CLK200</b>													
2.0 Coupe (C208) 16V	100, 141	07/97 →	FCP1049 ATE	✓									
<b>CLK230</b>													
2.3 Coupe (C208) Kompressor 16V	142	07/97 →	FCP1049 ATE	✓									
<b>CLK320</b>													
3.0 CDi 24v (C209) For vehicles with sports package	165	03/05 → 00/00	FCP1661 BRE	✓									
3.0 CDi 24v (C209) For vehicles with sports package	165	03/05 → 00/00	FCP1661 BRE	✓									
3.2 Coupe (C208) 18V	160	07/97 →	FCP1050 ATE	✓									
<b>CLK350</b>													
3.5 24v (C209) For vehicles with sports package	200	03/05 → 00/00	FCP1661 BRE	✓									
3.5 24v (C209) For vehicles with sports package	200	03/05 → 00/00	FCP1661 BRE	✓									
<b>CLK430 (C208)</b>													
4.3 24v	205	08/99 → 01/03	FCP1001 ATE	✓				✓					
<b>CLK500</b>													
5.0 24v (C209)	225	02/03 → 05/06	FCP1661 BRE	✓									
5.0 24v (C209)	225	08/02 → 05/06	FCP1661 BRE	✓									
5.5 32v (C209)	285	06/06 → 00/00	FCP1661 BRE	✓									
5.5 32v (C209)	285	06/06 → 00/00	FCP1661 BRE	✓									
<b>CLK55 AMG</b>													
5.4 24v (C208)	255	10/98 → 07/02	FCP1001 ATE	✓				✓					
<b>CLK63 AMG</b>													
6.2 Black Series 32v (C209)	373	05/07 → 00/00	FRP3133 Brembo	✓									
6.2 Black Series 32v (C209)	373	05/07 → 05/09	FRP3133 Brembo	✓									
<b>CLS280</b>													
3.0 24v (C219)	170	07/08 → 00/00	FCP1661 BRE	✓									
<b>CLS300</b>													
3.0 24v (C219)	170	04/09 → 00/00	FCP1661 BRE	✓									
<b>CLS320</b>													
3.0 CDi 24v (C219)	165	03/05 → 00/00	FCP1661 BRE	✓									
<b>CLS350</b>													
3.0 CDi 24v (C219)	165	04/09 → 00/00	FCP1661 BRE	✓									
3.5 24v (C219)	200	07/04 → 12/10	FCP1661 BRE	✓									
3.5 CGi 24v (C219)	215	04/06 → 00/00	FCP1661 BRE	✓									
<b>CLS500</b>													
5.0 24v (C219)	225	07/04 → 03/06	FCP1661 BRE	✓									
<b>CLS63 AMG</b>													
6.2 32v (C219)	375	04/06 → 12/10	FRP3133 Brembo	✓									
<b>E200</b>													
1.8 16v (S211) For vehicles with sports package	120	04/03 → 07/06	FCP1661 BRE	✓									
1.8 16v (S211) For vehicles with sports package	135	04/06 → 00/00	FCP1661 BRE	✓									
1.8 16v (W211) For vehicles with sports package	120	03/04 → 00/00	FCP1661 BRE	✓									
1.8 16v (W211) For vehicles with sports package	135	04/06 → 00/00	FCP1661 BRE	✓									
1.8 16v (W211) For vehicles with sports package	120	08/02 → 07/06	FCP1661 BRE	✓									
1.8 CGi 16v (W211) For vehicles with sports package	125	08/02 → 06/05	FCP1661 BRE	✓									
2.0 (W210)		06/95 →	FCP1049 ATE	✓									
2.0 D (W124)	55	07/93 → 06/95	FCP415 BDX	✓		✓							
2.2 CDi 16v (W211) For vehicles with sports package	100	04/06 → 00/00	FCP1661 BRE	✓									
2.2 CDi 16v (W211) For vehicles with sports package	90	07/02 → 07/06	FCP1661 BRE	✓									
2.2 CDi 16v (W211) For vehicles with sports package	75	11/02 → 07/05	FCP1661 BRE	✓									



KW



**...MERCEDES**

**E220**

2.2 (W210) 16V	70	06/95	→ 05/98
2.2 CDi 16v (W211 ) For vehicles with sports package	100	03/02	→ 00/00
2.2 CDi 16v (W211 ) For vehicles with sports package	110	04/02	→ 07/06
2.2 CDi 16v (W211 ) For vehicles with sports package	125	11/05	→ 00/00
2.2 D (W210)		06/95	→ 05/98

<b>FCP1049</b>	ATE	✓						
<b>FCP1661</b>	BRE	✓						
<b>FCP1661</b>	BRE	✓						
<b>FCP1661</b>	BRE	✓						
<b>FCP1049</b>	ATE	✓						

COMPOUND AVAILABILITY

H C R W Z

H C R W Z

COMPOUND AVAILABILITY

H C R W Z

H C R W Z

**E230**

2.3 (W210) 16V	110	06/95	→ 10/97
2.5 24v (S211 )	150	05/07	→ 00/00
2.5 24v (W211 ) For vehicles with sports package	150	09/07	→ 00/00

<b>FCP1049</b>	ATE	✓						
<b>FCP1661</b>	BRE	✓						
<b>FCP1661</b>	BRE	✓						

**E240**

2.4 i W210	125	04/97	→ 03/02
2.4 i W210 V6 ESP	125	04/97	→ 03/02

<b>FCP1049</b>	ATE	✓						
<b>FCP1050</b>	ATE	✓						

**E250**

2.5 24v (W211 ) For vehicles with sports package	150	05/07	→ 00/00
2.5 D (W210) 20V	83	06/95	→ 07/99

<b>FCP1661</b>	BRE	✓						
<b>FCP1049</b>	ATE	✓						

**E270**

2.7 CDi W210	125	07/99	→ 03/02
2.7 CDi W210 ESP	125	07/99	→ 03/02
2.7 CDi 20v (S211 )	130	04/03	→ 07/05

<b>FCP1049</b>	ATE	✓						
<b>FCP1050</b>	ATE	✓						
<b>FCP1661</b>	BRE	✓						

**E280**

2.8 (W210)	142	06/95	→ 11/96
2.8 (W210) 24V	142	12/96	→ 10/97
3.0 24v (S211 ) For vehicles with sports package	170	03/05	→ 00/00
3.0 24v (W211 ) For vehicles with sports package	170	03/05	→ 00/00
3.0 24v (W211 ) For vehicles without sports package	170	06/05	→ 08/05
3.0 CDi 24v (S211 )	140	03/05	→ 00/00
3.0 CDi 24v (W211 ) For vehicles with sports package	140	03/05	→ 00/00
3.0 CDi 24v (W211 ) For vehicles without sports package	140	03/05	→ 08/05
3.2 CDi 24v (W211 ) For armoured vehicles	130	08/03	→ 07/05

<b>FCP1050</b>	ATE	✓						
<b>FCP1050</b>	ATE	✓						
<b>FCP1661</b>	BRE	✓						
<b>FCP1661</b>	BRE	✓						
<b>FCP1661</b>	BRE	✓						
<b>FCP1661</b>	BRE	✓						
<b>FCP1661</b>	BRE	✓						
<b>FCP1661</b>	BRE	✓						
<b>FCP1661</b>	BRE	✓						
<b>FCP1661</b>	BRE	✓						

**E280 (W211)**

3.0 24v - For vehicles with sports package	170	06/05	→ 08/05
3.0 CDi 24v - For vehicles with sports package	140	03/05	→ 08/05

<b>FCP1001</b>	ATE, To Ch. 870950	✓				✓		
<b>FCP1001</b>	ATE, To Ch. 870950	✓				✓		

**E290**

2.9 TD (T210) SW Estate	95	06/95	→
2.9 TD (W210)	95	06/95	→

<b>FCP1049</b>	ATE	✓						
<b>FCP1049</b>	ATE	✓						

**E300**

3.0 CDi 24v (W211 ) For vehicles with sports package	155	09/07	→ 12/08
3.0 D (W210)	100	06/95	→ 01/96
3.0 TD (W210) 24V	130	12/96	→ 07/99

<b>FCP1661</b>	BRE	✓						
<b>FCP1049</b>	ATE	✓						
<b>FCP1050</b>	ATE	✓						

**E320**

3.0 CDi 24v (S211 )	165	03/05	→ 00/00
3.0 CDi 24v (S211 )	165	03/05	→ 00/00
3.0 CDi 24v (W211 ) For vehicles with sports package	165	03/05	→ 00/00
3.2 (W210) 18V	162, 165	06/95	→ 12/97
3.2 18v (S211 )	165	04/03	→ 07/04
3.2 18v (W211 )	165	04/02	→ 09/03
3.2 CDi T210		01/99	→ 03/03
3.2 CDi W210	145	07/99	→ 03/02
3.2 CDi 24v (S211 )	150	04/03	→ 07/06
3.2 CDi 24v (W211 ) For armoured vehicles	150	11/02	→ 07/06
3.2 i W124 E 24V		07/93	→ 07/96
3.2 i W210	165	12/97	→ 03/02

<b>FCP1661</b>	BRE	✓						
<b>FCP1661</b>	BRE	✓						
<b>FCP1661</b>	BRE	✓						
<b>FCP1050</b>	ATE	✓						
<b>FCP1661</b>	BRE	✓						
<b>FCP1050</b>	ATE	✓						
<b>FCP1050</b>	ATE	✓						
<b>FCP1661</b>	BRE	✓						
<b>FCP1661</b>	BRE	✓						
<b>FCP1661</b>	BRE	✓						
<b>FCP646</b>	ATE	✓				Ⓜ		
<b>FCP1050</b>	ATE	✓						

**E320 (W211)**

3.0 CDi 24v - For vehicles with sports package	165	03/05	→ 10/05
--	-----	-------	---------

<b>FCP1001</b>	ATE	✓				✓		
----------------	-----	---	--	--	--	---	--	--

**E350**

3.5 24v (S211 )	200	08/04	→ 07/06
3.5 24v (S211 )	200	08/04	→ 00/00
3.5 24v (W211 ) For vehicles with sports package	200	08/04	→ 00/00
3.5 24v (W211 ) For vehicles without sports package	200	08/04	→ 08/05
3.5 CGI 24v (S211 )	215	05/06	→ 00/00
3.5 CGI 24v (W211 )	215	05/06	→ 00/00

<b>FCP1661</b>	BRE	✓						
<b>FCP1661</b>	BRE	✓						
<b>FCP1661</b>	BRE	✓						
<b>FCP1661</b>	BRE	✓						
<b>FCP1661</b>	BRE	✓						
<b>FCP1661</b>	BRE	✓						

✓ Available ⚠ Exhausting  
 ✗ Not Available 📧 Make to order  
 📦 In Introduction



Updated on 30th Jan 2014

1061

MERCEDES



KW



MERCEDES

...MERCEDES				COMPOUND AVAILABILITY					COMPOUND AVAILABILITY						
				H	C	R	W	Z	H	C	R	W	Z		
<b>E350 (W211)</b>															
3.5 24v - For vehicles with sports package	200	08/04 → 06/05	FCP1001	ATE, To Ch. 870950	✓						✓				
<b>E36 AMG</b>															
3.6 i (W210)	200	02/96 → 03/02	FCP646	ATE	✓						✗				
<b>E360 AMG</b>															
3.6 24V		02/96 →	FCP646	ATE	✓						✗				
<b>E400</b>															
4.0 CDi 32v (W211)	191	02/03 → 07/05	FCP1661	BRE	✓										
<b>E420</b>															
4.2 (W210) 32V	205	01/96 → 10/97	FCP646	ATE	✓						✗				
<b>E430</b>															
4.3 i T210 SW Estate		09/97 →	FCP646	ATE	✓						✗				
4.3 i W210		09/97 → 03/02	FCP646	ATE	✓						✗				
<b>E430 (S210)</b>															
4.3 24v	205	09/99 → 05/03	FCP1001	ATE	✓							✓			
<b>E50 AMG</b>															
5.0 32v (W210)	255	09/96 → 10/97	FCP1001	ATE	✓							✓			
<b>E500</b>															
5.0 24v (S211)	225	08/03 → 07/06	FCP1661	BRE	✓										
5.0 24v (W211)	225	04/02 → 06/05	FCP1661	BRE	✓										
5.5 32v (W211) For vehicles without sports package	285	05/06 → 00/00	FCP1661	BRE	✓										
<b>E500 (S211)</b>															
5.0 24v	225	08/03 → 08/05	FCP1001	ATE, To Ch. 870950	✓							✓			
<b>E500 (W211)</b>															
5.0 24v - For vehicles without sports package	225	08/03 → 07/06	FCP1001	ATE	✓							✓			
<b>E55 AMG</b>															
5.4 24v (S210)	260	11/97 → 05/03	FCP1001	ATE	✓							✓			
5.4 24v (W210)	260	01/97 → 11/02	FCP1001	ATE	✓							✓			
<b>E63 AMG</b>															
6.2 32v (S211)	378	08/06 → 11/09	FRP3133	Brembo	✓										
6.2 32v (S212)	386	12/09 → 00/00	FRP3133	Brembo	✓										
6.2 32v (W211)	378	08/06 → 11/09	FRP3133	Brembo	✓										
<b>ML270</b>															
2.7 CDi 20v (W163)	120	09/00 → 07/05	FCP1661	BRE	✓										
<b>ML320</b>															
3.2 18v (W163)	160	09/00 → 08/02	FCP1661	BRE	✓										
<b>ML350</b>															
3.7 18v (W163)	173	04/03 → 07/05	FCP1661	BRE	✓										
3.7 18v (W163)	180	08/02 → 07/03	FCP1661	BRE	✓										
<b>ML400</b>															
4.0 CDi 32v (W163)	184	09/01 → 07/05	FCP1661	BRE	✓										
<b>ML430</b>															
4.3 24v (W163)	200	09/00 → 08/02	FCP1661	BRE	✓										
<b>ML500</b>															
5.0 24v (W163)	215	09/01 → 07/05	FCP1661	BRE	✓										
<b>ML55 AMG</b>															
5.4 24v (W163)	255	06/99 → 07/05	FCP1661	BRE	✓										
<b>S280</b>															
2.8 18v (W220)	150	02/99 → 09/02	FCP1661	BRE	✓										
2.8 18v (W220)	150	10/02 → 08/05	FCP1661	BRE	✓										



kW



**...MERCEDES**

COMPOUND AVAILABILITY

COMPOUND AVAILABILITY

H C R W Z

H C R W Z

**S320**

3.2 18v (W220 )	165	02/99 → 08/02	FCP1661	BRE	✓										
3.2 CDi 24v (W220 )	150	09/02 → 08/05	FCP1661	BRE	✓										
3.2 CDi 24v (W220 )	145	09/99 → 08/02	FCP1661	BRE	✓										

**S350**

3.7 18v (W220 )	180	09/02 → 08/05	FCP1661	BRE	✓										
-----------------	-----	---------------	---------	-----	---	--	--	--	--	--	--	--	--	--	--

**S400**

4.0 CDi 32v (W220 )	184	07/00 → 09/02	FCP1661	BRE	✓										
4.0 CDi 32v (W220 )	191	08/03 → 08/05	FCP1661	BRE	✓										
4.0 CDi 32v (W220 )	184	10/02 → 08/05	FCP1661	BRE	✓										

**S430**

4.3 24v (W220 )	205	09/98 → 09/02	FCP1661	BRE	✓										
4.3 24v (W220 )	205	10/02 → 08/05	FCP1661	BRE	✓										

**S430 (W220)**

4.3 24v	205	09/02 → 08/05	FCP1001	ATE	✓				✓						
---------	-----	---------------	---------	-----	---	--	--	--	---	--	--	--	--	--	--

**S500**

5.0 24v (W220 )	225	01/02 → 08/05	FCP1661	BRE	✓										
5.0 24v (W220 )	225	01/02 → 08/05	FCP1661	BRE	✓										
5.0 24v (W220 )	225	10/98 → 12/01	FCP1661	BRE	✓										

**S500 (W220)**

5.0 24v	225	09/02 → 08/05	FCP1001	ATE	✓				✓						
---------	-----	---------------	---------	-----	---	--	--	--	---	--	--	--	--	--	--

**S55 AMG**

5.4 24v (W220 )	265	09/99 → 08/02	FCP1661	BRE	✓										
-----------------	-----	---------------	---------	-----	---	--	--	--	--	--	--	--	--	--	--

**S600**

5.8 36v (W220 ) Not for armoured vehicles	270	09/99 → 08/02	FCP1661	BRE	✓										
---	-----	---------------	---------	-----	---	--	--	--	--	--	--	--	--	--	--

**SL24**

3.0 (R129)		01/89 → 06/93	FCP646	ATE	✓				✉						
3.2 (R129)		01/89 → 06/93	FCP646	ATE	✓				✉						

**SL280**

2.8 (R129)		07/93 → 08/94	FCP646	ATE	✓				✉						
3.0 24v (R230 ) For vehicles without sports package170		08/07 → 00/00	FCP1661	BRE	✓										

**SL300**

3.0 (R129)		01/89 → 06/93	FCP646	ATE	✓				✉						
3.0 24v (R230 ) For vehicles without sports package170		06/09 → 00/00								FCP1568	✓		✓		

**SL320**

3.2 (R129)		07/93 → 05/98	FCP646	ATE	✓				✉						
------------	--	---------------	--------	-----	---	--	--	--	---	--	--	--	--	--	--

**SL350**

3.5 24v (R230 ) For vehicles without sports package200		03/06 → 11/08	FCP1661	BRE	✓										
3.5 24v (R230 ) For vehicles without sports package232		11/07 → 00/00	FCP1661	BRE	✓										
3.7 18v (R230 )	180	08/02 → 07/05	FCP1661	BRE	✓										

**SL500**

5.0 (R129)		01/89 → 06/93	FCP646	ATE	✓				✉						
5.0 (R129) 32V	235	07/93 → 05/98	FCP646	ATE	✓				✉						
5.0 24v (R230 )	225	08/01 → 07/05	FCP1661	BRE	✓										

**SL55 AMG**

5.4 24v (R230)	380	03/06 → 01/12	FRP3133	Brembo	✓										
----------------	-----	---------------	---------	--------	---	--	--	--	--	--	--	--	--	--	--

**SL600**

6.0 (R129) 48V	290	07/93 →	FCP646	ATE	✓				✉						
----------------	-----	---------	--------	-----	---	--	--	--	---	--	--	--	--	--	--

**SL63 AMG**

6.2 32v (R230)	386	03/08 → 01/12	FRP3133	Brembo	✓										
----------------	-----	---------------	---------	--------	---	--	--	--	--	--	--	--	--	--	--

**SL65 AMG**

6.0 36 v (R230)	450	04/06 → 01/12	FRP3133	Brembo, From Chassis:122821	✓										
6.0 Black Series 36v (R230)	493	07/08 → 01/12	FRP3133	Brembo	✓										

- ✓ Available
- ✘ Not Available
- ✉ Make to order
- ✎ In Introduction
- ⚠ Exhausting



Updated on 30th Jan 2014



kW



**...MERCEDES**

**SLK200**

2.0 Kompressor (R170) 16V 141 09/96 →

FCP1049 ATE ✓

**SLK230**

2.3 Kompressor (R170) 16V 142 09/96 →

FCP1049 ATE ✓

**SLK32 AMG**

3.2 18v (R170) 260 04/00 → 01/04

FCP1001 ATE ✓ ✓

**SLK320**

3.2 V6 (R170) 218 03/00 → 04/04

FCP1050 ATE ✓

**SLK350**

3.5 24v (R171) 200 06/04 → 01/06

FCP1661 BRE ✓

**SLK55 AMG**

5.4 24v (R171) 265 04/08 → 00/00

FCP1661 BRE ✓

**MERCURY**

**Merkur Scorpio**

01/88 → 12/89

FCP408 ✓ ✓ ☒

**MG**

**MG B**

1.8 GT 68 01/62 → 12/81

FCP823 LKD ☒

1.8 Not V8 59 01/62 → 12/81

FCP823 LKD ☒

1.8 V8 01/62 → 12/81

FCP823 LKD ☒

**MG TF**

1.6 (115) 85 03/02 →

FRP3085 LKD ✓ ✓ ✓ ✓

1.8 (120) - 1.8 (135) 88, 100 03/02 →

FRP3085 LKD ✓ ✓ ✓ ✓

1.8 (160) 118 03/02 →

FRP3085 LKD ✓ ✓ ✓ ✓

1.8 i VVC 118 03/02 →

FRP3085 LKD ✓ ✓ ✓ ✓

**MG ZR**

1.4 i 105 16V 76 06/01 → 04/05

FCP613 LUC ✓ ✓

1.8 i 120 16V 86 06/01 → 04/05

FCP613 LUC ✓ ✓

1.8 i 160 16V 118 06/01 → 04/05

FCP613 LUC ✓ ✓

2.0 TDi 16V 74 06/01 → 04/05

FCP613 LUC ✓ ✓

1.8 i 120 16V 86 07/01 → 04/05

FCP613 LUC ✓ ✓

2.5 i 180 16V 130 07/01 → 04/05

FCP613 LUC ✓ ✓

1.8 i 120 16V 86 07/01 → 04/05

FCP613 LUC ✓ ✓

**MGR V8**

3.9 16V 140 10/92 → 12/95

FCP832 LKD ☒ ✓

**MINI**

**MINI COUNTRYMAN**

1.6 Cooper (R60) 85,90 06/10 → 00/00

FCP4080 TRW ✓ ✓ ✓

1.6 Cooper D (R60) 82 06/10 → 00/00

FCP4080 TRW ✓ ✓ ✓

1.6 Cooper DX (R60) 82 06/10 → 00/00

FCP4080 TRW ✓ ✓ ✓

1.6 Cooper S (R60) 135 06/10 → 00/00

FCP4080 TRW ✓ ✓ ✓

1.6 Cooper S (R60) 120 06/10 → 00/00

FCP4080 TRW ✓ ✓ ✓

**Mini Countryman**

1.6 Cooper S/Cooper SX (R60) 135 06/10 →

FCP4080 TRW ✓ ✓ ✓

1.6 Cooper SX (R60) 120 06/10 →

FCP4080 TRW ✓ ✓ ✓

**MINI COUNTRYMAN**

1.6 One (R60) 72 06/10 → 00/00

FCP4080 TRW ✓ ✓ ✓

1.6 One D (R60) 66 06/10 → 00/00

FCP4080 TRW ✓ ✓ ✓

COMPOUND AVAILABILITY  
H C R W Z

COMPOUND AVAILABILITY  
H C R W Z

MERCEDES



...MINI

**Mini Countryman**

1.6 S JCW (R60)	160	06/12 →	FCP4080	TRW	✓	FCP1806	TRW	✓
1.6 S JCW Tuning-Kit (R60)	147	02/12 →	FCP4080	TRW	✓	FCP1806	TRW	✓

**MINI COUNTRYMAN**

2.0 Cooper D (R60)	82	03/11 → 00/00	FCP4080	TRW	✓	FCP1806	TRW	✓
2.0 Cooper DX (R60)	82	03/11 → 00/00	FCP4080	TRW	✓	FCP1806	TRW	✓
2.0 Cooper SD (R60)	100	03/11 → 00/00	FCP4080	TRW	✓	FCP1806	TRW	✓
2.0 Cooper SD (R60)	105	03/11 → 00/00	FCP4080	TRW	✓	FCP1806	TRW	✓

**Mini Countryman**

2.0 Cooper SDX (R60)	100	02/11 →	FCP4080	TRW	✓	FCP1806	TRW	✓
2.0 Cooper SDX (R60)	105	03/11 →	FCP4080	TRW	✓	FCP1806	TRW	✓

**Mini Coupe**

1.6 Cooper (R58)	85	09/11 →	FCP1747	TRW	✓	FCP1975	TRW	✓
1.6 Cooper (R58)	90	09/11 →	FCP1747	TRW	✓	FCP1975	TRW	✓
1.6 Cooper (R58) - Brembo Front	85	09/11 →	FCP1561	BRE	✓	FCP1975	TRW	✓
1.6 Cooper S (R58)	120	09/11 →	FCP4080	TRW	✓	FCP1975	TRW	✓
1.6 Cooper S (R58)	135	09/11 →	FCP4080	TRW	✓	FCP1975	TRW	✓
1.6 Cooper S JCW (R58) - Brembo Front	155	09/11 → 00/00	FCP1561	BRE	✓	FCP1975	TRW	✓
1.6 S JCW Tuning-Kit (R58)	147	09/11 →	FCP4080	TRW	✓	FCP1975	TRW	✓
2.0 Cooper SD (R58)	100	09/11 →	FCP1747	TRW	✓	FCP1975	TRW	✓
2.0 Cooper SD (R58)	105	09/11 →	FCP1747	TRW	✓	FCP1975	TRW	✓
2.0 Cooper SD (R58) - Brembo Front	100	09/11 →	FCP1561	BRE	✓	FCP1975	TRW	✓

**Mini MK1**

1.4 One (R50) - ATE Front	55	04/03 → 10/06	FCP1499	ATE	✓	FCP1676	ATE	✓
1.4 One (R50) - TRW Front	55	04/03 → 10/06	FCP4080	TRW	✓	FCP1676	ATE	✓
1.4 One D	55	06/03 → 02/07	FCP1499	ATE	✓	FCP1676	ATE	✓
1.4 One D (R50) - ATE Front	55	04/03 → 09/05	FCP1499	ATE	✓	FCP1676	ATE	✓
1.4 One D (R50) - ATE Front	65	06/03 → 09/05	FCP1499	ATE	✓	FCP1676	ATE	✓
1.4 One D (R50) - TRW Front	55	04/03 → 09/05	FCP4080	TRW	✓	FCP1676	ATE	✓
1.4 One D (R50) - TRW Front	65	06/03 → 09/05	FCP4080	TRW	✓	FCP1676	ATE	✓
1.6 Cooper (R50)	85	04/01 → 12/08	FCP1499	ATE	✓	FCP1676	ATE	✓
1.6 Cooper (R52)	85	01/02 → 01/09	FCP1499	ATE	✓	FCP1676	ATE	✓
1.6 Cooper S (R52)	125	01/02 → 01/09	FCP1499	ATE	✓	FCP1676	ATE	✓
1.6 Cooper S (R52)	120	04/02 → 01/09	FCP1499	ATE	✓	FCP1676	ATE	✓
1.6 Cooper S (R53)	120	02/02 → 12/08	FCP1499	ATE	✓	FCP1676	ATE	✓
1.6 Cooper S (R53)	125	05/04 → 10/06	FCP1499	ATE	✓	FCP1676	ATE	✓
1.6 Cooper S JCW GP (R53)	160	01/06 → 07/07	FCP4080	TRW	✓	FCP1676	ATE	✓
1.6 Cooper S Works (R52)	155	07/04 → 01/09	FCP4080	TRW	✓	FCP1676	ATE	✓
1.6 Cooper S Works (R53)	155	07/05 → 10/06	FCP4080	TRW	✓	FCP1676	ATE	✓
1.6 Cooper S Works (R53)	147	11/03 → 06/05	FCP4080	TRW	✓	FCP1676	ATE	✓
1.6 One (R50)	66	04/01 → 07/07	FCP4080	TRW	✓	FCP1676	ATE	✓
1.6 One (R50) - vehicles without sports package	66	04/01 → 07/07	FCP1499	ATE	✓	FCP1676	ATE	✓
1.6 One (R52)	66	08/04 → 07/07	FCP1499	ATE	✓	FCP1676	ATE	✓

**Mini MK2**

1.4 One LPG (R56) - Brembo Front	55	03/09 → 03/10	FCP1561	BRE	✓	FCP1975	TRW	✓
1.4 One LPG (R56) - Front disc 280mm	55	03/09 → 03/10	FCP1747	TRW	✓	FCP1975	TRW	✓
1.4 One (R56) - Brembo Front	55	03/09 → 03/10	FCP1561	BRE	✓	FCP1975	TRW	✓
1.4 One (R56) - Brembo Front	70	11/06 → 03/10	FCP1561	BRE	✓	FCP1975	TRW	✓
1.4 One (R56) - Front disc 280mm	55	03/09 → 03/10	FCP1747	TRW	✓	FCP1975	TRW	✓

**Mini Mk2**

1.4 One (R56) - Front disc 280mm	70	11/06 → 03/10	FCP1747	TRW	✓	FCP1975	TRW	✓
----------------------------------	----	---------------	---------	-----	---	---------	-----	---

**Mini MK2**

1.4 One (R56) - Front disc 294mm	55	03/09 → 03/10	FCP4080	TRW	✓	FCP1975	TRW	✓
1.4 One (R56) - Front disc 294mm	70	11/06 → 03/10	FCP4080	TRW	✓	FCP1975	TRW	✓
1.4 One LPG (R56) - Front disc 294mm	55	03/09 → 03/10	FCP4080	TRW	✓	FCP1975	TRW	✓
1.6 Cooper (R56) - Brembo Front	85	03/10 →	FCP1561	BRE	✓	FCP1975	TRW	✓
1.6 Cooper (R56) - Brembo Front	90	03/10 →	FCP1561	BRE	✓	FCP1975	TRW	✓
1.6 Cooper (R56) - Brembo Front	88	11/06 → 08/10	FCP1561	BRE	✓	FCP1975	TRW	✓
1.6 Cooper (R56) - Front disc 280mm	85	03/10 →	FCP1747	TRW	✓	FCP1975	TRW	✓
1.6 Cooper (R56) - Front disc 280mm	90	03/10 →	FCP1747	TRW	✓	FCP1975	TRW	✓
1.6 Cooper (R56) - Front disc 280mm	88	11/06 → 08/10	FCP1747	TRW	✓	FCP1975	TRW	✓
1.6 Cooper (R56) - Front disc 294mm	85	03/10 →	FCP4080	TRW	✓	FCP1975	TRW	✓
1.6 Cooper (R56) - Front disc 294mm	90	03/10 →	FCP4080	TRW	✓	FCP1975	TRW	✓
1.6 Cooper (R56) - Front disc 294mm	88	11/06 → 08/10	FCP4080	TRW	✓	FCP1975	TRW	✓
1.6 Cooper (R57)	85	03/09 →	FCP1747	TRW	✓	FCP1975	TRW	✓
1.6 Cooper (R57) - Brembo Front	88	03/09 →	FCP1561	BRE	✓	FCP1975	TRW	✓
1.6 Cooper (R57) - Brembo Front	90	03/10 →	FCP1561	BRE	✓	FCP1975	TRW	✓
1.6 Cooper (R57) - Front disc 280mm	88	03/09 →	FCP1747	TRW	✓	FCP1975	TRW	✓
1.6 Cooper (R57) - Front disc 280mm	90	03/10 →	FCP1747	TRW	✓	FCP1975	TRW	✓
1.6 Cooper (R57) - Front disc 294mm	88	03/09 →	FCP4080	TRW	✓	FCP1975	TRW	✓
1.6 Cooper (R57) - Front disc 294mm	90	03/10 →	FCP4080	TRW	✓	FCP1975	TRW	✓
1.6 Cooper D (R56) - Brembo Front	80	11/06 → 09/10	FCP1561	BRE	✓	FCP1975	TRW	✓

- ✓ Available
- ✗ Not Available
- Ⓜ In Introduction
- 🔥 Exhausting
- 📧 Make to order



Updated on 30th Jan 2014

1065

MINI







KW

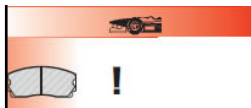

**...MINI**

**...Mini MK2**

2.0 Cooper SD (R56) - Front disc 294mm	100	02/11 →
2.0 Cooper SD (R56) - Front disc 294mm	105	03/11 →
2.0 Cooper SD (R57) - Brembo Front	105	03/11 →
2.0 Cooper SD (R57) - Brembo Front	100	03/11 →
2.0 Cooper SD (R57) - Front disc 280mm	100	03/11 →
2.0 Cooper SD (R57) - Front disc 280mm	105	03/11 →
2.0 Cooper SD (R57) - Front disc 294mm	100	03/11 →
2.0 Cooper SD (R57) - Front disc 294mm	105	03/11 →

COMPOUND AVAILABILITY					
H	C	R	W	Z	
✓			✓		
✓			✓		
✓		✓	✓	✓	
✓		✓	✓	✓	
✓					
✓			✓		
✓			✓		

COMPOUND AVAILABILITY					
H	C	R	W	Z	
✓					
✓					
✓					
✓					
✓					
✓					
✓					
✓					

**Mini Mk2**

Clubman 1.4 One (R55)	70	03/09 → 02/10
Clubman 1.4 One (R55)	72	03/10 →
Clubman 1.6 Cooper (R55)	85	03/10 →
Clubman 1.6 Cooper (R55)	90	03/10 →

✓					
✓					
✓					
✓					

✓					
✓					
✓					
✓					

**Mini Mk2**

Clubman 1.6 Cooper (R55)	88	09/07 →
--------------------------	----	---------

✓					
---	--	--	--	--	--

✓					
---	--	--	--	--	--

**Mini Mk2**

Clubman 1.6 Cooper (R55) - Brembo Front	85	03/10 →
Clubman 1.6 Cooper D (R55)	80	10/07 →
Clubman 1.6 Cooper D (R55)	82	03/10 →
Clubman 1.6 Cooper S (R55)	135	03/10 →
Clubman 1.6 Cooper S (R55) - Brembo Front	135	03/10 → 00/00
Clubman 1.6 Cooper S (R55) - Brembo Front	120	10/07 → 00/00
Clubman 1.6 Cooper S (R55) - Brembo Front	128	10/07 → 00/00
Clubman 1.6 One (R55)	72	03/10 →
Clubman 1.6 One D (R55)	66	03/10 →
Clubman 1.6 S JCW (R55) - Brembo Front	155	03/08 →
Clubman 1.6 S JCW Tuning-Kit (R55) - Brembo Front	147	03/10 →
Clubman 2.0 Cooper D (R55)	82	03/11 →
Clubman 2.0 Cooper D (R55) - Brembo Front	82	03/11 →
Clubman 2.0 Cooper SD (R55)	100	02/11 →
Clubman 2.0 Cooper SD (R55)	105	03/11 →
Clubman 2.0 Cooper SD (R55) - Brembo Front	100	02/11 →
Clubman 2.0 Cooper SD (R55) - Brembo Front	105	03/11 →

✓		✓	✓	✓	
✓					
✓					
✓			✓		
✓		✓	✓	✓	
✓		✓	✓	✓	
✓		✓	✓	✓	
✓					
✓					
✓		✓	✓	✓	
✓		✓	✓	✓	
✓					
✓		✓	✓	✓	
✓		✓	✓	✓	
✓		✓	✓	✓	
✓		✓	✓	✓	

✓					
✓					
✓					
✓					
✓					
✓					
✓					
✓					
✓					
✓					
✓					
✓					
✓					
✓					
✓					
✓					

**Mini Paceman**

1.6 Cooper (R61)	90	01/13 →
1.6 Cooper D (R61)	82	01/13 →
1.6 Cooper DX (R61)	82	01/13 →
1.6 Cooper S (R61)	135	01/13 →
1.6 Cooper SX (R61)	135	01/13 →
1.6 Cooper SX JCW (R61)	160	01/13 →
2.0 Cooper SD (R61)	105	01/13 →
2.0 Cooper SDX (R61)	105	01/13 →

✓			✓		
✓			✓		
✓			✓		
✓			✓		
✓			✓		
✓			✓		
✓			✓		
✓			✓		

✓					
✓					
✓					
✓					
✓					
✓					
✓					
✓					

**Mini Roadster**

1.6 Cooper (R59)	85	02/12 →
1.6 Cooper (R59)	90	02/12 →
1.6 Cooper (R59) - Brembo Front	85	02/12 →
1.6 Cooper (R59) - Brembo Front	90	02/12 →
1.6 Cooper S (R59)	120	02/12 →
1.6 Cooper S (R59)	135	02/12 →
1.6 Cooper S (R59) - Brembo Front	120	02/12 →
1.6 Cooper S (R59) - Brembo Front	135	02/12 →
1.6 Cooper S JCW (R59) - Brembo Front	155	02/12 →
1.6 S JCW Tuning-Kit (R59)	147	02/12 →
2.0 Cooper SD (R59)	100	02/12 →
2.0 Cooper SD (R59)	105	02/12 →
2.0 Cooper SD (R59) - Brembo Front	100	02/12 →
2.0 Cooper SD (R59) - Brembo Front	105	02/12 →

✓			✓		
✓			✓		
✓		✓	✓	✓	
✓		✓	✓	✓	
✓		✓	✓	✓	
✓		✓	✓	✓	
✓		✓	✓	✓	
✓		✓	✓	✓	
✓		✓	✓	✓	
✓			✓		
✓			✓		
✓			✓		
✓			✓		
✓		✓	✓	✓	
✓		✓	✓	✓	

✓					
✓					
✓					
✓					
✓					
✓					
✓					
✓					
✓					
✓					
✓					
✓					
✓					
✓					
✓					

- ✓ Available
- ✗ Not Available
- 🔵 In Introduction
- ⚠️ Exhausting
- 📦 Make to order



Updated on 30th Jan 2014



kw

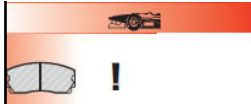

MITSUBISHI

3000 GT, GTO

Table row for 3000 GT, GTO with columns for model, power, date, and compound availability.

Carisma

Table rows for Carisma models including 1.8 16V and 1.9 TDi DA4A.

Galant

Table rows for Galant models including 2.0 and 2.5 24V.

L200

Table rows for L200 models including 1.6 i L021P and 2.5 TD.

Lancer

Table rows for Lancer models including 1.6 i 16V, Evo III, Evo IV, Evo IX, Evo V, Evo VI, Evo VII, Evo VIII, Evo VIII - Alcon, Evo X, Evo IX-X Gr.N Gravel, Evo IX-X Gr.N Tarmac, and Ralliart.

Montero

Table rows for Montero models including 2.3 L034, L048, 2.4 16V, 2.5 TD, 2.5 TD V24, V44, 2.8 TD V46 LWB, 2.8 V24, V44, 3.0 TD V23, and 3.5 V25, V45 24V.

Montero Sport

Table rows for Montero Sport models including 2.5 D, 3.0 i 24V, and 3.0 i 24V.

Outlander

Table rows for Outlander models including 2.0 i 4WD 16v, 2.0 i Turbo 4WD 16v, and 2.4 i 4WD 16v.

Pajero

Table rows for Pajero models including 2.3 TD L043, 2.3 TD L048, 2.4 (V21, 41) (II), 2.5 TD L044G, 2.5 TD L049GW, 2.5 TD V24, V44, 2.8 TD V46 LWB, 2.8 V24, V44, 3.0 TD V6 (V23, 43) (II), and 3.5 V25, V45 24V.

Pajero Sport

Table rows for Pajero Sport models including 2.5 D, 3.0 i 24V, and 3.0 i 24V.

MITSUBISHI



kw



**...MITSUBISHI**

**Sapporo**

2.0 Coupe A123A, A164A 05/78 → 02/84

FCP170 SUM

COMPOUND AVAILABILITY

H C R W Z

COMPOUND AVAILABILITY

H C R W Z

**Shogun**

2.3 TD L048 LWB 01/84 → 09/86

FCP170 SUM

2.4 i (V21/41) (II) 16V 82 01/91 → 08/94

FCP765

2.5 TD V24, V44 73 04/91 →

FCP765

2.8 TD V46 LWB 92 03/94 →

FCP765

2.8 V24, V44 04/91 →

FCP765

3.0 V23, V43 04/91 →

FCP765

3.5 V25, V45 24V 143, 153 04/94 →

FCP765

**Shogun Sport**

2.5 D 73 03/00 →

FCP765

2.5 D 73 03/00 →

FCP765

3.0 i 24V 130 03/00 →

FCP765

3.0 i 24V 130 03/00 →

FCP765

**Sigma**

1.6 i AV161 V SW Estate 01/80 → 12/81

FCP170 SUM

3.0 F16 130, 151 04/91 → 10/96

FCP765

**Space Star**

1.3 16V 63 08/98 →

FCP1093

1.6 i 16V 09/01 →

FCP1093

1.8 16V 90 08/98 →

FCP1093

1.9 Di 75 02/01 →

FCP1093

**MORGAN**

**4-4**

1.6 (Ford Engine) 01/68 → 01/86

FCP809 LUC

**Plus 8**

3.5 i V8 16V 03/84 → 05/90

FCP116 ATE

3.5 V8 16V 01/83 → 03/84

FCP116 ATE

**NISSAN**

**180 SX**

S13 01/96 → 01/99

FCP1430

**200SX**

1.8 S13 16V 124 04/89 → 09/91

FCP600

1.8 S13 16V 124 09/91 → 09/94

FCP691 SUM

2.0 i S14 16V 10/94 → 05/01

FCP484

2.0 i S14 16V Turbo 147 10/93 → 12/99

FCP986 Sumitomo

**280ZX**

2.8 Fairlady (S130) 08/81 → 12/84

FCP484

2.8 Fairlady (S130) 08/81 → 12/84

FCP484

**300ZX**

3.0 i Z31 01/84 → 12/86

FCP484

3.0 i Z31 01/87 → 08/87

FCP484

3.0 i Z31 09/87 → 03/90

FCP484

3.0 Z32 24V 208 03/90 → 12/94

FCP986

**350Z**

3.5 V6 24V 04/02 →

FCP1561 BRM

350Z 01/03 → 12/03

FCP1430

Enthusiast / Touring / Grand Touring / Track 01/04 → 12/08

FCP1690 Non BREMBO / Non 18 in. Wheels

**370 Z**

370 Z 01/09 →

FCP4172

**Altima**

2.5 S / SL 01/93 → 12/01

FCP1430 SUM

3.5 SE / SL 01/06 → 12/06

FCP1430

3.5 SE-R 01/06 → 12/06

FCP1786 TOK

- ✓ Available
- ✗ Not Available
- ⚡ Exhausting
- 📦 Make to order
- 🚚 In Introduction



Updated on 30th Jan 2014



kw



# ...NISSAN

## Cherry

1.0 i F10	33	01/77 → 12/79
1.0 N10	33, 37	11/78 → 04/82
1.2 N10	38	01/79 → 12/82
1.3 N10	44	11/78 → 04/82
1.4 N10	46	11/78 → 12/82
1.5 N10	51	11/78 → 12/82

		COMPOUND AVAILABILITY				
		H	C	R	W	Z
FCP39	TOK	☒				
FCP39	TOK	☒				
FCP39	TOK	☒				
FCP39	TOK	☒				
FCP39	TOK	☒				

		COMPOUND AVAILABILITY				
		H	C	R	W	Z

## Cherry Europe

1.2 (RX920, ZX920)	46	01/83 → 12/85
1.2 (RX920, ZX920)	46	01/83 → 12/85
1.5 (RX920, ZX920)	69	01/83 → 12/85
1.5 (RX920, ZX920)	69	01/83 → 12/85

FCP441	ATE		☒	☑		
FCP72	BDX	☑		☑		
FCP441	ATE		☒	☑		
FCP72	BDX	☑		☑		

## Juke

1.5 dCi	81	06/10 →
1.6	86	06/10 →
1.6 DIG-T	140	06/10 →
1.6 DIG-T 4x4	140	06/10 →

FCP1430	SUM	☑				
FCP1430	SUM	☑				
FCP1430	SUM	☑				
FCP1430	SUM	☑				

## Maxima

2.0	103	01/95 →
2.0	103	02/95 → 12/95
3.0 J30	125	06/89 → 09/94

FCP1430	SUM	☑				
FCP691	SUM	☑				
FCP691	SUM	☑				

## Micra

1.0 K11 16V	40	01/93 → 09/00
1.2 i K12 16V		01/03 →
1.3 K11 16V	55	01/93 → 09/00
1.4 i 16V	60	09/00 → 01/03
1.4 i K12 16V		01/03 →
1.5 D K11	42	05/98 → 01/03
1.5 dCi K12 16V		01/03 →

FCP859	LUC	☒		☑		
FCP1617	N.A.			☑	☒	☒
FCP859	LUC	☒		☑		
FCP859	LUC	☒		☑		
FCP1617	N.A.			☑	☒	☒
FCP859	LUC	☒		☑		
FCP1617	N.A.			☑	☒	☒

## Prairie

2.0 KA24E		01/92 → 12/93
2.0 M11	66, 72, 77, 85	04/89 → 12/91
2.4 KA24E	93	01/92 → 12/93

FCP600		☑		☒		
FCP600		☑		☒		
FCP600		☑		☒		

## Primera

1.6 i P12		03/02 →
1.6 W10 SW Estate 16V	66, 75	01/90 → 10/96
1.8 i P12		03/02 →
1.9 dCi P12		03/03 →
2.0 D W10 SW Estate	55	01/92 → 03/98
2.0 D W10 SW Estate	55	01/92 → 03/98
2.0 D W10 SW Estate	55	01/90 → 10/96
2.0 i P12		03/02 →
2.0 i P12 SW Estate		03/02 →
2.0 i P12 SW Estate		03/02 →
2.0 W10 Petrol SW Estate 16V	85	01/90 → 04/93
2.2 dCi P12		03/03 →
2.2 TD Di P12		03/02 →

FCP600		☑		☒		
FCP600		☑		☒		
FCP600		☑		☒		
FCP600		☑		☒		

FCP1540		☑				
FCP1540		☑				
FCP1540		☑				
FCP1540		☑				
FCP1540		☑				
FCP1540		☑				
FCP1540		☑				
FCP1540		☑				
FCP1540		☑				

## Silvia

S15, S13		01/99 →
1.8 i S12 (180ZX) (Turbo)		01/83 → 12/86
1.8 i S12 (180ZX) (Turbo)		01/87 → 12/89
2.0 i S12 (200ZX)		01/83 → 12/89
2.0 i S14 (200SX) (Turbo) 16V		04/94 →

FCP1430		☑				

FCP484		☑	☒	☒		
FCP484		☑	☒	☒		
FCP484		☑	☒	☒		
FCP484		☑	☒	☒		

## Skyline

R32 / R33 GTS		01/89 → 12/98
GT-R (R35)	357	01/08 →
GT-R (R35)	390	02/11 →
R33 GTR / R34		01/98 → 12/02

FCP986		☑		☑	☒	☑
FRP3106	BRM	☑	☒	☑	☑	☑
FRP3106	BRM	☑	☒	☑	☑	☑
FCP1298		☑		☑	☑	☑

FCP1281	BRM	☑		☑	☑	
FCP1281	BRM	☑		☑	☑	

## Sunny

1.2 B110		01/71 → 12/73
1.2 B210 (120Y)	38	01/73 → 12/75

FCP39	TOK	☒				
FCP39	TOK	☒				



1070



☑ Available    ⚠ Exhausting  
 ☒ Not Available    ☒ Make to order  
 ☒ In Introduction

Updated on 30th Jan 2014

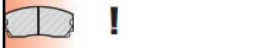
NISSAN



			COMPOUND AVAILABILITY					COMPOUND AVAILABILITY					
			H	C	R	W	Z	H	C	R	W	Z	
<b>...NISSAN</b>													
<b>Teana I (J31)</b>													
2.0	103	10/03 → 06/08	FCP1430	SUM	✓								
3.5	170	10/03 → 06/08	FCP1430	SUM	✓								
<b>Tiida (C11X&amp;SC11X)</b>													
1.5	78	09/07 →	FCP1430	SUM	✓								
1.6	81	09/07 →	FCP1430	SUM	✓								
1.8	93	09/07 →	FCP1430	SUM	✓								
<b>Tiida (C11X)</b>													
1.5	80	05/04 → 02/07	FCP1430	SUM	✓								
<b>NSU</b>													
<b>Prinz</b>													
	22	01/61 → 12/70	FCP3	ATE	✓		✓	☒					
<b>Spider</b>													
	37	01/64 → 12/67	FCP3	ATE	✓		✓	☒					
<b>OLDSMOBILE</b>													
<b>Eighty Eight</b>													
		01/74 → 12/85	FRP3057	KEL	✓		☒	✓	✓				
<b>Ninety Eight</b>													
		01/74 → 12/89	FRP3057	KEL	✓		☒	✓	✓				
<b>Omega</b>													
		01/75 → 12/79	FRP3057	KEL	✓		☒	✓	✓				
<b>Toronado</b>													
6.6 16V	105	01/72 → 12/78	FRP3057	KEL	✓		☒	✓	✓				
7.5 16V	140	01/72 → 12/78	FRP3057	KEL	✓		☒	✓	✓				
<b>OPEL</b>													
<b>Admiral</b>													
2.8 E	118	01/68 → 12/73	FCP11	ATE	✓		✓	☒	✓	FCP2	ATE	✓	☒
2.8 S	97, 103	01/64 → 12/73	FCP11	ATE	✓		✓	☒	✓	FCP2	ATE	✓	☒
<b>Ascona (A)</b>													
1.6		01/70 → 12/75	FCP2	ATE	✓	☒	✓		☒				
1.6 i		01/73 → 12/75	FCP2	ATE	✓	☒	✓		☒				
1.6 i S, Auto	51, 62	01/73 → 12/75	FCP2	ATE	✓	☒	✓		☒				
1.9	55, 66	01/70 → 12/75	FCP2	ATE	✓	☒	✓		☒				
1.9 i	55, 66	01/73 → 12/75	FCP2	ATE	✓	☒	✓		☒				
<b>Ascona (B)</b>													
1.1		01/78 → 12/81	FCP173	GM	✓		✓						
1.2	40, 44	09/75 → 08/78	FCP116	ATE	✓		✓						
1.2	40, 44	09/78 → 07/81	FCP173	GM	✓		✓						
1.3	44, 55	07/75 → 08/78	FCP116	ATE	✓		✓						
1.3	44, 55	09/78 → 07/81	FCP173	GM	✓		✓						
1.6	44, 55	07/75 → 08/78	FCP116	ATE	✓		✓						
1.6	44, 55	09/78 → 07/81	FCP173	GM	✓		✓						
1.9	55, 66	07/75 → 08/78	FCP116	ATE	✓		✓						
1.9	55, 66	09/78 → 07/81	FCP173	GM	✓		✓						
2.0	66, 74	07/75 → 08/78	FCP116	ATE	✓		✓						
2.0	43, 66, 74, 81	09/78 → 07/81	FCP173	GM	✓		✓						
<b>Ascona (C)</b>													
1.3	44, 55	08/81 → 12/88	FCP173	GM	✓		✓						
1.3	44, 55	12/83 → 12/88	FCP173	GM	✓		✓						
1.6	55	08/81 → 12/88	FCP173	GM	✓		✓						
1.6	55, 60	12/83 → 12/88	FCP173	GM	✓		✓						
1.8	85	08/81 → 12/83	FCP173	GM	✓		✓						
1.8	62, 74, 85	12/83 → 12/88	FCP173	GM	✓		✓						
2.0	81	01/81 → 12/89	FCP173	GM	✓		✓						
2.0	85	08/82 → 12/88	FCP173	GM	✓		✓						
2.0 GT Sport	95	12/83 → 02/89	FCP173	GM	✓		✓						























KW



...PEUGEOT

...405

Table with columns: Model, KW, Dates, Compound Code, Availability, and Compound Availability (H, C, R, W, Z). Rows include models like 1.8 TD Saloon, 1.9 i Saloon, etc.

406

Table with columns: Model, KW, Dates, Compound Code, Availability, and Compound Availability (H, C, R, W, Z). Rows include models like 1.9 TD Saloon, SW Estate, 2.0 Coupe 16V, etc.

407

Table with columns: Model, KW, Dates, Compound Code, Availability, and Compound Availability (H, C, R, W, Z). Rows include models like 1.6 1.6 Hdi 110 FAP, SW Estate 16V, 1.8 1.08, etc.

407 Estate

Table with columns: Model, KW, Dates, Compound Code, Availability, and Compound Availability (H, C, R, W, Z). Rows include models like 1.6 1.6 Hdi 110 FAP, 1.8 1.08, etc.

607

Table with columns: Model, KW, Dates, Compound Code, Availability, and Compound Availability (H, C, R, W, Z). Rows include models like 2.0 i 16V, 2.2 16V, etc.

806

Table with columns: Model, KW, Dates, Compound Code, Availability, and Compound Availability (H, C, R, W, Z). Rows include models like 1.9 TD, 2.0, 2.0 (Turbo), etc.

Enterprise

Table with columns: Model, KW, Dates, Compound Code, Availability, and Compound Availability (H, C, R, W, Z). Row: All Models

Expert

Table with columns: Model, KW, Dates, Compound Code, Availability, and Compound Availability (H, C, R, W, Z). Rows include models like 1.9 D 900 Kg, 1.9 TD 900 Kg, etc.

Legend: Available (green check), Not Available (red X), In Introduction (blue arrow), Exhausting (yellow triangle), Make to order (blue envelope)



Updated on 30th Jan 2014



kw



## ...PEUGEOT

### Partner

1.1	44	07/96	→	09/01
1.4	55	07/96	→	09/01
1.7 D		09/96	→	09/01
1.8 D	44	07/96	→	09/01
1.9 D	51	07/96	→	09/01
2.0 HDi	66	01/00	→	09/01

		COMPOUND AVAILABILITY				
		H	C	R	W	Z
FCP1112	LUC	✓				
FCP1112	LUC	✓				
FCP1112	LUC	✓				
FCP1112	LUC	✓				
FCP1112	LUC	✓				
FCP1112	LUC	✓				

		COMPOUND AVAILABILITY				
		H	C	R	W	Z

### Partner/Ranch

1.1 i	44	07/96	→	09/01
1.1 i	44	10/01	→	
1.4 i	55	07/96	→	09/01
1.4 i	55	10/01	→	
1.6 i 16V	80	10/00	→	09/01
1.6 i 16V	80	10/01	→	
1.8 i	66	05/97	→	09/01
1.9 D	51	07/96	→	09/01
1.9 D	51	10/01	→	
2.0 HDi	66	10/01	→	
2.0 HDi	66	12/99	→	09/01

FCP1112	LUC	✓				
FCP1399	Bosch	✓	✓			
FCP1112	LUC	✓				
FCP1399	Bosch	✓	✓			
FCP1112	LUC	✓				
FCP1112	LUC	✓				
FCP1399	Bosch	✓	✓			
FCP1399	Bosch	✓	✓			
FCP1112	LUC	✓				

## POLSKI

### 125

PX Linda 160		01/84	→	
PX1300, 1500		01/75	→	12/84
1.3	50	01/75	→	

FCP29	BDX	✓	✓			
FCP29	BDX	✓	✓			
FCP29	BDX	✓	✓			

### Baltic

06/78	→		
-------	---	--	--

FCP29	BDX	✓	✓			
-------	-----	---	---	--	--	--

--	--	--	--	--	--	--

### Polonez

1.5		06/78	→	06/90
-----	--	-------	---	-------

FCP29	BDX	✓	✓			
-------	-----	---	---	--	--	--

--	--	--	--	--	--	--

## PONTIAC

### 2+2

01/69	→	12/81
01/82	→	12/86

FRP3057	KEL	✓			✓	✓
FRP3058	KEL	✗	✓	⚠		✉

### Bonneville

4.9 16V	112	01/75	→	12/77
5.7 16V	125	01/75	→	12/77
6.6 16V	105	01/75	→	12/77

FRP3057	KEL	✓			✓	✓
FRP3057	KEL	✓			✓	✓
FRP3057	KEL	✓			✓	✓

### Cataline

01/69	→	12/81
01/82	→	12/86

FRP3057	KEL	✓			✓	✓
FRP3058	KEL	✗	✓	⚠		✉

### Firebird

		01/82	→	12/88
		01/89	→	12/92
3.8	86	01/72	→	12/81
4.1	83	01/72	→	12/81
4.9 16V	112	01/72	→	12/81
5.0 16V	119	01/72	→	12/81
5.7 16V	132	01/72	→	12/81
6.6 16V	138	01/72	→	12/81
7.5 16V	140	01/72	→	12/81

FRP3058	KEL	✗	✓	⚠		✉
FCP1224	KEL	✉				
FRP3057	KEL	✓			✓	✓
FRP3057	KEL	✓			✓	✓
FRP3057	KEL	✓			✓	✓
FRP3057	KEL	✓			✓	✓
FRP3057	KEL	✓			✓	✓
FRP3057	KEL	✓			✓	✓

FRP3058	KEL	✗	✓	⚠		✉

### Firebird, Trans Am

01/69	→	12/78
01/79	→	12/81

FRP3057	KEL	✓			✓	✓
FRP3057	KEL	✓			✓	✓

FRP3058	KEL	✗	✓	⚠		✉
---------	-----	---	---	---	--	---

### Grand Am

01/69	→	12/77
01/78	→	12/81

FRP3057	KEL	✓			✓	✓
FRP3058	KEL	✗	✓	⚠		✉





KW

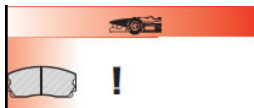

**...PONTIAC**

**Grand Prix**

01/69 → 12/77  
01/78 → 12/87

FRP3057 KEL  
FRP3058 KEL

COMPOUND AVAILABILITY  
H C R W Z

COMPOUND AVAILABILITY  
H C R W Z

**Grandville**

01/69 → 12/81  
01/82 → 12/86

FRP3057 KEL  
FRP3058 KEL

**GTO**

01/69 → 12/77  
01/78 → 12/81

FRP3057 KEL  
FRP3058 KEL

**Judge**

01/69 → 12/77  
01/78 → 12/81

FRP3057 KEL  
FRP3058 KEL

**Le Mans**

4.1 83 01/75 → 12/77 FRP3057 KEL  
5.7 16V 114 01/75 → 12/77 FRP3057 KEL  
6.6 16V 105 01/75 → 12/77 FRP3057 KEL  
6.6 16V 105 01/78 → 12/81 FRP3058 KEL

**Parisienne**

01/84 → 12/89

FRP3057 KEL

**Phoenix**

01/69 → 12/79

FRP3057 KEL

**Safari Wagon**

2.8 01/84 → 12/89

FRP3057 KEL

**Tempest**

01/69 → 12/77  
01/78 → 12/81

FRP3057 KEL  
FRP3058 KEL

**Ventura**

01/69 → 12/79

FRP3057 KEL

**PORSCHE**

**1600**

1.6 01/64 → 12/65

FCP2 ATE

FCP3 ATE

**356**

1.6 C, SC 01/63 → 12/66

FCP2 ATE

FCP3 ATE

**911**

2.0 01/65 → 12/69 FCP2 ATE  
2.2 01/70 → 12/71 FCP11 ATE  
2.3 01/72 → 12/73 FCP11 ATE  
3.3 (Turbo) 235 01/90 → 06/91 FCP560 ATE  
3.3 (Turbo) 235 07/91 → 09/93 FCP891 ATE  
3.3 ,Sport (Turbo) 243 09/77 → 06/89 FCP451 ATE  
3.4 Carrera 24V 221 01/98 → FCP1308  
3.6 (Turbo) 300 03/95 → 04/98 FCP891 ATE  
3.6 ,New Carrera (Turbo) 184 12/93 → 12/97 FCP560 ATE  
3.6 Carrera 2, 4 184 09/89 → 09/93 FCP451 ATE  
3.6 Carrera RS 191 09/91 → 06/93 FCP560 ATE  
3.8 Carrera 210, 221 06/95 → FCP560 ATE

FCP3 ATE  
FCP2 ATE  
FCP451 ATE  
FCP451 ATE  
FCP451 ATE  
FCP560 ATE  
FCP451 ATE  
FCP451 ATE  
FCP451 ATE  
FCP451 ATE

**911 (996)**

Carrera 2, 4, cabrio 09/97 → FRP3051 BRM  
Carrera GT2 01/02 → FRP3075 BRM  
Carrera GT3 Cup 01/02 → FRP3075 BRM  
3.4 Carrera, 3.4 Carrera 4 221, 235 06/97 → FRP3050 BRE  
3.6 Carrera, 3.6 Carrera 4, 3.6 Carrera 4S, 3.6 Carrera S, 235, 254 10/01 → FRP3050 BRE  
3.6 GT2, 3.6 GT3 265, 280, 340, 355 03/99 → 08/05 FRP3051 BRE  
3.6 Turbo 4, 3.6 Turbo 4S 309, 331 03/99 → FRP3050 BRE  
3.6 Turbo 4, 3.6 Turbo 4S 309, 331 03/99 → FRP3051 BRE

FCP1308  
FRP3051 BRM  
FRP3051 BRM  
FRP3050 BRE  
FRP3050 BRE  
FRP3051 BRE  
FRP3050 BRE  
FRP3051 BRE

✓ Available    ⚠ Exhausting  
✗ Not Available    📧 Make to order  
📦 In Introduction



Updated on 30th Jan 2014



KW



...PORSCHE

911 (997)

		COMPOUND AVAILABILITY					COMPOUND AVAILABILITY				
		H	C	R	W	Z	H	C	R	W	Z
3.6 Carrera 4 All	01/06 →	FRP3051	BRM	✓			FCP1308	BRM	✓	✉	✓
3.6 Carrera All	01/06 →	FRP3051	BRM	✓			FRP3051	BRM	✓	✉	✓
3.8 Carrera 4S	07/04 →	FRP3051	BRM	✓			FRP3051	BRM	✓	✉	✓
3.8 Carrera S	07/04 →	FRP3051	BRM	✓			FRP3051	BRM	✓	✉	✓
3.8 Carrera S, 4S	261 07/04 →	FRP3050	BRE	✓			FRP3050	BRE	✓		
3.8 Turbo	01/06 →	FRP3075	BRM	✓			FRP3095	BRM	✓		✓
GT2	390 09/07 →	FRP3075	BRM	✓			FRP3095	BRM	✓		✓
GT3	01/06 →	FRP3075	BRM	✓			FRP3095	BRM	✓		✓
GT3 CUP	01/05 → 12/09	FRP3096	BRM	✓		✓	FRP3095	BRM	✓		✓
GT3 CUP	01/10 →	FRP3075	BRM	✓			FRP3095	BRM	✓		✓
GT3 Cup Grand Am Spec	01/07 → 00/00	FRP3123	BRE			✓	FRP302	BRE		✉	✓
GT3 RS	01/06 →	FRP3075	BRM	✓			FRP3095	BRM	✓		✓
GT3 RSR	01/07 → 00/00	FRP3031	BRE			✓	FRP1078	BRE		✓	✓

911 Cabriolet (996)

3.4 Carrera, 3.4 Carrera 4	221, 235 02/98 →	FRP3050	BRE	✓							
3.4 Carrera, 3.4 Carrera 4	221, 235 02/98 →	FRP3051	BRE	✓							
3.6 Carrera, 3.6 Carrera 4, 3.6 Carrera 4S, 3.6 Carrera S, 3.6 Turbo 4235, 254, 309	10/01 →	FRP3050	BRE	✓							
3.6 Carrera, 3.6 Carrera 4, 3.6 Carrera 4S, 3.6 Carrera S, 3.6 Turbo 4235, 254, 309	10/01 →	FRP3051	BRE	✓							
3.6 Turbo 4S	331 10/03 →	FRP3050	BRE	✓							
3.6 Turbo 4S	331 10/03 →	FRP3051	BRE	✓							

911 Cabriolet (997)

3.6 Carrera, 3.6 Carrera 4	239 04/05 →	FRP3051	BRE	✓							
3.8 Carrera 4S, 3.8 Carrera S	261 04/05 →	FRP3050	BRE	✓							
3.8 Carrera 4S, 3.8 Carrera S	261 04/05 →	FRP3051	BRE	✓							

911 Targa (996)

3.6	235 12/01 →	FRP3051	BRE	✓							
-----	-------------	---------	-----	---	--	--	--	--	--	--	--

911 Targa (997)

3.6 Carrera 4	239 11/06 →	FRP3051	BRM	✓			FCP1308	BRM	✓	✉	✓
3.8 Carrera 4S	261 06/08 →	FRP3050	BRM	✓							
3.8 Carrera 4S	261 11/06 →	FRP3050	BRM	✓			FRP3051	BRM	✓		✓

912

1.6	01/65 → 12/70	FCP2	ATE	✓	✉	✓		FCP3	ATE	✓	✉
-----	---------------	------	-----	---	---	---	--	------	-----	---	---

914

1.7 VW-Porsche 4	63 01/69 → 12/75	FCP2	ATE	✓	✉	✓		FCP93	ATE	✓	✉
2.0 VW-Porsche 6	92 01/69 → 12/73	FCP3	ATE	✓		✉					

928

4.5 16V	177 12/79 → 07/82	FCP256	ATE	✓		✓					
4.7 S 16V	221 01/81 → 08/83	FCP256	ATE	✓		✓					
4.7 S series 2 16V	221 09/83 → 07/86	FCP560	ATE	✓		✉	FCP541	LUC	✓	✉	✉
5.0 S series 4, GT 32V	235, 243 09/86 → 05/92	FCP560	ATE	✓		✉	FCP541	LUC	✓	✉	✉
5.4 GTS 32V	257 05/92 → 01/95	FCP891	ATE	✓		✉	FCP451	ATE	✓	✉	✉

944

2.5 (Turbo)	220, 250 09/85 → 08/88	FCP451	ATE	✓		✉	FCP451	ATE	✓	✉	✉
2.5 (Turbo)	250 09/88 → 05/92	FCP560	ATE	✓		✉	FCP451	ATE	✓	✉	✉
2.7 S2	121 01/88 → 08/90	FCP451	ATE	✓		✉	FCP451	ATE	✓	✉	✉
3.0 S2 16V	156 01/89 → 05/92	FCP451	ATE	✓		✉	FCP451	ATE	✓	✉	✉

959

2.9	330 01/85 → 12/91	FCP560	ATE	✓		✉	FCP560	ATE	✓	✉	✉
-----	-------------------	--------	-----	---	--	---	--------	-----	---	---	---

968

3.0 (Turbo)	224 03/93 → 11/95	FCP891	ATE	✓		✉	FCP451	ATE	✓	✉	✉
3.0 Club Sport 16V	176 01/93 → 10/95	FCP560	ATE	✓		✉	FCP451	ATE	✓	✉	✉
3.0 Not Club Sport 16V	176 01/93 → 10/95	FCP451	ATE	✓		✉	FCP451	ATE	✓	✉	✉

993

Carrera	01/94 → 12/97	FCP560	ATE	✓		✉	FCP451	ATE	✓	✉	✉
Carrera RS	01/94 → 12/97	FCP891	ATE	✓		✉	FCP560	ATE	✓	✉	✉
GT3	→	FRP3042		✓		✓					
Turbo	01/94 → 12/97	FCP891	ATE	✓		✉	FCP560	ATE	✓	✉	✉

Boxster

S 3.2	206 11/04 →	FRP3051	BRE	✓							
-------	-------------	---------	-----	---	--	--	--	--	--	--	--

PORSCHE







KW



...RENAULT

Table with columns for model, date, part number, and availability (H, C, R, W, Z). Includes sections for Renault 19, 20, and 21.

Legend: Available (green check), Not Available (red X), In Introduction (blue arrow), Exhausting (yellow triangle), Make to order (blue envelope).



Updated on 30th Jan 2014

















kW

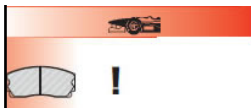

## ...RENAULT

### Scenic II

1.4 1.4i 16V	06/03 →
1.5 1.5DCi 16V	06/03 →
1.6 1.6i 16V	06/03 →
1.9 1.9DCi 16V	06/03 →
2.0 2.0i 16V	06/03 →

COMPOUND AVAILABILITY		H	C	R	W	Z
FCP1491	LUC	✓				✓
FCP1491	LUC	✓				✓
FCP1491	LUC	✓				✓
FCP1491	LUC	✓				✓
FCP1491	LUC	✓				✓

### Spider

2.0 16V	108	01/96 →
2.0 16V	108	01/96 →

FCP406	LUC	✓		✓		
FCP565	LUC	✓		✓	✓	

### Twingo

1.1	40, 44	01/98 →
1.1	40, 44	05/96 → 12/98
1.2	40	03/93 → 05/96
1.2 i		09/00 →
1.2 i 16V		01/01 →
1.6 16V 133Cv		01/10 →
R2		01/10 → 12/10
R2		01/11 →

COMPOUND AVAILABILITY		H	C	R	W	Z
FCP845	LUC	✓	✓	✓	✉	
FCP881	BDX	✉				
FCP881	BDX	✉				
FCP845	LUC	✓	✓	✓	✉	
FCP845	LUC	✓	✓	✓	✉	
FCP1441	LUC	✓				
FCP1441	LUC	✓				
FRP3119						✓
FCP1491	LUC	✓				✓
FCP1491	LUC	✓				✓

### Twingo II

1.2 8v (CN0D/GN0D)	43	03/07 →
1.5 dCi 8v (CN0E/GN0E)	47	03/07 →

FCP845	TRW	✓	✓	✓	✉	
FCP845	TRW	✓	✓	✓	✉	

### Vel Satis

2.0 i 16V		04/02 →
2.2 dCi		04/02 →
3.0 dCi V6		04/02 →
3.5 i V6		04/02 →

FCP1540	LUC	✓				
FCP1540	LUC	✓				
FCP1540	LUC	✓				
FCP1540	LUC	✓				

## RENAULT-ALPINE

### 1300

1.3		03/73 → 06/76
-----	--	---------------

FCP72	BDX	✓		✓		
FCP72	BDX	✓		✓		

### 1600

1.6		03/73 → 06/76
-----	--	---------------

FCP72	BDX	✓		✓		
FCP72	BDX	✓		✓		

### 2500

2.5		02/85 →
-----	--	---------

FCP845	LUC	✓	✓	✓	✉	
FCP393	BDX	✓		✓		

### 2700

2.7		10/76 → 12/80
-----	--	---------------

FCP72	BDX	✓		✓		
FCP72	BDX	✓		✓		

### 2800

2.8		02/85 → 02/90
-----	--	---------------

FCP845	LUC	✓	✓	✓	✉	
FCP393	BDX	✓		✓		

### 3000

3.0		06/91 →
-----	--	---------

FCP406	LUC	✓		✓		
FCP72	BDX	✓		✓		

### A310 (GTA)

1.4		01/71 → 08/83
-----	--	---------------

FCP72	BDX	✓		✓		
FCP72	BDX	✓		✓		

### A610 (GTA)

3.0 (Turbo)		01/91 →
3.0 (Turbo)		01/91 →

FCP406	LUC	✓		✓		
FCP565	LUC	✓		✓	✓	

### Alpine (GTA)

GT/V6 Turbo		09/85 → 12/90
-------------	--	---------------

FCP845	LUC	✓	✓	✓	✉	
FCP393	BDX	✓		✓		



# ROVER

				COMPOUND AVAILABILITY					COMPOUND AVAILABILITY				
				H	C	R	W	Z	H	C	R	W	Z
<b>1500</b>													
1.5 & TC Triumph	45, 55	01/70 → 12/74	FCP810 LUC	✓	☒	✓	☒	☒					
<b>1800</b>													
1.8	56	01/72 → 12/74	FCP9 LUC	✓		✓							
<b>1885</b>													
All i Wolseley S	56	01/69 → 12/72	FCP9 LUC	✓		✓							
<b>214</b>													
1.4	55, 66, 76	10/89 → 12/95	FCP613 LUC, Vented	✓		✓			FCP472	✓			
1.4 16V	55, 76	03/95 → 06/99	FCP613 LUC	✓		✓			FCP472	✓			
<b>216</b>													
1.6 16V	82, 90	03/95 → 06/99	FCP613 LUC	✓		✓			FCP472	✓			
1.6 16V	82, 85, 90, 96	10/89 → 12/95	FCP613 LUC, Vented	✓		✓							
1.6 i Coupe 16V		01/92 → 06/99	FCP613 LUC	✓		✓							
<b>218</b>													
1.8 16V	107	03/95 → 06/99	FCP613 LUC	✓		✓			FCP472	✓			
1.8 D	64, 65	03/91 → 12/95	FCP613 LUC, Vented	✓		✓			FCP472	✓			
1.8 i Coupe 16V		01/92 → 06/99	FCP613 LUC	✓		✓							
1.8 i Vi 16V		01/96 → 06/99	FCP613 LUC	✓		✓							
1.9 D	44, 47	03/91 → 12/95	FCP613 LUC, Vented	✓		✓			FCP472	✓			
<b>220</b>													
2.0 16V	100, 103, 147	06/91 → 09/92	FCP613 LUC	✓		✓			FCP472	✓			
2.0 D	63, 77	11/95 → 06/99	FCP613 LUC	✓		✓							
2.0 D SDi	77	01/96 → 06/99	FCP613 LUC	✓		✓							
<b>2200</b>													
2.2		01/72 → 12/74	FCP9 LUC	✓		✓							
<b>25</b>													
1.1	60	09/99 →	FCP613 LUC	✓		✓			FCP472	✓			
1.4 16V	62, 76	07/99 →	FCP613 LUC	✓		✓			FCP472	✓			
1.6 16V	80	07/99 →	FCP613 LUC	✓		✓			FCP472	✓			
1.8 16V	86, 107	07/99 →	FCP613 LUC	✓		✓			FCP472	✓			
2.0 D	74	07/99 →	FCP613 LUC	✓		✓			FCP472	✓			
<b>414</b>													
1.4 16V	66, 70, 76	03/90 → 12/95	FCP613 LUC, Vented	✓		✓			FCP472	✓			
1.4 16V	66, 76	03/95 → 06/99	FCP613 LUC	✓		✓			FCP472	✓			
<b>416</b>													
1.6 16V	82, 85, 90, 96	03/90 → 12/95	FCP613 LUC, Vented	✓		✓			FCP472	✓			
1.6 16V	82, 83, 90	03/95 → 06/99	FCP613 LUC	✓		✓			FCP472	✓			
<b>418</b>													
1.8 TD	65	03/90 → 12/95	FCP613 LUC, Vented	✓		✓			FCP472	✓			
1.8 TD	65	03/95 → 06/99	FCP613 LUC	✓		✓			FCP472	✓			
1.9 D	47	03/90 → 12/95	FCP613 LUC, Vented	✓		✓			FCP472	✓			
<b>420</b>													
2.0 i, Tourer, Turbo 16V	103, 152	01/91 → 12/96	FCP613 LUC	✓		✓			FCP472	✓			
2.0 i 16V	103	05/95 → 06/99	FCP613 LUC	✓		✓			FCP472	✓			
2.0 i Sli, Gsl, Exec., Sport 16V		01/91 → 12/95	FCP613 LUC	✓		✓			FCP472	✓			
2.0 TD	63	05/95 → 06/99	FCP613 LUC	✓		✓			FCP472	✓			
2.0 TDi	77	05/95 → 06/99	FCP613 LUC	✓		✓			FCP472	✓			
<b>45</b>													
1.4 16V	76	09/99 →	FCP613 LUC	✓		✓			FCP472	✓			
1.6 16V	80	09/99 →	FCP613 LUC	✓		✓			FCP472	✓			
1.8 16V	86	09/99 →	FCP613 LUC	✓		✓			FCP472	✓			
<b>618</b>													
1.8 16V	84	04/93 → 06/99	FCP904 AKE, 14" wheel	✓					FCP956 NIS	✓	✓	☒	
1.8 16V	84	04/93 → 06/99	FCP905 LUC, 15" wheel	✓		✓							
<b>620</b>													
2.0 16V		04/93 → 02/96	FCP904 AKE, 14" wheel	✓					FCP956 NIS	✓	✓	☒	
2.0 16V		04/93 → 02/96	FCP905 LUC, 15" wheel	✓		✓							
2.0 TD	77	04/93 → 06/99	FCP904 AKE, 14" wheel	✓					FCP956 NIS	✓	✓	☒	
2.0 TD	77	04/93 → 06/99	FCP905 LUC, 15" wheel	✓		✓							

✓ Available    ⚠ Exhausting  
 ✗ Not Available    ☒ Make to order  
 ☒ In Introduction



Updated on 30th Jan 2014





KW

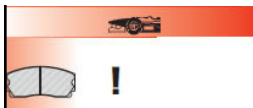

## ...ROVER

### Metro Van

				COMPOUND AVAILABILITY					COMPOUND AVAILABILITY				
				H	C	R	W	Z	H	C	R	W	Z
1.3		01/82 → 05/90	FCP840 LKD		☒	☑							
1.3 i		01/84 → 05/90	FCP840 LKD		☒	☑							

### Mini

1.3	41, 53	01/69 → 12/80	FCP825 LKD, 10" wheel	☑	☑	☑	☑	☑					
1.3 Cooper		01/63 → 12/69	FCP342	☑	☑	☑	☒	☒					
1.3 Cooper S		01/63 → 12/71	FCP825 LKD	☑	☑	☑	☑	☑					

### P5B

3.5 Rover V8		01/68 → 12/69	FCP9 LUC	☑		☑							
--------------	--	---------------	----------	---	--	---	--	--	--	--	--	--	--

### P6

3.5 Rover V8		01/68 → 12/69	FCP9 LUC	☑		☑							
--------------	--	---------------	----------	---	--	---	--	--	--	--	--	--	--

### Princess

All i		01/75 → 12/82	FCP832 LKD	☒		☑							
All i		01/75 → 12/82	FCP832 LKD	☒		☑							

### Six

Wolseley		01/72 → 12/74	FCP9 LUC	☑		☑							
All i Wolseley		01/72 → 12/74	FCP9 LUC	☑		☑							

### Spitfire

1.1		01/62 → 12/80	FCP809 LUC	☑	☑	☑	☒	☑					
-----	--	---------------	------------	---	---	---	---	---	--	--	--	--	--

### Streetwise

1.4 i		08/03 →	FCP613 LUC	☑		☑							
2.0 TD		08/03 →	FCP613 LUC	☑		☑							

### Toledo

All i		01/70 → 12/76	FCP810 LUC	☑	☒	☑	☒	☒					
All i		01/70 → 12/76	FCP810 LUC	☑	☒	☑	☒	☒					

## SAAB

### 9-3

2.0 16V	96, 113, 136, 147	03/98 →	FCP1068 ATE	☑									
2.2 TDi 16V	84	03/98 →	FCP1068 ATE	☑									
2.3 16V		03/98 →	FCP1068 ATE	☑									

### 9-3 (C75)

1.9	96	12/07 → 07/12	FCP1520 ATE	☑									
2.0	143	04/06 → 09/07	FCP1520 ATE	☑									
2.0 Turbo	120,162	01/11 → 07/12	FCP1520 ATE	☑									
2.0 Turbo	185	04/04 → 08/07	FCP1520 ATE	☑									
2.0 Turbo BioPower	120,162	01/11 → 07/12	FCP1520 ATE	☑									
2.0 Turbo BioPower	145,147	06/07 → 07/12	FCP1520 ATE	☑									
2.8 Turbo	169	02/06 → 07/12	FCP1520 ATE	☑									

### 9-3 (C75/C79)

1.9	132	06/07 → 07/12	FCP1520 ATE	☑									
1.9	118	12/07 → 07/12	FCP1520 ATE	☑									
1.9 TiD	110	02/06 → 07/12	FCP1520 ATE	☑									
2.0	110	08/03 → 07/12	FCP1520 ATE	☑									
2.0 BioPower		01/07 → 07/12	FCP1520 ATE	☑									
2.0 BioPower	129	01/07 → 07/12	FCP1520 ATE	☑									
2.0 Turbo	129,154	07/03 → 07/12	FCP1520 ATE	☑									
2.0 Turbo	147	09/07 → 07/12	FCP1520 ATE	☑									
2.0 Turbo BioPower	110	01/07 → 07/12	FCP1520 ATE	☑									
2.8 Turbo	184	06/05 → 07/12	FCP1520 ATE	☑									
2.8 Turbo	188	12/07 → 07/12	FCP1520 ATE	☑									

### 9-3 Sport (D41/D46)

1.9 TDi	110	04/04 → 07/12	FCP1520 ATE	☑									
---------	-----	---------------	-------------	---	--	--	--	--	--	--	--	--	--

### 9-3 Sport (D41/D46/D49)

1.9	132	02/08 → 07/12	FCP1520 ATE	☑									
-----	-----	---------------	-------------	---	--	--	--	--	--	--	--	--	--

☑ Available    ⚠ Exhausting  
 ☒ Not Available    ☒ Make to order  
 ☒ In Introduction

**FERODO**  
RACING

Updated on 30th Jan 2014

1097

SAAB







kW



**...SAAB**

**9-3 X (YS3)**

1.9	132	02/09 → 07/12
2.0 Turbo	120	01/07 → 07/12
2.0 Turbo	162	01/11 → 07/12
2.0 Turbo	154	02/09 → 07/12
2.0 Turbo BioPower	120,162	01/11 → 07/12
2.0 Turbo BioPower	154	02/09 → 07/12

		COMPOUND AVAILABILITY						COMPOUND AVAILABILITY					
		H	C	R	W	Z		H	C	R	W	Z	
FCP1520	ATE	✓											
FCP1520	ATE	✓											
FCP1520	ATE	✓											
FCP1520	ATE	✓											
FCP1520	ATE	✓											
FCP1520	ATE	✓											

**9-5**

2.0 16V	110, 140	01/97 →
2.3 16V	125	01/97 →
3.0 V6 24V	147	01/97 →

FCP1068	ATE	✓											
FCP1068	ATE	✓											
FCP1068	ATE	✓											

**90**

2.0 i L	73	09/84 → 12/87
---------	----	---------------

FCP3	ATE	✓								✓		✓	✉
------	-----	---	--	--	--	--	--	--	--	---	--	---	---

**900**

2.0	74	10/78 → 12/80
2.0	74	10/80 → 08/87
2.0 16V	96, 98, 136	08/96 → 05/98
2.0 16V	98, 136	09/93 → 07/96
2.3 16V	110	08/96 → 05/98
2.3 16V	110	09/93 → 07/96
2.5 24V	125	08/96 → 05/98
2.5 V6 24V	125	09/93 → 07/96

FCP3	ATE	✓								✓		✓	✉
FCP3	ATE	✓								✓		✓	✉
FCP1068	ATE	✓								✓		✓	
FCP685	ATE	✓			✓					✓		✓	
FCP1068	ATE	✓								✓		✓	
FCP685	ATE	✓			✓					✓		✓	
FCP1068	ATE	✓								✓		✓	
FCP685	ATE	✓			✓					✓		✓	

**9000**

2.0 16V	94, 96, 118, 136	01/87 → 12/89
2.0 16V	94, 96, 118	01/89 → 12/97

FCP660	LUC, ABS	✓			✓		✉						
FCP660	LUC, ABS	✓			✓		✉						

**99**

2.0	69	01/69 → 09/74
2.0 i	74, 87, 107	09/82 → 09/84

FCP2	ATE	✓	✉	✓			✉			FCP3	ATE	✓		✓	✉
FCP2	ATE	✓	✉	✓			✉			FCP3	ATE	✓		✓	✉

**SAO**

**Penza**

1.3	50, 55	01/91 → 12/94
-----	--------	---------------

FCP487	SUM	✓					✉								
--------	-----	---	--	--	--	--	---	--	--	--	--	--	--	--	--

**SCION**

**FR-S**

2.0 L	147	03/12 → 00/00
-------	-----	---------------

FCP1639		✓					✉			FCP4187	NBK	✓			✉
---------	--	---	--	--	--	--	---	--	--	---------	-----	---	--	--	---

**SEAT**

**124**

All i		01/68 → 12/83
All i		01/68 → 12/83

FCP29	BDX	✓			✓										
FCP29	BDX	✓			✓										

**127**

0.9 Not C, CL	36	01/71 → 12/82
1.0	39	01/71 → 12/86
1.0 i		01/83 → 12/86

FCP29	BDX	✓			✓										
FCP29	BDX	✓			✓										
FCP29	BDX	✓			✓										

**128**

All i		01/72 → 12/85
All i		01/72 → 12/85

FCP29	BDX	✓			✓										
FCP29	BDX	✓			✓										

**131**

1.4	55	01/75 → 12/85
1.6	72	01/75 → 12/85
1.8 CLX		01/75 → 12/85
2.0	83	01/75 → 12/85
2.4	54	01/75 → 12/85

FCP29	BDX	✓			✓										
FCP29	BDX	✓			✓										
FCP29	BDX	✓			✓										
FCP29	BDX	✓			✓										
FCP29	BDX	✓			✓										

✓ Available    ⚠ Exhausting  
 ✗ Not Available    ✉ Make to order  
 ⚡ In Introduction



Updated on 30th Jan 2014





kW



## ...SEAT

## ...Cordoba (I)

			COMPOUND AVAILABILITY					COMPOUND AVAILABILITY				
			H	C	R	W	Z	H	C	R	W	Z
1.9 TDi , Vario	66, 81	08/96 → 06/99	FCP1312	LUC	✓							
1.9 TDi , Vario	66, 81	08/96 → 06/99	FCP1312	LUC	✓							
2.0 i 16V	85	08/96 → 06/99	FCP775	LUC	✓	✓						
2.0 i GT	85	01/93 → 06/99	FCP1312	LUC	✓							

## Cordoba (II)

1.4 i , Vario 8V, 16V	44, 55	06/99 → 09/02	FCP1288	ATE	⚠							
1.6 i , Vario	55	06/99 → 09/02	FCP1288	ATE	⚠							
1.6 i , Vario	74	06/99 → 09/02	FCP1288	ATE	⚠							
1.6 i , Vario	74	06/99 → 09/02	FCP1312	LUC	✓							
1.9 SDi , Vario	50	06/99 → 09/02	FCP1288	ATE	⚠							
1.9 TDi , Vario	66	06/99 → 09/02	FCP1288	ATE	⚠							
1.9 TDi , Vario	66	06/99 → 09/02	FCP1312	LUC	✓							
1.9 TDi , Vario	81	06/99 → 09/02	FCP1312	LUC	✓							
1.9 TDi , Vario	81	06/99 → 09/02	FCP1312	LUC	✓							

## Cordoba (III)

1.2 i		10/02 →	FCP1094	ATE	✓							
1.2 i		10/02 →	FCP1419		✓	✓						
1.2 i		10/02 →	FCP1419	TRW	✓	✓						
1.4 i 16V		10/02 →	FCP1094	ATE	✓	✓						
1.4 i 16V		10/02 →	FCP1419		✓	✓						
1.4 i 16V		10/02 →	FCP1419	TRW	✓	✓						
1.4 TDi		10/02 →	FCP1419		✓	✓						
1.4 TDi		10/02 →	FCP1419	TRW	✓	✓						
1.4 TDi		10/02 →	FCP1094	ATE	✓	✓						
1.9 SDi	55, 66	10/02 →	FCP1094	ATE	✓	✓						
1.9 SDi	55, 66	10/02 →	FCP1419		✓	✓						
1.9 SDi	55, 66	10/02 →	FCP1419	TRW	✓	✓						
1.9 TDi	55, 66	10/02 →	FCP1094	ATE	✓	✓						
1.9 TDi	55, 66	10/02 →	FCP1419		✓	✓						
1.9 TDi	55, 66	10/02 →	FCP1419	TRW	✓	✓						

## Cordoba I Facelift (6K2)

1.8 T 20V Cupra	115	07/00 → 10/08	FCP1348	BRE	✓		✓	✓				
-----------------	-----	---------------	---------	-----	---	--	---	---	--	--	--	--

## Cordoba Vario

1.4	44	01/96 →	FCP1054	ATE	✓							
1.6		01/96 →	FCP1054	ATE	✓							
1.7 SDi		01/96 →	FCP1054	ATE	✓							
1.9 SDi		01/96 →	FCP1288	ATE	⚠							
1.9 TDi		01/96 →	FCP1312	LUC	✓							

## Fura

0.9	29	01/82 → 12/85	FCP29	BDX	✓		✓					
0.9	29	01/85 → 12/87	FCP351	BDX	✓		✓					
1.4	55	01/82 → 12/85	FCP29	BDX	✓		✓					
1.4	55	01/85 → 12/87	FCP351	BDX	✓		✓					

## Ibiza

0.9	29, 31	08/84 → 04/93	FCP351	BDX	✓		✓					
1.0	33, 37	05/93 →	FCP385	KEL	✓							
1.2	45, 46, 52	08/84 → 04/93	FCP351	BDX	✓		✓					
1.3	40	05/93 →	FCP385	KEL	✓							
1.4	44	06/94 →	FCP385	KEL	✓							
1.5	63, 64, 66, 73	08/84 → 04/93	FCP351	BDX	✓		✓					
1.5 XSi	65, 66, 74	01/87 → 04/93	FCP351	BDX	✓		✓					
1.6	55, 74	05/93 →	FCP419	KEL	✓							
1.8	66	05/93 → 08/99	FCP419	KEL	✓							
1.8 16V	95	05/93 → 08/99	FCP774	LUC	✓		✓					
1.9 D	47, 48	05/93 → 08/99	FCP419	KEL, Solid	✓							
1.9 D	47, 48	05/93 → 08/99	FCP774	LUC, Vented	✓		✓					
1.9 TD	55	05/93 → 08/99	FCP419	KEL, Solid	✓							
1.9 TD	55	05/93 → 08/99	FCP774	LUC, Vented	✓		✓					
1.9 TDi		01/05 →	FCP1094		✓							
1.9 TDi	66	07/96 → 02/02	FCP1054	ATE	✓							
1.9 TDi	81	07/97 → 02/02	FCP1312	LUC	✓							
2.0 i GTi, Cupra 16V	110	05/93 → 12/96	FCP774	LUC	✓							
2.0 i Sport 16V	110	01/97 → 02/02	FCP1054	ATE	✓							

## Ibiza (II)

1.3 i	40	05/93 → 08/99	FCP1054	ATE	✓							
1.3 i	40	05/93 → 08/99	FCP1288	ATE	⚠							
1.4 i	44	09/93 → 08/99	FCP1288	ATE	⚠							
1.4 i	44	09/93 → 08/99	FCP385	KEL	✓							
1.4 i	44	09/93 → 08/99	FCP1054	ATE	✓							
1.4 i	44	09/93 → 08/99	FCP419	KEL	✓							
1.4 i 16V	74	05/93 → 08/99	FCP1288	ATE	⚠							

✓ Available    ⚠ Exhausting  
 ✗ Not Available    📧 Make to order  
 📧 In Introduction



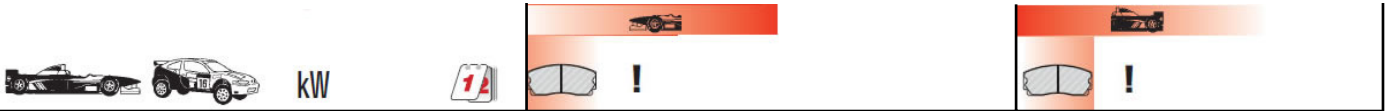

## ...SEAT

### Leon I

						COMPOUND AVAILABILITY					COMPOUND AVAILABILITY				
						H	C	R	W	Z	H	C	R	W	Z
1.4 16V	55	11/99	→	FCP1094	ATE	✓		☒		☒	FCP1491	TRW	✓		
1.6	74, 77	11/99	→	FCP1094	ATE	✓		☒		☒	FCP1491	TRW	✓		
1.6 16V	77	09/00	→	FCP1094	ATE	✓		☒		☒	FCP1491	TRW	✓		
1.8 20V	92	11/99	→	FCP1094	BRM	✓		☒		☒	FCP1491	TRW	✓		
1.8 20V T, 1.8 20V T 4, 1.8 T Cupra R	132, 154	11/99	→	FCP590	ATE	✓			☒		FCP1491	TRW	✓		
1.8 T Cupra R	165	07/03	→	FCP1348	BRE	✓		✓	☒		FCP1491	TRW	✓		
1.8T Cupra R	165	07/03	→	FCP590	ATE	✓		✓	☒		FCP1491	TRW	✓		
1.9 SDi	50	11/99	→	FCP1094	ATE	✓			☒		FCP1491	TRW	✓		
1.9 TDi	96	05/03	→	FCP1094	ATE, PR-1LQ/1LR/1LS	✓		☒		☒	FCP1491	TRW	✓		
1.9 TDi	96	05/03	→	FCP590	ATE, PR-1LE/1LN/1ZE	✓		✓	☒		FCP1491	TRW	✓		
1.9 TDi	74	10/05	→	FCP1094	ATE	✓			☒		FCP1491	TRW	✓		
1.9 TDi	66, 81	11/99	→	FCP1094	ATE	✓			☒		FCP1491	TRW	✓		
1.9 TDi, 1.9 TDi Syncro	110	02/01	→	FCP590	ATE	✓		✓	☒		FCP1491	TRW	✓		
1.9 TDi, 1.9 TDi Syncro	110	02/01	→	FCP1348	BRE	✓		✓	☒		FCP1491	TRW	✓		
2.8 Cupra 4	150	02/01	→	FCP590	ATE, Ch. Y000001 ->	✓		✓	☒		FCP1491	TRW	✓		

### Leon II

1.4 16V	55, 63	09/05	→	FCP1094	ATE	✓		☒		☒	FCP1491	TRW	✓		
1.4 TSi	92	11/07	→	FCP1094	ATE, PR: 1ZF, 1ZM	✓			☒		FCP1491	TRW	✓		
1.4 TSi	92	11/07	→	FCP1641	ATE, PR: 1LJ, 1ZE	✓		☒	✓	☒	FCP1491	TRW	✓		
1.6, 1.6 16V	75, 77	09/05	→	FCP1094	ATE	✓		☒		☒	FCP1491	TRW	✓		
1.8 T 20V	132	09/05	→	FCP1641	ATE	✓			✓	☒	FCP1491	TRW	✓		
1.8 T 20V	165	09/05	→	FCP1348	BRE	✓		✓	✓	☒	FCP1491	TRW	✓		
1.8 TSi	118	06/07	→	FCP1641	ATE	✓		☒	✓	☒	FCP1491	TRW	✓		
1.9 TDi	66, 77	09/05	→	FCP1094	ATE	✓		☒		☒	FCP1491	TRW	✓		
2.0 FSi	110	09/05	→	FCP1641	ATE	✓		☒	✓	☒	FCP1491	TRW	✓		
2.0 TDi	125	02/06	→	FCP1641	ATE	✓			✓	☒	FCP1491	TRW	✓		
2.0 TDi	100, 103	09/05	→	FCP1641	ATE	✓		☒	✓	☒	FCP1491	TRW	✓		
2.0 TFSi	136, 147	09/05	→	FCP1765	ATE	✓			☒	☒	FCP1491	TRW	✓		
2.0 TFSi	177	11/06	→	FCP1765	ATE	✓			☒	☒	FCP1491	TRW	✓		
2.0 TSFI	136, 147	09/05	→	FCP1641	ATE	✓		☒	✓	☒	FCP1491	TRW	✓		

### Malaga

0.8	25	01/87	→ 12/93	FCP351	BDX	✓			✓	✓					
0.9	29, 30	01/87	→	FCP351	BDX	✓			✓	✓					
1.2	45, 46, 52	05/85	→ 04/91	FCP351	BDX	✓			✓	✓					
1.5	64	05/85	→ 04/91	FCP351	BDX	✓			✓	✓					
1.5 i	73	01/87	→ 04/91	FCP351	BDX	✓			✓	✓					
1.7 D	41	01/87	→ 04/91	FCP351	BDX	✓			✓	✓					

### Marbella

0.8	25	11/86	→ 09/89	FCP351	BDX	✓			✓	✓					
0.9	29, 30	11/86	→ 05/89	FCP351	BDX	✓			✓	✓					
1.3	33	11/86	→ 09/91	FCP351	BDX	✓			✓	✓					

### Panda

0.9	31	01/79	→ 12/82	FCP29	BDX	✓			✓						
-----	----	-------	---------	-------	-----	---	--	--	---	--	--	--	--	--	--

### Ritmo

1.2	46	01/78	→ 12/88	FCP29	BDX	✓			✓						
1.4	55	01/78	→ 12/88	FCP29	BDX	✓			✓						

### Ronda

1.2	45, 46	06/82	→ 12/87	FCP351	BDX	✓			✓	✓					
1.4	54	06/82	→ 11/88	FCP351	BDX	✓			✓	✓					
1.5	66	08/83	→ 12/87	FCP351	BDX	✓			✓	✓					
1.6	68	06/82	→ 12/87	FCP351	BDX	✓			✓	✓					
1.7	41	06/82	→ 12/87	FCP351	BDX	✓			✓	✓					

### Terra

0.9	29	01/84	→	FCP351	BDX	✓			✓	✓					
1.3	33	03/90	→ 12/94	FCP351	BDX	✓			✓	✓					
1.4	35	01/84	→	FCP351	BDX	✓			✓	✓					

### Toledo

1.6	55	04/91	→ 10/98	FCP419	KEL	✓									
1.6	74	11/98	→	FCP1289	LUC	✗					FCP541	LUC	✓	✓	☒
1.8	66	04/91	→ 10/98	FCP419	KEL	✓									
1.8	92	11/98	→	FCP1289	LUC	✗					FCP541	LUC	✓	✓	☒
1.8 16V	95, 102	04/91	→ 03/99	FCP774	LUC	✓		✓			FCP541	LUC	✓	✓	☒
1.9	48, 55, 66, 81	01/96	→	FCP1054	ATE	✓									
1.9 D	48, 55, 66, 81	01/91	→	FCP419	KEL	✓									
1.9 TD	55	01/91	→	FCP419	KEL	✓									
1.9 TDi	66, 81	08/95	→ 10/98	FCP775	LUC	✓			✓						
1.9 TDi	66, 81	08/95	→ 10/98	FCP774	LUC	✓			✓						
1.9 TDi	66, 81	11/98	→	FCP1289	LUC	✗					FCP541	LUC	✓	✓	☒
2.0	85	04/91	→ 10/98	FCP774	LUC	✓		✓			FCP541	LUC	✓	✓	☒
2.0 GT 16V	110	01/94	→ 10/98	FCP774	LUC	✓		✓			FCP541	LUC	✓	✓	☒

✓ Available    ⚠ Exhausting  
 ✗ Not Available    ☒ Make to order  
 ⚡ In Introduction

**FERODO**  
RACING

Updated on 30th Jan 2014

1103

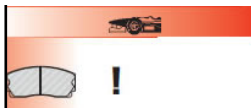

## ...SEAT

### ...Toledo

				COMPOUND AVAILABILITY					COMPOUND AVAILABILITY								
				H	C	R	W	Z	H	C	R	W	Z				
2.3 V5	110	11/98	→	FCP590	ATE	✓		✓	☒		FCP541	LUC	✓		✓	☒	☒

### Toledo (I)

1.6 i	55	04/91	→ 03/99	FCP419	KEL	✓											
1.6 i	55	04/91	→ 03/99	FCP1054	ATE	✓											
1.6 i	55	04/91	→ 03/99	FCP1288	ATE	⚠											
1.8 i	66	04/91	→ 12/96	FCP419	KEL	✓											
1.8 i	66	04/91	→ 12/96	FCP1054	ATE	✓											
1.8 i	66	04/91	→ 12/96	FCP1288	ATE	⚠											
1.8 i 16V	92, 98	05/91	→ 03/99	FCP1312	LUC	✓				☒							
1.9 D, TD, SDi	47, 50, 55	05/91	→ 03/99	FCP1288	ATE	⚠											
1.9 D, TD, SDi	47, 50, 55	05/91	→ 03/99	FCP1054	ATE	✓											
1.9 D, TD, SDi	47, 50, 55	05/91	→ 03/99	FCP419	KEL	✓											
1.9 TDi	66.81	08/95	→ 03/99	FCP1312	LUC	✓				☒							
1.9 TDi	66.81	08/95	→ 03/99	FCP774	LUC	✓		✓									
1.9 TDi	66.81	08/95	→ 03/99	FCP775	LUC	✓		✓									
2.0 i	85	04/91	→ 10/98	FCP774	LUC	✓		✓			FCP541	LUC	✓		✓	☒	☒
2.0 i	85	04/91	→ 10/98	FCP1312	LUC	✓				☒							

### Toledo (II)

1.8 i		04/99	→	FCP590		✓		✓	☒		FCP541	LUC	✓		✓	☒	☒
2.3 i V5		04/99	→	FCP590		✓		✓	☒		FCP541	LUC	✓		✓	☒	☒

### Toledo (III)

1.6 i	75	12/04	→	FCP1094	ATE	✓			☒								
1.9 TDi	77	12/04	→	FCP1094	ATE	✓			☒								
1.9 TDi	77	10/04	→	FCP1641	ATE	✓			☒	✓							
2.0 FSi	110	12/04	→	FCP1641	ATE	✓			☒	✓	✓	FCP1636	TRW	✓			
2.0 TDi	103	12/04	→	FCP1641	ATE	✓			☒	✓	✓	FCP1636	TRW	✓			

## SINGER

### Gazelle

		01/64	→ 12/65	FCP823	LKD				☒								
--	--	-------	---------	--------	-----	--	--	--	---	--	--	--	--	--	--	--	--

### Vogue

		01/61	→ 12/67	FCP823	LKD				☒								
--	--	-------	---------	--------	-----	--	--	--	---	--	--	--	--	--	--	--	--

## SKODA

### 130 (Estelle)

1.3 Rapide Coupe	46	01/85	→ 12/90	FCP461	ATE	✓		✓									
------------------	----	-------	---------	--------	-----	---	--	---	--	--	--	--	--	--	--	--	--

### 135 (Estelle)

1.3		01/85	→ 12/90	FCP461	ATE	✓		✓									
-----	--	-------	---------	--------	-----	---	--	---	--	--	--	--	--	--	--	--	--

### Fabia

1.0	37	07/00	→	FCP1101	ATE	☒		✗									
1.2		07/00	→	FCP1094	ATE	✓			☒								
1.4	50	10/99	→ 07/03	FCP1094	ATE	✓			☒								
1.4 16V	55, 74	10/99	→	FCP1094	ATE	✓			☒		FCP541	LUC	✓		✓	☒	☒
1.4 TDi PD 16V	55	08/03	→	FCP1094	ATE	✓			☒								
1.9 SDi		01/00	→	FCP1094	ATE	✓			☒								
1.9 TDi		01/00	→	FCP1094	ATE	✓			☒		FCP541	LUC	✓		✓	☒	☒
1.9 TDi RS	96	07/03	→	FCP1419	TRW	✓		✓									
2.0 i	88	08/03	→	FCP1419		✓		✓			FCP1491		✓		✓		
2.0 i	88	08/03	→	FCP1419	TRW	✓		✓			FCP1491	LUC	✓		✓		
2.0 Saloon & SW Estate		08/00	→	FCP1419		✓		✓			FCP541	LUC	✓		✓	☒	☒

### Octavia

1.4 EU4		08/00	→ 05/04	FCP1094	ATE	✓			☒								
1.4 i	44	04/99	→ 05/04	FCP1094	ATE	✓			☒								
1.4 i 16V	55	12/99	→ 07/00	FCP1094	ATE	✓			☒								
1.4 TSi 16v (1Z3,1Z5)	90	11/08	→ 00/00	FCP1094	ATE, PR 1ZM, 1ZF	✓			☒		FCP4316	BOSCH	✓				
1.6 8v (1Z3,1Z5)	75	05/04	→ 00/00	FCP1094	ATE, PR 1ZM, 1ZF	✓			☒		FCP4316	BOSCH	✓				
1.6 EU4		08/00	→ 05/04	FCP1094	ATE	✓			☒								
1.6 FSi 8v (1Z5)	75	09/04	→ 00/00	FCP1094	ATE, PR 1ZM, 1ZF	✓			☒		FCP4316	BOSCH	✓				
1.6 i	74	02/97	→ 05/04	FCP1094	ATE	✓			☒								
1.6 i	55	09/96	→ 07/00	FCP1094	ATE	✓			☒								
1.6 Multifuel 8v (1Z3,1Z5)	75	11/07	→ 05/10	FCP1094	ATE, PR 1ZM, 1ZF	✓			☒		FCP4316	BOSCH	✓				
1.6 TDi 16v (1Z5)	77	06/09	→ 00/00	FCP1094	ATE, PR 1ZM, 1ZF	✓			☒		FCP4316	BOSCH	✓				
1.8 20V		10/96	→ 04/99	FCP1094	ATE	✓			☒		FCP541	LUC	✓		✓	☒	☒
1.8 FSi/TSi 16v (1Z3,1Z5)	118	06/07	→ 00/00	FCP1641	ATE, PR 1ZE	✓			☒	✓	FCP4316	BOSCH	✓		✓		
1.8 TFSi 16v (1Z3,1Z5)	112	03/09	→ 00/00	FCP1641	ATE, PR 1ZE	✓			☒	✓	FCP4316	BOSCH	✓		✓		

SEAT





kW



**...SMART (until 2002 MCC)**

**City Coupe (450)**

City Coupe 0.6	52	06/02 → 01/04
City Coupe 0.6	40	07/98 → 01/04
City Coupe 0.6	33	07/98 → 01/04
City Coupe 0.6	45	10/00 → 10/03
City Coupe 0.7	45	01/03 → 01/04
City Coupe 0.7	37	01/03 → 01/04
City Coupe 0.7	55	05/03 → 01/04
City Coupe 0.7	33	07/98 → 01/04
City Coupe 0.7	40	08/98 → 01/03
City Coupe 0.8 CDI	30	12/99 → 01/04

Model	Part	COMPOUND AVAILABILITY				
		H	C	R	W	Z
FCP1162	Bosch	✓				
FCP1162	Bosch	✓				
FCP1162	Bosch	✓				
FCP1162	Bosch	✓				
FCP1162	Bosch	✓				
FCP1162	Bosch	✓				
FCP1162	Bosch	✓				
FCP1162	Bosch	✓				
FCP1162	Bosch	✓				
FCP1162	Bosch	✓				

Model	Part	COMPOUND AVAILABILITY				
		H	C	R	W	Z

**Crossblade (450)**

Crossblade 0.6	52	09/02 → 12/03
----------------	----	---------------

FCP1162	Bosch	✓				
---------	-------	---	--	--	--	--

--	--	--	--	--	--	--

**Fortwo (450)**

Fortwo Cabrio 0.6	55	08/03 → 12/06
Fortwo Cabrio 0.7	45	08/03 → 12/06
Fortwo Cabrio 0.7	55	08/03 → 12/06
Fortwo Cabrio 0.8 CDI	30	08/03 → 12/06
Fortwo Coupe 0.6	45	01/04 → 02/07
Fortwo Coupe 0.6	37	01/04 → 02/07
Fortwo Coupe 0.6	55	01/04 → 02/07
Fortwo Coupe 0.7	55	01/04 → 02/07
Fortwo Coupe 0.7	37	01/04 → 02/07
Fortwo Coupe 0.7	45	01/04 → 02/07
Fortwo Coupe 0.8 CDI	30	01/04 → 02/07

FCP1162	Bosch	✓				
FCP1162	Bosch	✓				
FCP1162	Bosch	✓				
FCP1162	Bosch	✓				
FCP1162	Bosch	✓				
FCP1162	Bosch	✓				
FCP1162	Bosch	✓				
FCP1162	Bosch	✓				
FCP1162	Bosch	✓				
FCP1162	Bosch	✓				
FCP1162	Bosch	✓				

**Fortwo (451)**

Fortwo Cabrio 0.0 Elektrik	35	09/11 → 00/00
Fortwo Cabrio 0.0 Elektrik	20	12/10 → 00/00
Fortwo Cabrio 0.8 CDI	33	01/07 → 00/00
Fortwo Cabrio 0.8 CDI	40	08/09 → 00/00
Fortwo Cabrio 1.0	52	01/07 → 00/00
Fortwo Cabrio 1.0	62	01/07 → 00/00
Fortwo Cabrio 1.0	72	01/07 → 00/00
Fortwo Cabrio 1.0	75	07/10 → 00/00
Fortwo Cabrio 1.0 Hybrid	52	01/07 → 00/00
Fortwo Coupe 0.0 Elektrik	35	09/11 → 00/00
Fortwo Coupe 0.0 Elektrik	20	12/10 → 00/00
Fortwo Coupe 0.8 CDI	33	01/07 → 00/00
Fortwo Coupe 0.8 CDI	40	08/09 → 00/00
Fortwo Coupe 1.0	45	01/07 → 00/00
Fortwo Coupe 1.0	52	01/07 → 00/00
Fortwo Coupe 1.0	62	01/07 → 00/00
Fortwo Coupe 1.0	72	01/07 → 00/00
Fortwo Coupe 1.0	75	07/10 → 00/00
Fortwo Coupe 1.0 Hybrid	45	01/07 → 00/00
Fortwo Coupe 1.0 Hybrid	52	01/07 → 00/00

FCP1162	Bosch	✓				
FCP1162	Bosch	✓				
FCP1162	Bosch	✓				
FCP1162	Bosch	✓				
FCP1162	Bosch	✓				
FCP1162	Bosch	✓				
FCP1162	Bosch	✓				
FCP1162	Bosch	✓				
FCP1162	Bosch	✓				
FCP1162	Bosch	✓				
FCP1162	Bosch	✓				
FCP1162	Bosch	✓				
FCP1162	Bosch	✓				
FCP1162	Bosch	✓				
FCP1162	Bosch	✓				
FCP1162	Bosch	✓				
FCP1162	Bosch	✓				
FCP1162	Bosch	✓				

**Roadster (452)**

Roadster 0.7	60	01/04 → 08/04
Roadster 0.7	74	03/04 → 04/06
Roadster 0.7	45	07/03 → 04/06
Roadster Coupe 0.7	60	01/03 → 04/06
Roadster Coupe 0.7	74	03/04 → 04/06
Roadster Coupe 0.7	45	07/03 → 04/06

FCP1162	Bosch	✓				
FCP1162	Bosch	✓				
FCP1162	Bosch	✓				
FCP1162	Bosch	✓				
FCP1162	Bosch	✓				
FCP1162	Bosch	✓				

**SSANGYONG**

**Korando**

2.3 16V	103	10/97 →
---------	-----	---------

FCP600		✓		✗		
--------	--	---	--	---	--	--

--	--	--	--	--	--	--

SMART (until 2002 MCC)



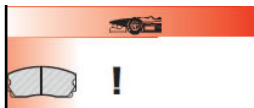

# SUBARU

					COMPOUND AVAILABILITY							COMPOUND AVAILABILITY				
					H	C	R	W	Z			H	C	R	W	Z
<b>Baja (US)</b>																
02.05.00		01/01 →	FCP1639		✓											
2.5 Turbo		01/01 →	FCP1639		✓											
<b>BRZ</b>																
2.0 L	147	03/12 → 00/00	FCP1639		✓					FCP4187	NBK	✓				
<b>Forester (US)</b>																
02.05.00		01/01 →	FCP1639		✓											
2.5 Turbo		01/01 →	FCP1639		✓											
<b>Forester I (SF)</b>																
2.0 S Turbo	130	04/01 → 09/30	FCP1639		✓											
<b>Forester II (SG)</b>																
02.05.00	155	12/01 →	FCP1639		✓					FCP1333		✓		✓		
2.0 X	158	09/01 →	FCP1639		✓					FCP1333		✓		✓		
2.0, 2.0 S Turbo	125,18	09/01 →	FCP1639		✓					FCP1333		✓		✓		
2.5 XT	169	09/01 →	FCP1639		✓					FCP1333		✓		✓		
<b>Forester III (SH)</b>																
2.0	110	01/08 →	FCP1639	TOK	✓											
<b>Impreza</b>																
02.00.00		01/01 → 12/31	FCP1639		✓											
1.5 R		01/01 →	FCP1639		✓											
1.6 16V		09/98 →	FCP1327		✓					FCP1333		✓		✓		
1.6 GF3, GC3 16V		05/93 → 08/98	FCP789		✓					FCP790	ABS	✓		✓		
1.8 GF6 16V		05/93 → 08/98	FCP789		✓					FCP790	ABS	✓		✓		
2.0 16V		01/94 → 08/98	FCP789		✓					FCP790	ABS	✓		✓		
2.0 16V		01/97 → 12/98	FCP1327		✓					FCP1333		✓		✓		
2.0 D (4WD)	110	01/09 →	FCP1639	TRW	✓											
2.0 GC8 (Turbo) 16V		01/94 → 08/98	FCP948		✓					FCP790		✓		✓		
2.0 i 4x4 16V		09/98 →	FCP1327		✓					FCP790		✓		✓		
2.0 P1		01/99 → 12/01	FCP986		✓					FCP1372		✓		✓		
2.0 R		01/01 →	FCP1639		✓											
2.0 Sport		01/01 →	FCP1639		✓											
2.0 STi (Brembo KIT 6 pistons)		01/08 →	FRP3100	BRM	✓					FCP1562	BRM	✓		✓		
2.0 STi version 7, WRX		01/02 → 12/07	FRP3067	BRM	✓					FCP1562	BRM	✓		✓		
2.5 Turbo WRX		01/01 →	FCP1639		✓											
VO Gr N		→	FRP216	AP RACING	✓					FRP219	AP RACING	✓		✓		
<b>Impreza (US)</b>																
02.05.00		01/01 →	FCP1639		✓											
2.0 Turbo WRX		01/01 → 12/31	FCP1639		✓											
2.5 RS/TS		01/01 → 12/31	FCP1639		✓											
2.5 WRX Turbo		01/01 → 12/31	FCP1639		✓											
2.5 WRX Turbo		01/01 →	FCP1639		✓											
<b>Impreza Outback (US)</b>																
02.02.00		01/01 → 12/31	FCP1639		✓											
02.02.00		01/01 → 00/00	FCP1639		✓											
<b>Justy (III)</b>																
1.3 1.3i G3X 16V		09/03 →	FCP1459													
1.5 1.3i G3X 16V		09/03 →	FCP1459													
<b>Legacy</b>																
02.00.00		01/01 →	FCP1639		✓											
02.05.00		01/01 →	FCP1639		✓											
1.8 4WD (Turbo)	76	07/90 → 12/93	FCP948		✓					FCP790		✓		✓		
1.8 BC3, BF3 16V	76	10/89 → 09/92	FCP789		✓					FCP790		✓		✓		
2.0 (Turbo) 16V	147	10/91 → 12/93	FCP948		✓					FCP790		✓		✓		
2.0 2.0 i BE/BH		08/00 →	FCP1327		✓					FCP1333		✓		✓		
2.0 BC5, BF5 16V		10/91 → 12/93	FCP789		✓					FCP790		✓		✓		
2.0 BG5, BD5 16V		01/94 → 08/97	FCP789		✓					FCP790		✓		✓		
2.0 TD		01/01 →	FCP1639		✓											
2.2 BF7, 8 16V	100	10/89 → 12/93	FCP789		✓					FCP790		✓		✓		
2.2 BG7, BD7 16V		01/94 → 08/97	FCP789		✓					FCP790		✓		✓		
2.5 16V		01/02 →	FCP1327		✓					FCP1333		✓		✓		
2.5 16V		01/96 → 08/97	FCP789		✓					FCP790		✓		✓		

SUBARU

✓ Available    ⚠ Exhausting  
 ✗ Not Available    📧 Make to order  
 🚚 In Introduction



Updated on 30th Jan 2014



kW

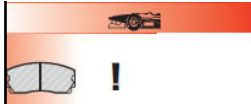

SUBARU

## ...SUBARU

### Legacy (US)

02.05.00		01/01 →	FCP1639		✓														
2.5 GT		01/01 → 12/31	FCP1639		✓														

### Legacy SW/Estate V

2.5 Turbo 16v (B14BR)	195	05/09 → 00/00																	
-----------------------	-----	---------------	--	--	--	--	--	--	--	--	--	--	--	--	--	--	--	--	--

### Legacy V

2.0D	110	09/09 →	FCP1639	TOK	✓														
2.5 Turbo 16v (B14BM)	195	05/09 → 00/00																	
3.6 AWD	191	09/10 → 00/00																	

### Outback

02.05.00		01/01 →	FCP1639		✓														
03.00.00		01/01 →	FCP1639		✓														
2.0 TD		01/01 →	FCP1639		✓														

### Outback (US)

02.05.00		01/01 → 12/31	FCP1639		✓														
02.05.00		01/01 →	FCP1639		✓														
03.00.00		01/01 →	FCP1639		✓														
2.5 Turbo		01/01 →	FCP1639		✓														

### SVX

3.3 i Coupe	169	01/92 → 12/97																	
-------------	-----	---------------	--	--	--	--	--	--	--	--	--	--	--	--	--	--	--	--	--

### Tribeca (B9)

3.0 24v (W10WX)	184	03/05 → 09/06																	
3.0 24v (W10WX)	180	10/06 → 09/07																	
3.6 24v (W10WX)	190	08/07 → 00/00																	

## SUNBEAM

### Rapier

		01/59 → 12/67	FCP823	LKD															
--	--	---------------	--------	-----	--	--	--	--	--	--	--	--	--	--	--	--	--	--	--

### Venezia

		01/64 → 12/65	FCP823	LKD															
--	--	---------------	--------	-----	--	--	--	--	--	--	--	--	--	--	--	--	--	--	--

## SUZUKI

### Swift

1.0 1.0i		01/98 →	FCP1459																
1.3 1.3i		01/98 →	FCP1459																
Swift Cup (NZ-Australia)- Tokico Caliper		01/10 →	FRP3118	TOK															

### Swift III

1.3	68	05/05 →	FCP1617	TRW															
1.5	75	05/05 →	FCP1617	TRW															
1.6	92	05/06 →	FCP1617	TRW															
1.6 Tokico Caliper	92	05/06 →	FRP3118	TOK															

### SWIFT IV

1.2	66	10/10 → 00/00	FCP4426	TRW, LUC	✓														
1.2	69	10/10 → 00/00	FCP4426	TRW, LUC	✓														
1.2 4x4	66	10/10 → 00/00	FCP4426	TRW, LUC	✓														
1.2 4x4	69	10/10 → 00/00	FCP4426	TRW, LUC	✓														
1.3 DDiS	55	10/10 → 00/00	FCP4426	TRW, LUC	✓														
1.6	100	01/12 → 00/00	FCP4426	TRW, LUC	✓														

### COMPOUND AVAILABILITY

H C R W Z

### COMPOUND AVAILABILITY

H C R W Z



KW



## TALBOT

### 1000

1.0 1000, Rallye I	01/69 → 12/81	FCP3	ATE	✓		✓	☒							
1.0 Rallye II, III	09/72 → 12/81	FCP2	ATE	✓	☒	✓		☒						

### 1100

1.1 Not Ti	10/70 → 12/84	FCP3	ATE	✓		✓	☒							
------------	---------------	------	-----	---	--	---	---	--	--	--	--	--	--	--

### Avenger

1.2	01/70 → 12/73	FCP809	LUC	✓	☒	✓	☒	☒	☒					
1.3	09/79 → 04/81	FCP810	LUC	✓	☒	✓	☒	☒	☒					
1.3 GT, SW Estate	01/70 → 12/76	FCP810	LUC	✓	☒	✓	☒	☒	☒					
1.5	01/70 → 12/73	FCP809	LUC	✓	☒	✓	☒	☒	☒					
1.6	09/79 → 04/81	FCP810	LUC	✓	☒	✓	☒	☒	☒					

### Samba

33, 37, 44, 53, 58, 65	02/82 → 12/87	FCP72	BDX	✓		✓								
------------------------	---------------	-------	-----	---	--	---	--	--	--	--	--	--	--	--

### Simca 1301

1.3	43, 48	01/66 → 12/76	FCP2	ATE	✓	☒	✓		☒					
-----	--------	---------------	------	-----	---	---	---	--	---	--	--	--	--	--

### Simca 1501

1.5	54	01/66 → 12/76	FCP2	ATE	✓	☒	✓		☒					
-----	----	---------------	------	-----	---	---	---	--	---	--	--	--	--	--

### Sunbeam

0.9	33	09/77 → 05/81	FCP810	LUC	✓	☒	✓	☒	☒					
1.3	42, 50	09/77 → 05/81	FCP810	LUC	✓	☒	✓	☒	☒					
1.6	59	09/77 → 05/81	FCP810	LUC	✓	☒	✓	☒	☒					
2.2	110, 114	10/79 → 03/82	FCP810	LUC	✓	☒	✓	☒	☒					

## TATRA

### T613

All	01/78 → 12/95												FCP461	ATE	✓		✓		
-----	---------------	--	--	--	--	--	--	--	--	--	--	--	--------	-----	---	--	---	--	--

### T700

All i	01/95 →													FCP461	ATE	✓		✓	
-------	---------	--	--	--	--	--	--	--	--	--	--	--	--	--------	-----	---	--	---	--

## TOYOTA

### Alphard

Alphard 240		→ 12/07	FRP3120			✓													
Alphard 240		01/08 →	FRP3121			✓			☒										
Alphard 350		→ 12/07	FRP3120			✓													
Alphard 350		01/08 →	FRP3121			✓			☒										

### Avalon

01/98 → 12/01	FCP1437		⚠																
---------------	---------	--	---	--	--	--	--	--	--	--	--	--	--	--	--	--	--	--	--

### Aygo

1.0	50	07/05 →	FCP1790	BOSCH		✓													
1.0 VVTi	50	07/05 →	FCP1790	BOSCH		✓													
1.4 D4d	40	07/05 →	FCP1790	BOSCH		✓													

### Camry

Solara 6 cyl		01/92 → 12/01	FCP1437			⚠													
1.8		01/82 → 12/86	FCP308	AKE	✓		✓												
1.8	66	11/86 → 12/89	FCP308	AKE	✓		✓												
2.0	62, 63, 89, 94	01/87 → 09/91	FCP602	AKE	✓		☒												
2.0	66	03/83 → 10/86	FCP308	AKE	✓		✓												
2.0	73, 79	04/84 → 01/87	FCP308	AKE	✓		✓												
2.0		10/91 → 12/92	FCP867		✓														
2.0 TD	62	02/88 → 05/91	FCP602	AKE	✓		☒												
2.0 TD	62	04/84 → 10/86	FCP602	AKE	✓		☒												
2.0 TD	62	11/86 → 01/88	FCP602	AKE	✓		☒												
2.0 TD Executive	62	01/84 → 12/87	FCP308	AKE	✓		✓												
2.2 (SXV10) 16V	100	10/91 → 09/96	FCP867		✓														
2.2 (SXV20) 16V	96	10/96 →	FCP867		✓														
2.5 (VZV21) 24V	118	02/88 → 08/88	FCP602	AKE	✓		☒												
2.5 24V	118	03/89 → 09/91	FCP602	AKE	✓		☒												
2.5 24V	118	10/91 → 12/92	FCP867		✓														

✓ Available    ⚠ Exhausting  
 ✗ Not Available    ☒ Make to order  
 ☒ In Introduction



Updated on 30th Jan 2014



kw

**...TOYOTA****Carina**

			COMPOUND AVAILABILITY					COMPOUND AVAILABILITY				
			H	C	R	W	Z	H	C	R	W	Z
1.6 AT151	52, 63	10/83 → 12/88	FCP308	AKE	✓		✓					
2.0 D (CT150)		10/83 → 12/88	FCP308	AKE	✓		✓					

**Carina E**

1.6 (AT190) 16V	73, 85	05/92 → 09/97	FCP867		✓							
1.8 (AT191) 16V	79	01/95 → 12/98	FCP867		✓							
2.0 D (CT190)	54, 62	01/92 → 12/98	FCP867		✓							
2.0 Not GTi 16V	94	05/92 → 09/97	FCP867		✓							

**Carina II**

1.6	66, 70, 77	03/88 → 05/92	FCP602	AKE	✓							
1.6	66, 70, 77	04/84 → 02/88	FCP308	AKE	✓							
1.8 (ST150)	74	04/84 → 03/88	FCP308	AKE	✓							
2.0	88, 94	03/89 → 05/92	FCP602	AKE	✓							
2.0	88, 94	04/84 → 02/89	FCP308	AKE	✓							
2.0 D (CT170)	54	01/88 → 12/92	FCP308	AKE	✓							

**Celica**

1.6 AT160 16V	63, 91	01/85 → 12/89	FCP308	AKE	✓		✓					
1.6 i	55, 63, 79	01/77 → 12/82	FCP170	SUM			✓					
1.6 Sti 16V	77, 85	01/90 → 12/94	FCP308	AKE	✓			✓				
1.6 Sti 16V	77	01/94 → 10/99	FCP867		✓							
1.8 16V	85	11/95 → 10/99	FCP867		✓							
1.8 VVTi 16V	105	11/99 →	FCP1528									
2.0	77, 88	11/85 → 01/90	FCP308	AKE	✓			✓				
2.0 16V	115	01/90 → 03/94	FCP602	AKE	✓							
2.0 16V	118, 136	01/90 → 03/94	FCP602	AKE	✓							
2.0 16V	150	01/90 → 03/94	FCP602	AKE	✓							
2.0 16V	129	03/94 → 10/99	FCP867	AKE	✓							
2.0 GT 16V	115	01/90 → 03/94	FCP602	AKE	✓							
2.0 i	65, 77, 86	01/77 → 12/82	FCP170	SUM			✓					

**Corolla**

1.3		01/83 → 08/87	FCP308	AKE	✓			✓				
1.3 (AE80/EE80)	48, 55	05/83 → 12/88	FCP308	AKE	✓			✓				
1.3 (EE101) 16V		08/92 → 04/97	FCP867		✓							
1.3 (EE90)	52, 55	08/87 → 08/92	FCP308	AKE	✓			✓				
1.3 i EE101 16V		08/95 → 04/97	FCP867		✓							
1.3 i EE101 16V		08/95 → 04/97	FCP867		✓							
1.4 VVTi (E12U)	71	01/02 →	FCP1573		✓							
1.6 (AE101) 16V		08/92 → 04/97	FCP867		✓							
1.6 (AE82)	54, 63	05/83 → 12/88	FCP308	AKE	✓			✓				
1.6 (AE92) 16V		01/87 → 12/92	FCP308	AKE	✓			✓				
1.6 (AE92) GTi 16V		01/87 → 12/92	FCP308	AKE	✓			✓				
1.6 (AE95) 4WD 16V	77	03/88 → 04/91	FCP308	AKE	✓			✓				
1.6 (AE95) Not 4WD	77	08/87 → 08/92	FCP308	AKE	✓			✓				
1.6 GT (AE82) 16V	91	05/87 → 12/88	FCP308	AKE	✓			✓				
1.6 GT (AE82) 16V	85, 91	10/84 → 08/87	FCP308	AKE	✓			✓				
1.6 Not GT		01/83 → 05/87	FCP308	AKE	✓			✓				
1.6 VVTi (E12U)	81	01/02 →	FCP1573		✓							
1.8 (AE102) 16V		08/92 → 07/95	FCP867		✓							
1.8 D (CE70)		01/83 → 05/87	FCP308	AKE	✓			✓				
1.8 D (CE80)		01/83 → 05/87	FCP308	AKE	✓			✓				
1.8 D (CE90)		06/87 → 08/92	FCP308	AKE	✓			✓				
1.8 D SW Estate		01/90 →	FCP308	AKE	✓			✓				
1.8 VVTi (E12U)	141	01/02 →	FCP1573		✓							
2.0 D (CE100)	54	11/92 → 07/95	FCP867		✓							
2.0 D D4D	66, 81	01/02 →	FCP1573		✓							

**Corolla Verso**

1.4 i VVTi 16V	71	01/02 → 03/04	FCP1528		✓			✓				
1.6 16V		01/02 →	FCP1528		✓			✓				
1.6 i VVTi 16V		04/04 →	FCP1528		✓			✓				
1.8 16V		01/02 →	FCP1528		✓			✓				
2.0 D D4D		01/02 →	FCP1528		✓			✓				

**Corona**

1.6		01/83 → 12/85	FCP308	AKE	✓			✓				
1.8	85	10/83 → 12/85	FCP308	AKE	✓			✓				
2.0		10/83 → 12/85	FCP308	AKE	✓			✓				
2.0 2000		01/83 →	FCP308	AKE	✓			✓				



...TOYOTA				COMPOUND AVAILABILITY					COMPOUND AVAILABILITY						
				H	C	R	W	Z	H	C	R	W	Z		
<b>Cressida</b>															
2.0 i GX71 24V	110	01/84 → 12/88	FCP170 SUM		✓										
2.4 TD LX70/71	66	08/84 → 12/88	FCP170 SUM		✓										
<b>FT-86</b>															
2.0 L	147	03/12 → 00/00	FCP1639	✓						FCP4187	✓				
<b>GT-86</b>															
2.0 L	147	03/12 → 00/00	FCP1639	✓						FCP4187 NBK	✓				
<b>MR2 I (W1)</b>															
1.6 16V (AW11)	85.96	11/84 → 06/90	FCP308 AKE	✓		✓									
<b>MR2 III (W3)</b>															
1.8 VT-i 16V	103	05/00 →	FCP1392	✓											
<b>Paseo</b>															
1.5 16V	66	11/95 → 03/99	FCP308 AKE	✓		✓									
<b>Picnic</b>															
2.0 16V	94	08/96 →	FCP867	✓											
2.2 TD	66	08/96 →	FCP867	✓											
<b>Prius</b>															
1.5 Hybrid		05/00 →	FCP1392	✓											
<b>RAV-4</b>															
2.0 i 16V	90	06/94 → 07/00	FCP867	✓											
<b>RAV4</b>															
2.0 i 16V	90	06/94 → 07/00	FCP867	✓											
<b>Tercel</b>															
1.3 (AL20)	51	01/82 → 12/84	FCP308 AKE	✓		✓									
1.5	55	01/82 → 04/88	FCP308 AKE	✓		✓									
1.5 4WD	55	01/82 → 12/88	FCP308 AKE	✓		✓									
<b>Yaris</b>															
1.0 16V	50	04/99 →	FCP1368	✓		✗									
1.3 16V	63	04/99 →	FCP1368	✓		✗									
1.4 D D-4D 16V		02/02 →	FCP1392	✓											
1.5 T-Sport 16V		01/01 →	FCP1392	✓											
<b>Yaris Verso</b>															
1.3 16V	63	09/99 →	FCP1392	✓											
1.4 D D-4D 16V		02/02 →	FCP1392	✓											
<b>TVR</b>															
<b>Cerbera</b>															
3.9 16V	176	06/96 →	FCP206 ATE	✓		✓				FCP408 LUC	✓		✓		
<b>Chimaera</b>															
5.0 16V	240	06/96 →	FCP206 ATE	✓		✓				FCP408 LUC	✓		✓		
<b>Griffith</b>															
4.3 16V	198	10/93 → 10/94	FCP206 ATE	✓		✓				FCP408 LUC	✓		✓		
5.0 16V	240	10/93 →	FCP206 ATE	✓		✓				FCP408 LUC	✓		✓		

VAUXHALL

✓ Available    ⚠ Exhausting  
 ✗ Not Available    📧 Make to order  
 🚧 In Introduction



Updated on 30th Jan 2014

1111



KW



**VAUXHALL**

**Astra**

				COMPOUND AVAILABILITY					COMPOUND AVAILABILITY				
				H	C	R	W	Z	H	C	R	W	Z
1.2	44	09/81 → 08/91	FCP173 GM	✓		✓							
1.2 i 16V	44	02/98 → 03/04	FCP1293	✓					FCP1294	✉			
1.3	51, 55	09/81 → 08/91	FCP173 GM	✓		✓							
1.3	51, 55	10/84 → 08/91	FCP173 GM	✓		✓							
1.3	51, 55	10/84 → 08/91	FCP173 GM	✓		✓							
1.4	44, 55	10/89 → 08/91	FCP173 GM	✓		✓							
1.4 16V	66	03/98 → 03/04	FCP1293	✓					FCP1294	✉			
1.4 Saloon/SW Estate	44, 60	09/91 → 02/98	FCP732 ATE	✓		✓							
1.4 Saloon/SW Estate	44, 60	09/91 → 02/98	FCP584 ATE, ABS	✓		✓							
1.6	52, 55, 74	02/92 → 02/98	FCP732 ATE	✓		✓							
1.6	52, 55, 74	02/92 → 02/98	FCP584 ATE, ABS	✓		✓							
1.6	52, 55, 74	03/98 → 03/04	FCP1293	✓					FCP1294	✉			
1.6	66	10/84 → 08/91	FCP173 GM	✓		✓							
1.6	66	10/84 → 08/91	FCP173 GM	✓		✓							
1.6	66	10/84 → 08/91	FCP173 GM	✓		✓							
1.6	66	12/81 → 08/91	FCP173 GM	✓		✓							
1.7 D	42	01/89 → 08/91	FCP173 GM	✓		✓							
1.7 TD	50	03/98 → 03/04	FCP1293	✓					FCP1294	✉			
1.7 TD		09/91 → 02/98	FCP732 ATE	✓		✓							
1.7 TD		09/91 → 02/98	FCP584 ATE, ABS	✓		✓							
1.8	85	01/80 → 10/84	FCP173 GM	✓		✓							
1.8		01/92 → 12/98	FCP173 GM	✓		✓							
1.8	81, 85	10/84 → 09/91	FCP173 GM	✓		✓							
1.8 16V	85	03/98 → 03/04	FCP1295 ABS	✓					FCP1294	✉			
1.8 Cabrio 16V	85	01/97 → 02/98	FCP584 ATE	✓		✓			FCP586 ATE	✓		✓	
2.0 16V		03/98 → 03/04	FCP1295 ABS	✓					FCP1294	✉			
2.0 GTE	90	03/87 → 08/91	FCP173 GM	✓		✓							
2.0 GTE 16V	110	05/88 → 08/91	FCP584 ATE	✓		✓			FCP586 ATE	✓		✓	
2.0 i GSi 16V	110	09/91 → 02/98	FCP584 ATE	✓		✓							
2.0 i SRi	85	09/91 → 02/98	FCP584 ATE	✓		✓							
2.0 TDi 16V		03/98 → 03/04	FCP1295 ABS	✓					FCP1294	✉			

**Astra (F48)**

2.0 DTi	74	09/00 → 03/05	FCP1520 ATE	✓									
---------	----	---------------	-------------	---	--	--	--	--	--	--	--	--	--

**Astra (L48)**

2.0 VXR	177	11/05 → 05/09	FCP1520 ATE	✓									
---------	-----	---------------	-------------	---	--	--	--	--	--	--	--	--	--

**Astra GTC (L08)**

2.0 VXR	176	02/09 → 09/11	FCP1520 ATE	✓									
---------	-----	---------------	-------------	---	--	--	--	--	--	--	--	--	--

**Astra Van**

1.3	51, 55	07/82 → 09/84	FCP173 GM	✓		✓							
1.3	34, 44, 55	10/84 → 10/89	FCP173 GM	✓		✓							
1.4	44	09/89 → 10/91	FCP173 GM	✓		✓							
1.4	44	11/91 → 03/04	FCP732 ATE	✓		✓							
1.4 i	44	06/90 → 10/91	FCP173 GM	✓		✓							
1.6	66	10/84 → 10/91	FCP173 GM	✓		✓							
1.6	66	10/84 → 10/91	FCP173 GM	✓		✓							
1.6	52, 55	11/91 → 08/95	FCP732 ATE	✓		✓							
1.7 D	42	01/89 → 10/91	FCP173 GM	✓		✓							
1.7 D	42, 44, 50, 60	11/91 → 03/04	FCP732 ATE	✓		✓							

**Astramax**

1.4	44, 55	09/85 → 10/91	FCP173 GM	✓		✓							
1.4	44	11/91 → 03/04	FCP732 ATE	✓		✓							
1.6		11/91 → 03/04	FCP732 ATE	✓		✓							
1.6 D	40, 42	09/85 → 10/91	FCP173 GM	✓		✓							
1.7 D	42, 44	11/91 → 03/04	FCP732 ATE	✓		✓							
1.7 D 365	42, 44	09/85 → 10/91	FCP173 GM	✓		✓							

**Belmont**

1.3	55	01/86 → 10/89	FCP173 GM	✓		✓							
1.4	55	10/89 → 06/92	FCP173 GM	✓		✓							
1.6	66	01/86 → 06/92	FCP173 GM	✓		✓							
1.7 D	42	01/89 → 06/92	FCP173 GM	✓		✓							
1.8	85	01/86 → 06/92	FCP173 GM	✓		✓							

**Calibra**

2.0	85	09/89 → 12/96	FCP584 ATE	✓		✓			FCP586 ATE	✓		✓	
2.0 (Turbo) 16V	150	09/89 → 12/96	FCP685 ATE	✓		✓			FCP586 ATE	✓		✓	
2.5 24V	125	09/89 → 12/96	FCP584 ATE	✓		✓			FCP586 ATE	✓		✓	





kW



# ...VAUXHALL

## Corsa

1.0		03/93	→ 08/00	FCP732	ATE	✓	✓								
1.0 i	43	09/00	→	FCP1424	LUC	✓									
1.2		03/93	→ 08/00	FCP732	ATE	✓	✓								
1.2 i 16V	55	09/00	→	FCP1424	LUC	✓									
1.4	40, 44	03/93	→ 08/94	FCP732	ATE	✓	✓								
1.4 16V		03/93	→ 08/00	FCP732	ATE	✓	✓								
1.4 i 16V	66	09/00	→	FCP1424	LUC	✓									
1.4 SE	60	03/93	→ 08/00	FCP732	ATE	✓	✓								
1.5 D		03/93	→ 08/94	FCP732	ATE	✓	✓								
1.5 TD		03/93	→ 08/94	FCP732	ATE	✓	✓								
1.6 GSi 16V	78, 80, 95	03/93	→ 07/94	FCP732	ATE	✓	✓								
1.7 D		03/93	→ 08/00	FCP732	ATE	✓	✓								
1.7 Di		09/00	→	FCP1424	LUC	✓									
1.7 DTi		09/00	→	FCP1424	LUC	✓									
1.8 i 16V	92	09/00	→	FCP1424	LUC	✓									

## Corsa Van

1.4	44	10/91	→	FCP732	ATE	✓	✓								
1.7	42, 44	10/91	→	FCP732	ATE	✓	✓								

## Nova

1.0	33	01/92	→ 03/93	FCP732	ATE	✓	✓								
1.0	33	04/83	→ 12/91	FCP173	GM	✓	✓								
1.0 i	33	01/84	→ 12/91	FCP173	GM	✓	✓								
1.2	33	01/92	→ 03/93	FCP732	ATE	✓	✓								
1.2	33, 40	04/83	→ 12/91	FCP173	GM	✓	✓								
1.2 i	33, 40	01/84	→ 12/91	FCP173	GM	✓	✓								
1.3	44, 51	01/84	→ 09/89	FCP173	GM	✓	✓								
1.3	51	06/83	→ 12/84	FCP173	GM	✓	✓								
1.4	44, 55, 60	01/92	→ 03/93	FCP732	ATE	✓	✓								
1.4	44, 55, 60	10/89	→ 12/91	FCP173	GM	✓	✓								
1.4 i		11/90	→ 12/91	FCP173	GM	✓	✓								
1.5 D	37, 49	01/92	→ 03/93	FCP732	ATE	✓	✓								
1.5 D	37, 49	09/89	→ 12/91	FCP173	GM	✓	✓								
1.6 GSi, GTE	74	01/92	→ 03/93	FCP732	ATE	✓	✓								
1.6 GSi, GTE	55, 60, 73, 74	05/88	→ 12/91	FCP173	GM	✓	✓								

## Omega

2.0 16V	100	04/94	→	FCP685	ATE	✓	✓								
2.5 V6 24V	125	04/94	→	FCP685	ATE	✓	✓								

## Royale

2.8	103	01/78	→ 12/84	FCP11	ATE	✓	✓	⊠	✓	FCP2	ATE	✓	⊠	✓	⊠
3.0	132	01/78	→ 12/84	FCP11	ATE	✓	✓	⊠	✓	FCP2	ATE	✓	⊠	✓	⊠

## Senator

2.5	103	10/84	→ 12/85	FCP11	ATE	✓	✓	⊠	✓	FCP2	ATE	✓	⊠	✓	⊠
3.0	132	10/84	→ 12/85	FCP11	ATE	✓	✓	⊠	✓	FCP2	ATE	✓	⊠	✓	⊠

## Signum (F48)

1.8	90	06/03	→ 07/05	FCP1520	ATE	✓				FCP1540		✓			
1.8	103	08/05	→ 03/08	FCP1520	ATE	✓									
1.9	74	01/05	→ 05/08	FCP1520	ATE	✓									
1.9 CDTi	110,88	05/04	→ 03/08	FCP1520	ATE	✓									
2.0	129	09/03	→ 03/08	FCP1520	ATE	✓				FCP1540		✓			
2.0 DTi	74	05/03	→ 04/04	FCP1520	ATE	✓				FCP1540		✓			
2.2 DGi	114	06/03	→ 03/08	FCP1520	ATE	✓				FCP1540		✓			
2.2 DTi	92	05/03	→ 04/04	FCP1520	ATE	✓				FCP1540		✓			
3.0 CDTi	130	06/03	→ 07/05	FCP1520	ATE	✓				FCP1540		✓			
3.2 DGi	155	06/03	→ 07/05	FCP1520	ATE	✓				FCP1540		✓			

## Tigra

1.4 16V	66	09/94	→	FCP732	ATE	✓	✓								
1.6 16V	78	09/94	→	FCP732	ATE	✓	✓								

## Tigra Twin Top

1.3 CDTi 16v	51	06/04	→	FCP1424	LUC	✓									
1.4 i 16V	66	06/04	→	FCP1424	LUC	✓									
1.8 i 16V	92	06/04	→	FCP1424	LUC	✓									

### COMPOUND AVAILABILITY

H C R W Z

### COMPOUND AVAILABILITY

H C R W Z





kw



...VAUXHALL

Vectra

Table with 4 columns: Power (kW), Torque, Validity Date, and Product Code/Type

Vectra (F19)

Table with 4 columns: Power (kW), Torque, Validity Date, and Product Code/Type

Vectra (F35)

Table with 4 columns: Power (kW), Torque, Validity Date, and Product Code/Type

Vectra (F68)

Table with 4 columns: Power (kW), Torque, Validity Date, and Product Code/Type

Vectra (F69)

Table with 4 columns: Power (kW), Torque, Validity Date, and Product Code/Type

Viceroy

Table with 4 columns: Power (kW), Torque, Validity Date, and Product Code/Type

Viva

Table with 4 columns: Power (kW), Torque, Validity Date, and Product Code/Type

VX220

Table with 4 columns: Power (kW), Torque, Validity Date, and Product Code/Type

Zafira

Table with 4 columns: Power (kW), Torque, Validity Date, and Product Code/Type

Compound Availability header table with columns H, C, R, W, Z

Compound Availability header table with columns H, C, R, W, Z

Main compound availability data table for various models

Main compound availability data table for various models

Legend: Available, Not Available, In Introduction, Exhausting, Make to order



Updated on 30th Jan 2014

1115

VAUXHALL



VAUXHALL

### ...VAUXHALL

#### Zafira (L75)

...VAUXHALL				COMPOUND AVAILABILITY						COMPOUND AVAILABILITY					
	H	C	R	W	Z	H	C	R	W	Z					
2.0 VXR	177	11/05 →	FCP1520	ATE	✓										

### VOLKSWAGEN

#### 1600

1.6 TA, TE, Variant		01/72 → 12/73	FCP2	ATE	✓	✉	✓			✉					
---------------------	--	---------------	------	-----	---	---	---	--	--	---	--	--	--	--	--

#### 411

1.7		01/67 → 12/73	FCP2	ATE	✓	✉	✓			✉					
-----	--	---------------	------	-----	---	---	---	--	--	---	--	--	--	--	--

#### Beetle

1.8 (Turbo) 20V		01/98 →	FCP1094	ATE	✓	✉				✉	FCP541	LUC	✓	✓	✉
1.8 (Turbo) 20V		01/98 →	FCP590	ATE	✓		✓	✉			FCP541	LUC	✓	✓	✉
1.8 i Turbo 20V		10/99 →	FCP1094	ATE	✓	✉				✉					
1.9 TDi		01/98 →	FCP1094	ATE	✓	✉				✉	FCP541	LUC	✓	✓	✉
2.0		01/98 →	FCP1094	ATE	✓	✉				✉	FCP541	LUC	✓	✓	✉
2.0 i		01/98 →	FCP1094	ATE	✓	✉				✉					
2.3 V5 20V		01/98 →	FCP590	ATE	✓		✓	✉			FCP541	LUC	✓	✓	✉

#### Bora

1.4 16V	55	04/98 →	FCP1094	ATE	✓	✉				✉	FCP541	LUC	✓	✓	✉
1.4 i 16V	55	03/00 →	FCP1094	ATE	✓					✉					
1.6	74, 77	08/98 →	FCP1094	ATE	✓	✉				✉	FCP541	LUC	✓	✓	✉
1.8 20V	92	08/98 →	FCP1094	ATE	✓					✉	FCP541	LUC	✓	✓	✉
1.9 TDi	66, 74, 81, 85	08/98 →	FCP1094	ATE	✓	✉				✉	FCP541	LUC	✓	✓	✉
1.9 TDi	66, 74, 81, 85	11/00 →	FCP590	ATE	✓		✓	✉			FCP541	LUC	✓	✓	✉
2.0	85, 88	08/98 →	FCP1094	ATE	✓	✉				✉	FCP541	LUC	✓	✓	✉
2.3 V5	110	08/98 →	FCP590	ATE	✓		✓	✉			FCP541	LUC	✓	✓	✉
2.8 V6 4Motion		05/99 →	FCP590	ATE	✓		✓	✉			FCP541	LUC	✓	✓	✉

#### Caddy

1.4 (CH No ->TR513)	44	01/96 →	FCP775	LUC	✓		✓								
1.4 (CH No TR514->)	44	04/96 →	FCP1312	LUC	✓					✉					
1.5	51	08/82 → 07/83	FCP419	KEL	✓										
1.6	55	01/84 → 12/93	FCP419	KEL	✓										
1.6 (CH No ->TR513)	55	01/96 → 12/00	FCP775	LUC	✓		✓								
1.6 (CH No TR514->)	55	04/96 → 12/00	FCP1312	LUC	✓					✉					
1.7 SD (CH No ->TR513)		01/96 → 12/00	FCP775	LUC	✓		✓								
1.7 SD (CH No TR514->)		04/96 → 12/00	FCP1312	LUC	✓					✉					
1.8	70	01/84 → 12/93	FCP419	KEL	✓										
1.9 SDi (CH No ->TR513)		01/96 → 12/00	FCP775	LUC	✓		✓								
1.9 SDi (CH No TR514->)		04/96 → 12/00	FCP1312	LUC	✓					✉					

#### Caddy (II)

1.4 i Ch.->TR513	44	01/96 → 02/04	FCP775	LUC	✓		✓								
1.4 i Ch.TR514->	44	04/96 → 02/04	FCP1312	LUC	✓					✉					
1.6 i Ch.->TR513	55	01/96 → 02/04	FCP775	LUC	✓		✓								
1.6 i Ch.TR514->	55	04/96 → 02/04	FCP1312	LUC	✓					✉					
1.7 SD Ch.->TR513		01/96 → 02/04	FCP775	LUC	✓		✓								
1.7 SD Ch.TR514->		04/96 → 02/04	FCP1312	LUC	✓					✉					
1.9 SDi Ch.->TR513		01/96 → 02/04	FCP775	LUC	✓		✓								
1.9 SDi Ch.TR514->		04/96 → 02/04	FCP1312	LUC	✓					✉					

#### Caddy (III)

1.4 i Life, Van	55	03/04 →	FCP1094	ATE	✓	✉				✉					
1.4 i Life, Van	55	03/04 →	FCP1094	ATE	✓										
1.6 i Life, Van	75	03/04 →	FCP1641	ATE	✓	✉	✓	✓	✓						
1.9 TDi Life, Van	77	03/04 →	FCP1641	ATE	✓	✉	✓	✓	✓						
2.0 SDi Life, Van	51	03/04 →	FCP1641	ATE	✓	✉	✓	✓	✓						

#### Caddy (IV)

2.0 TDi 16v (2CA,2CB)	81	10/10 → 00/00	FCP1094	ATE, PR 1ZF	✓	✉				✉	FCP4316	BOSCH	✓		
2.0 TDi 16v (2CA,2CB)	81	10/10 → 00/00	FCP1641	ATE, PR 1ZE, 1ZA	✓		✓	✓	✓		FCP4316	BOSCH	✓		
2.0 TDi 16v (2CA,2CB)	103	11/10 → 00/00	FCP1094	ATE, PR 1ZF	✓	✉				✉	FCP4316	BOSCH	✓		
2.0 TDi 16v (2CA,2CB)	103	11/10 → 00/00	FCP1641	ATE, PR 1ZE, 1ZA	✓	✉	✓	✓	✓		FCP4316	BOSCH	✓		

#### Caddy Maxi (IV)

2.0 TDi 16v (2CH,2CJ)	81	10/10 → 00/00	FCP1094	ATE, PR 1ZF	✓	✉				✉	FCP4316	BOSCH	✓		
2.0 TDi 16v (2CH,2CJ)	81	10/10 → 00/00	FCP1641	ATE, PR 1ZE, 1ZA	✓		✓	✓	✓		FCP4316	BOSCH	✓		
2.0 TDi 16v (2CH,2CJ)	103	11/10 → 00/00	FCP1094	ATE, PR 1ZF	✓	✉				✉	FCP4316	BOSCH	✓		
2.0 TDi 16v (2CH,2CJ)	103	11/10 → 00/00	FCP1641	ATE, PR 1ZE, 1ZA	✓	✉	✓	✓	✓		FCP4316	BOSCH	✓		





kw



...VOLKSWAGEN

Golf (3)

			COMPOUND AVAILABILITY					COMPOUND AVAILABILITY						
			H	C	R	W	Z							
1.4 i Variant	40, 44	01/93 → 09/97	FCP419	KEL	✓									
1.4 Saloon,Variant	40, 44	08/91 → 08/95	FCP1288	LUC	⚠				FCP541	LUC	✓		✓	✉
1.4 Saloon,Variant	40, 44	09/95 → 04/97	FCP1054	ATE	✓									
1.4 Variant	40, 44	01/95 → 09/97	FCP1288	KEL	⚠									
1.6	55	08/91 → 08/95	FCP419	KEL	✓									
1.6	55	08/91 → 08/95	FCP774	LUC	✓		✓		FCP541	LUC	✓		✓	✉
1.6	54, 74	09/95 → 04/97	FCP1054	ATE	✓									
1.6 i Cabrio	74	06/98 →	FCP1312	LUC	✓			✉						
1.6 i Cabrio	74	10/94 → 05/98	FCP775	LUC	✓		✓							
1.6 Saloon,Variant	55, 74	09/95 → 04/97	FCP775	LUC	✓		✓							
1.6 Saloon,Variant	55, 74	09/95 → 04/97	FCP1288	LUC	⚠									
1.8	55, 66	08/91 → 08/95	FCP419	KEL	✓									
1.8	55, 66	08/91 → 08/95	FCP1288	LUC	⚠				FCP541	LUC	✓		✓	✉
1.8	66, 72	09/95 → 09/97	FCP419	ATE, ABS	✓									
1.8	66, 72	09/95 → 09/97	FCP1054	ATE	✓									
1.8 GT	66	08/91 → 04/97	FCP774	LUC	✓		✓		FCP541	LUC	✓		✓	✉
1.8 i Cabrio	55	06/98 →	FCP775	LUC	✓		✓							
1.8 i Cabrio	66	06/98 →	FCP774	LUC	✓		✓							
1.8 i Cabrio	55, 66	07/93 → 05/98	FCP775	LUC	✓		✓							
1.8 Saloon,Variant		09/95 → 04/97	FCP775	LUC	✓		✓							
1.8 Saloon,Variant		09/95 → 04/97	FCP1288	LUC	⚠									
1.8 Variant	55, 66	01/93 → 09/97	FCP419	KEL	✓									
1.9 D	47, 48, 55	07/95 → 09/97	FCP1054	ATE	✓									
1.9 D	48, 55	08/91 → 06/95	FCP419	KEL	✓				FCP541	LUC	✓		✓	✉
1.9 D	48, 55	08/91 → 06/95	FCP774	LUC	✓		✓							
1.9 D GT	47, 48, 55	08/91 → 07/95	FCP774	LUC	✓		✓		FCP541	LUC	✓		✓	✉
1.9 D Variant		01/93 → 08/95	FCP775	LUC	✓		✓							
1.9 D Variant		09/95 → 09/97	FCP774	LUC	✓		✓							
1.9 TD	66	07/95 → 09/97	FCP1054	ATE	✓									
1.9 TD	66	08/91 → 06/95	FCP774	LUC	✓		✓							
1.9 TD	66	08/91 → 06/95	FCP419	KEL	✓				FCP541	LUC	✓		✓	✉
1.9 TD GT	66	08/91 → 07/95	FCP774	LUC	✓		✓		FCP541	LUC	✓		✓	✉
1.9 TD Variant		01/93 → 08/95	FCP775	LUC	✓		✓							
1.9 TD Variant		09/95 → 09/97	FCP774	LUC	✓		✓							
1.9 TDi		04/96 → 08/97	FCP774	LUC	✓		✓							
1.9 TDi		09/93 → 08/97	FCP774	LUC	✓		✓		FCP541	LUC	✓		✓	✉
1.9 TDi		09/93 → 08/97	FCP1312	LUC	✓			✉	FCP541	LUC	✓		✓	✉
1.9 TDi Cabrio	66	06/98 →	FCP775	LUC	✓		✓							
1.9 TDi Cabrio	81	06/98 →	FCP1312	LUC	✓			✉	FCP541	LUC	✓		✓	✉
1.9 TDi Cabrio	81	06/98 →	FCP1312	LUC	✓			✉						
1.9 TDi Cabrio	81	07/96 → 05/98	FCP1312	LUC	✓									
1.9 TDi Cabrio	66	08/95 → 05/98	FCP775	LUC	✓		✓							
1.9 TDi Cabrio	66	08/95 → 05/98	FCP1312	LUC	✓			✉	FCP541	LUC	✓		✓	✉
1.9 TDi Syncro		01/95 → 12/97	FCP590	ATE	✓			✉						
2.0 Cabrio, Variant	85	01/93 → 09/97	FCP774	LUC	✓		✓		FCP541	LUC	✓		✓	✉
2.0 GTi 16V	110	08/91 → 06/95	FCP775	LUC	✓		✓		FCP541	LUC	✓		✓	✉
2.0 i GTi 16V		07/95 → 09/97	FCP775	LUC	✓		✓		FCP541	LUC	✓		✓	✉
2.0 i Syncro		01/95 → 12/97	FCP590	ATE	✓			✉						
2.8 VR6	128	08/91 → 09/97	FCP775	LUC	✓		✓		FCP541	LUC	✓		✓	✉
2.9 i VR6 Syncro	140	11/94 → 12/97	FCP590	ATE	✓			✉						

Golf (4)

1.4 16V		01/00 → 09/03	FCP1094	ATE	✓			✉	FCP541	LUC	✓		✓	✉
1.4 16V		10/97 → 12/00	FCP1094	ATE	✓			✉	FCP541	LUC	✓		✓	✉
1.4 Saloon,Variant		04/97 → 03/98	FCP1054	ATE	✓									
1.4 Saloon,Variant		04/97 → 03/98	FCP392	ATE	✓		✓	✉						
1.4 Variant		09/97 → 03/98	FCP1288	KEL	⚠									
1.6		01/00 → 09/03	FCP1094	ATE	✓			✉	FCP541	LUC	✓		✓	✉
1.6	74	04/97 → 03/98	FCP1054	ATE	✓									
1.6	74	04/97 → 03/98	FCP392	ATE	✓		✓	✉						
1.6	74	04/98 → 12/00	FCP1094	ATE	✓			✉	FCP541	LUC	✓		✓	✉
1.6 16V	74	12/97 → 04/98	FCP1094	ATE	✓			✉	FCP541	LUC	✓		✓	✉
1.6 Saloon,Variant	74	04/97 → 03/98	FCP775	LUC	✓		✓							
1.6 Saloon,Variant	74	04/97 → 03/98	FCP1288	LUC	⚠									
1.8		01/00 → 09/03	FCP1094	ATE	✓			✉	FCP541	LUC	✓		✓	✉
1.8	92	04/98 → 12/00	FCP1094	ATE	✓			✉	FCP541	LUC	✓		✓	✉
1.8	66, 72	09/97 → 03/98	FCP392	ATE	✓		✓	✉						
1.8	66, 72	09/97 → 03/98	FCP1054	ATE	✓									
1.8 (Turbo)		01/00 → 09/03	FCP590	ATE	✓			✉	FCP541	LUC	✓		✓	✉
1.8 (Turbo)		04/98 → 12/00	FCP590	ATE	✓			✉	FCP541	LUC	✓		✓	✉
1.8 Saloon,Variant		04/97 → 03/98	FCP775	LUC	✓		✓							
1.8 Saloon,Variant		04/97 → 03/98	FCP1288	LUC	⚠									
1.8 Variant	55, 66	09/97 → 02/99	FCP419	KEL	✓									
1.9 D		09/97 → 03/98	FCP1054	ATE	✓									
1.9 D Variant		09/97 → 04/99	FCP774	LUC	✓		✓							
1.9 SDi		01/00 → 09/03	FCP1094	ATE	✓			✉	FCP541	LUC	✓		✓	✉
1.9 SDi	50	04/98 → 12/00	FCP1094	ATE	✓			✉	FCP541	LUC	✓		✓	✉
1.9 TD		09/97 → 03/98	FCP1054	ATE	✓									
1.9 TD Variant		09/97 → 04/99	FCP774	LUC	✓		✓							
1.9 TDi		01/00 → 09/03	FCP1094	ATE	✓			✉	FCP541	LUC	✓		✓	✉

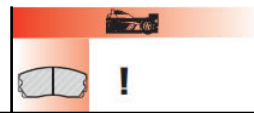
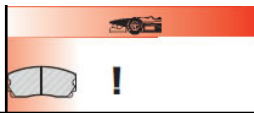

# ...VOLKSWAGEN

## ...Golf (4)

			COMPOUND AVAILABILITY					COMPOUND AVAILABILITY					
			H	C	R	W	Z	H	C	R	W	Z	
1.9 TDi	66, 81	04/98 → 12/00	FCP1094					FCP541	LUC	✓	✓	Ⓜ	Ⓜ
2.0 Cabrio, Variant	85	09/97 → 04/98	FCP774					FCP541	LUC	✓	✓	Ⓜ	Ⓜ
2.0 i 16V		01/00 → 09/03	FCP1094					FCP541	LUC	✓	✓	Ⓜ	Ⓜ
2.0 i 16V		05/98 → 12/00	FCP1094					FCP541	LUC	✓	✓	Ⓜ	Ⓜ
2.0 i GTI 16V		09/97 → 04/98	FCP775					FCP541	LUC	✓	✓	Ⓜ	Ⓜ
2.3 i VR5		01/00 → 09/03	FCP590					FCP541	LUC	✓	✓	Ⓜ	Ⓜ
2.3 i VR5	110	12/97 → 12/00	FCP590					FCP541	LUC	✓	✓	Ⓜ	Ⓜ

## Golf (5)

1.4 i 16V		10/03 → 12/03	FCP1094										
1.4 i 16V		12/03 →	FCP1094					FCP1636	TRW	✓			
1.6 FSi		10/03 → 12/03	FCP1094										
1.6 FSi		12/03 →	FCP1094					FCP1636	TRW	✓			
1.9 TDi		10/03 → 12/03	FCP1094										
1.9 TDi		12/03 →	FCP1094					FCP1636	TRW	✓			
2.0 FSi		01/04 →	FCP1641					FCP1636		✓			
2.0 GTI	147	10/04 →	FCP1641					FCP1636	TRW	✓			
2.0 TDi		10/03 →	FCP1641					FCP1636	TRW	✓			

## Golf (5) Plus

1.4 i 16V	55	01/05 →	FCP1094					FCP1636		✓			
1.6 FSi 16V	85	01/05 →	FCP1094					FCP1636		✓			
1.9 TDi	77	01/05 →	FCP1094					FCP1636		✓			
2.0 TDi 16V	103	01/05 →	FCP1641					FCP1636		✓			

## Golf (IV)

3.2 R32 24v (1J1)	177	01/03 → 05/04	FCP1001					FCP1491	TRW	✓			✓
-------------------	-----	---------------	---------	--	--	--	--	---------	-----	---	--	--	---

## Golf (VI)

2.0 TDi 16v (5K1)	103	05/09 → 00/00	FCP1641					FCP4316	BOSCH	✓			
-------------------	-----	---------------	---------	--	--	--	--	---------	-------	---	--	--	--

## Golf Cabrio (VI)

1.2 TSi 8v (517)	77	03/11 → 00/00	FCP1641					FCP4316	BOSCH	✓			
1.4 TSi 16v (517)	118	03/11 → 00/00	FCP1641					FCP4316	BOSCH	✓			
1.4 TSi 16v (517)	90	11/11 → 00/00	FCP1641					FCP4316	BOSCH	✓			
1.6 TDi 16v (517)	77	03/11 → 00/00	FCP1641					FCP4316	BOSCH	✓			
2.0 TDi 16v (517)	103	11/11 → 00/00	FCP1641					FCP4316	BOSCH	✓			
2.0 TFSi 16v (517)	155	11/11 → 00/00	FCP1641					FCP4316	BOSCH	✓			

## Golf Estate/Variant (VI)

2.0 TDi 16v (AJ5)	81	01/10 → 00/00	FCP1094					FCP4316	BOSCH	✓			
2.0 TDi 16v (AJ5)	81	01/10 → 00/00	FCP1641					FCP4316	BOSCH	✓			

## Golf Mk4 (1J1)

3.2 R32 4motion (1 piston caliper) 241	09/02 → 06/05	FCP1765	ATE (1 Piston) - [Different pad required for the 2 pistons ATE, PR 1Z]	✓									
--	---------------	---------	--	---	--	--	--	--	--	--	--	--	--

## Golf Mk5 (1K1)

2.0 GTI	230	09/06 →	FCP1765					FCP1636		✓			
3.2 R32 4motion	250	11/05 →	FCP1765					FCP1636		✓			

## Golf Van

1.3		01/84 → 05/92	FCP385										
1.6 D		01/84 → 05/92	FCP419										
1.6 TD		01/84 → 05/92	FCP419										
1.9 TD		05/92 →	FCP774										

## Golf VI

1.4	59	10/08 →	FCP1094					FCP1636	TRW, PR: 1KF, 1KY, 1KZ	✓			
1.4	59	10/08 →	FCP1641										
1.4 TSI	90	10/08 →	FCP1094					FCP1636	TRW, PR: 1KF, 1KY, 1KZ	✓			
1.4 TSI	90	10/08 →	FCP1641										
1.4 TSI	118	10/08 →	FCP1641					FCP1636	TRW, PR: 1KF, 1KY, 1KZ	✓			
1.6	75	10/08 →	FCP1094					FCP1636	TRW, PR: 1KF, 1KY, 1KZ	✓			
1.6	75	10/08 →	FCP1641										
2.0 TDi	81	10/08 →	FCP1641					FCP1636	TRW, PR: 1KF, 1KY, 1KZ	✓			
2.0 TDi	81	10/08 →	FCP1641										
2.0 TDi	103	10/08 →	FCP1641					FCP1636	TRW, PR: 1KF, 1KY, 1KZ	✓			

## GOLF VII

1.2 TSI	63	11/12 →	FCP4433										
1.2 TSI	77	11/12 →	FCP4433										
1.4 TSI	103	11/12 →	FCP4433										
1.4 TSI	90	11/12 →	FCP4433										
1.4 TSI E85-100	90	11/12 →	FCP4433										
1.6 TDI	77	11/12 →	FCP4433										
1.6 TDI 4motion	77	11/12 →	FCP4433										
2.0 TDI	110	11/12 →	FCP4433										

Available    
 Exhausting  
 Not Available    
 Make to order  
 In Introduction



Updated on 30th Jan 2014





kw

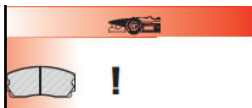

**...VOLKSWAGEN**

**...Passat**

1.8 SW Estate		04/88 → 10/93
1.8 Variant 20V	92	10/97 → 11/00
1.8 Variant Turbo 20V	110	01/97 → 11/00
1.8 Variant Turbo 20V	110	01/97 → 11/00
1.9		01/88 → 03/88
1.9		04/88 → 08/89
1.9 D	50	09/89 → 10/96
1.9 D , Variant	55, 66	09/89 → 10/96
1.9 GL5		09/81 → 12/83
1.9 TDi Saloon	66	10/96 → 11/00
1.9 TDi Saloon	81, 85	10/96 → 11/00
1.9 TDi Saloon	81, 85	10/96 → 11/00
1.9 TDi Variant	66	10/97 → 11/00
1.9 TDi Variant	66	10/97 → 11/00
1.9 TDi Variant	81	10/97 → 11/00
1.9 TDi Variant	81	10/97 → 11/00
2.0	85	04/88 → 10/93
2.0	85	10/93 → 10/96
2.0 16V	100	04/88 → 10/93
2.0 16V	110	10/93 → 10/96
2.0 GL5	84	08/83 → 03/88
2.2	85, 100	01/84 → 03/88
2.2 GT5		10/80 → 03/88
2.3 VR5	110	01/97 →
2.5 TDi Syncro, Variant 24V	110	12/98 →
2.8 V6 30V	142	01/97 →
2.8 V6 30V	142	01/97 →
2.8 VR6	128	04/88 → 10/93
2.8 VR6	128	10/93 → 10/96
2.9 VR6	135	10/93 → 11/96

**Passat (I)**

1.3 Auto, SW Estate	44	01/84 → 07/85
1.3 i Auto, SW Estate	44	11/79 → 12/83
1.3 i Saloon	40, 44	01/73 → 10/79
1.3 i Saloon	40, 44	11/79 → 12/83
1.5 i	63	01/73 → 10/79
1.6 D Saloon	40, 51	01/84 → 03/88
1.6 D Saloon	40, 51	04/88 → 08/89
1.6 D SW Estate	40, 51	01/84 → 03/88
1.6 i		01/73 → 10/79
1.6 i	55, 63	11/79 → 12/83
1.6 i Auto, SW Estate	55, 63, 81	11/79 → 12/83
1.6 i GLI Auto, SW Estate	81	11/79 → 12/83
1.6 Saloon	51, 53	01/84 → 03/88
1.6 SW Estate	55	01/84 → 03/88
1.6 TD Saloon	51, 59	01/84 → 03/88
1.6 TD SW Estate	40, 51	01/84 → 03/88
1.8 i Auto, SW Estate		11/79 → 12/83
1.8 i Saloon		11/79 → 12/83
1.8 Saloon	66, 68	01/84 → 03/88
1.8 SW Estate	66	01/84 → 03/88
1.9		01/88 → 03/88
1.9 i GL5		09/81 → 12/83
2.0	84	01/84 → 03/88
2.0 GL5		08/83 → 12/83
2.2	85, 100	01/84 → 03/88
2.2 GT5		10/80 → 03/88

**Passat (II)**

1.6 Saloon	53, 55	04/88 → 09/91
1.6 Saloon	53, 55	04/88 → 09/91
1.6 Saloon, Variant	74	07/94 → 08/96
1.6 Saloon, Variant	74	07/94 → 08/96
1.6 TD Saloon, Variant	51, 59	04/88 → 09/93
1.6 Variant	53, 55	04/88 → 09/91
1.8 GT, GL Saloon	79, 82	04/88 → 10/93
1.8 GT, GL Saloon	100	04/88 → 10/93
1.8 i G60 Syncro, Saloon, Variant	118	08/88 → 08/96
1.8 Saloon, Variant	55, 66	04/88 → 08/96
1.9 TDi Saloon, Variant	81	03/96 → 08/96
1.9 TDi Saloon, Variant	66	10/93 → 08/96
1.9 TDi Saloon, Variant	66	10/93 → 08/96
2.0 Saloon, Variant	79, 85	02/90 → 08/96
2.8 i VR6 Saloon, Variant	128	06/91 → 10/93

		COMPOUND AVAILABILITY					COMPOUND AVAILABILITY						
		H	C	R	W	Z			H	C	R	W	Z
FCP775	LUC	✓		✓									
FCP1289	LUC	✗					FCP541	LUC	✓		✓	✉	✉
FCP1323	ATE	✓					FCP541	LUC	✓		✓	✉	✉
FCP1289	LUC	✗											
FCP419	KEL	✓											
FCP775	LUC	✓		✓									
FCP775	LUC	✓		✓									
FCP775	LUC	✓		✓									
FCP419	KEL	✓											
FCP1289	ATE	✗					FCP541	LUC	✓		✓	✉	✉
FCP1323	ATE	✓					FCP596	LUC	✓		✓	✉	✉
FCP1289	LUC	✗					FCP541	LUC	✓		✓	✉	✉
FCP1323	ATE	✓					FCP541	LUC	✓		✓	✉	✉
FCP1289	LUC	✗					FCP541	LUC	✓		✓	✉	✉
FCP1323	ATE	✓					FCP541	LUC	✓		✓	✉	✉
FCP1289	LUC	✗					FCP541	LUC	✓		✓	✉	✉
FCP774	LUC	✓		✓			FCP541	LUC	✓		✓	✉	✉
FCP774	LUC	✓		✓			FCP541	LUC	✓		✓	✉	✉
FCP774	LUC	✓		✓			FCP541	LUC	✓		✓	✉	✉
FCP590	ATE	✓		✓	✉		FCP541	LUC	✓		✓	✉	✉
FCP419	KEL	✓											
FCP419	KEL	✓											
FCP774	LUC	✓		✓			FCP541	LUC	✓		✓	✉	✉
FCP1323	ATE	✓					FCP541	LUC	✓		✓	✉	✉
FCP1323	ATE	✓					FCP541	LUC	✓		✓	✉	✉
FCP1323	ATE	✓					FCP541	LUC	✓		✓	✉	✉
FCP1289	LUC	✗					FCP541	LUC	✓		✓	✉	✉
FCP775	LUC	✓		✓			FCP541	LUC	✓		✓	✉	✉
FCP590	ATE	✓		✓	✉		FCP541	LUC	✓		✓	✉	✉
FCP590	ATE	✓		✓	✉								
FCP419	KEL	✓											
FCP392	KEL	✓		✓	✉								
FCP105	ATE	✓		✉									
FCP419	KEL	✓											
FCP419	KEL	✓											
FCP419	KEL	✓											
FCP105	ATE	✓		✉									
FCP419	KEL	✓		✓	✉								
FCP392	KEL	✓		✓	✉								
FCP392	KEL	✓		✓	✉								
FCP392	KEL	✓		✓	✉								
FCP392	KEL	✓		✓	✉								
FCP774	LUC	✓		✓			FCP541	LUC	✓		✓	✉	✉

✓ Available    ⚠ Exhausting  
 ✗ Not Available    ✉ Make to order  
 ⚡ In Introduction



Updated on 30th Jan 2014



kW

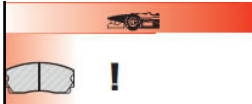

**...VOLKSWAGEN**

**Passat (III)**

1.6 i Saloon, Variant	74	10/96 → 10/00
1.8 i Saloon, Variant 20V	92	10/96 → 11/00
1.9 TDi Saloon, Variant	66, 74	10/96 → 11/00

**Passat (V)**

2.0 TFSI Estate (3C2)	200	07/05 →
-----------------------	-----	---------

**Passat (V)**

2.8 VR6 30v (3B2/3B3)	142	01/99 → 05/05
2.8 VR6 30v Estate/Variant (3B5/3B6)	142	01/99 → 05/05
3.2 FSI/ 3.2 FSI 4 Motion, Estate (3C2)	250	08/05 →
4.0 32v (3B3)	202	09/01 → 05/05
4.0 32v Estate/Variant (3B6)	202	11/01 → 05/05

**Polo**

GTI		01/06 →
0.9	25, 29	01/75 → 12/84
0.9		01/85 → 12/90
1.0	29, 33	01/85 → 12/86
1.0	29, 33	01/85 → 12/86
1.0	29, 33	01/87 → 08/90
1.0	33, 37	06/95 →
1.0	29	08/78 → 12/84
1.1	37, 44	01/75 → 12/84
1.3	43, 44	01/75 → 12/78
1.3	40, 44, 55, 85	01/85 → 12/86
1.3	40, 44, 55, 85	01/85 → 12/86
1.3	40, 56	06/95 →
1.3	43, 44, 55	08/78 → 12/84
1.3	40, 56	09/90 → 09/94
1.3	40, 56	09/90 → 09/94
1.3	40, 56	10/94 → 06/95
1.3	40, 56	10/94 → 06/95
1.3 G40	85	05/91 → 09/94
1.3 GT	40, 56	01/90 → 08/94
1.4 Classic	44	06/95 → 12/97
1.4 Variant	44	01/97 →
1.6 Hatchback		06/95 →
1.6 Saloon	55, 74	01/97 →
1.6 Saloon	55, 74	01/97 →
1.6 Saloon	55, 74	06/95 → 12/97
1.7 SDi	42	06/95 →
1.9 D Saloon	47	11/95 →
1.9 TDi Saloon	66	01/97 →

**Polo (I)**

0.9	25, 29	08/78 → 09/81
0.9	25, 29	10/81 → 12/84
0.9 i	25, 29	01/75 → 07/78
0.9 i		01/85 → 12/90
1.0	29, 33	01/85 → 12/86
1.0	29, 33	01/85 → 12/86
1.0	29	08/78 → 12/84
1.0 i	29, 33	01/87 → 08/90
1.1	37, 44	08/78 → 09/81
1.1	37, 44	10/81 → 12/84
1.1 i	37, 44	01/75 → 07/78
1.3	40, 44, 55, 85	01/85 → 12/86
1.3	40, 44, 55, 85	01/85 → 12/86
1.3	43, 44, 55	08/78 → 09/81
1.3	43, 44, 55	10/81 → 12/84
1.3 i	43, 44	01/75 → 12/78
1.3 i	40, 55	01/87 → 08/90
1.3 i	40, 56	09/90 → 09/94
1.3 i	40, 56	09/90 → 09/94

**Polo (II)**

1.0 i	33, 37	06/95 → 09/01
1.3 i	40, 56	10/94 → 06/95
1.4 i	40, 44	06/95 → 09/01
1.4 i 16V	55	10/99 → 09/01
1.4 i 16V	55	10/99 → 09/01
1.6 i	55	10/94 → 10/99
1.6 i GTi 16V	74	09/98 → 09/01
1.7 SDi	42	04/97 → 09/01
1.9 D, SDi	47	10/94 → 09/01

**COMPOUND AVAILABILITY**

H C R W Z

**COMPOUND AVAILABILITY**

H C R W Z

FCP1289	LUC	X							
FCP1289	LUC	X							
FCP1289	LUC	X							
FCP1765		✓			☑	✓	FCP1636	✓	
FCP1001	ATE, For PR 1LC	✓				✓	FCP1491	TRW	✓
FCP1001	ATE, For PR 1LC	✓				✓	FCP1491	TRW	✓
FCP1765		✓			☑	✓	FCP1636		✓
FCP1001	ATE, For PR 1LC	✓				✓	FCP1491	TRW	✓
FCP1001	ATE, For PR 1LC	✓				✓	FCP1491	TRW	✓
FCP1419		✓		✓					
FCP105	ATE			☑					
FCP385	KEL	☑							
FCP385	KEL	☑							
FCP419	KEL	✓							
FCP392	KEL	✓		✓	☑				
FCP1101	ATE	☑		X					
FCP105	ATE	☑		☑					
FCP105	ATE	☑		☑					
FCP385	KEL	☑		X					
FCP419	KEL	✓							
FCP1101	ATE	☑		X					
FCP105	ATE	☑		☑					
FCP385	KEL	☑		X					
FCP1101	ATE	☑		X					
FCP392	KEL	✓		✓	☑		FCP541	LUC	✓
FCP419	KEL	✓					FCP541	LUC	✓
FCP1101	ATE	☑		X					
FCP1101	ATE	☑		X					
FCP1101	ATE	☑		X					
FCP1101	ATE	☑		X					
FCP1101	ATE	☑		X					
FCP1312	LUC	✓			☑		FCP1312	LUC	✓
FCP105	ATE			☑					
FCP105	ATE			☑					
FCP105	ATE			☑					
FCP385	KEL	☑							
FCP385	KEL	☑							
FCP419	KEL	✓							
FCP105	ATE	☑		☑					
FCP392	KEL	✓		✓	☑				
FCP105	ATE	☑		☑					
FCP105	ATE	☑		☑					
FCP105	ATE	☑		☑					
FCP385	KEL	☑		X					
FCP1101	ATE	☑		X					
FCP1101	ATE	☑		X					
FCP1101	ATE	☑		X					
FCP1312	LUC	✓			☑				
FCP105	ATE	☑		X					
FCP1101	ATE	☑		X					
FCP1101	ATE	☑		X					
FCP1101	ATE	☑		X					
FCP1312	LUC	✓			☑				
FCP1101	ATE	☑		X					

✓ Available    ⚠ Exhausting  
 X Not Available    ☑ Make to order  
 ☑ In Introduction





KW

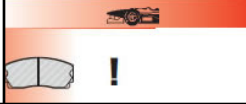

!



!

**...VOLKSWAGEN**

**Polo (II) Classic**

1.4 i	44	12/95 → 12/97
1.4 i	44	12/95 → 12/97
1.4 i	44, 55	12/97 → 09/01
1.6 i	55	11/96 → 09/01
1.6 i	55	11/96 → 09/01
1.6 i	74	11/96 → 09/01
1.6 i	74	11/96 → 09/01
1.7 SDi	42	07/97 → 09/01
1.7 SDi	42	07/97 → 09/01
1.9 SDi	47, 50	12/95 → 09/01
1.9 SDi	47, 50	12/95 → 09/01
1.9 TDi	66, 81	09/96 → 09/01

		COMPOUND AVAILABILITY				
		H	C	R	W	Z
FCP1054	ATE	✓				
FCP1288	ATE	✗				
FCP1288	ATE	✗				
FCP774	LUC	✓		✓		
FCP1312	LUC	✓				✗
FCP774	LUC	✓		✓		
FCP1312	LUC	✓				✗
FCP1054	ATE	✓				
FCP1288	ATE	✗				
FCP1054	ATE	✓				
FCP1288	ATE	✗				
FCP1312	LUC	✓				✗

**Polo (II) Variant**

1.4 i	40, 44, 55	05/97 → 12/97
1.4 i	40, 44, 55	12/97 → 09/01
1.6 i	55, 74	05/97 → 09/01
1.6 i	55, 74	05/97 → 09/01
1.7 SDi	42	08/97 → 09/01
1.7 SDi	42	08/97 → 09/01
1.9 SDi	47, 50	06/97 → 09/01
1.9 SDi	47, 50	06/97 → 09/01
1.9 TDi	66, 81	05/97 → 09/01

		H	C	R	W	Z
FCP1054	ATE	✓				
FCP1288	ATE	✗				
FCP774	LUC	✓		✓		
FCP1312	LUC	✓				✗
FCP1054	ATE	✓				
FCP1288	ATE	✗				
FCP1054	ATE	✓				
FCP1288	ATE	✗				
FCP1312	LUC	✓				✗

**Polo (III)**

1.2 i	40, 47	10/01 →
1.4 FSi		05/02 →
1.4 FSi		05/02 →
1.4 i 16V	55, 74	10/01 →
1.4 TDi	55	10/01 →
1.4 TDi	55	10/01 →
1.9 SDi	47	10/01 →
1.9 TDi	74	10/01 →

		H	C	R	W	Z
FCP1419		✓		✓		
FCP1419		✓		✓		
FCP1419	TRW	✓		✓		
FCP1419		✓		✓		
FCP1419		✓		✓		
FCP1419	TRW	✓		✓		
FCP1419	TRW	✓		✓		
FCP1419		✓		✓		

		H	C	R	W	Z
FCP1491			✓			✓
FCP1491			✓			✓
FCP1491	LUC		✓			✓

**Polo Van**

1.0	33	01/86 → 07/95
1.3		01/86 → 07/95
1.4	35	01/86 → 07/95
1.4 60	35	07/95 →
1.6	55	01/86 → 07/95
1.6 64, 75, 100	55	07/95 →
1.9	47	01/86 → 07/95
1.9 64, 75, 100	47	07/95 →

		H	C	R	W	Z
FCP385	KEL	✗				
FCP385	KEL	✗				
FCP385	KEL	✗				
FCP385	KEL	✗				
FCP385	KEL	✗				
FCP419	KEL	✓				
FCP385	KEL	✗				
FCP419	KEL	✓				

**Santana**

1.3	40	08/81 → 11/81
1.3	40	12/81 → 07/83
1.6 Auto	55	01/82 → 12/83
1.6 CX	55	01/84 → 01/85
1.6 D	40	08/81 → 12/84
1.6 Man	63	01/82 → 12/83
1.6 TD	40, 51	12/81 → 12/84
1.8	66	01/82 → 12/83
1.8 LX	66, 68	01/84 → 01/85
1.9	85	08/82 → 03/85
2.0	85	08/83 → 03/86
2.0	85	08/84 → 03/86

		H	C	R	W	Z
FCP105	ATE			✗		
FCP419	KEL	✓				
FCP419	KEL	✓				
FCP419	KEL	✓				
FCP419	KEL	✓				
FCP419	KEL	✓				
FCP419	KEL	✓				
FCP419	KEL	✓				
FCP419	KEL	✓				
FCP419	KEL	✓				
FCP419	KEL	✓				
FCP392	KEL	✓		✓		✗

**Scirocco**

1.1	37, 38	01/74 → 07/80
1.3	44	01/76 → 12/81
1.3	40, 44	01/81 → 01/84
1.3	40, 44	08/83 → 01/84
1.5	51, 55, 63	01/74 → 12/78
1.5	51	01/78 → 07/80
1.5	51	08/80 → 01/84
1.6	51, 55, 63, 81	01/74 → 07/80
1.6	51, 55	01/84 → 08/88
1.6	55, 63, 81	08/80 → 12/83
1.6 GLi	81	01/74 → 07/80
1.6 GLi	81	08/80 → 12/83
1.6 GTi	81	01/76 → 07/79
1.6 GTi		08/79 → 12/83
1.8	66, 70, 82	01/84 → 08/89
1.8	66, 70, 82	01/84 → 08/89
1.8 GL, GTi	66, 82	08/83 → 12/83
1.8 GT2	66, 70	08/89 → 10/91
1.8 i 16V	102	01/84 → 08/89
1.8 i Scala 16V	95, 102	09/89 → 10/91

		H	C	R	W	Z
FCP105	ATE			✗		
FCP105	ATE			✗		
FCP419	KEL	✓				
FCP419	KEL	✓				
FCP105	ATE			✗		
FCP419	KEL	✓				
FCP105	ATE			✗		
FCP392	KEL	✓		✓		✗
FCP419	KEL	✓				
FCP419	KEL	✓				
FCP105	ATE			✗		
FCP392	KEL	✓		✓		✗
FCP775	LUC	✓		✓		
FCP392	KEL	✓		✓		✗
FCP392	KEL	✓		✓		✗
FCP774	LUC	✓		✓		
FCP774	LUC	✓		✓		
FCP775	LUC	✓		✓		

		H	C	R	W	Z
FCP541	LUC		✓			✓
FCP541	LUC		✓			✓

✓ Available    ✗ Exhausting  
 ✗ Not Available    ✗ Make to order  
 ✗ In Introduction



Updated on 30th Jan 2014





kW



## ...VOLKSWAGEN

### ...Vento

				COMPOUND AVAILABILITY						COMPOUND AVAILABILITY					
				H	C	R	W	Z		H	C	R	W	Z	
2.0 GT	85	05/96 → 07/97	FCP590	ATE	✓		✓	✎	FCP541	LUC	✓		✓	✎	✎
2.0 GT	85	05/96 → 07/97	FCP775	LUC	✓				FCP541	LUC	✓		✓	✎	✎
2.8 VR6	128	01/92 → 02/95	FCP775	LUC	✓		✓		FCP541	LUC	✓		✓	✎	✎
2.8 VR6	128	02/95 → 07/97	FCP590	ATE	✓		✓	✎	FCP541	LUC	✓		✓	✎	✎
2.8 VR6	128	02/95 → 07/97	FCP775	LUC	✓		✓		FCP541	LUC	✓		✓	✎	✎

## VOLVO

### 142

2.0	80	01/68 → 01/75							FCP809	LUC	✓	✓	✓	✎	✓
-----	----	---------------	--	--	--	--	--	--	--------	-----	---	---	---	---	---

### 144

2.0	80	01/68 → 01/75							FCP809	LUC	✓	✓	✓	✎	✓
-----	----	---------------	--	--	--	--	--	--	--------	-----	---	---	---	---	---

### 145

2.0	80	01/68 → 01/75							FCP809	LUC	✓	✓	✓	✎	✓
-----	----	---------------	--	--	--	--	--	--	--------	-----	---	---	---	---	---

### 164

3.0	85	01/68 → 01/75							FCP809	LUC	✓	✓	✓	✎	✓
-----	----	---------------	--	--	--	--	--	--	--------	-----	---	---	---	---	---

### 1800

1.8 i ES		01/72 → 12/73							FCP809	LUC	✓	✓	✓	✎	✓
----------	--	---------------	--	--	--	--	--	--	--------	-----	---	---	---	---	---

1.8 S		01/69 → 12/70	FCP9	LUC	✓		✓								
-------	--	---------------	------	-----	---	--	---	--	--	--	--	--	--	--	--

### 221

2.0	66	01/69 → 12/70	FCP9	LUC	✓		✓								
-----	----	---------------	------	-----	---	--	---	--	--	--	--	--	--	--	--

### 240

		01/74 → 08/93							FCP809	LUC	✓	✓	✓	✎	✓
--	--	---------------	--	--	--	--	--	--	--------	-----	---	---	---	---	---

All i		01/74 → 08/93							FCP2	ATE	✓	✎	✓	✎	✎
-------	--	---------------	--	--	--	--	--	--	------	-----	---	---	---	---	---

All i		01/74 → 08/93							FCP809	LUC	✓	✓	✓	✎	✓
-------	--	---------------	--	--	--	--	--	--	--------	-----	---	---	---	---	---

### 242

All i	60, 73	09/74 → 12/79							FCP2	ATE	✓	✎	✓		✎
-------	--------	---------------	--	--	--	--	--	--	------	-----	---	---	---	--	---

All i	60, 73	09/74 → 12/79							FCP809	LUC	✓	✓	✓	✎	✓
-------	--------	---------------	--	--	--	--	--	--	--------	-----	---	---	---	---	---

### 244

		09/74 → 06/85							FCP809	LUC	✓	✓	✓	✎	✓
--	--	---------------	--	--	--	--	--	--	--------	-----	---	---	---	---	---

All i		09/74 → 06/85							FCP2	ATE	✓	✎	✓		✎
-------	--	---------------	--	--	--	--	--	--	------	-----	---	---	---	--	---

All i		09/74 → 06/85							FCP809	LUC	✓	✓	✓	✎	✓
-------	--	---------------	--	--	--	--	--	--	--------	-----	---	---	---	---	---

### 245

		09/74 → 06/85							FCP809	LUC	✓	✓	✓	✎	✓
--	--	---------------	--	--	--	--	--	--	--------	-----	---	---	---	---	---

All i		09/74 → 06/85							FCP2	ATE	✓	✎	✓		✎
-------	--	---------------	--	--	--	--	--	--	------	-----	---	---	---	--	---

All i		09/74 → 06/85							FCP809	LUC	✓	✓	✓	✎	✓
-------	--	---------------	--	--	--	--	--	--	--------	-----	---	---	---	---	---

### 262

2.7	92, 109	09/74 → 08/82							FCP809	LUC	✓	✓	✓	✎	✓
-----	---------	---------------	--	--	--	--	--	--	--------	-----	---	---	---	---	---

2.8	114	09/74 → 08/82							FCP809	LUC	✓	✓	✓	✎	✓
-----	-----	---------------	--	--	--	--	--	--	--------	-----	---	---	---	---	---

### 264

2.4	60	09/74 → 08/82							FCP809	LUC	✓	✓	✓	✎	✓
-----	----	---------------	--	--	--	--	--	--	--------	-----	---	---	---	---	---

2.7	92, 106	09/74 → 08/82							FCP809	LUC	✓	✓	✓	✎	✓
-----	---------	---------------	--	--	--	--	--	--	--------	-----	---	---	---	---	---

2.8	91, 114	09/74 → 08/82							FCP809	LUC	✓	✓	✓	✎	✓
-----	---------	---------------	--	--	--	--	--	--	--------	-----	---	---	---	---	---

### 265

2.7	92, 102, 109	09/74 → 08/82							FCP809	LUC	✓	✓	✓	✎	✓
-----	--------------	---------------	--	--	--	--	--	--	--------	-----	---	---	---	---	---

2.8	91, 114	09/74 → 08/82							FCP809	LUC	✓	✓	✓	✎	✓
-----	---------	---------------	--	--	--	--	--	--	--------	-----	---	---	---	---	---

### 340

1.4	47, 50, 52	09/82 → 10/91	FCP370	LUC	✓	✎	✓	✎							
-----	------------	---------------	--------	-----	---	---	---	---	--	--	--	--	--	--	--

1.6 D	40	09/82 → 10/91	FCP370	LUC	✓	✎	✓	✎							
-------	----	---------------	--------	-----	---	---	---	---	--	--	--	--	--	--	--

1.7	60	09/82 → 10/91	FCP370	LUC	✓	✎	✓	✎							
-----	----	---------------	--------	-----	---	---	---	---	--	--	--	--	--	--	--

### 343

1.4	47	02/76 → 08/92	FCP370	LUC	✓	✎	✓	✎							
-----	----	---------------	--------	-----	---	---	---	---	--	--	--	--	--	--	--

1.4	47	02/76 → 08/92	FCP810	LUC	✓	✎	✓	✎							
-----	----	---------------	--------	-----	---	---	---	---	--	--	--	--	--	--	--

2.0	71	02/76 → 08/92	FCP370	LUC	✓	✎	✓	✎							
-----	----	---------------	--------	-----	---	---	---	---	--	--	--	--	--	--	--

2.0	71	02/76 → 08/92	FCP810	LUC	✓	✎	✓	✎							
-----	----	---------------	--------	-----	---	---	---	---	--	--	--	--	--	--	--

- ✓ Available
- ✎ Exhausting
- ✗ Not Available
- ✎ Make to order
- ✎ In Introduction



kW



...VOLVO				COMPOUND AVAILABILITY					COMPOUND AVAILABILITY				
				H	C	R	W	Z	H	C	R	W	Z
<b>345</b>													
1.4	46, 47, 50, 51, 52	06/79 → 12/92	FCP370 LUC	✓	✉	✓	✉	✉					
2.0	71	06/79 → 12/92	FCP370 LUC	✓	✉	✓	✉	✉					
<b>360</b>													
1.4		01/76 → 08/79	FCP810 LUC	✓	✉	✓	✉	✉					
1.4		09/79 → 12/91	FCP370 LUC	✓	✉	✓	✉	✉					
2.0	66, 74, 75, 80, 82, 85	09/82 → 02/90	FCP370 LUC	✓	✉	✓	✉	✉					
<b>66</b>													
1.3	42	01/75 → 09/80	FCP3 ATE	✓		✓	✉						
<b>740</b>													
All i		01/83 → 10/91							FCP2 ATE	✓	✉	✓	✉
<b>760</b>													
All i		01/82 → 12/83							FCP2 ATE	✓	✉	✓	✉
All i		01/84 → 08/87							FCP2 ATE	✓	✉	✓	✉
All i		08/91 → 12/92							FCP2 ATE	✓	✉	✓	✉
All i		09/87 → 07/91							FCP2 ATE	✓	✉	✓	✉
<b>780</b>													
2.0 i		01/88 → 12/90							FCP2 ATE	✓	✉	✓	✉
2.4 i		01/88 → 12/90							FCP2 ATE	✓	✉	✓	✉
2.8 Bertone	108, 125	08/86 → 07/90							FCP2 ATE	✓	✉	✓	✉
<b>850</b>													
All i	103, 105, 125	06/91 → 12/96	FCP1285 ATE	✓		✓			FCP2 ATE	✓	✉	✓	✉
All i		01/94 → 12/96	FCP1285 ATE	✓		✓			FCP2 ATE	✓	✉	✓	✉
All i	103, 105, 125	06/91 → 12/93	FCP1285 ATE	✓		✓			FCP2 ATE	✓	✉	✓	✉
<b>940</b>													
All i		08/90 → 09/93							FCP2 ATE	✓	✉	✓	✉
<b>960</b>													
All i Saloon		08/90 → 08/93							FCP2 ATE	✓	✉	✓	✉
All i Saloon		09/93 → 11/94							FCP2 ATE	✓	✉	✓	✉
All i Saloon		11/94 → 10/96							FCP2 ATE	✓	✉	✓	✉
All i SW Estate		08/90 → 08/93							FCP2 ATE	✓	✉	✓	✉
All i SW Estate		09/93 → 10/96							FCP2 ATE	✓	✉	✓	✉
<b>C70</b>													
2.0 T5 20V		06/97 →	FCP1285 ATE	✓		✓			FCP2 ATE	✓	✉	✓	✉
2.3 i T5 20V	177	06/97 →	FCP1285 ATE	✓		✓			FCP2 ATE	✓	✉	✓	✉
2.5 T 20V	142	06/97 →	FCP1285 ATE	✓		✓			FCP2 ATE	✓	✉	✓	✉
<b>S40</b>													
1.6 16V	77	03/96 → 12/98	FCP1093	✓		✗							
1.8 16V	85	03/96 → 12/98	FCP1093	✓		✗							
1.9 T4 16V	147	06/97 → 12/98	FCP1093	✓		✗							
1.9 TD	66	03/96 → 12/98	FCP1093	✓		✗							
2.0 16V	100	03/96 → 12/98	FCP1093	✓		✗							
<b>S40 Mk2</b>													
All T5, T5 AWD	220	01/04 →	FCP1706 ATE	✓			✉						
<b>S60</b>													
2.0 i (Turbo) 20V		07/00 →	FCP1382		✉								
2.3 i (Turbo) 20V		07/00 →	FCP1382		✉								
2.4 i (Turbo) 20V		07/00 →	FCP1382		✉								
2.4 TDi 20V		03/01 →	FCP1382		✉								
2.5 i (Turbo) 20V		03/03 →	FCP1382		✉								
S60 R 2.5 T AWD	221	03/03 →	FCP1334 BRM	✓		✓	✓	✓	FCP1348 BRM	✓		✓	✓
<b>S70</b>													
2.0	93, 105, 132	01/97 → 11/00	FCP1285 ATE	✓		✓			FCP2 ATE	✓	✉	✓	✉
2.3 20V	177	01/97 → 11/00	FCP1285 ATE	✓		✓			FCP2 ATE	✓	✉	✓	✉
2.5 20V	106, 125	01/97 → 11/00	FCP1285 ATE	✓		✓			FCP2 ATE	✓	✉	✓	✉
<b>S80</b>													
2.0 i (Turbo) 20V		07/98 →	FCP1382		✉								
2.4 20V		07/98 →	FCP1285 ATE	✓		✓							
2.4 D		08/01 →	FCP1382		✉								
2.4 TDi D5		08/01 →	FCP1382		✉								
2.5 TDi		07/98 →	FCP1382		✉								
2.8 i T6 24V		07/98 →	FCP1382		✉								
2.9 i 24V		07/98 →	FCP1382		✉								



KW

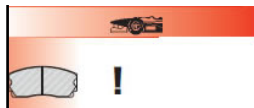

!



!

## ...VOLVO

### S80 II

2.0	107	01/08 →
2.0D	100	01/08 →
2.4 D	120	03/06 →
2.4 D5	136	03/06 →
2.5 T	147	03/06 →
3.0 T6	210	01/07 →
3.2	175	03/06 →
4.4 V8	232	03/06 →

#### COMPOUND AVAILABILITY

H C R W Z

FCP1917	TRW, without EPB	✓					
FCP1917	TRW, without EPB	✓					
FCP1917	TRW, without EPB	✓					
FCP1917	TRW, without EPB	✓					
FCP1917	TRW, without EPB	✓					
FCP1917	TRW, without EPB	✓					
FCP1917	TRW, without EPB	✓					
FCP1917	TRW, without EPB	✓					

#### COMPOUND AVAILABILITY

H C R W Z

### V40

1.6 16V	77	03/96 → 12/98
1.8 16V	85	03/96 → 12/98
1.9 16V	147	06/97 → 12/98
1.9 TD	66	03/96 → 12/98
2.0 16V	100	03/96 → 12/98

FCP1093	✓		✗				
FCP1093	✓		✗				
FCP1093	✓		✗				
FCP1093	✓		✗				
FCP1093	✓		✗				



### V50 Estate

All T5, T5 AWD	220	04/04 →
----------------	-----	---------

FCP1706	ATE	✓				☑	
---------	-----	---	--	--	--	---	--

--	--	--	--	--	--	--	--

--	--	--	--	--	--	--	--

### V70

2.0	93, 132, 166,	01/97 → 02/00
2.0 i (Turbo) 20V		07/01 →
2.3 20V	177	01/97 → 02/00
2.3 i T5		03/00 →
2.4	103, 106, 125, 142	01/97 → 02/00
2.4 i,(Turbo)		03/00 →
2.4 TD D5		03/00 →
2.5 TDi		03/00 →

FCP1285	ATE	✓		✓			
FCP1382		☑					
FCP1285	ATE	✓		✓			
FCP1382		☑					
FCP1285	ATE	✓		✓			
FCP1382		☑					
FCP1382		☑					
FCP1382		☑					

FCP2	ATE	✓	☑	✓		☑	
FCP2	ATE	✓	☑	✓		☑	
FCP2	ATE	✓	☑	✓		☑	

### V70 II

R 2.5 T AWD	221	03/03 →
-------------	-----	---------

FCP1334	BRM	✓		✓	✓	✓	
---------	-----	---	--	---	---	---	--

FCP1348	BRE	✓					☑
---------	-----	---	--	--	--	--	---

--	--	--	--	--	--	--	--

### V70 III

2.0	107	10/07 →
2.0D	100	10/07 →
2.4 D	120	03/06 →
2.4 D5	136	08/07 →
2.5 T	147	08/07 →
3.0 T6	210	08/07 →
3.2	175	08/07 →

FCP1917	TRW, without EPB	✓					
FCP1917	TRW, without EPB	✓					
FCP1917	TRW, without EPB	✓					
FCP1917	TRW, without EPB	✓					
FCP1917	TRW, without EPB	✓					
FCP1917	TRW, without EPB	✓					
FCP1917	TRW, without EPB	✓					

### XC70 II

2.4 D	120	08/07 →
2.4 D5	136	08/07 →
3.2	175	08/07 →

FCP1917	TRW, without EPB	✓					
FCP1917	TRW, without EPB	✓					
FCP1917	TRW, without EPB	✓					

### XC90

2.4 D5 (not for 16")	120, 147, 136	10/02 →
2.5 T (not for 16")	154	10/02 →
3.0 T6 (not for 16")	200	10/02 →
3.2 (not for 16")	175, 179	05/06 →
4.4 V8 (not for 16")	232	01/05 →

FCP1631	ATE	☑					
FCP1631	ATE	☑					
FCP1631	ATE	☑					
FCP1631	ATE	☑					
FCP1631	ATE	☑					



## WARTBURG

### 311

1.1 (A.W.E.)		01/83 →
--------------	--	---------

FCP461	ATE	✓		✓			
--------	-----	---	--	---	--	--	--

--	--	--	--	--	--	--	--

--	--	--	--	--	--	--	--

### 353

1.0	37	02/75 → 01/89
1.3 (A.W.E.)	43	01/83 →

FCP461	ATE	✓		✓			
FCP461	ATE	✓		✓			



✓ Available    ⚠ Exhausting  
 ✗ Not Available    ☑ Make to order  
 ⚡ In Introduction



Updated on 30th Jan 2014



kW



YUGO

YUGO					COMPOUND AVAILABILITY					COMPOUND AVAILABILITY							
					H	C	R	W	Z	H	C	R	W	Z			
<b>311</b>																	
1.1 (Zastava)	41	01/83 → 08/87	FCP29	BDX	✓		✓										
<b>313</b>																	
1.3 (Zastava)	47	01/83 → 07/88	FCP29	BDX	✓		✓										
<b>411</b>																	
1.1 (Zastava)	41	01/84 → 12/86	FCP29	BDX	✓		✓										
<b>413</b>																	
1.3 (Zastava)	47	01/84 → 12/86	FCP29	BDX	✓		✓										
<b>45</b>																	
0.9 (Zastava)	48	04/80 → 04/91	FCP29	BDX	✓		✓										
<b>511</b>																	
1.1 (Zastava)	41	01/83 → 08/90	FCP29	BDX	✓		✓										
<b>513</b>																	
1.3 (Zastava)	47	01/83 → 06/90	FCP29	BDX	✓		✓										
<b>65</b>																	
1.3 (Zastava)	50	04/80 → 04/91	FCP29	BDX	✓		✓										
<b>Florida</b>																	
1.4 (Zastava)	52	01/90 →	FCP524	LUC			✓										
<b>Miami</b>																	
1.4 (Zastava)	52	11/89 →	FCP524	LUC			✓										
<b>Sana</b>																	
1.4 (Zastava)	52	11/89 → 10/93	FCP524	LUC			✓										
<b>Tempo</b>																	
0.9 (Zastava)	33	05/91 → 12/93	FCP29	BDX	✓		✓										
1.1 (Zastava)	41	05/91 → 12/93	FCP29	BDX	✓		✓										
1.3 (Zastava)	48	02/91 → 05/98	FCP29	BDX	✓		✓										
1.3 Zastava		10/83 → 12/89	FCP29	BDX	✓		✓										



# PADS FOR RACING CALIPERS

## PASTIGLIE PER PINZE DA COMPETIZIONE



### ...ALCON

Advantage Extreme 4 piston	FRP3135
Advantage Extreme 6 piston	FRP3134
Alcon	FRP3069
B type - Th. 16.0mm	FRP1077
B type - Th. 18.0mm	FRP3007
B type - Th. 20.0mm	FRP302
B type - Th. 25.0mm	FRP1078
F type - Th. 28mm	FRP3059
H type - Th. 16.0mm	FRP219
H type - Th. 16.0mm	FRP218
K type - Th. 16mm	FRP3009
K type - Th. 20mm	FRP3012
PNF0083X264	FRP201
PNF0084X222 (Truck pad)	FRP3027
PNF0084X225	FRP3001
PNF0084X245	FRP216
PNF0084X265	FRP1077
PNF0084X272	FRP1058
PNF0084X276	FRP3018
PNF0084X282	FRP1064
PNF0084X283	FRP3004
PNF0084X284	FRP502
PNF0084X288	FRP216
PNF0084X304	FRP3028
PNF0084X305	FRP3025
PNF0084X306	FRP3025
PNF0084X322	FRP1079
PNF0084X331	FRP216
PNF3430X275	FRP3043
PNF4441X634	FRP302
PNF4441X714	FRP1077
PNF4441X723	FRP1077
PNF4441X728	FRP302
PNF4441X737	FRP302
PNF4441X754	FRP302
PNF4463X529	FRP219
PNF4463X551	FRP218
PNF4463X553	FRP218
PNF4463X554	FRP201
PNF4463X555	FRP201
PNF4463X568	FRP201
PNF4463X572	FRP219
PNF4476X541 / 545	FRP3009
PNF4476X549	FRP3012
PNF4489X519	FRP3000
PNF4489X532	FRP3003
PNF4489X534	FRP3000
PNF4489X543	FRP3015
PNF4489X544	FRP3015
PNF4489X562	FRP3000

PNF4493X501	FRP3026
PNF4493X503	FRP3026
PNF4493X603	FRP3044
PNF4495X501	FRP3039
PNF4495X504	FRP3037
PNF4495X505	FRP3039
PNF4496X515 (Subaru WRC 03 Front) - Th. 18mm	FRP3074
PNF4497x607 - Monoblock 6 - Th. 16mm	FRP3081
PNF4498x603 - Monoblock 4 - Th. 15mm	FRP3082
R type - Th. 14.4mm	FCP809
R type - Th. 14.4mm	FCP810
Subaru Impreza Alcon/Prodrive kit - Th. 16.0mm	FRP1077
TA 6 - Th. 20mm	FRP3014
TA 6+ type - Th. 20mm	FRP3039
Type 6 x 2 - Th. 16.0mm	FRP3006
XF type (scalloped) - Th. 28mm	FRP3060
XR 6 type - Th. 28mm	FRP3015

### AP RACING

"CP5111 Family"	FCP1562
A1GP cars 2006-2007	FRP3073
CP 2485 - Th. 14.4mm	FCP825
CP 2505 - Th. 10.4mm	FCP342
CP 2576 - Th. 14.4mm	FCP825
CP 2577 - Th. 14.4mm	FCP825
CP 3176 - Th. 14.4mm	FCP825
CP 3177 - Th. 14.4mm	FCP825
CP 3178 - Th. 14.4mm	FCP825
CP 3676 - Th. 14.4mm	FCP825
CP 3677 - Th. 14.4mm	FCP825
CP 3696 - Th. 10.4mm	FCP342
CP 4586 - Th. 14.4mm	FCP825
CP 4596 - Th. 14.4mm	FCP825
CP 5211 - Th. 14.4mm	FCP825
CP 5310 - Th. 14.4mm	FCP825
CP 5311 - Th. 14.4mm	FCP825
CP2270 - Th. 15.0mm	FRP203
CP2271 - Th. 15.0mm	FRP203
CP2279 - Th. 16.7mm	FRP3018
CP2279 - Th. 20.3mm	FRP3073
CP2279 - Th. 20.3mm	FRP212
CP2340	FRP218
CP2340	FRP3021
CP2340	FRP201
CP2361 - Th. 15.9mm	FRP201
CP2372 - Th. 15.8mm	FRP201
CP2373	FRP202
CP2382	FRP202
CP2383	FRP202
CP2383/3 - Th. 15.8mm	FRP201
CP2384	FRP202
CP2749 - Th. 28mm	FRP3059



# PADS FOR RACING CALIPERS

## PASTIGLIE PER PINZE DA COMPETIZIONE



### ...AP RACING

CP2749 Th. 28mm	FRP3060
CP3215	FRP216
CP3215	FRP3018
CP3215 - Th. 16.8mm (previously FRP3072)	FRP3091
CP3228 - Th. 16.0mm	FRP218
CP3307 - Th. 17.0mm	FRP216
CP3344 - Th. 16.0mm	FRP219
CP3345 - Th. 16.0mm	FRP219
CP3395 - Th. 20.3mm	FRP212
CP3434 - Th. 17.0mm	FRP216
CP3558	FRP1060
CP3558	FRP3061
CP3558	FRP3014
CP3714	FRP217
CP3720 - Th. 17.0mm	FRP216
CP3735 - Th. 16.0mm	FRP218
CP3788 - Th. 20.3mm	FRP212
CP3789 - Th. 20.3mm	FRP212
CP3796	FRP3006
CP3796 - Th. 18.0mm	FRP3000
CP3799 - Th. 20.3mm	FRP212
CP3894	FRP3003
CP3894 - Th. 18.0mm	FRP3000
CP3894 - Th. 18mm	FRP3054
CP3996 - Th. 18.0mm	FRP3000
CP4090 - Th. 18.0mm	FRP3000
CP4096 - Th. 18.0mm	FRP3000
CP4098 - Th. 18.0mm	FRP3000
CP4140	FRP3001
CP4152 - Th. 16.0mm	FRP219
CP4218 - Th. 25mm	FRP3014
CP4230 - Th. 28.5mm	FRP3015
CP4296	FRP1061
CP4556 - Th. 16.0mm	FRP218
CP4558 - Th. 16.0mm	FRP218
CP4567 - Th. 16.0mm	FRP219
CP4595	FRP3015
CP4751	FRP501
CP4848	FRP3086
CP4890 - Th. 16.0mm	FRP216
CP5000 - Th. 16.0mm	FRP216
CP5070 - Th. 17mm	FRP3076
CP5070 - Th. 17mm	FRP3077
CP5100 - Th. 16.0mm	FRP219
CP5104 - Th. 16.0mm	FRP219
CP5119	FRP3056
CP5144-1003 (Big Brake Kit)	FRP201
CP5148	FRP3020
CP5148 - Th. 18mm	FRP3086
CP5200 - Th. 17.0mm	FRP216

CP5555 - Th. 18mm	FRP3054
CP5570 Kits - Th. 17mm	FRP3076
CP5575-1004 (Big Brake Kit)	FRP3077
CP5788	FRP3024
CP5805	FRP503
CP5820 - Th. 30mm	FRP3040
CP6030 - Th. 16.0mm	FRP218
CP6210 - Th. 28mm	FRP3037
CP6210 -Th. 30mm	FRP3055
CP6230 - Th. 25mm	FRP3039
CP6600	FRP3107
CP6600 - Th. 16.9mm	FRP3083
CP6627	FRP3115
CP7031 - Th. 16mm (F3 system)	FRP3102
CP7040	FRP3114
CP7040 - Th. 16.9mm	FRP3084
CP7600 - Th. 16.1mm	FRP3085
CP8310	FRP3027
CP8350	FRP3116
CP8350 - Th. 20mm	FRP3097
CP8351	FRP3116
F3	FRP3021
Renault CLIO II Super 1600 - Front - Th. 17.0mm	FRP216
Renault CLIO II Super 1600 - Rear - Th. 10.4mm	FCP342
SC 200 - Th. 20.0mm	FRP501
SC 240 - Th. 20.0mm	FRP308
SC 300 - Th. 20.0mm	FRP501
SC 350 - Th. 20.0mm	FRP501
SC 360 - Th. 20.3mm	FRP503
SC 500 - Th. 28mm	FRP3059
SC 560 - Th. 20.3mm	FRP503
SC 660 - Th. 25mm	FRP3014
SC 660 - Th. 28.5mm	FRP3015
SC 670 - Th. 25mm	FRP3014
SC 670 - Th. 28.5mm	FRP3015
SC 680 - Th. 30mm	FRP3040
Subaru 06 MY VO Gr N - Rear - Th. 16.0mm	FRP219
Subaru IMPREZA 06 MY VO Gr N - Front - Th. 17.0mm	FRP216

### AP RACING/BREMBO

AP Racing/Brembo handbrake	FRP3126
----------------------------	---------

### BREMBO

07.5064.7	FRP308
07.5064.8	FRP1079
07.5139	FRP3032
07.5139.0	FRP1077
07.5139.3	FRP1078
07.5139.6	FRP302
07.5169.9	FRP3024
07.5308.9	FRP3042
07.5684.2	FRP1058

# PADS FOR RACING CALIPERS

## PASTIGLIE PER PINZE DA COMPETIZIONE



### ...BREMBO

07.5684.2	FRP1064
07.5684.5	FRP3022
07.5684.5	FRP3023
07.5684.8	FRP3033
07.5868	FRP1059
07.5868.2	FRP3004
07.6955.3	FRP3053
07.7293.6	FRP3031
07.7614.2	FRP3040
07.7614.3	FRP3046
07.7614.5	FRP3047
07.7810.1	FRP3035
07.7810.2	FRP3034
07.7810.3	FRP3045
07.7859.1	FRP3029
07.7859.2	FRP3030
07.7869.12	FRP3070
07.A262.20 - Th. 16mm (New Brembo F3 System 2007->)	FRP3103
107.8590.15 Nissan GTR (R35)	FRP3106
20.3655.01 - Th. 14.4mm	FCP825
20.4548.03 - Th. 25.0mm	FRP1078
20.4862.05 - Th. 18.4mm	FCP1281
20.5187.30 - Th. 17.3mm	FCP721
6 piston D48	FRP3099
6 piston D58	FRP3098
6 Pistons	FRP3100
6 Pistons - narrow annulus - Th. 27.8mm	FRP3080
Brembo F3 System (prior 2007) - Th. 16mm	FRP3071
Brembo System - S2000 Asphalt - Th. 17.5mm	FRP3088
Brembo System - S2000 Gravel - Th. 17.5mm	FRP3087
FERRARI 458 GT3	FRP3128
Ford WRC - Th. 16mm	FRP3022
GT front - Th. 29mm	FRP3031
GT3 caliper 2009	FRP3110
Mitsubishi EVO IX-X Gr N - Front Asphalt - Th. 17.5mm	FRP3088
Mitsubishi EVO IX-X Gr N - Front Gravel - Th. 17.5mm	FRP3087
Mitsubishi EVO IX-X Gr N - Rear - Th. 20mm	FRP308
Nascar - Th. 20.0mm	FRP308
VW upgrade Kit 2009 (SEAT Force, Leon II, Ibiza 6L / VW Golf IV-V)	FRP3109
x2.023.21 - Th. 20mm	FRP3024
x2.028.01 - Th. 20mm	FRP3024
x2.029.21 - Th. 20.0mm	FRP308
x2.029.71 - Th. 20.0mm	FRP308
x2.040.01 - Th. 16.0mm	FRP1079
X2.046.01 - Th. 18mm	FRP3070
x6.059.41 - Th. 20.0mm	FRP308
x9.005.91 - Th. 16.0mm	FRP1077
x9.011.01 - Th. 20.0mm	FRP308
x9.011.31 - Th. 20.0mm	FRP308
x9.014.03 - Th. 20.0mm	FRP308

x9.060.51 - Th. 25.0mm	FRP1078
x9.060.71 - Th. 26mm	FRP3028
x9.066.91 - Th. 16.0mm	FRP1079
X93.41.21/24 (8 Pistons WRC TARMAC & Touring Car)	FRP3113
x93.41.41 - Th. 20.0mm	FRP1064
x93.45.01 - Th. 26mm	FRP3029
x93.45.11 - Th. 27.5mm	FRP3053
x93.73.01 - Th. 20.0mm	FRP1064
x93.73.11 - Th. 20.0mm	FRP1064
x94.44.11 - Th. 21mm	FRP3034
X94.44.21	FRP3004
x94.75.11 - Th. 16.0mm	FRP1079
XA3.02.31/32 (6 POT)	FRP3031
XA5.E8.K1 + XA4.17.K7/K8	FRP3109

### CAPARO

F.Renault 2010 -> front & rear	FRP3117
--------------------------------	---------

### CHEVROLET CRUZE CUP

ATE Kit	FRP3122
---------	---------

### CL BRAKES

5015W58T17	FRP3078
------------	---------

### COLEMAN

GM type - Th. 15mm	FRP3057
series I,II - Th. 20.0mm	FRP501
Series III	FRP3070
Series IV - Th. 18.0mm	FRP3003

### HOWE

GM type - Th. 15mm	FRP3057
--------------------	---------

### JAS

Honda Civic Type R - Rally R3 Gravel [JAS Motorsport]	FRP3105
---	---------

### JFZ / SIERRA

GM type - Th. 15mm	FRP3057
GN series - Th. 20.3mm	FRP503
Mini GN dual - Th. 12.4mm	FRP502
Mini GN single - Th. 13.0mm	FRP506
XL series - Th. 20.3mm	FRP503

### KSPORT

12 pistons 380mm	FCP1625
------------------	---------

### LOCKHEED

LD - 20 - Th. 14.4mm	FCP825
LD -19 - Th. 10.4mm	FCP342

### LUCAS GIRLING

	FCP825
--	--------

# PADS FOR RACING CALIPERS

## PASTIGLIE PER PINZE DA COMPETIZIONE



### ...LUCAS GIRLING

12/3	FCP815
14LF & D14R	FCP809
17/3	FCP9
AR	FRP5002
AR MK5	FRP101
M16	FCP167

### MWE

Drag 2 piston - Th. 15.0mm	FRP506
----------------------------	--------

### OUTLAW

1000 - Th. 13.0mm	FRP506
1500 - Th. 13.0mm	FRP506
2000 / 2500 - Th. 12.4mm	FRP502
3000 / 3500 / 4000 - Th. 20.0mm	FRP501
9000 - Th. 28mm	FRP3059
Bridgebolt 2000 - Th. 12.4mm	FRP504
Bridgebolt 2500 - Th. 12.4mm	FRP504

### PBR

Corvette Z06 C6 3 sets front axle 2 sets rear axle	FRP3094
--	---------

### PFC

F3 Brake System FRONT-REAR - Th. 18mm [P7835]	FRP3092
---	---------

### PORSCHE

GT3 Super Cup - Front	FRP3123
GT3 Super Cup 2011 - Rear	FRP302

### RACING APPLICATION

FORD WRC	FRP3022
----------	---------

### RACING FITMENT

Acura / Honda / Rover (as FCP905 but Th. 19.5mm)	FRP3062
Buick - front and rear	FRP3057
Cadillac, Chevrolet, Jeep, Oldsmobile, Pontiac - front	FRP3057
Ferrari Challenge 3.6 ->Rear, Adaptable to Tarox Caliper	FRP3078
JFZ / Sierra caliper GM type	FRP3057
JFZ / Sierra caliper GN Series / XL Series	FRP503
JFZ / Sierra caliper Mini GN single	FRP506
Stock Cars	FRP3097

### ROTORA

FC2	FCP1562
FC4	FRP3028
FC6	FRP3003
FC8	FCP1664
FF4	FRP1077

### TAROX

TAROX B32-6 (6 pots) - adaptable	FRP3078
----------------------------------	---------

### TOYOTA

TOYOTA Hi-Ace	FRP3127
---------------	---------

### WILWOOD

CALIPER 150-8813 K 99686-CU Pad Type 7912 7B188 - Th. 12.4mm	FRP3108
Dynalite b/bolt - Th. 12.4mm	FRP504
Dynalite c/pin - Th. 12.4mm	FRP502
Dynalite single - Th. 13.0mm	FRP506
F3 - DYNAPRO Single Caliper, Type 6812 - Th. 12.7mm	FRP3104
GM II, GM III - Th. 15mm	FRP3057
GN III - Th. 20.3mm	FRP503
GT 4000	FRP3070
GT 6000 - Th. 28mm	FRP3059
GT 6000 radius - Th. 28mm	FRP3060
GT III - Th. 28mm	FRP3059
GT-III radius - Th. 28mm	FRP3060
Integra GT - Th. 20mm	FRP3024
Integra HP - Th. 27.5mm	FRP3053
Integra IP - Th. 26mm	FRP3029
IR - GT - Th. 20.0mm	FRP308
LC-GT - Th. 20.0mm	FRP501
SL-GT - Th. 20.0mm	FRP501
Superlite 4 - Th. 20.0mm	FRP501
Superlite 6 - Th. 20.0mm	FRP501

# FCP2



61.7mm = 2.429"



41.0mm = 1.614"



15.0mm = 0.591"

FMSI No: D031

**IMPORTANT NOTICE: Please note that the height measurement represents the radial depth, not the entire back plate**

ALFA ROMEO Front / Rear, AUDI Front, BMW Front / Rear, MASERATI Rear, MATRA Front, MERCEDES Rear, OPEL Front / Rear, PORSCHE Front / Rear, SAAB Front, TALBOT Front, VAUXHALL Front / Rear, VOLKSWAGEN Front, VOLVO Rear

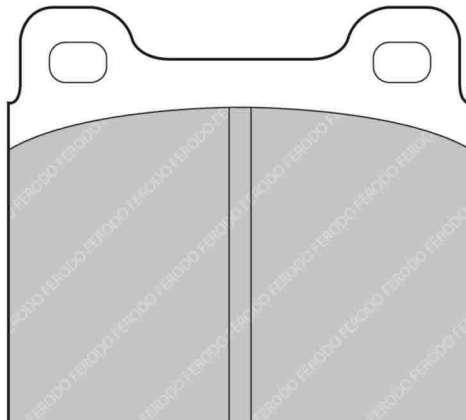

MATERIAL AVAILABILITY				
H	C	R	W	Z
✓	☒	✓		☒

CROSS REFERENCE	
CL BRAKES	4004
FMSI	D031
FMSI	D058
HAWK	HB172 0,595
MINTEX	MDB1002
MINTEX	MDB1068
PAGID	2723
PAGID	4304
PFC	0031.XX

# FCP3



55.7mm = 2.193"



37.7mm = 1.484"



14.5mm = 0.571"

WVA No: 20 009 15,00

FMSI No: D30

**IMPORTANT NOTICE: Please note that the height measurement represents the radial depth, not the entire back plate**

ALFA ROMEO Rear, BMW Rear, DAF Front, DODGE Front, NSU Front, OPEL Front, PORSCHE Front / Rear, SAAB Rear, TALBOT Front, VOLVO Front

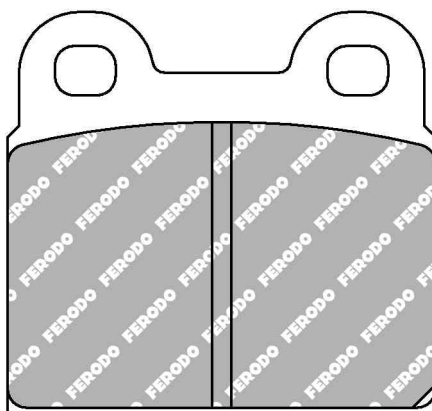

MATERIAL AVAILABILITY				
H	C	R	W	Z
✓		✓	☒	

CROSS REFERENCE	
CL BRAKES	4056
FMSI	D30
MINTEX	MDB1012
PAGID	4122
WVA	20 009 15,00

# FCP9



98.4mm = 3.874"



50.8mm = 2.000"



16.0mm = 0.630"

WVA No: 20 027 16,00

FMSI No: D004

**IMPORTANT NOTICE: Please note that the height measurement represents the radial depth, not the entire back plate**

AC Front, ASTON MARTIN Front, BRISTOL Front, FERRARI Front, FIAT Front, JAGUAR Front, JENSEN Front, LOTUS Front, ROVER Front, VOLVO Front

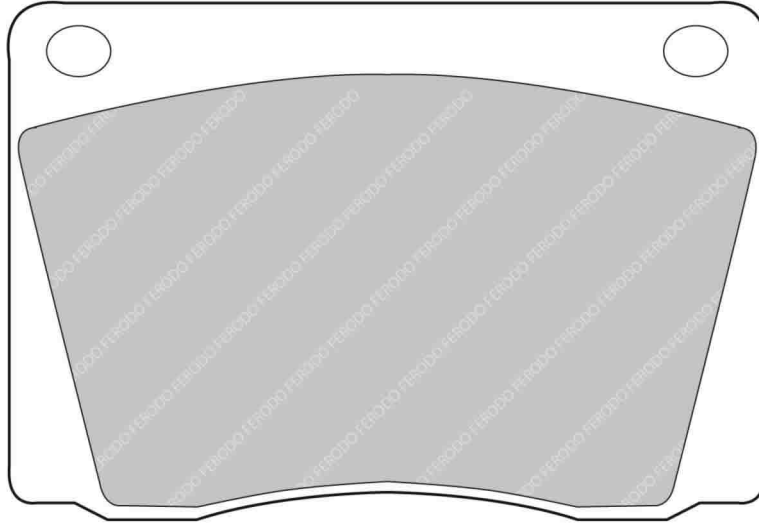

MATERIAL AVAILABILITY				
H	C	R	W	Z
✓		✓		

CROSS REFERENCE	
CL BRAKES	4114
EBC	DP108
FMSI	D004
MINTEX	MDB1499
MINTEX	MGB522
PAGID	8042
PAGID	ERS496
WVA	20 027 16,00

✓ Available    ⚠ Exhausting  
 ✗ Not Available    ✉ Make to order  
 🔄 In Introduction

**FERODO**  
RACING

Updated on 30th Jan 2014

**3001**

# FCP11



76.7mm = 3.020"



55.0mm = 2.165"



15.0mm = 0.591"

WVA No: 20 011 15,00

FMSI No: D045

**IMPORTANT NOTICE: Please note that the height measurement represents the radial depth, not the entire back plate**

ALFA ROMEO Front, FERRARI Front, LANCIA Front, MERCEDES Front, OPEL Front, PORSCHE Front, VAUXHALL Front

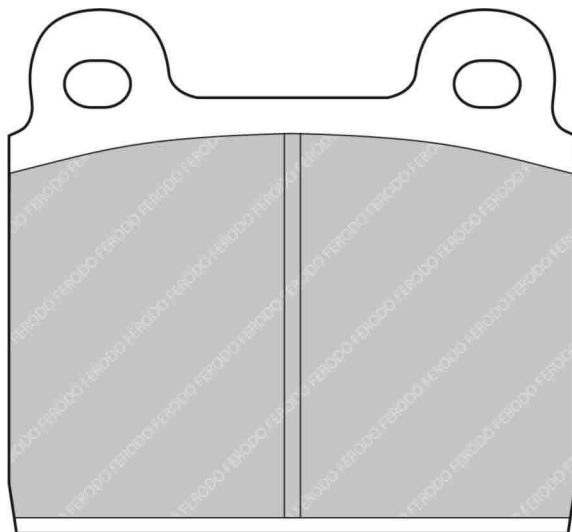

MATERIAL AVAILABILITY				
H	C	R	W	Z
✓		✓	✗	✓

CROSS REFERENCE	
CL BRAKES	4003
FMSI	D045
FMSI	D287
HAWK	HB171 0,59
MINTEX	MDB1003
MINTEX	MDB1455
PAGID	4501
PAGID	4503
PFC	0045.XX
WVA	20 011 15,00

# FCP22



109.0mm = 4.291"



36.0mm = 1.417"



10.0mm = 0.394"

**IMPORTANT NOTICE: Please note that the height measurement represents the radial depth, not the entire back plate**

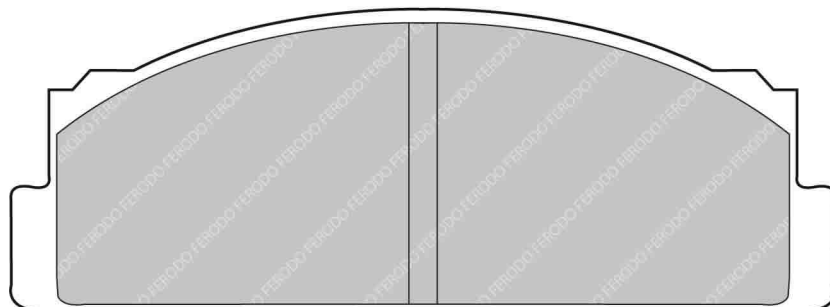

ALSO AVAILABLE		
SHAPE	TH. MM	NOTES
FCP29	17,5	

MATERIAL AVAILABILITY				
H	C	R	W	Z
✓				

3002

**FERODO**  
RACING

Updated on 30th Jan 2014

✓ Available    ⚠ Exhausting  
 ✗ Not Available    ✉ Make to order  
 🚧 In Introduction

# FCP29

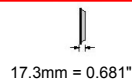
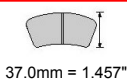
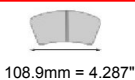

WVA No: 20 073 17,50 FMSI No: D54

**IMPORTANT NOTICE: Please note that the height measurement represents the radial depth, not the entire back plate**

AUTOBIANCHI Front, FIAT Front, FSO Front, INNOCENTI Front, LANCIA Front, POLSKI Front, SEAT Front, YUGO Front

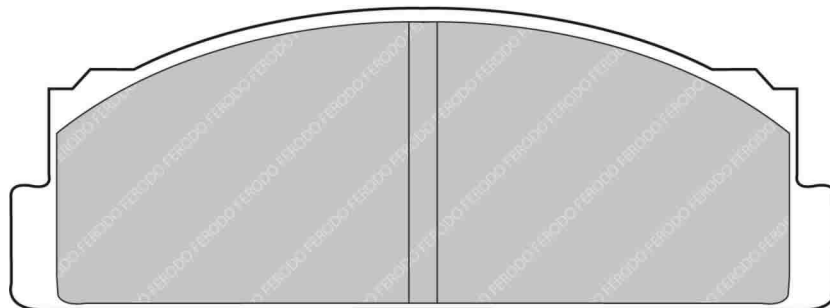

ALSO AVAILABLE		
SHAPE	TH. MM	NOTES
FCP22	10	

CROSS REFERENCE	
FMSI	D54
MINTEX	MDB1013
WVA	20 073 17,50

MATERIAL AVAILABILITY				
H	C	R	W	Z
✓		✓		

# FCP39

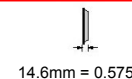
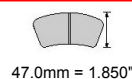

WVA No: 20 128 14,70

**IMPORTANT NOTICE: Please note that the height measurement represents the radial depth, not the entire back plate**

HONDA Front, NISSAN Front

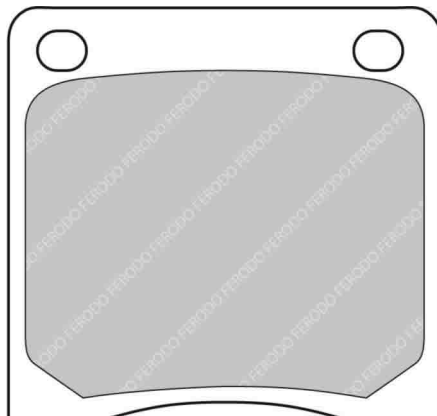

MATERIAL AVAILABILITY				
H	C	R	W	Z
	✉			

CROSS REFERENCE	
MINTEX	MDB1107
WVA	20 128 14,70

✓ Available    ⚠ Exhausting  
 ✗ Not Available    ✉ Make to order  
 🚧 In Introduction

# FCP72

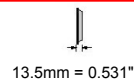
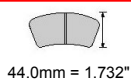

WVA No: 20 140 14,00

FMSI No: D97

**IMPORTANT NOTICE: Please note that the height measurement represents the radial depth, not the entire back plate**

ALFA ROMEO Front, CITROEN Front, DACIA Front, FIAT Front, MATRA Rear, NISSAN Front, PEUGEOT Front, RENAULT Front / Rear, RENAULT-ALPINE Front / Rear, TALBOT Front

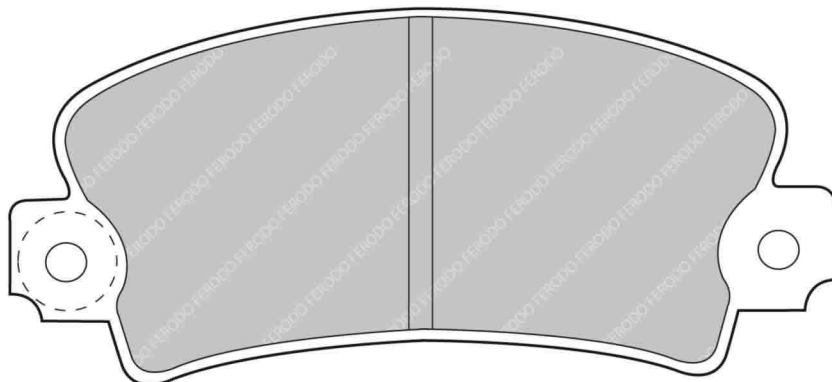

MATERIAL AVAILABILITY				
H	C	R	W	Z
✓		✓		

CROSS REFERENCE	
CL BRAKES	4062
FMSI	D97
WVA	20 140 14,00

# FCP93

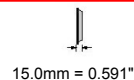
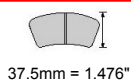

WVA No: 20 641 15,00

FMSI No: D127

**IMPORTANT NOTICE: Please note that the height measurement represents the radial depth, not the entire back plate**

ALFA ROMEO Rear, PORSCHE Rear

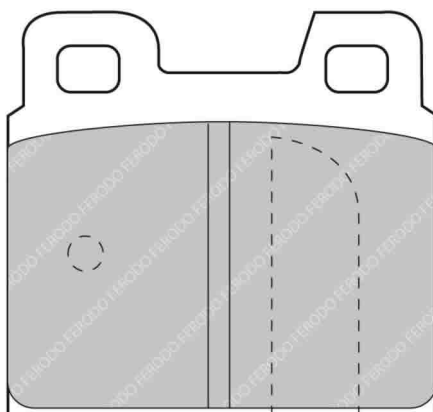

MATERIAL AVAILABILITY				
H	C	R	W	Z
✓		✓		

CROSS REFERENCE	
FMSI	D127
MINTEX	MDB1072
WVA	20 641 15,00



# FCP96

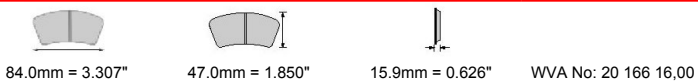

**IMPORTANT NOTICE: Please note that the height measurement represents the radial depth, not the entire back plate**

LADA Front

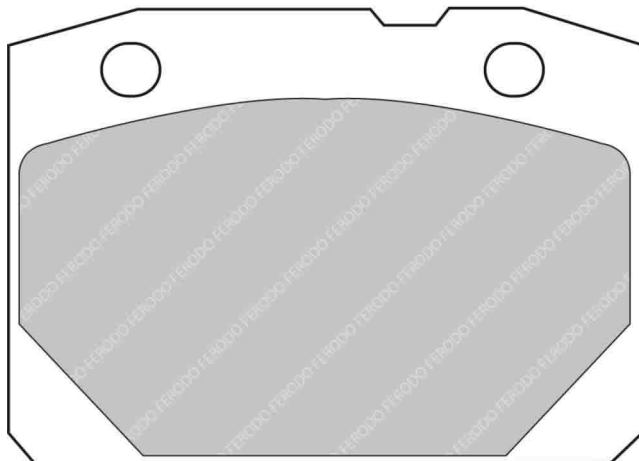

MATERIAL AVAILABILITY				
H	C	R	W	Z
✓		✓		

CROSS REFERENCE	
MINTEX	MDB1074
WVA	20 166 16,00

# FCP105

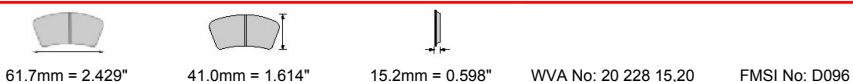

**IMPORTANT NOTICE: Please note that the height measurement represents the radial depth, not the entire back plate**

AUDI Front, VOLKSWAGEN Front

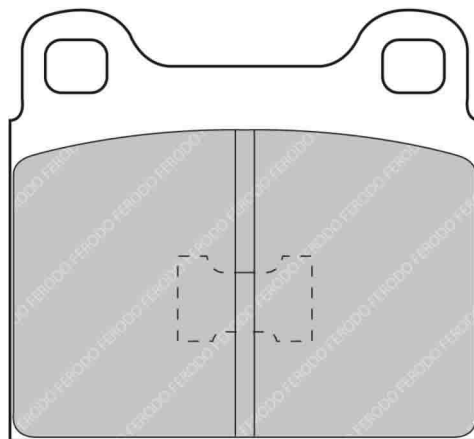

MATERIAL AVAILABILITY				
H	C	R	W	Z
		✉		

CROSS REFERENCE	
CL BRAKES	4009
FMSI	D096
HAWK	HB395 0,58
MINTEX	MDB1081
WVA	20 228 15,20



76.7mm = 3.020"



50.1mm = 1.972"



16.5mm = 0.650"

WVA No: 20 323 16,50

FMSI No: D109

**IMPORTANT NOTICE: Please note that the height measurement represents the radial depth, not the entire back plate**

ALFA ROMEO Front, BMW Front, LOTUS Front, MORGAN Front, OPEL Front, VAUXHALL Front

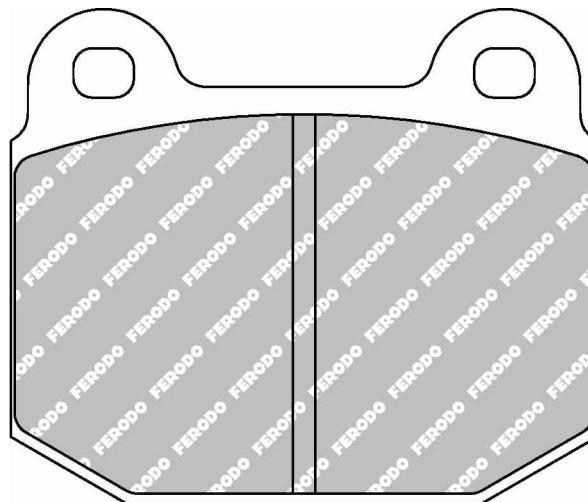

ALSO AVAILABLE		
SHAPE	TH. MM	NOTES
FCP1562	14.6	

MATERIAL AVAILABILITY				
H	C	R	W	Z
✓		✓		

CROSS REFERENCE	
CL BRAKES	4060
FMSI	D109
FMSI	D174
HAWK	HB180 0,64
MINTEX	MDB1099
PAGID	4507
PFC	0109.XX
PFC	0174.XX
WVA	20 323 16,50

# FCP167



78.1mm = 3.075"



52.0mm = 2.047"



15.4mm = 0.606"

WVA No: 20 491 15,20

FMSI No: D330

**IMPORTANT NOTICE: Please note that the height measurement represents the radial depth, not the entire back plate**

AC Front, CATERHAM Front, FORD Front, HYUNDAI Front, LOTUS Front

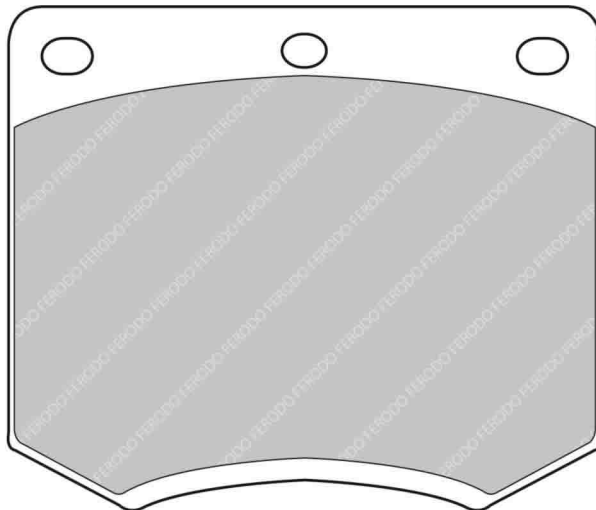

MATERIAL AVAILABILITY				
H	C	R	W	Z
✓	✓	✓	✗	✓

CROSS REFERENCE	
CL BRAKES	4085
EBC	DP2291
FMSI	D330
MINTEX	MGB633
PAGID	4905
WVA	20 491 15,20

# FCP170

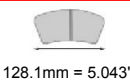

128.1mm = 5.043"



48.0mm = 1.890"



15.0mm = 0.591"

WVA No: 20 476 15,00

**IMPORTANT NOTICE: Please note that the height measurement represents the radial depth, not the entire back plate**

ASIA MOTORS Front, MAZDA Front, MITSUBISHI Front, TOYOTA Front

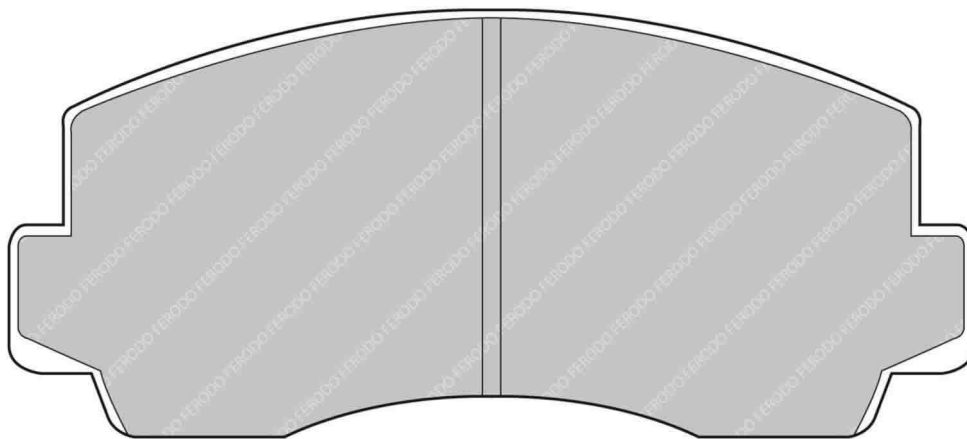

MATERIAL AVAILABILITY				
H	C	R	W	Z
	✓			

CROSS REFERENCE	
MINTEX	MDB1607
PAGID	9521
PFC	0195
WVA	20 476 15,00

✓ Available    ⚠ Exhausting  
 ✗ Not Available    ✉ Make to order  
 🚧 In Introduction

**FERODO**  
RACING

Updated on 30th Jan 2014

**3007**

# FCP173

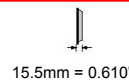
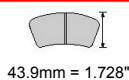

WVA No: 20 939 15,90

FMSI No: D378

**IMPORTANT NOTICE: Please note that the height measurement represents the radial depth, not the entire back plate**

DAEWOO Front, OPEL Front, VAUXHALL Front

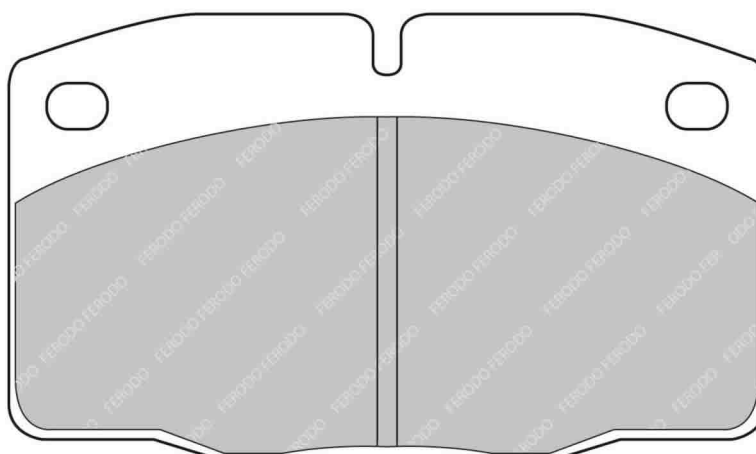

MATERIAL AVAILABILITY				
H	C	R	W	Z
✓		✓		

CROSS REFERENCE	
BREMBO	07.8301.02
EBC	DP2325
FMSI	D378
MINTEX	MDB1141
WVA	20 939 15,90

# FCP206

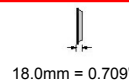
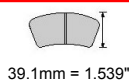

WVA No: 20 753 18,00

FMSI No: D350

**IMPORTANT NOTICE: Please note that the height measurement represents the radial depth, not the entire back plate**

FERRARI Rear, FORD Front, KIA Front, TVR Front

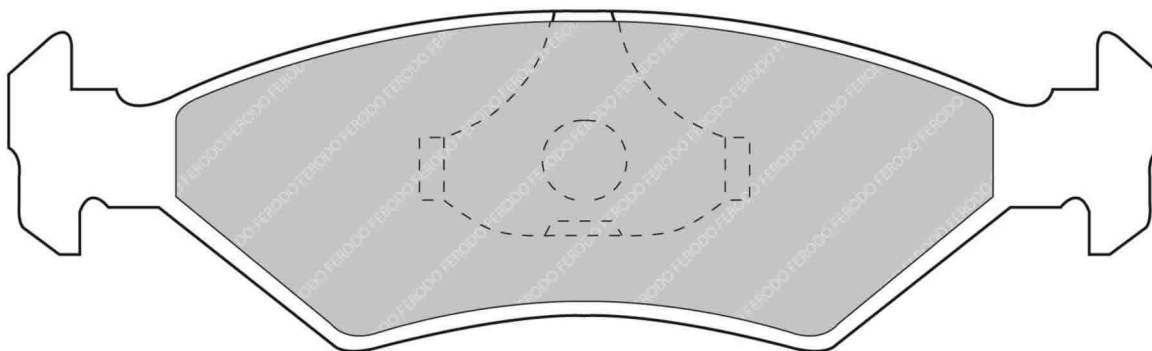

MATERIAL AVAILABILITY				
H	C	R	W	Z
✓		✓		✉

CROSS REFERENCE	
BREMBO	07.8301.03
CL BRAKES	4016
FMSI	D350
MINTEX	MDB1175
PAGID	4823
PFC	0350
WVA	20 753 18,00

# FCP253



84.0mm = 3.307"



45.0mm = 1.772"



12.7mm = 0.500"

**IMPORTANT NOTICE: Please note that the height measurement represents the radial depth, not the entire back plate**

CITROEN Front, PEUGEOT Front

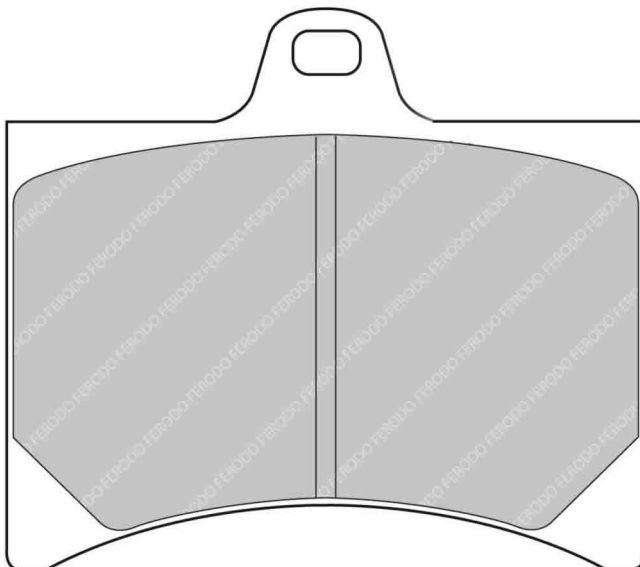

### MATERIAL AVAILABILITY

H	C	R	W	Z

- Available
- Exhausting
- Not Available
- Make to order
- In Introduction

# FCP256

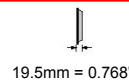
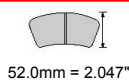

WVA No: 20 629 20,00

FMSI No: D253

**IMPORTANT NOTICE: Please note that the height measurement represents the radial depth, not the entire back plate**

BMW Front, FERRARI Front, MASERATI Front, PORSCHE Front

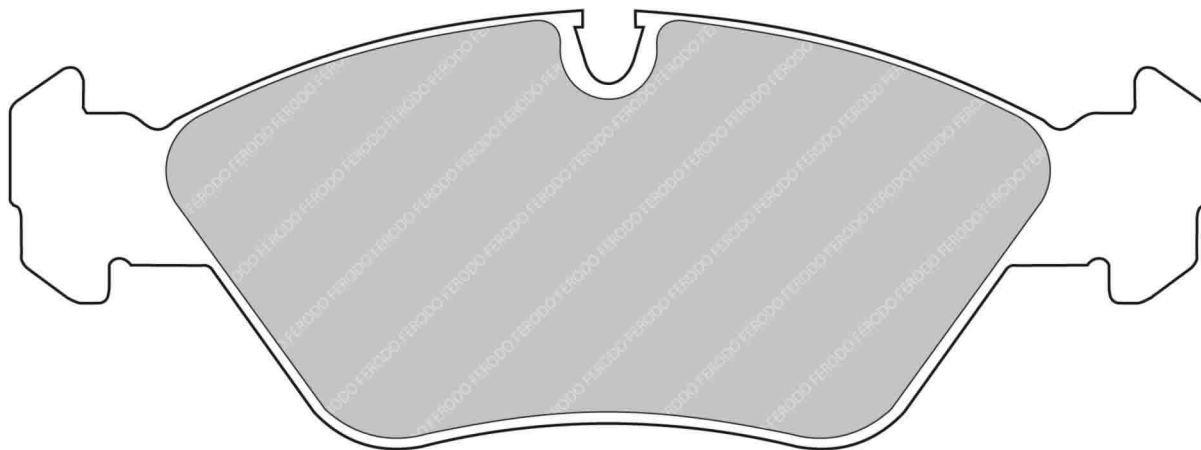

MATERIAL AVAILABILITY				
H	C	R	W	Z
✓		✓		

CROSS REFERENCE	
CL BRAKES	4025
FMSI	D253
FMSI	D395
HAWK	HB137 0,69
MINTEX	MDB1230
PAGID	1144
PFC	0253.XX
PFC	0395.XX
WVA	20 629 20,00

# FCP276

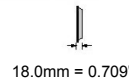
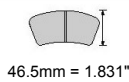

WVA No: 20 907 18,00

FMSI No: D298

**IMPORTANT NOTICE: Please note that the height measurement represents the radial depth, not the entire back plate**

AC Front, FORD Front

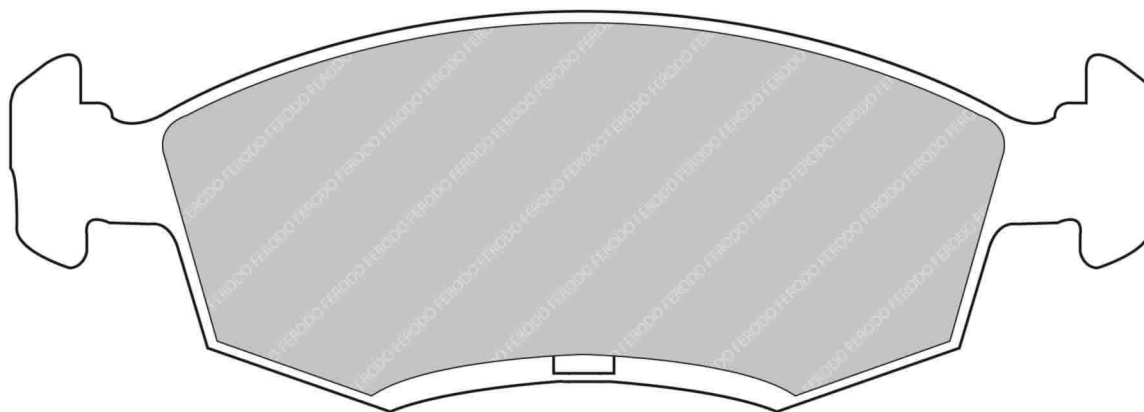

MATERIAL AVAILABILITY				
H	C	R	W	Z
✓		✓		

CROSS REFERENCE	
BREMBO	07.8301.04
CL BRAKES	4023
FMSI	D298
MINTEX	MDB1236
WVA	20 907 18,00

# FCP296



125.2mm = 4.929"



31.0mm = 1.220"



16.0mm = 0.630"

WVA No: 20 675 17,00

FMSI No: D279

**IMPORTANT NOTICE: Please note that the height measurement represents the radial depth, not the entire back plate**

BMW Rear

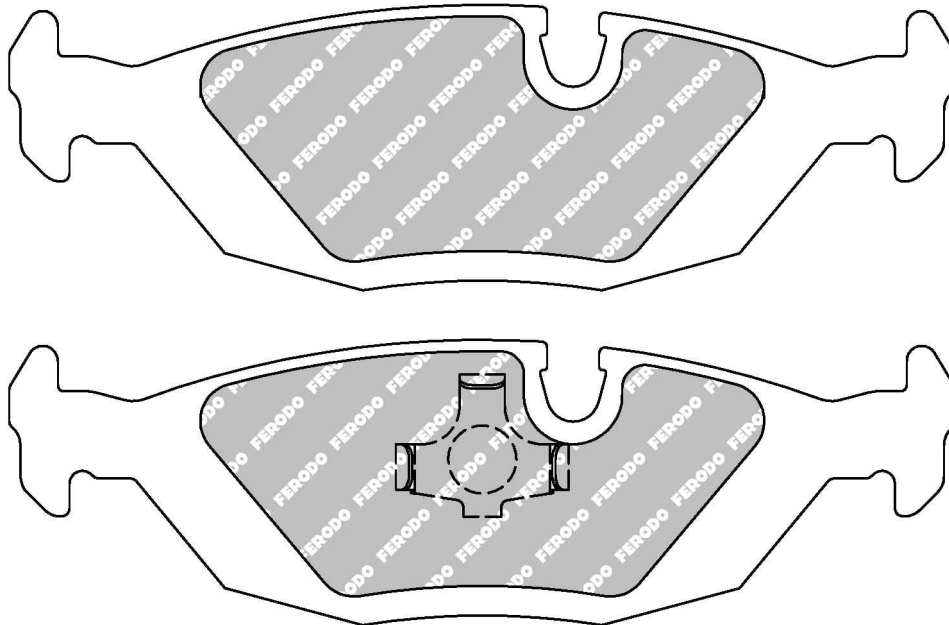

MATERIAL AVAILABILITY				
H	C	R	W	Z
✓		✓	✉	

CROSS REFERENCE	
FMSI	D279
HAWK	HB399 0,63
MINTEX	MDB1239
PAGID	1141
WVA	20 675 17,00

✓ Available    ⚠ Exhausting  
 ✗ Not Available    ✉ Make to order  
 📦 In Introduction

**FERODO**  
RACING

Updated on 30th Jan 2014

**3011**

# FCP308



120.0mm = 4.724"

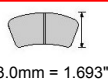

43.0mm = 1.693"



15.0mm = 0.591"

WVA No: 20 870 15,00

FMSI No: D242

**IMPORTANT NOTICE: Please note that the height measurement represents the radial depth, not the entire back plate**

CHEVROLET Front, GEO Front, TOYOTA Front

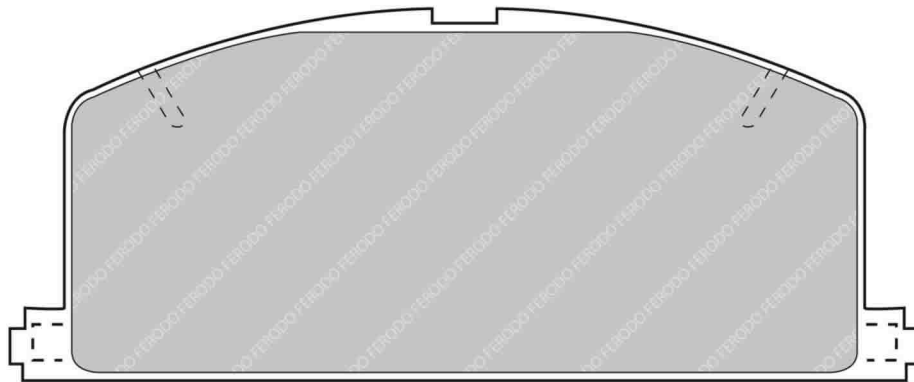

MATERIAL AVAILABILITY				
H	C	R	W	Z
✓		✓		

CROSS REFERENCE	
FMSI	D242
FMSI	D356
HAWK	HB191 0,59
MINTEX	MDB1251
PFC	0242.XX
PFC	0356.XX
WVA	20 870 15,00

# FCP342



59.5mm = 2.343"

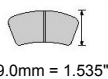

39.0mm = 1.535"



10.4mm = 0.409"

WVA No: 20 053 10,00

FMSI No: D064

**IMPORTANT NOTICE: Please note that the height measurement represents the radial depth, not the entire back plate**

RENAULT Rear, ROVER Front

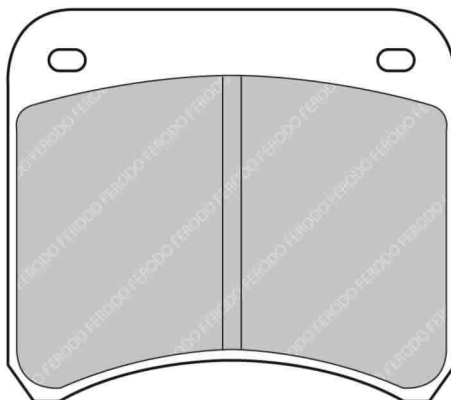

MATERIAL AVAILABILITY				
H	C	R	W	Z
✓	✓	✓	✗	✉

CROSS REFERENCE	
AP RACING	CP2195D38
CL BRAKES	5000W38T10
FMSI	D064
MINTEX	MLB19
PAGID	1362
PFC	7719
WVA	20 053 10,00



# FCP351



108.9mm = 4.287"



42.4mm = 1.669"



18.0mm = 0.709"

WVA No: 20 775 18,20

FMSI No: D125

**IMPORTANT NOTICE:** Please note that the height measurement represents the radial depth, not the entire back plate

AUTOBIANCHI Front, FIAT Front, INNOCENTI Front, LANCIA Front, SEAT Front

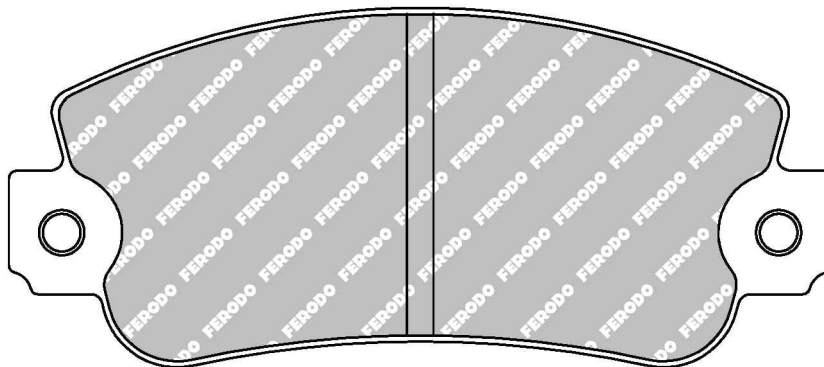

ALSO AVAILABLE		
SHAPE	TH. MM	NOTES
FCP360	12	

CROSS REFERENCE	
FMSI	D125
WVA	20 775 18,20

MATERIAL AVAILABILITY				
H	C	R	W	Z
✓		✓		✓

# FCP360



108.9mm = 4.287"



42.4mm = 1.669"



12.0mm = 0.472"

WVA No: 20 841 12,00

**IMPORTANT NOTICE:** Please note that the height measurement represents the radial depth, not the entire back plate

FIAT Rear, LANCIA Rear

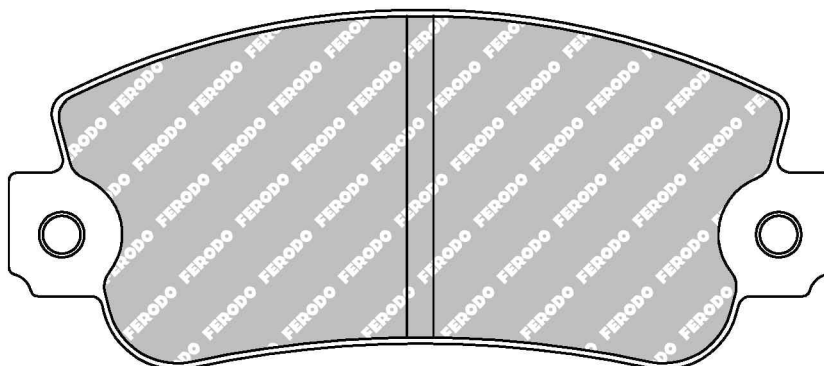

No bevel on backplate

ALSO AVAILABLE		
SHAPE	TH. MM	NOTES
FCP351	18	

CROSS REFERENCE	
BREMBO	07.8301.05
MINTEX	MDB1088
MINTEX	MDB1258
MINTEX	MDB1962
WVA	20 841 12,00

MATERIAL AVAILABILITY				
H	C	R	W	Z
✓				

- ✓ Available
- ✗ Not Available
- ⚠ Exhausting
- ✉ Make to order
- 🚧 In Introduction



Updated on 30th Jan 2014

# FCP370

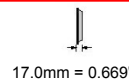
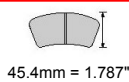
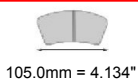

WVA No: 20 833 17,00

FMSI No: D147

**IMPORTANT NOTICE: Please note that the height measurement represents the radial depth, not the entire back plate**

ALFA ROMEO Front, AUDI Front, AUTOBIANCHI Front, FIAT Front, INNOCENTI Front, LANCIA Front, VOLVO Front

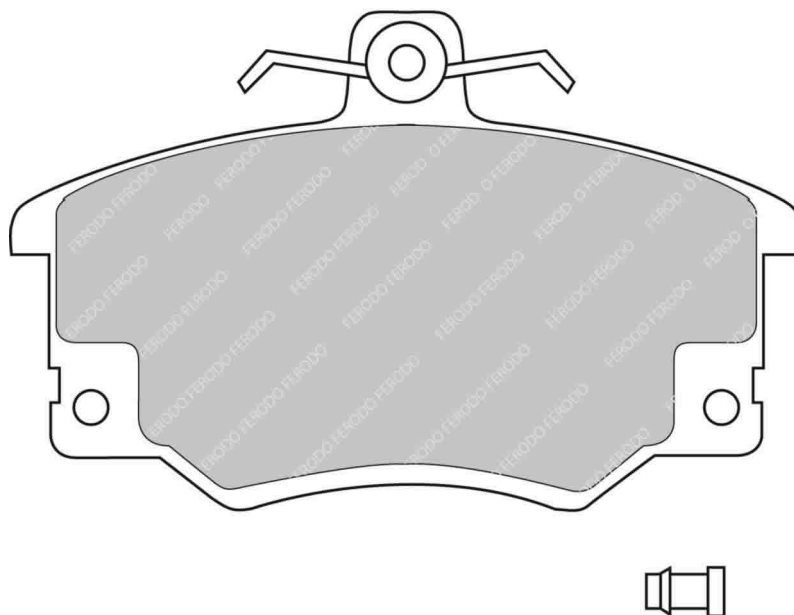

MATERIAL AVAILABILITY				
H	C	R	W	Z
✓	✗	✓	✗	✗

CROSS REFERENCE	
BREMBO	07.8301.06
CL BRAKES	4028
FMSI	D147
MINTEX	MDB1240
MINTEX	MDB1257
MINTEX	MDB2758
WVA	20 833 17,00

# FCP372

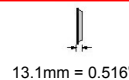
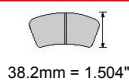

WVA No: 20 328 12,90

FMSI No: D283

**IMPORTANT NOTICE: Please note that the height measurement represents the radial depth, not the entire back plate**

MAZDA Rear

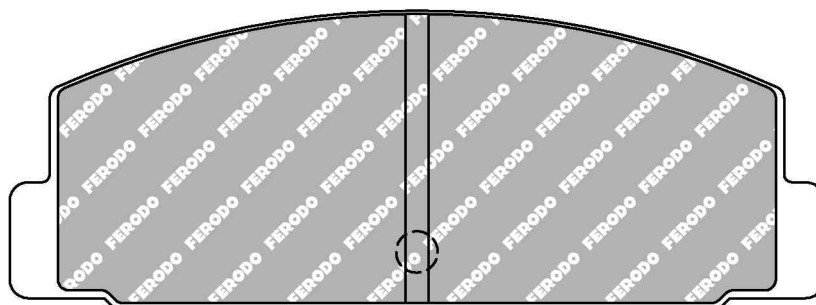

MATERIAL AVAILABILITY				
H	C	R	W	Z
✓	✗	✗	✗	✗

CROSS REFERENCE	
FMSI	D283
HAWK	HB158 0,515
MINTEX	MDB2309
WVA	20 328 12,90

# FCP385



137.0mm = 5.394"



45.0mm = 1.772"



17.0mm = 0.669"

WVA No: 20 889 17,30

FMSI No: D307

**IMPORTANT NOTICE: Please note that the height measurement represents the radial depth, not the entire back plate**

SEAT Front, VOLKSWAGEN Front

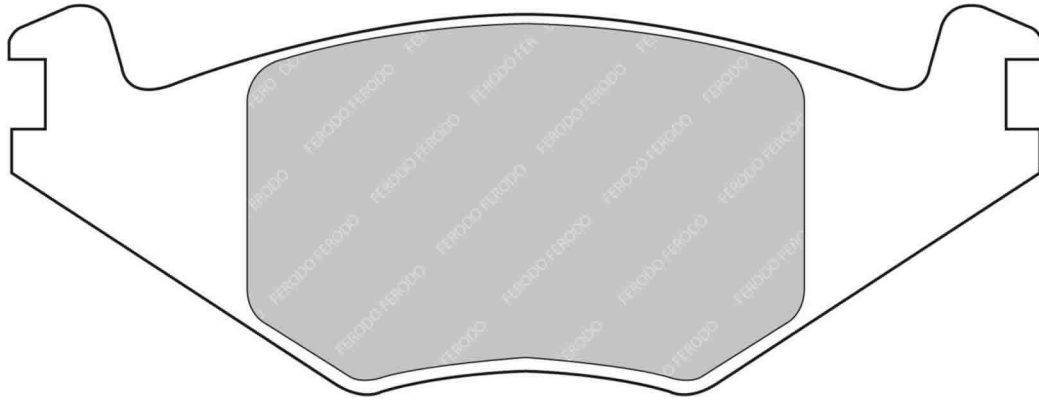

MATERIAL AVAILABILITY				
H	C	R	W	Z

CROSS REFERENCE	
BREMBO	07.8301.07
CL BRAKES	4021
FMSI	D307
MINTEX	MDB1273
MINTEX	MDB1436
PAGID	2130
WVA	20 889 17,30

- Available
- Exhausting
- Not Available
- Make to order
- In Introduction

# FCP392

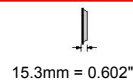
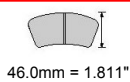

WVA No: 20 887 15,30

FMSI No: D280

**IMPORTANT NOTICE: Please note that the height measurement represents the radial depth, not the entire back plate**

SEAT Front, VOLKSWAGEN Front

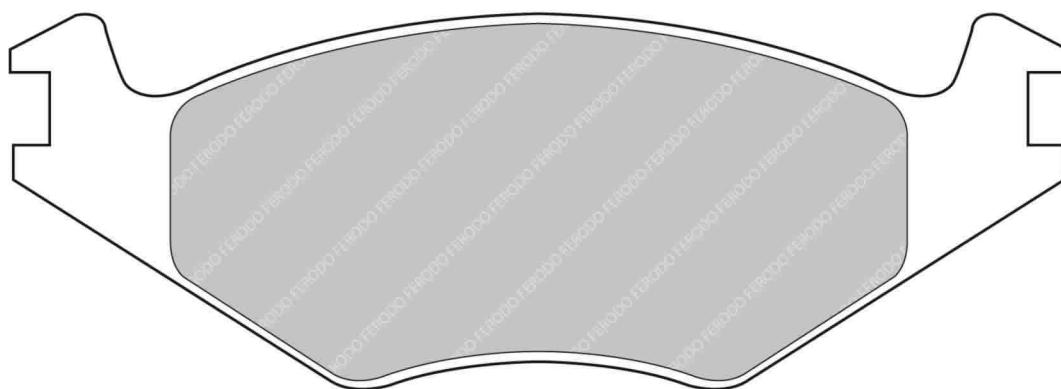
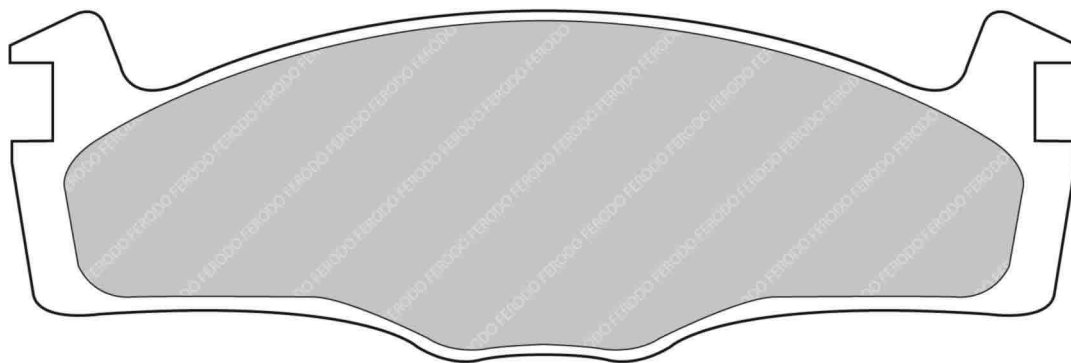

### ALSO AVAILABLE

SHAPE	TH. MM	NOTES
FCP419	19.7	

### MATERIAL AVAILABILITY

H	C	R	W	Z
✓		✓	✉	

### CROSS REFERENCE

BREMBO	07.8301.08
BREMBO	07.8301.12
BREMBO	07.8301.49
CL BRAKES	4021
FMSI	D280
FMSI	D569
HAWK	HB189 0,55
MINTEX	MDB1266
PAGID	4011
PFC	0280.XX
WVA	20 887 15,30

3016

**FERODO**  
RACING

Updated on 30th Jan 2014

✓ Available    ⚠ Exhausting  
 ✗ Not Available    ✉ Make to order  
 📦 In Introduction

# FCP393



105.0mm = 4.134"



42.3mm = 1.665"



18.0mm = 0.709"

WVA No: 20 905 18,00

FMSI No: D371

**IMPORTANT NOTICE: Please note that the height measurement represents the radial depth, not the entire back plate**

CITROEN Front, PEUGEOT Front, RENAULT Front, RENAULT-ALPINE Rear

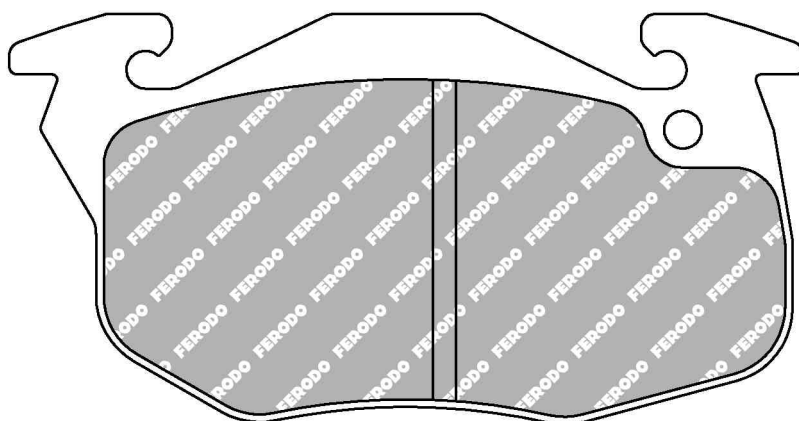
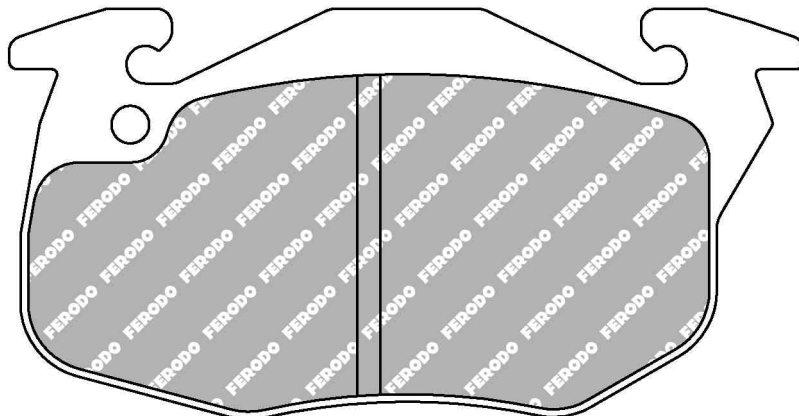

Set = 1 left / 1 right

MATERIAL AVAILABILITY				
H	C	R	W	Z
✓		✓		

CROSS REFERENCE	
BREMBO	07.8301.09
CL BRAKES	4007
FMSI	D371
MINTEX	MDB1291
PAGID	1609
WVA	20 905 18,00

✓ Available    ⚠ Exhausting  
 ✗ Not Available    📧 Make to order  
 📅 In Introduction

**FERODO**  
RACING

Updated on 30th Jan 2014

**3017**

# FCP399



89.7mm = 3.531"



53.0mm = 2.087"



17.0mm = 0.669"

WVA No: 21 088 17,00

FMSI No: D163

**IMPORTANT NOTICE: Please note that the height measurement represents the radial depth, not the entire back plate**

BMW Front, FORD Front, LAMBORGHINI Front, MASERATI Front

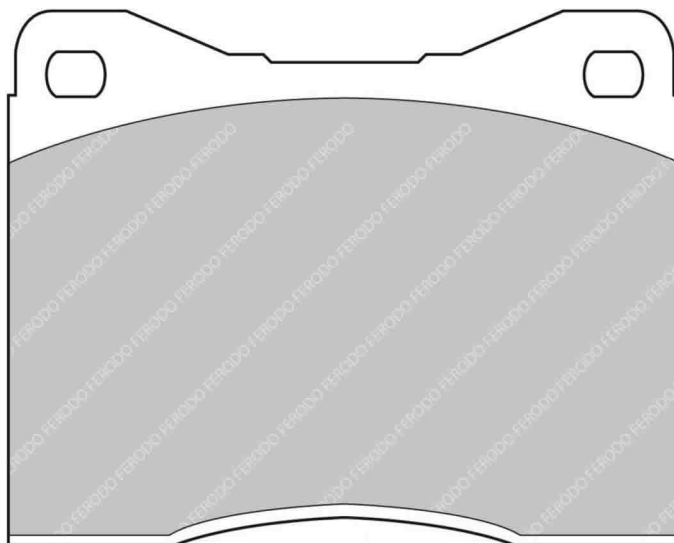

MATERIAL AVAILABILITY				
H	C	R	W	Z
✓		✓		

CROSS REFERENCE	
CL BRAKES	4014
FMSI	D163
HAWK	HB206 0,565
MINTEX	MDB1323
PFC	0163.XX
WVA	21 088 17,00

# FCP406

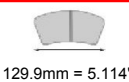

129.9mm = 5.114"



51.2mm = 2.016"



17.7mm = 0.697"

WVA No: 21 388 18,50

**IMPORTANT NOTICE: Please note that the height measurement represents the radial depth, not the entire back plate**

PEUGEOT Front, RENAULT Front, RENAULT-ALPINE Front

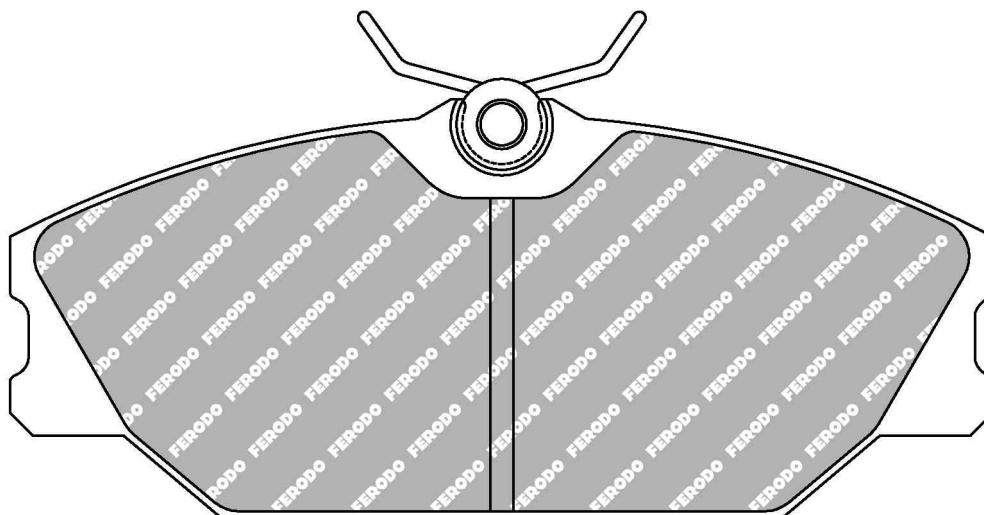

MATERIAL AVAILABILITY				
H	C	R	W	Z
✓		✓		

CROSS REFERENCE	
BREMBO	07.8301.10
MINTEX	MDB1316
WVA	21 388 18,50

3018

**FERODO**  
RACING

Updated on 30th Jan 2014

✓ Available    ⚠ Exhausting  
 ✗ Not Available    📦 Make to order  
 🚧 In Introduction

# FCP408

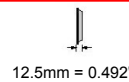
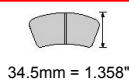

WVA No: 21 079 13,75

FMSI No: D382

**IMPORTANT NOTICE: Please note that the height measurement represents the radial depth, not the entire back plate**

CATERHAM Rear, FORD Rear, MERCURY Front, TVR Rear

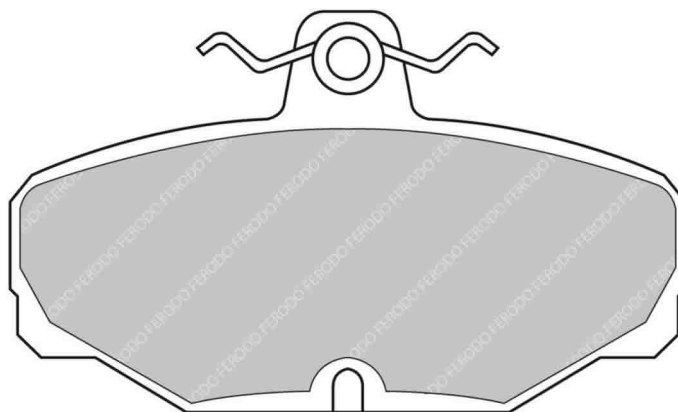

MATERIAL AVAILABILITY				
H	C	R	W	Z
✓		✓		✗

CROSS REFERENCE	
CL BRAKES	4035
FMSI	D382
MINTEX	MDB1286
PAGID	1163
PFC	0382
WVA	21 079 13,75

# FCP409

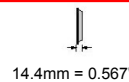
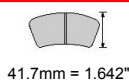

WVA No: 21 103 14,50

**IMPORTANT NOTICE: Please note that the height measurement represents the radial depth, not the entire back plate**

ALFA ROMEO Rear, AUDI Rear, FIAT Rear, LANCIA Rear

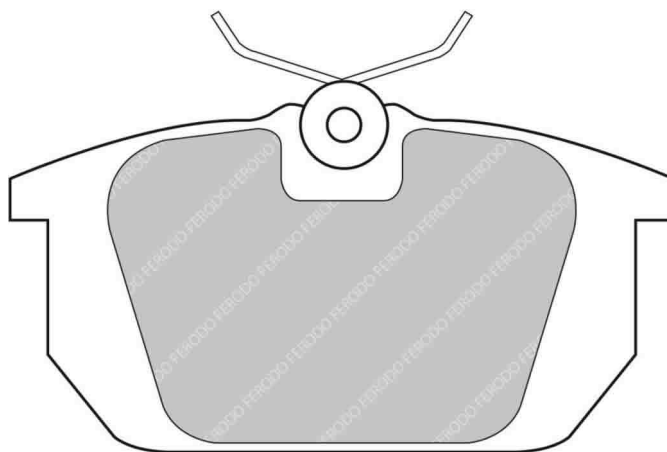

MATERIAL AVAILABILITY				
H	C	R	W	Z
✓		✓		

CROSS REFERENCE	
BREMBO	07.8301.11
WVA	21 103 14,50

✓ Available    ⚠ Exhausting  
 ✗ Not Available    ✉ Make to order  
 🚧 In Introduction

**FERODO**  
RACING

Updated on 30th Jan 2014

**3019**

# FCP415



108.3mm = 4.264"



52.0mm = 2.047"



19.3mm = 0.760"

WVA No: 20 941 19,30

FMSI No: D423

**IMPORTANT NOTICE: Please note that the height measurement represents the radial depth, not the entire back plate**

MERCEDES Front

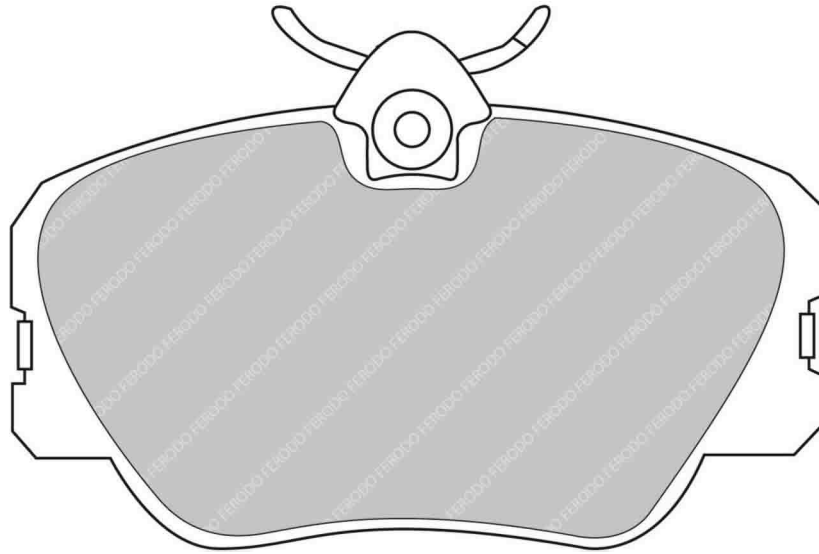

MATERIAL AVAILABILITY				
H	C	R	W	Z
✓		✓		

CROSS REFERENCE	
FMSI	D423
MINTEX	MDB1312
MINTEX	MDB1437
PAGID	1190
WVA	20 941 19,30



# FCP419



138.0mm = 5.433"

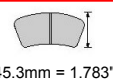

45.3mm = 1.783"



19.7mm = 0.776"

WVA No: 20 887 19,70

**IMPORTANT NOTICE: Please note that the height measurement represents the radial depth, not the entire back plate**

SEAT Front, VOLKSWAGEN Front

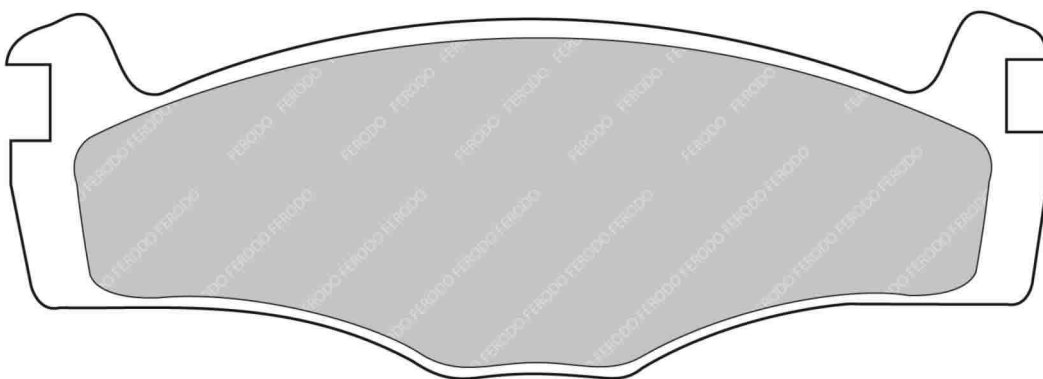
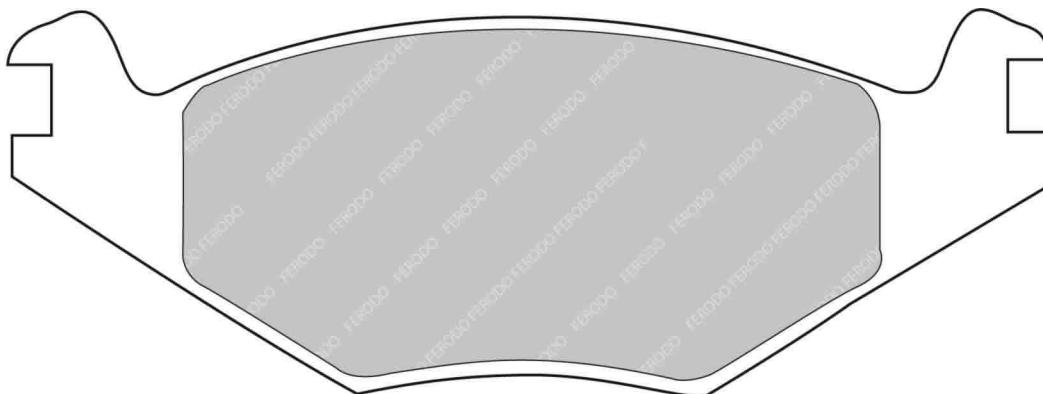

### ALSO AVAILABLE

SHAPE	TH. MM	NOTES
FCP392	15.3	

### MATERIAL AVAILABILITY

H	C	R	W	Z
✓				

### CROSS REFERENCE

MINTEX	CVP020
MINTEX	CVP020K
MINTEX	MDB1267
WVA	20 887 19,70

✓ Available    ⚠ Exhausting  
 ✗ Not Available    ✉ Make to order  
 🔄 In Introduction

**FERODO**  
RACING

Updated on 30th Jan 2014

**3021**

# FCP434

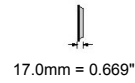
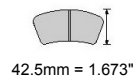

WVA No: 20 923 17,50

**IMPORTANT NOTICE: Please note that the height measurement represents the radial depth, not the entire back plate**

CITROEN Front, PEUGEOT Front

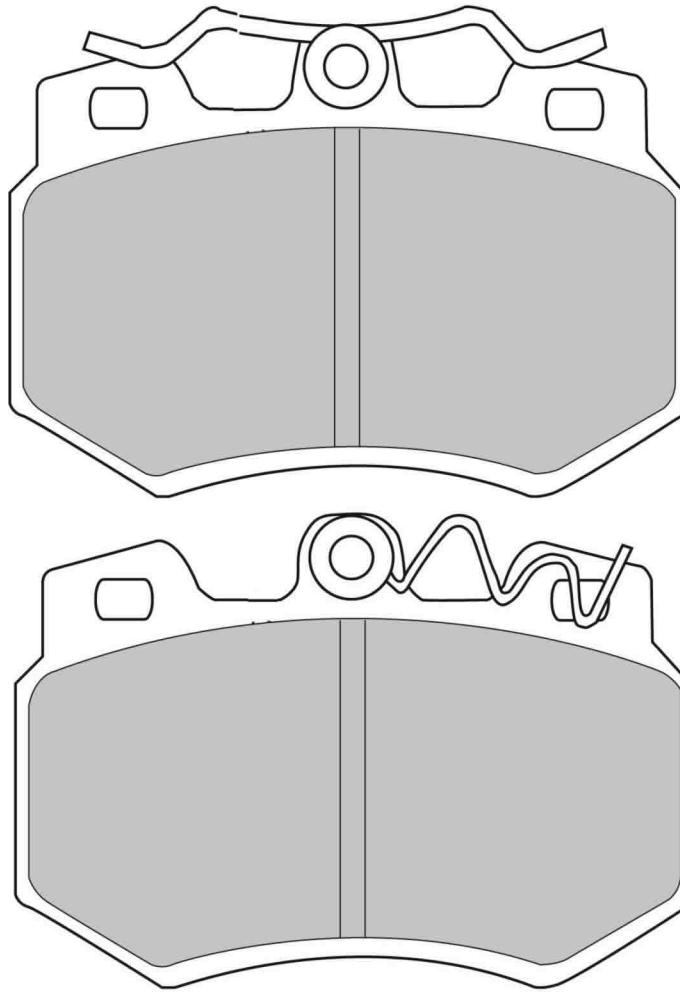

MATERIAL AVAILABILITY				
H	C	R	W	Z
✓		✉		

CROSS REFERENCE	
BREMBO	07.8301.13
MINTEX	MDB1327
WVA	20 923 17,50

# FCP441



100.0mm = 3.937"



41.0mm = 1.614"



16.0mm = 0.630"

WVA No: 21 098 16,00

**IMPORTANT NOTICE: Please note that the height measurement represents the radial depth, not the entire back plate**

ALFA ROMEO Front, NISSAN Front

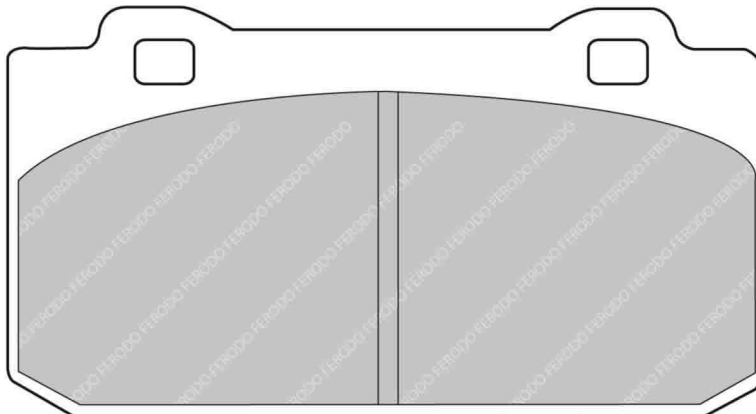

MATERIAL AVAILABILITY				
H	C	R	W	Z
	✗	✓		

CROSS REFERENCE	
MINTEX	MDB1357
WVA	21 098 16,00

# FCP448



76.8mm = 3.024"



44.0mm = 1.732"



15.0mm = 0.591"

WVA No: 20 323 16,50

FMSI No: D0109

**IMPORTANT NOTICE: Please note that the height measurement represents the radial depth, not the entire back plate**

ALFA ROMEO Front, OPEL Front

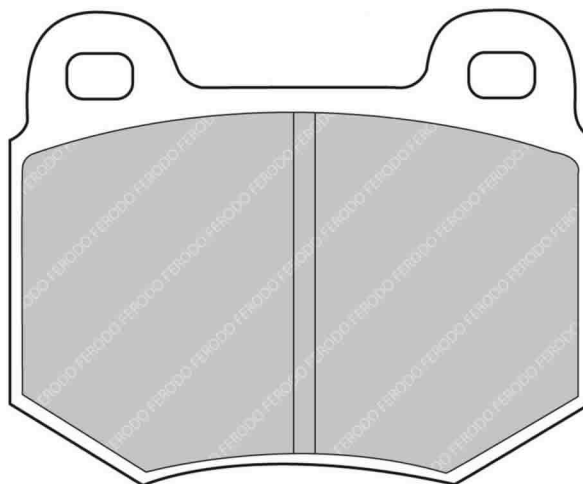

MATERIAL AVAILABILITY				
H	C	R	W	Z
✓		✓		

CROSS REFERENCE	
FMSI	D0109
HAWK	HB180 0,64
MINTEX	MTX1890
PFC	0174.XX
WVA	20 323 16,50

✓ Available    ⚠ Exhausting  
 ✗ Not Available    ✉ Make to order  
 🚧 In Introduction

**FERODO**  
RACING

Updated on 30th Jan 2014

**3023**

# FCP451



97.9mm = 3.854"



50.8mm = 2.000"



18.0mm = 0.709"

WVA No: 20 877 17,50

FMSI No: D345

**IMPORTANT NOTICE: Please note that the height measurement represents the radial depth, not the entire back plate**

FERRARI Front / Rear, MASERATI Rear, PORSCHE Front / Rear

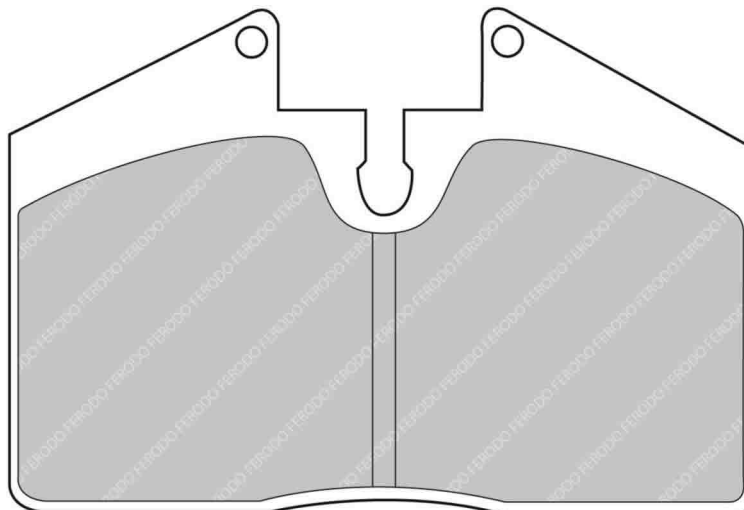

### ALSO AVAILABLE

SHAPE	TH. MM	NOTES
FRP3069	16	

### MATERIAL AVAILABILITY

H	C	R	W	Z
✓		✓	✗	✓

### CROSS REFERENCE

ALCON	PNF4436X508.4
CL BRAKES	4002
FMSI	D345
FMSI	D608
HAWK	HB170 0,65
MINTEX	MDB1456
PAGID	1203
PFC	0345.XX
WVA	20 877 17,50

# FCP461



84.9mm = 3.343"



46.1mm = 1.815"



14.6mm = 0.575"

WVA No: 20 561 15,00

**IMPORTANT NOTICE: Please note that the height measurement represents the radial depth, not the entire back plate**

SKODA Front, TATRA Rear, WARTBURG Front

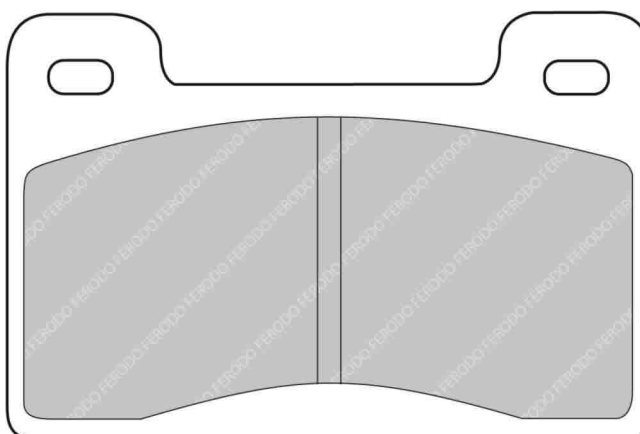

### MATERIAL AVAILABILITY

H	C	R	W	Z
✓		✓		

### CROSS REFERENCE

MINTEX	MDB1165
WVA	20 561 15,00

# FCP472

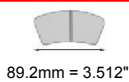

89.2mm = 3.512"

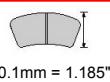

30.1mm = 1.185"

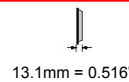

13.1mm = 0.516"

WVA No: 21 312 12,80

**IMPORTANT NOTICE: Please note that the height measurement represents the radial depth, not the entire back plate**

HONDA Rear, MG Rear, ROVER Rear

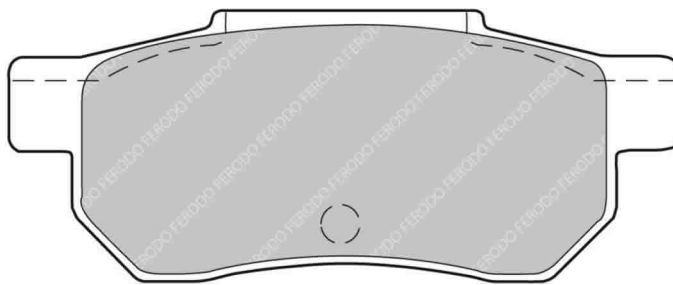

MATERIAL AVAILABILITY				
H	C	R	W	Z
✓				

CROSS REFERENCE	
MINTEX	MDB1360
MINTEX	MDB2191
WVA	21 312 12,80

# FCP483

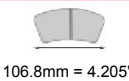

106.8mm = 4.205"

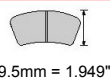

49.5mm = 1.949"

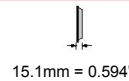

15.1mm = 0.594"

WVA No: 20 878 14,80

FMSI No: D331

**IMPORTANT NOTICE: Please note that the height measurement represents the radial depth, not the entire back plate**

MAZDA Front

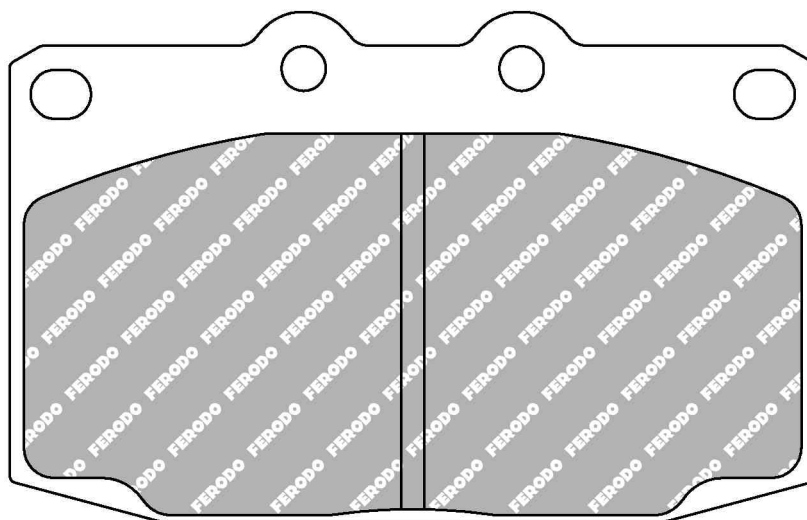

MATERIAL AVAILABILITY				
H	C	R	W	Z
✓		✓		✉

CROSS REFERENCE	
FMSI	D331
HAWK	HB155 0,58
MINTEX	MDB1351
MINTEX	MDB1935
PFC	0463
WVA	20 878 14,80

✓ Available    ⚠ Exhausting  
 ✗ Not Available    ✉ Make to order  
 🚧 In Introduction

**FERODO**  
RACING

Updated on 30th Jan 2014

**3025**

# FCP484



85.5mm = 3.366"



39.6mm = 1.559"



14.2mm = 0.559"

WVA No: 21 121 13,80

**IMPORTANT NOTICE: Please note that the height measurement represents the radial depth, not the entire back plate**

NISSAN Rear

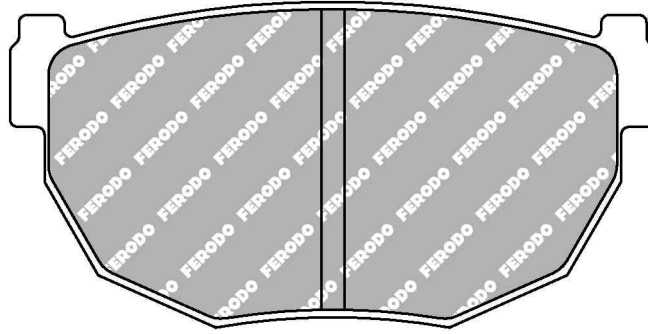

MATERIAL AVAILABILITY				
H	C	R	W	Z
✓	✗	✗		

CROSS REFERENCE	
MINTEX	MDB1295
PFC	0272
WVA	21 121 13,80

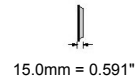
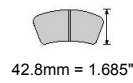

**IMPORTANT NOTICE: Please note that the height measurement represents the radial depth, not the entire back plate**

MAZDA Front, SAO Front

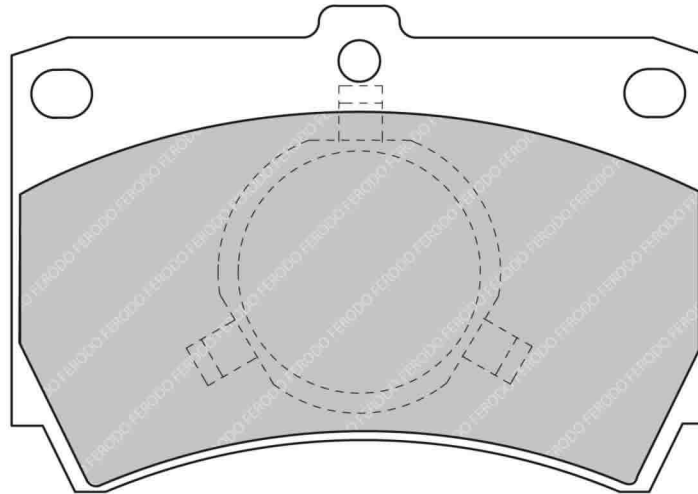
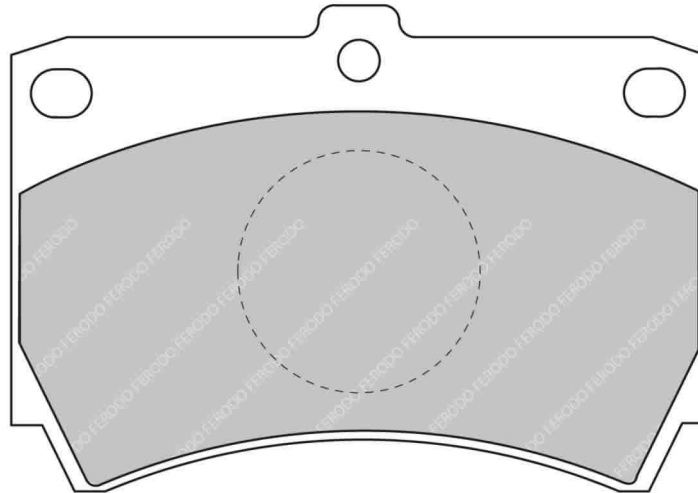

MATERIAL AVAILABILITY				
H	C	R	W	Z
✓		✉		

CROSS REFERENCE	
FMSI	D319
FMSI	D473
HAWK	HB246 0,567
MINTEX	MDB1348
PFC	0473.XX
WVA	21 277 15,00

# FCP519

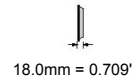
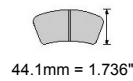
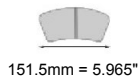

WVA No: 21 193 18,00

**IMPORTANT NOTICE: Please note that the height measurement represents the radial depth, not the entire back plate**

FIAT Front, FIAT AUTO POLAND Front, INNOCENTI Front

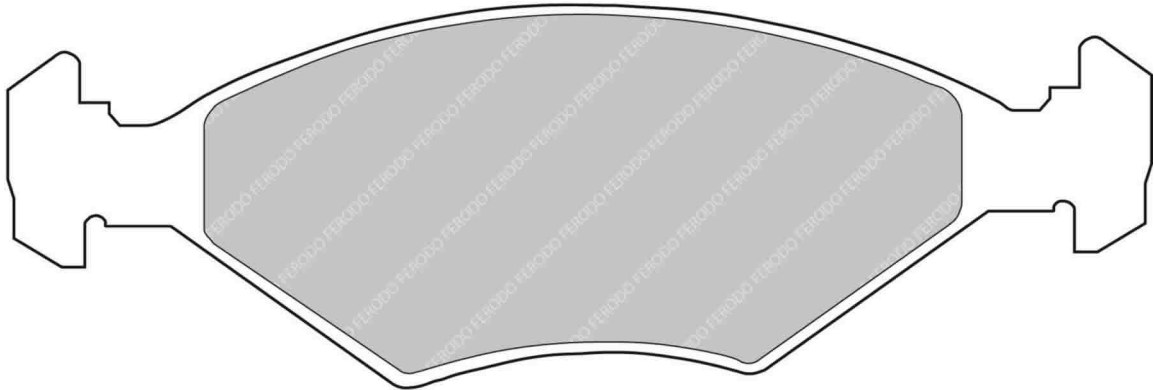

MATERIAL AVAILABILITY				
H	C	R	W	Z

CROSS REFERENCE	
BREMBO	07.8301.14
MINTEX	MDB1513
WVA	21 193 18,00

# FCP524

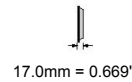
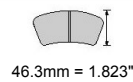

WVA No: 21 100 17,00

**IMPORTANT NOTICE: Please note that the height measurement represents the radial depth, not the entire back plate**

FIAT Front, LANCIA Front, YUGO Front

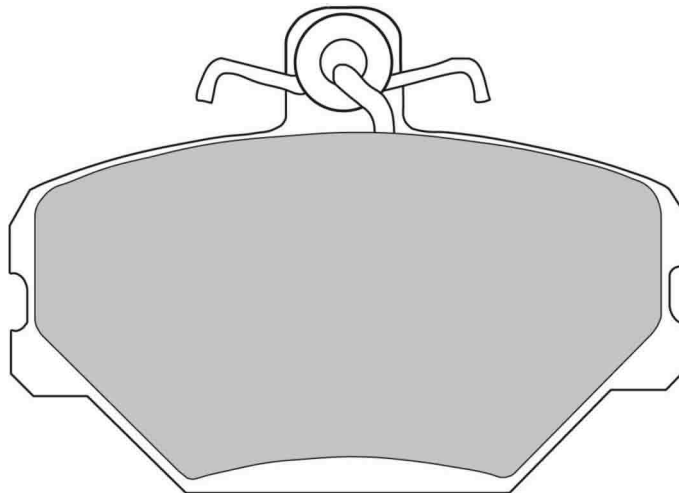

MATERIAL AVAILABILITY				
H	C	R	W	Z

CROSS REFERENCE	
BREMBO	07.8301.15
MINTEX	MDB1384
MINTEX	MDB1606
WVA	21 100 17,00



# FCP527



104.5mm = 4.114"

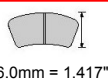

36.0mm = 1.417"



17.7mm = 0.697"

WVA No: 21 170 17,30

**IMPORTANT NOTICE: Please note that the height measurement represents the radial depth, not the entire back plate**

LADA Front

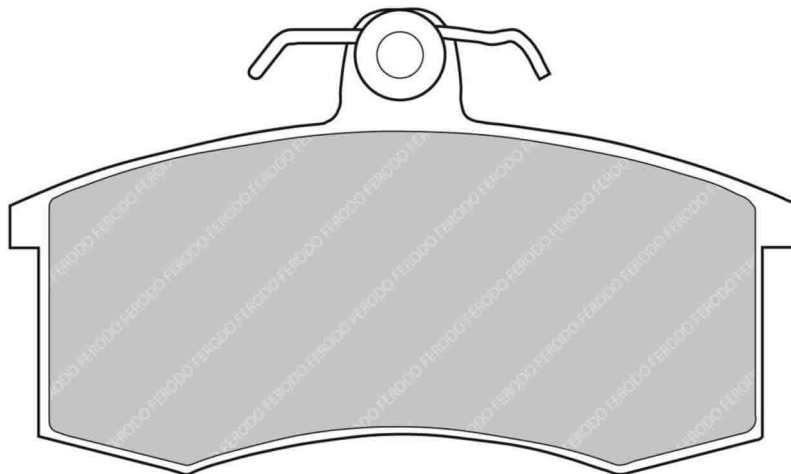

MATERIAL AVAILABILITY				
H	C	R	W	Z
✓		✓		

CROSS REFERENCE	
MINTEX	MDB1353
WVA	21 170 17,30

# FCP535



72.0mm = 2.835"

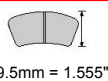

39.5mm = 1.555"



16.5mm = 0.650"

WVA No: 21 179 16,80

**IMPORTANT NOTICE: Please note that the height measurement represents the radial depth, not the entire back plate**

CITROEN Front, PEUGEOT Front

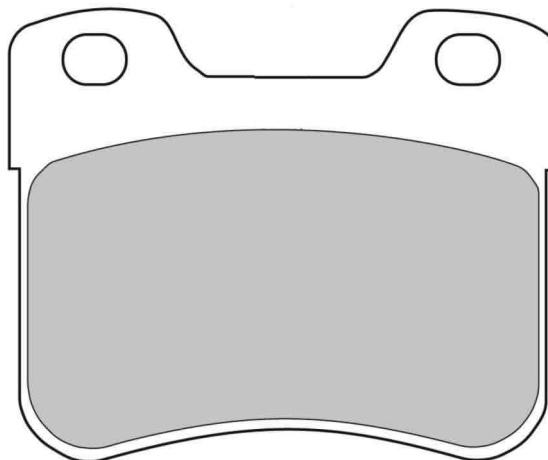

MATERIAL AVAILABILITY				
H	C	R	W	Z
✓	⚠	✓		

CROSS REFERENCE	
BREMBO	07.8301.16
MINTEX	MDB1483
WVA	21 179 16,80

✓ Available    ⚠ Exhausting  
 ✗ Not Available    ✉ Make to order  
 ⚡ In Introduction

**FERODO**  
RACING

Updated on 30th Jan 2014

**3029**

# FCP541



87.0mm = 3.425"



41.0mm = 1.614"



15.0mm = 0.591"

WVA No: 20 961 15,20

FMSI No: D306

**IMPORTANT NOTICE: Please note that the height measurement represents the radial depth, not the entire back plate**

AUDI Rear, CITROEN Rear, FORD Rear, HONDA Rear, MERCEDES Rear, PEUGEOT Rear, PORSCHE Rear, RENAULT Rear, SEAT Rear, SKODA Rear, VOLKSWAGEN Rear

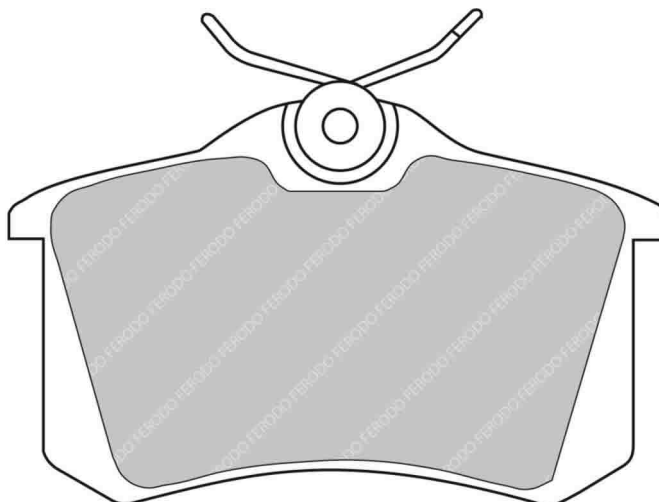

ALSO AVAILABLE		
SHAPE	TH. MM	NOTES
FCP1491	16	

MATERIAL AVAILABILITY				
H	C	R	W	Z
✓		✓	✗	✗

CROSS REFERENCE	
BREMBO	07.8301.17
CL BRAKES	4038
EBC	DP680
FMSI	D306
FMSI	D340
FMSI	D851
HAWK	HB271 0,635
HAWK	HB364 0,642
MINTEX	MDB1382
PAGID	1158
WVA	20 961 15,20

# FCP546



95.0mm = 3.740"



43.0mm = 1.693"



16.5mm = 0.650"

WVA No: 21 165 16,50

FMSI No: D454

**IMPORTANT NOTICE: Please note that the height measurement represents the radial depth, not the entire back plate**

ALFA ROMEO Front

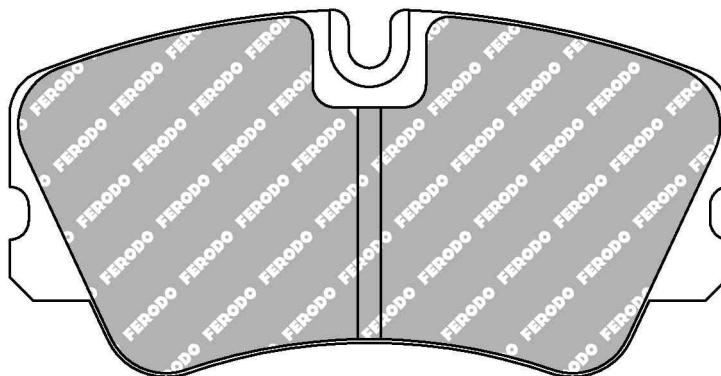

MATERIAL AVAILABILITY				
H	C	R	W	Z
✓		✓		

CROSS REFERENCE	
FMSI	D454
MINTEX	MDB1403
PAGID	1760
WVA	21 165 16,50

3030

**FERODO**  
RACING

Updated on 30th Jan 2014

✓ Available    ⚠ Exhausting  
 ✗ Not Available    ✉ Make to order  
 🚧 In Introduction

# FCP558



105.2mm = 4.142"



42.0mm = 1.654"



11.0mm = 0.433"

WVA No: 20 973 11,00

FMSI No: D516

**IMPORTANT NOTICE: Please note that the height measurement represents the radial depth, not the entire back plate**

CITROEN Rear, PEUGEOT Rear, RENAULT Rear

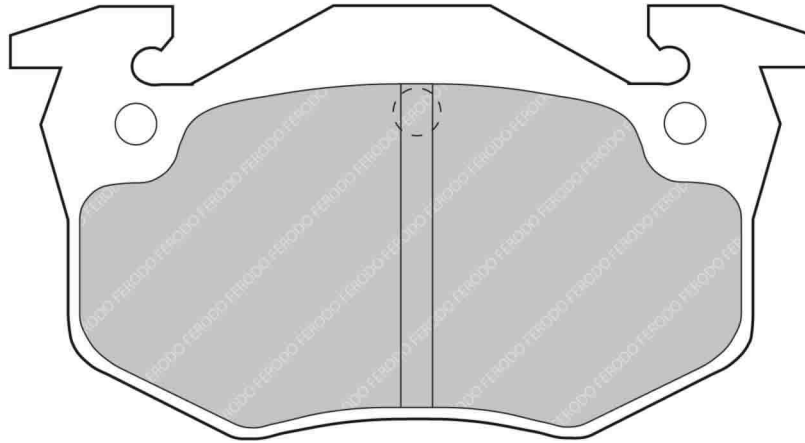

### ALSO AVAILABLE

SHAPE	TH. MM	NOTES
FCP881	15	

### MATERIAL AVAILABILITY

H	C	R	W	Z
✓	✗	✓		

### CROSS REFERENCE

ALCON	PNF0084X261.4
ALCON	PNF0084X317.4
CL BRAKES	4034
FMSI	D516
MINTEX	MDB1339
MINTEX	MDB2555
PAGID	1610
WVA	20 973 11,00

✓ Available    ⚠ Exhausting  
 ✗ Not Available    ✉ Make to order  
 🚧 In Introduction

**FERODO**  
RACING

Updated on 30th Jan 2014

**3031**

# FCP560



131.8mm = 5.189"



51.0mm = 2.008"



18.0mm = 0.709"

WVA No: 20 953 17,50

FMSI No: D372

**IMPORTANT NOTICE: Please note that the height measurement represents the radial depth, not the entire back plate**

AUDI Front, PORSCHE Front / Rear

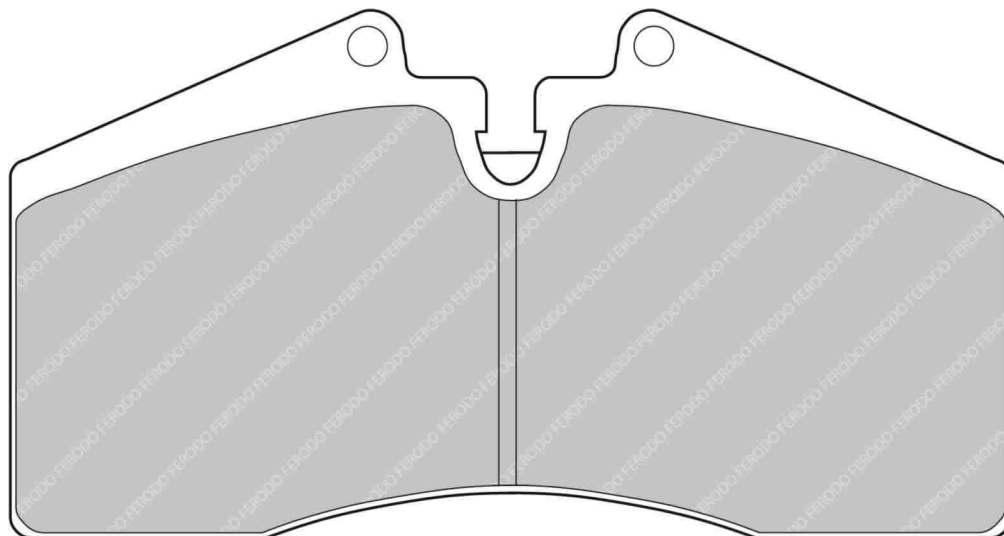

MATERIAL AVAILABILITY				
H	C	R	W	Z
✓		✓	✉	

CROSS REFERENCE	
CL BRAKES	4001
FMSI	D372
FMSI	D447
FMSI	D609
HAWK	HB141 0,65
MINTEX	MDB1457
PAGID	1204
PFC	0447
WVA	20 953 17,50

# FCP565



130.0mm = 5.118"



53.5mm = 2.106"



19.1mm = 0.752"

WVA No: 21 074 19,00

FMSI No: D590

**IMPORTANT NOTICE: Please note that the height measurement represents the radial depth, not the entire back plate**

ALFA ROMEO Front, CITROEN Front, FIAT Front, LANCIA Front, PEUGEOT Front, RENAULT Front, RENAULT-ALPINE Front

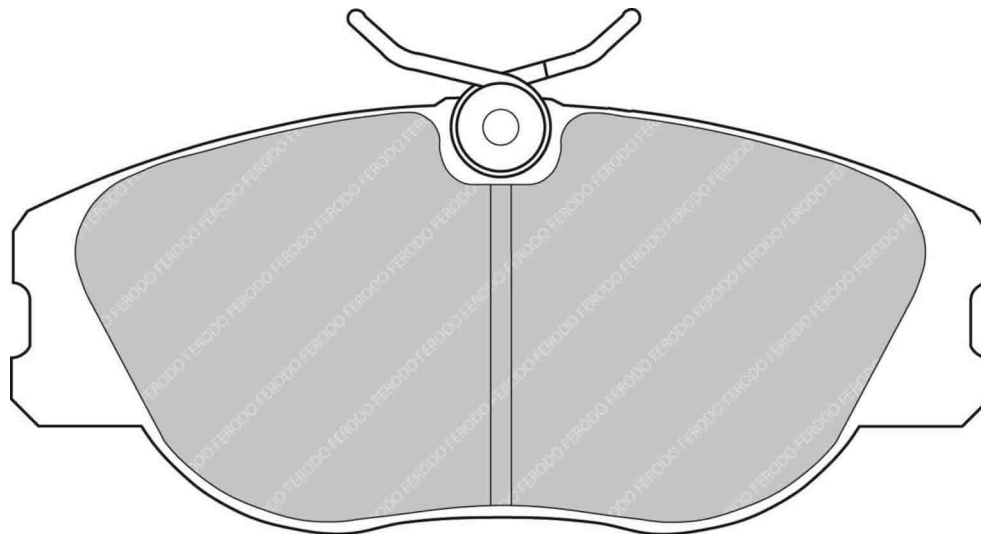

MATERIAL AVAILABILITY				
H	C	R	W	Z
✓		✓	✓	

CROSS REFERENCE	
BREMBO	07.8301.18
CL BRAKES	4027
FMSI	D590
MINTEX	MDB1518
PFC	0590
WVA	21 074 19,00

✓ Available    ⚠ Exhausting  
 ✗ Not Available    ✉ Make to order  
 🔄 In Introduction

**FERODO**  
RACING

Updated on 30th Jan 2014

**3033**

# FCP578



123.3mm = 4.854"



39.7mm = 1.563"



15.9mm = 0.626"

WVA No: 20 995 17,30

FMSI No: D396

**IMPORTANT NOTICE: Please note that the height measurement represents the radial depth, not the entire back plate**

BMW Rear, JAGUAR Rear

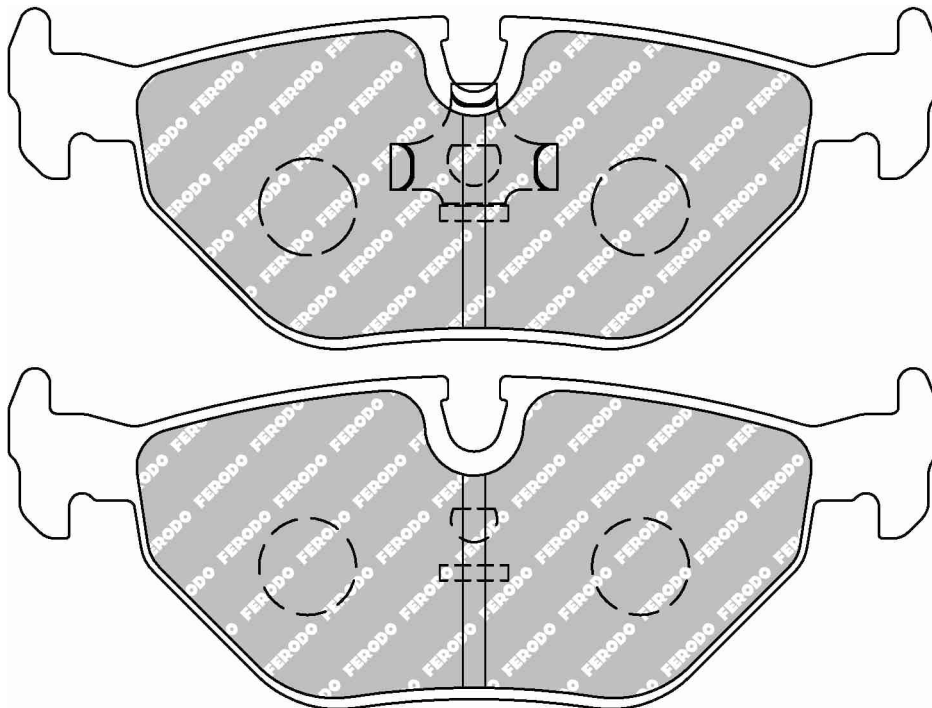

MATERIAL AVAILABILITY				
H	C	R	W	Z
✓		✓	📦	

CROSS REFERENCE	
FMSI	D396
HAWK	HB227 0,63
MINTEX	MDB1369
PAGID	1285
PFC	0396.XX
WVA	20 995 17,30

# FCP584



156.5mm = 6.161"

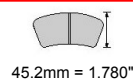

45.2mm = 1.780"

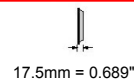

17.5mm = 0.689"

WVA No: 21 190 17,50

FMSI No: D403

**IMPORTANT NOTICE: Please note that the height measurement represents the radial depth, not the entire back plate**

DAEWOO Front, OPEL Front, VAUXHALL Front

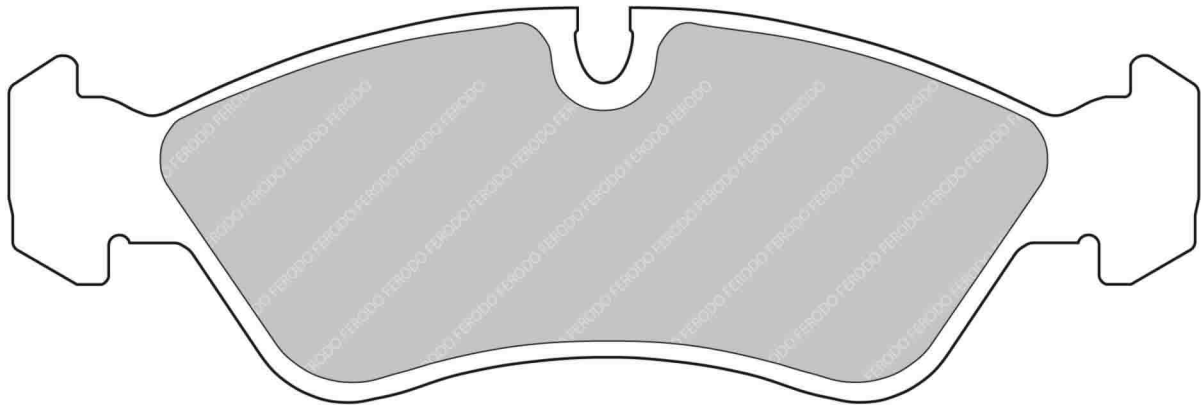

MATERIAL AVAILABILITY				
H	C	R	W	Z
✓		✓		

CROSS REFERENCE	
BREMBO	07.8301.19
CL BRAKES	4036
FMSI	D403
MINTEX	MDB1386
PAGID	1288
WVA	21 190 17,50

# FCP586



61.8mm = 2.433"

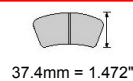

37.4mm = 1.472"

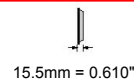

15.5mm = 0.610"

WVA No: 21 140 15,70

FMSI No: D427

**IMPORTANT NOTICE: Please note that the height measurement represents the radial depth, not the entire back plate**

OPEL Rear, SAAB Rear, VAUXHALL Rear

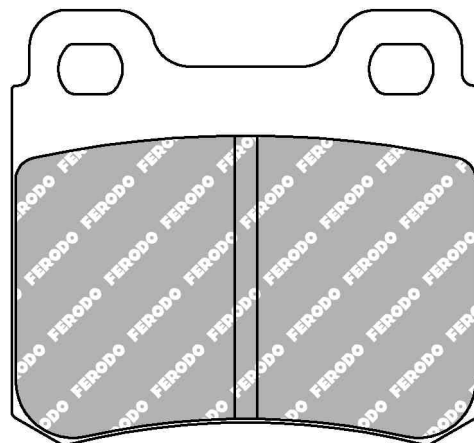

MATERIAL AVAILABILITY				
H	C	R	W	Z
✓		✓		

CROSS REFERENCE	
CL BRAKES	4037
FMSI	D427
MINTEX	MDB1385
WVA	21 140 15,70

- ✓ Available
- ✗ Not Available
- ⚠ Exhausting
- ✉ Make to order
- 🔵 In Introduction

# FCP590

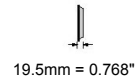
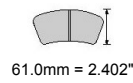

WVA No: 20 676 19,60

FMSI No: D555

**IMPORTANT NOTICE: Please note that the height measurement represents the radial depth, not the entire back plate**

AUDI Front, FORD Front, SEAT Front, SKODA Front, VOLKSWAGEN Front

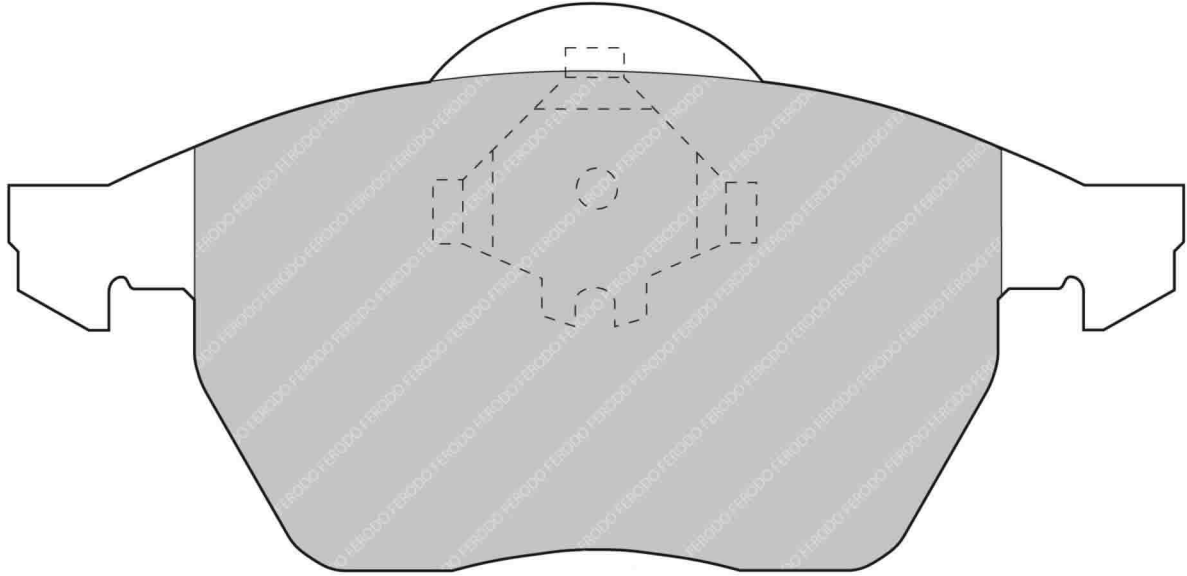

MATERIAL AVAILABILITY				
H	C	R	W	Z
✓		✓	✉	

CROSS REFERENCE	
BREMBO	07.8300.14
BREMBO	07.8300.38
BREMBO	07.8300.40
BREMBO	07.8301.73
FMSI	D555
FMSI	D687
HAWK	HB269 .763A
MINTEX	MDB1531
PAGID	1678
WVA	20 676 19,60



# FCP596

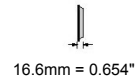
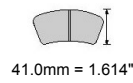

WVA No: 21 144 16,50

FMSI No: D228

**IMPORTANT NOTICE: Please note that the height measurement represents the radial depth, not the entire back plate**

ALFA ROMEO Rear, AUDI Rear, FIAT Rear, LANCIA Rear, VOLKSWAGEN Rear

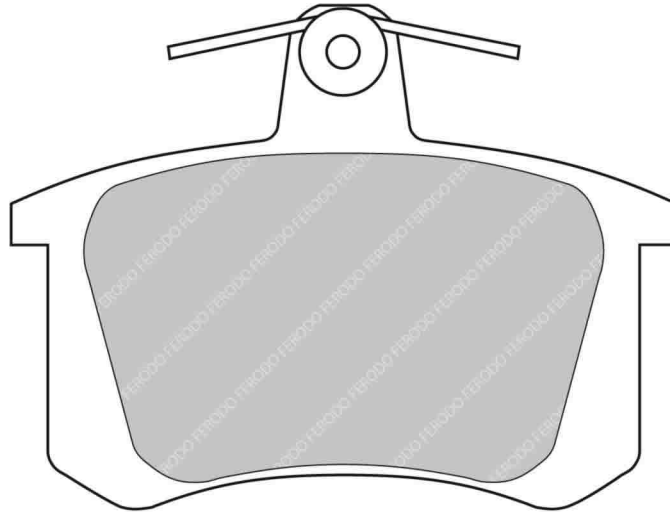

MATERIAL AVAILABILITY				
H	C	R	W	Z
✓		✓		

CROSS REFERENCE	
BREMBO	07.8301.21
CL BRAKES	4010
FMSI	D228
HAWK	HB271 0,635
PAGID	3242
WVA	21 144 16,50

✓ Available    ⚠ Exhausting  
 ✗ Not Available    ✉ Make to order  
 🔄 In Introduction

**FERODO**  
RACING

Updated on 30th Jan 2014

**3037**

# FCP598

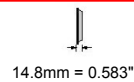
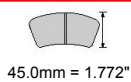
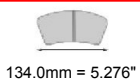

WVA No: 21 322 15,00

FMSI No: D373

**IMPORTANT NOTICE: Please note that the height measurement represents the radial depth, not the entire back plate**

HONDA Front

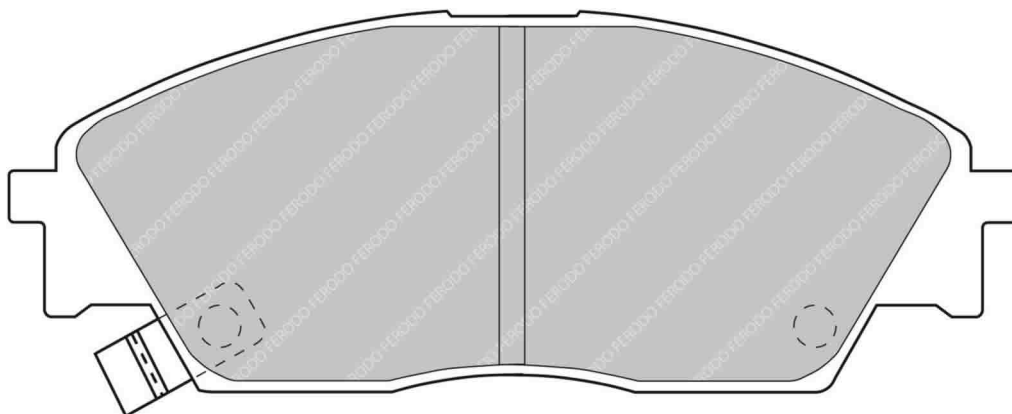

MATERIAL AVAILABILITY				
H	C	R	W	Z
✓		✓		

CROSS REFERENCE	
BREMBO	07.8301.22
CL BRAKES	4083
FMSI	D373
HAWK	HB113 0,59
MINTEX	MDB1374
MINTEX	MDB1525
PAGID	8010
PFC	0373.XX
WVA	21 322 15,00

# FCP600

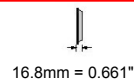
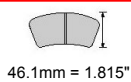

WVA No: 21 526 17,00

FMSI No: D449

**IMPORTANT NOTICE: Please note that the height measurement represents the radial depth, not the entire back plate**

DAEWOO Front, HYUNDAI Front, INFINITI Front, NISSAN Front, SSANGYONG Front

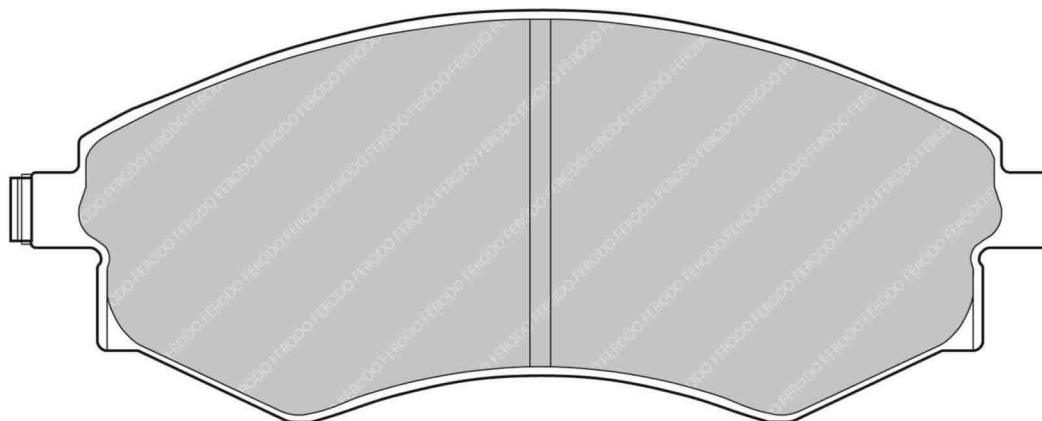

MATERIAL AVAILABILITY				
H	C	R	W	Z
✓		✗		

CROSS REFERENCE	
BREMBO	07.8301.23
FMSI	D449
FMSI	D462
FMSI	D485
FMSI	D700
HAWK	HB235 0,665
HAWK	HB261 0,665
MINTEX	MDB1488
MINTEX	MDB2351
WVA	21 526 17,00

# FCP602

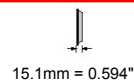
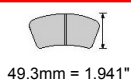
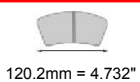

WVA No: 21 294 15,00

**IMPORTANT NOTICE: Please note that the height measurement represents the radial depth, not the entire back plate**

TOYOTA Front



MATERIAL AVAILABILITY				
H	C	R	W	Z
✓		✉		

CROSS REFERENCE	
BREMBO	07.8301.24
MINTEX	MDB1400
WVA	21 294 15,00

- ✓ Available
- ✗ Not Available
- ✉ Make to order
- ⚠ Exhausting
- 🔍 In Introduction



Updated on 30th Jan 2014

**3039**

# FCP613



**IMPORTANT NOTICE: Please note that the height measurement represents the radial depth, not the entire back plate**

HONDA Front, LAND ROVER Front, MG Front, ROVER Front

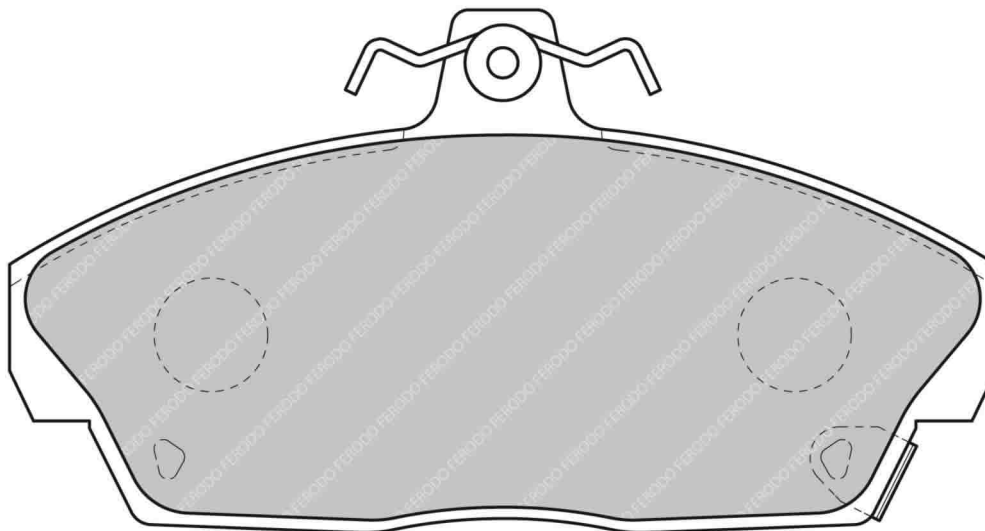

MATERIAL AVAILABILITY				
H	C	R	W	Z
✓		✓		

CROSS REFERENCE	
BREMBO	07.8301.25
MINTEX	MDB1659
WVA	21 515 17,50

# FCP617



**IMPORTANT NOTICE: Please note that the height measurement represents the radial depth, not the entire back plate**

FORD Front

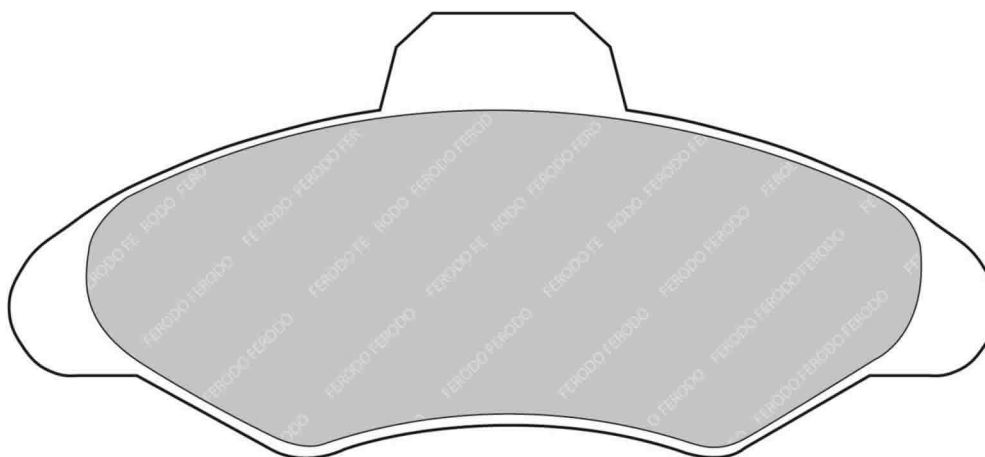

MATERIAL AVAILABILITY				
H	C	R	W	Z
✓				

CROSS REFERENCE	
BREMBO	07.8301.26
MINTEX	MDB1493
WVA	21 171 19,00

# FCP638



85.5mm = 3.366"

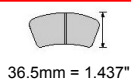

36.5mm = 1.437"

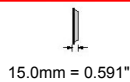

15.0mm = 0.591"

WVA No: 21 553 14,00

FMSI No: D272

**IMPORTANT NOTICE: Please note that the height measurement represents the radial depth, not the entire back plate**

HYUNDAI Rear

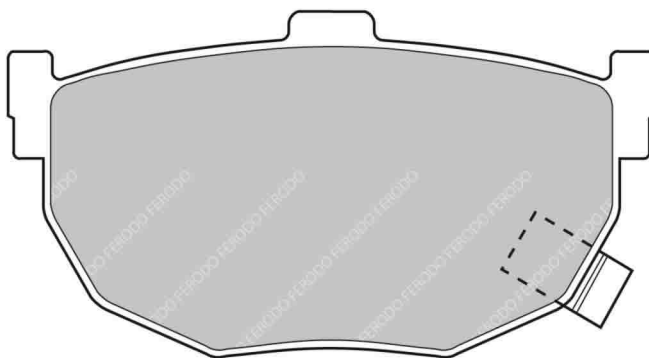

MATERIAL AVAILABILITY				
H	C	R	W	Z
✓				

CROSS REFERENCE	
FMSI	D272
FMSI	D323
FMSI	D464
HAWK	HB262 0,54
MINTEX	MDB2352
WVA	21 553 14,00

# FCP646



99.9mm = 3.933"

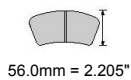

56.0mm = 2.205"

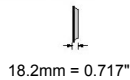

18.2mm = 0.717"

WVA No: 21 153 17,50

**IMPORTANT NOTICE: Please note that the height measurement represents the radial depth, not the entire back plate**

MERCEDES Front

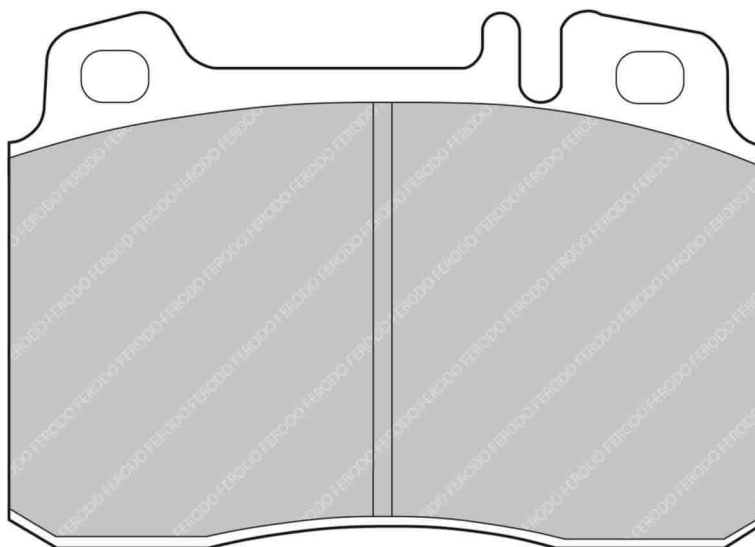

MATERIAL AVAILABILITY				
H	C	R	W	Z
✓			✉	

CROSS REFERENCE	
MINTEX	MDB1503
WVA	21 153 17,50

- ✓ Available
- ✗ Not Available
- ⚠ Exhausting
- ✉ Make to order
- 🔧 In Introduction

# FCP647



**IMPORTANT NOTICE: Please note that the height measurement represents the radial depth, not the entire back plate**

ALFA ROMEO Front

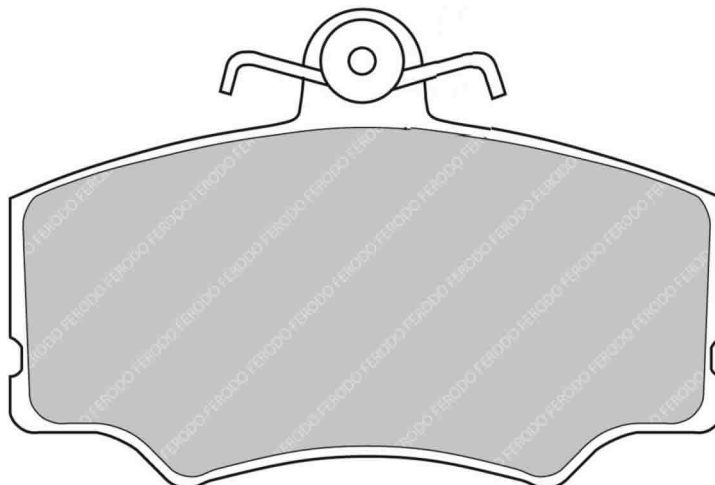

MATERIAL AVAILABILITY				
H	C	R	W	Z

CROSS REFERENCE	
MINTEX	MDB1511
WVA	21 271 17,00

# FCP660



**IMPORTANT NOTICE: Please note that the height measurement represents the radial depth, not the entire back plate**

BMW Front, MERCEDES Front, SAAB Front

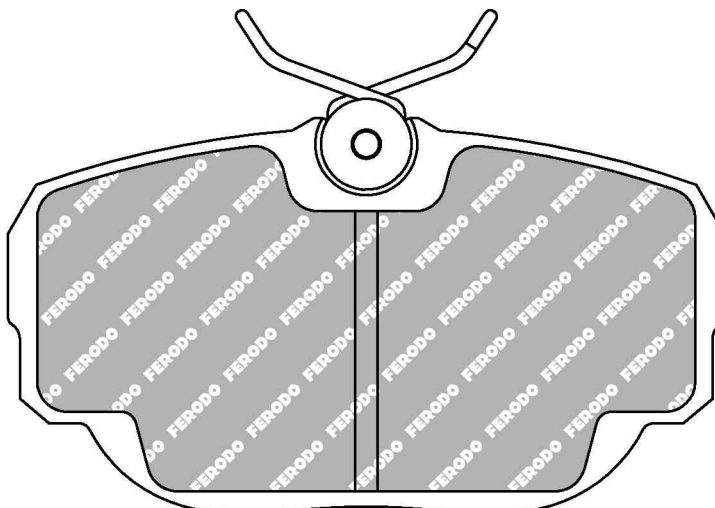

Replacing FCP303

MATERIAL AVAILABILITY				
H	C	R	W	Z

CROSS REFERENCE	
MINTEX	MDB1401
MINTEX	MDB1473
MINTEX	MDB1583
PAGID	1544
WVA	21 173 17,00

# FCP685

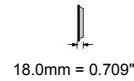
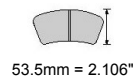
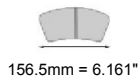

WVA No: 21 560 18,00

**IMPORTANT NOTICE: Please note that the height measurement represents the radial depth, not the entire back plate**

FORD Front, JAGUAR Front, OPEL Front, SAAB Front, VAUXHALL Front

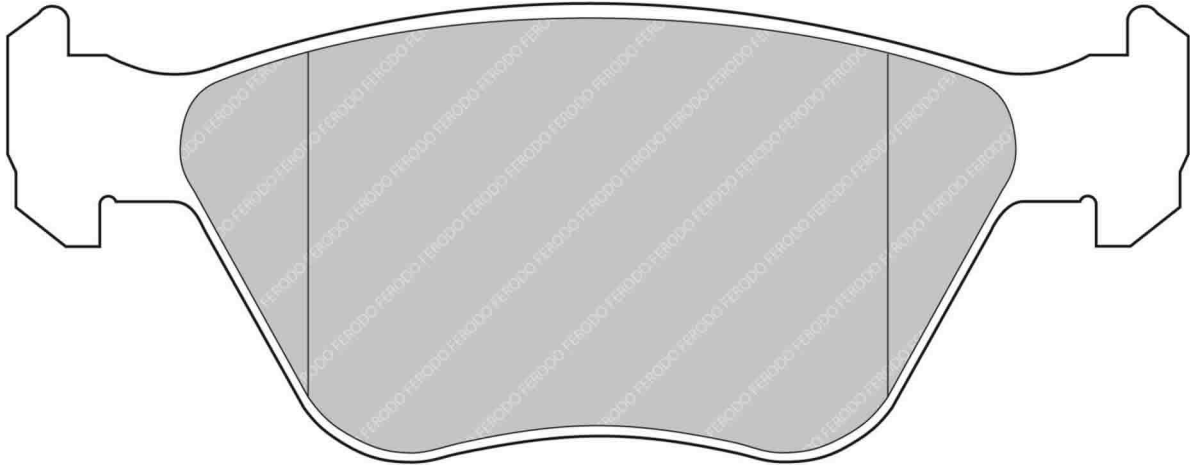

MATERIAL AVAILABILITY				
H	C	R	W	Z
✓		✓		

CROSS REFERENCE	
ALCON	PNF0084X235
ALCON	PNF0084X235.4
BREMBO	07.8301.28
MINTEX	MDB1637
PAGID	1675
PFC	0394
PFC	7760
WVA	21 560 18,00

# FCP691

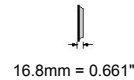
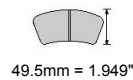
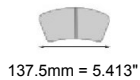

WVA No: 21 561 17,00

FMSI No: D430

**IMPORTANT NOTICE: Please note that the height measurement represents the radial depth, not the entire back plate**

INFINITI Front, NISSAN Front

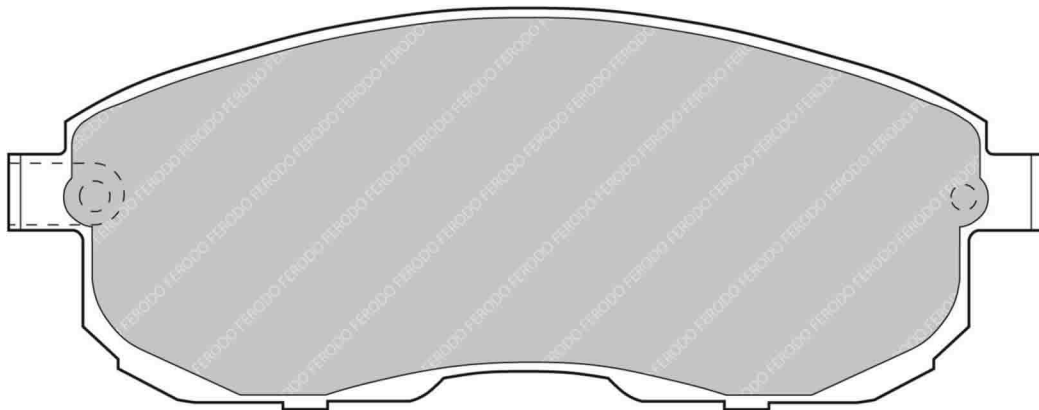

MATERIAL AVAILABILITY				
H	C	R	W	Z
✓				

CROSS REFERENCE	
BREMBO	07.8300.07
FMSI	D430
HAWK	HB268 0,665
MINTEX	MDB1451
WVA	21 561 17,00

✓ Available    ⚠ Exhausting  
 ✗ Not Available    📧 Make to order  
 🚧 In Introduction

**FERODO**  
RACING

Updated on 30th Jan 2014

**3043**

# FCP721



109.8mm = 4.323"



51.3mm = 2.020"



17.3mm = 0.681"

WVA No: 21 381 16,80

FMSI No: D1053

**IMPORTANT NOTICE: Please note that the height measurement represents the radial depth, not the entire back plate**

ALFA ROMEO Front, CHEVROLET Rear, DODGE Front, FIAT Front, LANCIA Front

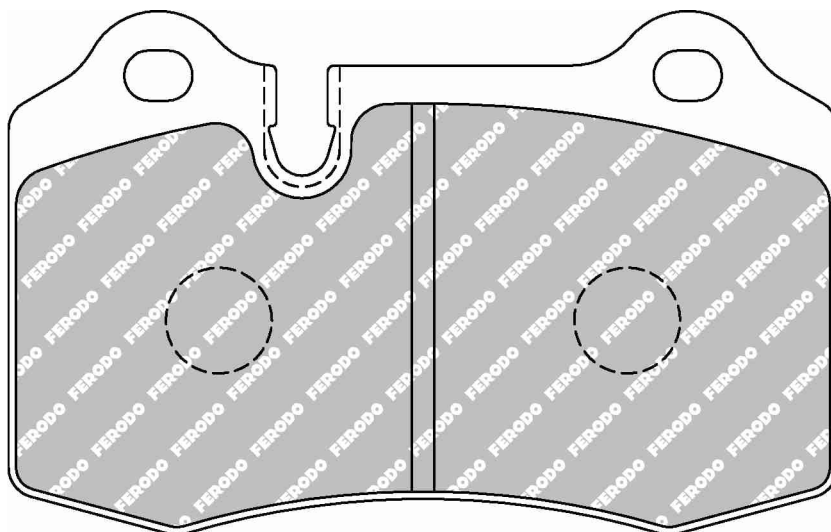

ALSO AVAILABLE		
SHAPE	TH. MM	NOTES
FCP1348	15	
FRP3109	12.5	

MATERIAL AVAILABILITY				
H	C	R	W	Z
✓		✓	✉	

CROSS REFERENCE	
BREMBO	07.7235.60
CL BRAKES	4022
FMSI	D1053
FMSI	D592
HAWK	HB194 0,57
HAWK	HB194 0,575
HAWK	HB194 0,665
MINTEX	MDB1633
MINTEX	MTX1968
PFC	0592.XX.17
WVA	21 381 16,80



# FCP725



151.5mm = 5.965"



52.0mm = 2.047"



16.4mm = 0.646"

VVA No: 21 292 17,30

FMSI No: D558

**IMPORTANT NOTICE: Please note that the height measurement represents the radial depth, not the entire back plate**

BMW Front

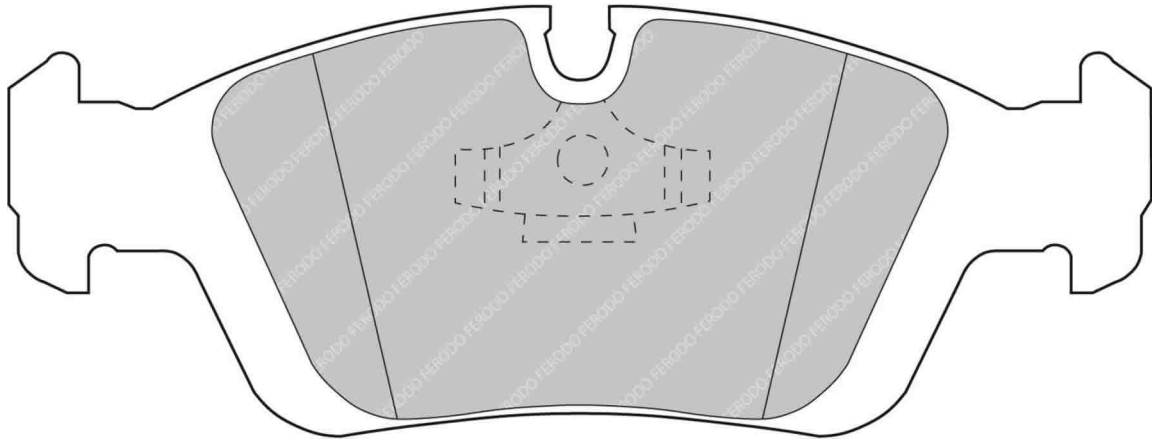

MATERIAL AVAILABILITY				
H	C	R	W	Z
✓		✓	✓	

CROSS REFERENCE	
BREMBO	07.8300.09
BREMBO	07.8301.68
FMSI	D558
HAWK	HB136 0,69
MINTEX	MDB1538
PAGID	2180
PFC	0558
PFC	0558.XX
WVA	21 292 17,30

# FCP726



88.0mm = 3.465"



41.0mm = 1.614"



14.4mm = 0.567"

VVA No: 21 589 15,00

FMSI No: D340

**IMPORTANT NOTICE: Please note that the height measurement represents the radial depth, not the entire back plate**

LANCIA Rear

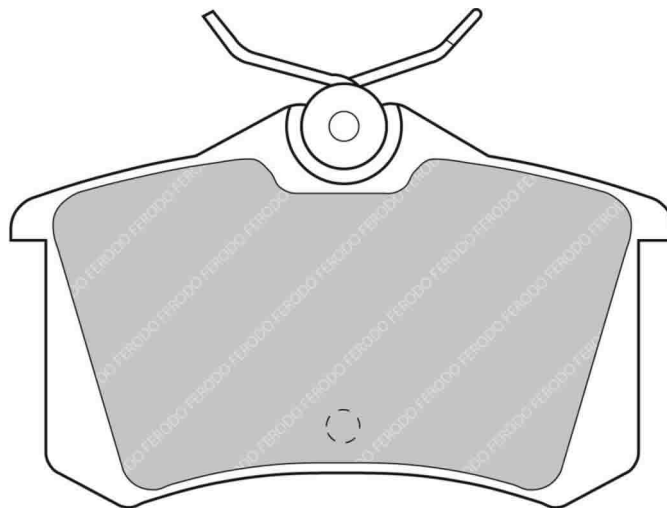

MATERIAL AVAILABILITY				
H	C	R	W	Z
✓		✓		

CROSS REFERENCE	
CL BRAKES	4038
FMSI	D340
WVA	21 589 15,00

✓ Available    ⚠ Exhausting  
 ✗ Not Available    ✉ Make to order  
 🚧 In Introduction

**FERODO**  
RACING

Updated on 30th Jan 2014

**3045**

# FCP732



141.4mm = 5.567"



44.6mm = 1.756"



16.0mm = 0.630"

WVA No: 20 547 16,80

**IMPORTANT NOTICE: Please note that the height measurement represents the radial depth, not the entire back plate**

ASTON MARTIN Rear, DAEWOO Front, OPEL Front, VAUXHALL Front

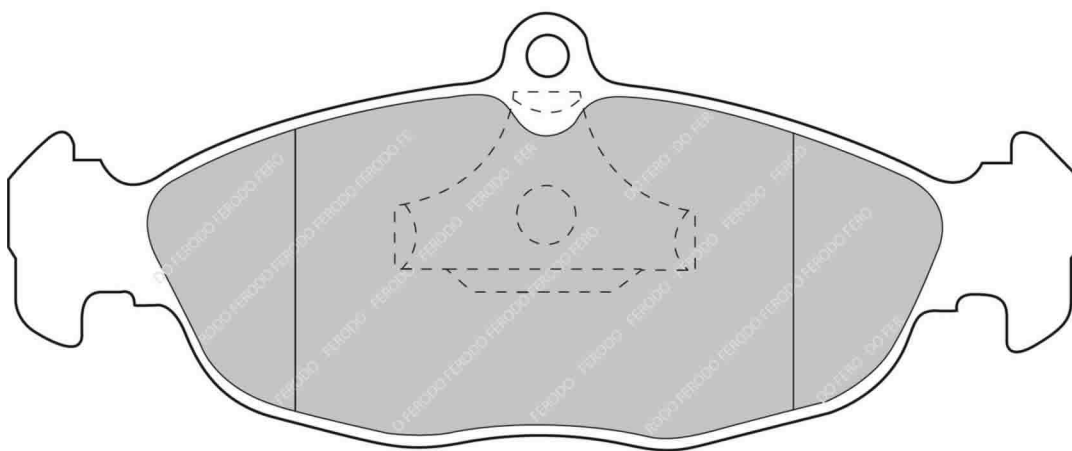

MATERIAL AVAILABILITY				
H	C	R	W	Z
✓		✓		

CROSS REFERENCE	
BREMBO	07.8301.29
MINTEX	MDB1556
WVA	20 547 16,80

# FCP748



129.0mm = 5.079"

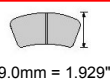

49.0mm = 1.929"

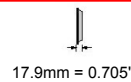

17.9mm = 0.705"

WVA No: 21 446 17,80

FMSI No: D341

**IMPORTANT NOTICE: Please note that the height measurement represents the radial depth, not the entire back plate**

ACURA Front, HONDA Front

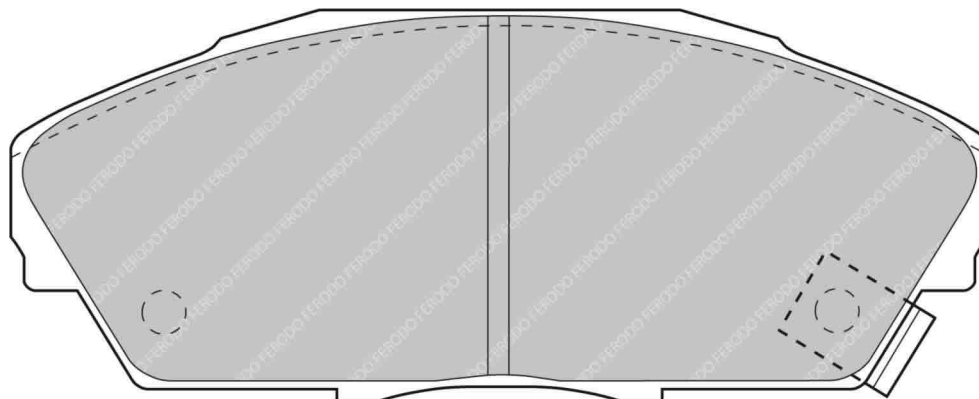

MATERIAL AVAILABILITY				
H	C	R	W	Z
✓				

CROSS REFERENCE	
BREMBO	07.8300.17
BREMBO	07.8300.23
FMSI	D341
FMSI	D409
HAWK	HB242 0,661
MINTEX	MDB1589
PAGID	1596
PFC	0409.XX
WVA	21 446 17,80

# FCP761

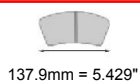

137.9mm = 5.429"

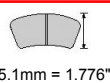

45.1mm = 1.776"

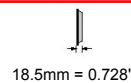

18.5mm = 0.728"

FMSI No: D465

**IMPORTANT NOTICE: Please note that the height measurement represents the radial depth, not the entire back plate**

ACURA Front, HONDA Front

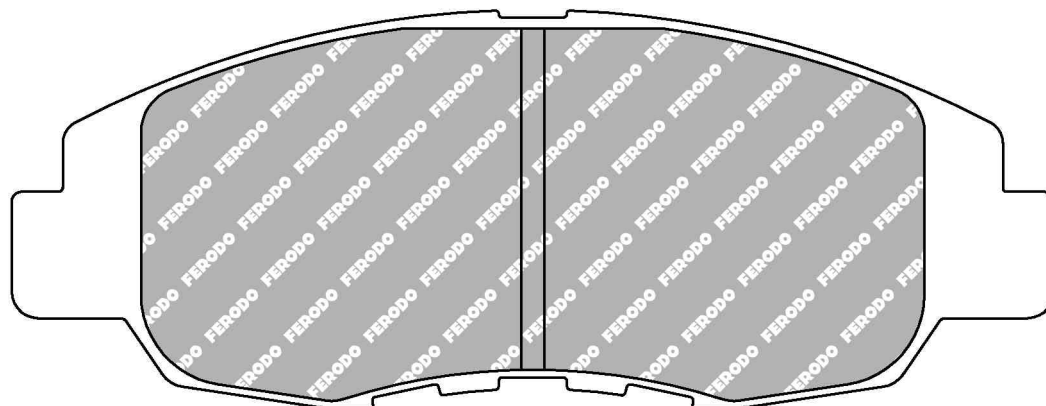

MATERIAL AVAILABILITY				
H	C	R	W	Z
✗				

CROSS REFERENCE	
BREMBO	07.8300.18
CL BRAKES	4102
FMSI	D465
FMSI	D764
HAWK	HB275 0,62
MINTEX	MDB1533
PFC	0465.XX

- ✓ Available
- ✗ Not Available
- ⚠ Exhausting
- ✉ Make to order
- 📦 In Introduction

# FCP765

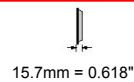
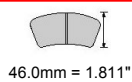

WVA No: 21 363 15,70

FMSI No: D530

**IMPORTANT NOTICE: Please note that the height measurement represents the radial depth, not the entire back plate**

DODGE Front, MITSUBISHI Front

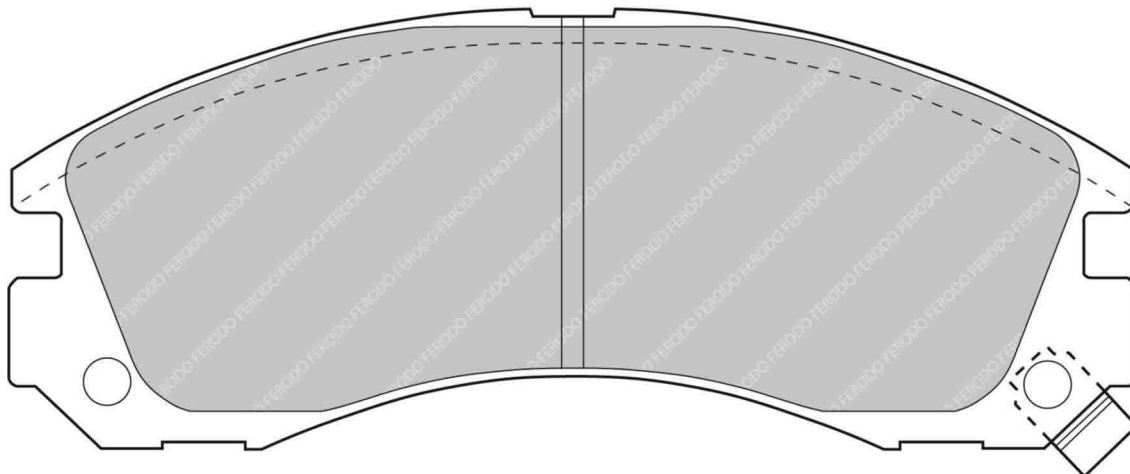

MATERIAL AVAILABILITY				
H	C	R	W	Z
✓		✓	✓	✓

CROSS REFERENCE	
FMSI	D530
FMSI	D723
HAWK	HB214 0,618
MINTEX	MDB1539
PAGID	1591
PFC	0530.XX
WVA	21 363 15,70

# FCP766



156.5mm = 6.161"



47.5mm = 1.870"



18.0mm = 0.709"

WVA No: 21 395 18,00

FMSI No: D648

**IMPORTANT NOTICE: Please note that the height measurement represents the radial depth, not the entire back plate**

FORD Front

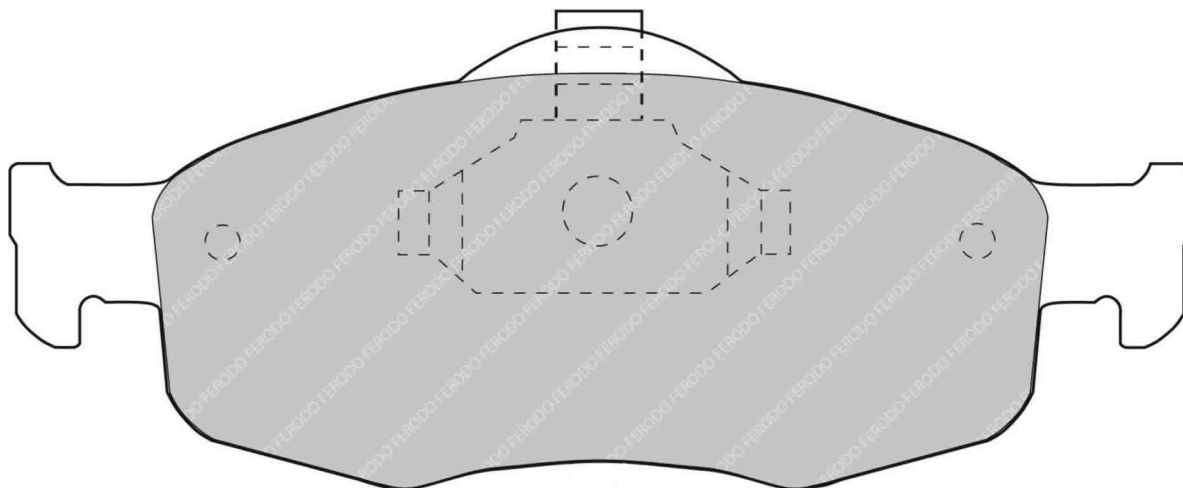

MATERIAL AVAILABILITY				
H	C	R	W	Z
⚠		✉		

CROSS REFERENCE	
BREMBO	07.8301.30
FMSI	D648
HAWK	HB420 0,748
MINTEX	MDB1622
PFC	0648.XX
WVA	21 395 18,00

✓ Available    ⚠ Exhausting  
 ✗ Not Available    ✉ Make to order  
 🔄 In Introduction

**FERODO**  
RACING

Updated on 30th Jan 2014

**3049**

# FCP767

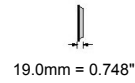
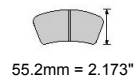

WVA No: 21 583 18,80

**IMPORTANT NOTICE: Please note that the height measurement represents the radial depth, not the entire back plate**

FORD Front

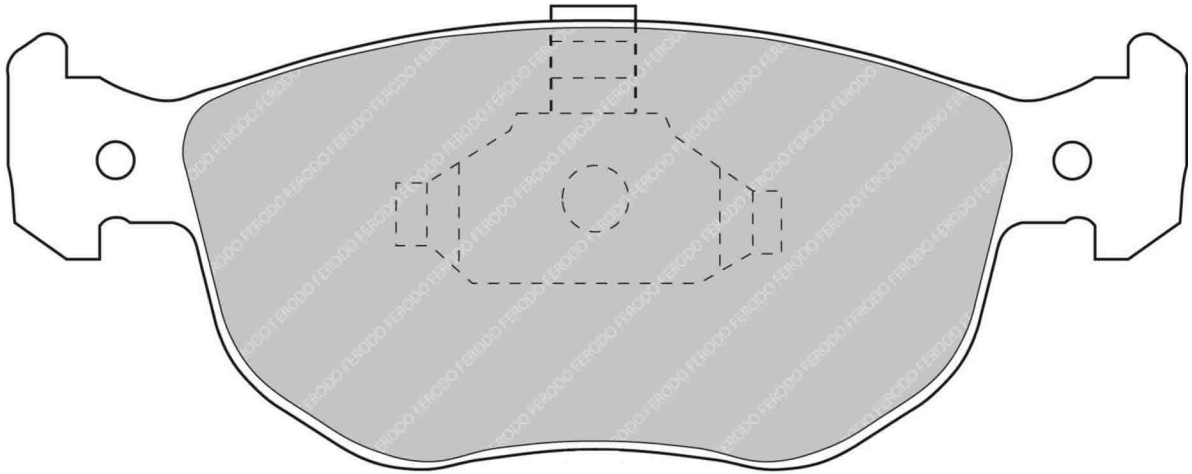

MATERIAL AVAILABILITY				
H	C	R	W	Z
✓		✗		

CROSS REFERENCE	
ALCON	PNF0084X238.4
BREMBO	07.8301.31
MINTEX	MDB1810
MINTEX	MDB1895
MINTEX	MDB2193
WVA	21 583 18,80

3050

**FERODO**  
RACING

Updated on 30th Jan 2014

✓ Available    ⚠ Exhausting  
 ✗ Not Available    📦 Make to order  
 🔄 In Introduction

# FCP774



119.0mm = 4.685"



47.5mm = 1.870"



16.2mm = 0.638"

WVA No: 20 168 16,20

FMSI No: D227

**IMPORTANT NOTICE: Please note that the height measurement represents the radial depth, not the entire back plate**

AUDI Front, SEAT Front, VOLKSWAGEN Front

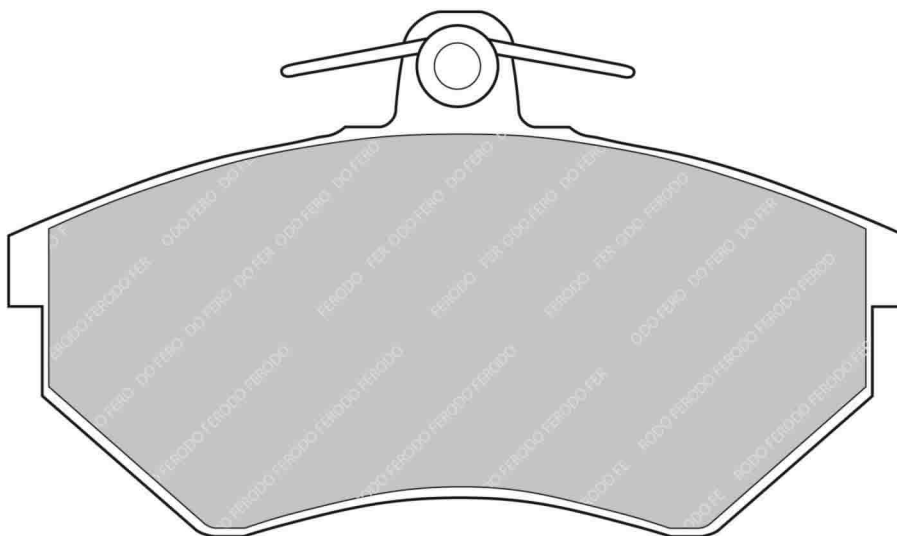

ALSO AVAILABLE		
SHAPE	TH. MM	NOTES
FCP775	19.6	

MATERIAL AVAILABILITY				
H	C	R	W	Z
✓		✓		

CROSS REFERENCE	
BREMBO	07.8301.32
BREMBO	07.8301.71
CL BRAKES	4011
FMSI	D227
FMSI	D696
HAWK	HB190 .600A
MINTEX	MDB1253
MINTEX	MDB1371
MINTEX	MDB1570
PAGID	1743
WVA	20 168 16,20

- ✓ Available
- ✗ Not Available
- ⚠ Exhausting
- ✉ Make to order
- 🔧 In Introduction

# FCP775



119.0mm = 4.685"



47.5mm = 1.870"



19.6mm = 0.772"

WVA No: 20 168 19,60

FMSI No: D227

**IMPORTANT NOTICE: Please note that the height measurement represents the radial depth, not the entire back plate**

AUDI Front, SEAT Front, VOLKSWAGEN Front

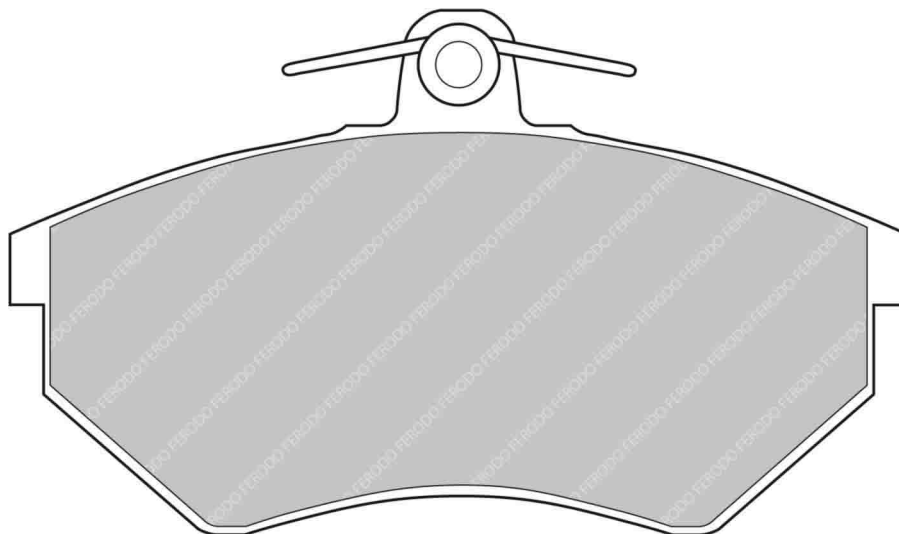

ALSO AVAILABLE		
SHAPE	TH. MM	NOTES
FCP774	16.2	

MATERIAL AVAILABILITY				
H	C	R	W	Z
✓		✓		

CROSS REFERENCE	
BREMBO	07.8300.02
BREMBO	07.8301.63
CL BRAKES	4011
FMSI	D227
FMSI	D290
FMSI	D684
HAWK	HB190 .730A
MINTEX	MDB1190
MINTEX	MDB1571
PAGID	1744
WVA	20 168 19,60



# FCP776



136.4mm = 5.370"



50.1mm = 1.972"



16.5mm = 0.650"

WVA No: 21 694 16,50

FMSI No: D621

**IMPORTANT NOTICE: Please note that the height measurement represents the radial depth, not the entire back plate**

AUDI Front, HONDA Front

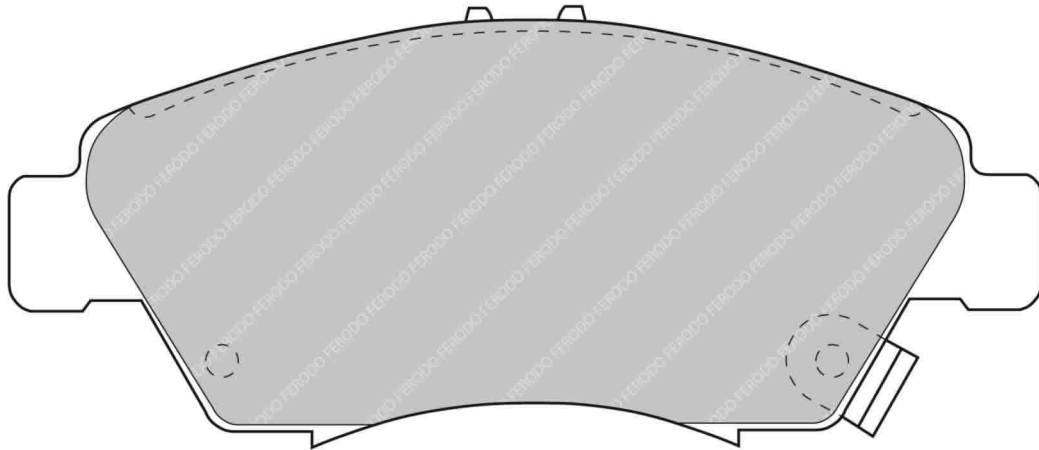

MATERIAL AVAILABILITY				
H	C	R	W	Z
✓		✓		✉

CROSS REFERENCE	
BREMBO	07.8300.01
FMSI	D621
MINTEX	MDB1610
PFC	0621
WVA	21 694 16,50

# FCP777



131.4mm = 5.173"



45.5mm = 1.791"



15.0mm = 0.591"

WVA No: 21 697 15,80

FMSI No: D568

**IMPORTANT NOTICE: Please note that the height measurement represents the radial depth, not the entire back plate**

HONDA Front

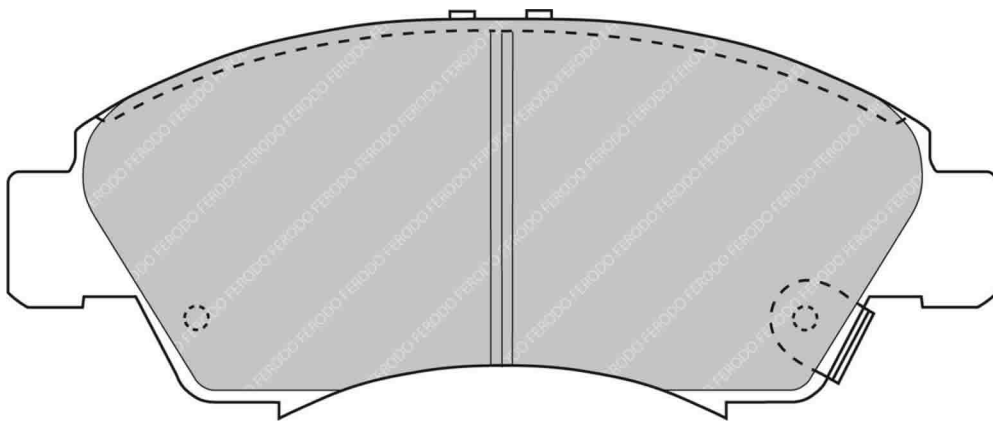

MATERIAL AVAILABILITY				
H	C	R	W	Z
✓				

CROSS REFERENCE	
BREMBO	07.8301.33
CL BRAKES	4077
FMSI	D568
MINTEX	MDB1615
WVA	21 697 15,80

✓ Available    ⚠ Exhausting  
 ✗ Not Available    ✉ Make to order  
 🚧 In Introduction

**FERODO**  
RACING

Updated on 30th Jan 2014

**3053**

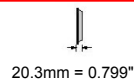
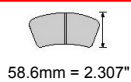

**IMPORTANT NOTICE: Please note that the height measurement represents the radial depth, not the entire back plate**

BMW Front

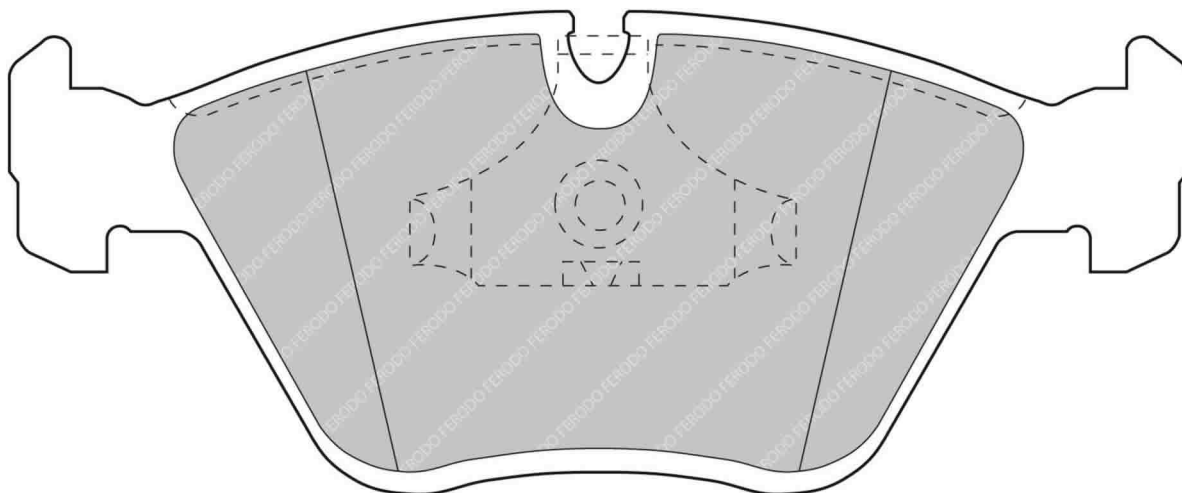

MATERIAL AVAILABILITY				
H	C	R	W	Z
✓		✓	✉	

CROSS REFERENCE	
BREMBO	07.8300.10
BREMBO	07.8301.50
CL BRAKES	4033
FMSI	D394
FMSI	D725
HAWK	HB135 0,77
MINTEX	MDB1393
PAGID	1295
PFC	0394.XX
WVA	20 968 20,30

# FCP789

128.1mm = 5.043"

43.7mm = 1.720"

16.1mm = 0.634"

WVA No: 21 495 17,00

FMSI No: D470

**IMPORTANT NOTICE: Please note that the height measurement represents the radial depth, not the entire back plate**

SUBARU Front

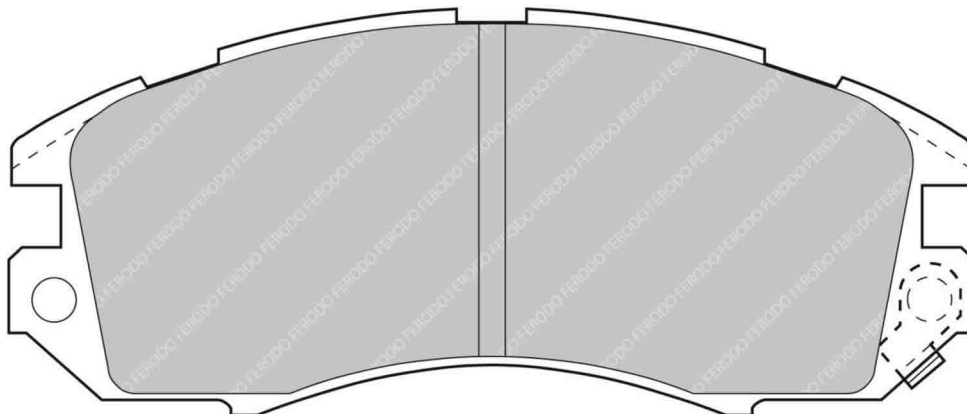

MATERIAL AVAILABILITY				
H	C	R	W	Z
✓		✓		

CROSS REFERENCE	
BREMBO	07.8301.34
CL BRAKES	4018
FMSI	D470
HAWK	HB408 0,665
MINTEX	MDB1496
PAGID	1349
WVA	21 495 17,00

# FCP790

108.1mm = 4.256"

33.1mm = 1.303"

14.6mm = 0.575"

WVA No: 21 703 14,80

FMSI No: D471

**IMPORTANT NOTICE: Please note that the height measurement represents the radial depth, not the entire back plate**

SUBARU Rear

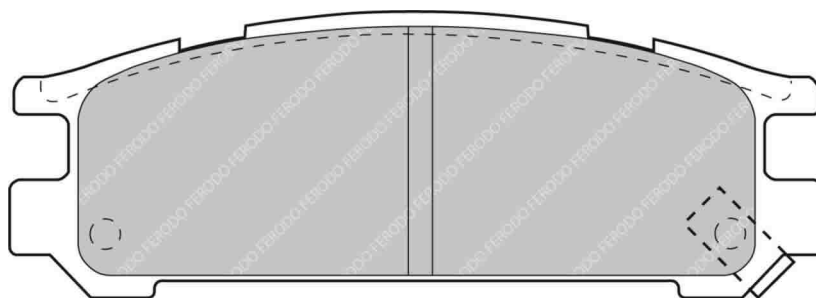

MATERIAL AVAILABILITY				
H	C	R	W	Z
✓		✓		

CROSS REFERENCE	
CL BRAKES	4019
FMSI	D471
HAWK	HB367 0,585
MINTEX	MDB1497
WVA	21 703 14,80

✓ Available    ⚠ Exhausting  
 ✗ Not Available    ✉ Make to order  
 🚧 In Introduction

**FERODO**  
RACING

Updated on 30th Jan 2014

**3055**

# FCP809

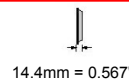
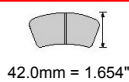
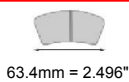

WVA No: 20 088 14,40 FMSI No: D044

**IMPORTANT NOTICE: Please note that the height measurement represents the radial depth, not the entire back plate**

CATERHAM Front, CITROEN Rear, FORD Front, INNOCENTI Front, LAMBORGHINI Rear, LANCIA Rear, LOTUS Front, MORGAN Front, PEUGEOT Rear, ROVER Front, TALBOT Front, VOLVO Rear

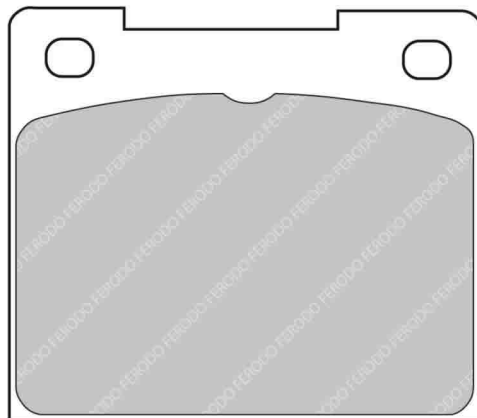

MATERIAL AVAILABILITY				
H	C	R	W	Z
✓	✓	✓	✉	✓

CROSS REFERENCE	
ALCON	PNF3451X521.4
ALCON	PNF3451X555.4
CL BRAKES	5002W43T14
EBC	DP114
FMSI	D044
HAWK	HB118 0,56
MINTEX	MD1723
MINTEX	MGB533
PAGID	3102
PFC	0044
WVA	20 088 14,40

# FCP810

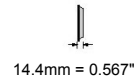
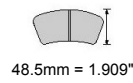

WVA No: 20 089 14,40

FMSI No: D51

**IMPORTANT NOTICE: Please note that the height measurement represents the radial depth, not the entire back plate**

CITROEN Rear, FORD Front, HYUNDAI Front, JENSEN Front, ROVER Front, TALBOT Front, VAUXHALL Front, VOLVO Front

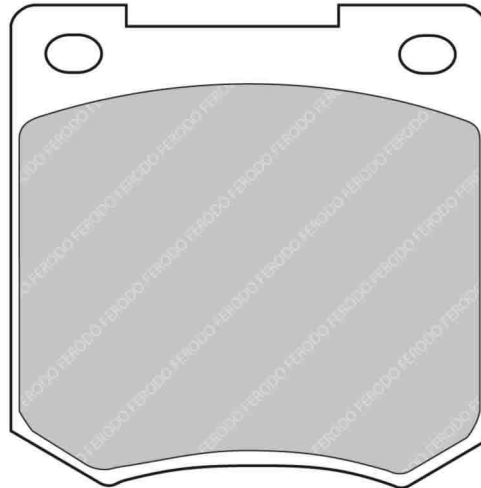

MATERIAL AVAILABILITY				
H	C	R	W	Z
✓	✉	✓	✉	✉

CROSS REFERENCE	
ALCON	PNF3451X522
ALCON	PNF3451X522.4
ALCON	PNF3451X554.4
ALCON	PNF3451X566.4
CL BRAKES	5002W48T14
FMSI	D51
MINTEX	MGB535
PAGID	3190
PFC	0051
WVA	20 089 14,40

✓ Available    ⚠ Exhausting  
 ✗ Not Available    ✉ Make to order  
 🚧 In Introduction

**FERODO**  
RACING

Updated on 30th Jan 2014

**3057**

# FCP815

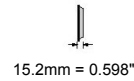
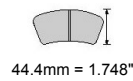
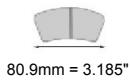

WVA No: 20 007 15,30

FMSI No: D009

**IMPORTANT NOTICE: Please note that the height measurement represents the radial depth, not the entire back plate**

AC Rear, ASTON MARTIN Rear, BRISTOL Rear, JAGUAR Rear, JENSEN Rear

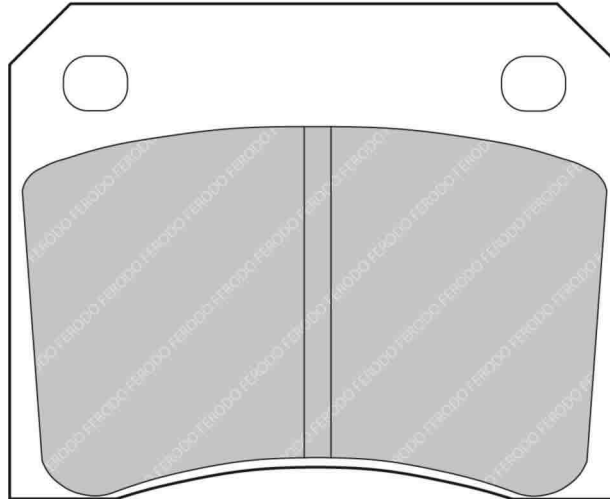

MATERIAL AVAILABILITY				
H	C	R	W	Z
✓	✗	✓	✗	

CROSS REFERENCE	
FMSI	D009
MINTEX	MGB521
PAGID	8041
WVA	20 007 15,30

# FCP817

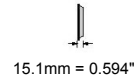
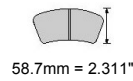
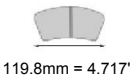

WVA No: 20 380 15,50

FMSI No: D135

**IMPORTANT NOTICE: Please note that the height measurement represents the radial depth, not the entire back plate**

ASTON MARTIN Front, JAGUAR Front, RENAULT Front

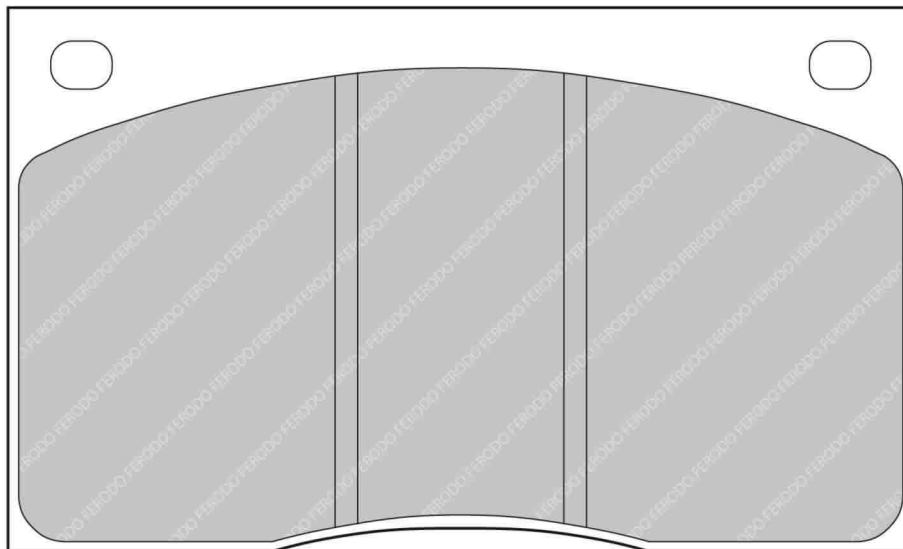

MATERIAL AVAILABILITY				
H	C	R	W	Z
✓		✓		

CROSS REFERENCE	
FMSI	D135
MINTEX	CVP043
MINTEX	MGB585
WVA	20 380 15,50

# FCP823

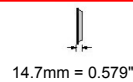
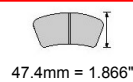

WVA No: 20 037 15,00 FMSI No: D027

**IMPORTANT NOTICE: Please note that the height measurement represents the radial depth, not the entire back plate**

HUMBER Front, MG Front, SINGER Front, SUNBEAM Front

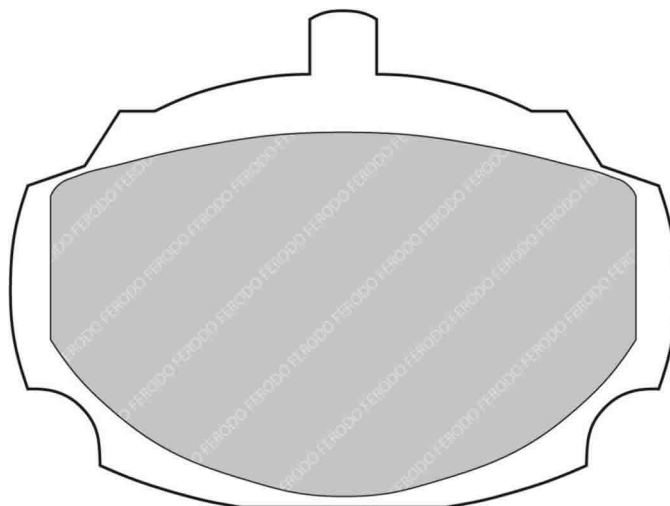

MATERIAL AVAILABILITY				
H	C	R	W	Z

CROSS REFERENCE	
FMSI	D027
MINTEX	MLB10
WVA	20 037 15,00

# FCP825

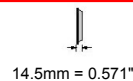
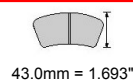

WVA No: 20 054 14,50 FMSI No: D005

**IMPORTANT NOTICE: Please note that the height measurement represents the radial depth, not the entire back plate**

CATERHAM Rear, ROVER Front, VAUXHALL Rear

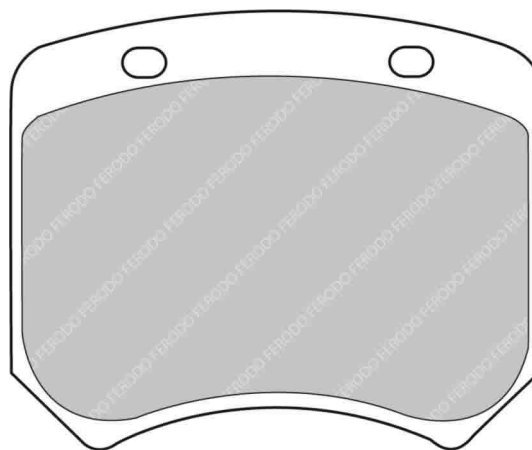

MATERIAL AVAILABILITY				
H	C	R	W	Z

CROSS REFERENCE	
AP RACING	CP2399D43
CL BRAKES	5001W43T14
FMSI	D005
HAWK	HB108
MINTEX	MLB20
PAGID	1363
PFC	7720
WVA	20 054 14,50

Available   
 Exhausting  
 Not Available   
 Make to order  
 In Introduction

**FERODO**  
RACING

Updated on 30th Jan 2014

**3059**

# FCP832

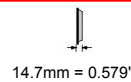
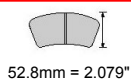

WVA No: 20 577 15,00 FMSI No: D081

**IMPORTANT NOTICE: Please note that the height measurement represents the radial depth, not the entire back plate**

MG Front, ROVER Front

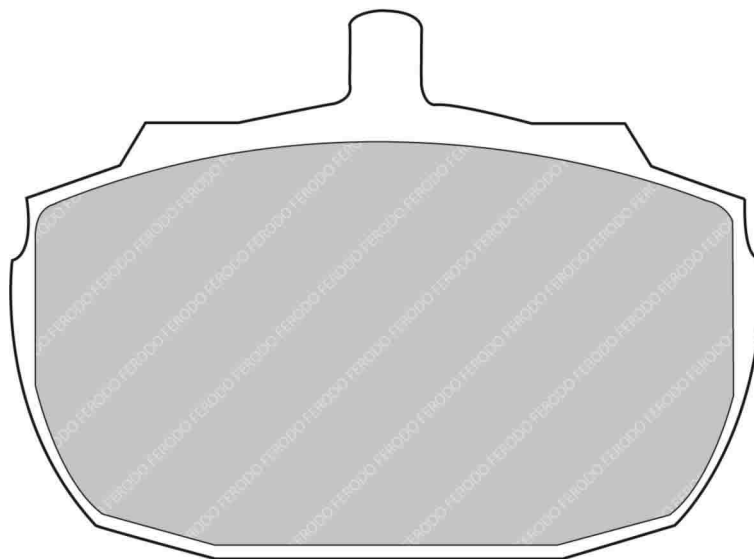

MATERIAL AVAILABILITY				
H	C	R	W	Z

CROSS REFERENCE	
FMSI	D081
MINTEX	MLB52
WVA	20 577 15,00

# FCP840

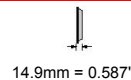
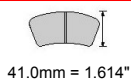

WVA No: 20 754 15,00

**IMPORTANT NOTICE: Please note that the height measurement represents the radial depth, not the entire back plate**

RELIANT Front, ROVER Front

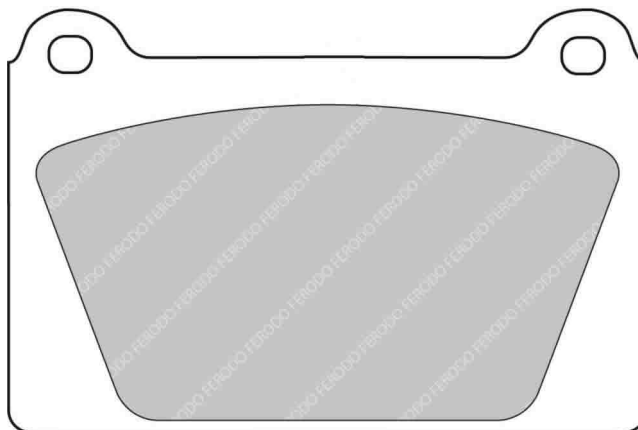

MATERIAL AVAILABILITY				
H	C	R	W	Z

CROSS REFERENCE	
AP RACING	CP2712D44
MINTEX	MLB65
PFC	7765
WVA	20 754 15,00



# FCP845

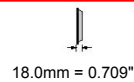
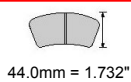

WVA No: 21 463 18,00

FMSI No: D292

**IMPORTANT NOTICE: Please note that the height measurement represents the radial depth, not the entire back plate**

CITROEN Front, DACIA Front, PEUGEOT Front, RENAULT Front, RENAULT-ALPINE Front

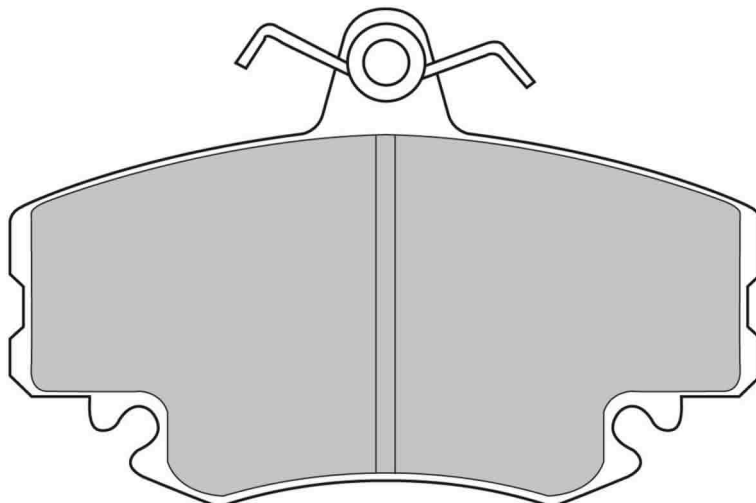

MATERIAL AVAILABILITY				
H	C	R	W	Z
✓	✓	✓	✉	

CROSS REFERENCE	
ALCON	PNF0084X262.4
BREMBO	07.8301.35
CL BRAKES	4000
FMSI	D292
MINTEX	MDB1628
PAGID	3276
PFC	0292
WVA	21 463 18,00

✓ Available    ⚠ Exhausting  
 ✗ Not Available    ✉ Make to order  
 🚧 In Introduction



Updated on 30th Jan 2014

**3061**

# FCP850



123.3mm = 4.854"



40.3mm = 1.587"



16.0mm = 0.630"

WVA No: 20 180 16,80

FMSI No: D396

**IMPORTANT NOTICE: Please note that the height measurement represents the radial depth, not the entire back plate**

BMW Rear, CITROEN Rear, FIAT Rear, LANCIA Rear, PEUGEOT Rear

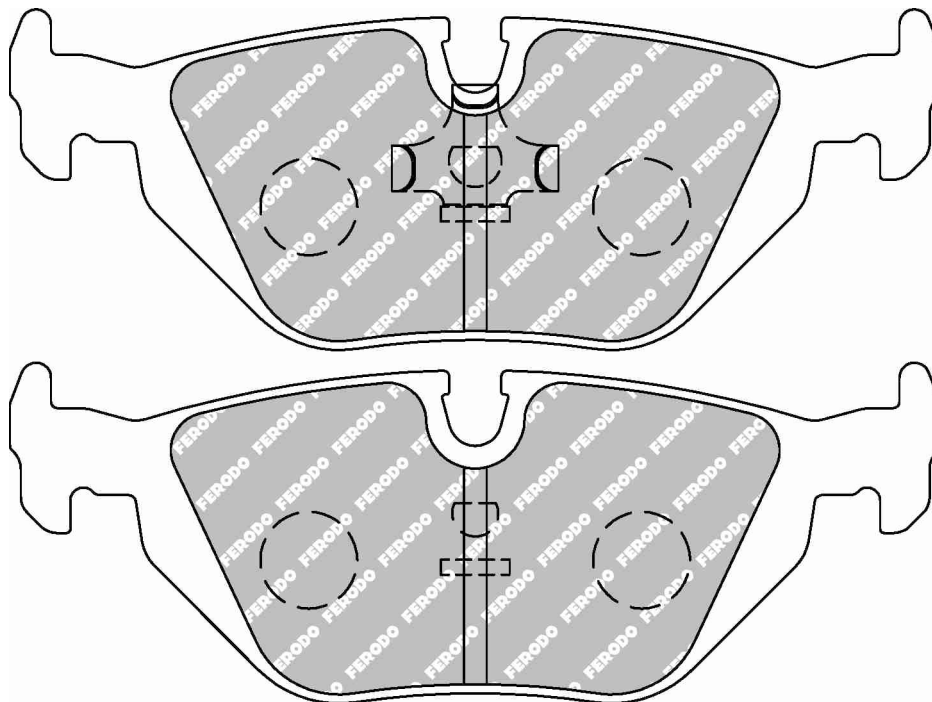

MATERIAL AVAILABILITY				
H	C	R	W	Z
✓		✓	✓	✓

CROSS REFERENCE	
BREMBO	07.8301.69
CL BRAKES	4032
FMSI	D396
FMSI	D692
FMSI	D763
HAWK	HB227 0,63
MINTEX	MDB1572
PAGID	8035
PFC	0396.XX
WVA	20 180 16,80

# FCP856



156.5mm = 6.161"



69.6mm = 2.740"



18.5mm = 0.728"

WVA No: 21 284 19,30

FMSI No: D547

**IMPORTANT NOTICE: Please note that the height measurement represents the radial depth, not the entire back plate**

BMW Front, MASERATI Front

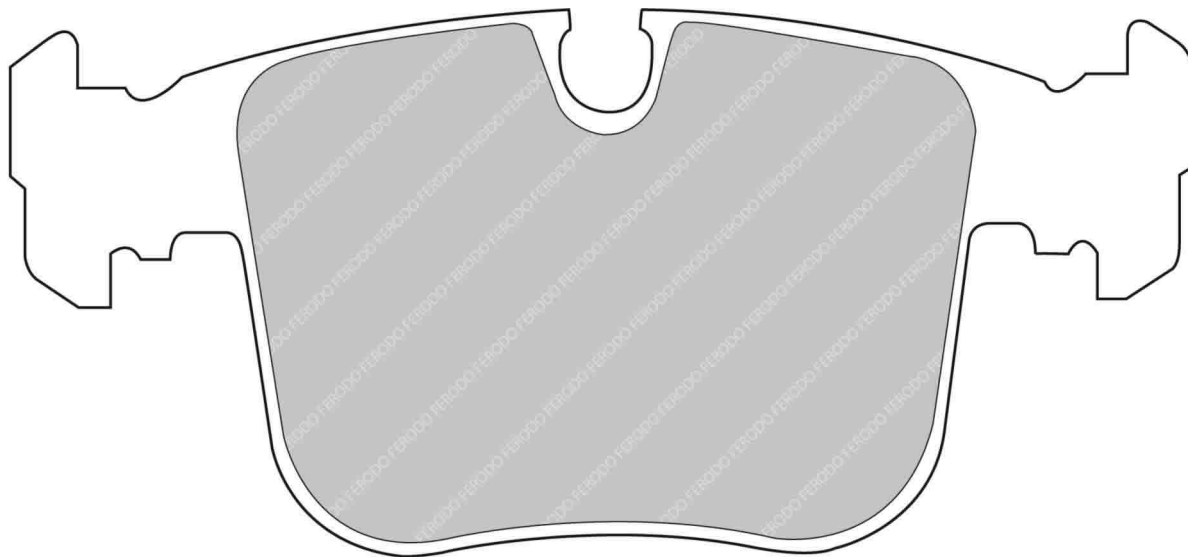

MATERIAL AVAILABILITY				
H	C	R	W	Z
✓		✉		

CROSS REFERENCE	
BREMBO	07.8300.11
FMSI	D547
HAWK	HB325 0,72
MINTEX	MDB1551
PAGID	2683
WVA	21 284 19,30

✓ Available    ⚠ Exhausting  
 ✗ Not Available    ✉ Make to order  
 📦 In Introduction

# FCP857

123.2mm = 4.850"

54.8mm = 2.157"

17.0mm = 0.669"

WVA No: 21 282 17,30

FMSI No: D548

**IMPORTANT NOTICE: Please note that the height measurement represents the radial depth, not the entire back plate**

BMW Rear, MASERATI Rear

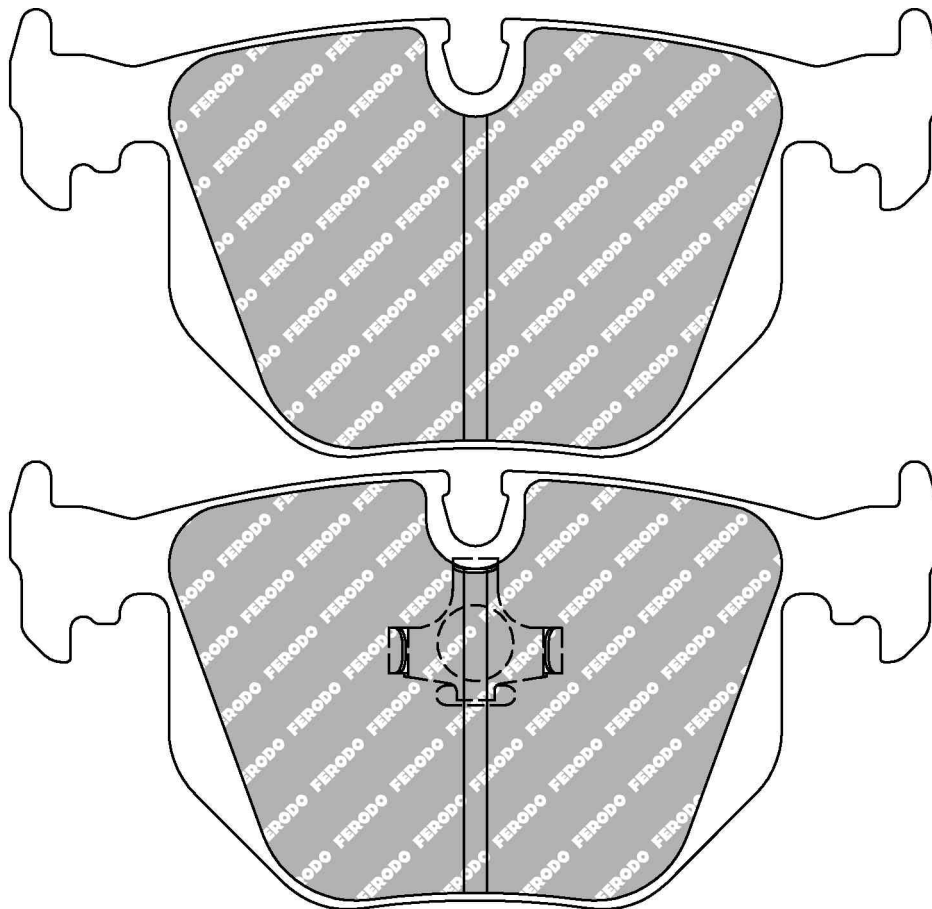

ALSO AVAILABLE		
SHAPE	TH. MM	NOTES
FCP1483	17.2	Different Spring Clip

MATERIAL AVAILABILITY				
H	C	R	W	Z
✓		✓	✉	

CROSS REFERENCE	
ALCON	PNF0084X347.4
FMSI	D548
HAWK	HB362 0,642
MINTEX	MDB1552
PAGID	2685
WVA	21 282 17,30

# FCP859

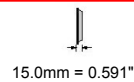
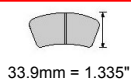

WVA No: 21 626 15,00

**IMPORTANT NOTICE: Please note that the height measurement represents the radial depth, not the entire back plate**

NISSAN Front

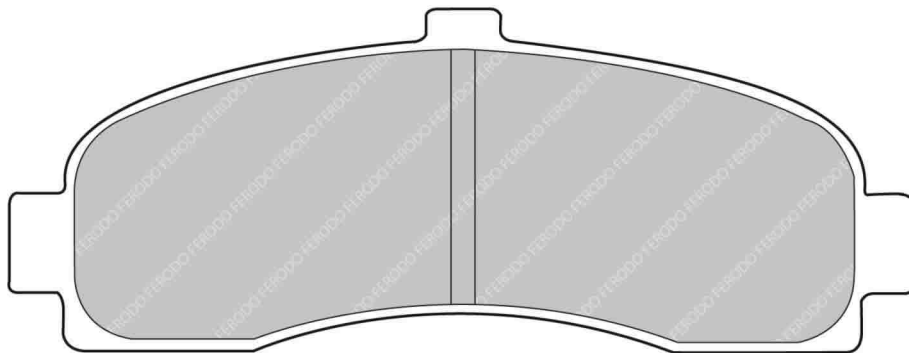

MATERIAL AVAILABILITY				
H	C	R	W	Z

CROSS REFERENCE	
BREMBO	07.8301.36
MINTEX	MDB1623
WVA	21 626 15,00

Available   
 Exhausting  
 Not Available   
 Make to order  
 In Introduction

**FERODO**  
RACING

Updated on 30th Jan 2014

**3065**

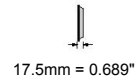
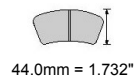

**IMPORTANT NOTICE: Please note that the height measurement represents the radial depth, not the entire back plate**

TOYOTA Front

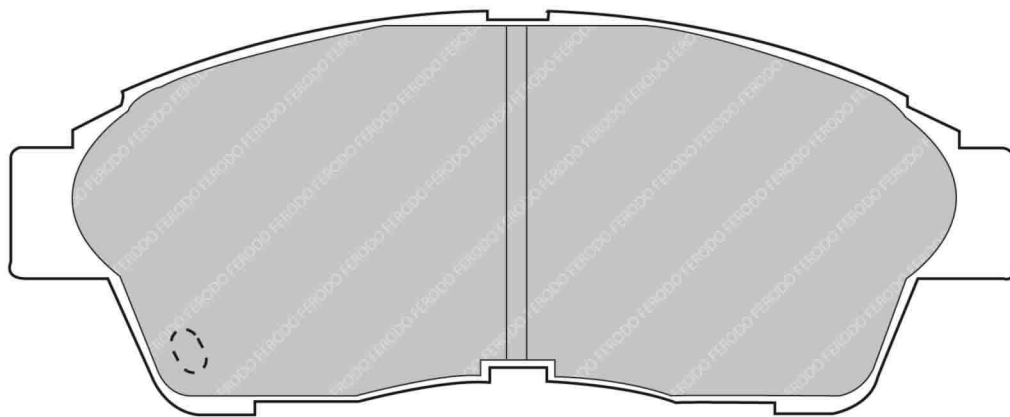
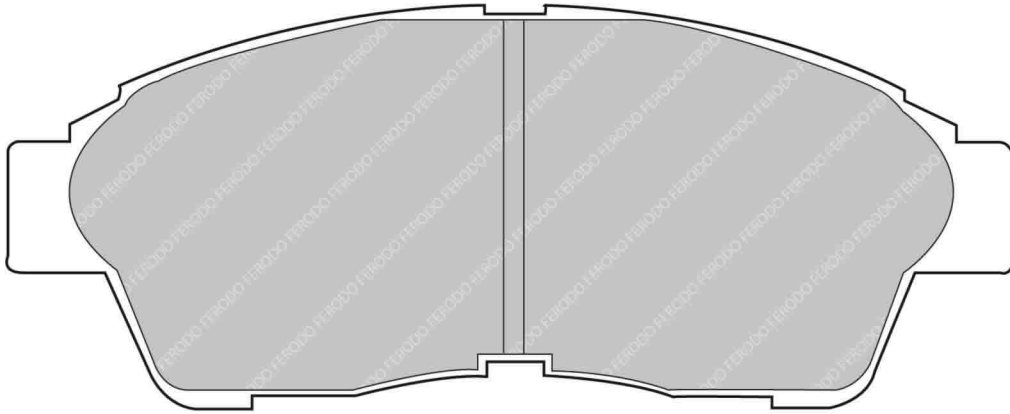

MATERIAL AVAILABILITY				
H	C	R	W	Z
✓				

CROSS REFERENCE	
BREMBO	07.8300.12
FMSI	D562
FMSI	D695
HAWK	HB310 0,689
MINTEX	MDB1658
PFC	0562.XX
WVA	21 601 17,50

# FCP876



141.5mm = 5.571"  
140.3mm = 5.524"



42.2mm = 1.661"  
42.2mm = 1.661"



16.5mm = 0.650"  
16.5mm = 0.650"

WVA No: 21 430 17,30

**IMPORTANT NOTICE:** Please note that the height measurement represents the radial depth, not the entire back plate

CITROEN Front, PEUGEOT Front

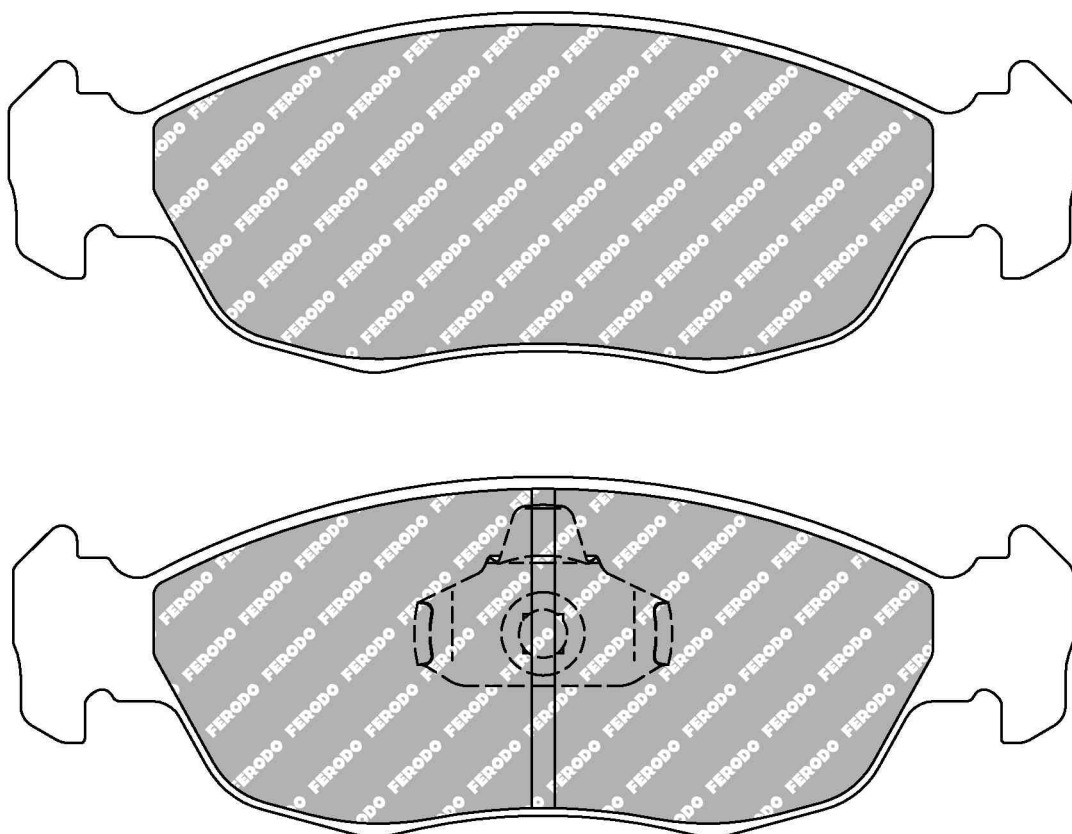

MATERIAL AVAILABILITY				
H	C	R	W	Z
✓		✓		

CROSS REFERENCE	
BREMBO	07.8301.37
MINTEX	MDB1662
PAGID	1620
WVA	21 430 17,30

- ✓ Available    ⚠ Exhausting
- ✗ Not Available    📧 Make to order
- 🔵 In Introduction

# FCP878

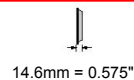
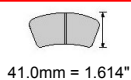

VVA No: 20 410 14,80

FMSI No: D491

**IMPORTANT NOTICE: Please note that the height measurement represents the radial depth, not the entire back plate**

DODGE Rear, RENAULT Rear

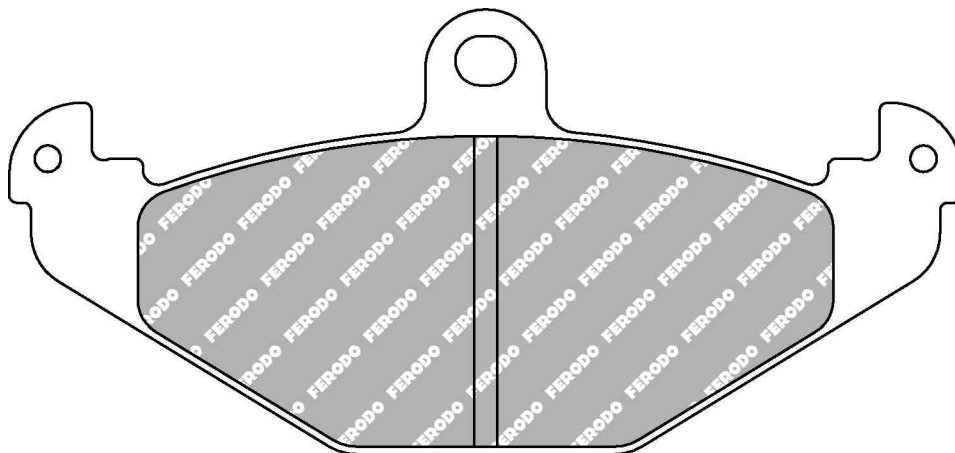

MATERIAL AVAILABILITY				
H	C	R	W	Z
✓		✓		

CROSS REFERENCE	
FMSI	D491
HAWK	HB278 0,583
MINTEX	MDB1445
PAGID	1682
PFC	0491
WVA	20 410 14,80

# FCP881

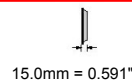
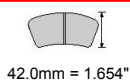
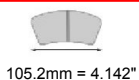

VVA No: 20 634 15,00

FMSI No: D453

**IMPORTANT NOTICE: Please note that the height measurement represents the radial depth, not the entire back plate**

RENAULT Front

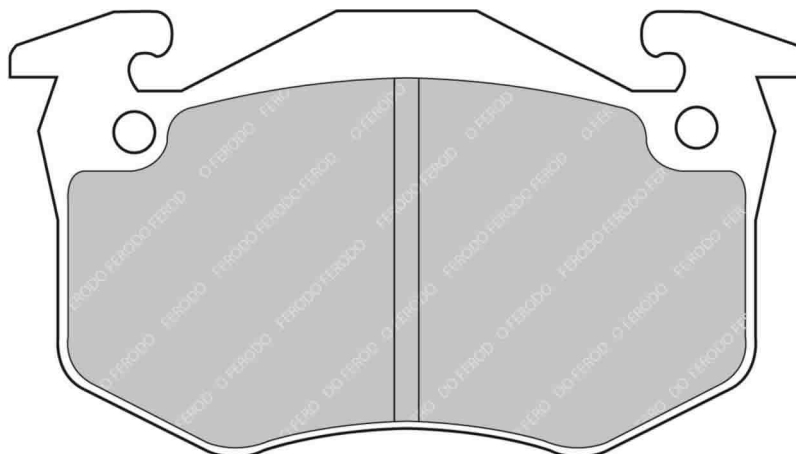

ALSO AVAILABLE		
SHAPE	TH. MM	NOTES
FCP558	11	

MATERIAL AVAILABILITY				
H	C	R	W	Z
✉				

CROSS REFERENCE	
BREMBO	07.8301.38
CL BRAKES	4005
FMSI	D453
MINTEX	MDB1676
WVA	20 634 15,00





131.8mm = 5.189"



66.0mm = 2.598"



17.5mm = 0.689"

WVA No: 21 402 17,50

FMSI No: D594

**IMPORTANT NOTICE: Please note that the height measurement represents the radial depth, not the entire back plate**

AUDI Front, PORSCHE Front

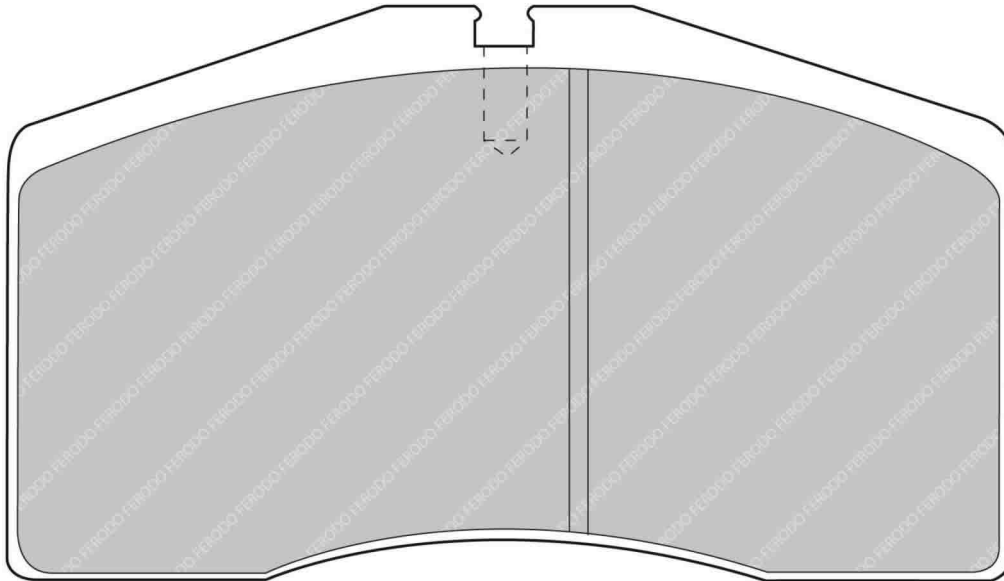

### ALSO AVAILABLE

SHAPE	TH. MM	NOTES
FRP3042	26.5	

### MATERIAL AVAILABILITY

H	C	R	W	Z
✓		✓	✉	

### CROSS REFERENCE

CL BRAKES	4005
FMSI	D594
HAWK	HB184 .650A
MINTEX	MDB1860
PAGID	1842
PFC	0594.XX.18
WVA	21 402 17,50

# FCP904



137.9mm = 5.429"



46.0mm = 1.811"



18.5mm = 0.728"

WVA No: 21 497 18,50

FMSI No: D568

**IMPORTANT NOTICE: Please note that the height measurement represents the radial depth, not the entire back plate**

HONDA Front, ROVER Front

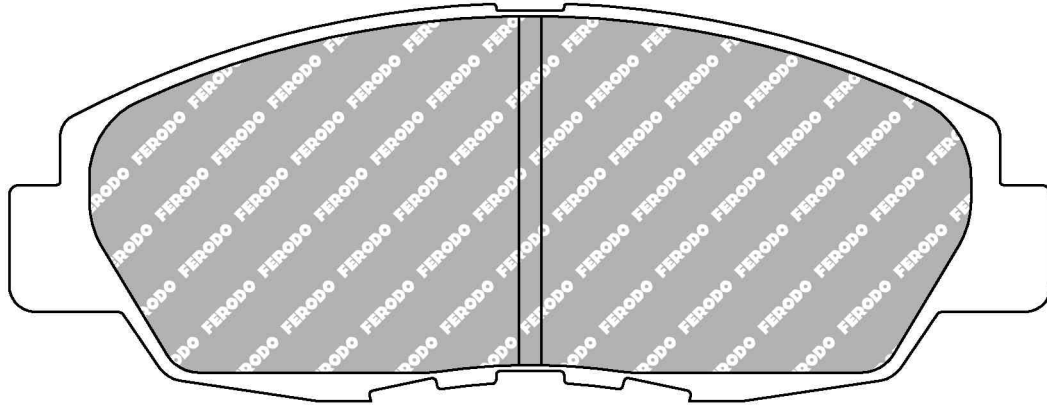

MATERIAL AVAILABILITY				
H	C	R	W	Z
✓				

CROSS REFERENCE	
BREMBO	07.8300.27
FMSI	D568
HAWK	HB144 0,719
MINTEX	MDB1635
MINTEX	MDB1971
WVA	21 497 18,50

# FCP905



148.8mm = 5.858"



50.5mm = 1.988"



18.5mm = 0.728"

WVA No: 21 651 18,50

FMSI No: D503

**IMPORTANT NOTICE: Please note that the height measurement represents the radial depth, not the entire back plate**

ACURA Front, HONDA Front, ROVER Front

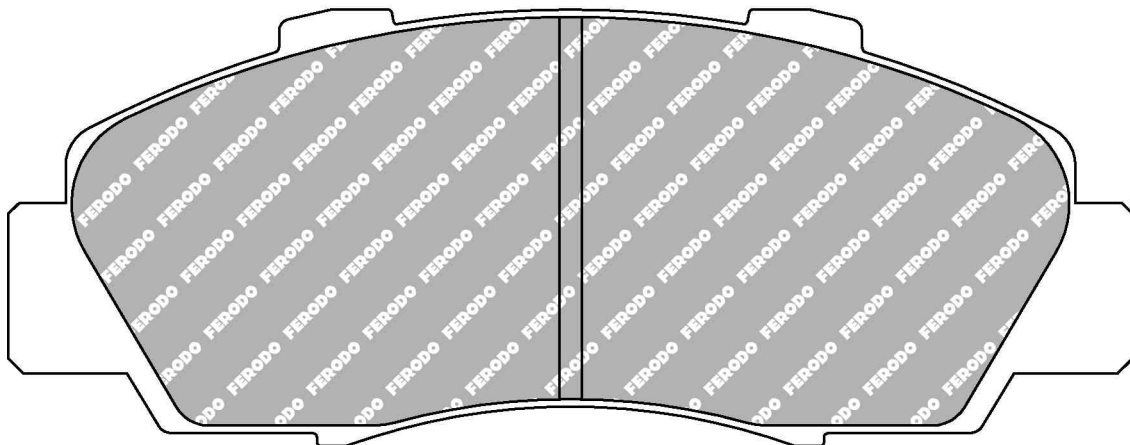

ALSO AVAILABLE		
SHAPE	TH. MM	NOTES
FRP3062	19.5	

MATERIAL AVAILABILITY				
H	C	R	W	Z
✓		✓		

CROSS REFERENCE	
BREMBO	07.8300.00
CL BRAKES	4044
FMSI	D503
HAWK	HB143 0,68
MINTEX	MDB1543
PAGID	2623
PFC	0503.XX
WVA	21 651 18,50

3070

**FERODO**  
RACING

Updated on 30th Jan 2014

✓ Available    ⚠ Exhausting  
 ✗ Not Available    📦 Make to order  
 🚧 In Introduction

# FCP925



**IMPORTANT NOTICE: Please note that the height measurement represents the radial depth, not the entire back plate**

FIAT Front, FIAT AUTO POLAND Front, LANCIA Front

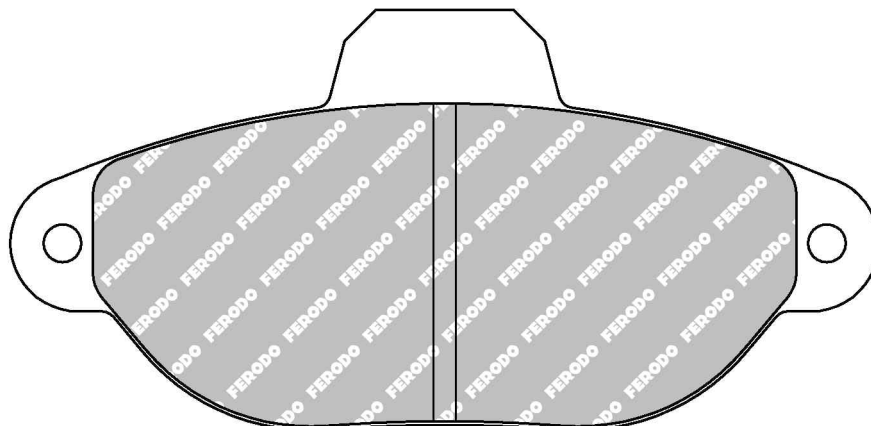

MATERIAL AVAILABILITY				
H	C	R	W	Z
✓		✓		

CROSS REFERENCE	
BREMBO	07.8301.39
MINTEX	MDB1666
WVA	21 436 17,00
WVA	21 437 17,00

# FCP948

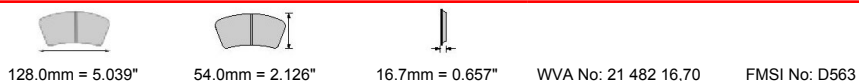

**IMPORTANT NOTICE: Please note that the height measurement represents the radial depth, not the entire back plate**

SUBARU Front

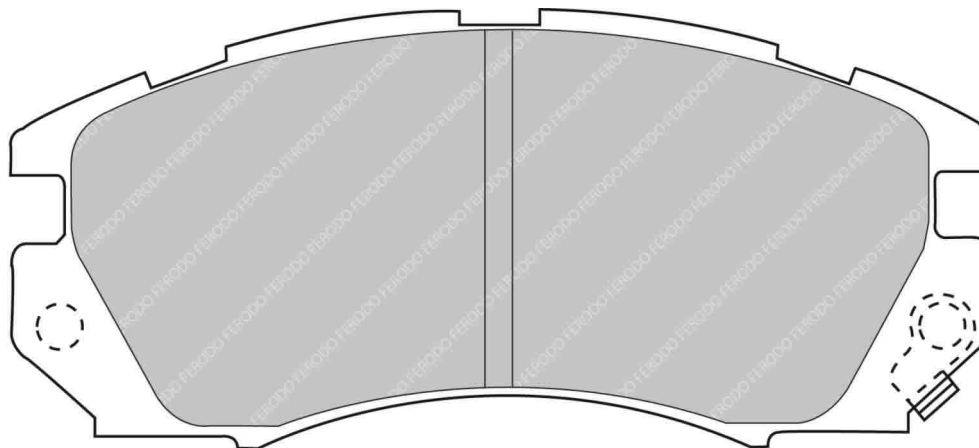

MATERIAL AVAILABILITY				
H	C	R	W	Z
✓		✓		

CROSS REFERENCE	
FMSI	D563
MINTEX	MDB1688
WVA	21 482 16,70

- ✓ Available    ⚠ Exhausting
- ✗ Not Available    ✉ Make to order
- 🔵 In Introduction

# FCP956

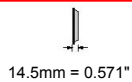
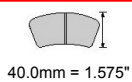

WVA No: 21 719 14,50

**IMPORTANT NOTICE: Please note that the height measurement represents the radial depth, not the entire back plate**

HONDA Rear, MG Rear, ROVER Rear, SUZUKI Rear

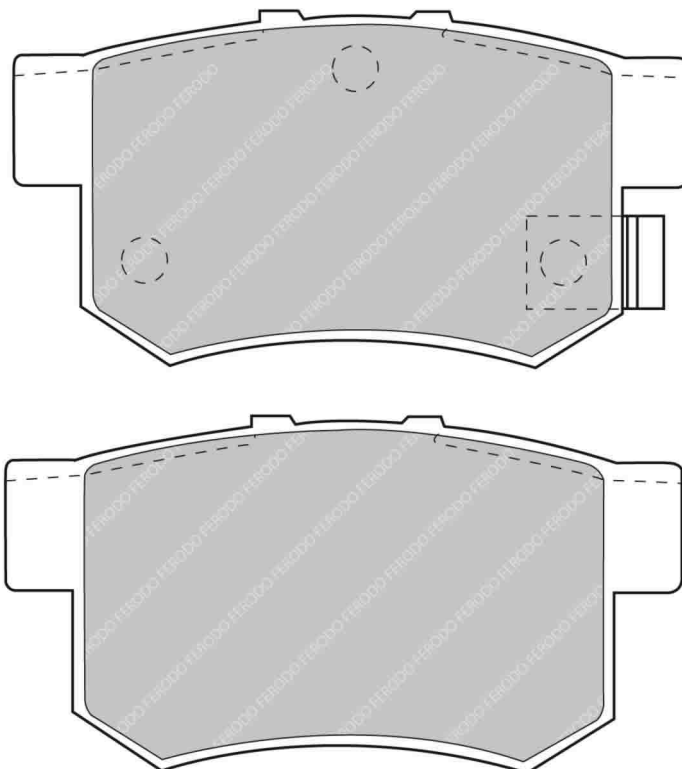

MATERIAL AVAILABILITY				
H	C	R	W	Z
✓		✓	✗	

CROSS REFERENCE	
MINTEX	MDB1564
PFC	0537
WVA	21 719 14,50

# FCP986

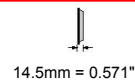
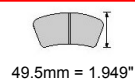

WVA No: 21 307 14,50

FMSI No: D460

**IMPORTANT NOTICE: Please note that the height measurement represents the radial depth, not the entire back plate**

NISSAN Front, SUBARU Front

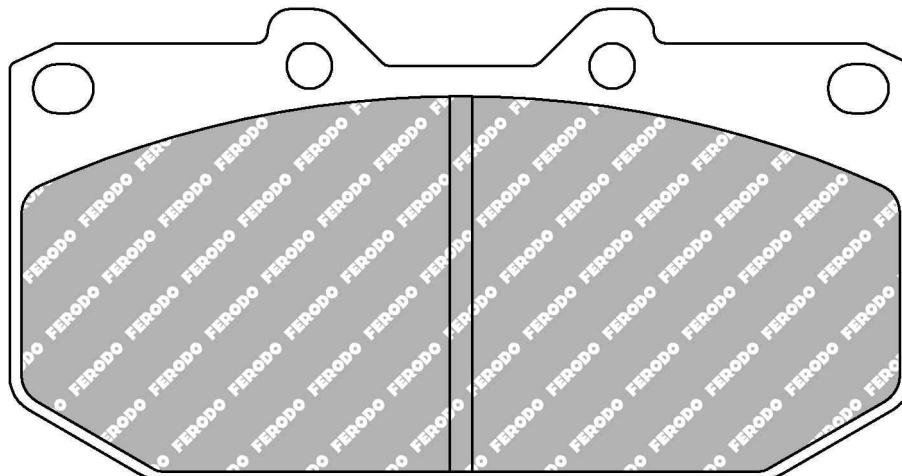

MATERIAL AVAILABILITY				
H	C	R	W	Z
✓		✓	✉	✓

CROSS REFERENCE	
ALCON	PNF0084X249.4
BREMBO	07.8300.15
FMSI	D460
FMSI	D647
HAWK	HB178 0,564
MINTEX	MDB1416
PAGID	1406
PFC	0460
PFC	0460.XX
WVA	21 307 14,50

# FCP995

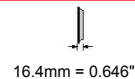
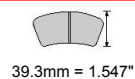

WVA No: 21 606 16,20

**IMPORTANT NOTICE: Please note that the height measurement represents the radial depth, not the entire back plate**

ALFA ROMEO Rear, LANCIA Rear

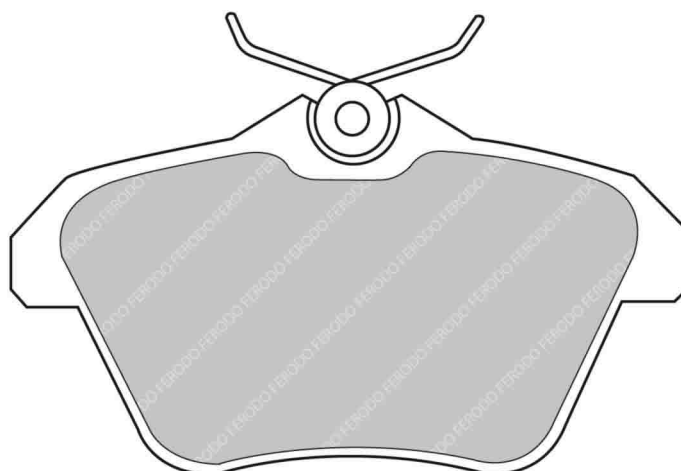

MATERIAL AVAILABILITY				
H	C	R	W	Z
✓				

CROSS REFERENCE	
MINTEX	MDB1742
WVA	21 606 16,20

- ✓ Available
- ✗ Not Available
- ⚠ Exhausting
- ✉ Make to order
- 🔵 In Introduction



Updated on 30th Jan 2014

**3073**

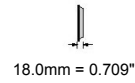
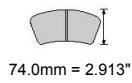

**IMPORTANT NOTICE: Please note that the height measurement represents the radial depth, not the entire back plate**

ALPINA Front, BMW Front

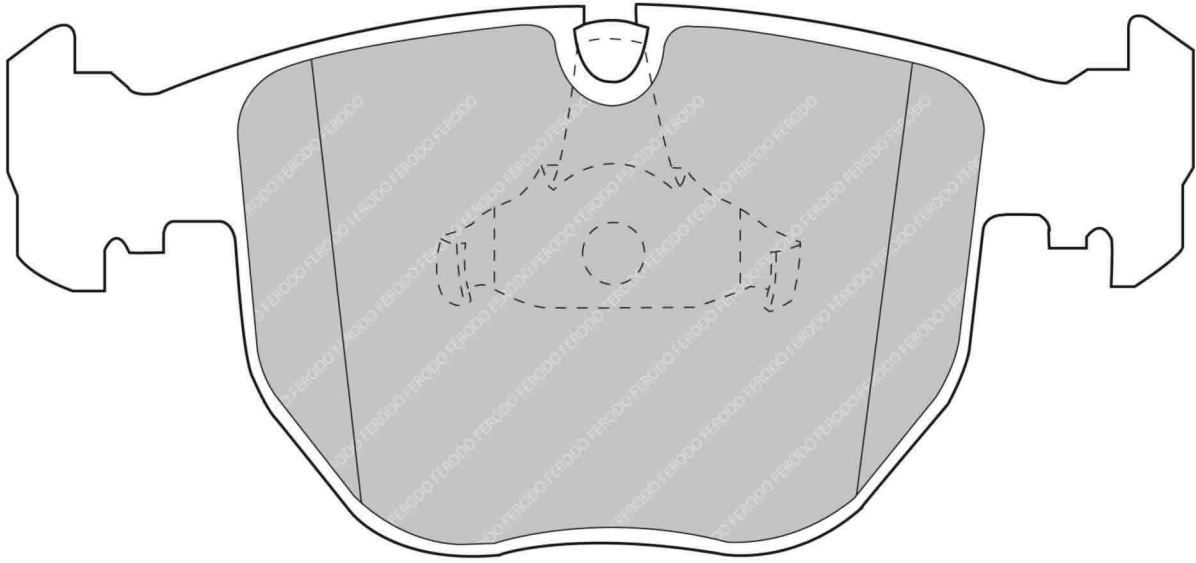

MATERIAL AVAILABILITY				
H	C	R	W	Z
✓		✉		

CROSS REFERENCE	
FMSI	D682
HAWK	HB497 0,776
MINTEX	MDB1745
PAGID	2683
PFC	0682.XX

# FCP1001

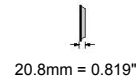
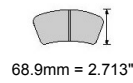

WVA No: 21 484 20

**IMPORTANT NOTICE: Please note that the height measurement represents the radial depth, not the entire back plate**

AUDI Front, BMW Front, CHRYSLER Front, MERCEDES Front, VOLKSWAGEN Front

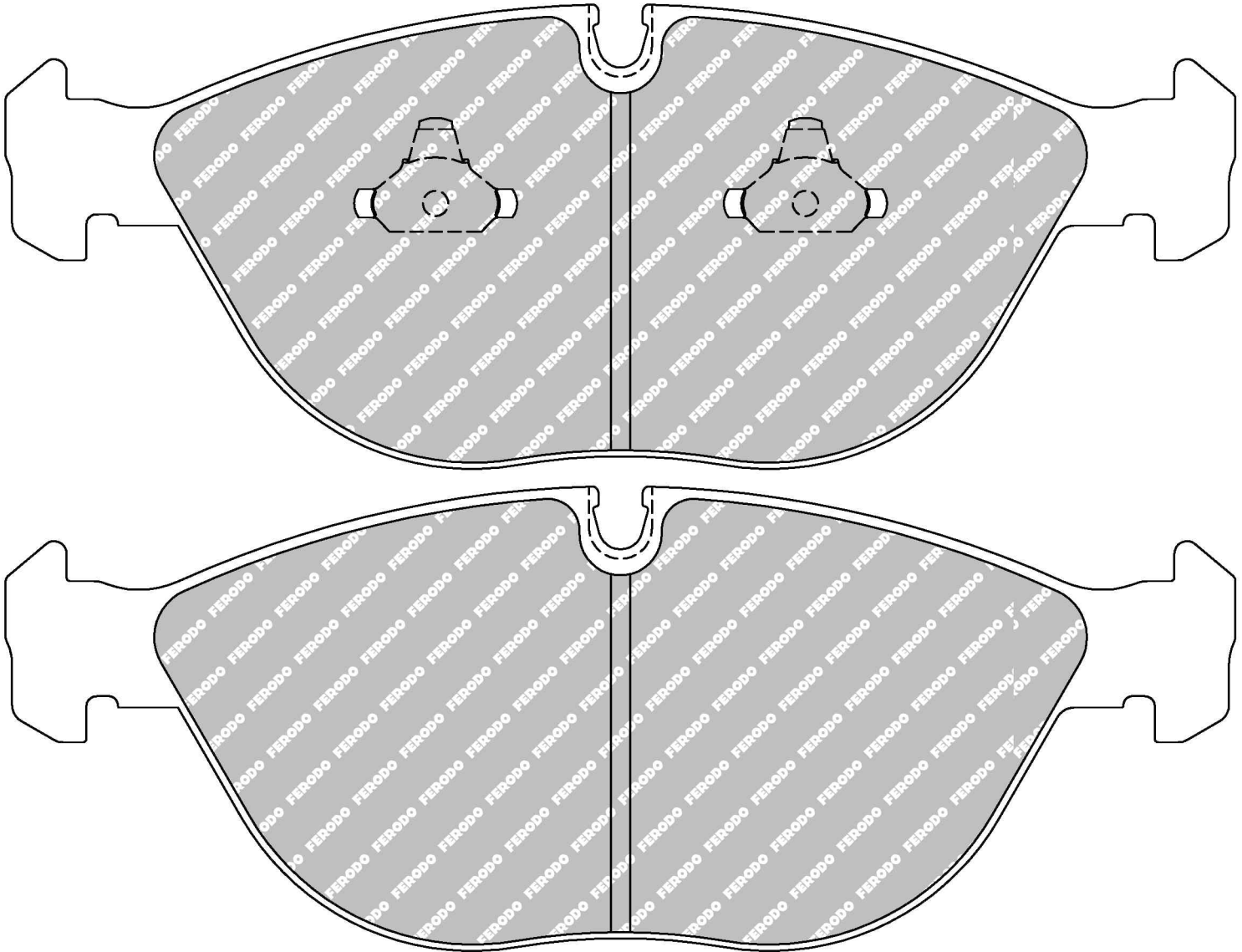

clip design indicative only

MATERIAL AVAILABILITY				
H	C	R	W	Z
✓				✓

CROSS REFERENCE	
WVA	21 484 20

- ✓ Available
- ✗ Not Available
- ⚠ Exhausting
- ✉ Make to order
- 🔧 In Introduction



Updated on 30th Jan 2014

**3075**

# FCP1011



110.1mm = 4.335"



52.5mm = 2.067"



12.9mm = 0.508"

WVA No: 23 354 13,00

FMSI No: D635

**IMPORTANT NOTICE: Please note that the height measurement represents the radial depth, not the entire back plate**

MAZDA Front

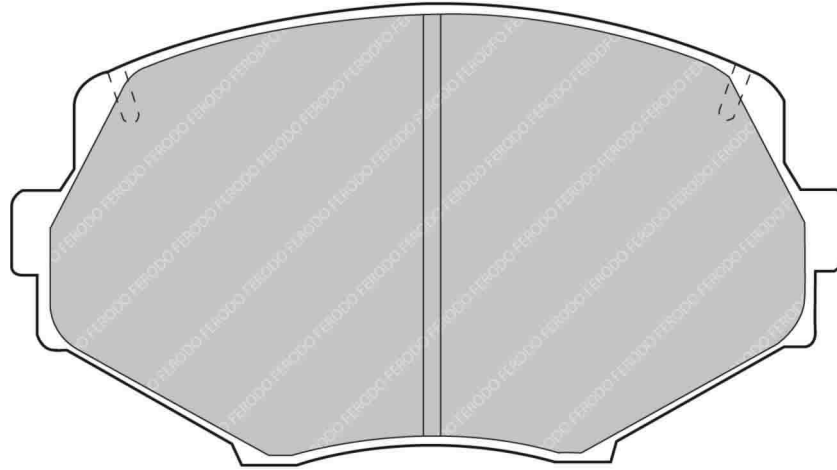

MATERIAL AVAILABILITY				
H	C	R	W	Z
✓		✉		

CROSS REFERENCE	
CL BRAKES	4107
FMSI	D635
HAWK	HB149 0,505
MINTEX	MDB1686
WVA	23 354 13,00

# FCP1012



102.0mm = 4.016"



30.3mm = 1.193"



13.0mm = 0.512"

WVA No: 23 387 12,50

FMSI No: D636

**IMPORTANT NOTICE: Please note that the height measurement represents the radial depth, not the entire back plate**

MAZDA Rear

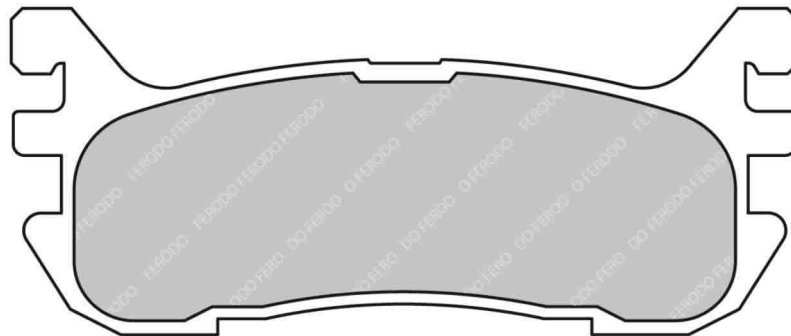

MATERIAL AVAILABILITY				
H	C	R	W	Z
✓				

CROSS REFERENCE	
CL BRAKES	4106
FMSI	D636
HAWK	HB159 0,492
MINTEX	MDB1705
MINTEX	MDB1893
WVA	23 387 12,50

3076

**FERODO**  
RACING

Updated on 30th Jan 2014

✓ Available    ⚠ Exhausting  
 ✗ Not Available    ✉ Make to order  
 🚧 In Introduction



# FCP1049

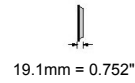
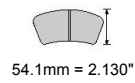

WVA No: 21 664 19,00

**IMPORTANT NOTICE: Please note that the height measurement represents the radial depth, not the entire back plate**

MERCEDES Front

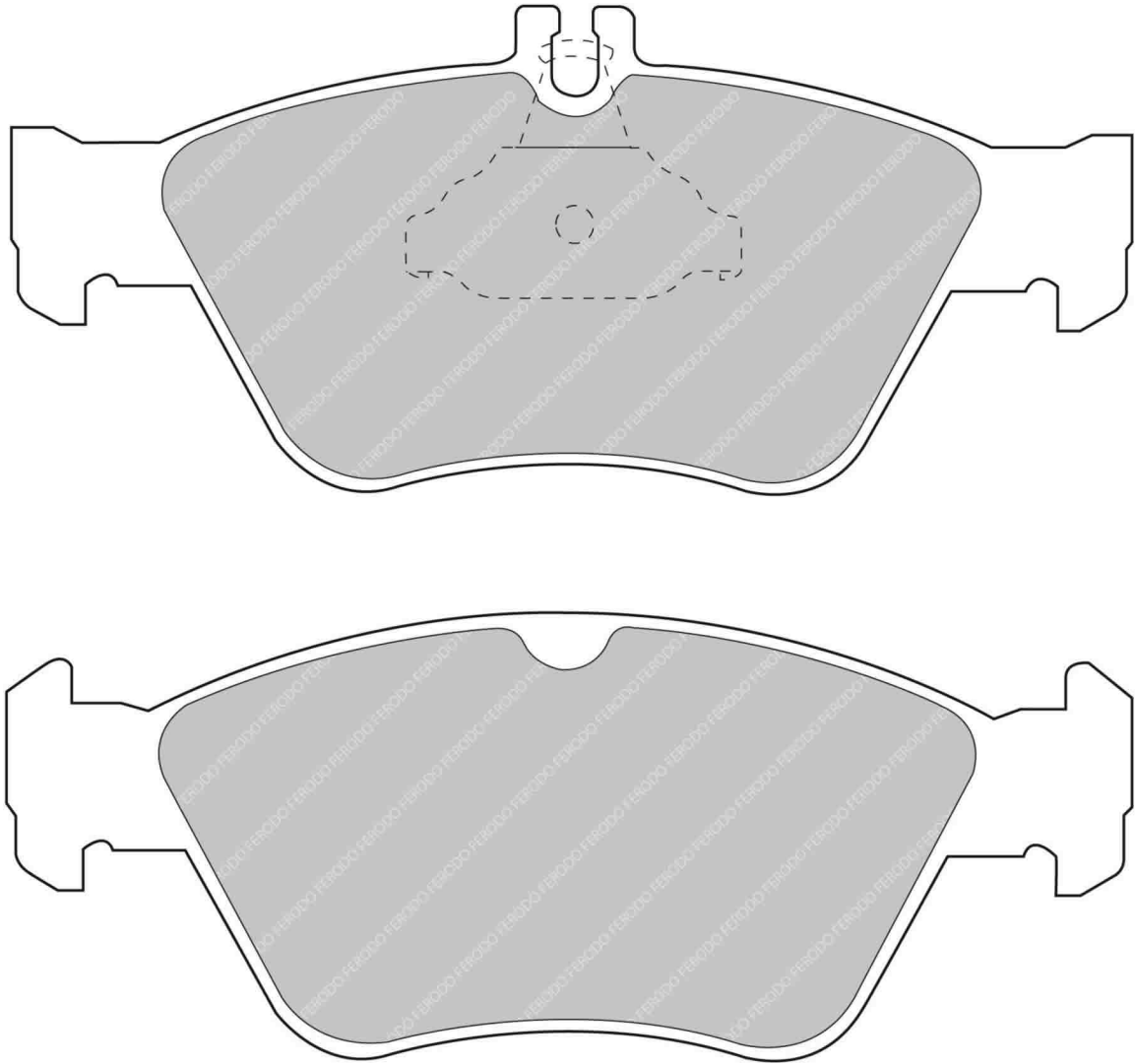

### MATERIAL AVAILABILITY

H	C	R	W	Z
✓				

### CROSS REFERENCE

BREMBO	07.8301.41
MINTEX	MDB1736
WVA	21 664 19,00

✓ Available    ⚠ Exhausting  
 ✗ Not Available    ✉ Make to order  
 🔄 In Introduction

**FERODO**  
RACING

Updated on 30th Jan 2014

**3077**

# FCP1050

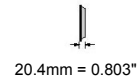
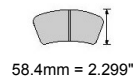

WVA No: 21 670 19,50

FMSI No: D740

**IMPORTANT NOTICE: Please note that the height measurement represents the radial depth, not the entire back plate**

CHRYSLER Front, MERCEDES Front

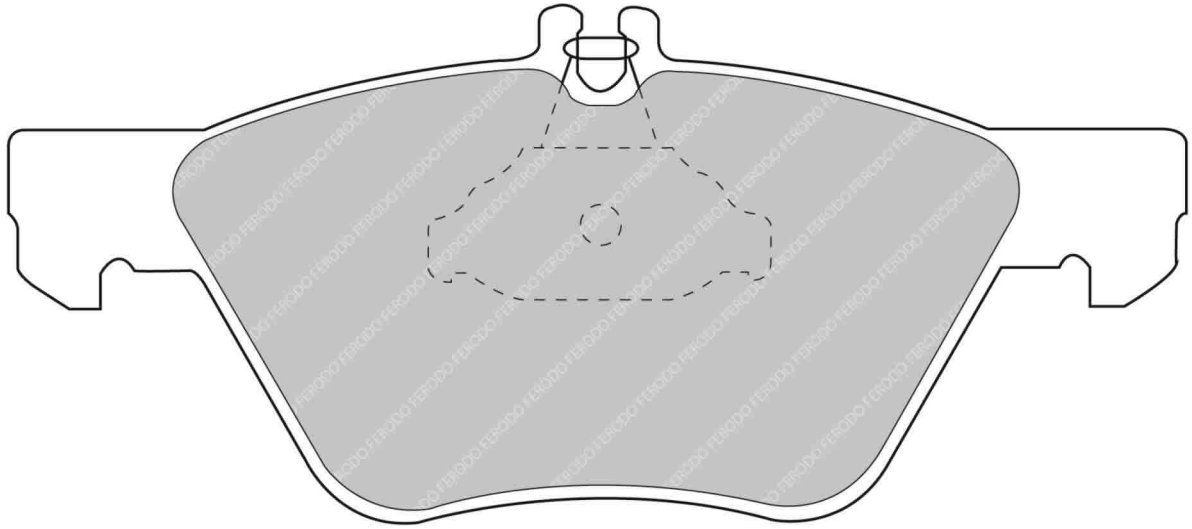

MATERIAL AVAILABILITY				
H	C	R	W	Z
✓				

CROSS REFERENCE	
BREMBO	07.8301.42
FMSI	D740
HAWK	HB495 0,756
MINTEX	MDB1871
WVA	21 670 19,50

3078

**FERODO**  
RACING

Updated on 30th Jan 2014

✓ Available    ⚠ Exhausting  
 ✗ Not Available    📦 Make to order  
 🚧 In Introduction

# FCP1052



155.2mm = 6.110"  
156.4mm = 6.157"



54.3mm = 2.138"  
54.3mm = 2.138"



18.5mm = 0.728"  
18.5mm = 0.728"

WVA No: 21 636 18,00

**IMPORTANT NOTICE:** Please note that the height measurement represents the radial depth, not the entire back plate

ALFA ROMEO Front, FIAT Front, LANCIA Front

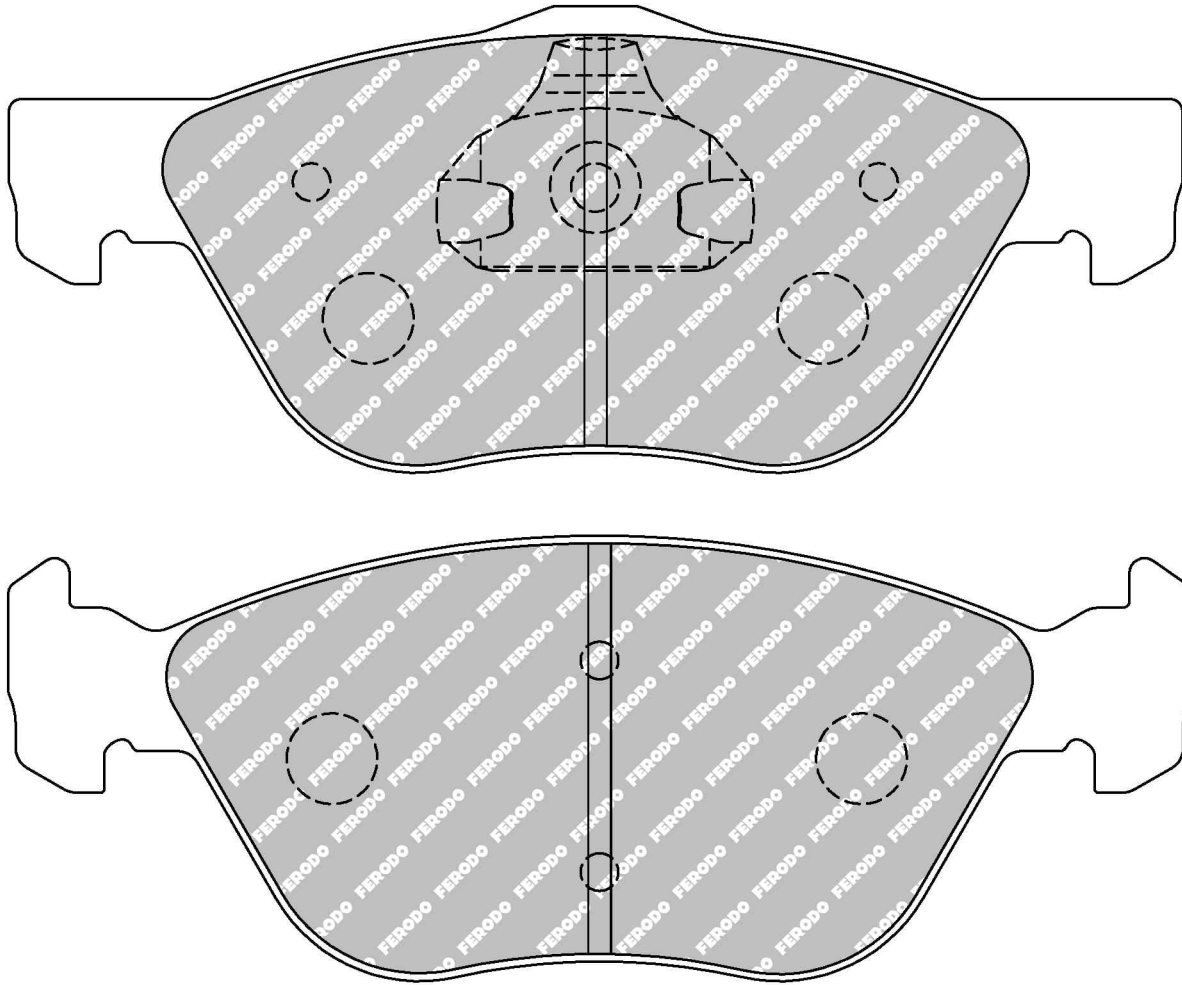

MATERIAL AVAILABILITY				
H	C	R	W	Z
✓		✓		

CROSS REFERENCE	
BREMBO	07.8301.43
MINTEX	MDB1735
MINTEX	MDB2068
WVA	21 636 18,00

✓ Available    ⚠ Exhausting  
 ✗ Not Available    📦 Make to order  
 🚧 In Introduction

**FERODO**  
RACING

Updated on 30th Jan 2014

**3079**

# FCP1054



141.8mm = 5.583"



45.0mm = 1.772"



19.3mm = 0.760"

WVA No: 21 866 19,70

**IMPORTANT NOTICE: Please note that the height measurement represents the radial depth, not the entire back plate**

SEAT Front, VOLKSWAGEN Front

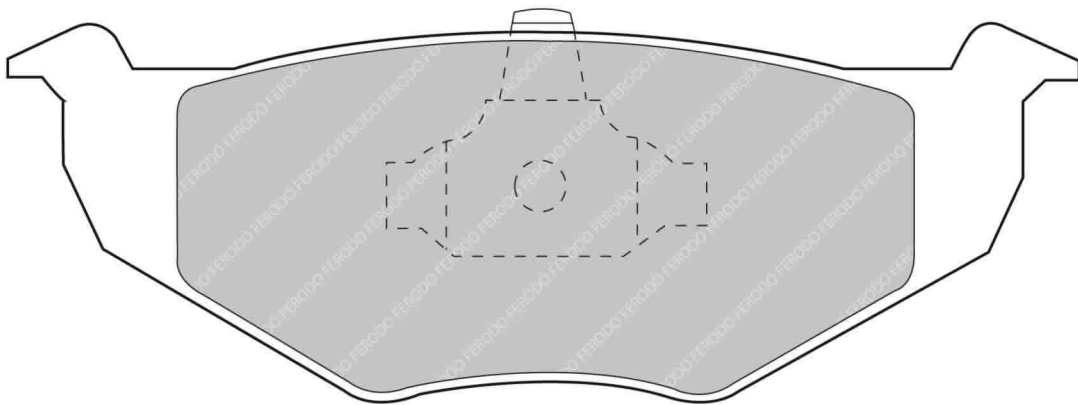
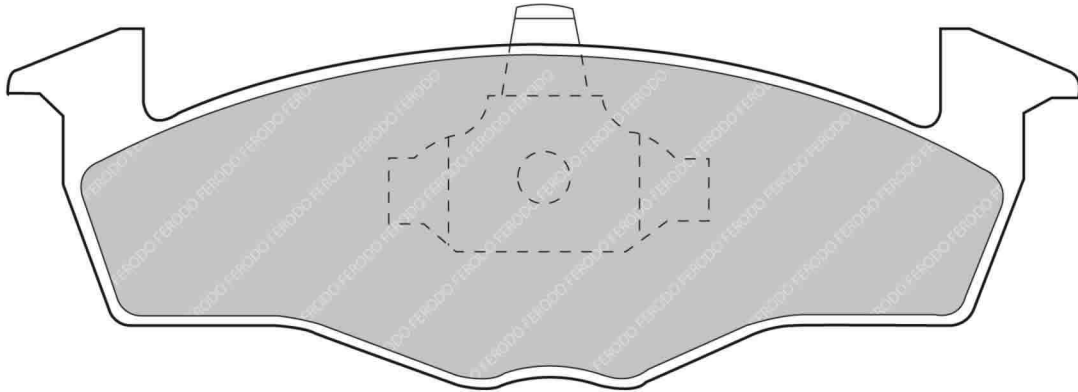

### ALSO AVAILABLE

SHAPE	TH. MM	NOTES
FCP1101	17.3	
FCP1288	15.3	

### CROSS REFERENCE

MINTEX	MDB1804
WVA	21 866 19,70

### MATERIAL AVAILABILITY

H	C	R	W	Z
✓				

# FCP1056



156.4mm = 6.157"



48.1mm = 1.894"



17.9mm = 0.705"

WVA No: 21 927 17,00

**IMPORTANT NOTICE: Please note that the height measurement represents the radial depth, not the entire back plate**

ALFA ROMEO Front, FIAT Front, LANCIA Front

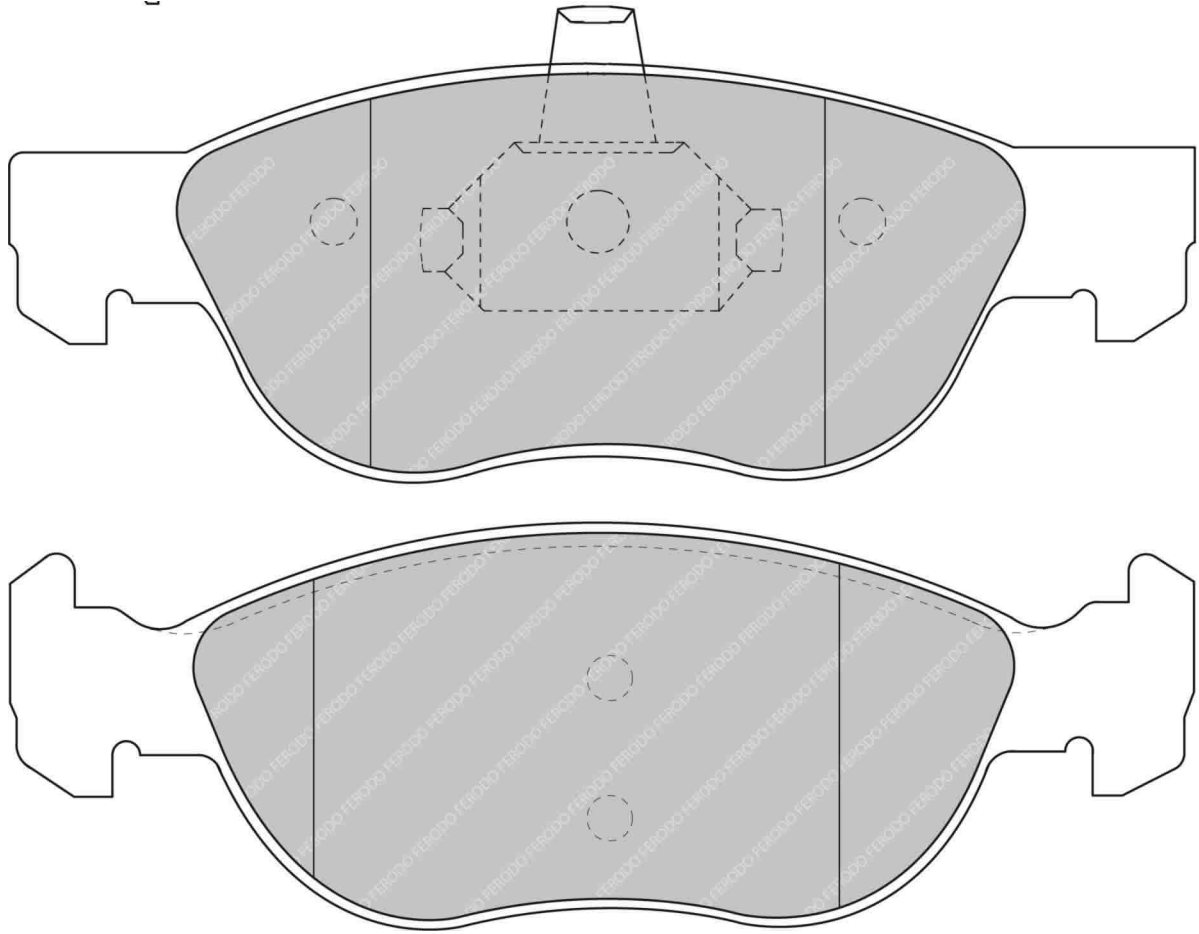

MATERIAL AVAILABILITY				
H	C	R	W	Z
✓				

CROSS REFERENCE	
BREMBO	07.8301.45
MINTEX	MDB1734
WVA	21 927 17,00

✓ Available    ⚠ Exhausting  
 ✗ Not Available    ✉ Make to order  
 🚧 In Introduction

**FERODO**  
RACING

Updated on 30th Jan 2014

**3081**

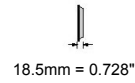
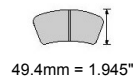
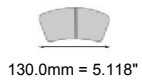

**IMPORTANT NOTICE: Please note that the height measurement represents the radial depth, not the entire back plate**

CITROEN Front, PEUGEOT Front

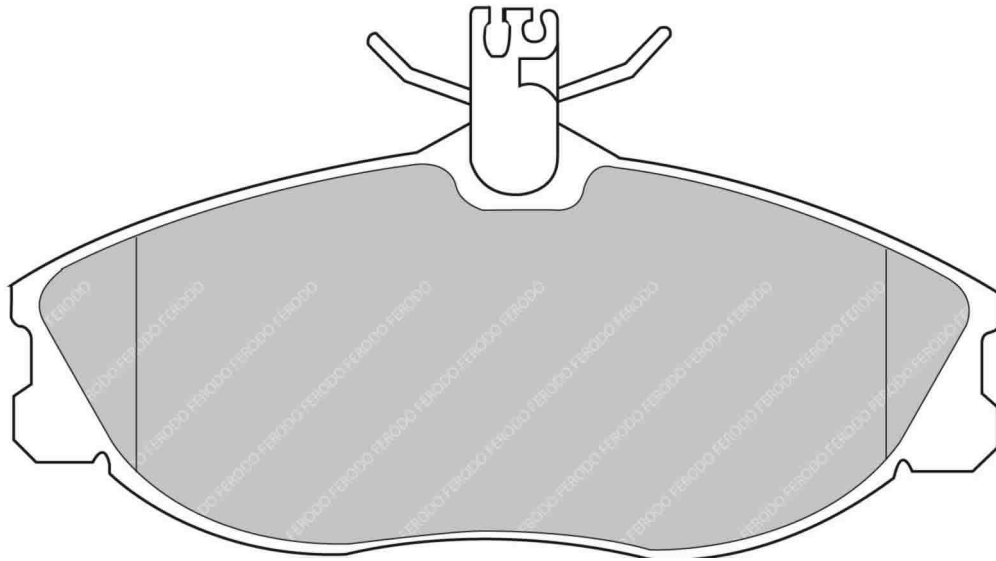

MATERIAL AVAILABILITY				
H	C	R	W	Z
✓		✓		

CROSS REFERENCE	
BREMBO	07.8301.00
BREMBO	07.8301.46
MINTEX	MDB1732
WVA	21 674 18,00

# FCP1068

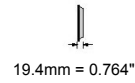
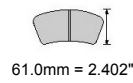

WVA No: 21 829 19,50

FMSI No: D819

**IMPORTANT NOTICE: Please note that the height measurement represents the radial depth, not the entire back plate**

OPEL Front, SAAB Front, VAUXHALL Front

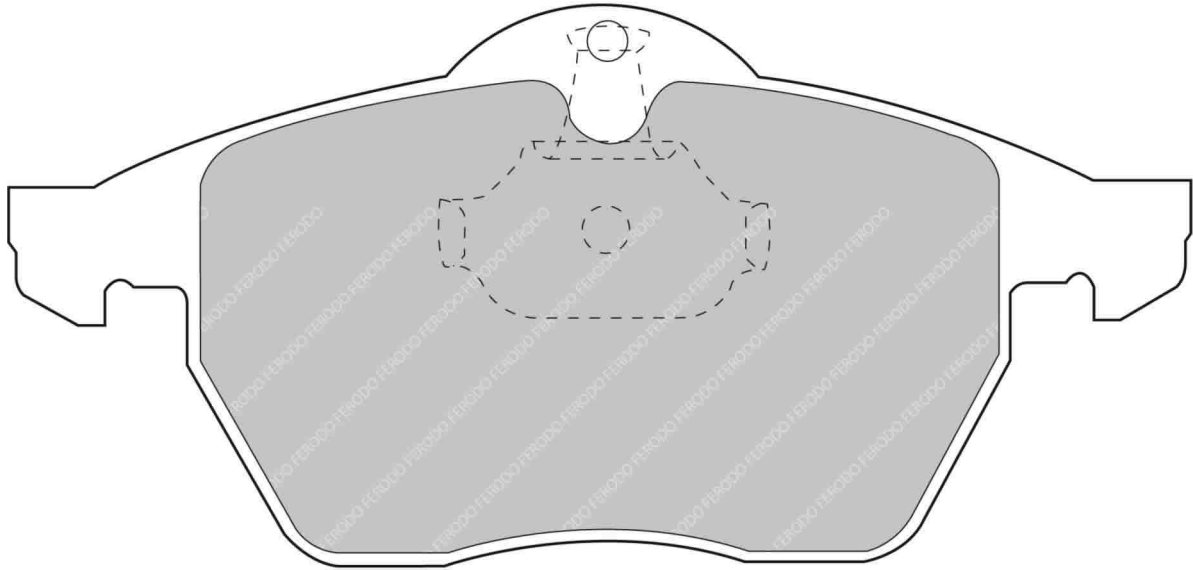

MATERIAL AVAILABILITY				
H	C	R	W	Z
✓				

CROSS REFERENCE	
BREMBO	07.8301.48
CL BRAKES	4031
FMSI	D819
HAWK	HB388 0,756
MINTEX	MDB1813
WVA	21 829 19,50

- ✓ Available
- ✗ Not Available
- ⚠ Exhausting
- ✉ Make to order
- 🔧 In Introduction

# FCP1073



156.5mm = 6.161"



56.7mm = 2.232"



20.2mm = 0.795"

WVA No: 21 677 19,50

FMSI No: D946

**IMPORTANT NOTICE: Please note that the height measurement represents the radial depth, not the entire back plate**

BMW Front

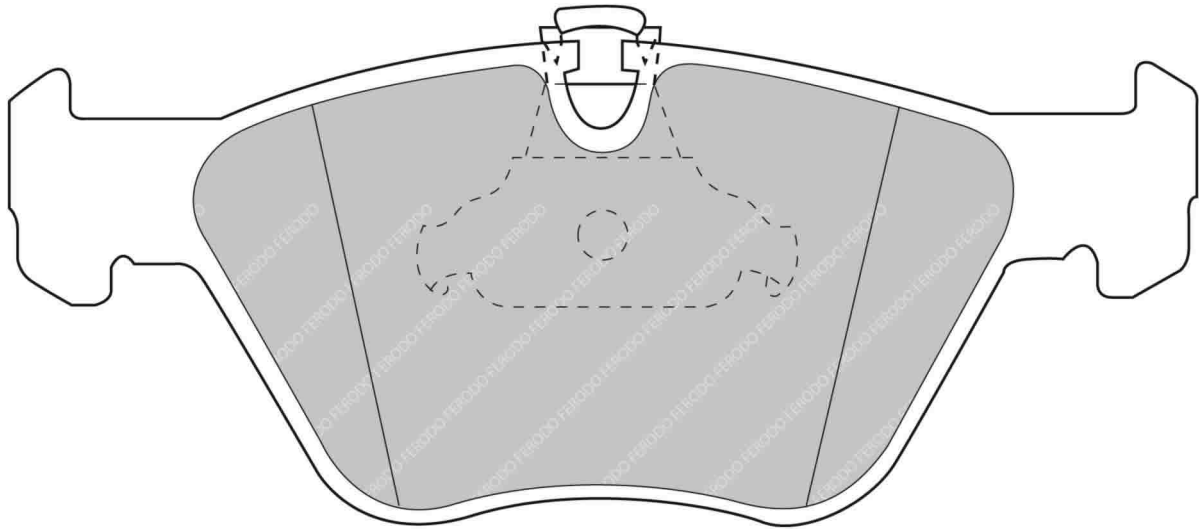

MATERIAL AVAILABILITY				
H	C	R	W	Z
✓			☒	☒

CROSS REFERENCE	
CL BRAKES	4033
FMSI	D946
HAWK	HB464 0,764
MINTEX	MDB1817
WVA	21 677 19,50

# FCP1081



151.5mm = 5.965"



39.1mm = 1.539"



18.0mm = 0.709"

WVA No: 23 103 18,00

FMSI No: D350

**IMPORTANT NOTICE: Please note that the height measurement represents the radial depth, not the entire back plate**

FORD Front, MAZDA Front

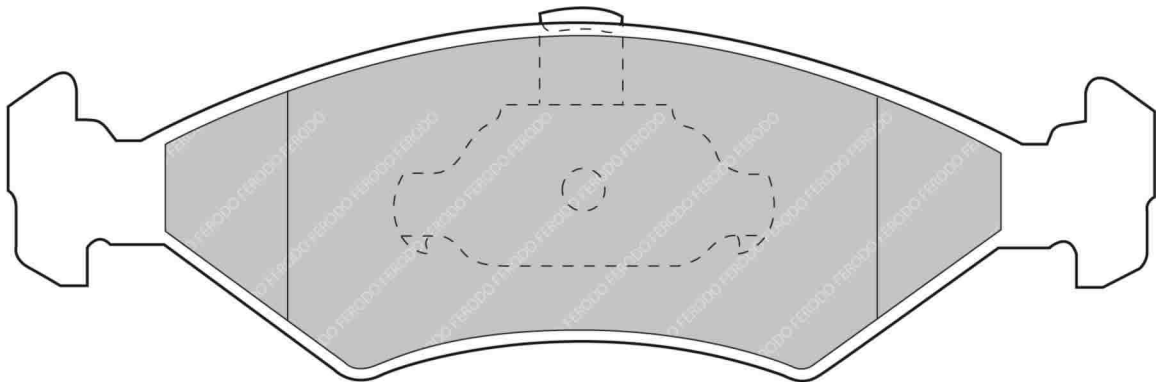

MATERIAL AVAILABILITY				
H	C	R	W	Z
✓		✓		

CROSS REFERENCE	
ALCON	PNF0084X325.4
BREMBO	07.8301.51
FMSI	D350
MINTEX	MDB1883
MINTEX	MDB2110
WVA	23 103 18,00



# FCP1082

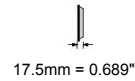
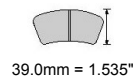
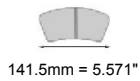

WVA No: 23 101 18,00

**IMPORTANT NOTICE: Please note that the height measurement represents the radial depth, not the entire back plate**

FORD Front, MAZDA Front

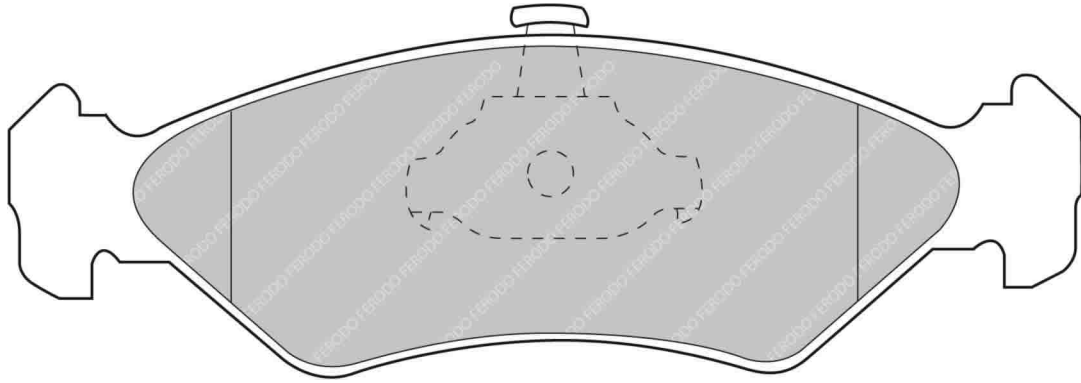

MATERIAL AVAILABILITY				
H	C	R	W	Z
✓		☒		

CROSS REFERENCE	
BREMBO	07.8301.52
MINTEX	MDB1884
WVA	23 101 18,00

# FCP1093

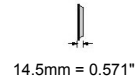
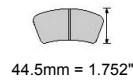
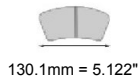

WVA No: 21 920 15,60

FMSI No: D837

**IMPORTANT NOTICE: Please note that the height measurement represents the radial depth, not the entire back plate**

mitsubishi Front, VOLVO Front

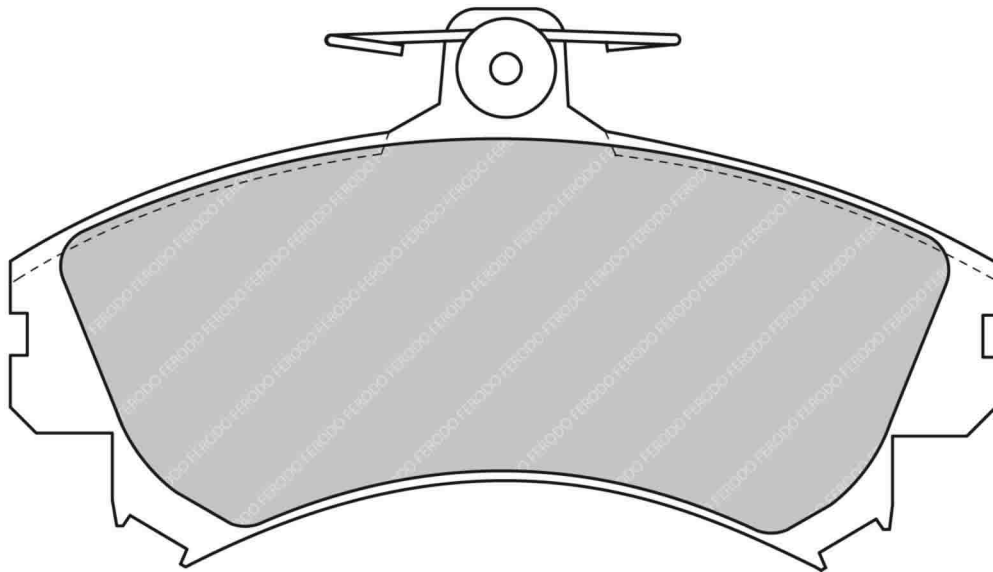

MATERIAL AVAILABILITY				
H	C	R	W	Z
✓		✗		

CROSS REFERENCE	
BREMBO	07.8301.53
FMSI	D837
HAWK	HB500 0,645
MINTEX	MDB1727
WVA	21 920 15,60

✓ Available    ⚠ Exhausting  
 ✗ Not Available    ☒ Make to order  
 ☒ In Introduction

**FERODO**  
RACING

Updated on 30th Jan 2014

**3085**

# FCP1094

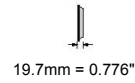
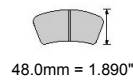

WVA No: 21 974 19,40

FMSI No: D768

**IMPORTANT NOTICE: Please note that the height measurement represents the radial depth, not the entire back plate**

AUDI Front, SEAT Front, SKODA Front, VOLKSWAGEN Front

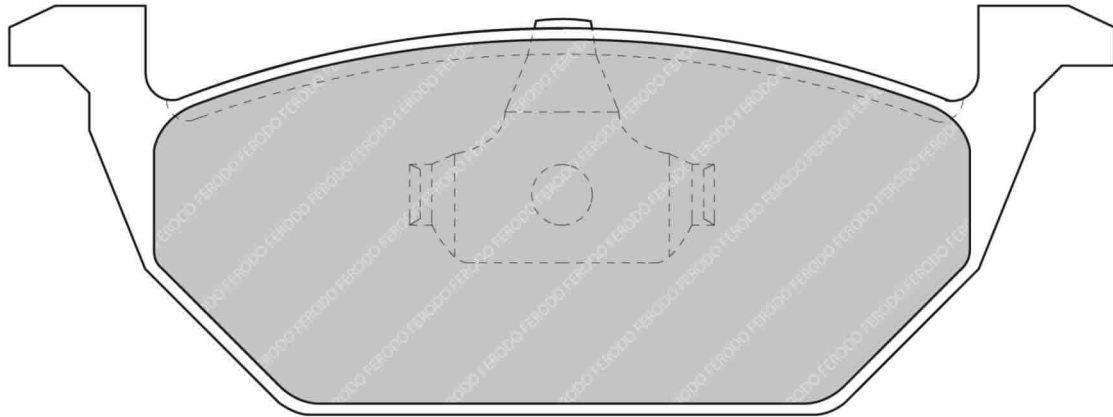

MATERIAL AVAILABILITY				
H	C	R	W	Z
✓		✉		✉

CROSS REFERENCE	
BREMBO	07.8300.04
CL BRAKES	4088
FMSI	D768
HAWK	HB365 0,728
MINTEX	MDB1811
MINTEX	MDB2034
WVA	21 974 19,40

# FCP1101

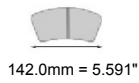

142.0mm = 5.591"

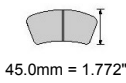

45.0mm = 1.772"



17.3mm = 0.681"

WVA No: 21 866 17,30

**IMPORTANT NOTICE: Please note that the height measurement represents the radial depth, not the entire back plate**

SEAT Front, SKODA Front, VOLKSWAGEN Front

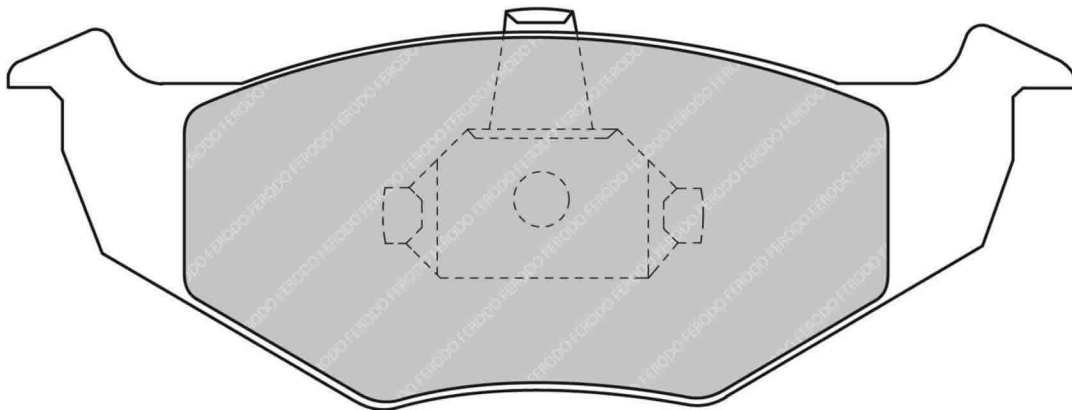
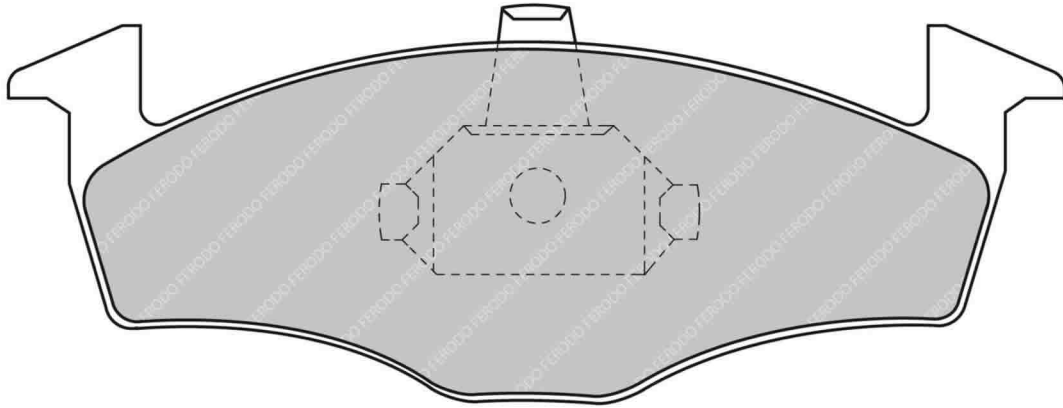

### ALSO AVAILABLE

SHAPE	TH. MM	NOTES
FCP1054	19.3	
FCP1288	15.3	

### MATERIAL AVAILABILITY

H	C	R	W	Z

### CROSS REFERENCE

BREMBO	07.8301.44
BREMBO	07.8301.54
MINTEX	MDB1805
WVA	21 866 17,30

- Available
- Exhausting
- Not Available
- Make to order
- In Introduction

# FCP1112

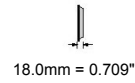
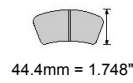
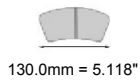

WVA No: 23 124 19,00

**IMPORTANT NOTICE: Please note that the height measurement represents the radial depth, not the entire back plate**

CITROEN Front, PEUGEOT Front

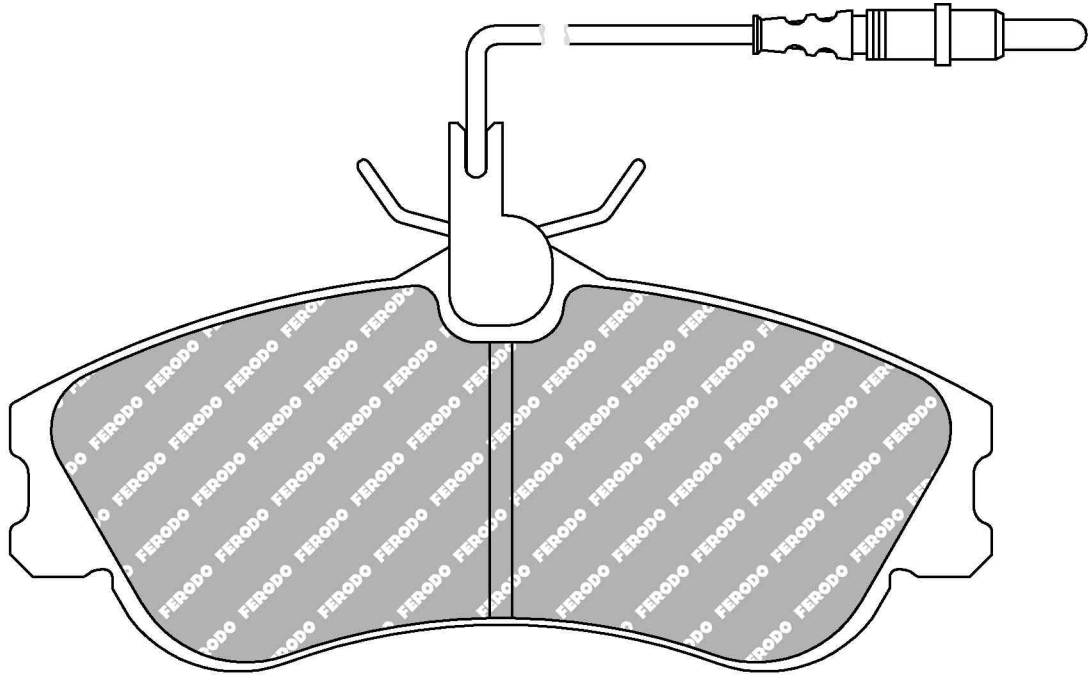

MATERIAL AVAILABILITY				
H	C	R	W	Z
✓				

CROSS REFERENCE	
MINTEX	MDB1812
WVA	23 124 19,00

# FCP1113

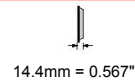
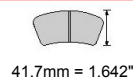
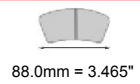

WVA No: 23 177 14,30

**IMPORTANT NOTICE: Please note that the height measurement represents the radial depth, not the entire back plate**

ALFA ROMEO Rear, FIAT Rear, LANCIA Rear

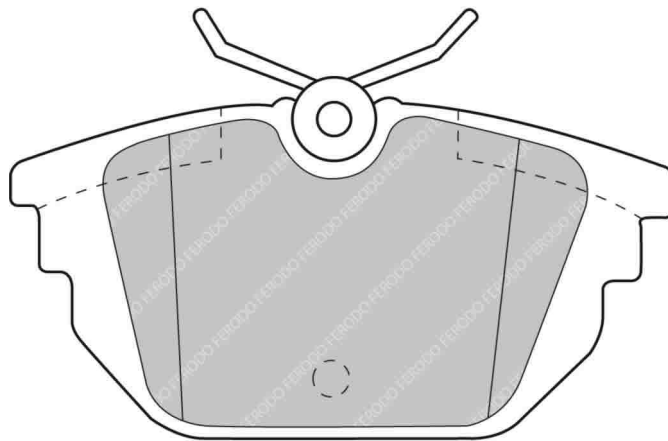

MATERIAL AVAILABILITY				
H	C	R	W	Z
✓		✓		

CROSS REFERENCE	
BREMBO	07.8301.55
MINTEX	MDB1309
MINTEX	MDB1876
WVA	23 177 14,30

# FCP1133



95.0mm = 3.740"



43.5mm = 1.713"



18.0mm = 0.709"

FMSI No: D278

**IMPORTANT NOTICE: Please note that the height measurement represents the radial depth, not the entire back plate**

CITROEN Front, PEUGEOT Front

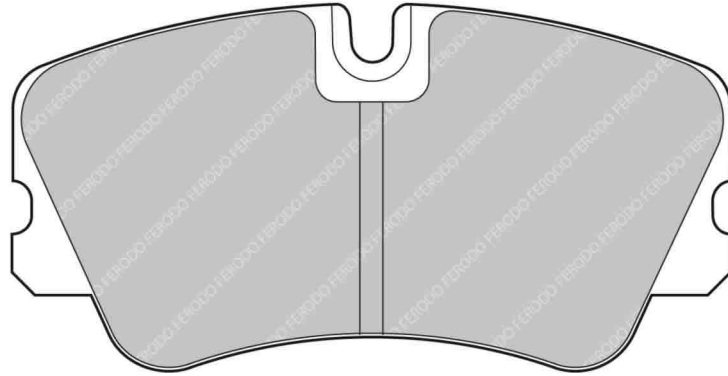

MATERIAL AVAILABILITY				
H	C	R	W	Z
✓		✓		

CROSS REFERENCE	
ALCON	PNF0084X299.4
BREMBO	07.8301.56
CL BRAKES	4020
FMSI	D278
FMSI	D439
FMSI	D493
HAWK	HB195 0,64
PFC	0278.XX

✓ Available    ⚠ Exhausting  
✗ Not Available    ✉ Make to order  
🔧 In Introduction

**FERODO**  
RACING

Updated on 30th Jan 2014

**3089**

# FCP1134

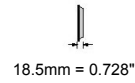
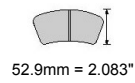

WVA No: 23 140 19,30

**IMPORTANT NOTICE: Please note that the height measurement represents the radial depth, not the entire back plate**

ALFA ROMEO Front

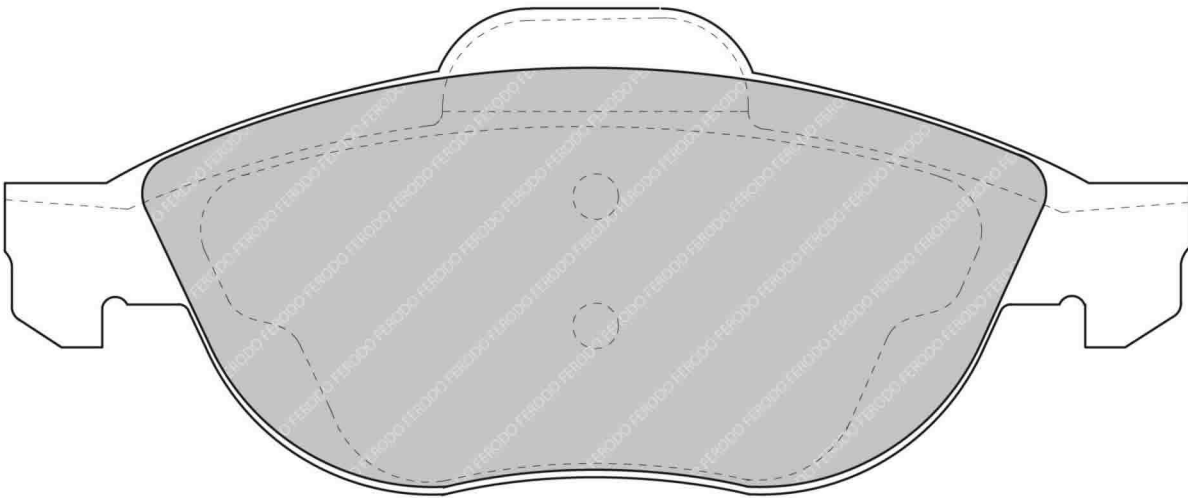
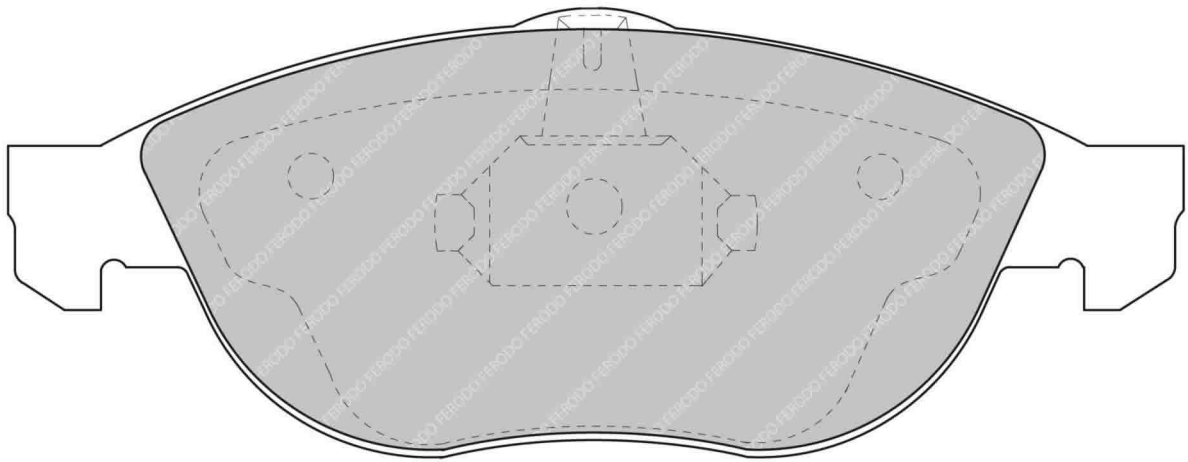

MATERIAL AVAILABILITY				
H	C	R	W	Z
✓				

CROSS REFERENCE	
BREMBO	07.8301.57
MINTEX	MDB1934
MINTEX	MDB2132
WVA	23 140 19,30

3090

**FERODO**  
RACING

Updated on 30th Jan 2014

✓ Available    ⚠ Exhausting  
 ✗ Not Available    📦 Make to order  
 🚧 In Introduction

# FCP1160



151.4mm = 5.961"



48.1mm = 1.894"



17.1mm = 0.673"

WVA No: 21 931 17,00

**IMPORTANT NOTICE: Please note that the height measurement represents the radial depth, not the entire back plate**

FIAT Front, LANCIA Front

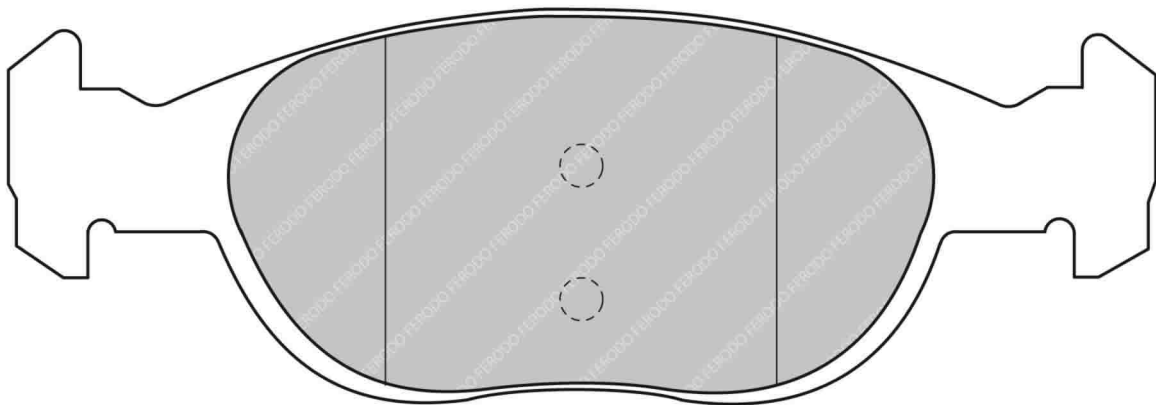
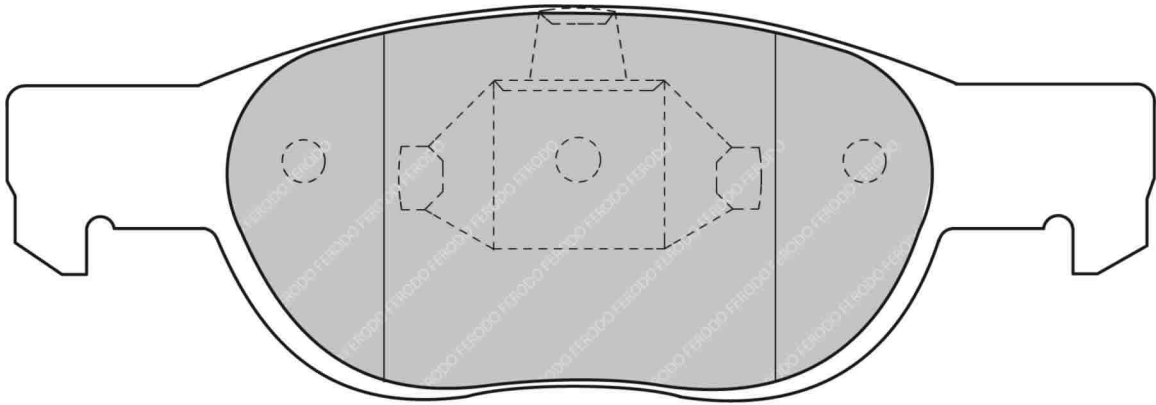

MATERIAL AVAILABILITY				
H	C	R	W	Z
✓				

CROSS REFERENCE	
BREMBO	07.8301.59
MINTEX	MDB1828
MINTEX	MDB1956
MINTEX	MDB2206
WVA	21 931 17,00

✓ Available    ⚠ Exhausting  
 ✗ Not Available    ✉ Make to order  
 🔄 In Introduction

**FERODO**  
RACING

Updated on 30th Jan 2014

**3091**

# FCP1162

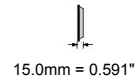
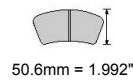
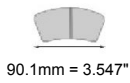

WVA No: 21 998 15,60

**IMPORTANT NOTICE: Please note that the height measurement represents the radial depth, not the entire back plate**

SMART (until 2002 MCC) Front

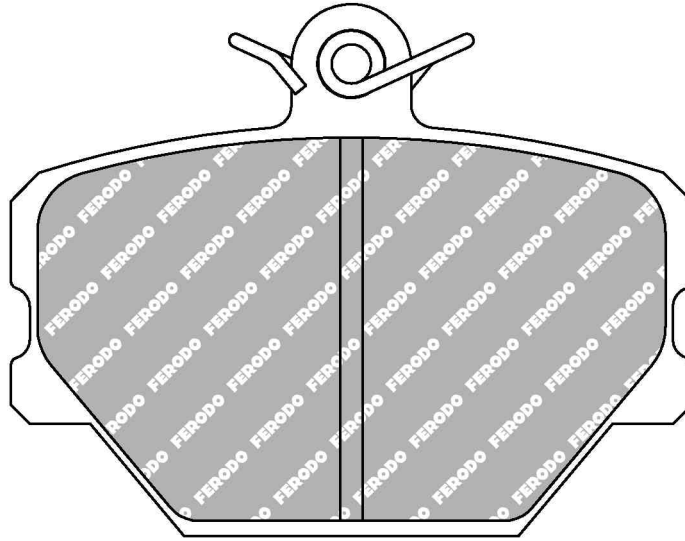

MATERIAL AVAILABILITY				
H	C	R	W	Z
✓				

CROSS REFERENCE	
BREMBO	07.8301.60
MINTEX	MDB2033
WVA	21 998 15,60



# FCP1213

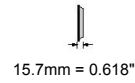
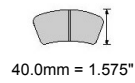

FMSI No: D369

**IMPORTANT NOTICE: Please note that the height measurement represents the radial depth, not the entire back plate**

CADILLAC Front

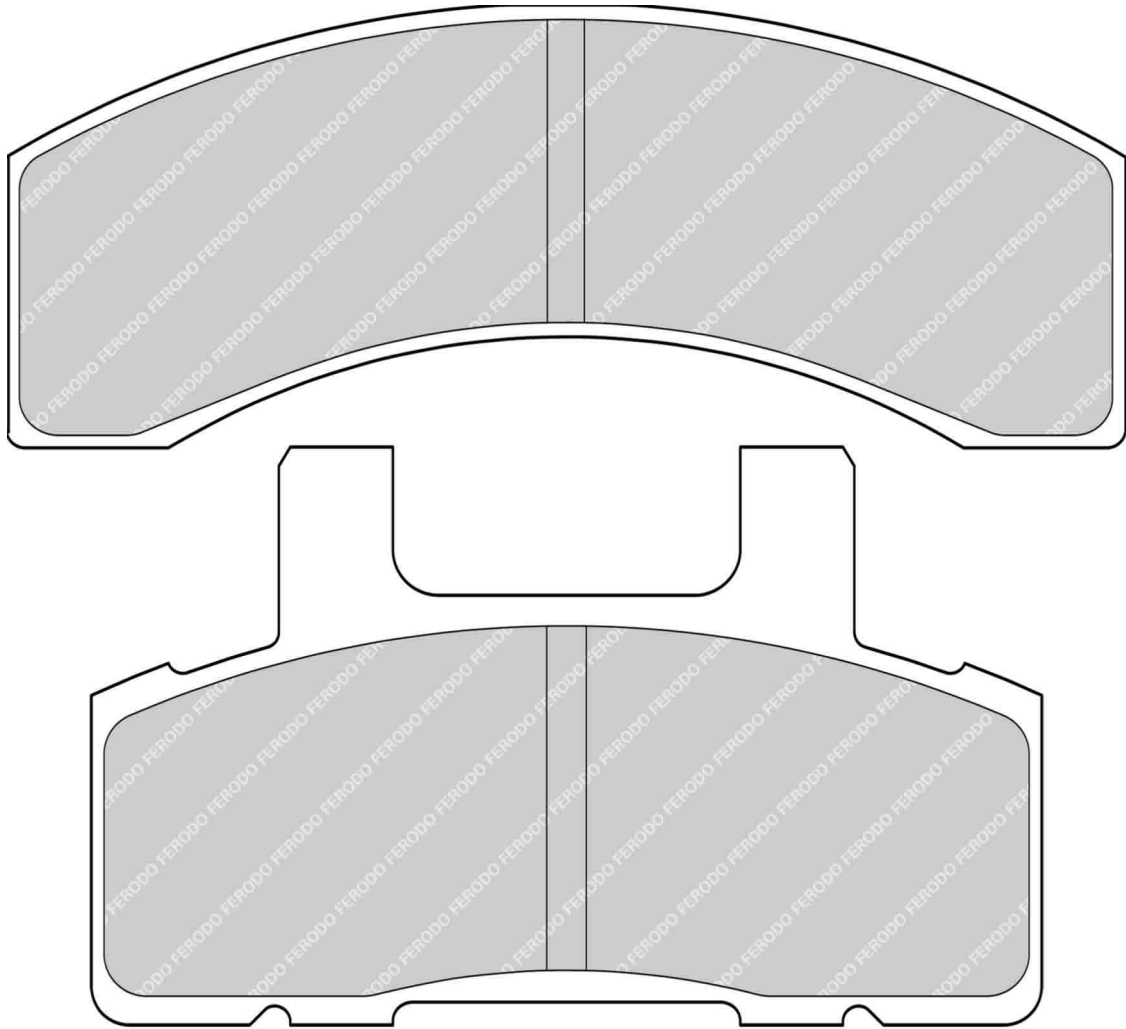

MATERIAL AVAILABILITY				
H	C	R	W	Z

CROSS REFERENCE	
BREMBO	07.8300.24
FMSI	D369
HAWK	HB332 0,654
PFC	0369.XX

- Available
- Exhausting
- Not Available
- Make to order
- In Introduction



Updated on 30th Jan 2014

**3093**

# FCP1224

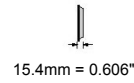
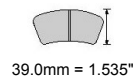

FMSI No: D412

**IMPORTANT NOTICE: Please note that the height measurement represents the radial depth, not the entire back plate**

ASTON MARTIN Front, CHEVROLET Front, FORD USA Front, PONTIAC Front

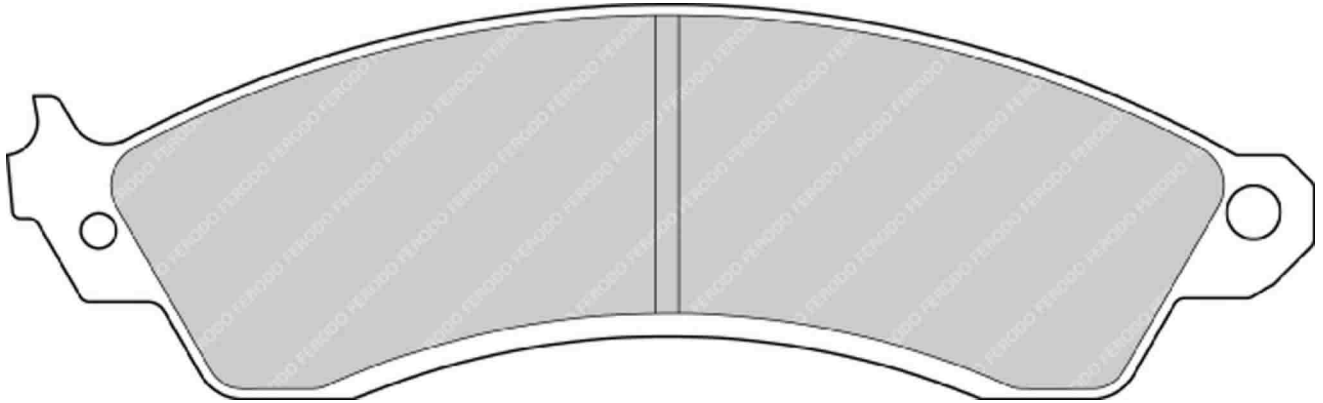

Set = 1 Left / 1 Right

MATERIAL AVAILABILITY				
H	C	R	W	Z

CROSS REFERENCE	
BREMBO	07.8300.25
FMSI	D412
HAWK	HB111 0,61
PFC	0412
PFC	0412.XX

# FCP1280

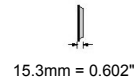
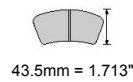
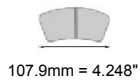

**IMPORTANT NOTICE: Please note that the height measurement represents the radial depth, not the entire back plate**

MITSUBISHI Rear

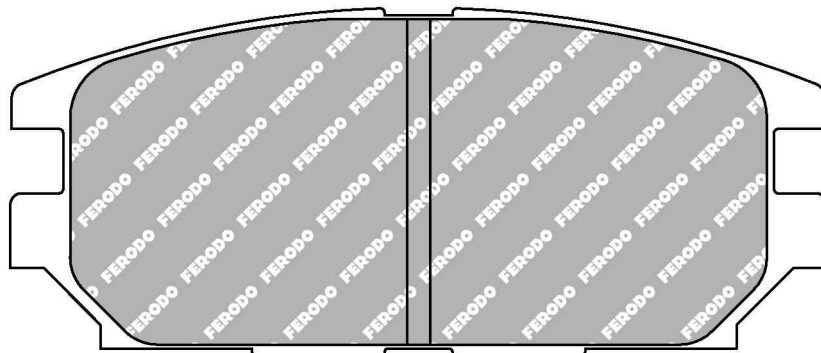

MATERIAL AVAILABILITY				
H	C	R	W	Z

CROSS REFERENCE	
ALCON	PNF0084X232.4
PAGID	2445

# FCP1281



131.8mm = 5.189"



51.5mm = 2.028"



18.2mm = 0.717"

FMSI No: D810

**IMPORTANT NOTICE: Please note that the height measurement represents the radial depth, not the entire back plate**

AUDI Rear, NISSAN Rear

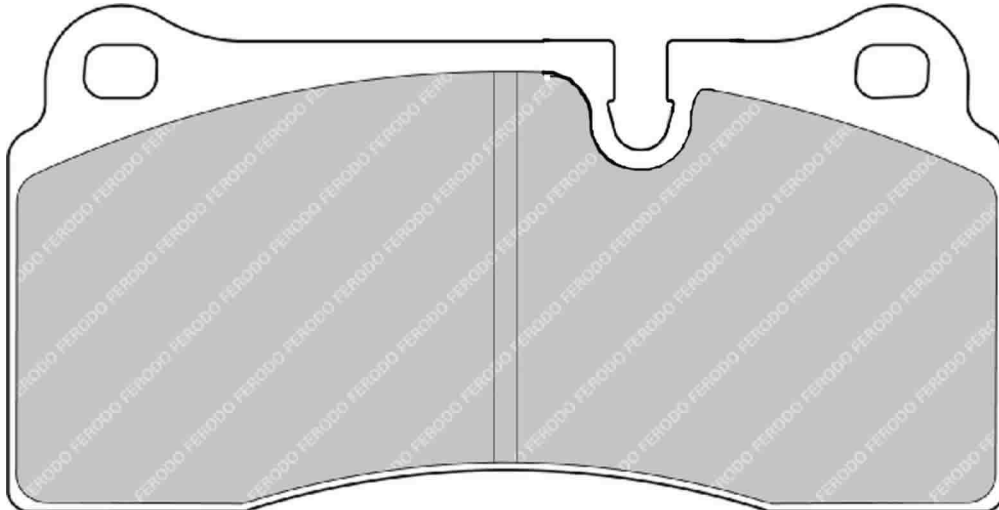

### ALSO AVAILABLE

SHAPE	TH. MM	NOTES
FRP3028	16	

### MATERIAL AVAILABILITY

H	C	R	W	Z
✓		✓	✓	

### CROSS REFERENCE

ALCON	PNF0084X233.4
BREMBO	07.4865.1
BREMBO	07.4865.80
BREMBO	07.8301.61
CL BRAKES	5008W52T18
FMSI	D810
FMSI	D968
HAWK	HB193 0,67
MINTEX	MTX1976
PAGID	1287
PFC	7780.XX.18

# FCP1283



99.0mm = 3.898"



35.0mm = 1.378"



14.3mm = 0.563"

**IMPORTANT NOTICE: Please note that the height measurement represents the radial depth, not the entire back plate**

MITSUBISHI Rear

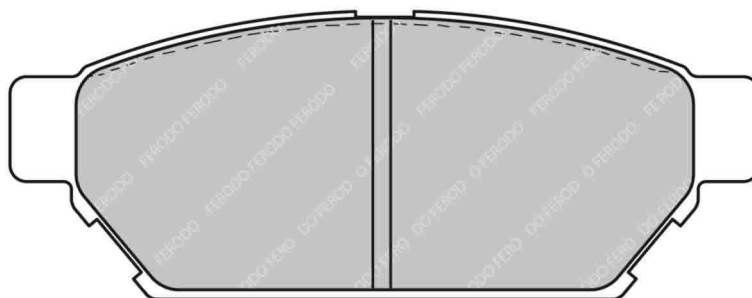

### MATERIAL AVAILABILITY

H	C	R	W	Z
		✓		

### CROSS REFERENCE

ALCON	PNF0084X236.4
PAGID	1897

✓ Available    ⚠ Exhausting  
 ✗ Not Available    ✉ Make to order  
 🚧 In Introduction

**FERODO**  
RACING

Updated on 30th Jan 2014

**3095**

# FCP1285

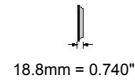
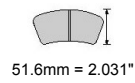

WVA No: 21 273 19,50

FMSI No: D618

**IMPORTANT NOTICE: Please note that the height measurement represents the radial depth, not the entire back plate**

VOLVO Front

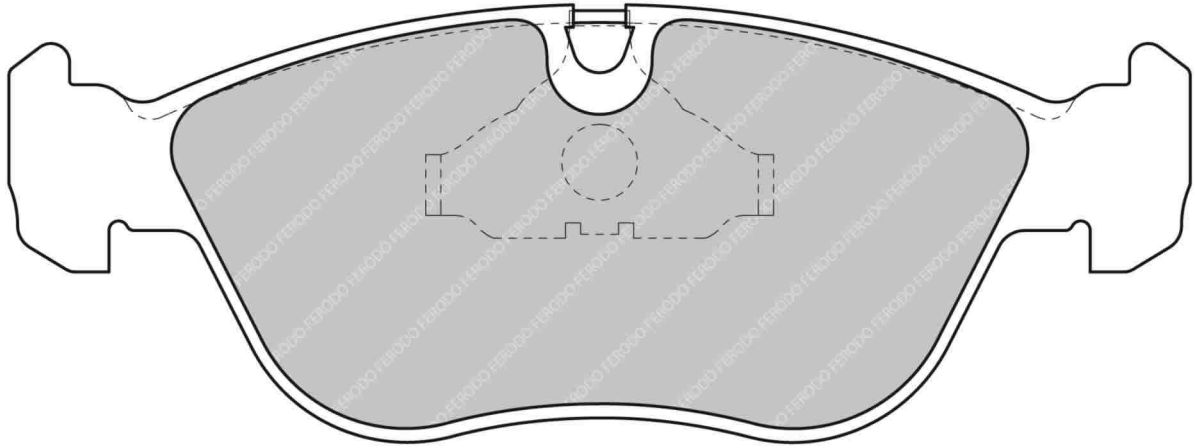

MATERIAL AVAILABILITY				
H	C	R	W	Z
✓		✓		

CROSS REFERENCE	
FMSI	D618
HAWK	HB492 0,732
MINTEX	MDB1984
WVA	21 273 19,50

# FCP1288



141.8mm = 5.583"



45.0mm = 1.772"



15.3mm = 0.602"

WVA No: 21 866 15,30

**IMPORTANT NOTICE: Please note that the height measurement represents the radial depth, not the entire back plate**

SEAT Front, VOLKSWAGEN Front

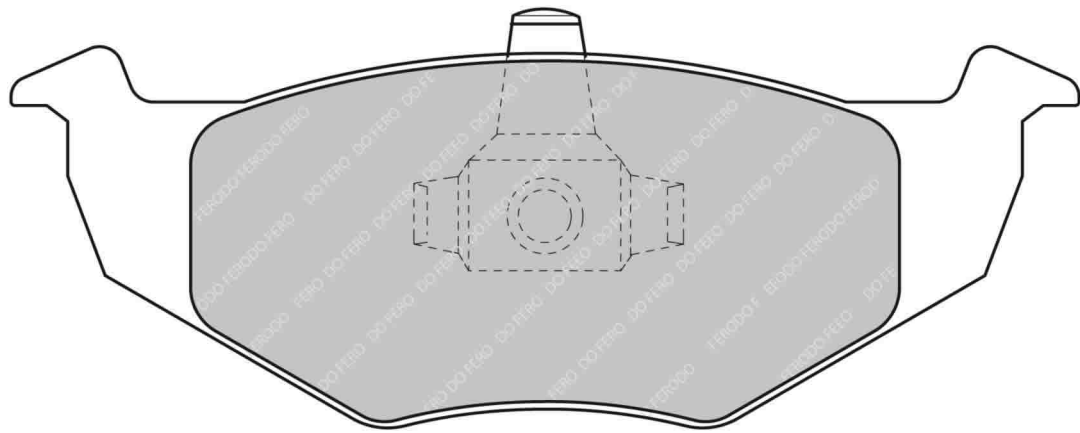
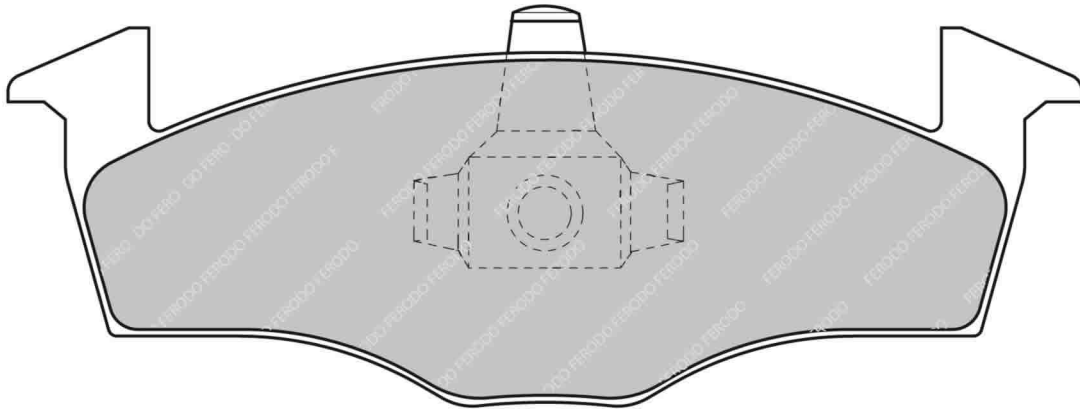

### ALSO AVAILABLE

SHAPE	TH. MM	NOTES
FCP1054	19.3	
FCP1101	17.3	

### CROSS REFERENCE

BREMBO	07.8301.62
MINTEX	MDB1872
WVA	21 866 15,30

### MATERIAL AVAILABILITY

H	C	R	W	Z
⚠				

✓ Available    ⚠ Exhausting  
 ✗ Not Available    ✉ Make to order  
 🚧 In Introduction

**FERODO**  
RACING

Updated on 30th Jan 2014

**3097**

# FCP1289



119.0mm = 4.685"



47.5mm = 1.870"



19.9mm = 0.783"

WVA No: 21 945 19,90

**IMPORTANT NOTICE: Please note that the height measurement represents the radial depth, not the entire back plate**

AUDI Front, SEAT Front, VOLKSWAGEN Front

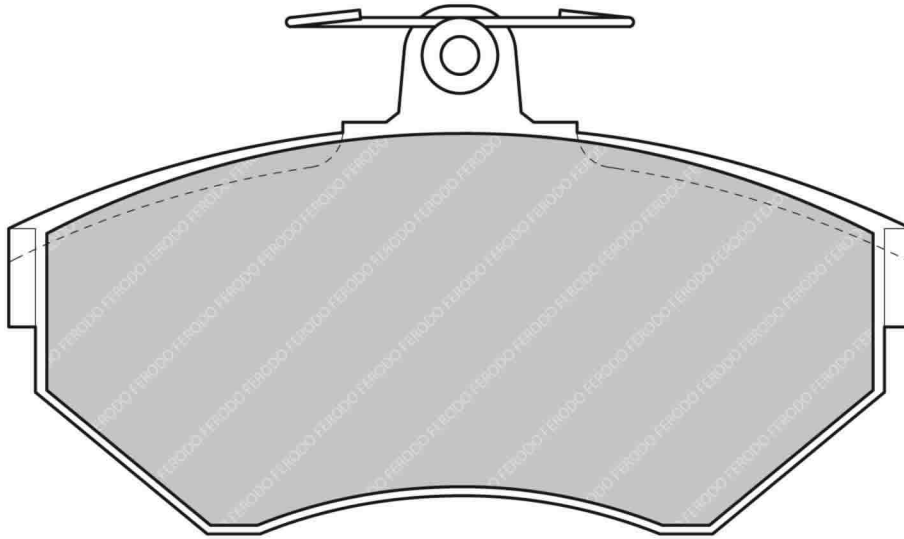

### ALSO AVAILABLE

SHAPE	TH. MM	NOTES
FCP1312	16	

### CROSS REFERENCE

MINTEX	MDB1919
WVA	21 945 19,90

### MATERIAL AVAILABILITY

H	C	R	W	Z
✗				

3098

**FERODO**  
RACING

Updated on 30th Jan 2014

✓ Available   
 ⚠ Exhausting  
✗ Not Available   
 ✉ Make to order  
🔧 In Introduction

# FCP1293



177.7mm = 6.996"  
160.1mm = 6.303"



52.4mm = 2.063"  
52.4mm = 2.063"



18.8mm = 0.740"  
18.8mm = 0.740"

WVA No: 23 063 18,40

**IMPORTANT NOTICE:** Please note that the height measurement represents the radial depth, not the entire back plate

OPEL Front, VAUXHALL Front

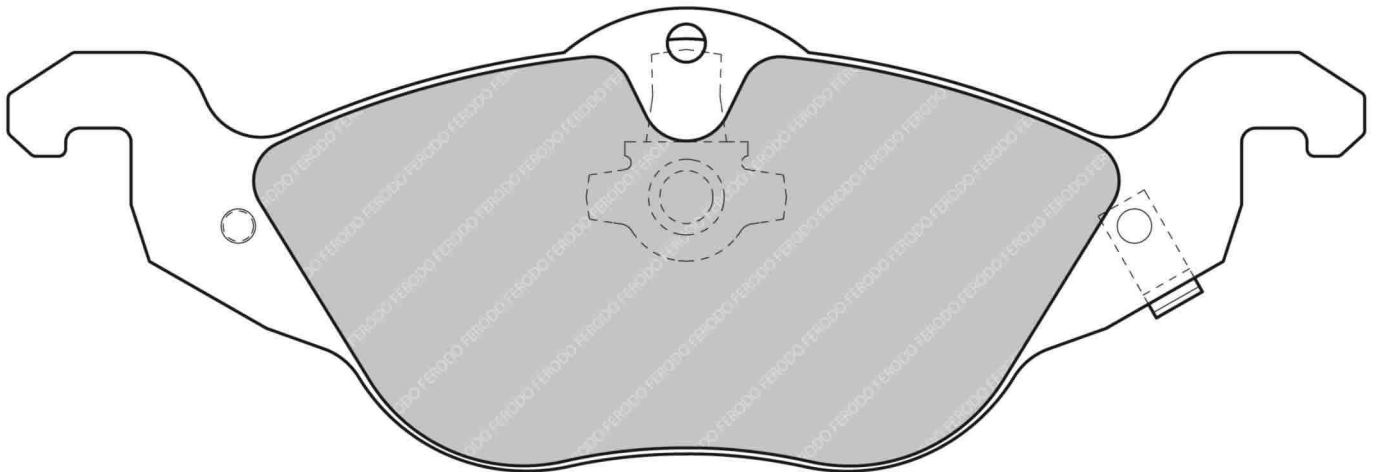
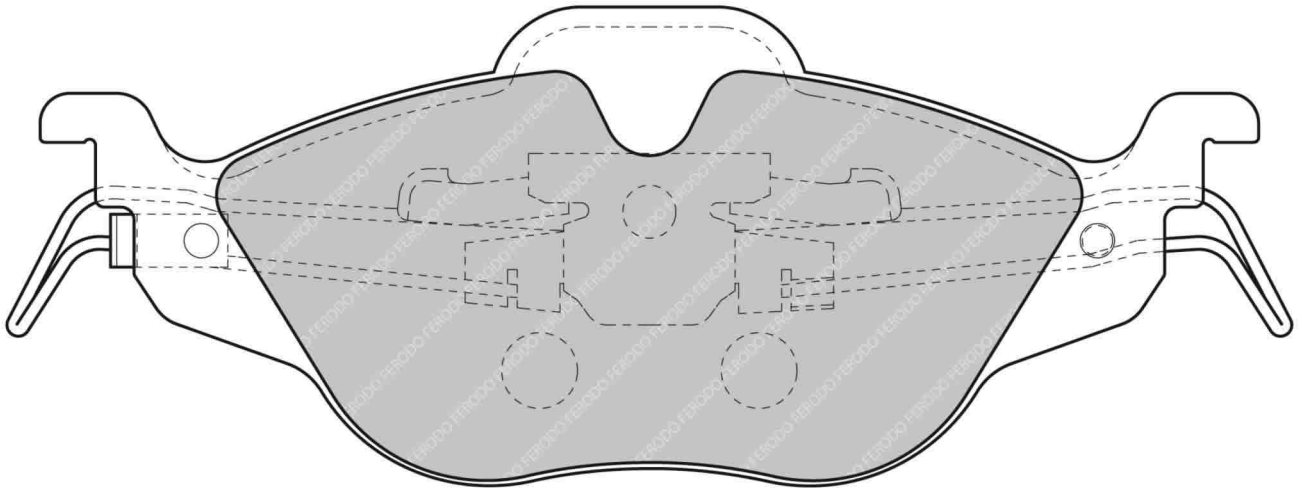

MATERIAL AVAILABILITY				
H	C	R	W	Z
✓				

CROSS REFERENCE	
BREMBO	07.8301.64
MINTEX	MDB1908
WVA	23 063 18,40

- ✓ Available    ⚠ Exhausting
- ✗ Not Available    ✉ Make to order
- 🔵 In Introduction

# FCP1294

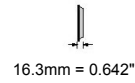
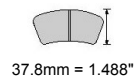
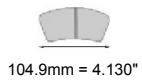

WVA No: 23 052 16,20

**IMPORTANT NOTICE: Please note that the height measurement represents the radial depth, not the entire back plate**

OPEL Rear, VAUXHALL Rear

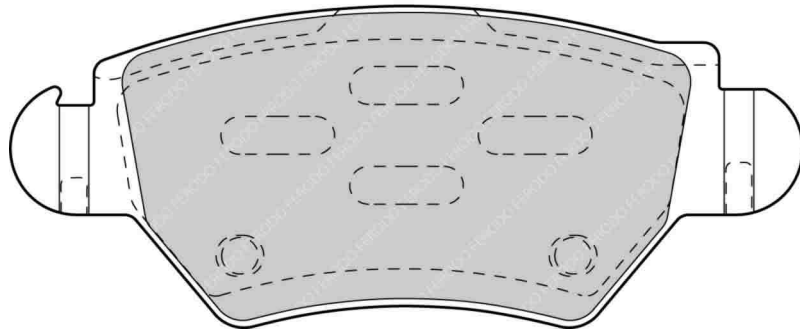
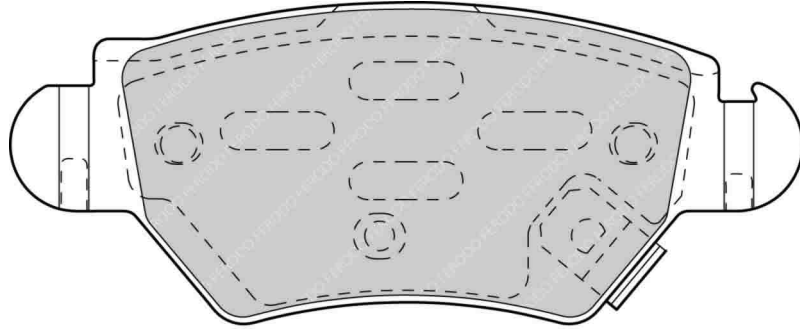

MATERIAL AVAILABILITY				
H	C	R	W	Z

CROSS REFERENCE	
MINTEX	MDB2130
WVA	23 052 16,20



# FCP1295



156.5mm = 6.161"



56.7mm = 2.232"



19.4mm = 0.764"

WVA No: 23 057 20,00

**IMPORTANT NOTICE: Please note that the height measurement represents the radial depth, not the entire back plate**

OPEL Front, VAUXHALL Front

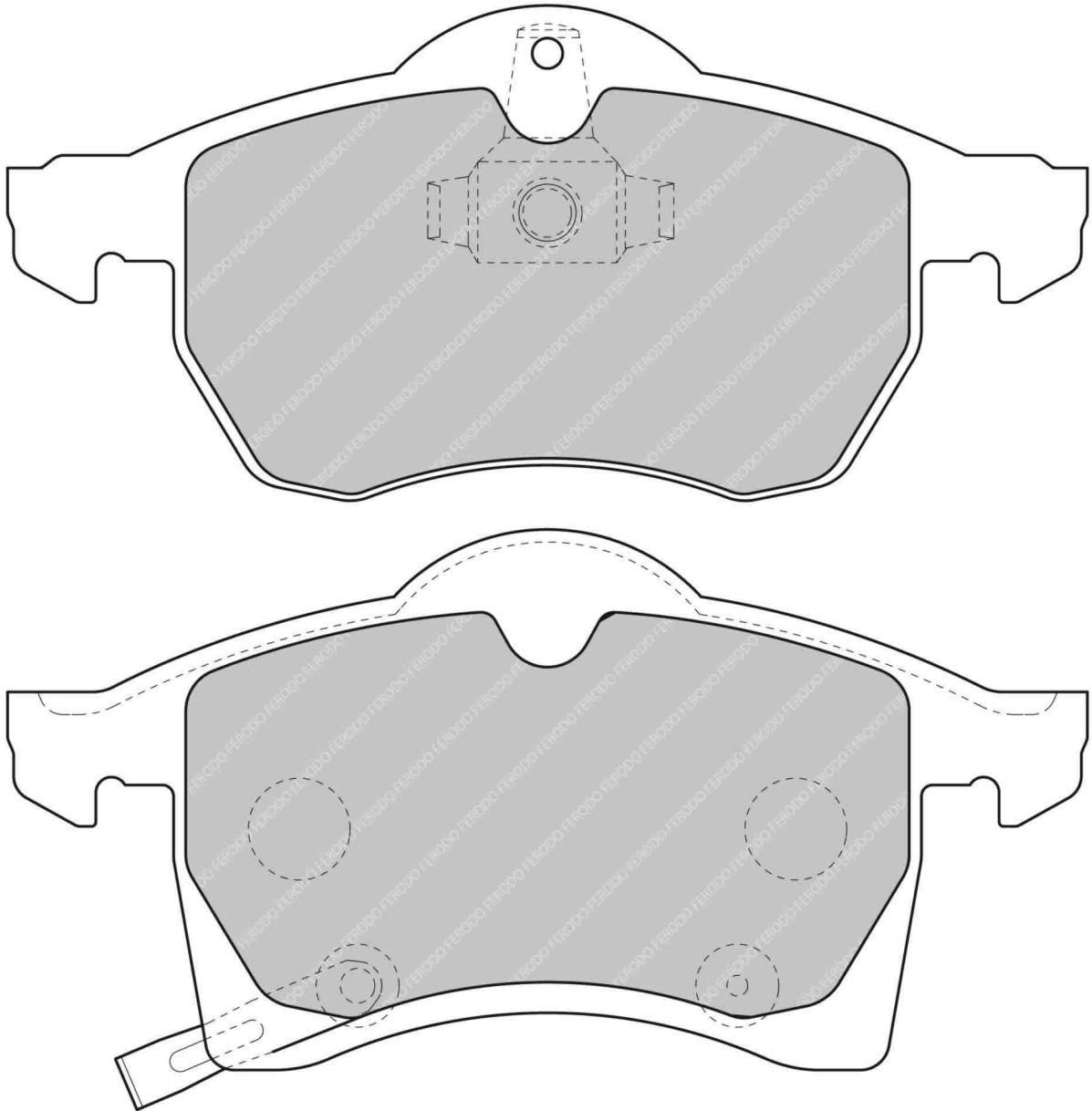

MATERIAL AVAILABILITY				
H	C	R	W	Z
✓				

CROSS REFERENCE	
BREMBO	07.8301.65
MINTEX	MDB1907
WVA	23 057 20,00

✓ Available    ⚠ Exhausting  
 ✗ Not Available    ✉ Make to order  
 🔄 In Introduction

**FERODO**  
RACING

Updated on 30th Jan 2014

**3101**

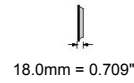
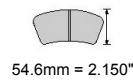

**IMPORTANT NOTICE: Please note that the height measurement represents the radial depth, not the entire back plate**

MASERATI Front, NISSAN Front

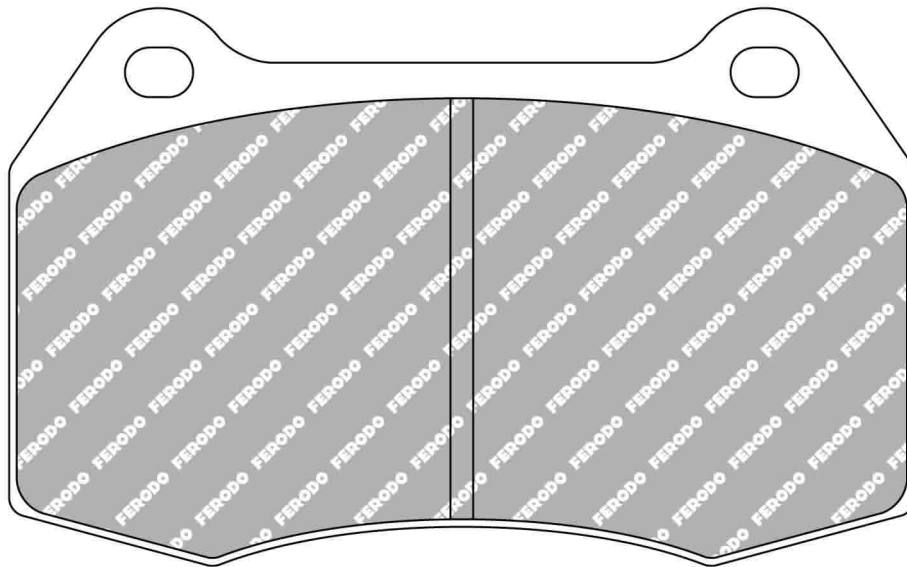

Replacing FCP998

MATERIAL AVAILABILITY				
H	C	R	W	Z
✓		✓	✉	✓

CROSS REFERENCE	
CL BRAKES	4061
FMSI	D639
HAWK	HB181 0,66
PAGID	1427
PFC	0639

# FCP1300



151.4mm = 5.961"



52.4mm = 2.063"



16.9mm = 0.665"

WVA No: 21 925 17,80

FMSI No: D781

**IMPORTANT NOTICE: Please note that the height measurement represents the radial depth, not the entire back plate**

BMW Front

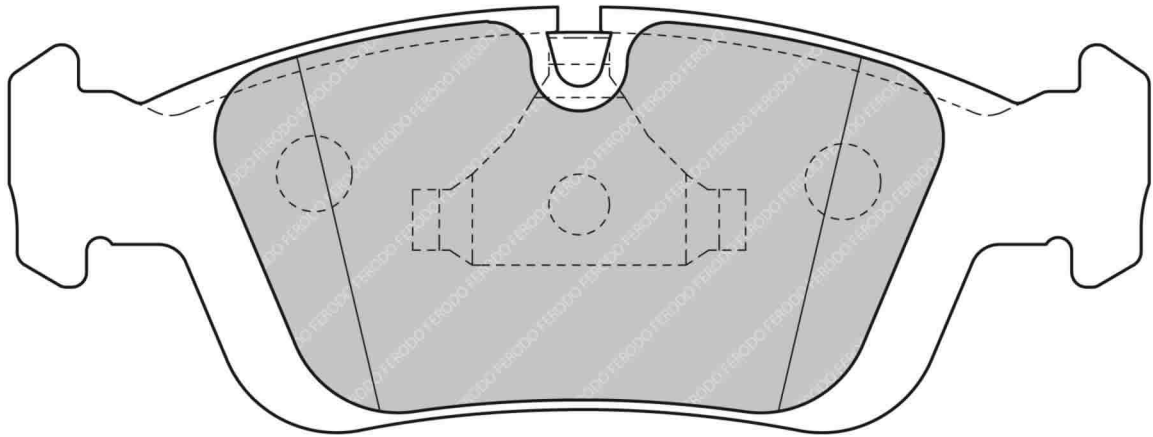

MATERIAL AVAILABILITY				
H	C	R	W	Z
✓				

CROSS REFERENCE	
CL BRAKES	4104
FMSI	D781
HAWK	HB546 0,654
MINTEX	MDB1901
PAGID	2180
WVA	21 925 17,80

# FCP1301



123.2mm = 4.850"



39.7mm = 1.563"



16.6mm = 0.654"

WVA No: 21 934 17,30

FMSI No: D692

**IMPORTANT NOTICE: Please note that the height measurement represents the radial depth, not the entire back plate**

BMW Rear

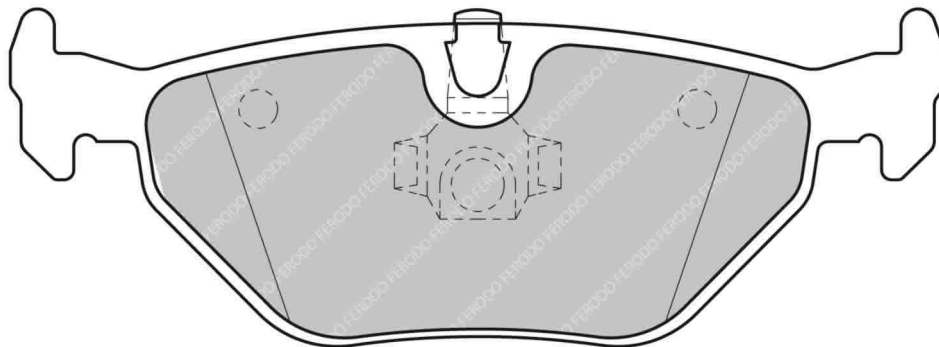

MATERIAL AVAILABILITY				
H	C	R	W	Z
✓		✉		

CROSS REFERENCE	
FMSI	D692
MINTEX	MDB1888
MINTEX	MDB2763
WVA	21 934 17,30

✓ Available    ⚠ Exhausting  
 ✗ Not Available    ✉ Make to order  
 🚧 In Introduction

**FERODO**  
RACING

Updated on 30th Jan 2014

**3103**

# FCP1307

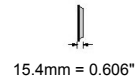
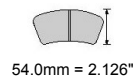

WVA No: 21 937 16,20

FMSI No: D737

**IMPORTANT NOTICE: Please note that the height measurement represents the radial depth, not the entire back plate**

PORSCHE Front

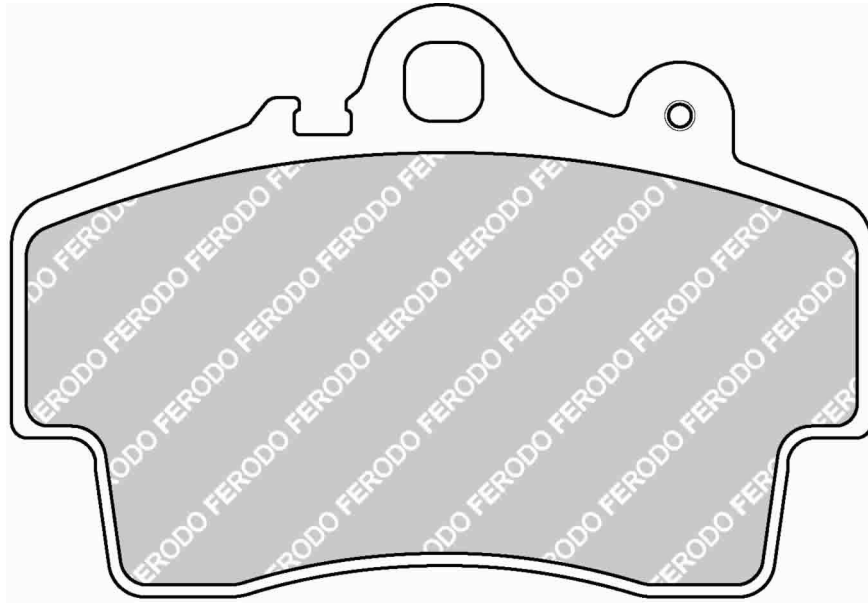

MATERIAL AVAILABILITY				
H	C	R	W	Z
✓		✓	✓	

CROSS REFERENCE	
FMSI	D737
HAWK	HB289 0,61
MINTEX	MDB1873
PAGID	2407
PFC	0738
WVA	21 937 16,20

# FCP1308

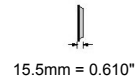
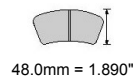
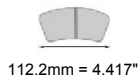

WVA No: 21 972 15,20

FMSI No: D738

**IMPORTANT NOTICE: Please note that the height measurement represents the radial depth, not the entire back plate**

PORSCHE Front / Rear, VOLKSWAGEN Rear

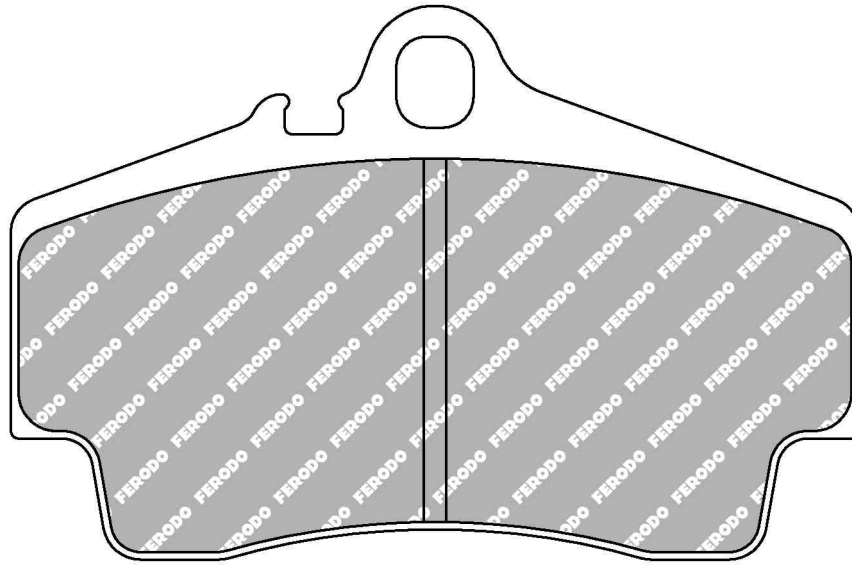

MATERIAL AVAILABILITY				
H	C	R	W	Z
✓		✉	✓	

CROSS REFERENCE	
CL BRAKES	4049
FMSI	D738
FMSI	D978
HAWK	HB290 0,583
MINTEX	MDB1874
PAGID	2406
PFC	0738
WVA	21 972 15,20
WVA	23 694

- ✓ Available    ⚠ Exhausting
- ✗ Not Available    ✉ Make to order
- 🔵 In Introduction



Updated on 30th Jan 2014

**3105**

# FCP1312



119.0mm = 4.685"



47.2mm = 1.858"



16.0mm = 0.630"

WVA No: 21 945 16,00

**IMPORTANT NOTICE: Please note that the height measurement represents the radial depth, not the entire back plate**

SEAT Front, VOLKSWAGEN Front / Rear

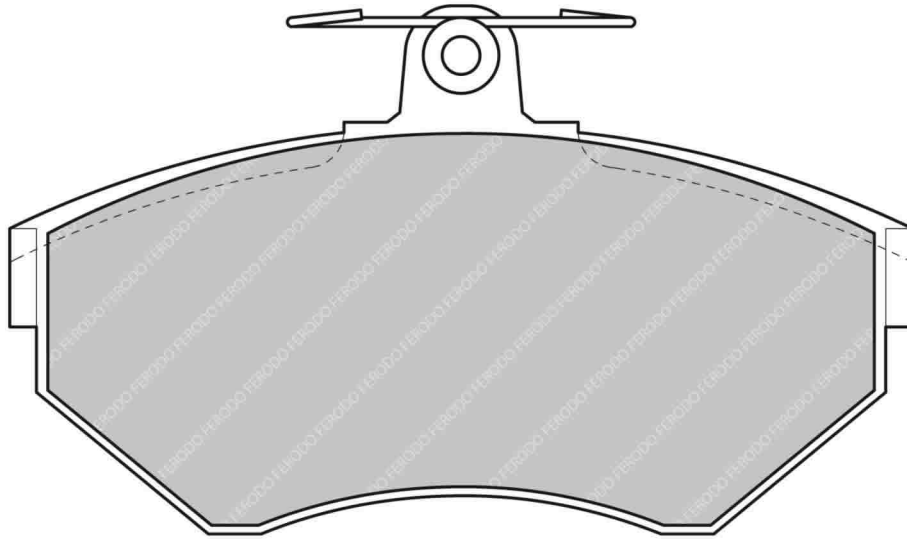

### ALSO AVAILABLE

SHAPE	TH. MM	NOTES
FCP1289	19.9	

### CROSS REFERENCE

MINTEX	MDB1868
WVA	21 945 16,00

### MATERIAL AVAILABILITY

H	C	R	W	Z
✓				✉

3106

**FERODO**  
RACING

Updated on 30th Jan 2014

✓ Available    ⚠ Exhausting  
 ✗ Not Available    ✉ Make to order  
 📦 In Introduction

# FCP1318

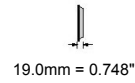
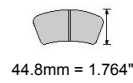
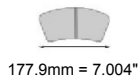

WVA No: 23 154 19,00

FMSI No: D816

**IMPORTANT NOTICE: Please note that the height measurement represents the radial depth, not the entire back plate**

FORD Front, FORD USA Front

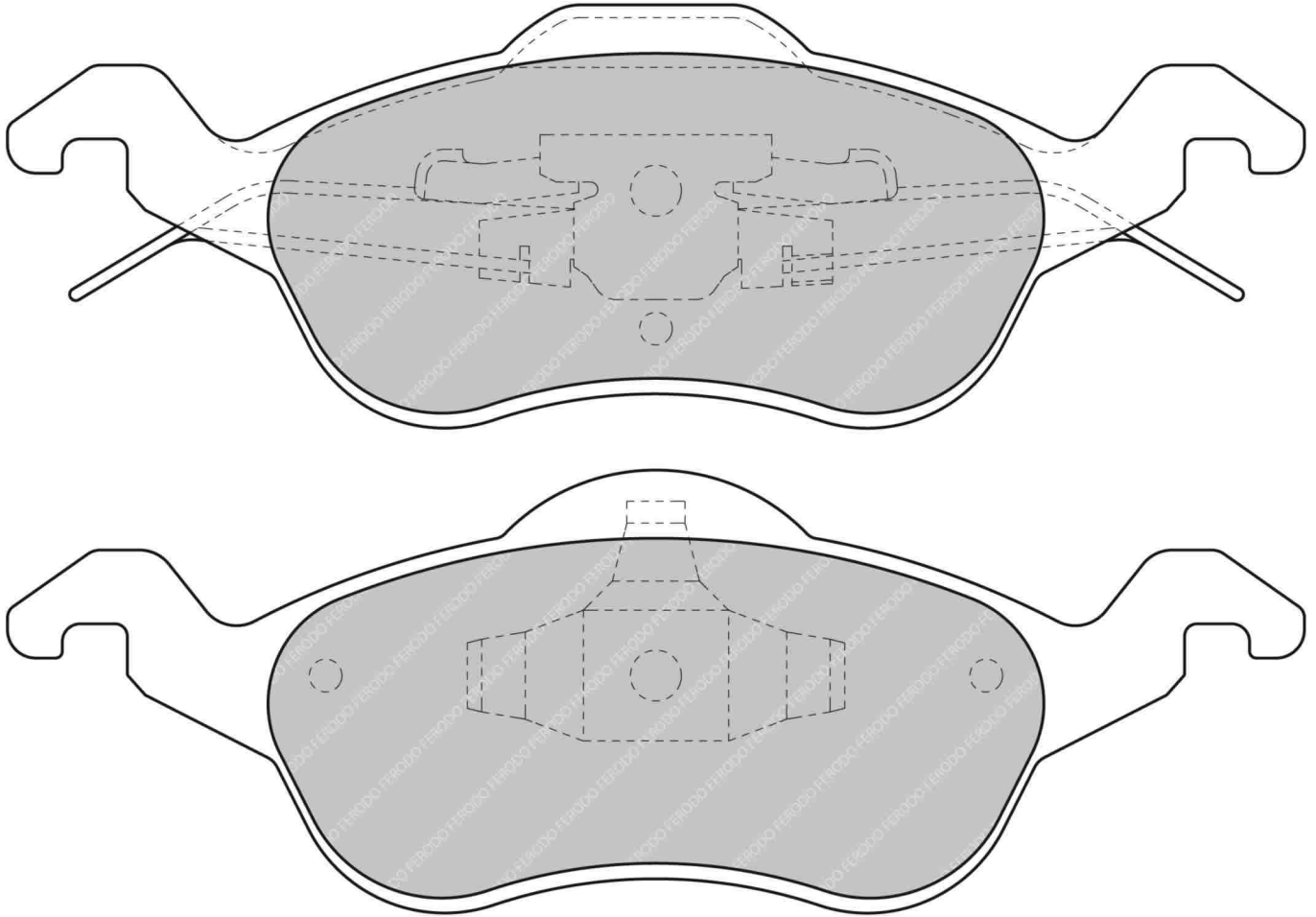

MATERIAL AVAILABILITY				
H	C	R	W	Z
✓		✉		

CROSS REFERENCE	
BREMBO	07.8301.72
FMSI	D816
HAWK	HB346 0,713
MINTEX	MDB1958
PFC	0816.XX
WVA	23 154 19,00

✓ Available    ⚠ Exhausting  
 ✗ Not Available    ✉ Make to order  
 🚧 In Introduction

**FERODO**  
RACING

Updated on 30th Jan 2014

**3107**

# FCP1319



87.7mm = 3.453"



34.9mm = 1.374"



14.9mm = 0.587"

WVA No: 23 353 14,70

FMSI No: D886

**IMPORTANT NOTICE: Please note that the height measurement represents the radial depth, not the entire back plate**

FORD Rear

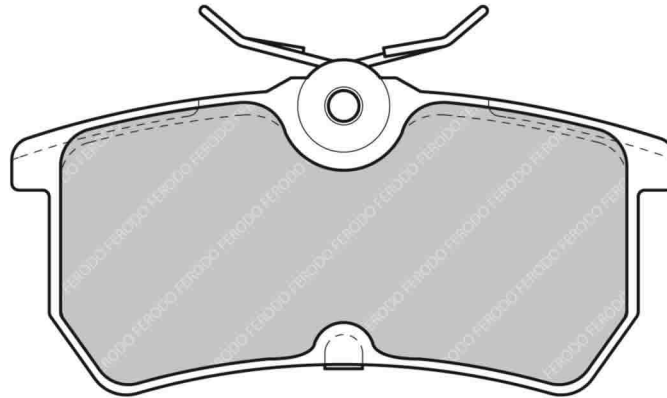

MATERIAL AVAILABILITY				
H	C	R	W	Z
✓				

CROSS REFERENCE	
FMSI	D886
HAWK	HB430 0,547
MINTEX	MDB1959
WVA	23 353 14,70



# FCP1323



156.5mm = 6.161"



61.0mm = 2.402"



21.3mm = 0.839"

WVA No: 21 938 20,40

FMSI No: D840

**IMPORTANT NOTICE: Please note that the height measurement represents the radial depth, not the entire back plate**

AUDI Front, VOLKSWAGEN Front

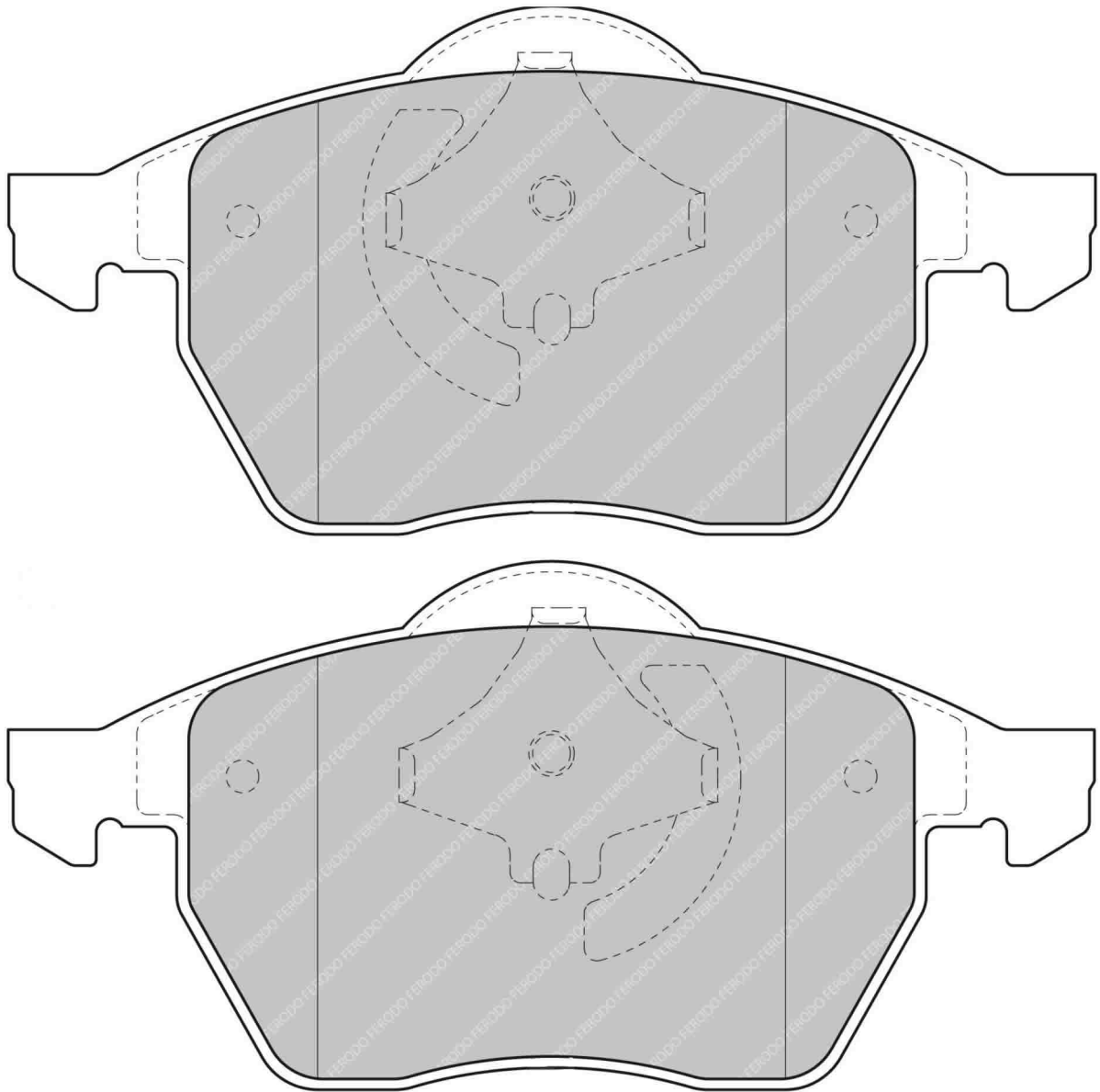

MATERIAL AVAILABILITY				
H	C	R	W	Z
✓				

CROSS REFERENCE	
CL BRAKES	4023
FMSI	D840
HAWK	HB354 .756A
MINTEX	MDB1826
WVA	21 938 20,40

✓ Available    ⚠ Exhausting  
 ✗ Not Available    📧 Make to order  
 🚧 In Introduction

**FERODO**  
RACING

Updated on 30th Jan 2014

**3109**

# FCP1324



96.0mm = 3.780"



42.0mm = 1.654"



13.9mm = 0.547"

VVA No: 23 601 16,70

**IMPORTANT NOTICE: Please note that the height measurement represents the radial depth, not the entire back plate**

FIAT Rear, LANCIA Rear

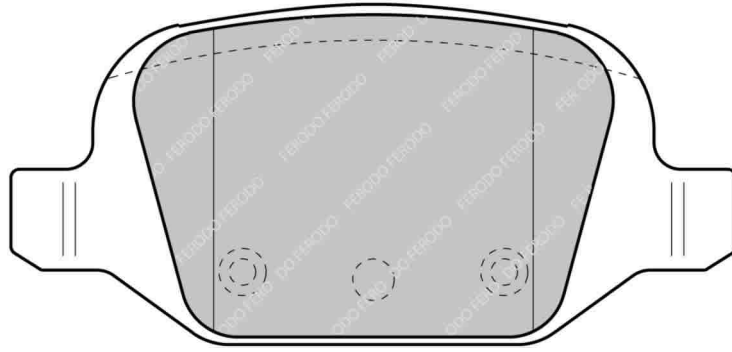

MATERIAL AVAILABILITY				
H	C	R	W	Z
✓				

CROSS REFERENCE	
MINTEX	MDB2042
WVA	23 601 16,70

# FCP1327



137.8mm = 5.425"



50.0mm = 1.969"



17.0mm = 0.669"

VVA No: 23 558 17,80

FMSI No: D721

**IMPORTANT NOTICE: Please note that the height measurement represents the radial depth, not the entire back plate**

SUBARU Front

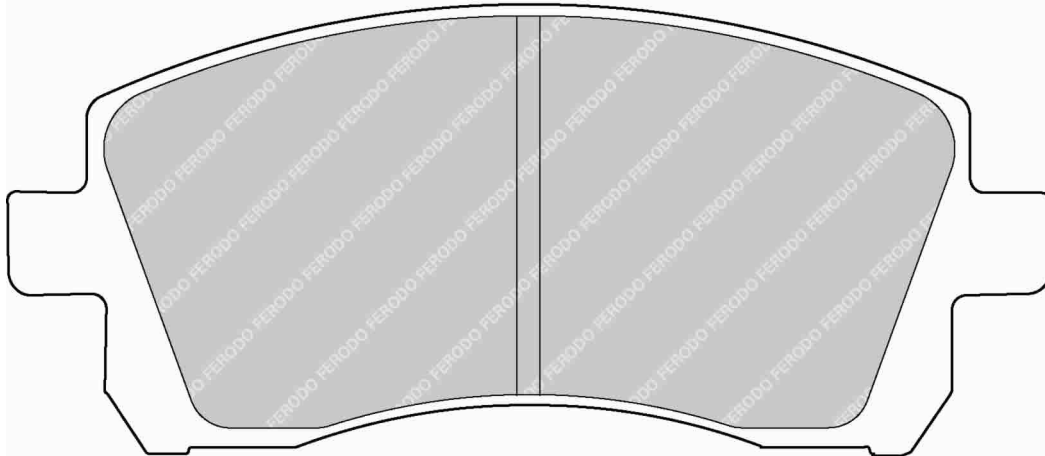

MATERIAL AVAILABILITY				
H	C	R	W	Z
✓		✉		

CROSS REFERENCE	
BREMBO	07.8300.42
CL BRAKES	4029
FMSI	D721
HAWK	HB352 0,665
MINTEX	MDB1794
PAGID	ERS651
WVA	23 558 17,80

# FCP1333



108.4mm = 4.268"



34.0mm = 1.339"



14.0mm = 0.551"

WVA No: 23 572 14,40

FMSI No: D770

**IMPORTANT NOTICE: Please note that the height measurement represents the radial depth, not the entire back plate**

SUBARU Rear

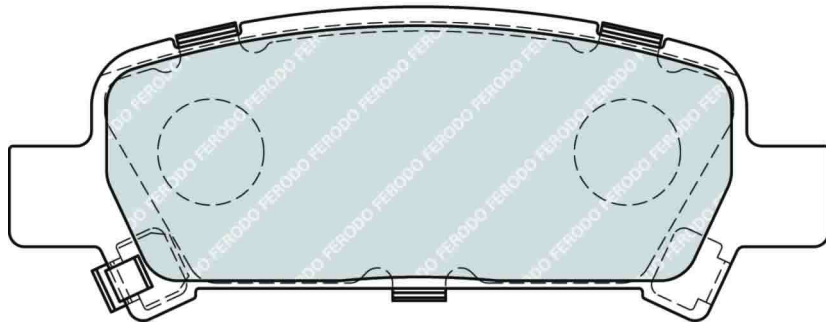
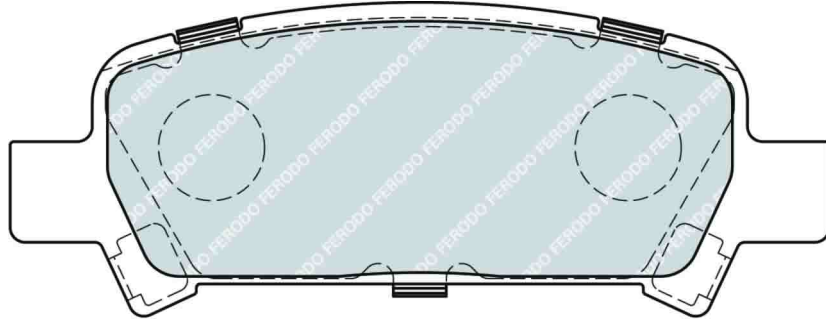

MATERIAL AVAILABILITY				
H	C	R	W	Z
✓		✓		

CROSS REFERENCE	
CL BRAKES	4059
FMSI	D770
HAWK	HB434 0,543
WVA	23 572 14,40

✓ Available    ⚠ Exhausting  
 ✗ Not Available    ✉ Make to order  
 🔄 In Introduction

**FERODO**  
RACING

Updated on 30th Jan 2014

**3111**

# FCP1334



131.8mm = 5.189"



62.0mm = 2.441"



16.0mm = 0.630"

WVA No: 23 092 16,00

FMSI No: D1001

**IMPORTANT NOTICE: Please note that the height measurement represents the radial depth, not the entire back plate**

ALFA ROMEO Front, AUDI Front, CHEVROLET Front, CITROEN Front, LANCIA Front, LAND ROVER Front, MASERATI Front, MITSUBISHI Front, RENAULT Front, VOLKSWAGEN Front, VOLVO Front

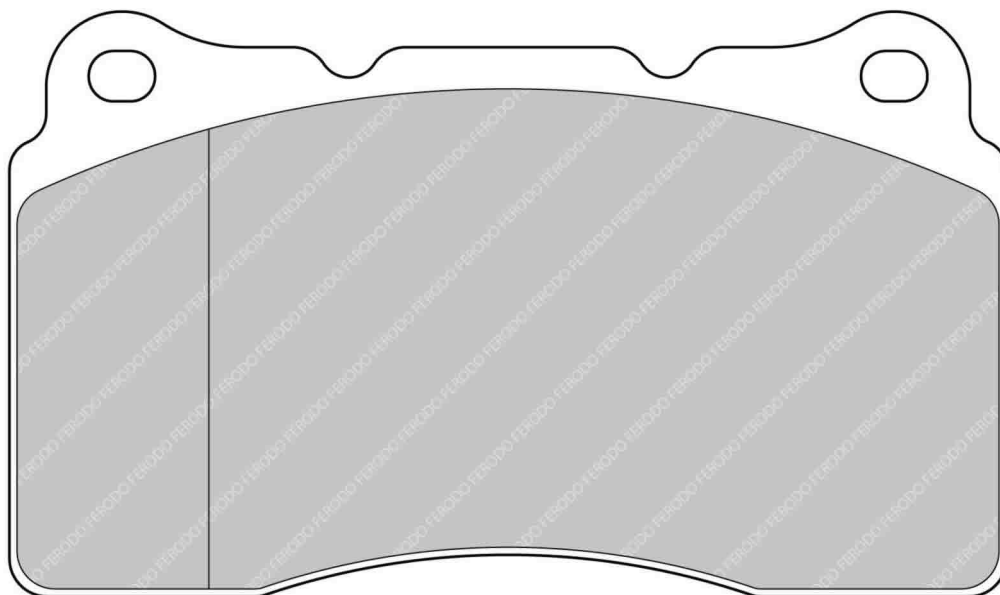

### ALSO AVAILABLE

SHAPE	TH. MM	NOTES
FRP3067	14.7	

### MATERIAL AVAILABILITY

H	C	R	W	Z
✓		✓	✓	✓

### CROSS REFERENCE

ALCON	PNF0084X268.4
ALCON	PNF0084X359.4
BREMBO	07.8301.74
CL BRAKES	4066
FMSI	D1001
FMSI	D1016
FMSI	D1050
HAWK	HB453 0,585
MINTEX	MDB1950
MINTEX	MTX1859
PAGID	2487
PFC	7781
WVA	23 092 16,00

# FCP1348



109.8mm = 4.323"



51.3mm = 2.020"



15.0mm = 0.591"

WVA No: 21 381 15,00

**IMPORTANT NOTICE:** Please note that the height measurement represents the radial depth, not the entire back plate

CITROEN Front, FERRARI Front / Rear, FORD Front, MASERATI Rear, PEUGEOT Front, RENAULT Front / Rear, SEAT Front, VOLVO Rear

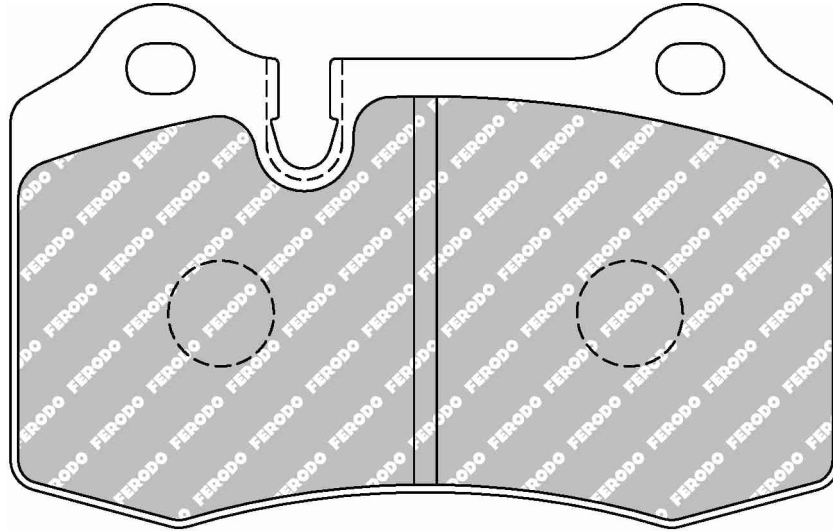

ALSO AVAILABLE		
SHAPE	TH. MM	NOTES
FCP721	17.3	
FRP3109	12.5	

MATERIAL AVAILABILITY				
H	C	R	W	Z
✓		✓	✓	✉

CROSS REFERENCE	
BREMBO	07.5146.30
BREMBO	07.5146.31
BREMBO	07.6953.9
BREMBO	07.8720.XX
PAGID	1408
PFC	0592.XX.15
WVA	21 381 15,00

# FCP1349



96.0mm = 3.780"



42.0mm = 1.654"



16.6mm = 0.654"

WVA No: 23 517 16,60

**IMPORTANT NOTICE:** Please note that the height measurement represents the radial depth, not the entire back plate

ALFA ROMEO Rear, LANCIA Rear

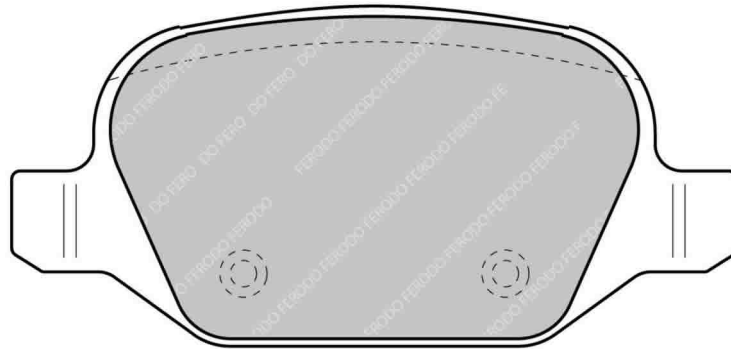

MATERIAL AVAILABILITY				
H	C	R	W	Z
✓		✉		

CROSS REFERENCE	
MINTEX	MDB2051
WVA	23 517 16,60

✓ Available    ⚠ Exhausting  
 ✗ Not Available    ✉ Make to order  
 📧 In Introduction

**FERODO**  
RACING

Updated on 30th Jan 2014

**3113**

# FCP1368



112.4mm = 4.425"

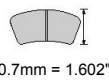

40.7mm = 1.602"

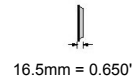

16.5mm = 0.650"

WVA No: 23 348 16,50

**IMPORTANT NOTICE: Please note that the height measurement represents the radial depth, not the entire back plate**

TOYOTA Front

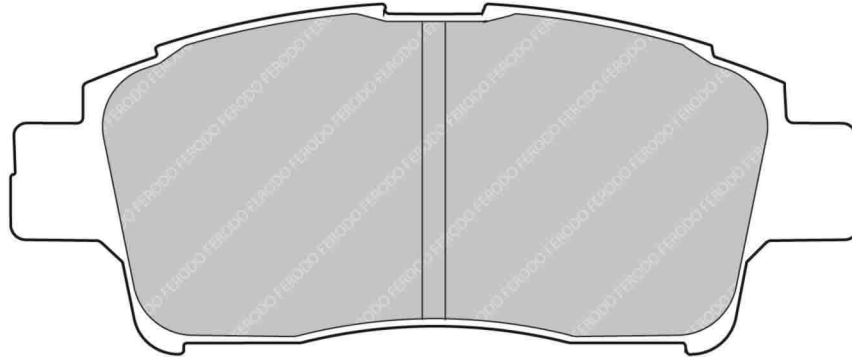

MATERIAL AVAILABILITY				
H	C	R	W	Z
✓		✗		

CROSS REFERENCE	
BREMBO	07.8301.76
MINTEX	MDB2006
WVA	23 348 16,50

# FCP1370

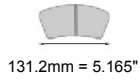

131.2mm = 5.165"

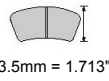

43.5mm = 1.713"

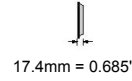

17.4mm = 0.685"

WVA No: 23 332 18,00

**IMPORTANT NOTICE: Please note that the height measurement represents the radial depth, not the entire back plate**

CITROEN Front, PEUGEOT Front

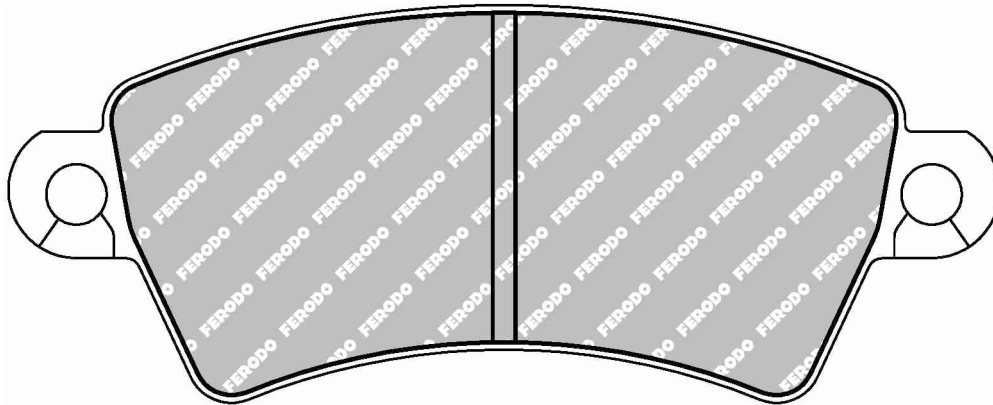

MATERIAL AVAILABILITY				
H	C	R	W	Z
✓		✓		

CROSS REFERENCE	
MINTEX	MDB2012
WVA	23 332 18,00

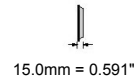
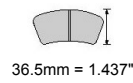
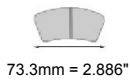

**IMPORTANT NOTICE: Please note that the height measurement represents the radial depth, not the entire back plate**

SUBARU Rear

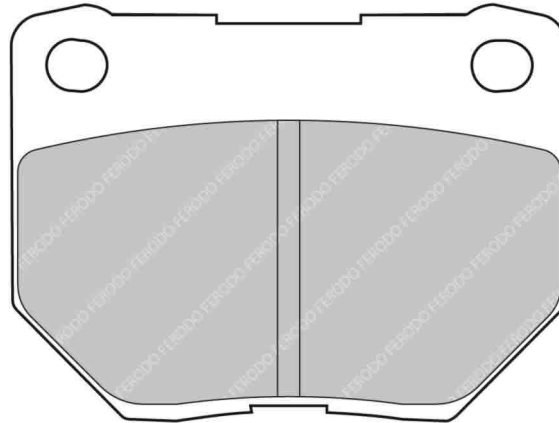

MATERIAL AVAILABILITY				
H	C	R	W	Z
✓		✓		

CROSS REFERENCE	
ALCON	PNF0084X298.4
CL BRAKES	4069
FMSI	D461
HAWK	HB179 0,63
PFC	0461
PFC	0461.XX

# FCP1376



151.0mm = 5.945"



46.0mm = 1.811"



17.0mm = 0.669"

WVA No: 23 552 17,80

**IMPORTANT NOTICE: Please note that the height measurement represents the radial depth, not the entire back plate**

FIAT Front

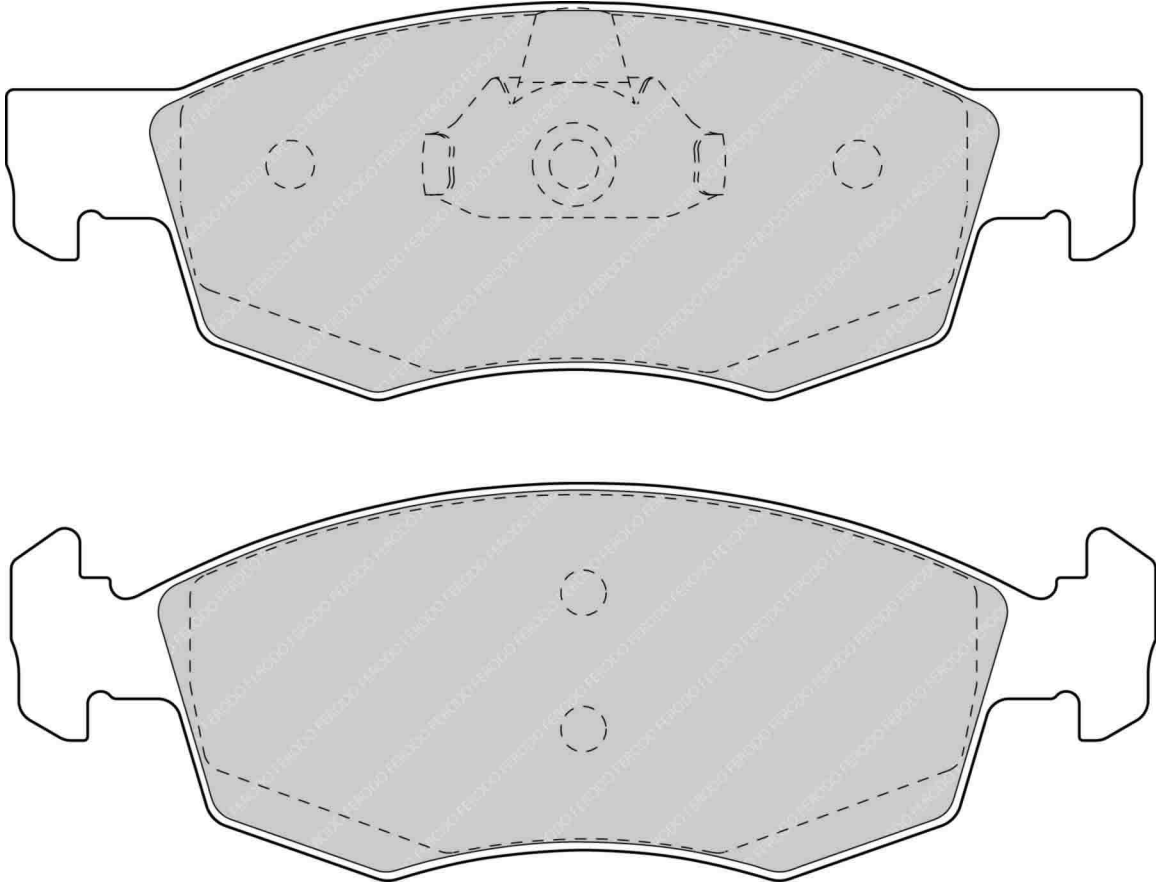

MATERIAL AVAILABILITY				
H	C	R	W	Z
✓		✓		

CROSS REFERENCE	
BREMBO	07.8301.77
MINTEX	MDB2076
WVA	23 552 17,80



# FCP1378

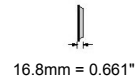
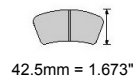
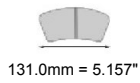

WVA No: 23 597 16,80

**IMPORTANT NOTICE: Please note that the height measurement represents the radial depth, not the entire back plate**

CITROEN Front / Rear, PEUGEOT Front

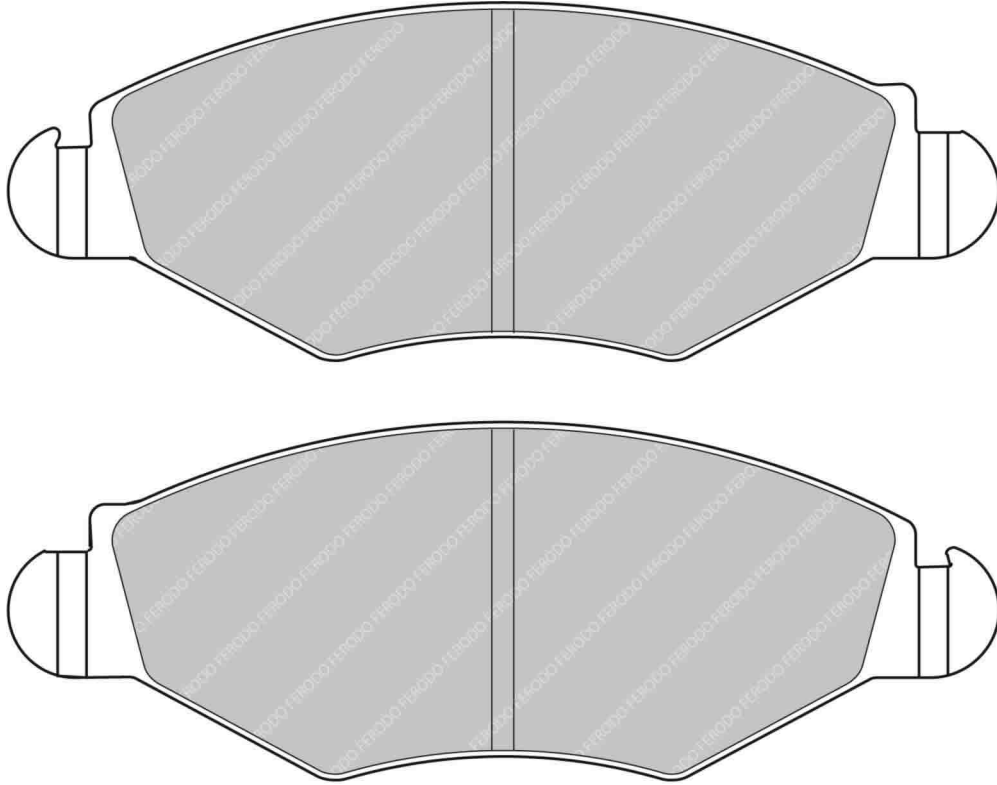

MATERIAL AVAILABILITY				
H	C	R	W	Z
✓		✓		

CROSS REFERENCE	
ALCON	PNF0084X321.4
BREMBO	07.8301.78
MINTEX	MDB2131
WVA	23 597 16,80

- ✓ Available    ⚠ Exhausting
- ✗ Not Available    ✉ Make to order
- 🔧 In Introduction

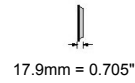
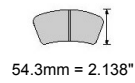

**IMPORTANT NOTICE: Please note that the height measurement represents the radial depth, not the entire back plate**

VOLVO Front

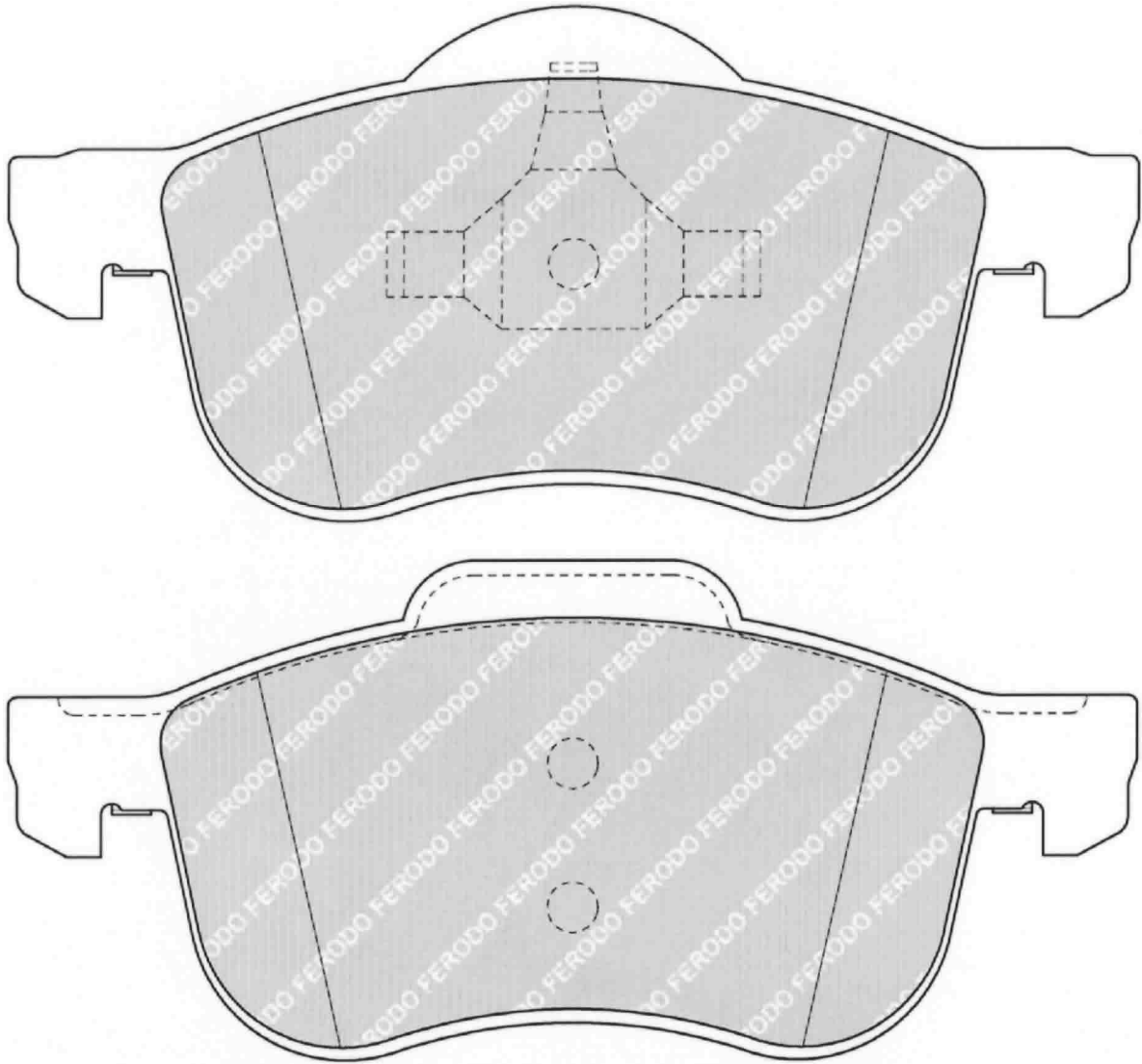

MATERIAL AVAILABILITY				
H	C	R	W	Z

CROSS REFERENCE	
FMSI	D794
HAWK	HB491 0,693
MINTEX	MDB1944
WVA	23 073 18,80

# FCP1392



116.6mm = 4.591"



46.0mm = 1.811"



16.5mm = 0.650"

WVA No: 23 510 16,50

FMSI No: D990

**IMPORTANT NOTICE: Please note that the height measurement represents the radial depth, not the entire back plate**

TOYOTA Front

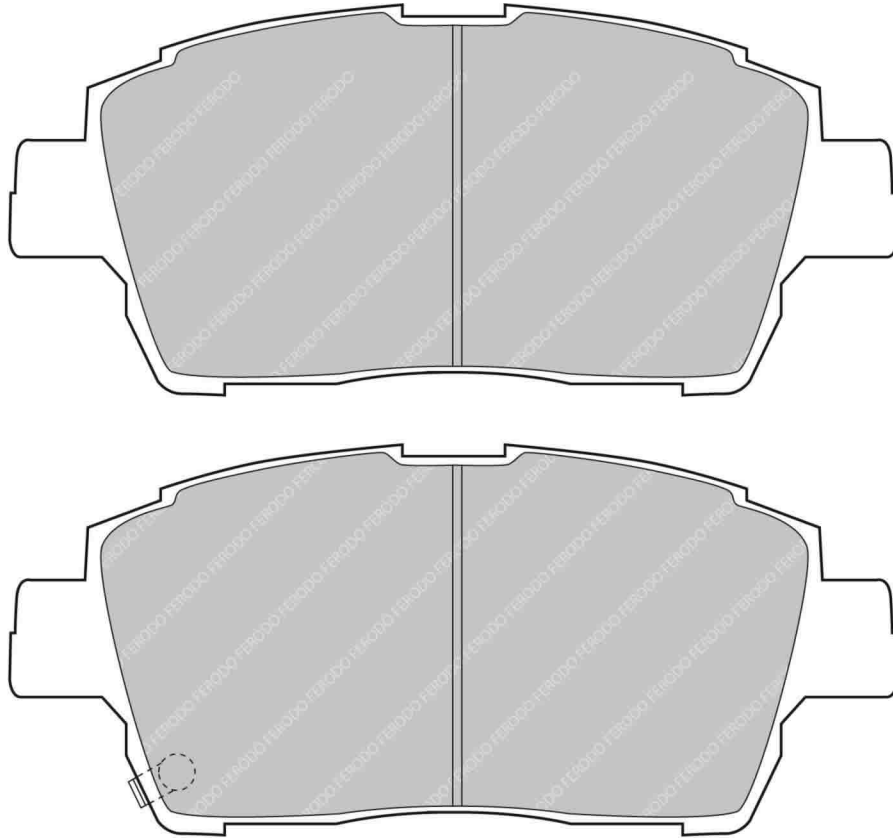

MATERIAL AVAILABILITY				
H	C	R	W	Z
✓				

CROSS REFERENCE	
FMSI	D990
HAWK	HB493 0,65
MINTEX	MDB2029
WVA	23 510 16,50

✓ Available    ⚠ Exhausting  
 ✗ Not Available    ✉ Make to order  
 🔄 In Introduction

**FERODO**  
RACING

Updated on 30th Jan 2014

**3119**

# FCP1394



150.2mm = 5.913"  
151.4mm = 5.961"



48.1mm = 1.894"  
48.1mm = 1.894"



18.6mm = 0.732"  
18.6mm = 0.732"

WVA No: 23 202 18,50

**IMPORTANT NOTICE:** Please note that the height measurement represents the radial depth, not the entire back plate

FORD Front, MAZDA Front

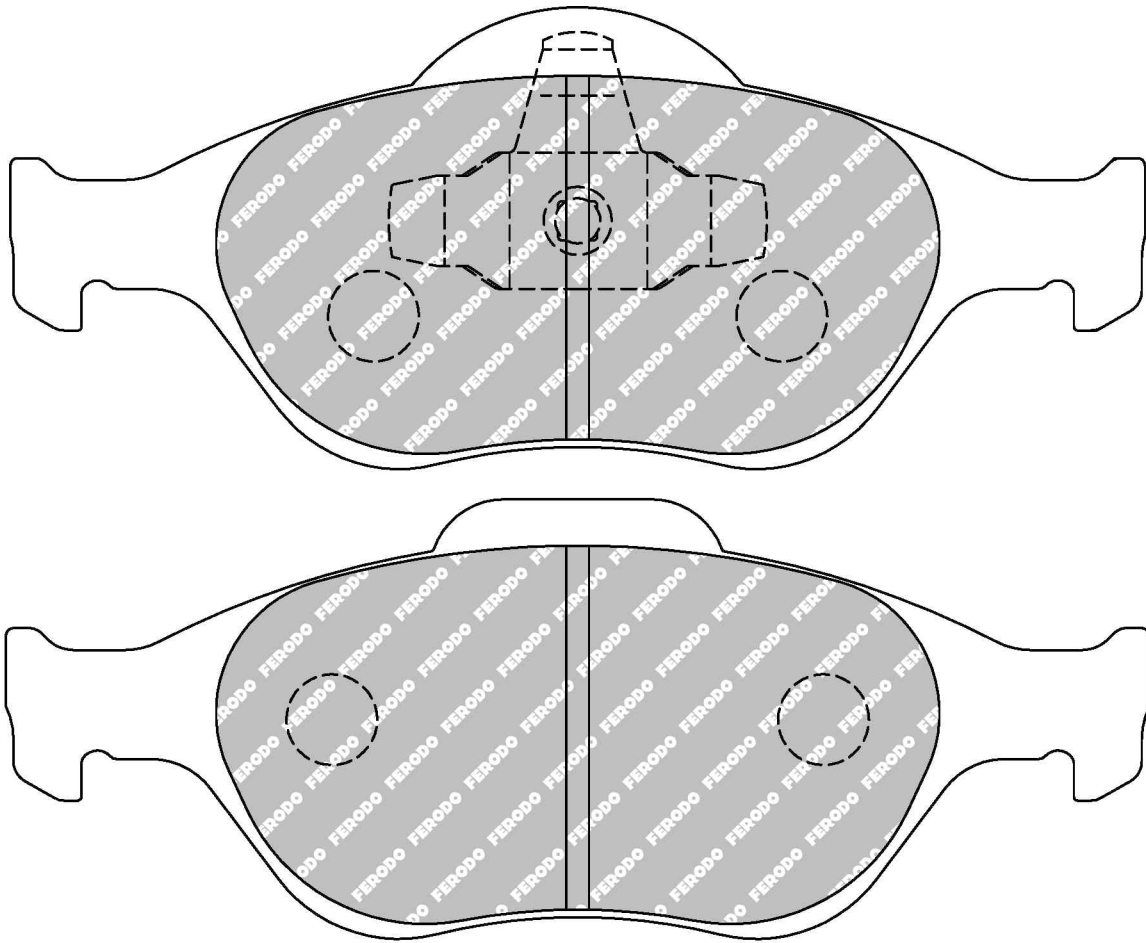

MATERIAL AVAILABILITY				
H	C	R	W	Z
✓		✓		

CROSS REFERENCE	
MINTEX	MDB2314
WVA	23 202 18,50

# FCP1399



137.0mm = 5.394"

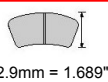

42.9mm = 1.689"



19.0mm = 0.748"

WVA No: 23 599 19,00

**IMPORTANT NOTICE: Please note that the height measurement represents the radial depth, not the entire back plate**

CITROEN Front, PEUGEOT Front

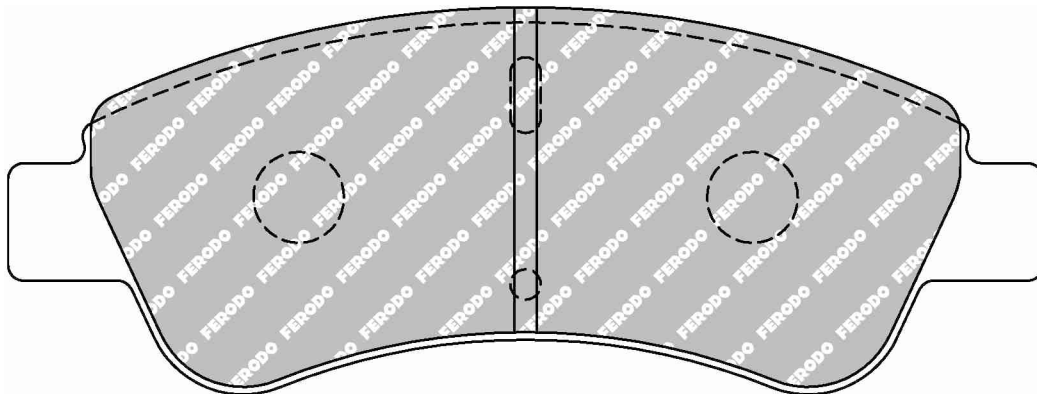

MATERIAL AVAILABILITY				
H	C	R	W	Z
✓		✓		

CROSS REFERENCE	
MINTEX	MDB2183
MINTEX	MDB2628
WVA	23 599 19,00

# FCP1419



132.0mm = 5.197"

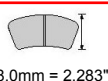

58.0mm = 2.283"



18.2mm = 0.717"

WVA No: 23 581 18,70

**IMPORTANT NOTICE: Please note that the height measurement represents the radial depth, not the entire back plate**

SEAT Front, SKODA Front, VOLKSWAGEN Front

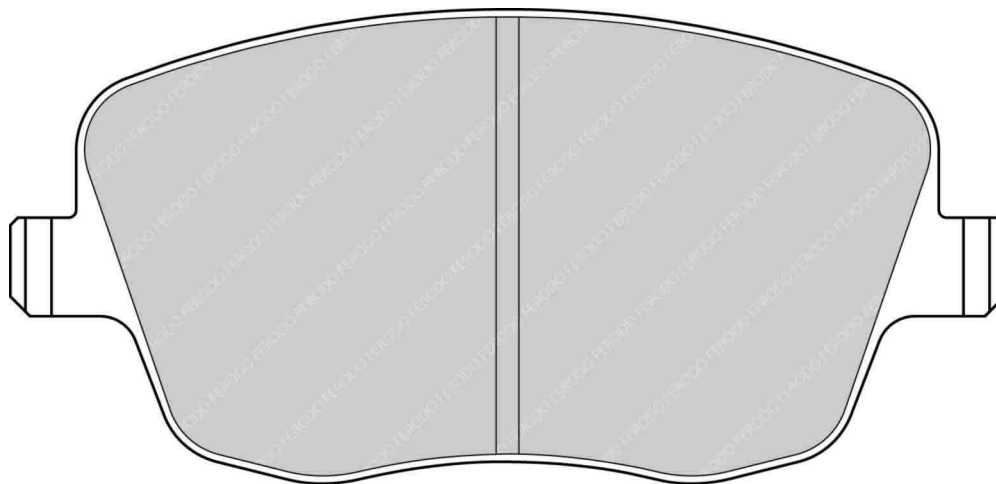

MATERIAL AVAILABILITY				
H	C	R	W	Z
✓		✓		

CROSS REFERENCE	
MINTEX	MDB2294
WVA	23 581 18,70

# FCP1424

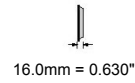
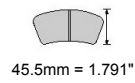

WVA No: 23 225 17,00

**IMPORTANT NOTICE: Please note that the height measurement represents the radial depth, not the entire back plate**

OPEL Front, VAUXHALL Front

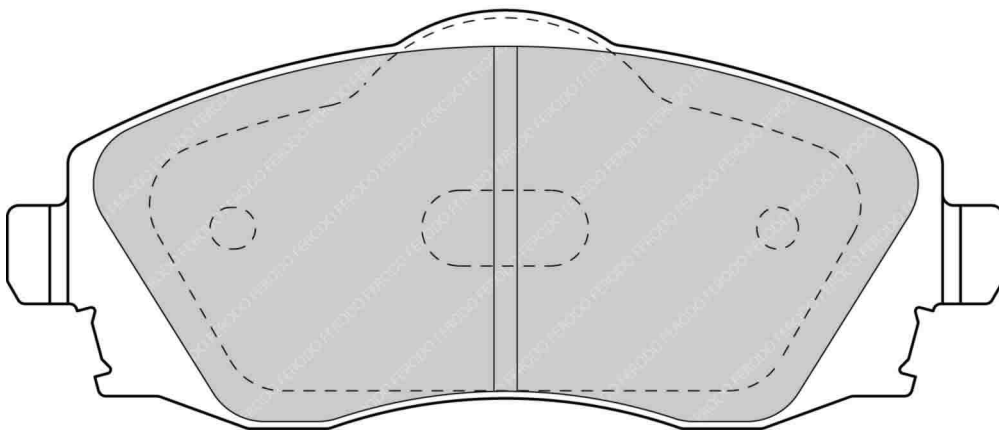
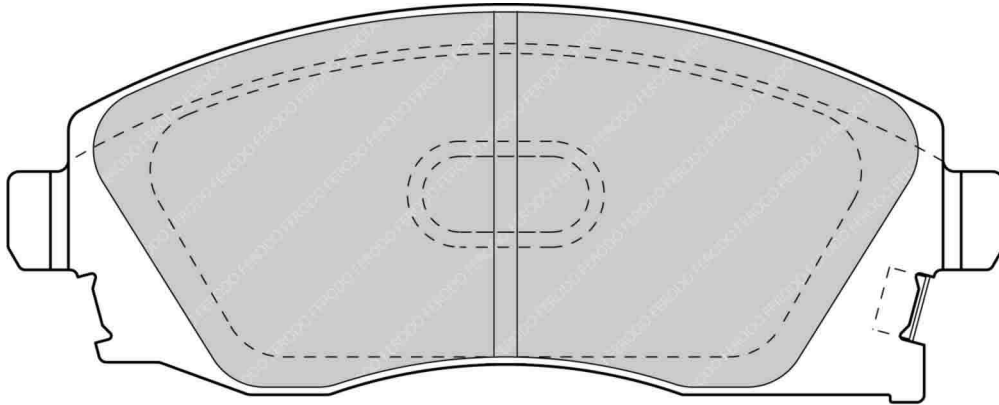

MATERIAL AVAILABILITY				
H	C	R	W	Z
✓				

CROSS REFERENCE	
MINTEX	MDB2073
WVA	23 225 17,00

# FCP1430



137.5mm = 5.413"



45.5mm = 1.791"



16.9mm = 0.665"

FMSI No: D526

**IMPORTANT NOTICE: Please note that the height measurement represents the radial depth, not the entire back plate**

INFINITI Front, NISSAN Front

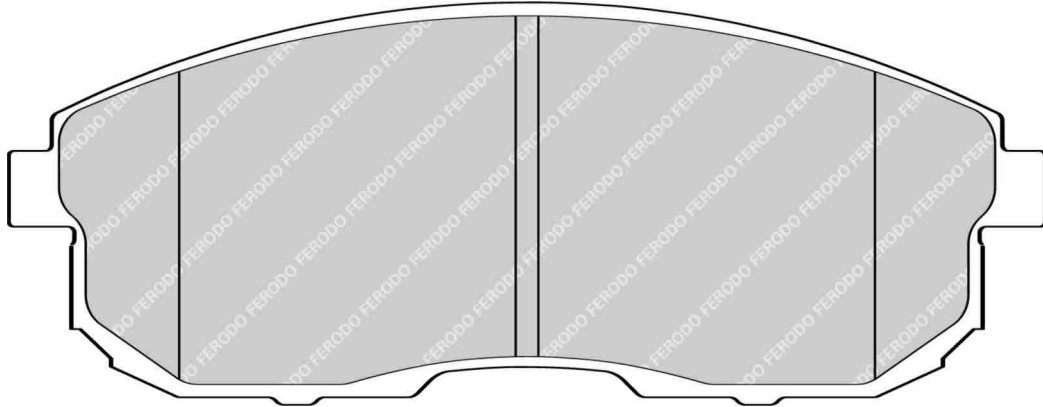

MATERIAL AVAILABILITY				
H	C	R	W	Z
✓				

CROSS REFERENCE	
BREMBO	07.8300.20
BREMBO	07.8300.26
FMSI	D526
FMSI	D653
FMSI	D815
HAWK	HB412 0,665
PFC	0526.XX
PFC	0815.XX

# FCP1436



129.0mm = 5.079"



48.0mm = 1.890"



16.2mm = 0.638"

FMSI No: D617

**IMPORTANT NOTICE: Please note that the height measurement represents the radial depth, not the entire back plate**

ACURA Front, HONDA Front

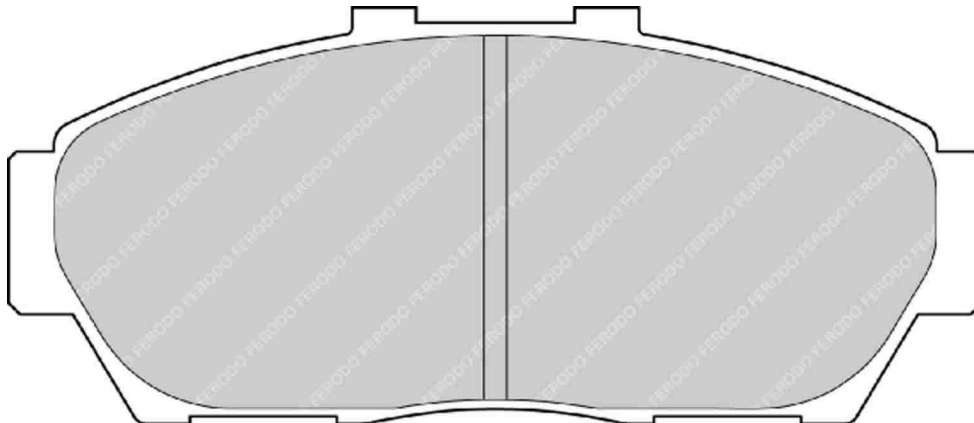

MATERIAL AVAILABILITY				
H	C	R	W	Z
✉				

CROSS REFERENCE	
BREMBO	07.8300.33
FMSI	D617
HAWK	HB245 0,631
PFC	0617.XX

✓ Available    ⚠ Exhausting  
 ✗ Not Available    ✉ Make to order  
 📦 In Introduction

**FERODO**  
RACING

Updated on 30th Jan 2014

**3123**

# FCP1437

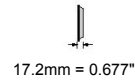
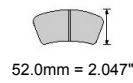

WVA No: 23 513 16,80

FMSI No: D707

**IMPORTANT NOTICE: Please note that the height measurement represents the radial depth, not the entire back plate**

LEXUS Front, TOYOTA Front

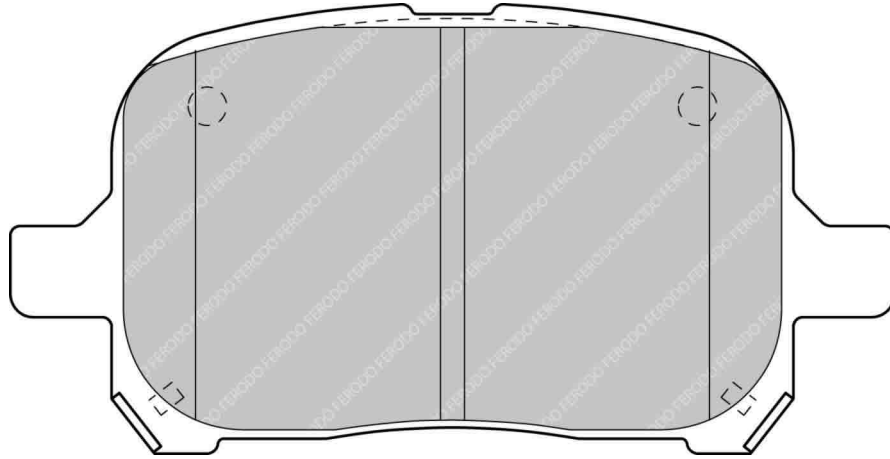

MATERIAL AVAILABILITY				
H	C	R	W	Z
⚠				

CROSS REFERENCE	
BREMBO	07.8300.36
FMSI	D707
HAWK	HB320 0,669
MINTEX	MDB1921
PFC	0707.XX
WVA	23 513 16,80



# FCP1441



156.0mm = 6.142"



57.0mm = 2.244"



18.3mm = 0.720"

WVA No: 23 245

**IMPORTANT NOTICE: Please note that the height measurement represents the radial depth, not the entire back plate**

RENAULT Front

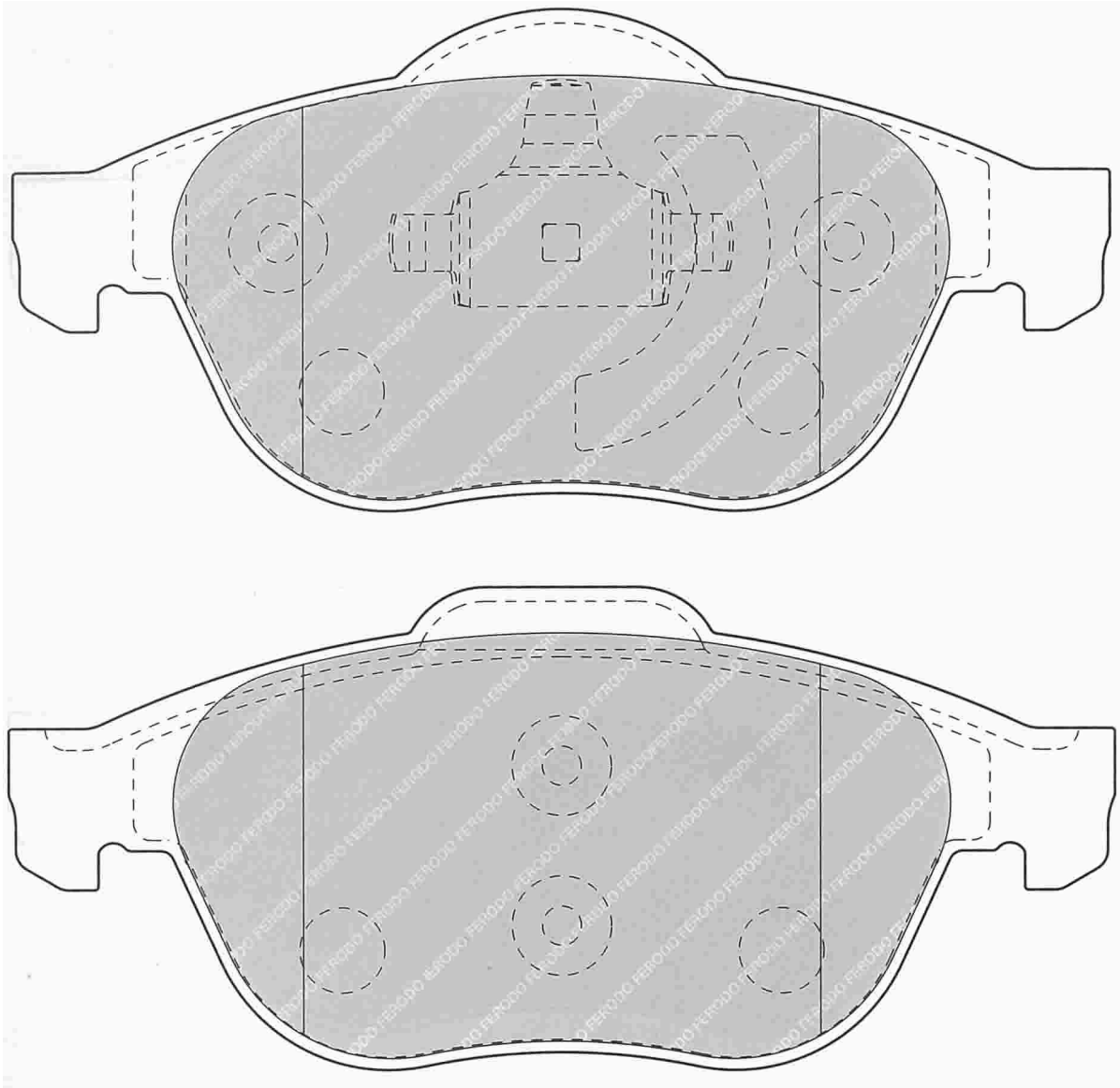

MATERIAL AVAILABILITY				
H	C	R	W	Z
✓				

CROSS REFERENCE	
7701206599	OE Renault
EBC	DP1958
WVA	23 245

✓ Available    ⚠ Exhausting  
 ✗ Not Available    📧 Make to order  
 🚧 In Introduction

**FERODO**  
RACING

Updated on 30th Jan 2014

**3125**

# FCP1444

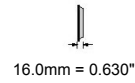
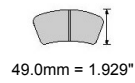

WVA No: 23 178 18,00

**IMPORTANT NOTICE: Please note that the height measurement represents the radial depth, not the entire back plate**

HONDA Front

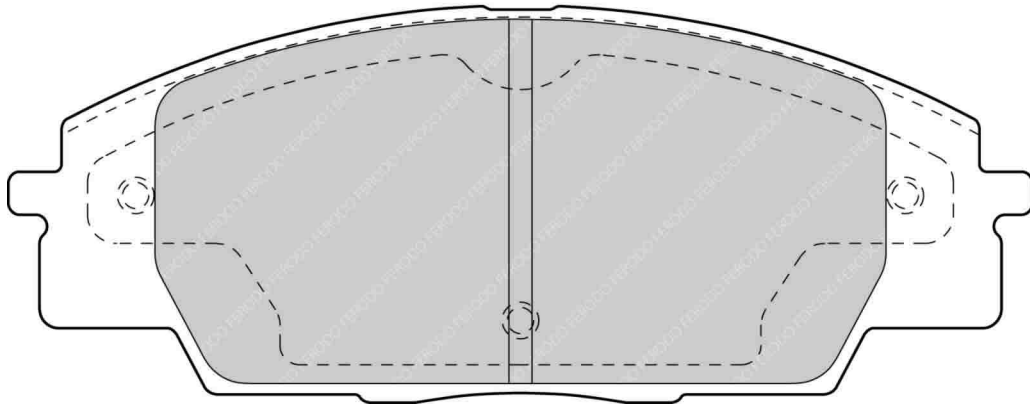
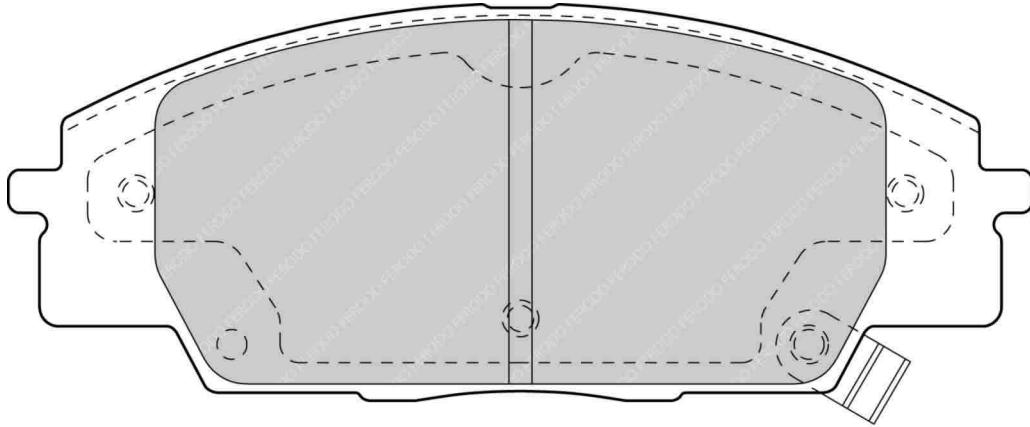

MATERIAL AVAILABILITY				
H	C	R	W	Z
✓		✓	✓	

CROSS REFERENCE	
BREMBO	07.8301.90
MINTEX	MDB2044
PFC	0829
WVA	23 178 18,00

# FCP1459

130.9mm = 5.154"

37.7mm = 1.484"

15.3mm = 0.602"

WVA No: 20 046 15,30

**IMPORTANT NOTICE: Please note that the height measurement represents the radial depth, not the entire back plate**

SUBARU Front, SUZUKI Front

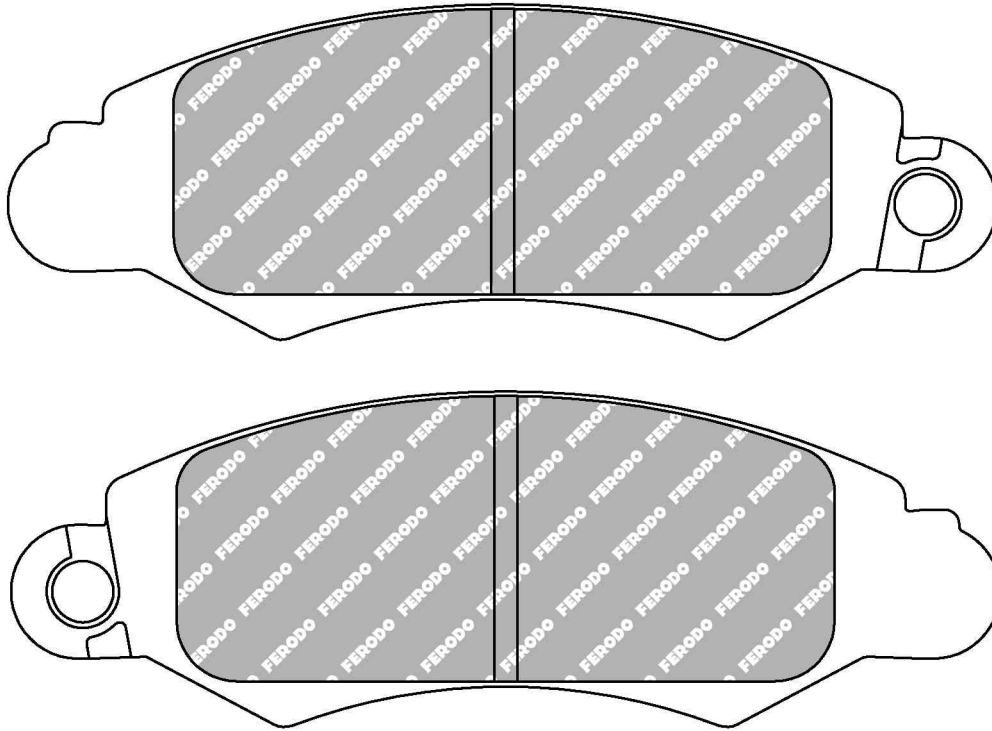

MATERIAL AVAILABILITY				
H	C	R	W	Z

CROSS REFERENCE	
MINTEX	MDB2003
WVA	20 046 15,30

# FCP1466

123.0mm = 4.843"

47.7mm = 1.878"

17.9mm = 0.705"

WVA No: 23 705 17,10 - 24 288 17,7&17,9

**IMPORTANT NOTICE: Please note that the height measurement represents the radial depth, not the entire back plate**

ALFA ROMEO Front, FIAT Front, OPEL Front

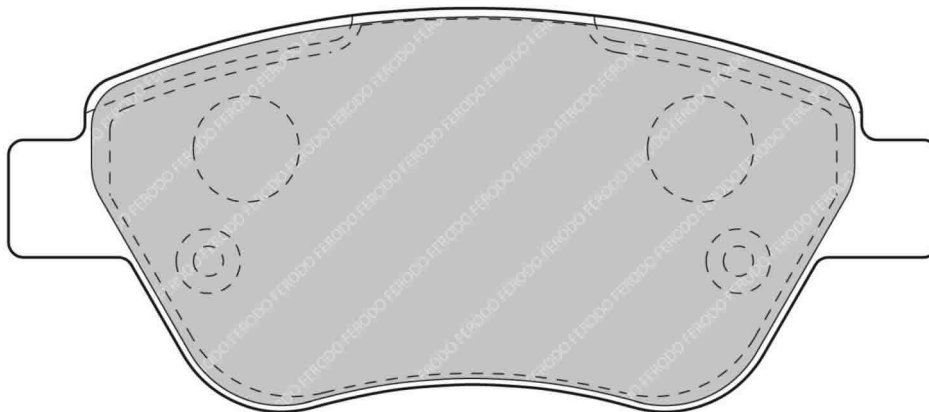

MATERIAL AVAILABILITY				
H	C	R	W	Z

CROSS REFERENCE	
MINTEX	MDB2239
WVA	23 705 17,10 - 24 288 17,7&17,9

- Available
- Exhausting
- Not Available
- Make to order
- In Introduction

# FCP1467

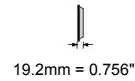
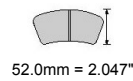
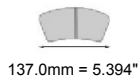

WVA No: 23 708 18,40

**IMPORTANT NOTICE: Please note that the height measurement represents the radial depth, not the entire back plate**

CITROEN Front, FIAT Front, LANCIA Front, OPEL Front, PEUGEOT Front

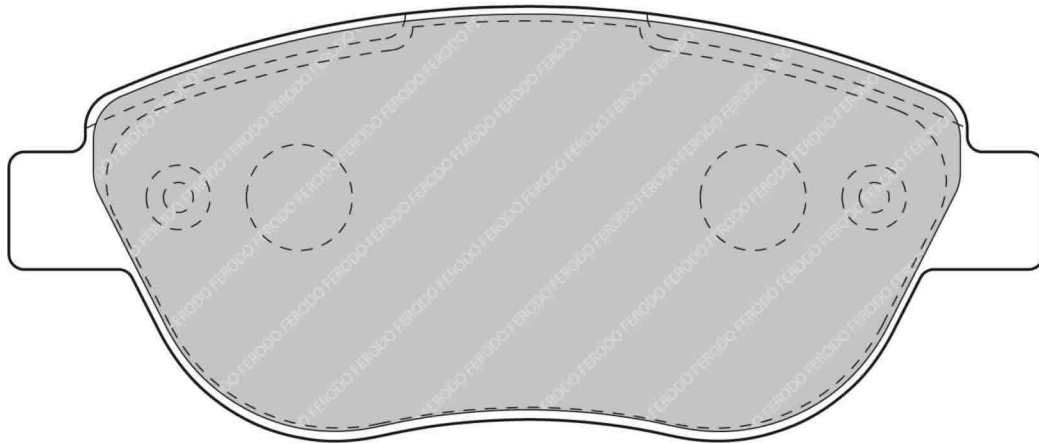

MATERIAL AVAILABILITY				
H	C	R	W	Z
✓		✓		✓

CROSS REFERENCE	
BREMBO	07.8301.79
MINTEX	MDB2240
WVA	23 708 18,40

# FCP1468

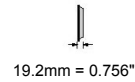
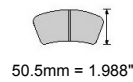
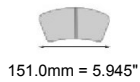

WVA No: 23 711 18,40

**IMPORTANT NOTICE: Please note that the height measurement represents the radial depth, not the entire back plate**

ALFA ROMEO Front, FIAT Front, LANCIA Front

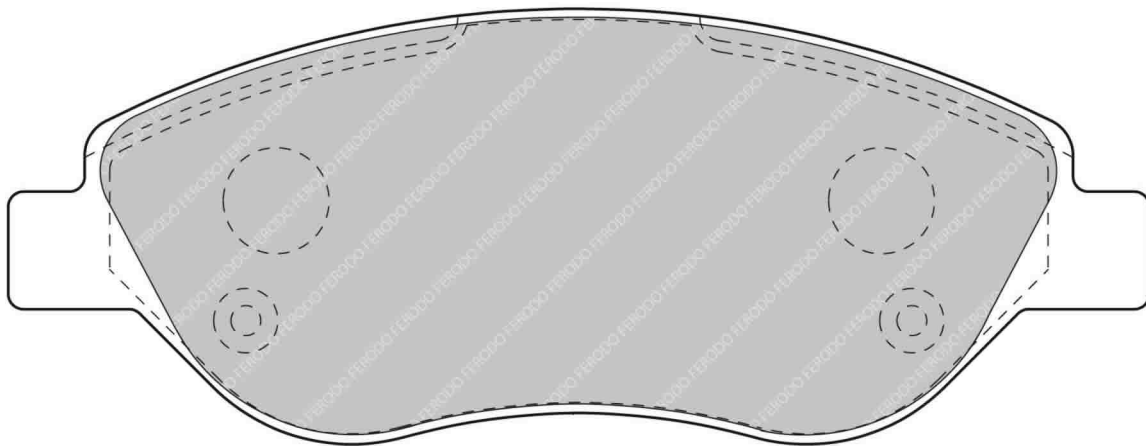

MATERIAL AVAILABILITY				
H	C	R	W	Z
✓		✓		

CROSS REFERENCE	
BREMBO	07.8301.80
MINTEX	MDB2241
WVA	23 711 18,40

# FCP1469



95.0mm = 3.740"

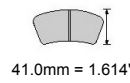

41.0mm = 1.614"

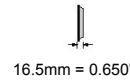

16.5mm = 0.650"

WVA No: 23 714 15,80

**IMPORTANT NOTICE: Please note that the height measurement represents the radial depth, not the entire back plate**

ALFA ROMEO Rear, FIAT Rear, LANCIA Rear, PEUGEOT Rear

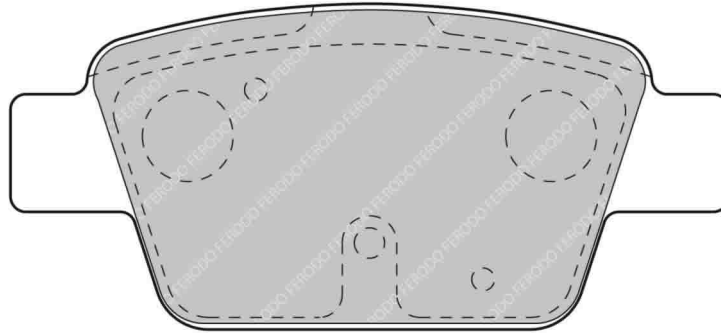

MATERIAL AVAILABILITY				
H	C	R	W	Z
✓		✓		

CROSS REFERENCE	
MINTEX	MDB2238
WVA	23 714 15,80

✓ Available    ⚠ Exhausting  
✗ Not Available    ✉ Make to order  
🔧 In Introduction

**FERODO**  
RACING

Updated on 30th Jan 2014

**3129**

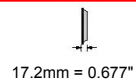
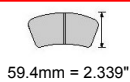

**IMPORTANT NOTICE: Please note that the height measurement represents the radial depth, not the entire back plate**

BMW Rear, LAND ROVER Rear

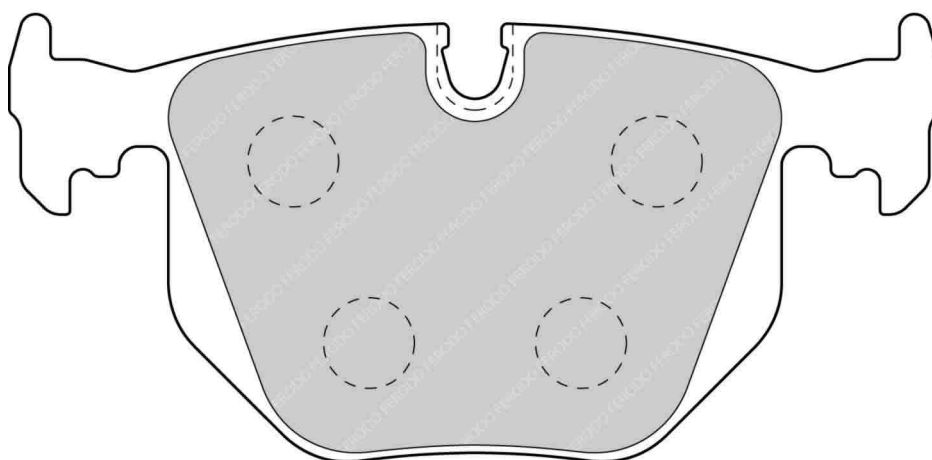
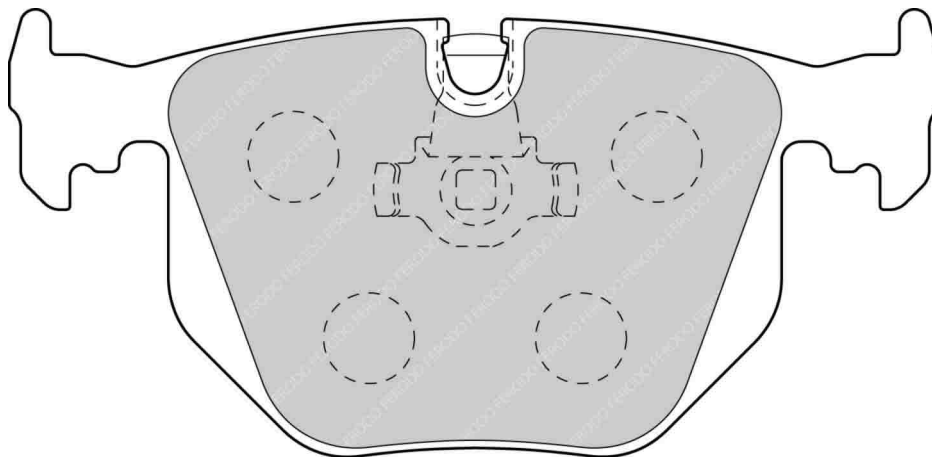

### ALSO AVAILABLE

SHAPE	TH. MM	NOTES
FCP857	17	Different Spring clip

### MATERIAL AVAILABILITY

H	C	R	W	Z
✓		✉	✉	✉

### CROSS REFERENCE

FMSI	D683
HAWK	HB518 0,642
MINTEX	MDB2004
PAGID	2685
PFC	0548
WVA	21 282 17,20

# FCP1491

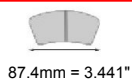

87.4mm = 3.441"

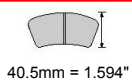

40.5mm = 1.594"

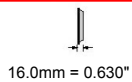

16.0mm = 0.630"

WVA No: 20 961 16,00

**IMPORTANT NOTICE: Please note that the height measurement represents the radial depth, not the entire back plate**

AUDI Rear, CITROEN Rear, PEUGEOT Rear, RENAULT Rear, SEAT Rear, SKODA Rear, VOLKSWAGEN Rear

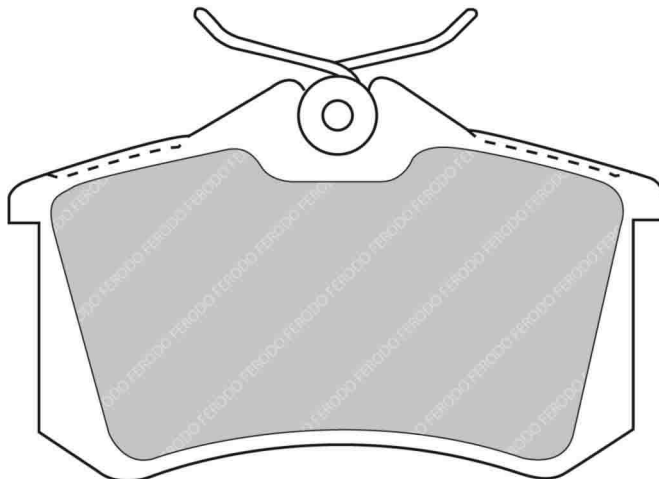

### ALSO AVAILABLE

SHAPE	TH. MM	NOTES
FCP541	15	

### MATERIAL AVAILABILITY

H	C	R	W	Z
✓			✓	

### CROSS REFERENCE

MINTEX	MDB2256
PAGID	1158
PFC	0340-07-15-44
WVA	20 961 16,00

✓ Available    ⚠ Exhausting  
 ✗ Not Available    📧 Make to order  
 🚧 In Introduction

**FERODO**  
RACING

Updated on 30th Jan 2014

**3131**

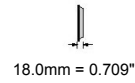
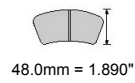

**IMPORTANT NOTICE: Please note that the height measurement represents the radial depth, not the entire back plate**

MINI Front

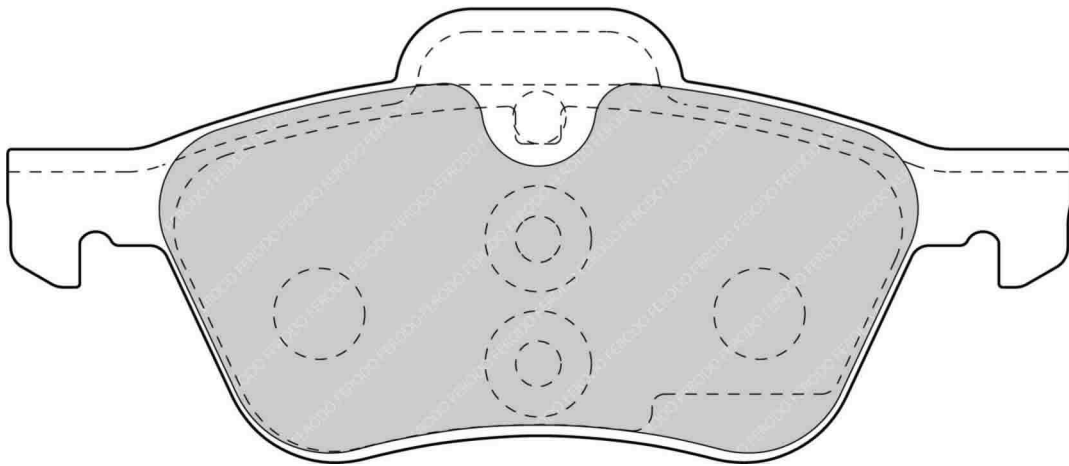
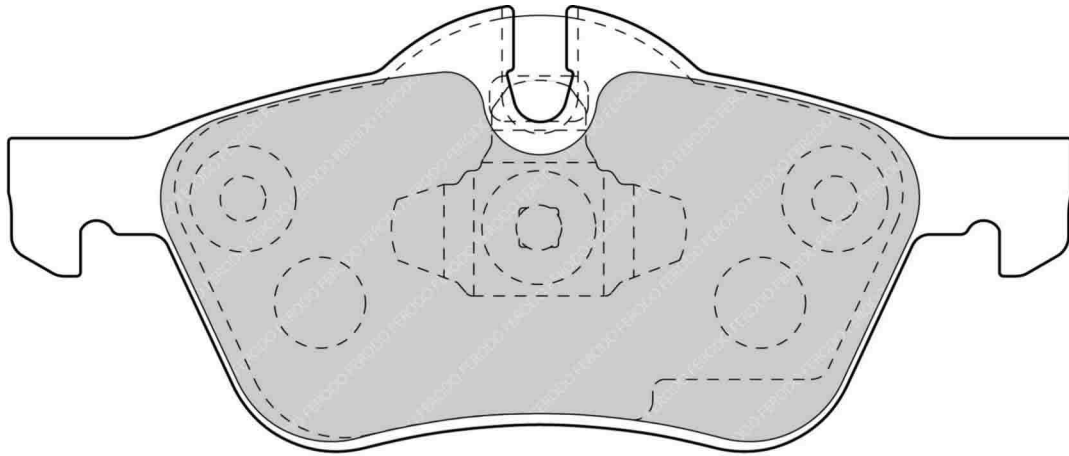

MATERIAL AVAILABILITY				
H	C	R	W	Z
✓		✓	✉	

CROSS REFERENCE	
BREMBO	07.8301.88
FMSI	D939
HAWK	HB444 0,685
MINTEX	MDB2162
WVA	23 281 18,00



# FCP1501



115.5mm = 4.547"  
95.0mm = 3.740"



39.0mm = 1.535"  
36.0mm = 1.417"



15.3mm = 0.602"  
15.4mm = 0.606"

WVA No: 23 497 15,40

**IMPORTANT NOTICE: Please note that the height measurement represents the radial depth, not the entire back plate**

DAIHATSU Front

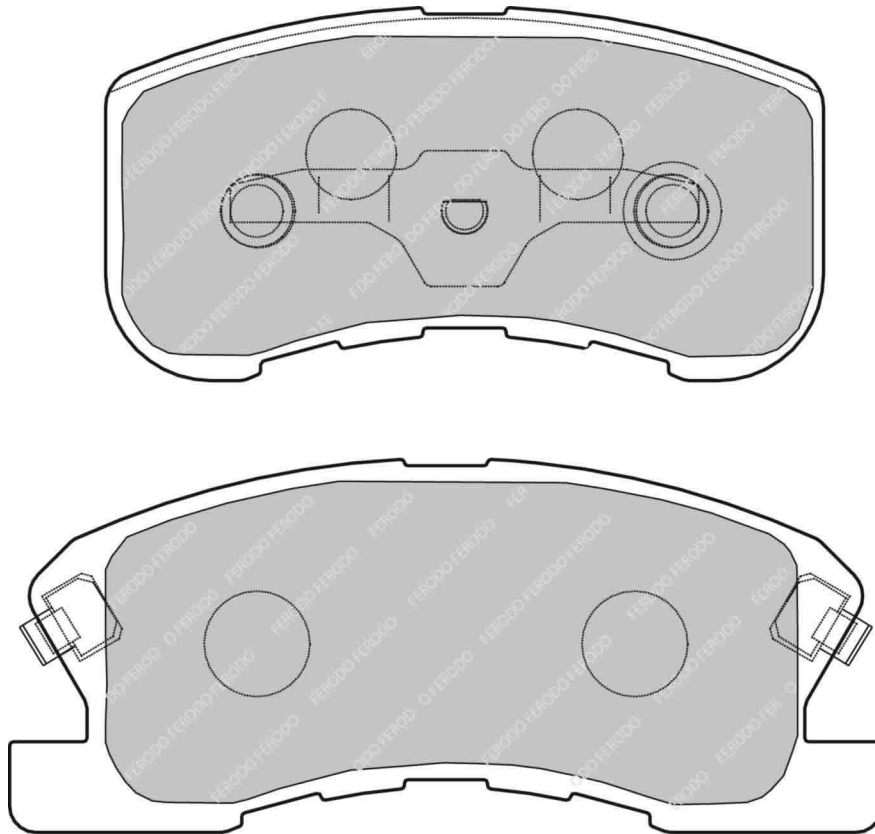

MATERIAL AVAILABILITY				
H	C	R	W	Z

CROSS REFERENCE	
MINTEX	MDB1910
WVA	23 497 15,40

Available    Exhausting  
 Not Available    Make to order  
 In Introduction

**FERODO**  
RACING

Updated on 30th Jan 2014

**3133**

# FCP1520



155.4mm = 6.118"  
156.6mm = 6.165"



59.7mm = 2.350"  
59.7mm = 2.350"



19.5mm = 0.768"  
19.5mm = 0.768"

WVA No: 23402 20,10 - 23403 20,1

**IMPORTANT NOTICE:** Please note that the height measurement represents the radial depth, not the entire back plate

CHEVROLET Front, FIAT Front, OPEL Front, SAAB Front, VAUXHALL Front

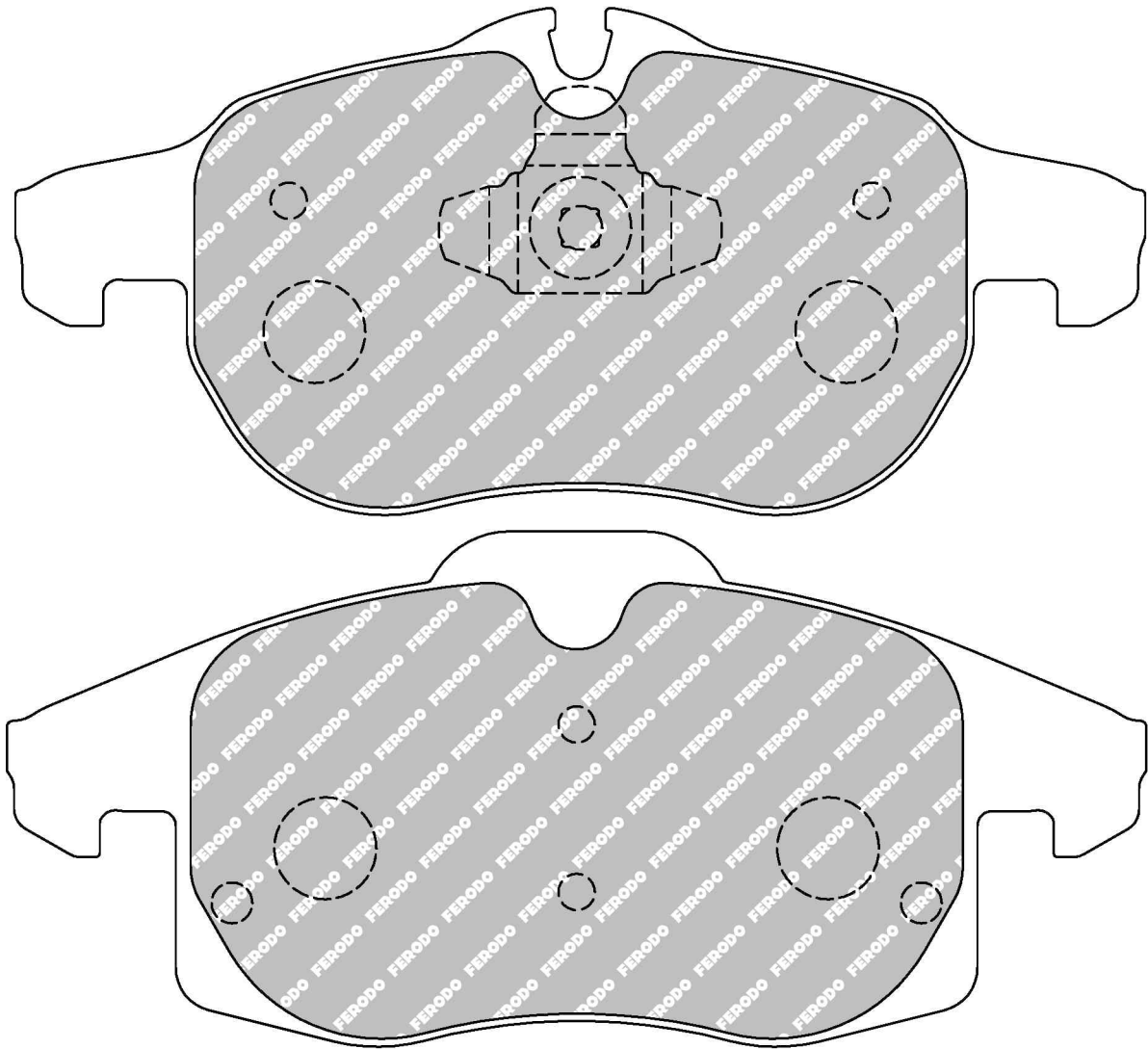

MATERIAL AVAILABILITY				
H	C	R	W	Z
✓				

CROSS REFERENCE	
WVA	23402 20,10 - 23403 20,1

# FCP1528

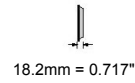
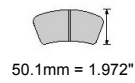

WVA No: 23 526 17,40

FMSI No: D817

**IMPORTANT NOTICE: Please note that the height measurement represents the radial depth, not the entire back plate**

TOYOTA Front

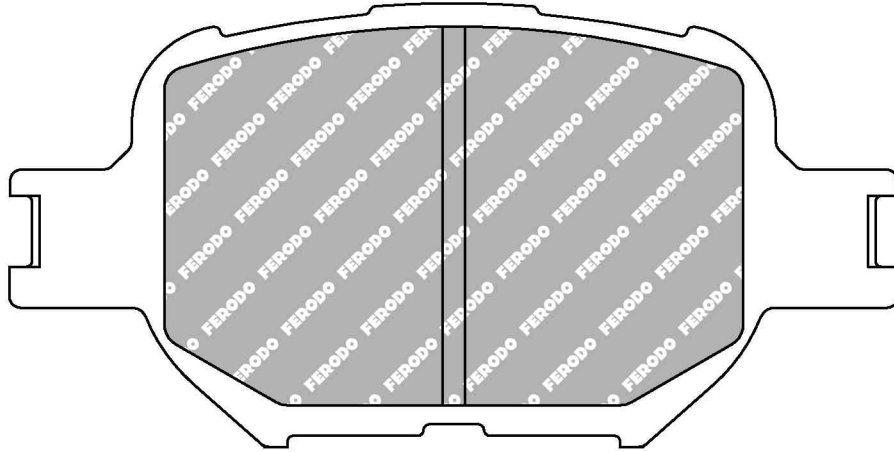

MATERIAL AVAILABILITY				
H	C	R	W	Z
✓		✓		

CROSS REFERENCE	
FMSI	D817
HAWK	HB328 0,685
MINTEX	MDB2013
MINTEX	MDB2291
WVA	23 526 17,40

✓ Available    ⚠ Exhausting  
 ✗ Not Available    ✉ Make to order  
 🔄 In Introduction



Updated on 30th Jan 2014

**3135**

# FCP1540

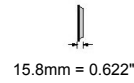
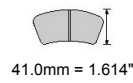
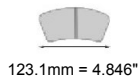

WVA No: 23 482 16,50

**IMPORTANT NOTICE: Please note that the height measurement represents the radial depth, not the entire back plate**

CHEVROLET Rear, FORD Rear, NISSAN Rear, OPEL Rear, RENAULT Rear, SAAB Rear, VAUXHALL Rear

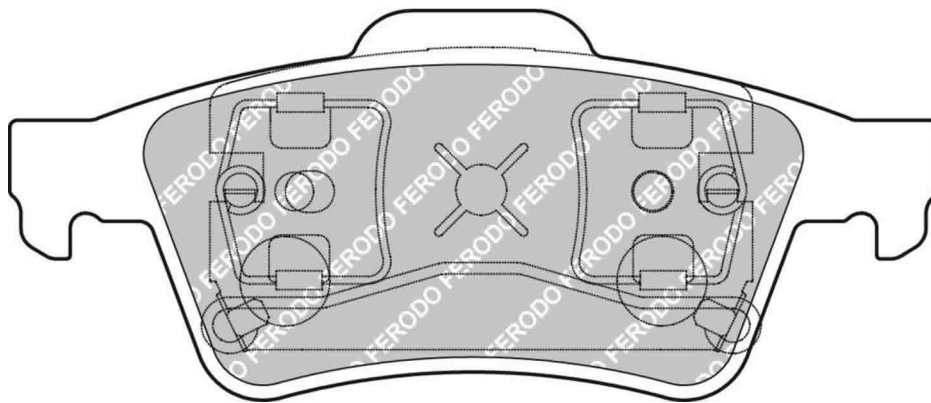
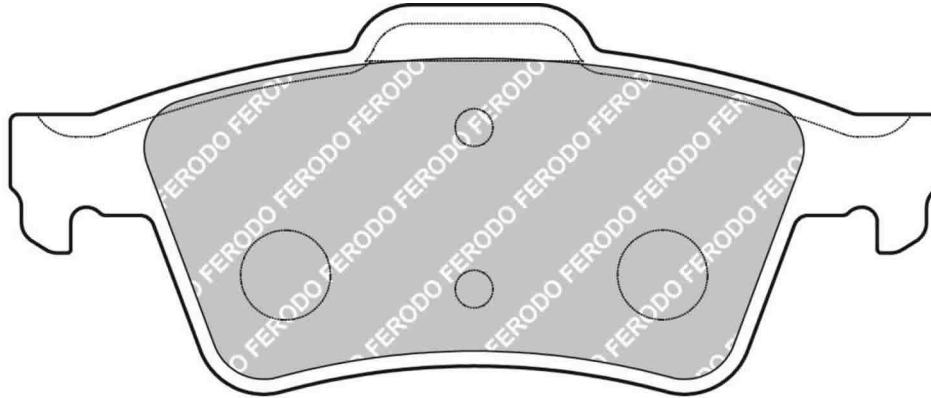

MATERIAL AVAILABILITY				
H	C	R	W	Z
✓				

CROSS REFERENCE	
MINTEX	MDB2210
MINTEX	MDB2281
WVA	23 482 16,50

# FCP1543



129.0mm = 5.079"



44.4mm = 1.748"





19.1mm = 0.752"

WVA No: 23 409 19,30

**IMPORTANT NOTICE: Please note that the height measurement represents the radial depth, not the entire back plate**

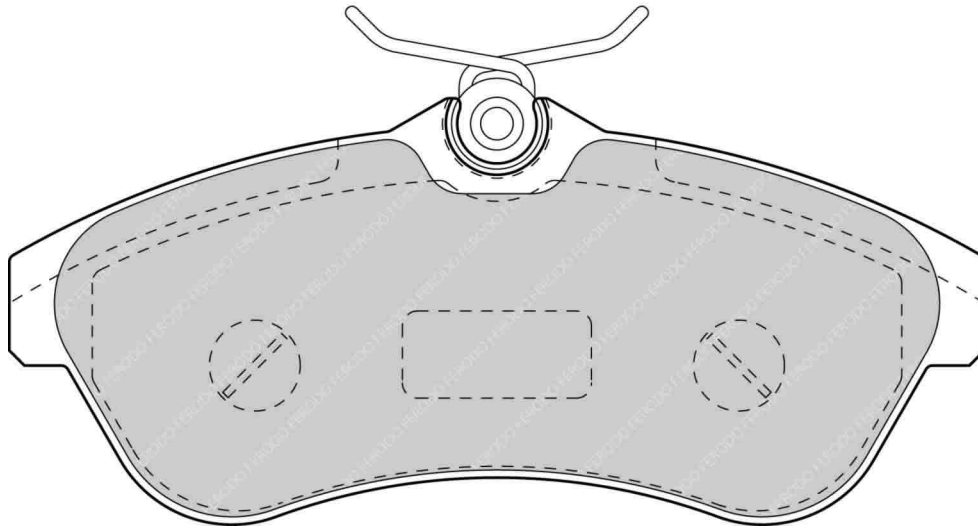
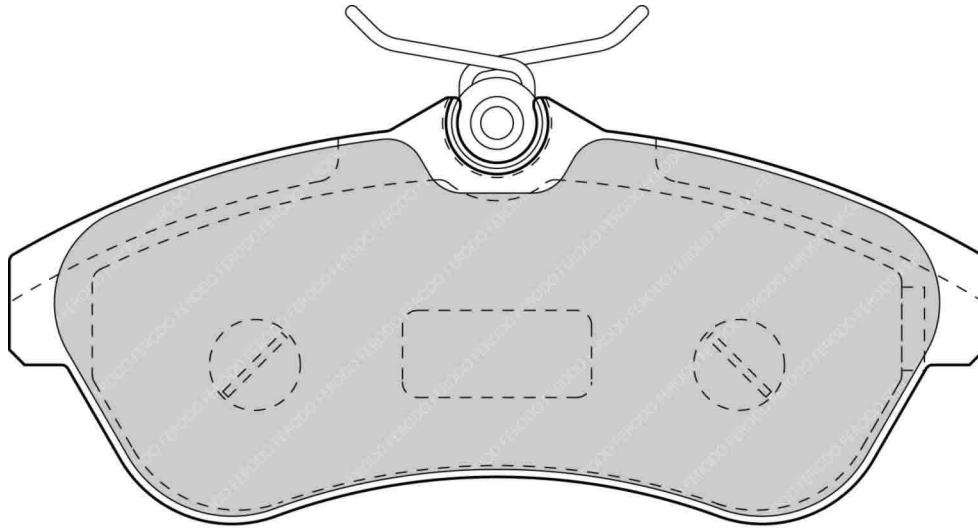
CITROEN Front



MATERIAL AVAILABILITY				
H	C	R	W	Z
				

CROSS REFERENCE	
BREMBO	07.8301.91
MINTEX	MDB2254
WVA	23 409 19,30

 Available   
  Exhausting  
 Not Available   
  Make to order  
 In Introduction

**FERODO**  
RACING

Updated on 30th Jan 2014

**3137**

# FCP1553

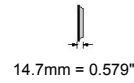
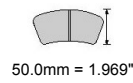
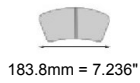

**IMPORTANT NOTICE:** Please note that the height measurement represents the radial depth, not the entire back plate

CHEVROLET Front, HOLDEN Front

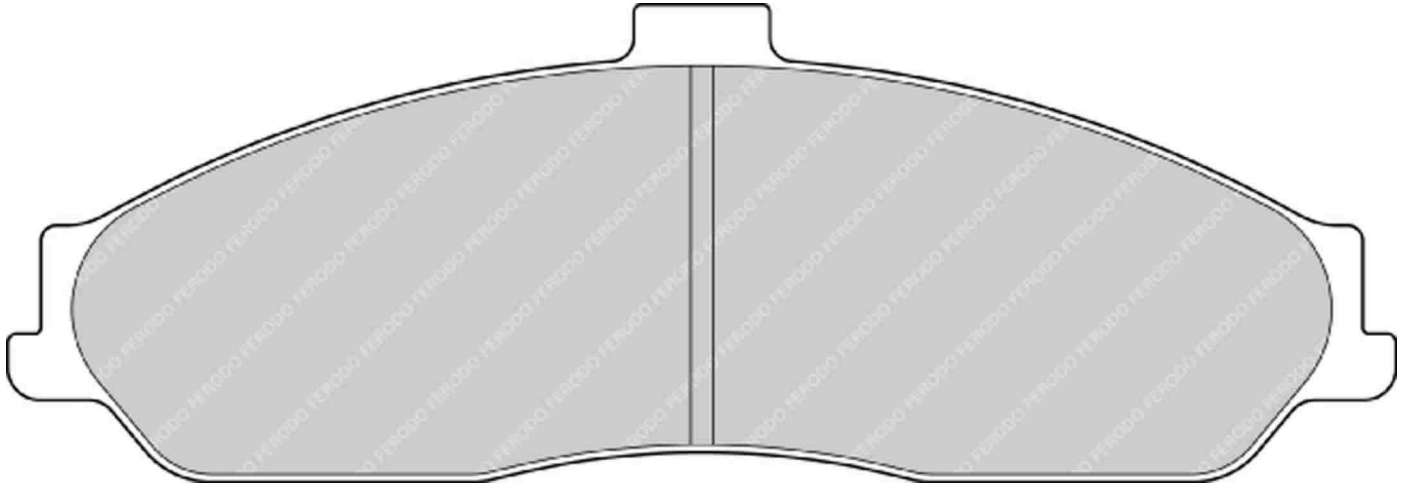

MATERIAL AVAILABILITY				
H	C	R	W	Z
✓		✉	✉	✉

CROSS REFERENCE	
PFC	0731

# FCP1560

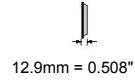
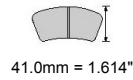
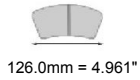

WVA No: 20 410 12,90

**IMPORTANT NOTICE:** Please note that the height measurement represents the radial depth, not the entire back plate

LOTUS Rear, OPEL Rear, VAUXHALL Rear

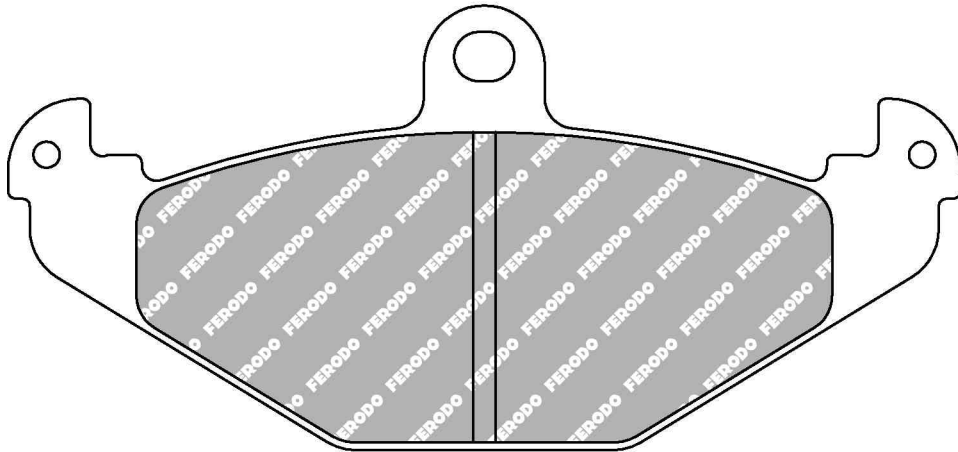

ALSO AVAILABLE		
SHAPE	TH. MM	NOTES
FCP878	14.6	

MATERIAL AVAILABILITY				
H	C	R	W	Z
✓		✉	✓	

CROSS REFERENCE	
AP RACING	CP3915D33
MINTEX	MDB1891
PAGID	1682
WVA	20 410 12,90

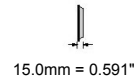
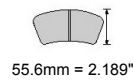

**IMPORTANT NOTICE: Please note that the height measurement represents the radial depth, not the entire back plate**

MINI Front, NISSAN Front

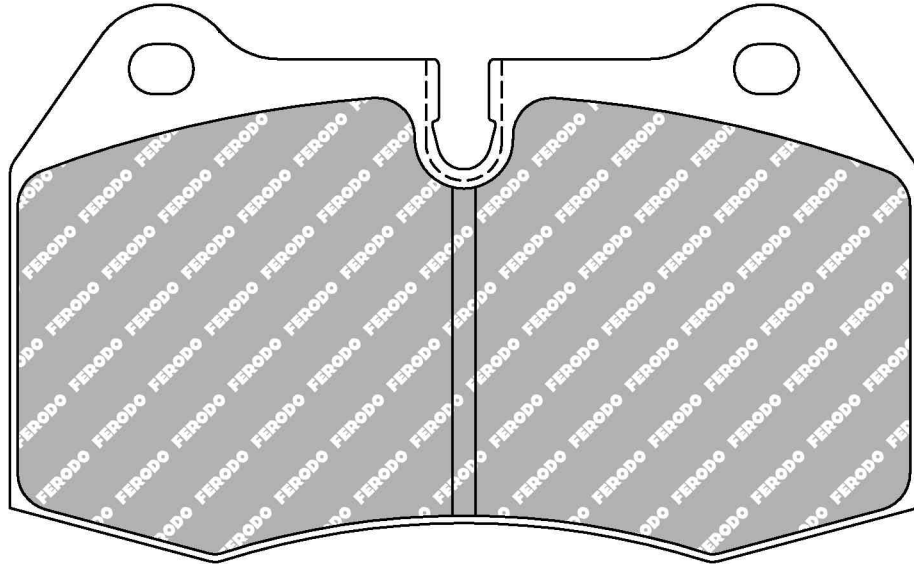

MATERIAL AVAILABILITY				
H	C	R	W	Z
✓		✓	✓	✓

CROSS REFERENCE	
CL BRAKES	4061
FMSI	D960
HAWK	HB545 0,564
MINTEX	MDB2341
PFC	0639
WVA	23 142 15,00

# FCP1562

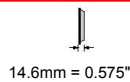
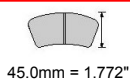
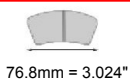

WVA No: 21 580 14,30 FMSI No: D961

**IMPORTANT NOTICE: Please note that the height measurement represents the radial depth, not the entire back plate**

LOTUS Front, MITSUBISHI Front / Rear, NISSAN Rear, OPEL Front, SUBARU Rear, VAUXHALL Front

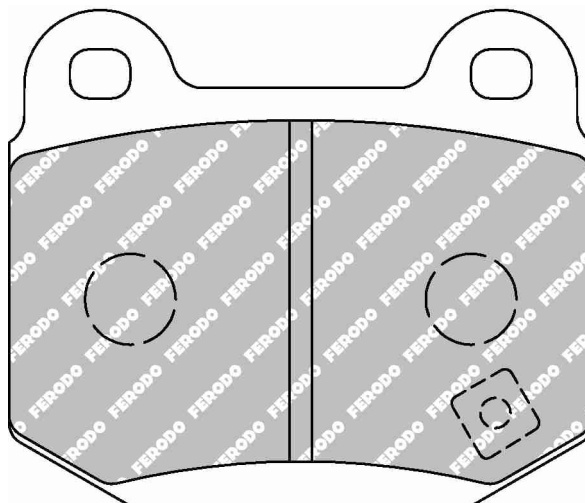

Replacing FCP1282

ALSO AVAILABLE		
SHAPE	TH. MM	NOTES
FCP116	16.5	

MATERIAL AVAILABILITY				
H	C	R	W	Z
✓		✓	✓	✓

CROSS REFERENCE	
ALCON	PNF0084X358.4
AP RACING	CP5119D50
BREMBO	07.5505.91
CL BRAKES	4060
FMSI	D961
HAWK	HB180 0,56
MINTEX	MDB2342
PAGID	1587
PAGID	2593
PFC	0109
WVA	21 580 14,30

# FCP1563

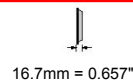
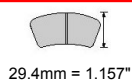

**IMPORTANT NOTICE: Please note that the height measurement represents the radial depth, not the entire back plate**

CHEVROLET Rear

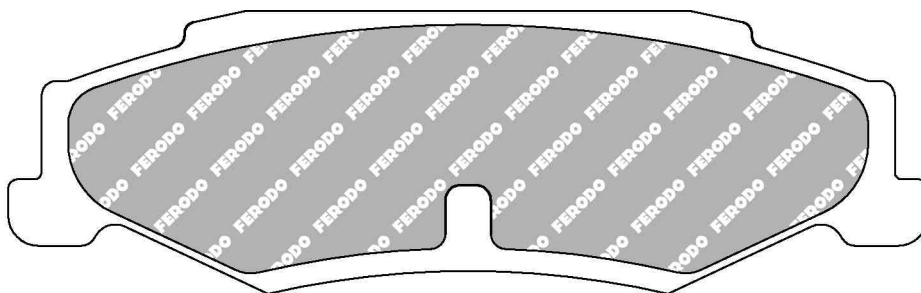

MATERIAL AVAILABILITY				
H	C	R	W	Z
☒			☒	☒

CROSS REFERENCE	
PFC	0732



# FCP1568



156.5mm = 6.161"  
156.5mm = 6.161"



53.5mm = 2.106"  
53.5mm = 2.106"



17.8mm = 0.701"  
18.2mm = 0.717"

FMSI No: D970

**IMPORTANT NOTICE:** Please note that the height measurement represents the radial depth, not the entire back plate

FORD Front, MERCEDES Rear

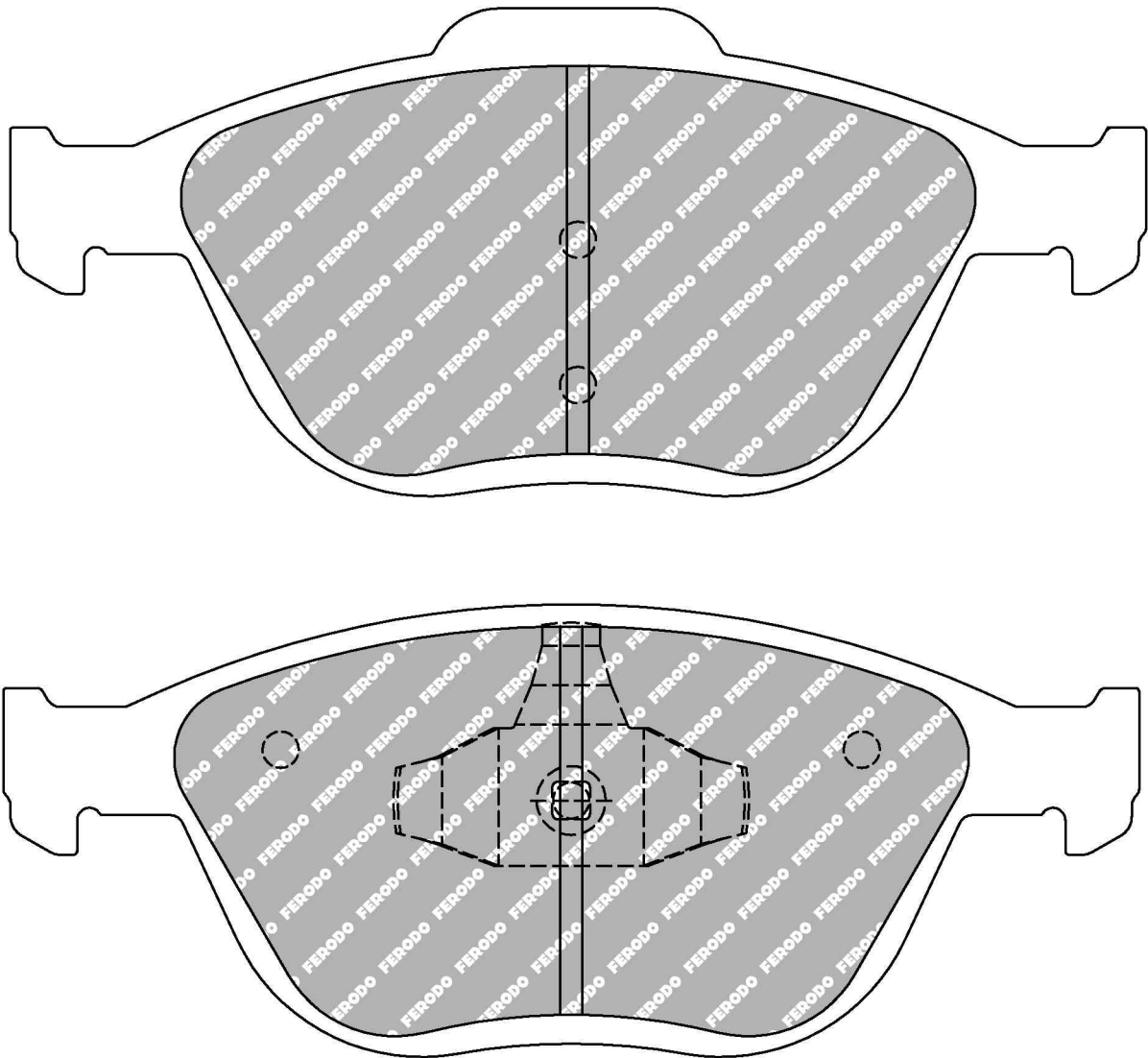

MATERIAL AVAILABILITY				
H	C	R	W	Z
✓		✓		

CROSS REFERENCE	
BREMBO	07.8301.92
FMSI	D970
HAWK	HB449 0,679

✓ Available    ⚠ Exhausting  
 ✗ Not Available    📦 Make to order  
 🚧 In Introduction

**FERODO**  
RACING

Updated on 30th Jan 2014

**3141**

# FCP1573



131.7mm = 5.185"



48.0mm = 1.890"



17.5mm = 0.689"

WVA No: 23 766 17,50

**IMPORTANT NOTICE: Please note that the height measurement represents the radial depth, not the entire back plate**

TOYOTA Front

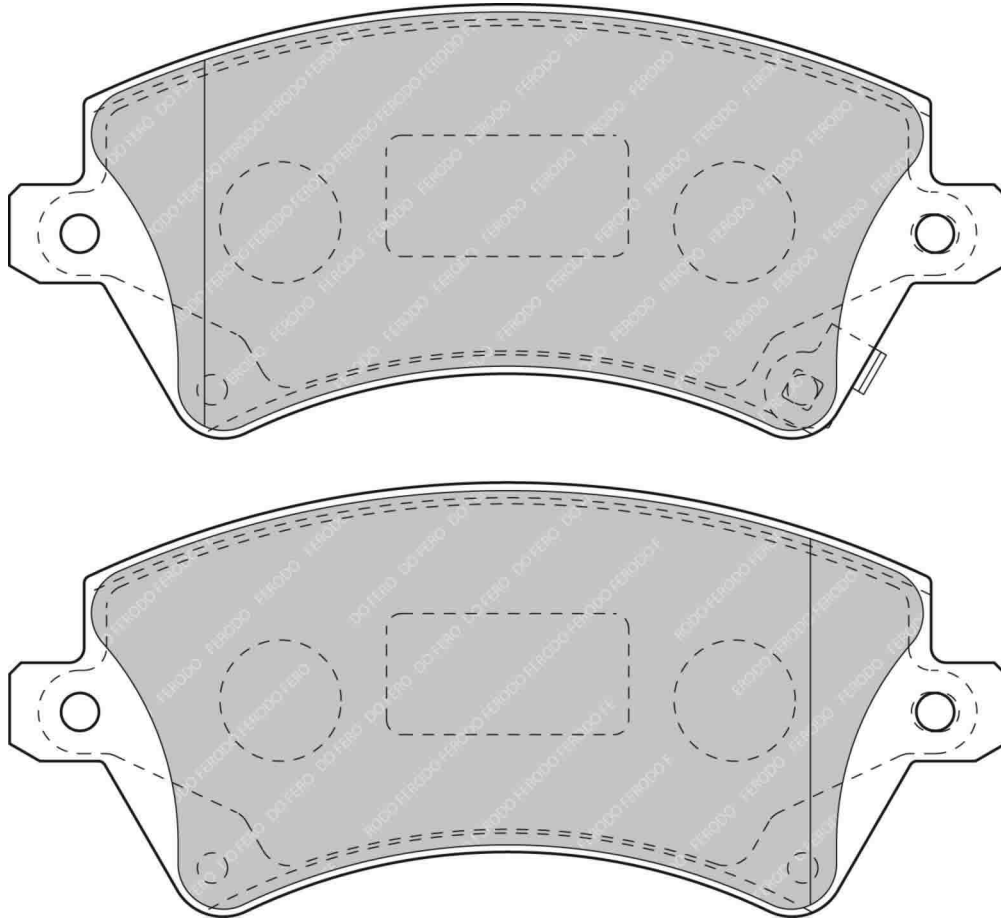

MATERIAL AVAILABILITY				
H	C	R	W	Z
✓				

CROSS REFERENCE	
BREMBO	07.8301.89
MINTEX	MDB2257
WVA	23 766 17,50

# FCP1617



116.4mm = 4.583"



47.0mm = 1.850"



17.5mm = 0.689"

WVA No: 23 973 16,80

**IMPORTANT NOTICE: Please note that the height measurement represents the radial depth, not the entire back plate**

NISSAN Front, RENAULT Front, SUZUKI Front

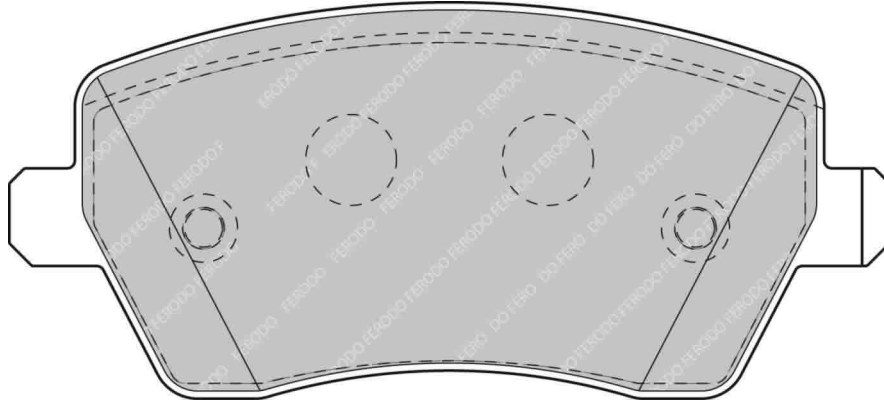

MATERIAL AVAILABILITY				
H	C	R	W	Z
		✓	✚	✚

CROSS REFERENCE	
MINTEX	MDB2595
WVA	23 973 16,80

✓ Available    ⚠ Exhausting  
 ✗ Not Available    ✉ Make to order  
 🚧 In Introduction

**FERODO**  
RACING

Updated on 30th Jan 2014

**3143**

# FCP1625

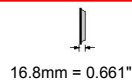
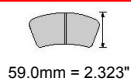
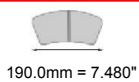

WVA No: 23 692

**IMPORTANT NOTICE: Please note that the height measurement represents the radial depth, not the entire back plate**

PORSCHE Front, VOLKSWAGEN Front

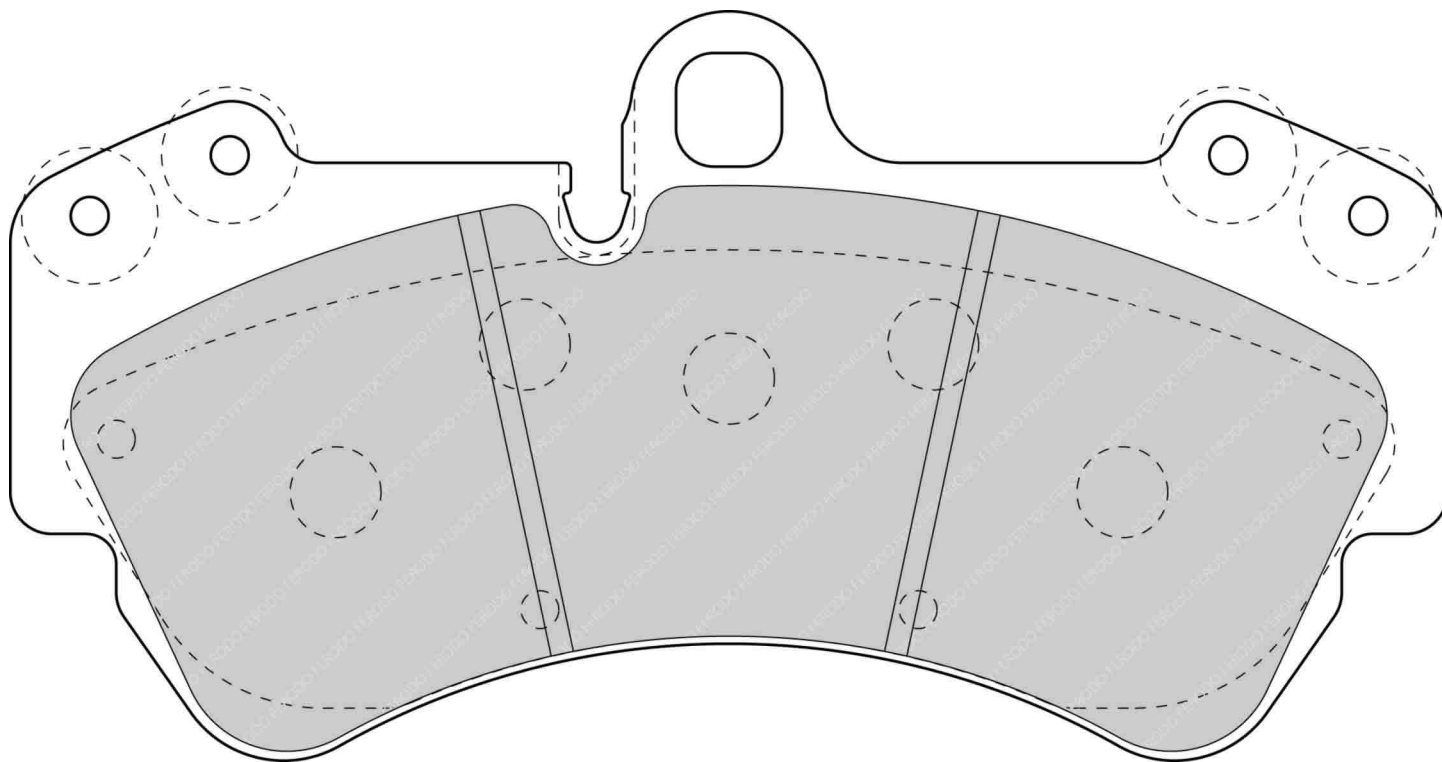

MATERIAL AVAILABILITY				
H	C	R	W	Z
✓				

CROSS REFERENCE	
OE PORSCHE	955.351.939.00 / .01 / .02
OE VOLKSWAGEN	7L0698151 / B / D / H
OE VOLKSWAGEN	7L6698151 / C
WVA	23 692

# FCP1626

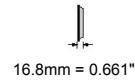
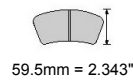
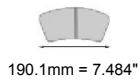

WVA No: 23 693 16,20

**IMPORTANT NOTICE: Please note that the height measurement represents the radial depth, not the entire back plate**

AUDI Front, PORSCHE Front, VOLKSWAGEN Front

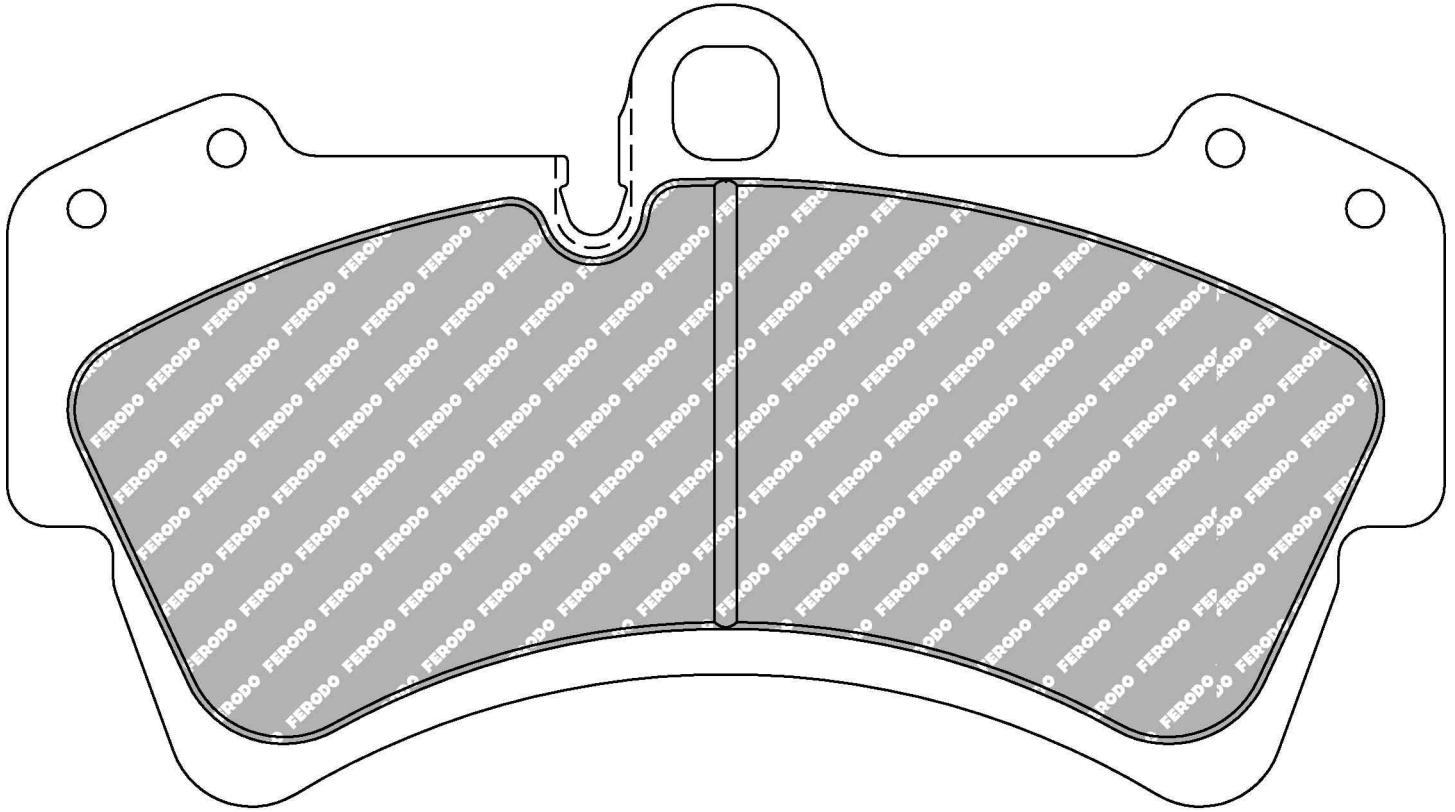

MATERIAL AVAILABILITY				
H	C	R	W	Z
✓				

CROSS REFERENCE	
MINTEX	MDB2751
PAGID	2845
WVA	23 693 16,20

- ✓ Available
- ✗ Not Available
- ⚠ Exhausting
- ✉ Make to order
- 🔵 In Introduction



Updated on 30th Jan 2014

**3145**

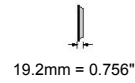
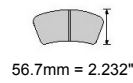
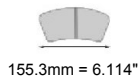

**IMPORTANT NOTICE: Please note that the height measurement represents the radial depth, not the entire back plate**

BMW Front

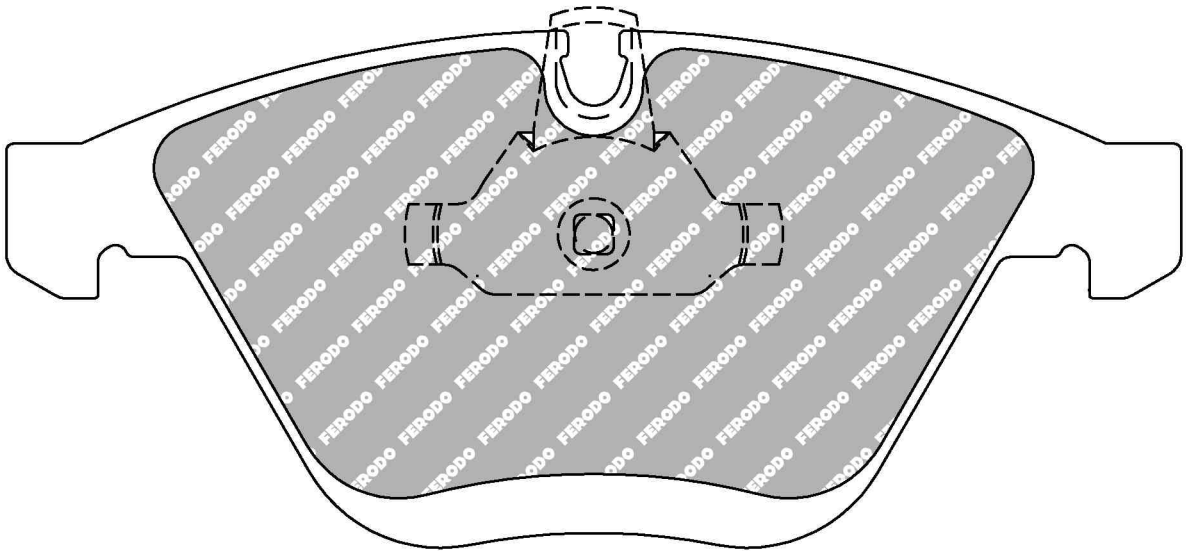
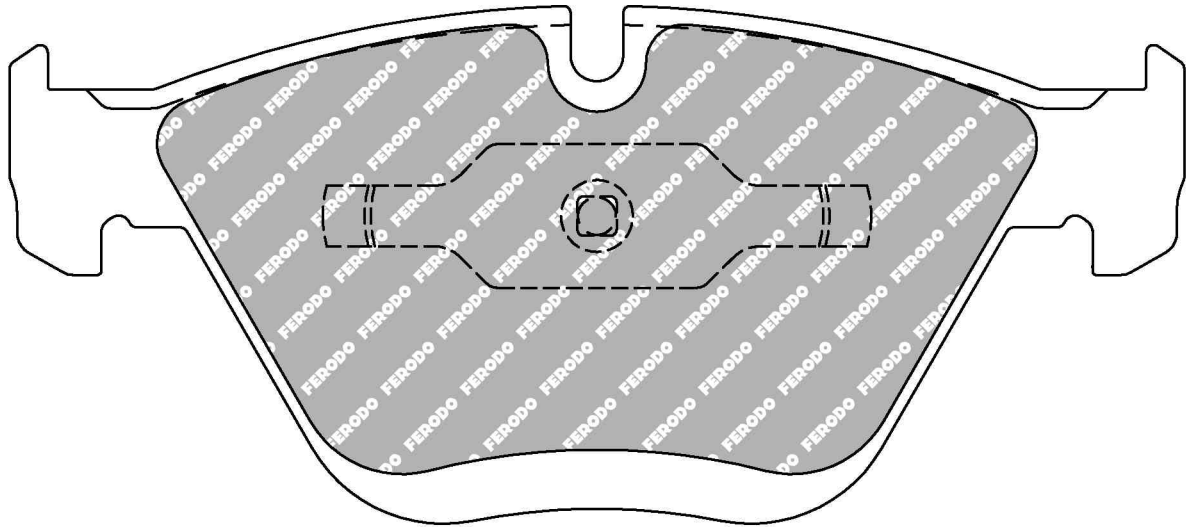

MATERIAL AVAILABILITY				
H	C	R	W	Z
✓		✉	✓	✓

CROSS REFERENCE	
FMSI	D918
MINTEX	MDB2418
WVA	23 312 20,30

# FCP1629



155.3mm = 6.114"  
156.5mm = 6.161"



64.4mm = 2.535"  
64.4mm = 2.535"



20.3mm = 0.799"  
20.3mm = 0.799"

WVA No: 23 762 20,2

**IMPORTANT NOTICE:** Please note that the height measurement represents the radial depth, not the entire back plate

AUDI Front

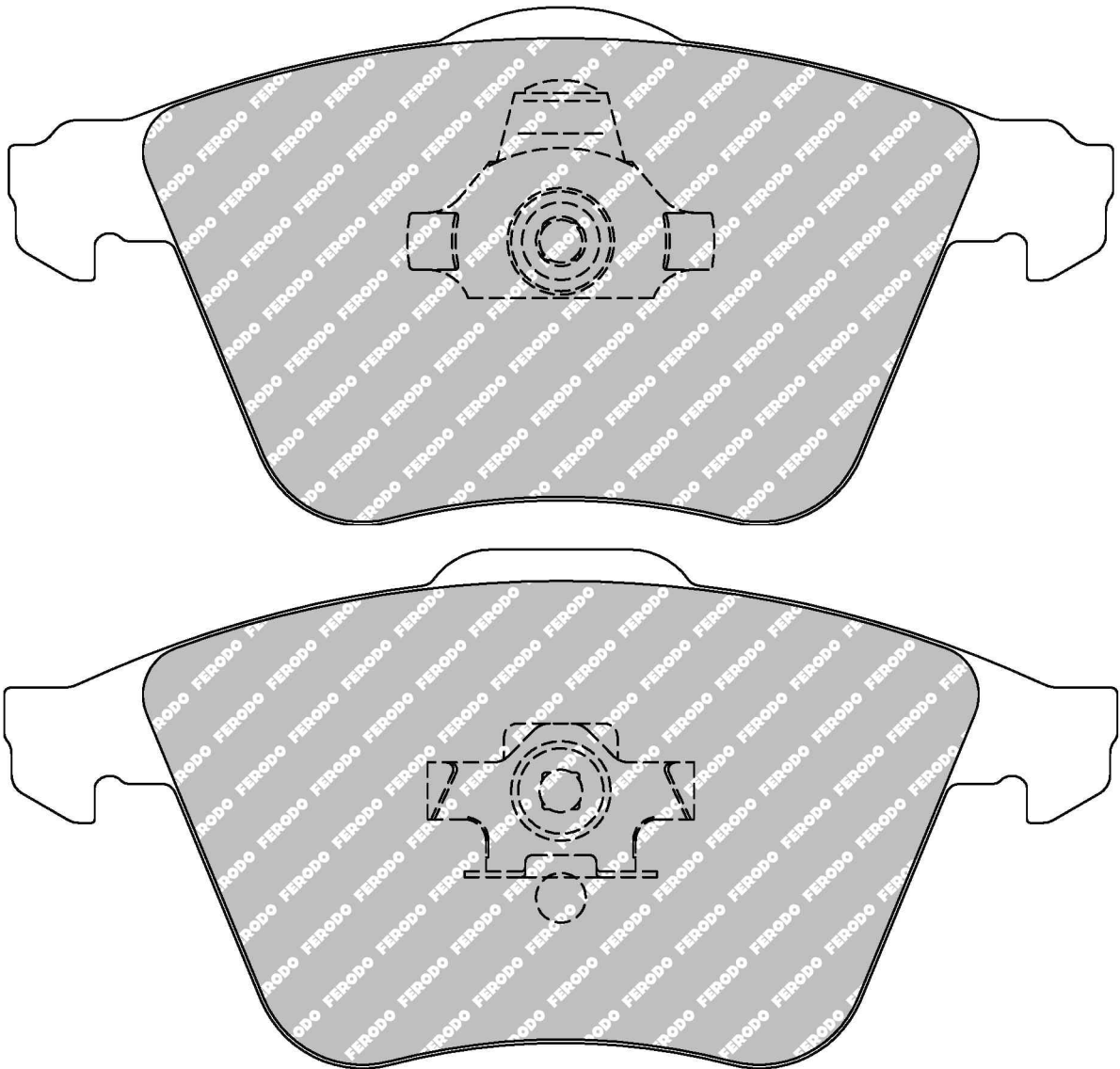

MATERIAL AVAILABILITY				
H	C	R	W	Z
✓				

CROSS REFERENCE	
MINTEX	MDB2694
PAGID	2275
PAGID	8021
WVA	23 762 20,2

✓ Available    ⚠ Exhausting  
 ✗ Not Available    📧 Make to order  
 📅 In Introduction

**FERODO**  
RACING

Updated on 30th Jan 2014

**3147**

# FCP1631



155.3mm = 6.114"  
156.4mm = 6.157"



65.0mm = 2.559"  
65.0mm = 2.559"



19.8mm = 0.780"  
18.3mm = 0.720"

WVA No: 24 142 20,6 - 24 141 19,1

**IMPORTANT NOTICE:** Please note that the height measurement represents the radial depth, not the entire back plate

VOLVO Front

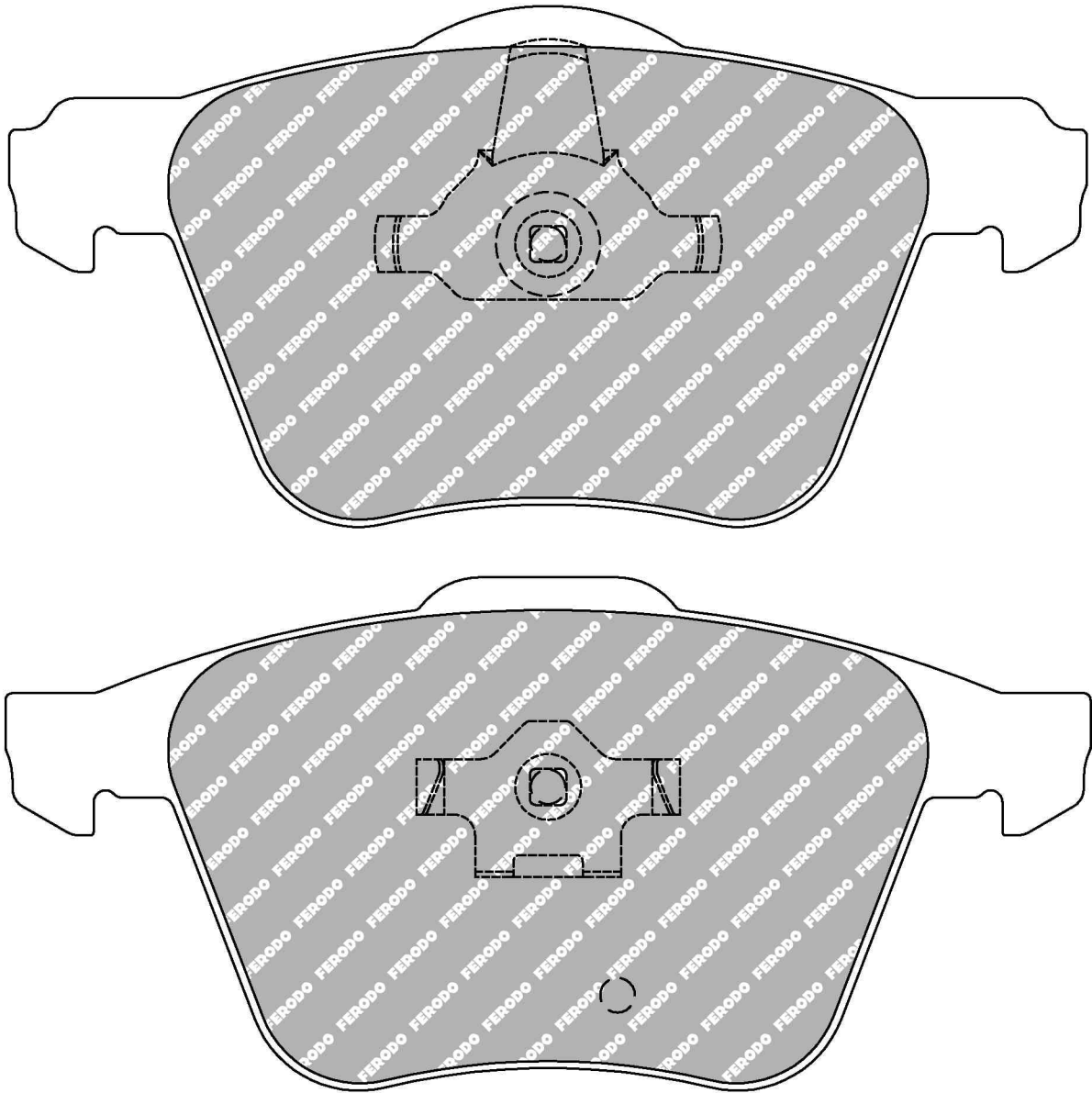

MATERIAL AVAILABILITY				
H	C	R	W	Z

CROSS REFERENCE	
WVA	24 142 20,6 - 24 141 19,1

3148

**FERODO**  
RACING

Updated on 30th Jan 2014

Available   
 Exhausting  
 Not Available   
 Make to order  
 In Introduction



# FCP1636

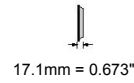
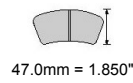
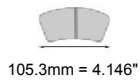

WVA No: 23 914 16,90

FMSI No: D1108

**IMPORTANT NOTICE: Please note that the height measurement represents the radial depth, not the entire back plate**

AUDI Rear, SEAT Rear, SKODA Rear, VOLKSWAGEN Rear

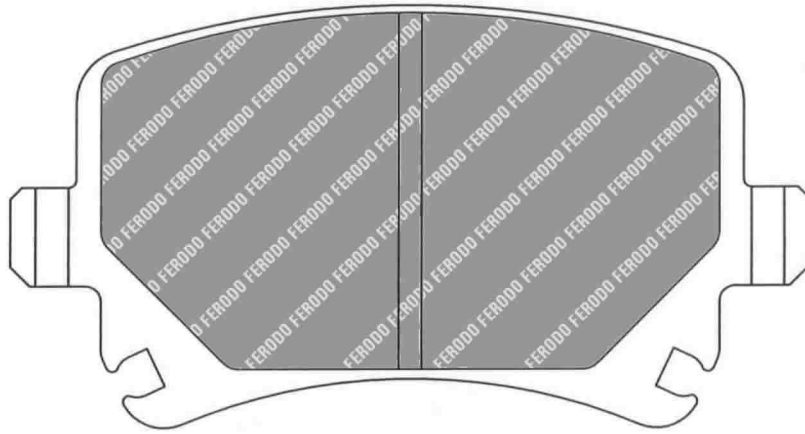

MATERIAL AVAILABILITY				
H	C	R	W	Z
✓				

CROSS REFERENCE	
ALCON	PNF0084X363.4
FMSI	D1108
HAWK	HB544 0,628
MINTEX	MDB2580
WVA	23 914 16,90

# FCP1639

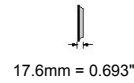
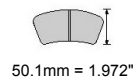

FMSI No: D929

**IMPORTANT NOTICE: Please note that the height measurement represents the radial depth, not the entire back plate**

SCION Front, SUBARU Front, TOYOTA Front

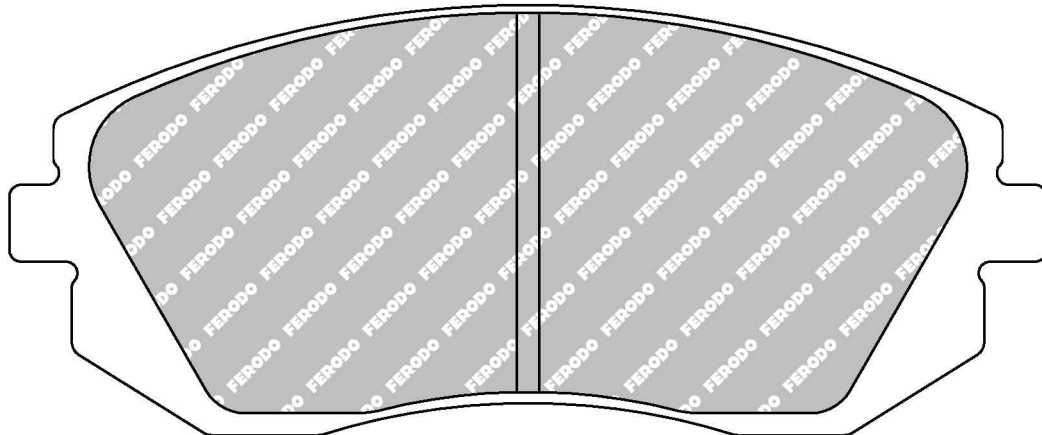

MATERIAL AVAILABILITY				
H	C	R	W	Z
✓			✉	

CROSS REFERENCE	
FMSI	D929
HAWK	HB432 0,661

- ✓ Available    ⚠ Exhausting
- ✗ Not Available    ✉ Make to order
- 🔵 In Introduction



Updated on 30th Jan 2014

**3149**

# FCP1641



156.5mm = 6.161"  
155.2mm = 6.110"



61.0mm = 2.402"  
61.0mm = 2.402"



19.4mm = 0.764"  
19.4mm = 0.764"

WVA No: 23 587 20,30

FMSI No: D1107

**IMPORTANT NOTICE: Please note that the height measurement represents the radial depth, not the entire back plate**

AUDI Front, CITROEN Front, PEUGEOT Front, SEAT Front, SKODA Front, VOLKSWAGEN Front

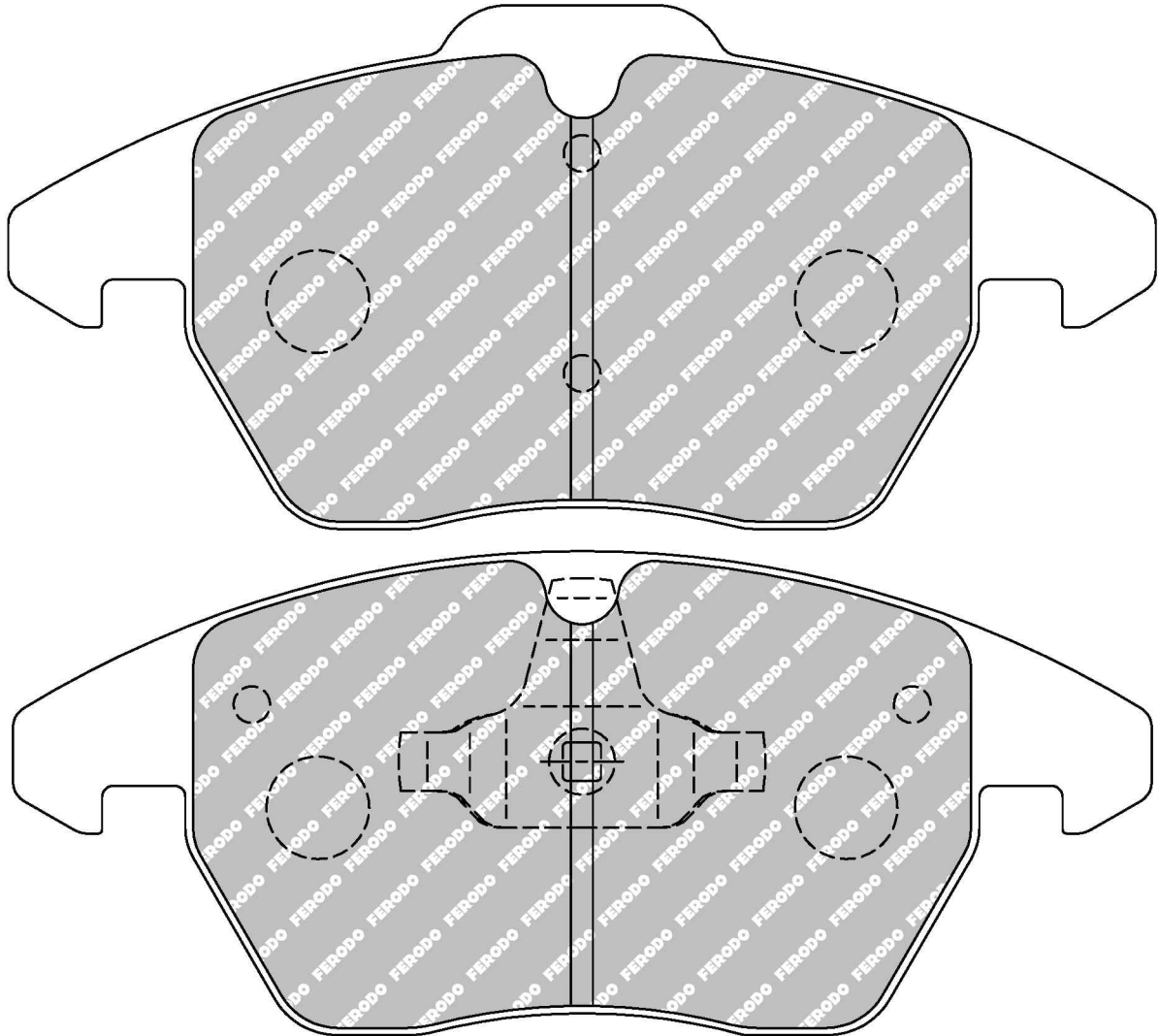

MATERIAL AVAILABILITY				
H	C	R	W	Z
✓		✉	✓	✓

CROSS REFERENCE	
FMSI	D1107
HAWK	HB543 0,76
MINTEX	MDB2604
PAGID	8001
WVA	23 587 20,30

# FCP1655

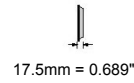
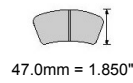
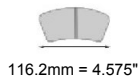

WVA No: 23 326

FMSI No: D1018

**IMPORTANT NOTICE: Please note that the height measurement represents the radial depth, not the entire back plate**

AUDI Rear

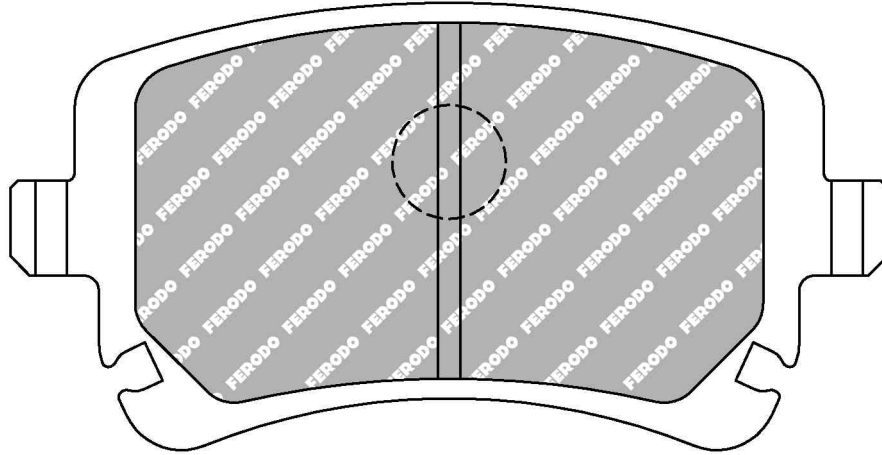

MATERIAL AVAILABILITY				
H	C	R	W	Z
✓				

CROSS REFERENCE	
FMSI	D1018
WVA	23 326

# FCP1661

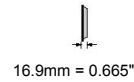
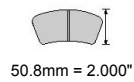
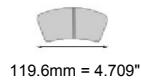

WVA No: 23 745-23 271 17,7

FMSI No: D847

**IMPORTANT NOTICE: Please note that the height measurement represents the radial depth, not the entire back plate**

MERCEDES Front

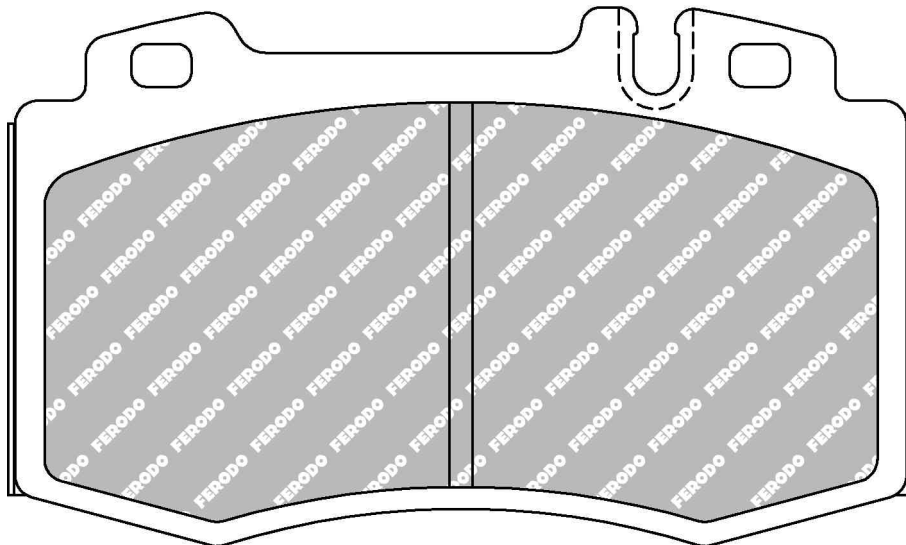

MATERIAL AVAILABILITY				
H	C	R	W	Z
✓				

CROSS REFERENCE	
FMSI	D847
WVA	23 745-23 271 17,7

- ✓ Available
- ✗ Not Available
- ⚠ Exhausting
- ✉ Make to order
- 🔵 In Introduction

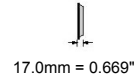
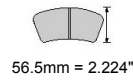

**IMPORTANT NOTICE: Please note that the height measurement represents the radial depth, not the entire back plate**

AUDI Front

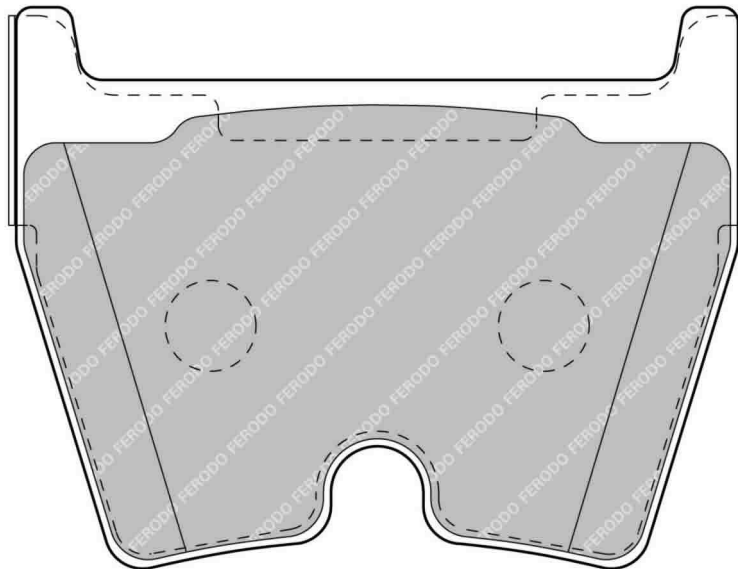
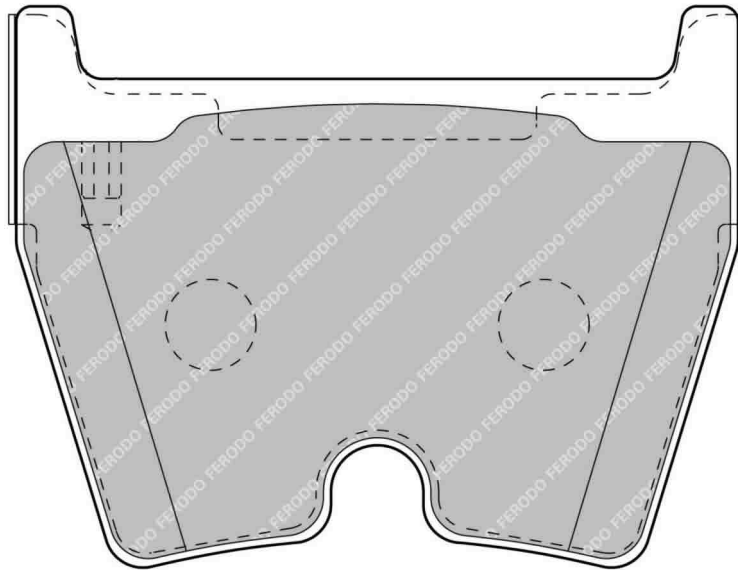

4 Pistons caliper

(1 set = 4 pads) - 2 sets per axle for the recommended applications

MATERIAL AVAILABILITY				
H	C	R	W	Z
✓		✓	✓	

CROSS REFERENCE	
BREMBO	07.9312.44
BREMBO	07.9312.45
BREMBO	07.9312.46
BREMBO	07.9312.47
HAWK	HB609 0,572
MINTEX	MDB2601
PAGID	2931
WVA	23 764 17,00

# FCP1667



124.8mm = 4.913"



52.1mm = 2.051"



15.5mm = 0.610"

WVA No: 24 764 17,00

**IMPORTANT NOTICE: Please note that the height measurement represents the radial depth, not the entire back plate**

ALFA ROMEO Front, FIAT Front, OPEL Front, RENAULT Front

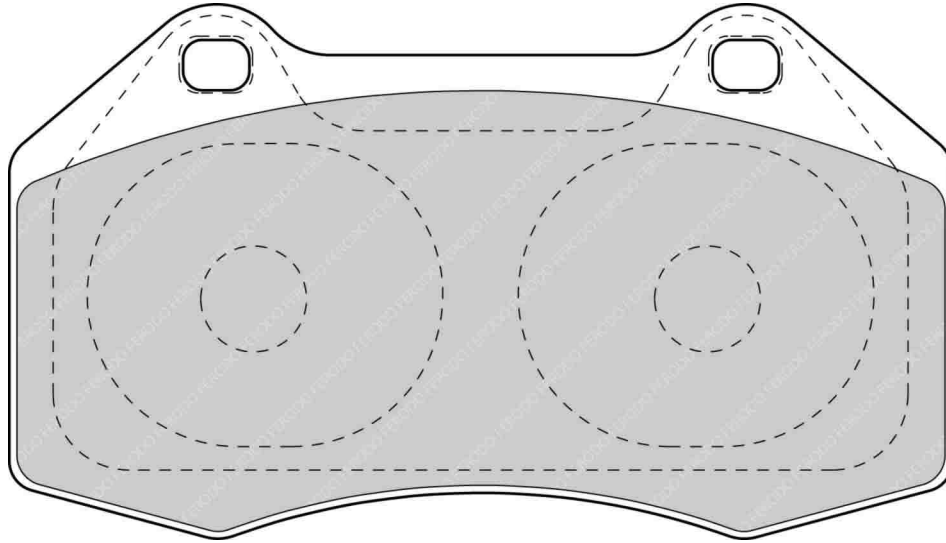

MATERIAL AVAILABILITY				
H	C	R	W	Z
✓		✓	✓	✓

CROSS REFERENCE	
MINTEX	MDB2725
PAGID	8023
PFC	7871-07-16-44
WVA	24 764 17,00

✓ Available    ⚠ Exhausting  
✗ Not Available    ✉ Make to order  
🔵 In Introduction

**FERODO**  
RACING

Updated on 30th Jan 2014

**3153**

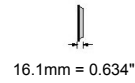
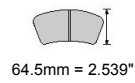

**IMPORTANT NOTICE: Please note that the height measurement represents the radial depth, not the entire back plate**

BMW Rear

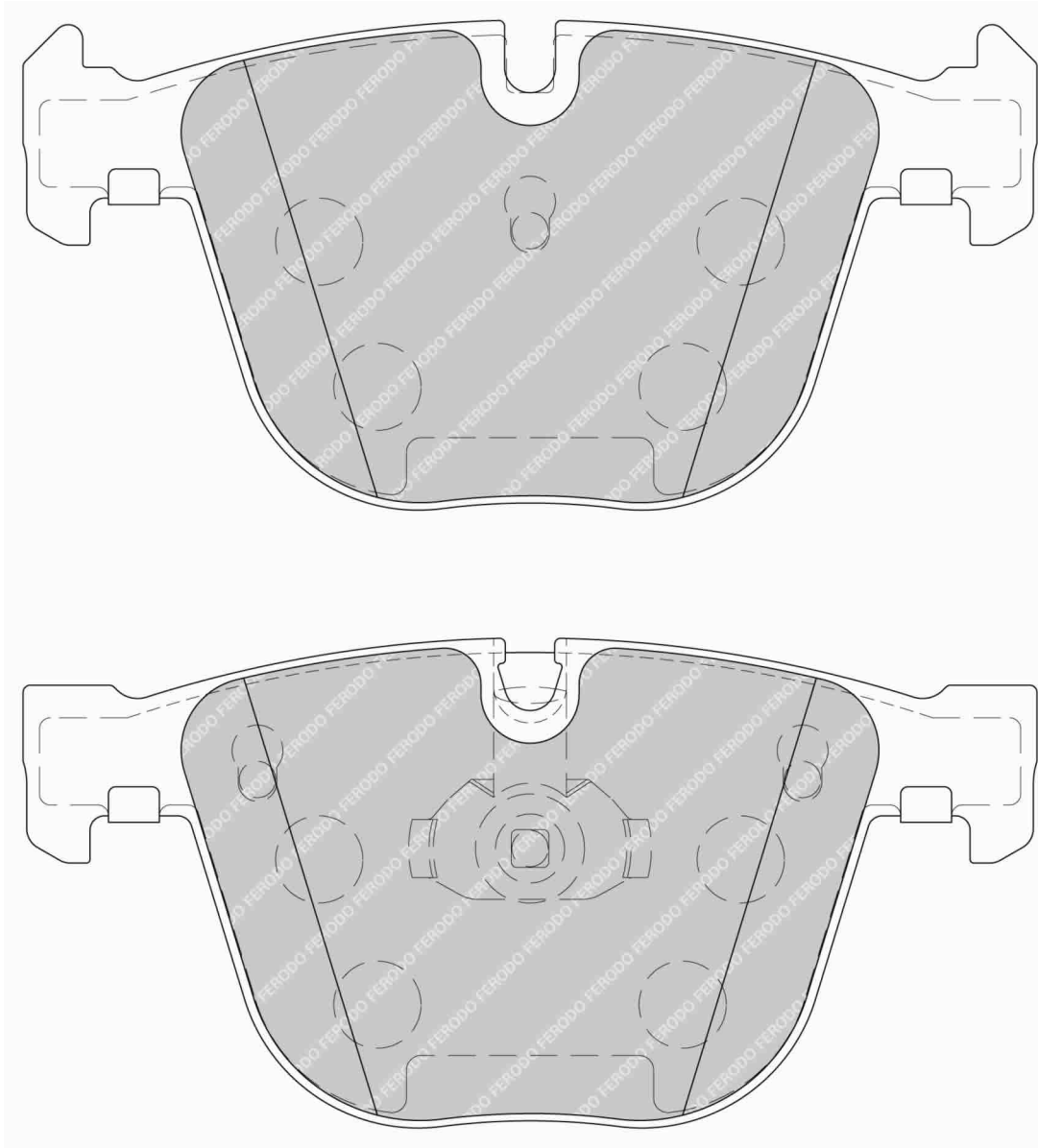

MATERIAL AVAILABILITY				
H	C	R	W	Z
✓			✉	✓

CROSS REFERENCE	
FMSI	D919
MINTEX	MDB2419
WVA	23 309 17,00

# FCP1676



123.2mm = 4.850"



32.5mm = 1.280"



15.9mm = 0.626"

WVA No: 23 716 16,40

FMSI No: D940

**IMPORTANT NOTICE: Please note that the height measurement represents the radial depth, not the entire back plate**

MINI Rear

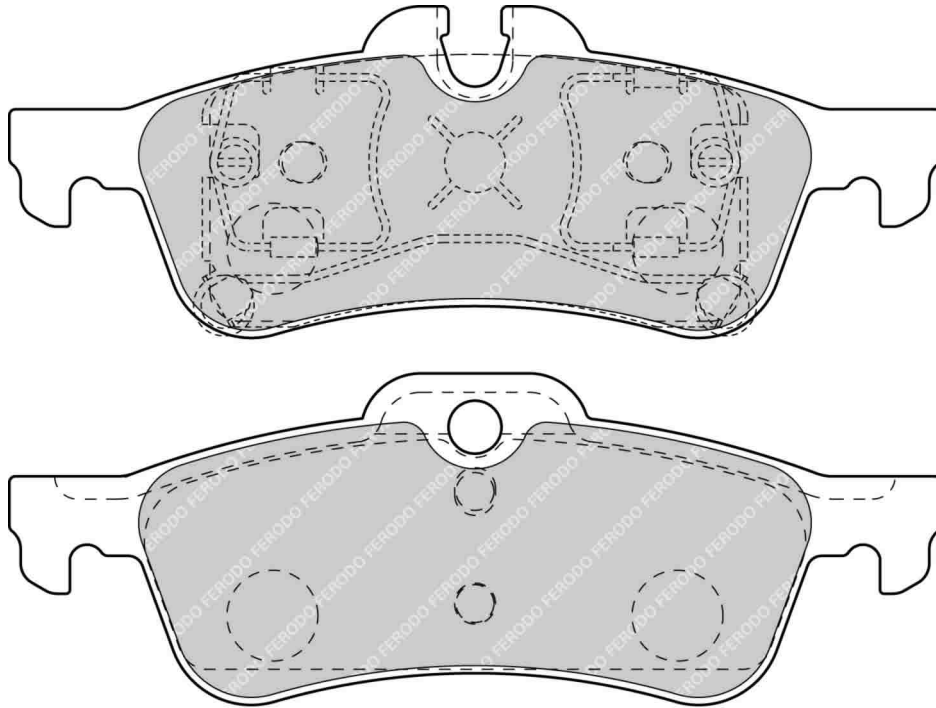

Replacing FCP1500

MATERIAL AVAILABILITY				
H	C	R	W	Z
✓				

CROSS REFERENCE	
BREMBO	07.8301.21
FMSI	D940
HAWK	HB445 0,61
MINTEX	MDB2639
WVA	23 716 16,40

✓ Available    ⚠ Exhausting  
 ✗ Not Available    📧 Make to order  
 🔄 In Introduction

**FERODO**  
RACING

Updated on 30th Jan 2014

**3155**

# FCP1690

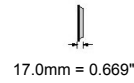
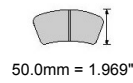

FMSI No: D888

**IMPORTANT NOTICE: Please note that the height measurement represents the radial depth, not the entire back plate**

INFINITI Front, NISSAN Front

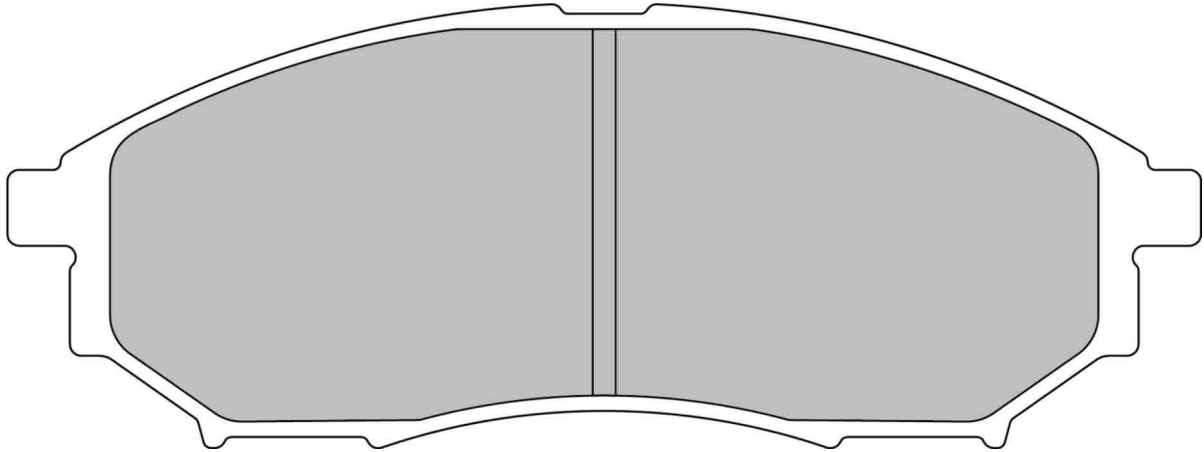

MATERIAL AVAILABILITY				
H	C	R	W	Z
✓				

CROSS REFERENCE	
FMSI	D888
HAWK	HB387 0,547

# FCP1693

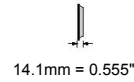
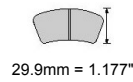
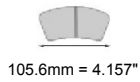

WVA No: 23 871 14,00

FMSI No: D905

**IMPORTANT NOTICE: Please note that the height measurement represents the radial depth, not the entire back plate**

INFINITI Rear, NISSAN Rear

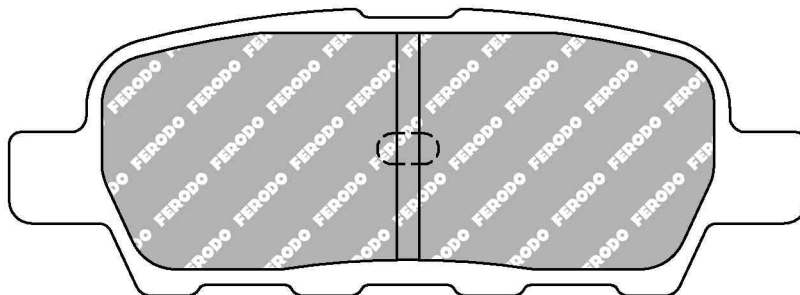

MATERIAL AVAILABILITY				
H	C	R	W	Z
✓				

CROSS REFERENCE	
FMSI	D905
HAWK	HB370 0,559
MINTEX	MDB2261
WVA	23 871 14,00



# FCP1706

155.3mm = 6.114"  
156.5mm = 6.161"

64.4mm = 2.535"  
64.4mm = 2.535"

18.0mm = 0.709"  
18.0mm = 0.709"

WVA No: 23 912 18,50

**IMPORTANT NOTICE:** Please note that the height measurement represents the radial depth, not the entire back plate

FORD Front, VOLVO Front

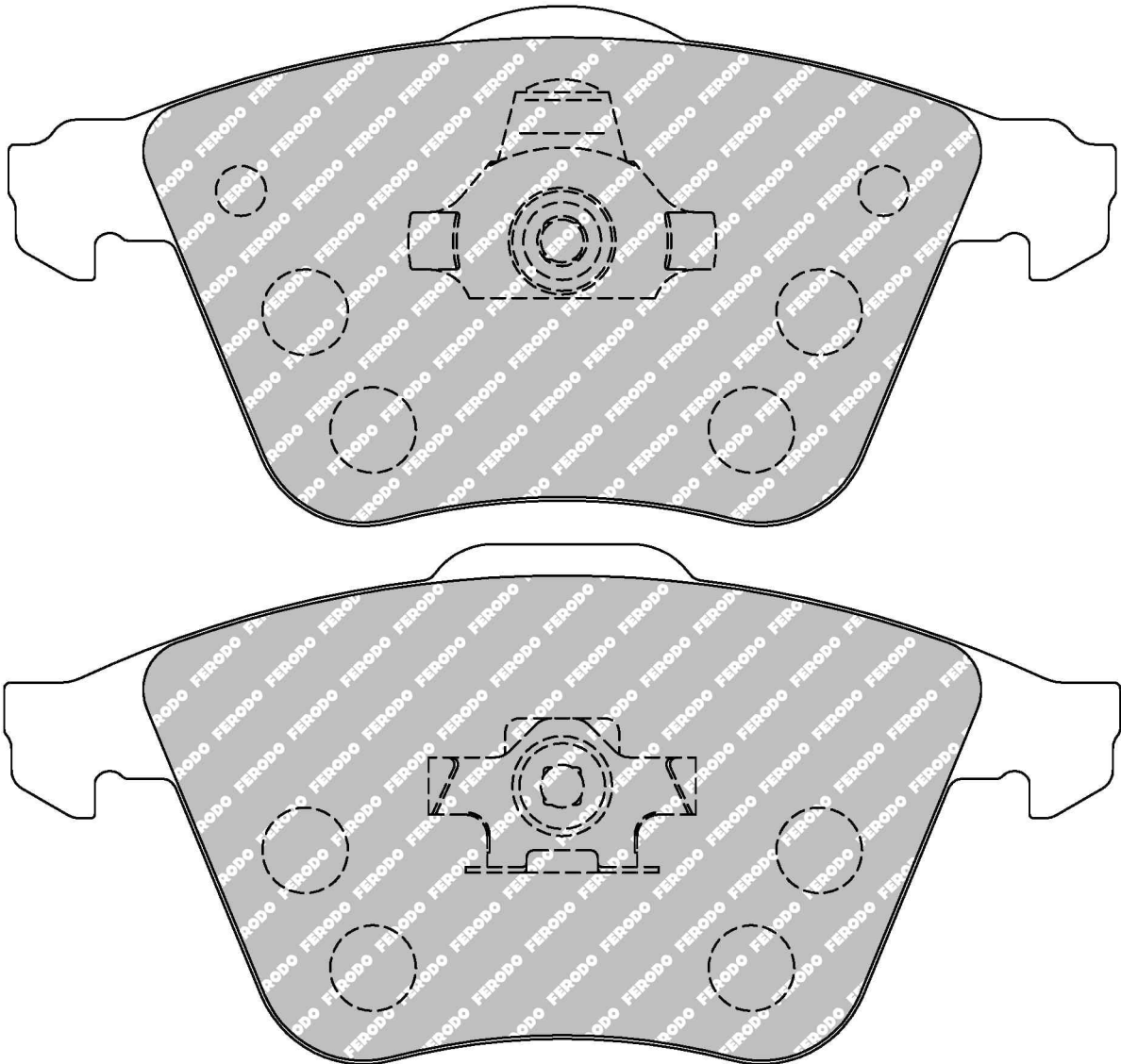

MATERIAL AVAILABILITY				
H	C	R	W	Z
✓			✉	

CROSS REFERENCE	
MINTEX	MDB2749
WVA	23 912 18,50

- ✓ Available
- ✗ Not Available
- ⚠ Exhausting
- ✉ Make to order
- 📦 In Introduction

# FCP1725



131.5mm = 5.177"



53.5mm = 2.106"





19.0mm = 0.748"

**IMPORTANT NOTICE: Please note that the height measurement represents the radial depth, not the entire back plate**

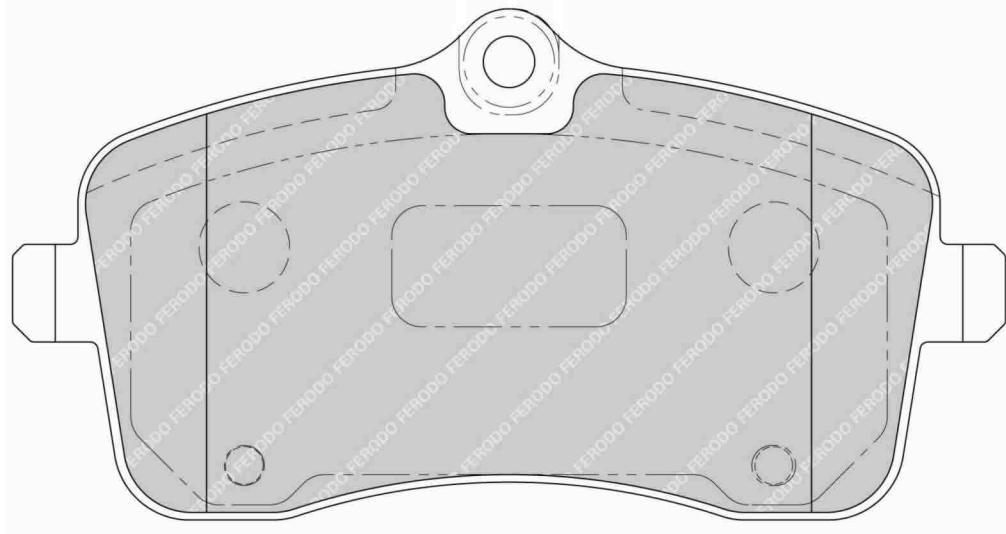
PEUGEOT Front



MATERIAL AVAILABILITY				
H	C	R	W	Z
				

# FCP1747



131.4mm = 5.173"



45.6mm = 1.795"



17.0mm = 0.669"

WVA No: 23 915 17,60

FMSI No: D1308

**IMPORTANT NOTICE: Please note that the height measurement represents the radial depth, not the entire back plate**

BMW Front, MINI Front

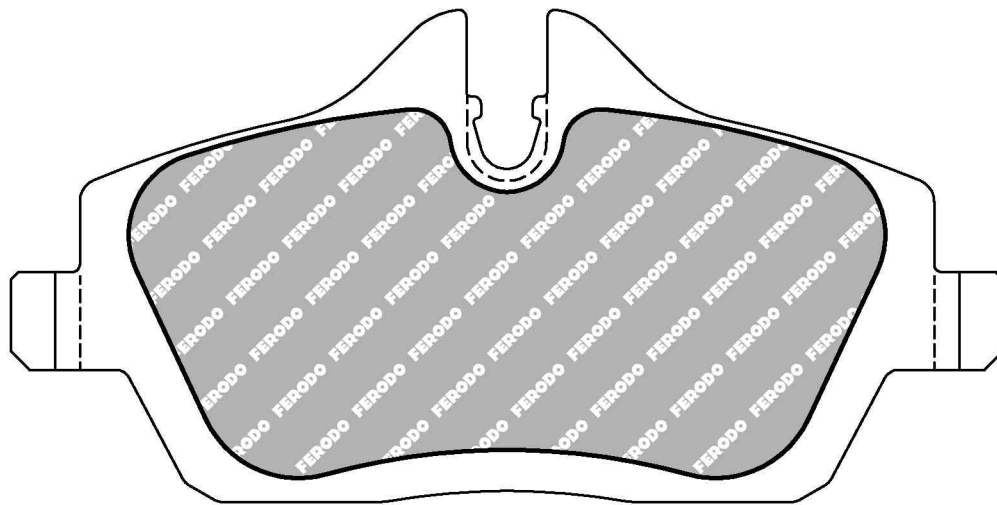
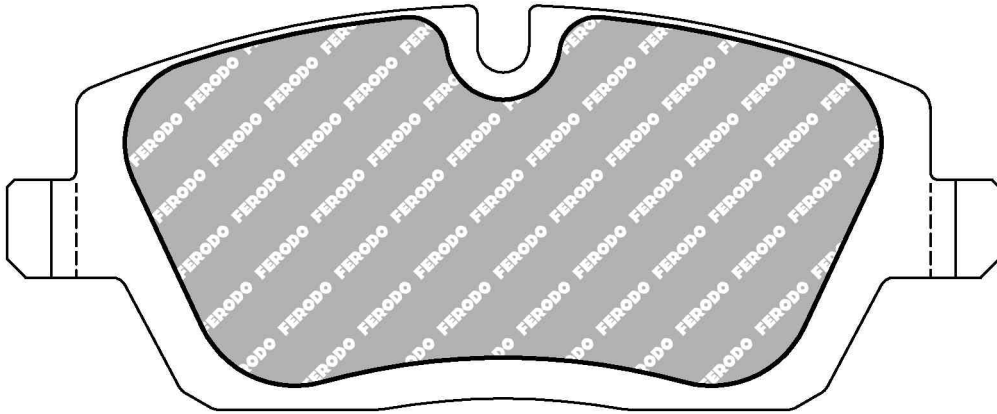

MATERIAL AVAILABILITY				
H	C	R	W	Z
✓				

CROSS REFERENCE	
FMSI	D1308
HAWK	HB570 .677
MINTEX	MDB2682
WVA	23 915 17,60

- ✓ Available
- ✗ Not Available
- ⚠ Exhausting
- ✉ Make to order
- 🔵 In Introduction

# FCP1751



150.0mm = 5.906"



56.0mm = 2.205"



17.6mm = 0.693"

WVA No: 23 935 17,60

**IMPORTANT NOTICE: Please note that the height measurement represents the radial depth, not the entire back plate**

BMW Front

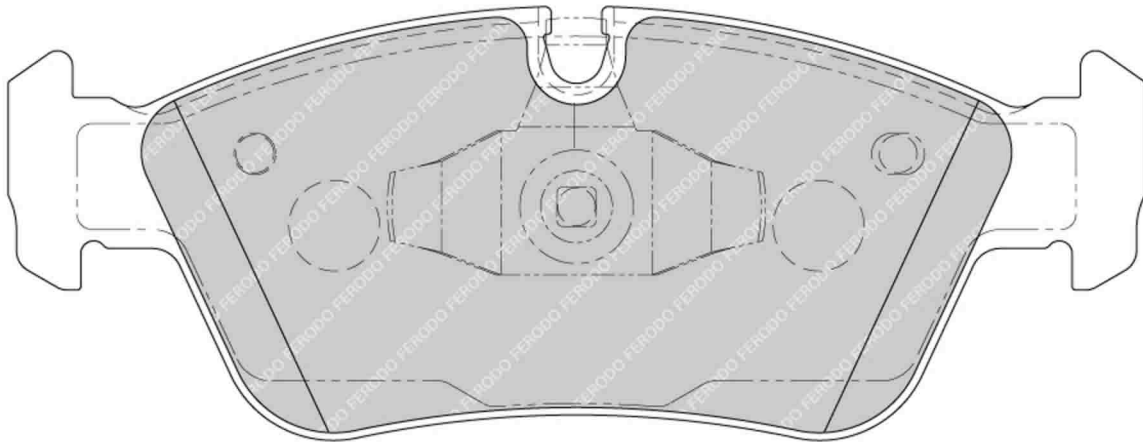
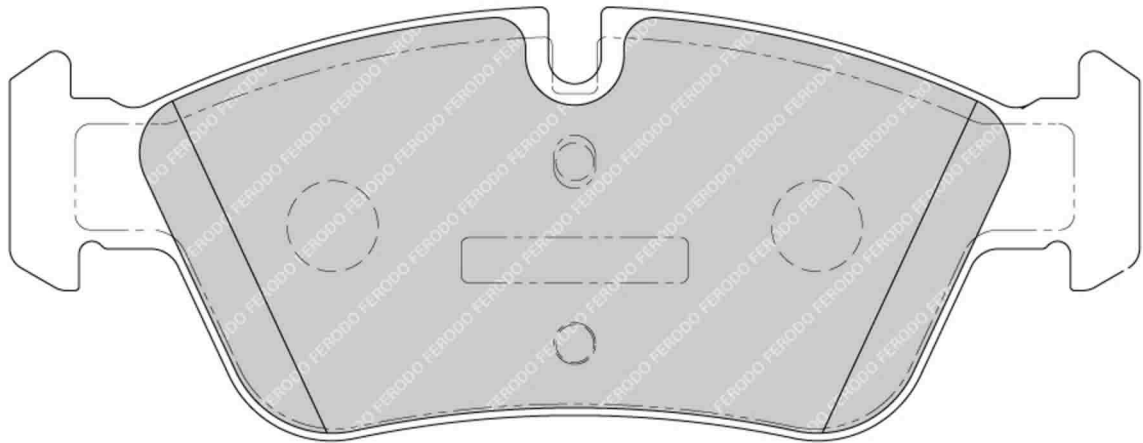

MATERIAL AVAILABILITY				
H	C	R	W	Z

CROSS REFERENCE	
WVA	23 935 17,60

3160

**FERODO**  
RACING

Updated on 30th Jan 2014

Available   
 Exhausting  
 Not Available   
 Make to order  
 In Introduction

# FCP1765



155.3mm = 6.114"  
156.5mm = 6.161"



56.7mm = 2.232"  
56.7mm = 2.232"



20.3mm = 0.799"  
20.3mm = 0.799"

WVA No: 23 801 20,40

**IMPORTANT NOTICE:** Please note that the height measurement represents the radial depth, not the entire back plate

AUDI Front, SEAT Front, VOLKSWAGEN Front

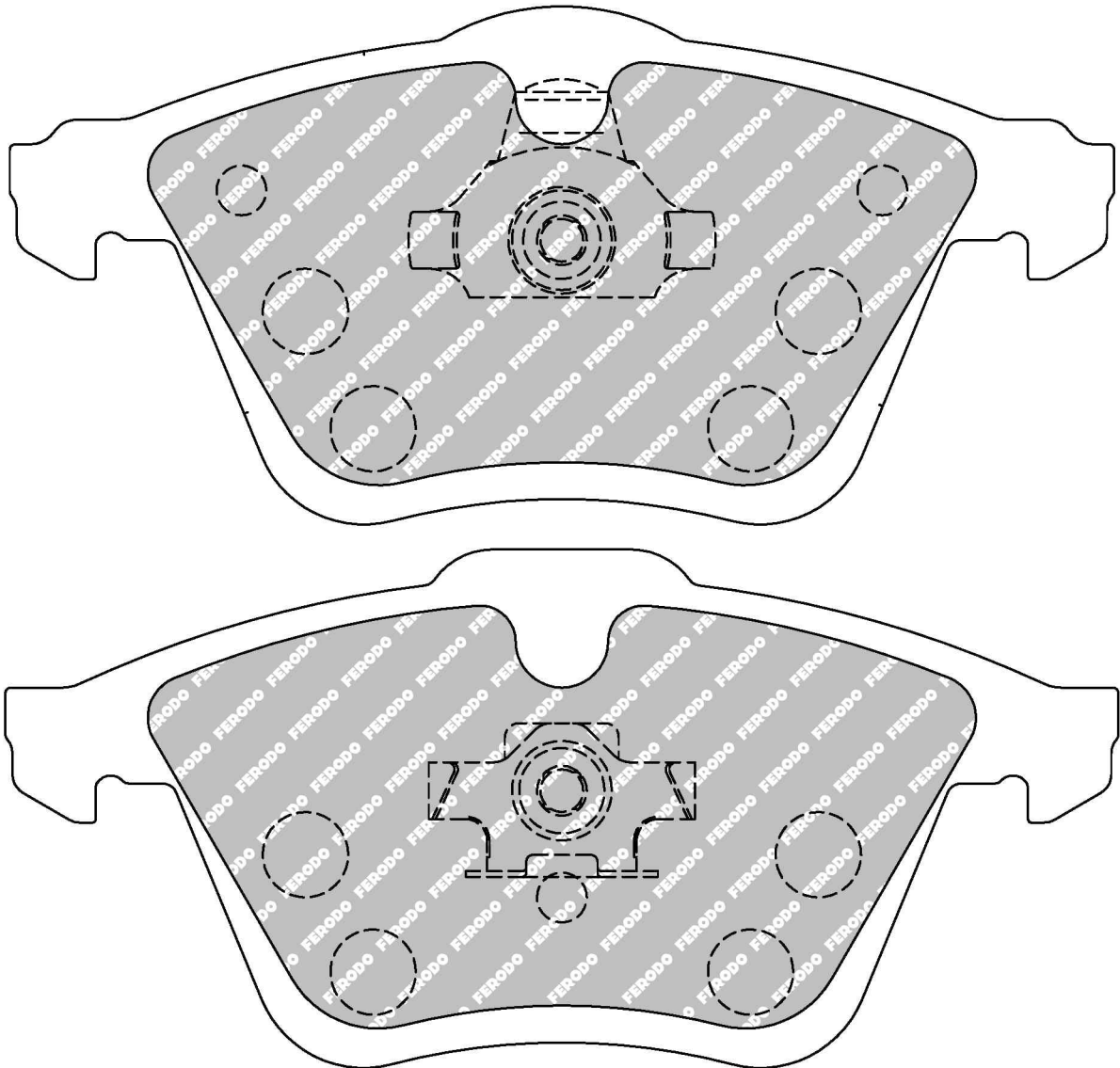

MATERIAL AVAILABILITY				
H	C	R	W	Z
✓			✉	✓

CROSS REFERENCE	
MINTEX	MDB2677
WVA	23 801 20,40

✓ Available    ⚠ Exhausting  
 ✗ Not Available    ✉ Make to order  
 📧 In Introduction

**FERODO**  
RACING

Updated on 30th Jan 2014

**3161**

# FCP1773



154.9mm = 6.098"  
155.3mm = 6.114"



58.0mm = 2.283"  
58.0mm = 2.283"



19.2mm = 0.756"  
19.2mm = 0.756"

WVA No: 23 794 19,80

**IMPORTANT NOTICE:** Please note that the height measurement represents the radial depth, not the entire back plate

BMW Front

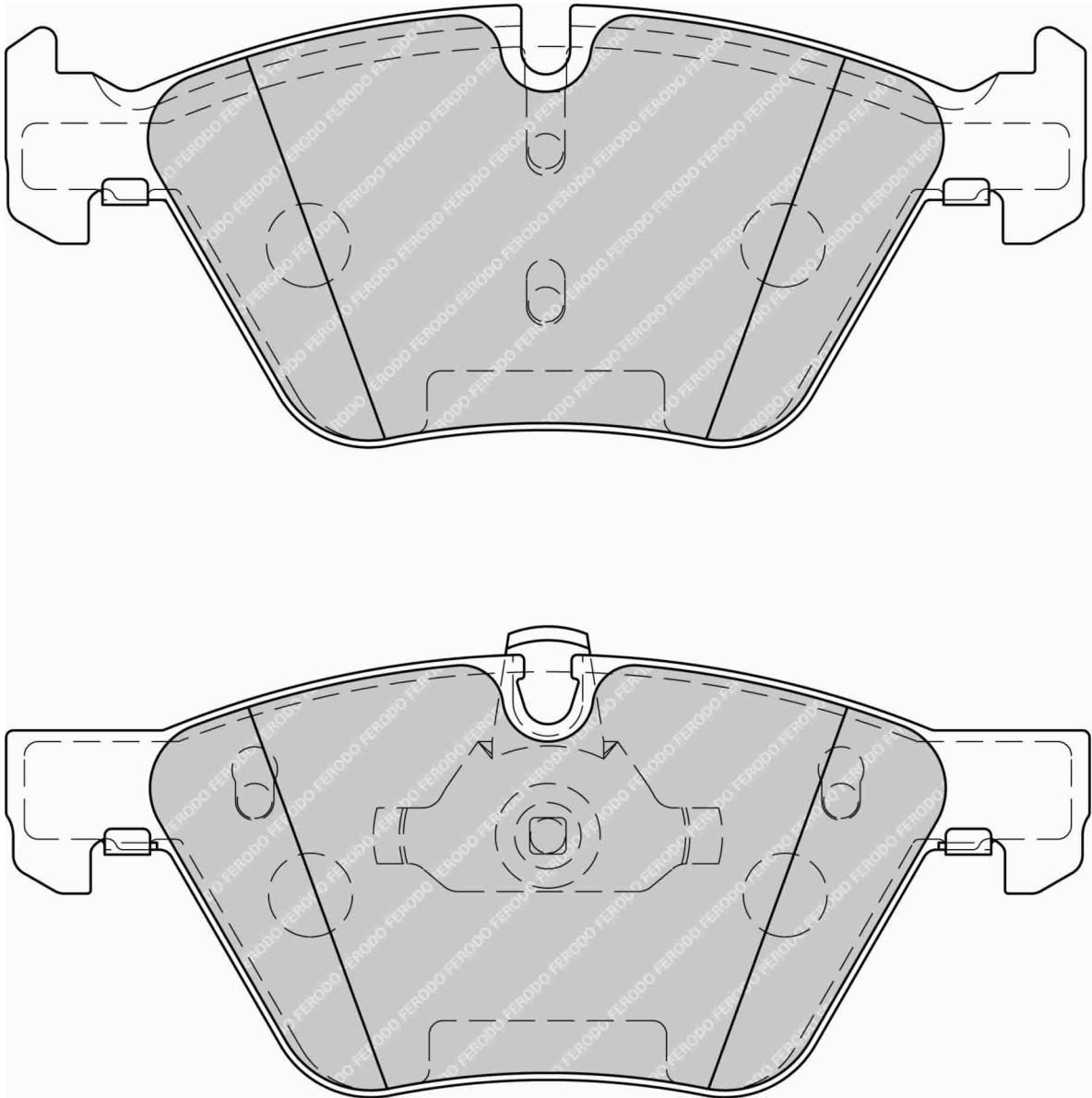

MATERIAL AVAILABILITY				
H	C	R	W	Z
✓				

CROSS REFERENCE	
MINTEX	MDB2692
PFC	0394
WVA	23 794 19,80

# FCP1783

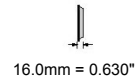
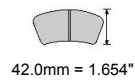
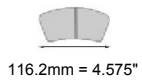

**IMPORTANT NOTICE: Please note that the height measurement represents the radial depth, not the entire back plate**

KIA Front

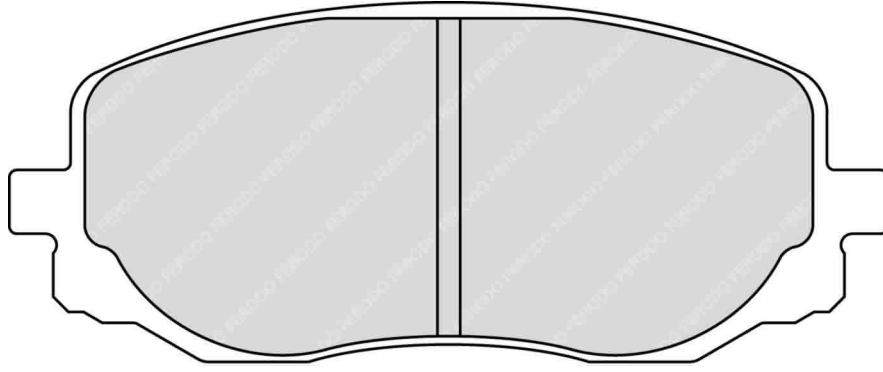

MATERIAL AVAILABILITY				
H	C	R	W	Z

- Available
- Exhausting
- Not Available
- Make to order
- In Introduction

# FCP1786



135.7mm = 5.343"



56.7mm = 2.232"



15.5mm = 0.610"

WVA No: 24 056 15,5

FMSI No: D969

**IMPORTANT NOTICE: Please note that the height measurement represents the radial depth, not the entire back plate**

INFINITI Front, NISSAN Front

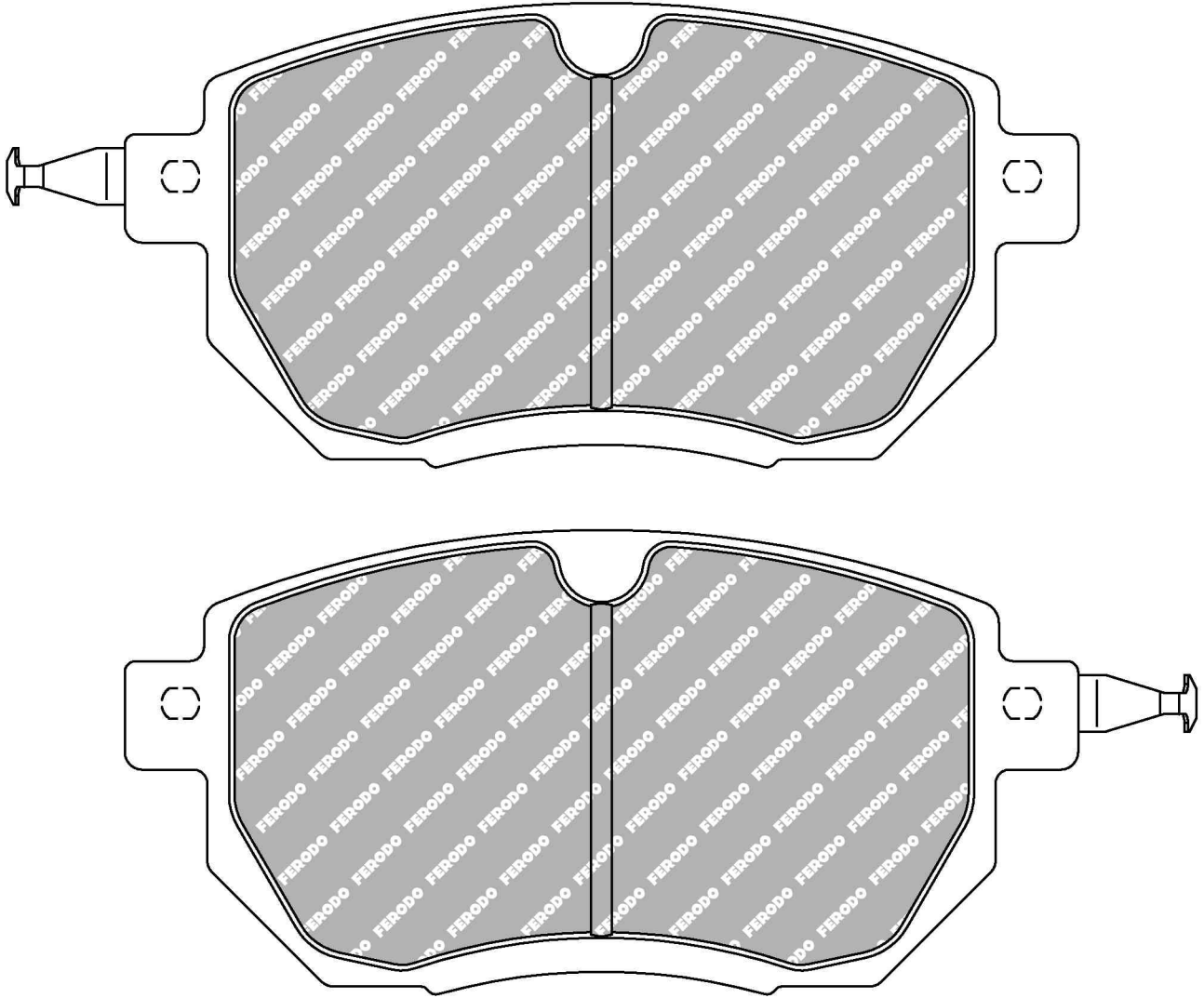

MATERIAL AVAILABILITY				
H	C	R	W	Z
✓				

CROSS REFERENCE	
FMSI	D969
HAWK	HB448 0,61
MINTEX	MDB2387
WVA	24 056 15,5

3164

**FERODO**  
RACING

Updated on 30th Jan 2014

✓ Available    ⚠ Exhausting  
 ✗ Not Available    📦 Make to order  
 🚧 In Introduction



# FCP1790



122.8mm = 4.835"



34.0mm = 1.339"



17.4mm = 0.685"

WVA No: 23 959 17,4

**IMPORTANT NOTICE: Please note that the height measurement represents the radial depth, not the entire back plate**

CITROEN Front, PEUGEOT Front, TOYOTA Front

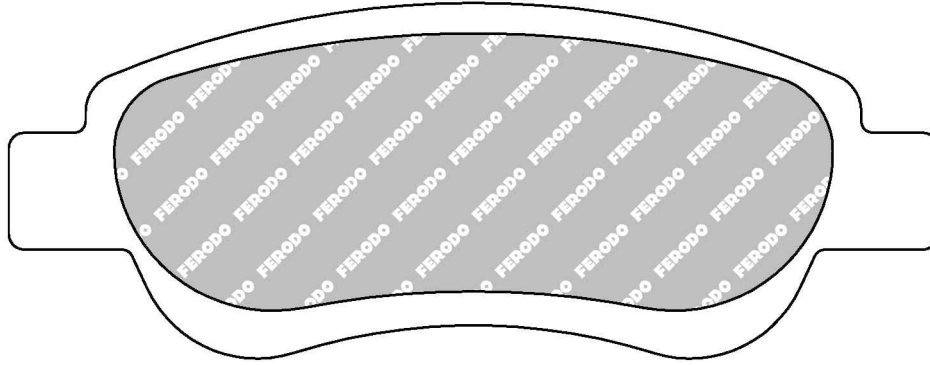

MATERIAL AVAILABILITY				
H	C	R	W	Z
✓				

CROSS REFERENCE	
WVA	23 959 17,4

- ✓ Available
- ✗ Not Available
- ⚡ In Introduction
- ⚠ Exhausting
- ✉ Make to order

# FCP1805



156.5mm = 6.161"  
155.4mm = 6.118"



57.7mm = 2.272"  
57.7mm = 2.272"



19.3mm = 0.760"  
18.5mm = 0.728"

WVA No: 24 339 19,90

**IMPORTANT NOTICE:** Please note that the height measurement represents the radial depth, not the entire back plate

ALFA ROMEO Front

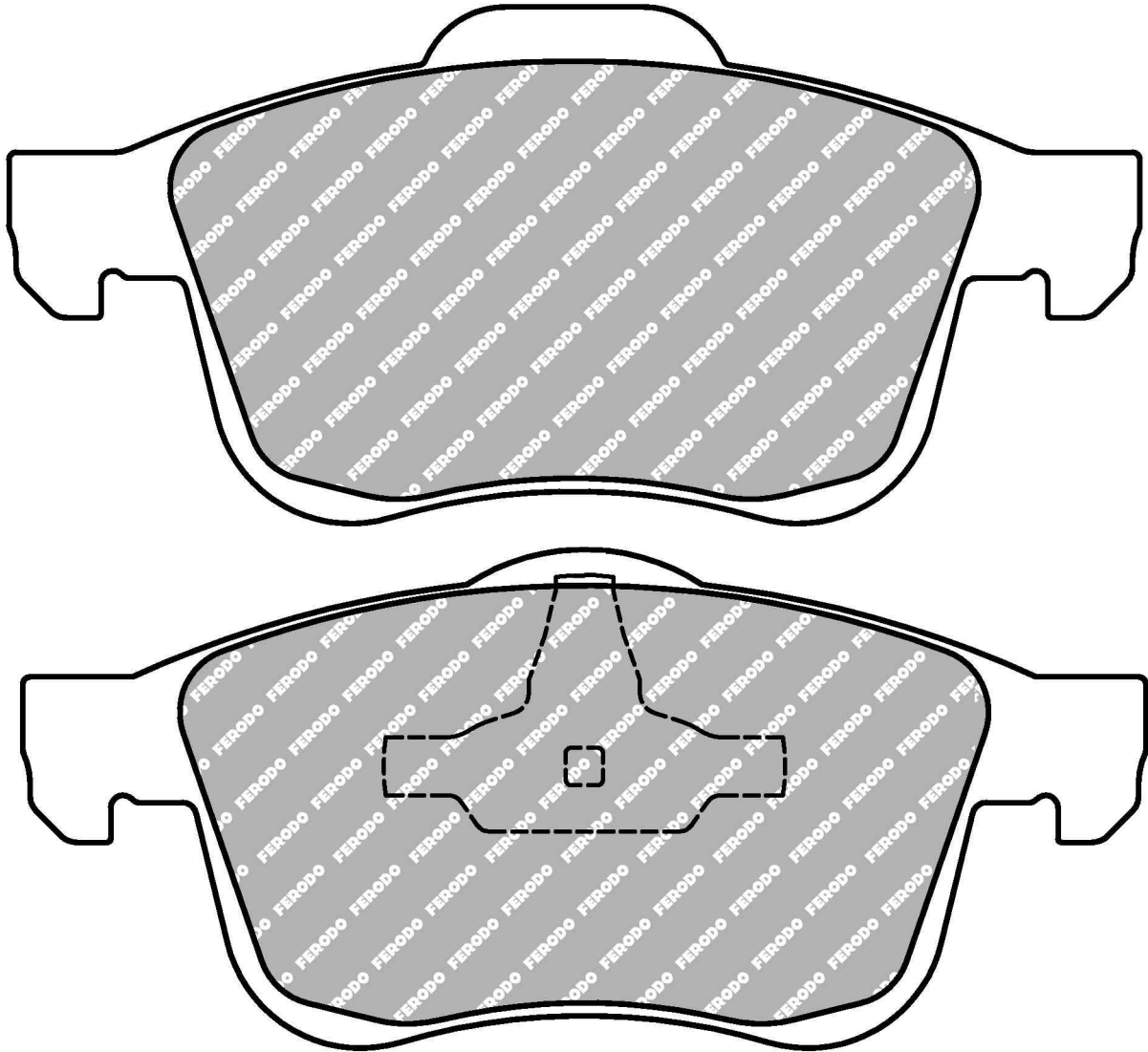

MATERIAL AVAILABILITY				
H	C	R	W	Z
✓				

CROSS REFERENCE	
MINTEX	MDB2790
WVA	24 339 19,90

3166

**FERODO**  
RACING

Updated on 30th Jan 2014

✓ Available    ⚠ Exhausting  
 ✗ Not Available    📦 Make to order  
 🚧 In Introduction

# FCP1806



95.5mm = 3.760"



43.0mm = 1.693"



16.6mm = 0.654"

WVA No: 23 623 17,20

FMSI No: D1309

**IMPORTANT NOTICE: Please note that the height measurement represents the radial depth, not the entire back plate**

BMW Rear, MINI Rear

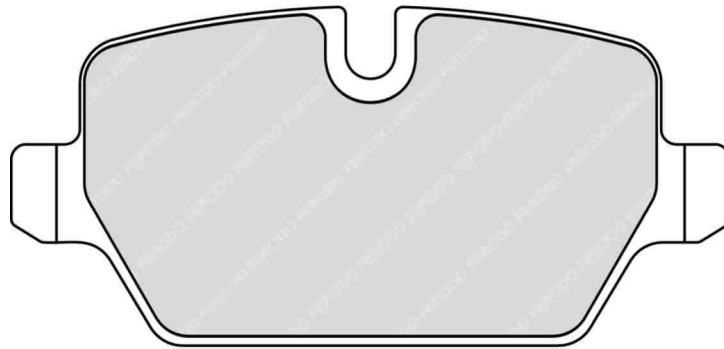
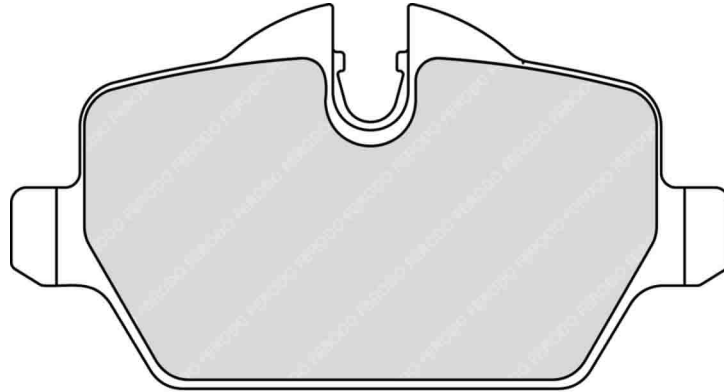

MATERIAL AVAILABILITY				
H	C	R	W	Z
✓				

CROSS REFERENCE	
FMSI	D1309
HAWK	HB574 .666
WVA	23 623 17,20

✓ Available    ⚠ Exhausting  
 ✗ Not Available    ✉ Make to order  
 🔄 In Introduction

**FERODO**  
RACING

Updated on 30th Jan 2014

**3167**

# FCP1807



123.2mm = 4.850"



39.7mm = 1.563"



16.4mm = 0.646"

WVA No: 23 926 17,00

**IMPORTANT NOTICE: Please note that the height measurement represents the radial depth, not the entire back plate**

BMW Rear

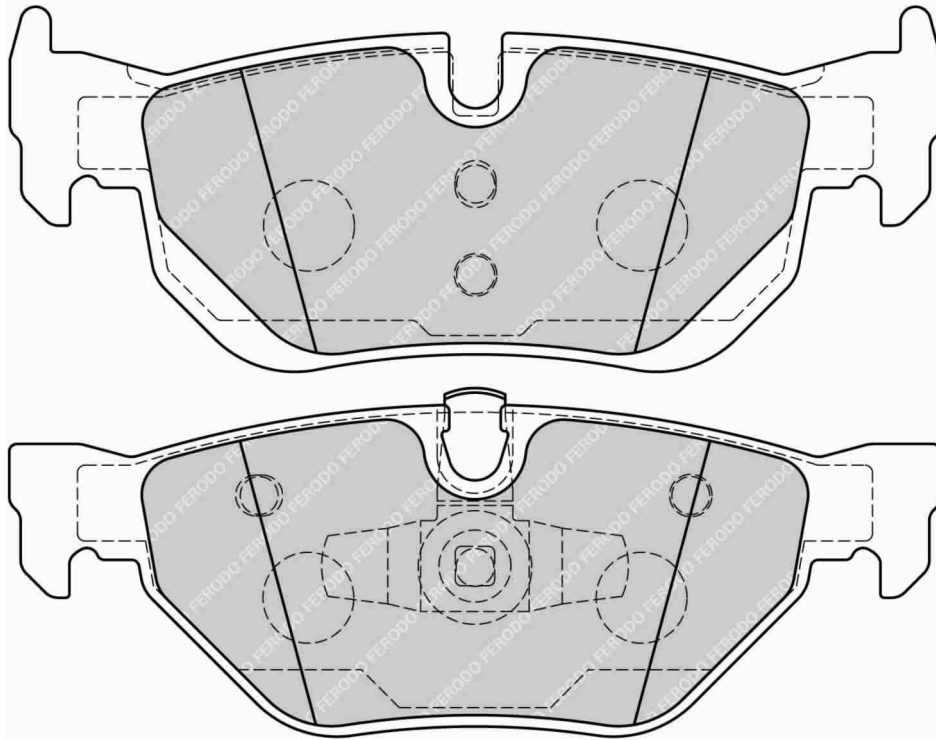

MATERIAL AVAILABILITY				
H	C	R	W	Z
✓				

CROSS REFERENCE	
PFC	0396
WVA	23 926 17,00

# FCP1808



123.2mm = 4.850"



54.8mm = 2.157"



16.4mm = 0.646"

WVA No: 23 550 17,00

FMSI No: D1170

**IMPORTANT NOTICE: Please note that the height measurement represents the radial depth, not the entire back plate**

BMW Rear

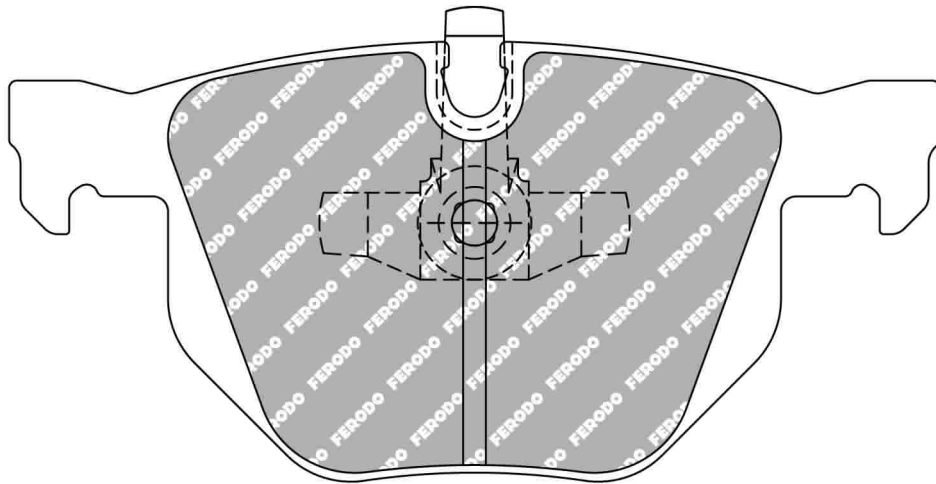
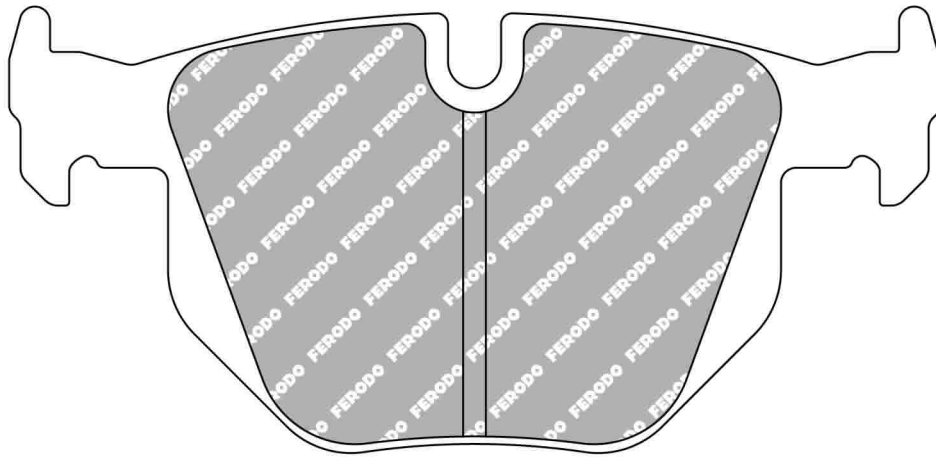

MATERIAL AVAILABILITY				
H	C	R	W	Z
✓				

CROSS REFERENCE	
EBC	DP21588
FMSI	D1170
HAWK	HB624x.642
WVA	23 550 17,00

✓ Available    ⚠ Exhausting  
 ✗ Not Available    ✉ Make to order  
 🔄 In Introduction

**FERODO**  
RACING

Updated on 30th Jan 2014

**3169**

# FCP1858

102.0mm = 4.016"

41.3mm = 1.626"

17.3mm = 0.681"

WVA No: 24 349 17,20

**IMPORTANT NOTICE: Please note that the height measurement represents the radial depth, not the entire back plate**

FIAT Rear

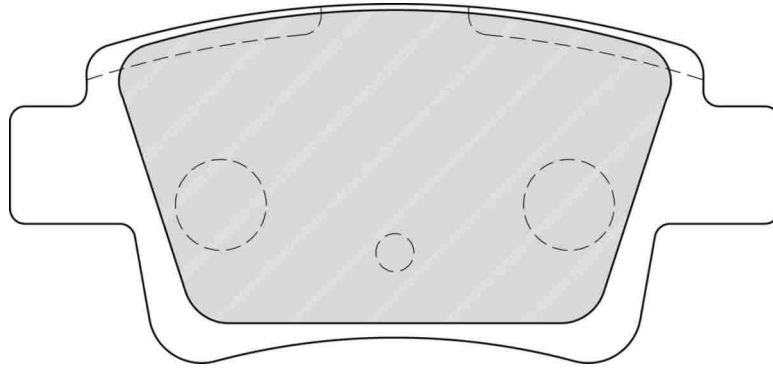

MATERIAL AVAILABILITY				
H	C	R	W	Z
✓				

CROSS REFERENCE	
WVA	24 349 17,20

# FCP1859

131.7mm = 5.185"

50.5mm = 1.988"

16.5mm = 0.650"

**IMPORTANT NOTICE: Please note that the height measurement represents the radial depth, not the entire back plate**

HONDA Front

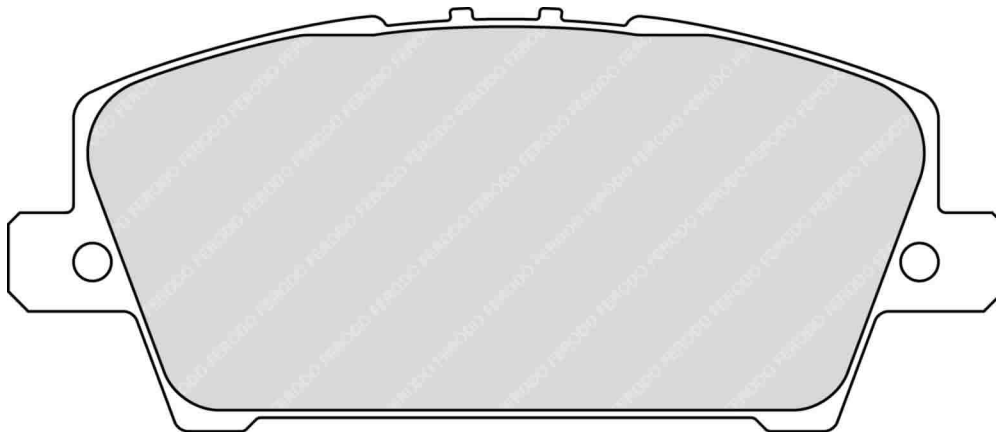

MATERIAL AVAILABILITY				
H	C	R	W	Z
✓				

# FCP1862

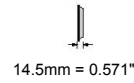
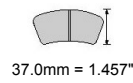

**IMPORTANT NOTICE:** Please note that the height measurement represents the radial depth, not the entire back plate

HONDA Rear

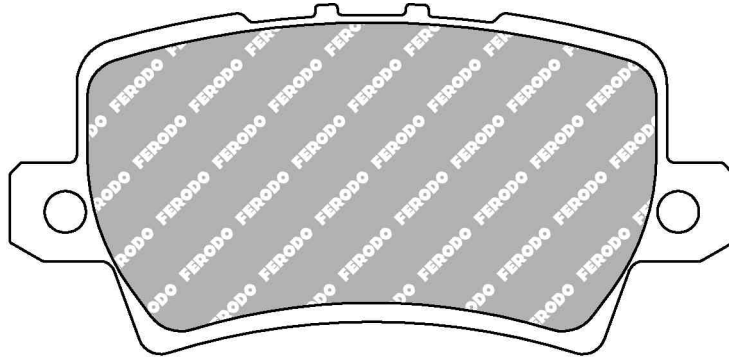

MATERIAL AVAILABILITY				
H	C	R	W	Z
✓				

# FCP1917

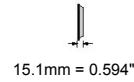
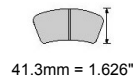

**IMPORTANT NOTICE:** Please note that the height measurement represents the radial depth, not the entire back plate

FORD Rear, VOLVO Rear

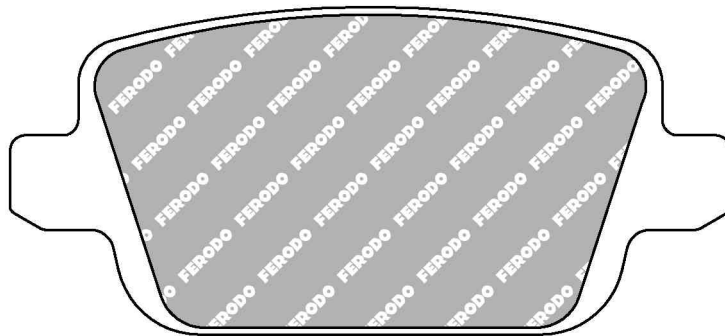

MATERIAL AVAILABILITY				
H	C	R	W	Z
✓				

# FCP1954



150.4mm = 5.921"

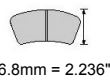

56.8mm = 2.236"

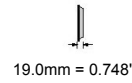

19.0mm = 0.748"

**IMPORTANT NOTICE: Please note that the height measurement represents the radial depth, not the entire back plate**

CHRYSLER Front

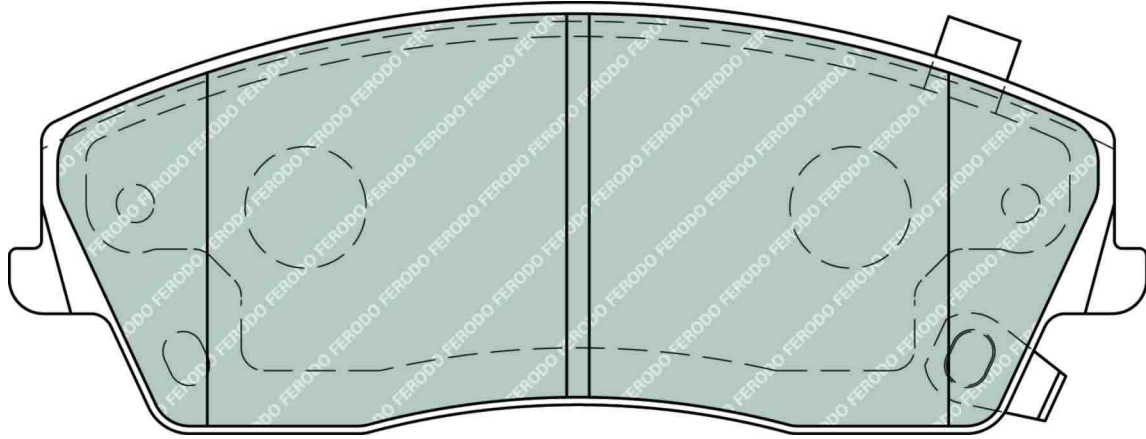

MATERIAL AVAILABILITY				
H	C	R	W	Z

# FCP1975

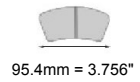

95.4mm = 3.756"

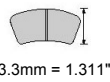

33.3mm = 1.311"

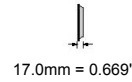

17.0mm = 0.669"

WVA No: 24 289 17.1

**IMPORTANT NOTICE: Please note that the height measurement represents the radial depth, not the entire back plate**

MINI Rear

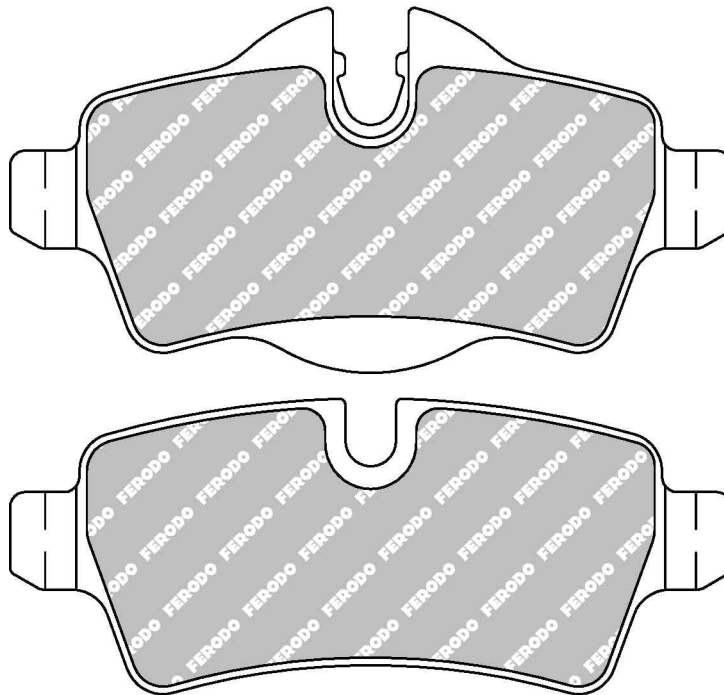

MATERIAL AVAILABILITY				
H	C	R	W	Z

CROSS REFERENCE	
WVA	24 289 17.1



# FCP4044



188.0mm = 7.402"



62.0mm = 2.441"



18.3mm = 0.720"

WVA No: 24 408 19,40

**IMPORTANT NOTICE: Please note that the height measurement represents the radial depth, not the entire back plate**

AUDI Front, FORD Front

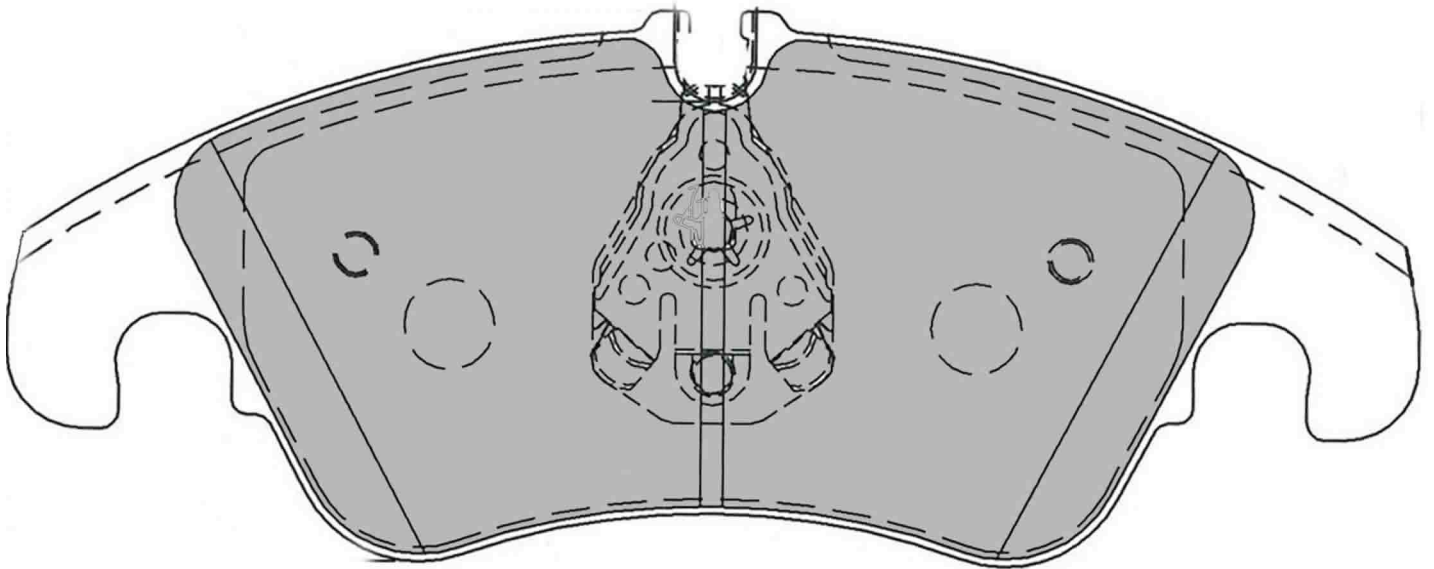
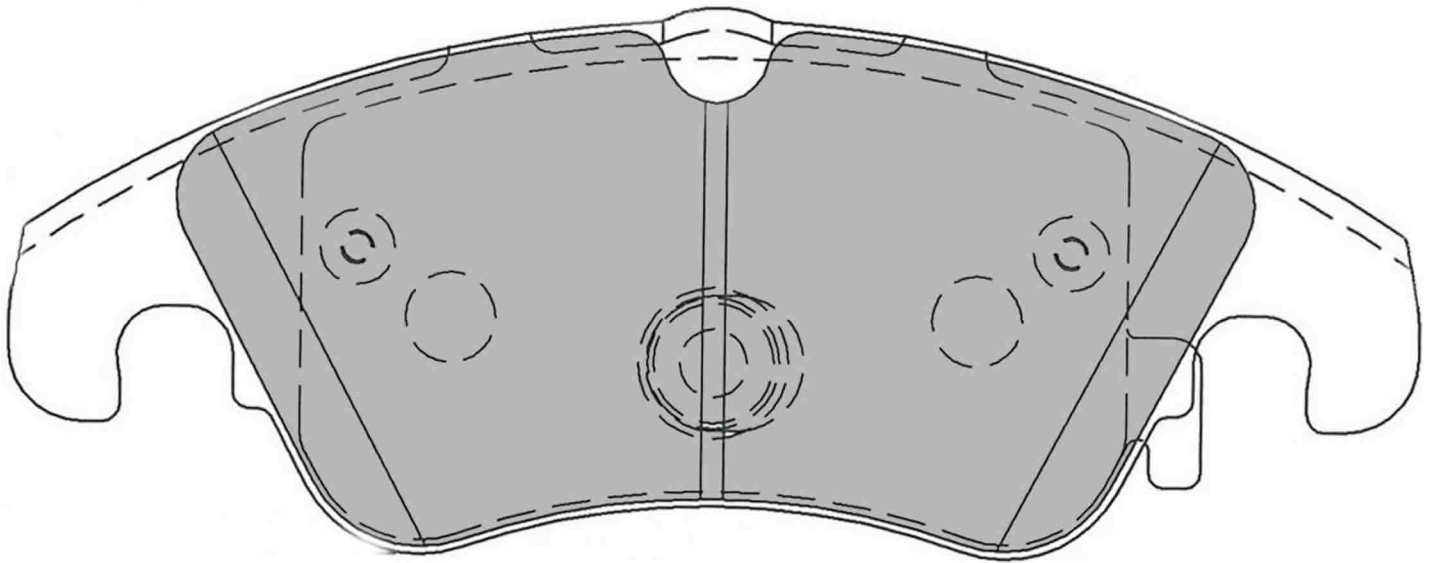

MATERIAL AVAILABILITY				
H	C	R	W	Z
✓				

CROSS REFERENCE	
MINTEX	MDB2934
OE AUDI	8K0698151 / B
PAGID	1748
WVA	24 408 19,40
WVA	24 409 19,40
WVA	24 743 19,40

✓ Available    ⚠ Exhausting  
 ✗ Not Available    📧 Make to order  
 🚧 In Introduction

**FERODO**  
RACING

Updated on 30th Jan 2014

**3173**

# FCP4045

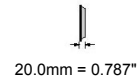
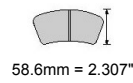
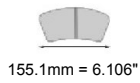

WVA No: 24 705 20,00

**IMPORTANT NOTICE: Please note that the height measurement represents the radial depth, not the entire back plate**

AUDI Front

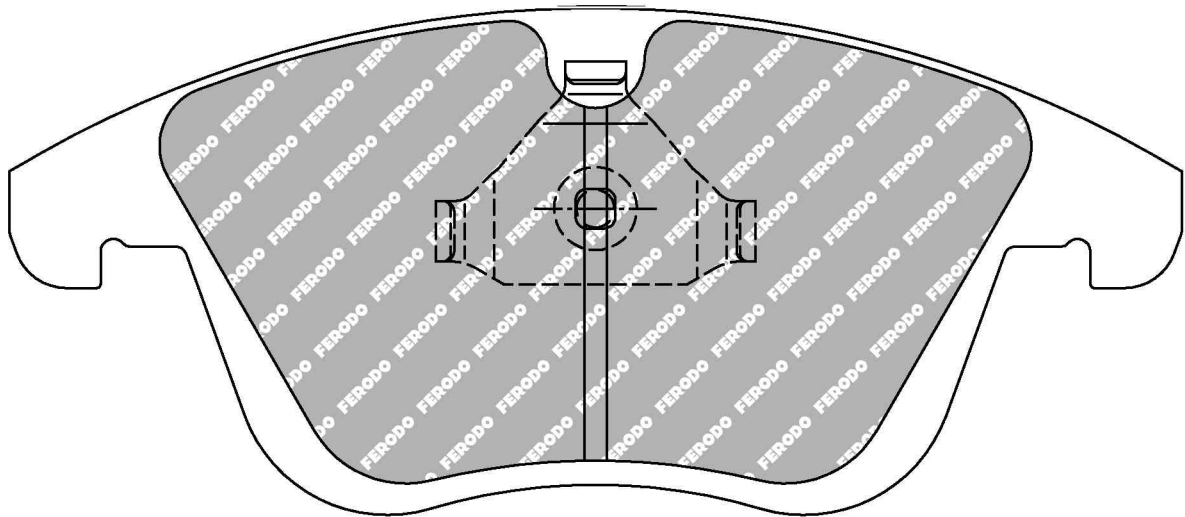
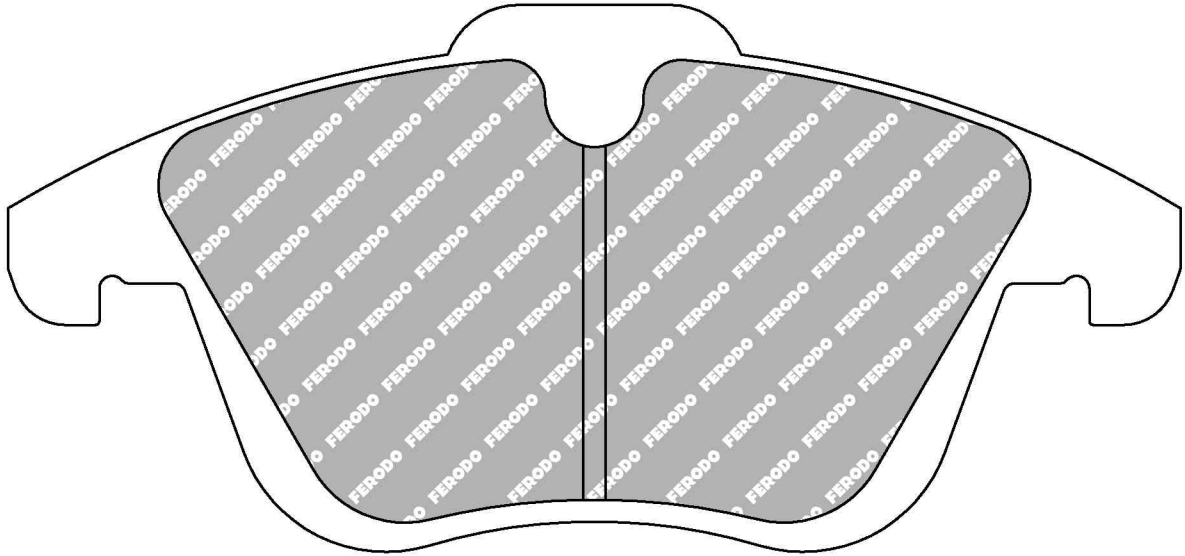

MATERIAL AVAILABILITY				
H	C	R	W	Z
✓				

CROSS REFERENCE	
MINTEX	MDB2952
OE AUDI	8K0698151A
PAGID	1760
WVA	24 705 20,00
WVA	24 706 20,00
WVA	24 707 20,00

3174



Updated on 30th Jan 2014

- ✓ Available
- ✗ Not Available
- ⚠ Exhausting
- 📦 Make to order
- 🔧 In Introduction

# FCP4050



116.4mm = 4.583"



48.1mm = 1.894"



17.8mm = 0.701"

WVA No: 24 606 17,50

**IMPORTANT NOTICE: Please note that the height measurement represents the radial depth, not the entire back plate**

AUDI Rear

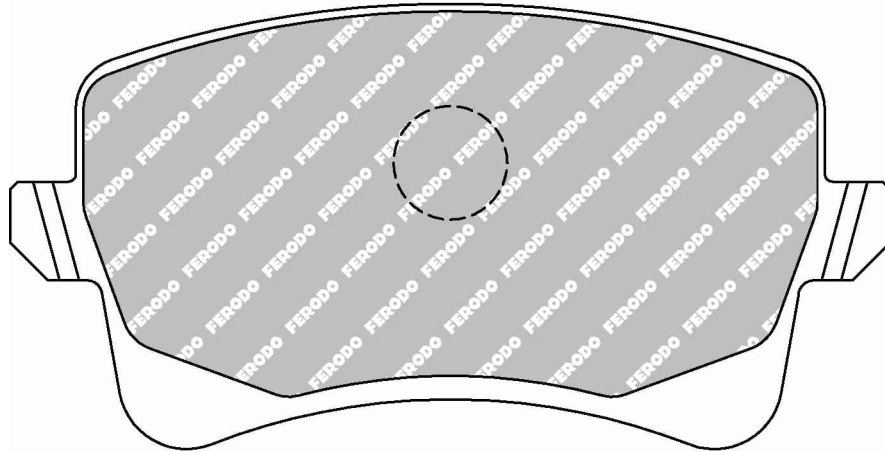

MATERIAL AVAILABILITY				
H	C	R	W	Z
✓				

CROSS REFERENCE	
MINTEX	MDB2929
OE AUDI	8K0698451
OE AUDI	8K0698451A
PAGID	1736
WVA	24 606 17,50

# FCP4064



209.9mm = 8.264"



66.4mm = 2.614"



17.2mm = 0.677"

WVA No: 24 553 16,1

**IMPORTANT NOTICE: Please note that the height measurement represents the radial depth, not the entire back plate**

AUDI Front, PORSCHE Front, VOLKSWAGEN Front

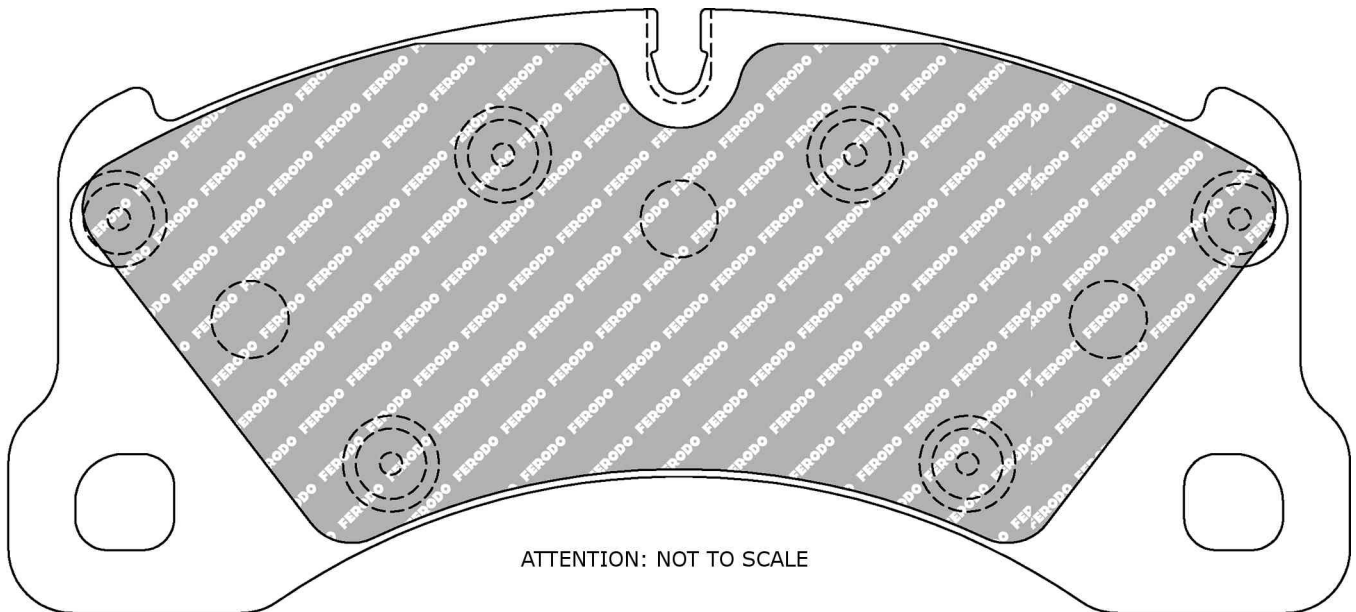

MATERIAL AVAILABILITY				
H	C	R	W	Z
✓				

CROSS REFERENCE	
WVA	24 553 16,1

- ✓ Available
- ✗ Not Available
- ⚠ Exhausting
- 📦 Make to order
- 🔵 In Introduction

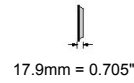
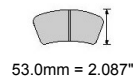

**IMPORTANT NOTICE: Please note that the height measurement represents the radial depth, not the entire back plate**

MINI Front

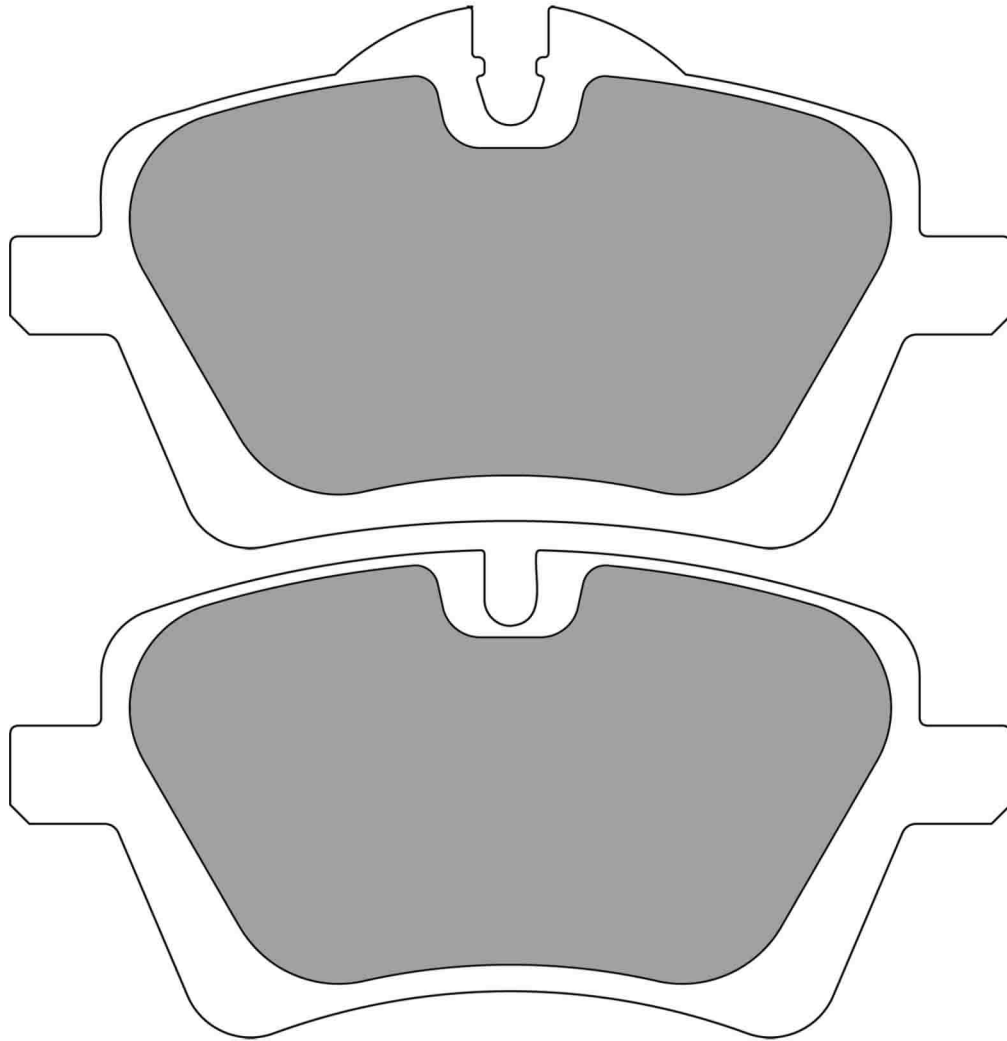

Please Note: does not fit wear indicator

MATERIAL AVAILABILITY				
H	C	R	W	Z
✓			✓	

CROSS REFERENCE	
EBC	DP21789
FMSI	D1204
HAWK	HB560
WVA	23984 17,9

# FCP4168



86.8mm = 3.417"



48.0mm = 1.890"



14.3mm = 0.563"

FMSI No: D1368

**IMPORTANT NOTICE: Please note that the height measurement represents the radial depth, not the entire back plate**

MITSUBISHI Rear

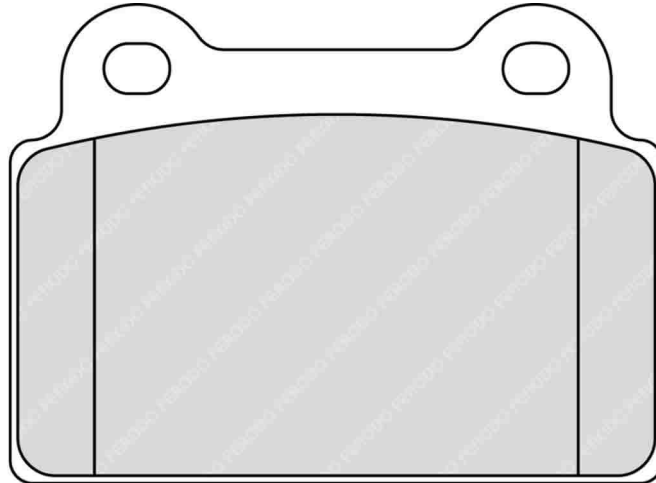

MATERIAL AVAILABILITY				
H	C	R	W	Z
✓		☒	✓	

CROSS REFERENCE	
BREMBO	XA7.G0.11
BREMBO	XA7.G0.12
FMSI	D1368

# FCP4172



127.3mm = 5.012"



55.0mm = 2.165"



16.1mm = 0.634"

FMSI No: D1346

**IMPORTANT NOTICE: Please note that the height measurement represents the radial depth, not the entire back plate**

INFINITI Front, NISSAN Front

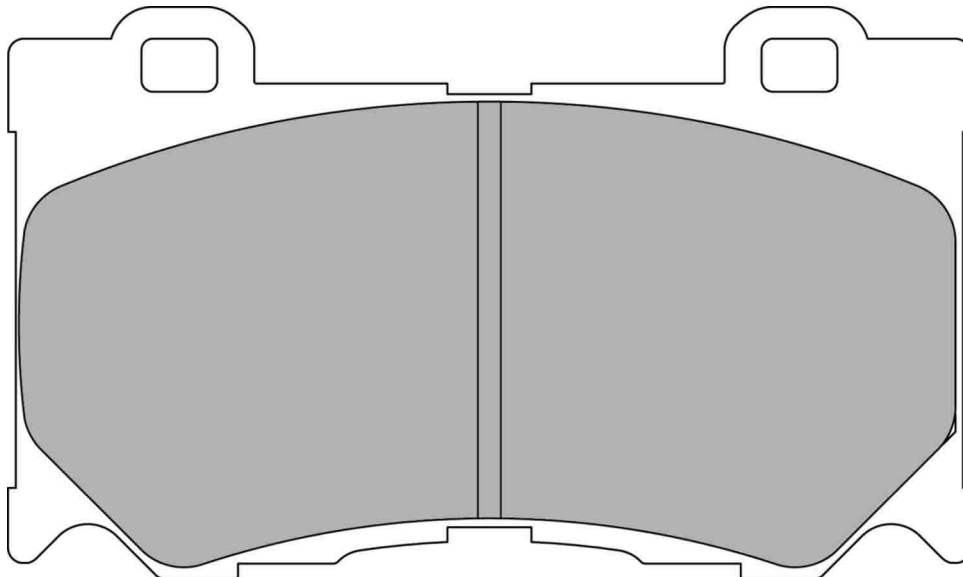

MATERIAL AVAILABILITY				
H	C	R	W	Z
✓				

CROSS REFERENCE	
FMSI	D1346
HAWK	HB601 .626

- ✓ Available    ⚠ Exhausting
- ✗ Not Available    ✉ Make to order
- 🔵 In Introduction

# FCP4173



99.7mm = 3.925"



47.4mm = 1.866"



13.4mm = 0.528"

FMSI No: D1347

**IMPORTANT NOTICE: Please note that the height measurement represents the radial depth, not the entire back plate**

INFINITI Rear, NISSAN Rear

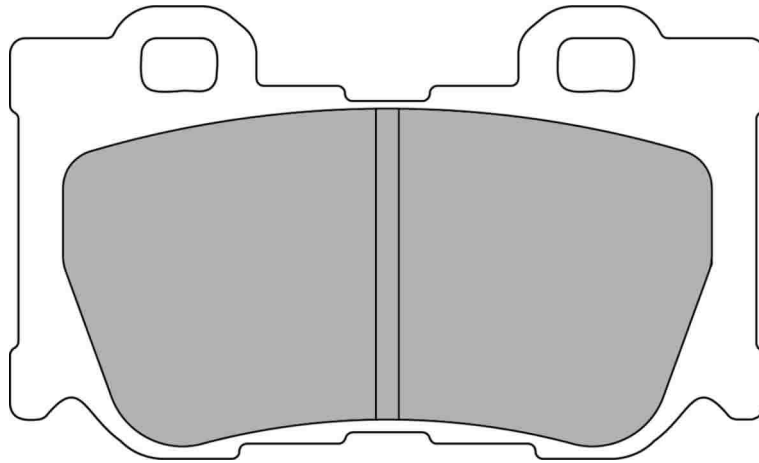

MATERIAL AVAILABILITY				
H	C	R	W	Z
✓				

CROSS REFERENCE	
FMSI	D1347
HAWK	HB602 .545

# FCP4187



110.6mm = 4.354"



34.0mm = 1.339"



16.7mm = 0.657"

WVA No: 24 854 16,7

FMSI No: D1124

**IMPORTANT NOTICE: Please note that the height measurement represents the radial depth, not the entire back plate**

SCION Rear, SUBARU Rear, TOYOTA Rear

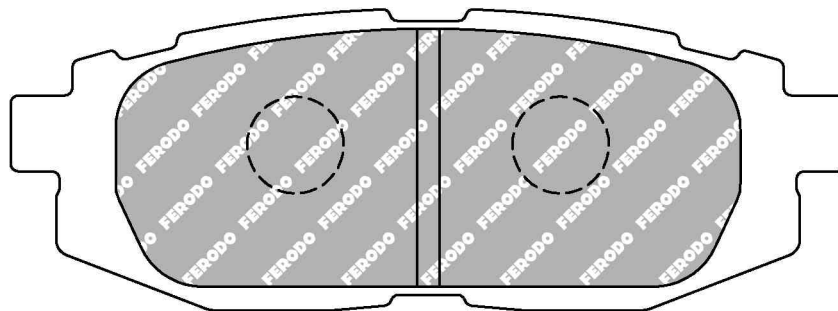

MATERIAL AVAILABILITY				
H	C	R	W	Z
✓			✉	

CROSS REFERENCE	
EBC	DP21758
ENDLESS	EP472
FMSI	D1124
HAWK	HB671
WVA	24 854 16,7

# FCP4191



155.3mm = 6.114"



56.7mm = 2.232"



20.3mm = 0.799"

WVA No: 23313 20,30 - 24255 20,30

**IMPORTANT NOTICE: Please note that the height measurement represents the radial depth, not the entire back plate**

BMW Front

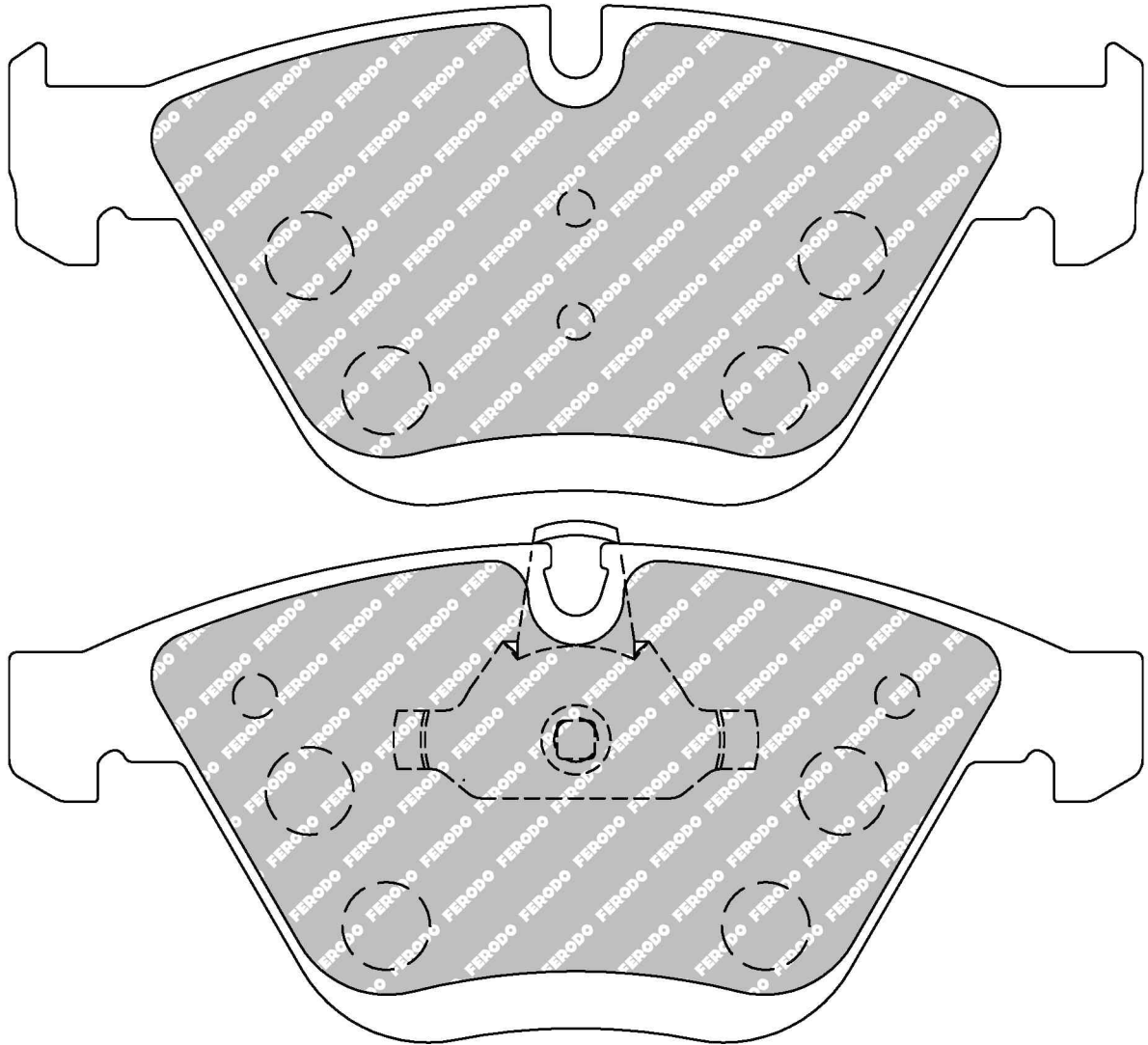

### MATERIAL AVAILABILITY

H	C	R	W	Z

### CROSS REFERENCE

WVA	23313 20,30 - 24255 20,30
-----	---------------------------

- Available
- Exhausting
- Not Available
- Make to order
- In Introduction



84.7mm = 3.335"



50.1mm = 1.972"



16.2mm = 0.638"

WVA No: 24 315 17,10

FMSI No: D1372

**IMPORTANT NOTICE: Please note that the height measurement represents the radial depth, not the entire back plate**

BMW Rear

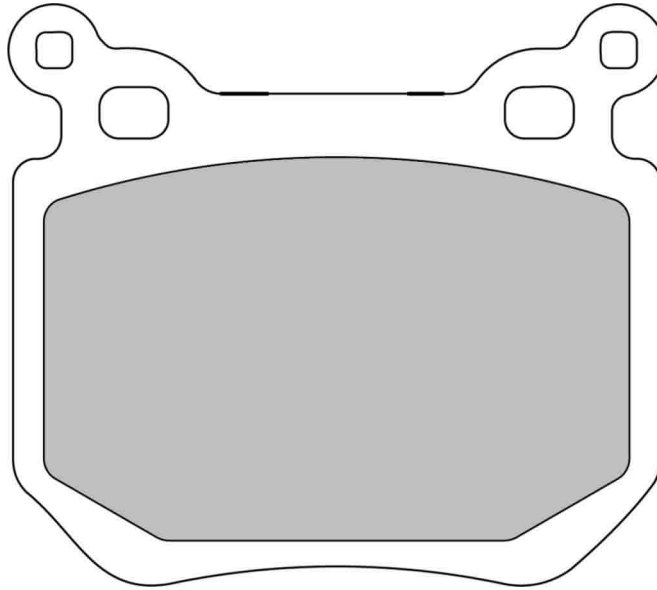

MATERIAL AVAILABILITY				
H	C	R	W	Z
✓		✉		

CROSS REFERENCE	
FMSI	D1372
HAWK	HB604x.598
MINTEX	MDB2828
OE BMW	34 216 784808
OE BMW	34 216 791421
PAGID	T1620
WVA	24 315 17,10



# FCP4218



162.8mm = 6.409"



61.0mm = 2.402"



16.7mm = 0.657"

WVA No: 24 316 17,00

FMSI No: D1371

**IMPORTANT NOTICE: Please note that the height measurement represents the radial depth, not the entire back plate**

BMW Front

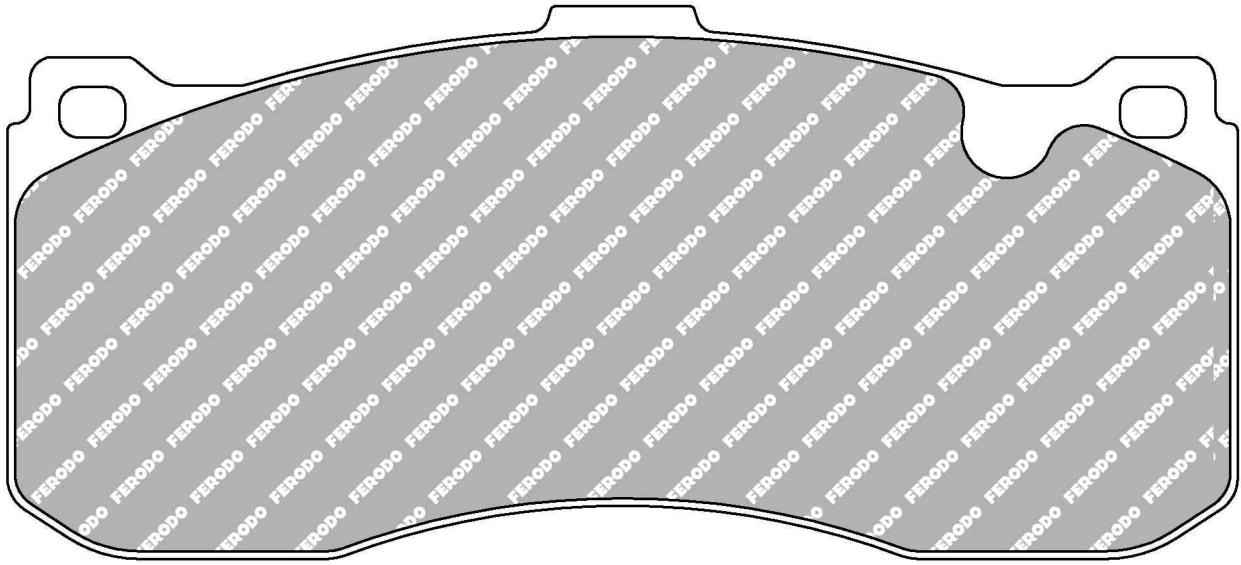

MATERIAL AVAILABILITY				
H	C	R	W	Z
✓		✗		

CROSS REFERENCE	
EBC	DP21995-DP31995
FMSI	D1371
HAWK	HB603x.616
MINTEX	MDB2974
OE BMW	34116786044
PAGID	T1784
WVA	24 316 17,00

# FCP4316



109.5mm = 4.311"



46.3mm = 1.823"



15.6mm = 0.614"

**IMPORTANT NOTICE: Please note that the height measurement represents the radial depth, not the entire back plate**

AUDI Rear, SEAT Rear, SKODA Rear, VOLKSWAGEN Rear

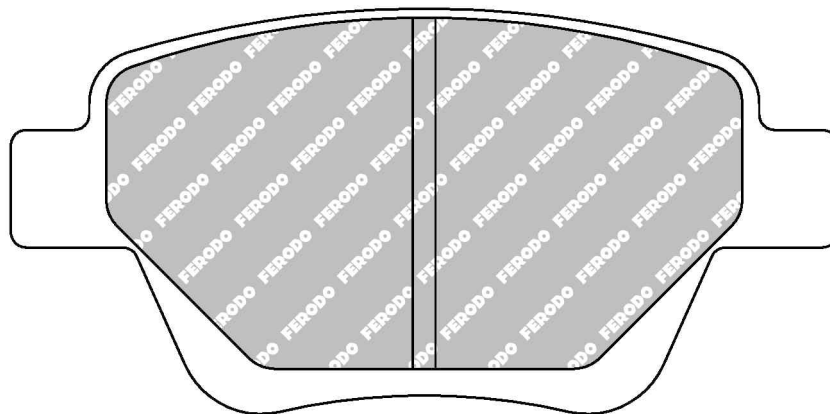

MATERIAL AVAILABILITY				
H	C	R	W	Z
✓				

✓ Available    ⚠ Exhausting  
 ✗ Not Available    ✉ Make to order  
 🚧 In Introduction

**FERODO**  
RACING

Updated on 30th Jan 2014

**3181**

# FCP4353



149.5mm = 5.886"



46.5mm = 1.831"



17.2mm = 0.677"

**IMPORTANT NOTICE: Please note that the height measurement represents the radial depth, not the entire back plate**

FIAT Front

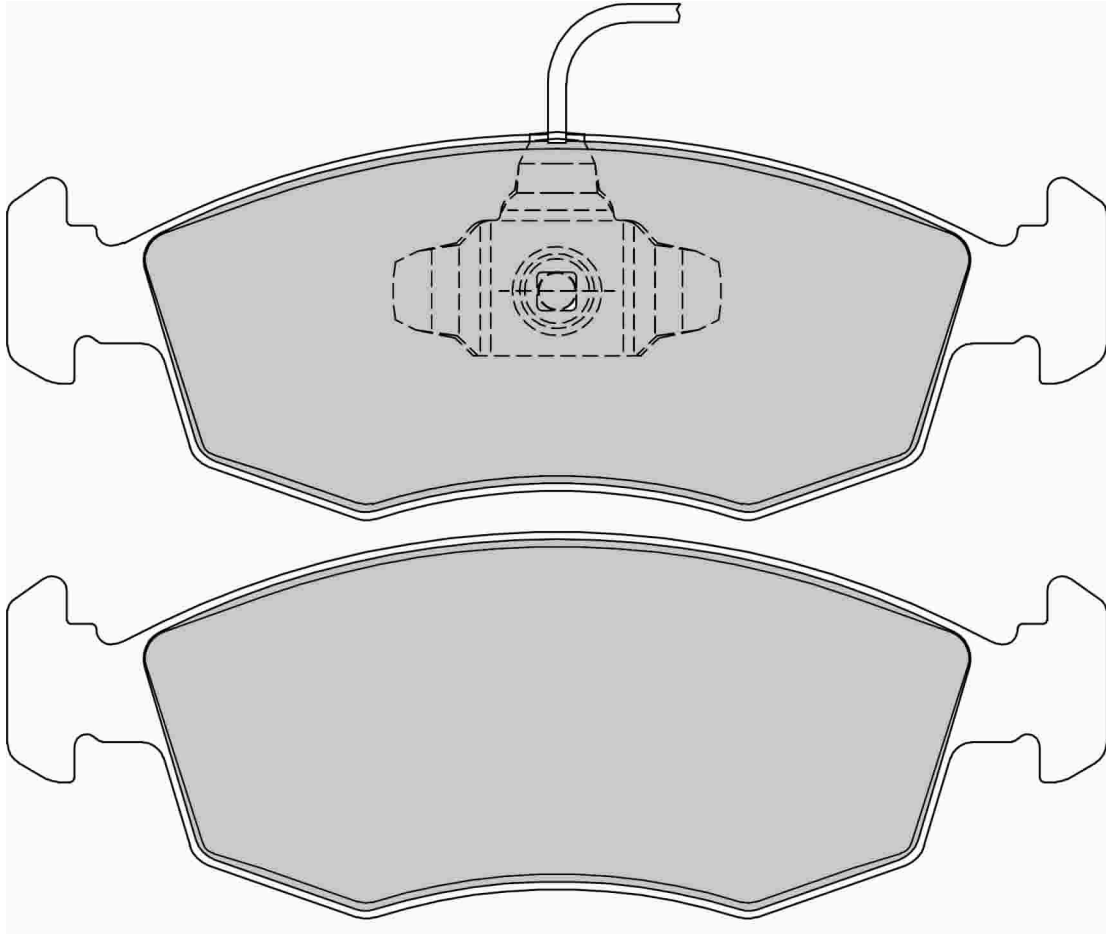

MATERIAL AVAILABILITY				
H	C	R	W	Z
				

# FCP4416



180.3mm = 7.098"



55.0mm = 2.165"





18.5mm = 0.728"

WVA No: 23723 - 23724

**IMPORTANT NOTICE: Please note that the height measurement represents the radial depth, not the entire back plate**

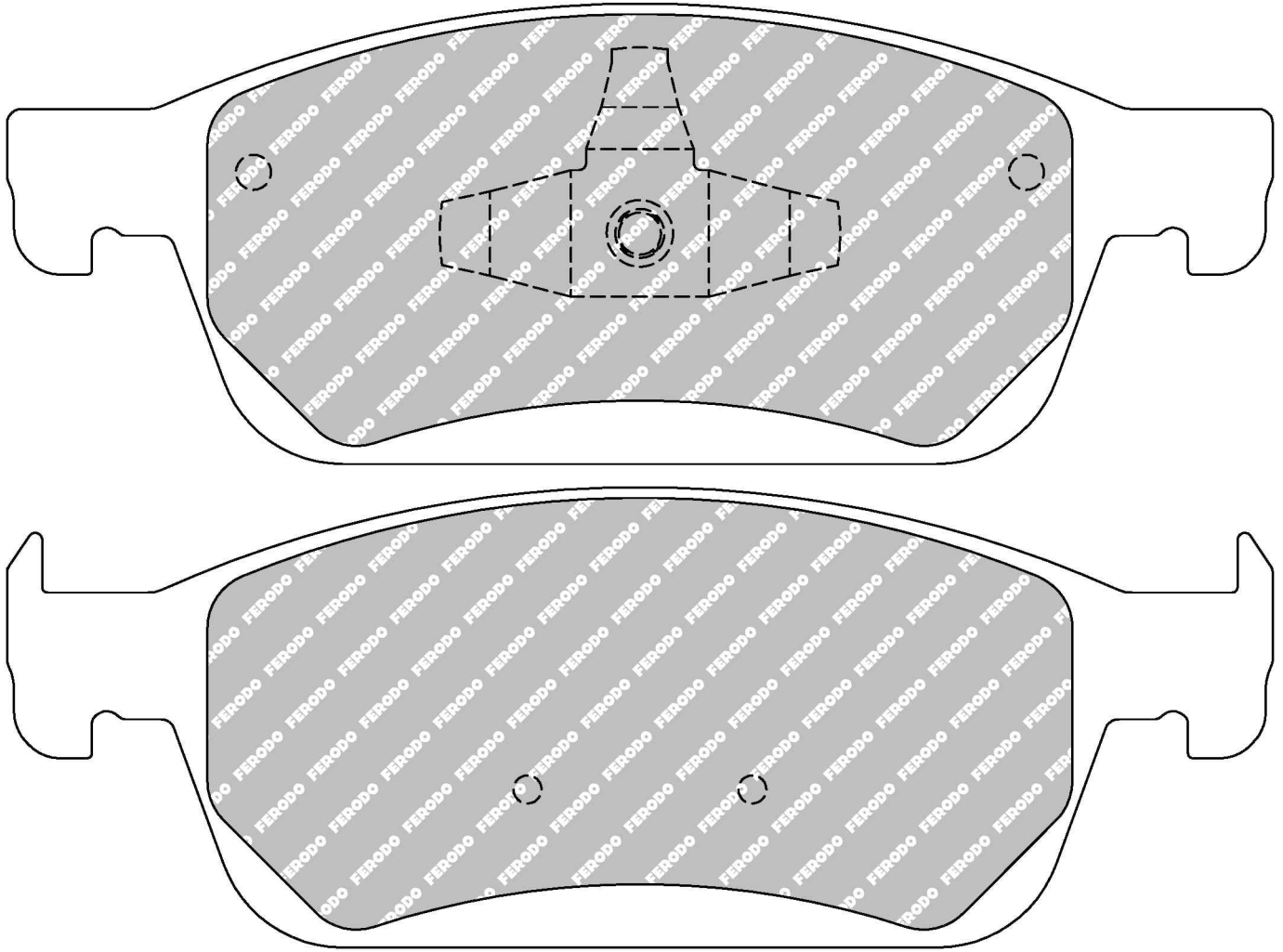
FORD Front



MATERIAL AVAILABILITY				
H	C	R	W	Z
				

CROSS REFERENCE	
WVA	23723 - 23724

-  Available
-  Exhausting
-  Not Available
-  Make to order
-  In Introduction

# FCP4426

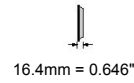
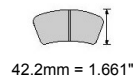

WVA No: 24 283

FMSI No: D1454

**IMPORTANT NOTICE: Please note that the height measurement represents the radial depth, not the entire back plate**

FORD Front, MAZDA Front, SUZUKI Front

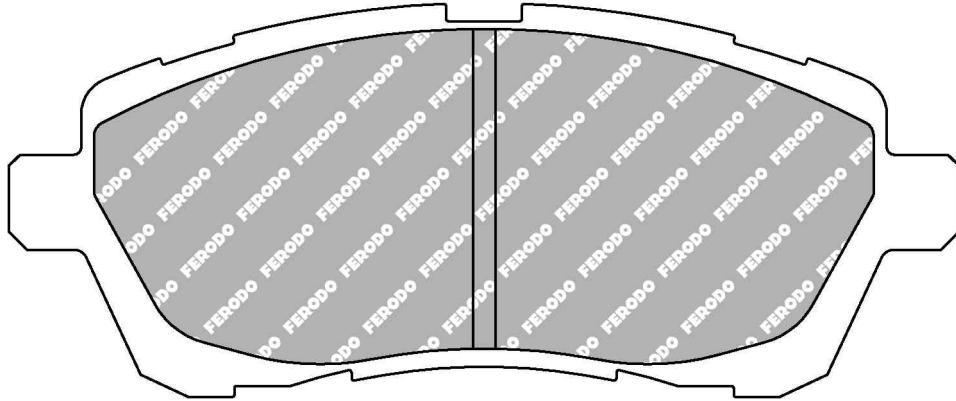

MATERIAL AVAILABILITY				
H	C	R	W	Z
✓		✓		✓

CROSS REFERENCE	
EBC	DPX2002
FMSI	D1454
HAWK	HB668
MINTEX	MDB2875
WVA	24 283

# FCP4430

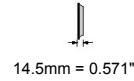
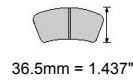
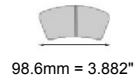

WVA No: 25 258

**IMPORTANT NOTICE: Please note that the height measurement represents the radial depth, not the entire back plate**

SUZUKI Rear

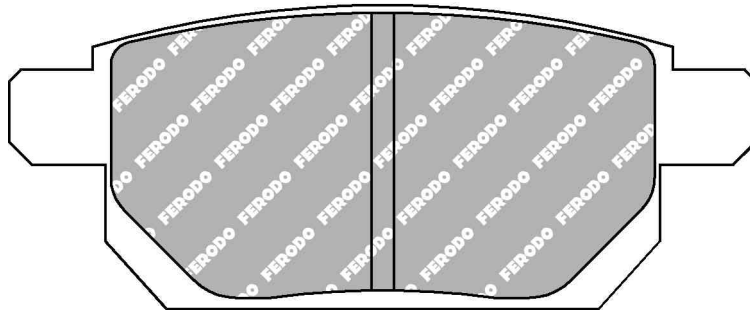

MATERIAL AVAILABILITY				
H	C	R	W	Z
✉				

CROSS REFERENCE	
WVA	25 258

# FCP4433

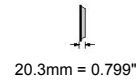
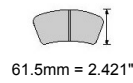

WVA No: 25 086

**IMPORTANT NOTICE: Please note that the height measurement represents the radial depth, not the entire back plate**

AUDI Front, SEAT Front, VOLKSWAGEN Front

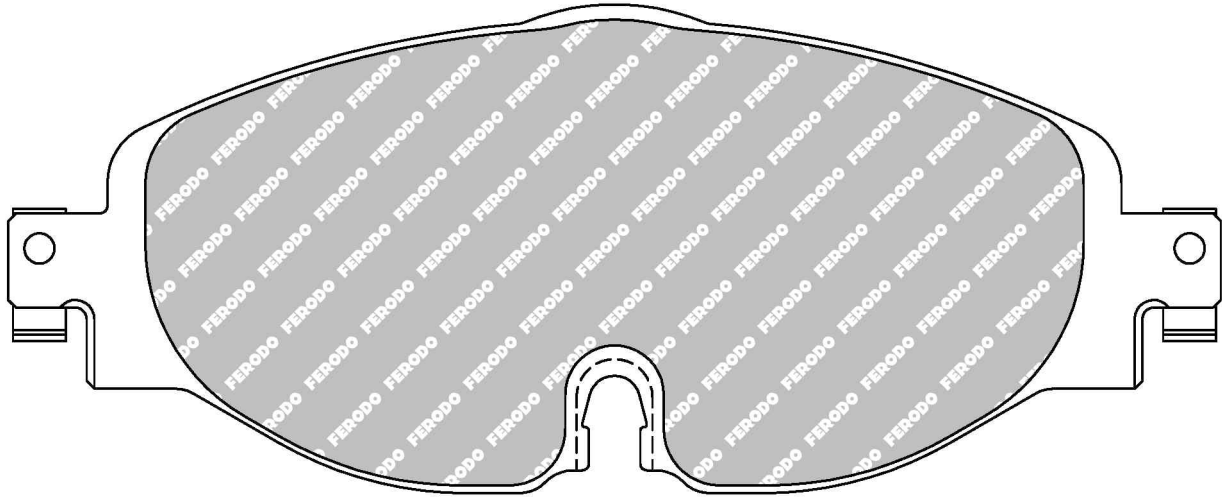

MATERIAL AVAILABILITY				
H	C	R	W	Z
✓				

CROSS REFERENCE	
OE AUDI	8V0698151
OE AUDI	8V0698151B
WVA	25 086

# FCP4612

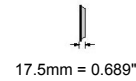
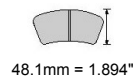
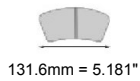

WVA No: 25 134 16,7

**IMPORTANT NOTICE: Please note that the height measurement represents the radial depth, not the entire back plate**

FORD Front

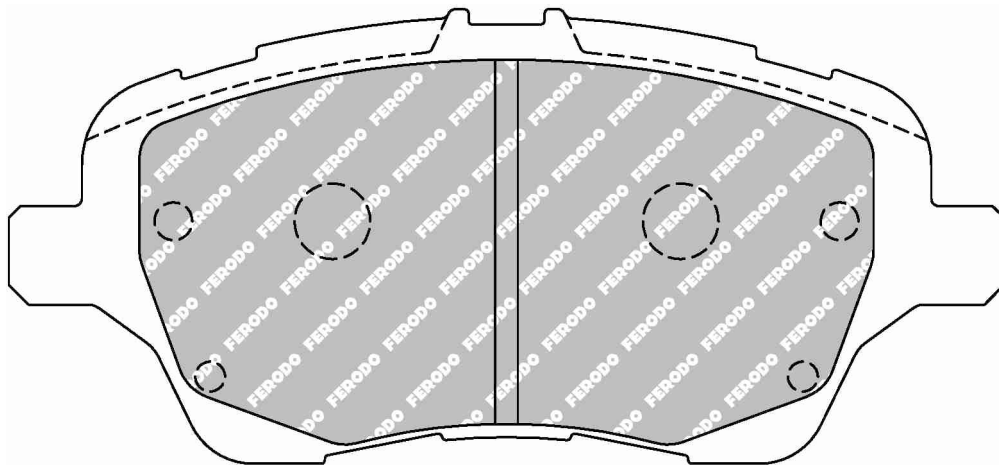

MATERIAL AVAILABILITY				
H	C	R	W	Z
⚡				

CROSS REFERENCE	
WVA	25 134 16,7

- ✓ Available    ⚠ Exhausting
- ✗ Not Available    ✉ Make to order
- ⚡ In Introduction

# FRP101

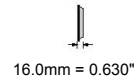
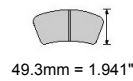
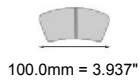

**IMPORTANT NOTICE:** Please note that the height measurement represents the radial depth, not the entire back plate

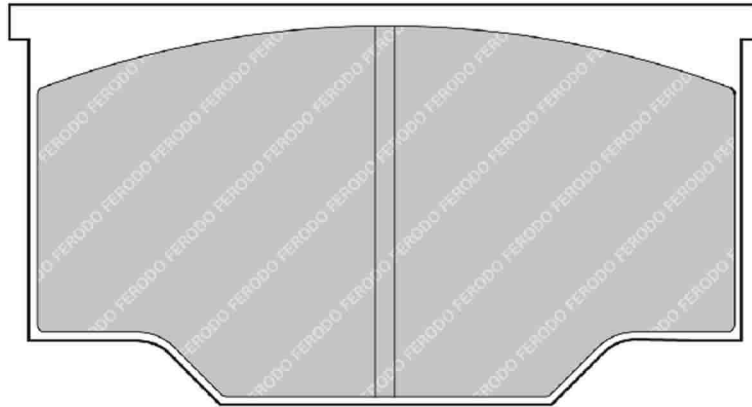

MATERIAL AVAILABILITY				
H	C	R	W	Z
		✓		

CROSS REFERENCE	
PAGID	1192
PFC	7710

# FRP201

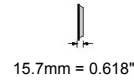
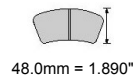
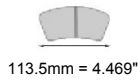

**IMPORTANT NOTICE:** Please note that the height measurement represents the radial depth, not the entire back plate

CATERHAM Front

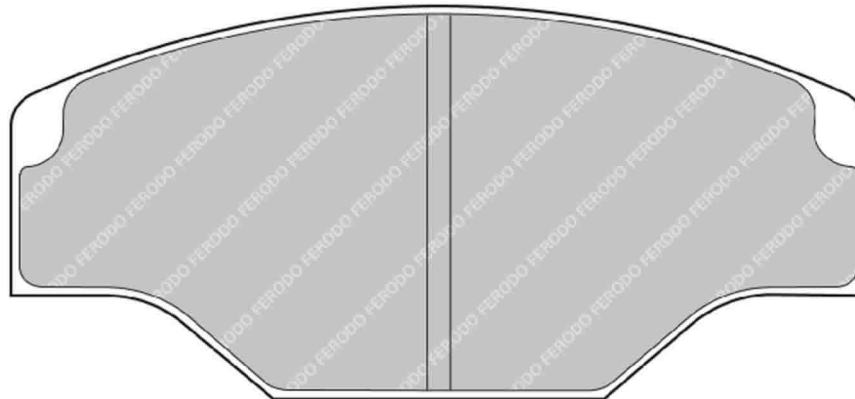

MATERIAL AVAILABILITY				
H	C	R	W	Z
✓	✗	✓	✓	✗

CROSS REFERENCE	
ALCON	PNF0084X264.4
ALCON	PNF4463X554
ALCON	PNF4463X554.4
ALCON	PNF4463X581.4
AP RACING	CP2340D51
PAGID	1265

# FRP202

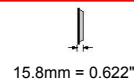
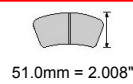

**IMPORTANT NOTICE:** Please note that the height measurement represents the radial depth, not the entire back plate

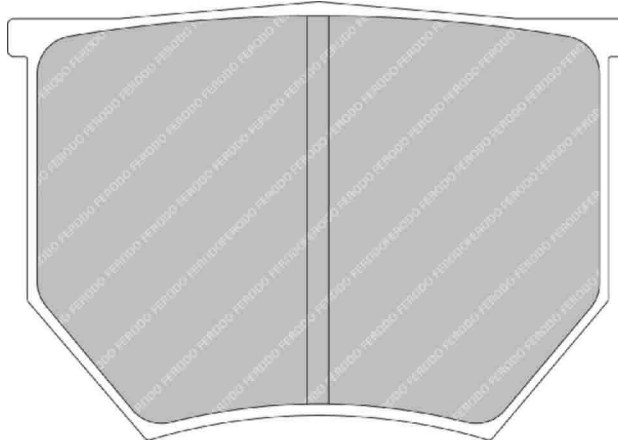

MATERIAL AVAILABILITY				
H	C	R	W	Z
✓	✓	✓		

CROSS REFERENCE	
AP RACING	CP2373
AP RACING	CP2382
AP RACING	CP2383
AP RACING	CP2384
PAGID	8040

# FRP203

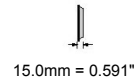
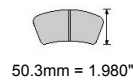
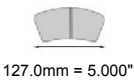

**IMPORTANT NOTICE:** Please note that the height measurement represents the radial depth, not the entire back plate

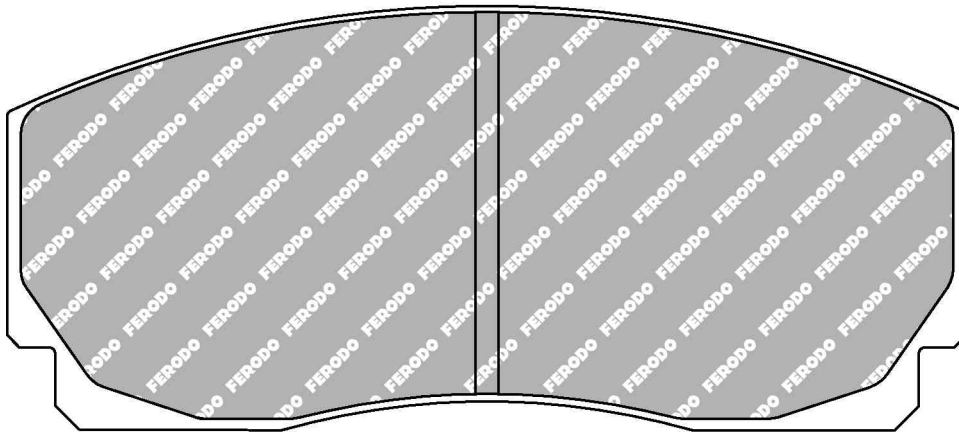

MATERIAL AVAILABILITY				
H	C	R	W	Z
✓		✓		✓

CROSS REFERENCE	
AP RACING	CP2270D50
PAGID	1269

# FRP212

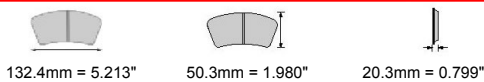

**IMPORTANT NOTICE: Please note that the height measurement represents the radial depth, not the entire back plate**

CHEVROLET Rear, OPEL Front

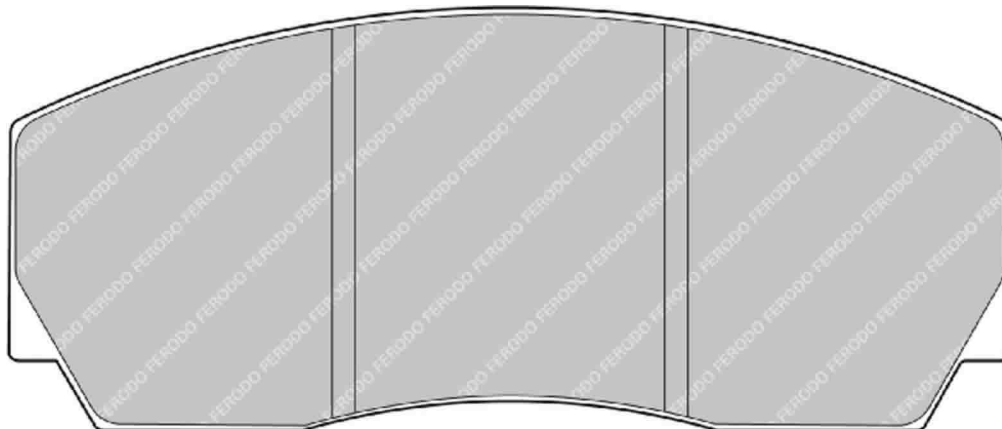

ALSO AVAILABLE		
SHAPE	TH. MM	NOTES
FRP216	17	

MATERIAL AVAILABILITY				
H	C	R	W	Z
✓		✓	✓	✓

CROSS REFERENCE	
AP RACING	CP2279D50
PAGID	1270
PFC	7767
PFC	7767.XX.20

# FRP216

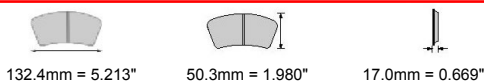

**IMPORTANT NOTICE: Please note that the height measurement represents the radial depth, not the entire back plate**

AC Front, ASTON MARTIN Front, RENAULT Front, SUBARU Front

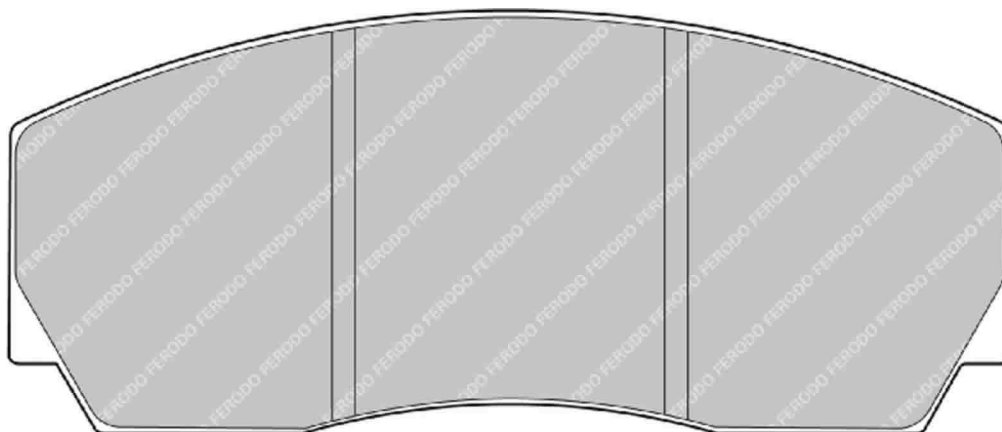

ALSO AVAILABLE		
SHAPE	TH. MM	NOTES
FRP212	20.3	

MATERIAL AVAILABILITY				
H	C	R	W	Z
✓	✗	✓	✓	✓

CROSS REFERENCE	
ALCON	PNF0084X245.4
ALCON	PNF0084X331
ALCON	PNF0084X331.4
AP RACING	CP3215D50
BREMBO	7767.XX.17
PAGID	1361



# FRP217

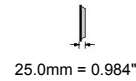
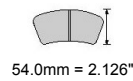
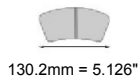

**IMPORTANT NOTICE: Please note that the height measurement represents the radial depth, not the entire back plate**

ASTON MARTIN Front

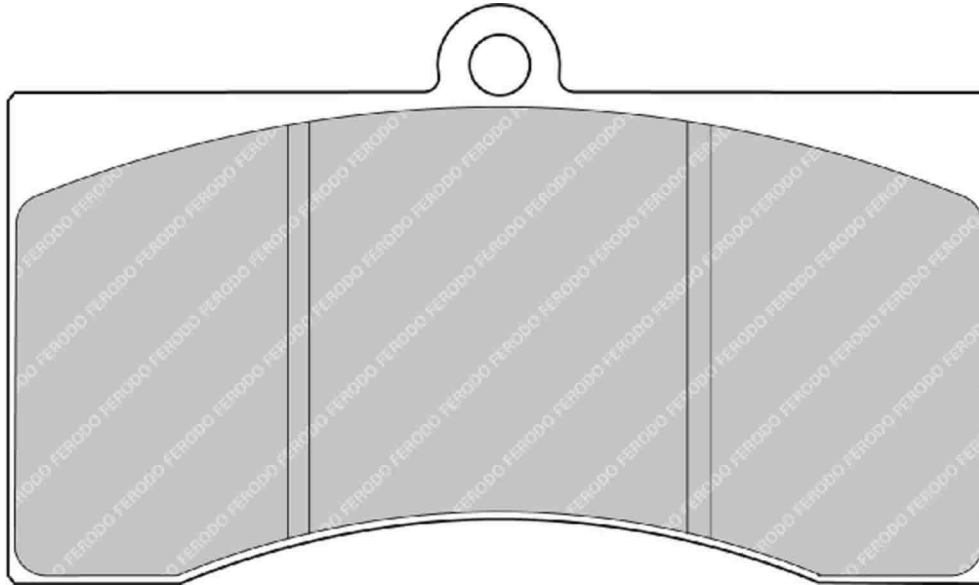

MATERIAL AVAILABILITY				
H	C	R	W	Z
		✓	✗	

CROSS REFERENCE	
AP RACING	CP3714D54
PAGID	1267
PFC	7714

# FRP218

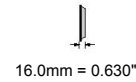
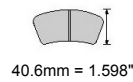

**IMPORTANT NOTICE: Please note that the height measurement represents the radial depth, not the entire back plate**

CITROEN Front

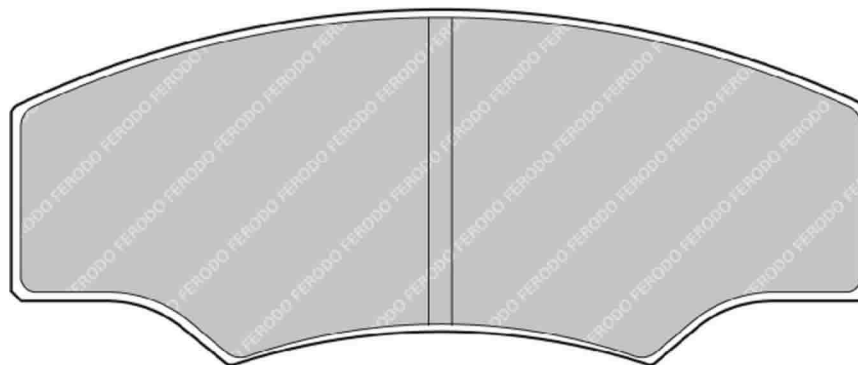

MATERIAL AVAILABILITY				
H	C	R	W	Z
✓	✓	✓	✓	

CROSS REFERENCE	
ALCON	PNF4463X551
ALCON	PNF4463X551.4
AP RACING	CP2340D43
PFC	7740

✓ Available    ⚠ Exhausting  
 ✗ Not Available    📧 Make to order  
 📌 In Introduction

**FERODO**  
RACING

Updated on 30th Jan 2014

**3189**

# FRP219

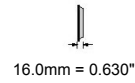
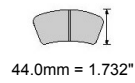

**IMPORTANT NOTICE: Please note that the height measurement represents the radial depth, not the entire back plate**

PEUGEOT Front, SUBARU Rear

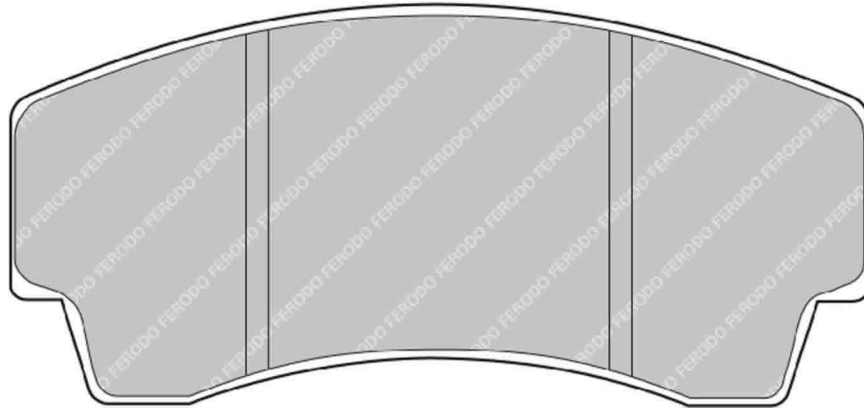

MATERIAL AVAILABILITY				
H	C	R	W	Z
✓	✓	✓	✓	✓

CROSS REFERENCE	
ALCON	PNF4463X529
ALCON	PNF4463X529.4
ALCON	PNF4463X572
AP RACING	CP3345D44
PAGID	1749
PAGID	2127
PFC	7745

# FRP302

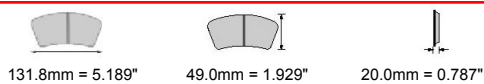

**IMPORTANT NOTICE:** Please note that the height measurement represents the radial depth, not the entire back plate

CITROEN Front, PORSCHE Rear

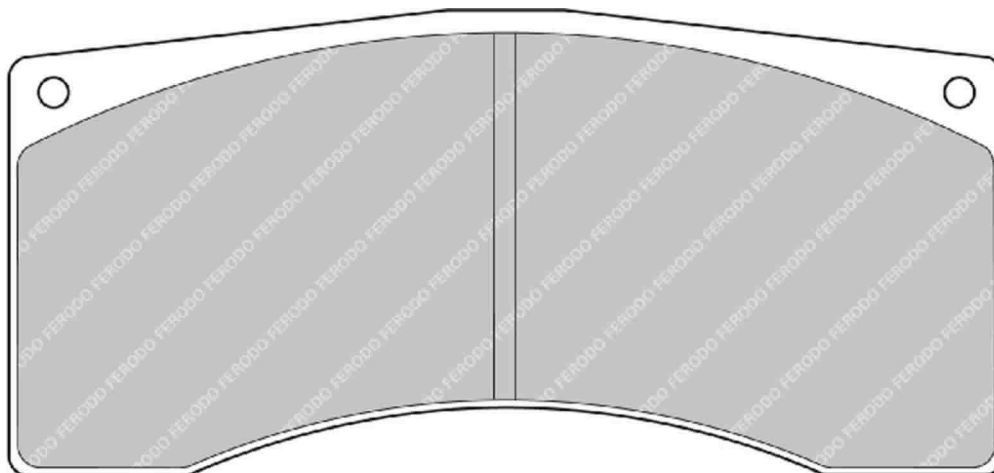

ALSO AVAILABLE		
SHAPE	TH. MM	NOTES
FRP1077	16	
FRP1078	25	
FRP3007	18	

MATERIAL AVAILABILITY				
H	C	R	W	Z
✓		✓	✉	✓

CROSS REFERENCE	
ALCON	PNF4441X728
ALCON	PNF4441X728.4
ALCON	PNF4441X754
ALCON	PNF4441X754.4
ALCON	PNF4441X757.4
BREMBO	07.5139.6
BREMBO	07.5139.65
BREMBO	07.5139.69
PAGID	1607
PFC	7700.XX.20

# FRP308

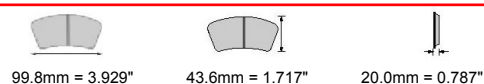

**IMPORTANT NOTICE:** Please note that the height measurement represents the radial depth, not the entire back plate

MITSUBISHI Rear

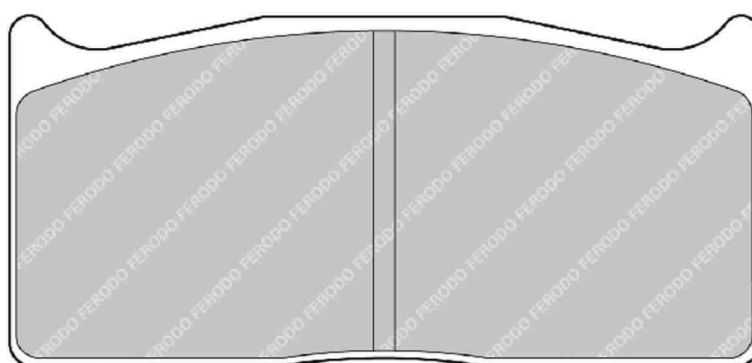

ALSO AVAILABLE		
SHAPE	TH. MM	NOTES
FRP1079	16	

MATERIAL AVAILABILITY				
H	C	R	W	Z
✓	✉	✓	✓	✓

CROSS REFERENCE	
BREMBO	07.5064.27
BREMBO	07.5064.7
BREMBO	07.5064.72
BREMBO	07.5064.73
PAGID	1283
PFC	7735.XX.20

- ✓ Available    ⚠ Exhausting
- ✗ Not Available    ✉ Make to order
- 📦 In Introduction

# FRP501

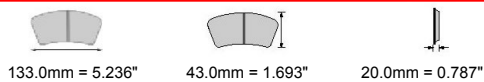

**IMPORTANT NOTICE:** Please note that the height measurement represents the radial depth, not the entire back plate

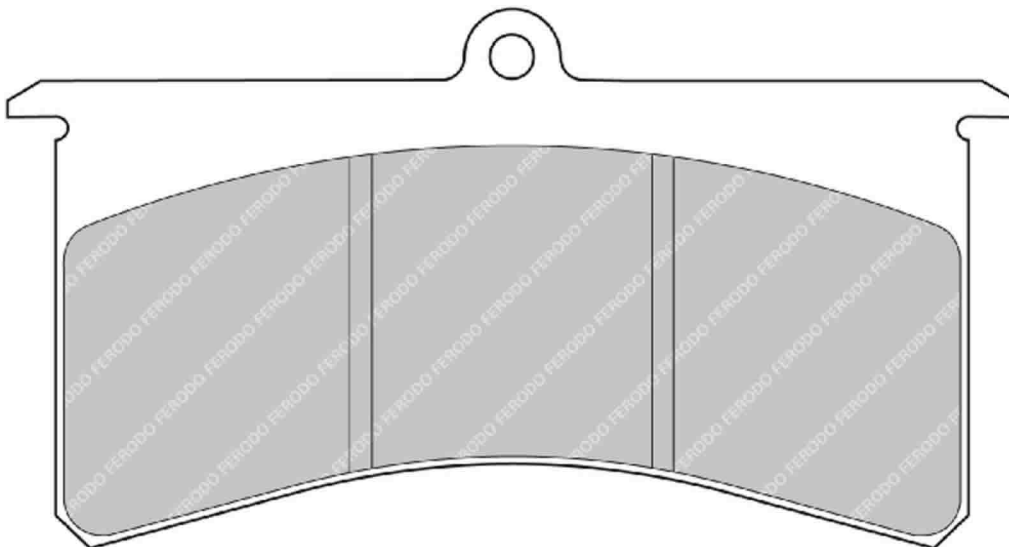

Same as FRP3097 but NON-fixed bridge caliper

ALSO AVAILABLE		
SHAPE	TH. MM	NOTES
FRP3097	none	Fixed Bridge Caliper

CROSS REFERENCE	
AP RACING	CP4751D43
PAGID	2555
PFC	7751

MATERIAL AVAILABILITY				
H	C	R	W	Z
✓		✓	✓	✉

# FRP502

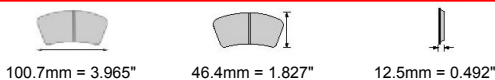

**IMPORTANT NOTICE:** Please note that the height measurement represents the radial depth, not the entire back plate

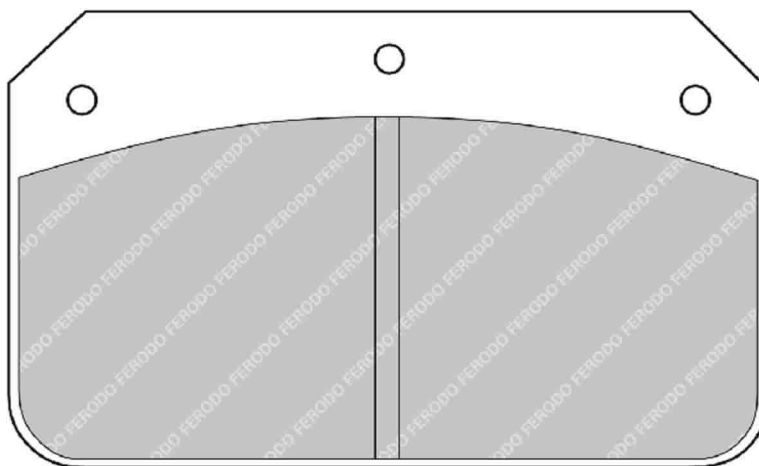

MATERIAL AVAILABILITY				
H	C	R	W	Z
✓	✓	✓	✓	

CROSS REFERENCE	
ALCON	PNF0084X284
ALCON	PNF0084X284.4
PFC	7752

# FRP503

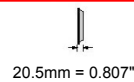
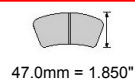

**IMPORTANT NOTICE:** Please note that the height measurement represents the radial depth, not the entire back plate

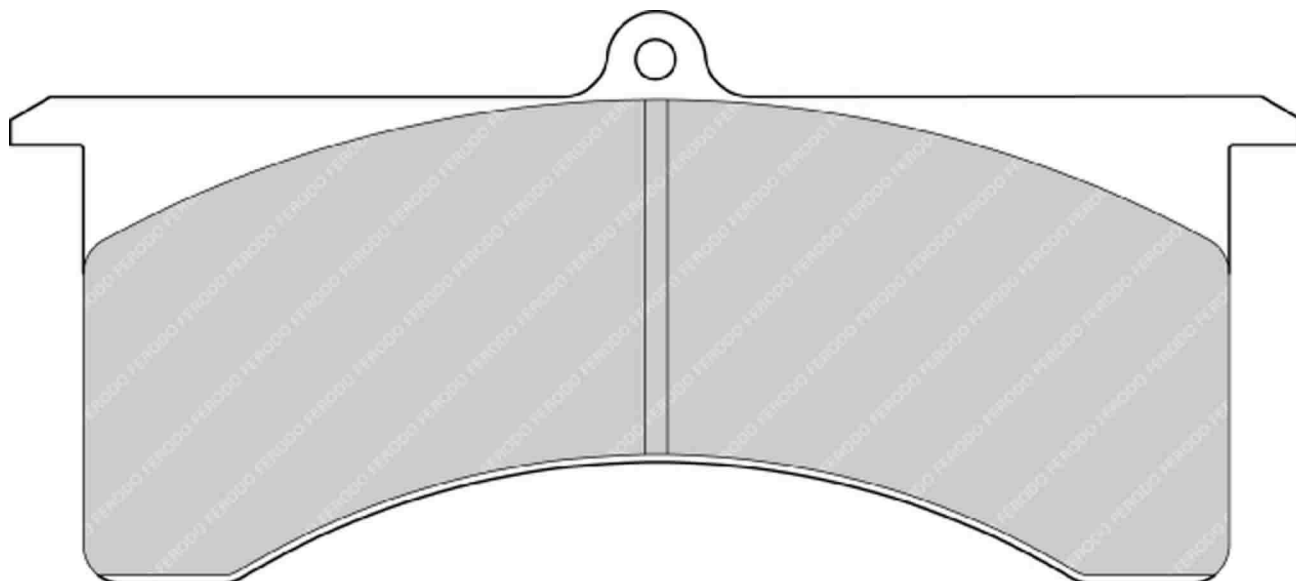

MATERIAL AVAILABILITY				
H	C	R	W	Z
⚠		✓	✓	

CROSS REFERENCE	
ALCON	PNF0084X350.4
AP RACING	CP5805D45

# FRP504

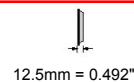
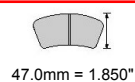
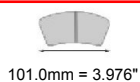

**IMPORTANT NOTICE:** Please note that the height measurement represents the radial depth, not the entire back plate

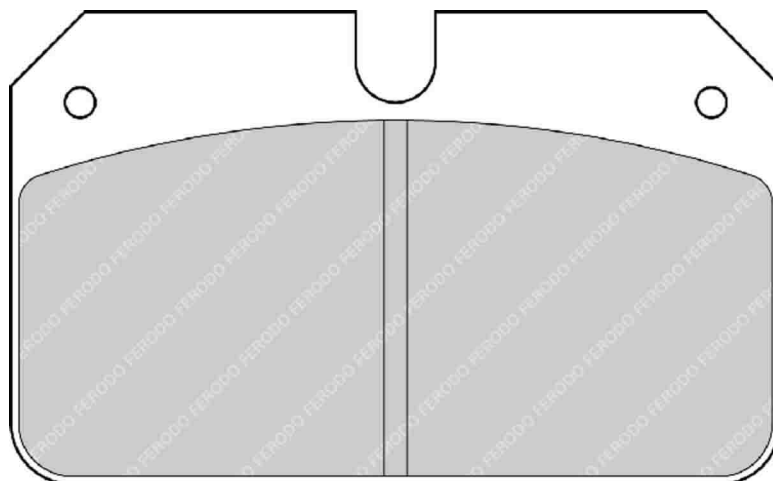

MATERIAL AVAILABILITY				
H	C	R	W	Z
✉		✓	✓	✓

CROSS REFERENCE	
PFC	7754

- ✓ Available    ⚠ Exhausting
- ✗ Not Available    ✉ Make to order
- 📦 In Introduction

# FRP506

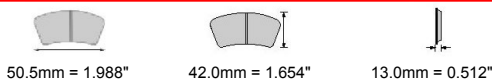

**IMPORTANT NOTICE:** Please note that the height measurement represents the radial depth, not the entire back plate

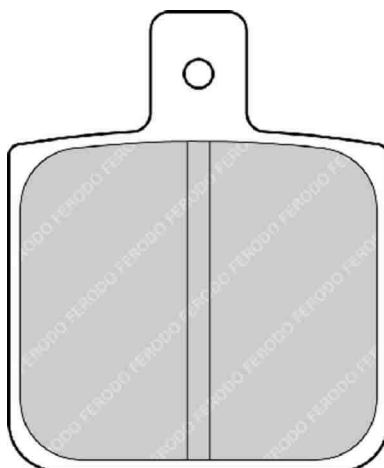

MATERIAL AVAILABILITY				
H	C	R	W	Z

CROSS REFERENCE	
PFC	7757

# FRP1058

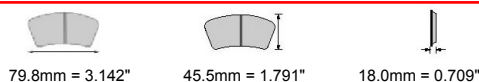

**IMPORTANT NOTICE:** Please note that the height measurement represents the radial depth, not the entire back plate

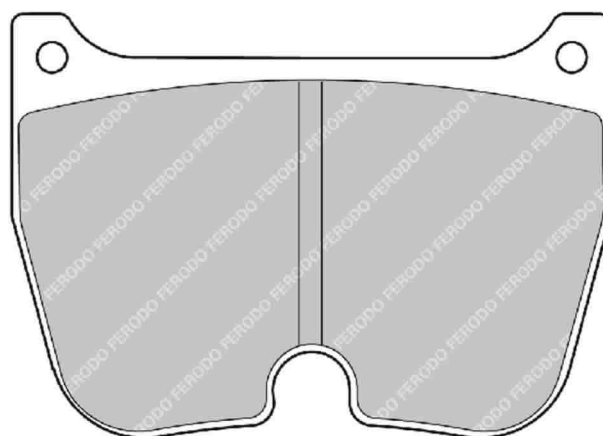

4 Pistons caliper

(1 set = 4 pads) - 2 sets per axle for the recommended applications

ALSO AVAILABLE		
SHAPE	TH. MM	NOTES
FRP1064	20	

CROSS REFERENCE	
BREMBO	07.5684.2
PFC	7748.XX.18

MATERIAL AVAILABILITY				
H	C	R	W	Z

# FRP1059



84.8mm = 3.339"



51.5mm = 2.028"



22.0mm = 0.866"

**IMPORTANT NOTICE:** Please note that the height measurement represents the radial depth, not the entire back plate

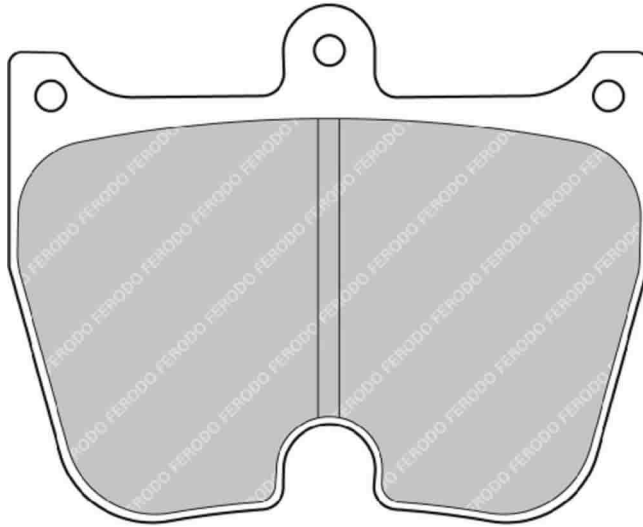

4 Pistons caliper

(1 set = 4 pads) - 2 sets per axle for the recommended applications

### ALSO AVAILABLE

SHAPE	TH. MM	NOTES
FRP3004	20	
FRP3034	21	
FRP3045	18	

### CROSS REFERENCE

BREMBO	07.5868
PAGID	2105
PFC	7742.XX.22
PFC	7802.XX.22

### MATERIAL AVAILABILITY

H	C	R	W	Z
		⚠		

✓ Available    ⚠ Exhausting  
 ✗ Not Available    ✉ Make to order  
 🔄 In Introduction

**FERODO**  
RACING

Updated on 30th Jan 2014

**3195**

# FRP1060

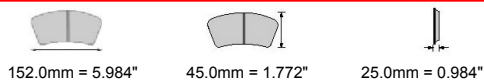

**IMPORTANT NOTICE:** Please note that the height measurement represents the radial depth, not the entire back plate

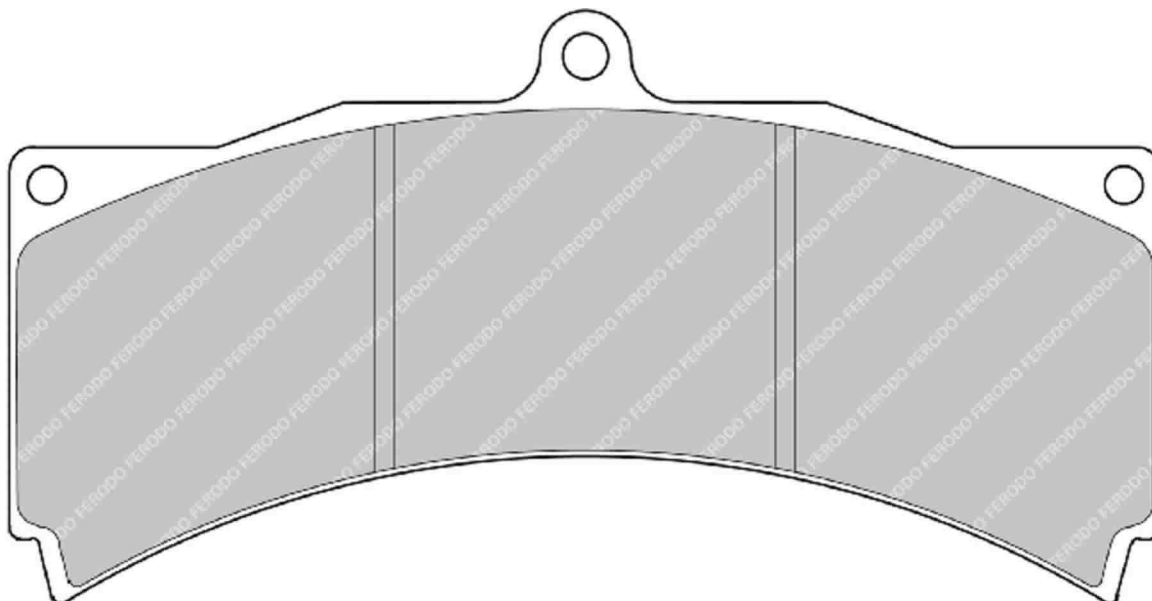

ALSO AVAILABLE		
SHAPE	TH. MM	NOTES
FRP3000	18	

CROSS REFERENCE	
AP RACING	CP3558D46
PAGID	1813

MATERIAL AVAILABILITY				
H	C	R	W	Z
		✓		✓

# FRP1061

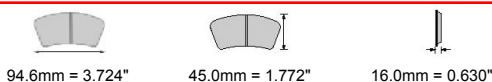

**IMPORTANT NOTICE:** Please note that the height measurement represents the radial depth, not the entire back plate

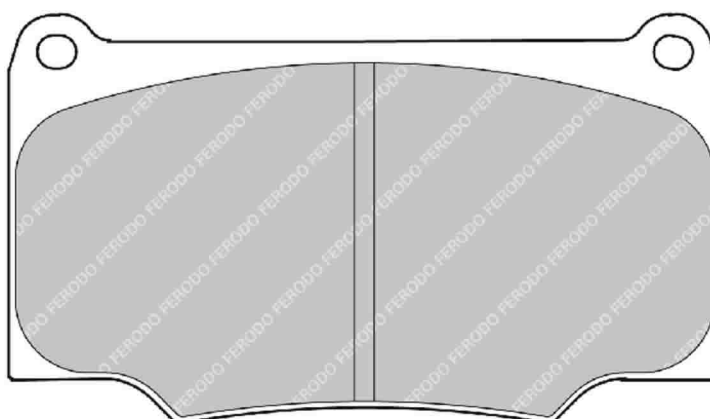

MATERIAL AVAILABILITY				
H	C	R	W	Z
		✗		

CROSS REFERENCE	
AP RACING	CP4296D43
PAGID	2141
PFC	7708



# FRP1064



79.8mm = 3.142"



45.5mm = 1.791"



20.0mm = 0.787"

**IMPORTANT NOTICE:** Please note that the height measurement represents the radial depth, not the entire back plate

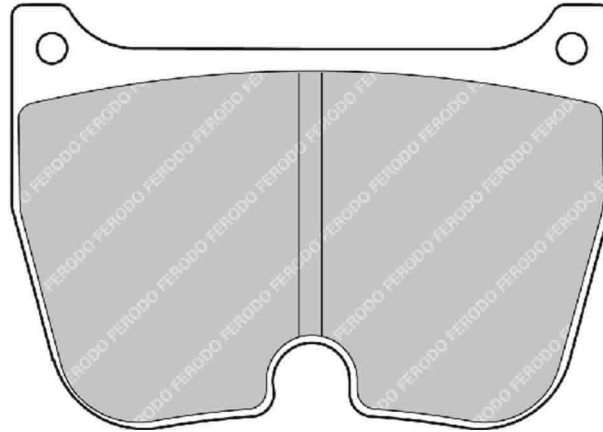

4 Pistons caliper

(1 set = 4 pads) - 2 sets per axle for the recommended applications

### ALSO AVAILABLE

SHAPE	TH. MM	NOTES
FRP1058	18	

### MATERIAL AVAILABILITY

H	C	R	W	Z

### CROSS REFERENCE

ALCON	PNF0084X282.4
BREMBO	07.5684.2
BREMBO	07.5684.25
BREMBO	07.5684.26
PAGID	2053
PFC	7748.XX.20

Available   
 Exhausting  
 Not Available   
 Make to order  
 In Introduction

**FERODO**  
RACING

Updated on 30th Jan 2014

**3197**

# FRP1077



131.8mm = 5.189"



49.0mm = 1.929"



16.0mm = 0.630"

**IMPORTANT NOTICE: Please note that the height measurement represents the radial depth, not the entire back plate**

FERRARI Rear, PEUGEOT Front

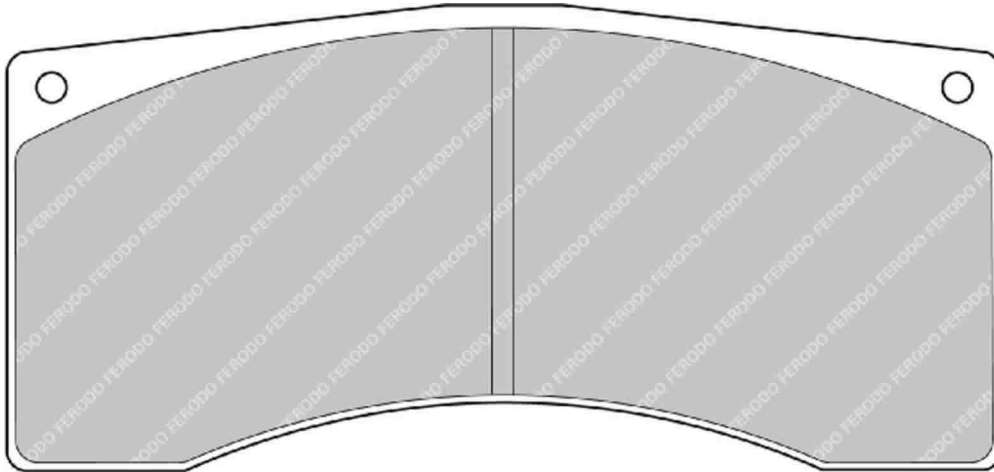

### ALSO AVAILABLE

SHAPE	TH. MM	NOTES
FRP1078	25	
FRP3007	18	
FRP302	20	

### MATERIAL AVAILABILITY

H	C	R	W	Z
✓		✓	✓	✓

### CROSS REFERENCE

ALCON	PNF4441X723
ALCON	PNF4441X723.4
ALCON	PNF4441X753
ALCON	PNF4441X753S.4
ALCON	PNF4441X769.4
BREMBO	07.5139.0
BREMBO	07.5139.07
BREMBO	07.5139.19
HAWK	HB105 0,62
PAGID	1595
PFC	7700.XX.16

# FRP1078

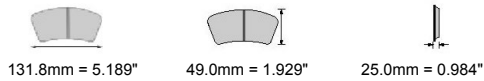

**IMPORTANT NOTICE:** Please note that the height measurement represents the radial depth, not the entire back plate

FERRARI Front / Rear, PORSCHE Rear

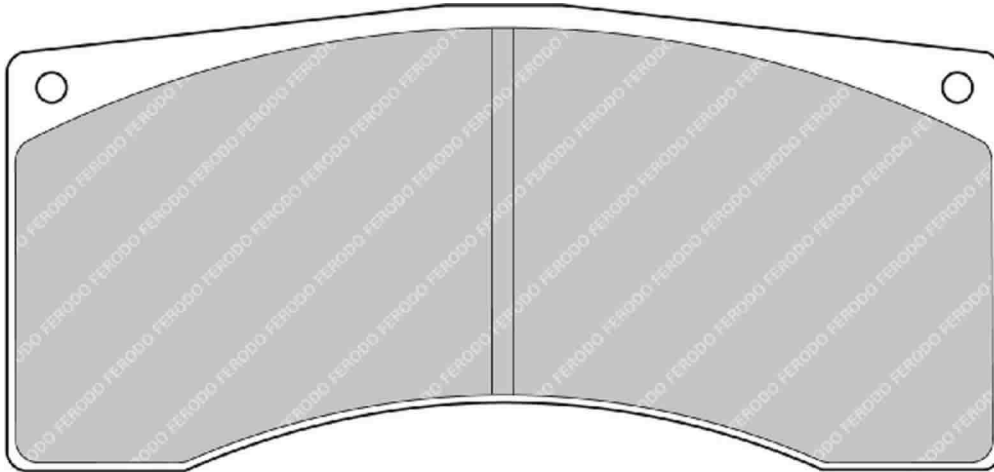

ALSO AVAILABLE		
SHAPE	TH. MM	NOTES
FRP1077	16	
FRP3007	18	
FRP302	20	

CROSS REFERENCE	
AP RACING	CP6070D49
BREMBO	07.5139.3
BREMBO	07.5139.34
BREMBO	07.5139.81
PAGID	1674
PFC	7700.XX.25

MATERIAL AVAILABILITY				
H	C	R	W	Z
		✓	✓	✓

# FRP1079

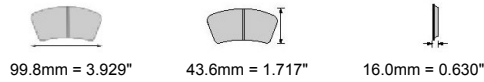

**IMPORTANT NOTICE:** Please note that the height measurement represents the radial depth, not the entire back plate

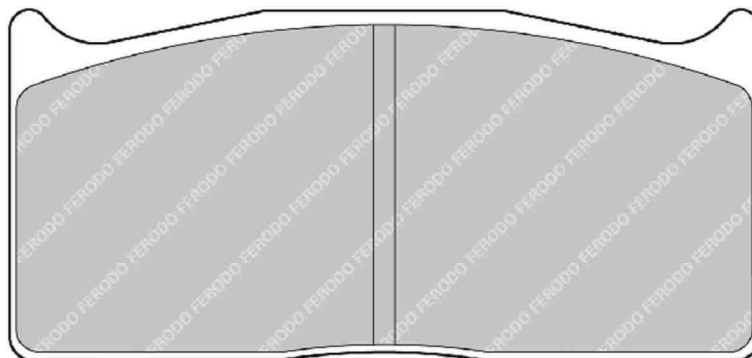

ALSO AVAILABLE		
SHAPE	TH. MM	NOTES
FRP308	20	

CROSS REFERENCE	
ALCON	PNF0084X322.4
BREMBO	07.5064.49
BREMBO	07.5064.8
BREMBO	07.5064.82
BREMBO	07.5064.84
PAGID	1705
PFC	7735.XX.16

MATERIAL AVAILABILITY				
H	C	R	W	Z
✉	✉	✓		

- ✓ Available    ⚠ Exhausting
- ✗ Not Available    ✉ Make to order
- 📧 In Introduction

# FRP3000

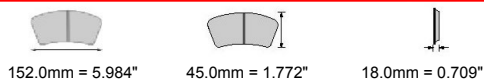

**IMPORTANT NOTICE:** Please note that the height measurement represents the radial depth, not the entire back plate

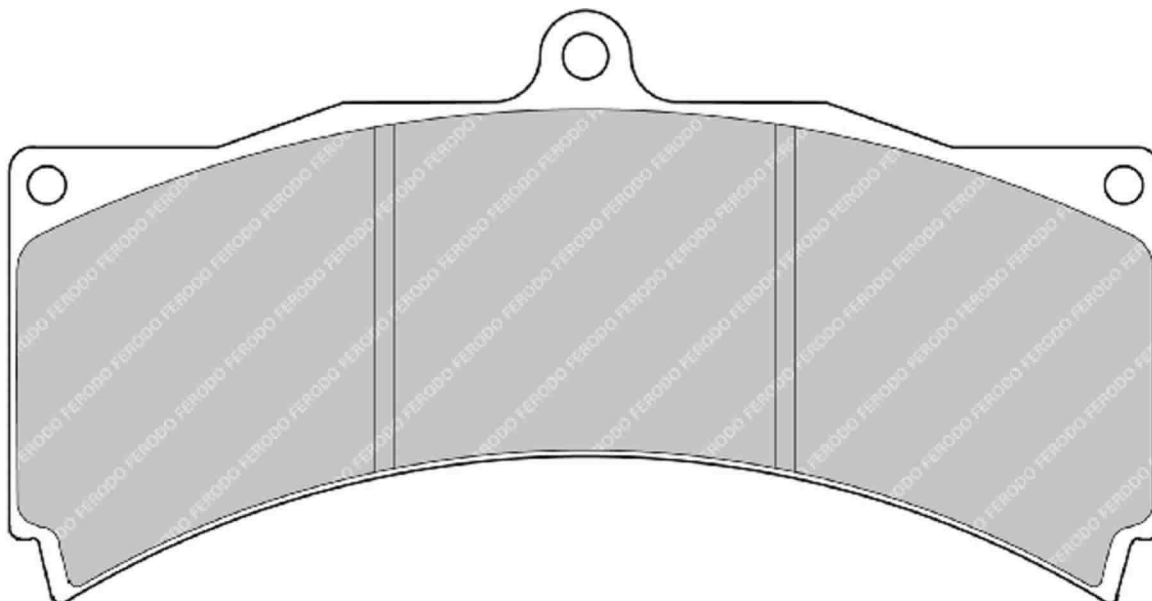

ALSO AVAILABLE		
SHAPE	TH. MM	NOTES
FRP1060	25	

CROSS REFERENCE	
ALCON	PNF4489X519.4
ALCON	PNF4489X562.4
ALCON	PNF4489X565.4
AP RACING	CP3894D46
PAGID	1852

MATERIAL AVAILABILITY				
H	C	R	W	Z
✓		✓	✉	

# FRP3001

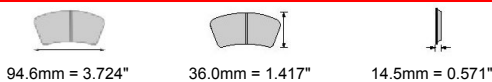

**IMPORTANT NOTICE:** Please note that the height measurement represents the radial depth, not the entire back plate

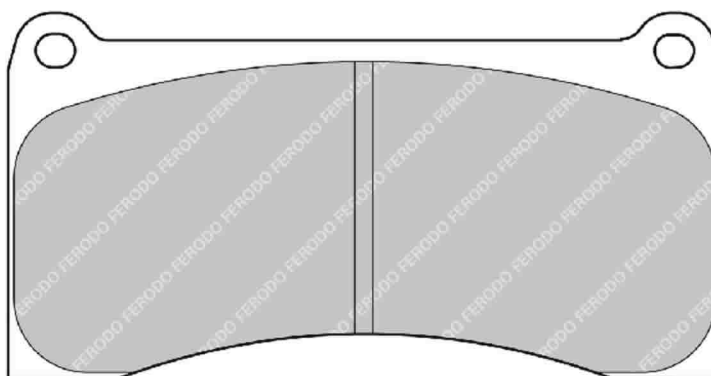

MATERIAL AVAILABILITY				
H	C	R	W	Z
⚠	⚠	⚠		

CROSS REFERENCE	
AP RACING	CP4140D36

# FRP3003



152.1mm = 5.988"



54.0mm = 2.126"



18.0mm = 0.709"

**IMPORTANT NOTICE:** Please note that the height measurement represents the radial depth, not the entire back plate

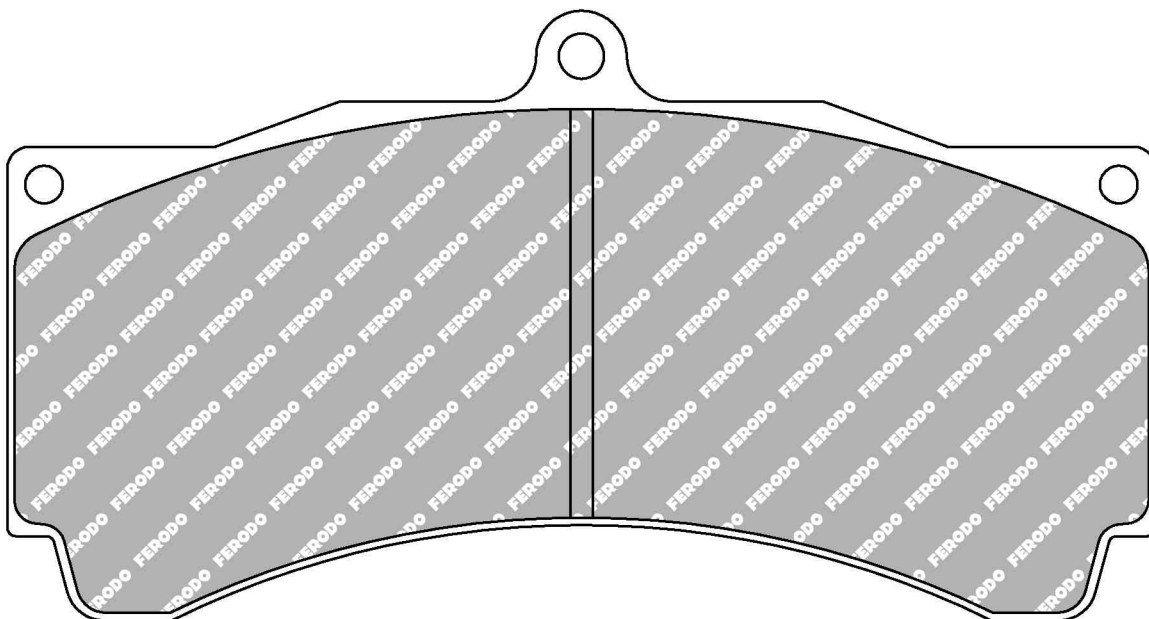

ALSO AVAILABLE		
SHAPE	TH. MM	NOTES
FRP3014	25	
FRP3015	28.5	
FRP3077	17	

CROSS REFERENCE	
ALCON	PNF4489X532.4
AP RACING	CP3894D54
HAWK	HB109 0,71
PFC	7790.XX.18

MATERIAL AVAILABILITY				
H	C	R	W	Z
✓		✓	✓	✓

- ✓ Available    ⚠ Exhausting
- ✗ Not Available    📧 Make to order
- 🔵 In Introduction

# FRP3004



84.8mm = 3.339"



51.5mm = 2.028"



20.0mm = 0.787"

**IMPORTANT NOTICE: Please note that the height measurement represents the radial depth, not the entire back plate**

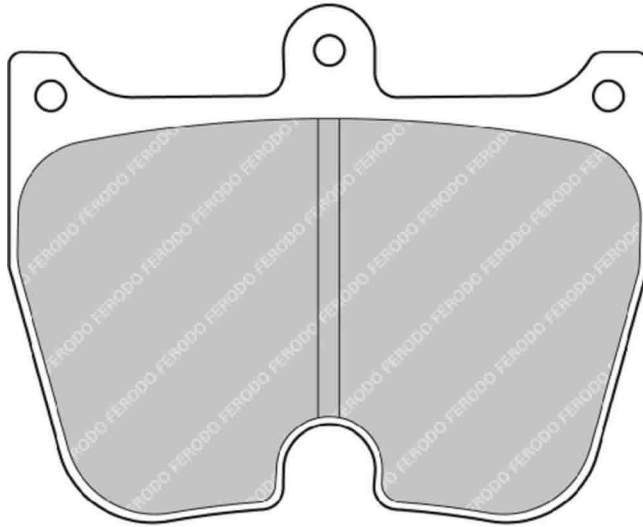

4 Pistons caliper

(1 set = 4 pads) - 2 sets per axle for the recommended applications

ALSO AVAILABLE		
SHAPE	TH. MM	NOTES
FRP1059	22	
FRP3034	21	
FRP3045	18	

CROSS REFERENCE	
ALCON	PNF0084X283.4
BREMBO	07.5868.2
BREMBO	07.5868.29
PFC	7742.XX.20
PFC	7802.XX.20

MATERIAL AVAILABILITY				
H	C	R	W	Z

# FRP3006



152.0mm = 5.984"



54.0mm = 2.126"



16.0mm = 0.630"

**IMPORTANT NOTICE:** Please note that the height measurement represents the radial depth, not the entire back plate

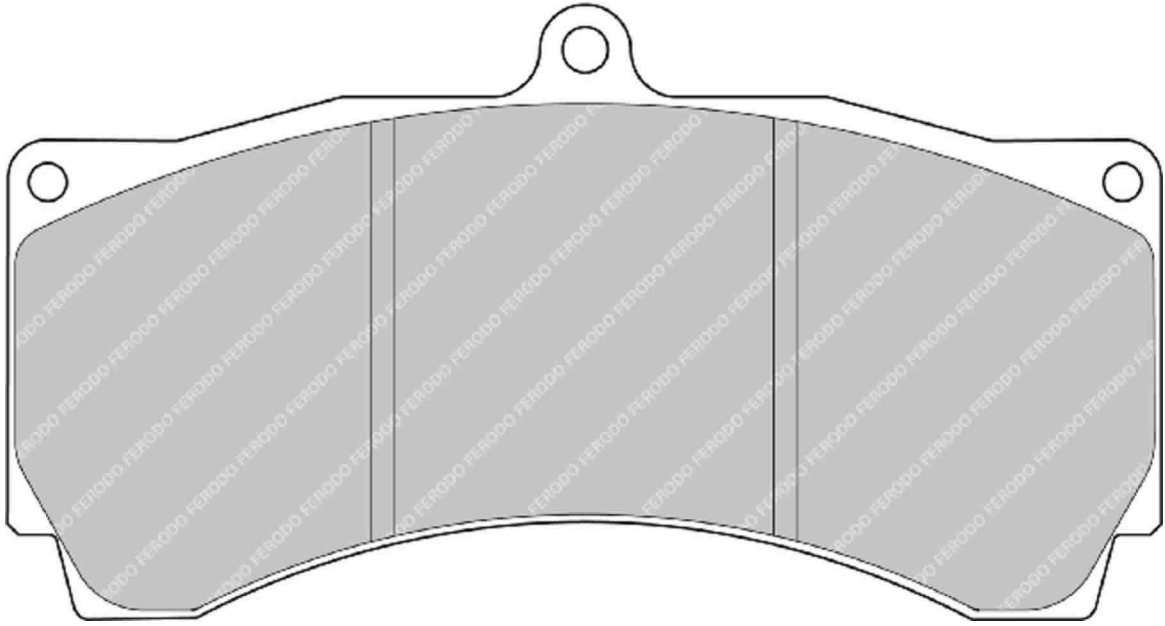

MATERIAL AVAILABILITY				
H	C	R	W	Z

CROSS REFERENCE	
AP RACING	CP3796D54

- Available
- Not Available
- In Introduction
- Exhausting
- Make to order

# FRP3007



131.8mm = 5.189"



49.0mm = 1.929"



18.0mm = 0.709"

**IMPORTANT NOTICE:** Please note that the height measurement represents the radial depth, not the entire back plate

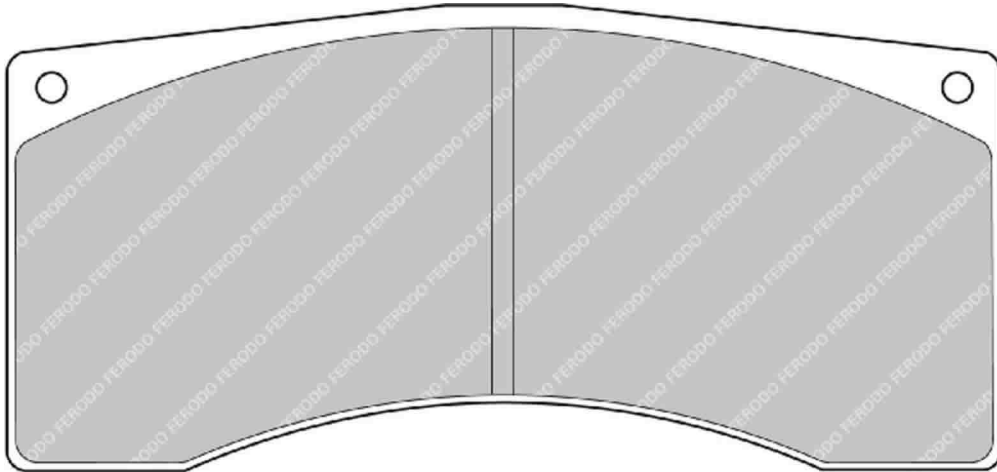

### ALSO AVAILABLE

SHAPE	TH. MM	NOTES
FRP1077	16	
FRP1078	25	
FRP302	20	

### CROSS REFERENCE

PFC	7700.XX.18
-----	------------

### MATERIAL AVAILABILITY

H	C	R	W	Z



# FRP3009



131.7mm = 5.185"



59.0mm = 2.323"



16.0mm = 0.630"

**IMPORTANT NOTICE:** Please note that the height measurement represents the radial depth, not the entire back plate

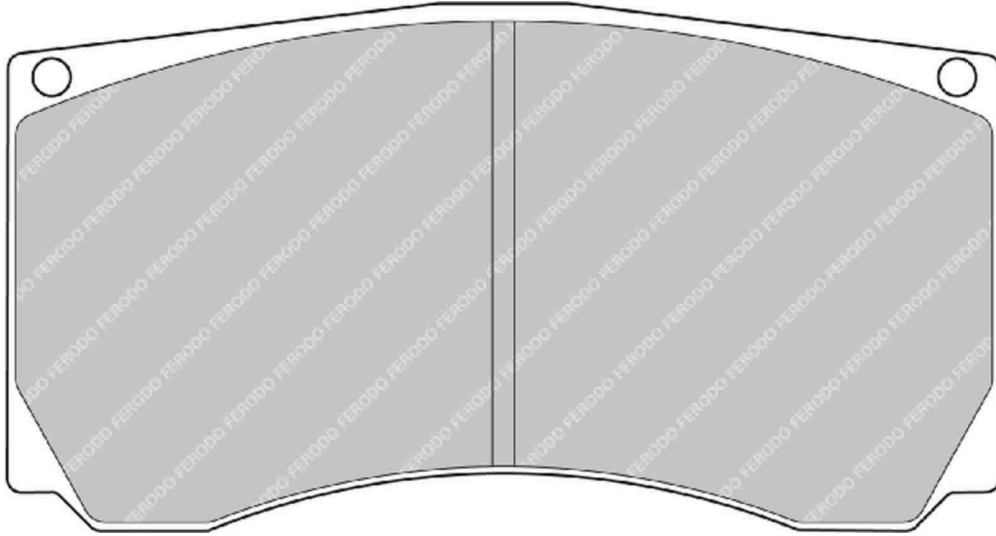

### ALSO AVAILABLE

SHAPE	TH. MM	NOTES
FRP3012	20	

### MATERIAL AVAILABILITY

H	C	R	W	Z

### CROSS REFERENCE

ALCON	PNF4476X545
ALCON	PNF4476X545.4
PFC	7755

Available   
 Exhausting  
 Not Available   
 Make to order  
 In Introduction

**FERODO**  
RACING

Updated on 30th Jan 2014

**3205**

# FRP3012



131.7mm = 5.185"



59.0mm = 2.323"



20.0mm = 0.787"

**IMPORTANT NOTICE:** Please note that the height measurement represents the radial depth, not the entire back plate

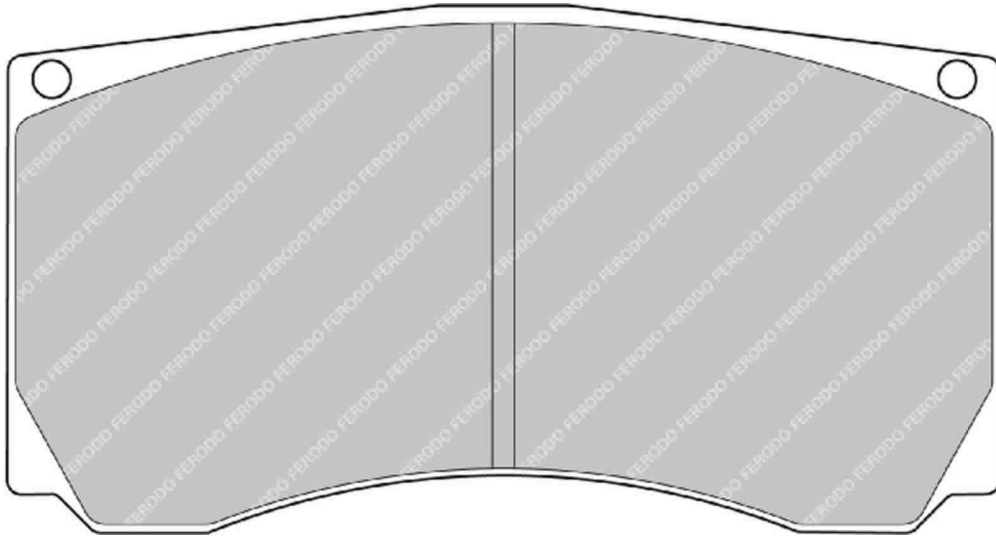

### ALSO AVAILABLE

SHAPE	TH. MM	NOTES
FRP3009	16	

### MATERIAL AVAILABILITY

H	C	R	W	Z

### CROSS REFERENCE

ALCON	PNF4476X549
ALCON	PNF4476X549.4
PAGID	1756
PFC	7756

# FRP3014



152.1mm = 5.988"



54.0mm = 2.126"



25.0mm = 0.984"

**IMPORTANT NOTICE:** Please note that the height measurement represents the radial depth, not the entire back plate

CHEVROLET Front

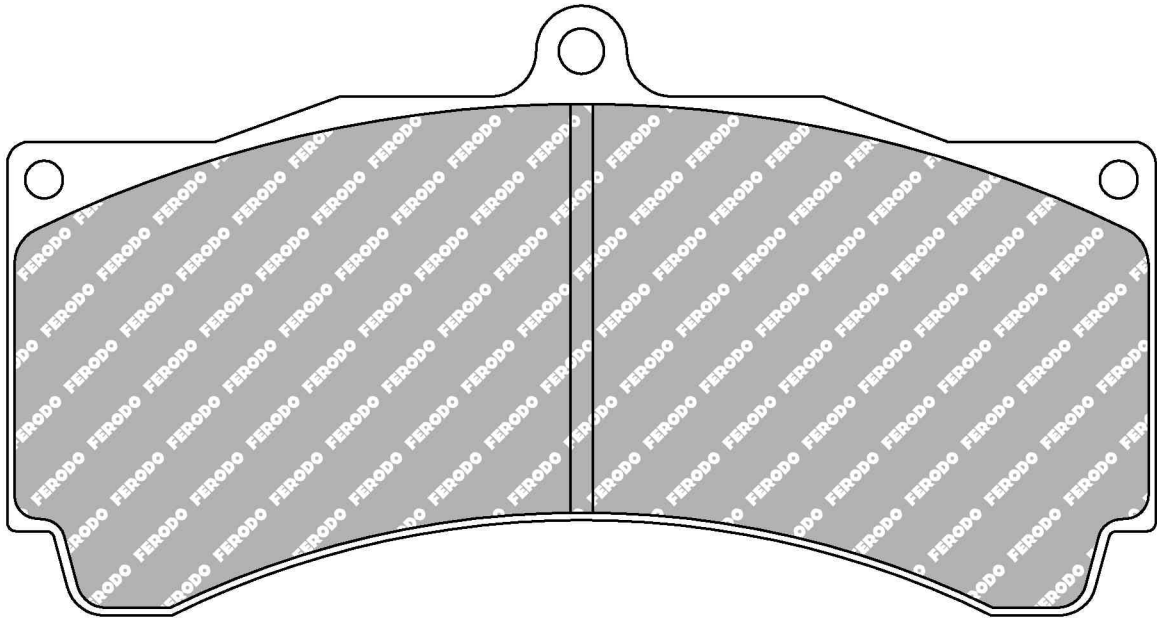

ALSO AVAILABLE		
SHAPE	TH. MM	NOTES
FRP3003	18	
FRP3015	28.5	
FRP3077	17	

CROSS REFERENCE	
AP RACING	CP3558D54
PFC	7790.XX.25

MATERIAL AVAILABILITY				
H	C	R	W	Z
		✓	✓	✓

- ✓ Available    ⚠ Exhausting
- ✗ Not Available    📧 Make to order
- 🔵 In Introduction

# FRP3015



152.1mm = 5.988"



54.0mm = 2.126"



28.5mm = 1.122"

**IMPORTANT NOTICE:** Please note that the height measurement represents the radial depth, not the entire back plate

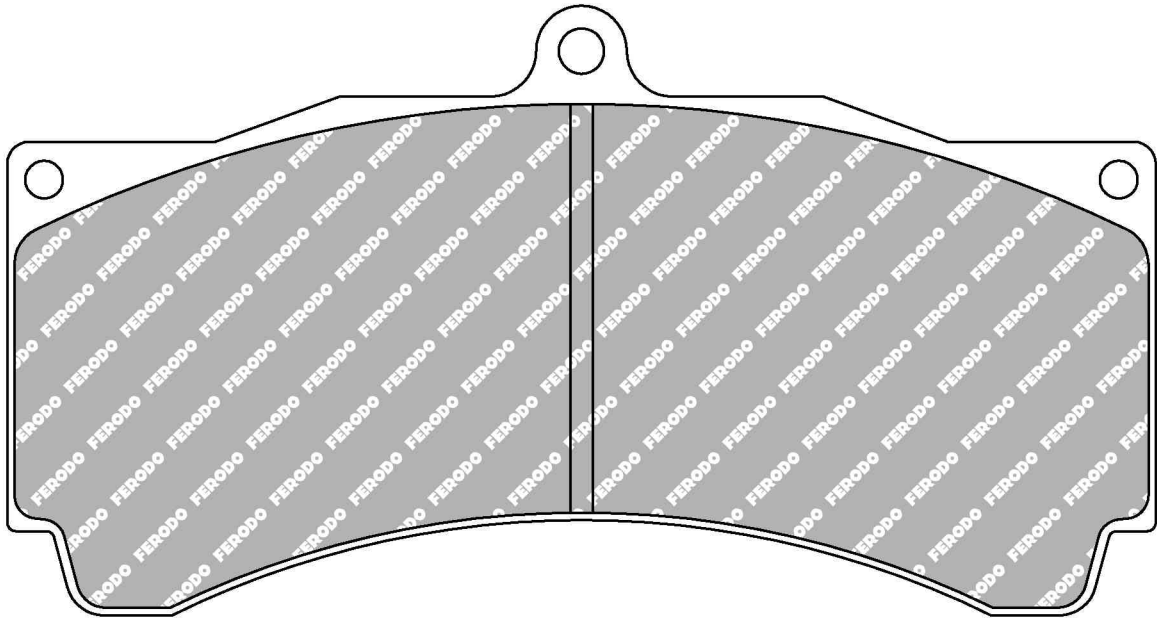

### ALSO AVAILABLE

SHAPE	TH. MM	NOTES
FRP3003	18	
FRP3014	25	
FRP3077	17	

### CROSS REFERENCE

ALCON	PNF4489X543
AP RACING	CP4595D54
PFC	7790.XX.28

### MATERIAL AVAILABILITY

H	C	R	W	Z
			✓	

# FRP3018

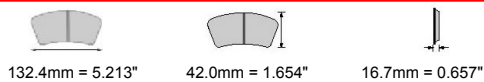

**IMPORTANT NOTICE:** Please note that the height measurement represents the radial depth, not the entire back plate

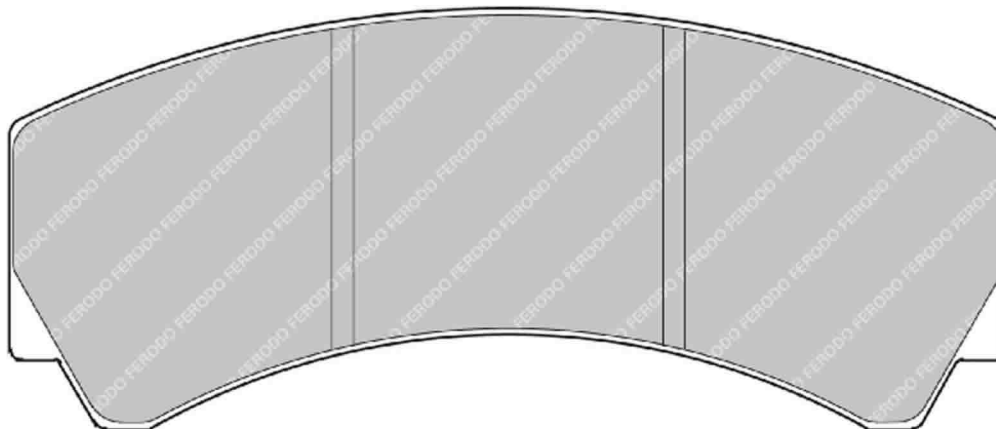

ALSO AVAILABLE		
SHAPE	TH. MM	NOTES
FRP3073	20.3	

CROSS REFERENCE	
ALCON	PNF0084X276.4
AP RACING	CP3215D42
PAGID	2126
PFC	7768.XX.16

MATERIAL AVAILABILITY				
H	C	R	W	Z
✓		✓	✓	

# FRP3020

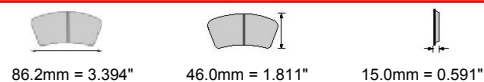

**IMPORTANT NOTICE:** Please note that the height measurement represents the radial depth, not the entire back plate

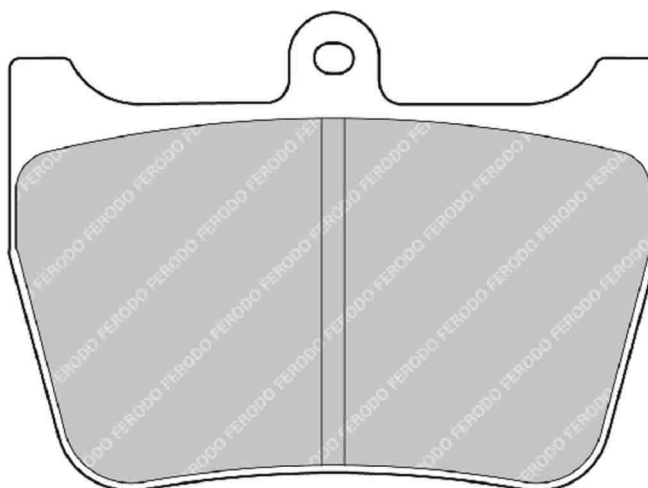

4 Pistons caliper (1 set = 4 pads) - 2 sets per axle for the recommended applications

ALSO AVAILABLE		
SHAPE	TH. MM	NOTES
FRP3086	18	

CROSS REFERENCE	
AP RACING	CP5148D46
PFC	7804.XX.15

MATERIAL AVAILABILITY				
H	C	R	W	Z
		✓		

- ✓ Available
- ✗ Not Available
- ⚠ Exhausting
- ✉ Make to order
- 🔵 In Introduction

# FRP3021

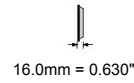
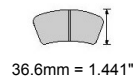

**IMPORTANT NOTICE:** Please note that the height measurement represents the radial depth, not the entire back plate

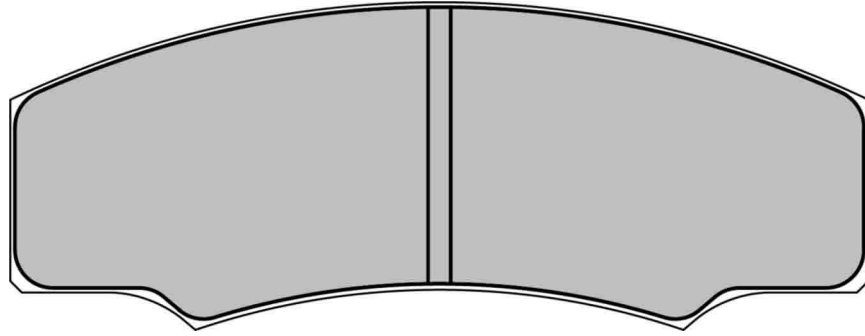

MATERIAL AVAILABILITY				
H	C	R	W	Z

CROSS REFERENCE	
AP RACING	CP2340D38

# FRP3022

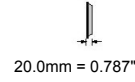
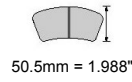
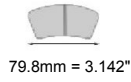

**IMPORTANT NOTICE:** Please note that the height measurement represents the radial depth, not the entire back plate

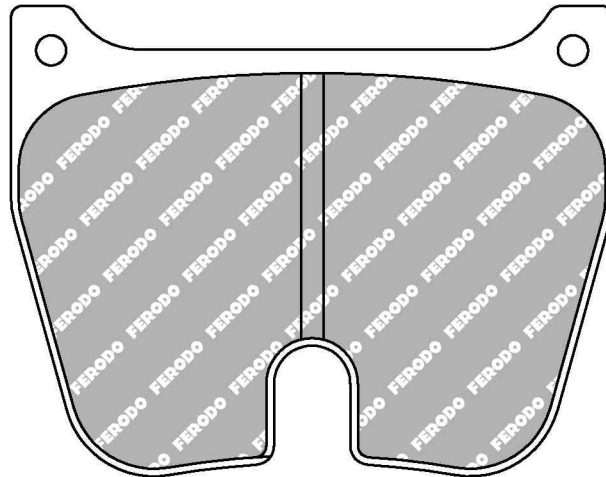

4 Pistons caliper (1 set = 4 pads) - 2 sets per axle for the recommended applications

ALSO AVAILABLE		
SHAPE	TH. MM	NOTES
FRP3023	17.5	
FRP3033	21	

CROSS REFERENCE	
BREMBO	07.5684.5
BREMBO	07.5684.52
BREMBO	07.5684.56
PFC	7743.XX.20

MATERIAL AVAILABILITY				
H	C	R	W	Z

- Available
- Exhausting
- Not Available
- Make to order
- In Introduction

# FRP3023



79.8mm = 3.142"



50.5mm = 1.988"



17.5mm = 0.689"

**IMPORTANT NOTICE:** Please note that the height measurement represents the radial depth, not the entire back plate

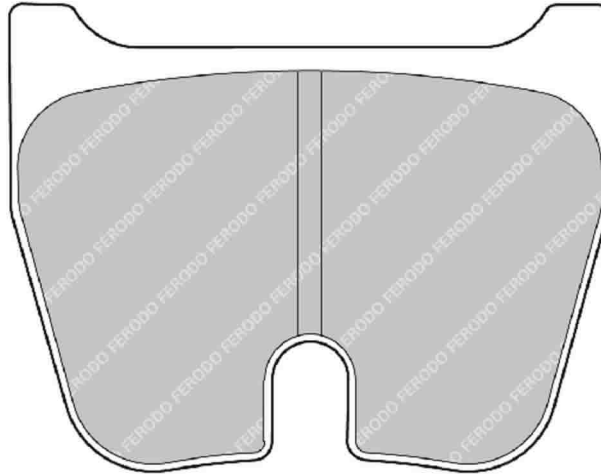

4 Pistons caliper (1 set = 4 pads) - 2 sets per axle for the recommended applications

ALSO AVAILABLE		
SHAPE	TH. MM	NOTES
FRP3022	20	
FRP3033	21	

CROSS REFERENCE	
BREMBO	07.5684.5
BREMBO	07.5684.53
BREMBO	07.5684.55
PFC	7743.XX.17

MATERIAL AVAILABILITY				
H	C	R	W	Z
		✓		

✓ Available    ⚠ Exhausting  
 ✗ Not Available    ✉ Make to order  
 🚧 In Introduction

# FRP3024



139.8mm = 5.504"



48.0mm = 1.890"



20.0mm = 0.787"

**IMPORTANT NOTICE:** Please note that the height measurement represents the radial depth, not the entire back plate

FERRARI Front

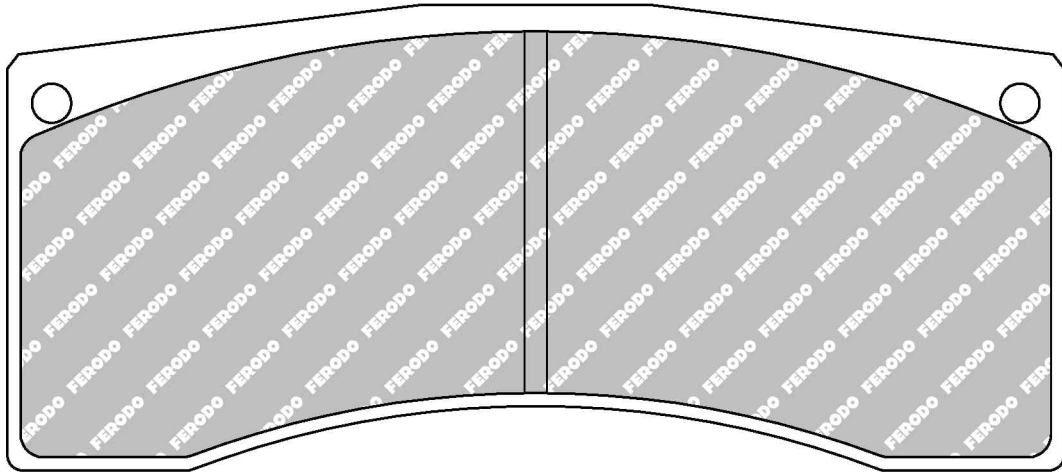

### ALSO AVAILABLE

SHAPE	TH. MM	NOTES
FRP3029	26	
FRP3030	28	
FRP3087	17.5	

### CROSS REFERENCE

AP RACING	CP5788D48
BREMBO	07.5169.9
BREMBO	07.5169.90
BREMBO	07.5169.92
PAGID	1896
PFC	7770.XX.20

### MATERIAL AVAILABILITY

H	C	R	W	Z
		✓	✓	✓

# FRP3025



149.8mm = 5.898"



66.0mm = 2.598"



30.0mm = 1.181"

**IMPORTANT NOTICE:** Please note that the height measurement represents the radial depth, not the entire back plate

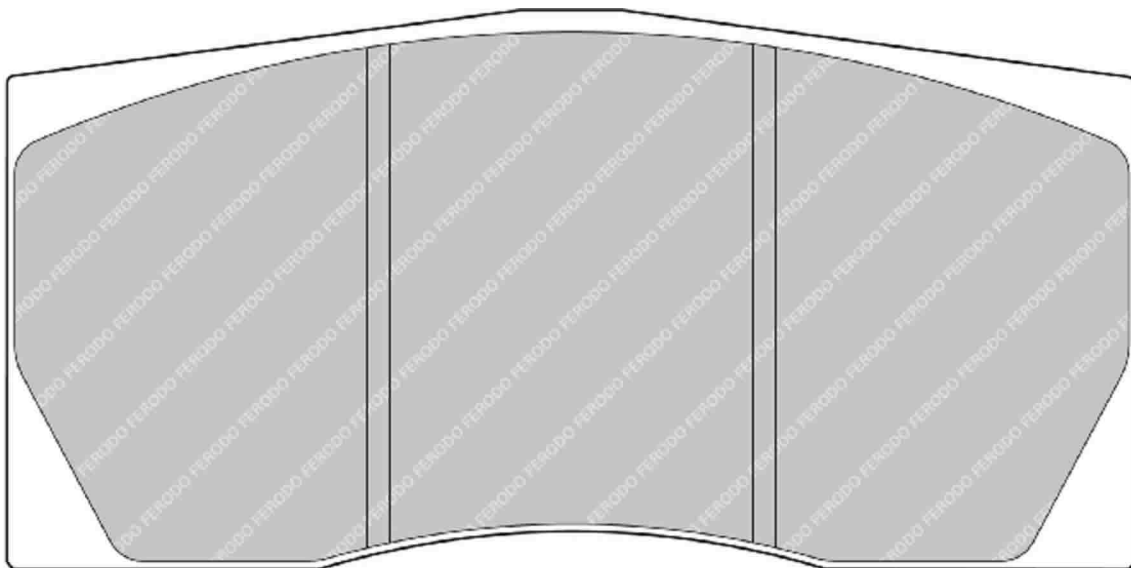

### MATERIAL AVAILABILITY

H	C	R	W	Z
		✗		

### CROSS REFERENCE

ALCON	PNF0084X305.4
PFC	7683

3212

**FERODO**  
RACING

Updated on 30th Jan 2014

✓ Available    ⚠ Exhausting  
 ✗ Not Available    ✉ Make to order  
 ⚡ In Introduction



# FRP3026

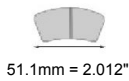

51.1mm = 2.012"



51.0mm = 2.008"

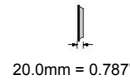

20.0mm = 0.787"

**IMPORTANT NOTICE: Please note that the height measurement represents the radial depth, not the entire back plate**



MATERIAL AVAILABILITY				
H	C	R	W	Z

CROSS REFERENCE	
ALCON	PNF4493X501.4
ALCON	PNF4493X502
ALCON	PNF4493X503

# FRP3027

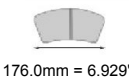

176.0mm = 6.929"



70.0mm = 2.756"

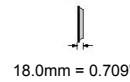

18.0mm = 0.709"

**IMPORTANT NOTICE: Please note that the height measurement represents the radial depth, not the entire back plate**

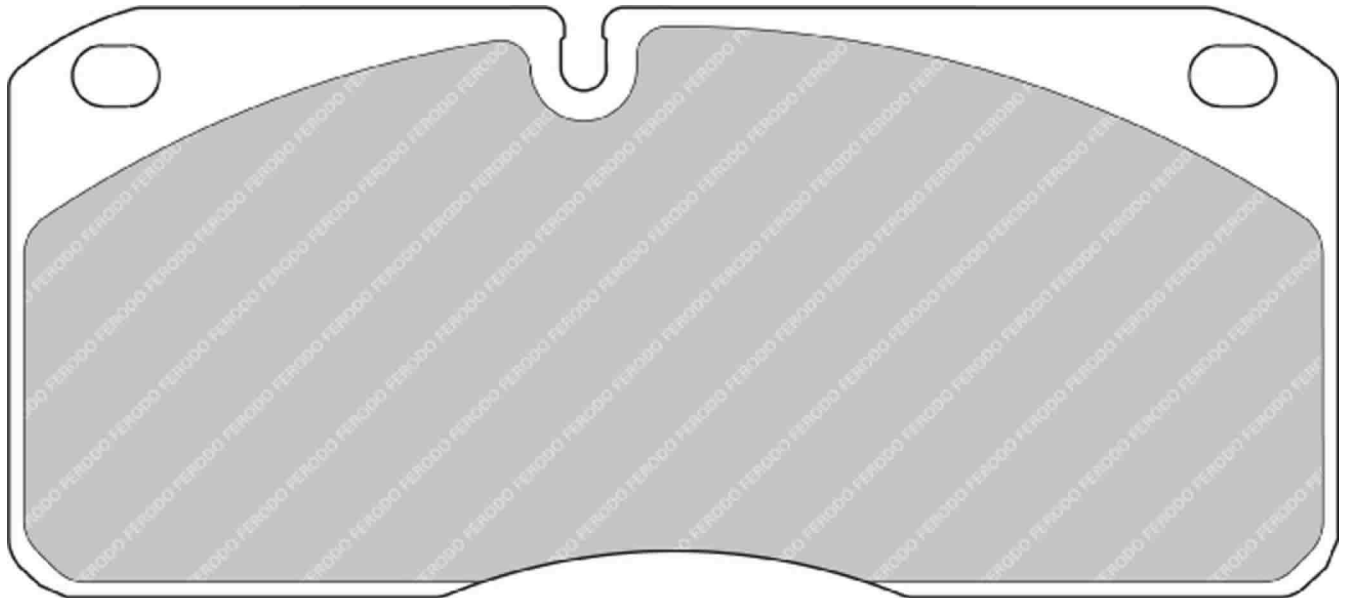

MATERIAL AVAILABILITY				
H	C	R	W	Z

CROSS REFERENCE	
ALCON	PNF0084X222
ALCON	PNF0084X222.4
AP RACING	CP8310D70

- Available
- Exhausting
- Not Available
- Make to order
- In Introduction

# FRP3028



131.8mm = 5.189"



51.5mm = 2.028"



16.0mm = 0.630"

**IMPORTANT NOTICE: Please note that the height measurement represents the radial depth, not the entire back plate**

ASTON MARTIN Front

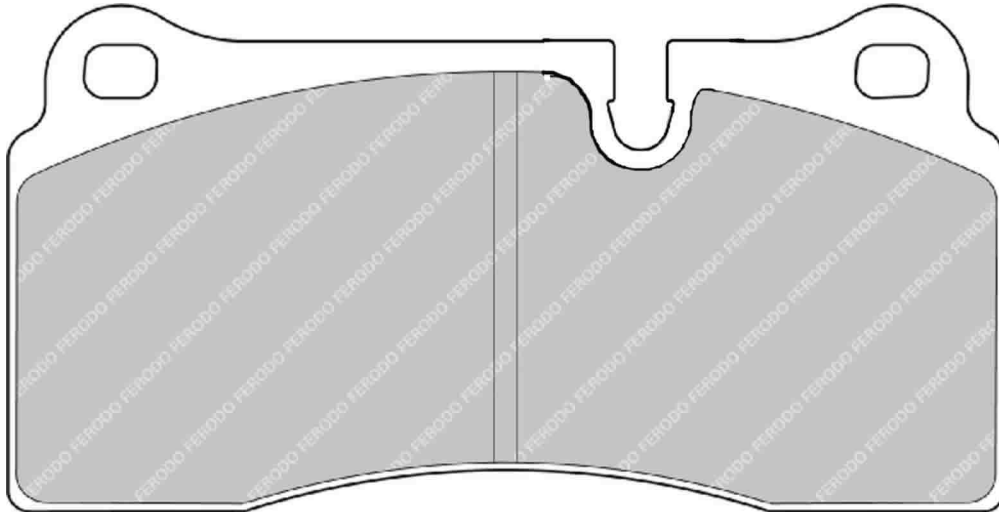

### ALSO AVAILABLE

SHAPE	TH. MM	NOTES
FCP1281	18.2	

### CROSS REFERENCE

HAWK	HB193 0,61
PFC	7780.XX.16

### MATERIAL AVAILABILITY

H	C	R	W	Z
✓		✓	✉	

3214

**FERODO**  
RACING

Updated on 30th Jan 2014

✓ Available    ⚠ Exhausting  
 ✗ Not Available    ✉ Make to order  
 🚧 In Introduction

# FRP3029

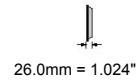
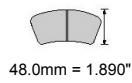
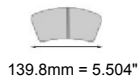

**IMPORTANT NOTICE:** Please note that the height measurement represents the radial depth, not the entire back plate

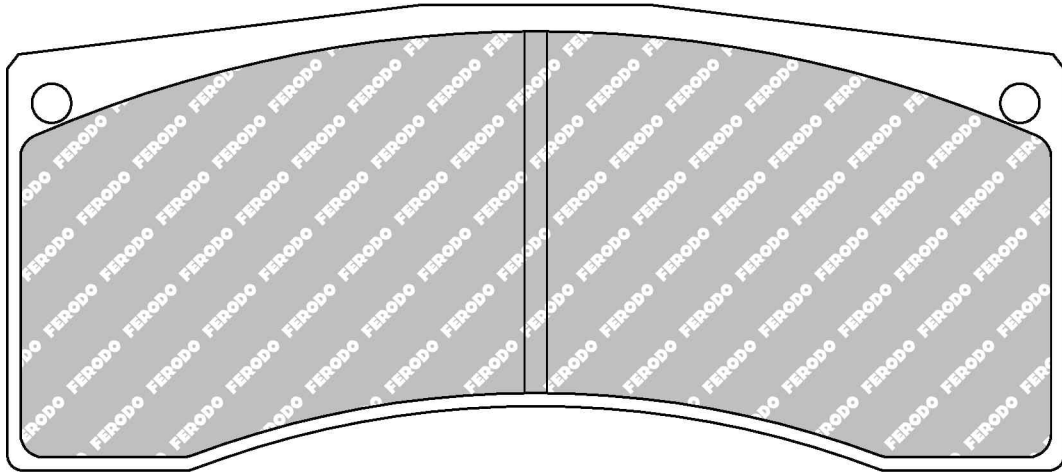

ALSO AVAILABLE		
SHAPE	TH. MM	NOTES
FRP3024	20	
FRP3030	28	
FRP3087	17.5	

CROSS REFERENCE	
BREMBO	07.7859.1
BREMBO	07.7859.10
BREMBO	07.7859.11
PAGID	1619
PAGID	8030
PFC	7770.XX.26

MATERIAL AVAILABILITY				
H	C	R	W	Z

- Available
- Exhausting
- Not Available
- Make to order
- In Introduction

# FRP3030



139.8mm = 5.504"



48.0mm = 1.890"



28.0mm = 1.102"

**IMPORTANT NOTICE:** Please note that the height measurement represents the radial depth, not the entire back plate

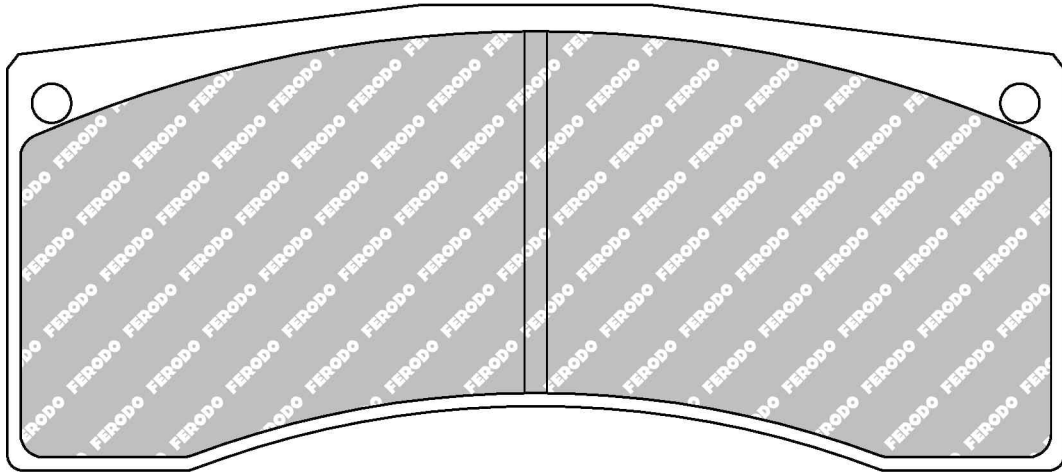

### ALSO AVAILABLE

SHAPE	TH. MM	NOTES
FRP3024	20	
FRP3029	26	
FRP3087	17.5	

### CROSS REFERENCE

BREMBO	07.7859.2
BREMBO	07.7859.20
BREMBO	07.7859.21
PFC	7770.XX.26

### MATERIAL AVAILABILITY

H	C	R	W	Z

# FRP3031

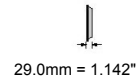
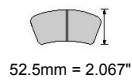
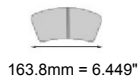

**IMPORTANT NOTICE: Please note that the height measurement represents the radial depth, not the entire back plate**

PORSCHE Front

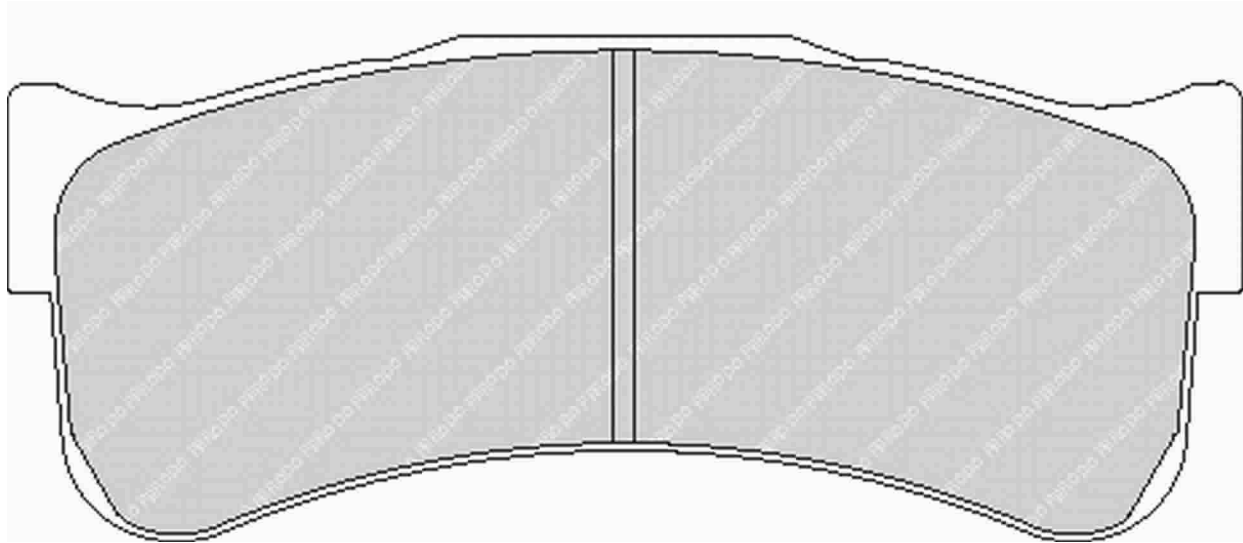

### ALSO AVAILABLE

SHAPE	TH. MM	NOTES
FRP3110	25	
FRP3123	21.5	

### MATERIAL AVAILABILITY

H	C	R	W	Z
		✓	✓	✓

### CROSS REFERENCE

BREMBO	07.7293.6
BREMBO	07.7293.60
BREMBO	07.7293.61
BREMBO	07.7293.63
BREMBO	07.7293.70
PAGID	2488
PFC	7797.XX.29

✓ Available    ⚠ Exhausting  
 ✗ Not Available    ✉ Make to order  
 🔄 In Introduction

**FERODO**  
RACING

Updated on 30th Jan 2014

**3217**

# FRP3032

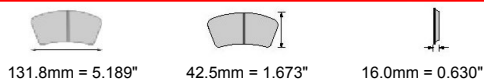

**IMPORTANT NOTICE:** Please note that the height measurement represents the radial depth, not the entire back plate

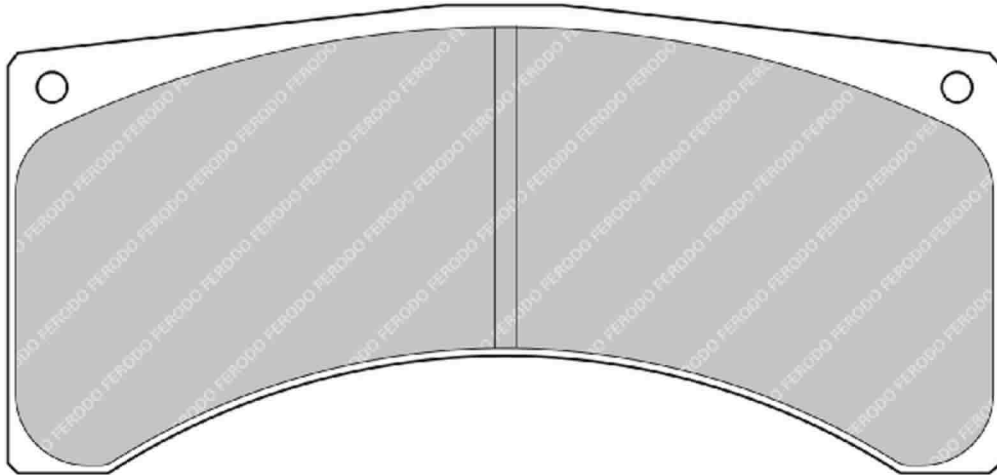

ALSO AVAILABLE		
SHAPE	TH. MM	NOTES
FRP3070	18	

CROSS REFERENCE	
BREMBO	07.5139
BREMBO	07.5139.85
BREMBO	07.5139.88
PFC	7718.XX.16

MATERIAL AVAILABILITY				
H	C	R	W	Z
		✔		

# FRP3033

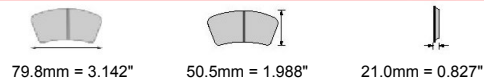

**IMPORTANT NOTICE:** Please note that the height measurement represents the radial depth, not the entire back plate

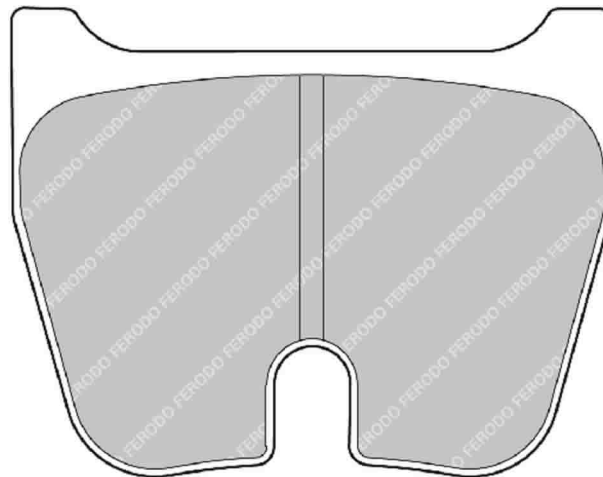

ALSO AVAILABLE		
SHAPE	TH. MM	NOTES
FRP3022	20	
FRP3023	17.5	

CROSS REFERENCE	
BREMBO	07.5684.8
BREMBO	07.5684.80
BREMBO	07.5684.81
PFC	7743.XX.21

MATERIAL AVAILABILITY				
H	C	R	W	Z
		✘		

**3218**



Updated on 30th Jan 2014

- ✔ Available
- ✘ Not Available
- ⚠ Exhausting
- ✉ Make to order
- 🔧 In Introduction

# FRP3034



84.8mm = 3.339"



51.5mm = 2.028"



21.0mm = 0.827"

**IMPORTANT NOTICE:** Please note that the height measurement represents the radial depth, not the entire back plate

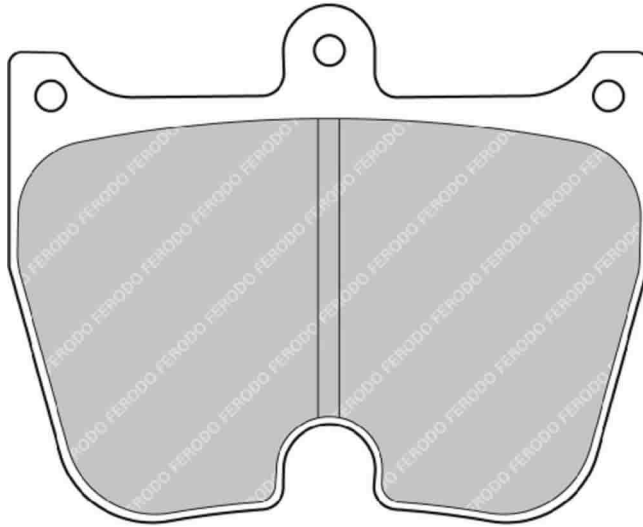

4 Pistons caliper

(1 set = 4 pads) - 2 sets per axle for the recommended applications

### ALSO AVAILABLE

SHAPE	TH. MM	NOTES
FRP1059	22	
FRP3004	20	
FRP3045	18	

### CROSS REFERENCE

BREMBO	07.7810.2
BREMBO	07.7810.20
BREMBO	07.7810.21
PFC	7742.XX.21

### MATERIAL AVAILABILITY

H	C	R	W	Z

Available   
 Exhausting  
 Not Available   
 Make to order  
 In Introduction

**FERODO**  
RACING

Updated on 30th Jan 2014

**3219**

# FRP3035

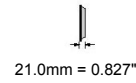
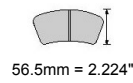

**IMPORTANT NOTICE: Please note that the height measurement represents the radial depth, not the entire back plate**

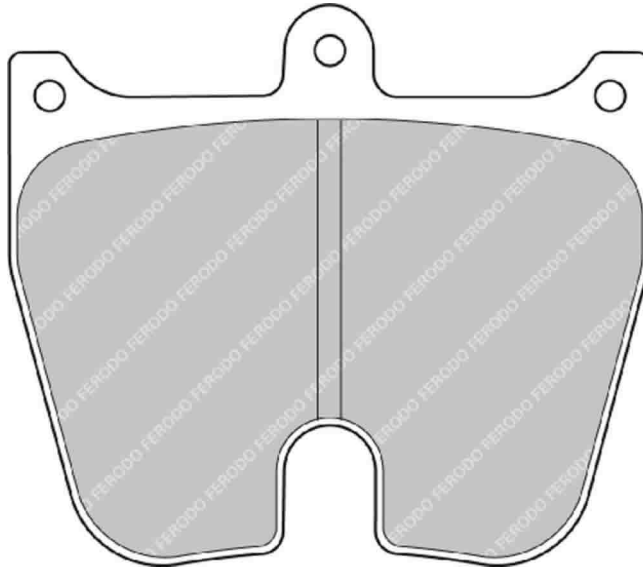

4 Pistons caliper (1 set = 4 pads) - 2 sets per axle for the recommended applications

MATERIAL AVAILABILITY				
H	C	R	W	Z

CROSS REFERENCE	
BREMBO	07.7810.1
BREMBO	07.7810.10
BREMBO	07.7810.11



# FRP3037

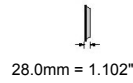
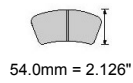
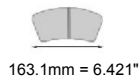

**IMPORTANT NOTICE:** Please note that the height measurement represents the radial depth, not the entire back plate

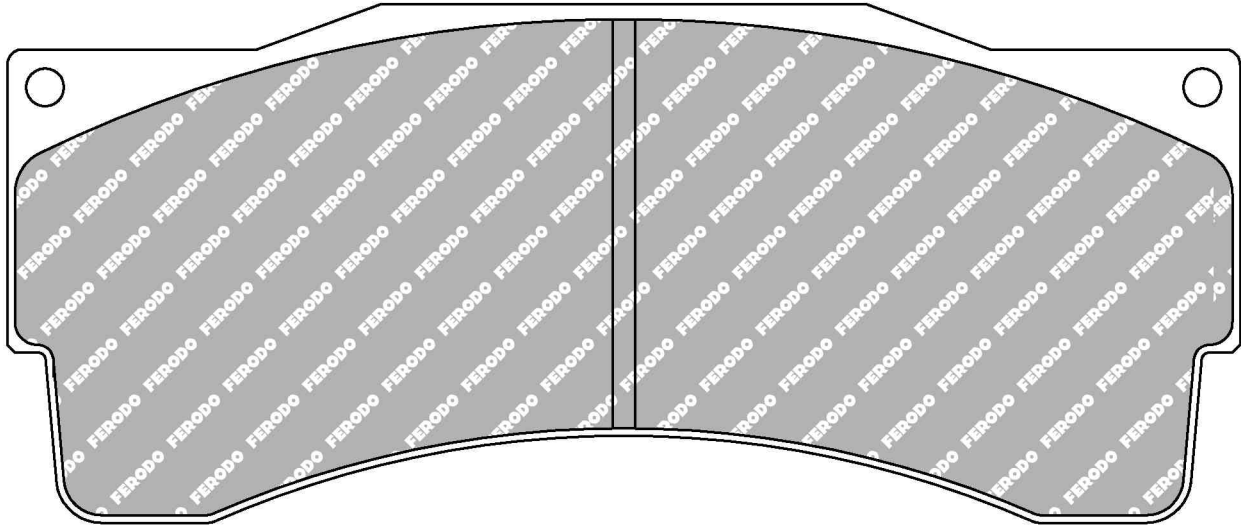

### ALSO AVAILABLE

SHAPE	TH. MM	NOTES
FRP3039	25	
FRP3055	30	

### MATERIAL AVAILABILITY

H	C	R	W	Z

### CROSS REFERENCE

ALCON	PNF4495X514.4
ALCON	PNF4495X516.4
AP RACING	CP6210D54 (28 mm)
PAGID	2557
PFC	7778.XX.28

- Available
- Exhausting
- Not Available
- Make to order
- In Introduction

# FRP3039



163.1mm = 6.421"



54.0mm = 2.126"



25.0mm = 0.984"

**IMPORTANT NOTICE:** Please note that the height measurement represents the radial depth, not the entire back plate

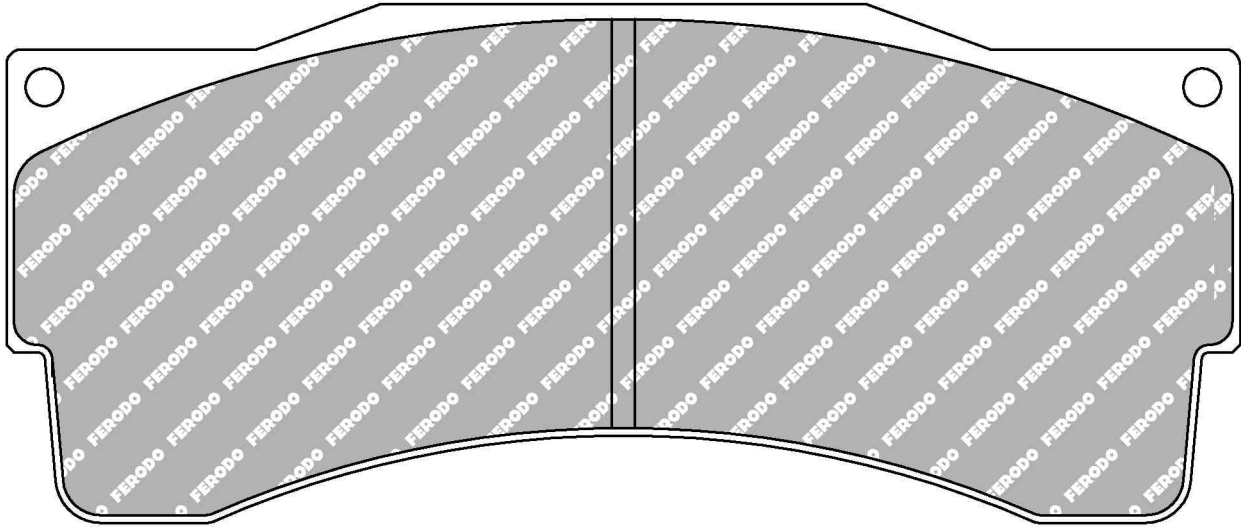

### ALSO AVAILABLE

SHAPE	TH. MM	NOTES
FRP3037	28	
FRP3055	30	

### CROSS REFERENCE

ALCON	PNF4495X501.4
AP RACING	CP6230D54 (25 mm)
PAGID	2688
PFC	7778.XX.25

### MATERIAL AVAILABILITY

H	C	R	W	Z
		✓	✉	

# FRP3040



163.9mm = 6.453"



62.0mm = 2.441"



30.0mm = 1.181"

**IMPORTANT NOTICE:** Please note that the height measurement represents the radial depth, not the entire back plate

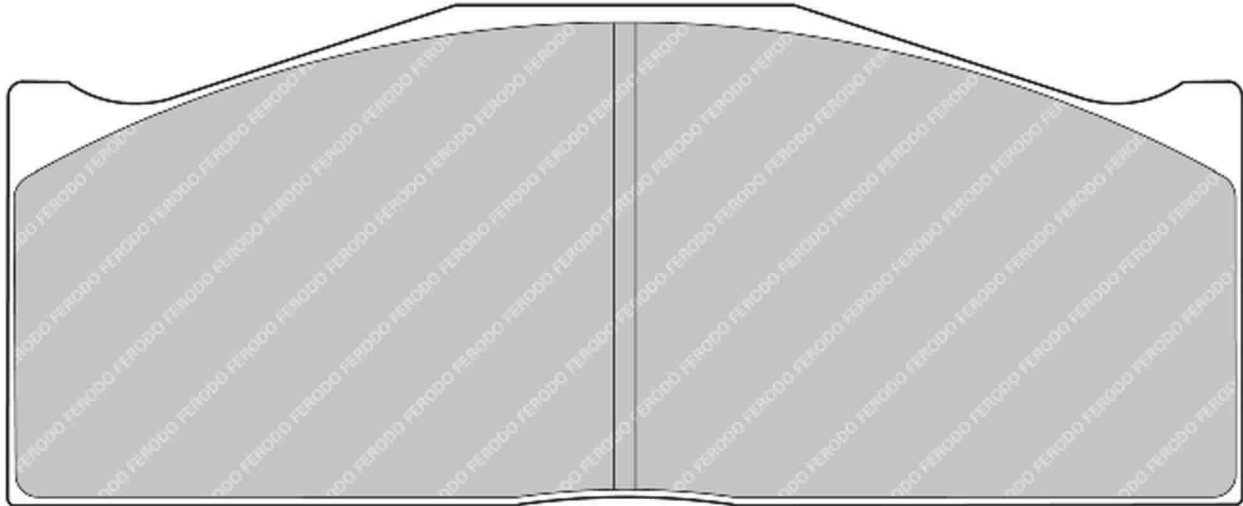

### ALSO AVAILABLE

SHAPE	TH. MM	NOTES
FRP3047	22	

### MATERIAL AVAILABILITY

H	C	R	W	Z

### CROSS REFERENCE

BREMBO	07.7614.2
BREMBO	07.7614.20
BREMBO	07.7614.21
PFC	7773.XX.30

Available   
 Exhausting  
 Not Available   
 Make to order  
 In Introduction

**FERODO**  
RACING

Updated on 30th Jan 2014

**3223**

# FRP3042



131.8mm = 5.189"



66.0mm = 2.598"



26.5mm = 1.043"

**IMPORTANT NOTICE: Please note that the height measurement represents the radial depth, not the entire back plate**

PORSCHE Front

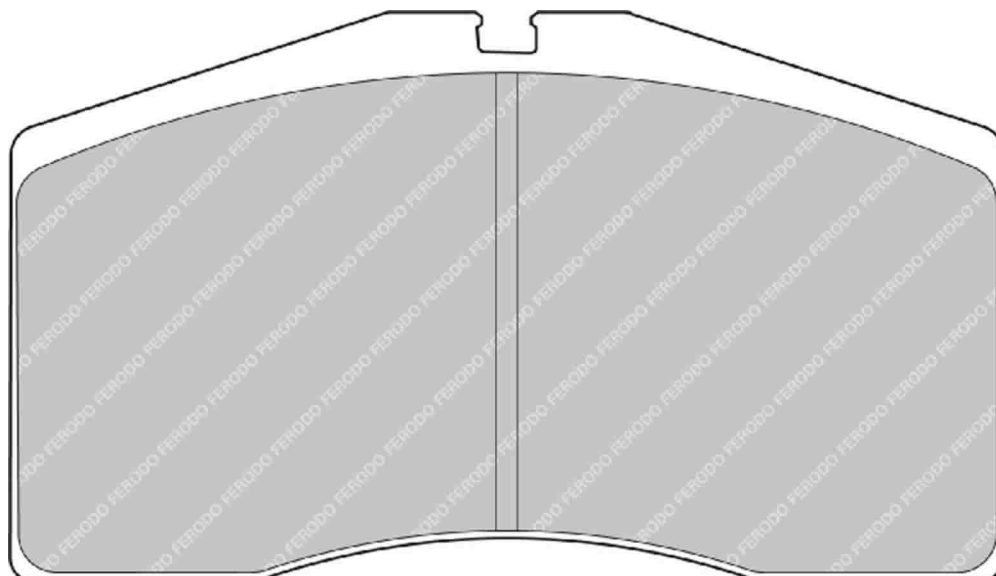

ALSO AVAILABLE		
SHAPE	TH. MM	NOTES
FCP891	17.5	

CROSS REFERENCE	
BREMBO	07.5308.9
BREMBO	07.5308.91
PAGID	2703

MATERIAL AVAILABILITY				
H	C	R	W	Z
		✓	✓	

# FRP3043



132.1mm = 5.201"



46.5mm = 1.831"



17.0mm = 0.669"

**IMPORTANT NOTICE: Please note that the height measurement represents the radial depth, not the entire back plate**

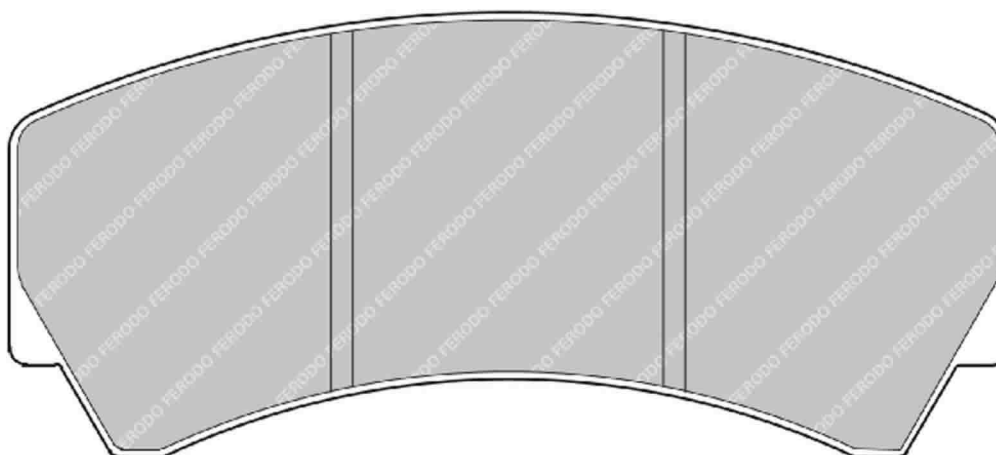

MATERIAL AVAILABILITY				
H	C	R	W	Z
		✓		✉

CROSS REFERENCE	
ALCON	PNF3430X275.4

# FRP3044

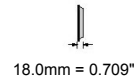
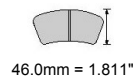
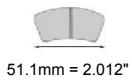

**IMPORTANT NOTICE: Please note that the height measurement represents the radial depth, not the entire back plate**

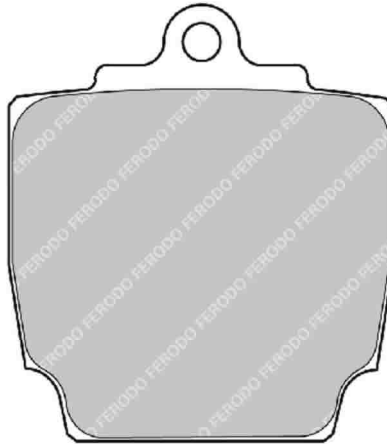

MATERIAL AVAILABILITY				
H	C	R	W	Z
		✓		

CROSS REFERENCE	
ALCON	PNF4493X603
ALCON	PNF4493X603.12
ALCON	PNF4493X603.4
ALCON	PNF4493X610.12
ALCON	PNF4493X610.4

✓ Available    ⚠ Exhausting  
 ✗ Not Available    ✉ Make to order  
 🚧 In Introduction

# FRP3045



84.8mm = 3.339"



51.5mm = 2.028"



18.0mm = 0.709"

**IMPORTANT NOTICE: Please note that the height measurement represents the radial depth, not the entire back plate**

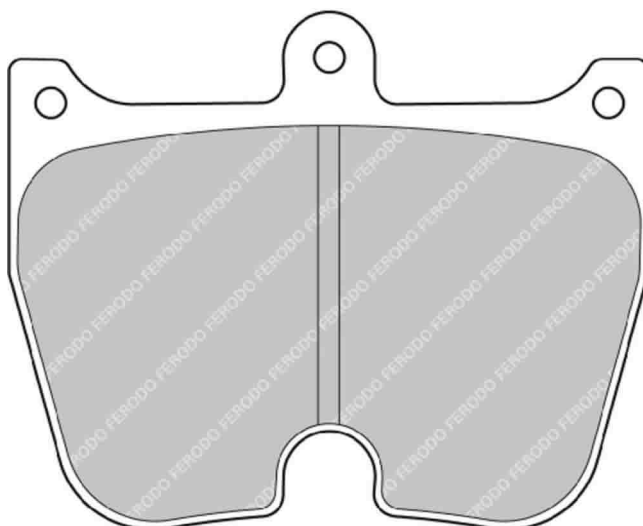

4 Pistons caliper

(1 set = 4 pads) - 2 sets per axle for the recommended applications

ALSO AVAILABLE		
SHAPE	TH. MM	NOTES
FRP1059	22	
FRP3004	20	
FRP3034	21	

MATERIAL AVAILABILITY				
H	C	R	W	Z

CROSS REFERENCE	
BREMBO	07.7810.3
BREMBO	07.7810.30
BREMBO	07.7810.31
PFC	7742.XX.18
PFC	7802.XX.18

# FRP3046

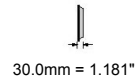
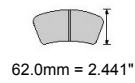

**IMPORTANT NOTICE:** Please note that the height measurement represents the radial depth, not the entire back plate

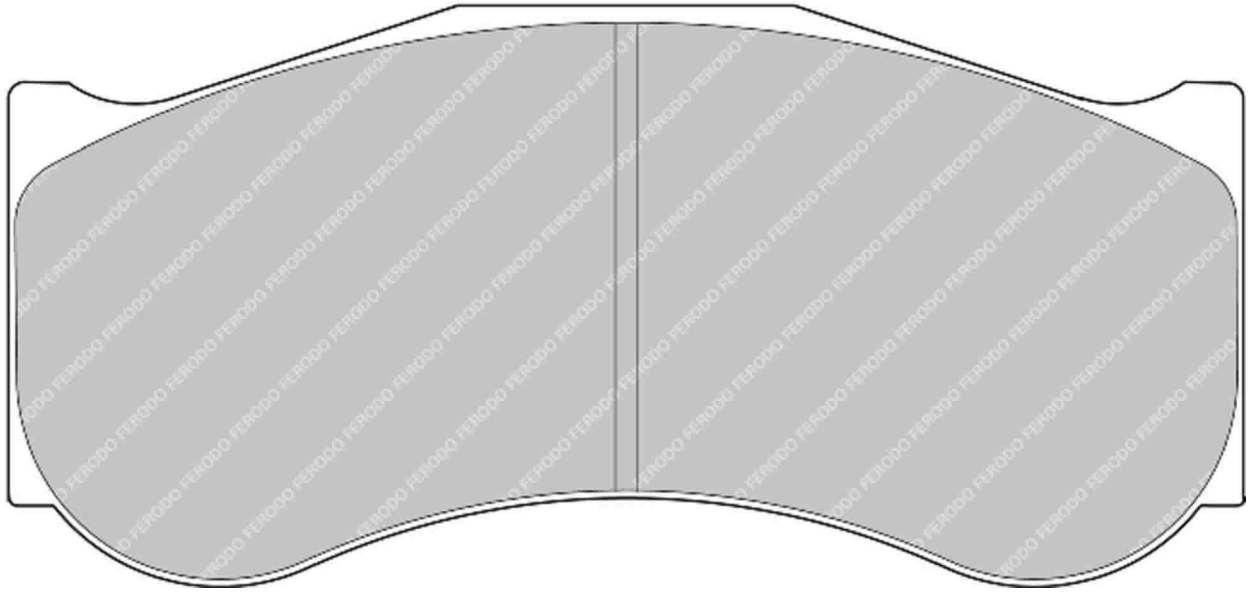

MATERIAL AVAILABILITY				
H	C	R	W	Z
			✔	

CROSS REFERENCE	
BREMBO	07.7614.3
BREMBO	07.7614.30
BREMBO	07.7614.31

- ✔ Available     ⚠ Exhausting
- ✘ Not Available     📧 Make to order
- 🔧 In Introduction

# FRP3050

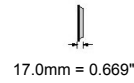
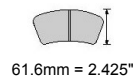

WVA No: 23 139 17,00

**IMPORTANT NOTICE: Please note that the height measurement represents the radial depth, not the entire back plate**

PORSCHE Front

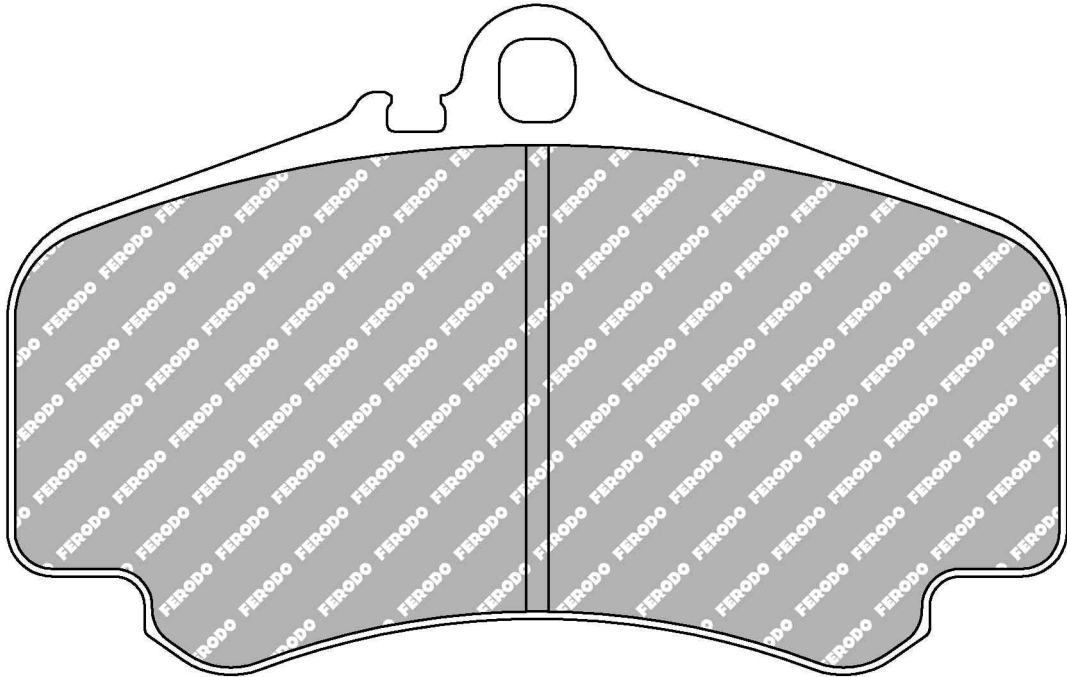

MATERIAL AVAILABILITY				
H	C	R	W	Z
✓		✓	✓	

CROSS REFERENCE	
MINTEX	MDB2039
PAGID	1291
PAGID	2474
PFC	7818.XX.17
WVA	23 139 17,00



# FRP3051



121.0mm = 4.764"



59.0mm = 2.323"



16.8mm = 0.661"

FMSI No: D776

**IMPORTANT NOTICE: Please note that the height measurement represents the radial depth, not the entire back plate**

PORSCHE Front / Rear

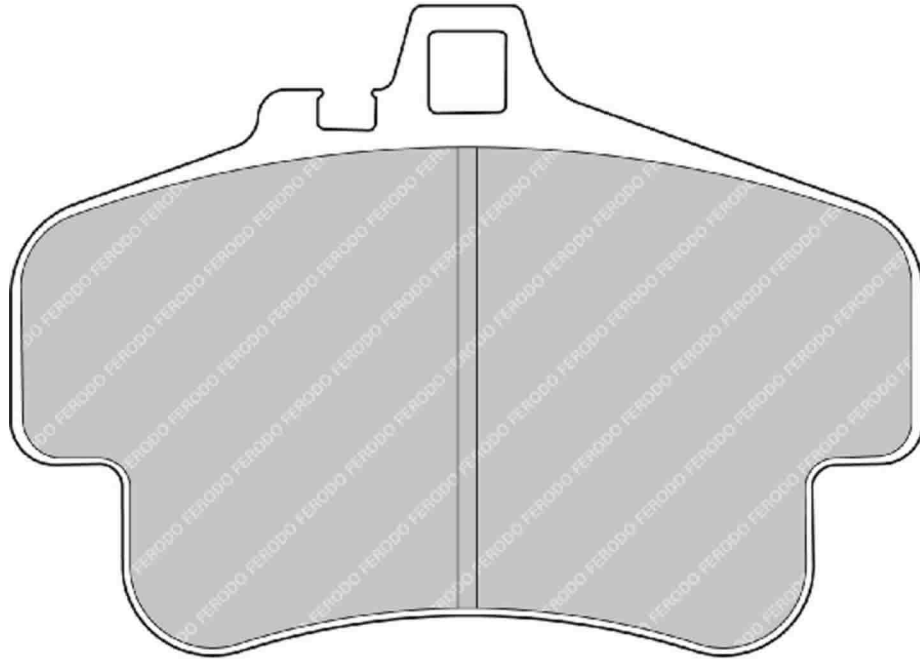

MATERIAL AVAILABILITY				
H	C	R	W	Z
✓		✓	✓	

CROSS REFERENCE	
FMSI	D776
HAWK	HB291 0,642
PAGID	2405
PFC	0776

✓ Available    ⚠ Exhausting  
 ✗ Not Available    ✉ Make to order  
 🚧 In Introduction

**FERODO**  
RACING

Updated on 30th Jan 2014

**3229**

# FRP3053



139.8mm = 5.504"





61.0mm = 2.402"

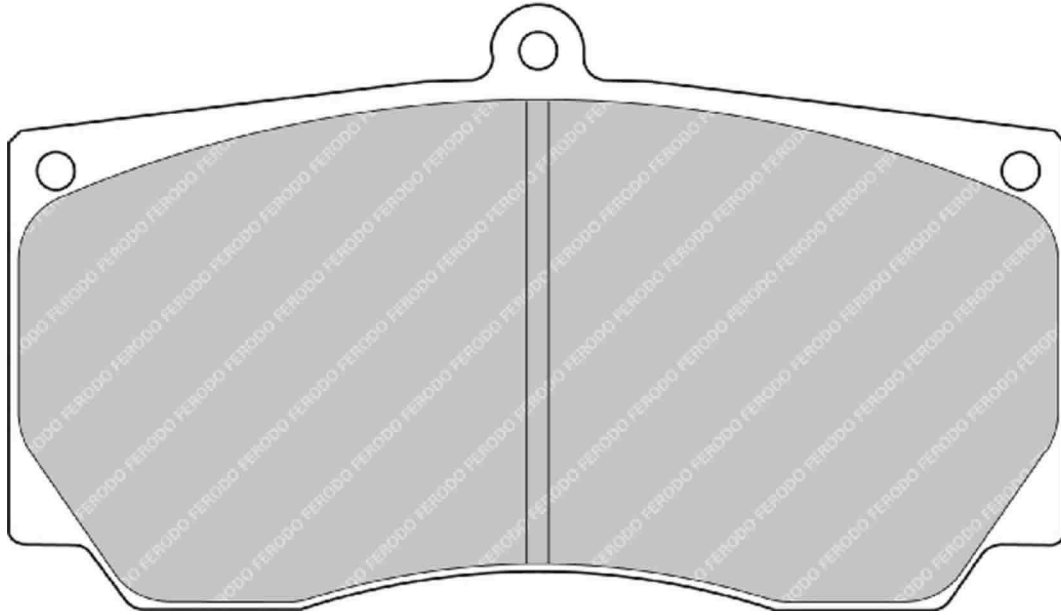

27.5mm = 1.083"

**IMPORTANT NOTICE: Please note that the height measurement represents the radial depth, not the entire back plate**



MATERIAL AVAILABILITY				
H	C	R	W	Z
				

CROSS REFERENCE	
BREMBO	07.6955.3
BREMBO	07.6955.30
BREMBO	07.6955.31
PFC	7775.XX.28

# FRP3054

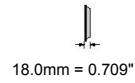
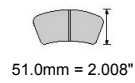
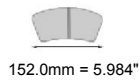

**IMPORTANT NOTICE:** Please note that the height measurement represents the radial depth, not the entire back plate

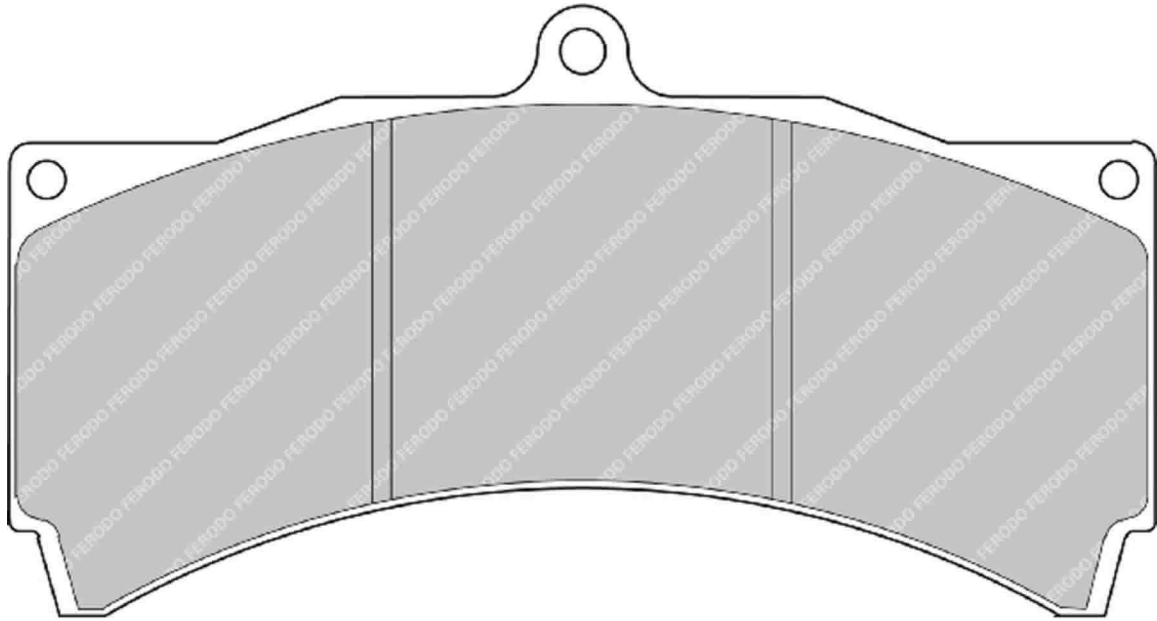

### ALSO AVAILABLE

SHAPE	TH. MM	NOTES
FRP3061	25	
FRP3076	17	

### CROSS REFERENCE

ALCON	PNF4489X545.4
AP RACING	CP3894D51 (18 mm)
PAGID	1903
PFC	7793.XX.18

### MATERIAL AVAILABILITY

H	C	R	W	Z
✓		✓	✓	✓

✓ Available    ⚠ Exhausting  
 ✗ Not Available    ✉ Make to order  
 🚧 In Introduction

**FERODO**  
RACING

Updated on 30th Jan 2014

**3231**

# FRP3055



163.1mm = 6.421"



54.0mm = 2.126"



30.0mm = 1.181"

**IMPORTANT NOTICE:** Please note that the height measurement represents the radial depth, not the entire back plate

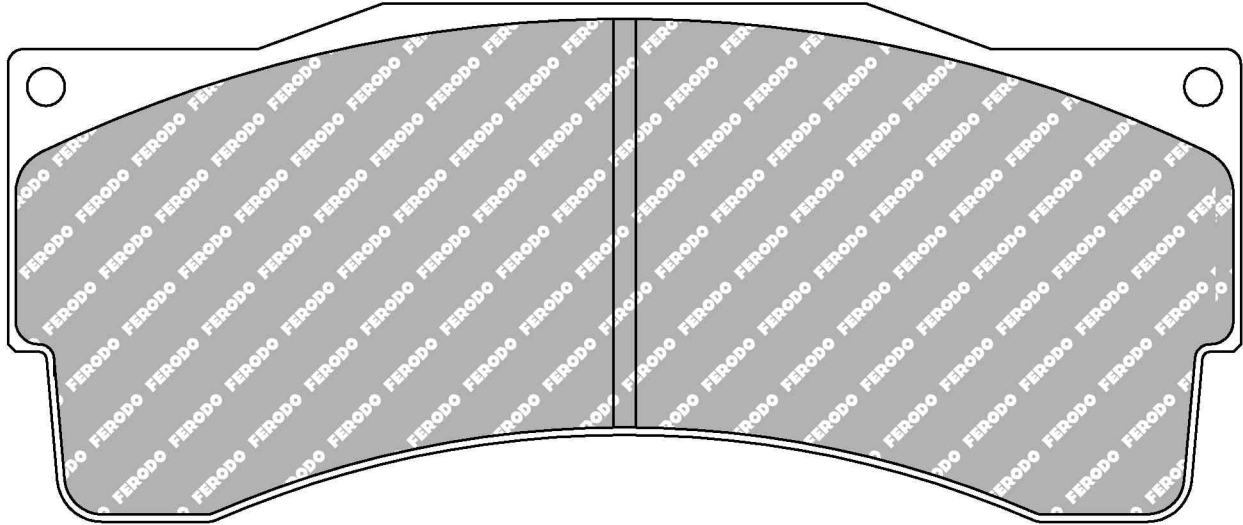

### ALSO AVAILABLE

SHAPE	TH. MM	NOTES
FRP3037	28	
FRP3039	25	

### CROSS REFERENCE

ALCON	PNF4495X517.4
ALCON	PNF4495X518.4
AP RACING	CP6210D54 (30 mm)
PAGID	2557
PFC	7778.XX.30

### MATERIAL AVAILABILITY

H	C	R	W	Z

# FRP3056



77.6mm = 3.055"



50.1mm = 1.972"



14.5mm = 0.571"

**IMPORTANT NOTICE:** Please note that the height measurement represents the radial depth, not the entire back plate

RENAULT Rear

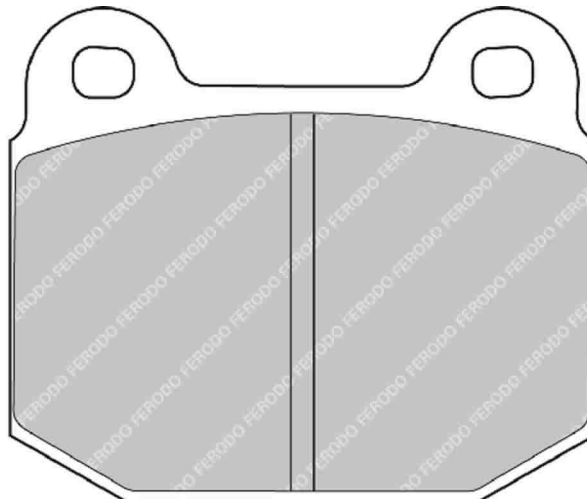

### MATERIAL AVAILABILITY

H	C	R	W	Z

### CROSS REFERENCE

AP RACING	CP5119D50
PFC	0109-07-16-44

3232

**FERODO**  
RACING

Updated on 30th Jan 2014

Available   
 Exhausting  
 Not Available   
 Make to order  
 In Introduction

# FRP3057



183.2mm = 7.213"  
197.3mm = 7.768"



46.0mm = 1.811"  
46.0mm = 1.811"



16.0mm = 0.630"  
13.6mm = 0.535"

FMSI No: D052

**IMPORTANT NOTICE: Please note that the height measurement represents the radial depth, not the entire back plate**

BUICK Front / Rear, CADILLAC Front, CHEVROLET Front, JEEP Front, OLDSMOBILE Front, PONTIAC Front

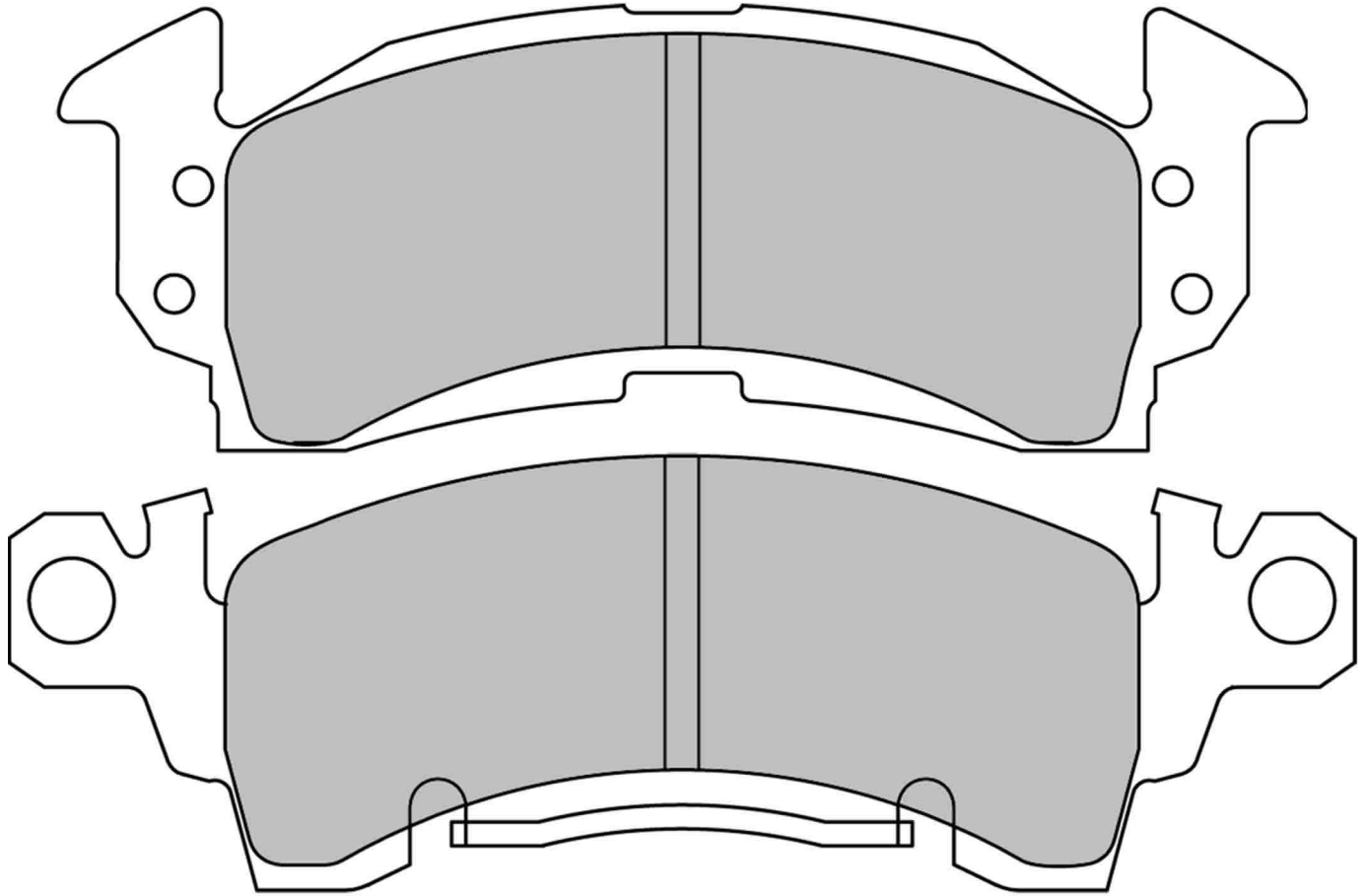

MATERIAL AVAILABILITY				
H	C	R	W	Z
✓		✘	✓	✓

CROSS REFERENCE	
FMSI	D052
FMSI	D313
HAWK	HB103 0,59
MINTEX	MTX1594
PFC	0052.XX

✓ Available    ⚠ Exhausting  
 ✘ Not Available    ✉ Make to order  
 🚧 In Introduction

**FERODO**  
RACING

Updated on 30th Jan 2014

**3233**

# FRP3058



152.0mm = 5.984"  
123.1mm = 4.846"



41.2mm = 1.622"  
41.2mm = 1.622"



16.0mm = 0.630"  
14.0mm = 0.551"

FMSI No: D154

**IMPORTANT NOTICE: Please note that the height measurement represents the radial depth, not the entire back plate**

CHEVROLET Front / Rear, PONTIAC Front / Rear

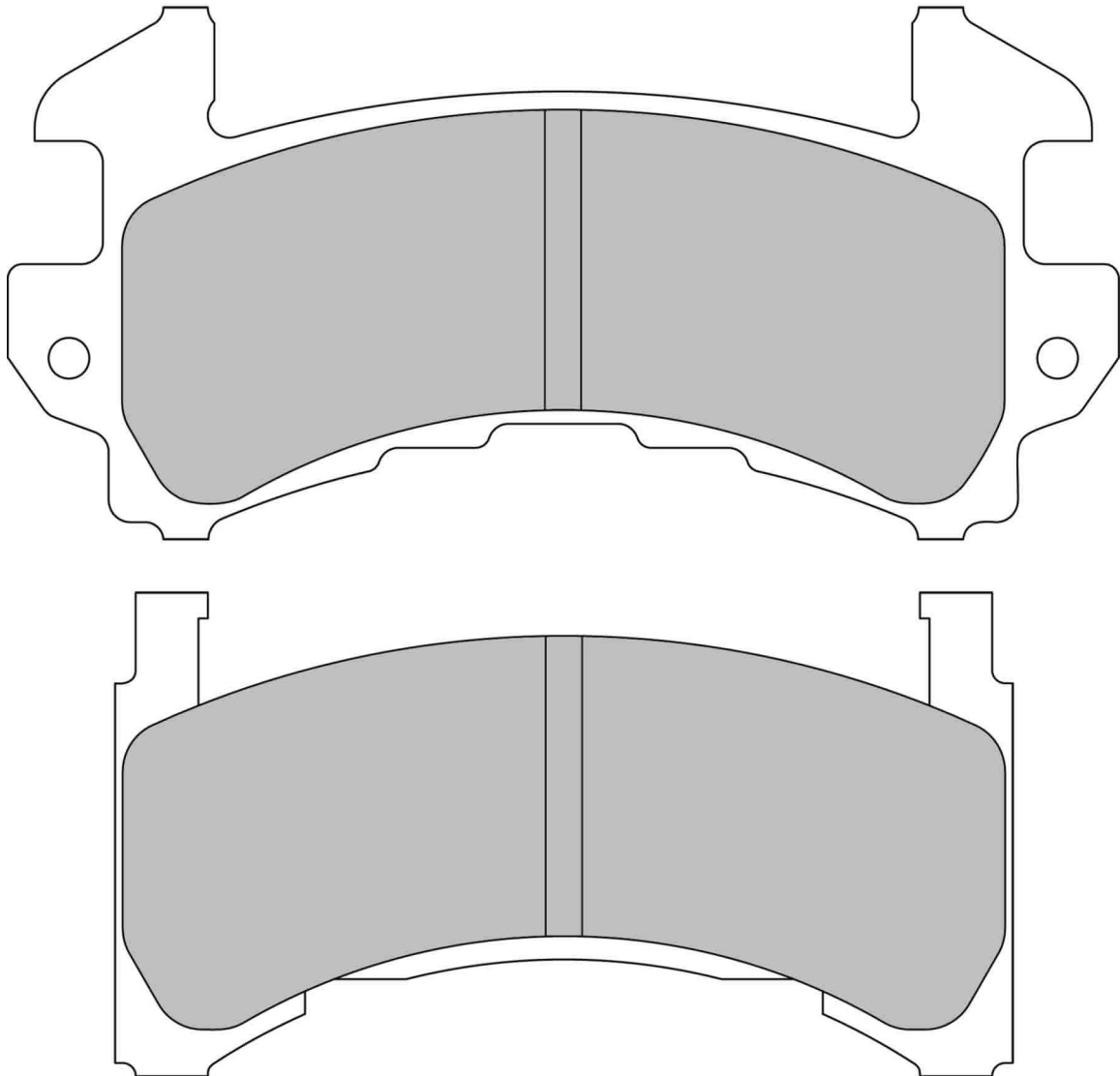

MATERIAL AVAILABILITY				
H	C	R	W	Z
✘		✔	⚠	✉

CROSS REFERENCE	
FMSI	D154
FMSI	D202
HAWK	HB119 0,594
MINTEX	MTX1595
PFC	0154.XX

# FRP3059

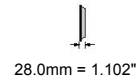
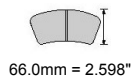

**IMPORTANT NOTICE:** Please note that the height measurement represents the radial depth, not the entire back plate

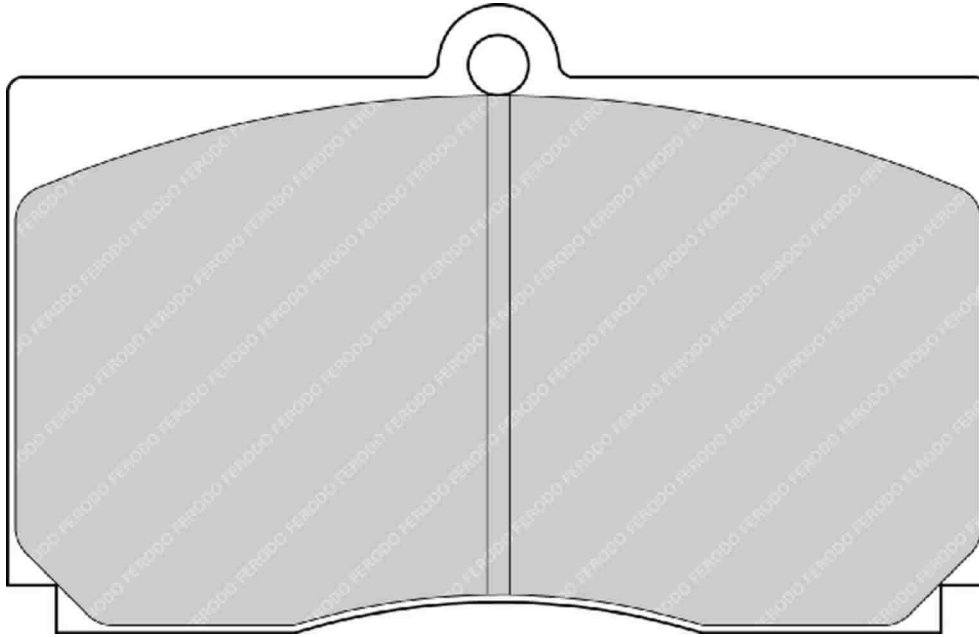

MATERIAL AVAILABILITY				
H	C	R	W	Z
		✓	✗	

CROSS REFERENCE	
AP RACING	CP2749D66 (28 mm)
PAGID	1218
PFC	7702

✓ Available    ⚠ Exhausting  
 ✗ Not Available    ✉ Make to order  
 📦 In Introduction

# FRP3060

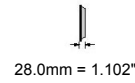
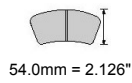

**IMPORTANT NOTICE:** Please note that the height measurement represents the radial depth, not the entire back plate

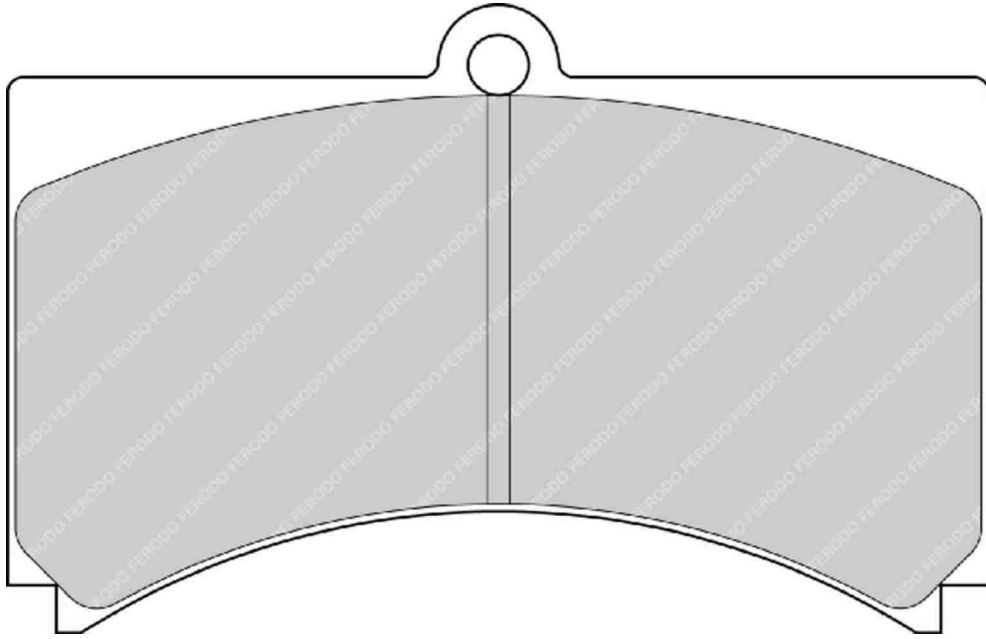

MATERIAL AVAILABILITY				
H	C	R	W	Z
		✗	✓	

CROSS REFERENCE	
AP RACING	CP2749D55 (28 mm)
PFC	7712



# FRP3061

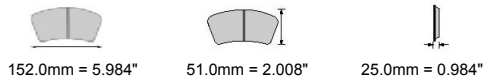

**IMPORTANT NOTICE:** Please note that the height measurement represents the radial depth, not the entire back plate

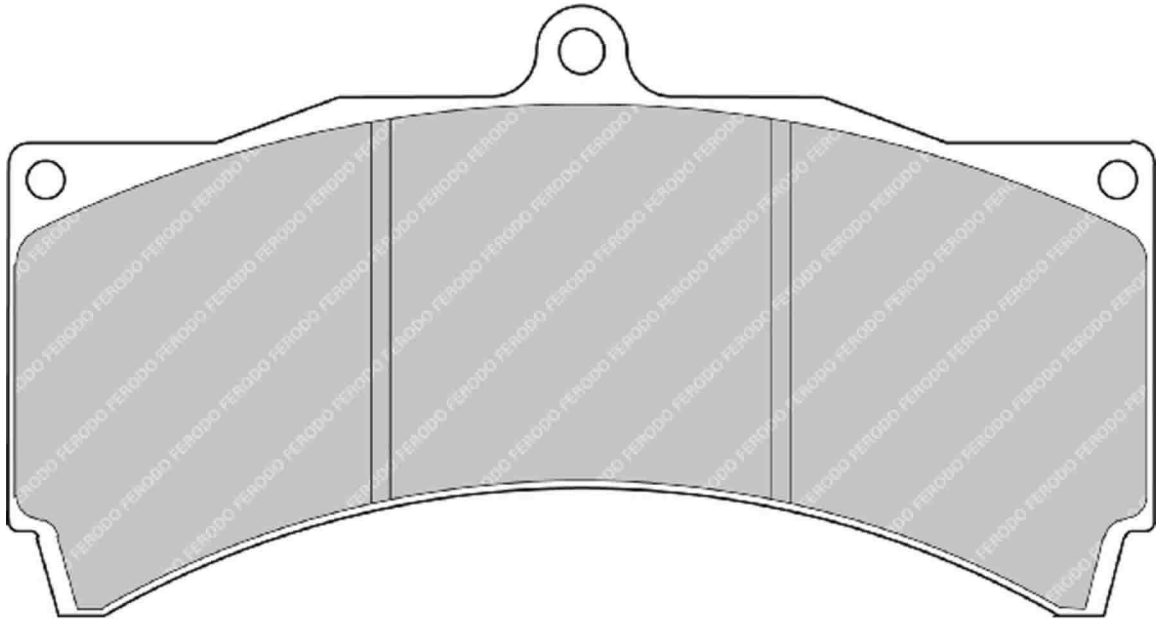

### ALSO AVAILABLE

SHAPE	TH. MM	NOTES
FRP3054	18	
FRP3076	17	

### CROSS REFERENCE

AP RACING	CP3558D51
PAGID	1538
PFC	7790.XX.25

### MATERIAL AVAILABILITY

H	C	R	W	Z

Available    Exhausting  
 Not Available    Make to order  
 In Introduction

**FERODO**  
RACING

Updated on 30th Jan 2014

**3237**

# FRP3062

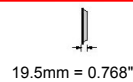
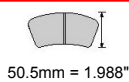

**IMPORTANT NOTICE:** Please note that the height measurement represents the radial depth, not the entire back plate

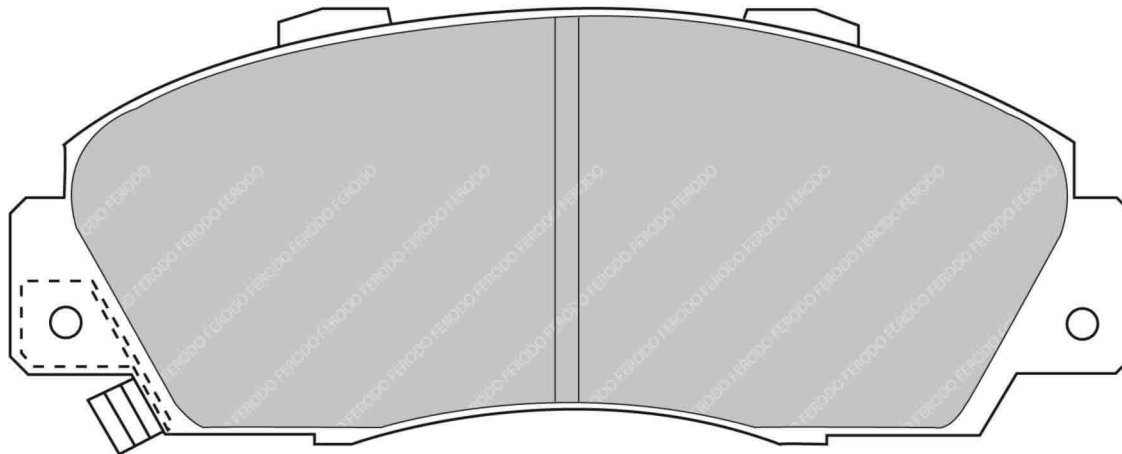

### ALSO AVAILABLE

SHAPE	TH. MM	NOTES
FCP905	18.5	

### MATERIAL AVAILABILITY

H	C	R	W	Z

# FRP3067



131.8mm = 5.189"



62.0mm = 2.441"



14.7mm = 0.579"

FMSI No: D1001

**IMPORTANT NOTICE: Please note that the height measurement represents the radial depth, not the entire back plate**

ALFA ROMEO Front, ASTON MARTIN Front, SUBARU Front

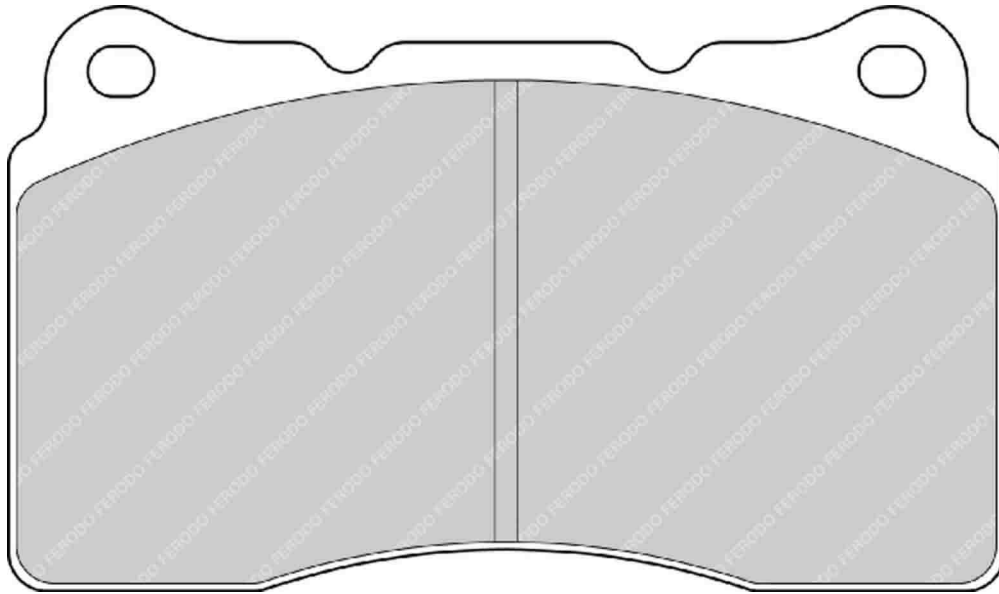

### ALSO AVAILABLE

SHAPE	TH. MM	NOTES
FCP1334	16	

### MATERIAL AVAILABILITY

H	C	R	W	Z
✓		✓	✓	

### CROSS REFERENCE

ALCON	PNF0084X336.4
BREMBO	07.8301.84
FMSI	D1001
HAWK	HB453 0,585
PAGID	2487
PFC	7781

✓ Available    ⚠ Exhausting  
 ✗ Not Available    ✉ Make to order  
 🚧 In Introduction

**FERODO**  
RACING

Updated on 30th Jan 2014

**3239**

# FRP3069

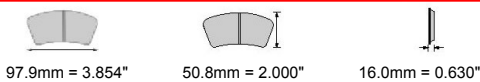

**IMPORTANT NOTICE:** Please note that the height measurement represents the radial depth, not the entire back plate

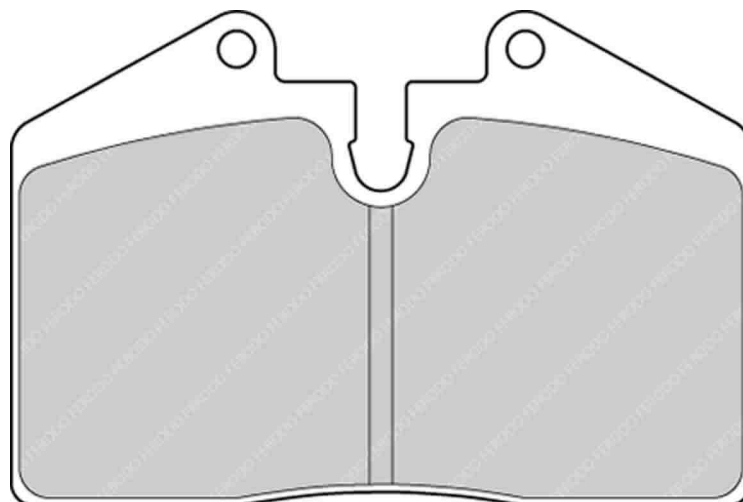

ALSO AVAILABLE		
SHAPE	TH. MM	NOTES
FCP451	18	

CROSS REFERENCE	
ALCON	PNF4436X509
ALCON	PNF4436X509.4

MATERIAL AVAILABILITY				
H	C	R	W	Z
✓		✓	✉	

# FRP3070

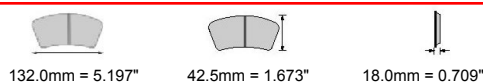

**IMPORTANT NOTICE:** Please note that the height measurement represents the radial depth, not the entire back plate

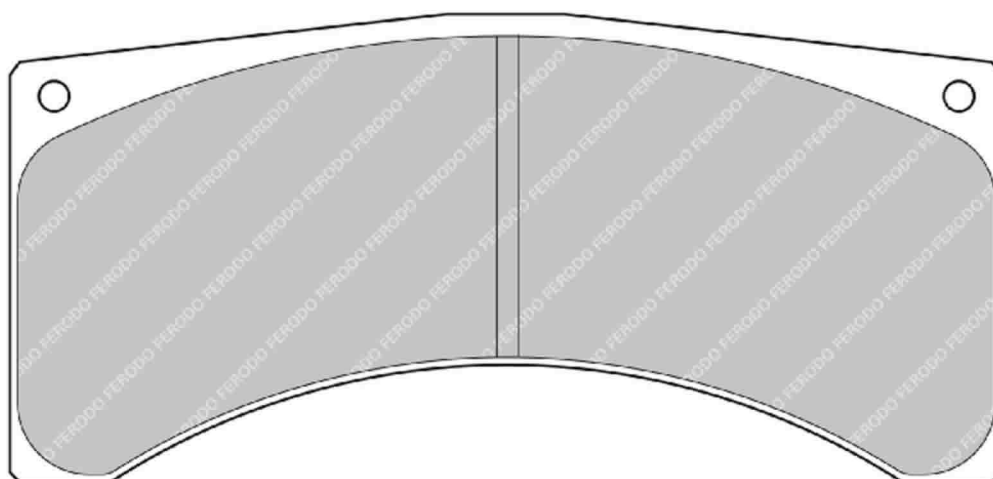

ALSO AVAILABLE		
SHAPE	TH. MM	NOTES
FRP3032	16	

CROSS REFERENCE	
BREMBO	07.7869.12
PFC	7718.XX.18

MATERIAL AVAILABILITY				
H	C	R	W	Z
		✓	✓	

3240



Updated on 30th Jan 2014

- ✓ Available
- ✗ Not Available
- ⚠ Exhausting
- ✉ Make to order
- 🔧 In Introduction

# FRP3071



100.0mm = 3.937"



37.0mm = 1.457"



16.0mm = 0.630"

**IMPORTANT NOTICE:** Please note that the height measurement represents the radial depth, not the entire back plate

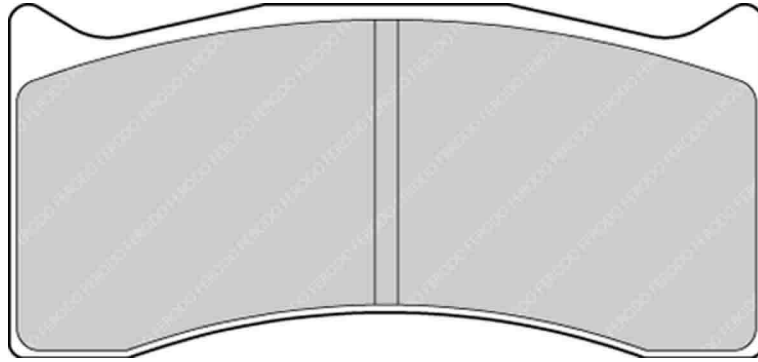

MATERIAL AVAILABILITY				
H	C	R	W	Z

CROSS REFERENCE	
PAGID	8000
PFC	7736

# FRP3073



132.4mm = 5.213"



42.0mm = 1.654"



20.3mm = 0.799"

**IMPORTANT NOTICE:** Please note that the height measurement represents the radial depth, not the entire back plate

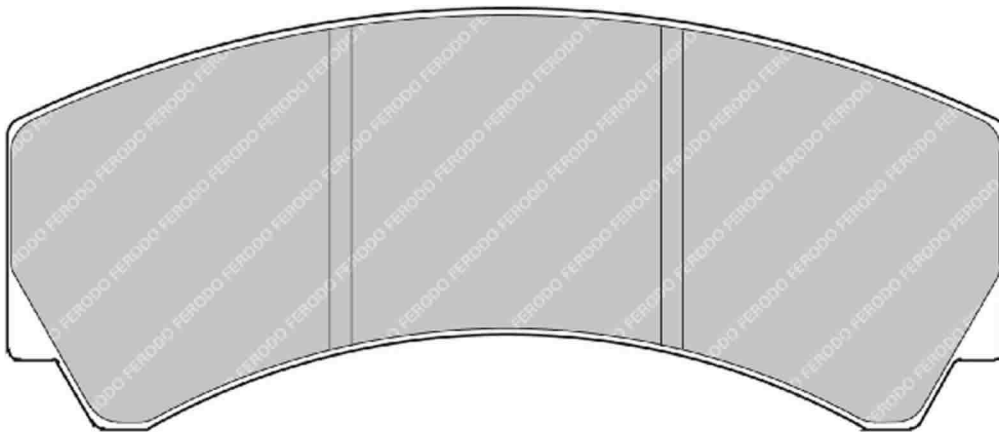

ALSO AVAILABLE		
SHAPE	TH. MM	NOTES
FRP3018	16.7	

CROSS REFERENCE	
AP RACING	CP2279D42
PFC	7768.XX.20

MATERIAL AVAILABILITY				
H	C	R	W	Z

Available   
 Exhausting  
 Not Available   
 Make to order  
 In Introduction

**FERODO**  
RACING

Updated on 30th Jan 2014

**3241**

# FRP3074



58.1mm = 2.287"



47.9mm = 1.886"



18.0mm = 0.709"

**IMPORTANT NOTICE: Please note that the height measurement represents the radial depth, not the entire back plate**



MATERIAL AVAILABILITY				
H	C	R	W	Z
		✓		

CROSS REFERENCE	
PFC	7746
PFC	7750.XX.20

# FRP3075

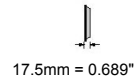
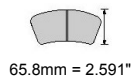
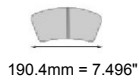

FMSI No: D991

**IMPORTANT NOTICE: Please note that the height measurement represents the radial depth, not the entire back plate**

PORSCHE Front

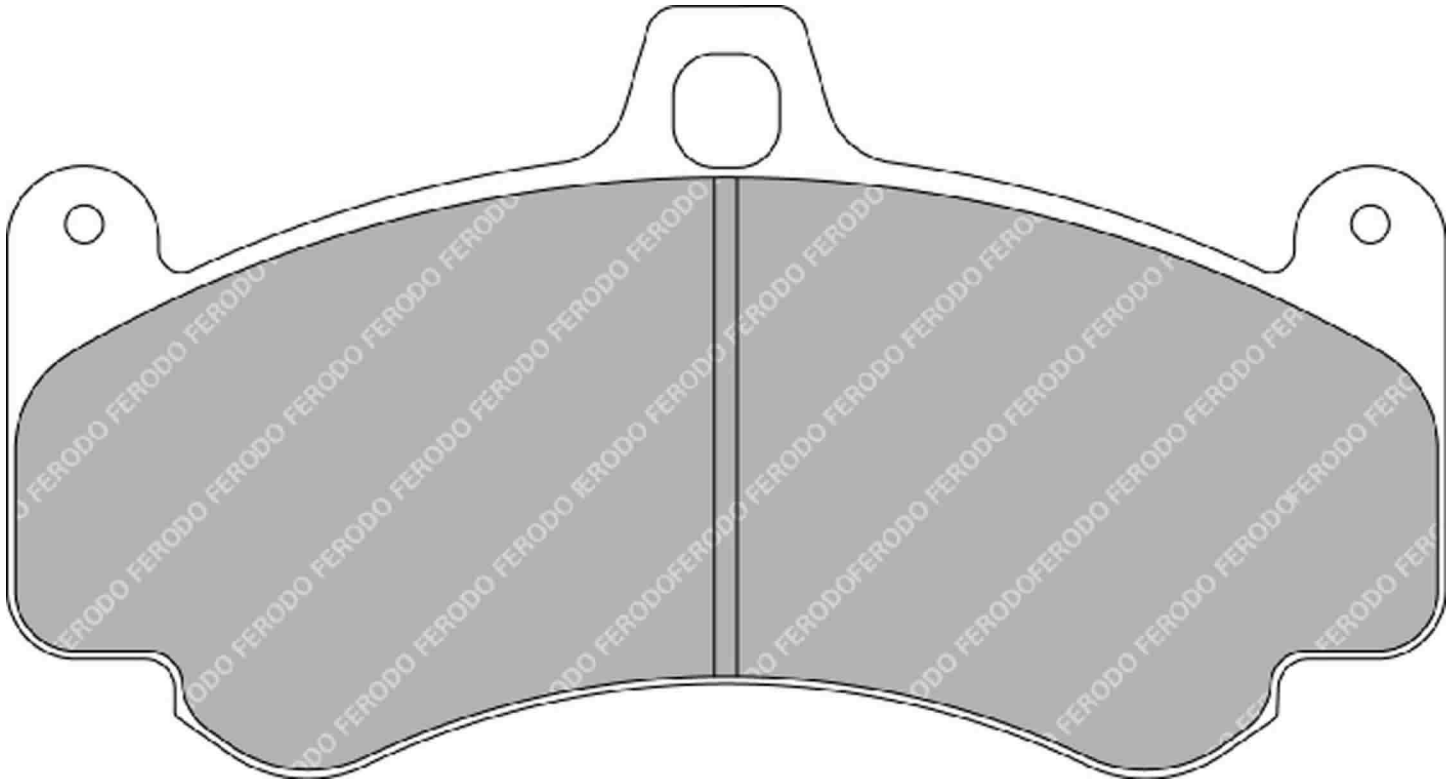

### ALSO AVAILABLE

SHAPE	TH. MM	NOTES
FRP3096	19	

### MATERIAL AVAILABILITY

H	C	R	W	Z
✓			✓	

### CROSS REFERENCE

FMSI	D991
HAWK	HB483 0,635
PAGID	2707
PFC	7819

✓ Available    ⚠ Exhausting  
 ✗ Not Available    ✉ Make to order  
 🚧 In Introduction

**FERODO**  
RACING

Updated on 30th Jan 2014

**3243**

# FRP3076

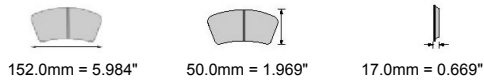

**IMPORTANT NOTICE:** Please note that the height measurement represents the radial depth, not the entire back plate

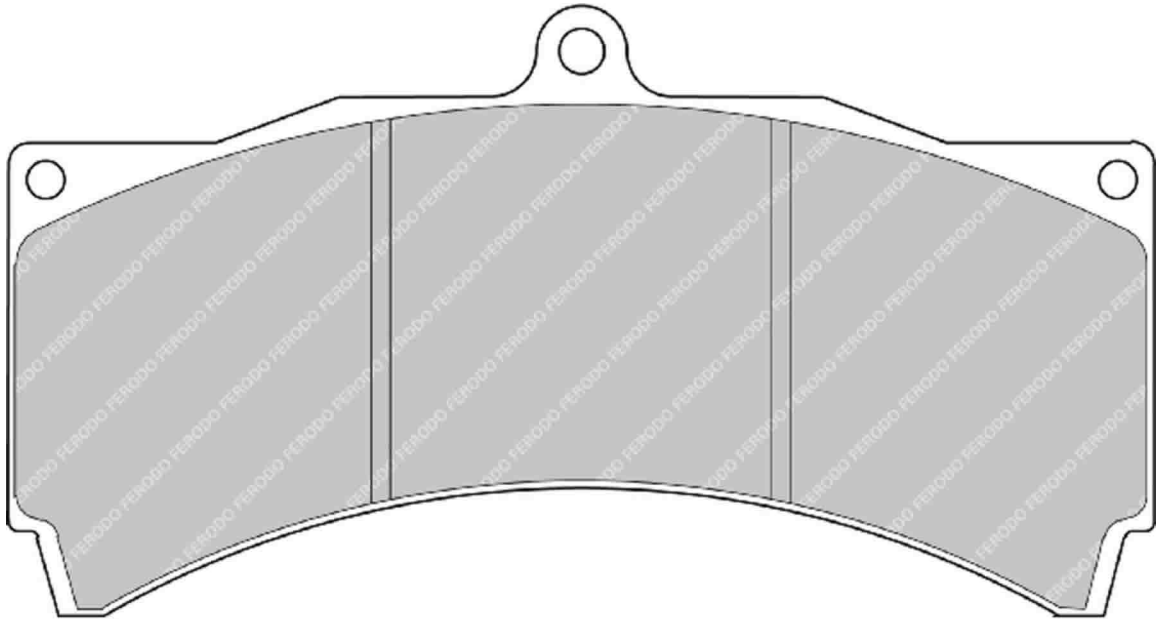

ALSO AVAILABLE		
SHAPE	TH. MM	NOTES
FRP3054	18	
FRP3061	25	

CROSS REFERENCE	
AP RACING	CP5070D51
PAGID	8028

MATERIAL AVAILABILITY				
H	C	R	W	Z
✓		✓		✉



# FRP3077



152.0mm = 5.984"



54.0mm = 2.126"



17.0mm = 0.669"

**IMPORTANT NOTICE:** Please note that the height measurement represents the radial depth, not the entire back plate

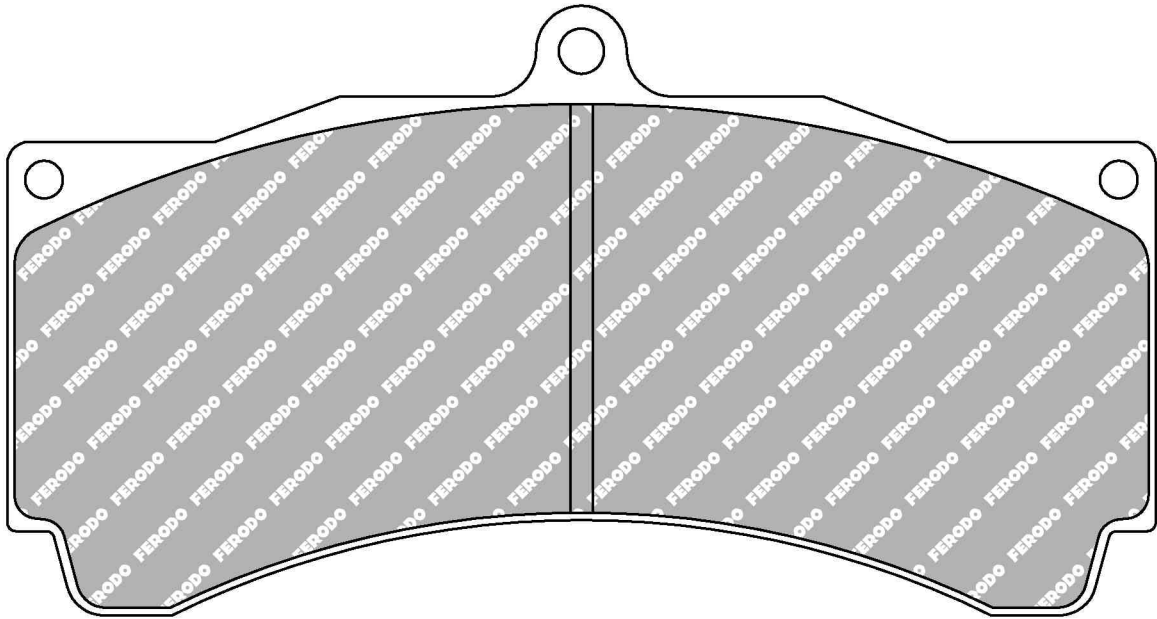

ALSO AVAILABLE		
SHAPE	TH. MM	NOTES
FRP3003	18	
FRP3014	25	
FRP3015	28.5	

CROSS REFERENCE	
AP RACING	CP5070D54
PFC	7790.XX.17

MATERIAL AVAILABILITY				
H	C	R	W	Z
✓		✉	✉	✓

- ✓ Available    ⚠ Exhausting
- ✗ Not Available    ✉ Make to order
- 🔵 In Introduction

# FRP3078



149.2mm = 5.874"



58.5mm = 2.303"



18.0mm = 0.709"

**IMPORTANT NOTICE:** Please note that the height measurement represents the radial depth, not the entire back plate

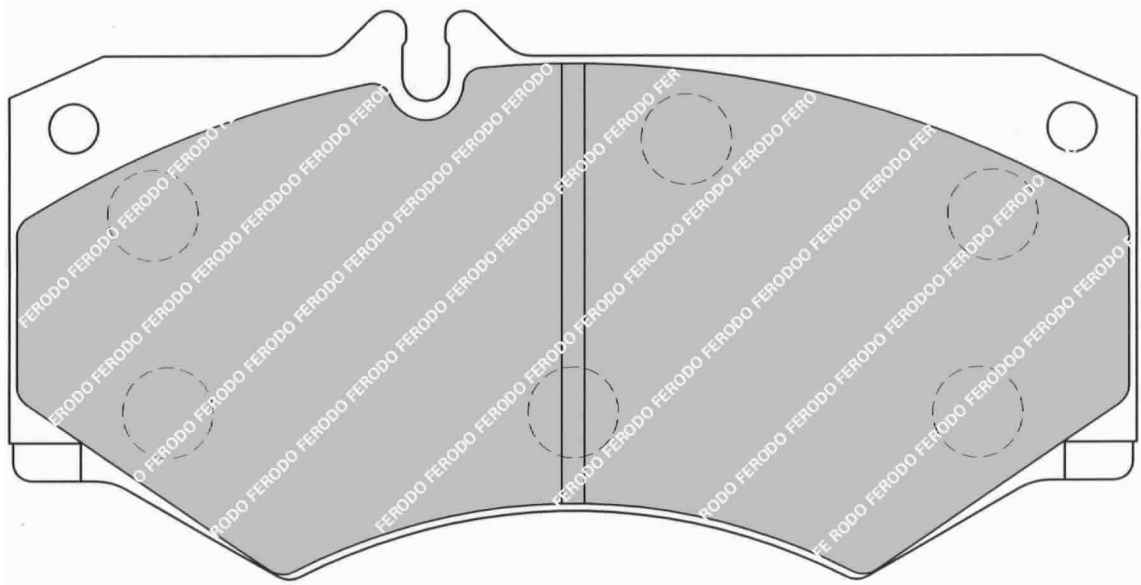

MATERIAL AVAILABILITY				
H	C	R	W	Z

# FRP3080



164.0mm = 6.457"



50.5mm = 1.988"



27.8mm = 1.094"

**IMPORTANT NOTICE:** Please note that the height measurement represents the radial depth, not the entire back plate

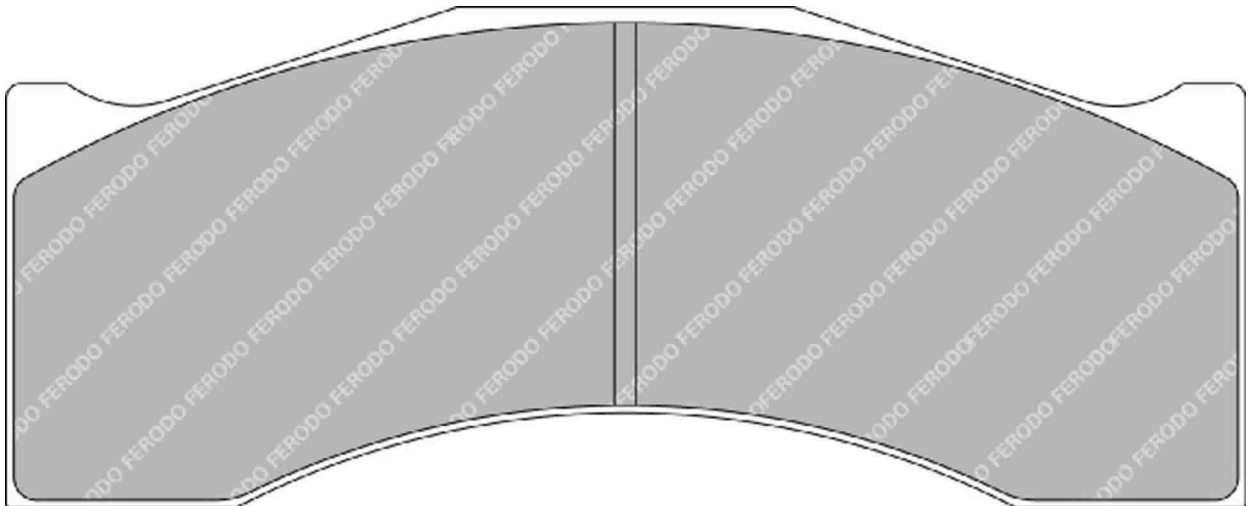

MATERIAL AVAILABILITY				
H	C	R	W	Z

# FRP3081

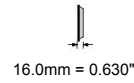
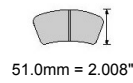

**IMPORTANT NOTICE: Please note that the height measurement represents the radial depth, not the entire back plate**

MITSUBISHI Front

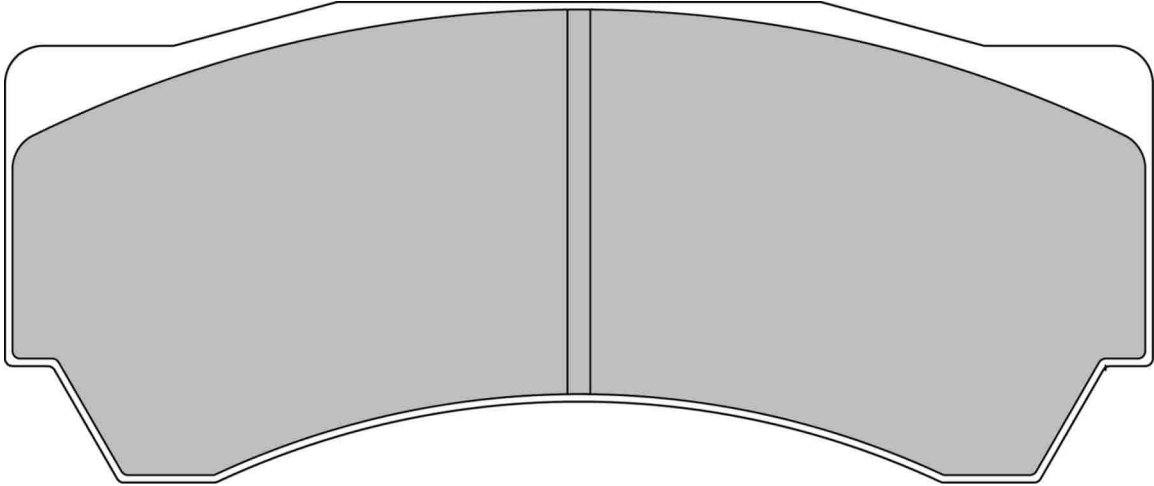

MATERIAL AVAILABILITY				
H	C	R	W	Z
✓		✓	✗	

CROSS REFERENCE	
ALCON	PNF4497X607.4
ALCON	PNF4497X617.4

# FRP3082

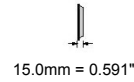
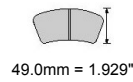
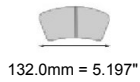

**IMPORTANT NOTICE: Please note that the height measurement represents the radial depth, not the entire back plate**

MITSUBISHI Rear

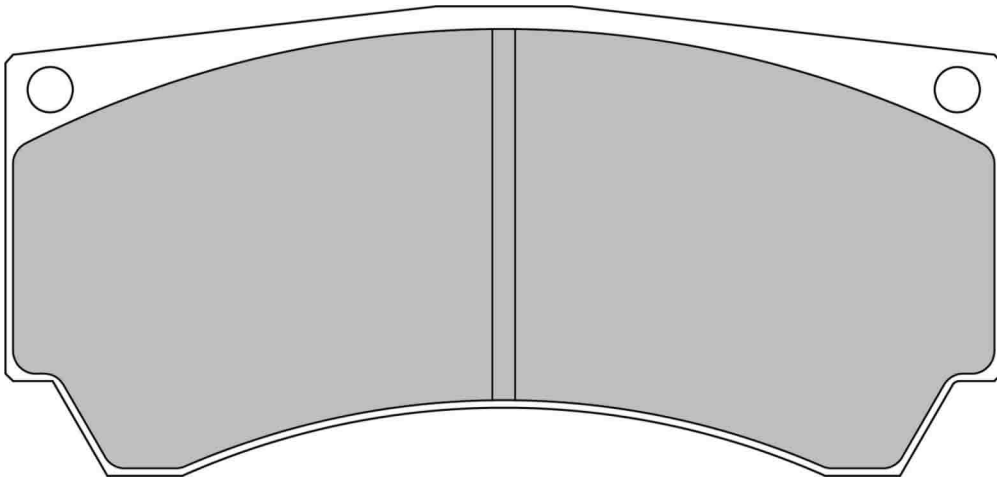

MATERIAL AVAILABILITY				
H	C	R	W	Z
✓		✓	✗	✗

CROSS REFERENCE	
ALCON	PNF4498X703.4
ALCON	PNF4498X705.4

# FRP3083



130.3mm = 5.130"



55.0mm = 2.165"



16.9mm = 0.665"

WVA No: 24974 16,7 - 20345 16,9

**IMPORTANT NOTICE: Please note that the height measurement represents the radial depth, not the entire back plate**

LOTUS Front, RENAULT Front, SEAT Front

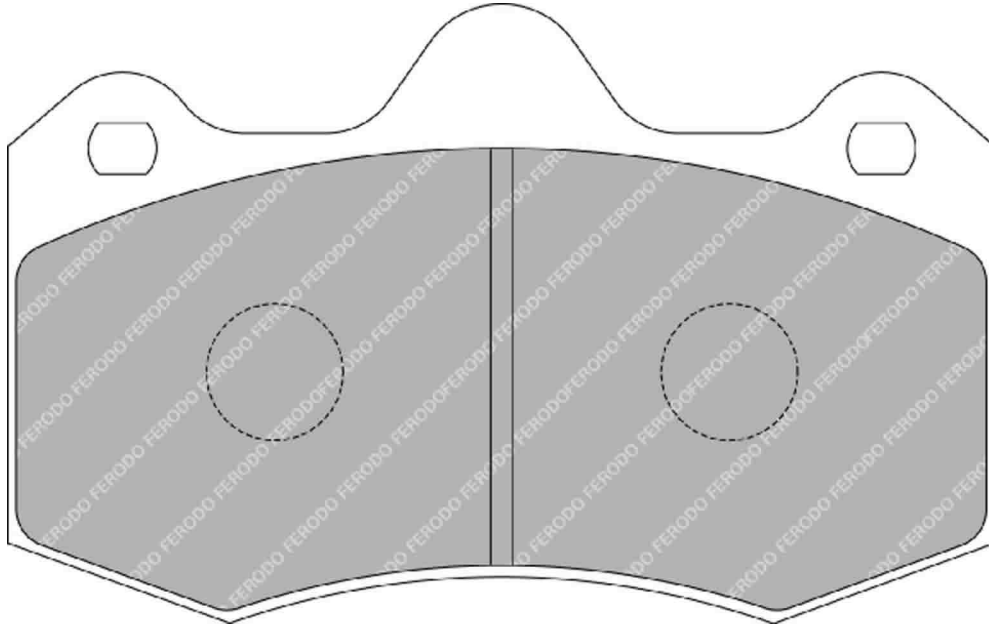

### ALSO AVAILABLE

SHAPE	TH. MM	NOTES
FRP3107	no	D50

### CROSS REFERENCE

AP RACING	CP6600D55
PAGID	20345
WVA	24974 16,7 - 20345 16,9

### MATERIAL AVAILABILITY

H	C	R	W	Z
✓		✓	✓	✓

# FRP3084

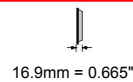
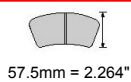

**IMPORTANT NOTICE: Please note that the height measurement represents the radial depth, not the entire back plate**

ASTON MARTIN Front, KIA Front

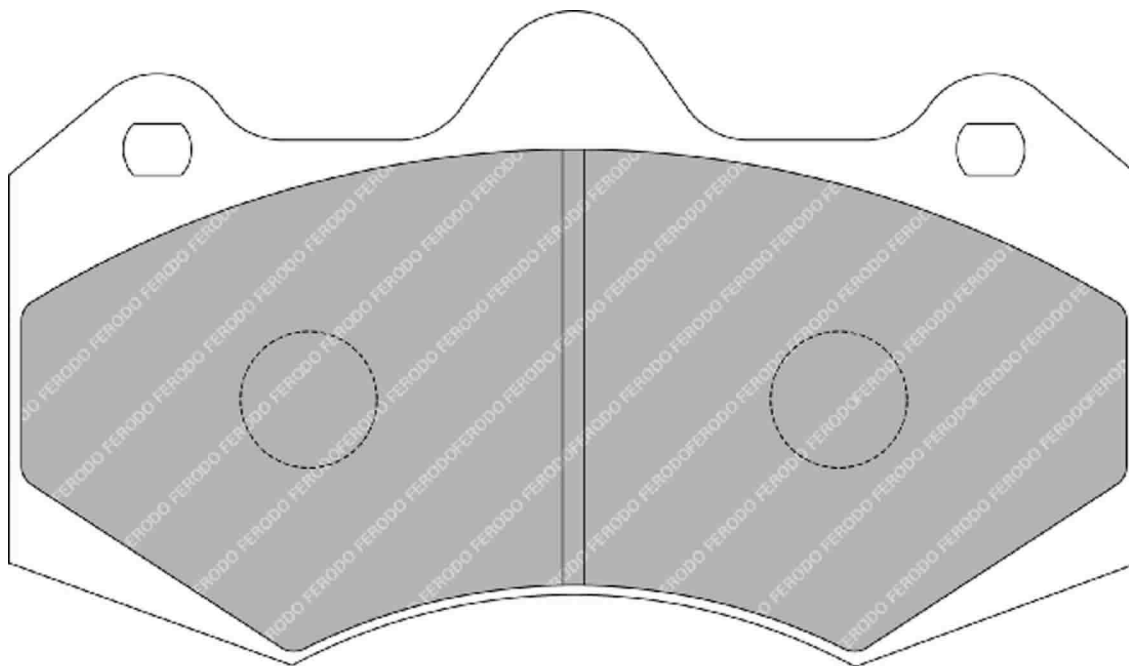

MATERIAL AVAILABILITY				
H	C	R	W	Z
✓		✓	✓	✓

CROSS REFERENCE	
AP RACING	CP7040D61
PAGID	20346

# FRP3085

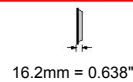
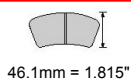

**IMPORTANT NOTICE: Please note that the height measurement represents the radial depth, not the entire back plate**

MG Front

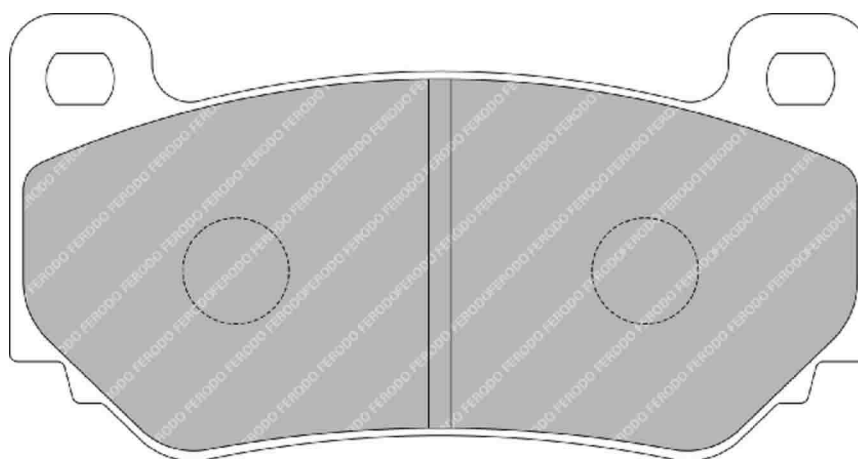

MATERIAL AVAILABILITY				
H	C	R	W	Z
✓		✓	✓	✓

CROSS REFERENCE	
AP RACING	CP7600D46
PAGID	20349

- ✓ Available
- ✗ Not Available
- ⚠ Exhausting
- ✉ Make to order
- 🔧 In Introduction

# FRP3086



86.2mm = 3.394"



46.0mm = 1.811"



18.0mm = 0.709"

**IMPORTANT NOTICE: Please note that the height measurement represents the radial depth, not the entire back plate**

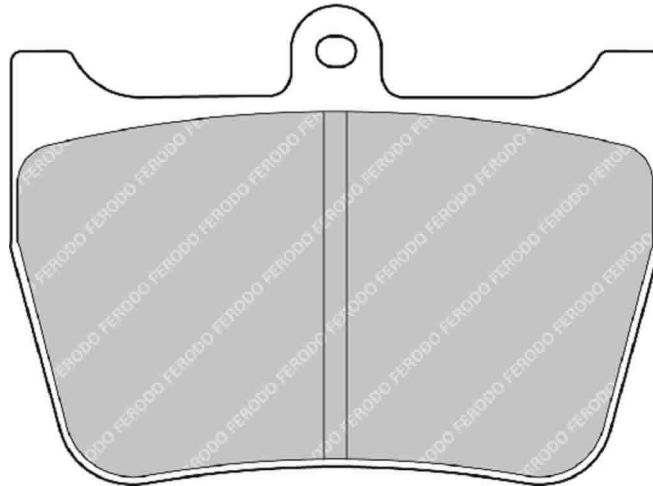

4 Pistons caliper (1 set = 4 pads) - 2 sets per axle for the recommended applications

ALSO AVAILABLE		
SHAPE	TH. MM	NOTES
FRP3020	15	

CROSS REFERENCE	
AP RACING	CP4848D46 (18 mm)
AP RACING	CP5148DXX
PFC	7804.XX.18

MATERIAL AVAILABILITY				
H	C	R	W	Z
		✓		

# FRP3087



139.8mm = 5.504"



48.4mm = 1.906"



17.5mm = 0.689"

**IMPORTANT NOTICE: Please note that the height measurement represents the radial depth, not the entire back plate**

MITSUBISHI Front

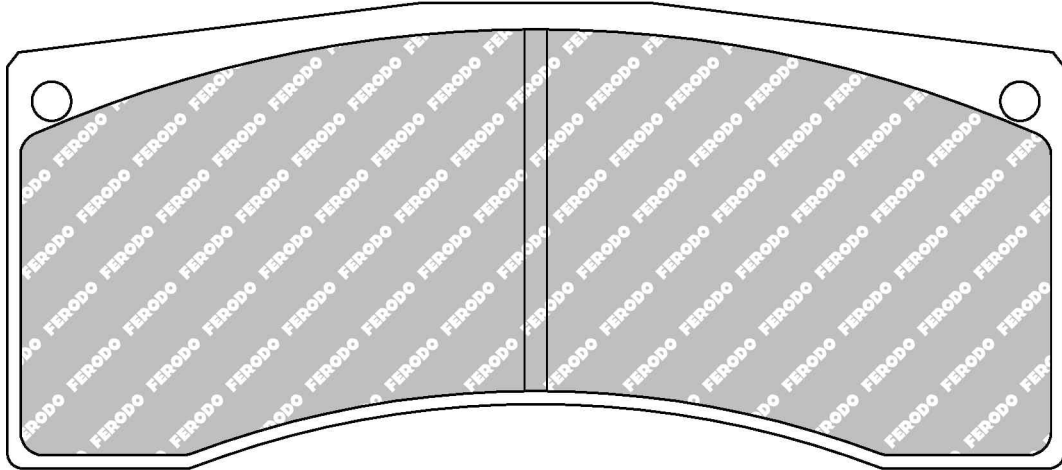

### ALSO AVAILABLE

SHAPE	TH. MM	NOTES
FRP3024	20	
FRP3029	26	
FRP3030	28	

### CROSS REFERENCE

BREMBO	07.7859.60
BREMBO	07.7859.70
PFC	7770.XX.17

### MATERIAL AVAILABILITY

H	C	R	W	Z
		✓	✓	✓

✓ Available    ⚠ Exhausting  
 ✗ Not Available    ✉ Make to order  
 🚧 In Introduction

**FERODO**  
RACING

Updated on 30th Jan 2014

**3251**

# FRP3088

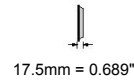
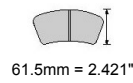

**IMPORTANT NOTICE:** Please note that the height measurement represents the radial depth, not the entire back plate

MITSUBISHI Front, PEUGEOT Front

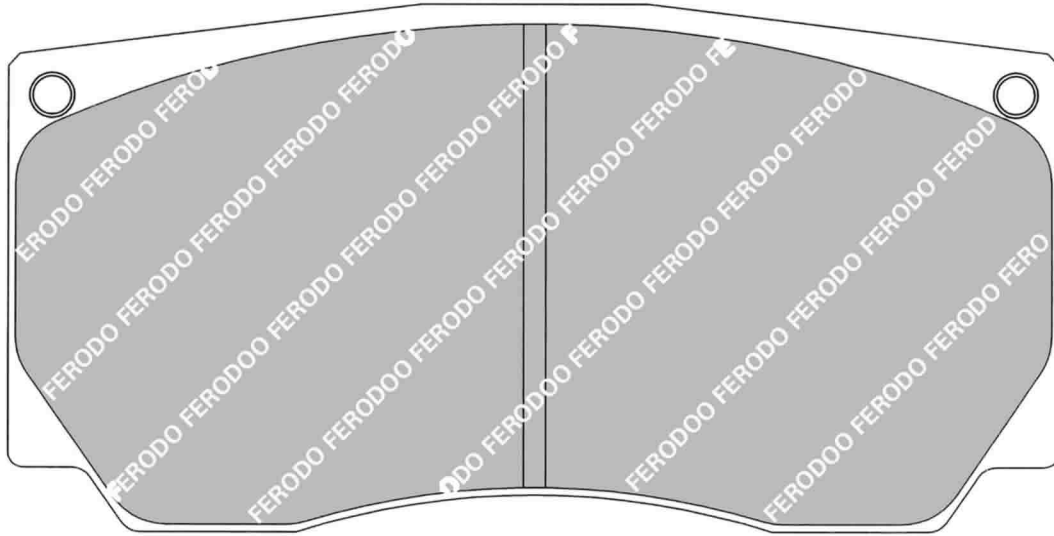

MATERIAL AVAILABILITY				
H	C	R	W	Z
		✓	✗	✓

CROSS REFERENCE	
BREMBO	07.6955.50
PAGID	8033
PFC	7772.XX.18

# FRP3091

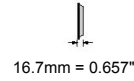
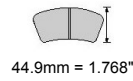
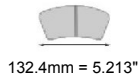

**IMPORTANT NOTICE:** Please note that the height measurement represents the radial depth, not the entire back plate

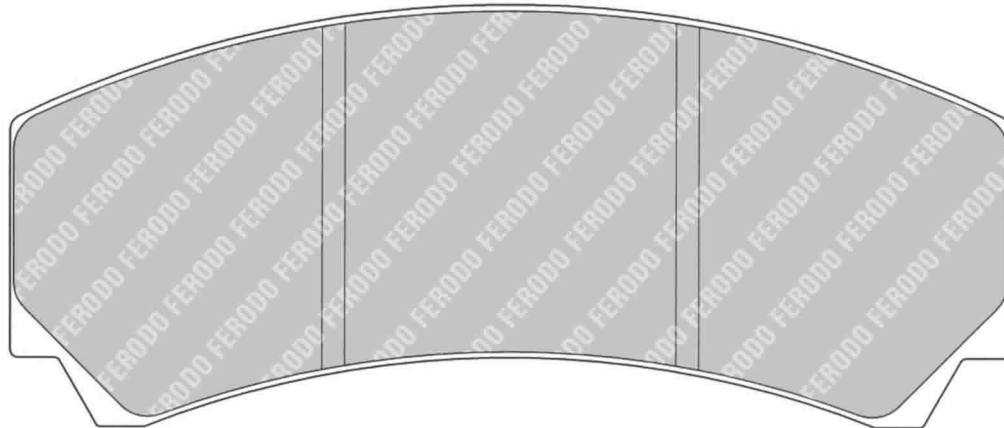

MATERIAL AVAILABILITY				
H	C	R	W	Z
		✗		

CROSS REFERENCE	
AP RACING	CP3215D46



# FRP3092

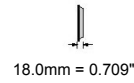
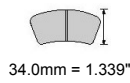

**IMPORTANT NOTICE:** Please note that the height measurement represents the radial depth, not the entire back plate

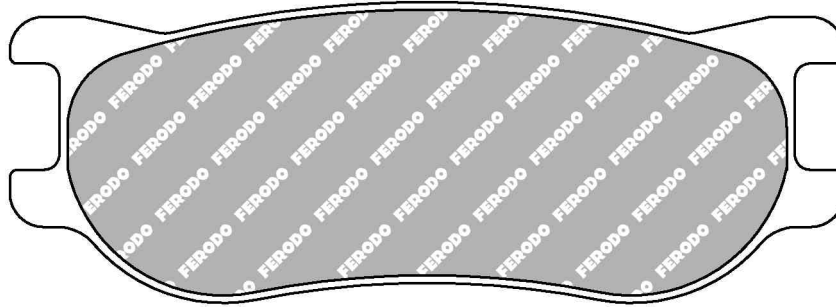

MATERIAL AVAILABILITY				
H	C	R	W	Z
			✓	✉

CROSS REFERENCE	
PAGID	8034

# FRP3094

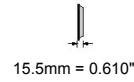
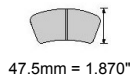
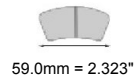

**IMPORTANT NOTICE:** Please note that the height measurement represents the radial depth, not the entire back plate

CHEVROLET Front / Rear

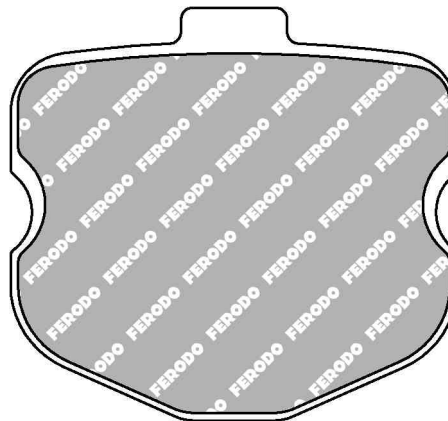

MATERIAL AVAILABILITY				
H	C	R	W	Z
✉			✓	

- ✓ Available
- ✗ Not Available
- ⚠ Exhausting
- ✉ Make to order
- 🚚 In Introduction

# FRP3095

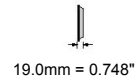
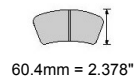
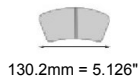

**IMPORTANT NOTICE: Please note that the height measurement represents the radial depth, not the entire back plate**

PORSCHE Rear

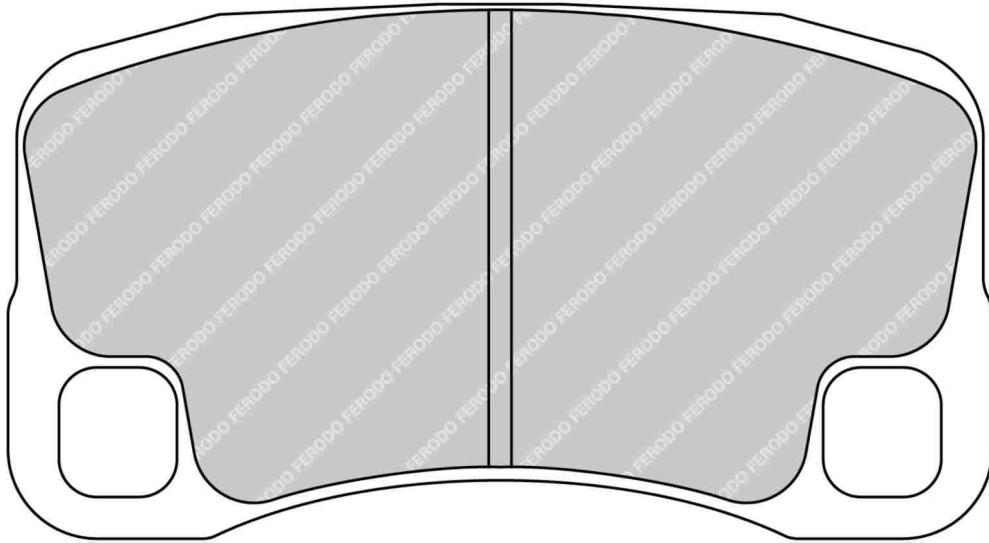

MATERIAL AVAILABILITY				
H	C	R	W	Z
✓			✓	✓

CROSS REFERENCE	
PAGID	8006

# FRP3096

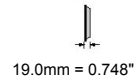
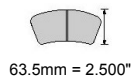
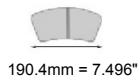

**IMPORTANT NOTICE: Please note that the height measurement represents the radial depth, not the entire back plate**

PORSCHE Front

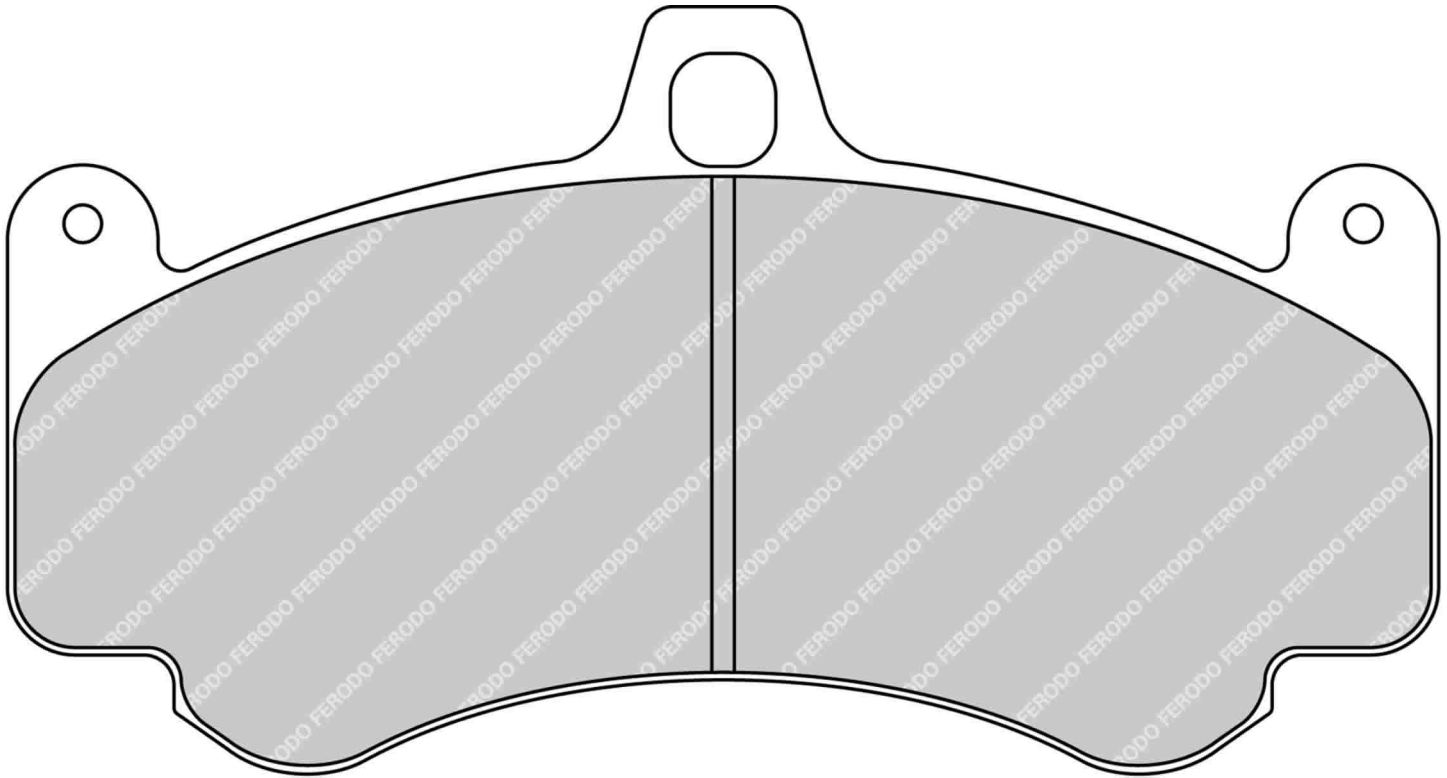

### ALSO AVAILABLE

SHAPE	TH. MM	NOTES
FRP3075	17.5	

### CROSS REFERENCE

CL Brakes	4126
PAGID	8004

### MATERIAL AVAILABILITY

H	C	R	W	Z
✓			✓	✓

✓ Available    ⚠ Exhausting  
 ✗ Not Available    ✉ Make to order  
 🚧 In Introduction

**FERODO**  
RACING

Updated on 30th Jan 2014

**3255**

# FRP3097

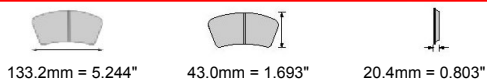

**IMPORTANT NOTICE: Please note that the height measurement represents the radial depth, not the entire back plate**

FORD Front

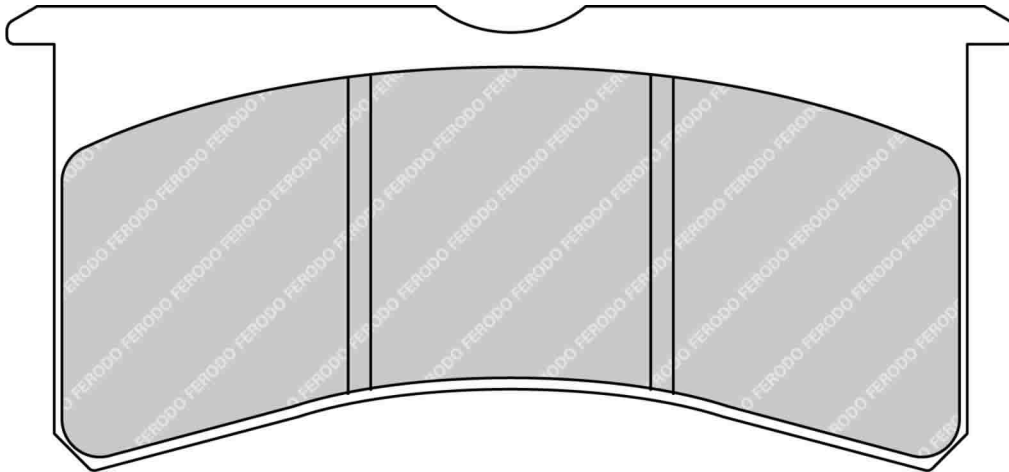

Same as FRP501 but fixed bridge caliper

### ALSO AVAILABLE

SHAPE	TH. MM	NOTES
FRP501	none	Non-Fixed Bridge caliper

### CROSS REFERENCE

AP RACING	CP8250-D41
-----------	------------

### MATERIAL AVAILABILITY

H	C	R	W	Z
✓		✓	✓	✓

3256

**FERODO**  
RACING

Updated on 30th Jan 2014

✓ Available    ⚠ Exhausting  
 ✗ Not Available    📦 Make to order  
 🚧 In Introduction

# FRP3098

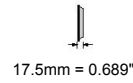
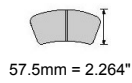

**IMPORTANT NOTICE:** Please note that the height measurement represents the radial depth, not the entire back plate

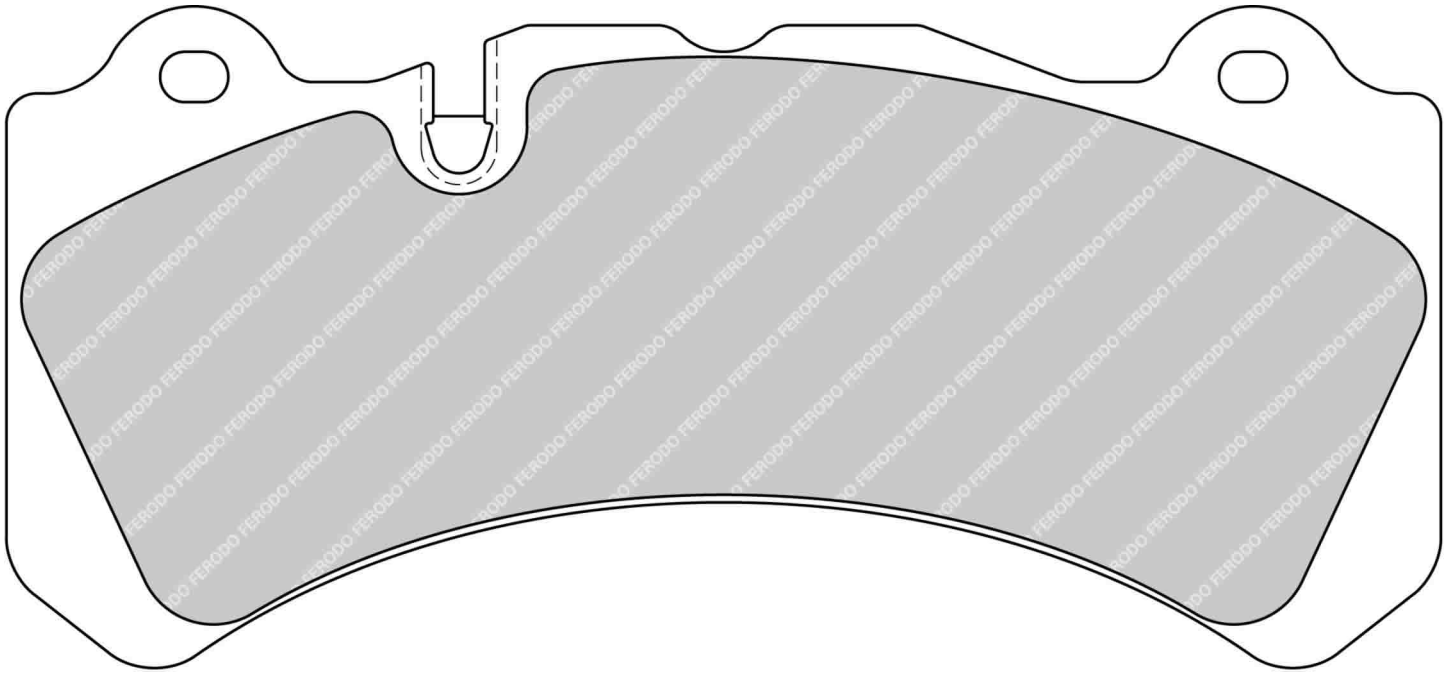

MATERIAL AVAILABILITY				
H	C	R	W	Z
✓		✓	✓	✓

CROSS REFERENCE	
BREMBO	07.9551.13
BREMBO	07.B314.59 (Th 16.8)

- ✓ Available    ⚠ Exhausting
- ✗ Not Available    ✉ Make to order
- 🔵 In Introduction

# FRP3099

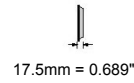
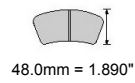

**IMPORTANT NOTICE:** Please note that the height measurement represents the radial depth, not the entire back plate

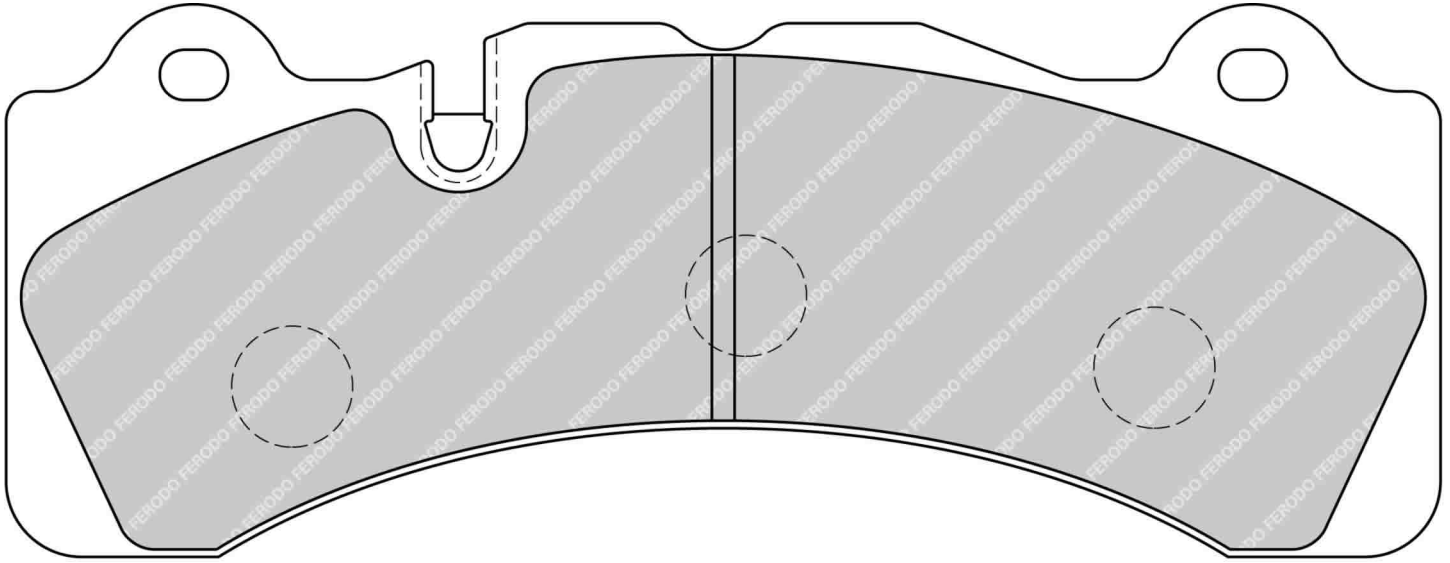

MATERIAL AVAILABILITY				
H	C	R	W	Z
✓		✓	✕	✕

CROSS REFERENCE	
BREMBO	XA5.71.M2

# FRP3100

164.8mm = 6.488"

55.0mm = 2.165"

16.1mm = 0.634"

FMSI No: D1116

**IMPORTANT NOTICE: Please note that the height measurement represents the radial depth, not the entire back plate**

MASERATI Front, MERCEDES Front, SUBARU Front

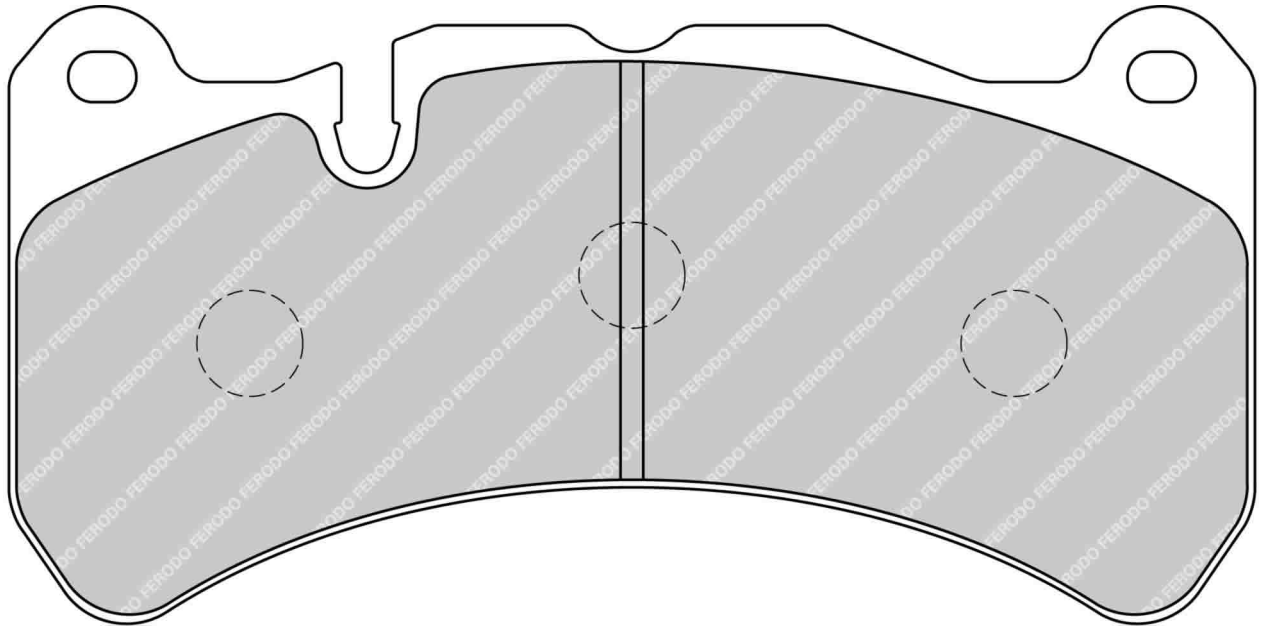

MATERIAL AVAILABILITY				
H	C	R	W	Z
✓		✉		

CROSS REFERENCE	
BREMBO	07.8365.33
BREMBO	07.9209.xx
FMSI	D1116
PAGID	8005

# FRP3101

138.1mm = 5.437"

43.0mm = 1.693"

17.5mm = 0.689"

**IMPORTANT NOTICE: Please note that the height measurement represents the radial depth, not the entire back plate**

PEUGEOT Front / Rear

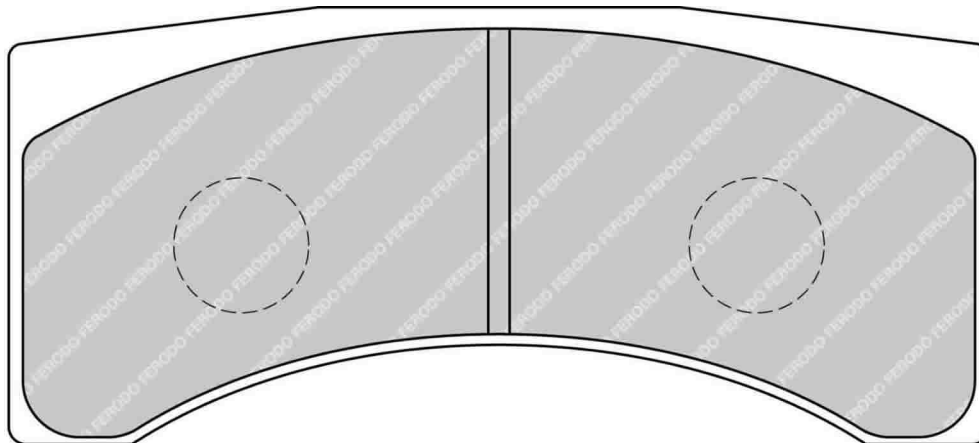

MATERIAL AVAILABILITY				
H	C	R	W	Z
				✓

- ✓ Available
- ✗ Not Available
- ✉ Make to order
- ⚠ Exhausting
- 🚚 In Introduction

# FRP3102

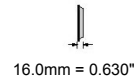
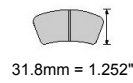

**IMPORTANT NOTICE:** Please note that the height measurement represents the radial depth, not the entire back plate

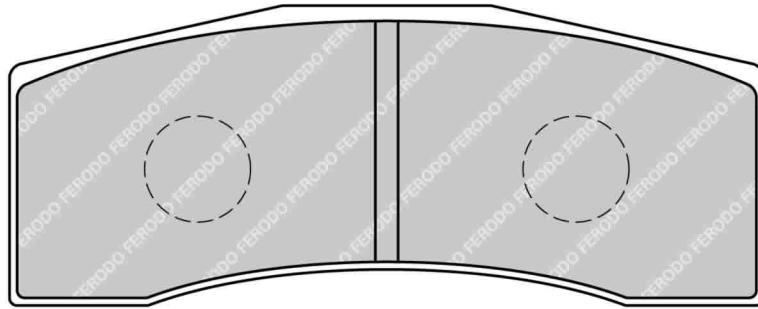

MATERIAL AVAILABILITY				
H	C	R	W	Z
			✓	✓

CROSS REFERENCE	
AP RACING	CP7031D32

# FRP3103

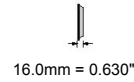
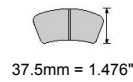
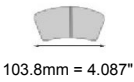

**IMPORTANT NOTICE:** Please note that the height measurement represents the radial depth, not the entire back plate

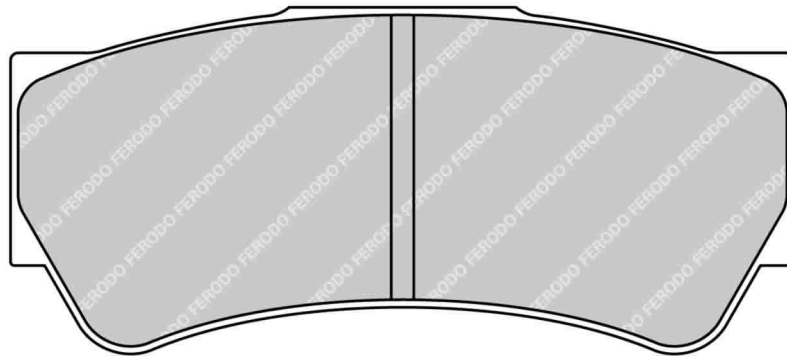

MATERIAL AVAILABILITY				
H	C	R	W	Z
			✓	✓

CROSS REFERENCE	
BREMBO	07.A262.20



# FRP3104



50.3mm = 1.980"



42.2mm = 1.661"



12.7mm = 0.500"

**IMPORTANT NOTICE: Please note that the height measurement represents the radial depth, not the entire back plate**

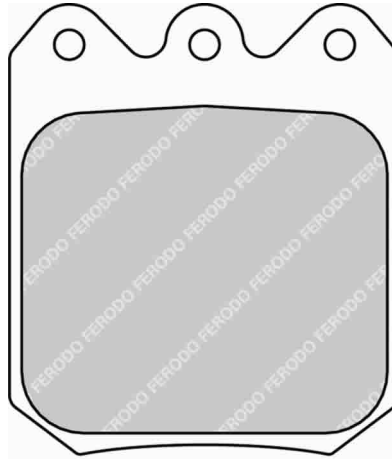

MATERIAL AVAILABILITY				
H	C	R	W	Z
	✓	✉		

CROSS REFERENCE	
WILWOOD	6812

# FRP3105



120.0mm = 4.724"



50.0mm = 1.969"



15.0mm = 0.591"

**IMPORTANT NOTICE: Please note that the height measurement represents the radial depth, not the entire back plate**

HONDA Front

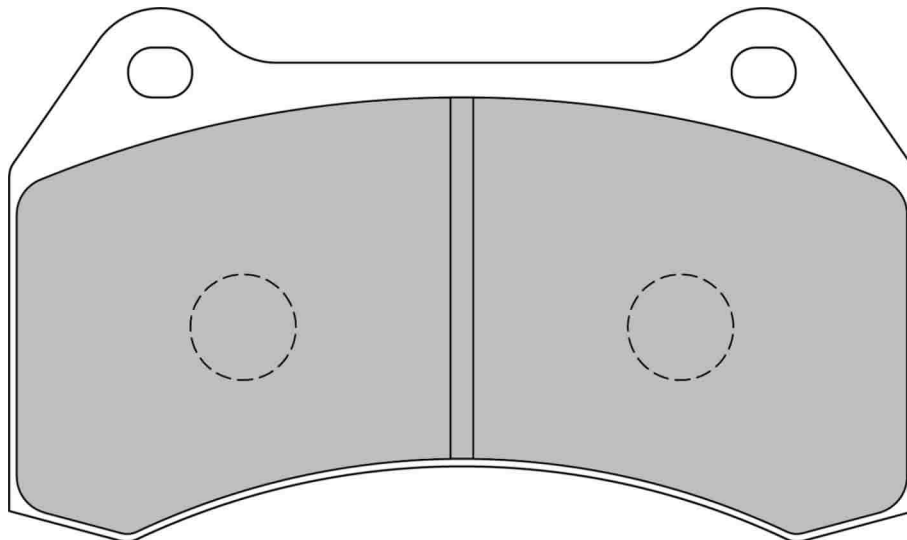

MATERIAL AVAILABILITY				
H	C	R	W	Z
		✉		

- ✓ Available
- ✗ Not Available
- ✉ Make to order
- ⚠ Exhausting
- 📧 In Introduction

# FRP3106

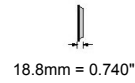
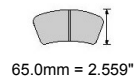

FMSI No: D1382

**IMPORTANT NOTICE: Please note that the height measurement represents the radial depth, not the entire back plate**

NISSAN Front

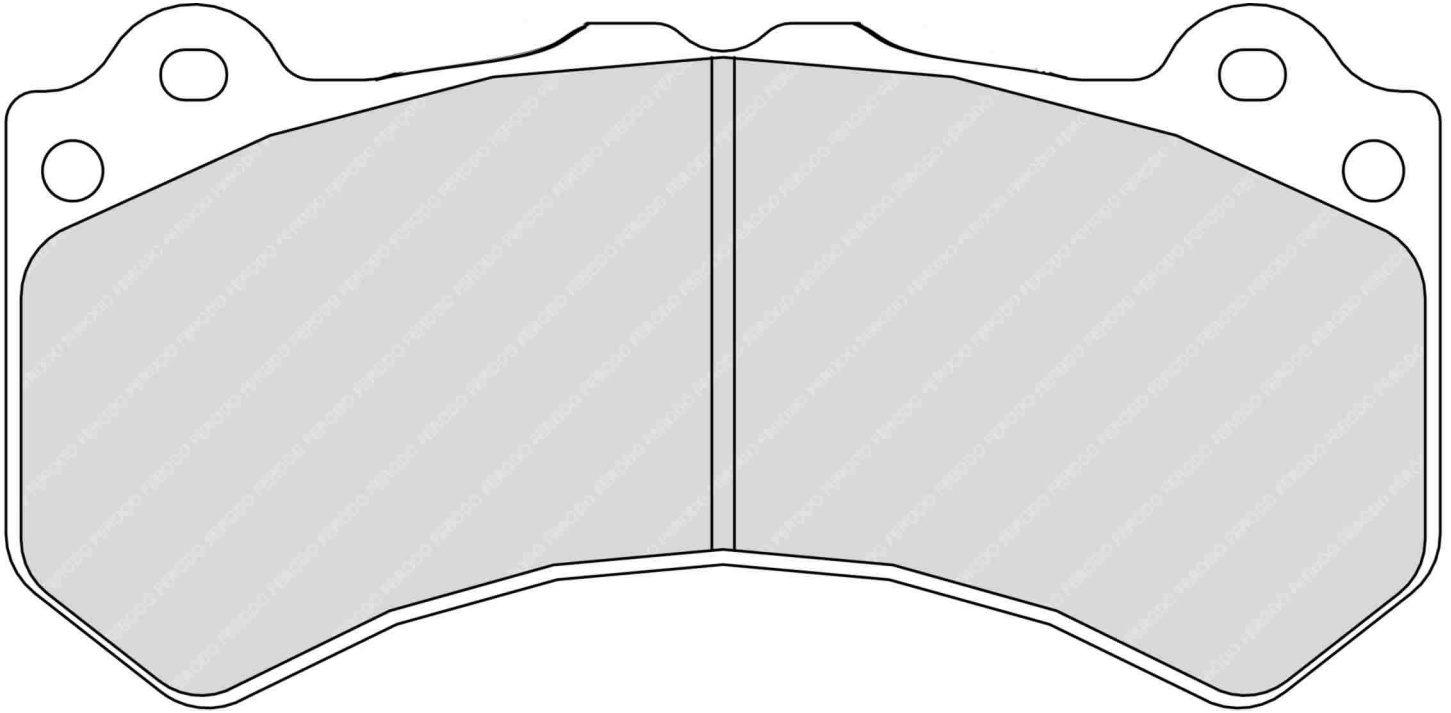

MATERIAL AVAILABILITY				
H	C	R	W	Z
✓		✗	✓	✓

CROSS REFERENCE	
BREMBO	07.8590.15
FMSI	D1382

# FRP3107

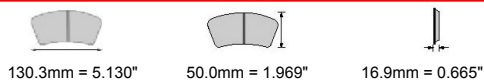

**IMPORTANT NOTICE:** Please note that the height measurement represents the radial depth, not the entire back plate

PEUGEOT Front

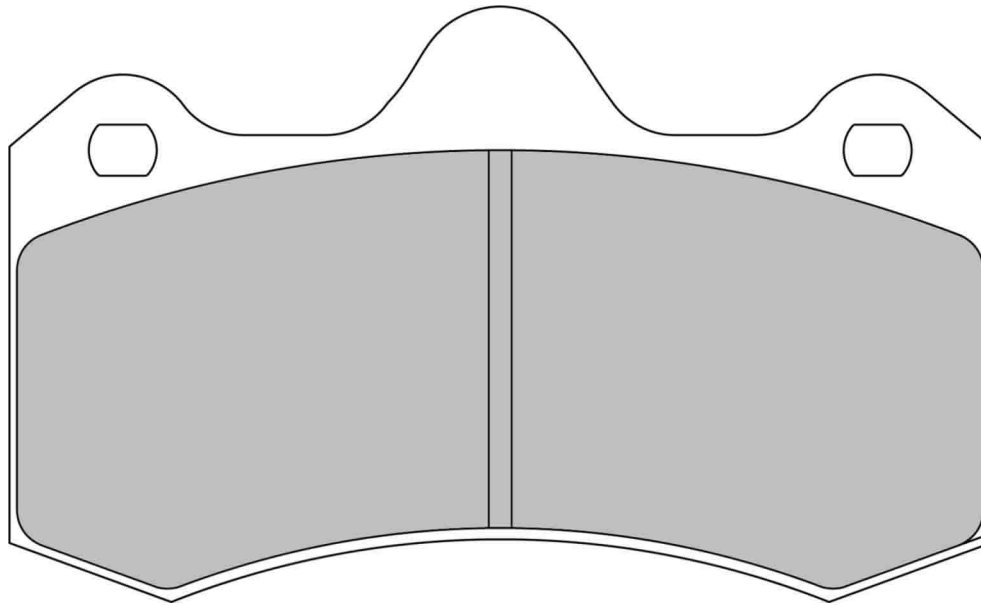

ALSO AVAILABLE		
SHAPE	TH. MM	NOTES
FRP3083	no	D55

CROSS REFERENCE	
AP RACING	CP6600D50

MATERIAL AVAILABILITY				
H	C	R	W	Z
✓		✓		

# FRP3108

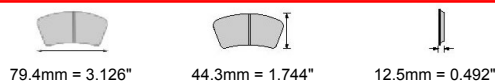

**IMPORTANT NOTICE:** Please note that the height measurement represents the radial depth, not the entire back plate

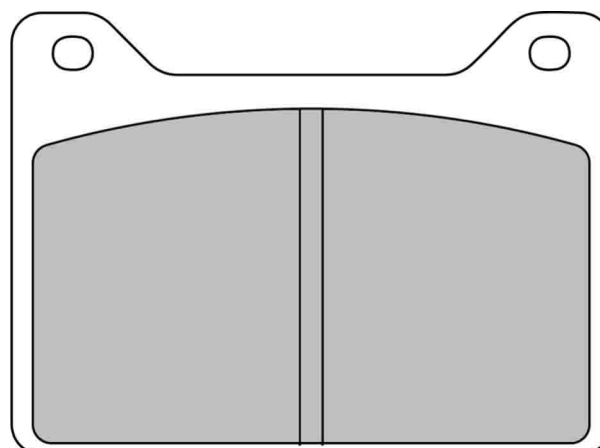

MATERIAL AVAILABILITY				
H	C	R	W	Z
✓				✉

CROSS REFERENCE	
WILWOOD	7912

- ✓ Available
- ✗ Not Available
- ⚠ Exhausting
- ✉ Make to order
- 📦 In Introduction

# FRP3109



109.8mm = 4.323"



51.3mm = 2.020"



12.5mm = 0.492"

**IMPORTANT NOTICE: Please note that the height measurement represents the radial depth, not the entire back plate**

ASTON MARTIN Rear

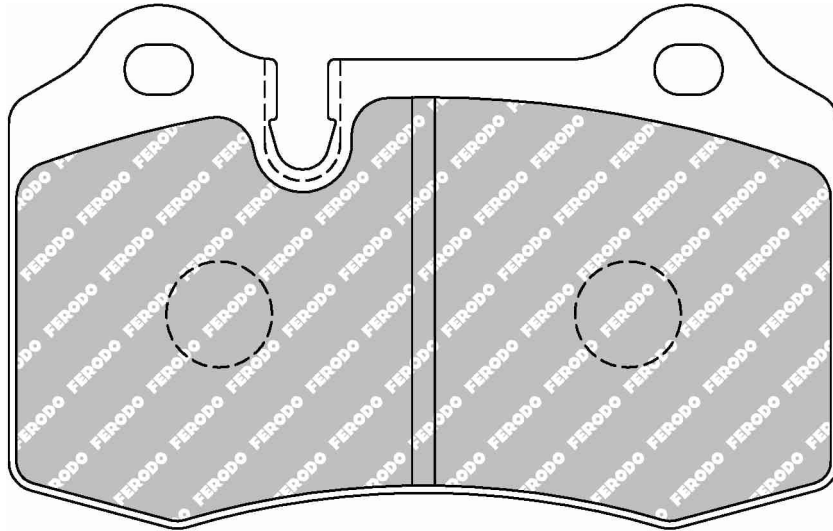

ALSO AVAILABLE		
SHAPE	TH. MM	NOTES
FCP1348	15	
FCP721	17.3	

CROSS REFERENCE	
BREMBO	XA4.17.M4

MATERIAL AVAILABILITY				
H	C	R	W	Z

# FRP3110

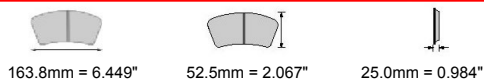

**IMPORTANT NOTICE:** Please note that the height measurement represents the radial depth, not the entire back plate

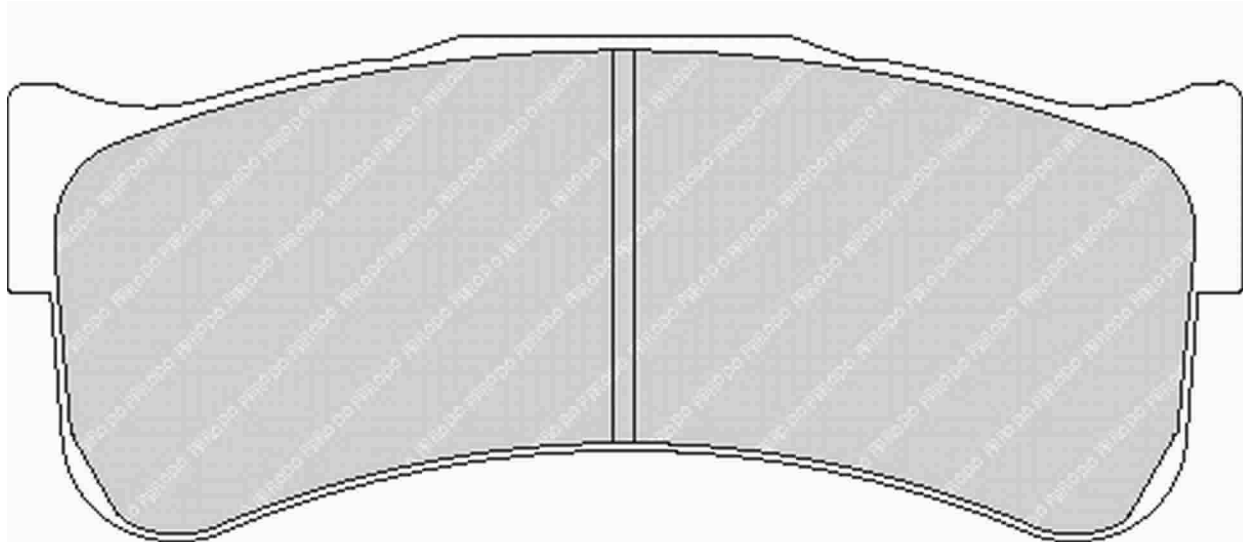

ALSO AVAILABLE		
SHAPE	TH. MM	NOTES
FRP3031	29	
FRP3123	21.5	

CROSS REFERENCE	
BREMBO	07.7293.7

MATERIAL AVAILABILITY				
H	C	R	W	Z

# FRP3112

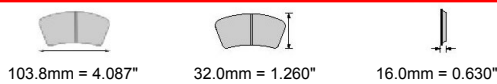

**IMPORTANT NOTICE:** Please note that the height measurement represents the radial depth, not the entire back plate

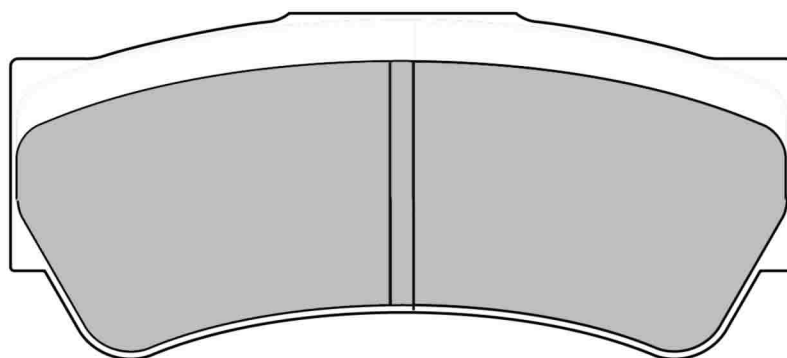

BREMBO 2009 F3 System - for reduced diameter rear disc - Material availability on request

MATERIAL AVAILABILITY				
H	C	R	W	Z

- Available
- Not Available
- In Introduction
- Exhausting
- Make to order

# FRP3113

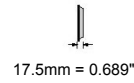
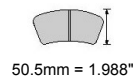
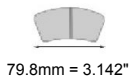

**IMPORTANT NOTICE: Please note that the height measurement represents the radial depth, not the entire back plate**

FORD Front

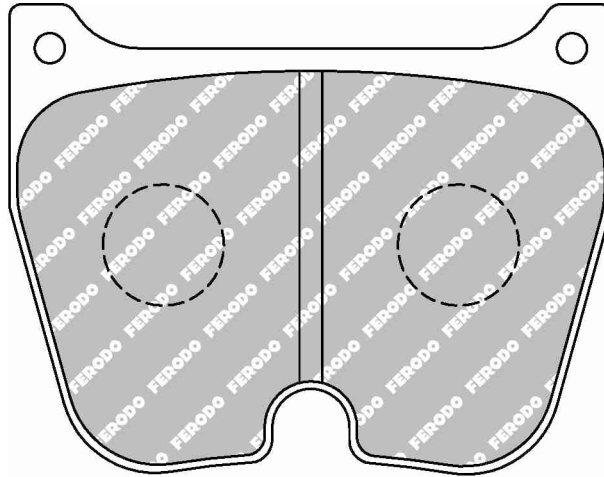

MATERIAL AVAILABILITY				
H	C	R	W	Z

CROSS REFERENCE	
BREMBO	07.A010.10

# FRP3114

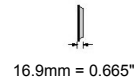
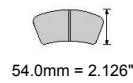

**IMPORTANT NOTICE: Please note that the height measurement represents the radial depth, not the entire back plate**

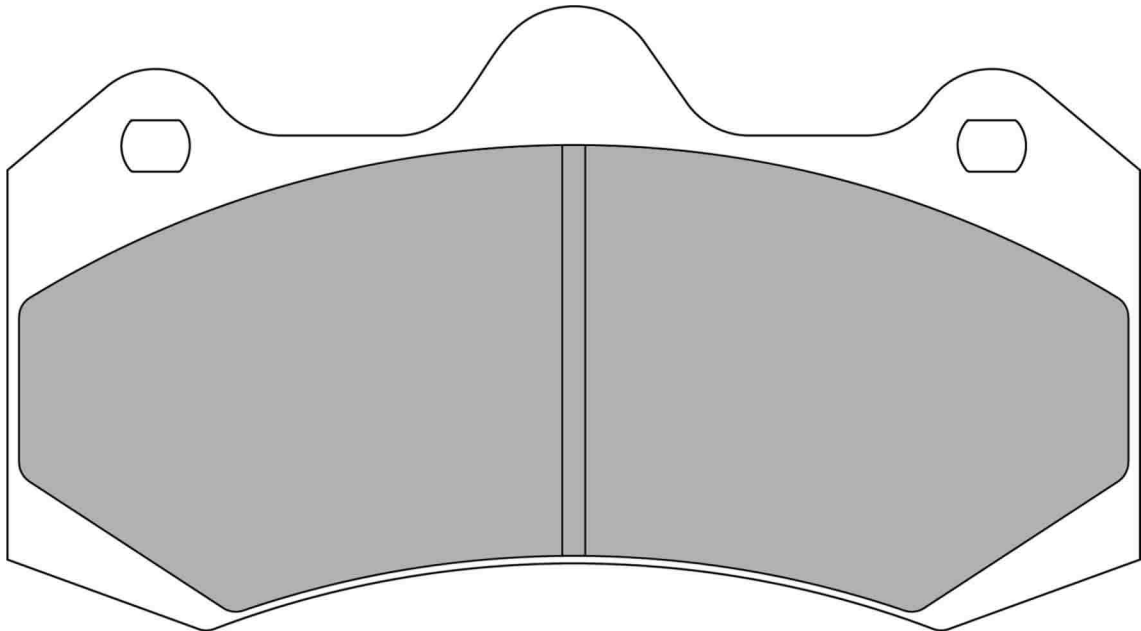

MATERIAL AVAILABILITY				
H	C	R	W	Z

CROSS REFERENCE	
AP RACING	CP7040D54

# FRP3115

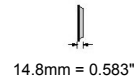
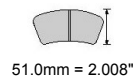

**IMPORTANT NOTICE:** Please note that the height measurement represents the radial depth, not the entire back plate

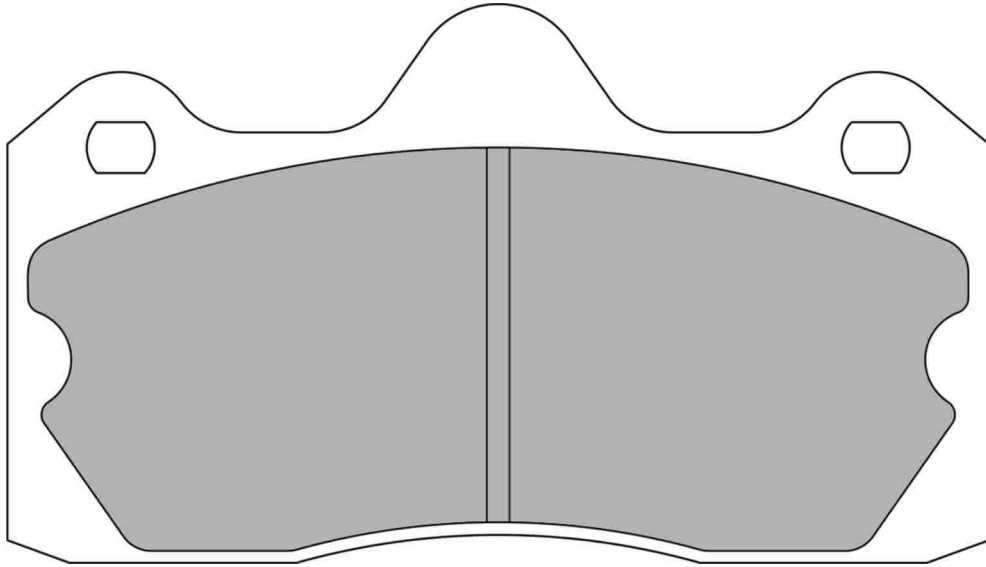

MATERIAL AVAILABILITY				
H	C	R	W	Z
✓		✉	✓	

CROSS REFERENCE	
AP RACING	CP6627D51

# FRP3116

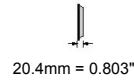
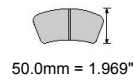
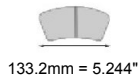

**IMPORTANT NOTICE:** Please note that the height measurement represents the radial depth, not the entire back plate

FORD Front

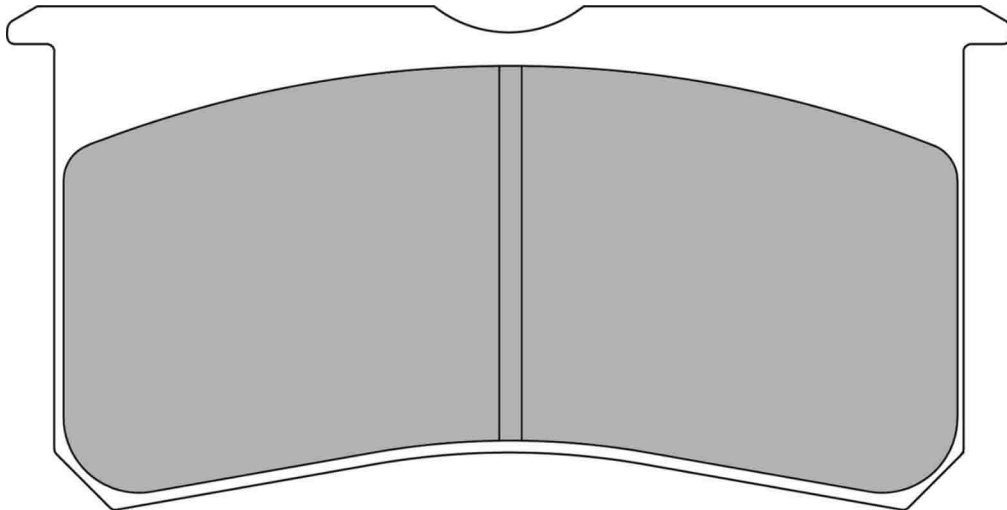

MATERIAL AVAILABILITY				
H	C	R	W	Z
✓		✓	✓	✓

CROSS REFERENCE	
AP RACING	CP8250D50

- ✓ Available    ⚠ Exhausting
- ✗ Not Available    ✉ Make to order
- 🔵 In Introduction

# FRP3117

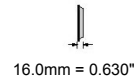
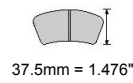

**IMPORTANT NOTICE:** Please note that the height measurement represents the radial depth, not the entire back plate

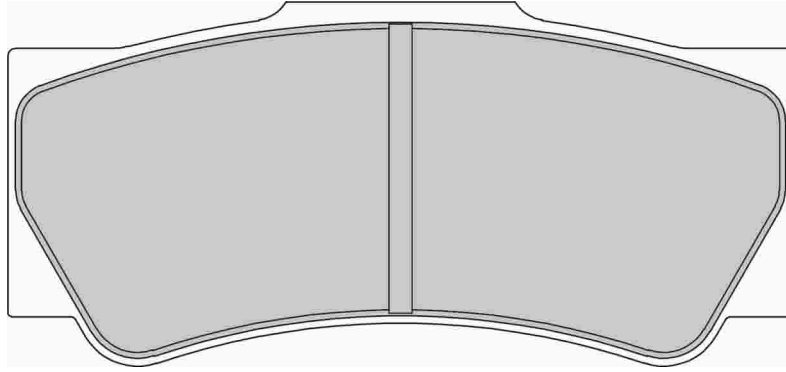

MATERIAL AVAILABILITY				
H	C	R	W	Z
		✓		

# FRP3118

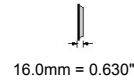
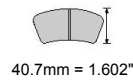
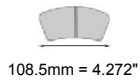

**IMPORTANT NOTICE:** Please note that the height measurement represents the radial depth, not the entire back plate

SUZUKI Front

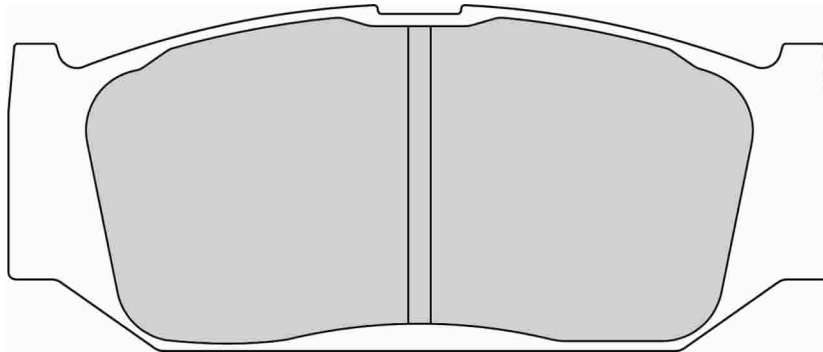

MATERIAL AVAILABILITY				
H	C	R	W	Z
			✓	

CROSS REFERENCE	
Oe Suzuki	5581057K01



# FRP3119



156.4mm = 6.157"



48.1mm = 1.894"



17.9mm = 0.705"

**IMPORTANT NOTICE: Please note that the height measurement represents the radial depth, not the entire back plate**

RENAULT Front

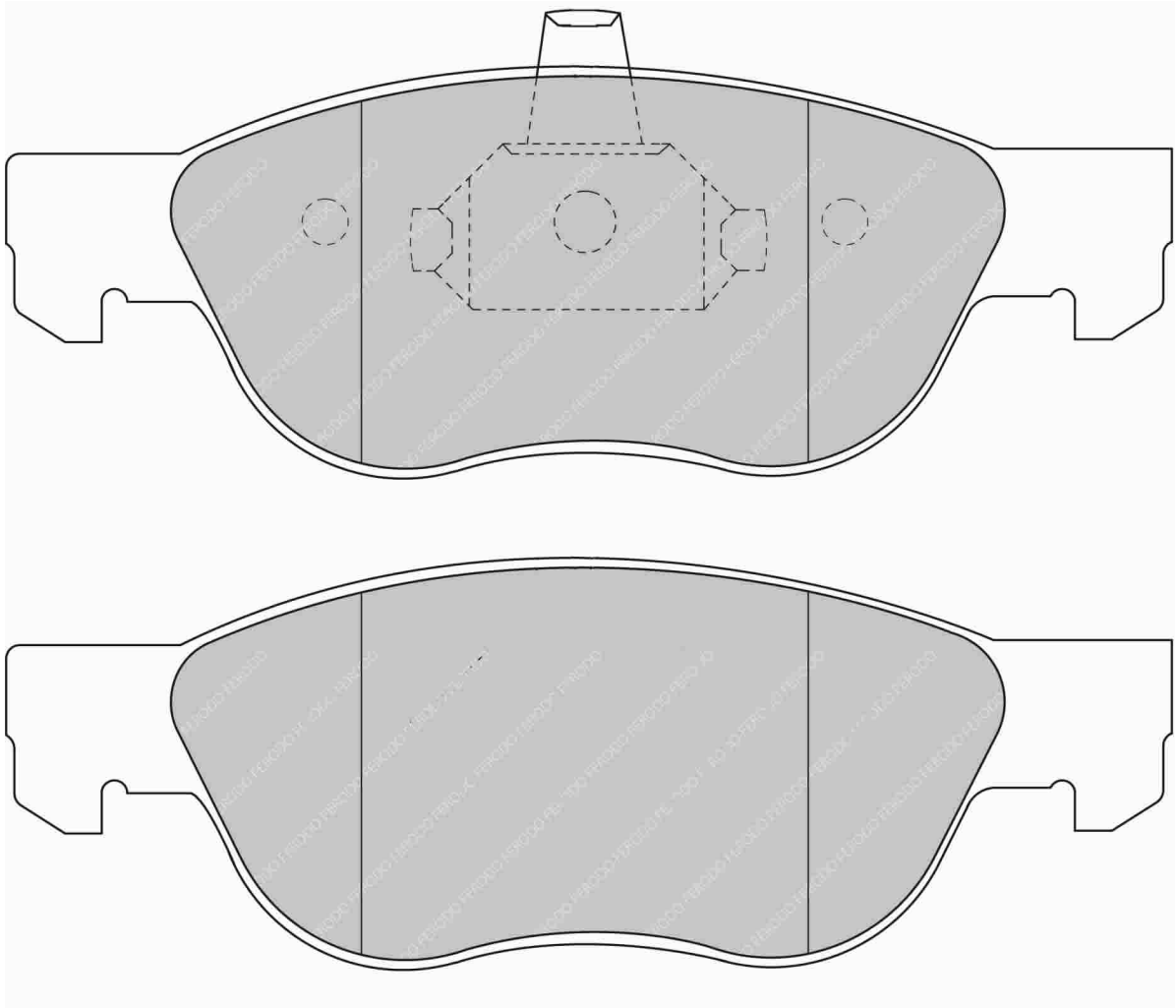

MATERIAL AVAILABILITY				
H	C	R	W	Z
				✔

✔ Available    ⚠ Exhausting  
 ✘ Not Available    ✉ Make to order  
 🔄 In Introduction

**FERODO**  
RACING

Updated on 30th Jan 2014

**3269**

# FRP3120

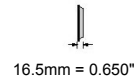
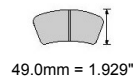

**IMPORTANT NOTICE: Please note that the height measurement represents the radial depth, not the entire back plate**

TOYOTA Front

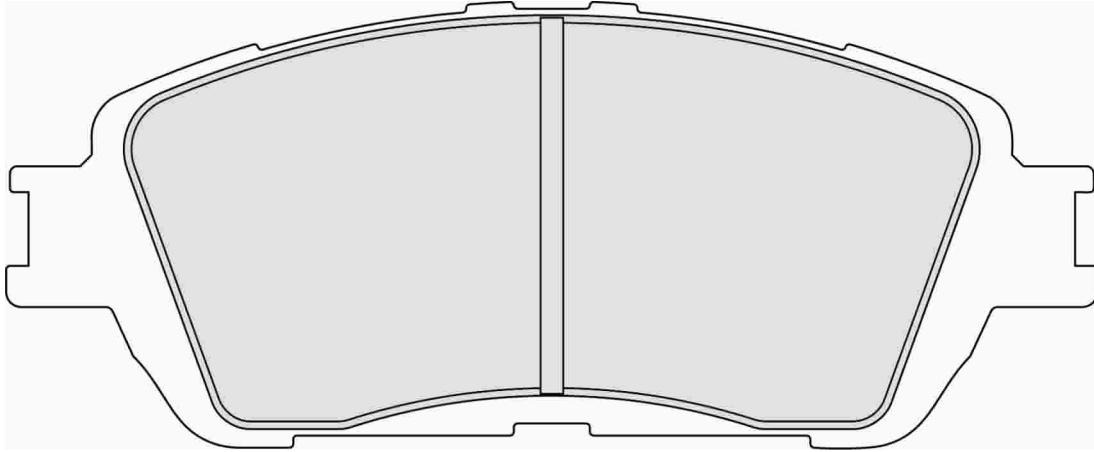

MATERIAL AVAILABILITY				
H	C	R	W	Z
✓				

# FRP3121

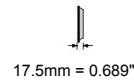
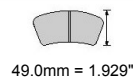

**IMPORTANT NOTICE: Please note that the height measurement represents the radial depth, not the entire back plate**

TOYOTA Front

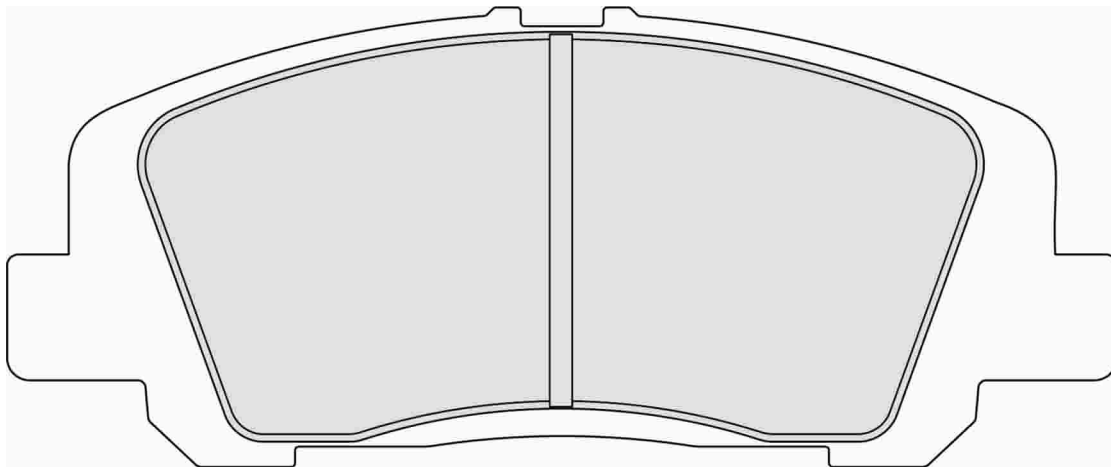

MATERIAL AVAILABILITY				
H	C	R	W	Z
✓				✉

# FRP3122

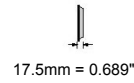
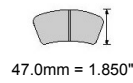

**IMPORTANT NOTICE:** Please note that the height measurement represents the radial depth, not the entire back plate

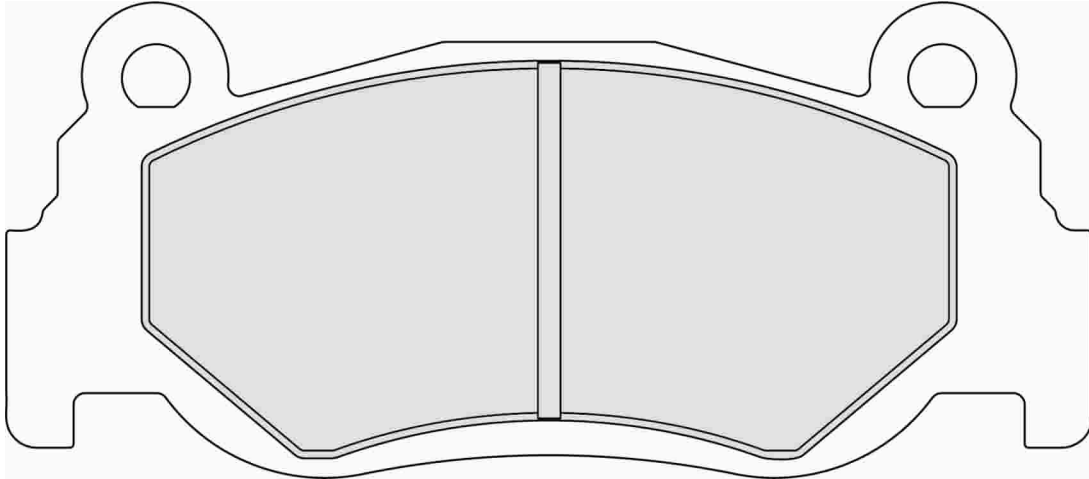

ATE Kit

MATERIAL AVAILABILITY				
H	C	R	W	Z

# FRP3123

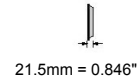
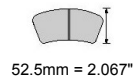
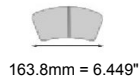

**IMPORTANT NOTICE:** Please note that the height measurement represents the radial depth, not the entire back plate

PORSCHE Front

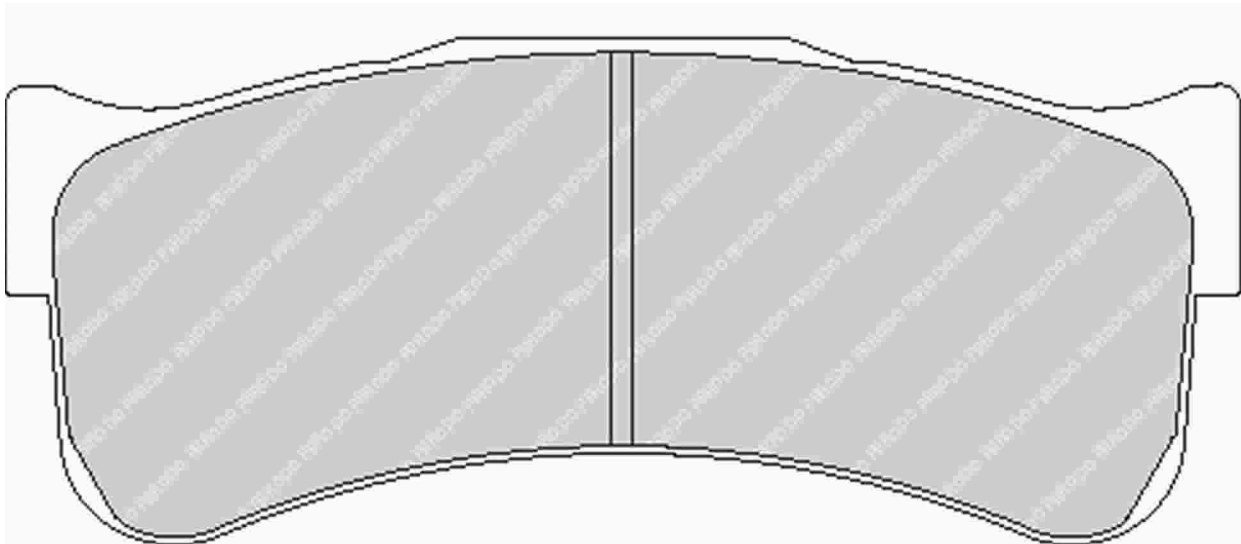

ALSO AVAILABLE		
SHAPE	TH. MM	NOTES
FRP3031	29	
FRP3110	25	

CROSS REFERENCE	
PAGID	8038

MATERIAL AVAILABILITY				
H	C	R	W	Z

- Available
- Exhausting
- Not Available
- Make to order
- In Introduction

# FRP3126



88.0mm = 3.465"

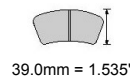

39.0mm = 1.535"

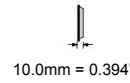

10.0mm = 0.394"

**IMPORTANT NOTICE: Please note that the height measurement represents the radial depth, not the entire back plate**

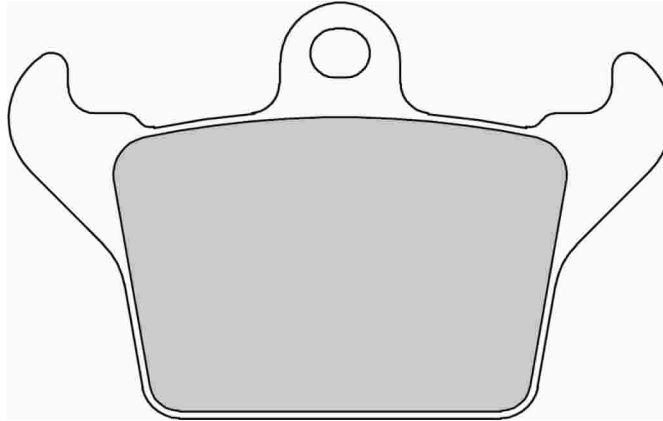

AP Racing/Brembo handbrake

MATERIAL AVAILABILITY				
H	C	R	W	Z
✓				

# FRP3127



145.4mm = 5.724"

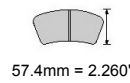

57.4mm = 2.260"

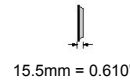

15.5mm = 0.610"

WVA No: 21 468 15,5

**IMPORTANT NOTICE: Please note that the height measurement represents the radial depth, not the entire back plate**

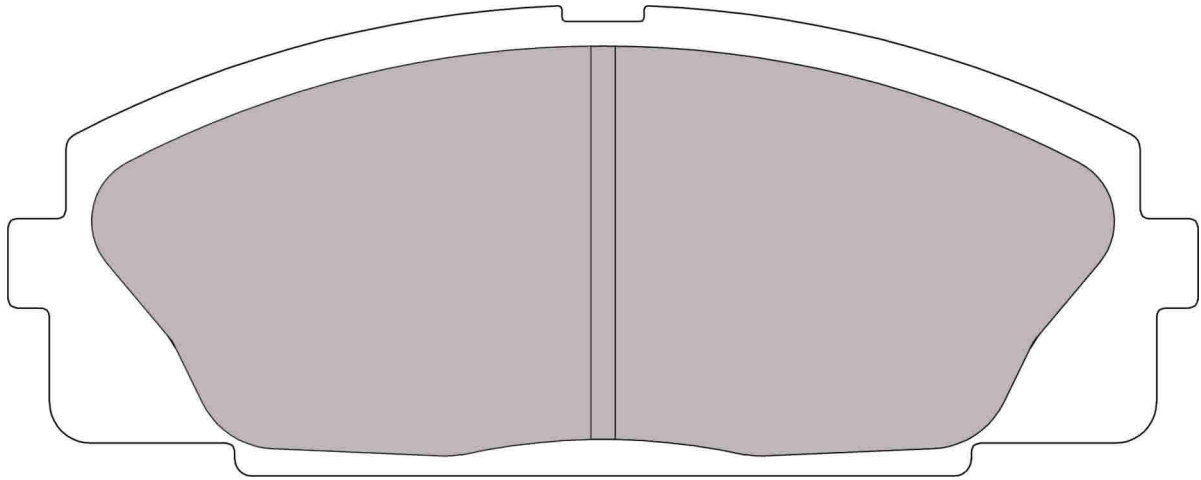

MATERIAL AVAILABILITY				
H	C	R	W	Z
✓				

CROSS REFERENCE	
WVA	21 468 15,5

# FRP3128

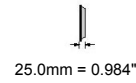
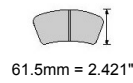

**IMPORTANT NOTICE:** Please note that the height measurement represents the radial depth, not the entire back plate

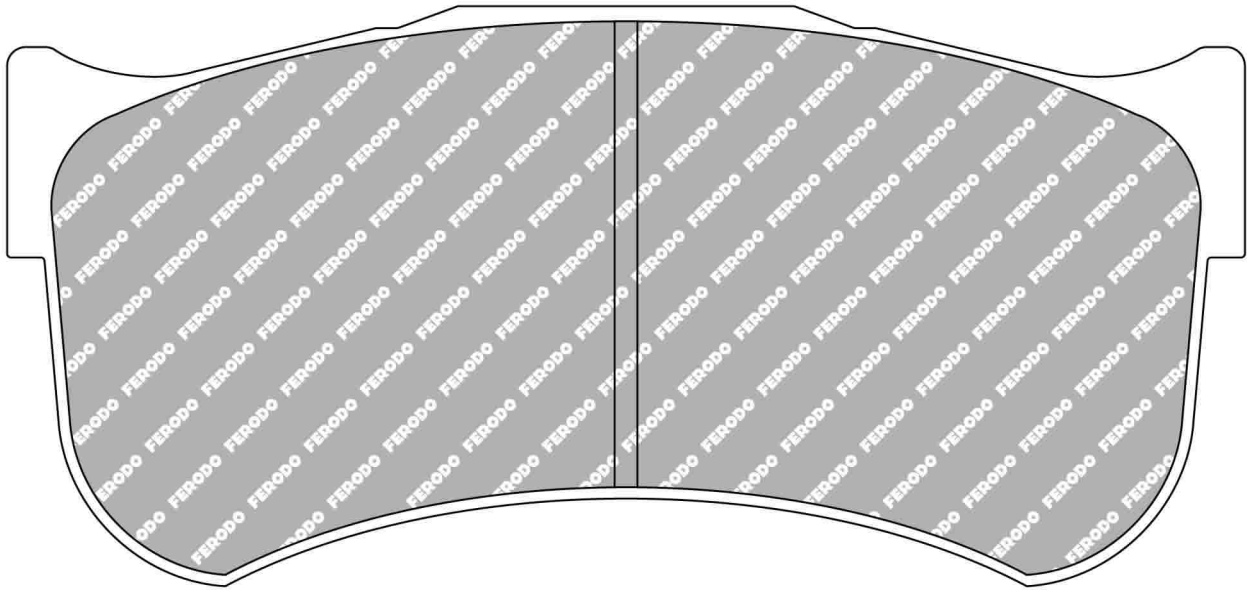

MATERIAL AVAILABILITY				
H	C	R	W	Z
				✔

# FRP3129

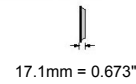
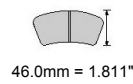
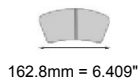

FMSI No: D1081

**IMPORTANT NOTICE:** Please note that the height measurement represents the radial depth, not the entire back plate

FORD Front

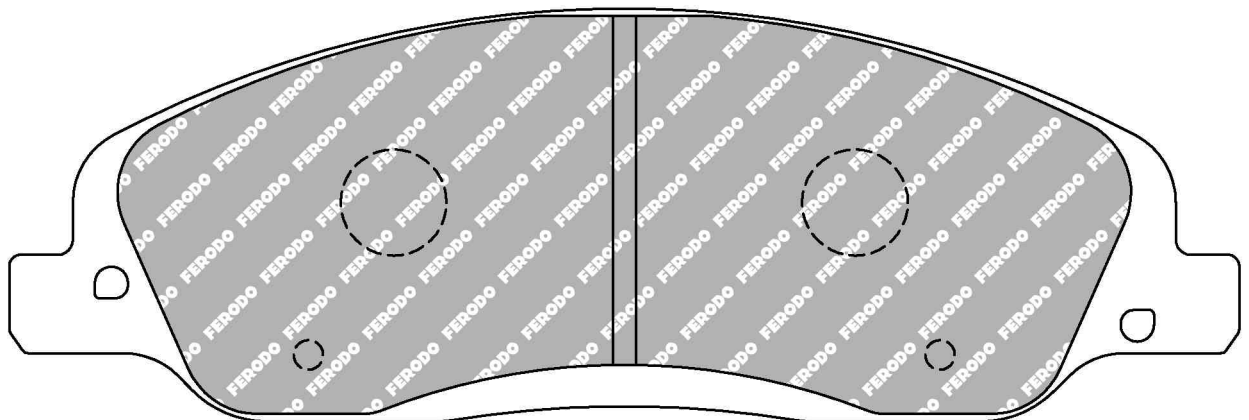

MATERIAL AVAILABILITY				
H	C	R	W	Z
✔				

CROSS REFERENCE	
FMSI	D1081
HAWK	HB484 0,670

- ✔ Available
- ✘ Not Available
- ⚠ Exhausting
- 📦 Make to order
- 🚧 In Introduction

# FRP3130

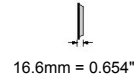
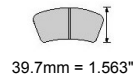

FMSI No: D1082

**IMPORTANT NOTICE: Please note that the height measurement represents the radial depth, not the entire back plate**

FORD Rear

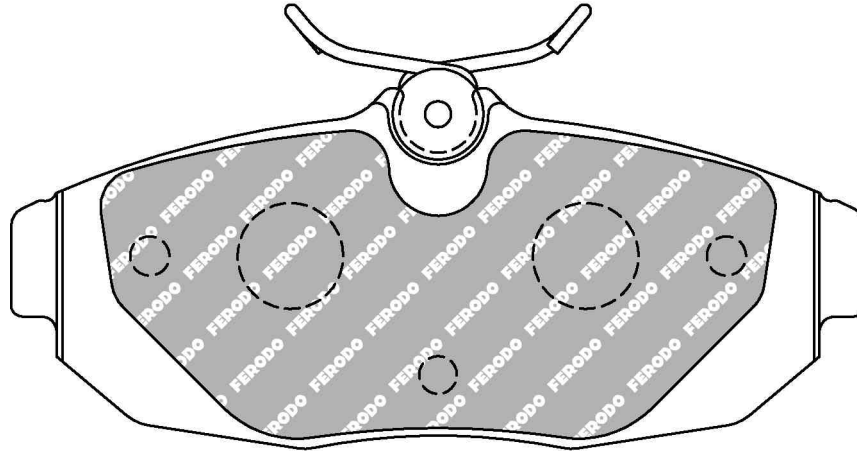

MATERIAL AVAILABILITY				
H	C	R	W	Z
✓			☒	

CROSS REFERENCE	
FMSI	D1082
HAWK	HB485 0,656

# FRP3133

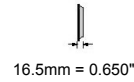
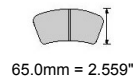
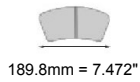

WVA No: 24 455 16,9

**IMPORTANT NOTICE: Please note that the height measurement represents the radial depth, not the entire back plate**

AUDI Front, LAND ROVER Front, MERCEDES Front

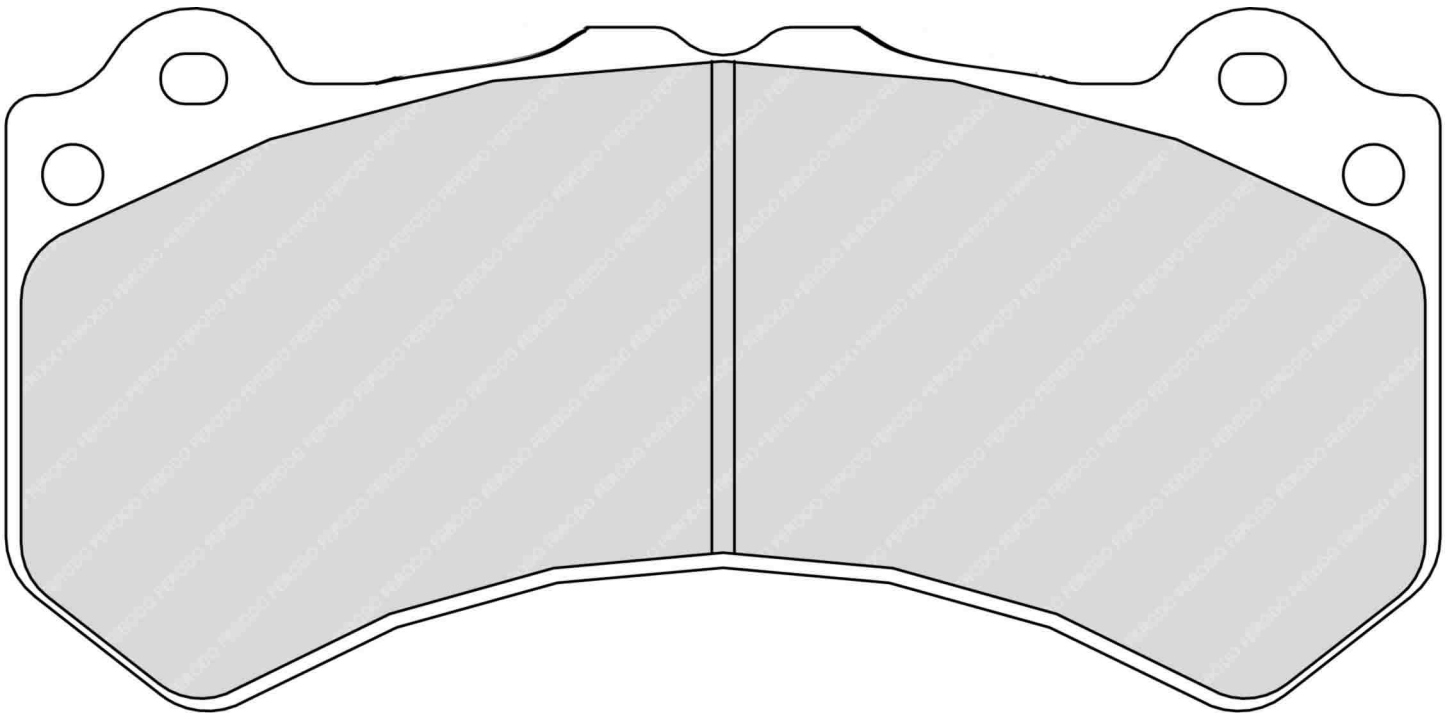

Pad will fit listed Landrover applications, though varies from OE spec (WVA 24659 16,9)

MATERIAL AVAILABILITY				
H	C	R	W	Z
✓				

CROSS REFERENCE	
WVA	24 455 16,9

3274



Updated on 30th Jan 2014

- ✓ Available
- ✗ Not Available
- ☒ In Introduction
- ⚠ Exhausting
- ☒ Make to order

# FRP3134

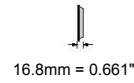
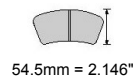

**IMPORTANT NOTICE:** Please note that the height measurement represents the radial depth, not the entire back plate

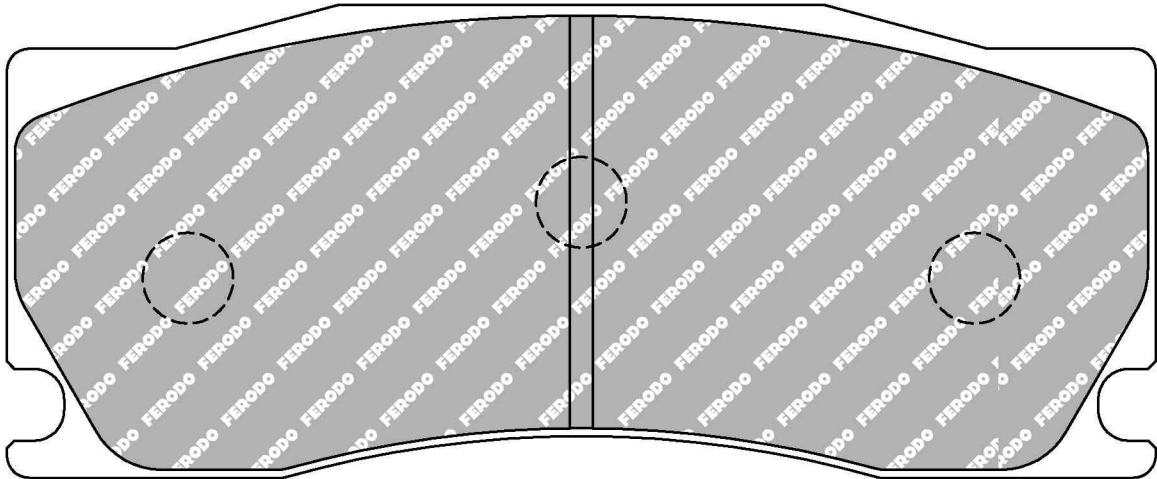

### MATERIAL AVAILABILITY

H	C	R	W	Z
✓		☒		☒

### CROSS REFERENCE

ALCON	PNF4497X831S
-------	--------------

# FRP3135

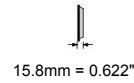
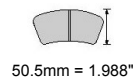
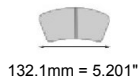

**IMPORTANT NOTICE:** Please note that the height measurement represents the radial depth, not the entire back plate

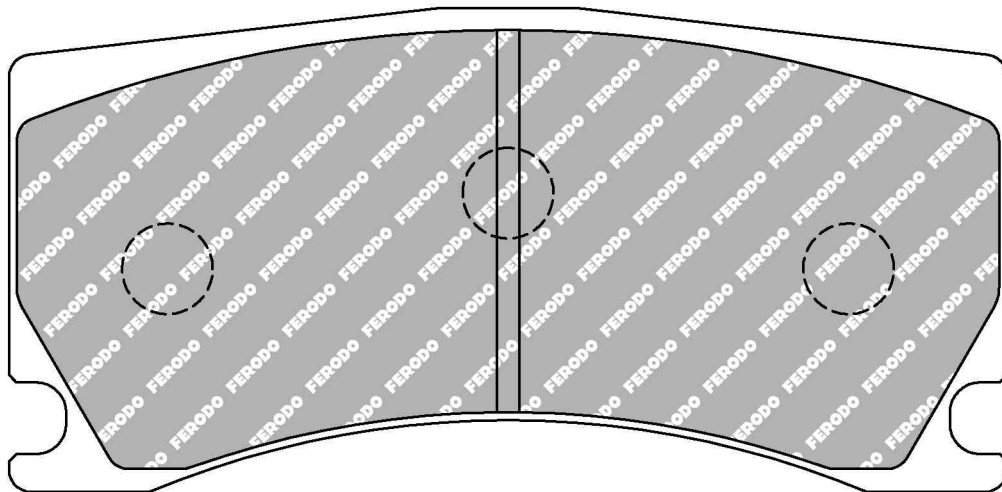

### MATERIAL AVAILABILITY

H	C	R	W	Z
✓		☒		☒

### CROSS REFERENCE

ALCON	PNF4498X821S
-------	--------------

- ✓ Available
- ✗ Not Available
- ☒ Exhausting
- ☒ Make to order
- ⚡ In Introduction

# FRP3136

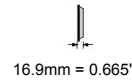
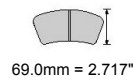

**IMPORTANT NOTICE:** Please note that the height measurement represents the radial depth, not the entire back plate

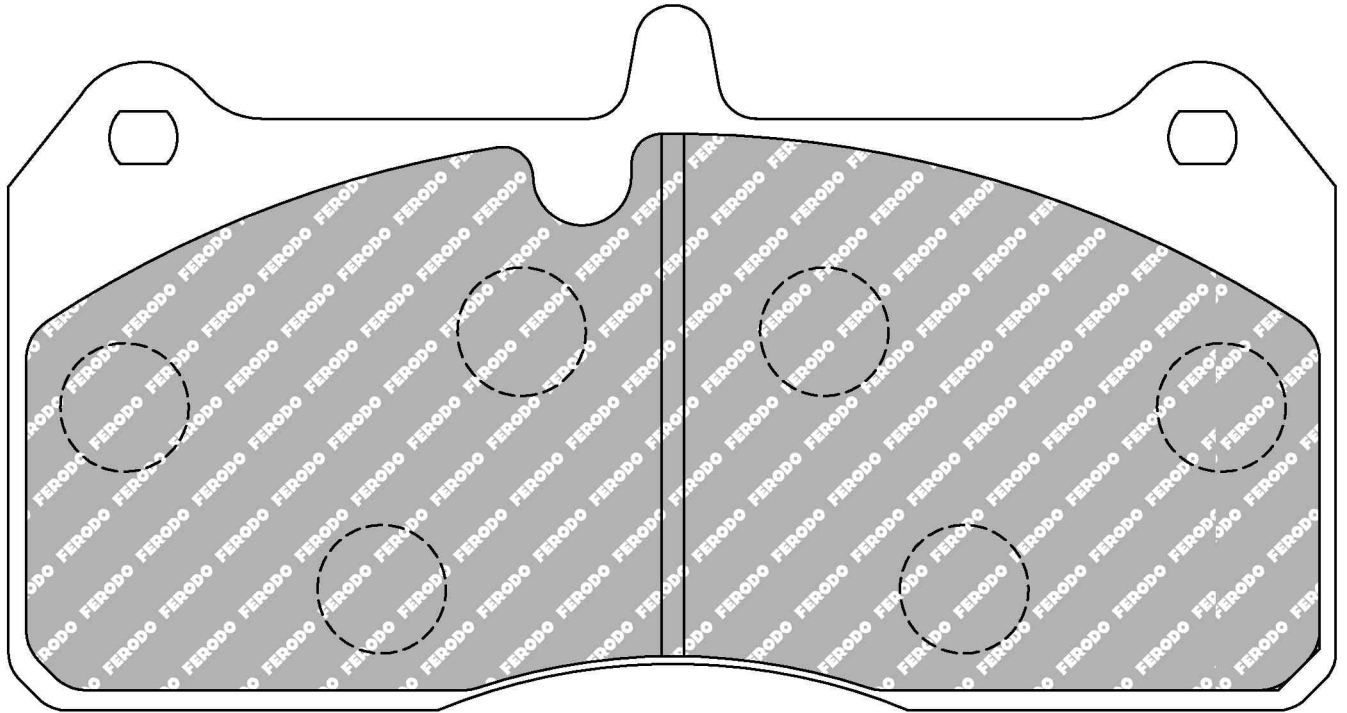

MATERIAL AVAILABILITY				
H	C	R	W	Z
✓				

CROSS REFERENCE	
AP RACING	CP8318D70

# FRP3137

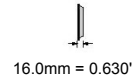
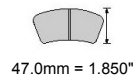

**IMPORTANT NOTICE:** Please note that the height measurement represents the radial depth, not the entire back plate

CHEVROLET Rear

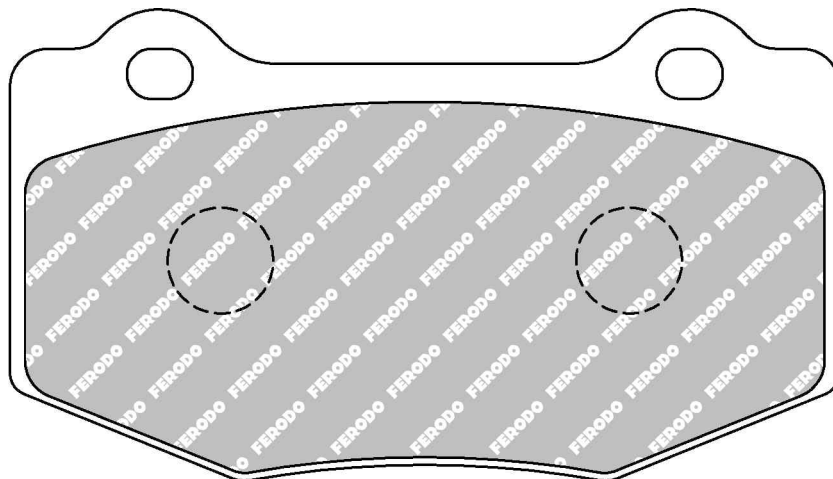

MATERIAL AVAILABILITY				
H	C	R	W	Z
☒				

- ✓ Available
- ✗ Not Available
- ☒ In Introduction
- ⚠ Exhausting
- ☒ Make to order

**3276**



Updated on 30th Jan 2014



# FRP5001



60.0mm = 2.362"



64.6mm = 2.543"



18.2mm = 0.717"

**IMPORTANT NOTICE:** Please note that the height measurement represents the radial depth, not the entire back plate

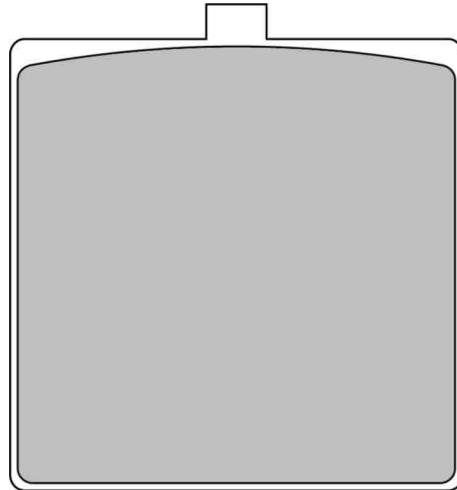

PLEASE NOTE that this pad can be cut to fit MGB704 (rear caliper)

### MATERIAL AVAILABILITY

H	C	R	W	Z

# FRP5002



76.7mm = 3.020"



50.0mm = 1.969"



17.1mm = 0.673"

**IMPORTANT NOTICE:** Please note that the height measurement represents the radial depth, not the entire back plate

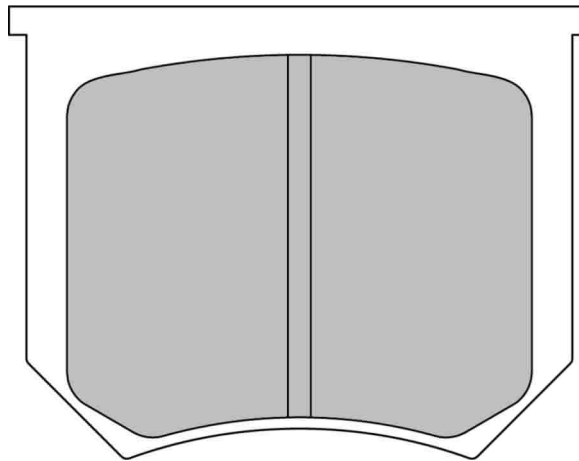

Historical Cars

### MATERIAL AVAILABILITY

H	C	R	W	Z

### CROSS REFERENCE

EBC	DP2035
-----	--------

Available   
 Exhausting  
 Not Available   
 Make to order  
 In Introduction

**FERODO**  
RACING

Updated on 30th Jan 2014

**3277**

# BRAKE PADS X-REF

# COMPETITORS TO FERODO

7701206599	Ferodo	ALCON	Ferodo	AP RACING	Ferodo	BREMBO	Ferodo
OE Renault	FCP1441	PNF4441X769.4	FRP1077	CP3215D46	FRP3091	07.5139.3	FRP1078
		PNF4463X529	FRP219	CP3215D50	FRP216	07.5139.34	FRP1078
ALCON	Ferodo	PNF4463X529.4	FRP219	CP3345D44	FRP219	07.5139.6	FRP302
PNF0084X222	FRP3027	PNF4463X551	FRP218	CP3558D46	FRP1060	07.5139.65	FRP302
PNF0084X222.4	FRP3027	PNF4463X551.4	FRP218	CP3558D51	FRP3061	07.5139.69	FRP302
PNF0084X232.4	FCP1280	PNF4463X554	FRP201	CP3558D54	FRP3014	07.5139.81	FRP1078
PNF0084X233.4	FCP1281	PNF4463X554.4	FRP201	CP3714D54	FRP217	07.5139.85	FRP3032
PNF0084X235	FCP685	PNF4463X572	FRP219	CP3796D54	FRP3006	07.5139.88	FRP3032
PNF0084X235.4	FCP685	PNF4463X581.4	FRP201	CP3894D46	FRP3000	07.5146.30	FCP1348
PNF0084X236.4	FCP1283	PNF4476X545	FRP3009	CP3894D51 (18 mm)	FRP3054	07.5146.31	FCP1348
PNF0084X238.4	FCP767	PNF4476X545.4	FRP3009	CP3894D54	FRP3003	07.5169.9	FRP3024
PNF0084X245.4	FRP216	PNF4476X549	FRP3012	CP3915D33	FCP1560	07.5169.90	FRP3024
PNF0084X249.4	FCP986	PNF4476X549.4	FRP3012	CP4140D36	FRP3001	07.5169.92	FRP3024
PNF0084X261.4	FCP558	PNF4489X519.4	FRP3000	CP4296D43	FRP1061	07.5308.9	FRP3042
PNF0084X262.4	FCP845	PNF4489X532.4	FRP3003	CP4595D54	FRP3015	07.5308.91	FRP3042
PNF0084X264.4	FRP201	PNF4489X543	FRP3015	CP4751D43	FRP501	07.5505.91	FCP1562
PNF0084X268.4	FCP1334	PNF4489X545.4	FRP3054	CP4848D46 (18 mm)	FRP3086	07.5684.2	FRP1058
PNF0084X276.4	FRP3018	PNF4489X562.4	FRP3000	CP5070D51	FRP3076	07.5684.2	FRP1064
PNF0084X282.4	FRP1064	PNF4489X565.4	FRP3000	CP5070D54	FRP3077	07.5684.25	FRP1064
PNF0084X283.4	FRP3004	PNF4493X501.4	FRP3026	CP5119D50	FCP1562	07.5684.26	FRP1064
PNF0084X284	FRP502	PNF4493X502	FRP3026	CP5119D50	FRP3056	07.5684.5	FRP3022
PNF0084X284.4	FRP502	PNF4493X503	FRP3026	CP5148D46	FRP3020	07.5684.5	FRP3023
PNF0084X298.4	FCP1372	PNF4493X603	FRP3044	CP5148DXX	FRP3086	07.5684.52	FRP3022
PNF0084X299.4	FCP1133	PNF4493X603.12	FRP3044	CP5788D48	FRP3024	07.5684.53	FRP3023
PNF0084X305.4	FRP3025	PNF4493X603.4	FRP3044	CP5805D45	FRP503	07.5684.55	FRP3023
PNF0084X317.4	FCP558	PNF4493X610.12	FRP3044	CP6070D49	FRP1078	07.5684.56	FRP3022
PNF0084X321.4	FCP1378	PNF4493X610.4	FRP3044	CP6210D54 (28 mm)	FRP3037	07.5684.8	FRP3033
PNF0084X322.4	FRP1079	PNF4495X501.4	FRP3039	CP6210D54 (30 mm)	FRP3055	07.5684.80	FRP3033
PNF0084X325.4	FCP1081	PNF4495X514.4	FRP3037	CP6230D54 (25 mm)	FRP3039	07.5684.81	FRP3033
PNF0084X331	FRP216	PNF4495X516.4	FRP3037	CP6600D50	FRP3107	07.5868	FRP1059
PNF0084X331.4	FRP216	PNF4495X517.4	FRP3055	CP6600D55	FRP3083	07.5868.2	FRP3004
PNF0084X336.4	FRP3067	PNF4495X518.4	FRP3055	CP6627D51	FRP3115	07.5868.29	FRP3004
PNF0084X347.4	FCP857	PNF4497X607.4	FRP3081	CP7031D32	FRP3102	07.6953.9	FCP1348
PNF0084X350.4	FRP503	PNF4497X617.4	FRP3081	CP7040D54	FRP3114	07.6955.3	FRP3053
PNF0084X358.4	FCP1562	PNF4497X831S	FRP3134	CP7040D61	FRP3084	07.6955.30	FRP3053
PNF0084X359.4	FCP1334	PNF4498X703.4	FRP3082	CP7600D46	FRP3085	07.6955.31	FRP3053
PNF0084X363.4	FCP1636	PNF4498X705.4	FRP3082	CP8250-D41	FRP3097	07.6955.50	FRP3088
PNF3430X275.4	FRP3043	PNF4498X821S	FRP3135	CP8250D50	FRP3116	07.7235.60	FCP721
PNF3451X521.4	FCP809			CP8310D70	FRP3027	07.7293.6	FRP3031
PNF3451X522	FCP810	AP RACING	Ferodo	CP8318D70	FRP3136	07.7293.60	FRP3031
PNF3451X522.4	FCP810	CP2195D38	FCP342			07.7293.61	FRP3031
PNF3451X554.4	FCP810	CP2270D50	FRP203	BREMBO	Ferodo	07.7293.63	FRP3031
PNF3451X555.4	FCP809	CP2279D42	FRP3073	07.4865.1	FCP1281	07.7293.7	FRP3110
PNF3451X566.4	FCP810	CP2279D50	FRP212	07.4865.80	FCP1281	07.7293.70	FRP3031
PNF4436X508.4	FCP451	CP2340D38	FRP3021	07.5064.27	FRP308	07.7614.2	FRP3040
PNF4436X509	FRP3069	CP2340D43	FRP218	07.5064.49	FRP1079	07.7614.20	FRP3040
PNF4436X509.4	FRP3069	CP2340D51	FRP201	07.5064.7	FRP308	07.7614.21	FRP3040
PNF4441X723	FRP1077	CP2373	FRP202	07.5064.72	FRP308	07.7614.3	FRP3046
PNF4441X723.4	FRP1077	CP2382	FRP202	07.5064.73	FRP308	07.7614.30	FRP3046
PNF4441X728	FRP302	CP2383	FRP202	07.5064.8	FRP1079	07.7614.31	FRP3046
PNF4441X728.4	FRP302	CP2384	FRP202	07.5064.82	FRP1079	07.7614.5	FRP3047
PNF4441X753	FRP1077	CP2399D43	FCP825	07.5064.84	FRP1079	07.7614.50	FRP3047
PNF4441X753S.4	FRP1077	CP2712D44	FCP840	07.5139	FRP3032	07.7614.51	FRP3047
PNF4441X754	FRP302	CP2749D55 (28 mm)	FRP3060	07.5139.0	FRP1077	07.7810.1	FRP3035
PNF4441X754.4	FRP302	CP2749D66 (28 mm)	FRP3059	07.5139.07	FRP1077	07.7810.10	FRP3035
PNF4441X757.4	FRP302	CP3215D42	FRP3018	07.5139.19	FRP1077	07.7810.11	FRP3035

# BRAKE PADS X-REF

# COMPETITORS TO FERODO

BREMBO	Ferodo	BREMBO	Ferodo	BREMBO	Ferodo	CL BRAKES	Ferodo
07.7810.2	FRP3034	07.8301.18	FCP565	07.8301.88	FCP1499	4036	FCP584
07.7810.20	FRP3034	07.8301.19	FCP584	07.8301.89	FCP1573	4037	FCP586
07.7810.21	FRP3034	07.8301.21	FCP596	07.8301.90	FCP1444	4038	FCP541
07.7810.3	FRP3045	07.8301.21	FCP1676	07.8301.91	FCP1543	4038	FCP726
07.7810.30	FRP3045	07.8301.22	FCP598	07.8301.92	FCP1568	4044	FCP905
07.7810.31	FRP3045	07.8301.23	FCP600	07.8365.33	FRP3100	4049	FCP1308
07.7859.1	FRP3029	07.8301.24	FCP602	07.8590.15	FRP3106	4056	FCP3
07.7859.10	FRP3029	07.8301.25	FCP613	07.8720.XX	FCP1348	4059	FCP1333
07.7859.11	FRP3029	07.8301.26	FCP617	07.9209.xx	FRP3100	4060	FCP116
07.7859.2	FRP3030	07.8301.28	FCP685	07.9312.44	FCP1664	4060	FCP1562
07.7859.20	FRP3030	07.8301.29	FCP732	07.9312.45	FCP1664	4061	FCP1298
07.7859.21	FRP3030	07.8301.30	FCP766	07.9312.46	FCP1664	4061	FCP1561
07.7859.60	FRP3087	07.8301.31	FCP767	07.9312.47	FCP1664	4062	FCP72
07.7859.70	FRP3087	07.8301.32	FCP774	07.9551.13	FRP3098	4066	FCP1334
07.7869.12	FRP3070	07.8301.33	FCP777	07.A010.10	FRP3113	4069	FCP1372
07.8300.00	FCP905	07.8301.34	FCP789	07.A262.20	FRP3103	4077	FCP777
07.8300.01	FCP776	07.8301.35	FCP845	07.B314.59 (Th 16.8)	FRP3098	4083	FCP598
07.8300.02	FCP775	07.8301.36	FCP859	7767.XX.17	FRP216	4085	FCP167
07.8300.04	FCP1094	07.8301.37	FCP876	XA4.17.M4	FRP3109	4088	FCP1094
07.8300.07	FCP691	07.8301.38	FCP881	XA5.71.M2	FRP3099	4102	FCP761
07.8300.09	FCP725	07.8301.39	FCP925	XA7.G0.11	FCP4168	4104	FCP1300
07.8300.10	FCP779	07.8301.41	FCP1049	XA7.G0.12	FCP4168	4106	FCP1012
07.8300.11	FCP856	07.8301.42	FCP1050			4107	FCP1011
07.8300.12	FCP867	07.8301.43	FCP1052	CL BRAKES	Ferodo	4114	FCP9
07.8300.14	FCP590	07.8301.44	FCP1101	4000	FCP845		
07.8300.15	FCP986	07.8301.45	FCP1056	4001	FCP560	CL Brakes	Ferodo
07.8300.17	FCP748	07.8301.46	FCP1063	4002	FCP451	4126	FRP3096
07.8300.18	FCP761	07.8301.48	FCP1068	4003	FCP11		
07.8300.20	FCP1430	07.8301.49	FCP392	4004	FCP2	CL BRAKES	Ferodo
07.8300.23	FCP748	07.8301.50	FCP779	4005	FCP881	5000W38T10	FCP342
07.8300.24	FCP1213	07.8301.51	FCP1081	4005	FCP891	5001W43T14	FCP825
07.8300.25	FCP1224	07.8301.52	FCP1082	4007	FCP393	5002W43T14	FCP809
07.8300.26	FCP1430	07.8301.53	FCP1093	4009	FCP105	5002W48T14	FCP810
07.8300.27	FCP904	07.8301.54	FCP1101	4010	FCP596	5008W52T18	FCP1281
07.8300.33	FCP1436	07.8301.55	FCP1113	4011	FCP774		
07.8300.36	FCP1437	07.8301.56	FCP1133	4011	FCP775	EBC	Ferodo
07.8300.38	FCP590	07.8301.57	FCP1134	4014	FCP399	DP108	FCP9
07.8300.40	FCP590	07.8301.59	FCP1160	4016	FCP206	DP114	FCP809
07.8300.42	FCP1327	07.8301.60	FCP1162	4018	FCP789	DP1958	FCP1441
07.8301.00	FCP1063	07.8301.61	FCP1281	4018	FCP789	DP2035	FRP5002
07.8301.02	FCP173	07.8301.62	FCP1288	4019	FCP790	DP21588	FCP1808
07.8301.03	FCP206	07.8301.63	FCP775	4020	FCP1133	DP21758	FCP4187
07.8301.04	FCP276	07.8301.64	FCP1293	4021	FCP385	DP21789	FCP4080
07.8301.05	FCP360	07.8301.65	FCP1295	4021	FCP392	DP21995-DP31995	FCP4218
07.8301.06	FCP370	07.8301.66	FCP725	4022	FCP721	DP2291	FCP167
07.8301.07	FCP385	07.8301.68	FCP725	4023	FCP276	DP2325	FCP173
07.8301.08	FCP392	07.8301.69	FCP850	4023	FCP1323	DP680	FCP541
07.8301.09	FCP393	07.8301.71	FCP774	4025	FCP256	DPX2002	FCP4426
07.8301.10	FCP406	07.8301.72	FCP1318	4027	FCP565		
07.8301.11	FCP409	07.8301.73	FCP590	4028	FCP370		
07.8301.12	FCP392	07.8301.74	FCP1334	4029	FCP1327	ENDLESS	Ferodo
07.8301.13	FCP434	07.8301.76	FCP1368	4031	FCP1068	EP472	FCP4187
07.8301.14	FCP519	07.8301.77	FCP1376	4032	FCP850		
07.8301.15	FCP524	07.8301.78	FCP1378	4033	FCP779	FMSI	Ferodo
07.8301.16	FCP535	07.8301.79	FCP1467	4033	FCP1073	D004	FCP9
07.8301.17	FCP541	07.8301.80	FCP1468	4034	FCP558	D005	FCP825
		07.8301.84	FRP3067	4035	FCP408	D009	FCP815

# BRAKE PADS X-REF

# COMPETITORS TO FERODO

FMSI	Ferodo	FMSI	Ferodo	FMSI	Ferodo	FMSI	Ferodo
D0109	FCP448	D30	FCP3	D558	FCP725	D919	FCP1672
D027	FCP823	D306	FCP541	D562	FCP867	D929	FCP1639
D031	FCP2	D307	FCP385	D563	FCP948	D939	FCP1499
D044	FCP809	D313	FRP3057	D568	FCP777	D940	FCP1676
D045	FCP11	D319	FCP487	D568	FCP904	D946	FCP1073
D052	FRP3057	D323	FCP638	D569	FCP392	D960	FCP1561
D058	FCP2	D330	FCP167	D590	FCP565	D961	FCP1562
D064	FCP342	D331	FCP483	D592	FCP721	D968	FCP1281
D081	FCP832	D340	FCP541	D594	FCP891	D969	FCP1786
D096	FCP105	D340	FCP726	D608	FCP451	D97	FCP72
D1001	FCP1334	D341	FCP748	D609	FCP560	D970	FCP1568
D1001	FRP3067	D345	FCP451	D617	FCP1436	D978	FCP1308
D1016	FCP1334	D350	FCP206	D618	FCP1285	D990	FCP1392
D1018	FCP1655	D350	FCP1081	D621	FCP776	D991	FRP3075
D1050	FCP1334	D356	FCP308	D635	FCP1011		
D1053	FCP721	D369	FCP1213	D636	FCP1012	HAWK	Ferodo
D1081	FRP3129	D371	FCP393	D639	FCP1298	HB103 0,59	FRP3057
D1082	FRP3130	D372	FCP560	D647	FCP986	HB105 0,62	FRP1077
D109	FCP116	D373	FCP598	D648	FCP766	HB108	FCP825
D1107	FCP1641	D378	FCP173	D653	FCP1430	HB109 0,71	FRP3003
D1108	FCP1636	D382	FCP408	D682	FCP997	HB111 0,61	FCP1224
D1116	FRP3100	D394	FCP779	D683	FCP1483	HB113 0,59	FCP598
D1124	FCP4187	D395	FCP256	D684	FCP775	HB118 0,56	FCP809
D1170	FCP1808	D396	FCP578	D687	FCP590	HB119 0,594	FRP3058
D1204	FCP4080	D396	FCP850	D692	FCP850	HB135 0,77	FCP779
D125	FCP351	D403	FCP584	D692	FCP1301	HB136 0,69	FCP725
D127	FCP93	D409	FCP748	D695	FCP867	HB137 0,69	FCP256
D1308	FCP1747	D412	FCP1224	D696	FCP774	HB141 0,65	FCP560
D1309	FCP1806	D423	FCP415	D700	FCP600	HB143 0,68	FCP905
D1346	FCP4172	D427	FCP586	D707	FCP1437	HB144 0,719	FCP904
D1347	FCP4173	D430	FCP691	D721	FCP1327	HB149 0,505	FCP1011
D135	FCP817	D439	FCP1133	D723	FCP765	HB155 0,58	FCP483
D1368	FCP4168	D447	FCP560	D725	FCP779	HB158 0,515	FCP372
D1371	FCP4218	D449	FCP600	D737	FCP1307	HB159 0,492	FCP1012
D1372	FCP4217	D453	FCP881	D738	FCP1308	HB170 0,65	FCP451
D1382	FRP3106	D454	FCP546	D740	FCP1050	HB171 0,59	FCP11
D1454	FCP4426	D460	FCP986	D763	FCP850	HB172 0,595	FCP2
D147	FCP370	D461	FCP1372	D764	FCP761	HB178 0,564	FCP986
D154	FRP3058	D462	FCP600	D768	FCP1094	HB179 0,63	FCP1372
D163	FCP399	D464	FCP638	D770	FCP1333	HB180 0,56	FCP1562
D174	FCP116	D465	FCP761	D776	FRP3051	HB180 0,64	FCP116
D202	FRP3058	D470	FCP789	D781	FCP1300	HB180 0,64	FCP448
D227	FCP774	D471	FCP790	D794	FCP1382	HB181 0,66	FCP1298
D227	FCP775	D473	FCP487	D810	FCP1281	HB184 .650A	FCP891
D228	FCP596	D485	FCP600	D815	FCP1430	HB189 0,55	FCP392
D242	FCP308	D491	FCP878	D816	FCP1318	HB190 .600A	FCP774
D253	FCP256	D493	FCP1133	D817	FCP1528	HB190 .730A	FCP775
D272	FCP638	D503	FCP905	D819	FCP1068	HB191 0,59	FCP308
D278	FCP1133	D51	FCP810	D837	FCP1093	HB193 0,61	FRP3028
D279	FCP296	D516	FCP558	D840	FCP1323	HB193 0,67	FCP1281
D280	FCP392	D526	FCP1430	D847	FCP1661	HB194 0,57	FCP721
D283	FCP372	D530	FCP765	D851	FCP541	HB194 0,575	FCP721
D287	FCP11	D54	FCP29	D886	FCP1319	HB194 0,665	FCP721
D290	FCP775	D547	FCP856	D888	FCP1690	HB195 0,64	FCP1133
D292	FCP845	D548	FCP857	D905	FCP1693	HB206 0,565	FCP399
D298	FCP276	D555	FCP590	D918	FCP1628	HB214 0,618	FCP765

# BRAKE PADS X-REF

# COMPETITORS TO FERODO

HAWK	Ferodo	HAWK	Ferodo	MINTEX	Ferodo	MINTEX	Ferodo
HB227 0,63	FCP578	HB518 0,642	FCP1483	MDB1339	FCP558	MDB1623	FCP859
HB227 0,63	FCP850	HB543 0,76	FCP1641	MDB1348	FCP487	MDB1628	FCP845
HB235 0,665	FCP600	HB544 0,628	FCP1636	MDB1351	FCP483	MDB1633	FCP721
HB242 0,661	FCP748	HB545 0,564	FCP1561	MDB1353	FCP527	MDB1635	FCP904
HB245 0,631	FCP1436	HB546 0,654	FCP1300	MDB1357	FCP441	MDB1637	FCP685
HB246 0,567	FCP487	HB560	FCP4080	MDB1360	FCP472	MDB1658	FCP867
HB261 0,665	FCP600	HB570 .677	FCP1747	MDB1369	FCP578	MDB1659	FCP613
HB262 0,54	FCP638	HB574 .666	FCP1806	MDB1371	FCP774	MDB1662	FCP876
HB268 0,665	FCP691	HB601 .626	FCP4172	MDB1374	FCP598	MDB1666	FCP925
HB269 .763A	FCP590	HB602 .545	FCP4173	MDB1382	FCP541	MDB1676	FCP881
HB271 0,635	FCP541	HB603x.616	FCP4218	MDB1384	FCP524	MDB1686	FCP1011
HB271 0,635	FCP596	HB604x.598	FCP4217	MDB1385	FCP586	MDB1688	FCP948
HB275 0,62	FCP761	HB609 0,572	FCP1664	MDB1386	FCP584	MDB1705	FCP1012
HB278 0,583	FCP878	HB624x.642	FCP1808	MDB1393	FCP779	MDB1727	FCP1093
HB289 0,61	FCP1307	HB668	FCP4426	MDB1400	FCP602	MDB1732	FCP1063
HB290 0,583	FCP1308	HB671	FCP4187	MDB1401	FCP660	MDB1734	FCP1056
HB291 0,642	FRP3051			MDB1403	FCP546	MDB1735	FCP1052
HB310 0,689	FCP867	MINTEX	Ferodo	MDB1416	FCP986	MDB1736	FCP1049
HB320 0,669	FCP1437	CVP020	FCP419	MDB1436	FCP385	MDB1742	FCP995
HB325 0,72	FCP856	CVP020K	FCP419	MDB1437	FCP415	MDB1745	FCP997
HB328 0,685	FCP1528	CVP043	FCP817	MDB1445	FCP878	MDB1794	FCP1327
HB332 0,654	FCP1213	MD1723	FCP809	MDB1451	FCP691	MDB1804	FCP1054
HB346 0,713	FCP1318	MDB1002	FCP2	MDB1455	FCP11	MDB1805	FCP1101
HB352 0,665	FCP1327	MDB1003	FCP11	MDB1456	FCP451	MDB1810	FCP767
HB354 .756A	FCP1323	MDB1012	FCP3	MDB1457	FCP560	MDB1811	FCP1094
HB362 0,642	FCP857	MDB1013	FCP29	MDB1473	FCP660	MDB1812	FCP1112
HB364 0,642	FCP541	MDB1068	FCP2	MDB1483	FCP535	MDB1813	FCP1068
HB365 0,728	FCP1094	MDB1072	FCP93	MDB1488	FCP600	MDB1817	FCP1073
HB367 0,585	FCP790	MDB1074	FCP96	MDB1493	FCP617	MDB1826	FCP1323
HB370 0,559	FCP1693	MDB1081	FCP105	MDB1496	FCP789	MDB1828	FCP1160
HB387 0,547	FCP1690	MDB1088	FCP360	MDB1497	FCP790	MDB1860	FCP891
HB388 0,756	FCP1068	MDB1099	FCP116	MDB1499	FCP9	MDB1868	FCP1312
HB395 0,58	FCP105	MDB1107	FCP39	MDB1503	FCP646	MDB1871	FCP1050
HB399 0,63	FCP296	MDB1141	FCP173	MDB1511	FCP647	MDB1872	FCP1288
HB408 0,665	FCP789	MDB1165	FCP461	MDB1513	FCP519	MDB1873	FCP1307
HB412 0,665	FCP1430	MDB1175	FCP206	MDB1518	FCP565	MDB1874	FCP1308
HB420 0,748	FCP766	MDB1190	FCP775	MDB1525	FCP598	MDB1876	FCP1113
HB430 0,547	FCP1319	MDB1230	FCP256	MDB1531	FCP590	MDB1883	FCP1081
HB432 0,661	FCP1639	MDB1236	FCP276	MDB1533	FCP761	MDB1884	FCP1082
HB434 0,543	FCP1333	MDB1239	FCP296	MDB1538	FCP725	MDB1888	FCP1301
HB444 0,685	FCP1499	MDB1240	FCP370	MDB1539	FCP765	MDB1891	FCP1560
HB445 0,61	FCP1676	MDB1251	FCP308	MDB1543	FCP905	MDB1893	FCP1012
HB448 0,61	FCP1786	MDB1253	FCP774	MDB1551	FCP856	MDB1895	FCP767
HB449 0,679	FCP1568	MDB1257	FCP370	MDB1552	FCP857	MDB1901	FCP1300
HB453 0,585	FCP1334	MDB1258	FCP360	MDB1556	FCP732	MDB1907	FCP1295
HB453 0,585	FRP3067	MDB1266	FCP392	MDB1564	FCP956	MDB1908	FCP1293
HB464 0,764	FCP1073	MDB1267	FCP419	MDB1570	FCP774	MDB1910	FCP1501
HB483 0,635	FRP3075	MDB1273	FCP385	MDB1571	FCP775	MDB1919	FCP1289
HB484 0,670	FRP3129	MDB1286	FCP408	MDB1572	FCP850	MDB1921	FCP1437
HB485 0,656	FRP3130	MDB1291	FCP393	MDB1583	FCP660	MDB1934	FCP1134
HB491 0,693	FCP1382	MDB1295	FCP484	MDB1589	FCP748	MDB1935	FCP483
HB492 0,732	FCP1285	MDB1309	FCP1113	MDB1606	FCP524	MDB1944	FCP1382
HB493 0,65	FCP1392	MDB1312	FCP415	MDB1607	FCP170	MDB1950	FCP1334
HB495 0,756	FCP1050	MDB1316	FCP406	MDB1610	FCP776	MDB1956	FCP1160
HB497 0,776	FCP997	MDB1323	FCP399	MDB1615	FCP777	MDB1958	FCP1318
HB500 0,645	FCP1093	MDB1327	FCP434	MDB1622	FCP766	MDB1959	FCP1319

# BRAKE PADS X-REF

# COMPETITORS TO FERODO

MINTEX	Ferodo	MINTEX	Ferodo	PAGID	Ferodo	PAGID	Ferodo
MDB1962	FCP360	MDB2682	FCP1747	1144	FCP256	1903	FRP3054
MDB1971	FCP904	MDB2692	FCP1773	1158	FCP541	20345	FRP3083
MDB1984	FCP1285	MDB2694	FCP1629	1158	FCP1491	20346	FRP3084
MDB2003	FCP1459	MDB2725	FCP1667	1163	FCP408	20349	FRP3085
MDB2004	FCP1483	MDB2749	FCP1706	1190	FCP415	2053	FRP1064
MDB2006	FCP1368	MDB2751	FCP1626	1192	FRP101	2105	FRP1059
MDB2012	FCP1370	MDB2758	FCP370	1203	FCP451	2126	FRP3018
MDB2013	FCP1528	MDB2763	FCP1301	1204	FCP560	2127	FRP219
MDB2029	FCP1392	MDB2790	FCP1805	1218	FRP3059	2130	FCP385
MDB2033	FCP1162	MDB2828	FCP4217	1265	FRP201	2141	FRP1061
MDB2034	FCP1094	MDB2875	FCP4426	1267	FRP217	2180	FCP725
MDB2039	FRP3050	MDB2929	FCP4050	1269	FRP203	2180	FCP1300
MDB2042	FCP1324	MDB2934	FCP4044	1270	FRP212	2275	FCP1629
MDB2044	FCP1444	MDB2952	FCP4045	1283	FRP308	2405	FRP3051
MDB2051	FCP1349	MDB2974	FCP4218	1285	FCP578	2406	FCP1308
MDB2068	FCP1052	MGB521	FCP815	1287	FCP1281	2407	FCP1307
MDB2073	FCP1424	MGB522	FCP9	1288	FCP584	2445	FCP1280
MDB2076	FCP1376	MGB533	FCP809	1291	FRP3050	2474	FRP3050
MDB2110	FCP1081	MGB535	FCP810	1295	FCP779	2487	FCP1334
MDB2130	FCP1294	MGB585	FCP817	1349	FCP789	2487	FRP3067
MDB2131	FCP1378	MGB633	FCP167	1361	FRP216	2488	FRP3031
MDB2132	FCP1134	MLB10	FCP823	1362	FCP342	2555	FRP501
MDB2162	FCP1499	MLB19	FCP342	1363	FCP825	2557	FRP3037
MDB2183	FCP1399	MLB20	FCP825	1406	FCP986	2557	FRP3055
MDB2191	FCP472	MLB52	FCP832	1408	FCP1348	2593	FCP1562
MDB2193	FCP767	MLB65	FCP840	1427	FCP1298	2623	FCP905
MDB2206	FCP1160	MTX1594	FRP3057	1538	FRP3061	2683	FCP856
MDB2210	FCP1540	MTX1595	FRP3058	1544	FCP660	2683	FCP997
MDB2238	FCP1469	MTX1859	FCP1334	1587	FCP1562	2685	FCP857
MDB2239	FCP1466	MTX1890	FCP448	1591	FCP765	2685	FCP1483
MDB2240	FCP1467	MTX1968	FCP721	1595	FRP1077	2688	FRP3039
MDB2241	FCP1468	MTX1976	FCP1281	1596	FCP748	2703	FRP3042
MDB2254	FCP1543			1607	FRP302	2707	FRP3075
MDB2256	FCP1491	OE AUDI	Ferodo	1609	FCP393	2723	FCP2
MDB2257	FCP1573	8K0698151 / B	FCP4044	1610	FCP558	2845	FCP1626
MDB2261	FCP1693	8K0698151A	FCP4045	1619	FRP3029	2931	FCP1664
MDB2281	FCP1540	8K0698451	FCP4050	1620	FCP876	3102	FCP809
MDB2291	FCP1528	8K0698451A	FCP4050	1674	FRP1078	3190	FCP810
MDB2294	FCP1419	8V0698151	FCP4433	1675	FCP685	3242	FCP596
MDB2309	FCP372	8V0698151B	FCP4433	1678	FCP590	3276	FCP845
MDB2314	FCP1394			1682	FCP878	4011	FCP392
MDB2341	FCP1561	OE BMW	Ferodo	1682	FCP1560	4122	FCP3
MDB2342	FCP1562	34 216 784808	FCP4217	1705	FRP1079	4304	FCP2
MDB2351	FCP600	34 216 791421	FCP4217	1736	FCP4050	4501	FCP11
MDB2352	FCP638	34116786044	FCP4218	1743	FCP774	4503	FCP11
MDB2387	FCP1786			1744	FCP775	4507	FCP116
MDB2418	FCP1628	OE PORSCHE	Ferodo	1748	FCP4044	4823	FCP206
MDB2419	FCP1672	955.351.939.00 / .01 / .02	FCP1625	1749	FRP219	4905	FCP167
MDB2555	FCP558			1756	FRP3012	8000	FRP3071
MDB2580	FCP1636	Oe Suzuki	Ferodo	1760	FCP546	8001	FCP1641
MDB2595	FCP1617	5581057K01	FRP3118	1760	FCP4045	8004	FRP3096
MDB2601	FCP1664			1813	FRP1060	8005	FRP3100
MDB2604	FCP1641	OE VOLKSWAGEN	Ferodo	1842	FCP891	8006	FRP3095
MDB2628	FCP1399	7L0698151 / B / D / H	FCP1625	1852	FRP3000	8010	FCP598
MDB2639	FCP1676	7L6698151 / C	FCP1625	1896	FRP3024	8021	FCP1629
MDB2677	FCP1765			1897	FCP1283	8023	FCP1667
		PAGID	Ferodo				
		1141	FCP296				

# BRAKE PADS X-REF

# COMPETITORS TO FERODO

PAGID	Ferodo	PFC	Ferodo	PFC	Ferodo	WVA	Ferodo
8028	FRP3076	0461.XX	FCP1372	7743.XX.21	FRP3033	20 011 15,00	FCP11
8030	FRP3029	0463	FCP483	7745	FRP219	20 027 16,00	FCP9
8033	FRP3088	0465.XX	FCP761	7746	FRP3074	20 037 15,00	FCP823
8034	FRP3092	0473.XX	FCP487	7748.XX.18	FRP1058	20 046 15,30	FCP1459
8035	FCP850	0491	FCP878	7748.XX.20	FRP1064	20 053 10,00	FCP342
8038	FRP3123	0503.XX	FCP905	7750.XX.20	FRP3074	20 054 14,50	FCP825
8040	FRP202	0526.XX	FCP1430	7751	FRP501	20 073 17,50	FCP29
8041	FCP815	0530.XX	FCP765	7752	FRP502	20 088 14,40	FCP809
8042	FCP9	0537	FCP956	7754	FRP504	20 089 14,40	FCP810
9521	FCP170	0548	FCP1483	7755	FRP3009	20 128 14,70	FCP39
ERS496	FCP9	0558	FCP725	7756	FRP3012	20 140 14,00	FCP72
ERS651	FCP1327	0558.XX	FCP725	7757	FRP506	20 166 16,00	FCP96
T1620	FCP4217	0562.XX	FCP867	7760	FCP685	20 168 16,20	FCP774
T1784	FCP4218	0590	FCP565	7765	FCP840	20 168 19,60	FCP775
		0592.XX.15	FCP1348	7767	FRP212	20 180 16,80	FCP850
PFC	Ferodo	0592.XX.17	FCP721	7767.XX.20	FRP212	20 228 15,20	FCP105
0031.XX	FCP2	0594.XX.18	FCP891	7768.XX.16	FRP3018	20 323 16,50	FCP116
0044	FCP809	0617.XX	FCP1436	7768.XX.20	FRP3073	20 323 16,50	FCP448
0045.XX	FCP11	0621	FCP776	7770.XX.17	FRP3087	20 328 12,90	FCP372
0051	FCP810	0639	FCP1298	7770.XX.20	FRP3024	20 380 15,50	FCP817
0052.XX	FRP3057	0639	FCP1561	7770.XX.26	FRP3029	20 410 12,90	FCP1560
0109	FCP1562	0648.XX	FCP766	7770.XX.26	FRP3030	20 410 14,80	FCP878
0109-07-16-44	FRP3056	0682.XX	FCP997	7772.XX.18	FRP3088	20 476 15,00	FCP170
0109.XX	FCP116	0707.XX	FCP1437	7773.XX.22	FRP3047	20 491 15,20	FCP167
0154.XX	FRP3058	0731	FCP1553	7773.XX.30	FRP3040	20 547 16,80	FCP732
0163.XX	FCP399	0732	FCP1563	7775.XX.28	FRP3053	20 561 15,00	FCP461
0174.XX	FCP116	0738	FCP1307	7778.XX.25	FRP3039	20 577 15,00	FCP832
0174.XX	FCP448	0738	FCP1308	7778.XX.28	FRP3037	20 629 20,00	FCP256
0195	FCP170	0776	FRP3051	7778.XX.30	FRP3055	20 634 15,00	FCP881
0242.XX	FCP308	0815.XX	FCP1430	7780.XX.16	FRP3028	20 641 15,00	FCP93
0253.XX	FCP256	0816.XX	FCP1318	7780.XX.18	FCP1281	20 675 17,00	FCP296
0272	FCP484	0829	FCP1444	7781	FCP1334	20 676 19,60	FCP590
0278.XX	FCP1133	7683	FRP3025	7781	FRP3067	20 753 18,00	FCP206
0280.XX	FCP392	7700.XX.16	FRP1077	7790.XX.17	FRP3077	20 754 15,00	FCP840
0292	FCP845	7700.XX.18	FRP3007	7790.XX.18	FRP3003	20 775 18,20	FCP351
0340-07-15-44	FCP1491	7700.XX.20	FRP302	7790.XX.25	FRP3014	20 833 17,00	FCP370
0345.XX	FCP451	7700.XX.25	FRP1078	7790.XX.25	FRP3061	20 841 12,00	FCP360
0350	FCP206	7702	FRP3059	7790.XX.28	FRP3015	20 870 15,00	FCP308
0356.XX	FCP308	7708	FRP1061	7793.XX.18	FRP3054	20 877 17,50	FCP451
0369.XX	FCP1213	7710	FRP101	7797.XX.29	FRP3031	20 878 14,80	FCP483
0373.XX	FCP598	7712	FRP3060	7802.XX.18	FRP3045	20 887 15,30	FCP392
0382	FCP408	7714	FRP217	7802.XX.20	FRP3004	20 887 19,70	FCP419
0394	FCP685	7718.XX.16	FRP3032	7802.XX.22	FRP1059	20 889 17,30	FCP385
0394	FCP1773	7718.XX.18	FRP3070	7804.XX.15	FRP3020	20 905 18,00	FCP393
0394.XX	FCP779	7719	FCP342	7804.XX.18	FRP3086	20 907 18,00	FCP276
0395.XX	FCP256	7720	FCP825	7818.XX.17	FRP3050	20 923 17,50	FCP434
0396	FCP1807	7735.XX.16	FRP1079	7819	FRP3075	20 939 15,90	FCP173
0396.XX	FCP578	7735.XX.20	FRP308	7871-07-16-44	FCP1667	20 941 19,30	FCP415
0396.XX	FCP850	7736	FRP3071			20 953 17,50	FCP560
0409.XX	FCP748	7740	FRP218	WILWOOD	Ferodo	20 961 15,20	FCP541
0412	FCP1224	7742.XX.18	FRP3045	6812	FRP3104	20 961 16,00	FCP1491
0412.XX	FCP1224	7742.XX.20	FRP3004	7912	FRP3108	20 968 20,30	FCP779
0447	FCP560	7742.XX.21	FRP3034			20 973 11,00	FCP558
0460	FCP986	7742.XX.22	FRP1059	WVA	Ferodo	20 995 17,30	FCP578
0460.XX	FCP986	7743.XX.17	FRP3023	20 007 15,30	FCP815	21 074 19,00	FCP565
0461	FCP1372	7743.XX.20	FRP3022	20 009 15,00	FCP3	21 079 13,75	FCP408

# BRAKE PADS X-REF

# COMPETITORS TO FERODO

WVA	Ferodo	WVA	Ferodo	WVA	Ferodo	WVA	Ferodo
21 088 17,00	FCP399	21 670 19,50	FCP1050	23 550 17,00	FCP1808	25 086	FCP4433
21 098 16,00	FCP441	21 674 18,00	FCP1063	23 552 17,80	FCP1376	25 134 16,7	FCP4612
21 100 17,00	FCP524	21 677 19,50	FCP1073	23 558 17,80	FCP1327	25 258	FCP4430
21 103 14,50	FCP409	21 694 16,50	FCP776	23 572 14,40	FCP1333		
21 121 13,80	FCP484	21 697 15,80	FCP777	23 581 18,70	FCP1419		
21 140 15,70	FCP586	21 703 14,80	FCP790	23 587 20,30	FCP1641		
21 144 16,50	FCP596	21 719 14,50	FCP956	23 597 16,80	FCP1378		
21 153 17,50	FCP646	21 829 19,50	FCP1068	23 599 19,00	FCP1399		
21 165 16,50	FCP546	21 866 15,30	FCP1288	23 601 16,70	FCP1324		
21 170 17,30	FCP527	21 866 17,30	FCP1101	23 623 17,20	FCP1806		
21 171 19,00	FCP617	21 866 19,70	FCP1054	23 692	FCP1625		
21 173 17,00	FCP660	21 920 15,60	FCP1093	23 693 16,20	FCP1626		
21 179 16,80	FCP535	21 925 17,80	FCP1300	23 694	FCP1308		
21 190 17,50	FCP584	21 927 17,00	FCP1056	23 705 17,10 - 24 288 17,7&17,9	FCP1466		
21 193 18,00	FCP519	21 931 17,00	FCP1160	23 708 18,40	FCP1467		
21 271 17,00	FCP647	21 934 17,30	FCP1301	23 711 18,40	FCP1468		
21 273 19,50	FCP1285	21 937 16,20	FCP1307	23 714 15,80	FCP1469		
21 277 15,00	FCP487	21 938 20,40	FCP1323	23 716 16,40	FCP1676		
21 282 17,20	FCP1483	21 945 16,00	FCP1312	23 745-23 271 17,7	FCP1661		
21 282 17,30	FCP857	21 945 19,90	FCP1289	23 762 20,2	FCP1629		
21 284 19,30	FCP856	21 972 15,20	FCP1308	23 764 17,00	FCP1664		
21 292 17,30	FCP725	21 974 19,40	FCP1094	23 766 17,50	FCP1573		
21 294 15,00	FCP602	21 998 15,60	FCP1162	23 794 19,80	FCP1773		
21 307 14,50	FCP986	23 052 16,20	FCP1294	23 801 20,40	FCP1765		
21 312 12,80	FCP472	23 057 20,00	FCP1295	23 871 14,00	FCP1693		
21 322 15,00	FCP598	23 063 18,40	FCP1293	23 912 18,50	FCP1706		
21 363 15,70	FCP765	23 073 18,80	FCP1382	23 914 16,90	FCP1636		
21 381 15,00	FCP1348	23 092 16,00	FCP1334	23 915 17,60	FCP1747		
21 381 16,80	FCP721	23 101 18,00	FCP1082	23 926 17,00	FCP1807		
21 388 18,50	FCP406	23 103 18,00	FCP1081	23 935 17,60	FCP1751		
21 395 18,00	FCP766	23 124 19,00	FCP1112	23 959 17,4	FCP1790		
21 402 17,50	FCP891	23 139 17,00	FRP3050	23 973 16,80	FCP1617		
21 430 17,30	FCP876	23 140 19,30	FCP1134	23313 20,30 - 24255 20,30	FCP4191		
21 436 17,00	FCP925	23 142 15,00	FCP1561	23402 20,10 - 23403 20,1	FCP1520		
21 437 17,00	FCP925	23 154 19,00	FCP1318	23723 - 23724	FCP4416		
21 446 17,80	FCP748	23 177 14,30	FCP1113	23984 17,9	FCP4080		
21 463 18,00	FCP845	23 178 18,00	FCP1444	24 056 15,5	FCP1786		
21 468 15,5	FRP3127	23 202 18,50	FCP1394	24 142 20,6 - 24 141 19,1	FCP1631		
21 482 16,70	FCP948	23 225 17,00	FCP1424	24 283	FCP4426		
21 484 20	FCP1001	23 245	FCP1441	24 289 17.1	FCP1975		
21 495 17,00	FCP789	23 281 18,00	FCP1499	24 315 17,10	FCP4217		
21 497 18,50	FCP904	23 309 17,00	FCP1672	24 316 17,00	FCP4218		
21 515 17,50	FCP613	23 312 20,30	FCP1628	24 339 19,90	FCP1805		
21 526 17,00	FCP600	23 326	FCP1655	24 349 17,20	FCP1858		
21 553 14,00	FCP638	23 332 18,00	FCP1370	24 408 19,40	FCP4044		
21 560 18,00	FCP685	23 348 16,50	FCP1368	24 409 19,40	FCP4044		
21 561 17,00	FCP691	23 353 14,70	FCP1319	24 455 16,9	FRP3133		
21 580 14,30	FCP1562	23 354 13,00	FCP1011	24 553 16,1	FCP4064		
21 583 18,80	FCP767	23 387 12,50	FCP1012	24 606 17,50	FCP4050		
21 589 15,00	FCP726	23 409 19,30	FCP1543	24 705 20,00	FCP4045		
21 601 17,50	FCP867	23 482 16,50	FCP1540	24 706 20,00	FCP4045		
21 606 16,20	FCP995	23 497 15,40	FCP1501	24 707 20,00	FCP4045		
21 626 15,00	FCP859	23 510 16,50	FCP1392	24 743 19,40	FCP4044		
21 636 18,00	FCP1052	23 513 16,80	FCP1437	24 764 17,00	FCP1667		
21 651 18,50	FCP905	23 517 16,60	FCP1349	24 854 16,7	FCP4187		
21 664 19,00	FCP1049	23 526 17,40	FCP1528	24974 16,7 - 20345 16,9	FRP3083		



# BRAKE PADS X-REF

# FERODO TO COMPETITORS

Ferodo Code	Competitor	Competitor Code
FCP2	CL BRAKES	4004
	FMSI	D031
	FMSI	D058
	HAWK	HB172 0,595
	MINTEX	MDB1002
	MINTEX	MDB1068
	PAGID	2723
	PAGID	4304
	PFC	0031.XX
FCP3	CL BRAKES	4056
	FMSI	D30
	MINTEX	MDB1012
	PAGID	4122
	WVA	20 009 15,00
FCP9	CL BRAKES	4114
	EBC	DP108
	FMSI	D004
	MINTEX	MDB1499
	MINTEX	MGB522
	PAGID	8042
	PAGID	ERS496
	WVA	20 027 16,00
FCP11	CL BRAKES	4003
	FMSI	D045
	FMSI	D287
	HAWK	HB171 0,59
	MINTEX	MDB1003
	MINTEX	MDB1455
	PAGID	4501
	PAGID	4503
	PFC	0045.XX
	WVA	20 011 15,00
FCP29	FMSI	D54
	MINTEX	MDB1013
	WVA	20 073 17,50
FCP39	MINTEX	MDB1107
	WVA	20 128 14,70
FCP72	CL BRAKES	4062
	FMSI	D97
	WVA	20 140 14,00
FCP93	FMSI	D127
	MINTEX	MDB1072
	WVA	20 641 15,00
FCP96	MINTEX	MDB1074
	WVA	20 166 16,00
FRP101	PAGID	1192
	PFC	7710
FCP105	CL BRAKES	4009
	FMSI	D096
	HAWK	HB395 0,58
	MINTEX	MDB1081
	WVA	20 228 15,20
FCP116	CL BRAKES	4060
	FMSI	D109
	FMSI	D174
	HAWK	HB180 0,64

Ferodo Code	Competitor	Competitor Code
...FCP116	MINTEX	MDB1099
	PAGID	4507
	PFC	0109.XX
	PFC	0174.XX
	WVA	20 323 16,50
FCP167	CL BRAKES	4085
	EBC	DP2291
	FMSI	D330
	MINTEX	MGB633
	PAGID	4905
	WVA	20 491 15,20
FCP170	MINTEX	MDB1607
	PAGID	9521
	PFC	0195
	WVA	20 476 15,00
FCP173	BREMBO	07.8301.02
	EBC	DP2325
	FMSI	D378
	MINTEX	MDB1141
	WVA	20 939 15,90
FRP201	ALCON	PNF0084X264.4
	ALCON	PNF4463X554
	ALCON	PNF4463X554.4
	ALCON	PNF4463X581.4
	AP RACING	CP2340D51
	PAGID	1265
FRP202	AP RACING	CP2373
	AP RACING	CP2382
	AP RACING	CP2383
	AP RACING	CP2384
	PAGID	8040
FRP203	AP RACING	CP2270D50
	PAGID	1269
FCP206	BREMBO	07.8301.03
	CL BRAKES	4016
	FMSI	D350
	MINTEX	MDB1175
	PAGID	4823
	PFC	0350
	WVA	20 753 18,00
FRP212	AP RACING	CP2279D50
	PAGID	1270
	PFC	7767
	PFC	7767.XX.20
FRP216	ALCON	PNF0084X245.4
	ALCON	PNF0084X331
	ALCON	PNF0084X331.4
	AP RACING	CP3215D50
	BREMBO	7767.XX.17
	PAGID	1361
FRP217	AP RACING	CP3714D54
	PAGID	1267
	PFC	7714
FRP218	ALCON	PNF4463X551
	ALCON	PNF4463X551.4
	AP RACING	CP2340D43

Ferodo Code	Competitor	Competitor Code
...FRP218	PFC	7740
FRP219	ALCON	PNF4463X529
	ALCON	PNF4463X529.4
	ALCON	PNF4463X572
	AP RACING	CP3345D44
	PAGID	1749
	PAGID	2127
	PFC	7745
FCP256	CL BRAKES	4025
	FMSI	D253
	FMSI	D395
	HAWK	HB137 0,69
	MINTEX	MDB1230
	PAGID	1144
	PFC	0253.XX
	PFC	0395.XX
	WVA	20 629 20,00
FCP276	BREMBO	07.8301.04
	CL BRAKES	4023
	FMSI	D298
	MINTEX	MDB1236
	WVA	20 907 18,00
FCP296	FMSI	D279
	HAWK	HB399 0,63
	MINTEX	MDB1239
	PAGID	1141
	WVA	20 675 17,00
FRP302	ALCON	PNF4441X728
	ALCON	PNF4441X728.4
	ALCON	PNF4441X754
	ALCON	PNF4441X754.4
	ALCON	PNF4441X757.4
	BREMBO	07.5139.6
	BREMBO	07.5139.65
	BREMBO	07.5139.69
	PAGID	1607
	PFC	7700.XX.20
FRP308	BREMBO	07.5064.27
	BREMBO	07.5064.7
	BREMBO	07.5064.72
	BREMBO	07.5064.73
FCP308	FMSI	D242
	FMSI	D356
	HAWK	HB191 0,59
	MINTEX	MDB1251
FRP308	PAGID	1283
FCP308	PFC	0242.XX
	PFC	0356.XX
FRP308	PFC	7735.XX.20
FCP308	WVA	20 870 15,00
FCP342	AP RACING	CP2195D38
	CL BRAKES	5000W38T10
	FMSI	D064
	MINTEX	MLB19
	PAGID	1362
	PFC	7719

# BRAKE PADS X-REF

# FERODO TO COMPETITORS

Ferodo Code	Competitor	Competitor Code
...FCP342	WVA	20 053 10,00
FCP351	FMSI	D125
	WVA	20 775 18,20
FCP360	BREMBO	07.8301.05
	MINTEX	MDB1088
	MINTEX	MDB1258
	MINTEX	MDB1962
	WVA	20 841 12,00
FCP370	BREMBO	07.8301.06
	CL BRAKES	4028
	FMSI	D147
	MINTEX	MDB1240
	MINTEX	MDB1257
	MINTEX	MDB2758
	WVA	20 833 17,00
FCP372	FMSI	D283
	HAWK	HB158 0,515
	MINTEX	MDB2309
	WVA	20 328 12,90
FCP385	BREMBO	07.8301.07
	CL BRAKES	4021
	FMSI	D307
	MINTEX	MDB1273
	MINTEX	MDB1436
	PAGID	2130
	WVA	20 889 17,30
FCP392	BREMBO	07.8301.08
	BREMBO	07.8301.12
	BREMBO	07.8301.49
	CL BRAKES	4021
	FMSI	D280
	FMSI	D569
	HAWK	HB189 0,55
	MINTEX	MDB1266
	PAGID	4011
	PFC	0280.XX
	WVA	20 887 15,30
FCP393	BREMBO	07.8301.09
	CL BRAKES	4007
	FMSI	D371
	MINTEX	MDB1291
	PAGID	1609
	WVA	20 905 18,00
FCP399	CL BRAKES	4014
	FMSI	D163
	HAWK	HB206 0,565
	MINTEX	MDB1323
	PFC	0163.XX
	WVA	21 088 17,00
FCP406	BREMBO	07.8301.10
	MINTEX	MDB1316
	WVA	21 388 18,50
FCP408	CL BRAKES	4035
	FMSI	D382
	MINTEX	MDB1286
	PAGID	1163

Ferodo Code	Competitor	Competitor Code
...FCP408	PFC	0382
	WVA	21 079 13,75
FCP409	BREMBO	07.8301.11
	WVA	21 103 14,50
FCP415	FMSI	D423
	MINTEX	MDB1312
	MINTEX	MDB1437
	PAGID	1190
	WVA	20 941 19,30
FCP419	MINTEX	CVP020
	MINTEX	CVP020K
	MINTEX	MDB1267
	WVA	20 887 19,70
FCP434	BREMBO	07.8301.13
	MINTEX	MDB1327
	WVA	20 923 17,50
FCP441	MINTEX	MDB1357
	WVA	21 098 16,00
FCP448	FMSI	D0109
	HAWK	HB180 0,64
	MINTEX	MTX1890
	PFC	0174.XX
	WVA	20 323 16,50
FCP451	ALCON	PNF4436X508.4
	CL BRAKES	4002
	FMSI	D345
	FMSI	D608
	HAWK	HB170 0,65
	MINTEX	MDB1456
	PAGID	1203
	PFC	0345.XX
	WVA	20 877 17,50
FCP461	MINTEX	MDB1165
	WVA	20 561 15,00
FCP472	MINTEX	MDB1360
	MINTEX	MDB2191
	WVA	21 312 12,80
FCP483	FMSI	D331
	HAWK	HB155 0,58
	MINTEX	MDB1351
	MINTEX	MDB1935
	PFC	0463
	WVA	20 878 14,80
FCP484	MINTEX	MDB1295
	PFC	0272
	WVA	21 121 13,80
FCP487	FMSI	D319
	FMSI	D473
	HAWK	HB246 0,567
	MINTEX	MDB1348
	PFC	0473.XX
	WVA	21 277 15,00
FRP501	AP RACING	CP4751D43
	PAGID	2555
	PFC	7751
FRP502	ALCON	PNF0084X284

Ferodo Code	Competitor	Competitor Code
...FRP502	ALCON	PNF0084X284.4
	PFC	7752
FRP503	ALCON	PNF0084X350.4
	AP RACING	CP5805D45
FRP504	PFC	7754
FRP506	PFC	7757
FCP519	BREMBO	07.8301.14
	MINTEX	MDB1513
	WVA	21 193 18,00
FCP524	BREMBO	07.8301.15
	MINTEX	MDB1384
	MINTEX	MDB1606
	WVA	21 100 17,00
FCP527	MINTEX	MDB1353
	WVA	21 170 17,30
FCP535	BREMBO	07.8301.16
	MINTEX	MDB1483
	WVA	21 179 16,80
FCP541	BREMBO	07.8301.17
	CL BRAKES	4038
	EBC	DP680
	FMSI	D306
	FMSI	D340
	FMSI	D851
	HAWK	HB271 0,635
	HAWK	HB364 0,642
	MINTEX	MDB1382
	PAGID	1158
	WVA	20 961 15,20
FCP546	FMSI	D454
	MINTEX	MDB1403
	PAGID	1760
	WVA	21 165 16,50
FCP558	ALCON	PNF0084X261.4
	ALCON	PNF0084X317.4
	CL BRAKES	4034
	FMSI	D516
	MINTEX	MDB1339
	MINTEX	MDB2555
	PAGID	1610
	WVA	20 973 11,00
FCP560	CL BRAKES	4001
	FMSI	D372
	FMSI	D447
	FMSI	D609
	HAWK	HB141 0,65
	MINTEX	MDB1457
	PAGID	1204
	PFC	0447
	WVA	20 953 17,50
FCP565	BREMBO	07.8301.18
	CL BRAKES	4027
	FMSI	D590
	MINTEX	MDB1518
	PFC	0590
	WVA	21 074 19,00

# BRAKE PADS X-REF

# FERODO TO COMPETITORS

Ferodo Code	Competitor	Competitor Code
...FCP578	FMSI	D396
FCP578	HAWK	HB227 0,63
	MINTEX	MDB1369
	PAGID	1285
	PFC	0396.XX
	WVA	20 995 17,30
FCP584	BREMBO	07.8301.19
	CL BRAKES	4036
	FMSI	D403
	MINTEX	MDB1386
	PAGID	1288
	WVA	21 190 17,50
FCP586	CL BRAKES	4037
	FMSI	D427
	MINTEX	MDB1385
	WVA	21 140 15,70
FCP590	BREMBO	07.8300.14
	BREMBO	07.8300.38
	BREMBO	07.8300.40
	BREMBO	07.8301.73
	FMSI	D555
	FMSI	D687
	HAWK	HB269 .763A
	MINTEX	MDB1531
	PAGID	1678
	WVA	20 676 19,60
FCP596	BREMBO	07.8301.21
	CL BRAKES	4010
	FMSI	D228
	HAWK	HB271 0,635
	PAGID	3242
	WVA	21 144 16,50
FCP598	BREMBO	07.8301.22
	CL BRAKES	4083
	FMSI	D373
	HAWK	HB113 0,59
	MINTEX	MDB1374
	MINTEX	MDB1525
	PAGID	8010
	PFC	0373.XX
	WVA	21 322 15,00
FCP600	BREMBO	07.8301.23
	FMSI	D449
	FMSI	D462
	FMSI	D485
	FMSI	D700
	HAWK	HB235 0,665
	HAWK	HB261 0,665
	MINTEX	MDB1488
	MINTEX	MDB2351
	WVA	21 526 17,00
FCP602	BREMBO	07.8301.24
	MINTEX	MDB1400
	WVA	21 294 15,00
FCP613	BREMBO	07.8301.25
	MINTEX	MDB1659

Ferodo Code	Competitor	Competitor Code
...FCP613	WVA	21 515 17,50
FCP617	BREMBO	07.8301.26
	MINTEX	MDB1493
	WVA	21 171 19,00
FCP638	FMSI	D272
	FMSI	D323
	FMSI	D464
	HAWK	HB262 0,54
	MINTEX	MDB2352
	WVA	21 553 14,00
FCP646	MINTEX	MDB1503
	WVA	21 153 17,50
FCP647	MINTEX	MDB1511
	WVA	21 271 17,00
FCP660	MINTEX	MDB1401
	MINTEX	MDB1473
	MINTEX	MDB1583
	PAGID	1544
	WVA	21 173 17,00
FCP685	ALCON	PNF0084X235
	ALCON	PNF0084X235.4
	BREMBO	07.8301.28
	MINTEX	MDB1637
	PAGID	1675
	PFC	0394
	PFC	7760
	WVA	21 560 18,00
FCP691	BREMBO	07.8300.07
	FMSI	D430
	HAWK	HB268 0,665
	MINTEX	MDB1451
	WVA	21 561 17,00
FCP721	BREMBO	07.7235.60
	CL BRAKES	4022
	FMSI	D1053
	FMSI	D592
	HAWK	HB194 0,57
	HAWK	HB194 0,575
	HAWK	HB194 0,665
	MINTEX	MDB1633
	MINTEX	MTX1968
	PFC	0592.XX.17
	WVA	21 381 16,80
FCP725	BREMBO	07.8300.09
	BREMBO	07.8301.68
	FMSI	D558
	HAWK	HB136 0,69
	MINTEX	MDB1538
	PAGID	2180
	PFC	0558
	PFC	0558.XX
	WVA	21 292 17,30
FCP726	CL BRAKES	4038
	FMSI	D340
	WVA	21 589 15,00
FCP732	BREMBO	07.8301.29

Ferodo Code	Competitor	Competitor Code
...FCP732	MINTEX	MDB1556
	WVA	20 547 16,80
FCP748	BREMBO	07.8300.17
	BREMBO	07.8300.23
	FMSI	D341
	FMSI	D409
	HAWK	HB242 0,661
	MINTEX	MDB1589
	PAGID	1596
	PFC	0409.XX
	WVA	21 446 17,80
FCP761	BREMBO	07.8300.18
	CL BRAKES	4102
	FMSI	D465
	FMSI	D764
	HAWK	HB275 0,62
	MINTEX	MDB1533
	PFC	0465.XX
FCP765	FMSI	D530
	FMSI	D723
	HAWK	HB214 0,618
	MINTEX	MDB1539
	PAGID	1591
	PFC	0530.XX
	WVA	21 363 15,70
FCP766	BREMBO	07.8301.30
	FMSI	D648
	HAWK	HB420 0,748
	MINTEX	MDB1622
	PFC	0648.XX
	WVA	21 395 18,00
FCP767	ALCON	PNF0084X238.4
	BREMBO	07.8301.31
	MINTEX	MDB1810
	MINTEX	MDB1895
	MINTEX	MDB2193
	WVA	21 583 18,80
FCP774	BREMBO	07.8301.32
	BREMBO	07.8301.71
	CL BRAKES	4011
	FMSI	D227
	FMSI	D696
	HAWK	HB190 .600A
	MINTEX	MDB1253
	MINTEX	MDB1371
	MINTEX	MDB1570
	PAGID	1743
	WVA	20 168 16,20
FCP775	BREMBO	07.8300.02
	BREMBO	07.8301.63
	CL BRAKES	4011
	FMSI	D227
	FMSI	D290
	FMSI	D684
	HAWK	HB190 .730A
	MINTEX	MDB1190

# BRAKE PADS X-REF

# FERODO TO COMPETITORS

Ferodo Code	Competitor	Competitor Code
...FCP775	MINTEX	MDB1571
	PAGID	1744
	WVA	20 168 19,60
FCP776	BREMBO	07.8300.01
	FMSI	D621
	MINTEX	MDB1610
	PFC	0621
	WVA	21 694 16,50
FCP777	BREMBO	07.8301.33
	CL BRAKES	4077
	FMSI	D568
	MINTEX	MDB1615
	WVA	21 697 15,80
FCP779	BREMBO	07.8300.10
	BREMBO	07.8301.50
	CL BRAKES	4033
	FMSI	D394
	FMSI	D725
	HAWK	HB135 0,77
	MINTEX	MDB1393
	PAGID	1295
	PFC	0394.XX
	WVA	20 968 20,30
FCP789	BREMBO	07.8301.34
	CL BRAKES	4018
	FMSI	D470
	HAWK	HB408 0,665
	MINTEX	MDB1496
	PAGID	1349
	WVA	21 495 17,00
FCP790	CL BRAKES	4019
	FMSI	D471
	HAWK	HB367 0,585
	MINTEX	MDB1497
	WVA	21 703 14,80
FCP809	ALCON	PNF3451X521.4
	ALCON	PNF3451X555.4
	CL BRAKES	5002W43T14
	EBC	DP114
	FMSI	D044
	HAWK	HB118 0,56
	MINTEX	MD1723
	MINTEX	MGB533
	PAGID	3102
	PFC	0044
	WVA	20 088 14,40
FCP810	ALCON	PNF3451X522
	ALCON	PNF3451X522.4
	ALCON	PNF3451X554.4
	ALCON	PNF3451X566.4
	CL BRAKES	5002W48T14
	FMSI	D51
	MINTEX	MGB535
	PAGID	3190
	PFC	0051
	WVA	20 089 14,40

Ferodo Code	Competitor	Competitor Code
...FCP815	FMSI	D009
FCP815	MINTEX	MGB521
	PAGID	8041
	WVA	20 007 15,30
FCP817	FMSI	D135
	MINTEX	CVP043
	MINTEX	MGB585
	WVA	20 380 15,50
FCP823	FMSI	D027
	MINTEX	MLB10
	WVA	20 037 15,00
FCP825	AP RACING	CP2399D43
	CL BRAKES	5001W43T14
	FMSI	D005
	HAWK	HB108
	MINTEX	MLB20
	PAGID	1363
	PFC	7720
	WVA	20 054 14,50
FCP832	FMSI	D081
	MINTEX	MLB52
	WVA	20 577 15,00
FCP840	AP RACING	CP2712D44
	MINTEX	MLB65
	PFC	7765
	WVA	20 754 15,00
FCP845	ALCON	PNF0084X262.4
	BREMBO	07.8301.35
	CL BRAKES	4000
	FMSI	D292
	MINTEX	MDB1628
	PAGID	3276
	PFC	0292
	WVA	21 463 18,00
FCP850	BREMBO	07.8301.69
	CL BRAKES	4032
	FMSI	D396
	FMSI	D692
	FMSI	D763
	HAWK	HB227 0,63
	MINTEX	MDB1572
	PAGID	8035
	PFC	0396.XX
	WVA	20 180 16,80
FCP856	BREMBO	07.8300.11
	FMSI	D547
	HAWK	HB325 0,72
	MINTEX	MDB1551
	PAGID	2683
	WVA	21 284 19,30
FCP857	ALCON	PNF0084X347.4
	FMSI	D548
	HAWK	HB362 0,642
	MINTEX	MDB1552
	PAGID	2685
	WVA	21 282 17,30

Ferodo Code	Competitor	Competitor Code
...FCP859	BREMBO	07.8301.36
FCP859	MINTEX	MDB1623
	WVA	21 626 15,00
FCP867	BREMBO	07.8300.12
	FMSI	D562
	FMSI	D695
	HAWK	HB310 0,689
	MINTEX	MDB1658
	PFC	0562.XX
	WVA	21 601 17,50
FCP876	BREMBO	07.8301.37
	MINTEX	MDB1662
	PAGID	1620
	WVA	21 430 17,30
FCP878	FMSI	D491
	HAWK	HB278 0,583
	MINTEX	MDB1445
	PAGID	1682
	PFC	0491
	WVA	20 410 14,80
FCP881	BREMBO	07.8301.38
	CL BRAKES	4005
	FMSI	D453
	MINTEX	MDB1676
	WVA	20 634 15,00
FCP891	CL BRAKES	4005
	FMSI	D594
	HAWK	HB184 .650A
	MINTEX	MDB1860
	PAGID	1842
	PFC	0594.XX.18
	WVA	21 402 17,50
FCP904	BREMBO	07.8300.27
	FMSI	D568
	HAWK	HB144 0,719
	MINTEX	MDB1635
	MINTEX	MDB1971
	WVA	21 497 18,50
FCP905	BREMBO	07.8300.00
	CL BRAKES	4044
	FMSI	D503
	HAWK	HB143 0,68
	MINTEX	MDB1543
	PAGID	2623
	PFC	0503.XX
	WVA	21 651 18,50
FCP925	BREMBO	07.8301.39
	MINTEX	MDB1666
	WVA	21 436 17,00
	WVA	21 437 17,00
FCP948	FMSI	D563
	MINTEX	MDB1688
	WVA	21 482 16,70
FCP956	MINTEX	MDB1564
	PFC	0537
	WVA	21 719 14,50

# BRAKE PADS X-REF

# FERODO TO COMPETITORS

Ferodo Code	Competitor	Competitor Code
...FCP986	ALCON	PNF0084X249.4
FCP986	BREMBO	07.8300.15
	FMSI	D460
	FMSI	D647
	HAWK	HB178 0,564
	MINTEX	MDB1416
	PAGID	1406
	PFC	0460
	PFC	0460.XX
	WVA	21 307 14,50
FCP995	MINTEX	MDB1742
	WVA	21 606 16,20
FCP997	FMSI	D682
	HAWK	HB497 0,776
	MINTEX	MDB1745
	PAGID	2683
	PFC	0682.XX
FCP1001	WVA	21 484 20
FCP1011	CL BRAKES	4107
	FMSI	D635
	HAWK	HB149 0,505
	MINTEX	MDB1686
	WVA	23 354 13,00
FCP1012	CL BRAKES	4106
	FMSI	D636
	HAWK	HB159 0,492
	MINTEX	MDB1705
	MINTEX	MDB1893
	WVA	23 387 12,50
FCP1049	BREMBO	07.8301.41
	MINTEX	MDB1736
	WVA	21 664 19,00
FCP1050	BREMBO	07.8301.42
	FMSI	D740
	HAWK	HB495 0,756
	MINTEX	MDB1871
	WVA	21 670 19,50
FCP1052	BREMBO	07.8301.43
	MINTEX	MDB1735
	MINTEX	MDB2068
	WVA	21 636 18,00
FCP1054	MINTEX	MDB1804
	WVA	21 866 19,70
FCP1056	BREMBO	07.8301.45
	MINTEX	MDB1734
	WVA	21 927 17,00
FRP1058	BREMBO	07.5684.2
	PFC	7748.XX.18
FRP1059	BREMBO	07.5868
	PAGID	2105
	PFC	7742.XX.22
	PFC	7802.XX.22
FRP1060	AP RACING	CP3558D46
	PAGID	1813
FRP1061	AP RACING	CP4296D43
	PAGID	2141

Ferodo Code	Competitor	Competitor Code
...FRP1061	PFC	7708
FCP1063	BREMBO	07.8301.00
	BREMBO	07.8301.46
	MINTEX	MDB1732
	WVA	21 674 18,00
FRP1064	ALCON	PNF0084X282.4
	BREMBO	07.5684.2
	BREMBO	07.5684.25
	BREMBO	07.5684.26
	PAGID	2053
	PFC	7748.XX.20
FCP1068	BREMBO	07.8301.48
	CL BRAKES	4031
	FMSI	D819
	HAWK	HB388 0,756
	MINTEX	MDB1813
	WVA	21 829 19,50
FCP1073	CL BRAKES	4033
	FMSI	D946
	HAWK	HB464 0,764
	MINTEX	MDB1817
	WVA	21 677 19,50
FRP1077	ALCON	PNF4441X723
	ALCON	PNF4441X723.4
	ALCON	PNF4441X753
	ALCON	PNF4441X753S.4
	ALCON	PNF4441X769.4
	BREMBO	07.5139.0
	BREMBO	07.5139.07
	BREMBO	07.5139.19
	HAWK	HB105 0,62
	PAGID	1595
	PFC	7700.XX.16
FRP1078	AP RACING	CP6070D49
	BREMBO	07.5139.3
	BREMBO	07.5139.34
	BREMBO	07.5139.81
	PAGID	1674
	PFC	7700.XX.25
FRP1079	ALCON	PNF0084X322.4
	BREMBO	07.5064.49
	BREMBO	07.5064.8
	BREMBO	07.5064.82
	BREMBO	07.5064.84
	PAGID	1705
	PFC	7735.XX.16
FCP1081	ALCON	PNF0084X325.4
	BREMBO	07.8301.51
	FMSI	D350
	MINTEX	MDB1883
	MINTEX	MDB2110
	WVA	23 103 18,00
FCP1082	BREMBO	07.8301.52
	MINTEX	MDB1884
	WVA	23 101 18,00
FCP1093	BREMBO	07.8301.53

Ferodo Code	Competitor	Competitor Code
...FCP1093	FMSI	D837
	HAWK	HB500 0,645
	MINTEX	MDB1727
	WVA	21 920 15,60
FCP1094	BREMBO	07.8300.04
	CL BRAKES	4088
	FMSI	D768
	HAWK	HB365 0,728
	MINTEX	MDB1811
	MINTEX	MDB2034
	WVA	21 974 19,40
FCP1101	BREMBO	07.8301.44
	BREMBO	07.8301.54
	MINTEX	MDB1805
	WVA	21 866 17,30
FCP1112	MINTEX	MDB1812
	WVA	23 124 19,00
FCP1113	BREMBO	07.8301.55
	MINTEX	MDB1309
	MINTEX	MDB1876
	WVA	23 177 14,30
FCP1133	ALCON	PNF0084X299.4
	BREMBO	07.8301.56
	CL BRAKES	4020
	FMSI	D278
	FMSI	D439
	FMSI	D493
	HAWK	HB195 0,64
	PFC	0278.XX
FCP1134	BREMBO	07.8301.57
	MINTEX	MDB1934
	MINTEX	MDB2132
	WVA	23 140 19,30
FCP1160	BREMBO	07.8301.59
	MINTEX	MDB1828
	MINTEX	MDB1956
	MINTEX	MDB2206
	WVA	21 931 17,00
FCP1162	BREMBO	07.8301.60
	MINTEX	MDB2033
	WVA	21 998 15,60
FCP1213	BREMBO	07.8300.24
	FMSI	D369
	HAWK	HB332 0,654
	PFC	0369.XX
FCP1224	BREMBO	07.8300.25
	FMSI	D412
	HAWK	HB111 0,61
	PFC	0412
	PFC	0412.XX
FCP1280	ALCON	PNF0084X232.4
	PAGID	2445
FCP1281	ALCON	PNF0084X233.4
	BREMBO	07.4865.1
	BREMBO	07.4865.80
	BREMBO	07.8301.61

# BRAKE PADS X-REF

# FERODO TO COMPETITORS

Ferodo Code	Competitor	Competitor Code
...FCP1281	CL BRAKES	5008W52T18
	FMSI	D810
	FMSI	D968
	HAWK	HB193 0,67
	MINTEX	MTX1976
	PAGID	1287
	PFC	7780.XX.18
FCP1283	ALCON	PNF0084X236.4
	PAGID	1897
FCP1285	FMSI	D618
	HAWK	HB492 0,732
	MINTEX	MDB1984
	WVA	21 273 19,50
FCP1288	BREMBO	07.8301.62
	MINTEX	MDB1872
	WVA	21 866 15,30
FCP1289	MINTEX	MDB1919
	WVA	21 945 19,90
FCP1293	BREMBO	07.8301.64
	MINTEX	MDB1908
	WVA	23 063 18,40
FCP1294	MINTEX	MDB2130
	WVA	23 052 16,20
FCP1295	BREMBO	07.8301.65
	MINTEX	MDB1907
	WVA	23 057 20,00
FCP1298	CL BRAKES	4061
	FMSI	D639
	HAWK	HB181 0,66
	PAGID	1427
	PFC	0639
FCP1300	CL BRAKES	4104
	FMSI	D781
	HAWK	HB546 0,654
	MINTEX	MDB1901
	PAGID	2180
	WVA	21 925 17,80
FCP1301	FMSI	D692
	MINTEX	MDB1888
	MINTEX	MDB2763
	WVA	21 934 17,30
FCP1307	FMSI	D737
	HAWK	HB289 0,61
	MINTEX	MDB1873
	PAGID	2407
	PFC	0738
	WVA	21 937 16,20
FCP1308	CL BRAKES	4049
	FMSI	D738
	FMSI	D978
	HAWK	HB290 0,583
	MINTEX	MDB1874
	PAGID	2406
	PFC	0738
	WVA	21 972 15,20
	WVA	23 694

Ferodo Code	Competitor	Competitor Code
...FCP1312	MINTEX	MDB1868
FCP1312	WVA	21 945 16,00
FCP1318	BREMBO	07.8301.72
	FMSI	D816
	HAWK	HB346 0,713
	MINTEX	MDB1958
	PFC	0816.XX
	WVA	23 154 19,00
FCP1319	FMSI	D886
	HAWK	HB430 0,547
	MINTEX	MDB1959
	WVA	23 353 14,70
FCP1323	CL BRAKES	4023
	FMSI	D840
	HAWK	HB354 .756A
	MINTEX	MDB1826
	WVA	21 938 20,40
FCP1324	MINTEX	MDB2042
	WVA	23 601 16,70
FCP1327	BREMBO	07.8300.42
	CL BRAKES	4029
	FMSI	D721
	HAWK	HB352 0,665
	MINTEX	MDB1794
	PAGID	ERS651
	WVA	23 558 17,80
FCP1333	CL BRAKES	4059
	FMSI	D770
	HAWK	HB434 0,543
	WVA	23 572 14,40
FCP1334	ALCON	PNF0084X268.4
	ALCON	PNF0084X359.4
	BREMBO	07.8301.74
	CL BRAKES	4066
	FMSI	D1001
	FMSI	D1016
	FMSI	D1050
	HAWK	HB453 0,585
	MINTEX	MDB1950
	MINTEX	MTX1859
	PAGID	2487
	PFC	7781
	WVA	23 092 16,00
FCP1348	BREMBO	07.5146.30
	BREMBO	07.5146.31
	BREMBO	07.6953.9
	BREMBO	07.8720.XX
	PAGID	1408
	PFC	0592.XX.15
	WVA	21 381 15,00
FCP1349	MINTEX	MDB2051
	WVA	23 517 16,60
FCP1368	BREMBO	07.8301.76
	MINTEX	MDB2006
	WVA	23 348 16,50
FCP1370	MINTEX	MDB2012

Ferodo Code	Competitor	Competitor Code
...FCP1370	WVA	23 332 18,00
FCP1372	ALCON	PNF0084X298.4
	CL BRAKES	4069
	FMSI	D461
	HAWK	HB179 0,63
	PFC	0461
	PFC	0461.XX
FCP1376	BREMBO	07.8301.77
	MINTEX	MDB2076
	WVA	23 552 17,80
FCP1378	ALCON	PNF0084X321.4
	BREMBO	07.8301.78
	MINTEX	MDB2131
	WVA	23 597 16,80
FCP1382	FMSI	D794
	HAWK	HB491 0,693
	MINTEX	MDB1944
	WVA	23 073 18,80
FCP1392	FMSI	D990
	HAWK	HB493 0,65
	MINTEX	MDB2029
	WVA	23 510 16,50
FCP1394	MINTEX	MDB2314
	WVA	23 202 18,50
FCP1399	MINTEX	MDB2183
	MINTEX	MDB2628
	WVA	23 599 19,00
FCP1419	MINTEX	MDB2294
	WVA	23 581 18,70
FCP1424	MINTEX	MDB2073
	WVA	23 225 17,00
FCP1430	BREMBO	07.8300.20
	BREMBO	07.8300.26
	FMSI	D526
	FMSI	D653
	FMSI	D815
	HAWK	HB412 0,665
	PFC	0526.XX
	PFC	0815.XX
FCP1436	BREMBO	07.8300.33
	FMSI	D617
	HAWK	HB245 0,631
	PFC	0617.XX
FCP1437	BREMBO	07.8300.36
	FMSI	D707
	HAWK	HB320 0,669
	MINTEX	MDB1921
	PFC	0707.XX
	WVA	23 513 16,80
FCP1441	7701206599	OE Renault
	EBC	DP1958
	WVA	23 245
FCP1444	BREMBO	07.8301.90
	MINTEX	MDB2044
	PFC	0829
	WVA	23 178 18,00

# BRAKE PADS X-REF

# FERODO TO COMPETITORS

Ferodo Code	Competitor	Competitor Code
...FCP1459	MINTEX	MDB2003
FCP1459	WVA	20 046 15,30
FCP1466	MINTEX	MDB2239
	WVA	23 705 17,10 - 24 288 17,7&17,9
FCP1467	BREMBO	07.8301.79
	MINTEX	MDB2240
	WVA	23 708 18,40
FCP1468	BREMBO	07.8301.80
	MINTEX	MDB2241
	WVA	23 711 18,40
FCP1469	MINTEX	MDB2238
	WVA	23 714 15,80
FCP1483	FMSI	D683
	HAWK	HB518 0,642
	MINTEX	MDB2004
	PAGID	2685
	PFC	0548
	WVA	21 282 17,20
FCP1491	MINTEX	MDB2256
	PAGID	1158
	PFC	0340-07-15-44
	WVA	20 961 16,00
FCP1499	BREMBO	07.8301.88
	FMSI	D939
	HAWK	HB444 0,685
	MINTEX	MDB2162
	WVA	23 281 18,00
FCP1501	MINTEX	MDB1910
	WVA	23 497 15,40
FCP1520	WVA	23402 20,10 - 23403 20,1
FCP1528	FMSI	D817
	HAWK	HB328 0,685
	MINTEX	MDB2013
	MINTEX	MDB2291
	WVA	23 526 17,40
FCP1540	MINTEX	MDB2210
	MINTEX	MDB2281
	WVA	23 482 16,50
FCP1543	BREMBO	07.8301.91
	MINTEX	MDB2254
	WVA	23 409 19,30
FCP1553	PFC	0731
FCP1560	AP RACING	CP3915D33
	MINTEX	MDB1891
	PAGID	1682
	WVA	20 410 12,90
FCP1561	CL BRAKES	4061
	FMSI	D960
	HAWK	HB545 0,564
	MINTEX	MDB2341
	PFC	0639
	WVA	23 142 15,00
FCP1562	ALCON	PNF0084X358.4
	AP RACING	CP5119D50
	BREMBO	07.5505.91
	CL BRAKES	4060

Ferodo Code	Competitor	Competitor Code
...FCP1562	FMSI	D961
	HAWK	HB180 0,56
	MINTEX	MDB2342
	PAGID	1587
	PAGID	2593
	PFC	0109
	WVA	21 580 14,30
FCP1563	PFC	0732
FCP1568	BREMBO	07.8301.92
	FMSI	D970
	HAWK	HB449 0,679
FCP1573	BREMBO	07.8301.89
	MINTEX	MDB2257
	WVA	23 766 17,50
FCP1617	MINTEX	MDB2595
	WVA	23 973 16,80
FCP1625	OE PORSCHE	955.351.939.00 / .01 / .02
	OE VOLKSWAGEN	7L0698151 / B / D / H
	OE VOLKSWAGEN	7L6698151 / C
	WVA	23 692
FCP1626	MINTEX	MDB2751
	PAGID	2845
	WVA	23 693 16,20
FCP1628	FMSI	D918
	MINTEX	MDB2418
	WVA	23 312 20,30
FCP1629	MINTEX	MDB2694
	PAGID	2275
	PAGID	8021
	WVA	23 762 20,2
FCP1631	WVA	24 142 20,6 - 24 141 19,1
FCP1636	ALCON	PNF0084X363.4
	FMSI	D1108
	HAWK	HB544 0,628
	MINTEX	MDB2580
	WVA	23 914 16,90
FCP1639	FMSI	D929
	HAWK	HB432 0,661
FCP1641	FMSI	D1107
	HAWK	HB543 0,76
	MINTEX	MDB2604
	PAGID	8001
	WVA	23 587 20,30
FCP1655	FMSI	D1018
	WVA	23 326
FCP1661	FMSI	D847
	WVA	23 745-23 271 17,7
FCP1664	BREMBO	07.9312.44
	BREMBO	07.9312.45
	BREMBO	07.9312.46
	BREMBO	07.9312.47
	HAWK	HB609 0,572
	MINTEX	MDB2601
	PAGID	2931
	WVA	23 764 17,00
FCP1667	MINTEX	MDB2725

Ferodo Code	Competitor	Competitor Code
...FCP1667	PAGID	8023
	PFC	7871-07-16-44
	WVA	24 764 17,00
FCP1672	FMSI	D919
	MINTEX	MDB2419
	WVA	23 309 17,00
FCP1676	BREMBO	07.8301.21
	FMSI	D940
	HAWK	HB445 0,61
	MINTEX	MDB2639
	WVA	23 716 16,40
FCP1690	FMSI	D888
	HAWK	HB387 0,547
FCP1693	FMSI	D905
	HAWK	HB370 0,559
	MINTEX	MDB2261
	WVA	23 871 14,00
FCP1706	MINTEX	MDB2749
	WVA	23 912 18,50
FCP1747	FMSI	D1308
	HAWK	HB570 .677
	MINTEX	MDB2682
	WVA	23 915 17,60
FCP1751	WVA	23 935 17,60
FCP1765	MINTEX	MDB2677
	WVA	23 801 20,40
FCP1773	MINTEX	MDB2692
	PFC	0394
	WVA	23 794 19,80
FCP1786	FMSI	D969
	HAWK	HB448 0,61
	MINTEX	MDB2387
	WVA	24 056 15,5
FCP1790	WVA	23 959 17,4
FCP1805	MINTEX	MDB2790
	WVA	24 339 19,90
FCP1806	FMSI	D1309
	HAWK	HB574 .666
	WVA	23 623 17,20
FCP1807	PFC	0396
	WVA	23 926 17,00
FCP1808	EBC	DP21588
	FMSI	D1170
	HAWK	HB624x.642
	WVA	23 550 17,00
FCP1858	WVA	24 349 17,20
FCP1975	WVA	24 289 17,1
FRP3000	ALCON	PNF4489X519.4
	ALCON	PNF4489X562.4
	ALCON	PNF4489X565.4
	AP RACING	CP3894D46
	PAGID	1852
FRP3001	AP RACING	CP4140D36
FRP3003	ALCON	PNF4489X532.4
	AP RACING	CP3894D54
	HAWK	HB109 0,71

# BRAKE PADS X-REF

# FERODO TO COMPETITORS

Ferodo Code	Competitor	Competitor Code	Ferodo Code	Competitor	Competitor Code	Ferodo Code	Competitor	Competitor Code
...FRP3003	PFC	7790.XX.18	...FRP3029	PFC	7770.XX.26	...FRP3046	BREMBO	07.7614.31
FRP3004	ALCON	PNF0084X283.4	FRP3030	BREMBO	07.7859.2	FRP3047	BREMBO	07.7614.5
	BREMBO	07.5868.2		BREMBO	07.7859.20		BREMBO	07.7614.50
	BREMBO	07.5868.29		BREMBO	07.7859.21		BREMBO	07.7614.51
	PFC	7742.XX.20		PFC	7770.XX.26		PFC	7773.XX.22
	PFC	7802.XX.20	FRP3031	BREMBO	07.7293.6	FRP3050	MINTEX	MDB2039
FRP3006	AP RACING	CP3796D54		BREMBO	07.7293.60		PAGID	1291
FRP3007	PFC	7700.XX.18		BREMBO	07.7293.61		PAGID	2474
FRP3009	ALCON	PNF4476X545		BREMBO	07.7293.63		PFC	7818.XX.17
	ALCON	PNF4476X545.4		BREMBO	07.7293.70		WVA	23 139 17,00
	PFC	7755		PAGID	2488	FRP3051	FMSI	D776
FRP3012	ALCON	PNF4476X549		PFC	7797.XX.29		HAWK	HB291 0,642
	ALCON	PNF4476X549.4	FRP3032	BREMBO	07.5139		PAGID	2405
	PAGID	1756		BREMBO	07.5139.85		PFC	0776
	PFC	7756		BREMBO	07.5139.88	FRP3053	BREMBO	07.6955.3
FRP3014	AP RACING	CP3558D54		PFC	7718.XX.16		BREMBO	07.6955.30
	PFC	7790.XX.25	FRP3033	BREMBO	07.5684.8		BREMBO	07.6955.31
FRP3015	ALCON	PNF4489X543		BREMBO	07.5684.80		PFC	7775.XX.28
	AP RACING	CP4595D54		BREMBO	07.5684.81	FRP3054	ALCON	PNF4489X545.4
	PFC	7790.XX.28		PFC	7743.XX.21		AP RACING	CP3894D51 (18 mm)
FRP3018	ALCON	PNF0084X276.4	FRP3034	BREMBO	07.7810.2		PAGID	1903
	AP RACING	CP3215D42		BREMBO	07.7810.20		PFC	7793.XX.18
	PAGID	2126		BREMBO	07.7810.21	FRP3055	ALCON	PNF4495X517.4
	PFC	7768.XX.16		PFC	7742.XX.21		ALCON	PNF4495X518.4
FRP3020	AP RACING	CP5148D46	FRP3035	BREMBO	07.7810.1		AP RACING	CP6210D54 (30 mm)
	PFC	7804.XX.15		BREMBO	07.7810.10		PAGID	2557
FRP3021	AP RACING	CP2340D38		BREMBO	07.7810.11	FRP3056	AP RACING	CP5119D50
FRP3022	BREMBO	07.5684.5	FRP3037	ALCON	PNF4495X514.4		PFC	0109-07-16-44
	BREMBO	07.5684.52		ALCON	PNF4495X516.4			
	BREMBO	07.5684.56		AP RACING	CP6210D54 (28 mm)	FRP3057	FMSI	D052
	PFC	7743.XX.20		PAGID	2557		FMSI	D313
FRP3023	BREMBO	07.5684.5		PFC	7778.XX.28		HAWK	HB103 0,59
	BREMBO	07.5684.53	FRP3039	ALCON	PNF4495X501.4		MINTEX	MTX1594
	BREMBO	07.5684.55		AP RACING	CP6230D54 (25 mm)		PFC	0052.XX
	PFC	7743.XX.17		PAGID	2688	FRP3058	FMSI	D154
FRP3024	AP RACING	CP5788D48		PFC	7778.XX.25		FMSI	D202
	BREMBO	07.5169.9	FRP3040	BREMBO	07.7614.2		HAWK	HB119 0,594
	BREMBO	07.5169.90		BREMBO	07.7614.20		MINTEX	MTX1595
	BREMBO	07.5169.92		BREMBO	07.7614.21		PFC	0154.XX
	PAGID	1896		PFC	7773.XX.30	FRP3059	AP RACING	CP2749D66 (28 mm)
	PFC	7770.XX.20	FRP3042	BREMBO	07.5308.9		PAGID	1218
FRP3025	ALCON	PNF0084X305.4		BREMBO	07.5308.91		PFC	7702
	PFC	7683		PAGID	2703	FRP3060	AP RACING	CP2749D55 (28 mm)
FRP3026	ALCON	PNF4493X501.4	FRP3043	ALCON	PNF3430X275.4		PFC	7712
	ALCON	PNF4493X502	FRP3044	ALCON	PNF4493X603	FRP3061	AP RACING	CP3558D51
	ALCON	PNF4493X503		ALCON	PNF4493X603.12		PAGID	1538
FRP3027	ALCON	PNF0084X222		ALCON	PNF4493X603.4		PFC	7790.XX.25
	ALCON	PNF0084X222.4		ALCON	PNF4493X610.12	FRP3067	ALCON	PNF0084X336.4
	AP RACING	CP8310D70		ALCON	PNF4493X610.4		BREMBO	07.8301.84
FRP3028	HAWK	HB193 0,61	FRP3045	BREMBO	07.7810.3		FMSI	D1001
	PFC	7780.XX.16		BREMBO	07.7810.30		HAWK	HB453 0,585
FRP3029	BREMBO	07.7859.1		BREMBO	07.7810.31		PAGID	2487
	BREMBO	07.7859.10		PFC	7742.XX.18		PFC	7781
	BREMBO	07.7859.11		PFC	7802.XX.18	FRP3069	ALCON	PNF4436X509
	PAGID	1619	FRP3046	BREMBO	07.7614.3		ALCON	PNF4436X509.4
	PAGID	8030		BREMBO	07.7614.30	FRP3070	BREMBO	07.7869.12



# BRAKE PADS X-REF

# FERODO TO COMPETITORS

Ferodo Code	Competitor	Competitor Code
...FRP3070	PFC	7718.XX.18
FRP3071	PAGID	8000
	PFC	7736
FRP3073	AP RACING	CP2279D42
	PFC	7768.XX.20
FRP3074	PFC	7746
	PFC	7750.XX.20
FRP3075	FMSI	D991
	HAWK	HB483 0,635
	PAGID	2707
	PFC	7819
FRP3076	AP RACING	CP5070D51
	PAGID	8028
FRP3077	AP RACING	CP5070D54
	PFC	7790.XX.17
FRP3081	ALCON	PNF4497X607.4
	ALCON	PNF4497X617.4
FRP3082	ALCON	PNF4498X703.4
	ALCON	PNF4498X705.4
FRP3083	AP RACING	CP6600D55
	PAGID	20345
	WVA	24974 16,7 - 20345 16,9
FRP3084	AP RACING	CP7040D61
	PAGID	20346
FRP3085	AP RACING	CP7600D46
	PAGID	20349
FRP3086	AP RACING	CP4848D46 (18 mm)
	AP RACING	CP5148DXX
	PFC	7804.XX.18
FRP3087	BREMBO	07.7859.60
	BREMBO	07.7859.70
	PFC	7770.XX.17
FRP3088	BREMBO	07.6955.50
	PAGID	8033
	PFC	7772.XX.18
FRP3091	AP RACING	CP3215D46
FRP3092	PAGID	8034
FRP3095	PAGID	8006
FRP3096	CL Brakes	4126
	PAGID	8004
FRP3097	AP RACING	CP8250-D41
FRP3098	BREMBO	07.9551.13
	BREMBO	07.B314.59 (Th 16.8)
FRP3099	BREMBO	XA5.71.M2
FRP3100	BREMBO	07.8365.33
	BREMBO	07.9209.xx
	FMSI	D1116
	PAGID	8005
FRP3102	AP RACING	CP7031D32
FRP3103	BREMBO	07.A262.20
FRP3104	WILWOOD	6812
FRP3106	BREMBO	07.8590.15
	FMSI	D1382
FRP3107	AP RACING	CP6600D50
FRP3108	WILWOOD	7912
FRP3109	BREMBO	XA4.17.M4

Ferodo Code	Competitor	Competitor Code
...FRP3110	BREMBO	07.7293.7
FRP3113	BREMBO	07.A010.10
FRP3114	AP RACING	CP7040D54
FRP3115	AP RACING	CP6627D51
FRP3116	AP RACING	CP8250D50
FRP3118	Oe Suzuki	5581057K01
FRP3123	PAGID	8038
FRP3127	WVA	21 468 15,5
FRP3129	FMSI	D1081
	HAWK	HB484 0,670
FRP3130	FMSI	D1082
	HAWK	HB485 0,656
FRP3133	WVA	24 455 16,9
FRP3134	ALCON	PNF4497X831S
FRP3135	ALCON	PNF4498X821S
FRP3136	AP RACING	CP8318D70
FCP4044	MINTEX	MDB2934
	OE AUDI	8K0698151 / B
	PAGID	1748
	WVA	24 408 19,40
	WVA	24 409 19,40
	WVA	24 743 19,40
FCP4045	MINTEX	MDB2952
	OE AUDI	8K0698151A
	PAGID	1760
	WVA	24 705 20,00
	WVA	24 706 20,00
	WVA	24 707 20,00
FCP4050	MINTEX	MDB2929
	OE AUDI	8K0698451
	OE AUDI	8K0698451A
	PAGID	1736
	WVA	24 606 17,50
FCP4064	WVA	24 553 16,1
FCP4080	EBC	DP21789
	FMSI	D1204
	HAWK	HB560
	WVA	23984 17,9
FCP4168	BREMBO	XA7.G0.11
	BREMBO	XA7.G0.12
	FMSI	D1368
FCP4172	FMSI	D1346
	HAWK	HB601 .626
FCP4173	FMSI	D1347
	HAWK	HB602 .545
FCP4187	EBC	DP21758
	ENDLESS	EP472
	FMSI	D1124
	HAWK	HB671
	WVA	24 854 16,7
FCP4191	WVA	23313 20,30 - 24255 20,30
FCP4217	FMSI	D1372
	HAWK	HB604x.598
	MINTEX	MDB2828
	OE BMW	34 216 784808
	OE BMW	34 216 791421

Ferodo Code	Competitor	Competitor Code
...FCP4217	PAGID	T1620
	WVA	24 315 17,10
FCP4218	EBC	DP21995-DP31995
	FMSI	D1371
	HAWK	HB603x.616
	MINTEX	MDB2974
	OE BMW	34116786044
	PAGID	T1784
	WVA	24 316 17,00
FCP4416	WVA	23723 - 23724
FCP4426	EBC	DPX2002
	FMSI	D1454
	HAWK	HB668
	MINTEX	MDB2875
	WVA	24 283
FCP4430	WVA	25 258
FCP4433	OE AUDI	8V0698151
	OE AUDI	8V0698151B
	WVA	25 086
FCP4612	WVA	25 134 16,7
FRP5002	EBC	DP2035