

Power Transmission Group  
Our Drive – Your Success



# New products

2012 / 2013

Zuordnungsliste  
Generatorfreilauf &  
Torsionsschwingungsdämpfer

Application guide  
Overrunning alternator pulley &  
Torsional vibration damper

Liste de correspondance  
Roue libre d'alternateur &  
Armortisseur de vibrations de torsion

Lista de aplicaciones  
Polea libre del alternador &  
Amortiguador de vibraciones de torsión

Elenco di corrispondenza  
Ruota libera dell'alternatore &  
Puleggia smorzatrice per vibrazioni torsionali

Таблица применяемости  
Муфта свободного хода генератора &  
Гаситель крутильных колебаний



**Continental**   
**CONTITECH**



## Service

- 2 — ContiTech im Internet  
 ContiTech in the Internet  
 ContiTech sur Internet  
 ContiTech Internet  
 ContiTech i Internet  
 ContiTech в Интернете

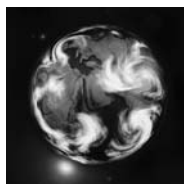

- 4 — Service-Zubehör  
 Service accessories  
 Accessoires  
 Accesorios  
 Accessori  
 Принадлежности



## Produkte, Products, Produits, Productos, Prodotti, Продукты

- 8 — Generatorfreilauf  
 Overrunning alternator pulley  
 Roue libre d'alternateur  
 Polea libre de alternador  
 Ruota libera dell'alternatore  
 Муфта свободного хода генератора

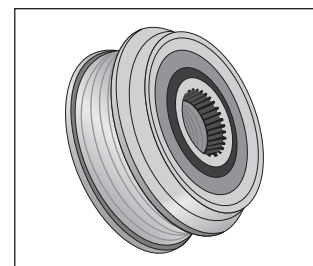

- 14 — Torsionsschwingungsdämpfer  
 Torsional vibration damper  
 Amortisseur de vibrations de torsion  
 Amortiguador de vibraciones de torsión  
 Puleggia smorzatrice per vibrazioni torsionali  
 Гаситель крутильных колебаний

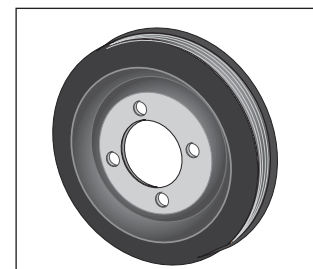

- 19 — Keilrippenriemen + Torsionsschwingungsdämpfer  
 Multiple V-Ribbed Belts + Torsional vibration damper  
 Courroies striées + Amortisseur de vibrations de torsion  
 Correas ranuradas longitudinalmente + Amortiguador de vibraciones de torsión  
 Cinghie scanalate + Puleggia smorzatrice per vibrazioni torsionali  
 Поликлиновые ремни + Гаситель крутильных колебаний



- 20 — Fehlerbilder Torsionsschwingungsdämpfer  
 Defect patterns in torsional vibration damper  
 Types de défaut Amortisseurs de vibrations de torsion  
 Imágenes de fallos Amortiguador de vibraciones de torsión  
 Illustrazioni dei guasti smorzatore di vibrazioni torsionali  
 Возможные неисправности у гасителя крутильных колебаний

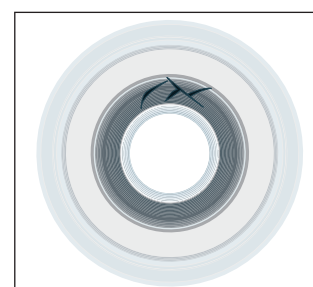



- 24 — Original-Teile-Nr.  
 Original part no.  
 Réf. automobile  
 Ref. original  
 Numeri originali  
 Оригинальный №
- 29 — Wettbewerbsbezeichnungen  
 Competitor part no.s  
 Références autres produits  
 Referencias de otros fabricantes  
 Referenza per prodotti di terzi  
 Наименование конкурентной продукции
- 40 — Zuordnungsliste PKW  
 Cross-reference list for passenger cars  
 Liste de correspondance voitures de tourisme  
 Lista indicativa de correas para turismos  
 Elenco di correlazione per autovetture  
 Таблица соответствий для легковых автомобилей

Original-Teile-Nr.	Original part no.	Réf. automobile	Ref. original	Numeri originali	Оригинальный №
...	...	...	...	...	...
...	...	...	...	...	...

- 237 — Abkürzungsverzeichnis / Zeichenerklärung  
 List of abbreviations / Key to symbols  
 Liste des abréviations / Signification des symboles  
 Índice de abreviaturas / Significado de símbolos  
 Indice delle abbreviazioni / Spiegazione de simbolos  
 Значение аббревиатуры / Условное обозначение

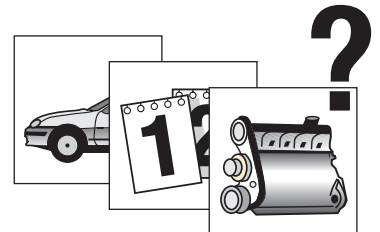

Electronic Business  
 für den Automotive Aftermarket  
 Electronic business  
 for the automotive aftermarket  
 E-business pour l'après-vente  
 automobile  
 Electronic Business  
 para el Automotive Aftermarket  
 Электронный бизнес в  
 автомобильном  
 афтермаркете



Das elektronische Kataloginfor-  
 mationssystem der Automobil-Zulieferindustrie.  
 The electronic catalogue information  
 system of the automotive supplier  
 industry.  
 Le système d'informations sur catalo-  
 gue électronique des sous-traitants  
 del'Industrie Automobile.  
 El sistema de catálogo electrónico de la  
 industria proveedora del automóvil.  
 Электронная информационная  
 система по поставщикам в  
 автомобилестроении



Das Entsorgungskonzept für den  
 Kfz-Teilekreislauf.  
 The disposal concept to  
 recycleautomotive parts.  
 Le concept d'élimination contrôlée pour  
 le recyclage des pièces Auto.  
 El concepto de gestión residual para la  
 circulación de piezas de recambio del  
 automóvil.  
 Концепция процесса утилизации  
 автомобильных запчастей

**ContiTech im Internet**  
**ContiTech in the Internet**  
**ContiTech sur Internet**  
**ContiTech Internet**  
**ContiTech i Internet**  
**ContiTech в Интернете**

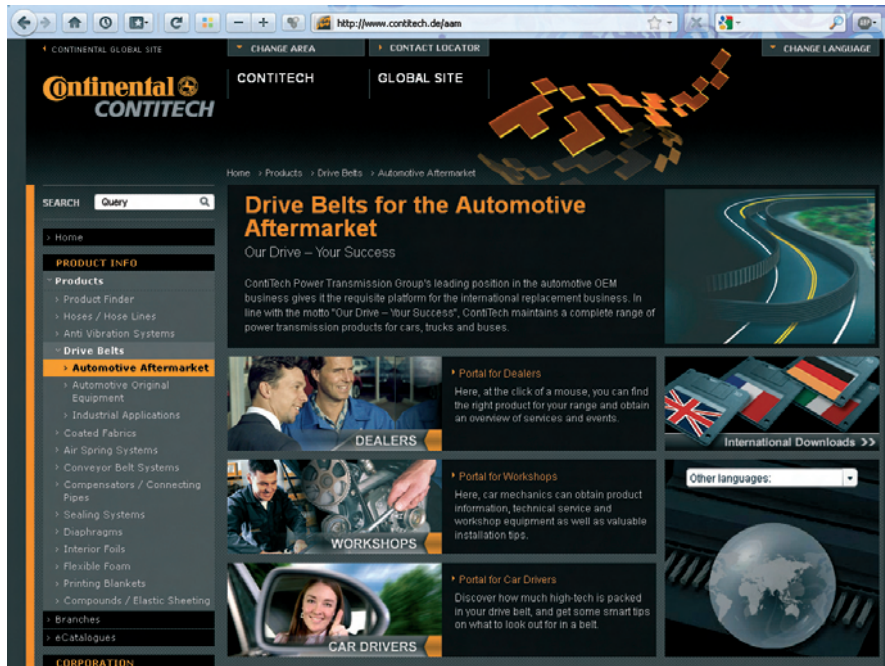

**www.contitech.de/aam**

**ContiTech im Internet**

Auf unserer Homepage finden Sie Informationen über:

- Produkte
- Serviceprogramm
- Broschüren
- Downloads
- Online Katalog
- Newsletter (Technical News)

**ContiTech en Internet**

En nuestra página Web encontrará informaciones sobre:

- productos
- programa de servicios
- folletos
- downloads
- catálogo Online
- Boletín informativo (Technical News)

**ContiTech in the Internet**

On our homepage you can find the following information:

- products
- service programme
- brochures
- downloads
- Online Katalog
- Newsletter (Technical News)

**ContiTech i Internet.**

Nella nostra homepage troverete informazioni su:

- prodotti
- programmi di assistenza
- prospetti
- downloads
- Catalogo online
- Newsletter (Technical News)

**ContiTech sur Internet**

Vous trouverez sur notre site Internet des informations sur:

- nos produits
- notre programme de services
- nos brochures
- le téléchargement
- catalogue en ligne
- Bulletin d'informations (Technical News)

**ContiTech в Интернете**

Здесь вы найдете информацию о

- продукции
- сервисных программах
- брошюрах и проспектах
- downloads
- онлайн-каталог
- бюллетене Technical News



[www.contitech.de/pic](http://www.contitech.de/pic)

**PIC Product Information Center**  
Sie benötigen Daten, Anleitungen und weitere Informationen zu einem bestimmten Artikel? Nutzen Sie unser Product Information Center.

**PIC Product Information Center**  
¿Necesita datos, instrucciones y otras informaciones sobre un artículo determinado? Utilice nuestro Centro de Información de Producto (PIC).

**PIC Product Information Center**  
You need data, instructions and other info on a certain article? Use our Product Information Center.

**PIC Product Information Center**  
Avete bisogno di dati, istruzioni e informazioni ulteriori su un articolo determinato? Utilizzate il nostro Product Information Center.

**PIC Product Information Center**  
Vous avez besoin de données, d'instructions et d'autres informations sur un article déterminé ? Alors, utilisez notre Centre d'Informations sur les Produits.

**Центр информации о продукции (англ.: PIC)**  
Вам требуются данные, инструкции и дополнительная информация по определенному продукту? Обращайтесь в наш центр информации о продукции (англ.: PIC).

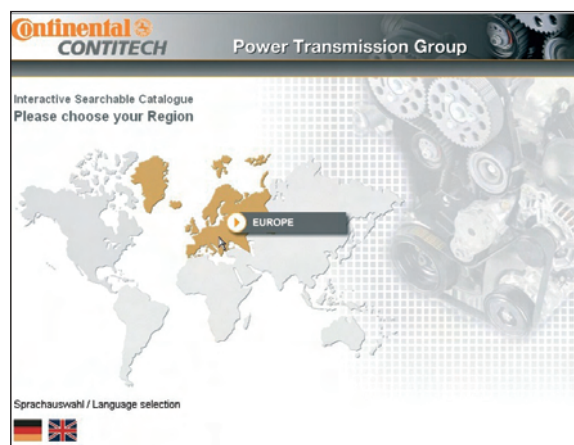

[www.contitech.de/aamcat](http://www.contitech.de/aamcat)

**Online Katalog**  
Aktuelle Zuordnungen finden Sie in unserem Online Katalog unter [www.contitech.de/aamcat](http://www.contitech.de/aamcat)

**Catálogo online**  
Encontrará las clasificaciones actuales en nuestro catálogo online en [www.contitech.de/aamcat](http://www.contitech.de/aamcat)

**Online catalog**  
Current references can found in our online catalog at [www.contitech.de/aamcat](http://www.contitech.de/aamcat)

**Catalogo online**  
Le assegnazioni attuali sono indicate nel nostro catalogo online alla pagina [www.contitech.de/aamcat](http://www.contitech.de/aamcat)

**Catalogue en ligne**  
Veuillez trouver notre catalogue hiérarchique actuel en ligne sous [www.contitech.de/aamcat](http://www.contitech.de/aamcat)

**Онлайн-каталог**  
Актуальные распределения Вы найдете в нашем онлайн-каталоге на интернет-сайте: [www.contitech.de/aamcat](http://www.contitech.de/aamcat)

**Service-Zubehör**  
**Service accessories**  
**Accessoires**  
**Accesorios**  
**Accessori**  
**Принадлежности**



Die Präsentation für ContiTech Keil-, Keilrippen- und Zahnriemen.  
 An eye-catching way of displaying ContiTech V-belts, multiple V-ribbed belts and timing belts.  
 La présentation des courroies trapézoïdales, striées et synchrones de ContiTech.  
 La presentación de las correas trapeciales, ranuradas longitudinalmente y dentadas de ContiTech.  
 La presentazione delle cinghie trapezoidali, cinghie trapezoidali dentate e cinghie dentate della ContiTech.  
 Выставочно-торговое оборудование для клиновых, поликлиновых и зубчатых ремней ContiTech



Art.-Nr.: 67 79 013 000

Verkaufsständer / Stand-alone sales unit  
 Présentoir de vente / Expositor de ventas  
 Banchi di vendita / Торговая стойка



Art.-Nr.: 67 79 015 000

Wandaufhänger Typ B  
 Wall display rack, Type B  
 Présentoir mural, type B  
 Expositor mural tipo B  
 Presentatore a parete tipo B  
 Стеллаж настенный, тип B



Art.-Nr.: 67 79 045 000

Wandaufhänger Typ C/E  
 Wall display rack, Type C/E  
 Présentoir mural, type C/E  
 Expositor mural tipo C/E  
 Presentatore a parete tipo C/E  
 Стеллаж настенный, тип C/E



Art.-Nr.: 67 79 046 000

Zahnriemenkorb für 18 Zahnriemen oder 6 Zahnriemen Kits  
 Timing belt tray for 18 timing belts or 6 timing belt kits  
 Présentoir de courroies synchrones pour 18 courroies synchrones ou 6 kits de courroies synchrones  
 Expositor para 18 correas dentadas o 6 juegos de correas dentadas  
 Presentatore per 18 cinghie dentate o 6 kit di cinghie dentate  
 Контейнер для 18 зубчатых ремней или 6 комплектов с зубчатых ремнем



Art.-Nr.: 67 79 312 000

Wandleiste  
 Wall-hung belt holder  
 Présentoir mural  
 Expositor mural  
 Espositore a parete  
 Полка с крючками



**Service total** durch praktisches und erprobtes Zubehör von ContiTech.

**All-round service** using practical and time-tested accessories from ContiTech.

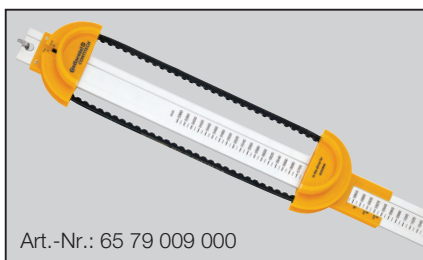

Art.-Nr.: 65 79 009 000

**Service complet** grâce aux accessoires pratiques et éprouvés de ContiTech.

**Servicio completo** gracias a los accesorios prácticos y probados de ContiTech.

Längenmessgerät für Keilriemen und Keilrippenriemen.

Length gauge for V-belts and multiple V-ribbed belts.

Mesureur de longueur pour courroies trapézoïdales et courroies striées.

**Servizio completo** grazie agli accessori ContiTech, pratici e collaudati.

**Полное обслуживание** проверенным и практичным инструментом ContiTech.

Medidor de correas trapeciales y ranuradas longitudinalmente.

Apparecchiatura di misurazione lunghezza per cinghie trapezoidali e cinghie trapezoidali scanalate.

Линейка для измерения длины клиновых и поликлиновых ремней

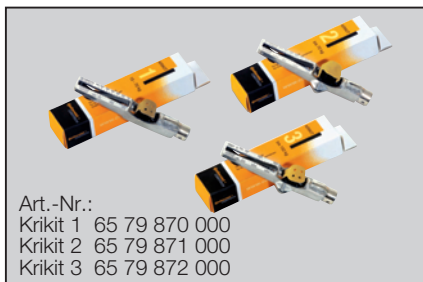

Art.-Nr.:  
Krikit 1 65 79 870 000  
Krikit 2 65 79 871 000  
Krikit 3 65 79 872 000

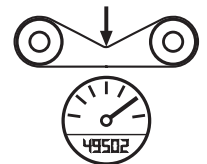
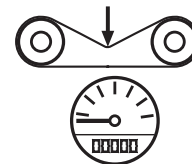

<b>Krikit 1</b>	15 - 70 kg	AVX 10	40 kg	25 - 30 kg
		AVX 13	55 kg	40 - 45 kg
<b>Krikit 2</b>	15 - 70 kg	3 PK - 6 PK	12 - 14 kg / $\sqrt{\quad}$	9 - 10 kg / $\sqrt{\quad}$
<b>Krikit 3</b>	50 - 150 kg	7 PK - 12 PK	12 - 14 kg / $\sqrt{\quad}$	9 - 10 kg / $\sqrt{\quad}$



Art.-Nr.: 67 79 873 000

Zahnriemen-Spannungsmessgerät

Tension gauge for timing belts

Mesureur de tension pour courroies synchrones

Medidor de tensión para correas dentadas

Misuratore di tensione

Прибор для измерения натяжения зубчатых ремней



Art.-Nr.: 65 57 237 000

Spezialwerkzeug für Zahnriemen- und Nebenaggregateantriebe

Special tools for drives on timing belts and auxiliary units

Outil spécial pour transmissions par courroie synchrone et entraînement des accessoires

Herramienta especial para transmisiones de correas de distribución y del grupo auxiliar

Attrezzatura speciale per motori ausiliari e con trasmissione a cinghiadentata

Специальный инструмент для вспомогательных приводов и приводов с зубчатым ремнем

**Service-Zubehör**  
**Service accessories**  
**Accessoires**  
**Accesorios**  
**Accessori**  
**Принадлежности**



Artikel-Nr. 67 76 956 000

Hochwertiges Universalwerkzeug zur Montage und Demontage von elastischen Keilrippenriemen

High-quality universal tool for mounting and removing elastic V-ribbed belts

Outil universel de grande qualité pour le montage et le démontage de courroies striées élastiques

Herramienta universal de alta calidad para montar y desmontar correas acanaladas elásticas

Pregiato strumento universale per il montaggio e lo smontaggio di cinghie trapezoidali scanalate elastiche

Высококачественный универсальный инструмент для монтажа и демонтажа эластичных поликлиновых ремней



Artikel.-Nr. 67 57 240 000

Elast-Montagewerkzeug für Ford 1.4 /1.6l Motoren

Elastic mounting tool for Ford 1.4 /1.6 L engines

Outil de montage Elast pour moteurs Ford 1,4/1,6 l

Herramienta de montaje Elast para motores Ford 1.4 /1.6l

Utensile di montaggio Elast per motori Ford 1.4 /1.6l

Эластичный монтажный инструмент для двигателей Ford 1.4/1.6л



Zuordnungslisten für PKW und Nutzfahrzeuge.

Listas indicativas para turismos y vehículos comerciales.

Application guides for passenger cars and commercial vehicles.

Elenchi di correlazione per automobili e veicoli commerciali.

Listes de correspondance pour voitures de tourisme et véhicules utilitaires.

Таблицы соответствий для легкового и коммерческого транспорта



Zuordnungsliste  
 Generatorfreilauf &  
 Torsionsschwingungsdämpfer

Listas indicativas  
 Polea libre del alternador &  
 Amortiguador de vibraciones de torsión

Application guides  
 Overrunning alternator pulley &  
 Torsional vibration damper

Elenchi di correlazione  
 Ruota libera dell'alternatore &  
 Puleggia smorzatrice per vibrazioni torsionali

Listes de correspondance  
 Roue libre d'alternateur &  
 Amortisseur de vibrations de torsion

Таблицы соответствий  
 Муфта свободного хода генератора &  
 Гаситель крутильных колебаний





Praxistipps  
Practical tips  
Conseils pratiques  
Consejos prácticos  
Informazioni tecniche  
Практические советы



Zahnriemenflyer  
Timing belt leaflet  
Dépliant sur les courroies synchrones  
Prospecto de correas dentadas  
Opuscolo di cinghie dentate  
Листовка по зубчатым ремням



Aktuelle Themen und technische  
Informationen für Handel und Werkstatt  
Topical subjects and technical information  
for the replacement market and workshops  
Sujets d'actualité et informations techniques  
pour les revendeurs et les garages  
Temas actuales e informaciones técnicas  
para comercios y talleres  
Temi attuali ed informazioni tecniche per Ricambisti  
e Officine  
Актуальные темы и техническая информация  
для дистрибьюторов и СТО

**Generatorfreilauf  
Overrunning alternator pulley  
Roue libre d'alternateur  
Polea libre de alternador  
Ruota libera dell'alternatore  
Муфта свободного хода генератора**

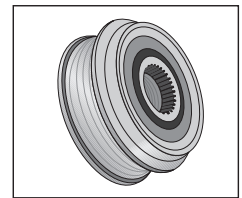

Erstausrüsterqualität ist der beste Ersatz. Das gilt auch für unsere neuen Generatorfreiläufe (OAP) und Generatorkoppler (OAD). Beide Komponenten sind optimal auf die Keilrippenriemen abgestimmt.

Durch die Drehungleichförmigkeiten der Kurbelwelle kommt es bei Nebenaggregatetriegen mit starrer Generator-Riemenscheibe zu Schwingungen und Schlupf des Keilrippenriemens. Dies führt zu unerwünschten Geräuscentwicklungen, Vibrationen, erhöhter Materialbeanspruchung und erhöhtem Verbrauch. Außerdem behindert die hohe Massenträgheit des Generators ein schnelles Absenken der Drehzahl, zum Beispiel beim Schaltvorgang.

Um diese Nachteile zu beseitigen, befindet sich in vielen Fahrzeugen konstruktionsseitig ein Generatorfreilauf oder Generatorkoppler.

Der Generatorfreilauf tilgt durch seine Freilaufkupplung die Schwingungen, die durch die Drehungleichförmigkeiten der Kurbelwelle im Riemetrieb entstehen und ermöglicht zusätzlich eine schnelle Verringerung der Motordrehzahl bei plötzlichen Lastwechseln.

Der Generatorkoppler entkoppelt zusätzlich durch sein integriertes Feder-Dämpfer-System den Keilrippenriemen vom Generator und kann so auftretende Resonanzschwingungen effektiver tilgen.

Original quality is the best replacement. The same applies to our new overrunning alternator pulleys (OAP) and overrunning alternator decouplers (OAD). Both components are optimally tuned to the V-ribbed belts.

Due to the rotational irregularities of the crankshaft, vibration and slip arises on the V-ribbed belt when auxiliary assemblies have rigid alternator belt pulleys. This leads to undesirable noise buildup, vibrations, higher material stress and a rise in consumption. In addition, the large rotating mass in the alternator prevents the rotational speed from falling quickly, for instance during a gear shift.

To eliminate these disadvantages, many vehicles are equipped with an overrunning alternator pulley or overrunning alternator decoupler.

With its overrunning clutch, the overrunning alternator pulley absorbs vibrations that arise in the belt drive as a result of the natural flexing of the crankshaft, and also makes it possible to reduce the engine speed quickly in the case of sudden load alteration.

With its integrated spring/damper system, the alternator decoupler also decouples the V-ribbed belt from the alternator, thus effectively absorbing resonant vibrations that may arise.

La qualité d'origine est la meilleure recharge. Cela s'applique également à nos nouvelles poulies à roue-libre d'alternateur (OAP) et découpleurs d'alternateur (OAD). Les deux composants sont adaptés de manière optimale aux courroies striées.

Les irrégularités de rotation du vilebrequin causent des vibrations et un glissement de la courroie striée dans les transmissions de groupes auxiliaires. Cela provoque la formation de bruits indésirables, de vibrations, une sollicitation du matériel plus importante et une consommation plus élevée. L'inertie des masses de l'alternateur empêche en outre la réduction rapide du nombre de tours, lors du changement de rapport par exemple.

Afin d'éliminer ces inconvénients, on trouve dans de nombreux véhicules une poulie à roue-libre d'alternateur ou un découpleur d'alternateur.

Grâce à son accouplement à roue-libre, cette poulie d'alternateur amortit les vibrations résultant des irrégularités de rotation du vilebrequin au cours de la transmission par courroie et permet en plus une réduction rapide du régime moteur lors de variations soudaines de charge.

Le découpleur d'alternateur désaccouple en plus la courroie striée de l'alternateur grâce à son système d'amortissement à ressorts et atténue ainsi plus efficacement les vibrations de résonance pouvant



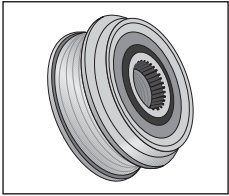

**Generatorfreilauf**  
**Overrunning alternator pulley**  
**Roue libre d'alternateur**  
**Polea libre de alternador**  
**Ruota libera dell'alternatore**  
**Муфта свободного хода генератора**



La calidad original es el mejor recambio. Esto también es válido para nuestras nuevas poleas libres del alternador (OAP) y desacoplador libre del alternador (OAD). Ambos componentes están adaptados de forma óptima a las correas acanaladas.

Debido a las rotaciones del cigüeñal, en transmisiones de grupos auxiliares con polea de correa del alternador rígida se dan vibraciones y derrapes de correa lo que provoca ruidos no deseados, vibraciones, un mayor esfuerzo del material y un consumo más alto. Además, la elevada inercia del alternador impide un rápido descenso del régimen de revoluciones por ejemplo al cambiar las marchas.

Para solucionar estas desventajas, muchos vehículos están equipados con una polea libre de alternador o un desacoplador libre del alternador.

La polea libre de alternador amortigua con su acoplamiento de marcha libre las vibraciones que resultan de las rotaciones del cigüeñal en la transmisión por correa y permite una rápida reducción de revoluciones del motor al cambiar rápidamente de carga.

Con su sistema integrado de resorte-amortiguador, el desacoplador libre desacopla adicionalmente la correa acanalada del alternador, pudiendo amortiguar así eficazmente las vibraciones de resonancia aparecidas.

Il miglior ricambio: la qualità originale. Ciò vale anche per le nostre nuove pulegge per alternatore (OAP) e disaccoppiatori per alternatore (OAD). Entrambi i componenti sono ottimali per le cinghie trapezoidali scanalate.

A causa della rotazione non uniforme dell'albero motore, negli organi di trasmissione di gruppi ausiliari con puleggia rigida dell'alternatore si verificano vibrazioni e scorrimenti della cinghia trapezoidale scanalata. Questo porta a rumori indesiderati, a vibrazioni, ad una maggiore sollecitazione dei materiali e ad un maggior consumo. L'alto momento di inerzia dell'alternatore ostacola inoltre la rapida riduzione del numero di giri, ad esempio al cambio della marcia.

Per eliminare questi svantaggi, in molti veicoli si trova una puleggia per alternatore o un disaccoppiatore per alternatore.

Mediante il suo giunto a ruota libera, la puleggia dell'alternatore elimina le vibrazioni generate nella cinghia di trasmissione dalla rotazione non uniforme dell'albero motore e consente anche la rapida riduzione del numero di giri del motore in caso di improvvise variazioni di carico.

Grazie al suo sistema di smorzamento a molla integrato, il disaccoppiatore per alternatore disaccoppia inoltre la cinghia trapezoidale scanalata dall'alternatore, annullando efficacemente le vibrazioni di risonanza che si manifestano.

Качество заводской комплектации – такой должна быть наилучшая запасная часть. Это также действительно для наших новых обгонных муфты генератора (OAP) и обгонных разобщающих муфт генератора (OAD). Оба компонента оптимально подходят к поликлиновым ремням.

Из-за неравномерности вращения коленчатого вала в приводах вспомогательных агрегатов с неподвижным шкивом генератора возникают колебания и происходит проскальзывание поликлинового ремня. Это ведет к возникновению нежелательных шумов, вибрации, повышенным нагрузкам на материалы и повышенному износу. Кроме того, высокая инерция масс генератора препятствует быстрому уменьшению числа оборотов, например, во время переключения.

Для устранения этих недостатков во многих транспортных средствах имеется обгонная муфта генератора или обгонная разобщающая муфта генератора.

Обгонная муфта генератора гасит колебания, которые возникают из-за неравномерности вращения коленчатого вала в ременном приводе, и, кроме того, позволяет быстро уменьшить число оборотов двигателя в случае внезапного изменения нагрузки.

Обгонная разобщающая муфта генератора благодаря своей встроенной пружинной амортизирующей системе также отделяет поликлиновый ремень от генератора и тем самым более эффективно гасит возникающие резонансные колебания.

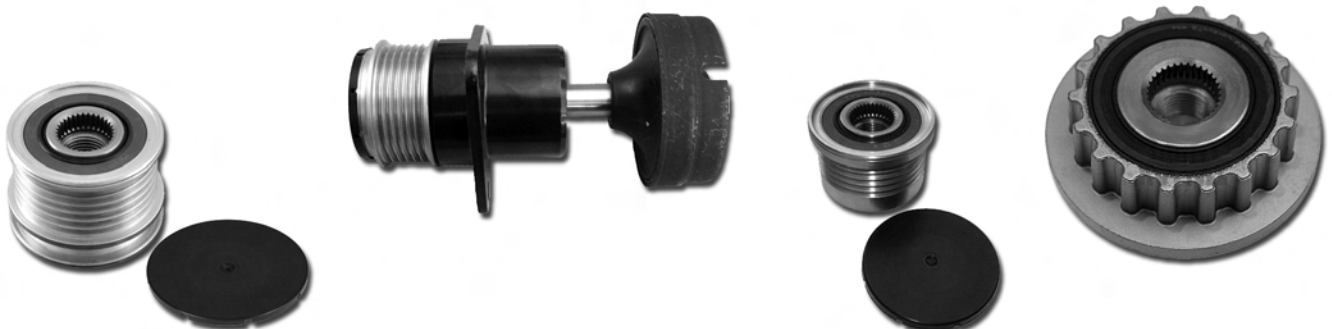

Generatorfreilauf  
 Overrunning alternator pulley  
 Roue libre d'alternateur  
 Polea libre de alternador  
 Ruota libera dell'alternatore  
 Муфта свободного хода генератора

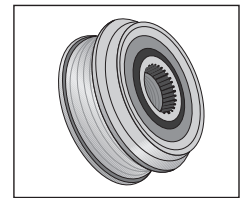

AP 9001



AP 9002



AP 9003



AP 9004



AP 9005



AP 9006



AP 9007



AP 9008



AP 9009



AP 9010



AP 9011



AP 9012



AP 9013



AP 9014



AP 9015



AP 9016



AP 9017



AP 9018



AP 9019



AP 9020

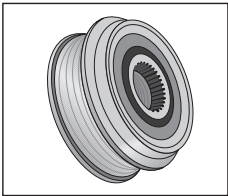

**Generatorfreilauf**  
**Overrunning alternator pulley**  
**Roue libre d'alternateur**  
**Polea libre de alternador**  
**Ruota libera dell'alternatore**  
**Муфта свободного хода генератора**



AP 9021



AP 9022



AP 9023



AP 9024



AP 9025



AP 9026



AP 9027



AP 9028



AP 9029



AP 9030



AP 9031



AP 9032



AP 9033



AP 9034



AP 9035



AP 9036

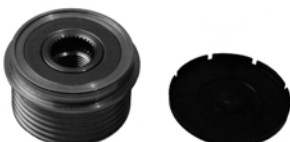

AP 9037



AP 9038



AP 9039

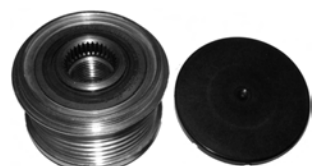

AP 9040

Generatorfreilauf  
 Overrunning alternator pulley  
 Roue libre d'alternateur  
 Polea libre de alternador  
 Ruota libera dell'alternatore  
 Муфта свободного хода генератора

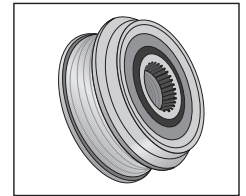

AP 9041



AP 9042



AP 9043



AP 9044



AP 9045



AP 9046



AP 9047



AP 9048



AP 9049



AP 9050



AP 9051



AP 9052



AP 9053



AP 9054



AP 9055



AP 9056



AP 9057



AP 9058



AP 9059



AP 9060

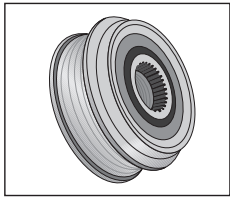

**Generatorfreilauf**  
**Overrunning alternator pulley**  
**Roue libre d'alternateur**  
**Polea libre de alternador**  
**Ruota libera dell'alternatore**  
**Муфта свободного хода генератора**



AP 9061



AP 9062



**Torsionsschwingungsdämpfer**  
**Torsional vibration damper**  
**Armortisseur de vibrations de torsion**  
**Amortiguador de vibraciones de torsión**  
**Puleggia smorzatrice per vibrazioni torsionali**  
**Гаситель крутильных колебаний**

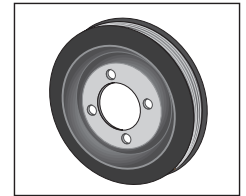

Erstausrüsterqualität ist der beste Ersatz. Das gilt auch für unsere neuen Torsionsschwingungsdämpfer. Die Riemenscheiben sind optimal auf die Keilrippenriemen abgestimmt.

Torsionsschwingungsdämpfer (TSD) übernehmen im Antriebssystem moderner Motoren eine zentrale Funktion: Sie dämpfen die Vibrationen der Kurbelwelle. So werden Antriebsriemen und Aggregate geschont. Bei entkoppelten Torsionsschwingungsdämpfern (eTSD) wird zusätzlich der Riementrieb der Nebenaggregate entkoppelt. Die durch Drehungleichförmigkeiten der Kurbelwelle auftretenden Resonanzschwingungen werden so besonders effektiv getilgt. Damit das Antriebssystem reibungslos funktioniert, sollte beim Riemenwechsel immer der Zustand des TSD/eTSD geprüft und der TSD/eTSD ggf. mitgewechselt werden. Zudem ist es wirtschaftlich sinnvoll, gleich alle Komponenten des Antriebssystems bei ersten Anzeichen von Verschleiß in einem Arbeitsgang zu erneuern. Spätestens bei sichtbaren Schäden an der Gummispur ist der Torsionsschwingungsdämpfer zu erneuern.

Original quality is the best replacement. The same applies to our new torsional vibration dampers. The belt pulleys are optimally tuned to the V-ribbed belts.

In the drive system of modern engines, torsional vibration dampers (TVDs) have a key function to perform: They dampen the vibrations from the crankshaft, thus protecting the drive belts and assemblies. In the case of torsional vibration damper isolators (TVDi), the belt drive of the auxiliary assemblies is also decoupled. Resonant vibrations that arise as a result of the rotational irregularities of the crankshaft are absorbed highly effectively. To ensure that the drive system functions smoothly, the TVD/TVDi should always be checked when the belt is replaced, and replaced along with the belt if necessary. From an economic point of view, it makes sense to replace all the drive components in one procedure at the first sign of wear. The torsional vibration damper is to be replaced at the latest when damage is evident in the rubber track.

La qualité d'origine est la meilleure recharge. Ceci est également valable pour notre nouvel amortisseur de vibrations de torsion. Nos poulies sont adaptées de manière optimale aux courroies striées.

Les amortisseurs de vibrations de torsion (AVT) assument une fonction centrale dans le système de transmission des moteurs modernes : ils amortissent les vibrations du vilebrequin, ménageant de ce fait les courroies de transmission et les composants. Dans le cas des amortisseurs de vibrations de torsion désaccouplés (AVTd), la transmission par courroie des composants auxiliaires est également désaccouplée. Les vibrations de résonance dues aux irrégularités de rotation du vilebrequin sont ainsi efficacement atténuées. Pour que le système de transmission fonctionne sans problème, il est recommandé de toujours vérifier l'état de l'AVT ou de l'AVTd lors du changement de courroie et de le remplacer en même temps le cas échéant. En outre, il est bien plus économique de toujours remplacer tous les composants d'un système de transmission en même temps aux premiers signes d'usure. L'amortisseur de vibrations de torsion doit être remplacé au plus tard lors de l'apparition de dommages visibles au niveau de la couche de caoutchouc.





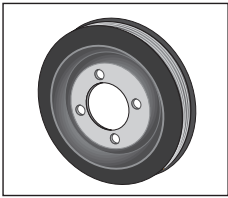

**Torsionsschwingungsdämpfer**  
**Torsional vibration damper**  
**Armortisseur de vibrations de torsion**  
**Amortiguador de vibraciones de torsión**  
**Puleggia smorzatrice per vibrazioni torsionali**  
**Гаситель крутильных колебаний**



La calidad original es el mejor recambio. Esto también es válido para nuestros nuevos amortiguadores de vibraciones de torsión. Las poleas están adaptadas de forma óptima a las correas acanaladas.

En los sistemas de transmisión de motores modernos, los amortiguadores de vibraciones de torsión (AVT) asumen una función central: amortiguan las vibraciones del cigüeñal, así protegen las correas de transmisión y los equipos relevantes. En los amortiguadores de vibraciones de torsión desacoplados (AVTd) se desacopla además la transmisión por correa de los equipos auxiliares. Así se amortiguan eficazmente las vibraciones de resonancia que resultan de las rotaciones del cigüeñal. A fin de que el sistema de transmisión funcione perfectamente, siempre se debería controlar el estado del AVT/AVTd en el cambio de correa y cambiarlo si fuera necesario. Además es económicamente conveniente renovar todos los componentes del sistema de transmisión en una sola reparación al primer signo de desgaste. El amortiguador de vibraciones de torsión se debe renovar lo más tarde cuando se vean daños en la franja de goma.

Il miglior ricambio: la qualità originale. Ciú vale anche per i nostri nuovi smorzatori di vibrazioni torsionali. Le pulegge della cinghia sono ottimali per le cinghie trapezoidali scanalate.

Gli smorzatori di vibrazioni torsionali (TVD) svolgono un ruolo fondamentale nei sistemi di trasmissione di moderni motori: smorzano le vibrazioni dell'albero motore, proteggendo così le cinghie di trasmissione ed i gruppi. Nel caso di smorzatori di vibrazioni torsionali disaccoppiati (TVDi) viene disaccoppiata anche la cinghia di trasmissione dei gruppi ausiliari. Le vibrazioni di risonanza derivanti dalla rotazione non uniforme dell'albero motore vengono assorbite in modo estremamente efficace. Per assicurare il funzionamento corretto del sistema di trasmissione, si raccomanda di controllare il TVD/TVDi in occasione di ogni sostituzione della cinghia e, se necessario, di sostituirlo insieme alla cinghia. Da un punto di vista economico è conveniente sostituire tutti i componenti di trasmissione in un solo passo ai primi cenni di usura. Lo smorzatore di vibrazioni torsionali deve essere sostituito almeno quando risultano evidenti danni alla frangia di gomma.

Качество заводской комплектации – такой должна быть наилучшая запасная часть. Это относится и к нашим новым гасителям крутильных колебаний. Шкивы оптимально подходят к поликлиновым ремням.

„асители крутильных колебаний (TSD) выполняют в системе привода современных двигателей центральную функцию: Они „асят вибрации коленчатого вала. Благодаря этому приводные ремни и а„режаты подвер„аются меньшей нагрузке. В разобщающих „асителях крутильных колебаний (eTSD) ременной привод вспомогательных агрегатов не имеет жесткого соединения с коленчатым валом. Благодаря этому особенно эффективно гасятся резонансные колебания, возникающие из-за неравномерности вращения коленчатого вала. Для обеспечения бесперебойного функционирования системы привода при замене ремней всегда необходимо проверять состояние гасителя крутильных колебаний/разобщающего гасителя крутильных колебаний и при необходимости заменять его. Кроме того, с точки зрения экономичности целесообразно заменять в рамках одной рабочей операции сразу все компоненты системы привода при первых признаках износа. Гаситель крутильных колебаний необходимо заменять самое позднее при возникновении видимых повреждений резиновой прокладки.



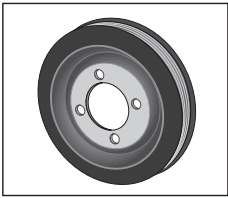

**Torsionsschwingungsdämpfer**  
**Torsional vibration damper**  
**Armortisseur de vibrations de torsion**  
**Amortiguador de vibraciones de torsión**  
**Puleggia smorzatrice per vibrazioni torsionali**  
**Гаситель крутильных колебаний**



VD 1002



VD 1025



VD 1027



VD 1028



VD 1030



VD 1031



VD 1032



VD 1033



VD 1036



VD 1039



VD 1041



VD 1042



VD 1062



VD 1063

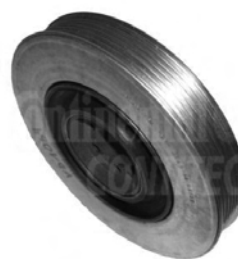

VD 1064



VD 1065



VD 1067



VD 1068



VD 1070



VD 1071

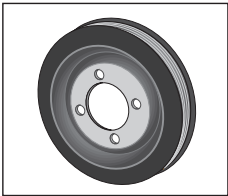

**Torsionsschwingungsdämpfer**  
**Torsional vibration damper**  
**Armortisseur de vibrations de torsion**  
**Amortiguador de vibraciones de torsión**  
**Puleggia smorzatrice per vibrazioni torsionali**  
**Гаситель крутильных колебаний**



VD 1072



VD 1073



VD 1076



VD 1077



VD 1078



VD 1080



VD 1081



VD 1084



VD 1085



VD 1086



VD 1087



VD 1088



VD 1089



VD 1090



VD 1091



VD 1092



VD 1093



VD 1094



VD 1095



VD 1096

**Torsionsschwingungsdämpfer**  
**Torsional vibration damper**  
**Armortisseur de vibrations de torsion**  
**Amortiguador de vibraciones de torsión**  
**Puleggia smorzatrice per vibrazioni torsionali**  
**Гаситель крутильных колебаний**

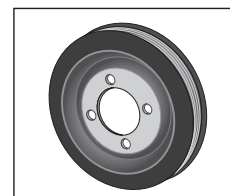

VD 1096



VD 1097



VD 1098



VD 1099



VD 1100



VD 1101



VD 1102



VD 1103



VD 1104



VD 1105



VD 1106



VD 1107



VD 1109









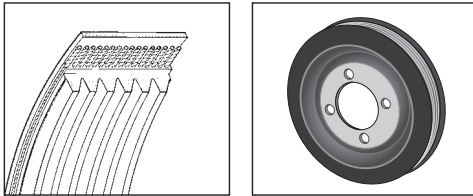

VD 1110



VD 1111



Keilrippenriemen + Torsionsschwingungsdämpfer  
 Multiple V-Ribbed Belts + Torsional vibration damper  
 Courroies striées + Armortisseur de vibrations de torsion  
 Correas ranuradas longitudinalmente + Amortiguador de vibraciones de torsión  
 Cinghie scanalate + Puleggia smorzatrice per vibrazioni torsionali  
 Поликлиновый ремень + Гаситель крутильных колебаний

KIT					KIT				
5PK1815D1	5PK1815		VD1025	2	6PK2196D1	6PK2196		VD1041	3
5PK2030D1	5PK2030	5PK836	VD1030	2	6PK2215D1	6PK2215		VD1002	1
5PK2060D1	5PK2060	5PK813	VD1027	4	6PK2236D1	6PK2236		VD1002	1
6DPK1195D1	6DPK1195		VD1076	6	6PK2241D1	6PK2241		VD1041	3
6DPK1195D2	6DPK1195		VD1076	6	6PK2260D1	6PK2260		VD1036	3
6DPK1215D1	6DPK1215		VD1076	6	6PK2260D3	6PK2260		VD1042	4
6DPK1841D1	6DPK1841		VD1077	6	6PK2264D1	6PK2264		VD1042	4
6PK1050D1	6PK1050		VD1067	5	6PK2271D1	6PK2271		VD1036	3
6PK1050D2	6PK1050		VD1076	10	6PK2271D2	6PK2271		VD1041	3
6PK1138D1	6PK1138		VD1063	2	6PK2380D1	6PK2380		VD1070	2
6PK1138D2	6PK1138		VD1081	1	6PK2390D1	6PK2390		VD1070	2
6PK1180D1	6PK1180		VD1076	6	6PK2404D1	6PK2404	4PK1237	VD1032	9
6PK1275D1	6PK1275		VD1068	7	6PK2404D2	6PK2404	4PK1217	VD1032	9
6PK1345D1	6PK1345		VD1002	1	6PK2415D1	6PK2415		VD1072	2
6PK1370D1	6PK1370		VD1067	5	6PK2460D1	6PK2460		VD1033	9
6PK1413D1	6PK1413		VD1039	2	6PK2490D1	6PK2490		VD1033	9
6PK1413D2	6PK1413		VD1067	5	6PK995D1	6PK995		VD1062	3
6PK1468D1	6PK1468		VD1080	0	7PK2000D1	7PK2000		VD1078	2
6PK1600D1	6PK1600		VD1068	7	7PK2035D1	7PK2035		VD1073	3
6PK1610D1	6PK1610		VD1076	14					
6PK1623D1	6PK1623		VD1068	7					
6PK1642D1	6PK1642		VD1063	2					
6PK1642D2	6PK1642		VD1081	1					
6PK1660D1	6PK1660		VD1076	10					
6PK1660D2	6PK1660		VD1076	6					
6PK1715D1	6PK1715		VD1002	1					
6PK1720D1	6PK1720		VD1039	2					
6PK1740D1	6PK1740		VD1080	0					
6PK1750D1	6PK1750		VD1002	1					
6PK1750D2	6PK1750		VD1080	0					
6PK1760D1	6PK1760		VD1064	7					
6PK1767D1	6PK1767		VD1002	1					
6PK1800D1	6PK1800		VD1031	2					
6PK1863D1	6PK1863		VD1031	2					
6PK1870D1	6PK1870		VD1031	2					
6PK1870D2	6PK1870		VD1079	2					
6PK1900D1	6PK1900		VD1031	2					
6PK2080D1	6PK2080	4PK970	VD1028	2					
6PK2080D2	6PK2080	4PK917 ELAST	VD1028	2					
6PK2090D1	6PK2090	4PK970	VD1028	2					
6PK2160D1	6PK2160		VD1041	3					

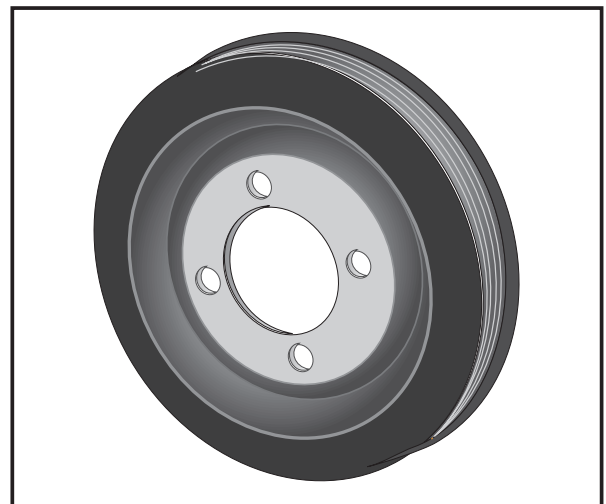

**Fehlerbilder Torsionsschwingungsdämpfer**  
**Defect patterns in torsional vibration damper**  
**Types de défaut Amortisseurs de vibrations de torsion**  
**Imágenes de fallos Amortiguador de vibraciones de torsión**  
**возможные неисправности у гасителя крутильных колебаний**

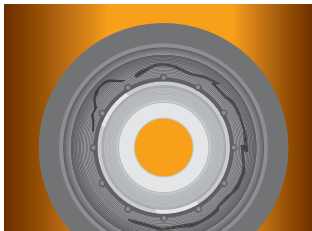
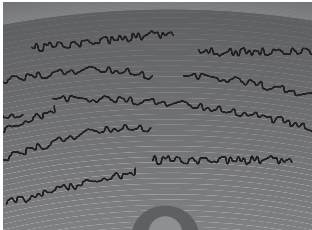
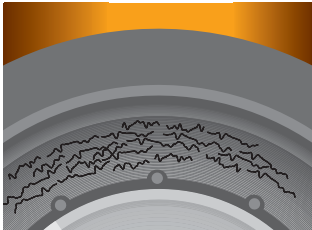

Alterung führt zu Oberflächenverhärtung mit Micro-Rissen und erhöhten Belastungen welche letztendlich zum Ausfall der Kupplung führen.

Aging results in hardening of the surface, with microcracking and higher load levels, and ultimately leads to failure of the clutch.

Le vieillissement provoque un durcissement superficiel avec formation de microfissures et des contraintes supérieures qui entraînent en définitive la défaillance de l'embrayage.

El envejecimiento lleva a un endurecimiento de la superficie con grietas microscópicas y elevadas cargas mecánicas que provocan por último el fallo del acoplamiento.

Тарение приводит к отвердеванию поверхностей с образованием микротрещин и повышенным нагрузкам, ведущим в конечном итоге к выходу из строя самого сцепления.

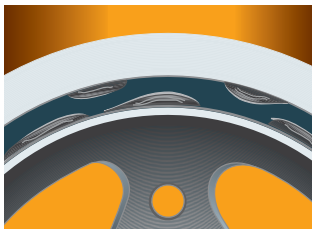

Schadensverlauf / Failure pattern / évolution de la détérioration  
 Historial del da-ño / иды повреждений

**Überlastung / Alterung**

• deutliche Einarbeitungen an der Oberfläche und in der Gummispur; im weiteren Verlauf Rissbildung und Ausbrüche

**Overload / aging**

• Marked recesses on surface and in the rubber track, eventually cracking and breakouts

**Surcharge / Vieillesissement**

• nettes empreintes en surface et dans la trace de gomme, suivies de la formation de fissures et de détachements de morceaux de gomme.

**Exceso de carga / Envejecimiento**

• claras adaptaciones a la superficie y en la franja de goma; en el siguiente transcurso agrietamiento y roturas

**Церегрузка / тарение**

• Явные изменения на поверхности и на резине, в дальнейшем образование трещин и сколов

**Fehlerbilder Torsionsschwingungsdämpfer**  
**Defect patterns in torsional vibration damper**  
**Types de défaut Amortisseurs de vibrations de torsion**  
**Imágenes de fallos Amortiguador de vibraciones de torsión**  
**,озможные неисправности у гасителя крутильных колебаний**



**Überhitzung am Außendurchmesser**

- Folgeschaden nach Riemenrutschen

**Excessive heat buildup on outer diameter**

- Collateral damage due to belt slippage

**Surchauffe sur le diamètre extérieur**

- Dommages consécutifs à un glissement de la courroie

**Sobrecalentamiento en el diámetro exterior**

- Daños consecuentes tras resbalamiento de correa

**Церегрев по внешнему диаметру**

- Последствия после сползания ремня

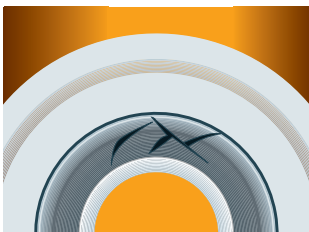

**Klassischer 45° Überlastungsriß in Torsionsrichtung**

- extremer Leerlaufbedarf – Taxi

**Classic 45° overload cracking in direction of torsion**

- Extremely high use of idling position – taxi

**Fissure à 45° dans le sens de la torsion, typique en cas de surcharge**

- fonctionnement très fréquent du moteur au ralenti - taxi

**Grieta clásica de 45° por exceso de carga en sentido de torsión**

- extrema necesidad de marcha de ralent – Taxi

**Наиболее распространенный разрыв по углом 45° по направлению извращения в результате перегрузок**

- наиболее высокая вероятность в режиме такси (на холостом ходу)

**ContiTech empfiehlt:**

Torsionsschwingungsdämpfer sollten alle 60.000 km auf Rissbildung, Verformung und Korrosionsspuren kontrolliert werden. Ein Wechsel alle 120.000 km ist sinnvoll, da nicht jeder Alterungs-/Belastungsprozess zu einer offensichtlichen Fehlerbildung führt, aber sehr wohl das Laufverhalten des Motors beeinträchtigt.

**ContiTech recommends:**

Torsional vibration damper should be checked for cracking, deformation and signs of corrosion every 60,000 km. Replacement is advisable every 120,000 km. This is because not every case of aging/overload is clearly evident in the form of a defect pattern, although the proper functioning of the engine is nonetheless very much impaired.

**ContiTech recommande :**

Il faudrait vérifier tous les 60'000 km si les amortisseurs de vibrations de torsion présentent des fissures, des déformations ou des traces de corrosion. Il est opportun de les remplacer tous les 120'000 km parce que les phénomènes de vieillissement/décontrainte n'entraînent pas forcément l'apparition de défauts manifestes, mais qu'ils risquent par contre de porter préjudice au comportement du moteur en fonctionnement

**ContiTech recomienda:**

Se debe a controlar cada 60.000 km. si el amortiguador de vibraciones de torsión presenta grietas, deformaciones y huellas de corrosión. Es conveniente un cambio cada 120.000 km., puesto que no todo proceso de envejecimiento / carga lleva a fallos claros pero sí puede menoscabar el funcionamiento del motor.





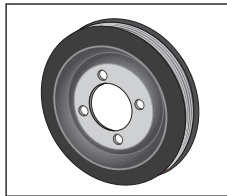
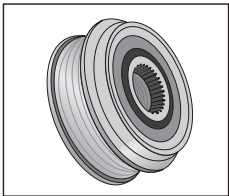

**ContiTech рекомендует:**

гаситель крутильных колебаний необходимо проверять каждые 60 000 км на деформацию, образование трещин и коррозии. Замена целесообразна через каждые 120 000 км, т.к. процесс старения или перегрузок может вести к скрытым повреждениям, которые в свою очередь могут влиять на работу двигателя.











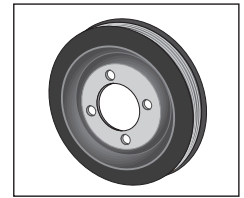
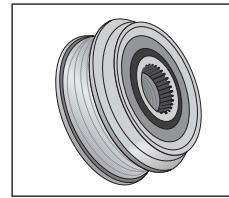

	OE-No.			OE-No.			OE-No.	
ALFA ROMEO	46742883	VD1065	AUDI	03C 903 119 C	AP9012	BMW	1231 7 552 352	AP9008
ALFA ROMEO	46742884	VD1064	AUDI	03C 903 119 F	AP9012	BMW	1231 7 552 353	AP9005
ALFA ROMEO	46780491	VD1065	AUDI	03G 903 119 B	AP9022	BMW	1231 7 560 483	AP9005
ALFA ROMEO	55185403	VD1065	AUDI	03G105243	VD1076	BMW	4 466 271	AP9008
ALFA ROMEO	55185409	VD1065	AUDI	03G105243C	VD1076	BMW	7 550 001	AP9021
ALFA ROMEO	55187707	VD1064	AUDI	045 903 119 A	AP9022	CITROËN	0515G3	VD1086
ALFA ROMEO	55190424	VD1065	AUDI	059105251AC	VD1032	CITROËN	0515J9	VD1088
ALFA ROMEO	55196301	VD1065	AUDI	059105251AD	VD1033	CITROËN	0515L6	VD1085
ALFA ROMEO	55208280	VD1065	AUDI	059105251M	VD1032	CITROËN	0515L7	VD1097
ALFA ROMEO	60815929	VD1064	AUDI	059105251S	VD1033	CITROËN	0515L8	VD1080
ALFA ROMEO	71728498	VD1065	AUDI	06A105243E	VD1107	CITROËN	0515L9	VD1080
ALFA ROMEO	71747796	VD1064	AUDI	06B 903 119 B	AP9009	CITROËN	0515N0	VD1100
ALFA ROMEO	71747797	VD1065	AUDI	06B105243F	VD1107	CITROËN	0515N2	VD1062
ALFA ROMEO	73501275	VD1065	AUDI	074105251AC	VD1002	CITROËN	0515N8	VD1062
ALFA ROMEO	9948 225	AP9058	AUDI	074105251N	VD1002	CITROËN	0515P1	VD1100
ALFA ROMEO	9948513	AP9017	AUDI	074105251R	VD1002	CITROËN	0515P2	VD1080
ALFA ROMEO	9949129	AP9017	AUDI	074105251T	VD1002	CITROËN	0515P3	VD1062
ALFA ROMEO	9951 162	AP9058	BMW	11232245377	VD1025	CITROËN	0515P8	VD1094
ALFA ROMEO	9951269	AP9017	BMW	11232246511	VD1025	CITROËN	0515P9	VD1062
AUDI	021 903 119 G	AP9001	BMW	11232247565	VD1030	CITROËN	0515Q6	VD1097
AUDI	022 903 119 A	AP9001	BMW	11232247886	VD1027	CITROËN	0515Q8	VD1092
AUDI	022 903 119 B	AP9002	BMW	11232247887	VD1087	CITROËN	0515R2	VD1095
AUDI	022 903 119 C	AP9001	BMW	11232247890	VD1027	CITROËN	0515R8	VD1100
AUDI	022 903 119 D	AP9002	BMW	11237787304	VD1028	CITROËN	0515R9	VD1095
AUDI	028 903 119 AC	AP9002	BMW	11237788611	VD1105	CITROËN	0515S1	VD1100
AUDI	028 903 119 AM	AP9001	BMW	11237790921	VD1028	CITROËN	0515S4	VD1095
AUDI	028 903 119 AN	AP9032	BMW	11237793593	VD1105	CITROËN	0515T0	VD1094
AUDI	028 903 119 AP	AP9059	BMW	11237793882	VD1028	CITROËN	0515T1	VD1098
AUDI	028 903 119 S	AP9059	BMW	11237797995	VD1071	CITROËN	0515T3	VD1096
AUDI	028 903 119 T	AP9032	BMW	11237799153	VD1071	CITROËN	0515T8	VD1080
AUDI	028105243T	VD1084	BMW	11237801977	VD1028	CITROËN	0515V0	VD1094
AUDI	038 903 119	AP9016	BMW	11237805696	VD1028	CITROËN	0515V5	VD1080
AUDI	038 903 119 A	AP9001	BMW	11237823191	VD1071	CITROËN	0515V6	VD1080
AUDI	038 903 119 M	AP9002	BMW	11238511371	VD1105	CITROËN	0515V7	VD1094
AUDI	038 903 119 P	AP9007	BMW	12 31 4 466 273	AP9005	CITROËN	0515V8	VD1094
AUDI	038 903 119 T	AP9001	BMW	12 31 751 6105	AP9021	CITROËN	9643354180	VD1092
AUDI	038105243	VD1089	BMW	12 31 753 6960	AP9021	FIAT	46742883	VD1065
AUDI	038105243F	VD1090	BMW	12 31 755 0001	AP9021	FIAT	46742884	VD1064
AUDI	038105243K	VD1091	BMW	12 31 757 0152	AP9021	FIAT	46780491	VD1065
AUDI	038105243L	VD1111	BMW	1231 7 516 099	AP9008	FIAT	500312310	VD1062
AUDI	038105243M	VD1111	BMW	1231 7 516 103	AP9005	FIAT	500332292	VD1062







Original-Teile-Nr.  
Original part No.  
Réf. automobile  
Ref. original  
Numeri originali  
Оригинальный №

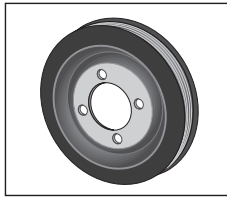
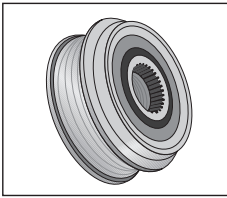

	OE-No.			OE-No.			OE-No.	
FIAT	55184474	VD1064	FORD	1133969	AP9045	FORD	3M5T-10300PD	AP9029
FIAT	55185403	VD1065	FORD	1143413	VD1039	FORD	4C1Q6B319C1A	VD1110
FIAT	55185409	VD1065	FORD	1147683	VD1094	FORD	4C1Q6B319C1B	VD1110
FIAT	55190424	VD1065	FORD	1151207	AP9045	FORD	4C1Q6B319DB	VD1110
FIAT	55196301	VD1065	FORD	1151392	VD1039	FORD	4C1Q6B319DC	VD1110
FIAT	55208280	VD1065	FORD	1151394	VD1110	FORD	5M5Q-10344-AA	AP9046
FIAT	60815929	VD1064	FORD	1226637	VD1110	FORD	5M5Q-10D310-AA	AP9045
FIAT	71728498	VD1065	FORD	1226638	VD1110	FORD	5M5Q-10D310-AB	AP9045
FIAT	71747796	VD1064	FORD	1229258	AP9029	FORD	6C1Q6B319CC	VD1098
FIAT	71747797	VD1065	FORD	1231959	VD1092	FORD	6C1Q6B319EA	VD1099
FIAT	73501275	VD1065	FORD	1315782	VD1076	FORD	95VW-10344-FA	AP9004
FIAT	77362558	AP9023	FORD	1319519	VD1094	FORD	95VW6B321CB	VD1084
FIAT	77362721	AP9035	FORD	1329203	VD1110	GM	09195337	AP9003
FIAT	77363948	AP9054	FORD	1349993	VD1110	GM	55564350	AP9028
FIAT	77364082	AP9048	FORD	1351731	VD1110	GM	55571966	AP9028
FIAT	9467510480	VD1095	FORD	1369546	VD1094	GM	93 178 273	AP9035
FIAT	9467586180	VD1080	FORD	1379766	VD1099	GM	93170214	AP9003
FIAT	9608938980	VD1086	FORD	1387095	VD1098	GM	93190867	AP9043
FIAT	9617894180	VD1088	FORD	1423796	AP9045	GM	93190868	AP9039
FIAT	9624596880	VD1097	FORD	1473366	VD1094	GM	93192631	AP9035
FIAT	9630647180	VD1080	FORD	1477441	AP9045	GM	93297735	AP9006
FIAT	9630647280	VD1095	FORD	1485765	VD1094	GM	97186700	AP9044
FIAT	9637218980	VD1097	FORD	1517975	VD1094	GM	97355778	AP9044
FIAT	9641548980	VD1080	FORD	1517976	VD1094	HYUNDAI	37322-27500	AP9062
FIAT	9651770980	VD1095	FORD	1594853	VD1110	HYUNDAI	37322-27501	AP9062
FIAT	9681761480	VD1080	FORD	1S4Q-10C382-AC	AP9045	KIA	0K55318W11	AP9061
FIAT	994 9627	AP9031	FORD	1S4Q6B319AE	VD1039	KIA	0K55418W11	AP9061
FIAT	99461230	VD1062	FORD	1S4Q6B319AF	VD1039	LANCIA	46742884	VD1064
FIAT	9948 225	AP9058	FORD	1S7Q6B319AB	VD1110	LANCIA	55185403	VD1065
FIAT	9948225	AP9058	FORD	1S7Q6B319AC	VD1110	LANCIA	55185409	VD1065
FIAT	9948513	AP9017	FORD	1S7Q6B319BA	VD1110	LANCIA	55187707	VD1064
FIAT	9949129	AP9017	FORD	1S7Q6B319BB	VD1110	LANCIA	55208280	VD1065
FIAT	9949520	AP9038	FORD	2S6Q6B319AD	VD1094	LANCIA	60815929	VD1064
FIAT	9949627	AP9031	FORD	2S6QGB319AA	VD1094	LANCIA	71747796	VD1064
FIAT	9951 162	AP9058	FORD	2S6QGB319AB	VD1094	LANCIA	71747797	VD1065
FIAT	9951162	AP9058	FORD	3M216B320AA	VD1076	LANCIA	73501275	VD1065
FIAT	9951269	AP9017	FORD	3M5Q6B319AA	VD1092	LANCIA	77363948	AP9054
FORD	01477441	AP9045	FORD	3M5Q6B319CB	VD1094	LANCIA	9617894180	VD1088
FORD	1069593	VD1084	FORD	3M5Q6B319CC	VD1094	LANCIA	994 9627	AP9031
FORD	1106734	AP9004	FORD	3M5T-10300PB	AP9029	LANCIA	9948 225	AP9058
FORD	1124891	VD1110	FORD	3M5T-10300PC	AP9029	LANCIA	9948513	AP9017



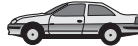



Original-Teile-Nr.  
 Original part No.  
 Réf. automobile  
 Ref. orriginal  
 Numeri originali  
 Оригинальный №

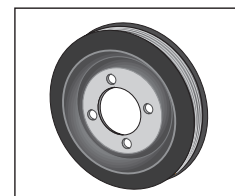
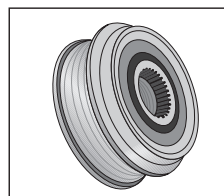

	OE-No.			OE-No.			OE-No.	
LANCIA	9949129	AP9017	MERCEDES-BENZ	6110300303	VD1036	NISSAN	A660C-300BX	AP9056
LANCIA	9949520	AP9038	MERCEDES-BENZ	6110300503	VD1042	NISSAN	A660C-300EX	AP9056
LANCIA	9951 162	AP9058	MERCEDES-BENZ	6110301003	VD1041	OPEL	0614352	VD1065
LANCIA	9951269	AP9017	MERCEDES-BENZ	6110301403	VD1041	OPEL	0614411	VD1031
LAND ROVER	LHG100750L	VD1087	MERCEDES-BENZ	6110301703	VD1036	OPEL	0614610	VD1025
MAZDA	RF5C-18-330	AP9049	MERCEDES-BENZ	6130300003	VD1103	OPEL	0614612	VD1025
MAZDA	RF5C-18-330A	AP9049	MERCEDES-BENZ	640 150 0360	AP9014	OPEL	0615045	VD1106
MAZDA	RF5C-18-W11	AP9049	MERCEDES-BENZ	640 150 0560	AP9014	OPEL	12 04 517	AP9035
MAZDA	Y40111401 V	D1094	MERCEDES-BENZ	640 150 0660	AP9014	OPEL	120 4392	AP9035
MAZDA	Y40111401A	VD1094	MERCEDES-BENZ	640 150 0760	AP9014	OPEL	1204151	AP9028
MAZDA	Y40111401B	VD1094	MERCEDES-BENZ	6420300003	VD1073	OPEL	1204175	AP9028
MAZDA	Y40111401C	VD1094	MERCEDES-BENZ	6420300403	VD1073	OPEL	1204366	AP9044
MERCEDES-BENZ	1120350600	VD1070	MERCEDES-BENZ	646 150 0260	AP9027	OPEL	1204412	AP9003
MERCEDES-BENZ	1120350800	VD1070	MERCEDES-BENZ	6460300903	VD1042	OPEL	1204413	AP9017
MERCEDES-BENZ	1120350900	VD1070	MERCEDES-BENZ	6461550115	AP9050	OPEL	24430551	VD1106
MERCEDES-BENZ	1120351300	VD1070	MERCEDES-BENZ	648 155 0015	AP9027	OPEL	4413748	VD1101
MERCEDES-BENZ	1120351400	VD1070	MERCEDES-BENZ	6480300003	VD1103	OPEL	4413749	VD1101
MERCEDES-BENZ	166 155 0215	AP9055	MERCEDES-BENZ	6480300203	VD1103	OPEL	4414115	VD1101
MERCEDES-BENZ	1660300003	VD1093	MERCEDES-BENZ	668 155 0015	AP9036	OPEL	4414116	VD1101
MERCEDES-BENZ	1660300203	VD1093	MERCEDES-BENZ	668 155 0715	AP9036	OPEL	4417573	AP9043
MERCEDES-BENZ	1660300303	VD1093	MERCEDES-BENZ	A1120350600	VD1070	OPEL	4417574	AP9039
MERCEDES-BENZ	1660300393	VD1093	MERCEDES-BENZ	A1120350800	VD1070	OPEL	4430728	VD1109
MERCEDES-BENZ	266 155 0115	AP9011	MERCEDES-BENZ	A1120350900	VD1070	OPEL	55 186 280	AP9035
MERCEDES-BENZ	271 155 0115	AP9020	MERCEDES-BENZ	A1120351300	VD1070	OPEL	55196301	VD1065
MERCEDES-BENZ	271 155 0215	AP9026	MERCEDES-BENZ	A1120351400	VD1070	OPEL	55351711	VD1031
MERCEDES-BENZ	2720300003	VD1072	MERCEDES-BENZ	A1660300003	VD1093	OPEL	55559328	VD1106
MERCEDES-BENZ	2720300903	VD1072	MERCEDES-BENZ	A1660300203	VD1093	OPEL	55564573	VD1067
MERCEDES-BENZ	602 150 0060	AP9034	MERCEDES-BENZ	A1660300303	VD1093	OPEL	5614415	VD1031
MERCEDES-BENZ	604 150 0060	AP9034	MERCEDES-BENZ	A1660300393	VD1093	OPEL	5614437	VD1031
MERCEDES-BENZ	604 150 0160	AP9060	MERCEDES-BENZ	A2720300003	VD1072	OPEL	5614441	VD1068
MERCEDES-BENZ	604 150 0360	AP9034	MERCEDES-BENZ	A2720300903	VD1072	OPEL	5614445	VD1065
MERCEDES-BENZ	604 150 0560	AP9060	MERCEDES-BENZ	A6110300503	VD1042	OPEL	5614447	VD1106
MERCEDES-BENZ	611 150 0160	AP9015	MERCEDES-BENZ	A6420300003	VD1073	OPEL	614352	VD1065
MERCEDES-BENZ	611 150 0360	AP9024	MERCEDES-BENZ	A6420300403	VD1073	OPEL	614411	VD1031
MERCEDES-BENZ	611 155 0015	AP9024	MERCEDES-BENZ	A6460300903	VD1042	OPEL	614571	VD1065
MERCEDES-BENZ	611 155 0215	AP9015	NISSAN	A 628 X 92071	AP9049	OPEL	614584	VD1067
MERCEDES-BENZ	611 155 0315	AP9010	NISSAN	MN960267	AP9014	OPEL	614610	VD1025
MERCEDES-BENZ	611 155 0415	AP9024	NISSAN	1230300QBD	VD1104	OPEL	614612	VD1025
MERCEDES-BENZ	611 155 0515	AP9010	NISSAN	12303AW300	VD1104	OPEL	615045	VD1106
MERCEDES-BENZ	611 155 0715	AP9010	NISSAN	23151-00Q0A	AP9043	OPEL	62 04 889	AP9044
MERCEDES-BENZ	6110300203	VD1042	NISSAN	23151-00Q0B	AP9039	OPEL	90487878	VD1025







**Original-Teile-Nr.**  
**Original part No.**  
**Réf. automobile**  
**Ref. original**  
**Numeri originali**  
**Оригинальный №**

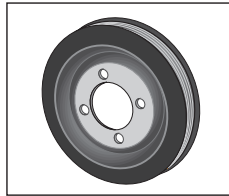
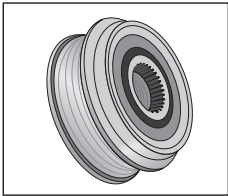

	OE-No.			OE-No.			OE-No.	
OPEL	90528648	VD1031	RENAULT	77 01 477 502	AP9052	SEAT	022 903 119 B	AP9002
OPEL	90541669	VD1025	RENAULT	7700107145	VD1081	SEAT	022 903 119 C	AP9001
OPEL	9128177	VD1031	RENAULT	7700110329	VD1063	SEAT	022 903 119 D	AP9002
OPEL	93161258	VD1101	RENAULT	7700110616	AP9025	SEAT	028 903 119 AA	AP9004
OPEL	93161259	VD1101	RENAULT	7700112999	VD1081	SEAT	028 903 119 AC	AP9002
OPEL	93161444	VD1109	RENAULT	7700113018	VD1063	SEAT	028 903 119 AM	AP9001
OPEL	93170224	VD1101	RENAULT	7700113776	VD1101	SEAT	028 903 119 AP	AP9059
OPEL	93170225	VD1101	RENAULT	7700115309	VD1063	SEAT	028 903 119 P	AP9004
OPEL	93182514	AP9017	RENAULT	7700115766	VD1101	SEAT	028 903 119 S	AP9059
OPEL	93183257	VD1065	RENAULT	7700724249	VD1081	SEAT	028105243T	VD1084
OPEL	93190867	AP9043	RENAULT	7700864763	VD1081	SEAT	038 903 119	AP9016
OPEL	93190868	AP9039	RENAULT	7701 055 871	AP9052	SEAT	038 903 119 A	AP9001
OPEL	93191381	VD1065	RENAULT	7701 207 807	AP9052	SEAT	038 903 119 M	AP9002
OPEL	97353964	VD1068	RENAULT	7701477689	AP9025	SEAT	038 903 119 Q	AP9057
PEUGEOT	0515G3	VD1086	RENAULT	8200 113 636	AP9056	SEAT	038 903 119 T	AP9001
PEUGEOT	0515J9	VD1088	RENAULT	8200051126	VD1109	SEAT	038105243	VD1089
PEUGEOT	0515L6	VD1085	RENAULT	8200079183	VD1101	SEAT	038105243K	VD1091
PEUGEOT	0515L7	VD1097	RENAULT	8200195546	VD1109	SEAT	038105243L	VD1111
PEUGEOT	0515L8	VD1080	RENAULT	8200207436	VD1109	SEAT	038105243M	VD1111
PEUGEOT	0515L9	VD1080	RENAULT	8200213058	VD1109	SEAT	03C 903 119 A	AP9012
PEUGEOT	0515N0	VD1100	RENAULT	8200268426	VD1104	SEAT	03C 903 119 F	AP9012
PEUGEOT	0515N2	VD1062	RENAULT	8200297936	VD1104	SEAT	03G 903 119 B	AP9022
PEUGEOT	0515N8	VD1062	RENAULT	8200376911	VD1104	SEAT	03G105243	VD1076
PEUGEOT	0515P1	VD1100	RENAULT	8200386445	VD1081	SEAT	045 903 119 A	AP9022
PEUGEOT	0515P2	VD1080	RENAULT	8200386446	VD1101	SKODA	021 903 119 G	AP9001
PEUGEOT	0515P3	VD1062	RENAULT	8200386451	VD1101	SKODA	022 903 119 A	AP9001
PEUGEOT	0515P8	VD1094	RENAULT	8200457775	VD1104	SKODA	022 903 119 B	AP9002
PEUGEOT	0515P9	VD1062	RENAULT	8200468081	VD1109	SKODA	022 903 119 C	AP9001
PEUGEOT	0515Q6	VD1097	RENAULT	8200523072	VD1104	SKODA	022 903 119 D	AP9002
PEUGEOT	0515R8	VD1100	RENAULT	8200545437	VD1081	SKODA	028 903 119 AC	AP9002
PEUGEOT	0515S1	VD1100	RENAULT	8200555547	VD1109	SKODA	028 903 119 AM	AP9001
PEUGEOT	0515T0	VD1094	RENAULT	8200584039	AP9043	SKODA	028 903 119 AP	AP9059
PEUGEOT	0515T1	VD1098	RENAULT	8200664348	VD1109	SKODA	028 903 119 S	AP9059
PEUGEOT	0515T8	VD1080	RENAULT	8200689702	VD1063	SKODA	028105243T	VD1084
PEUGEOT	0515V0	VD1094	RENAULT	8200802664	VD1109	SKODA	038 903 119	AP9016
PEUGEOT	0515V5	VD1080	ROVER	LHG100750	VD1087	SKODA	038 903 119 A	AP9001
PEUGEOT	0515V6	VD1080	SAAB	12759596	AP9054	SKODA	038 903 119 M	AP9002
PEUGEOT	0515V7	VD1094	SAAB	93 182 514	AP9017	SKODA	038 903 119 P	AP9007
PEUGEOT	0515V8	VD1094	SAAB	9544461	VD1031	SKODA	038 903 119 T	AP9001
RENAULT	77 01 055 871	AP9052	SEAT	021 903 119 G	AP9001	SKODA	038105243	VD1089
RENAULT	77 01 207 807	AP9052	SEAT	022 903 119 A	AP9001	SKODA	038105243F	VD1090

Original-Teile-Nr.  
 Original part No.  
 Réf. automobile  
 Ref. orriginal  
 Numeri originali  
 Оригинальный №



	OE-No.			OE-No.			OE-No.	
SKODA	038105243K	VD1091	VOLKSWAGEN	028105243T	VD1084	VOLVO	31251073	AP9043
SKODA	038105243L	VD1111	VOLKSWAGEN	038 903 119	AP9016	VOLVO	31251074	AP9039
SKODA	038105243M	VD1111	VOLKSWAGEN	038 903 119 A	AP9001	VOLVO	31251290	VD1094
SKODA	03C 903 119 A	AP9012	VOLKSWAGEN	038 903 119 M	AP9002	VOLVO	31272289	VD1094
SKODA	03C 903 119 F	AP9012	VOLKSWAGEN	038 903 119 P	AP9007	VOLVO	8627933	VD1002
SKODA	03D 903 119 A	AP9006	VOLKSWAGEN	038 903 119 Q	AP9057	VOLVO	8641 982	AP9052
SKODA	03G105243	VD1076	VOLKSWAGEN	038 903 119 S	AP9001	VOLVO	8641982	AP9052
SKODA	045 903 119 A	AP9022	VOLKSWAGEN	038 903 119 T	AP9001	VOLVO	8642368	VD1077
SKODA	059105251AC	VD1032	VOLKSWAGEN	038105243	VD1089	VOLVO	8666126	AP9039
SMART	640 150 0360	AP9014	VOLKSWAGEN	038105243F	VD1090	VOLVO	8666579	AP9029
SMART	640 150 0560	AP9014	VOLKSWAGEN	038105243K	VD1091	VOLVO	8676497	AP9041
SMART	640 150 0660	AP9014	VOLKSWAGEN	038105243L	VD1111	VOLVO	8692285	VD1102
SUZUKI	31771-68D00	AP9031	VOLKSWAGEN	038105243M	VD1111	VOLVO	9163918	VD1002
SUZUKI	31771-68D01	AP9031	VOLKSWAGEN	03C 903 119 A	AP9012	VOLVO	9180620	VD1002
SUZUKI	31771-85E00	AP9035	VOLKSWAGEN	03C 903 119 C	AP9012	VOLVO	9459747	AP9041
SUZUKI	437504	AP9035	VOLKSWAGEN	03C 903 119 F	AP9012	VOLVO	9472 909	AP9051
TOYOTA	134080R011	VD1078	VOLKSWAGEN	03D 903 119 A	AP9006			
TOYOTA	13408-0R011	VD1078	VOLKSWAGEN	03G105243	VD1076			
TOYOTA	134080R030	VD1078	VOLKSWAGEN	03G105243C	VD1076			
TOYOTA	13408-0R030	VD1078	VOLKSWAGEN	045 903 119	AP9022			
TOYOTA	13470-0D040	VD1079	VOLKSWAGEN	045 903 119 A	AP9022			
TOYOTA	1347022040	VD1079	VOLKSWAGEN	059105251AC	VD1032			
TOYOTA	13470-22041	VD1079	VOLKSWAGEN	059105251AD	VD1033			
TOYOTA	SU001-00759	VD1094	VOLKSWAGEN	059105251M	VD1032			
TOYOTA	SU001-00840	VD1094	VOLKSWAGEN	059105251S	VD1033			
VOLKSWAGEN	021 903 119 G	AP9001	VOLKSWAGEN	06B 903 119 B	AP9009			
VOLKSWAGEN	021 903 119H	AP9033	VOLKSWAGEN	06B 903 119 D	AP9009			
VOLKSWAGEN	021 903 119K	AP9033	VOLKSWAGEN	070 903 201 C	AP9030			
VOLKSWAGEN	022 903 119 A	AP9001	VOLKSWAGEN	070 903 201 E	AP9030			
VOLKSWAGEN	022 903 119 B	AP9002	VOLKSWAGEN	074105251AC	VD1002			
VOLKSWAGEN	022 903 119 C	AP9001	VOLKSWAGEN	074105251N	VD1002			
VOLKSWAGEN	022 903 119 D	AP9002	VOLKSWAGEN	074105251R	VD1002			
VOLKSWAGEN	028 903 119 AA	AP9004	VOLKSWAGEN	074105251T	VD1002			
VOLKSWAGEN	028 903 119 AC	AP9002	VOLKSWAGEN	L 038 903 119 S	AP9001			
VOLKSWAGEN	028 903 119 AM	AP9001	VOLVO	30637335	VD1077			
VOLKSWAGEN	028 903 119 AN	AP9032	VOLVO	30667067	AP9029			
VOLKSWAGEN	028 903 119 AP	AP9059	VOLVO	30667878	AP9041			
VOLKSWAGEN	028 903 119 P	AP9004	VOLVO	3073 7517	AP9041			
VOLKSWAGEN	028 903 119 S	AP9059	VOLVO	30731039	VD1102			
VOLKSWAGEN	028 903 119 T	AP9032	VOLVO	30731865	VD1077			
VOLKSWAGEN	028 903 165	AP9032	VOLVO	31251071	AP9052			

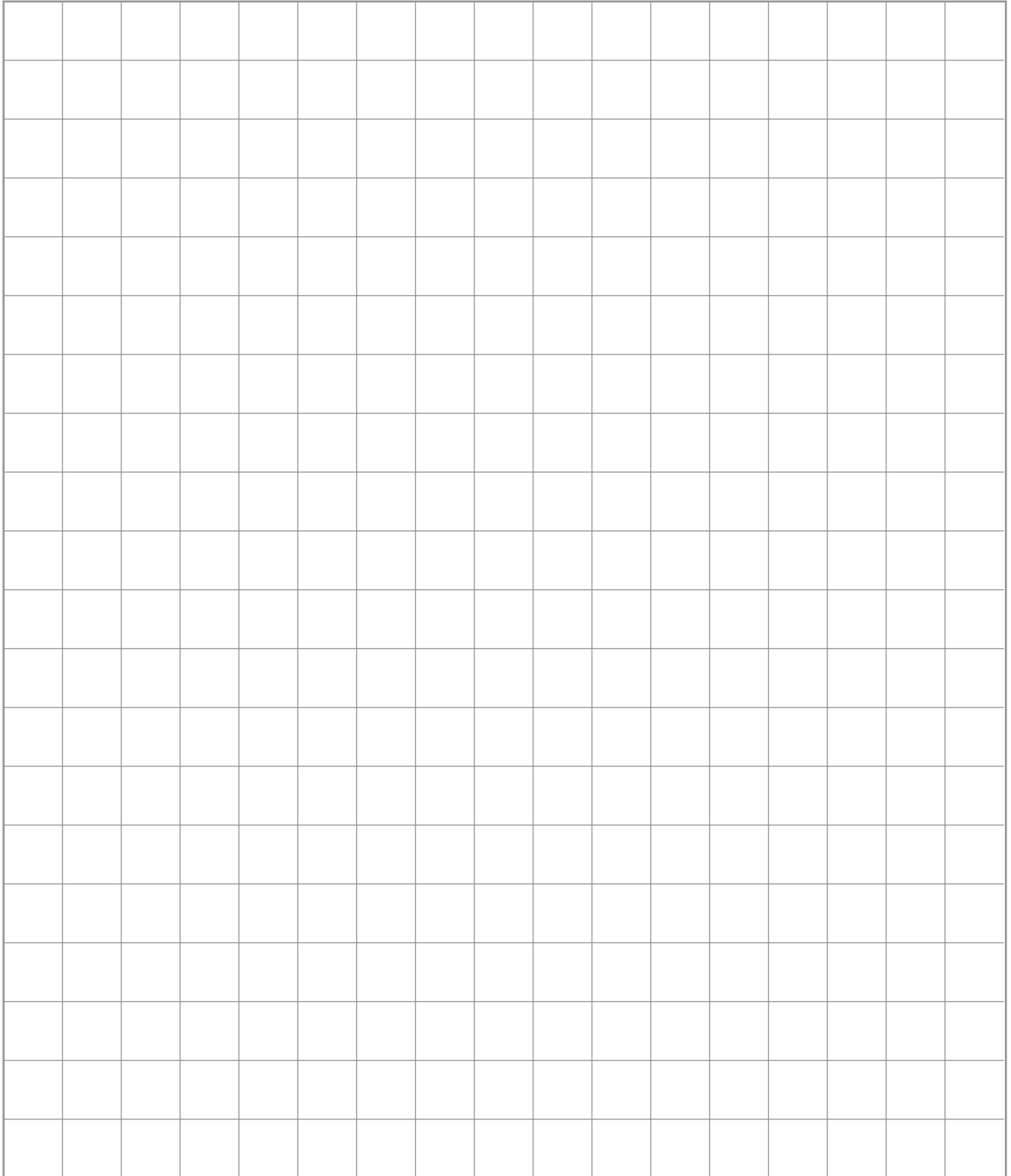
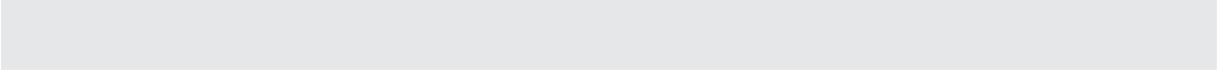

**Wettbewerbsbezeichnungen**  
**Competitors part No.**  
**References autres produits**  
**Referencias de otros fabricados**  
**Referenza per prodotti di terzi**  
**Наименование конкурентной продукции**

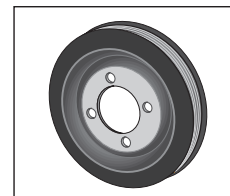
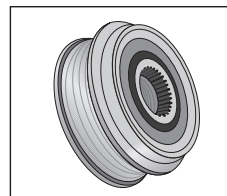

ContiTech			ContiTech			ContiTech		
BOSCH	0 122 1AA 5L0	AP9024	BOSCH	F 00M 991 171	AP9023	CORTECO	80000352	VD1086
BOSCH	0 122 1AA 7V0	AP9024	BOSCH	F 00M 991 181	AP9027	CORTECO	80000363	VD1070
BOSCH	1 126 601 534	AP9032	BOSCH	F 00M 991 190	AP9010	CORTECO	80000366	VD1087
BOSCH	1 126 601 556	AP9059	BOSCH	F 00M 991 204	AP9012	CORTECO	80000374	VD1028
BOSCH	1 126 601 559	AP9016	BOSCH	F 00M 991 206	AP9001	CORTECO	80000385	VD1088
BOSCH	1 126 601 565	AP9004	BOSCH	F 00M 991 216	AP9047	CORTECO	80000394	VD1089
BOSCH	1 126 601 566	AP9032	BOSCH	F 00M 991 231	AP9047	CORTECO	80000395	VD1090
BOSCH	1 126 601 572	AP9060	BOSCH	F 00M 991 232	AP9041	CORTECO	80000396	VD1091
BOSCH	1 126 601 597	AP9015	BOSCH	F 00M 991 265	AP9041	CORTECO	80000426	VD1092
BOSCH	1 127 011 844	AP9016	BOSCH	F 00M 991 281	AP9028	CORTECO	80000543	VD1076
BOSCH	1 127 011 846	AP9004	BOSCH	F 00M 991 284	AP9001	CORTECO	80000544	VD1093
BOSCH	1 209 367 06	AP9009	BOSCH	F 00M 991 301	AP9005	CORTECO	80000597	VD1094
BOSCH	6 033 GD5 036	AP9034	BOSCH	F 00M 991 302	AP9020	CORTECO	80000598	VD1095
BOSCH	F 00M 061 023	AP9015	BOSCH	F 00M 991 303	AP9010	CORTECO	80000599	VD1063
BOSCH	F 00M 147 716	AP9041	BOSCH	F 00M 991 304	AP9015	CORTECO	80000678	VD1111
BOSCH	F 00M 147 724	AP9002	BOSCH	F 00M 991 308	AP9033	CORTECO	80000682	VD1096
BOSCH	F 00M 147 736	AP9033	BOSCH	F 00M 991 378	AP9002	CORTECO	80000707	VD1097
BOSCH	F 00M 147 737	AP9001	BOSCH	F 00M 991 389	AP9004	CORTECO	80000819	VD1073
BOSCH	F 00M 147 746	AP9005	BOSCH	F 00M 991 392	AP9060	CORTECO	80000821	VD1036
BOSCH	F 00M 147 760	AP9041	BOSCH	F 00M 992 725	AP9028	CORTECO	80000822	VD1041
BOSCH	F 00M 147 800	AP9012	BOSCH	F 00M A47 701	AP9005	CORTECO	80000830	VD1072
BOSCH	F 00M 147 801	AP9001	BOSCH	F00M 147 876	AP9022	CORTECO	80000831	VD1042
BOSCH	F 00M 147 854	AP9028	BOSCH	F00M 991 247	AP9022	CORTECO	80000833	VD1039
BOSCH	F 00M 147 907	AP9023	BOSCH	F00M 991 287	AP9022	CORTECO	80000834	VD1098
BOSCH	F 00M 147 914	AP9005	BOSCH	F00M147999	AP9042	CORTECO	80000835	VD1099
BOSCH	F 00M 349 820	AP9005	BOSCH	F00M391107	AP9048	CORTECO	80000837	VD1068
BOSCH	F 00M 349 898	AP9005	BOSCH	F00M391118	AP9048	CORTECO	80000855	VD1067
BOSCH	F 00M 391 122	AP9005	BOSCH	F00M391120	AP9048	CORTECO	80000857	VD1078
BOSCH	F 00M 391 157	AP9005	BOSCH	F00M991076	AP9003	CORTECO	80000860	VD1079
BOSCH	F 00M 391 159	AP9005	BOSCH	F00M991128	AP9003	CORTECO	80000873	VD1080
BOSCH	F 00M 991 002	AP9001	BOSCH	F00M991172	AP9042	CORTECO	80000918	VD1062
BOSCH	F 00M 991 039	AP9057	BOSCH	F00M991247	AP9022	CORTECO	80000931	VD1100
BOSCH	F 00M 991 042	AP9007	BOSCH	F00M991287	AP9022	CORTECO	80000936	VD1071
BOSCH	F 00M 991 045	AP9002	CORTECO	21652976	VD1002	CORTECO	80000990	VD1077
BOSCH	F 00M 991 095	AP9033	CORTECO	21653130	VD1027	CORTECO	80001010	VD1101
BOSCH	F 00M 991 108	AP9009	CORTECO	21653131	VD1030	CORTECO	80001032	VD1065
BOSCH	F 00M 991 122	AP9001	CORTECO	80000025	VD1025	CORTECO	80001052	VD1102
BOSCH	F 00M 991 125	AP9010	CORTECO	80000085	VD1031	CORTECO	80001091	VD1103
BOSCH	F 00M 991 138	AP9020	CORTECO	80000200	VD1032	CORTECO	80001093	VD1104
BOSCH	F 00M 991 141	AP9005	CORTECO	80000202	VD1033	CORTECO	80001103	VD1105
BOSCH	F 00M 991 142	AP9008	CORTECO	80000204	VD1084	CORTECO	80001108	VD1042
BOSCH	F 00M 991 156	AP9041	CORTECO	80000205	VD1081	CORTECO	80001114	VD1106
BOSCH	F 00M 991 160	AP9020	CORTECO	80000351	VD1085	CORTECO	80001118	VD1107

**Wettbewerbsbezeichnungen**  
**Competitors part No.**  
**References autres produits**  
**Referencias de otros fabricantes**  
**Referenza per prodotti di terzi**  
**Наименование конкурентной продукции**

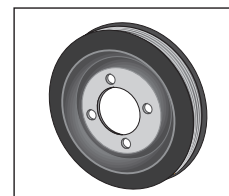
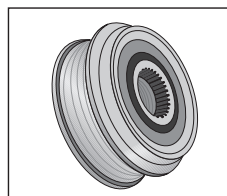

ContiTech			ContiTech			ContiTech		
CORTECO	80001142	VD1064	DAYCO	DPV1019	VD1064	DENSO	081020-0011	AP9062
CORTECO	80001154	VD1109	DAYCO	DPV1022	VD1065	DENSO	104210-3511	AP9029
CORTECO	80001159	VD1065	DAYCO	DPV1029	VD1100	DENSO	104210-3512	AP9029
CORTECO	80001201	VD1110	DAYCO	DPV1032	VD1063	DENSO	8362516	AP9017
DAYCO	ALP2325	AP9004	DAYCO	DPV1041	VD1110	FEBI BILSTEIN	11701	AP9004
DAYCO	ALP2326	AP9060	DAYCO	DPV1046	VD1065	FEBI BILSTEIN	14043	AP9060
DAYCO	ALP2328	AP9032	DAYCO	DPV1053	VD1097	FEBI BILSTEIN	14064	AP9016
DAYCO	ALP2329	AP9002	DAYCO	DPV1054	VD1086	FEBI BILSTEIN	14997	AP9041
DAYCO	ALP2332	AP9007	DAYCO	DPV1055	VD1085	FEBI BILSTEIN	15090	AP9058
DAYCO	ALP2333	AP9059	DAYCO	DPV1056	VD1080	FEBI BILSTEIN	15153	AP9036
DAYCO	ALP2334	AP9016	DAYCO	DPV1057	VD1025	FEBI BILSTEIN	15154	AP9015
DAYCO	ALP2335	AP9001	DAYCO	DPV1058	VD1030	FEBI BILSTEIN	15155	AP9024
DAYCO	ALP2337	AP9015	DAYCO	DPV1059	VD1028	FEBI BILSTEIN	15157	AP9055
DAYCO	ALP2338	AP9024	DAYCO	DPV1062	VD1081	FEBI BILSTEIN	15165	AP9034
DAYCO	ALP2340	AP9057	DAYCO	DPV1063	VD1105	FEBI BILSTEIN	15252	AP9032
DAYCO	ALP2343	AP9058	DAYCO	DPV1064	VD1027	FEBI BILSTEIN	15254	AP9002
DAYCO	ALP2345	AP9052	DAYCO	DPV1067	VD1092	FEBI BILSTEIN	15260	AP9007
DAYCO	ALP2346	AP9039	DAYCO	DPV1068	VD1094	FEBI BILSTEIN	15262	AP9001
DAYCO	ALP2349	AP9038	DAYCO	DPV1071	VD1039	FEBI BILSTEIN	15264	AP9057
DAYCO	ALP2350	AP9009	DAYCO	DPV1072	VD1084	FEBI BILSTEIN	21683	AP9010
DAYCO	ALP2352	AP9043	DAYCO	DPV1073	VD1087	FEBI BILSTEIN	21684	AP9020
DAYCO	ALP2354	AP9010	DAYCO	DPV1075	VD1041	FEBI BILSTEIN	23949	VD1030
DAYCO	ALP2355	AP9033	DAYCO	DPV1076	VD1031	FEBI BILSTEIN	24179	AP9052
DAYCO	ALP2357	AP9023	DAYCO	DPV1077	VD1002	FEBI BILSTEIN	24181	VD1027
DAYCO	ALP2358	AP9035	DAYCO	DPV1078	VD1098	FEBI BILSTEIN	24413	AP9031
DAYCO	ALP2360	AP9041	DAYCO	DPV1079	VD1099	FEBI BILSTEIN	24934	VD1063
DAYCO	ALP2361	AP9031	DAYCO	DPV1080	VD1067	FEBI BILSTEIN	26135	VD1084
DAYCO	ALP2362	AP9005	DAYCO	DPV1082	VD1078	FEBI BILSTEIN	26338	VD1033
DAYCO	ALP2362	AP9008	DAYCO	DPV1085	VD1079	FEBI BILSTEIN	26367	VD1093
DAYCO	ALP2363	AP9014	DAYCO	DPV1089	VD1102	FEBI BILSTEIN	26458	AP9056
DAYCO	ALP2366	AP9020	DAYCO	DPV1090	VD1071	FEBI BILSTEIN	26741	VD1028
DAYCO	ALP2367	AP9006	DAYCO	DPV1095	VD1103	FEBI BILSTEIN	26742	VD1025
DAYCO	ALP2371	AP9047	DAYCO	DPV1099	VD1042	FEBI BILSTEIN	26825	VD1070
DAYCO	ALP2372	AP9049	DAYCO	DPV1109	VD1107	FEBI BILSTEIN	26834	VD1002
DAYCO	ALP2374	AP9056	DAYCO	DPV1122	VD1070	FEBI BILSTEIN	26870	VD1076
DAYCO	ALP2376	AP9036	DAYCO	DPV1123	VD1076	FEBI BILSTEIN	26874	VD1111
DAYCO	ALP2378	AP9034	DAYCO	DPV1126	VD1036	FEBI BILSTEIN	26888	VD1032
DAYCO	ALP2379	AP9027	DAYCO	DPV1127	VD1072	FEBI BILSTEIN	26922	VD1095
DAYCO	ALP2382	AP9030	DAYCO	DPV1129	VD1068	FEBI BILSTEIN	26923	VD1086
DAYCO	ALP2383	AP9051	DELPHI	10451570	AP9024	FEBI BILSTEIN	26924	VD1085
DAYCO	ALP2385	AP9014	DELPHI	10453582	AP9024	FEBI BILSTEIN	26957	VD1081
DAYCO	ALP2387	AP9055	DELPHI	211242	AP9060	FEBI BILSTEIN	26958	AP9030
DAYCO	DPV1006	VD1062	DENSO	021040-0970	AP9051	FEBI BILSTEIN	27215	VD1031



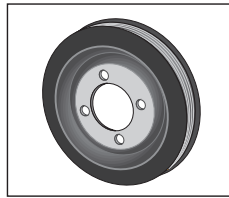
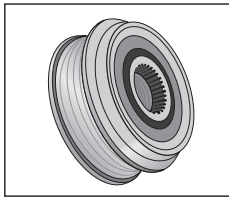

**Wettbewerbsbezeichnungen**  
**Competitors part No.**  
**References autres produits**  
**Referencias de otros fabricados**  
**Referenza per prodotti di terzi**  
**Наименование конкурентной продукции**

**ContiTech**
**ContiTech**
**ContiTech**

FEBI BILSTEIN	27340	VD1105	GATES	OAP7013	AP9001	GATES	OAP7090	AP9012
FEBI BILSTEIN	27444	VD1090	GATES	OAP7030	AP9031	GATES	OAP7092	AP9050
FEBI BILSTEIN	27720	VD1097	GATES	OAP7031	AP9003	GATES	OAP7093	AP9061
FEBI BILSTEIN	27722	VD1088	GATES	OAP7032	AP9017	GATES	OAP7100	AP9060
FEBI BILSTEIN	27822	VD1065	GATES	OAP7033	AP9002	GATES	OAP7102	AP9057
FEBI BILSTEIN	27823	VD1064	GATES	OAP7034	AP9038	GATES	OAP7106	AP9025
FEBI BILSTEIN	27836	AP9038	GATES	OAP7035	AP9028	GATES	OAP7108	AP9056
FEBI BILSTEIN	27837	AP9014	GATES	OAP7036	AP9041	GATES	OAP7110	AP9047
FEBI BILSTEIN	27841	AP9011	GATES	OAP7037	AP9044	GATES	OAP7111	AP9005
FEBI BILSTEIN	28242	VD1072	GATES	OAP7039	AP9035	GATES	TVD1001	VD1076
FEBI BILSTEIN	28243	VD1042	GATES	OAP7040	AP9004	GATES	TVD1002	VD1080
FEBI BILSTEIN	28525	VD1080	GATES	OAP7041	AP9032	GATES	TVD1003	VD1089
FEBI BILSTEIN	29333	VD1094	GATES	OAP7042	AP9006	GATES	TVD1004	VD1084
FEBI BILSTEIN	29904	AP9023	GATES	OAP7043	AP9052	GATES	TVD1005	VD1086
FEBI BILSTEIN	29989	VD1041	GATES	OAP7044	AP9009	GATES	TVD1006	VD1095
FEBI BILSTEIN	29990	VD1042	GATES	OAP7046	AP9027	GATES	TVD1008	VD1063
FEBI BILSTEIN	30029	AP9035	GATES	OAP7047	AP9016	GATES	TVD1009	VD1107
FEBI BILSTEIN	30097	VD1110	GATES	OAP7048	AP9058	GATES	TVD1010	VD1081
FEBI BILSTEIN	30113	AP9021	GATES	OAP7049	AP9024	GATES	TVD1011	VD1097
FEBI BILSTEIN	30147	AP9051	GATES	OAP7050	AP9045	GATES	TVD1012	VD1031
FEBI BILSTEIN	30150	AP9026	GATES	OAP7051	AP9046	GATES	TVD1013	VD1065
FEBI BILSTEIN	30214	VD1091	GATES	OAP7052	AP9054	GATES	TVD1014	VD1091
FEBI BILSTEIN	31100	VD1096	GATES	OAP7053	AP9014	GATES	TVD1015	VD1090
FEBI BILSTEIN	31212	VD1099	GATES	OAP7054	AP9008	GATES	TVD1017	VD1104
FEBI BILSTEIN	31385	AP9027	GATES	OAP7055	AP9021	GATES	TVD1020	VD1092
FEBI BILSTEIN	31405	AP9006	GATES	OAP7056	AP9020	GATES	TVD1021	VD1039
FEBI BILSTEIN	31483	VD1109	GATES	OAP7057	AP9010	GATES	TVD1022	VD1028
FEBI BILSTEIN	31541	AP9054	GATES	OAP7058	AP9026	GATES	TVD1023	VD1093
FEBI BILSTEIN	31729	AP9008	GATES	OAP7059	AP9051	GATES	TVD1025	VD1094
FEBI BILSTEIN	31743	AP9005	GATES	OAP7060	AP9015	GATES	TVD1026	VD1085
FEBI BILSTEIN	31754	AP9017	GATES	OAP7064	AP9011	GATES	TVD1029	VD1068
FEBI BILSTEIN	32026	VD1089	GATES	OAP7066	AP9033	GATES	TVD1030	VD1032
FEBI BILSTEIN	32107	VD1036	GATES	OAP7067	AP9059	GATES	TVD1033	VD1002
FEBI BILSTEIN	32187	VD1107	GATES	OAP7070	AP9053	GATES	TVD1034	VD1033
FEBI BILSTEIN	32221	VD1106	GATES	OAP7071	AP9049	GATES	TVD1035	VD1088
FEBI BILSTEIN	32254	VD1092	GATES	OAP7072	AP9034	GATES	TVD1037	VD1030
FEBI BILSTEIN	32297	AP9028	GATES	OAP7076	AP9007	GATES	TVD1038	VD1027
FEBI BILSTEIN	32315	AP9003	GATES	OAP7077	AP9013	GATES	TVD1039	VD1025
FEBI BILSTEIN	32995	VD1071	GATES	OAP7079	AP9036	GATES	TVD1040	VD1111
FEBI BILSTEIN	33473	AP9050	GATES	OAP7080	AP9023	GATES	TVD1041	VD1109
FEBI BILSTEIN	33640	VD1077	GATES	OAP7081	AP9039	GATES	TVD1042	VD1064
FEBI BILSTEIN	34166	VD1028	GATES	OAP7082	AP9043	GATES	TVD1050	VD1105
FEBI BILSTEIN	34196	VD1068	GATES	OAP7089	AP9055	GATES	TVD1055	VD1100

Wettbewerbsbezeichnungen  
 Competitors part No.  
 References autres produits  
 Referencias de otros fabricantes  
 Referenza per prodotti di terzi  
 Наименование конкурентной продукции

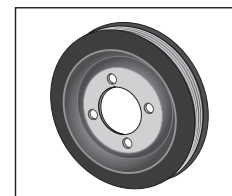
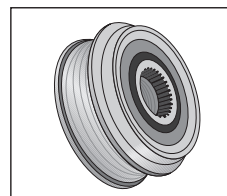

ContiTech			ContiTech			ContiTech		
GATES	TVD1060	VD1110	INA	535002810	AP9052	INA	535018310	AP9005
GATES	TVD1061	VD1096	INA	535003010	AP9039	INA	535018810	AP9028
GATES	TVD1064	VD1094	INA	535003410	AP9061	INA	535019310	AP9018
HITACHI	GD214998-1	AP9001	INA	535003910	AP9038	INA	535019410	AP9019
HITACHI	GD218089-1	AP9044	INA	535004110	AP9009	INA	544 0004 10	VD1084
HUTCHINSON	D7512RA	AP9025	INA	535004210	AP9020	INA	544 0005 10	VD1089
HUTCHINSON	DB0261	AP9043	INA	535004810	AP9043	INA	544 0009 10	VD1063
HUTCHINSON	DB0267	AP9008	INA	535004910	AP9049	INA	544 0010 10	VD1065
HUTCHINSON	DP001	VD1030	INA	535005010	AP9010	INA	544 0015 10	VD1062
HUTCHINSON	DP002	VD1025	INA	535005210	AP9033	INA	544 0028 10	VD1064
HUTCHINSON	DP003	VD1028	INA	535005910	AP9023	INA	544 0039 10	VD1080
HUTCHINSON	DP006	VD1086	INA	535006010	AP9006	INA	544 0040 10	VD1097
HUTCHINSON	DP009	VD1085	INA	535006210	AP9013	INA	544 0042 10	VD1086
HUTCHINSON	DP013	VD1062	INA	535006310	AP9035	INA	544 0044 10	VD1088
HUTCHINSON	DP016	VD1080	INA	535006510	AP9044	INA	544 0045 10	VD1085
HUTCHINSON	DP026	VD1064	INA	535007210	AP9041	INA	544 0046 10	VD1093
HUTCHINSON	DP030	VD1039	INA	535007310	AP9031	INA	544 0047 10	VD1086
HUTCHINSON	DP033	VD1081	INA	535007410	AP9037	INA	544 0050 10	VD1065
HUTCHINSON	DP044	VD1089	INA	535007510	AP9008	INA	544 0053 10	VD1101
HUTCHINSON	DP045	VD1002	INA	535007710	AP9060	INA	544 0064 10	VD1090
HUTCHINSON	DP047	VD1032	INA	535008110	AP9047	INA	544 0065 10	VD1091
HUTCHINSON	DP048	VD1076	INA	535008610	AP9027	INA	544 0072 10	VD1031
HUTCHINSON	DP050	VD1033	INA	535008710	AP9053	INA	544 0079 10	VD1094
HUTCHINSON	DP051	VD1090	INA	535009810	AP9046	INA	F-225355.07	AP9004
HUTCHINSON	DP053	VD1093	INA	535010110	AP9014	INA	F-225355.10	AP9004
HUTCHINSON	DP054	VD1105	INA	535010510	AP9025	INA	F-225355.11	AP9004
HUTCHINSON	DP064	VD1079	INA	535011010	AP9062	INA	F-225355.4	AP9004
HUTCHINSON	DP065	VD1111	INA	535011210	AP9054	INA	F-225355.5	AP9004
INA	535000110	AP9004	INA	535011510	AP9017	INA	F-225355.6	AP9004
INA	535000410	AP9032	INA	535011610	AP9056	INA	F-225355.7	AP9004
INA	535000510	AP9002	INA	535011810	AP9030	INA	F-225643.1	AP9060
INA	535000810	AP9007	INA	535012410	AP9022	INA	F-225643.10	AP9060
INA	535000910	AP9059	INA	535012710	AP9021	INA	F-225643.11	AP9060
INA	535001010	AP9016	INA	535012910	AP9011	INA	F-225643.12	AP9060
INA	535001110	AP9036	INA	535014910	AP9040	INA	F-225643.13	AP9060
INA	535001210	AP9001	INA	535015510	AP9012	INA	F-225643.4	AP9060
INA	535001310	AP9034	INA	535015710	AP9045	INA	F-225643.5	AP9060
INA	535001510	AP9015	INA	535016010	AP9048	INA	F-225643.6	AP9060
INA	535001610	AP9024	INA	535016510	AP9026	INA	F-225643.7	AP9060
INA	535001810	AP9057	INA	535016810	AP9050	INA	F-225643.8	AP9060
INA	535002010	AP9055	INA	535017210	AP9003	INA	F-225643.9	AP9060
INA	535002310	AP9058	INA	535017910	AP9042	INA	F-225644.05	AP9034
INA	535002410	AP9051	INA	535018110	AP9029	INA	F-225644.2	AP9034

**Wettbewerbsbezeichnungen**  
**Competitors part No.**  
**References autres produits**  
**Referencias de otros fabricados**  
**Referenza per prodotti di terzi**  
**Наименование конкурентной продукции**

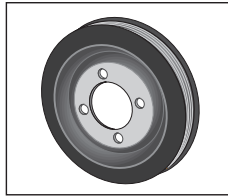
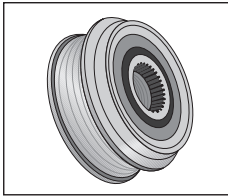

ContiTech			ContiTech			ContiTech		
INA	F-225644.4	AP9034	INA	F-227820.08	AP9033	INA	F-229643.11	AP9039
INA	F-225644.5	AP9034	INA	F-227820.09	AP9033	INA	F-229643.3	AP9039
INA	F-225644.6	AP9034	INA	F-227820.10	AP9033	INA	F-229643.4	AP9039
INA	F-225644.7	AP9034	INA	F-227820.12	AP9033	INA	F-229643.7	AP9039
INA	F-225653.10	AP9002	INA	F-227820.13	AP9033	INA	F-230147	AP9057
INA	F-225653.11	AP9002	INA	F-228215	AP9034	INA	F-230147.03	AP9057
INA	F-225653.12	AP9032	INA	F-228215.03	AP9034	INA	F-230147.04	AP9057
INA	F-225653.13	AP9032	INA	F-228215.04	AP9034	INA	F-230147.05	AP9057
INA	F-225653.3	AP9032	INA	F-228215.1	AP9034	INA	F-230147.1	AP9057
INA	F-225653.4	AP9032	INA	F-228215.2	AP9034	INA	F-230147.2	AP9057
INA	F-225653.5	AP9032	INA	F-228824.1	AP9015	INA	F-230147.3	AP9057
INA	F-225653.6	AP9002	INA	F-228824.10	AP9015	INA	F-230329.02	AP9021
INA	F-225653.7	AP9002	INA	F-228824.11	AP9015	INA	F-230329.04	AP9021
INA	F-225653.8	AP9032	INA	F-228824.12	AP9015	INA	F-230401.09	AP9041
INA	F-225653.9	AP9032	INA	F-228824.4	AP9015	INA	F-230401.8	AP9041
INA	F-226322.10	AP9007	INA	F-228824.6	AP9015	INA	F-230759.05	AP9055
INA	F-226322.11	AP9007	INA	F-228824.7	AP9015	INA	F-230759.1	AP9055
INA	F-226322.14	AP9007	INA	F-228824.9	AP9015	INA	F-230759.2	AP9055
INA	F-226322.6	AP9007	INA	F-228881.2	AP9052	INA	F-230866.10	AP9058
INA	F-226322.9	AP9007	INA	F-228881.3	AP9052	INA	F-230866.11	AP9058
INA	F-226556.10	AP9059	INA	F-229363.09	AP9024	INA	F-230866.4	AP9058
INA	F-226556.11	AP9059	INA	F-229363.5	AP9024	INA	F-230866.5	AP9058
INA	F-226556.4	AP9059	INA	F-229363.6	AP9024	INA	F-230866.7	AP9058
INA	F-226556.5	AP9059	INA	F-229363.7	AP9024	INA	F-231108	AP9051
INA	F-226556.6	AP9059	INA	F-229363.9	AP9024	INA	F-231108.02	AP9051
INA	F-226556.7	AP9059	INA	F-229603	AP9038	INA	F-231142	AP9009
INA	F-226804	AP9016	INA	F-229603.1	AP9038	INA	F-231142.05	AP9009
INA	F-226804.07	AP9016	INA	F-229603.10	AP9038	INA	F-231142.08	AP9009
INA	F-226804.08	AP9016	INA	F-229603.11	AP9038	INA	F-231142.1	AP9009
INA	F-226804.09	AP9016	INA	F-229603.12	AP9031	INA	F-231618.02	AP9061
INA	F-226804.4	AP9016	INA	F-229603.13	AP9031	INA	F-231618.04	AP9061
INA	F-226804.5	AP9016	INA	F-229603.14	AP9038	INA	F-231618.05	AP9061
INA	F-226954.07	AP9036	INA	F-229603.15	AP9031	INA	F-231618.1	AP9061
INA	F-226954.4	AP9036	INA	F-229603.16	AP9031	INA	F-232001.06	AP9020
INA	F-226954.5	AP9036	INA	F-229603.2	AP9031	INA	F-232001.07	AP9020
INA	F-227628	AP9001	INA	F-229603.3	AP9031	INA	F-232001.08	AP9020
INA	F-227628.10	AP9001	INA	F-229603.4	AP9038	INA	F-232001.09	AP9020
INA	F-227628.11	AP9001	INA	F-229603.5	AP9038	INA	F-232001.2	AP9020
INA	F-227628.12	AP9001	INA	F-229603.6	AP9031	INA	F-232001.4	AP9020
INA	F-227628.4	AP9001	INA	F-229603.7	AP9031	INA	F-232353	AP9044
INA	F-227628.5	AP9001	INA	F-229603.8	AP9031	INA	F-232353.03	AP9044
INA	F-227628.6	AP9001	INA	F-229603.9	AP9031	INA	F-232353.1	AP9044
INA	F-227628.7	AP9001	INA	F-229643.10	AP9039	INA	F-232369	AP9042

**Wettbewerbsbezeichnungen**

**Competitors part No.**

**References autres produits**

**Referencias de otros fabricados**

**Referenza per prodotti di terzi**

**Наименование конкурентной продукции**

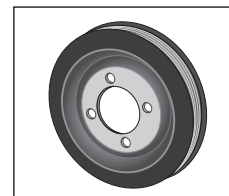
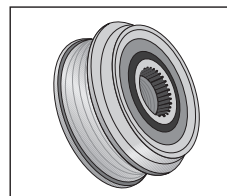

ContiTech			ContiTech			ContiTech		
INA	F-232369.03	AP9042	INA	F-236001.01	AP9049	INA	F-240113	AP9044
INA	F-232369.05	AP9023	INA	F-236001.02	AP9049	INA	F-240113.01	AP9044
INA	F-232369.07	AP9023	INA	F-236528	AP9005	INA	F-240139	AP9012
INA	F-232369.08	AP9023	INA	F-236528.01	AP9005	INA	F-240139.01	AP9012
INA	F-232369.09	AP9042	INA	F-236528.02	AP9005	INA	F-240139.02	AP9012
INA	F-232369.2	AP9042	INA	F-236528.03	AP9005	INA	F-240139.03	AP9012
INA	F-232369.4	AP9023	INA	F-236528.04	AP9005	INA	F-240139.04	AP9012
INA	F-232854.06	AP9037	INA	F-236528.06	AP9005	INA	F-240139.05	AP9012
INA	F-232854.3	AP9037	INA	F-236528.07	AP9005	INA	F-550181.03	AP9025
INA	F-233106.03	AP9062	INA	F-236566	AP9008	INA	F-550181.04	AP9025
INA	F-233106.04	AP9062	INA	F-236566.01	AP9008	INA	F-550181.05	AP9025
INA	F-233106.05	AP9062	INA	F-236566.02	AP9008	INA	F-550426	AP9040
INA	F-233106.06	AP9062	INA	F-236591.01	AP9013	INA	F-551406.01	AP9022
INA	F-233106.1	AP9062	INA	F-236591.02	AP9013	INA	F-551406.02	AP9022
INA	F-233197	AP9010	INA	F-236591.04	AP9013	INA	F-552699	AP9002
INA	F-233197.01	AP9010	INA	F-236591.05	AP9019	INA	F-552699.02	AP9002
INA	F-233197.04	AP9010	INA	F-236591.06	AP9013	INA	F-552901.02	AP9050
INA	F-233197.05	AP9010	INA	F-237045	AP9053	INA	F-552901.03	AP9050
INA	F-233197.2	AP9010	INA	F-237045.02	AP9053	INA	F-552923	AP9041
INA	F-233197.3	AP9010	INA	F-237101.01	AP9035	INA	F-552923.01	AP9041
INA	F-233197.4	AP9010	INA	F-237101.02	AP9035	INA	F-553099	AP9041
INA	F-233197.5	AP9010	INA	F-237101.03	AP9035	INA	F-553099.01	AP9041
INA	F-233593	AP9006	INA	F-237101.04	AP9035	INA	F-553470	AP9001
INA	F-233593.03	AP9006	INA	F-237653	AP9030	INA	F-553470.01	AP9001
INA	F-233593.04	AP9006	INA	F-238005	AP9021	INA	F-553470.02	AP9001
INA	F-233593.05	AP9006	INA	F-238005.02	AP9021	INA	F-553470.05	AP9001
INA	F-233593.1	AP9006	INA	F-238512.02	AP9047	INA	F-553857	AP9014
INA	F-233593.2	AP9006	INA	F-238512.03	AP9047	INA	F-553857.01	AP9014
INA	F-233608.01	AP9046	INA	F-238512.05	AP9047	INA	F-553857.02	AP9014
INA	F-233608.02	AP9046	INA	F-238512.06	AP9047	INA	F-553857.03	AP9014
INA	F-233608.03	AP9046	INA	F-238822	AP9054	INA	F-553857.04	AP9014
INA	F-234637	AP9043	INA	F-238822.01	AP9054	INA	F-553857.05	AP9014
INA	F-234637.04	AP9043	INA	F-238822.02	AP9054	INA	F-553857.06	AP9014
INA	F-234637.1	AP9043	INA	F-239809.02	AP9014	INA	F-553857.08	AP9014
INA	F-235968	AP9027	INA	F-239809.03	AP9014	INA	F-553857.09	AP9014
INA	F-235968.01	AP9027	INA	F-239809.2	AP9014	INA	F-554053.01	AP9017
INA	F-235968.03	AP9027	INA	F-239809.3	AP9014	INA	F-554053.02	AP9017
INA	F-235968.05	AP9027	INA	F-239973	AP9011	INA	F-554766	AP9048
INA	F-235968.06	AP9027	INA	F-239973.01	AP9011	INA	F-554766.01	AP9048
INA	F-235968.07	AP9027	INA	F-239973.02	AP9011	INA	F-556599.01	AP9052
INA	F-235968.08	AP9027	INA	F-239973.03	AP9011	INA	F-556615	AP9037
INA	F-235968.09	AP9027	INA	F-239973.04	AP9011	INA	F-557311	AP9026
INA	F-236001	AP9049	INA	F-239973.05	AP9011	INA	F-557311.01	AP9026

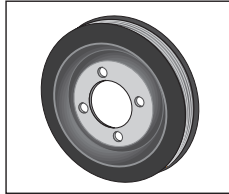
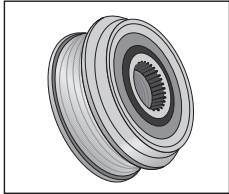

**Wettbewerbsbezeichnungen**  
**Competitors part No.**  
**References autres produits**  
**Referencias de otros fabricados**  
**Referenza per prodotti di terzi**  
**Наименование конкурентной продукции**



ContiTech			ContiTech			ContiTech		
INA	F-557755	AP9025	QH	1010186	AP9005	RUVILLE	55058	AP9008
INA	F-559320	AP9010	QH	1010265	AP9027	RUVILLE	55063	AP9021
INA	F-559320.01	AP9010	QH	1010266	AP9003	RUVILLE	55088	AP9021
INA	F-559585	AP9024	QH	1010281	AP9040	RUVILLE	55128	AP9015
INA	F-559585.01	AP9024	QH	1010289	AP9029	RUVILLE	55142	AP9024
INA	F-560968	AP9018	QH	QCD1	VD1086	RUVILLE	55151	AP9055
INA	F-568861	AP9029	QH	QCD124	VD1106	RUVILLE	55153	AP9036
QH	1010045	AP9032	QH	QCD13	VD1084	RUVILLE	55169	AP9014
QH	1010047	AP9015	QH	QCD16	VD1085	RUVILLE	55170	AP9010
QH	1010048	AP9059	QH	QCD18	VD1002	RUVILLE	55171	AP9034
QH	1010053	AP9060	QH	QCD28	VD1089	RUVILLE	55173	AP9020
QH	1010062	AP9002	QH	QCD30	VD1111	RUVILLE	55177	AP9027
QH	1010067	AP9016	QH	QCD38	VD1090	RUVILLE	55186	AP9011
QH	1010073	AP9004	QH	QCD5	VD1081	RUVILLE	55188	AP9060
QH	1010076	AP9036	QH	QCD53	VD1093	RUVILLE	55284	AP9053
QH	1010078	AP9033	QH	QCD62	VD1100	RUVILLE	55293	AP9046
QH	010081	AP9024	QH	QCD6v	VD1097	RUVILLE	55294	AP9045
QH	1010083	AP9039	QH	QCD8	VD1088	RUVILLE	55375	AP9044
QH	1010088	AP9036	QH	QCD89	VD1105	RUVILLE	55376	AP9017
QH	1010089	AP9051	RUVILLE	515000	VD1025	RUVILLE	55381	AP9003
QH	1010090	AP9058	RUVILLE	515001	VD1030	RUVILLE	55382	AP9047
QH	1010091	AP9007	RUVILLE	515100	VD1093	RUVILLE	55451	AP9002
QH	1010092	AP9055	RUVILLE	515201	VD1094	RUVILLE	55467	AP9016
QH	1010093	AP9034	RUVILLE	515300	VD1065	RUVILLE	55468	AP9059
QH	1010095	AP9052	RUVILLE	515302	VD1031	RUVILLE	55470	AP9032
QH	1010097	AP9057	RUVILLE	515400	VD1002	RUVILLE	55471	AP9004
QH	1010101	AP9010	RUVILLE	515402	VD1084	RUVILLE	55472	AP9001
QH	1010107	AP9001	RUVILLE	515403	VD1089	RUVILLE	55473	AP9033
QH	1010107	AP9025	RUVILLE	515405	VD1032	RUVILLE	55487	AP9007
QH	1010146	AP9001	RUVILLE	515408	VD1090	RUVILLE	55583	AP9043
QH	1010150	AP9031	RUVILLE	515409	VD1091	RUVILLE	55593	AP9039
QH	1010152	AP9014	RUVILLE	515503	VD1063	RUVILLE	55594	AP9052
QH	1010152	AP9043	RUVILLE	515504	VD1101	RUVILLE	55627	AP9025
QH	1010154	AP9013	RUVILLE	515800	VD1065	RUVILLE	55718	AP9057
QH	1010156	AP9023	RUVILLE	515805	VD1062	RUVILLE	55721	AP9009
QH	1010162	AP9017	RUVILLE	515818	VD1064	RUVILLE	55877	AP9058
QH	1010166	AP9021	RUVILLE	515827	VD1086	RUVILLE	55886	AP9035
QH	1010169	AP9035	RUVILLE	515832	VD1095	RUVILLE	55948	AP9031
QH	1010174	AP9020	RUVILLE	515902	VD1080	RUVILLE	55966	AP9023
QH	1010177	AP9047	RUVILLE	515903	VD1097	RUVILLE	56032	AP9054
QH	1010179	AP9053	RUVILLE	516601	VD1086	RUVILLE	56324	AP9012
QH	1010183	AP9044	RUVILLE	516603	VD1088	RUVILLE	56328	AP9030
QH	1010184	AP9054	RUVILLE	516604	VD1085	RUVILLE	56329	AP9006

**Wettbewerbsbezeichnungen**

**Competitors part No.**

**References autres produits**

**Referencias de otros fabricantes**

**Referenza per prodotti di terzi**

**Наименование конкурентной продукции**

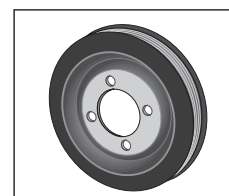
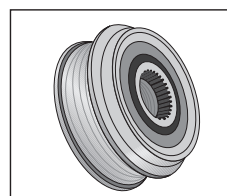

ContiTech			ContiTech			ContiTech		
RUVILLE	56334	AP9056	SASIC	400704	VD1063	SKF	VKM 03824	AP9060
RUVILLE	56336	AP9022	SASIC	5150G30	VD1086	SKF	VKM 03825	AP9055
RUVILLE	56535	AP9041	SASIC	5150J90	VD1088	SKF	VKM 03826	AP9014
RUVILLE	56540	AP9051	SASIC	5150L60	VD1085	SKF	VKM 03827	AP9036
RUVILLE	56646	AP9038	SASIC	5150Q60	VD1097	SKF	VKM 03828	AP9010
RUVILLE	56656	AP9013	SASIC	9001800	VD1107	SKF	VKM 03829	AP9020
RUVILLE	56657	AP9042	SASIC	9001802	VD1084	SKF	VKM 03870	AP9008
RUVILLE	57057	AP9049	SASIC	9001803	VD1089	SKF	VKM 03871	AP9021
RUVILLE	57063	AP9061	SASIC	9001805	VD1033	SKF	VKM 06403	AP9049
RUVILLE	57101	AP9037	SASIC	9001806	VD1032	SKF	VKM 93101	VD1084
RUVILLE	59914	AP9048	SASIC	9001807	VD1002	SKF	VKM 93102	VD1089
RUVILLE	59919	AP9026	SASIC	9001808	VD1028	SKF	VKM 93103	VD1091
RUVILLE	59922	AP9050	SASIC	9001810	VD1030	SKF	VKM 93104	VD1076
RUVILLE	59927	AP9029	SASIC	9001812	VD1027	SKF	VKM 93106	VD1090
RUVILLE	59929	AP9005	SASIC	9001813	VD1065	SKF	VKM 93108	VD1111
RUVILLE	59938	AP9062	SKF	VKM 03100	AP9001	SKF	VKM 93301	VD1080
RUVILLE	59945	AP9040	SKF	VKM 03101	AP9016	SKF	VKM 93302	VD1086
RUVILLE	59950	AP9028	SKF	VKM 03102	AP9032	SKF	VKM 93305	VD1085
RUVILLE	59955	AP9018	SKF	VKM 03103	AP9057	SKF	VKM 93306	VD1088
RUVILLE	59956	AP9019	SKF	VKM 03106	AP9004	SKF	VKM 93312	VD1097
SASIC	2150001	VD1100	SKF	VKM 03107	AP9002	SKF	VKM 93601	VD1081
SASIC	2150002	VD1095	SKF	VKM 03109	AP9059	SKF	VKM 93801	VD1093
SASIC	2150004	VD1096	SKF	VKM 03111	AP9006	SWAG	10140001	AP9015
SASIC	2150011	VD1080	SKF	VKM 03112	AP9022	SWAG	10140002	AP9036
SASIC	2150012	VD1094	SKF	VKM 03113	AP9007	SWAG	10140006	AP9060
SASIC	2150014	VD1094	SKF	VKM 03114	AP9033	SWAG	10140007	AP9024
SASIC	2150016	VD1062	SKF	VKM 03115	AP9030	SWAG	10915157	AP9055
SASIC	2154006	VD1101	SKF	VKM 03116	AP9009	SWAG	10915165	AP9034
SASIC	2154009	VD1104	SKF	VKM 03118	AP9012	SWAG	20 93 1729	AP9008
SASIC	2154013	VD1109	SKF	VKM 03204	AP9054	SWAG	20 93 1743	AP9005
SASIC	2154015	VD1101	SKF	VKM 03206	AP9017	SWAG	30030093	AP9004
SASIC	2156004	VD1090	SKF	VKM 03504	AP9003	SWAG	30140002	AP9016
SASIC	2156008	VD1031	SKF	VKM 03505	AP9028	SWAG	30140004	AP9057
SASIC	2156010	VD1093	SKF	VKM 03508	AP9044	SWAG	30140006	AP9002
SASIC	2156011	VD1091	SKF	VKM 03600	AP9052	SWAG	30140007	AP9032
SASIC	2156017	VD1068	SKF	VKM 03604	AP9056	SWAG	30140008	AP9001
SASIC	2156018	VD1111	SKF	VKM 03612	AP9025	SWAG	32140003	AP9007
SASIC	2156019	VD1039	SKF	VKM 03651	AP9041	SWAG	60 92 6957	VD1081
SASIC	2156020	VD1065	SKF	VKM 03652	AP9051	SWAG	62 92 8525	VD1080
SASIC	2156021	VD1076	SKF	VKM 03814	AP9024	SWAG	70140001	AP9058
SASIC	2156024	VD1106	SKF	VKM 03815	AP9026	VALEO	254 985 8	AP9009
SASIC	2156029	VD1067	SKF	VKM 03820	AP9027	VALEO	2546778	AP9001
SASIC	4000701	VD1081	SKF	VKM 03821	AP9015	VALEO	2546952	AP9052

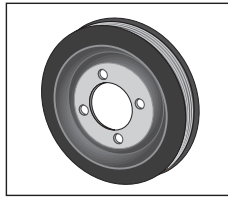
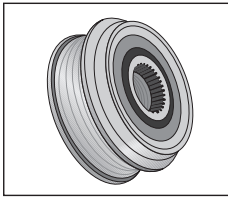

Wettbewerbsbezeichnungen  
 Competitors part No.  
 References autres produits  
 Referencias de otros fabricados  
 Referenza per prodotti di terzi  
 Наименование конкурентной продукции



**ContiTech**

VALEO	2546999	AP9036
VALEO	2547439	AP9002
VALEO	2547655	AP9039
VALEO	2547737	AP9055
VALEO	2547917	AP9038
VALEO	2548543	AP9031
VALEO	2548543A	AP9031
VALEO	2548621	AP9043
VALEO	2549800	AP9010
VALEO	2549858	AP9009
VALEO	2600001	AP9039
VALEO	2600161	AP9035
VALEO	2601052	AP9013
VALEO	2601991	AP9011
VALEO	2602484	AP9012
VALEO	2602751	AP9014
VALEO	2602877	AP9031
VALEO	2602881	AP9025
VALEO	2602911	AP9001
VALEO	2603341	AP9021
VALEO	2603530	AP9019
VALEO	2604126	AP9050
VALEO	2604211	AP9025
VALEO	2604332	AP9021
VALEO	2604504	AP9001
VALEO	2604640	AP9050
VALEO	2604787	AP9022
VALEO	2605442	AP9035
VALEO	2610606	AP9014
VALEO	2655139	AP9060
VALEO	593493	AP9055
VALEO	593515	AP9001
VALEO	593600	AP9001
VALEO	593891	AP9035
VALEO	593999	AP9001
VALEO	595203	AP9055





Power Transmission Group  
Our Drive – Your Success



# New products

2012 / 2013

Zuordnungsliste  
Generatorfreilauf &  
Torsionsschwingungsdämpfer

Application guide  
Overrunning alternator pulley &  
Torsional vibration damper

Liste de correspondance  
Roue libre d'alternateur &  
Armortisseur de vibrations de torsion

Lista de aplicaciones  
Polea libre del alternador &  
Amortiguador de vibraciones de torsión

Elenco di corrispondenza  
Ruota libera dell'alternatore &  
Puleggia smorzatrice per vibrazioni torsionali

Таблица применяемости  
Муфта свободного хода генератора &  
Гаситель крутильных колебаний



**Inhaltsverzeichnis**  
**Content**  
**Sommaire**  
**Indice**  
**Indice**  
**Содержание**



Zuordnungsliste PKW

Application guide  
for passenger cars

Liste de correspondance  
voitures de tourisme

Lista de aplicaciones  
para turismos

Elenco di correlazione  
per autovetture

Таблица применяемости  
легковые автомобили

41	___	ALFA ROMEO
42	___	AUDI
62	___	BMW
70	___	CHRYSLER
70	___	CITROËN
86	___	DACIA
88	___	FIAT
94	___	FORD
100	___	HYUNDAI
101	___	KIA
101	___	LANCIA
103	___	LAND ROVER
103	___	LOTUS
103	___	MAZDA
104	___	MERCEDES-BENZ
128	___	MG
129	___	MINI
129	___	MITSUBISHI
129	___	NISSAN
132	___	OPEL
140	___	PEUGEOT
157	___	RENAULT
166	___	ROVER
166	___	SAAB
167	___	SEAT
175	___	SG AUTOMOTIVE
175	___	SKODA
182	___	SMART
183	___	SUZUKI
183	___	TOYOTA
184	___	VAUXHALL
190	___	VOLVO
194	___	VW



## ALFA ROMEO

<b>145 (930)</b>									
1.9 JTD	02/99-01/01	AR32302	77	1910	AP9058	ALT, (Magneti-Marelli), 100A			VD1065
<b>146 (930)</b>									
1.9 JTD	02/99-01/01	AR32302	77	1910	AP9058	ALT, (Magneti-Marelli), 100A			VD1065
<b>147 (937)</b>									
1.9 JTD	06/03-	182B9.000	74	1910	AP9017	ALT, (Denso), OE-NO 60816557, 105A			VD1065
1.9 JTD (937AXD1A)	04/01-	937A2.000	85	1910	AP9017	ALT, (Denso), OE-NO 60816557, 105A			VD1065
1.9 JTD 16V	09/03-09/04	937A4.000	93	1910	AP9017	ALT, (Denso), OE-NO 46782213, 105A			VD1065
	10/04-	192B1.000	100	1910					VD1065
	11/02-	192A5.000	103	1910	AP9017	ALT, (Denso), OE-NO 46782213, 105A			VD1065
1.9 JTDM 16V	07/05-	937A5.000	110	1910					VD1065
	10/04-	939A7.000	85	1910	AP9017	ALT, (Denso), OE-NO 46782213, 105A			VD1065
1.9 JTDM 8V	07/05-	937A3.000	88	1910					VD1065
<b>156 (932)</b>									
1.9 JTD	09/04-09/05	937A5.000	110	1910					VD1065
1.9 JTD (932A2B, 932A2C)	05/01-09/05	937A2.000	85	1910	AP9017	ALT, (Denso), OE-NO 60816557, 105A			VD1065
1.9 JTD (932A2B_)	10/00-05/01	AR37101	81	1910	AP9017	ALT, (Denso), OE-NO 60816557, 105A			VD1065
1.9 JTD (932B2)	09/97-10/00	AR32302	77	1910	AP9058	ALT, (Magneti-Marelli), 100A			VD1065
1.9 JTD 16V	11/02-09/05	192A5.000	103	1910					VD1065
2.4 JTD	10/03-09/05	841G.000	129	2387	AP9017	ALT, (Denso), OE-NO 46809068, 120A ALT, PS, AC			6PK1760D1 VD1064
2.4 JTD (932A1B_)	10/00-09/05	839A6.000	103	2387		ALT, PS, AC			6PK1760D1 VD1064
2.4 JTD (932AXC)	03/02-09/05	841C000	110	2387		ALT, PS, AC			6PK1760D1 VD1064
2.4 JTD (932B1)	09/97-10/00	AR32501	100	2387	AP9058	ALT, (Magneti-Marelli), 100A 04/2000⇒, MTR-NO 1904013⇒, ALT, PS, AC			6PK1760D1 VD1064
<b>156 Sportwagon (932)</b>									
1.9 JTD	03/05-05/06	937A5.000	110	1910					VD1065
1.9 JTD (932B2)	05/00-10/00	AR32302	77	1910	AP9058	ALT, (Magneti-Marelli), 100A			VD1065
1.9 JTD (932B2B, 932B2C)	05/01-05/06	937A2.000	85	1910					VD1065
1.9 JTD (932B2B_)	10/00-05/01	AR37101	81	1910					VD1065
1.9 JTD 16V	11/02-05/06	192A5.000	103	1910					VD1065
1.9 JTD 16V Q4	07/04-05/06	937A5.000	110	1910	AP9017 AP9017	ALT, (Denso), OE-NO 46809068, 120A ALT, (Denso), OE-NO 46823540, 140A			VD1065
2.4 JTD	10/03-05/06	841G.000	129	2387		ALT, PS, AC			6PK1760D1 VD1064
2.4 JTD (932B1)	05/00-10/00	AR32501	100	2387	AP9058	ALT, (Magneti-Marelli), 100A MTR-NO 1904013⇒, ALT, PS, AC			6PK1760D1 VD1064
2.4 JTD (932B1B_)	10/00-05/06	839A6.000	103	2387		ALT, PS, AC			6PK1760D1 VD1064
2.4 JTD (932BXC)	03/02-05/06	841C000	110	2387		ALT, PS, AC			6PK1760D1 VD1064
<b>159</b>									
1.9 JTDM 16V	09/05-	939A8.000, 937A8.000	100	1910	AP9017 AP9017	ALT, (Denso), OE-NO 73501591, 140A ALT, (Denso), OE-NO 73503235, 120A			VD1065 VD1065
1.9 JTDM 8V	09/05-	939A1.000	88	1910	AP9017 AP9017	ALT, (Denso), OE-NO 73501591, 140A ALT, (Denso), OE-NO 73503235, 120A			VD1065
2.0 JTDM	05/09-	939B3.000	125	1956					VD1065
	06/10-	939B4.000	100	1956					VD1065
2.4 JTDM	05/07-	939A9.000	154	2387					VD1064
	09/05-	939A3.000	147	2387					VD1064
2.4 JTDM Q4	05/07-	939A9.000	154	2387					VD1064
<b>159 Sportwagon</b>									
1.9 JTDM 16V	03/06-	937A8.000	100	1910	AP9017 AP9017	ALT, (Denso), OE-NO 73501591, 140A ALT, (Denso), OE-NO 73503235, 120A			VD1065 VD1065
		939A2.000	110	1910					VD1065





## ALFA ROMEO

### 159 Sportwagon

1.9 JTDM 8V	03/06-	939A1.000	88	1910	<b>AP9017</b> <b>AP9017</b>	ALT, (Denso), OE-NO 73501591, 140A ALT, (Denso), OE-NO 73503235, 120A	<b>VD1065</b>
2.0 JTDM	05/09- 06/10-	939B3.000 939B4.000	125 100	1956 1956			<b>VD1065</b> <b>VD1065</b>
2.4 JTDM	03/06- 05/07-	939A3.000 939A9.000	147 154	2387 2387			<b>VD1064</b> <b>VD1064</b>
2.4 JTDM Q4	05/07-	939A9.000	154	2387			<b>VD1064</b>
<b>166 (936)</b>							
2.4 JTD	04/02- 07/05- 07/06- 10/03-	841C000 936B.000, 841M.000 841M.000 841G.000, 841H.000	110 136 132 129	2387 2387 2387 2387			<b>VD1064</b> <b>VD1064</b> <b>VD1064</b> <b>VD1064</b>
2.4 JTD (936A2A )	09/98-10/00	AR34202	100	2387			<b>VD1064</b>
2.4 JTD (936A2B )	10/00-	839A6.000	103	2387			<b>VD1064</b>
<b>BRERA</b>							
2.0 JTDM	05/09-	939B3.000	125	1956			<b>VD1065</b>
2.4 JTDM 20V	01/06- 05/07-	939A3.000 939A9.000	147 154	2387 2387			<b>VD1064</b> <b>VD1064</b>
<b>GIULIETTA (940)</b>							
1.6 JTDM	04/10-	940A3.000	77	1598			<b>VD1065</b>
2.0 JTDM	04/10-	940A4.000	125	1956		OE-NO 71747797	<b>VD1065</b>
<b>GT</b>							
1.9 JTD	11/03-	937A5.000	110	1910	<b>AP9017</b>	ALT, (Denso), OE-NO 46782213, 105A	<b>VD1065</b>
<b>MITO (955)</b>							
1.6 JTDM	09/08-	198A2.000, 955A3.000	88	1598			<b>VD1065</b>
<b>SPIDER (939)</b>							
2.0 JTDM	05/09-	939B3.000	125	1956			<b>VD1065</b>
2.4 JTDM	03/08- 04/07-	939A3.000 939A3.000	154 147	2387 2387			<b>VD1064</b> <b>VD1064</b>

## AUDI

### 80 (8C, B4)

1.9 TD	09/91-12/94	AAZ	55	1896			<b>VD1084</b>
1.9 TDI	09/91-12/94	1Z	66	1896			<b>VD1084</b>
<b>80 Avant (8C, B4)</b>							
1.9 TD	09/91-12/94	AAZ	55	1896			<b>VD1084</b>
1.9 TDI	07/92-01/96	1Z	66	1896			<b>VD1084</b>
<b>A1 (8X1)</b>							
1.6 TDI	05/10-	CAYC	77	1598			<b>VD1111</b>
<b>A2 (8Z0)</b>							
1.4 TDI	02/00-08/05	AMF, BHC	55	1422	<b>AP9001</b>	ALT, (Bosch,Valeo), 90A, 120A	
<b>A3 (8L1)</b>							
1.6	08/00- 09/96-08/00	AVU, BFQ AEH, AKL, APF	75 74	1595 1595	<b>AP9001</b> <b>AP9001</b>	ALT, (Bosch,Valeo), 120A ALT, CH-NO 8L-W-095 001⇨, (Bosch), 120A	
1.8	09/96-	AGN, APG	92	1781	<b>AP9001</b>	ALT, CH-NO 8L-W-095 001⇨, (Bosch,Valeo), (Hitachi), 120A	<b>VD1107</b>
1.8 T	12/96- 12/98-	AGU, AQA, ARZ, AUM AJQ, APP, ARY, AUQ	110 132	1781 1781	<b>AP9001</b> <b>AP9001</b>	ALT, CH-NO 8L-W-095 001⇨, (Bosch), 120A ALT, MTR-CODE: AGU, AUM, (Valeo,Hitachi), 120A ALT, CH-NO 8L-W-095 001⇨, (Bosch), 120A	<b>VD1107</b> <b>VD1107</b>
1.8 T quattro	10/98- 12/96-	AJQ, ARY AGU, AQA, ARX	132 110	1781 1781	<b>AP9001</b> <b>AP9001</b>	ALT, CH-NO 8L-W-095 001⇨, (Bosch), 120A ALT, MTR-CODE: ARY, (Valeo,Hitachi), 120A ALT, CH-NO 8L-W-095 001⇨, (Bosch), 120A ALT, MTR-CODE: AGU, ARX, (Valeo,Hitachi), 120A	<b>VD1107</b> <b>VD1107</b>
1.9 TDI	08/00- 08/97-07/01	ASZ AHF, ASV	96 81	1896 1896	<b>AP9001</b> <b>AP9001</b>	ALT, (Bosch), 70A, 90A, 120A ALT, (Valeo,Hitachi), 120A ALT, (Hitachi), 120A ALT, CH-NO 8L-W-095 001⇨,	<b>VD1091</b>





## AUDI

**A3 (8L1)**

					<b>AP9016</b>	(Bosch,Valeo), 70A, 90A, 120A ALT, MTR-CODE: AHF, ⇒CH-NO 8L-W-010 000, (Bosch), 70A	
					<b>AP9016</b>	ALT, MTR-CODE: AHF, ⇒CH-NO 8L-W-095 000, (Bosch), 90A, 120A MTR-CODE: ASV, AHF, CH-NO 8L-3-070 001⇒, 8L-31222 001⇒ MTR-CODE: ASV, AHF, ⇒CH-NO 8L-3-070 000, 8L-31222 000	<b>VD1076</b> <b>VD1089</b>
	09/96-07/01	AGR, ALH	66	1896	<b>AP9001</b>	ALT, CH-NO 8L-W-095 001⇒, (Bosch,Valeo), 70A, 90A, 120A	
					<b>AP9016</b>	ALT, ⇒CH-NO 8L-W-010 000, (Bosch), 70A	
					<b>AP9016</b>	ALT, ⇒CH-NO 8L-W-095 000, (Bosch), 90A, 120A MTR-CODE: ALH, CH-NO 8L-3-070 001⇒, 8L-31222 001⇒ MTR-CODE: AGR MTR-CODE: ALH, ⇒CH-NO 8L-3-070 000, 8L-31222 000	<b>VD1076</b> <b>VD1089</b> <b>VD1089</b>
	10/00-	ATD, AXR	74	1896	<b>AP9001</b>	ALT, (Bosch), 70A, 90A, 120A	
					<b>AP9001</b>	ALT, (Valeo,Hitachi), 120A	<b>VD1091</b>
1.9 TDI quattro	08/00-	ASZ	96	1896	<b>AP9001</b>	ALT, (Bosch), 70A, 90A, 120A	
					<b>AP9001</b>	ALT, (Valeo,Hitachi), 120A	<b>VD1091</b>
S3 quattro	03/99-	APY, AMK, AUL	154	1781	<b>AP9001</b>	ALT, CH-NO 8L-W-095 001⇒, (Bosch), 120A	
					<b>AP9001</b>	ALT, MTR-CODE: AMK, (Valeo,Hitachi), 120A	
<b>A3 (8P1)</b>							
1.4 TFSI	09/07-	CAXC, CMSA	92	1390	<b>AP9012</b>	(Bosch), OE-NO 03C 903 023 A, 140A	
					<b>AP9012</b>	(Valeo), OE-NO 03C 903 023 C, 140A	
					<b>AP9012</b>	(Valeo), OE-NO 03C 903 023 G, 110A	
					<b>AP9012</b>	ALT	
1.6	05/03-	BGU, BSE, BSF, CCSA, CMXA	75	1595	<b>AP9001</b>	ALT, (Bosch,Valeo), 140A	
1.6 TDI	05/09-	CAYB	66	1598		MTR-CODE: CAYB, CAYC, ⇒10/2009	<b>VD1076</b>
						MTR-CODE: CAYB, CAYC, 11/2009⇒	<b>VD1111</b>
		CAYC	77	1598		MTR-CODE: CAYB, CAYC, ⇒10/2009	<b>VD1076</b>
						MTR-CODE: CAYB, CAYC, 11/2009⇒	<b>VD1111</b>
1.8 TFSI	11/06-	BYT, BZB, CDA A	118	1798	<b>AP9009</b>	ALT, (Bosch), 140A, OE-NO 06B903016AB	
					<b>AP9009</b>	ALT, (Valeo), 140A, OE-NO 06D903016A, 06J903023C, 06H903017E	
1.8 TFSI quattro	07/08-	CDA A	118	1798	<b>AP9009</b>	ALT, (Bosch), 140A, OE-NO 06B903016AB	
					<b>AP9009</b>	ALT, (Valeo), 140A, OE-NO 06D903016A, 06J903023C, 06H903017E	
1.9 TDI	05/03-	BKC, BLS, BXE	77	1896	<b>AP9001</b>	ALT, (Bosch,Valeo), 110A, 140A ALT, (AC)	<b>6PK1050D2</b> <b>VD1076</b>
2.0 FSI	05/03-	AXW, BLX, BLY, BMB, BLR, BVY, BVZ	110	1984	<b>AP9001</b>	ALT, (Bosch,Valeo), 140A	<b>VD1107</b>
2.0 TDI	03/06-	BMN, CBBB, CFG B	125	1968		MTR-CODE: BMN, ALT, (AC) MTR-CODE: BMN, CBBB MTR-CODE: CFG B	<b>6PK1050D2</b> <b>VD1076</b> <b>VD1111</b>
	05/03-	AZV, CBAA, CFFA	100	1968	<b>AP9001</b>	ALT, (Bosch,Valeo), 140A MTR-CODE: AZV, BKD, ALT, (AC) MTR-CODE: AZV, BKD, CBAA, CBAB MTR-CODE: CFFA, CFFB	<b>6PK1050D2</b> <b>VD1076</b> <b>VD1111</b>
	06/05-	BMM	103	1968		ALT, (AC)	<b>6PK1050D2</b> <b>VD1076</b>
	06/06-06/08	BUY	120	1968		ALT, (AC)	<b>6PK1050D2</b> <b>VD1076</b>
2.0 TDI quattro	01/06-	BMM	103	1968		ALT, (AC)	<b>6PK1050D2</b> <b>VD1076</b>
2.0 TDI 16V	05/03-	BKD, CBAB, CFFB, CLJA	103	1968	<b>AP9001</b>	ALT, (Bosch,Valeo), 110A, 140A MTR-CODE: AZV, BKD, ALT, (AC) MTR-CODE: AZV, BKD, CBAA, CBAB MTR-CODE: CFFA, CFFB, CLJA	<b>6PK1050D2</b> <b>VD1076</b> <b>VD1111</b>
2.0 TDI 16V quattro	08/04-	BKD, CBAB, CFFB	103	1968	<b>AP9001</b>	ALT, (Bosch,Valeo), 110A, 140A MTR-CODE: AZV, BKD, ALT, (AC) MTR-CODE: AZV, BKD, CBAA, CBAB MTR-CODE: CFFA, CFFB	<b>6PK1050D2</b> <b>VD1076</b> <b>VD1111</b>





## AUDI

A3 (8P1)							
2.0 TDI quattro	03/06-	BMN, CBBB, CFCB	125	1968		MTR-CODE: BMN, ALT, (AC) MTR-CODE: BMN, CBBB MTR-CODE: CFCB	6PK1050D2 VD1076 VD1111
	05/03-	AZV	100	1968	AP9001	ALT, (Bosch,Valeo), 110A, 140A MTR-CODE: AZV, BKD, ALT, (AC) MTR-CODE: AZV, BKD, CBAA, CBAB MTR-CODE: CFFA, CFFB, CLJA	6PK1050D2 VD1076 VD1111
2.0 TFSI	09/04-	AXX, BWA, CAWB, CCZA	147	1984	AP9001 AP9009 AP9009	ALT, (Bosch,Valeo), 140A ALT, (Bosch), 140A, OE-NO 06B903016AB ALT, (Valeo), 140A, OE-NO 06D903016A, 06J903023C, 06H903017E, MTR-CODE: CAWB, CCZA	
2.0 TFSI quattro	09/04-	AXX, BWA, CCZA	147	1984	AP9001 AP9009 AP9009	ALT, (Bosch,Valeo), 140A ALT, (Bosch), 140A, OE-NO 06B903016AB ALT, (Valeo), 140A, OE-NO 06D903016A, 06J903023C, 06H903017E, MTR-CODE: CCZA	
3.2 V6 quattro	07/03-	BDB, BMJ, BUB	184	3189	AP9001 AP9022	ALT, (Bosch,Valeo), 140A ALT, (Valeo), 140A, OE-NO 06F903023P	
A3 Cabriolet							
1.6 TDI	05/09-	CAYC	77	1598		MTR-CODE: CAYB, CAYC, ⇨10/2009 MTR-CODE: CAYB, CAYC, 11/2009⇨	VD1076 VD1111
1.8 TFSI	04/08-	BZB, CDAA	118	1798	AP9009 AP9009	ALT, (Bosch), 140A, OE-NO 06B903016AB ALT, (Valeo), 140A, OE-NO 06D903016A, 06J903023C, 06H903017E	
1.9 TDI	04/08-	BLS	77	1896		ALT, (AC)	6PK1050D2 VD1076
2.0 TDI	04/08-	CBAA, CFFA	100	1968		MTR-CODE: CBAA, CBAB MTR-CODE: CFFA, CFFB	VD1076 VD1111
		CBAB, CFFB	103	1968		MTR-CODE: CBAA, CBAB MTR-CODE: CFFA, CFFB	VD1076 VD1111
2.0 TFSI	04/08-	CAWB, CCZA	147	1984	AP9009 AP9009	ALT, (Bosch), 140A, OE-NO 06B903016AB ALT, (Valeo), 140A, OE-NO 06D903016A, 06J903023C, 06H903017E, MTR-CODE: CCZA, CAWB,	
A3 Sportback (8PA)							
1.4 TFSI	09/07-	CAXC, CMSA	92	1390	AP9012 AP9012 AP9012 AP9012	(Bosch), OE-NO 03C 903 023 A, 140A (Valeo), OE-NO 03C 903 023 C, 140A (Valeo), OE-NO 03C 903 023 G, 110A ALT	
1.6	09/04-	BGU, BSE, BSF, CCSA, CMXA	75	1595	AP9001	ALT, (Bosch,Valeo), 140A	
1.6 TDI	05/09-	CAYB	66	1598		MTR-CODE: CAYB, CAYC, ⇨10/2009 MTR-CODE: CAYB, CAYC, 11/2009⇨	VD1076 VD1111
		CAYC	77	1598		MTR-CODE: CAYB, CAYC, ⇨10/2009 MTR-CODE: CAYB, CAYC, 11/2009⇨	VD1076 VD1111
1.8 TFSI	11/06-	BYT, BZB, CDAA	118	1798	AP9009 AP9009	ALT, (Bosch), 140A, OE-NO 06B903016AB ALT, (Valeo), 140A, OE-NO 06D903016A, 06J903023C, 06H903017E	
1.8 TFSI quattro	07/08-	CDAA	118	1798	AP9009 AP9009	ALT, (Bosch), 140A, OE-NO 06B903016AB ALT, (Valeo), 140A, OE-NO 06D903016A, 06J903023C, 06H903017E	
1.9 TDI	09/04-	BKC, BLS, BXE	77	1896	AP9001	ALT, (Bosch,Valeo), 110A, 140A ALT, (AC)	6PK1050D2 VD1076
2.0 FSI	09/04-	BLX, BLY, BMB, BLR, BVY, BVZ	110	1984	AP9001	ALT, (Bosch,Valeo), 140A	VD1107
2.0 TDI	03/06-	BMN, CBBB, CFCB	125	1968		MTR-CODE: BMN, ALT, (AC) MTR-CODE: BMN, CBBB MTR-CODE: CFCB	6PK1050D2 VD1076 VD1111
	06/05-	BMM	103	1968		ALT, (AC)	6PK1050D2 VD1076
	06/06-06/08	BUY	120	1968		ALT, (AC)	6PK1050D2 VD1076
	09/04-	AZV, CBAA, CFFA	100	1968	AP9001	ALT, (Bosch,Valeo), 110A MTR-CODE: AZV, BKD, ALT, (AC)	6PK1050D2



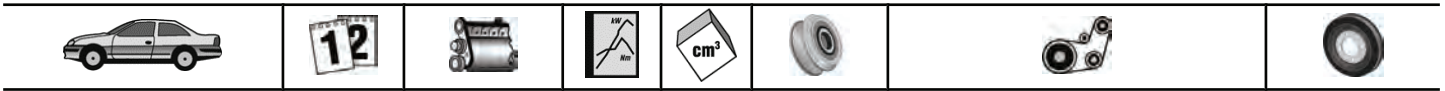

## AUDI

### A3 Sportback (8PA)

						MTR-CODE: AZV, BKD, CBAA, CBAB MTR-CODE: CFFA, CFFB ALT, (AC)	<b>VD1076</b> <b>VD1111</b> <b>6PK1050D2</b> <b>VD1076</b>
2.0 TDI quattro	01/06-	BMM	103	1968			
2.0 TDI 16V	09/04-	BKD, CBAB, CFFB, CLJA	103	1968	<b>AP9001</b>	ALT, (Bosch,Valeo), 110A, 140A MTR-CODE: AZV, BKD, ALT, (AC) MTR-CODE: AZV, BKD, CBAA, CBAB MTR-CODE: CFFA, CFFB, CLJA	<b>6PK1050D2</b> <b>VD1076</b> <b>VD1111</b>
2.0 TDI 16V quattro	11/05-	BKD, CBAB, CFFB	103	1968	<b>AP9001</b>	ALT, (Bosch,Valeo), 110A, 140A MTR-CODE: AZV, BKD, ALT, (AC) MTR-CODE: AZV, BKD, CBAA, CBAB MTR-CODE: CFFA, CFFB	<b>6PK1050D2</b> <b>VD1076</b> <b>VD1111</b>
2.0 TDI quattro	03/06-	BMN, CBBB, CFCB	125	1968		MTR-CODE: BMN, ALT, (AC) MTR-CODE: BMN, CBBB MTR-CODE: CFCB	<b>6PK1050D2</b> <b>VD1076</b> <b>VD1111</b>
2.0 TFSI	09/04-	AXX, BWA, BPY, CAWB, CCZA, CBFA	147	1984	<b>AP9001</b> <b>AP9009</b> <b>AP9009</b>	ALT, (Bosch,Valeo), 140A ALT, (Bosch), 140A, OE-NO 06B903016AB ALT, (Valeo), 140A, OE-NO 06D903016A, 06J903023C, 06H903017E, MTR-CODE: CAWB, CCZA	
2.0 TFSI quattro	09/04-	AXX, BWA, CCZA	147	1984	<b>AP9001</b> <b>AP9009</b> <b>AP9009</b>	ALT, (Bosch,Valeo), 140A ALT, (Bosch), 140A, OE-NO 06B903016AB ALT, (Valeo), 140A, OE-NO 06D903016A, 06J903023C, 06H903017E, MTR-CODE: CCZA	
3.2 V6 quattro	09/04-	BMJ, BUB	184	3189	<b>AP9001</b> <b>AP9022</b>	ALT, (Bosch,Valeo), 140A ALT, (Valeo), 140A, OE-NO 06F903023P	

### A4 (8D2, B5)

1.6	01/95-07/00	ADP, AHL, ANA, ARM	74	1595	<b>AP9002</b> <b>AP9007</b>	ALT, MTR-CODE: AHL, ANA, ARM, (Valeo), 120A ALT, MTR-CODE: AHL, ANA, ARM, (Bosch), 120A	
	07/00-11/00	ALZ	75	1595	<b>AP9007</b>	ALT, CH-NO 8D-X-200 001⇔, (Bosch), 120A	
1.8	01/95-11/00	ADR, APT, ARG, AVV	92	1781	<b>AP9002</b> <b>AP9007</b>	ALT, (Valeo), 120A ALT, CH-NO 8D-X-200 001⇔, (Bosch), 120A	
	04/95-11/00	AFY	85	1781	<b>AP9002</b> <b>AP9007</b>	ALT, (Valeo), 120A ALT, CH-NO 8D-X-200 001⇔, (Bosch), 120A	
	05/00-09/00	AMB	125	1781	<b>AP9009</b> <b>AP9009</b>	ALT, (Bosch), 120A, OE-NO 06B903016P, 140A, OE-NO 06B903016AB, 150A, OE-NO 06B903016Q ALT, (Valeo), 120A, OE-NO 06B903016AE, 140A, OE-NO 06B903016AF, 150A, OE-NO 06B903016AC	
1.8 quattro	01/95-11/00	ADR, APT, ARG	92	1781	<b>AP9002</b> <b>AP9007</b>	ALT, (Valeo), 120A ALT, CH-NO 8D-X-200 001⇔, (Bosch), 120A	
	07/95-11/00	AFY	85	1781	<b>AP9002</b> <b>AP9007</b>	ALT, (Valeo), 120A ALT, CH-NO 8D-X-200 001⇔, (Bosch), 120A	
1.8 T	01/95-11/00	AEB, ARK, ANB, APU, AWT	110	1781	<b>AP9002</b> <b>AP9007</b>	ALT, MTR-CODE: AEB, ANB, APU, AWT, (Valeo), 120A ALT, MTR-CODE: AEB, ANB, APU, AWT, CH-NO 8D-X-200 001⇔, (Bosch), 120A	
	12/97-11/00	AJL	132	1781	<b>AP9002</b> <b>AP9007</b>	ALT, (Valeo), 120A ALT, CH-NO 8D-X-200 001⇔, (Bosch), 120A	
1.8 T quattro	01/95-11/00	AEB, ARK, ANB, APU, AWT	110	1781	<b>AP9002</b> <b>AP9007</b>	ALT, MTR-CODE: AEB, ANB, APU, AWT, (Valeo), 120A ALT, MTR-CODE: AEB, ANB, APU, AWT, CH-NO 8D-X-200 001⇔, (Bosch), 120A	
	12/97-11/00	AJL	132	1781	<b>AP9002</b> <b>AP9007</b>	ALT, (Valeo), 120A ALT, CH-NO 8D-X-200 001⇔, (Bosch), 120A	
1.9 TDI	01/95-11/00	1Z, AHU, AHH	66	1896	<b>AP9002</b> <b>AP9002</b>	ALT, CH-NO 8D-X-200 001⇔, (Bosch,Valeo), 90A ALT, CH-NO 8D-X-200 001⇔, ⇔CH-NO 8D-X-400 000, (Bosch,Valeo), 120A	





**AUDI**

A4 (8D2, B5)

	03/00-11/00	AJM	85	1896	AP9032	ALT, ⇒CH-NO 8D-X-199 999, (Bosch), 70A, 90A, 120A	
					AP9002	ALT, CH-NO 8D-X-200 001⇒, (Bosch,Valeo), 90A	
					AP9002	ALT, CH-NO 8D-X-200 001⇒, ⇒CH-NO 8D-X-400 000, (Bosch,Valeo), 120A	
					AP9032	ALT, ⇒CH-NO 8D-X-199 999, (Bosch), 70A, 90A, 120A	VD1090
	10/95-11/00	AFN, AVG	81	1896	AP9002	ALT, CH-NO 8D-X-200 001⇒, (Bosch,Valeo), 90A	
					AP9002	ALT, CH-NO 8D-X-200 001⇒, ⇒CH-NO 8D-X-400 000, (Bosch,Valeo), 120A	
					AP9032	ALT, MTR-CODE: AFN, ⇒CH-NO 8D-X-199 999, (Bosch), 70A, 90A, 120A	
	12/95-11/00	AFF	55	1896	AP9002	ALT, CH-NO 8D-X-200 001⇒, (Bosch,Valeo), 90A	
					AP9002	ALT, CH-NO 8D-X-200 001⇒, ⇒CH-NO 8D-X-400 000, (Bosch,Valeo), 120A	
					AP9032	ALT, ⇒CH-NO 8D-X-199 999, (Bosch), 70A, 90A, 120A	
1.9 TDI quattro	03/00-11/00	AJM, ATJ	85	1896	AP9002	ALT, CH-NO 8D-X-200 001⇒, (Bosch,Valeo), 90A	
					AP9002	ALT, CH-NO 8D-X-200 001⇒, ⇒CH-NO 8D-X-400 000, (Bosch,Valeo), 120A	
					AP9032	ALT, MTR-CODE: AJM, ⇒CH-NO 8D-X-199 999, (Bosch), 70A, 90A, 120A	VD1090
	09/96-11/00	AFN, AVG	81	1896	AP9002	ALT, CH-NO 8D-X-200 001⇒, (Bosch,Valeo), 90A	
					AP9002	ALT, CH-NO 8D-X-200 001⇒, ⇒CH-NO 8D-X-400 000, (Bosch,Valeo), 120A	
					AP9032	ALT, MTR-CODE: AFN, ⇒CH-NO 8D-X-199 999, (Bosch), 70A, 90A, 120A	
2.5 TDI	09/97-11/00	AFB, AKN	110	2496		ALT, PS, AC, CH-NO 8D-Y-100 718⇒	6PK2404D1 VD1032
2.5 TDI quattro	09/97-11/00	AFB, AKN	110	2496		ALT, PS, AC, CH-NO 8D-Y-100 718⇒	6PK2404D1 VD1032
A4 (8E2, B6) 1.6	11/00-12/04	ALZ	75	1595	AP9009	ALT, (Bosch), 120A, OE-NO 06B903016P, 140A, OE-NO 06B903016AB, 150A, OE-NO 06B903016Q	
					AP9009	ALT, (Valeo), 140A, OE-NO 06B903016AF, 150A, OE-NO 06B903016AC	
					AP9009	ALT, CH-NO 8E-3-024 776⇒, (Valeo), 120A, OE-NO 06B903016AE	
1.8 T	07/01-12/04	AMB	125	1781	AP9009	ALT, (Bosch), 120A, OE-NO 06B903016P, 140A, OE-NO 06B903016AB, 150A, OE-NO 06B903016Q	
					AP9009	ALT, (Valeo), 140A, OE-NO 06B903016AF, 150A, OE-NO 06B903016AC	
					AP9009	ALT, CH-NO 8E-3-024 776⇒, (Valeo), 120A, OE-NO 06B903016AE	
	07/02-12/04	BFB, BKB	120	1781	AP9009	ALT, (Bosch), 120A, OE-NO 06B903016P, 140A, OE-NO 06B903016AB, 150A, OE-NO 06B903016Q	
					AP9009	ALT, (Valeo), 140A, OE-NO 06B903016AF, 150A, OE-NO 06B903016AC	
					AP9009	ALT, CH-NO 8E-3-024 776⇒, (Valeo), 120A, OE-NO 06B903016AE	
					AP9009	MTR-CODE: BFB	VD1107
	11/00-07/02	AVJ	110	1781	AP9009	ALT, (Bosch), 120A, OE-NO 06B903016P, 140A, OE-NO 06B903016AB, 150A, OE-NO 06B903016Q	
					AP9009	ALT, (Valeo), 150A, OE-NO 06B903016AC	
	11/02-12/04	BEX	140	1781	AP9009	ALT, (Bosch), 120A, OE-NO 06B903016P, 140A, OE-NO 06B903016AB, 150A, OE-NO	





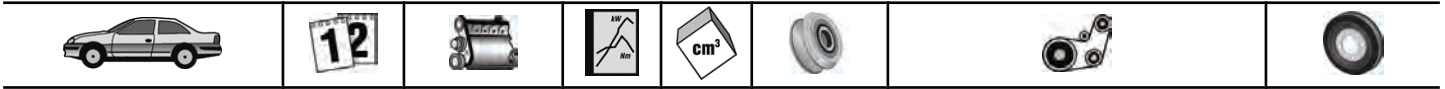

## AUDI

A4 (8E2, B6)

					<b>AP9009</b>	06B903016Q ALT, (Valeo), 140A, OE-NO 06B903016AF, 150A, OE-NO 06B903016AC	
					<b>AP9009</b>	ALT, CH-NO 8E-3-024 776⇒, (Valeo), 120A, OE-NO 06B903016AE	<b>VD1107</b>
1.8 T quattro	07/01-12/04	AMB	125	1781	<b>AP9009</b>	ALT, (Bosch), 120A, OE-NO 06B903016P, 140A, OE-NO 06B903016AB, 150A, OE-NO 06B903016Q	
					<b>AP9009</b>	ALT, (Valeo), 140A, OE-NO 06B903016AF, 150A, OE-NO 06B903016AC	
					<b>AP9009</b>	ALT, CH-NO 8E-3-024 776⇒, (Valeo), 120A	
					<b>AP9009</b>	ALT, CH-NO 8E-3-024 776⇒, (Valeo), 120A, OE-NO 06B903016AE	<b>VD1107</b>
	07/02-12/04	BFB	120	1781	<b>AP9009</b>	ALT, (Bosch), 120A, OE-NO 06B903016P, 140A, OE-NO 06B903016AB, 150A, OE-NO 06B903016Q	
					<b>AP9009</b>	ALT, (Valeo), 140A, OE-NO 06B903016AF, 150A, OE-NO 06B903016AC	
					<b>AP9009</b>	ALT, CH-NO 8E-3-024 776⇒, (Valeo), 120A, OE-NO 06B903016AE	<b>VD1107</b>
	11/00-07/02	AVJ	110	1781	<b>AP9009</b>	ALT, (Bosch), 120A, OE-NO 06B903016P, 140A, OE-NO 06B903016AB, 150A, OE-NO 06B903016Q	
					<b>AP9009</b>	ALT, (Valeo), 150A, OE-NO 06B903016AC	<b>VD1107</b>
	11/02-12/04	BEX	140	1781	<b>AP9009</b>	ALT, (Bosch), 120A, OE-NO 06B903016P, 140A, OE-NO 06B903016AB, 150A, OE-NO 06B903016Q	
					<b>AP9009</b>	ALT, (Valeo), 140A, OE-NO 06B903016AF, 150A, OE-NO 06B903016AC	
					<b>AP9009</b>	ALT, CH-NO 8E-3-024 776⇒, (Valeo), 120A, OE-NO 06B903016AE	<b>VD1107</b>
1.9 TDI	05/01-12/04	AVB	74	1896	<b>AP9001</b>	ALT, CH-NO 8E-4-000 001⇒, (Bosch,Valeo), 140A	
					<b>AP9002</b>	ALT, ⇒CH-NO 8E-3-500 000, (Bosch,Valeo), 140A, 150A	
						ALT, PS, (AC), CH-NO 8E-4-000 001⇒ CH-NO 8E-3-410 001⇒ ⇒CH-NO 8E-3-410 000	<b>6PK1610D1</b> <b>VD1076</b> <b>VD1090</b>
	06/04-12/04	BKE	85	1896	<b>AP9001</b>	ALT, (Bosch,Valeo), 140A	
						ALT, PS, (AC), CH-NO 8E-3-410 001⇒ CH-NO 8E-3-410 001⇒ ⇒CH-NO 8E-3-410 000	<b>6PK1610D1</b> <b>VD1076</b> <b>VD1090</b>
	11/00-12/04	AVF, AWX	96	1896	<b>AP9001</b>	ALT, MTR-CODE: AVF, CH-NO 8E-4-000 001⇒, (Bosch,Valeo), 140A	
					<b>AP9002</b>	ALT, (Bosch,Valeo), 140A, 150A, ⇒CH-NO 8E-3-500 000	
						ALT, PS, (AC), (AUTOM), MTR-CODE: AVF, CH-NO 8E-4-000 001⇒	<b>6PK1610D1</b>
						ALT, PS, (AC), (MANL), MTR-CODE: AWX, AVF, CH-NO 8E-4-010 001⇒	<b>6PK1610D1</b>
						CH-NO 8E-3-410 001⇒ ⇒CH-NO 8E-3-410 000	<b>VD1076</b> <b>VD1090</b>
1.9 TDI quattro	11/01-12/04	AVF	96	1896	<b>AP9001</b>	ALT, CH-NO 8E-4-000 001⇒, (Bosch,Valeo), 140A	
					<b>AP9002</b>	ALT, ⇒CH-NO 8E-3-500 000, (Bosch,Valeo), 140A, 150A	
						ALT, PS, (AC), (AUTOM), CH-NO 8E-4-000 001⇒	<b>6PK1610D1</b>
						ALT, PS, (AC), (MANL), CH-NO 8E-4-010 001⇒	<b>6PK1610D1</b>
						CH-NO 8E-3-410 001⇒ ⇒CH-NO 8E-3-410 000	<b>VD1076</b> <b>VD1090</b>
2.0	11/00-12/04	ALT	96	1984	<b>AP9009</b>	ALT, (Bosch), 120A, OE-NO 06B903016P, 140A, OE-NO	



**AUDI**
**A4 (8E2, B6)**

					<b>AP9009</b>	06B903016AB, 150A, OE-NO 06B903016Q ALT, (Valeo), 140A, OE-NO 06B903016AF, 150A, OE-NO 06B903016AC	
					<b>AP9009</b>	ALT, CH-NO 8E-3-024 776⇒, (Valeo), 120A, OE-NO 06B903016AE	<b>VD1107</b>
2.0 FSI	07/02-12/04	AWA	110	1984	<b>AP9009</b>	ALT, (Bosch), 120A, OE-NO 06B903016P, 140A, OE-NO 06B903016AB, 150A, OE-NO 06B903016Q	
					<b>AP9009</b>	ALT, (Valeo), 120A, OE-NO 06B903016AE, 140A, OE-NO 06B903016AF, 150A, OE-NO 06B903016AC	
					<b>AP9009</b>	ALT, CH-NO 8E-3-024 776⇒, (Valeo), 120A	<b>VD1107</b>
2.5 D	10/00-05/03	AKE	132	2496		ALT, PS, AC	<b>6PK2404D2</b>
2.5 TDI	07/02-12/04	BFC, BCZ, BDG	120	2496		ALT, PS, AC	<b>6PK2404D2</b> <b>VD1032</b>
	08/01-07/02	AYM	114	2496		ALT, PS, AC	<b>6PK2404D2</b> <b>VD1032</b>
2.5 TDI quattro	11/00-12/04	AKE, BAU, BDH	132	2496		ALT, PS, AC	<b>6PK2404D2</b> <b>VD1032</b>
<b>A4 (8EC)</b>							
1.6	11/04-	ALZ	75	1595	<b>AP9009</b>	ALT, (Bosch), 120A, OE-NO 06B903016P, 140A, OE-NO 06B903016AB	
					<b>AP9009</b>	ALT, (Valeo), 120A, OE-NO 06B903016AE, 140A, OE-NO 06B903016AF, 06D903016A, 150A, OE-NO 06B903016AC, 06D903016	
1.8 T	11/04-	BFB	120	1781	<b>AP9009</b>	ALT, (Bosch), 120A, OE-NO 06B903016P, 140A, OE-NO 06B903016AB	
					<b>AP9009</b>	ALT, (Valeo), 120A, OE-NO 06B903016AE, 140A, OE-NO 06B903016AF, 06D903016A, 150A, OE-NO 06B903016AC, 06D903016	<b>VD1107</b>
1.8 T quattro	11/04-	BFB	120	1781	<b>AP9009</b>	ALT, (Bosch), 120A, OE-NO 06B903016P, 140A, OE-NO 06B903016AB	
					<b>AP9009</b>	ALT, (Valeo), 120A, OE-NO 06B903016AE, 140A, OE-NO 06B903016AF, 06D903016A, 150A, OE-NO 06B903016AC, 06D903016	<b>VD1107</b>
1.9 TDI	11/04-	BKE, BRB	85	1896	<b>AP9001</b>	ALT, (Bosch,Valeo), 140A ALT, PS, (AC)	<b>6PK1610D1</b> <b>VD1076</b>
2.0	11/04-	ALT	96	1984	<b>AP9009</b>	ALT, (Bosch), 120A, OE-NO 06B903016P, 140A, OE-NO 06B903016AB	
					<b>AP9009</b>	ALT, (Valeo), 120A, OE-NO 06B903016AE, 140A, OE-NO 06B903016AF, 06D903016A, 150A, OE-NO 06D903016, 06B903016AC	<b>VD1107</b>
2.0 TDI	06/06-	BVA	120	1968		MTR-CODE: BVA, ALT	<b>6PK1610D1</b> <b>VD1076</b>
		BRD	125	1968		MTR-CODE: BRD, ALT, (AC)	<b>6PK1610D1</b> <b>VD1076</b>
	09/05-09/06	BVG	89	1968		MTR-CODE: BVG, ALT, (AC)	<b>6PK1610D1</b> <b>VD1076</b>
	11/04-	BNA, BRF	100	1968		MTR-CODE: BNA, BRF, ALT, PS, AC	<b>6PK1610D1</b> <b>VD1076</b>
		BPW	103	1968		ALT, PS, AC	<b>6PK1610D1</b> <b>VD1076</b>
2.0 TDi	11/05-10/07	BVF	93	1968		MTR-CODE: BVF, ALT	<b>6PK1610D1</b>
2.0 TDI 16V	11/04-	BLB, BRE	103	1968		MTR-CODE: BRE, BLB, ALT, PS, (AC)	<b>6PK1610D1</b> <b>VD1076</b>
2.0 TDI quattro	01/06-	BPW	103	1968		ALT, PS, AC	<b>6PK1610D1</b> <b>VD1076</b>
	06/06-	BVA	120	1968		MTR-CODE: BVA, ALT	<b>6PK1610D1</b> <b>VD1076</b>



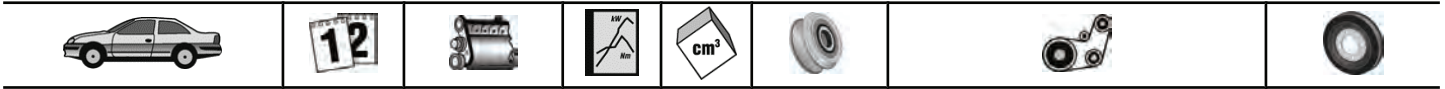

## AUDI

### A4 (8EC)

		BRD	125	1968		MTR-CODE: BRD, ALT, (AC)	<b>6PK1610D1</b> <b>VD1076</b>
2.0 TFSI	06/05-	BUL	162	1984	<b>AP9009</b>	ALT, (Bosch), 140A, OE-NO 06B903016AB	
					<b>AP9009</b>	ALT, (Valeo), 140A, OE-NO 06B903016AF, 06D903016A, 150A, OE-NO 06D903016	
	10/06-	BPJ, BYK	125	1984	<b>AP9009</b>	ALT, (Bosch), 140A, OE-NO 06B903016AB	
					<b>AP9009</b>	ALT, (Valeo), 140A, OE-NO 06B903016AF, 06D903016A, 150A, OE-NO 06D903016	
	11/04-	BGB, BWE, BWT, BPG	147	1984	<b>AP9009</b>	ALT, (Bosch), 140A, OE-NO 06B903016AB	
					<b>AP9009</b>	ALT, (Valeo), 140A, OE-NO 06B903016AF, 06D903016A, 150A, OE-NO 06D903016	
2.0 TFSI quattro	06/05-	BUL	162	1984	<b>AP9009</b>	ALT, (Bosch), 140A, OE-NO 06B903016AB	
					<b>AP9009</b>	ALT, (Valeo), 140A, OE-NO 06B903016AF, 06D903016A, 150A, OE-NO 06D903016	
	11/04-	BGB, BWE, BWT, BPG	147	1984	<b>AP9009</b>	ALT, (Bosch), 140A, OE-NO 06B903016AB	
					<b>AP9009</b>	ALT, (Valeo), 140A, OE-NO 06B903016AF, 06D903016A, 150A, OE-NO 06D903016	
2.5 TDI	11/04-05/06	BDG	120	2496		ALT, PS, AC	<b>6PK2404D2</b> <b>VD1032</b>
2.7 TDI	01/06-	BPP	132	2698		ALT, PS, AC, CH-NO 8E-6-252 205⇒ ALT, PS, AC, ⇒CH-NO 8E-6-252 204 MTR-CODE: BPP	<b>6PK2460D1</b> <b>6PK2490D1</b> <b>VD1033</b>
	11/05-	BSG	120	2698		CH-NO 8E-6-252205⇒, MTR-CODE: BSG MTR-CODE: BSG, ⇒CH-NO 8E-6-252204, ONLY WITH 059 145 201 F, ONLY WITH 059 903 137 AB	<b>VD1033</b>  <b>VD1033</b>
3.0 TDI quattro	01/06-	ASB	171	2967		ALT, PS, AC, CH-NO 8E-5-565001⇒ MTR-CODE: ASB	<b>6PK2460D1</b> <b>VD1033</b>
	11/04-	BKN	150	2967		ALT, PS, AC, CH-NO 8E-5-565001⇒ MTR-CODE: BKN	<b>6PK2460D1</b> <b>VD1033</b>

### A4 (8K2)

2.0 TDI	01/08-	CAHA	125	1968	<b>AP9022</b>	ALT, (Bosch), 140A, OE-NO 03G903016E	<b>VD1076</b>
2.0 TDi	06/08-	CAGC	88	1968	<b>AP9022</b>	ALT, (Bosch), 140A, OE-NO 03G903016E	<b>VD1076</b>
2.0 TDI	08/08-	CAHB	120	1968	<b>AP9022</b>	ALT, (Bosch), 140A, OE-NO 03G903016E	<b>VD1076</b>
	11/07-	CAGB, CJCB	100	1968	<b>AP9022</b>	ALT, (Bosch), 140A, OE-NO 03G903016E MTR-CODE: CAGA, CAGB, CAGC MTR-CODE: CJCB	<b>VD1076</b> <b>VD1111</b>
		CAGA, CMEA	105	1968	<b>AP9022</b>	ALT, (Bosch), 140A, OE-NO 03G903016E	<b>VD1076</b>
2.0 TDi quattro	01/08-	CAHA	125	1968	<b>AP9022</b>	ALT, (Bosch), 140A, OE-NO 03G903016E	<b>VD1076</b>
2.0 TDI quattro	11/08-	CAGA	105	1968	<b>AP9022</b>	ALT, (Bosch), 140A, OE-NO 03G903016E	<b>VD1076</b>

### A4 Allroad (8KH)

2.0 TDI quattro	04/09-	CAHB	120	1968	<b>AP9022</b>	ALT, (Bosch), 140A, OE-NO 03G903016E	<b>VD1076</b>
		CAHA	125	1968	<b>AP9022</b>	ALT, (Bosch), 140A, OE-NO 03G903016E	<b>VD1076</b>
	09/09-	CAGB	100	1968	<b>AP9022</b>	ALT, (Bosch), 140A, OE-NO 03G903016E	<b>VD1076</b>
		CAGA	105	1968	<b>AP9022</b>	ALT, (Bosch), 140A, OE-NO 03G903016E	<b>VD1076</b>



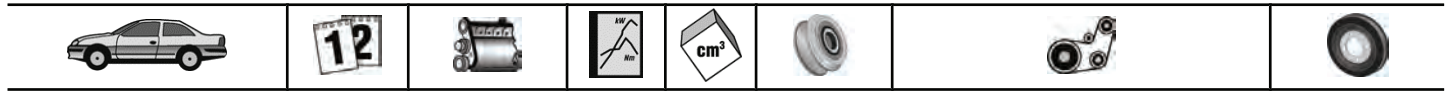

# AUDI

## A4 Avant (8D5, B5)

1.6	03/96-07/00	ADP, AHL, ANA, ARM	74	1595	AP9007	ALT, MTR-CODE: AHL, ANA, ARM, (Bosch), 120A	
	07/00-09/01	ALZ	75	1595	AP9007	ALT, CH-NO 8D-X-200 001⇔, (Bosch), 120A	
1.8	02/96-09/01	ADR, APT, ARG, AVV	92	1781	AP9002 AP9007	ALT, (Valeo), 120A ALT, CH-NO 8D-X-200 001⇔, (Bosch), 120A	
	07/95-09/01	AFY	85	1781	AP9002 AP9007	ALT, (Valeo), 120A ALT, CH-NO 8D-X-200 001⇔, (Bosch), 120A	
1.8 quattro	01/96-09/01	ADR, APT, ARG	92	1781	AP9002 AP9007	ALT, (Valeo), 120A ALT, CH-NO 8D-X-200 001⇔, (Bosch), 120A	
	07/95-09/01	AFY	85	1781	AP9002 AP9007	ALT, (Valeo), 120A ALT, CH-NO 8D-X-200 001⇔, (Bosch), 120A	
1.8 T	03/96-09/01	AEB, ARK, ANB, APU, AWT	110	1781	AP9002 AP9007	ALT, MTR-CODE: AEB, ANB, APU, AWT, (Valeo), 120A ALT, MTR-CODE: AEB, ANB, APU, AWT, CH-NO 8D-X-200 001⇔, (Bosch), 120A	
	12/97-09/01	AJL	132	1781	AP9002 AP9007	ALT, (Valeo), 120A ALT, CH-NO 8D-X-200 001⇔, (Bosch), 120A	
1.8 T quattro	01/96-09/01	AEB, ARK, ANB, APU, AWT	110	1781	AP9002 AP9007	ALT, MTR-CODE: AEB, ANB, APU, AWT, (Valeo), 120A ALT, MTR-CODE: AEB, ANB, APU, AWT, CH-NO 8D-X-200 001⇔, (Bosch), 120A	
	12/97-09/01	AJL	132	1781	AP9002 AP9007	ALT, (Valeo), 120A ALT, CH-NO 8D-X-200 001⇔, (Bosch), 120A	
1.9 TDI	02/96-09/01	1Z, AHU, AHH	66	1896	AP9002 AP9002 AP9032	ALT, CH-NO 8D-X-200 001⇔, (Bosch,Valeo), 90A ALT, CH-NO 8D-X-200 001⇔, ⇨CH-NO 8D-X-400 000, (Bosch,Valeo), 120A ALT, ⇨CH-NO 8D-X-199 999, (Bosch), 70A, 90A, 120A	
			81	1896	AP9002 AP9002 AP9032	ALT, CH-NO 8D-X-200 001⇔, (Bosch,Valeo), 90A ALT, CH-NO 8D-X-200 001⇔, ⇨CH-NO 8D-X-400 000, (Bosch,Valeo), 120A ALT, MTR-CODE: AFN, ⇨CH-NO 8D-X-199 999, (Bosch), 70A, 90A, 120A	
	03/00-09/01	AJM	85	1896	AP9002 AP9002 AP9032	ALT, CH-NO 8D-X-200 001⇔, (Bosch,Valeo), 90A ALT, CH-NO 8D-X-200 001⇔, ⇨CH-NO 8D-X-400 000, (Bosch,Valeo), 120A ALT, ⇨CH-NO 8D-X-199 999, (Bosch), 70A, 90A, 120A	VD1090
	03/96-09/01	AFF	55	1896	AP9002 AP9002 AP9032	ALT, CH-NO 8D-X-200 001⇔, (Bosch,Valeo), 90A ALT, CH-NO 8D-X-200 001⇔, ⇨CH-NO 8D-X-400 000, (Bosch,Valeo), 120A ALT, ⇨CH-NO 8D-X-199 999, (Bosch), 70A, 90A, 120A	
1.9 TDI quattro	03/00-09/01	AJM, ATJ	85	1896	AP9002 AP9002 AP9032	ALT, CH-NO 8D-X-200 001⇔, (Bosch,Valeo), 90A ALT, CH-NO 8D-X-200 001⇔, ⇨CH-NO 8D-X-400 000, (Bosch,Valeo), 120A ALT, MTR-CODE: AJM, ⇨CH-NO 8D-X-199 999, (Bosch), 70A, 90A, 120A	VD1090
	09/96-09/01	AFN, AVG	81	1896	AP9002 AP9002 AP9032	ALT, CH-NO 8D-X-200 001⇔, (Bosch,Valeo), 90A ALT, CH-NO 8D-X-200 001⇔, ⇨CH-NO 8D-X-400 000, (Bosch,Valeo), 120A ALT, MTR-CODE: AFN, ⇨CH-NO 8D-X-199 999, (Bosch), 70A, 90A, 120A	
2.5 TDI	09/97-09/01	AFB, AKN	110	2496		ALT, PS, AC, CH-NO 8D-Y-100 718⇔	6PK2404D1 VD1032
2.5 TDI quattro	09/97-09/01	AFB, AKN	110	2496		ALT, PS, AC, CH-NO 8D-Y-100 718⇔	6PK2404D1 VD1032
A4 Avant (8E5, B6) 1.6	09/01-12/04	ALZ	75	1595	AP9009	ALT, (Bosch), 120A, OE-NO 06B903016P, 140A, OE-NO 06B903016AB, 150A, OE-NO	



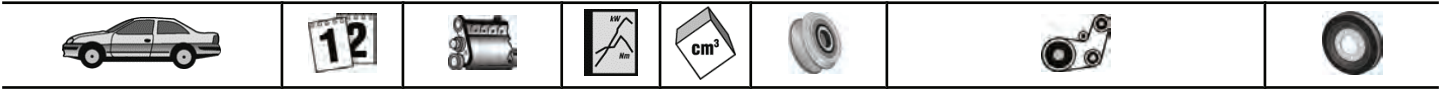

# AUDI

A4 Avant (8E5, B6)

					AP9009	06B903016Q ALT, (Valeo), 140A, OE-NO 06B903016AF, 150A, OE-NO 06B903016AC	
					AP9009	ALT, CH-NO 8E-3-024 776⇒, (Valeo), 120A, OE-NO 06B903016AE	
1.8 T	07/02-12/04	BFB	120	1781	AP9009	ALT, (Bosch), 120A, OE-NO 06B903016P, 140A, OE-NO 06B903016AB, 150A, OE-NO 06B903016Q	
					AP9009	ALT, (Valeo), 140A, OE-NO 06B903016AF, 150A, OE-NO 06B903016AC	
					AP9009	ALT, CH-NO 8E-3-024 776⇒, (Valeo), 120A, OE-NO 06B903016AE	VD1107
	09/01-07/02	AVJ	110	1781	AP9009	ALT, (Bosch), 120A, OE-NO 06B903016P, 140A, OE-NO 06B903016AB, 150A, OE-NO 06B903016Q	
					AP9009	ALT, (Valeo), 150A, OE-NO 06B903016AC	VD1107
	11/02-12/04	BEX	140	1781	AP9009	ALT, (Bosch), 120A, OE-NO 06B903016P, 140A, OE-NO 06B903016AB, 150A, OE-NO 06B903016Q	
					AP9009	ALT, (Valeo), 140A, OE-NO 06B903016AF, 150A, OE-NO 06B903016AC	
					AP9009	ALT, CH-NO 8E-3-024 776⇒, (Valeo), 120A, OE-NO 06B903016AE	VD1107
1.8 T quattro	07/02-12/04	BFB	120	1781	AP9009	ALT, (Bosch), 120A, OE-NO 06B903016P, 140A, OE-NO 06B903016AB, 150A, OE-NO 06B903016Q	
					AP9009	ALT, (Valeo), 140A, OE-NO 06B903016AF, 150A, OE-NO 06B903016AC	
					AP9009	ALT, CH-NO 8E-3-024 776⇒, (Valeo), 120A, OE-NO 06B903016AE	VD1107
	09/01-07/02	AVJ	110	1781	AP9009	ALT, (Bosch), 120A, OE-NO 06B903016P, 140A, OE-NO 06B903016AB, 150A, OE-NO 06B903016Q	
					AP9009	ALT, (Valeo), 150A, OE-NO 06B903016AC	VD1107
	09/01-12/04	AMB	125	1781	AP9009	ALT, (Bosch), 120A, OE-NO 06B903016P, 140A, OE-NO 06B903016AB, 150A, OE-NO 06B903016Q	
					AP9009	ALT, (Valeo), 140A, OE-NO 06B903016AF, 150A, OE-NO 06B903016AC	
					AP9009	ALT, CH-NO 8E-3-024 776⇒, (Valeo), 120A	
					AP9009	ALT, CH-NO 8E-3-024 776⇒, (Valeo), 120A, OE-NO 06B903016AE	
	11/02-12/04	BEX	140	1781	AP9009	ALT, (Bosch), 120A, OE-NO 06B903016P, 140A, OE-NO 06B903016AB, 150A, OE-NO 06B903016Q	
					AP9009	ALT, (Valeo), 140A, OE-NO 06B903016AF, 150A, OE-NO 06B903016AC	
					AP9009	ALT, CH-NO 8E-3-024 776⇒, (Valeo), 120A, OE-NO 06B903016AE	VD1107
1.9 TDI	06/04-12/04	BKE	85	1896	AP9001	ALT, (Bosch,Valeo), 140A ALT, PS, (AC), CH-NO 8E-3-410 001⇒ CH-NO 8E-3-410 001⇒ ⇒CH-NO 8E-3-410 000	6PK1610D1 VD1076 VD1090
	09/01-12/04	AVF, AWX	96	1896	AP9001	ALT, MTR-CODE: AVF, CH-NO 8E-4-000 001⇒, (Bosch,Valeo), 140A	
					AP9002	ALT, (Bosch,Valeo), 140A, 150A,	



**AUDI**
**A4 Avant (8E5, B6)**

						⇒CH-NO 8E-3-500 000 ALT, PS, (AC), (AUTOM), MTR-CODE: AVF, CH-NO 8E-4-000 001⇒	<b>6PK1610D1</b>
						ALT, PS, (AC), (MANL), MTR-CODE: AWX, AVF, CH-NO 8E-4-010 001⇒ CH-NO 8E-3-410 001⇒ ⇒CH-NO 8E-3-410 000	<b>6PK1610D1</b> <b>VD1076</b> <b>VD1090</b>
	11/01-12/04	AVB	74	1896	<b>AP9001</b> <b>AP9002</b>	ALT, CH-NO 8E-4-000 001⇒, (Bosch,Valeo), 140A ALT, ⇒CH-NO 8E-3-500 000, (Bosch,Valeo), 140A, 150A ALT, PS, (AC), CH-NO 8E-4-000 001⇒ CH-NO 8E-3-410 001⇒ ⇒CH-NO 8E-3-410 000	<b>6PK1610D1</b> <b>VD1076</b> <b>VD1090</b>
1.9 TDI quattro	11/01-12/04	AVF	96	1896	<b>AP9001</b> <b>AP9002</b>	ALT, CH-NO 8E-4-000 001⇒, (Bosch,Valeo), 140A ALT, ⇒CH-NO 8E-3-500 000, (Bosch,Valeo), 140A, 150A ALT, PS, (AC), (AUTOM), CH-NO 8E-4-000 001⇒ ALT, PS, (AC), (MANL), CH-NO 8E-4-010 001⇒ CH-NO 8E-3-410 001⇒ ⇒CH-NO 8E-3-410 000	<b>6PK1610D1</b> <b>6PK1610D1</b> <b>VD1076</b> <b>VD1090</b>
2.0	09/01-12/04	ALT	96	1984	<b>AP9009</b> <b>AP9009</b> <b>AP9009</b>	ALT, (Bosch), 120A, OE-NO 06B903016P, 140A, OE-NO 06B903016AB, 150A, OE-NO 06B903016Q ALT, (Valeo), 140A, OE-NO 06B903016AF, 150A, OE-NO 06B903016AC ALT, CH-NO 8E-3-024 776⇒, (Valeo), 120A, OE-NO 06B903016AE	<b>VD1107</b>
2.0 FSI	07/02-12/04	AWA	110	1984	<b>AP9009</b> <b>AP9009</b> <b>AP9009</b>	ALT, (Bosch), 120A, OE-NO 06B903016P, 140A, OE-NO 06B903016AB, 150A, OE-NO 06B903016Q ALT, (Valeo), 120A, OE-NO 06B903016AE, 140A, OE-NO 06B903016AF, 150A, OE-NO 06B903016AC ALT, CH-NO 8E-3-024 776⇒, (Valeo), 120A	<b>VD1107</b>
2.5 TDI	07/02-12/04	BFC, BCZ, BDG	120	2496		ALT, PS, AC	<b>6PK2404D2</b> <b>VD1032</b>
	09/01-07/02	AYM	114	2496		ALT, PS, AC	<b>6PK2404D2</b> <b>VD1032</b>
2.5 TDi	10/00-05/03	AKE	132	2496		ALT, PS, AC	<b>6PK2404D2</b>
2.5 TDI quattro	09/01-12/04	AKE, BAU, BDH	132	2496		ALT, PS, AC	<b>6PK2404D2</b> <b>VD1032</b>
<b>A4 Avant (8ED)</b>							
1.6	11/04-	ALZ	75	1595	<b>AP9009</b> <b>AP9009</b>	ALT, (Bosch), 120A, OE-NO 06B903016P, 140A, OE-NO 06B903016AB ALT, (Valeo), 120A, OE-NO 06B903016AE, 140A, OE-NO 06B903016AF, 06D903016A, 150A, OE-NO 06B903016AC, 06D903016	
1.8 T	11/04-	BFB	120	1781	<b>AP9009</b> <b>AP9009</b>	ALT, (Bosch), 120A, OE-NO 06B903016P, 140A, OE-NO 06B903016AB ALT, (Valeo), 120A, OE-NO 06B903016AE, 140A, OE-NO 06B903016AF, 06D903016A, 150A, OE-NO 06B903016AC, 06D903016	<b>VD1107</b>
1.8 T quattro	11/04-	BFB	120	1781	<b>AP9009</b> <b>AP9009</b>	ALT, (Bosch), 120A, OE-NO 06B903016P, 140A, OE-NO 06B903016AB ALT, (Valeo), 120A, OE-NO 06B903016AE, 140A, OE-NO 06B903016AF, 06D903016A, 150A, OE-NO 06B903016AC, 06D903016	<b>VD1107</b>
1.9 TDI	11/04-	BKE, BRB	85	1896	<b>AP9001</b>	ALT, (Bosch,Valeo), 140A ALT, PS, (AC)	<b>6PK1610D1</b>



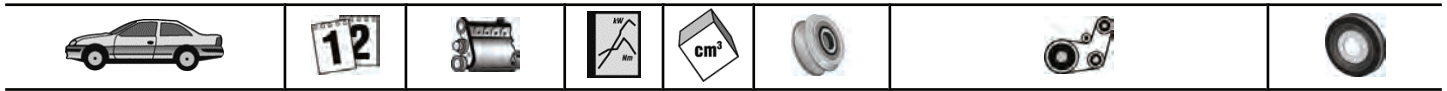

## AUDI

### A4 Avant (8ED)

									VD1076
2.0	11/04-	ALT	96	1984	AP9009	ALT, (Bosch), 120A, OE-NO 06B903016P, 140A, OE-NO 06B903016AB			
					AP9009	ALT, (Valeo), 120A, OE-NO 06B903016AE, 140A, OE-NO 06B903016AF, 06D903016A, 150A, OE-NO 06B903016AC, 06D903016			
2.0 TDI	06/06-	BVA	120	1968		MTR-CODE: BVA, ALT			VD1107 6PK1610D1 VD1076
		BRD	125	1968		MTR-CODE: BRD, ALT, (AC)			6PK1610D1 VD1076
	09/05-09/06	BVG	89	1968		MTR-CODE: BVG, ALT, (AC)			6PK1610D1 VD1076
	11/04-	BNA, BRF	100	1968		MTR-CODE: BNA, BRF, ALT, PS, AC			6PK1610D1 VD1076
		BPW	103	1968		ALT, PS, AC			6PK1610D1 VD1076
2.0 TDi	11/05-03/08	BVF	93	1968		MTR-CODE: BVF, ALT			6PK1610D1
2.0 TDI 16V	11/04-	BLB, BRE	103	1968		MTR-CODE: BRE, BLB, ALT, PS, (AC)			6PK1610D1 VD1076
2.0 TDI quattro	01/06-	BPW	103	1968		ALT, PS, AC			6PK1610D1 VD1076
	06/06-	BVA	120	1968		MTR-CODE: BVA, ALT			6PK1610D1 VD1076
		BRD	125	1968		MTR-CODE: BRD, ALT, (AC)			6PK1610D1 VD1076
2.0 TFSI	06/05-	BUL	162	1984	AP9009	ALT, (Bosch), 140A, OE-NO 06B903016AB			
					AP9009	ALT, (Valeo), 140A, OE-NO 06B903016AF, 06D903016A, 150A, OE-NO 06D903016			
	10/06-	BPJ, BYK	125	1984	AP9009	ALT, (Bosch), 140A, OE-NO 06B903016AB			
					AP9009	ALT, (Valeo), 140A, OE-NO 06B903016AF, 06D903016A, 150A, OE-NO 06D903016			
					AP9009	MTR-CODE: BYK			
	11/04-	BGB, BWE	147	1984	AP9009	ALT, (Bosch), 140A, OE-NO 06B903016AB			
					AP9009	ALT, (Valeo), 140A, OE-NO 06B903016AF, 06D903016A, 150A, OE-NO 06D903016			
2.0 TFSI quattro	06/05-	BUL	162	1984	AP9009	ALT, (Bosch), 140A, OE-NO 06B903016AB			
					AP9009	ALT, (Valeo), 140A, OE-NO 06B903016AF, 06D903016A, 150A, OE-NO 06D903016			
	11/04-	BGB, BWE	147	1984	AP9009	ALT, (Bosch), 140A, OE-NO 06B903016AB			
					AP9009	ALT, (Valeo), 140A, OE-NO 06B903016AF, 06D903016A, 150A, OE-NO 06D903016			
2.5 TDI	11/04-05/06	BDG	120	2496		ALT, PS, AC			6PK2404D2 VD1032
2.7 TDI	01/06-	BPP	132	2698		ALT, PS, AC, CH-NO 8E-6-252 205⇒ ALT, PS, AC, ⇒CH-NO 8E-6-252 204 MTR-CODE: BPP			6PK2460D1 6PK2490D1 VD1033
2.7 TDi	11/05-03/08	BSG	120	2698		MTR-CODE: BSG, ⇒CH-NO 8E-6-252204, ONLY WITH 059 145 201 F, ONLY WITH 059 903 137 AB MTR-CODE: BSG, CH-NO 8E-6-252205⇒			VD1033 VD1033
3.0 TDI quattro	01/06-	ASB	171	2967		ALT, PS, AC, CH-NO 8E-5-565001⇒ MTR-CODE: ASB			6PK2460D1 VD1033
	11/04-	BKN	150	2967		ALT, PS, AC, CH-NO 8E-5-565001⇒ MTR-CODE: BKN			6PK2460D1 VD1033
<b>A4 Avant (8K5)</b>									
2.0 TDI	04/08-	CAGB, CJC	100	1968	AP9022	ALT, (Bosch), 140A, OE-NO 03G903016E			
						MTR-CODE: CAGA, CAGB, CAGC MTR-CODE: CJC			VD1076 VD1111
		CAGA, CMEA	105	1968	AP9022	ALT, (Bosch), 140A, OE-NO 03G903016E			VD1076
		CAHA	125	1968	AP9022	ALT, (Bosch), 140A, OE-NO 03G903016E			





# AUDI

## A4 Avant (8K5)

	06/08-	CAGC	88	1968	AP9022	ALT, (Bosch), 140A, OE-NO 03G903016E	VD1076
	08/08-	CAHB	120	1968	AP9022	ALT, (Bosch), 140A, OE-NO 03G903016E	VD1076
2.0 TDI quattro	04/08-	CAGA	105	1968	AP9022	ALT, (Bosch), 140A, OE-NO 03G903016E	VD1076
	08/08-	CAHA	125	1968	AP9022	ALT, (Bosch), 140A, OE-NO 03G903016E	VD1076

## A4 Cabriolet (8H7, 8HE)

1.8 T	07/02-	BFB	120	1781	AP9009	ALT, (Bosch), 120A, OE-NO 06B903016P, 140A, OE-NO 06B903016AB, 150A, OE-NO 06B903016Q	VD1107
					AP9009	ALT, (Valeo), 120A, OE-NO 06B903016AE, 140A, OE-NO 06B903016AF, 150A, OE-NO 06B903016AC	VD1107
1.8 T quattro	05/03-	BFB	120	1781	AP9009	ALT, (Bosch), 120A, OE-NO 06B903016P, 140A, OE-NO 06B903016AB, 150A, OE-NO 06B903016Q	VD1107
					AP9009	ALT, (Valeo), 120A, OE-NO 06B903016AE, 140A, OE-NO 06B903016AF, 06D903016A, 150A, OE-NO 06B903016AC, 06D903016	VD1107
2.0	09/04-12/05	ALT	96	1984	AP9009	ALT, (Bosch), 120A, OE-NO 06B903016P, 140A, OE-NO 06B903016AB	VD1107
					AP9009	ALT, (Valeo), 120A, OE-NO 06B903016AE, 140A, OE-NO 06B903016AF, 150A, OE-NO 06B903016AC	VD1107
2.0 TDI	01/06-	BRC	100	1968		ALT	6PK1610D1 VD1076
		BPW	103	1968		ALT, PS, AC	6PK1610D1 VD1076
2.0 TFSI 16V	01/06-	BWE, BWT	147	1984	AP9009	ALT, (Bosch), 120A, OE-NO 06B903016P, 140A, OE-NO 06B903016AB, 150A, OE-NO 06B903016Q	VD1107
					AP9009	ALT, (Valeo), 120A, OE-NO 06B903016AE, 140A, OE-NO 06B903016AF, 06D903016A, 150A, OE-NO 06B903016AC, 06D903016	VD1107
2.5 TDI	08/02-12/05	BFC, BCZ, BDG	120	2496		ALT, PS, AC, CH-NO 8H-5-025501⇨, 8H-5-904701⇨	6PK2404D2 VD1032
2.7 TDI	06/06-	BPP	132	2698		ALT, PS, AC MTR-CODE: BPP	6PK2460D1 VD1033
3.0 TDI quattro	01/06-	BKN	150	2967		ALT, PS, AC MTR-CODE: BKN	6PK2460D1 VD1033
		ASB	171	2967		ALT, PS, AC MTR-CODE: ASB	6PK2460D1 VD1033

## A5 (8T)

2.0 TDI	08/08-	CAHB	120	1968			VD1076
		CAHA	125	1968	AP9022	ALT, (Bosch), 140A, OE-NO 03G903016E	VD1076
2.0 TDI quattro	08/08-	CAHA	125	1968	AP9022	ALT, (Bosch), 140A, OE-NO 03G903016E	VD1076

## A5 Cabriolet (8F)

2.0 TDI	05/09-	CAHB	120	1968	AP9022	ALT, (Bosch), 140A, OE-NO 03G903016E	VD1076
		CAHA	125	1968	AP9022	ALT, (Bosch), 140A, OE-NO 03G903016E	VD1076

## A5 Sportback

2.0 TDI	09/09-	CAGB	100	1968			VD1076
---------	--------	------	-----	------	--	--	--------





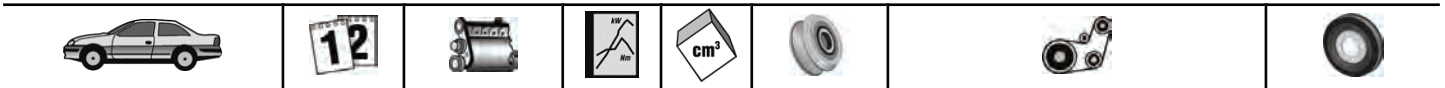

## AUDI

### A5 Sportback

		CAGA, CMEA	105	1968			VD1076
		CAHB	120	1968			VD1076
		CAHA	125	1968	AP9022	ALT, (Bosch), 140A, OE-NO 03G903016E	VD1076
2.0 TDI quattro	09/09-	CAHA	125	1968	AP9022	ALT, (Bosch), 140A, OE-NO 03G903016E	VD1076

### A6 (4A, C4)

1.9 TDI	06/94-10/97	1Z, AHU	66	1896	AP9002	ALT, (Bosch,Valeo), 90A, 120A, 150A	VD1084
2.5 TDI	01/95-10/97	AAT	84	2461			VD1002
	06/94-10/97	AAT	85	2461		ALT, WP, PS	6PK1345D1 VD1002
	08/94-10/97	AEL	103	2461		ALT, WP, PS	6PK1345D1 VD1002
2.5 TDI quattro	10/95-10/97	AEL	103	2461			VD1002

### A6 (4B, C5)

1.8	05/97-01/05	AFY	85	1781	AP9007	ALT, (MANL), CH-NO 4B-X-000 001⇨, (Bosch), 120A	
	07/97-01/05	AJP, AQE, ARH, ANQ	92	1781	AP9007	ALT, (MANL), CH-NO 4B-X-000 001⇨, (Bosch), 120A	
1.8 T	01/97-01/05	AEB, ARK, ANB, APU, AWT, AWL	110	1781	AP9007	ALT, (MANL), CH-NO 4B-X-000 001⇨, (Bosch), 120A	
	12/97-01/05	AJL	132	1781	AP9007	ALT, (MANL), CH-NO 4B-X-000 001⇨, (Bosch), 120A	
1.8 T quattro	02/97-01/05	AEB, ARK, ANB, APU, AWT	110	1781	AP9007	ALT, (MANL), CH-NO 4B-X-000 001⇨, (Bosch), 120A	
	12/97-01/05	AJL	132	1781	AP9007	ALT, (MANL), CH-NO 4B-X-000 001⇨, (Bosch), 120A	
1.9 TDI	04/97-10/00	AFN, AVG	81	1896	AP9002 AP9032	ALT, (MANL), CH-NO 4B-X-000 001⇨, (Bosch,Valeo), 120A ALT, MTR-CODE: AFN, ⇨CH-NO 4B-W-220 000, (Bosch), 70A, 90A, 120A	
	07/00-01/05	AJM	85	1896			VD1090
	08/01-01/05	AVF, AWX	96	1896			VD1090
2.0	08/01-01/05	ALT	96	1984	AP9009 AP9009	ALT, (Bosch), 120A, OE-NO 06B903016P, 140A, OE-NO 06B903016AB, 150A, OE-NO 06B903016Q ALT, (Valeo), 120A, OE-NO 06B903016AE, 140A, OE-NO 06B903016AF, 150A, OE-NO 06B903016AC	VD1107
	2.5 TDI	02/00-01/05	AKE, BAU, BDH, BND	132	2496		ALT, PS, AC, ⇨12/2001 ALT, PS, AC, 01/2002⇨
2.5 TDI	07/02-01/05	BFC, BCZ, BDG	120	2496		ALT, PS, AC	6PK2404D2 VD1032
	07/97-01/05	AFB, AKN	110	2496		ALT, PS, AC	6PK2404D1 VD1032
	08/01-01/05	AYM	114	2496		ALT, PS, AC, 01/2002⇨	6PK2404D2 VD1032
	2.5 TDI quattro	02/00-01/05	AKE, BAU, BDH	132	2496		ALT, PS, AC, ⇨12/2001 ALT, PS, AC, 01/2002⇨
	07/97-01/05	AFB, AKN	110	2496		ALT, PS, AC	6PK2404D1 VD1032

### A6 (4F2)

2.0 TDI	04/09-	CAHB	120	1968	AP9022	ALT, (Bosch), 180A, OE-NO 03G903023L MTR-CODE: CAHA, CAHB, ⇨08/2009 MTR-CODE: CAHA, CAHB, 03/2010⇨	VD1076 VD1076
	07/04-	BNA, BRF, CAGB	100	1968	AP9022	ALT, (Bosch), 180A, OE-NO 03G903023L, MTR-CODE: CAGB MTR-CODE: BRF, BNA, ALT MTR-CODE: BRF, BNA MTR-CODE: CAGB, ⇨08/2009 MTR-CODE: CAGB, 03/2010⇨	6PK1610D1 VD1076 VD1076 VD1076
	07/04-10/08	BLB, BRE	103	1968		MTR-CODE: BRE, BLB, ALT, PS, (AC)	6PK1610D1 VD1076
	09/05-06/06	BVG	89	1968		MTR-CODE: BVG, ALT, (AC)	6PK1610D1 VD1076
	11/08-	CAHA	125	1968	AP9022	ALT, (Bosch), 180A, OE-NO 03G903023L MTR-CODE: CAHA, CAHB, ⇨08/2009	VD1076



**AUDI**

A6 (4F2)					MTR-CODE: CAHA, CAHB, 03/2010⇒	VD1076
2.0 TFSI	06/05-	BPJ, BYK	125	1984	AP9009	ALT, (Valeo), 150A, OE-NO 06E903016D, 06D903016D
2.7 TDI	11/04-	BSG, CANB, CAND	120	2698		MTR-CODE: BSG, ALT, PS, AC, ⇒CH-NO 4F-7-029 698, (CVT-AUTOM) MTR-CODE: BSG, ALT, PS, AC, CH-NO 4F-6-172 454⇒, ⇒CH-NO 4F-7-029 698, (MANL) MTR-CODE: BSG, ALT, PS, AC, CH-NO 4F-7-029 699⇒ MTR-CODE: BSG, ALT, PS, AC, ESTATE, ⇒CH-NO 4F-6-017 400 MTR-CODE: BSG, ALT, PS, AC, NOTCHBACK, ⇒CH-NO 4F-5-140 000 MTR-CODE: BSG, ALT, PS, AC, CH-NO 4F-6-172 454⇒, ⇒CH-NO 4F-7-029 698, (AUTOM) MTR-CODE: BSG, ALT, PS, AC, ESTATE, (AUTOM), CH-NO 4F-6-017 401⇒, ⇒CH-NO 4F-6-172 453 MTR-CODE: BSG, ALT, PS, AC, ESTATE, (MANL), CH-NO 4F-6-017 401⇒, ⇒CH-NO 4F-6-172 453 MTR-CODE: BSG, ALT, PS, AC, NOTCHBACK, (AUTOM), CH-NO 4F-5-140 001⇒, ⇒CH-NO 4F-6-172 453 MTR-CODE: BSG, ALT, PS, AC, NOTCHBACK, (MANL), CH-NO 4F-5-140 001⇒, ⇒CH-NO 4F-6-172 453 MTR-CODE: BSG
	11/04-10/08	BPP	132	2698		ALT, PS, AC, ⇒CH-NO 4F-7-029 698, (CVT-AUTOM) ALT, PS, AC, CH-NO 4F-6-172 454⇒, ⇒CH-NO 4F-7-029 698, (MANL) ALT, PS, AC, CH-NO 4F-7-029 699⇒ ALT, PS, AC, ESTATE, ⇒CH-NO 4F-6-017 400 ALT, PS, AC, NOTCHBACK, ⇒CH-NO 4F-5-140 000 ALT, PS, AC, CH-NO 4F-6-172 454⇒, ⇒CH-NO 4F-7-029 698, (AUTOM) ALT, PS, AC, ESTATE, (AUTOM), CH-NO 4F-6-017 401⇒, ⇒CH-NO 4F-6-172 453 ALT, PS, AC, ESTATE, (MANL), CH-NO 4F-6-017 401⇒, ⇒CH-NO 4F-6-172 453 ALT, PS, AC, NOTCHBACK, (AUTOM), CH-NO 4F-5-140 001⇒, ⇒CH-NO 4F-6-172 453 ALT, PS, AC, NOTCHBACK, (MANL), CH-NO 4F-5-140 001⇒, ⇒CH-NO 4F-6-172 453 MTR-CODE: BPP
2.7 TDI quattro	06/05-	BSG, CANB, CAND	120	2698		MTR-CODE: BSG, ALT, PS, AC, ⇒CH-NO 4F-7-029 698, (CVT-AUTOM) MTR-CODE: BSG, ALT, PS, AC, CH-NO 4F-6-172 454⇒, ⇒CH-NO 4F-7-029 698, (MANL) MTR-CODE: BSG, ALT, PS, AC, CH-NO 4F-7-029 699⇒ MTR-CODE: BSG, ALT, PS, AC, ESTATE, ⇒CH-NO 4F-6-017 400 MTR-CODE: BSG, ALT, PS, AC, NOTCHBACK, ⇒CH-NO 4F-5-140 000 MTR-CODE: BSG, ALT, PS, AC, CH-NO 4F-6-172 454⇒, ⇒CH-NO 4F-7-029 698, (AUTOM) MTR-CODE: BSG, ALT, PS, AC, ESTATE, (AUTOM), CH-NO 4F-6-017 401⇒, ⇒CH-NO 4F-6-172 453 MTR-CODE: BSG, ALT, PS, AC, ESTATE, (MANL), CH-NO 4F-6-017 401⇒, ⇒CH-NO 4F-6-172 453 MTR-CODE: BSG, ALT, PS, AC, NOTCHBACK, (AUTOM), CH-NO 4F-5-140 001⇒, ⇒CH-NO 4F-6-172 453 MTR-CODE: BSG, ALT, PS, AC, NOTCHBACK, (MANL), CH-NO 4F-5-140 001⇒, ⇒CH-NO 4F-6-172 453



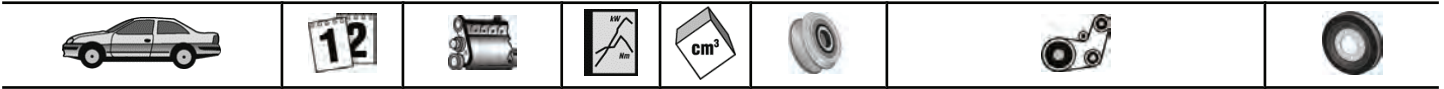

# AUDI

A6 (4F2)

	11/04-10/08	BPP	132	2698	4F-5-140 001⇒, ⇒CH-NO 4F-6-172 453 MTR-CODE: BSG VD1033 ALT, PS, AC, ⇒CH-NO 4F-7-029 698, (CVT-AUTOM) 6PK2460D1 ALT, PS, AC, CH-NO 4F-6-172 454⇒, ⇒CH-NO 4F-7-029 698, (MANL) 6PK2460D1 ALT, PS, AC, CH-NO 4F-7-029 699⇒ 6PK2460D1 ALT, PS, AC, ESTATE, ⇒CH-NO 4F-6-017 400 6PK2460D1 ALT, PS, AC, NOTCHBACK, ⇒CH-NO 4F-5-140 000 6PK2460D1 ALT, PS, AC, CH-NO 4F-6-172 454⇒, ⇒CH-NO 4F-7-029 698, (AUTOM) 6PK2490D1 ALT, PS, AC, ESTATE, (AUTOM), CH-NO 4F-6-017 401⇒, ⇒CH-NO 4F-6-172 453 6PK2490D1 ALT, PS, AC, ESTATE, (MANL), CH-NO 4F-6-017 401⇒, ⇒CH-NO 4F-6-172 453 6PK2490D1 ALT, PS, AC, NOTCHBACK, (AUTOM), CH-NO 4F-5-140 001⇒, ⇒CH-NO 4F-6-172 453 6PK2490D1 ALT, PS, AC, NOTCHBACK, (MANL), CH-NO 4F-5-140 001⇒, ⇒CH-NO 4F-6-172 453 6PK2490D1 MTR-CODE: BPP, ⇒CH-NO 4F-7-029698, ONLY WITH 059 145 201 F, ONLY WITH 059 903 137 AB VD1033 MTR-CODE: BPP, CH-NO 4F-7-029699⇒ VD1033
3.0 TDI	06/06-	ASB	171	2967	ALT, PS, AC, ⇒CH-NO 4F-6-100 000 6PK2460D1 ALT, PS, AC, CH-NO 4F-6-172 454⇒, ⇒CH-NO 4F-7-029 698, (MANL) 6PK2460D1 ALT, PS, AC, CH-NO 4F-7-029 699⇒ 6PK2460D1 ALT, PS, AC, CH-NO 4F-6-100 001⇒, ⇒CH-NO 4F-6-172 453 6PK2490D1 ALT, PS, AC, CH-NO 4F-6-172 454⇒, ⇒CH-NO 4F-7-029 698, (AUTOM) 6PK2490D1 VD1033
3.0 TDI quattro	05/04-	BNG, CDYB	155	2967	ALT, PS, AC, ⇒CH-NO 4F-6-100 000 6PK2460D1 ALT, PS, AC, CH-NO 4F-6-172 454⇒, ⇒CH-NO 4F-7-029 698, (MANL) 6PK2460D1 ALT, PS, AC, CH-NO 4F-7-029 699⇒ 6PK2460D1 ALT, PS, AC, CH-NO 4F-6-100 001⇒, ⇒CH-NO 4F-6-172 453 6PK2490D1 ALT, PS, AC, CH-NO 4F-6-172 454⇒, ⇒CH-NO 4F-7-029 698, (AUTOM) 6PK2490D1 MTR-CODE: BNG VD1033
	05/04-05/06	BMK	165	2967	ALT, PS, AC, ⇒CH-NO 4F-6-100 000 6PK2460D1 ALT, PS, AC, CH-NO 4F-6-172 454⇒, ⇒CH-NO 4F-7-029 698, (MANL) 6PK2460D1 ALT, PS, AC, CH-NO 4F-7-029 699⇒ 6PK2460D1 ALT, PS, AC, CH-NO 4F-6-100 001⇒, ⇒CH-NO 4F-6-172 453 6PK2490D1 ALT, PS, AC, CH-NO 4F-6-172 454⇒, ⇒CH-NO 4F-7-029 698, (AUTOM) 6PK2490D1 MTR-CODE: BMK VD1033
	06/06-10/08	ASB	171	2967	ALT, PS, AC, ⇒CH-NO 4F-6-100 000 6PK2460D1 ALT, PS, AC, CH-NO 4F-6-172 454⇒, ⇒CH-NO 4F-7-029 698, (MANL) 6PK2460D1 ALT, PS, AC, CH-NO 4F-7-029 699⇒ 6PK2460D1 ALT, PS, AC, CH-NO 4F-6-100 001⇒, ⇒CH-NO 4F-6-172 453 6PK2490D1 ALT, PS, AC, CH-NO 4F-6-172 454⇒, ⇒CH-NO 4F-7-029 698, (AUTOM) 6PK2490D1 MTR-CODE: ASB VD1033
A6 Allroad (4FH)					
2.7 TDI quattro	05/06-	BSG, CAND	120	2698	ALT, PS, AC, CH-NO 4F-7-029 699⇒ 6PK2460D1 ALT, PS, AC, ⇒CH-NO 4F-7-029 698 6PK2490D1 MTR-CODE: BSG VD1033
		BPP	132	2698	ALT, PS, AC, CH-NO 4F-7-029 699⇒ 6PK2460D1 ALT, PS, AC, ⇒CH-NO 4F-7-029 698 6PK2490D1 MTR-CODE: BPP VD1033
3.0 TDI quattro	05/06-	BNG, CDYB	155	2967	ALT, PS, AC, CH-NO 4F-7-029 699⇒ 6PK2460D1 ALT, PS, AC, ⇒CH-NO 4F-7-029 698 6PK2490D1 MTR-CODE: BNG VD1033
		ASB	171	2967	ALT, PS, AC, CH-NO 4F-7-029 699⇒ 6PK2460D1 ALT, PS, AC, ⇒CH-NO 4F-7-029 698 6PK2490D1 MTR-CODE: ASB VD1033

AUDI



# AUDI

## A6 Avant (4A, C4)

1.9 TDI	06/94-12/97	1Z, AHU	66	1896	AP9002	ALT, (Bosch,Valeo), 90A, 120A, 150A	VD1084
2.5 TDI	01/95-12/97	AAT	84	2461			VD1002
	06/94-12/97	AAT	85	2461		ALT, WP, PS	6PK1345D1 VD1002
	08/94-12/97	AEL	103	2461		ALT, WP, PS	6PK1345D1 VD1002
2.5 TDI quattro	07/95-12/97	AEL	103	2461			VD1002

## A6 Avant (4B, C5)

1.8	02/98-01/05	AFY	85	1781	AP9007	ALT, (MANL), CH-NO 4B-X-000 001⇨, (Bosch), 120A	
	12/97-01/05	AJP, AQE, ARH	92	1781	AP9007	ALT, (MANL), CH-NO 4B-X-000 001⇨, (Bosch), 120A	
1.8 T	04/99-01/05	AJL	132	1781	AP9007	ALT, (MANL), CH-NO 4B-X-000 001⇨, (Bosch), 120A	
	12/97-01/05	AEB, ARK, ANB, APU, AWT	110	1781	AP9007	ALT, (MANL), CH-NO 4B-X-000 001⇨, (Bosch), 120A	
1.8 T quattro	12/97-01/05	AEB, ARK, ANB, APU, AWT	110	1781	AP9007	ALT, (MANL), CH-NO 4B-X-000 001⇨, (Bosch), 120A	
		AJL	132	1781	AP9007	ALT, (MANL), CH-NO 4B-X-000 001⇨, (Bosch), 120A	
1.9 TDI	02/98-04/01	AFN	81	1896	AP9002 AP9032	ALT, (MANL), CH-NO 4B-X-000 001⇨, (Bosch,Valeo), 120A ALT, MTR-CODE: AFN, ⇨CH-NO 4B-W-220 000, (Bosch), 70A, 90A, 120A	
	07/00-01/05	AJM	85	1896			VD1090
	08/01-01/05	AVF, AWX	96	1896			VD1090
2.0	08/01-01/05	ALT	96	1984	AP9009	ALT, (Bosch), 120A, OE-NO 06B903016P, 140A, OE-NO 06B903016AB, 150A, OE-NO 06B903016Q	
					AP9009	ALT, (Valeo), 120A, OE-NO 06B903016AE, 140A, OE-NO 06B903016AF, 150A, OE-NO 06B903016AC	
					AP9009	ALT, CH-NO 4B-3-000 001⇨, (Valeo), 120A, 140A	VD1107
2.5 TDI	02/00-01/05	AKE, BAU, BDH	132	2496		ALT, PS, AC, ⇨12/2001 ALT, PS, AC, 01/2002⇨	6PK2404D1 6PK2404D2 VD1032
	07/02-01/05	BFC, BCZ, BDG	120	2496		ALT, PS, AC	6PK2404D2 VD1032
	08/01-01/05	AYM	114	2496		ALT, PS, AC, 01/2002⇨	6PK2404D2 VD1032
	12/97-01/05	AFB, AKN	110	2496		ALT, PS, AC	6PK2404D1 VD1032
	02/00-01/05	AKE, BAU, BDH	132	2496		ALT, PS, AC, ⇨12/2001 ALT, PS, AC, 01/2002⇨	6PK2404D1 6PK2404D2 VD1032
2.5 TDI quattro	12/97-01/05	AFB, AKN	110	2496		ALT, PS, AC	6PK2404D1 VD1032

## A6 Avant (4F5)

2.0 TDI	04/09-	CAHB	120	1968	AP9022	ALT, (Bosch), 180A, OE-NO 03G903023L MTR-CODE: CAHA, CAHB, ⇨08/2009 MTR-CODE: CAHA, CAHB, 03/2010⇨	VD1076 VD1076
	06/05-	BNA, BRF, CAGB	100	1968	AP9022	ALT, (Bosch), 180A, OE-NO 03G903023L, MTR-CODE: CAGB MTR-CODE: BRF, BNA, ALT MTR-CODE: BRF, BNA MTR-CODE: CAGB, ⇨08/2009 MTR-CODE: CAGB, 03/2010⇨	6PK1610D1 VD1076 VD1076 VD1076
	06/05-10/08	BLB, BRE	103	1968		MTR-CODE: BRE, BLB, ALT, PS, (AC)	6PK1610D1 VD1076
	09/05-06/06	BVG	89	1968		MTR-CODE: BVG, ALT, (AC)	6PK1610D1 VD1076
	10/08-	CAHA	125	1968	AP9022	ALT, (Bosch), 180A, OE-NO 03G903023L MTR-CODE: CAHA, CAHB, ⇨08/2009 MTR-CODE: CAHA, CAHB, 03/2010⇨	VD1076 VD1076
	2.0 TFSI	06/05-	BPJ	125	1984	AP9009	ALT, (Valeo), 150A, OE-NO 06E903016D, 06D903016D
2.7 TDI	03/05-	BSG, CANB	120	2698		MTR-CODE: BSG, ALT, PS, AC, ⇨CH-NO 4F-7-029 698, (CVT-AUTOM)	6PK2460D1
						MTR-CODE: BSG, ALT, PS, AC, CH-NO 4F-6-172 454⇨, ⇨CH-NO 4F-7-029	6PK2460D1





## AUDI

A6 Avant (4F5)

					<p>698, (MANL) MTR-CODE: BSG, ALT, PS, AC, CH-NO 4F-7-029 699⇒ <b>6PK2460D1</b></p> <p>MTR-CODE: BSG, ALT, PS, AC, ESTATE, ⇒CH-NO 4F-6-017 400 <b>6PK2460D1</b></p> <p>MTR-CODE: BSG, ALT, PS, AC, NOTCHBACK, ⇒CH-NO 4F-5-140 000 <b>6PK2460D1</b></p> <p>MTR-CODE: BSG, ALT, PS, AC, CH-NO 4F-6-172 454⇒, ⇒CH-NO 4F-7-029 698, (AUTOM) <b>6PK2490D1</b></p> <p>MTR-CODE: BSG, ALT, PS, AC, ESTATE, (AUTOM), CH-NO 4F-6-017 401⇒, ⇒CH-NO 4F-6-172 453 <b>6PK2490D1</b></p> <p>MTR-CODE: BSG, ALT, PS, AC, ESTATE, (MANL), CH-NO 4F-6-017 401⇒, ⇒CH-NO 4F-6-172 453 <b>6PK2490D1</b></p> <p>MTR-CODE: BSG, ALT, PS, AC, NOTCHBACK, (AUTOM), CH-NO 4F-5-140 001⇒, ⇒CH-NO 4F-6-172 453 <b>6PK2490D1</b></p> <p>MTR-CODE: BSG, ALT, PS, AC, NOTCHBACK, (MANL), CH-NO 4F-5-140 001⇒, ⇒CH-NO 4F-6-172 453 <b>6PK2490D1</b></p> <p>MTR-CODE: BSG <b>VD1033</b></p>
	03/05-10/08	BPP	132	2698	<p>ALT, PS, AC, ⇒CH-NO 4F-7-029 698, (CVT-AUTOM) <b>6PK2460D1</b></p> <p>ALT, PS, AC, CH-NO 4F-6-172 454⇒, ⇒CH-NO 4F-7-029 698, (MANL) <b>6PK2460D1</b></p> <p>ALT, PS, AC, CH-NO 4F-7-029 699⇒ <b>6PK2460D1</b></p> <p>ALT, PS, AC, ESTATE, ⇒CH-NO 4F-6-017 400 <b>6PK2460D1</b></p> <p>ALT, PS, AC, NOTCHBACK, ⇒CH-NO 4F-5-140 000 <b>6PK2460D1</b></p> <p>ALT, PS, AC, CH-NO 4F-6-172 454⇒, ⇒CH-NO 4F-7-029 698, (AUTOM) <b>6PK2490D1</b></p> <p>ALT, PS, AC, ESTATE, (AUTOM), CH-NO 4F-6-017 401⇒, ⇒CH-NO 4F-6-172 453 <b>6PK2490D1</b></p> <p>ALT, PS, AC, ESTATE, (MANL), CH-NO 4F-6-017 401⇒, ⇒CH-NO 4F-6-172 453 <b>6PK2490D1</b></p> <p>ALT, PS, AC, NOTCHBACK, (AUTOM), CH-NO 4F-5-140 001⇒, ⇒CH-NO 4F-6-172 453 <b>6PK2490D1</b></p> <p>ALT, PS, AC, NOTCHBACK, (MANL), CH-NO 4F-5-140 001⇒, ⇒CH-NO 4F-6-172 453 <b>6PK2490D1</b></p> <p>MTR-CODE: BPP <b>VD1033</b></p>
2.7 TDI quattro	03/05-10/08	BPP	132	2698	<p>ALT, PS, AC, ⇒CH-NO 4F-7-029 698, (CVT-AUTOM) <b>6PK2460D1</b></p> <p>ALT, PS, AC, CH-NO 4F-6-172 454⇒, ⇒CH-NO 4F-7-029 698, (MANL) <b>6PK2460D1</b></p> <p>ALT, PS, AC, CH-NO 4F-7-029 699⇒ <b>6PK2460D1</b></p> <p>ALT, PS, AC, ESTATE, ⇒CH-NO 4F-6-017 400 <b>6PK2460D1</b></p> <p>ALT, PS, AC, NOTCHBACK, ⇒CH-NO 4F-5-140 000 <b>6PK2460D1</b></p> <p>ALT, PS, AC, CH-NO 4F-6-172 454⇒, ⇒CH-NO 4F-7-029 698, (AUTOM) <b>6PK2490D1</b></p> <p>ALT, PS, AC, ESTATE, (AUTOM), CH-NO 4F-6-017 401⇒, ⇒CH-NO 4F-6-172 453 <b>6PK2490D1</b></p> <p>ALT, PS, AC, ESTATE, (MANL), CH-NO 4F-6-017 401⇒, ⇒CH-NO 4F-6-172 453 <b>6PK2490D1</b></p> <p>ALT, PS, AC, NOTCHBACK, (AUTOM), CH-NO 4F-5-140 001⇒, ⇒CH-NO 4F-6-172 453 <b>6PK2490D1</b></p> <p>ALT, PS, AC, NOTCHBACK, (MANL), CH-NO 4F-5-140 001⇒, ⇒CH-NO 4F-6-172 453 <b>6PK2490D1</b></p> <p>MTR-CODE: BPP <b>VD1033</b></p>
	06/05-	BSG, CAND	120	2698	<p>MTR-CODE: BPP <b>VD1033</b></p> <p>MTR-CODE: BSG, ALT, PS, AC, ⇒CH-NO 4F-7-029 698, (CVT-AUTOM) <b>6PK2460D1</b></p> <p>MTR-CODE: BSG, ALT, PS, AC, CH-NO 4F-6-172 454⇒, ⇒CH-NO 4F-7-029 698, (MANL) <b>6PK2460D1</b></p> <p>MTR-CODE: BSG, ALT, PS, AC, CH-NO 4F-7-029 699⇒ <b>6PK2460D1</b></p> <p>MTR-CODE: BSG, ALT, PS, AC, ESTATE, ⇒CH-NO 4F-6-017 400 <b>6PK2460D1</b></p>





# AUDI

## A6 Avant (4F5)

					MTR-CODE: BSG, ALT, PS, AC, NOTCHBACK, ⇒CH-NO 4F-5-140 000	6PK2460D1
					MTR-CODE: BSG, ALT, PS, AC, CH-NO 4F-6-172 454⇒, ⇒CH-NO 4F-7-029 698, (AUTOM)	6PK2490D1
					MTR-CODE: BSG, ALT, PS, AC, ESTATE, (AUTOM), CH-NO 4F-6-017 401⇒, ⇒CH-NO 4F-6-172 453	6PK2490D1
					MTR-CODE: BSG, ALT, PS, AC, ESTATE, (MANL), CH-NO 4F-6-017 401⇒, ⇒CH-NO 4F-6-172 453	6PK2490D1
					MTR-CODE: BSG, ALT, PS, AC, NOTCHBACK, (AUTOM), CH-NO 4F-5-140 001⇒, ⇒CH-NO 4F-6-172 453	6PK2490D1
					MTR-CODE: BSG, ALT, PS, AC, NOTCHBACK, (MANL), CH-NO 4F-5-140 001⇒, ⇒CH-NO 4F-6-172 453	6PK2490D1
					MTR-CODE: BSG	VD1033
3.0 TDi	06/06-	ASB	171	2967	ALT, PS, AC, ⇒CH-NO 4F-6-100 000	6PK2460D1
					ALT, PS, AC, CH-NO 4F-6-172 454⇒, ⇒CH-NO 4F-7-029 698, (MANL)	6PK2460D1
					ALT, PS, AC, CH-NO 4F-7-029 699⇒	6PK2460D1
					ALT, PS, AC, CH-NO 4F-6-100 001⇒, ⇒CH-NO 4F-6-172 453	6PK2490D1
					ALT, PS, AC, CH-NO 4F-6-172 454⇒, ⇒CH-NO 4F-7-029 698, (AUTOM)	6PK2490D1
					MTR-CODE: BNG	VD1033
3.0 TDI quattro	03/05-	BNG, CDYB	155	2967	ALT, PS, AC, ⇒CH-NO 4F-6-100 000	6PK2460D1
					ALT, PS, AC, CH-NO 4F-6-172 454⇒, ⇒CH-NO 4F-7-029 698, (MANL)	6PK2460D1
					ALT, PS, AC, CH-NO 4F-7-029 699⇒	6PK2460D1
					ALT, PS, AC, CH-NO 4F-6-100 001⇒, ⇒CH-NO 4F-6-172 453	6PK2490D1
					ALT, PS, AC, CH-NO 4F-6-172 454⇒, ⇒CH-NO 4F-7-029 698, (AUTOM)	6PK2490D1
					MTR-CODE: BNG	VD1033
	03/05-05/06	BMK	165	2967	ALT, PS, AC, ⇒CH-NO 4F-6-100 000	6PK2460D1
					ALT, PS, AC, CH-NO 4F-6-172 454⇒, ⇒CH-NO 4F-7-029 698, (MANL)	6PK2460D1
					ALT, PS, AC, CH-NO 4F-7-029 699⇒	6PK2460D1
					ALT, PS, AC, CH-NO 4F-6-100 001⇒, ⇒CH-NO 4F-6-172 453	6PK2490D1
					ALT, PS, AC, CH-NO 4F-6-172 454⇒, ⇒CH-NO 4F-7-029 698, (AUTOM)	6PK2490D1
					MTR-CODE: BMK	VD1033
	06/06-10/08	ASB	171	2967	ALT, PS, AC, ⇒CH-NO 4F-6-100 000	6PK2460D1
					ALT, PS, AC, CH-NO 4F-6-172 454⇒, ⇒CH-NO 4F-7-029 698, (MANL)	6PK2460D1
					ALT, PS, AC, CH-NO 4F-7-029 699⇒	6PK2460D1
					ALT, PS, AC, CH-NO 4F-6-100 001⇒, ⇒CH-NO 4F-6-172 453	6PK2490D1
					ALT, PS, AC, CH-NO 4F-6-172 454⇒, ⇒CH-NO 4F-7-029 698, (AUTOM)	6PK2490D1
					MTR-CODE: ASB	VD1033
<b>A8 (4D2, 4D8)</b>						
2.5 TDI	01/97-04/00	AFB, AKN	110	2496		VD1032
	09/00-09/02	AKE	132	2496		VD1032
2.5 TDI quattro	07/97-04/00	AFB, AKN	110	2496		VD1032
	09/00-09/02	AKE	132	2496		VD1032
<b>A8 (4E_)</b>						
3.0 TDI quattro	08/03-07/10	ASB	171	2967	ALT, PS, AC, ⇒CH-NO 4E-6-020 000	6PK2460D1
					ALT, PS, AC, CH-NO 4E-7-003 343⇒, ⇒CH-NO 4E-7-030 000	6PK2460D1
					ALT, PS, AC, CH-NO 4E-6-020 001⇒, ⇒CH-NO 4E-7-003 342	6PK2490D1
					MTR-CODE: ASB	VD1033
	11/03-07/10	BNG	155	2967	ALT, PS, AC, ⇒CH-NO 4E-6-020 000	6PK2460D1
					ALT, PS, AC, CH-NO 4E-7-003 343⇒, ⇒CH-NO 4E-7-030 000	6PK2460D1
					ALT, PS, AC, CH-NO 4E-6-020 001⇒, ⇒CH-NO 4E-7-003 342	6PK2490D1
					MTR-CODE: BNG	VD1033
<b>ALLROAD (4BH)</b>						
2.5 TDI quattro	05/00-08/05	AKE, BAU	132	2496	ALT, PS, AC, CH-NO 4B-5-028501⇒	6PK2404D2
						VD1032
	05/03-08/05	BCZ	120	2496	ALT, PS, AC, CH-NO 4B-5-028501⇒	6PK2404D2
						VD1032



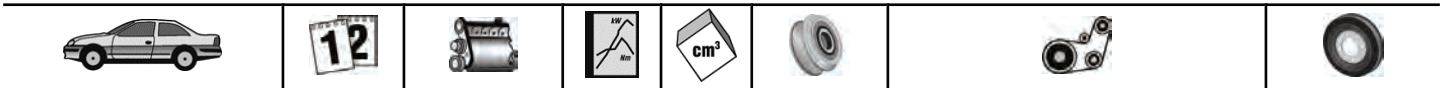

# AUDI

## CABRIOLET (8G7, B4)

↩ 1.9 TDI	06/95-08/00	1Z, AHU	66	1896	AP9002	ALT	VD1084
-----------	-------------	---------	----	------	--------	-----	--------

## Q5 (8R)

2.0 TDI	08/09-	CAGB	100	1968	AP9022	ALT, (Bosch), 140A, OE-NO 03G903016E	VD1076
		CAGA, CJCA	105	1968		MTR-CODE: CAGA, CAGB MTR-CODE: CAGA, CAGB MTR-CODE: CJCA	VD1076 VD1111
	11/08-	CAHB, CGLA	120	1968	AP9022	ALT, (Bosch), 140A, OE-NO 03G903016E	VD1076
		CAHA, CGLB	125	1968	AP9022	ALT, (Bosch), 140A, OE-NO 03G903016E	VD1076 VD1111

## Q7 (4L)

3.0 TDI	03/06-	BUN, CASB	155	2967		ALT, CH-NO 4L-7-034 592⇒, ⇒CH-NO 4L-9-017 200	6PK2490D1
						MTR-CODE: BUN, CH-NO 4L-7-034 592⇒	VD1033
		BUG	171	2967		ALT, CH-NO 4L-7-034 592⇒, ⇒CH-NO 4L-9-017 200	6PK2490D1
						MTR-CODE: BUG, CH-NO 4L-7-034 592⇒	VD1033

## TT (8J3)

1.8 TFSI	06/08-	CDAА	118	1798	AP9009	ALT, (Bosch), 140A, OE-NO 06B903016AB	
2.0 TDI quattro	06/08-	CBBB, CFGB	125	1968		MTR-CODE: CBBB MTR-CODE: CFGB	VD1076 VD1111
2.0 TFSI	10/06-	BWA, BPY, CCZA, CCTA	147	1984	AP9009	ALT, (Bosch), 140A, OE-NO 06B903016AB, MTR-CODE: CCZA, CCTA	
3.2 V6 quattro	10/06-	BUB	184	3189	AP9022	ALT, (Valeo), 140A, OE-NO 06F903023P, CH-NO 8J-7-013501⇒	

## TT (8N3)

1.8 T	09/02-06/06	AUM	110	1781	AP9001	ALT, (Bosch), 120A	VD1107
	09/05-06/06	BVP	120	1781	AP9001	ALT, (Bosch), 120A	VD1107
		BVR	140	1781	AP9001	ALT, (Bosch), 120A	VD1107
	10/98-06/06	AJQ, APP, ARY, AUQ, AWP, ATC	132	1781	AP9001 AP9001	ALT, ⇒CH-NO 8N-4-050 000, (Bosch,Valeo), (Hitachi), 120A ALT, CH-NO 8N-5-000 001⇒, (Bosch,Valeo), 120A	VD1107
1.8 T quattro	03/05-06/06	BFV	176	1781	AP9001	ALT, (Bosch), 120A	VD1107
	09/05-06/06	BVR	140	1781	AP9001	ALT, (Bosch), 120A	VD1107
	10/98-06/06	AJQ, ARY, AWP, ATC	132	1781	AP9001 AP9001	ALT, ⇒CH-NO 8N-4-050 000, (Bosch,Valeo), (Hitachi), 120A ALT, CH-NO 8N-5-000 001⇒, (Bosch,Valeo), 120A	VD1107
		APX, AMU, BAM	165	1781	AP9001 AP9001	ALT, ⇒CH-NO 8N-4-050 000, (Bosch,Valeo), (Hitachi), 120A ALT, CH-NO 8N-5-000 001⇒, (Bosch,Valeo), 120A	VD1107

## TT Roadster (8J9)

1.8 TFSI	06/08-	CDAА	118	1798	AP9009	ALT, (Bosch), 140A, OE-NO 06B903016AB	
2.0 TDI quattro	06/08-	CBBB, CFGB	125	1968		MTR-CODE: CBBB MTR-CODE: CFGB	VD1076 VD1111
2.0 TFSI	02/07-	BWA, BPY, CCZA, CCTA	147	1984	AP9009	ALT, (Bosch), 140A, OE-NO 06B903016AB, MTR-CODE: CCTA, CCZA	
3.2 V6 quattro	02/07-	BUB	184	3189	AP9022	ALT, (Valeo), 140A, OE-NO 06F903023P, CH-NO 8J-7-013501⇒	

## TT Roadster (8N9)

1.8 T	01/01-06/06	AUM	110	1781	AP9001 AP9001	ALT, ⇒CH-NO 8N-4-050 000, (Bosch,Valeo), (Hitachi), 120A ALT, CH-NO 8N-5-000 001⇒, (Bosch,Valeo), 120A	VD1107
-------	-------------	-----	-----	------	------------------	-----------------------------------------------------------------------------------------------------------	--------





## AUDI

### TT Roadster (8N9)

	09/05-06/06	BVP	120	1781	AP9001	ALT, (Bosch), 120A	VD1107
		BVR	140	1781	AP9001	ALT, (Bosch), 120A	VD1107
	10/99-06/06	AJQ, APP, AUQ, AWP, ATC	132	1781	AP9001 AP9001	ALT, ⇨CH-NO 8N-4-050 000, (Bosch,Valeo), (Hitachi), 120A ALT, CH-NO 8N-5-000 001⇨, (Bosch,Valeo), 120A	VD1107
1.8 T quattro	02/00-06/06	AJQ, ARY, AWP, ATC	132	1781	AP9001 AP9001	ALT, ⇨CH-NO 8N-4-050 000, (Bosch,Valeo), (Hitachi), 120A ALT, CH-NO 8N-5-000 001⇨, (Bosch,Valeo), 120A	VD1107
	09/05-06/06	BVR	140	1781	AP9001	ALT, (Bosch), 120A	VD1107
	10/99-06/06	APX, AMU, BAM	165	1781	AP9001 AP9001	ALT, ⇨CH-NO 8N-4-050 000, (Bosch,Valeo), (Hitachi), 120A ALT, CH-NO 8N-5-000 001⇨, (Bosch,Valeo), 120A	VD1107

## BMW

### 1 (E81, E87)

116d	03/09-	N47D20A, N47D20C	85	1995			VD1071
116i	09/04-	N45B16A, N45B16TU2, N45B16	85	1596	AP9005 AP9008	ALT, (Bosch), 150A, OE-NO 1231 7 532 966 ALT, (Bosch), OE-NO 1231 7 533 268, 1231 7 532 964, 110A	
	09/07-	N45B16TU2	90	1597	AP9005 AP9008	ALT, (Bosch), 150A, OE-NO 1231 7 532 966 ALT, (Bosch), OE-NO 1231 7 533 268, 1231 7 532 964, 110A	
118d	04/07-	N47D20A, N47D20C	105	1995			VD1071
	09/04-	M47N204D4	90	1995			VD1028
118i	04/07-	N43B20A	105	1995	AP9005	ALT, (Bosch), 150A, OE-NO 1231 7 532 966, MTR-CODE: N46B20B	
	09/04-	N42B20B, N46B20	95	1995	AP9005 AP9008	ALT, (Bosch), 150A, OE-NO 1231 7 532 966, MTR-CODE: N46B20B ALT, (Bosch), OE-NO 1231 7 533 268, 1231 7 532 964, 110A	
120d	03/07-	N47D20A, N47D20C	130	1995			VD1071
	09/04-	M47N204D4, N47D20A	120	1995		(E87) (E81 / E87 Facelift)	VD1028 VD1071
120i	03/07-	N43B20A	115	1995	AP9005	ALT, (Bosch), 150A, OE-NO 1231 7 532 966, MTR-CODE: N46B20B	
			120	1995	AP9005	ALT, (Bosch), 150A, OE-NO 1231 7 532 966, MTR-CODE: N46B20B	
	04/07-	N46B20B, N43B20A	125	1995	AP9005	ALT, (Bosch), 150A, OE-NO 1231 7 532 966, MTR-CODE: N46B20B	
	09/04-	N42B20A, N46B20	110	1995	AP9005 AP9008	ALT, (Bosch), 150A, OE-NO 1231 7 532 966 ALT, (Bosch), OE-NO 1231 7 533 268, 1231 7 532 964, 110A	
130i	09/05-	N52B30A, N52B30	195	2996	AP9005	ALT, (Bosch), 150A, OE-NO 1231 7 550 967, 180A, OE-NO 1231 7 551 256	
					AP9021	ALT, (Valeo)	

### 1 Cabriolet (E88)

118d	09/08-	N47D20A, N47D20C	105	1995			VD1071
118i	03/08-	N43B20A	105	1995	AP9008	ALT, (Bosch), OE-NO 1231 7 533 268, 1231 7 532 964, 110A, MTR-CODE: N46B20B	
120d	03/08-	N47D20A, N47D20C	130	1995			VD1071
120i	03/08-	N43B20A	120	1995	AP9008	ALT, (Bosch), OE-NO 1231 7 533 268, 1231 7 532 964, 110A, MTR-CODE: N46B20B	
			125	1995	AP9005 AP9008	ALT, (Bosch), 150A, OE-NO 1231 7 532 966, MTR-CODE: N46B20B ALT, (Bosch), OE-NO 1231 7 533 268, 1231 7 532 964, 110A, MTR-CODE: N46B20B	
125i	03/08-	N52B30A	160	2996	AP9005	ALT, (Bosch), 150A, OE-NO 1231 7 550	





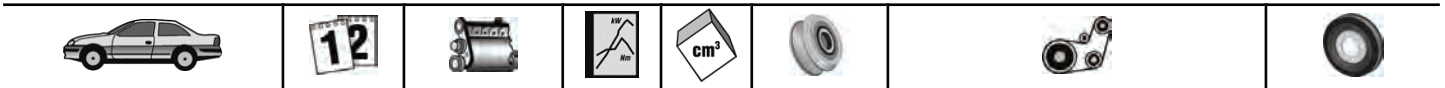

# BMW

## 1 Cabriolet (E88)

							967, 180A, OE-NO 1231 7 551 256, MTR-CODE: N52B30A
--	--	--	--	--	--	--	-------------------------------------------------------

## 1 Coupe (E82)

118d	09/09-	N47D20C	105	1995			<b>VD1071</b>
120d	10/07-	N47D20A, N47D20C	130	1995			<b>VD1071</b>
125i	10/07-	N53B30A	160	2996	<b>AP9005</b>	ALT, (bosch), 150A, OE-NO 1231 7 550 967, 180A, OE-NO 1231 7 551 256, MTR-CODE: N52B30A	

## 3 (E36)

325 td	09/91-02/98	M51D25	85	2497		ALT, WP	<b>5PK1815D1</b> <b>VD1025</b>
325 tds	05/93-02/98	M51D25 (Inter.)	105	2503		ALT, WP	<b>5PK1815D1</b> <b>VD1025</b>

## 3 (E46)

316 i	02/02-02/05	N42B18, N46B18A, N46B18	85	1796	<b>AP9005</b>	ALT, (Bosch), 120A, OE-NO 1231 7 516 101, 1231 7 516 723, 150A, OE-NO 1231 7 521 384, 1231 7 521 490, 1231 7 521 491, MTR-CODE: N40B16A, N42B18A, N45B16A	
					<b>AP9008</b>	ALT, (Bosch), OE-NO 1231 7 533 268, 1231 7 532 964, 110A	
					<b>AP9021</b>	(Valeo), 120A, 140A	
					<b>AP9021</b>	ALT, 04/2002⇒, (Valeo), 90A, 110A	
	04/00-02/05	M43B16, M43B16 (164E3)	77	1596	<b>AP9008</b>	ALT, (Bosch), OE-NO 1231 7 533 268, 1231 7 532 964, 110A, MTR-CODE: N40B16A	
318 i	06/02-02/05	N45B16A, N45B16	85	1596	<b>AP9005</b>	ALT, (Bosch), 120A, OE-NO 1231 7 516 101, 1231 7 516 723, 150A, OE-NO 1231 7 521 384, 1231 7 521 490, 1231 7 521 491, MTR-CODE: N40B16A, N42B18A, N45B16A	
					<b>AP9008</b>	ALT, (Bosch), OE-NO 1231 7 533 268, 1231 7 532 268, 110A	
					<b>AP9021</b>	ALT, (Valeo), 110A, 140A, 150A	
318 d	09/98-02/05	M43164E3, M43B19TU	77	1895	<b>AP9005</b>	ALT, (Bosch), 120A, OE-NO 1231 7 516 101, 1231 7 516 723, 150A, OE-NO 1231 7 521 384, 1231 7 521 490, 1231 7 521 491, MTR-CODE: N40B16A, N42B18A, N45B16A, 03/2002⇒	
	03/03-02/05	M47N204D4	85	1995		ALT, WP, AC, ⇒09/2004 ALT, WP, AC, 10/2004⇒	<b>6PK2080D1</b> <b>6PK2080D2</b> <b>VD1028</b>
318 i	09/01-03/03	M47D20, M47204D1	85	1951		ALT, WP, AC	<b>5PK2030D1</b> <b>VD1030</b>
	09/01-02/05	N42B20, N46B20A, N46B20	105	1995	<b>AP9005</b>	ALT, (Bosch), 120A, OE-NO 1231 7 516 101, 1231 7 516 723, 150A, OE-NO 1231 7 521 384, 1231 7 521 490, 1231 7 521 491	
320 d					<b>AP9008</b>	ALT, (Bosch), 110A, OE-NO 1231 7 533 268, 1231 7 532 964	
					<b>AP9021</b>	(Valeo), 120A, 140A	
					<b>AP9021</b>	ALT, 04/2002⇒, (Valeo), 90A, 110A	
320 d	04/98-09/01	M47D20, M47204D1	100	1951		ALT, WP, AC	<b>5PK2030D1</b> <b>VD1030</b>
	09/01-02/05	M47N204D4	110	1995		ALT, WP, AC, 10/2002⇒, ⇒09/2004 ALT, WP, AC, 10/2004⇒ ALT, WP, AC, ⇒09/2002	<b>6PK2080D1</b> <b>6PK2080D2</b> <b>6PK2090D1</b> <b>VD1028</b>
330 d	03/03-02/05	M57N306D2	150	2993			<b>VD1105</b>
	10/99-02/05	M57D30, M57306D1	135	2926		⇒03/2003, ALT, WP, AC	<b>5PK2060D1</b> <b>VD1027</b>
330 xd	03/03-02/05	M57N306D2	150	2993			<b>VD1105</b>
	06/00-02/05	M57D30	135	2926		⇒03/2003, ALT, WP, AC	<b>5PK2060D1</b> <b>VD1027</b>

## 3 (E90)

316d	07/09-	N47D20C	85	1995			<b>VD1071</b>
316i	02/06-	N45B16A, N45B16TU2, N45B16	85	1596	<b>AP9005</b>	ALT, (Bosch), 150A, OE-NO 1231 7 532 965, 1231 7 532 966, 1231 7 532 969, 1231 7 533 270	
					<b>AP9008</b>	ALT, (Bosch), OE-NO 1231 7 533 268, 1231 7 533 964, 110A	
318d	09/05-	M47N204D4	90	1995	<b>AP9021</b>	ALT, (Valeo)	<b>VD1028</b>
		N47D20A, N47D20C	105	1995			<b>VD1071</b>
318i	09/05-03/07	N46B20B, N46B20	95	1995	<b>AP9005</b>	ALT, (Bosch), 150A, OE-NO 1231 7 532 965, 1231 7 532 966, 1231 7 532 969,	



**BMW**
**3 (E90)**

					<b>AP9008</b>	1231 7 533 270 ALT, (Bosch), OE-NO 1231 7 533 268, 1231 7 532 964, 110A	
	09/07-	N43B20A, N46B20TU2	105	1995	<b>AP9008</b>	ALT, (Bosch), OE-NO 1231 7 533 268, 1231 7 532 964, 110A, MTR-CODE: N 46 B 20 TU2	
320 si	05/06-	N45B20A	127	1997	<b>AP9005</b>	ALT, (Bosch), 150A, OE-NO 1231 7 532 965, 1231 7 532 966, 1231 7 532 969, 1231 7 533 270	
320d	01/05-	M47N204D4, N47D20C	120	1995	<b>AP9021</b>	ALT, (Valeo) (E90), MTR-CODE: M47N (E90 Facelift) (E90), MTR-CODE: N47	<b>VD1028</b> <b>VD1071</b> <b>VD1071</b>
	01/10-	N47D20C	135	1995			<b>VD1071</b>
	09/05-	M47N204D4	110	1995			<b>VD1028</b>
	09/07-	N47D20A	130	1995			<b>VD1071</b>
320d xDrive	01/10-	N47D20C	135	1995			<b>VD1071</b>
	09/08-	N47D20C	130	1995			<b>VD1071</b>
320i	01/05-03/07	N46B20A, N46B20C, N46B20	110	1995	<b>AP9005</b> <b>AP9008</b>	(Bosch), 150A ALT, (Bosch), OE-NO 1231 7 533 268, 1231 7 532 964, 110A	
320xd	09/07-	N47D20C	130	1995			<b>VD1071</b>
325d	01/10-	N57D30A	150	2993		MTR-CODE: M57 N2	<b>VD1105</b>
	09/06-	M57306D3	145	2993			<b>VD1105</b>
325i	01/05-	N52B25A, N52B25	160	2497	<b>AP9005</b>	ALT, (Bosch), 150A, OE-NO 1231 7 550 967, 1231 7 551 254, 180A, OE-NO 1231 7 551 256, 1231 7 555 926	
					<b>AP9021</b>	ALT, (Valeo)	
	09/07-	N53B30A, N53B30	160	2996	<b>AP9005</b>	ALT, (Bosch), 150A, OE-NO 1231 7 550 967, 1231 7 551 254, 180A, OE-NO 1231 7 551 256, 1231 7 555 926	
325xi	01/05-	N52B25A	160	2497	<b>AP9005</b>	ALT, (Bosch), 150A, OE-NO 1231 7 550 967, 1231 7 551 254, 180A, OE-NO 1231 7 551 256, 1231 7 555 926	
					<b>AP9021</b>	ALT, (Valeo)	
	09/07-	N53B30A	160	2996	<b>AP9005</b>	ALT, (Bosch), 150A, OE-NO 1231 7 550 967, 1231 7 551 254, 180A, OE-NO 1231 7 551 256, 1231 7 555 926	
328i	07/05-11/07	N52NB30A	187	2996	<b>AP9005</b>	ALT, (Bosch), 150A, OE-NO 1231 7 551 254, 1231 7 550 967, 180A, OE-NO 1231 7 555 926, 1231 7 551 256	
330d	01/09-	N57D30A, M57N2306D3	180	2993		MTR-CODE: M57 N2	<b>VD1105</b>
	09/05-	M57306D3, M57D30TU2	170	2993			<b>VD1105</b>
330i	01/05-	N52B30A, N52B30	190	2996	<b>AP9005</b>	ALT, (Bosch), 150A, OE-NO 1231 7 550 967, 1231 7 551 254, 180A, OE-NO 1231 7 551 256, 1231 7 555 926	
					<b>AP9021</b>	ALT, (Valeo)	
	09/07-	N52B30A, N53B30A, N53B30	200	2996	<b>AP9005</b>	ALT, (Bosch), 150A, OE-NO 1231 7 550 967, 1231 7 551 254, 180A, OE-NO 1231 7 551 256, 1231 7 555 926	
330xd	09/05-	M57306D3, M57D30TU2	170	2993			<b>VD1105</b>
330xi	01/05-	N52B30A	190	2996	<b>AP9005</b>	ALT, (Bosch), 150A, OE-NO 1231 7 550 967, 1231 7 551 254, 180A, OE-NO 1231 7 551 256, 1231 7 555 926	
					<b>AP9021</b>	ALT, (Valeo)	
	09/07-	N53B30A	200	2996	<b>AP9005</b>	ALT, (Bosch), 150A, OE-NO 1231 7 550 967, 1231 7 551 254, 180A, OE-NO 1231 7 551 256, 1231 7 555 926	
335d	09/06-	M57N306D5	210	2993			<b>VD1105</b>
<b>3 Cabriolet (E46)</b>							
318 Ci	02/05-	N46B20B	110	1995	<b>AP9008</b>	ALT, (Bosch), OE-NO 1231 7 533 268, 1231 7 532 964, 110A	
	09/01-	N42B20, N46B20	105	1995	<b>AP9005</b>	ALT, (Bosch), 120A, OE-NO 1231 7 516 101, 1231 7 516 723, 150A, OE-NO 1231 7 521 384, 1231 7 521 490, 1231 7 521 491	
					<b>AP9008</b>	ALT, (Bosch), OE-NO 1231 7 533 268, 1231 7 532 964, 110A	
					<b>AP9021</b>	(Valeo), 120A, 140A	
					<b>AP9021</b>	ALT, 04/2002⇄, (Valeo), 90A, 110A	
320 Cd	02/05-	M47N204D4	110	1995			<b>VD1028</b>
330 Cd	08/05-	M57N306D2	150	2993			<b>VD1105</b>
<b>3 Cabriolet (E93)</b>							
320d	01/10-	N47D20C	135	1995			<b>VD1071</b>



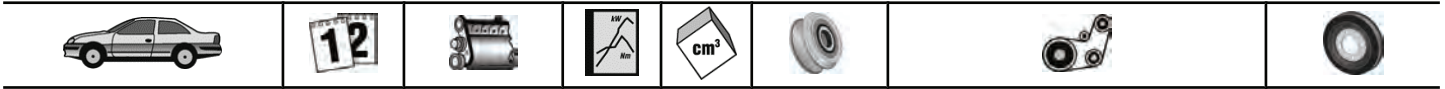

## BMW

### 3 Cabriolet (E93)

320i	03/07- 03/07-	N47D20A N43B20A	130 125	1995 1995				<b>VD1071</b>
325d	03/07-	N57306D3, M57D30TU2	145	2993				<b>VD1105</b>
325i	03/07-	N52B25A, N52B25	160	2497	<b>AP9005</b>	ALT, (Bosch), 150A, OE-NO 1231 7 550 967, 1231 7 551 254, 180A, OE-NO 1231 7 551 256, 1231 7 555 926		
		N53B30A, N53B30	160	2996	<b>AP9005</b>	ALT, (Bosch), 150A, OE-NO 1231 7 550 967, 1231 7 551 254, 180A, OE-NO 1231 7 551 256, 1231 7 555 926		
330d	01/09- 03/07-	N57D30A, M57N2306D3 N57N306D3, M57D30TU2	180 170	2993 2993		MTR-CODE: M57 N2		<b>VD1105</b> <b>VD1105</b>
330i	03/07-	N52NB30B	190	2996	<b>AP9005</b>	ALT, (Bosch), 150A, OE-NO 1231 7 550 967, 1231 7 551 254, 180A, OE-NO 1231 7 551 256, 1231 7 555 926		
		N52B30A, N53B30A, N53B30	200	2996	<b>AP9005</b>	ALT, (Bosch), 150A, OE-NO 1231 7 550 967, 1231 7 551 254, 180A, OE-NO 1231 7 551 256, 1231 7 555 926		

### 3 Compact (E46)

2.0 TD	10/01-12/02	M47204D1	100	1951		ALT, WP, AC		<b>5PK2030D1</b> <b>VD1030</b>
316 ti	06/01-02/05	N42B18, N46B18A	85	1796	<b>AP9005</b>	ALT, (Bosch), 120A, OE-NO 1231 7 516 101, 1231 7 516 723, 150A, OE-NO 1231 7 521 384, 1231 7 521 490, 1231 7 521 491, MTR-CODE: N40B16A, N42B18A, N45B16A		
					<b>AP9008</b>	ALT, (Bosch), OE-NO 1231 7 533 268, 1231 7 532 964, 110A		
					<b>AP9021</b>	(Valeo), 120A, 140A		
					<b>AP9021</b>	ALT, 04/2002⇒, (Valeo), 90A, 110A		
	06/02-02/05	N40B16A, N45B16A	85	1596	<b>AP9005</b>	ALT, (Bosch), 120A, OE-NO 1231 7 516 101, 1231 7 516 723, 150A, OE-NO 1231 7 521 384, 1231 7 521 490, 1231 7 521 491, MTR-CODE: N40B16A, N42B18A, N45B16A		
					<b>AP9008</b>	ALT, (Bosch), OE-NO 1231 7 533 268, 1231 7 532 964, 110A, MTR-CODE: N40B20B		
318 td	03/03-02/05	M47N204D4	85	1995		ALT, WP, AC, ⇒09/2004 ALT, WP, AC, 10/2004⇒		<b>6PK2080D1</b> <b>6PK2080D2</b> <b>VD1028</b>
318 ti	09/01-02/05	N42B20, N46B20A	105	1995	<b>AP9005</b>	ALT, (Bosch), 120A, OE-NO 1231 7 516 101, 1231 7 516 723, 150A, OE-NO 1231 7 521 384, 1231 7 521 490, 1231 7 521 491		
					<b>AP9008</b>	ALT, (Bosch), OE-NO 1231 7 533 268, 1231 7 532 964, 110A		
					<b>AP9021</b>	(Valeo), 120A, 140A		
					<b>AP9021</b>	ALT, 04/2002⇒, (Valeo), 90A, 110A		
320 td	09/01-02/05	M47N204D4	110	1995		ALT, WP, AC, 10/2002⇒, ⇒09/2004 ALT, WP, AC, 10/2004⇒ ALT, WP, AC, ⇒09/2002		<b>6PK2080D1</b> <b>6PK2080D2</b> <b>6PK2090D1</b> <b>VD1028</b>

### 3 Coupe (E46)

316 Ci	04/00- 06/02-	M43B16 (164E3) N45B16A	77 85	1596 1596	<b>AP9008</b>	ALT, (Bosch), OE-NO 1231 7 533 268, 1231 7 532 964, 110A, MTR-CODE: N40B16A		
					<b>AP9008</b>	ALT, (Bosch), OE-NO 1231 7 533 268, 1231 7 532 964, 110A		
					<b>AP9021</b>	ALT, (Valeo), 110A, 140A, 150A		
318 Ci	03/05- 09/01-	N46B20A N42B20, N46B20	110 105	1995 1995	<b>AP9008</b>	ALT, (Bosch), 110A, OE-NO 1231 7 532 268, 1231 7 532964		
					<b>AP9005</b>	ALT, (Bosch), 120A, OE-NO 1231 7 516 101, 1231 7 516 723, 150A, OE-NO 1231 7 521 384, 1231 7 521 490, 1231 7 521 491		
					<b>AP9008</b>	ALT, (Bosch), OE-NO 1231 7 533 268, 1231 7 532 964, 110A		
					<b>AP9021</b>	(Valeo), 120A, 140A		
					<b>AP9021</b>	ALT, 04/2002⇒, (Valeo), 90A, 110A		
320 Cd	11/03-	M47N204D4	110	1995		ALT, WP, AC, ⇒09/2004 ALT, WP, AC, 10/2004⇒		<b>6PK2080D1</b> <b>6PK2080D2</b> <b>VD1028</b>
330 Cd	03/03-	M57N306D2	150	2993				<b>VD1105</b>





## BMW

### 3 Coupe (E92)

320d	01/10-	N47D20C	135	1995			<b>VD1071</b>
	03/07-	N47D20A	130	1995			<b>VD1071</b>
320d xDrive	01/10-	N47D20C	135	1995			<b>VD1071</b>
	09/08-	N47D20C	130	1995			<b>VD1071</b>
320i	03/07-	N43B20A	125	1995	<b>AP9005</b>	ALT, (Bosch), 150A, OE-NO 1231 7 532 965, 1231 7 532 966, 1231 7 532 969, 1231 7 533 270, MTR-CODE: N46B20B	
	11/06-06/07	N46B20A, N46NB20B	110	1995	<b>AP9005</b>  <b>AP9008</b>	ALT, (Bosch), 150A, OE-NO 1231 7 532 965, 1231 7 532 966, 1231 7 532 969, 1231 7 533 270 ALT, (Bosch), OE-NO 1231 7 533 268, 1231 7 532 964, 110A	
320xd	03/07-	N47D20A	130	1995			<b>VD1071</b>
325d	03/07-	N57N306D3, M57D30TU2	145	2993			<b>VD1105</b>
	04/10-	N57D30A, M57N2306D3	150	2993		MTR-CODE: M57 N2	<b>VD1105</b>
325i	09/06-	N52B25C, N52B25A, N52B25	160	2497	<b>AP9005</b>	ALT, (Bosch), 150A, OE-NO 1231 7 550 967, 1231 7 551 254, 180A, OE-NO 1231 7 551 256, 1231 7 555 926	
	09/07-	N53B30A, N53B30	160	2996	<b>AP9005</b>	ALT, (Bosch), 150A, OE-NO 1231 7 550 967, 1231 7 551 254, 180A, OE-NO 1231 7 551 256, 1231 7 555 926	
325xi	09/06-	N52B25C, N52B25A	160	2497	<b>AP9005</b>	ALT, (Bosch), 150A, OE-NO 1231 7 550 967, 1231 7 551 254, 180A, OE-NO 1231 7 551 256, 1231 7 555 926	
328i	08/06-11/07	N52NB30A	187	2996	<b>AP9005</b>	ALT, (Bosch), 150A, OE-NO 1231 7 550 967, 1231 7 551 254, 180A, OE-NO 1231 7 551 256, 1231 7 555 926	
330d	01/09-	N57D30A, M57N2306D3	180	2993		MTR-CODE: M57 N2	<b>VD1105</b>
	09/06-	M57306D3, M57D30TU2	170	2993			<b>VD1105</b>
330d xDrive	01/09-	N57D30A	180	2993		MTR-CODE: M57 N2	<b>VD1105</b>
330i	09/06-	N52B30A, N53B30A, N53B30	200	2996	<b>AP9005</b>	ALT, (Bosch), 150A, OE-NO 1231 7 550 967, 1231 7 551 254, 180A, OE-NO 1231 7 551 256, 1231 7 555 926	
330xd	01/09-	N57D30A, M57N2306D3	180	2993		MTR-CODE: M57 N2	<b>VD1105</b>
	09/06-	M57306D3, M57D30TU2	170	2993			<b>VD1105</b>
330xi	09/06-	N52B30A	190	2996	<b>AP9005</b>	ALT, (Bosch), 150A, OE-NO 1231 7 550 967, 1231 7 551 254, 180A, OE-NO 1231 7 551 256, 1231 7 555 926	
			200	2996	<b>AP9005</b>	ALT, (Bosch), 150A, OE-NO 1231 7 550 967, 1231 7 551 254, 180A, OE-NO 1231 7 551 256, 1231 7 555 926	
335d	09/06-	M57N306D5	210	2993			<b>VD1105</b>

### 3 Touring (E36)

325 tds	01/95-10/99	M51D25 (Inter.)	105	2503		ALT, WP	<b>5PK1815D1</b> <b>VD1025</b>
---------	-------------	-----------------	-----	------	--	---------	-----------------------------------

### 3 Touring (E46)

316 i	03/02-02/05	N42B18, N46B18A, N46B18	85	1796	<b>AP9005</b>  <b>AP9008</b>  <b>AP9021</b> <b>AP9021</b>	ALT, (Bosch), 120A, OE-NO 1231 7 516 101, 1231 7 516 723, 150A, OE-NO 1231 7 521 384, 1231 7 521 490, 1231 7 521 491, MTR-CODE: N40B16A, N42B18A, N45B16A ALT, (Bosch), OE-NO 1231 7 533 268, 1231 7 532 964, 110A (Valeo), 120A, 140A ALT, 04/2002⇔, (Valeo), 90A, 110A	
	06/02-02/05	N45B16A, N45B16	85	1596	<b>AP9005</b>	ALT, (Bosch), 120A, OE-NO 1231 7 516 101, 1231 7 516 723, 150A, OE-NO 1231 7 521 384, 1231 7 521 490, 1231 7 521 491, MTR-CODE: N40B16A, N42B18A, N45B16A	
318 d	03/02-02/05	M47D20, M47204D1	85	1951		ALT, WP, AC	<b>5PK2030D1</b> <b>VD1030</b>
	03/03-02/05	M47N204D4	85	1995		ALT, WP, AC, ⇔09/2004 ALT, WP, AC, 10/2004⇔	<b>6PK2080D1</b> <b>6PK2080D2</b> <b>VD1028</b>
318 i	09/01-02/05	N42B20, N46B20A, N46B20	105	1995	<b>AP9005</b>  <b>AP9008</b>	ALT, (Bosch), 120A, OE-NO 1231 7 516 101, 1231 7 516 723, 150A, OE-NO 1231 7 521 384, 1231 7 521 490, 1231 7 521 491 ALT, (Bosch), OE-NO 1231 7 533 268, 1231 7 532 964, 110A	



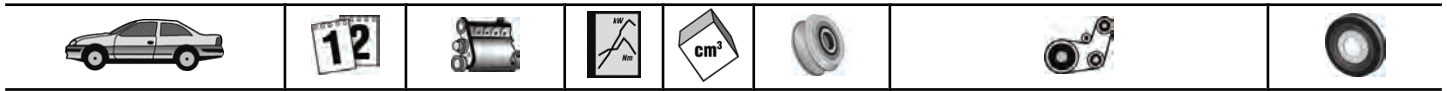

## BMW

### 3 Touring (E46)

					<b>AP9021</b>	(Valeo), 120A, 140A	
					<b>AP9021</b>	ALT, 04/2002⇒, (Valeo), 90A, 110A	
320 d	03/00-09/01	M47D20, M47204D1	100	1951		ALT, WP, AC	<b>5PK2030D1</b> <b>VD1030</b>
	09/01-02/05	M47N204D4	110	1995		ALT, WP, AC, 10/2002⇒, ⇒09/2004 ALT, WP, AC, 10/2004⇒ ALT, WP, AC, ⇒09/2002	<b>6PK2080D1</b> <b>6PK2080D2</b> <b>6PK2090D1</b> <b>VD1028</b>
330 d	03/03-02/05	M57N306D2	150	2993			<b>VD1105</b>
	10/99-02/05	M57D30, M57306D1	135	2926		⇒03/2003, ALT, WP, AC	<b>5PK2060D1</b> <b>VD1027</b>
330 xd	03/03-02/05	M57N306D2	150	2993			<b>VD1105</b>
	06/00-02/05	M57D30	135	2926		⇒03/2003, ALT, WP, AC	<b>5PK2060D1</b> <b>VD1027</b>

### 3 Touring (E91)

318d	09/05-	M47N204D4	90	1995	<b>AP9021</b>	ALT, (Valeo)	<b>VD1028</b>
	09/07-	N47D20A, N47D20C	105	1995			<b>VD1071</b>
318i	01/06-	N46B20B, N46B20	95	1995	<b>AP9005</b>	ALT, (Bosch), 150A, OE-NO 1231 7 532 965, 1231 7 532 966, 1231 7 532 969, 1231 7 533 270	
					<b>AP9008</b>	ALT, (Bosch), OE-NO 1231 7 533 268, 1231 7 532 964, 110A	
	09/07-	N43B20A, N46B20TU2	105	1995	<b>AP9008</b>	ALT, (Bosch), OE-NO 1231 7 533 268, 1231 7 532 964, 110A	
320d	01/10-	N47D20C	135	1995			<b>VD1071</b>
	09/05-	M47N204D4, M47D20TU	110	1995		MTR-CODE: M47N 204 D4 MTR-CODE: M47 D20 TU	<b>VD1028</b> <b>VD1105</b>
		M47N204D5, N47D20A	120	1995			<b>VD1028</b>
	09/07-	N47D20A	130	1995			<b>VD1071</b>
320d xDrive	01/10-	N47D20C	135	1995			<b>VD1071</b>
	09/08-	N47D20C	130	1995			<b>VD1071</b>
320i	09/05-	N46B20A, N46B20C, N46B20	110	1995	<b>AP9005</b>	ALT, (Bosch), 150A, OE-NO 1231 7 532 965, 1231 7 532 966, 1231 7 532 969, 1231 7 533 270	
					<b>AP9008</b>	ALT, (Bosch), OE-NO 1231 7 533 268, 1231 7 532 964, 110A	
325d	04/10-	N57D30A, M57N2306D3	150	2993		MTR-CODE: M57 N2	<b>VD1105</b>
	09/06-	M57306D3, M57D30TU2	145	2993			<b>VD1105</b>
325i	09/05-	N52B25C, N52B25A, N52B25	160	2497	<b>AP9005</b>	ALT, (Bosch), 150A, OE-NO 1231 7 550 967, 1231 7 551 254, 180A, OE-NO 1231 7 551 256, 1231 7 555 926	
					<b>AP9021</b>	ALT, (Valeo)	
	09/07-	N53B30A, N53B30	160	2996	<b>AP9005</b>	ALT, (Bosch), 150A, OE-NO 1231 7 550 967, 1231 7 551 254, 180A, OE-NO 1231 7 551 256, 1231 7 555 926	
325xi	09/05-	N52B25C	160	2497	<b>AP9021</b>	ALT, (Valeo)	
330d	01/09-	N57D30A, M57N2306D3	180	2993		MTR-CODE: M57 N2	<b>VD1105</b>
	09/05-	M57306D3	170	2993			<b>VD1105</b>
330i	09/05-	N52B30A, N52B30	190	2996	<b>AP9005</b>	ALT, (Bosch), 150A, OE-NO 1231 7 550 967, 1231 7 551 254, 180A, OE-NO 1231 7 551 256, 1231 7 555 926	
					<b>AP9021</b>	ALT, (Valeo)	
	09/07-	N52B30A, N53B30	200	2996	<b>AP9005</b>	ALT, (Bosch), 150A, OE-NO 1231 7 550 967, 1231 7 551 254, 180A, OE-NO 1231 7 551 256, 1231 7 555 926	
330xd	01/09-	N57D30A, M57N2306D3	180	2993		MTR-CODE: M57 N2	<b>VD1105</b>
	09/05-	M57306D3, M57D30TU2	170	2993			<b>VD1105</b>
330xi	09/05-	N52B30A	190	2996	<b>AP9021</b>	ALT, (Valeo)	
335d	09/06-	M57N306D5	210	2993			<b>VD1105</b>

### 5 (E34)

525 td	04/93-09/95	M51D25	85	2497		ALT, WP	<b>5PK1815D1</b> <b>VD1025</b>
525 tds	09/91-09/95	M51D25 (Inter.)	105	2503		ALT, WP	<b>5PK1815D1</b> <b>VD1025</b>

### 5 (E39)

520 d	02/00-06/03	M47D20, M47204D1	100	1951		ALT, WP, AC	<b>5PK2030D1</b> <b>VD1030</b>
525 d	02/00-06/03	M57256D1, M57D25	120	2497		⇒03/2003, ALT, WP, AC	<b>5PK2060D1</b> <b>VD1027</b>



**BMW**
**5 (E39)**

525 td	01/97-06/03	M51D25	85	2497		ALT, 95A, WP	<b>5PK1815D1</b> <b>VD1025</b>
525 tds	01/96-06/03	M51D25 (Inter.)	105	2503		(MANL), ALT, 95A, WP	<b>5PK1815D1</b> <b>VD1025</b>
530 d	08/98-09/00	M57D30	135	2926		ALT, WP, AC	<b>5PK2060D1</b> <b>VD1027</b>
	09/00-06/03	M57D30	142	2926		⇒03/2003, ALT, WP, AC	<b>5PK2060D1</b> <b>VD1027</b>

**5 (E60)**

520d	07/05-	M47N204D5, N47D20A	120	1995		(E60 Facelift), MTR-CODE: M47N (E60) (E60 Facelift), MTR-CODE: N47	<b>VD1028</b> <b>VD1028</b> <b>VD1071</b>
	09/05-	M47N204D4	110	1995			<b>VD1028</b>
	09/07-	M47N204D4, N47D20A, N47D20C	130	1995		(E60 Facelift), MTR-CODE: M47N (E60) (E60 Facelift), MTR-CODE: N47	<b>VD1028</b> <b>VD1028</b> <b>VD1071</b>
520i	09/07-	N43B20A	125	1995	<b>AP9008</b>	ALT, (Bosch), OE-NO 1231 7 533 268, 1231 7 532 964, 110A, MTR-CODE: N46B20B	
523i	01/07-	N52B25A	140	2497	<b>AP9005</b>	ALT, (Bosch), 150A, OE-NO 1231 7 550 967, 1231 7 551 254, 180A, OE-NO 1231 7 551 256, 1231 7 555 926	
	07/05-	N52B25A, N52B25	130	2497	<b>AP9005</b>  <b>AP9021</b>	ALT, (Bosch), 150A, OE-NO 1231 7 550 967, 1231 7 551 254, 180A, OE-NO 1231 7 551 256, 1231 7 555 926 ALT, (Valeo)	
525d	01/07-	M57306D3	145	2993			<b>VD1105</b>
	06/04-	M57N256D4, M57D25TU	130	2497			<b>VD1105</b>
	12/04-	M57256D1	120	2497			<b>VD1105</b>
525d xDrive	09/08-	N57306D3	145	2993			<b>VD1105</b>
525i	01/07-	N53B30A, N53B30	160	2996	<b>AP9005</b>	ALT, (Bosch), 150A, OE-NO 1231 7 550 967, 1231 7 551 254, 180A, OE-NO 1231 7 551 256, 1231 7 555 926	
	07/05-	N52B25A, N52B25	160	2497	<b>AP9005</b>  <b>AP9021</b>	ALT, (Bosch), 150A, OE-NO 1231 7 550 967, 1231 7 551 254, 180A, OE-NO 1231 7 551 256, 1231 7 555 926 ALT, (Valeo)	
525xd	01/07-	M57306D3	145	2993			<b>VD1105</b>
525xi	07/05-	N52B25A	160	2497	<b>AP9005</b>  <b>AP9021</b>	ALT, (Bosch), 150A, OE-NO 1231 7 550 967, 1231 7 551 254, 180A, OE-NO 1231 7 551 256, 1231 7 555 926 ALT, (Valeo)	
	01/07-	M57306D3	173	2993			<b>VD1105</b>
530d	07/03-	N57306D2	160	2993			<b>VD1105</b>
		M57306D3	170	2993			<b>VD1105</b>
530d xDrive	09/08-	M57N2306D3	173	2993			<b>VD1105</b>
530i	01/07-	N52B30A, N53B30A, N53B30	200	2996	<b>AP9005</b>	ALT, (Bosch), 150A, OE-NO 1231 7 550 967, 1231 7 551 254, 180A, OE-NO 1231 7 551 256, 1231 7 555 926	
	07/05-	N52B30A, N52B30	190	2996	<b>AP9005</b>  <b>AP9021</b>	ALT, (Bosch), 150A, OE-NO 1231 7 550 967, 1231 7 551 254, 180A, OE-NO 1231 7 551 256, 1231 7 555 926 ALT, (Valeo)	
530xd	01/07-	M57306D3	173	2993			<b>VD1105</b>
	07/05-	M57306D3	170	2993			<b>VD1105</b>
530xi	07/05-	N52B30A	190	2996	<b>AP9021</b>	ALT, (Valeo)	
535d	01/07-	M57N306D5	210	2993			<b>VD1105</b>
	09/04-	M57306D4	200	2993			<b>VD1105</b>

**5 Touring (E34)**

525 td	03/93-01/97	M51D25	85	2497		ALT, WP	<b>5PK1815D1</b> <b>VD1025</b>
525 tds	12/91-01/97	M51D25 (Inter.)	105	2503		ALT, WP	<b>5PK1815D1</b> <b>VD1025</b>

**5 Touring (E39)**

520 d	02/00-09/03	M47D20, M47204D1	100	1951		ALT, WP, AC	<b>5PK2030D1</b> <b>VD1030</b>
525 d	02/00-05/04	M57256D1, M57D25	120	2497		⇒03/2003, ALT, WP, AC	<b>5PK2060D1</b> <b>VD1027</b>
525 tds	03/97-05/04	M51D25 (Inter.)	105	2503		(MANL), ALT, 95A, WP	<b>5PK1815D1</b> <b>VD1025</b>
530 d	08/98-09/00	M57D30	135	2926		ALT, WP, AC	<b>5PK2060D1</b> <b>VD1027</b>
	09/00-05/04	M57D30	142	2926		⇒03/2003, ALT, WP, AC	<b>5PK2060D1</b> <b>VD1027</b>

**5 Touring (E61)**

520d	07/05-	M47N204D5,	120	1995		(E61 Facelift), MTR-CODE: M47N	<b>VD1028</b>
------	--------	------------	-----	------	--	--------------------------------	---------------





## BMW

### 5 Touring (E61)

		N47D20A				(E61) (E61 Facelift), MTR-CODE: N47	VD1028 VD1071
	09/05-	M47N204D4	110	1995			VD1028
	09/07-	N47D20A, N47D20C	130	1995		(E61 Facelift), MTR-CODE: M47N (E61) (E61 Facelift), MTR-CODE: N47	VD1028 VD1028 VD1071
523i	01/07-	N52B25A	140	2497	AP9005	ALT, (Bosch), 150A, OE-NO 1231 7 550 967, 1231 7 551 254, 180A, OE-NO 1231 7 551 256, 1231 7 555 926	
	07/05-	N52B25A, N52B25	130	2497	AP9005 AP9021	ALT, (Bosch), 150A, OE-NO 1231 7 550 967, 1231 7 551 254, 180A, OE-NO 1231 7 551 256, 1231 7 555 926 ALT, (Valeo)	
525d	01/07-	M57306D3	145	2993			VD1105
	06/04-	M57N256D4, M57D25TU	130	2497			VD1105
	12/04-	M57N256D4	120	2497			VD1105
525d xDrive	09/08-	N57306D3	145	2993			VD1105
525i	01/07-	N53B30A, N53B30	160	2996	AP9005	ALT, (Bosch), 150A, OE-NO 1231 7 550 967, 1231 7 551 254, 180A, OE-NO 1231 7 551 256, 1231 7 555 926	
	07/05-	N52B25A, N52B25	160	2497	AP9005 AP9021	ALT, (Bosch), 150A, OE-NO 1231 7 550 967, 1231 7 551 254, 180A, OE-NO 1231 7 551 256, 1231 7 555 926 ALT, (Valeo)	
525xd	01/07-	M57306D3	145	2993			VD1105
525xi	07/05-	N52B25A	160	2497	AP9005 AP9021	ALT, (Bosch), 150A, OE-NO 1231 7 550 967, 1231 7 551 254, 180A, OE-NO 1231 7 551 256, 1231 7 555 926 ALT, (Valeo)	
530d	01/07-	M57306D3	173	2993			VD1105
	06/04-	N57306D2	160	2993			VD1105
	07/05-	M57306D3	170	2993			VD1105
530d xDrive	09/08-	M57N2306D3	173	2993			VD1105
530i	01/07-	N52B30A, N53B30A, N53B30	200	2996	AP9005	ALT, (Bosch), 150A, OE-NO 1231 7 550 967, 1231 7 551 254, 180A, OE-NO 1231 7 551 256, 1231 7 555 926	
	07/05-	N52B30A, N52B30	190	2996	AP9005 AP9021	ALT, (Bosch), 150A, OE-NO 1231 7 550 967, 1231 7 551 254, 180A, OE-NO 1231 7 551 256, 1231 7 555 926 ALT, (Valeo)	
530xd	01/07-	M57306D3	173	2993			VD1105
	07/05-	M57306D3	170	2993			VD1105
530xi	07/05-	N52B30A	190	2996	AP9021	ALT, (Valeo)	
535d	01/07-	M57N306D5	210	2993			VD1105
	09/04-	M57306D4	200	2993			VD1105
<b>6 (E63)</b>							
630i	07/07-	N52B30A, N53B30	200	2996	AP9005	ALT, (Bosch), 150A, OE-NO 1231 7 550 967, 1231 7 551 254, 180A, OE-NO 1231 7 551 256, 1231 7 555 926	
	09/04-	N52B30A, N52B30	190	2996	AP9005 AP9021	ALT, (Bosch), 150A, OE-NO 1231 7 550 967, 1231 7 551 254, 180A, OE-NO 1231 7 551 256, 1231 7 555 926 ALT, (Valeo)	
635d	07/07-	N57N306D5	210	2993			VD1105
<b>6 Cabriolet (E64)</b>							
630i	07/07-	N52B30A, N53B30	200	2996	AP9005	ALT, (Bosch), 150A, OE-NO 1231 7 550 967, 1231 7 551 254, 180A, OE-NO 1231 7 551 256, 1231 7 555 926	
	09/04-	N52B30A, N52B30	190	2996	AP9005 AP9021	ALT, (Bosch), 150A, OE-NO 1231 7 550 967, 1231 7 551 254, 180A, OE-NO 1231 7 551 256, 1231 7 555 926 ALT, (Valeo)	
635d	07/07-	M57N306D5	210	2993			VD1105
<b>7 (E38)</b>							
725 tds	04/96-11/01	M51D25 (Inter.)	105	2503		(MANL)	VD1025
<b>7 (E65, E66)</b>							
3.0	03/05-		184	2996	AP9005	ALT, (Bosch), 155A, OE-NO 1231 4 487 081, 1231 7 542 529, 1231 70 543 083	
730 d	10/02-	M57N2306D2	160	2993			VD1105
730 i,Li	03/05-	N52B30A, N52B30	190	2996	AP9005 AP9021	ALT, (Bosch), 155A, OE-NO 1231 4 487 081, 1231 7 542 529, 1231 7 543 083 ALT, MTR-CODE: N52, (Valeo)	
730 Ld	07/05-	M57306D3, N57N306D2	170	2993			VD1105
<b>X1 (E84)</b>							
sDrive18d	10/09-	N47D20C	105	1995			VD1071



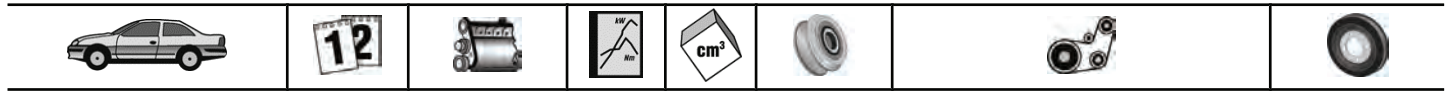

CITROËN

## BMW

<b>X1 (E84)</b>							
sDrive20d	10/09-	N47D20C	130	1995			VD1071
xDrive18d	10/09-	N47D20C	105	1995			VD1071
xDrive20d	10/09-	N47D20C	130	1995			VD1071
<b>X3 (E83)</b>							
2.0 d	09/07-	N47D20A	130	1995			VD1071
	10/04-	M47N204D4	110	1995		ALT, WP, AC	6PK2080D2 VD1028
2.0 i	07/05-	N46B20A, N46B20	110	1995	AP9005	ALT, (Bosch), 150A, OE-NO 1231 7 532 965, 1231 7 532 966, 1231 7 532 969, 1231 7 533 270	
2.5 si	09/06-	N52B25A	160	2497	AP9005	ALT, (Bosch), 150A, OE-NO 1231 7 550 967, 1231 7 551 254, 180A, OE-NO 1231 7 551 256, 1231 7 555 926	
3.0 d	01/04-	M54N306D2	150	2993			VD1105
		M57N2306D2	160	2993			VD1105
3.0 sd	09/06-	M57306D5	210	2993			VD1105
3.0 si	09/06-	N52B30A	200	2996	AP9005	ALT, (Bosch), 150A, OE-NO 1231 7 550 967, 1231 7 551 254, 180A, OE-NO 1231 7 551 256, 1231 7 555 926	
xDrive18d	09/08-	M47N204D4	105	1995			VD1071
xDrive20d	09/08-	N47D20C	130	1995			VD1071
xDrive30d	09/08-	M57N2306D3	160	2993			VD1105
xDrive35d	09/08-	N57N306D5	210	2993			VD1105
<b>X5 (E53)</b>							
3.0 d	05/01-	M57306D1	135	2925		ALT, WP, AC, (MANL)	5PK2060D1 VD1027
	12/03-	M57N306D4	160	2993			VD1105
<b>X5 (E70)</b>							
3.0 d	02/07-	M57N2306D3	155	2993			VD1105
		M57306D3	173	2993			VD1105
3.0 sd	09/07-	M57N306D5	210	2993			VD1105
3.0 si	02/07-	N52B30A, N52B30	200	2996	AP9005	ALT, (Bosch), 150A, OE-NO 1231 7 550 967, 1231 7 551 254, 180A, OE-NO 1231 7 551 256, 1231 7 555 926	
xDrive30d	09/08-	N57D30A	173	2993			VD1105
xDrive35d	09/08-		210	2993			VD1105
<b>X6 (E71, E72)</b>							
30d	05/08-	M57N2306D3	173	2993			VD1105
35d	05/08-	N57N306D5	210	2993			VD1105
xDrive30d	09/08-	N57D30A	173	2993			VD1105
xDrive35d	09/08-	N57N306D5	210	2993			VD1105
<b>Z4 (E85)</b>							
2.0 i	04/05-	N46B20A, N46B20	110	1995	AP9005	ALT, (Bosch), 150A, OE-NO 1231 7 532 965, 1231 7 532 966, 1231 7 532 969, 1231 7 533 270	
					AP9008	ALT, (Bosch), OE-NO 1231 7 533 268, 1231 7 532 964, 110A	
					AP9021	ALT, (Valeo), 110A	
2.5 i	01/06-	N52B25A	130	2497	AP9005	ALT, (Bosch), 150A, OE-NO 1231 7 550 967, 1231 7 551 254, 180A, OE-NO 1231 7 551 256, 1231 7 555 926	
2.5 si	01/06-	N52B25A	160	2497	AP9005	ALT, (Bosch), 150A, OE-NO 1231 7 550 967, 1231 7 551 254, 180A, OE-NO 1231 7 551 256, 1231 7 555 926	
3.0 si	01/06-	N52B30A, N52B30	195	2996	AP9005	ALT, (Bosch), 150A, OE-NO 1231 7 550 967, 1231 7 551 254, 180A, OE-NO 1231 7 551 256, 1231 7 555 926	
<b>Z4 Coupe (E86)</b>							
3.0 si	03/06-	N52B30A, N52B30	195	2996	AP9005	ALT, (Bosch), 150A, OE-NO 1231 7 550 967, 1231 7 551 254, 180A, OE-NO 1231 7 551 256, 1231 7 555 926	

## CHRYSLER

<b>PT CRUISER (PT_)</b>							
2.2 CRD	03/02-	EDJ	89	2148	AP9010	ALT, (Bosch), 150A, OE-NO 05080 464AB, 05080 464AC, 05080 464AD	
	08/05-		110	2148	AP9010	ALT, (Bosch), 150A, OE-NO 05080 464AB, 05080 464AC, 05080 464AD	

## CITROËN

<b>AX (ZA-)</b>							
15 D	08/94-12/97	VJY (TUD5)	40	1527			VD1085
<b>BERLINGO</b>							
1.6	04/08-	NFR (TU5JP4B)	66	1587	AP9018	ALT, (Mitsubishi), 80A, OE-NO 5705KQ, 5702J3, ALT-No: A005TG0881ZE, 120A, OE-NO 5705KG, 5702J0,	







## CITROËN

### BERLINGO

		NFU (TU5JP4)	80	1587	<b>AP9018</b>	ALT-No: A003TG5281ZE ALT, (Mitsubishi), 80A, OE-NO 5705KQ, 5702J3, ALT-No: A005TG0881ZE, 120A, OE-NO 5705KG, 5702J0, ALT-No: A003TG5281ZE MTR-CODE: TU5JP4, (M59)	<b>VD1100</b>
1.6 HDi 110	04/08-	9HZ-DV6TED4	80	1560	<b>AP9013</b>  <b>AP9013</b> <b>AP9019</b> <b>AP9040</b>	ALT, (Valeo), 150A, OE-NO 5702H4, 5705AS, 5705EY, ALT-No: TG15C020, TG15C028, TG15C053 ALT, (Valeo), 180A, OE-NO 5705AX, 5705EE, ALT-No: FG 18 S 017 ALT, (Valeo), ALT-No: TG15C118, 150A, OE-NO 5705AS, 5705EY ALT, (Mitsubishi), 180A, OE-NO 5705AX, 5705EE, ALT-No: A004TJ0084	<b>VD1096</b> <b>VD1096</b>
1.6 HDi 75	04/08-	9HT (DV6BTED4)	55	1560	<b>AP9013</b>  <b>AP9013</b> <b>AP9019</b> <b>AP9040</b>	ALT, (Valeo), 150A, OE-NO 5702H4, 5705AS, 5705EY, ALT-No: TG15C020, TG15C028, TG15C053 ALT, (Valeo), 180A, OE-NO 5705AX, 5705EE, ALT-No: FG 18 S 017 ALT, (Valeo), ALT-No: TG15C118, 150A, OE-NO 5705AS, 5705EY ALT, (Mitsubishi), 180A, OE-NO 5705AX, 5705EE, ALT-No: A004TJ0084	<b>VD1096</b>
1.6 HDi 90	04/08-	9HX (DV6ATED4)	66	1560	<b>AP9013</b>  <b>AP9013</b> <b>AP9019</b> <b>AP9040</b>	ALT, (Valeo), 150A, OE-NO 5702H4, 5705AS, 5705EY, ALT-No: TG15C020, TG15C028, TG15C053 ALT, (Valeo), 180A, OE-NO 5705AX, 5705EE, ALT-No: FG 18 S 017 ALT, (Valeo), ALT-No: TG15C118, 150A, OE-NO 5705AS, 5705EY ALT, (Mitsubishi), 180A, OE-NO 5705AX, 5705EE, ALT-No: A004TJ0084	<b>VD1096</b>
<b>BERLINGO (MF)</b>							
1.1 i (MFHDZ)	07/96-	HDZ (TU1M), HFX (TU1JP)	44	1124		(M59), MTR-CODE: TU1JP	<b>VD1100</b>
1.4 i (MFKFX)	07/96-	KFX (TU3JP), KFW (TU3JP)	55	1360		(M59), MTR-CODE: TU3JP	<b>VD1100</b>
1.6 16V (MFNFU)	10/00-	NFU (TU5JP4)	80	1587		(M59), MTR-CODE: TU5JP4	<b>VD1100</b>
1.6 HDi 110	08/05-	DV6TED4	80	1560	<b>AP9013</b>  <b>AP9013</b> <b>AP9019</b>	ALT, (Valeo), 150A, OE-NO 5702H4, 5705AS, 5705EY, ALT-No: TG15C020, TG15C028, TG15C053 ALT, (Valeo), 180A, OE-NO 5705AX, 5705EE, ALT-No: FG 18 S 017 ALT, (Valeo), ALT-No: TG15C118, 150A, OE-NO 5705AS, 5705EY	
1.6 HDi 90	07/05-	DV6ATED4	66	1560	<b>AP9013</b>  <b>AP9013</b> <b>AP9019</b>	ALT, (Valeo), 150A, OE-NO 5702H4, 5705AS, 5705EY, ALT-No: TG15C020, TG15C028, TG15C053 ALT, (Valeo), 180A, OE-NO 5705AX, 5705EE, ALT-No: FG 18 S 017 ALT, (Valeo), ALT-No: TG15C118, 150A, OE-NO 5705AS, 5705EY	
1.8 D (MFA9A)	07/98-	A9A (XUD7)	43	1769			<b>VD1086</b>
1.9 D (MFDJY)	07/96-	D9B (XUD9A /L), DJY (XUD9A)	50	1905			<b>VD1086</b>
1.9 D (MFWJZ)	07/98-	WJZ (DW8), WJY (DW8B)	51	1868		(M49), MTR-CODE: DW8B, ALT, (PS), (AC), ORG-NO 09154⇒, ⇒ORG-NO 11892 (AC), (M59), ⇒ORG-NO 10177 (AC), ORG-NO 09377⇒, ⇒ORG-NO 10897 (AC), (M59), ORG-NO 10178⇒ (AC), ORG-NO 10898⇒ (AC), ORG-NO 09154⇒, ⇒ORG-NO 09376 (-AC), ORG-NO 09154⇒, ⇒ORG-NO 09858	<b>6PK1750D2</b>  <b>VD1080</b> <b>VD1080</b> <b>VD1095</b> <b>VD1095</b> <b>VD1097</b> <b>VD1097</b>
1.9 D 4WD (MFWJZ)	07/98-	WJZ (DW8)	51	1868		(M49), MTR-CODE: DW8B, ALT, (PS), (AC), ORG-NO 09377⇒, ⇒ORG-NO 10897	<b>6PK1750D2</b>

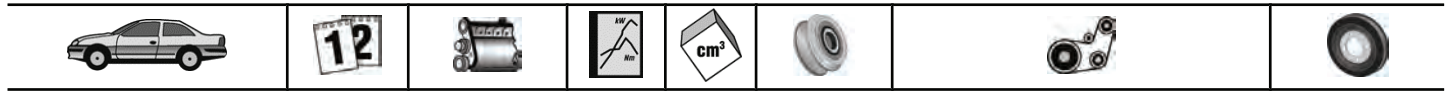

CITROËN

## CITROËN

### BERLINGO (MF)

						(AC), (M59), ⇒ORG-NO 10177 (AC), ORG-NO 09377⇒, ⇒ORG-NO 10897 (AC), (M59), ORG-NO 10178⇒ (AC), ORG-NO 10898⇒ (AC), ORG-NO 09154⇒, ⇒ORG-NO 09376 (-AC), ORG-NO 09154⇒, ⇒ORG-NO 09858	<b>VD1080</b> <b>VD1080</b> <b>VD1095</b> <b>VD1095</b> <b>VD1097</b> <b>VD1097</b>
2.0 HDi	11/02-10/05	DW10TD	66	1997	<b>AP9038</b>	ALT, OE-NO 5705 4F, 5705 GC, (Valeo), (Mitsubishi), 150A (M49), ALT, (-AC) (M59), ALT, (-AC), ⇒ORG-NO 10179 (M59), ALT, (AC), ⇒ORG-NO 10179 (M49), ALT, (AC)	<b>6PK1468D1</b> <b>6PK1468D1</b> <b>6PK1740D1</b> <b>6PK1750D2</b> <b>VD1080</b>
2.0 HDi 4x4	11/02-10/05	DW10TD	66	1997	<b>AP9038</b>	ALT, OE-NO 5705 4F, 5705 GC, (Valeo), (Mitsubishi), 150A	
2.0 HDI 90 (MFRHY)	12/99-	RHY (DW10TD)	66	1997	<b>AP9038</b>	ALT, OE-NO 5705 4F, 5705 GC, (Valeo), (Mitsubishi), 150A ALT, (-AC), (M49), (M59) ALT, (AC), (M59), ⇒ORG-NO 10179 ALT, (AC), (M49)	<b>6PK1468D1</b> <b>6PK1740D1</b> <b>6PK1750D2</b> <b>VD1080</b>

### BERLINGO Kasten

1.6	04/08-	NFR (TU5JP4B)	66	1587	<b>AP9018</b>	ALT, (Mitsubishi), 80A, OE-NO 5705KQ, 5702J3, ALT-No: A005TG0881ZE, 120A, OE-NO 5705KG, 5702J0, ALT-No: A003TG5281ZE	
		NFU (TU5JP4)	80	1587	<b>AP9018</b>	ALT, (Mitsubishi), 80A, OE-NO 5705KQ, 5702J3, ALT-No: A005TG0881ZE, 120A, OE-NO 5705KG, 5702J0, ALT-No: A003TG5281ZE	
1.6 HDi 110	04/08-	9HZ-DV6TED4	80	1560	<b>AP9013</b>	ALT, (Valeo), 150A, OE-NO 5702H4, 5705AS, 5705EY, ALT-No: TG15C020, TG15C028, TG15C053	
					<b>AP9013</b>	ALT, (Valeo), 180A, OE-NO 5705AX, 5705EE, ALT-No: FG 18 S 017	
					<b>AP9019</b>	ALT, (Valeo), ALT-No: TG15C118, 150A, OE-NO 5705AS, 5705EY	
					<b>AP9040</b>	ALT, (Mitsubishi), 180A, OE-NO 5705AX, 5705EE, ALT-No: A004TJ0084	
1.6 HDi 75	04/08-	9HT (DV6BUTED4)	55	1560	<b>AP9013</b>	ALT, (Valeo), 150A, OE-NO 5702H4, 5705AS, 5705EY, ALT-No: TG15C020, TG15C028, TG15C053	
					<b>AP9013</b>	ALT, (Valeo), 180A, OE-NO 5705AX, 5705EE, ALT-No: FG 18 S 017	
					<b>AP9019</b>	ALT, (Valeo), ALT-No: TG15C118, 150A, OE-NO 5705AS, 5705EY	
					<b>AP9040</b>	ALT, (Mitsubishi), 180A, OE-NO 5705AX, 5705EE, ALT-No: A004TJ0084	
1.6 HDi 90	04/08-	9HX (DV6ATED4)	66	1560	<b>AP9013</b>	ALT, (Valeo), 150A, OE-NO 5702H4, 5705AS, 5705EY, ALT-No: TG15C020, TG15C028, TG15C053	
					<b>AP9013</b>	ALT, (Valeo), 180A, OE-NO 5705AX, 5705EE, ALT-No: FG 18 S 017	
					<b>AP9019</b>	ALT, (Valeo), ALT-No: TG15C118, 150A, OE-NO 5705AS, 5705EY	
					<b>AP9040</b>	ALT, (Mitsubishi), 180A, OE-NO 5705AX, 5705EE, ALT-No: A004TJ0084	

### BERLINGO Kasten (M\_)

1.4 i (MBKFX)	07/96-	KFX (TU3JP), KFW (TU3JP)	55	1360		(M59), MTR-CODE: TU3JP	<b>VD1100</b>
1.6 16V	10/00-	NFU (TU5JP4)	80	1587		(M59), MTR-CODE: TU5JP4	<b>VD1100</b>
1.6 HDI 75	07/05-	DV6B	55	1560	<b>AP9013</b>	ALT, (Valeo), 150A, OE-NO 5702H4, 5705AS, 5705EY, ALT-No: TG15C020, TG15C028, TG15C053	
					<b>AP9013</b>	ALT, (Valeo), 180A, OE-NO 5705AX, 5705EE, ALT-No: FG 18 S 017	
					<b>AP9019</b>	ALT, (Valeo), ALT-No: TG15C118, 150A, OE-NO 5705AS, 5705EY	
1.6 HDI 90	07/05-	DV6ATED4	66	1560	<b>AP9013</b>	ALT, (Valeo), 150A, OE-NO 5702H4, 5705AS, 5705EY, ALT-No: TG15C020, TG15C028, TG15C053	
					<b>AP9013</b>	ALT, (Valeo), 180A, OE-NO 5705AX,	



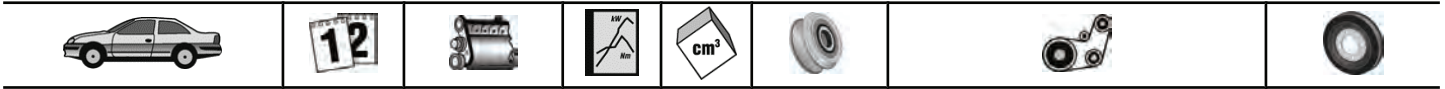

# CITROËN

## BERLINGO Kasten (M.)

					<b>AP9019</b>	5705EE, ALT-No: FG 18 S 017 ALT, (Valeo), ALT-No: TG15C118, 150A, OE-NO 5705AS, 5705EY	
1.8 D (MBA9A, MCA9A)	07/96-	A9A (XUD7)	43	1769			<b>VD1086</b>
1.9 D	07/96-	DJY (XUD9A)	51	1905			<b>VD1086</b>
1.9 D 70 4WD	07/98-	WJZ (DW8)	51	1868		(M49), MTR-CODE: DW8B, ALT, (PS), (AC), ORG-NO 09377⇒, ⇒ORG-NO 10897	<b>6PK1750D2</b>
						(AC), (M59), ⇒ORG-NO 10177	<b>VD1080</b>
						(AC), ORG-NO 09377⇒, ⇒ORG-NO 10897	<b>VD1080</b>
						(AC), (M59), ORG-NO 10178⇒	<b>VD1095</b>
						(AC), ORG-NO 10898⇒	<b>VD1095</b>
						(AC), ORG-NO 09154⇒, ⇒ORG-NO 09376	<b>VD1097</b>
						(-AC), ORG-NO 09154⇒, ⇒ORG-NO 09858	<b>VD1097</b>
1.9 D 70 (MBWJZ, MCWJZ)	04/99-	WJZ (DW8)	51	1868		(M49), MTR-CODE: DW8B, ALT, (PS), (AC), ORG-NO 09377⇒, ⇒ORG-NO 10897	<b>6PK1750D2</b>
						(AC), (M59), ⇒ORG-NO 10177	<b>VD1080</b>
						(AC), ORG-NO 09377⇒, ⇒ORG-NO 10897	<b>VD1080</b>
						(AC), (M59), ORG-NO 10178⇒	<b>VD1095</b>
						(AC), ORG-NO 10898⇒	<b>VD1095</b>
						(AC), ORG-NO 09154⇒, ⇒ORG-NO 09376	<b>VD1097</b>
						(-AC), ORG-NO 09154⇒, ⇒ORG-NO 09858	<b>VD1097</b>
2.0 HDI 90 4WD	11/00-	RHY (DW10TD)	66	1997	<b>AP9038</b>	ALT, OE-NO 5705 4F, 5705 GC, (Valeo), (Mitsubishi), 150A	<b>6PK1468D1</b>
						(M49), ALT, (-AC)	<b>6PK1468D1</b>
						(M59), ALT, (-AC), ⇒ORG-NO 10179	<b>6PK1740D1</b>
						(M59), ALT, (AC), ⇒ORG-NO 10179	<b>6PK1750D2</b>
						(M49), ALT, (AC)	<b>VD1080</b>
2.0 HDI 90 (MBRHY, MCRHY)	12/99-	RHY (DW10TD)	66	1997	<b>AP9038</b>	ALT, OE-NO 5705 4F, 5705 GC, (Valeo), (Mitsubishi), 150A	<b>6PK1468D1</b>
						(M49), ALT, (-AC)	<b>6PK1468D1</b>
						(M59), ALT, (-AC), ⇒ORG-NO 10179	<b>6PK1740D1</b>
						(M59), ALT, (AC), ⇒ORG-NO 10179	<b>6PK1750D2</b>
						(M49), ALT, (AC)	<b>VD1080</b>
<b>BX (XB-)</b>							
1.8 D	10/85-09/93	161 (XUD7)	44	1769		(AUTOM)	<b>VD1086</b>
TRD Turbo	03/88-02/93	A8A (XUD7TE), AJZ (XUD7TE)	66	1769		(AUTOM)	<b>VD1086</b>
<b>BX Break (XB-)</b>							
1.8 D	10/85-09/93	161A (XUD7)	44	1769		(AUTOM)	<b>VD1086</b>
TRD Turbo	03/88-12/94	A8A (XUD7TE), AJZ (XUD7TE)	66	1769		(AUTOM)	<b>VD1086</b>
<b>C1 (PM_, PN_)</b>							
1.4 HDi	06/05-	DV4D	40	1398			<b>VD1094</b>
<b>C15 (VD-)</b>							
1.9 D	12/00-12/05		44	1868		MTR-CODE: DW8B, ⇒ORG-NO 09894	<b>VD1097</b>
<b>C2 (JM_)</b>							
1.1	09/03-	HFX (TU1JP)	44	1124		(MANL)	<b>VD1100</b>
1.4	09/03-	KFV (TU3JP)	54	1360			<b>VD1100</b>
1.4 HDi	09/03-	8HX (DV4TD)	50	1398	<b>AP9013</b>	ALT, (Valeo), 150A, OE-NO 5702H4, 5705AS, 5705EY, ALT-No: TG15C020, TG15C028, TG15C053	
					<b>AP9019</b>	ALT, (Valeo), ALT-No: TG15C118, 150A, OE-NO 5705AS, 5705EY	
						⇒ORG-NO 10415	<b>VD1094</b>
						ORG-NO 10416⇒	<b>VD1096</b>
1.6	09/03-	NFU (TU5JP4)	80	1587			<b>VD1100</b>
1.6 HDi	09/05-	9HZ-DV6TED4	80	1560	<b>AP9013</b>	ALT, (Valeo), 150A, OE-NO 5702H4, 5705AS, 5705EY, ALT-No: TG15C020, TG15C028, TG15C053	
					<b>AP9019</b>	ALT, (Valeo), ALT-No: TG15C118, 150A, OE-NO 5705AS, 5705EY	
							<b>VD1096</b>
1.6 VTS	01/05-	NFS (TU5JP4S)	90	1587			<b>VD1100</b>
<b>C3</b>							
1.4	11/09-		54	1360	<b>AP9018</b>	ALT, (Mitsubishi), 80A, OE-NO 5705KQ, ALT-No: A005TG0881ZE, 120A, OE-NO 5705KG, ALT-No:	



**CITROËN**
**C3**  

						A003TG5281ZE	<b>VD1100</b>
1.4 VTi 95	11/09-		70	1397	<b>AP9018</b>	ALT, (Mitsubishi), 80A, OE-NO 5705KQ, ALT-No: A005TG0881ZE, 120A, OE-NO 5705KG, ALT-No: A003TG5281ZE	
1.6 HDi	11/09-		68	1560	<b>AP9013</b> <b>AP9019</b>	ALT, (Valeo), 150A, OE-NO 5702H4, 5705AS, 5705EY, ALT-No: TG15C020, TG15C028, TG15C053 ALT, (Valeo), ALT-No: TG15C118, 150A, OE-NO 5705AS, 5705EY MTR-CODE: DV6ATED4, ⇒ORG-NO 10555 MTR-CODE: DV6ATED4, ORG-NO 10556⇒ MTR-CODE: DV6DTEd	<b>VD1094</b> <b>VD1096</b> <b>VD1096</b>
1.6 HDi 110	11/09-		82	1560	<b>AP9013</b> <b>AP9019</b>	ALT, (Valeo), 150A, OE-NO 5702H4, 5705AS, 5705EY, ALT-No: TG15C020, TG15C028, TG15C053 ALT, (Valeo), ALT-No: TG15C118, 150A, OE-NO 5705AS, 5705EY MTR-CODE: DV6ATED4, ⇒ORG-NO 10555 MTR-CODE: DV6ATED4, ORG-NO 10556⇒ MTR-CODE: DV6DTEd	<b>VD1094</b> <b>VD1096</b> <b>VD1096</b>

**C3 (FC.)**

1.1 i	02/02-	HFX (TU1JP)	44	1124			<b>VD1100</b>
1.4 16V	12/03-	KFU (ET3J4)	65	1360	<b>AP9018</b>	ALT, (Mitsubishi), 80A, OE-NO 5705KQ, ALT-No: A005TG0881ZE, 120A, OE-NO 5705KG, ALT-No: A003TG5281ZE (-START-STOP), MTR-CODE: ET3J4	<b>VD1100</b>
1.4 16V HDi	02/02-	8HY (DV4TED4)	66	1398	<b>AP9013</b> <b>AP9019</b>	ALT, (Valeo), 150A, OE-NO 5702H4, 5705AS, 5705EY, ALT-No: TG15C020, TG15C028, TG15C053 ALT, (Valeo), ALT-No: TG15C118, 150A, OE-NO 5705AS, 5705EY	<b>VD1094</b>
1.4 HDi	02/02-	8HX (DV4TD)	50	1398	<b>AP9013</b> <b>AP9019</b>	ALT, (Valeo), 150A, OE-NO 5702H4, 5705AS, 5705EY, ALT-No: TG15C020, TG15C028, TG15C053 ALT, (Valeo), ALT-No: TG15C118, 150A, OE-NO 5705AS, 5705EY ⇒ORG-NO 10415 ORG-NO 10416⇒	<b>VD1094</b> <b>VD1096</b>
1.4 i	02/02-	KFV (TU3JP)	54	1360	<b>AP9018</b>	ALT, (Mitsubishi), 80A, OE-NO 5705KQ, ALT-No: A005TG0881ZE, 120A, OE-NO 5705KG, ALT-No: A003TG5281ZE	<b>VD1100</b>
1.4 i Bivalent	02/02-	KFV (TU3JP)	54	1360	<b>AP9018</b>	ALT, (Mitsubishi), 80A, OE-NO 5705KQ, ALT-No: A005TG0881ZE, 120A, OE-NO 5705KG, ALT-No: A003TG5281ZE	<b>VD1100</b>
1.6 16V	02/02-	NFU (TU5JP4)	80	1587	<b>AP9018</b>	ALT, (Mitsubishi), 80A, OE-NO 5705KQ, ALT-No: A005TG0881ZE, 120A, OE-NO 5705KG, ALT-No: A003TG5281ZE	<b>VD1100</b>
1.6 16V HDi	09/05-	DV6TED4	80	1560	<b>AP9013</b> <b>AP9019</b>	ALT, (Valeo), 150A, OE-NO 5702H4, 5705AS, 5705EY, ALT-No: TG15C020, TG15C028, TG15C053 ALT, (Valeo), ALT-No: TG15C118, 150A, OE-NO 5705AS, 5705EY ⇒ORG-NO 10555 ORG-NO 10556⇒	<b>VD1094</b> <b>VD1096</b>
	10/05-	9HX (DV6ATED4)	66	1560	<b>AP9013</b> <b>AP9019</b>	ALT, (Valeo), 150A, OE-NO 5702H4, 5705AS, 5705EY, ALT-No: TG15C020, TG15C028, TG15C053 ALT, (Valeo), ALT-No: TG15C118, 150A, OE-NO 5705AS, 5705EY ⇒ORG-NO 10555 ORG-NO 10556⇒	<b>VD1094</b> <b>VD1096</b>

**C3 Picasso**

1.4 VTi 95	02/09-	8FS (EP3)	70	1397	<b>AP9018</b>	ALT, (Mitsubishi), 80A, OE-NO 5705KQ, ALT-No: A005TG0881ZE, 120A,	
------------	--------	-----------	----	------	---------------	-------------------------------------------------------------------	--



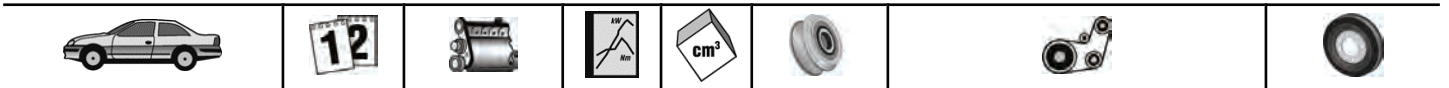

## CITROËN

### C3 Picasso

1.6 HDi	02/09-	9HX (DV6ATED4)	66	1560	<b>AP9013</b>  <b>AP9019</b>	OE-NO 5705KG, ALT-No: A003TG5281ZE ALT, (Valeo), 150A, OE-NO 5702H4, 5705AS, 5705EY, ALT-No: TG15C020, TG15C028, TG15C053 ALT, (Valeo), ALT-No: TG15C118, 150A, OE-NO 5705AS, 5705EY	<b>VD1096</b>
		9HZ-DV6TED4	80	1560	<b>AP9013</b>  <b>AP9019</b>	ALT, (Valeo), 150A, OE-NO 5702H4, 5705AS, 5705EY, ALT-No: TG15C020, TG15C028, TG15C053 ALT, (Valeo), ALT-No: TG15C118, 150A, OE-NO 5705AS, 5705EY	<b>VD1096</b>
1.6 HDi 90	07/10-		68	1560	<b>AP9013</b>  <b>AP9019</b>	ALT, (Valeo), 150A, OE-NO 5702H4, 5705AS, 5705EY, ALT-No: TG15C020, TG15C028, TG15C053 ALT, (Valeo), ALT-No: TG15C118, 150A, OE-NO 5705AS, 5705EY	<b>VD1096</b>
1.6 VTi 120	02/09-	5FW (EP6), 5FS (EP6C)	88	1598	<b>AP9018</b>	ALT, (Mitsubishi), 80A, OE-NO 5705KQ, ALT-No: A005TG0881ZE, 120A, OE-NO 5705KG, ALT-No: A003TG5281ZE	

### C3 Pluriel (HB\_)

1.4	05/03-	KFV (TU3JP)	54	1360	<b>AP9018</b>	ALT, (Mitsubishi), 80A, OE-NO 5705KQ, ALT-No: A005TG0881ZE, 120A, OE-NO 5705KG, ALT-No: A003TG5281ZE	<b>VD1100</b>
1.4 HDi	04/04-	8HX (DV4TD)	50	1398	<b>AP9013</b>  <b>AP9019</b>	ALT, (Valeo), 150A, OE-NO 5702H4, 5705AS, 5705EY, ALT-No: TG15C020, TG15C028, TG15C053 ALT, (Valeo), ALT-No: TG15C118, 150A, OE-NO 5705AS, 5705EY ⇒ORG-NO 10555 ORG-NO 10556⇒	<b>VD1094</b> <b>VD1096</b>
1.6	05/03-	NFU (TU5JP4)	80	1587	<b>AP9018</b>	ALT, (Mitsubishi), 80A, OE-NO 5705KQ, ALT-No: A005TG0881ZE, 120A, OE-NO 5705KG, ALT-No: A003TG5281ZE	<b>VD1100</b>

### C4 (LC\_)

1.4 16V	11/04-	KFU (ET3J4)	65	1360	<b>AP9018</b>	ALT, (Mitsubishi), 80A, OE-NO 5705KQ, ALT-No: A005TG0881ZE, 120A, OE-NO 5705KG, ALT-No: A003TG5281ZE	<b>VD1100</b>
1.6 16V	11/04-	NFU (TU5JP4)	80	1587	<b>AP9018</b>	ALT, (Mitsubishi), 80A, OE-NO 5705KQ, ALT-No: A005TG0881ZE, 120A, OE-NO 5705KG, ALT-No: A003TG5281ZE	<b>VD1100</b>
1.6 16V Bio-Flex	09/07-	NFU (TU5JP4)	80	1587	<b>AP9018</b>	ALT, (Mitsubishi), 80A, OE-NO 5705KQ, ALT-No: A005TG0881ZE, 120A, OE-NO 5705KG, ALT-No: A003TG5281ZE	<b>VD1100</b>
1.6 HDi	11/04-	9HX (DV6ATED4)	66	1560	<b>AP9013</b>  <b>AP9019</b>	ALT, (Valeo), 150A, OE-NO 5702H4, 5705AS, 5705EY, ALT-No: TG15C020, TG15C028, TG15C053 ALT, (Valeo), ALT-No: TG15C118, 150A, OE-NO 5705AS, 5705EY ⇒ORG-NO 10555 ORG-NO 10556⇒	<b>VD1094</b> <b>VD1096</b>
		DV6TED4, 9HZ-DV6TED4, 9HY (DV6TED4)	80	1560	<b>AP9013</b>  <b>AP9019</b>	ALT, (Valeo), 150A, OE-NO 5702H4, 5705AS, 5705EY, ALT-No: TG15C020, TG15C028, TG15C053 ALT, (Valeo), ALT-No: TG15C118, 150A, OE-NO 5705AS, 5705EY (-PARTCL-FILTER), ⇒ORG-NO 10555 (PARTCL-FILTER) (-PARTCL-FILTER), ORG-NO 10556⇒	<b>VD1094</b> <b>VD1096</b> <b>VD1096</b>
1.6 THP 140	07/08-		103	1598	<b>AP9018</b>	ALT, (Mitsubishi), 80A, OE-NO 5705KQ, ALT-No: A005TG0881ZE, 120A, OE-NO 5705KG, ALT-No: A003TG5281ZE	
1.6 THP 150	07/08-	5FX (EP6DT)	110	1598	<b>AP9018</b>	ALT, (Mitsubishi), 80A, OE-NO 5705KQ,	



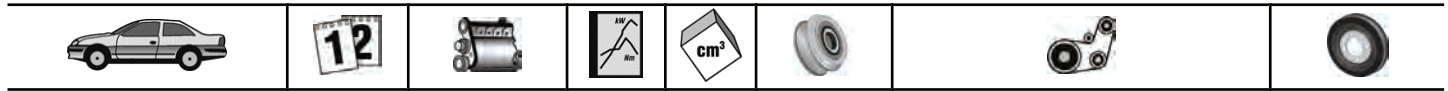

## CITROËN

C4 (LC.)							
1.6 VTi 120	07/08-		88	1598	AP9018	ALT-No: A005TG0881ZE, 120A, OE-NO 5705KG, ALT-No: A003TG5281ZE	
						ALT, (Mitsubishi), 80A, OE-NO 5705KQ, ALT-No: A005TG0881ZE, 120A, OE-NO 5705KG, ALT-No: A003TG5281ZE	
C4 Coupe (LA_)							
1.4 16V	11/04-	KFU (ET3J4)	65	1360	AP9018	ALT, (Mitsubishi), 80A, OE-NO 5705KQ, ALT-No: A005TG0881ZE, 120A, OE-NO 5705KG, ALT-No: A003TG5281ZE	VD1100
1.6 16V	11/04-	NFU (TU5JP4)	80	1587	AP9018	ALT, (Mitsubishi), 80A, OE-NO 5705KQ, ALT-No: A005TG0881ZE, 120A, OE-NO 5705KG, ALT-No: A003TG5281ZE	VD1100
1.6 HDi	11/04-	9HX (DV6ATED4)	66	1560	AP9013 AP9019	ALT, (Valeo), 150A, OE-NO 5702H4, 5705AS, 5705EY, ALT-No: TG15C020, TG15C028, TG15C053 ALT, (Valeo), ALT-No: TG15C118, 150A, OE-NO 5705AS, 5705EY ⇒ORG-NO 10555 ORG-NO 10556⇒	VD1094 VD1096
		DV6TED4, 9HZ-DV6TED4, 9HY (DV6TED4)	80	1560	AP9013 AP9019	ALT, (Valeo), 150A, OE-NO 5702H4, 5705AS, 5705EY, ALT-No: TG15C020, TG15C028, TG15C053 ALT, (Valeo), ALT-No: TG15C118, 150A, OE-NO 5705AS, 5705EY (-PARTCL-FILTER), ⇒ORG-NO 10555 (PARTCL-FILTER) (-PARTCL-FILTER), ORG-NO 10556⇒	VD1094 VD1096 VD1096
1.6 THP 150	07/08-	5FX (EP6DT)	110	1598	AP9018	ALT, (Mitsubishi), 80A, OE-NO 5705KQ, ALT-No: A005TG0881ZE, 120A, OE-NO 5705KG, ALT-No: A003TG5281ZE	
1.6 VTi 120	07/08-		88	1598	AP9018	ALT, (Mitsubishi), 80A, OE-NO 5705KQ, ALT-No: A005TG0881ZE, 120A, OE-NO 5705KG, ALT-No: A003TG5281ZE	
C4 Grand Picasso (UA_)							
1.6 16V	07/08-	5FT (EP6DT)	103	1598	AP9018	ALT, (Mitsubishi), 80A, OE-NO 5705KQ, ALT-No: A005TG0881ZE, 120A, OE-NO 5705KG, ALT-No: A003TG5281ZE	
	10/08-	5FX (EP6DT)	110	1598	AP9018	ALT, (Mitsubishi), 80A, OE-NO 5705KQ, ALT-No: A005TG0881ZE, 120A, OE-NO 5705KG, ALT-No: A003TG5281ZE	
1.6 HDi	10/06-	9HZ-DV6TED4, 9HY (DV6TED4)	80	1560	AP9013 AP9019	ALT, (Valeo), 150A, OE-NO 5702H4, 5705AS, 5705EY, ALT-No: TG15C020, TG15C028, TG15C053 ALT, (Valeo), ALT-No: TG15C118, 150A, OE-NO 5705AS, 5705EY	VD1096
1.6 VTi 120	07/08-	5FW (EP6)	88	1598	AP9018	ALT, (Mitsubishi), 80A, OE-NO 5705KQ, ALT-No: A005TG0881ZE, 120A, OE-NO 5705KG, ALT-No: A003TG5281ZE	
2.0 HDi	10/06-	RHJ-DW10BTED4, RHR (DW10BTED4)	100	1997	AP9013 AP9040	ALT, (Valeo), 180A, OE-NO 5705AX, 5705EE, ALT-No: FG 18 S 017 ALT, (Mitsubishi), 180A, OE-NO 5705AX, 5705EE, ALT-No: A004TJ0084	
2.0 HDi 150	07/09-		110	1997	AP9013 AP9040	ALT, (Valeo), 180A, OE-NO 5705AX, 5705EE, ALT-No: FG 18 S 017 ALT, (Mitsubishi), 180A, OE-NO 5705AX, 5705EE, ALT-No: A004TJ0084	
C4 Picasso (UD_)							
1.6 16V	07/08-	5FX (EP6DT)	110	1598	AP9018	ALT, (Mitsubishi), 80A, OE-NO 5705KQ, ALT-No: A005TG0881ZE, 120A, OE-NO 5705KG, ALT-No: A003TG5281ZE	
1.6 HDi	02/07-	9HZ-DV6TED4, 9HY (DV6TED4)	80	1560	AP9013	ALT, (Valeo), 150A, OE-NO 5702H4, 5705AS, 5705EY, ALT-No: TG15C020, TG15C028, TG15C053	





## CITROËN

### C4 Picasso (UD\_)

					<b>AP9019</b>	ALT, (Valeo), ALT-No: TG15C118, 150A, OE-NO 5705AS, 5705EY	<b>VD1096</b>
1.6 THP 140	07/08-	5FT (EP6DT)	103	1598	<b>AP9018</b>	ALT, (Mitsubishi), 80A, OE-NO 5705KQ, ALT-No: A005TG0881ZE, 120A, OE-NO 5705KG, ALT-No: A003TG5281ZE	
1.6 VTi 120	07/08-	5FW (EP6)	88	1598	<b>AP9018</b>	ALT, (Mitsubishi), 80A, OE-NO 5705KQ, ALT-No: A005TG0881ZE, 120A, OE-NO 5705KG, ALT-No: A003TG5281ZE	
2.0 HDi	02/07-	RHJ-DW10BTED4, RHR (DW10BTED4)	100	1997	<b>AP9013</b>	ALT, (Valeo), 180A, OE-NO 5705AX, 5705EE, ALT-No: FG 18 S 017	
2.0 HDi 150	07/09-		110	1997	<b>AP9013</b> <b>AP9040</b>	ALT, (Valeo), 180A, OE-NO 5705AX, 5705EE, ALT-No: FG 18 S 017 ALT, (Mitsubishi), 180A, OE-NO 5705AX, 5705EE, ALT-No: A004TJ0084	

### C4 Stufenheck

1.6 16V	07/06-	NFU (TU5JP4)	80	1587	<b>AP9018</b>	ALT, (Mitsubishi), 80A, OE-NO 5705KQ, ALT-No: A005TG0881ZE, 120A, OE-NO 5705KG, ALT-No: A003TG5281ZE	<b>VD1100</b>
1.6 HDi	07/06-	DV6TED4	80	1560	<b>AP9013</b> <b>AP9019</b>	ALT, (Valeo), 150A, OE-NO 5702H4, 5705AS, 5705EY, ALT-No: TG15C020, TG15C028, TG15C053 ALT, (Valeo), ALT-No: TG15C118, 150A, OE-NO 5705AS, 5705EY (PARTCL-FILTER) (-PARTCL-FILTER), ORG-NO 10556⇒	<b>VD1096</b> <b>VD1096</b>

### C5 (DC\_)

2.0 HDi	03/01-08/04	RHZ (DW10ATED), RHS (DW10ATED)	79	1997	<b>AP9042</b>	ALT, (Bosch), 150A, ALT-No: 0124 615 027, OE-NO 5705AA, 5705ER, (AC), ⇒12/2002 ALT, (AC), ⇒ORG-NO 09337, (SANDEN) ALT, (AC), (AUTOM), ⇒ORG-NO 09365, (DELPHI) ALT, (AC), (MANL), ⇒ORG-NO 09337, (DELPHI) (AUTOM), ⇒ORG-NO 09365 (MANL), ⇒ORG-NO 09337 (AUTOM), ORG-NO 09366⇒ (MANL), ORG-NO 09338⇒	<b>6PK1740D1</b> <b>6PK1750D2</b> <b>6PK1750D2</b> <b>VD1080</b> <b>VD1080</b> <b>VD1095</b> <b>VD1095</b>
2.0 HDi (DCRHVB)	03/01-08/04	RHY (DW10TD)	66	1997	<b>AP9023</b> <b>AP9031</b> <b>AP9042</b>	ALT, (Bosch), ALT-No: 0124525035, 150A, OE-NO 5705AS, 5705EY (AC), ⇒ORG-NO 09520, ALT, OE-NO 5705 AA, 5705 ER, (Valeo), 150A ALT, (Bosch), 150A, ALT-No: 0124 615 027, OE-NO 5705AA, 5705ER, (AC), ⇒12/2002 ALT, (AC), (SANDEN), ⇒ORG-NO 09337 ALT, (AC), (DELPHI), ⇒ORG-NO 09337 (AUTOM), ⇒ORG-NO 09365 (MANL), ⇒ORG-NO 09337 (AUTOM), ORG-NO 09366⇒ (MANL), ORG-NO 09338⇒	<b>6PK1740D1</b> <b>6PK1750D2</b> <b>VD1080</b> <b>VD1080</b> <b>VD1095</b> <b>VD1095</b>
2.0 HDi (DCRHVB, DCRHZE)	03/01-08/04	RHZ (DW10ATED)	80	1997	<b>AP9023</b> <b>AP9031</b> <b>AP9042</b>	ALT, (Bosch), ALT-No: 0124525035, 150A, OE-NO 5705AS, 5705EY (AC), ⇒ORG-NO 09520, ALT, OE-NO 5705 AA, 5705 ER, (Valeo), 150A ALT, (Bosch), 150A, ALT-No: 0124 615 027, OE-NO 5705AA, 5705ER, (AC), ⇒12/2002 ALT, (AC), ⇒ORG-NO 09337, (SANDEN) ALT, (AC), (AUTOM), ⇒ORG-NO 09365, (DELPHI) ALT, (AC), (MANL), ⇒ORG-NO 09337, (DELPHI) (AUTOM), ⇒ORG-NO 09365 (MANL), ⇒ORG-NO 09337 (AUTOM), ORG-NO 09366⇒ (MANL), ORG-NO 09338⇒	<b>6PK1740D1</b> <b>6PK1750D2</b> <b>6PK1750D2</b> <b>VD1080</b> <b>VD1080</b> <b>VD1095</b> <b>VD1095</b>



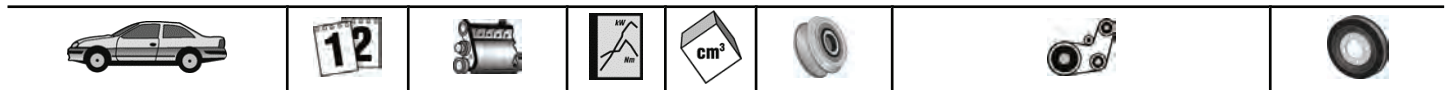

CITROËN

CITROËN							
<b>C5 (DC_)</b>							
↔	2.2 HDi (DC4HXB, DC4HXE)	03/01-08/04	4HX (DW12TED4 /FAP)	98	2179	<b>AP9023</b> <b>AP9031</b> <b>AP9042</b>	ALT, (Bosch), ALT-No: 0124525035, 150A, OE-NO 5705AS, 5705EY ALT, OE-NO 5705 AA, 5705 ER, (Valeo), 150A ALT, (Bosch), 150A, ALT-No: 0124 615 027, OE-NO 5705AA, 5705ER, ⇒12 /2002 ALT, (AC), (SANDEN) ALT, (AC), (DELPHI)
							<b>6PK1740D1</b> <b>6PK1750D2</b> <b>VD1080</b>
<b>C5 (RC_)</b>							
	1.6 HDi (RC8HZB)	09/04-	DV6TED4	80	1560	<b>AP9013</b>  <b>AP9019</b>	ALT, (Valeo), 150A, OE-NO 5702H4, 5705AS, 5705EY, ALT-No: TG15C020, TG15C028, TG15C053 ALT, (Valeo), ALT-No: TG15C118, 150A, OE-NO 5705AS, 5705EY ⇒ORG-NO 10555 ORG-NO 10556⇒
							<b>VD1094</b> <b>VD1096</b>
	2.2 HDi (RC4HXE)	09/04-	4HX (DW12TED4 /FAP)	98	2179	<b>AP9023</b> <b>AP9031</b>	ALT, (Bosch), ALT-No: 0124525035, 150A, OE-NO 5705AS, 5705EY ALT, OE-NO 5705 AA, 5705 ER, (Valeo), 150A MTR-CODE: DW12TED4, ALT, (AC)
							<b>6PK1740D1</b> <b>VD1080</b>
<b>C5 (RD_)</b>							
	1.6 HDi	02/08-	DV6TED4	80	1560	<b>AP9013</b>  <b>AP9019</b>	ALT, (Valeo), 150A, OE-NO 5702H4, 5705AS, 5705EY, ALT-No: TG15C020, TG15C028, TG15C053 ALT, (Valeo), ALT-No: TG15C118, 150A, OE-NO 5705AS, 5705EY
							<b>VD1096</b>
	1.6 HDi 110	07/10-		82	1560	<b>AP9013</b>  <b>AP9019</b>	ALT, (Valeo), 150A, OE-NO 5702H4, 5705AS, 5705EY, ALT-No: TG15C020, TG15C028, TG15C053 ALT, (Valeo), ALT-No: TG15C118, 150A, OE-NO 5705AS, 5705EY MTR-CODE: DV6TED4
							<b>VD1096</b>
	1.6 THP 155	04/09-	5FV (EP6DT)	115	1598	<b>AP9018</b>	ALT, (Mitsubishi), 120A, OE-NO 5705KG, 5702J0, ALT-No: A003TG5281ZE
	2.0 HDi	02/08-	DW10BTED4	100	1997	<b>AP9013</b> <b>AP9040</b>	ALT, (Valeo), 180A, OE-NO 5705AX, 5705EE, ALT-No: FG 18 S 017 ALT, (Mitsubishi), 180A, OE-NO 5705AX, 5705EE, ALT-No: A004TJ0084
	2.0 HDi 140	04/09-		103	1997	<b>AP9013</b> <b>AP9040</b>	ALT, (Valeo), 180A, OE-NO 5705AX, 5705EE, ALT-No: FG 18 S 017 ALT, (Mitsubishi), 180A, OE-NO 5705AX, 5705EE, ALT-No: A004TJ0084
	2.0 HDi 165	04/09-	RHH (DW10CTED4)	120	1997	<b>AP9013</b> <b>AP9040</b>	ALT, (Valeo), 180A, OE-NO 5705AX, 5705EE, ALT-No: FG 18 S 017 ALT, (Mitsubishi), 180A, OE-NO 5705AX, 5705EE, ALT-No: A004TJ0084
	2.2 HDi	02/08-	4HT (DW12BTED4)	125	2179	<b>AP9013</b> <b>AP9040</b>	ALT, (Valeo), 180A, OE-NO 5705AX, 5705EE, ALT-No: FG 18 S 017 ALT, (Mitsubishi), 180A, OE-NO 5705AX, 5705EE, ALT-No: A004TJ0084
<b>C5 Break (DE_)</b>							
	2.0 HDi	06/01-08/04	RHZ (DW10ATED)	80	1997	<b>AP9042</b>	ALT, (Bosch), 150A, ALT-No: 0124 615 027, OE-NO 5705AA, 5705ER, (AC), ⇒12/2002
	2.0 HDi (DERHSB, DERHSE)	06/01-08/04	RHZ (DW10ATED), RHS (DW10ATED)	79	1997	<b>AP9023</b> <b>AP9031</b> <b>AP9042</b>	ALT, (Bosch), ALT-No: 0124525035, 150A, OE-NO 5705AS, 5705EY (AC), ⇒ORG-NO 09520, ALT, OE-NO 5705 AA, 5705 ER, (Valeo), 150A ALT, (Bosch), 150A, ALT-No: 0124 615 027, OE-NO 5705AA, 5705ER, (AC), ⇒12/2002 ALT, (AC), ⇒ORG-NO 09337, (SANDEN) ALT, (AC), (AUTOM), ⇒ORG-NO 09365, (DELPHI) ALT, (AC), (MANL), ⇒ORG-NO 09337, (DELPHI) (AUTOM), ⇒ORG-NO 09365
							<b>6PK1740D1</b> <b>6PK1750D2</b> <b>6PK1750D2</b> <b>VD1080</b>







## CITROËN

### C5 Break (DE\_)

						(MANL), ⇒ORG-NO 09337 (AUTOM), ORG-NO 09366⇒ (MANL), ORG-NO 09338⇒	VD1080 VD1095 VD1095
2.0 HDi (DERHYB)	06/01-08/04	RHY (DW10TD)	66	1997	AP9023 AP9031 AP9042	ALT, (Bosch), ALT-No: 0124525035, 150A, OE-NO 5705AS, 5705EY (AC), ⇒ORG-NO 09520, ALT, OE-NO 5705 AA, 5705 ER, (Valeo), 150A ALT, (Bosch), 150A, ALT-No: 0124 615 027, OE-NO 5705AA, 5705ER, (AC), ⇒12/2002 ALT, (AC), (SANDEN), ⇒ORG-NO 09337 ALT, (AC), (DELPHI), ⇒ORG-NO 09337 (AUTOM), ⇒ORG-NO 09365 (MANL), ⇒ORG-NO 09337 (AUTOM), ORG-NO 09366⇒ (MANL), ORG-NO 09338⇒	6PK1740D1 6PK1750D2 VD1080 VD1080 VD1095 VD1095
2.2 HDi (DE4HXB, DE4HXE)	06/01-08/04	4HX (DW12TED4 /FAP)	98	2179	AP9023 AP9031 AP9042	ALT, (Bosch), ALT-No: 0124525035, 150A, OE-NO 5705AS, 5705EY ALT, OE-NO 5705 AA, 5705 ER, (Valeo), 150A ALT, (Bosch), 150A, ALT-No: 0124 615 027, OE-NO 5705AA, 5705ER, ⇒12 /2002 ALT, (AC), (SANDEN) ALT, (AC), (DELPHI)	6PK1740D1 6PK1750D2 VD1080
<b>C5 Break (RE_)</b>							
1.6 HDi (RE8HZB)	09/04-	9HY (DV6TED4)	80	1560	AP9013 AP9019	ALT, (Valeo), 150A, OE-NO 5702H4, 5705AS, 5705EY, ALT-No: TG15C020, TG15C028, TG15C053 ALT, (Valeo), ALT-No: TG15C118, 150A, OE-NO 5705AS, 5705EY ⇒ORG-NO 10555 ORG-NO 10556⇒	VD1094 VD1096
2.2 HDi (RE4HXE)	09/04-	4HX (DW12TED4 /FAP)	98	2179	AP9023 AP9031	ALT, (Bosch), ALT-No: 0124525035, 150A, OE-NO 5705AS, 5705EY ALT, OE-NO 5705 AA, 5705 ER, (Valeo), 150A MTR-CODE: DW12TED4, ALT, (AC)	6PK1740D1 VD1080
<b>C5 Break (TD_)</b>							
1.6 HDi	02/08-	DV6TED4, 9HZ-DV6TED4	80	1560	AP9013 AP9019	ALT, (Valeo), 150A, OE-NO 5702H4, 5705AS, 5705EY, ALT-No: TG15C020, TG15C028, TG15C053 ALT, (Valeo), ALT-No: TG15C118, 150A, OE-NO 5705AS, 5705EY	VD1096
1.6 HDi 110	07/10-		82	1560	AP9013 AP9019	ALT, (Valeo), 150A, OE-NO 5702H4, 5705AS, 5705EY, ALT-No: TG15C020, TG15C028, TG15C053 ALT, (Valeo), ALT-No: TG15C118, 150A, OE-NO 5705AS, 5705EY MTR-CODE: DV6TED4	VD1096
1.6 THP 155	04/09-	5FV (EP6DT)	115	1598	AP9018	ALT, (Mitsubishi), 120A, OE-NO 5705KG, 5702JO, ALT-No: A003TG5281ZE	
2.0 HDi	02/08-	DW10BTED4, RHR (DW10BTED4)	100	1997	AP9013 AP9040	ALT, (Valeo), 180A, OE-NO 5705AX, 5705EE, ALT-No: FG 18 S 017 ALT, (Mitsubishi), 180A, OE-NO 5705AX, 5705EE, ALT-No: A004TJ0084	
2.0 HDi 140	04/09-		103	1997	AP9013 AP9040	ALT, (Valeo), 180A, OE-NO 5705AX, 5705EE, ALT-No: FG 18 S 017 ALT, (Mitsubishi), 180A, OE-NO 5705AX, 5705EE, ALT-No: A004TJ0084	
2.0 HDi 165	04/09-	RHH (DW10CTED4)	120	1997	AP9013 AP9040	ALT, (Valeo), 180A, OE-NO 5705AX, 5705EE, ALT-No: FG 18 S 017 ALT, (Mitsubishi), 180A, OE-NO 5705AX, 5705EE, ALT-No: A004TJ0084	
2.2 HDi	02/08-	4HT (DW12BTED4)	125	2179	AP9013 AP9040	ALT, (Valeo), 180A, OE-NO 5705AX, 5705EE, ALT-No: FG 18 S 017 ALT, (Mitsubishi), 180A, OE-NO 5705AX, 5705EE, ALT-No: A004TJ0084	



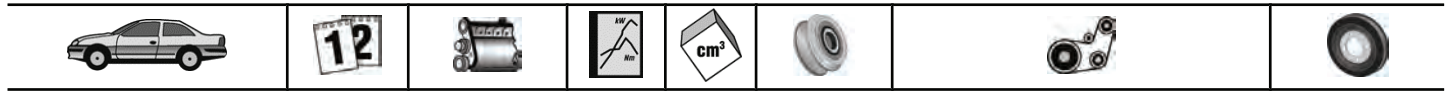

## CITROËN

<b>C6 (TD_)</b>							
↔ 2.2 HDi	06/06-	4HT (DW12BTED4)	125	2179	<b>AP9013</b> <b>AP9040</b>	ALT, (Valeo), 180A, OE-NO 5705AX, 5705EE, ALT-No: FG 18 S 017 ALT, (Mitsubishi), 180A, OE-NO 5705AX, 5705EE, ALT-No: A004TJ0084	
<b>C8 (EA_, EB_)</b>							
2.0 HDi	02/07-	RHK (DW10UTED4)	88	1997	<b>AP9013</b> <b>AP9040</b>	ALT, (Valeo), 180A, OE-NO 5705AX, 5705EE, ALT-No: FG 18 S 017 ALT, (Mitsubishi), 180A, OE-NO 5705AX, 5705EE, ALT-No: A004TJ0084	
	07/02-	RHW (DW10ATED4), RHT (DW10ATED4), RHM (DW10ATED4)	79	1997	<b>AP9023</b> <b>AP9031</b> <b>AP9031</b> <b>AP9042</b>	ALT, (Bosch), ALT-No: 0124525035, 150A, OE-NO 5705AS, 5705EY (-PARTCL-FILTER), ⇒ORG-NO 09519, ALT, OE-NO 5705 AA, 5705 ER, (Valeo), 150A (PARTCL-FILTER), ⇒ORG-NO 09551, ALT, OE-NO 5705 AA, 5705 ER, (Valeo), 150A ALT, (Bosch), 150A, ALT-No: 0124 615 027, OE-NO 5705AA, 5705ER ALT, (AC), ⇒ORG-NO 09519 ⇒ORG-NO 09519 ORG-NO 09520⇒	<b>6PK1740D1</b> <b>VD1080</b> <b>VD1095</b>
2.0 HDi 135	03/06-	RHR (DW10BTED4)	100	1997	<b>AP9013</b> <b>AP9040</b>	ALT, (Valeo), 180A, OE-NO 5705AX, 5705EE, ALT-No: FG 18 S 017 ALT, (Mitsubishi), 180A, OE-NO 5705AX, 5705EE, ALT-No: A004TJ0084	
2.2 HDi	06/06-	4HT (DW12BTED4)	125	2179	<b>AP9013</b> <b>AP9040</b>	ALT, (Valeo), 180A, OE-NO 5705AX, 5705EE, ALT-No: FG 18 S 017 ALT, (Mitsubishi), 180A, OE-NO 5705AX, 5705EE, ALT-No: A004TJ0084	
	07/02-	4HW (DW12TED4)	94	2179	<b>AP9023</b> <b>AP9031</b> <b>AP9042</b>	ALT, (Bosch), ALT-No: 0124525035, 150A, OE-NO 5705AS, 5705EY (-PARTCL-FILTER), ALT, OE-NO 5705 AA, 5705 ER, (Valeo), 150A ALT, (Bosch), 150A, ALT-No: 0124 615 027, OE-NO 5705AA, 5705ER ALT, (AC), ⇒ORG-NO 10247 ⇒ORG-NO 10247 ORG-NO 10248⇒	<b>6PK1740D1</b> <b>VD1080</b> <b>VD1095</b>
<b>DS3</b>							
1.4 VTi 95	04/10-		70	1397	<b>AP9018</b> <b>AP9018</b>	ALT, (Mitsubishi), 120A, OE-NO 5705KG, ALT-No: A003TG5281ZE, (AC) ALT, (Mitsubishi), 80A, OE-NO 5705KQ, ALT-No: A005TG0881ZE, (-AC)	
1.6 HDi 110	11/09-		82	1560			<b>VD1096</b>
1.6 HDi 90	11/09-		68	1560			<b>VD1096</b>
1.6 THP 150	04/10-	5FR (EP6DT)	115	1598	<b>AP9018</b>	ALT, (Mitsubishi), 80A, OE-NO 5705KQ, 5702J3, ALT-No: A005TG0881ZE, 120A, OE-NO 5705KG, 5702J0, ALT-No: A003TG5281ZE	
1.6 VTi 120	04/10-		88	1598	<b>AP9018</b> <b>AP9018</b>	ALT, (Mitsubishi), 120A, OE-NO 5705KG, ALT-No: A003TG5281ZE, (AC) ALT, (Mitsubishi), 80A, OE-NO 5705KQ, ALT-No: A005TG0881ZE, (-AC)	
<b>EVIASION (22, U6)</b>							
1.9 TD	10/95-12/98	D8B (XUD9TF)	68	1905		MTR-CODE: XUD9TE	<b>VD1086</b>
	11/94-07/02	DHX (XUD9TF /BTF), D8B (XUD9TF)	66	1905		MTR-CODE: XUD9TE	<b>VD1086</b>
2.0 HDI	08/99-07/02	RHZ (DW10ATED)	80	1997	<b>AP9031</b> <b>AP9038</b> <b>AP9042</b>	ALT, OE-NO 5705 AA, 5705 ER, (Valeo), 150A (AC), ALT, OE-NO 5705 4F, 5705 GC, (Valeo), (Mitsubishi), 150A ALT, (Bosch), 150A, ALT-No: 0124 615 027, OE-NO 5705AA, 5705ER ALT, (-AC) ALT, (AC), (SANDEN) ALT, (AC), (DELPHI)	<b>6PK1468D1</b> <b>6PK1740D1</b> <b>6PK1750D2</b> <b>VD1080</b>
2.0 HDI 16V	09/99-07/02	RHW (DW10ATED4)	80	1997	<b>AP9042</b>	ALT, (Bosch), 150A, ALT-No: 0124 615 027, OE-NO 5705AA, 5705ER ALT, (-AC)	<b>6PK1468D1</b>



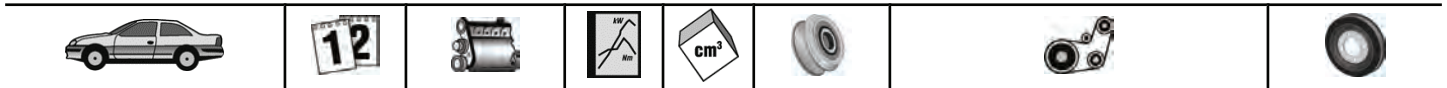

<b>CITROËN</b>							
<b>EVASION (22, U6)</b>							
						ALT, (AC), (SANDEN) ALT, (AC), (DELPHI)	<b>6PK1740D1</b> <b>6PK1750D2</b> <b>VD1080</b>
2.0 TD	05/97-07/02		68	1998		MTR-CODE: XUD9TE	<b>VD1086</b>
2.1 TD	05/96-07/02	P8C (XUD11BTE)	80	2088			<b>VD1088</b>
<b>JUMPER Bus</b>							
2.2 HDi 100	04/06-	4HV	74	2198	<b>AP9048</b>	ALT, (Bosch), 156A	
2.2 HDi 120	04/06-	4HU	88	2198	<b>AP9048</b>	ALT, (Bosch), 156A MTR-CODE: 22DT	<b>VD1098</b>
<b>JUMPER Bus (230P)</b>							
1.9 D	01/99-04/02	D9B (XUD9A/U)	51	1905		(-PS)	<b>VD1086</b>
1.9 TD	02/94-04/02	D8C (XUD9UTF)	68	1905		(-PS)	<b>VD1086</b>
	08/94-04/02	D8C (XUD9UTF)	66	1905		(-PS)	<b>VD1086</b>
1.9 TD 4x4	08/96-04/02	D8C (XUD9UTF)	68	1905		(-PS)	<b>VD1086</b>
2.8 HDi	09/00-04/02	8140.43S	94	2798		(-AC)	<b>VD1062</b>
2.8 HDi 4x4	09/00-04/02	8140.43S	94	2798		(-AC)	<b>VD1062</b>
<b>JUMPER Bus (244, Z_)</b>							
2.0 HDi	04/02-	DW10UTD	62	1997	<b>AP9031</b>	ALT, OE-NO 5705 AA, 57057 ER, (Valeo), 150A	
					<b>AP9042</b>	ALT, (Bosch), ALT-No: 0124 615 027, 150A, OE-NO 5705AA, (AC) MTR-CODE: DW10TD, ⇒04/2004, ALT, PS, (-AC) (-AC) (AC)	<b>6PK1468D1</b> <b>VD1080</b> <b>VD1095</b>
2.2 HDi	04/02-	DW12TED	74	2179	<b>AP9031</b>	⇒05/2004, ALT, OE-NO 5705 AA, 5705 ER, (Valeo), 150A	
					<b>AP9042</b>	ALT, (Bosch), ALT-No: 0124 615 027, 150A, OE-NO 5705AA, 5705ER ALT, PS, (-AC) MTR-CODE: DW12UTED	<b>6PK1468D1</b> <b>VD1080</b> <b>VD1062</b>
2.8 HDi	04/02-	8140.43S	94	2798		(-AC)	<b>VD1062</b>
<b>JUMPER Kasten</b>							
2.2 HDi 100	04/06-	4HV	74	2198	<b>AP9048</b>	ALT, (Bosch), 156A	
2.2 HDi 120	04/06-	4HU	88	2198	<b>AP9048</b>	ALT, (Bosch), 156A MTR-CODE: 22DT	<b>VD1098</b>
<b>JUMPER Kasten (230L)</b>							
1.9 D	02/94-04/02	D9B (XUD9A/U)	51	1905		(-PS)	<b>VD1086</b>
	07/99-04/02	DJY (XUD9A)	50	1905		(-PS)	<b>VD1086</b>
1.9 TD	03/94-04/02	DHX (XUD9TF /BTF)	66	1905		(-PS)	<b>VD1086</b>
		D8C (XUD9UTF)	68	1905		(-PS)	<b>VD1086</b>
2.0 HDi	11/01-04/02	DW10UTD	62	1997	<b>AP9031</b>	ALT, OE-NO 5705 AA, 57057 ER, (Valeo), 150A	
					<b>AP9042</b>	ALT, (Bosch), ALT-No: 0124 615 027, 150A, OE-NO 5705AA, (AC) MTR-CODE: DW10TD, ⇒04/2004, ALT, PS, (-AC) (-AC)	<b>6PK1468D1</b> <b>VD1080</b>
2.8 HDi	09/00-04/02	8140.43S	94	2798		(-AC)	<b>VD1062</b>
2.8 HDi 4x4	09/00-04/02	8140.43S	94	2798		(-AC)	<b>VD1062</b>
<b>JUMPER Kasten (244)</b>							
2.0 HDi	04/02-	DW10UTD	62	1997	<b>AP9031</b>	ALT, OE-NO 5705 AA, 5705 ER, (Valeo), 150A	
					<b>AP9042</b>	ALT, (Bosch), ALT-No: 0124 615 027, 150A, OE-NO 5705AA, (AC) MTR-CODE: DW10TD, ⇒04/2004, ALT, PS, (-AC) (-AC), MTR-CODE: DW10TD (AC), MTR-CODE: DW10TD	<b>6PK1468D1</b> <b>VD1080</b> <b>VD1095</b>
2.2 HDi	04/02-	DW12TED	74	2179	<b>AP9031</b>	⇒05/2004, ALT, OE-NO 5705 AA, 5705 ER, (Valeo), 150A	
					<b>AP9042</b>	ALT, (Bosch), ALT-No: 0124 615 027, 150A, OE-NO 5705AA, 5705ER ALT, PS, (-AC) MTR-CODE: DW12UTED	<b>6PK1468D1</b> <b>VD1080</b> <b>VD1062</b>
2.8 HDi	04/02-	8140.43S	94	2798		(-AC)	<b>VD1062</b>
	05/04-	8140.43N	107	2798		(-AC)	<b>VD1062</b>
2.8 HDi 4x4	04/02-	8140.43S	94	2798		(-AC)	<b>VD1062</b>
<b>JUMPER Pritsche/Fahrgestell</b>							
2.2 HDi 100	04/06-	4HV	74	2198	<b>AP9048</b>	ALT, (Bosch), 156A	
2.2 HDi 120	04/06-	4HU	88	2198	<b>AP9048</b>	ALT, (Bosch), 156A	

**CITROËN**

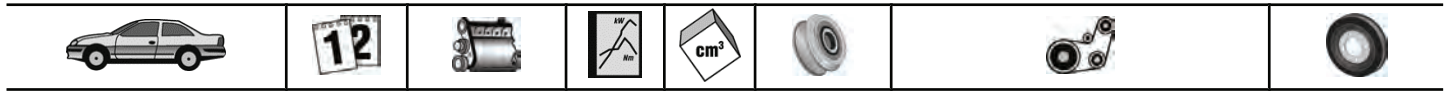
## CITROËN

JUMPER Pritsche/Fahrgestell						MTR-CODE: 22DT	VD1098
<b>JUMPER Pritsche/Fahrgestell (230)</b>							
1.9 TD	03/94-04/02	DHX (XUD9TF /BTF)	66	1905		(-PS)	VD1086
		D8C (XUD9UTF)	68	1905		(-PS)	VD1086
2.8 HDi	09/00-04/02	8140.43S	94	2798		(-AC)	VD1062
	10/00-01/02	8140.43S	93	2798		(-AC)	VD1062
<b>JUMPER Pritsche/Fahrgestell (244)</b>							
2.0 HDi	04/02-	DW10UTD	62	1997	AP9031	ALT, OE-NO 5705 AA, 5705 ER, (Valeo), 150A	
					AP9042	ALT, (Bosch), ALT-No: 0124 615 027, 150A, OE-NO 5705AA, (AC)	
						MTR-CODE: DW10TD, ⇒04/2004, ALT, PS, (-AC)	6PK1468D1
						MTR-CODE: DW10TD, (-AC)	VD1080
						MTR-CODE: DW10TD, (AC)	VD1095
2.2 HDi	02/02-06/06		74	2179		MTR-CODE: DW12UTED, ALT, PS, (-AC)	6PK1468D1
						(-AC)	VD1080
2.2 HDi 16V	04/02-	DW12TED	74	2179	AP9031	⇒05/2004, ALT, OE-NO 5705 AA, 5705 ER, (Valeo), 150A	
					AP9042	ALT, (Bosch), ALT-No: 0124 615 027, 150A, OE-NO 5705AA, 5705ER	
						MTR-CODE: DW12UTED, ALT, PS, (-AC)	6PK1468D1
							VD1080
2.8 HDi	04/02-	8140.43S	94	2798		(-AC)	VD1062
	05/04-	8140.43N	107	2800		(-AC)	VD1062
2.8 HDi 4x4	02/02-06/06	F28TDCR	94	2798		(-AC)	VD1062
<b>JUMPY</b>							
1.6 HDi 90	01/07-	9HU (DV6UTED4)	66	1560	AP9013	ALT, (Valeo), 150A, OE-NO 5702H4, 5705AS, 5705EY, ALT-No: TG15C020, TG15C028, TG15C053	
					AP9019	ALT, (Valeo), ALT-No: TG15C118, 150A, OE-NO 5705AS, 5705EY	VD1096
2.0 HDi 120	01/07-	RHK (DW10UTED4)	88	1997	AP9013	ALT, (Valeo), 180A, OE-NO 5705AX, 5705EE, ALT-No: FG 18 S 017	
					AP9040	ALT, (Mitsubishi), 180A, OE-NO 5705AX, 5705EE, ALT-No: A004TJ0084	
2.0 HDi 140	01/07-	RHR (DW10BTED4)	100	1997	AP9013	ALT, (Valeo), 180A, OE-NO 5705AX, 5705EE, ALT-No: FG 18 S 017	
					AP9040	ALT, (Mitsubishi), 180A, OE-NO 5705AX, 5705EE, ALT-No: A004TJ0084	
<b>JUMPY (U6U)</b>							
1.9 D	10/95-04/98	D9B (XUD9A/U)	51	1905			VD1086
1.9 D 70	04/98-	WJZ (DW8)	51	1868		(AC), ⇒ORG-NO 10177	VD1080
						(AC), ORG-NO 10178⇒	VD1095
						(-AC), ⇒ORG-NO 09894	VD1097
1.9 TD	04/96-	D8B (XUD9TF)	68	1905			VD1086
	10/95-	DHX (XUD9TF /BTF)	66	1905			VD1086
2.0 HDi 110	03/00-	RHZ (DW10ATED)	80	1997	AP9031	ALT, (Valeo), 150A, OE-NO 5705 AA, 5705 ER	
					AP9038	(AC), ALT, OE-NO 5705 4F, 5705 GC, (Valeo), (Mitsubishi), 150A	
					AP9042	ALT, (Bosch), ALT-No: 0124 615 027, 150A, OE-NO 5705AA, 5705ER	
						MTR-CODE: DW10ATED, ALT, (-AC)	6PK1468D1
						MTR-CODE: DW10ATED, ALT, (AC), ⇒ORG-NO 09519	6PK1740D1
						⇒11/2003	VD1080
						12/2003⇒	VD1095
2.0 HDi 95	10/99-	RHX	69	1997	AP9042	ALT, (Bosch), ALT-No: 0124 615 027, 150A, OE-NO 5705AA, 5705ER	
						MTR-CODE: DW10BTED, ALT, (-AC), ⇒ORG-NO 09519	6PK1468D1
						MTR-CODE: DW10BTED, ALT, (AC), ⇒ORG-NO 09519	6PK1750D2
						⇒11/2003	VD1080
						12/2003⇒	VD1095
<b>JUMPY Kasten</b>							
1.6 HDi 90	01/07-	9HU (DV6UTED4)	66	1560	AP9013	ALT, (Valeo), 150A, OE-NO 5702H4, 5705AS, 5705EY, ALT-No: TG15C020, TG15C028, TG15C053	



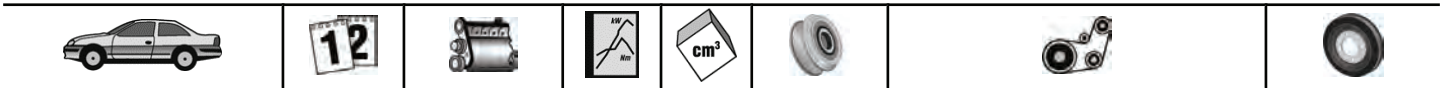

# CITROËN

## JUMPY Kasten

					<b>AP9019</b>	ALT, (Valeo), ALT-No: TG15C118, 150A, OE-NO 5705AS, 5705EY	<b>VD1096</b>
2.0 HDi 120	01/07-	RHK (DW10UTED4)	88	1997	<b>AP9013</b> <b>AP9040</b>	ALT, (Valeo), 180A, OE-NO 5705AX, 5705EE, ALT-No: FG 18 S 017 ALT, (Mitsubishi), 180A, OE-NO 5705AX, 5705EE, ALT-No: A004TJ0084	
2.0 HDi 140	01/07-	RHR (DW10BTED4)	100	1997	<b>AP9013</b> <b>AP9040</b>	ALT, (Valeo), 180A, OE-NO 5705AX, 5705EE, ALT-No: FG 18 S 017 ALT, (Mitsubishi), 180A, OE-NO 5705AX, 5705EE, ALT-No: A004TJ0084	

## JUMPY Kasten (BS\_, BT\_, BY\_, BZ\_)

1.9 D 70	04/98-	WJZ (DW8)	51	1868		(AC), ⇒ORG-NO 10177 (AC), ORG-NO 10178⇒ (-AC), ⇒ORG-NO 09894	<b>VD1080</b> <b>VD1095</b> <b>VD1097</b>
1.9 TD	10/95-	DHX (XUD9TF /BTF)	66	1905		MTR-CODE: XUD9TE	<b>VD1086</b>
2.0 HDi 110	01/02-	RHZ (DW10ATED)	80	1997	<b>AP9031</b> <b>AP9038</b> <b>AP9042</b>	ALT, (Valeo), 150A, OE-NO 5705 AA, 5705 ER (AC), ALT, OE-NO 5705 4F, 5705 GC, (Valeo), (Mitsubishi), 150A ALT, (Bosch), ALT-No: 0124 615 027, 150A, OE-NO 5705AA, 5705ER MTR-CODE: DW10ATED, ALT, (-AC) MTR-CODE: DW10ATED, ALT, (AC) ⇒11/2003 12/2003⇒	<b>6PK1468D1</b> <b>6PK1740D1</b> <b>VD1080</b> <b>VD1095</b>
2.0 HDi 95	10/99-	RHX (DW10BTED)	69	1997	<b>AP9042</b>	ALT, (Bosch), ALT-No: 0124 615 027, 150A, OE-NO 5705AA, 5705ER MTR-CODE: DW10BTED, ALT, (-AC), ⇒ORG-NO 09519 MTR-CODE: DW10BTED, ALT, (AC), ⇒ORG-NO 09519 ⇒ORG-NO 09519 ORG-NO 09520⇒	<b>6PK1468D1</b> <b>6PK1750D2</b> <b>VD1080</b> <b>VD1095</b>

## JUMPY Pritsche/Fahrgestell (BU\_, BV\_, BW\_, BX\_)

1.9 TD	10/99-	D8B (XUD9TF)	68	1905			<b>VD1086</b>
2.0 HDi	12/03-10/06		80	1997	<b>AP9031</b> <b>AP9038</b>	ALT, (Valeo), 150A, OE-NO 5705 AA, 5705 ER (AC), ALT, OE-NO 5705 4F, 5705 GC, (Valeo), (Mitsubishi), 150A ⇒ORG-NO 09519, OE-NO 0515.V6 ORG-NO 09520⇒, OE-NO 0515.S4	<b>VD1080</b> <b>VD1095</b>
2.0 HDi 95	10/99-	RHX	69	1997	<b>AP9042</b>	ALT, (Bosch), ALT-No: 0124 615 027, 150A, OE-NO 5705AA, 5705ER MTR-CODE: DW10BTED, ALT, (-AC), ⇒ORG-NO 09519 MTR-CODE: DW10BTED, ALT, (AC), ⇒ORG-NO 09519 ⇒ORG-NO 09519 ORG-NO 09520⇒	<b>6PK1468D1</b> <b>6PK1750D2</b> <b>VD1080</b> <b>VD1095</b>

## NEMO Kasten (AA\_)

1.4	02/08-	KFV (TU3A)	54	1360			<b>VD1100</b>
1.4 HDi	02/08-	8HS (DV4TD)	50	1398			<b>VD1096</b>

## NEMO Kombi

1.4 HDi	04/09-	8HS (DV4TD)	50	1399			<b>VD1096</b>
---------	--------	-------------	----	------	--	--	---------------

## SAXO (S0, S1)

1.5 D	07/01-04/04		43	1527			<b>VD1085</b>
	09/96-06/01	VJZ (TUD5)	42	1527			<b>VD1085</b>
	09/96-09/03	VJY (TUD5)	40	1527			<b>VD1085</b>

## XANTIA (X1)

1.9 D	06/94-01/98	DJZ (XUD9Y) D9B (XUD9A/L)	50 51	1905 1905		MTR-CODE: XUD9A MTR-CODE: XUD9A	<b>VD1086</b> <b>VD1086</b>
1.9 SD	02/96-01/98	DHW (XUD9SD)	55	1905			<b>VD1086</b>
1.9 Turbo D	10/94-01/98	DHX (XUD9TF /BTF), DHY (XUD9TE /Y)	66	1905		MTR-CODE: XUD9TE	<b>VD1086</b>
2.1 Turbo D 12V	06/95-01/98	P8C (XUD11BTE)	80	2088			<b>VD1088</b>

## XANTIA (X2)

1.9 SD	01/98-04/03	DHW (XUD9SD)	55	1905			<b>VD1086</b>
1.9 Turbo D	01/98-04/03	DHX (XUD9TF /BTF),	66	1905		MTR-CODE: XUD9TE	<b>VD1086</b>





## CITROËN

### XANTIA (X2)

2.0 HDI 109	02/99-04/03	DHY (XUD9TE /Y) RHZ (DW10ATED)	80	1997	AP9023 AP9038	ALT, (Bosch), ALT-No: 0124525035, 150A, OE-NO 5705AS, 5705EY ALT, OE-NO 5705 4F, 5705 GC, (Valeo), (Mitsubishi), 150A ALT, (AC), (SANDEN) ALT, (AC), (DELPHI)	6PK1740D1 6PK1750D2 VD1080
2.0 HDI 90	03/99-04/03	RHY (DW10TD)	66	1997		ALT, (AC), (SANDEN) ALT, (AC), (DELPHI)	6PK1740D1 6PK1750D2 VD1080
2.1 Turbo D 12V	01/98-02/99	P8C (XUD11BTE)	80	2088			VD1088

### XANTIA Break (X1)

1.9 SD	04/97-01/98	DHW (XUD9SD)	55	1905			VD1086
1.9 Turbo D	06/95-01/98	DHX (XUD9TF /BTF), DHY (XUD9TE /Y), D8B (XUD9TF)	66	1905		MTR-CODE: XUD9TE	VD1086
2.1 Turbo D 12V	06/96-01/98	P8C (XUD11BTE)	80	2088			VD1088

### XANTIA Break (X2)

1.9 SD	01/98-04/03	DHW (XUD9SD)	55	1905			VD1086
1.9 Turbo D	01/98-04/03	DHX (XUD9TF /BTF), D8B (XUD9TF)	66	1905		MTR-CODE: XUD9TE	VD1086
2.0 HDI 109	02/99-04/03	RHZ (DW10ATED)	80	1997	AP9023 AP9038	ALT, (Bosch), ALT-No: 0124525035, 150A, OE-NO 5705AS, 5705EY ALT, OE-NO 5705 4F, 5705 GC, (Valeo), (Mitsubishi), 150A ALT, (AC), (SANDEN) ALT, (AC), (DELPHI)	6PK1740D1 6PK1750D2 VD1080
2.0 HDI 90	03/99-04/03	RHY (DW10TD)	66	1997		ALT, (AC), (SANDEN) ALT, (AC), (DELPHI)	6PK1740D1 6PK1750D2 VD1080
2.1 Turbo D 12V	01/98-02/99	P8C (XUD11BTE)	80	2088			VD1088

### XM (Y3)

2.1 TD 12V	05/89-06/94	P8A (XUD11ATE), PHZ (XUD11ATE), PJZ (XUD11ATE)	80	2088		MTR-CODE: XUD11ATE, (AUTOM), ORG-NO 06779⇒, ⇒ORG-NO 07237 MTR-CODE: XUD11ATE, (MANL), ORG-NO 06779⇒ MTR-CODE: XUD11BTE, (AUTOM) MTR-CODE: XUD11BTE, (MANL), ORG-NO 06779⇒	VD1088 VD1088 VD1088 VD1088
------------	-------------	------------------------------------------------------	----	------	--	---------------------------------------------------------------------------------------------------------------------------------------------------------------------------------------------	--------------------------------------

### XM (Y4)

2.1 TD 12V	05/94-10/00	P8A (XUD11ATE), PHZ (XUD11ATE), PJZ (XUD11ATE), P8C (XUD11BTE)	80	2088		MTR-CODE: XUD11ATE, (AUTOM), ORG-NO 06779⇒, ⇒ORG-NO 07237 MTR-CODE: XUD11ATE, (MANL), ORG-NO 06779⇒ MTR-CODE: XUD11BTE, (AUTOM) MTR-CODE: XUD11BTE, (MANL), ORG-NO 06779⇒	VD1088 VD1088 VD1088 VD1088
------------	-------------	-------------------------------------------------------------------------	----	------	--	---------------------------------------------------------------------------------------------------------------------------------------------------------------------------------------------	--------------------------------------

### XM Break (Y3)

2.1 TD 12V	11/91-04/94	P8A (XUD11ATE), PHZ (XUD11ATE), PJZ (XUD11ATE), P8C (XUD11BTE)	80	2088		MTR-CODE: XUD11ATE, (AUTOM), ORG-NO 06779⇒, ⇒ORG-NO 07237 MTR-CODE: XUD11ATE, (MANL), ORG-NO 06779⇒ MTR-CODE: XUD11BTE, (AUTOM) MTR-CODE: XUD11BTE, (MANL), ORG-NO 06779⇒	VD1088 VD1088 VD1088 VD1088
------------	-------------	-------------------------------------------------------------------------	----	------	--	---------------------------------------------------------------------------------------------------------------------------------------------------------------------------------------------	--------------------------------------

### XM Break (Y4)

2.1 TD 12V	05/94-10/00	PHZ (XUD11ATE), PJZ (XUD11ATE), P8C (XUD11BTE)	80	2088		MTR-CODE: XUD11ATE, (AUTOM), ORG-NO 06779⇒, ⇒ORG-NO 07237 MTR-CODE: XUD11ATE, (MANL), ORG-NO 06779⇒ MTR-CODE: XUD11BTE, (AUTOM) MTR-CODE: XUD11BTE, (MANL), ORG-NO 06779⇒	VD1088 VD1088 VD1088 VD1088
------------	-------------	------------------------------------------------------	----	------	--	---------------------------------------------------------------------------------------------------------------------------------------------------------------------------------------------	--------------------------------------

### XSARA (N1)

1.4 HDi	01/03-03/05	8HX (DV4TD)	50	1398			VD1094
---------	-------------	-------------	----	------	--	--	--------





## CITROËN

### XSARA (N1)

↖ 1.4 i	04/97-03/05	KFX (TU3JP), KFW (TU3JP)	55	1360				VD1100
1.5 D	04/97-09/00	VJZ (TUD5)	42	1527		ORG-NO 08162⇒		VD1085
1.6 16V	09/00-03/05	NFU (TU5JP4)	80	1587				VD1100
1.8 D	04/97-09/00	161A (XUD7), A9A (XUD7)	43	1769				VD1086
1.9 D	04/97-09/00	DJY (XUD9A)	50	1905				VD1086
	07/98-03/05	WJZ (DW8), WJY (DW8B)	51	1868		(AC), MTR-CODE: DW8B, ORG-NO 09520⇒ (AC), MTR-CODE: DW8B, ⇒ORG-NO 09519 MTR-CODE: DW8		VD1080 VD1097 VD1097
1.9 SD	01/98-09/00	DHV (XUD9BSD)	55	1905				VD1086
1.9 TD	04/97-09/00	DHY (XUD9TE /Y)	66	1905				VD1086
2.0 HDi 109	05/01-03/05	RHZ (DW10ATED)	80	1997	AP9023	ALT, (Bosch), ALT-No: 0124525035, 150A, OE-NO 5705AS, 5705EY (AC), ALT, OE-NO 5705 4F, 5705 GC, (Valeo), (Mitsubishi), 150A	6PK1468D1 6PK1740D1 VD1080	
					AP9038			ALT, (-AC) ALT, (AC)
2.0 HDi 90	02/99-03/05	RHY (DW10TD)	66	1997	AP9023	ALT, (Bosch), ALT-No: 0124525035, 150A, OE-NO 5705AS, 5705EY (AC), ALT, OE-NO 5705 4F, 5705 GC, (Valeo), (Mitsubishi), 150A	6PK1468D1 6PK1740D1 6PK1750D2 VD1080	
					AP9038			ALT, (-AC) ALT, (AC), (XSARA II) ALT, (AC), (XSARA I)

### XSARA Break (N2)

1.4 HDi	01/03-08/05	8HX (DV4TD)	50	1398				VD1094
1.4 i	10/97-08/05	KFX (TU3JP), KFW (TU3JP)	55	1360				VD1100
1.5 D	10/97-09/00	VJZ (TUD5)	42	1527		ORG-NO 08162⇒		VD1085
1.6 16V	09/00-08/05	NFU (TU5JP4)	80	1587				VD1100
1.8 D	10/97-09/00	A9A (XUD7)	43	1769		MTR-CODE: XUD7		VD1086
1.9 D	01/98-09/00	DHV (XUD9BSD)	55	1905				VD1086
	07/98-08/05	WJZ (DW8), WJY (DW8B)	51	1868		(AC), MTR-CODE: DW8B, ORG-NO 09520⇒ (AC), MTR-CODE: DW8B, ⇒ORG-NO 09519 MTR-CODE: DW8		VD1080 VD1097 VD1097
						MTR-CODE: XUD9A		VD1086
10/97-09/00	DJY (XUD9A)	50	1905		MTR-CODE: XUD9TE		VD1086	
1.9 TD	10/97-09/00	DHY (XUD9TE /Y)	66	1905				VD1086
2.0 HDi 109	05/01-08/05	RHZ (DW10ATED)	80	1997	AP9023	ALT, (Bosch), ALT-No: 0124525035, 150A, OE-NO 5705AS, 5705EY (AC), ⇒ORG-NO 09520, ALT, OE-NO 5705 AA, 5705 ER, (Valeo), 150A	6PK1468D1 6PK1740D1 VD1080	
					AP9038			ALT, OE-NO 5705 4F, 5705 GC, (Valeo), (Mitsubishi), 150A ALT, (-AC) ALT, (AC)
2.0 HDi 90	02/99-08/05	RHY (DW10TD)	66	1997	AP9023	ALT, (Bosch), ALT-No: 0124525035, 150A, OE-NO 5705AS, 5705EY (AC), ALT, OE-NO 5705 4F, 5705 GC, (Valeo), (Mitsubishi), 150A	6PK1468D1 6PK1740D1 6PK1750D2 VD1080	
					AP9038			ALT, (-AC) ALT, (AC), (XSARA II) ALT, (AC), (XSARA I)

### XSARA Coupe (N0)

1.4 HDi	01/03-03/05	8HX (DV4TD)	50	1398				VD1094
1.4 i	03/98-03/05	KFX (TU3JP), KFW (TU3JP)	55	1360				VD1100
1.6 16V	09/00-03/05	NFU (TU5JP4)	80	1587				VD1100
1.9 D	02/98-09/00	DJY (XUD9A)	50	1905				VD1086
	02/99-03/05	WJZ (DW8), WJY (DW8B)	51	1868		(AC), MTR-CODE: DW8B, ORG-NO 09520⇒ (AC), MTR-CODE: DW8B, ⇒ORG-NO 09519 MTR-CODE: DW8		VD1080 VD1097 VD1097
1.9 TD	02/98-09/00	DHY (XUD9TE	66	1905				VD1086





## CITROËN

### XSARA Coupe (N0)

2.0 HDi 109	05/01-03/05	RHZ (DW10ATED)	80	1997	AP9023 AP9031 AP9038	ALT, (Bosch), ALT-No: 0124525035, 150A, OE-NO 5705AS, 5705EY (AC), ⇒ORG-NO 09520, ALT, OE-NO 5705 AA, 5705 ER, (Valeo), 150A ALT, OE-NO 5705 4F, 5705 GC, (Valeo), (Mitsubishi), 150A ALT, (-AC) ALT, (AC)	6PK1468D1 6PK1740D1 VD1080
2.0 HDi 90	02/99-03/05	RHY (DW10TD)	66	1997	AP9023 AP9031 AP9038	ALT, (Bosch), ALT-No: 0124525035, 150A, OE-NO 5705AS, 5705EY (AC), ⇒ORG-NO 09520, ALT, OE-NO 5705 AA, 5705 ER, (Valeo), 150A ALT, OE-NO 5705 4F, 5705 GC, (Valeo), (Mitsubishi), 150A ALT, (-AC) ALT, (AC), (XSARA II) ALT, (AC), (XSARA I)	6PK1468D1 6PK1740D1 6PK1750D2 VD1080

### XSARA PICASSO (N68)

1.6	12/99-	NFZ (TU5JP)	65	1587		(MANL)	VD1100
		NFV (TU5JP)	70	1587		(MANL)	VD1100
1.6 16V	09/05-	NFU (TU5JP4)	80	1587		(MANL)	VD1100
1.6 HDi	05/04-	DV6TED4	80	1560	AP9013 AP9019	ALT, (Valeo), 150A, OE-NO 5702H4, 5705AS, 5705EY, ALT-No: TG15C020, TG15C028, TG15C053 ALT, (Valeo), ALT-No: TG15C118, 150A, OE-NO 5705AS, 5705EY ⇒ORG-NO 10569 ORG-NO 10570⇒	VD1094 VD1096
	09/05-		66	1560	AP9013 AP9019	ALT, (Valeo), 150A, OE-NO 5702H4, 5705AS, 5705EY, ALT-No: TG15C020, TG15C028, TG15C053 ALT, (Valeo), ALT-No: TG15C118, 150A, OE-NO 5705AS, 5705EY	VD1096
2.0 HDi	12/99-	RHY (DW10TD)	66	1997	AP9023 AP9038 AP9038	ALT, (Bosch), ALT-No: 0124525035, 150A, OE-NO 5705AS, 5705EY (-AC), ⇒ORG-NO 09519, ALT, OE-NO 5705 4F, 5705 GC, (Valeo), (Mitsubishi), 150A (AC), ORG-NO 08365FV⇒, ⇒ORG-NO 09680FV, ALT, OE-NO 5705 4F, 5705GC, (Valeo), (Mitsubishi), 150A ALT, (-AC), (MANL) ALT, (AC), (MANL)	6PK1468D1 6PK1740D1 VD1080

### ZX (N2)

1.8 D	06/93-06/97	161A (XUD7)	44	1769			VD1086
1.9 D	03/91-06/97	DJZ (XUD9Y)	47	1905			VD1086
	06/94-06/97	D9B (XUD9A /U), DJY (XUD9A)	50	1905			VD1086
1.9 DT	06/92-06/94		68	1905			VD1086
	07/94-10/97		65	1905			VD1086
1.9 TD	07/92-06/97	DHY (XUD9TE /Y)	66	1905			VD1086

### ZX Break (N2)

1.8 D	10/93-10/97	161A (XUD7)	44	1769			VD1086
1.9 D	06/94-10/97	D9B (XUD9A/U)	50	1905			VD1086
	10/93-10/97	DJZ (XUD9Y)	47	1905			VD1086
1.9 TD	10/93-10/97	DHY (XUD9TE /Y)	66	1905			VD1086

## DACIA

<b>DUSTER</b>							
1.5 dCi	04/10-	K9K796	63	1461	AP9025 AP9025	ALT, (Valeo), 110A, ALT-No: TG11C034, TG11C064, 125A, ALT-No: SG12B089, SG12B105 ALT, 110A, OE-NO 82 00 667 608, 125A, OE-NO 82 00 537 415	
<b>LOGAN (LS.)</b>							
1.4 (LSOA, LSOC, LSOE, LSOG)	09/04-	K7J710	55	1390	AP9025	98A	
1.4 MPI LPG (LS0C)	02/06-	K7J710, K7J714	55	1390	AP9025	ALT, (Bosch), 98A, OE-NO 77 01 473 636, 77 01 477 694, 77 00 429 217	







## DACIA

### LOGAN (LS\_)

↔ 1.5 dCi (LS0J, LS0Y)	09/05-	K9K790	48	1461	<b>AP9025</b>	ALT, (Valeo), 110A, ALT-No: TG11C034, TG11C064, 125A, ALT-No: SG12B089, SG12B105
					<b>AP9025</b>	ALT, 110A, OE-NO 82 00 667 608, 125A, OE-NO 82 00 537 415
1.5 dCi (LS0K)	01/06-	K9K792	50	1461	<b>AP9025</b>	ALT, (Valeo), 110A, ALT-No: TG11C034, TG11C064, 125A, ALT-No: SG12B089, SG12B105
					<b>AP9025</b>	ALT, 110A, OE-NO 82 00 667 608, 125A, OE-NO 82 00 537 415
1.5 dCi (LS0W)	09/07-	K9K796	63	1461	<b>AP9025</b>	ALT, (Valeo), 110A, ALT-No: TG11C034, TG11C064, 125A, ALT-No: SG12B089, SG12B105
					<b>AP9025</b>	ALT, 110A, OE-NO 82 00 667 608, 125A, OE-NO 82 00 537 415
1.6 (LS0B, LS0D, LS0F, LS0H)	09/04-	K7M710	64	1598	<b>AP9025</b>	98A

### LOGAN EXPRESS (FS\_)

1.4	03/09-	K7J710	55	1390	<b>AP9025</b>	ALT, (Bosch), 98A, OE-NO 77 01 473 636, 77 01 477 694, 77 00 429 217
1.5 dCi (FS0K)	03/09-	K9K792	50	1461	<b>AP9025</b>	ALT, (Valeo), 110A, ALT-No: TG11C034, TG11C064, 125A, ALT-No: SG12B089, SG12B105
					<b>AP9025</b>	ALT, 110A, OE-NO 82 00 667 608, 125A, OE-NO 82 00 537 415
1.5 dCi (FS0W)	03/09-	K9K796	63	1461	<b>AP9025</b>	ALT, (Valeo), 110A, ALT-No: TG11C034, TG11C064, 125A, ALT-No: SG12B089, SG12B105
					<b>AP9025</b>	ALT, 110A, OE-NO 82 00 667 608, 125A, OE-NO 82 00 537 415
1.6	03/09-	K7M710	64	1598	<b>AP9025</b>	ALT, (Bosch), 98A, OE-NO 77 01 473 636, 77 01 477 694, 77 00 429 217

### LOGAN MCV (KS\_)

1.4	02/07-	K7J710	55	1390	<b>AP9025</b>	ALT, (Bosch), 98A, OE-NO 77 01 473 636, 77 01 477 694, 77 00 429 217
1.5 dCi (KS0K)	02/07-	K9K792	50	1461	<b>AP9025</b>	ALT, (Valeo), 110A, ALT-No: TG11C034, TG11C064, 125A, ALT-No: SG12B089, SG12B105
					<b>AP9025</b>	ALT, 110A, OE-NO 82 00 667 608, 125A, OE-NO 82 00 537 415
1.5 dCi (KS0W)	09/07-	K9K796	63	1461	<b>AP9025</b>	ALT, (Valeo), 110A, ALT-No: TG11C034, TG11C064, 125A, ALT-No: SG12B089, SG12B105
					<b>AP9025</b>	ALT, 110A, OE-NO 82 00 667 608, 125A, OE-NO 82 00 537 415
1.6	02/07-	K7M710	64	1598	<b>AP9025</b>	ALT, (Bosch), 98A, OE-NO 77 01 473 636, 77 01 477 694, 77 00 429 217
1.6 Bifuel	11/08-	K7M710	64	1598	<b>AP9025</b>	ALT, (Bosch), 98A, OE-NO 77 01 473 636, 77 01 477 694, 77 00 429 217

### LOGAN Pick-up (US\_)

1.4	01/09-	K7J710	55	1390	<b>AP9025</b>	ALT, (Bosch), 98A, OE-NO 77 01 473 636, 77 01 477 694, 77 00 429 217
1.5 dCi (US0K)	03/08-	K9K792	50	1461	<b>AP9025</b>	ALT, (Valeo), 110A, ALT-No: TG11C034, TG11C064, 125A, ALT-No: SG12B089, SG12B105
					<b>AP9025</b>	ALT, 110A, OE-NO 82 00 667 608, 125A, OE-NO 82 00 537 415
1.5 dCi (US0W)	03/08-	K9K796	63	1461	<b>AP9025</b>	ALT, (Valeo), 110A, ALT-No: TG11C034, TG11C064, 125A, ALT-No: SG12B089, SG12B105
					<b>AP9025</b>	ALT, 110A, OE-NO 82 00 667 608, 125A, OE-NO 82 00 537 415
1.6	03/08-	K7M710	64	1598	<b>AP9025</b>	ALT, (Bosch), 98A, OE-NO 77 01 473 636, 77 01 477 694, 77 00 429 217

### SANDERO

1.4	06/08-	K7J710	55	1390	<b>AP9025</b>	ALT, (Bosch), 98A, OE-NO 77 01 473 636, 77 01 477 694, 77 00 429 217
1.5 dCi	11/08-	K9K792	50	1461	<b>AP9025</b>	ALT, (Valeo), 110A, ALT-No: TG11C034, TG11C064, 125A, ALT-No: SG12B089, SG12B105
					<b>AP9025</b>	ALT, 110A, OE-NO 82 00 667 608, 125A, OE-NO 82 00 537 415
		K9K796	63	1461	<b>AP9025</b>	ALT, (Valeo), 110A, ALT-No: TG11C034, TG11C064, 125A, ALT-No: SG12B089, SG12B105
					<b>AP9025</b>	ALT, 110A, OE-NO 82 00 667 608, 125A, OE-NO 82 00 537 415
1.6	06/08-	K7M710	64	1598	<b>AP9025</b>	ALT, (Bosch), 98A, OE-NO 77 01 473 636, 77 01 477 694, 77 00 429 217



**DACIA**
**SANDERO**

636, 77 01 477 694, 77 00 429 217

**FIAT**
**500**

1.3 D Multijet	10/07-	169A1.000	55	1248	<b>AP9035</b>	ALT, (Valeo), OE-NO 46823547, 51784845, 90A, OE-NO 46835095, 51784846, 105A	
----------------	--------	-----------	----	------	---------------	-----------------------------------------------------------------------------	--

**BRAVA (182)**

1.9 JTD	09/00-10/01	182B9.000	74	1910	<b>AP9058</b>	ALT, (AC), MTR-NO 1199498⇒, (Magneti-Marelli), 85A, 100A, OE-NO 4654@4329	<b>VD1065</b>
---------	-------------	-----------	----	------	---------------	---------------------------------------------------------------------------	---------------

1.9 JTD 105	12/98-10/01	182B4.000	77	1910	<b>AP9017</b> <b>AP9058</b>	ALT, (Denso), OE-NO 46782213, 105A ALT, (AC), MTR-NO 1199498⇒, (Magneti-Marelli), 100A, OE-NO 4654@4329	<b>VD1065</b>
-------------	-------------	-----------	----	------	--------------------------------	------------------------------------------------------------------------------------------------------------	---------------

1.9 TD 100 S (182.BF)	03/96-10/01	182A7.000	74	1910			<b>VD1065</b>
1.9 TD 75 S (182.BF)	03/96-10/01	182A8.000	55	1910			<b>VD1065</b>

**BRAVO (182)**

1.9 JTD	09/00-10/01	182B9.000	74	1910	<b>AP9058</b>	ALT, (AC), MTR-NO 1199498⇒, (Magneti-Marelli), 85A, 100A, OE-NO 4654@4329	<b>VD1065</b>
---------	-------------	-----------	----	------	---------------	---------------------------------------------------------------------------	---------------

1.9 JTD 105	12/98-10/01	182B4.000	77	1910	<b>AP9017</b> <b>AP9058</b>	ALT, (Denso), OE-NO 46782213, 105A ALT, (AC), MTR-NO 1199498⇒, (Magneti-Marelli), 100A, OE-NO 4654@4329	<b>VD1065</b>
-------------	-------------	-----------	----	------	--------------------------------	------------------------------------------------------------------------------------------------------------	---------------

1.9 TD 100 S (182.AF)	03/96-10/01	182A7.000	74	1910			<b>VD1065</b>
1.9 TD 75 S (182.AF)	03/96-10/01	182A8.000	55	1910		(AC)	<b>VD1065</b>

**BRAVO (198)**

1.4	04/07-	192B2.000	66	1368		(AC)	<b>VD1065</b>
-----	--------	-----------	----	------	--	------	---------------

1.6 D Multijet	03/08-	198A3.000	77	1598			<b>VD1065</b>
----------------	--------	-----------	----	------	--	--	---------------

		198A2.000	88	1598			<b>VD1065</b>
--	--	-----------	----	------	--	--	---------------

1.9 D Multijet	04/07-	192A8.000	88	1910	<b>AP9017</b> <b>AP9054</b>	ALT, (Denso), OE-NO 46809068, 140A 90A (AC)	<b>VD1065</b>
----------------	--------	-----------	----	------	--------------------------------	---------------------------------------------------	---------------

		937A5.000	110	1910	<b>AP9017</b> <b>AP9054</b>	ALT, (Denso), OE-NO 73503235, 120A 90A (AC)	<b>VD1065</b>
--	--	-----------	-----	------	--------------------------------	---------------------------------------------------	---------------

2.0 D Multijet	09/08-	198A5.000, 844A2.000	121	1956		⇒12/2009	<b>VD1065</b>
----------------	--------	-------------------------	-----	------	--	----------	---------------

**CROMA (194)**

1.9 D Multijet	06/05-	939A7.000	85	1910			<b>VD1065</b>
----------------	--------	-----------	----	------	--	--	---------------

		939A1.000	88	1910	<b>AP9017</b> <b>AP9017</b>	ALT, (Denso), OE-NO 73501591, 140A ALT, (Denso), OE-NO 73503235, 120A ⇒MTR-NO 5452805	<b>VD1065</b>
--	--	-----------	----	------	--------------------------------	---------------------------------------------------------------------------------------------	---------------

		939A2.000	110	1910	<b>AP9017</b> <b>AP9017</b>	ALT, (Denso), OE-NO 73501591, 140A ALT, (Denso), OE-NO 73503235, 120A	<b>VD1065</b>
--	--	-----------	-----	------	--------------------------------	--------------------------------------------------------------------------	---------------

2.4 D Multijet	06/05-	939A3.000	147	2387			<b>VD1064</b>
----------------	--------	-----------	-----	------	--	--	---------------

**DOBLO (119)**

1.3 D Multijet	10/05-	223A9.000	62	1248	<b>AP9035</b>	ALT, (AC), (Valeo), OE-NO 46823547, 90A, OE-NO 46835095, 51784846, 105A	
----------------	--------	-----------	----	------	---------------	-------------------------------------------------------------------------	--

1.3 JTD	05/05-	199A2.000	55	1248	<b>AP9035</b>	ALT, (Valeo), OE-NO 46823547, 51784845, 90A, OE-NO 46835095, 51784846, 105A	
---------	--------	-----------	----	------	---------------	-----------------------------------------------------------------------------	--

1.9 D (223AXB1A)	03/01-	223A6.000	46	1910	<b>AP9017</b> <b>AP9017</b>	ALT, (Denso), OE-NO 46774430, 90A ALT, (Denso), OE-NO 46782213, 105A (AC)	<b>VD1065</b>
------------------	--------	-----------	----	------	--------------------------------	---------------------------------------------------------------------------------	---------------

1.9 D Multijet	10/05-	186A9.000	88	1910	<b>AP9017</b> <b>AP9017</b> <b>AP9017</b>	ALT, (Denso), OE-NO 46774430, 90A ALT, (Denso), OE-NO 46782213, 105A ALT, (Denso), OE-NO 46809068, 120A	<b>VD1065</b>
----------------	--------	-----------	----	------	-------------------------------------------------	---------------------------------------------------------------------------------------------------------------	---------------

1.9 JTD	07/03-	223A7.000, 223B1.000	77	1910	<b>AP9017</b> <b>AP9017</b>	ALT, (Denso), OE-NO 46774430, 90A ALT, (denso), OE-NO 46782213, 105A MTR-CODE: 223 A7.000	<b>VD1065</b>
---------	--------	-------------------------	----	------	--------------------------------	-------------------------------------------------------------------------------------------------	---------------

1.9 JTD (223AXE1A)	10/01-	182B9.000, 223B2.000	74	1910		MTR-CODE: 182 B9.000	<b>VD1065</b>
--------------------	--------	-------------------------	----	------	--	----------------------	---------------

**DOBLO (152)**

1.6 D Multijet	02/10-	198A3.000	77	1598			<b>VD1065</b>
----------------	--------	-----------	----	------	--	--	---------------

2.0 D Multijet	02/10-	263A1.000	99	1956			<b>VD1065</b>
----------------	--------	-----------	----	------	--	--	---------------

**DOBLO Cargo (223)**

1.3 D Multijet	10/05-	199A2.000	55	1248	<b>AP9035</b>	ALT, (AC), (Valeo), OE-NO 46823547, 51784845, 90A, OE-NO 51784846,	
----------------	--------	-----------	----	------	---------------	--------------------------------------------------------------------	--





## FIAT

### DOBLO Cargo (223)

						46835095, 105A	
1.3 JTD 16V	05/04-	188A9.000	51	1248	<b>AP9035</b>	ALT, (AC), (Valeo), OE-NO 46823547, 51784845, 90A, OE-NO 51784846, 46835095, 105A	
1.9 D (223ZXB1A)	03/01-	223A6.000	46	1910	<b>AP9017</b> <b>AP9017</b>	ALT, (Denso), OE-NO 46774430, 90A ALT, (Denso), OE-NO 46782213, 105A (AC)	<b>VD1065</b>
1.9 JTD	07/03-	223A7.000, 223B1.000	77	1910	<b>AP9017</b> <b>AP9017</b>	ALT, (Denso), OE-NO 46774430, 90A ALT, (Denso), OE-NO 46782213, 105A 05/2005⇒	<b>VD1065</b>
1.9 JTD (223ZXE1A)	10/01-	182B9.000	74	1910			<b>VD1065</b>

### DOBLO Cargo (263)

1.6 D Multijet	02/10-	263A3.000 198A3.000	74 77	1598 1598			<b>VD1065</b> <b>VD1065</b>
2.0 D Multijet	02/10-	263A1.000	99	1956			<b>VD1065</b>

### DUCATO Bus (230)

1.9 D	04/98-04/02	D9B, DJY, D9B (XUD9A)	50	1905		(-PS)	<b>VD1086</b>
1.9 TD	04/98-04/02	DHX (XUD9TF /L)	66	1905		(-PS)	<b>VD1086</b>
2.0 JTD	10/01-04/02	RHV (DW10)	62	1997	<b>AP9023</b> <b>AP9031</b>	ALT, (Bosch), 150A, OE-NO 9646321880 ALT, (Valeo), OE-NO 96107787780, 9645907580, 150A ALT, PS, (-AC) (-AC)	<b>6PK1468D1</b> <b>VD1080</b>
2.8 D	02/98-04/02	8140.63	64	2800		(-AC)	<b>VD1062</b>
2.8 JTD	11/00-04/02	8140.43S	94	2798		ALT, WP (-AC)	<b>6PK995D1</b> <b>VD1062</b>
2.8 JTD 4x4	11/00-04/02	8140.43S	94	2798		ALT, WP (-AC)	<b>6PK995D1</b> <b>VD1062</b>

### DUCATO Bus (244, Z\_)

2.0 JTD	04/02-	RHV (DW10)	62	1997	<b>AP9013</b> <b>AP9013</b> <b>AP9023</b> <b>AP9031</b>	ALT, (Valeo), OE-NO 9646321780, 150A ALT, (Valeo), OE-NO 9649611280, 90A ALT, (Bosch), 150A, OE-NO 9646321880 ALT, (Valeo), OE-NO 96107787780, 9645907580, 150A ALT, PS, (-AC) (-AC)	<b>6PK1468D1</b> <b>VD1080</b>
2.3 JTD	04/02-	F1AE0481C	81	2286	<b>AP9031</b>	ALT, (Valeo), OE-NO 96107787780, 9645907580, 150A	
2.8 JTD	04/02-	8140.43S	94	2798		ALT, (AUTOM) (-AC)	<b>6PK995D1</b> <b>VD1062</b>
2.8 JTD 4x4	07/02-	8140.43S	94	2798		ALT, (AUTOM) (-AC)	<b>6PK995D1</b> <b>VD1062</b>

### DUCATO Bus (250)

100 Multijet 2,2 D	07/06-	4HV	74	2198	<b>AP9023</b> <b>AP9048</b>	ALT, (Bosch), 150A, OE-NO 9646321880 ALT, (Bosch), OE-NO 9659918080, 156A	
--------------------	--------	-----	----	------	--------------------------------	------------------------------------------------------------------------------	--

### DUCATO Kasten (230L)

1.9 D	04/98-04/02	DJY	50	1905		(-PS)	<b>VD1086</b>
1.9 TD	04/98-04/02	DHX (XUD9TF /L)	66	1905		(-PS)	<b>VD1086</b>
2.0 JTD	10/01-04/02	RHV (DW10)	62	1997	<b>AP9023</b> <b>AP9031</b>	ALT, (Bosch), 150A, OE-NO 9646321880 ALT, (Valeo), OE-NO 96107787780, 9645907580, 150A ALT, PS, (-AC) (-AC)	<b>6PK1468D1</b> <b>VD1080</b>
2.8 D	05/98-04/02	8140.63	64	2800		(-AC)	<b>VD1062</b>
2.8 D 4x4	08/98-04/02	8140.63	64	2800		(-AC)	<b>VD1062</b>
2.8 JTD	11/00-04/02	8140.43S	94	2798		ALT, WP (-AC)	<b>6PK995D1</b> <b>VD1062</b>
2.8 JTD 4x4	11/00-04/02	8140.43S	94	2798		ALT, WP	<b>6PK995D1</b>

### DUCATO Kasten (244)

2.0 JTD	04/02-	RHV (DW10)	62	1997	<b>AP9013</b> <b>AP9013</b> <b>AP9023</b> <b>AP9031</b>	ALT, (Valeo), OE-NO 9646321780, 150A ALT, (Valeo), OE-NO 9649611280, 90A ALT, (Bosch), 150A, OE-NO 9646321880 ALT, (Valeo), OE-NO 96107787780, 9645907580, 150A ALT, PS, (-AC) (-AC)	<b>6PK1468D1</b> <b>VD1080</b>
---------	--------	------------	----	------	------------------------------------------------------------------	-----------------------------------------------------------------------------------------------------------------------------------------------------------------------------------------------------	-----------------------------------





# FIAT

## DUCATO Kasten (244)

2.3 JTD	04/02-	F1AE0481C	81	2286	<b>AP9031</b>	ALT, (Valeo), OE-NO 9610787780, 9645907580, 150A	
2.8 JTD	04/02-	8140.43S	94	2798		ALT, (AUTOM) (-AC)	<b>6PK995D1</b> <b>VD1062</b>
2.8 JTD 4x4	07/02-	8140.43S	94	2798		ALT, (AUTOM) (-AC)	<b>6PK995D1</b> <b>VD1062</b>

## DUCATO Kasten (250)

100 Multijet 2,2 D	07/06-	4HV	74	2198	<b>AP9048</b>	ALT, (Bosch), OE-NO 9659918080, 156A	
--------------------	--------	-----	----	------	---------------	--------------------------------------	--

## DUCATO Pritsche/Fahrgestell (230)

1.9 D	04/98-04/02	DJY	50	1905		(-PS)	<b>VD1086</b>
1.9 TD	04/98-04/02	DHX (XUD9TF /L)	66	1905		(-PS)	<b>VD1086</b>
2.8 D	02/98-04/02	8140.63	64	2800		(-AC)	<b>VD1062</b>
2.8 JTD	11/00-04/02	8140.43S	94	2798		ALT, WP (-AC)	<b>6PK995D1</b> <b>VD1062</b>

## DUCATO Pritsche/Fahrgestell (244)

2.0 JTD	04/02-	RHV (DW10)	62	1997	<b>AP9013</b> <b>AP9013</b> <b>AP9023</b> <b>AP9031</b>	ALT, (Valeo), OE-NO 9646321780, 150A ALT, (Valeo), OE-NO 9649611280, 90A ALT, (Bosch), 150A, OE-NO 9646321880 ALT, (Valeo), OE-NO 9610787780, 9645907580, 150A ALT, PS, (-AC)	<b>6PK1468D1</b> <b>VD1080</b>
2.3 JTD	04/02-	F1AE0481C	81	2286	<b>AP9031</b>	ALT, (Valeo), OE-NO 9610787780, 9645907580, 150A	
2.8 JTD	04/02-	8140.43S	94	2798		ALT, (AUTOM) (-AC)	<b>6PK995D1</b> <b>VD1062</b>
2.8 JTD 4x4	10/02-	8140.43S	94	2798		ALT, (AUTOM) (-AC)	<b>6PK995D1</b> <b>VD1062</b>

## DUCATO Pritsche/Fahrgestell (250)

100 Multijet 2,2 D	07/06-	4HV	74	2198	<b>AP9048</b>	ALT, (Bosch), OE-NO 9659918080, 156A	
--------------------	--------	-----	----	------	---------------	--------------------------------------	--

## FIORINO Kasten/Kombi

1.3 D Multijet	02/08-	199A2.000, 199A9.000	55	1248	<b>AP9035</b>	ALT, (AC), (Valeo), OE-NO 46823547, 51784845, 90A	
----------------	--------	----------------------	----	------	---------------	---------------------------------------------------	--

## IDEA

1.3 D Multijet	10/05-	199A3.000	66	1248	<b>AP9035</b>	ALT, (AC), (Valeo), OE-NO 46823547, 90A, OE-NO 46835095, 105A	
1.3 JTD	01/04-	188A9.000	51	1248	<b>AP9035</b>	ALT, (Valeo), OE-NO 46823547, 51784845, 90A, OE-NO 46835095, 51784846, 105A	
1.9 JTD	01/04-	188B2.000	74	1910	<b>AP9017</b> <b>AP9017</b> <b>AP9054</b>	ALT, (Denso), OE-NO 46782213, 105A ALT, (Denso), OE-NO 46809068 90A, 120A	<b>VD1065</b>

## LINEA

1.3 D Multijet	06/07-	199A3.000	66	1248	<b>AP9035</b>	ALT, (AC), (Valeo), OE-NO 46823547, 90A, OE-NO 46835095, 105A	
1.6 D Multijet	06/09-	198A3.000	77	1598			<b>VD1065</b>

## MAREA (185)

1.9 JTD 105	04/99-01/01	182B4.000	77	1910	<b>AP9058</b>	ALT, (Magneti-Marelli), 100A	<b>VD1065</b>
1.9 JTD 110	01/01-	186A6.000	81	1910	<b>AP9017</b> <b>AP9017</b> <b>AP9058</b>	ALT, (Denso), OE-NO 46782213, 105A ALT, (Denso), OE-NO 46809068, 120A ALT, (Magneti-Marelli), 100A	<b>VD1065</b>
1.9 TD 100	09/96-	182A7.000	74	1910			<b>VD1065</b>
1.9 TD 75	09/96-	182A8.000	55	1910			<b>VD1065</b>
2.4 JTD 130	04/99-	839A5.000, 185A6.000	96	2387		ALT, PS, AC	<b>6PK1760D1</b> <b>VD1064</b>
2.4 TD 125	09/96-04/99	185A2.000	91	2387			<b>VD1064</b>

## MAREA Weekend (185)

1.9 JTD 105	04/99-	182B4.000	77	1910	<b>AP9058</b>	ALT, (Magneti-Marelli), 100A	<b>VD1065</b>
1.9 JTD 110	01/01-	186A6.000	81	1910	<b>AP9058</b>	ALT, (Magneti-Marelli), 100A	<b>VD1065</b>
1.9 TD 100	09/96-	182A7.000, 182B9.000	74	1910			<b>VD1065</b>
1.9 TD 75	09/96-	182A8.000	55	1910			<b>VD1065</b>
2.4 JTD 130	04/99-	839A5.000, 185A6.000	96	2387		ALT, PS, AC	<b>6PK1760D1</b> <b>VD1064</b>
2.4 TD 125	09/96-04/99	185A2.000	91	2387			<b>VD1064</b>

## MULTIPLA (186)

1.9 JTD (186AXE1A)	04/02-	186A9.000	88	1910	<b>AP9017</b>	ALT, (Denso), OE-NO 46774430, 90A	
--------------------	--------	-----------	----	------	---------------	-----------------------------------	--





## FIAT

### MULTIPLA (186)

					AP9017	ALT, (Denso), OE-NO 46782213, 105A	VD1065
1.9 JTD 105 (186AXB1A)	04/99-	182B4.000	77	1910	AP9058	ALT, (AC), MTR-NO 1189616⇒, 100A, OE-NO 4654@4329	
					AP9058	ALT, MTR-NO 01331863⇒, 85A, OE-NO 4655@4408	VD1065
1.9 JTD 110	03/01-07/02	186A6.000	81	1910	AP9017	ALT, (Denso), OE-NO 46774430, 90A	
					AP9017	ALT, (Denso), OE-NO 46782213, 105A	VD1065
1.9 JTD 115	07/02-	186A8.000	85	1910	AP9017	ALT, (Denso), OE-NO 46774430, 90A	
					AP9017	ALT, (Denso), OE-NO 46782213, 105A	VD1065

### PALIO (178BX)

1.3 JTD Multijet	06/03-	188A9.000	51	1248	AP9035	ALT, MTR-CODE: 199A2000, 188A9000, (AC), (Valeo), OE-NO 46823547, 51784845, 90A	
------------------	--------	-----------	----	------	--------	---------------------------------------------------------------------------------------	--

### PALIO Weekend (178DX)

1.9 D (178DYD1A07)	03/01-	223A6.000	46	1910	AP9017	ALT, (Denso), OE-NO 46774430, 90A	
					AP9017	ALT, (Denso), OE-NO 46782218, 65A (AC)	VD1065

### PANDA (169)

1.3 D Multijet	06/06-	169A1.000	55	1248	AP9035	ALT, (AC), (Valeo), OE-NO 46823547, 51784845, 90A	
	09/03-	188A9.000	51	1248	AP9035	ALT, (AC), (Valeo), OE-NO 46823547, 51784845, 90A	
1.3 D Multijet 4x4	10/04-	188A9.000	51	1248	AP9035	ALT, (AC), (Valeo), OE-NO 46823547, 51784845, 90A	

### PANDA Van (169)

1.3 JTD	01/06-	169A1.000	55	1248	AP9035	ALT, (AC), (Valeo), OE-NO 46823547, 51784845, 90A, MTR-CODE: 169A1.000	
	03/04-	188A9.000	51	1248	AP9035	ALT, (AC), (Valeo), OE-NO 46823547, 51784845, 90A, MTR-CODE: 188A8.000	

### PUNTO (188)

1.3 JTD 16V	06/03-	188A9.000	51	1248	AP9035	ALT, (AC), (Valeo), OE-NO 51718499, 75A, OE-NO 46823547, 90A, OE-NO 46835095, 105A	
1.9 DS 60 (188.031, .051, .231, .251)	09/99-	188A3.000	44	1910	AP9017	ALT, (Denso), OE-NO 46774430, 90A	
					AP9017	ALT, (Denso), OE-NO 46809068, 120A	
1.9 JTD	06/03-	188B2.000	74	1910	AP9054	90A, 120A	VD1065
	10/01-	188A7.000	63	1910	AP9017	ALT, (Denso), OE-NO 46774430, 90A, ALT, (Denso), OE-NO 46782213, 105A	VD1065
1.9 JTD 80 (188.237, .257, .337, .357)	09/99-	188A2.000	59	1910	AP9017	ALT, (Denso), OE-NO 46782213, 105A	
					AP9058	ALT, (AC), 100A, OE-NO 4654@4329	VD1065

### PUNTO / GRANDE PUNTO (199)

1.3 D Multijet	10/05-	199A2.000	55	1248	AP9035	ALT, (AC), (Valeo), OE-NO 46823547, 51784845, 90A, OE-NO 46835095, 51784846, 105A	
		199A3.000	66	1248	AP9035	ALT, (AC), (Valeo), OE-NO 46823547, 90A, OE-NO 46835095, 105A	
1.9 D Multijet	10/05-	939A1.000	88	1910	AP9017	ALT, (Denso), OE-NO 73501591, 140A ⇒MTR-NO 5452805	VD1065
		199A5.000	96	1910	AP9017	ALT, (Denso), OE-NO 73503235, 120A ⇒MTR-NO 5452805	VD1065

### PUNTO EVO

1.6 D Multijet	10/09-	955A3.000	88	1598			VD1065
----------------	--------	-----------	----	------	--	--	--------

### PUNTO Van (188AX)

1.3 JTD	06/03-10/05	188A9.000	51	1248	AP9035	ALT, (AC), (Valeo), OE-NO 51718499, 75A, OE-NO 46823547, 90A, OE-NO 46835095, 105A, MTR-CODE: 188A9.000	
1.9 JTD	02/00-	188A7.000	63	1910	AP9017	ALT, (Denso), OE-NO 46774430, 90A	
					AP9017	ALT, (Denso), OE-NO 46782213, 105A	VD1065

### SCUDO

1.6 D Multijet	01/07-	9HU	66	1560	AP9023	ALT, (Bosch), 150A, OE-NO 964065480	
2.0 D Multijet	01/07-	RHK	88	1997	AP9013	ALT, (Valeo), OE-NO 71733552, 150A	
					AP9023	ALT, (Bosch), OE-NO 964065480, 150A	
					AP9040	ALT, (Mitsubishi), 180A, OE-NO 9646065180, ALT-No: A004TJ0084	
		RHR	100	1997	AP9013	ALT, (Valeo), OE-NO 71733552, 150A	



**FIAT**
**SCUDO**

					<b>AP9023</b>	ALT, (Bosch), OE-NO 9646065480, 150A	
					<b>AP9040</b>	ALT, (Mitsubishi), 180A, OE-NO 9646065180, ALT-No: A004TJ0084	
<b>SCUDO Combinato (220P)</b>							
1.9 D	02/96-04/98	D9B	51	1905			<b>VD1086</b>
	04/98-	WJZ (DW8)	51	1868	<b>AP9023</b>	ALT, (Bosch), 150A, OE-NO 964065480	<b>VD1097</b>
1.9 TD	02/96-	D8B	68	1905			<b>VD1086</b>
1.9 TD Eco	02/96-	DHX (XUD9TF /L)	66	1905			<b>VD1086</b>
2.0 JTD	01/04-	RHX	69	1997	<b>AP9013</b> <b>AP9013</b> <b>AP9013</b> <b>AP9023</b>	ALT, (Valeo), OE-NO 71733552, 150A ALT, (Valeo), OE-NO 71748885, 150A ALT, (Valeo), OE-NO 71749232, 150A ALT, (Bosch), OE-NO 9646065480, 150A	
					<b>AP9031</b> <b>AP9038</b>	ALT, (Valeo), OE-NO 9640878780, 150A ALT, (Valeo), OE-NO 9621791480, 150A	
						12/2002⇒	<b>VD1095</b>
	12/99-	RHZ	80	1997	<b>AP9013</b> <b>AP9023</b> <b>AP9031</b> <b>AP9038</b>	ALT, (Valeo), OE-NO 71733552, 150A ALT, (Bosch), 150A, OE-NO 964065480 ALT, (Valeo), OE-NO 9640878780, 150A ALT, (Valeo), OE-NO 9621791480, 150A	
						ALT, (-AC), ⇒11/2004 ALT, (AC), ⇒11/2004	<b>6PK1468D1</b> <b>6PK1740D1</b> <b>VD1080</b>
<b>SCUDO Kasten</b>							
1.6 D Multijet	01/07-	9HU	66	1560	<b>AP9023</b>	ALT, (Bosch), 150A, OE-NO 964065480	
2.0 D Multijet	01/07-	RHK	88	1997	<b>AP9013</b> <b>AP9023</b> <b>AP9040</b>	ALT, (Valeo), OE-NO 71733552, 150A ALT, (Bosch), 150A, OE-NO 964065480 ALT, (Mitsubishi), 180A, OE-NO 9646065180, ALT-No: A004TJ0084	
		RHR	100	1997	<b>AP9013</b> <b>AP9023</b> <b>AP9040</b>	ALT, (Valeo), OE-NO 717133552, 150A ALT, (Bosch), OE-NO 9646065480, 150A ALT, (Mitsubishi), 180A, OE-NO 9646065180, ALT-No: A004TJ0084	
<b>SCUDO Kasten (220L)</b>							
1.9 D	02/96-04/98	D9B	51	1905			<b>VD1086</b>
		WJZ (DW8)	51	1868	<b>AP9023</b>	ALT, (Bosch), 150A, OE-NO 964065480	<b>VD1097</b>
1.9 TD	02/96-	DHX (XUD9TF /L)	66	1905			<b>VD1086</b>
	02/98-	D8B	68	1905			<b>VD1086</b>
2.0 JTD	12/02-	RHZ	80	1997	<b>AP9013</b> <b>AP9023</b> <b>AP9031</b> <b>AP9038</b>	ALT, (Valeo), OE-NO 71733552, 150A ALT, (Bosch), 150A, OE-NO 964065480 ALT, (Valeo), OE-NO 9640878780, 150A ALT, (Valeo), OE-NO 9621791480, 150A	
						ALT, (-AC), ⇒11/2004 ALT, (AC), ⇒11/2004 ⇒11/2004	<b>6PK1468D1</b> <b>6PK1740D1</b> <b>VD1080</b>
	12/99-	RHX	69	1997	<b>AP9013</b> <b>AP9023</b> <b>AP9031</b> <b>AP9038</b>	ALT, (Valeo), OE-NO 71733552, 150A ALT, (Bosch), OE-NO 9646065480, 150A, 12/2002⇒ ALT, (Valeo), OE-NO 9640878780, 150A ALT, (Valeo), OE-NO 9621791480, 150A	
						ALT, (-AC), ⇒11/2004 ALT, (AC), ⇒11/2004 ⇒12/2002 12/2002⇒	<b>6PK1468D1</b> <b>6PK1740D1</b> <b>VD1080</b> <b>VD1095</b>
<b>SCUDO Pritsche/Fahrgestell</b>							
1.6 D Multijet	01/07-	9HU	66	1560	<b>AP9023</b>	ALT, (Bosch), 150A, OE-NO 964065480	
2.0 D Multijet	01/07-	RHK	88	1997	<b>AP9013</b> <b>AP9023</b> <b>AP9040</b>	ALT, (Valeo), OE-NO 71733552, 150A ALT, (Bosch), OE-NO 9646065480, 150A ALT, (Mitsubishi), 180A, OE-NO 9646065180, ALT-No: A004TJ0084	
		RHR	100	1997	<b>AP9013</b> <b>AP9023</b>	ALT, (Valeo), OE-NO 71733552, 150A ALT, (Bosch), OE-NO 9646065480, 150A	



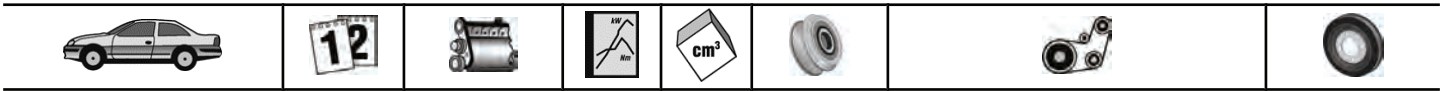

# FIAT

## SCUDO Pritsche/Fahrgestell

					<b>AP9040</b>	ALT, (Mitsubishi), 180A, OE-NO 9646065180, ALT-No: A004TJ0084	
--	--	--	--	--	---------------	---------------------------------------------------------------	--

## SEDICI

1.9 D Multijet	06/06-	D19AA	88	1910			<b>VD1065</b>
----------------	--------	-------	----	------	--	--	---------------

## STILO (192)

1.9 D Multijet	09/05-	192A9.000	74	1910	<b>AP9054</b>	90A (AC)	<b>VD1065</b>
		192A8.000	88	1910	<b>AP9017</b> <b>AP9017</b> <b>AP9054</b>	ALT, (Denso), OE-NO 46774430, 90A ALT, (Denso), OE-NO 46782213, 105A (VM-Motori), 90A, 90A (AC)	<b>VD1065</b>
		937A5.000	110	1910	<b>AP9017</b>	ALT, (Denso), OE-NO 73503235, 120A	<b>VD1065</b>
1.9 JTD	01/04- 04/04- 09/03-	192A5.000	103	1910	<b>AP9054</b>	(VM-Motori), 90A	<b>VD1065</b>
		192B1.000	100	1910	<b>AP9054</b>	90A	
		937A4.000	93	1910	<b>AP9054</b>	90A	
1.9 JTD (192_XE1A)	10/01-	192A1.000, 937A7.000	85	1910	<b>AP9054</b>	90A (AC)	<b>VD1065</b>
1.9 JTD (192_XF1A)	02/02-	192A3.000	59	1910	<b>AP9017</b> <b>AP9017</b> <b>AP9017</b> <b>AP9054</b>	ALT, (Denso), OE-NO 46774430, 90A ALT, (Denso), OE-NO 46782213, 105A ALT, (Denso), OE-NO 46809068, 120A 90A (AC)	<b>VD1065</b>
						192B5.000	66

## STILO Multi Wagon (192)

1.9 D	09/04-	192B5.000	66	1910	<b>AP9054</b>	90A	<b>VD1065</b>
1.9 D Multijet	09/05-	192A9.000	74	1910	<b>AP9054</b>	90A (AC)	<b>VD1065</b>
		192A8.000	88	1910	<b>AP9054</b>	(VM-Motori), 90A, 90A (AC)	<b>VD1065</b>
		937A5.000	110	1910	<b>AP9017</b>	ALT, (Denso), OE-NO 73503235, 120A	<b>VD1065</b>
		1.9 JTD	01/03-	192A3.000	59	1910	<b>AP9017</b> <b>AP9017</b> <b>AP9054</b>
192A1.000, 937A7.000	85			1910	<b>AP9054</b>	90A (AC)	<b>VD1065</b>
01/04-	192A5.000			103	1910	<b>AP9017</b> <b>AP9054</b>	ALT, (Denso), OE-NO 73503235, 120A (VM-Motori), 90A
	04/04-	192B1.000	100	1910	<b>AP9054</b>	90A	
	09/03-	937A4.000	93	1910	<b>AP9054</b>	90A	

## STRADA (178E)

1.3 D Multijet	05/06-	223A9.000	62	1248	<b>AP9035</b>	ALT, (AC), (Valeo), OE-NO 46823547, 90A, OE-NO 46835095, 51784846, 105A	
1.9 D	12/00-	223A6.000	46	1910			<b>VD1065</b>
1.9 JTD	04/03-	188A2.000	59	1910	<b>AP9017</b> <b>AP9017</b>	ALT, (Denso), OE-NO 46774430, 90A ALT, (Denso), OE-NO 46782218, 65A	<b>VD1065</b>

## ULYSSE (179AX)

2.0 D Multijet	05/06-	RHK	88	1997	<b>AP9013</b> <b>AP9023</b> <b>AP9040</b>	ALT, (Valeo), OE-NO 71733552, 150A ALT, (Bosch), 150A, OE-NO 964065480 ALT, (Mitsubishi), 180A, OE-NO 9646065180, ALT-No: A004TJ0084	
		RHR	100	1997	<b>AP9013</b> <b>AP9023</b> <b>AP9040</b>	ALT, (Valeo), OE-NO 71733552, 150A ALT, (Bosch), OE-NO 9646065480, 150A ALT, (Mitsubishi), 180A, OE-NO 9646065180, ALT-No: A004TJ0084	
2.0 JTD	05/03-	RHM (DW10ATED4)	79	1997	<b>AP9013</b> <b>AP9023</b> <b>AP9031</b>	ALT, (Valeo), OE-NO 71733552, 150A ALT, (Bosch), OE-NO 9646065480, 150A ALT, (Valeo), OE-NO 9640878780, 150A	<b>VD1095</b>
		RHW (DW10ATED4)	80	1997	<b>AP9013</b> <b>AP9023</b> <b>AP9031</b>	ALT, (Valeo), OE-NO 71733552, 150A ALT, (Bosch), OE-NO 9646065480, 150A, 12/2002⇒ ALT, (Valeo), OE-NO 9640878780, 150A ALT, (AC), ⇒11/2004 ⇒11/2004	<b>6PK1740D1</b> <b>VD1080</b>



**FIAT**
**ULYSSE (179AX)**

						12/2004⇨	<b>VD1095</b>
2.2 D Multijet	03/08-	4HS	125	2179	<b>AP9013</b> <b>AP9013</b> <b>AP9013</b>	ALT, (Valeo), OE-NO 71733552, 150A ALT, (Valeo), OE-NO 71748885, 150A ALT, (Valeo), OE-NO 9661544880, 180A	
					<b>AP9023</b> <b>AP9040</b>	ALT, (Bosch), 150A, OE-NO 964065480 ALT, (Mitsubishi), 180A, OE-NO 9646065180, ALT-No: A004TJ0084	
2.2 JTD	08/02-	4HW (DW12ATED4)	94	2179	<b>AP9013</b> <b>AP9013</b> <b>AP9013</b>	ALT, (Valeo), OE-NO 71733552, 150A ALT, (Valeo), OE-NO 71748885, 150A ALT, (Valeo), OE-NO 9661544880, 180A	
					<b>AP9023</b> <b>AP9031</b> <b>AP9040</b>	ALT, (Bosch), 150A, OE-NO 964065480 ALT, (Valeo), OE-NO 9640878780, 150A ALT, (Mitsubishi), 180A, OE-NO 9646065180, ALT-No: A004TJ0084	
						ALT, (AC), ⇨11/2004 ⇨11/2004, ⇨ORG-NO 10248 11/2004⇨, ORG-NO 10249⇨	<b>6PK1740D1</b> <b>VD1080</b> <b>VD1095</b>

**ULYSSE (220)**

1.9 TD (220AH5)	02/95-08/02	DHX (XUD9TF /L)	66	1905			<b>VD1086</b>
2.0 JTD	10/99-08/02	RHZ	80	1997	<b>AP9023</b> <b>AP9031</b> <b>AP9038</b>	ALT, (Bosch), 150A, OE-NO 964065480, 01/2001⇨ ALT, (Valeo), OE-NO 9640878780, 150A ALT, (Valeo), OE-NO 9621791480, 150A	
						ALT, (-AC) ALT, (AC), (SANDEN) ALT, (AC), (DELPHI)	<b>6PK1468D1</b> <b>6PK1740D1</b> <b>6PK1750D2</b> <b>VD1080</b> <b>VD1088</b>
2.1 TD	03/96-10/99	P8C	80	2088			

**FORD**
**C-MAX**

1.6 TDCi	02/07-	HHDA, HHDB, GPDA	66	1560	<b>AP9029</b>	ALT, (Denso), 120A, OE-NO 3M5T-10300-PB, 3M5T-10300-PD, MTR-CODE: HHDA, HHJA	<b>VD1094</b>
		G8DA, G8DB, G8DD	80	1560	<b>AP9029</b>	ALT, (Denso), 120A, OE-NO 3M5T-10300-PB, 3M5T-10300-PD, MTR-CODE: G8DA	<b>VD1094</b>
1.8 TDCi	02/07-	KKDA	85	1753	<b>AP9045</b> <b>AP9046</b>	ALT, (Denso), 105A, OE-NO 4M5T-10300-CC, 4M5T-10300-LC, 150A, OE-NO 4M5T-10300-BC, 4M5T-10300-UC, OPT ALT, (Denso), 105A, OE-NO 4M5T-10300-CC, 4M5T-10300-LC, 150A, OE-NO 4M5T-10300-BC, 4M5T-10300-UC	
2.0 TDCi	02/07-	G6DA, G6DB, G6DD, G6DG	100	1997	<b>AP9029</b>	ALT, (Denso), 120A, OE-NO 3M5T-10300-PD, MTR-CODE: G6DA	
	02/08-	IXDA	81	1997	<b>AP9029</b>	ALT, (Denso), 120A, OE-NO 3M5T-10300-PD	

**FIESTA V (JH., JD.)**

1.4 TDCi	11/01-	F6JA, F6JB	50	1399	<b>AP9019</b> <b>AP9031</b>	ALT, (Valeo), 120A, OE-NO 8V21-10300-AB, 150A, OE-NO 8V21-10300-BB ALT, (Valeo), 150A, OE-NO 2S6T-10300-BA, (2.HEATER)	<b>VD1094</b>
1.6 TDCi	11/04-	HHJA, HHJB	66	1560	<b>AP9019</b> <b>AP9029</b>	ALT, (Valeo), 120A, OE-NO 8V21-10300-AB, 150A, OE-NO 8V21-10300-BB ALT, (Denso), 120A, OE-NO 3M5T-10300-PB, 3M5T-10300-PD, MTR-CODE: HHJA	<b>VD1094</b>

**FIESTA Van**

1.4 TDCi	01/09- 10/03-	F6JB, F6JD F6JA, F6JB	50 50	1399 1399	<b>AP9019</b> <b>AP9031</b>	ALT, (Valeo), 120A, OE-NO 8V21-10300-AB, 150A, OE-NO 8V21-10300-BB ALT, (Valeo), 150A, OE-NO 2S6T-10300-BA, (2.HEATER)	<b>VD1094</b>
----------	------------------	--------------------------	----------	--------------	--------------------------------	---------------------------------------------------------------------------------------------------------------------------	---------------







## FORD

### FIESTA Van

1.6 TDCi	01/09-	HHJD, HHJC, HHJE	66	1560							VD1094
											VD1094

### FIESTA VI

1.4 TDCi	01/09-	F6JB	50	1399	AP9019	ALT, (Valeo), 120A, OE-NO 8V21-10300-AB, 150A, OE-NO 8V21-10300-BB					VD1094
1.6 TDCi	10/08-	HHJF, UBJA	55	1560	AP9019	ALT, (Valeo), 120A, OE-NO 8V21-10300-AB, 150A, OE-NO 8V21-10300-BB					VD1094
		HHJD, HHJC, HHJE	66	1560	AP9019	ALT, (Valeo), 120A, OE-NO 8V21-10300-AB, 150A, OE-NO 8V21-10300-BB					VD1094

### FOCUS (DAW, DBW)

1.8 TDCi	03/01-11/04	F9DA, F9DB	85	1753	AP9045	ALT, (Denso), 90A, OE-NO 1M5T-10300-BC, R1M5T-10300-BD, OPT					
					AP9046	ALT, (Denso), 90A, OE-NO 1M5T-10300-BC, R1M5T-10300-BD ALT, PS, (-AC) ALT, PS, AC ⇨01/2004					6PK1413D1 6PK1720D1 VD1039
	09/02-11/04	FFDA	74	1753	AP9045	ALT, (Denso), 90A, OE-NO 1M5T-10300-BC, R1M5T-10300-BD, OPT					
					AP9046	ALT, (Denso), 90A, OE-NO 1M5T-10300-BC, R1M5T-10300-BD ALT, PS, (-AC) ALT, PS, AC ⇨01/2004					6PK1413D1 6PK1720D1 VD1039

### FOCUS C-MAX

1.6 TDCi	02/05-03/07	HHDA, HHDB	66	1560	AP9029	ALT, (Denso), 120A, OE-NO 3M5T-10300-PB, 3M5T-10300-PD, MTR-CODE: HHDA					
	10/03-03/07	G8DA, G8DB	80	1560	AP9029	ALT, (Denso), 120A, OE-NO 3M5T-10300-PB, 3M5T-10300-PD, MTR-CODE: G8DA					
1.8 TDCi	01/05-03/07	KKDA	85	1753	AP9045	ALT, (Denso), 150A, OE-NO 4M5T-10300-BC, 4M5T-10300-UC, 4M5T-10300-CC, 105A, OE-NO 4M5T-10300-LC, 4M5T-10300-AB, RM4M5T-10300-KB, OPT					
					AP9046	ALT, (Denso), 150A, OE-NO 4M5T-10300-BC, 4M5T-10300-UC, 4M5T-10300-CC, 105A, OE-NO 4M5T-10300-LC, 4M5T-10300-AB, RM4M5T-10300-KB					
2.0 TDCi	10/03-03/07	G6DA, G6DB, G6DD	100	1997	AP9029	ALT, (Denso), 1203A, OE-NO 3M5T-10300-PB, 3M5T-10300-PD, MTR-CODE: G6DA					

### FOCUS II (DA\_)

1.6 TDCi	01/05-	HHDA, HHDB, GPDA, GPDC	66	1560	AP9029	ALT, (Denso), 120A, OE-NO 3M5T-10300-PB, 3M5T-10300-PD, MTR-CODE: HHDA					VD1094
	11/04-	G8DA, G8DB	80	1560	AP9029	ALT, (Denso), 120A, OE-NO 3M5T-10300-PB, 3M5T-10300-PD, MTR-CODE: G8DA					VD1094
1.8 TDCi	01/05-	KKDA, KKDB	85	1753	AP9045	ALT, (Denso), 150A, OE-NO 4M5T-10300-BC, 4M5T-10300-UC, OPT					
					AP9046	ALT, (Denso), 150A, OE-NO 4M5T-10300-BC, 4M5T-10300-UC					
2.0 TDCi	11/04-	G6DA, G6DB, G6DD	100	1997	AP9029	ALT, (Denso), 120A, OE-NO 3M5T-10300-PB, 3M5T-10300-PD, MTR-CODE: G6DA					

### FOCUS II Cabriolet

2.0 TDCi	10/06-	G6DA, G6DB, G6DD	100	1997	AP9029	ALT, (Denso), 120A, OE-NO 3M5T-10300-PB, 3M5T-10300-PD, MTR-CODE: G6DA					
----------	--------	------------------	-----	------	--------	------------------------------------------------------------------------------	--	--	--	--	--

### FOCUS II Kombi (DAW\_)

1.6 TDCi	11/04-	HHDA, HHDB, GPDA, GPDC	66	1560	AP9029	ALT, (Denso), 120A, OE-NO 3M5T-10300-PB, 3M5T-10300-PD, MTR-CODE: HHDA					
----------	--------	------------------------	----	------	--------	------------------------------------------------------------------------------	--	--	--	--	--





# FORD

## FOCUS II Kombi (DAW\_)

		G8DA, G8DB	80	1560	AP9029	ALT, (Denso), 120A, OE-NO 3M5T-10300-PB, 3M5T-10300-PD, MTR-CODE: G8DA	VD1094
1.8 TDCi	11/04-	KKDA, KKDB	85	1753	AP9045	ALT, (Denso), 150A, OE-NO 4M5T-10300-BC, 4M5T-10300-UC, OPT	VD1094
					AP9046	ALT, (Denso), 150A, OE-NO 4M5T-10300-BC, 4M5T-10300-UC	
2.0 TDCi	11/04-	G6DA, G6DB, G6DD	100	1997	AP9029	ALT, (Denso), 120A, OE-NO 3M5T-10300-PB, 3M5T-10300-PD, MTR-CODE: G6DA	

## FOCUS II Stufenheck (DA\_)

1.6 TDCi	04/05-	HHDA, HHDB	66	1560	AP9029	ALT, (Denso), 120A, OE-NO 3M5T-10300-PB, 3M5T-10300-PD, MTR-CODE: HHDA	VD1094
		G8DA, G8DB	80	1560	AP9029	ALT, (Denso), 120A, OE-NO 3M5T-10300-PB, 3M5T-10300-PD, MTR-CODE: G8DA	VD1094
1.8 TDCi	04/05-	KKDA, KKDB	85	1753	AP9045	ALT, (Denso), 150A, OE-NO 4M5T-10300-BC, 4M5T-10300-UC, OPT	VD1094
					AP9046	ALT, (Denso), 150A, OE-NO 4M5T-10300-BC, 4M5T-10300-UC	
2.0 TDCi	04/05-	G6DA, G6DB, G6DD	100	1997	AP9029	ALT, (Denso), 120A, OE-NO 3M5T-10300-PB, 3M5T-10300-PD, MTR-CODE: G6DA	

## FOCUS Kombi (DNW)

1.8 TDCi	03/01-11/04	F9DA, F9DB	85	1753	AP9045	ALT, (Denso), 90A, OE-NO 1M5T-10300-BC, R1M5T-10300-BD, OPT	
					AP9046	ALT, (Denso), 90A, OE-NO 1M5T-10300-BC, R1M5T-10300-BD ALT, PS, (-AC) ALT, PS, AC ⇒01/2004	6PK1413D1 6PK1720D1 VD1039
	09/02-11/04	FFDA	74	1753	AP9045	ALT, (Denso), 90A, OE-NO 1M5T-10300-BC, R1M5T-10300-BD, OPT	
					AP9046	ALT, (Denso), 90A, OE-NO 1M5T-10300-BC, R1M5T-10300-BD ALT, PS, (-AC) ALT, PS, AC ⇒01/2004	6PK1413D1 6PK1720D1 VD1039

## FOCUS Stufenheck (DFW)

1.8 TDCi	03/01-11/04	F9DA, F9DB	85	1753	AP9045	ALT, (Denso), 90A, OE-NO 1M5T-10300-BC, R1M5T-10300-BD, OPT	
					AP9046	ALT, (Denso), 90A, OE-NO 1M5T-10300-BC, R1M5T-10300-BD ALT, PS, (-AC) ALT, PS, AC ⇒01/2004	6PK1413D1 6PK1720D1 VD1039
	09/02-11/04	FFDA	74	1753	AP9045	ALT, (Denso), 90A, OE-NO 1M5T-10300-BC, R1M5T-10300-BD, OPT	
					AP9046	ALT, (Denso), 90A, OE-NO 1M5T-10300-BC, R1M5T-10300-BD ALT, PS, (-AC) ALT, PS, AC ⇒01/2004	6PK1413D1 6PK1720D1 VD1039

## FUSION (JU\_)

1.4 TDCi	08/02-	F6JA, F6JB	50	1399	AP9031	ALT, (Valeo), 150A, OE-NO 2S6T-10300-BA, (2.HEATER)	VD1094
1.6 TDCi	11/04-	HHJA, HHJB	66	1560	AP9029	ALT, (Denso), 120A, OE-NO 3M5T-10300-PB, 3M5T-10300-PD, MTR-CODE: HHJA	VD1094

## GALAXY

1.8 TDCi	05/06-	FFWA	74	1753	AP9045	ALT, (Denso), 150A, OE-NO 6G9N-10300-UD, OPT	
					AP9046	ALT, (Denso), 150A, OE-NO 6G9N-10300-UD	VD1039



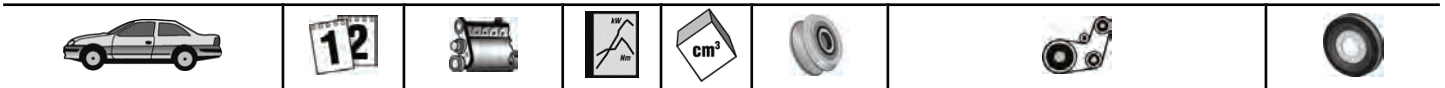

## FORD

### GALAXY

		QYWA	92	1753	<b>AP9045</b>	ALT, (Denso), 150A, OE-NO 6G9N-10300-UD, OPT	
					<b>AP9046</b>	ALT, (Denso), 150A, OE-NO 6G9N-10300-UD	<b>VD1039</b>
2.0 TDCi	05/06-	AZWA	96	1997	<b>AP9023</b>	ALT, (Bosch), 150A, OE-NO 6G9N-10300-XC	
		QXWA, QXWB, QXWC, UFWA	103	1997	<b>AP9023</b>	ALT, (Bosch), 150A, OE-NO 6G9N-10300-XC	
	11/07-	TYWA, KLWA	85	1997	<b>AP9023</b>	ALT, (Bosch), 150A, OE-NO 6G9N-10300-XC	
2.2 TDCi	03/08-	Q4BA, Q4WA	129	2179	<b>AP9023</b>	ALT, (Bosch), 156A, OE-NO 6G9N 10300 ADA, 6G9N 10300 ADB, ALT-No: 0 121 615 021	

### GALAXY (WGR)

1.9 TDI	02/03-05/06	ASZ	96	1896	<b>AP9004</b>	ALT, (Bosch), 90A, 120A ALT, (AC), 08/2003⇒, ⇒08/2006 MTR-CODE: ASZ, 09/2003⇒ MTR-CODE: ASZ, ⇒08/2003	<b>6DPK1195D2</b> <b>VD1076</b> <b>VD1091</b>
	03/95-05/06	AHU, 1Z, ANU	66	1896	<b>AP9004</b>	ALT, (Bosch), 90A, 120A ALT, PS, (AC), MTR-CODE: ANU, CH-NO 7M-4-015 001⇒ 09/2003⇒ ⇒03/2000 04/2000⇒, ⇒08/2003	<b>6DPK1195D1</b>  <b>VD1076</b> <b>VD1084</b> <b>VD1091</b>
	04/00-05/06	AUY	85	1896	<b>AP9004</b>	ALT, (Bosch), 90A, 120A ALT, (AC), 08/2003⇒, ⇒08/2006 MTR-CODE: ASZ, 09/2003⇒ MTR-CODE: ASZ, ⇒08/2003	<b>6DPK1195D2</b> <b>VD1076</b> <b>VD1091</b>
	05/05-05/06	BTB	110	1896	<b>AP9004</b>	ALT, (Bosch), 90A, 120A ALT, (AC), 01/2005⇒, ⇒08/2006	<b>6DPK1195D2</b> <b>VD1076</b>
	08/97-04/00	AFN, AVG	81	1896	<b>AP9004</b>	ALT, (Bosch), 90A, 120A	<b>VD1084</b>
2.8 V6	04/00-05/06	AYL	150	2792	<b>AP9001</b>	ALT, (Bosch), OE-NO 98VW10300EA, 120A, OE-NO YM2110300CA, 150A	

### KUGA

2.0 TDCi	03/08-	G6DG, UKDA	100	1997	<b>AP9029</b>	ALT, (Denso), 120A, OE-NO 3M5T-10300-PD	
2.0 TDCi 4x4	03/08-	G6DG, UKDA	100	1997	<b>AP9029</b>	ALT, (Denso), 120A, OE-NO 3M5T-10300-PD	

### MONDEO III (B5Y)

1.8 16V	11/00-08/07	CGBA, CGBB	81	1798	<b>AP9037</b>	ALT, (Visteon), 90A, 115A	
		CHBA, CHBB	92	1798	<b>AP9037</b>	ALT, (Visteon), 90A, 115A	
1.8 SCi	06/03-08/07	CFBA	96	1798	<b>AP9037</b>	ALT, (Visteon), 90A, 115A	
2.0 16V	11/00-08/07	CJBA, CJBB	107	1999	<b>AP9037</b>	ALT, (Visteon), 90A, 115A	
2.0 16V DI / TDDi / TDCi	11/00-08/07	D5BA, SDBA	66	1998			<b>VD1110</b>
2.0 16V TDDi / TDCi	11/00-08/07	D6BA, HJBA, HJBB, HJBC	85	1998			<b>VD1110</b>
2.0 TDCi	10/01-08/07	FMBA, N7BA	96	1998			<b>VD1110</b>
2.2 TDCi	09/04-08/07	QJBA, QJBB	114	2198			<b>VD1110</b>

### MONDEO III Kombi (BWY)

1.8 16V	11/00-08/07	CGBA, CGBB	81	1798	<b>AP9037</b>	ALT, (Visteon), 90A, 115A	
		CHBA, CHBB	92	1798	<b>AP9037</b>	ALT, (Visteon), 90A, 115A	
1.8 SCi	06/03-08/07	CFBA	96	1798	<b>AP9037</b>	ALT, (Visteon), 90A, 115A	
2.0 16V	11/00-08/07	CJBA, CJBB	107	1999	<b>AP9037</b>	ALT, (Visteon), 90A, 115A	
2.0 16V DI / TDDi / TDCi	11/00-08/07	D5BA, SDBA	66	1998			<b>VD1110</b>
2.0 16V TDDi / TDCi	11/00-08/07	D6BA, HJBA, HJBB, HJBC	85	1998			<b>VD1110</b>
2.0 TDCi	10/01-08/07	FMBA, N7BA	96	1998			<b>VD1110</b>
2.2 TDCi	09/04-08/07	QJBA, QJBB	114	2198			<b>VD1110</b>

### MONDEO III Stufenheck (B4Y)

1.8 16V	11/00-08/07	CGBA, CGBB	81	1798	<b>AP9037</b>	ALT, (Visteon), 90A, 115A	
		CHBA, CHBB	92	1798	<b>AP9037</b>	ALT, (Visteon), 90A, 115A	
1.8 SCi	06/03-08/07	CFBA	96	1798	<b>AP9037</b>	ALT, (Visteon), 90A, 115A	
2.0 16V	11/00-08/07	CJBA, CJBB	107	1999	<b>AP9037</b>	ALT, (Visteon), 90A, 115A	
2.0 16V DI / TDDi / TDCi	11/00-08/07	D5BA, SDBA	66	1998			<b>VD1110</b>
2.0 16V TDDi / TDCi	11/00-08/07	D6BA, HJBA, HJBB, HJBC	85	1998			<b>VD1110</b>
2.0 TDCi	10/01-08/07	FMBA, N7BA	96	1998			<b>VD1110</b>
2.2 TDCi	09/04-08/07	QJBA, QJBB	114	2198			<b>VD1110</b>

### MONDEO IV

1.8 TDCi	03/07-	FFBA	74	1753	<b>AP9045</b>	ALT, (Denso), 150A, OE-NO 6G9N-10300-UD, OPT	
					<b>AP9046</b>	ALT, (Denso), 150A, OE-NO 6G9N-10300-UD	<b>VD1039</b>





# FORD

## MONDEO IV

2.0 TDCi	06/07-	QYBA, KHBA	92	1753	<b>AP9045</b> <b>AP9046</b>	ALT, (Denso), 150A, OE-NO 6G9N-10300-UD, OPT ALT, (Denso), 150A, OE-NO 6G9N-10300-UD	
	03/07-	AZBA	96	1997	<b>AP9023</b>	ALT, (Bosch), 156A, OE-NO 6G9N 10300 ADA, 6G9N 10300 ADB, ALT-No: 0 121 615 021, 150A, OE-NO 7G9N 10300 EA, ALT-No: 0 121 615 028	
2.2 TDCi	11/07-	QXBB, UFBA	103	1997	<b>AP9023</b>	ALT, (Bosch), 156A, OE-NO 6G9N 10300 ADA, 6G9N 10300 ADB, ALT-No: 0 121 615 021, 150A, OE-NO 7G9N 10300 EA, ALT-No: 0 121 615 028	
		KLBA, LPBA, TYBA	85	1997	<b>AP9023</b>	ALT, (Bosch), 156A, OE-NO 6G9N 10300 ADA, 6G9N 10300 ADB, ALT-No: 0 121 615 021, 150A, OE-NO 7G9N 10300 EA, ALT-No: 0 121 615 028	
2.2 TDCi	03/08-	Q4BA	129	2179	<b>AP9023</b>	ALT, (Bosch), 156A, OE-NO 6G9N 10300 ADA, 6G9N 10300 ADB, ALT-No: 0 121 615 021	

## MONDEO IV Stufenheck

1.8 TDCi	03/07-	FFBA	74	1753	<b>AP9045</b> <b>AP9046</b>	ALT, (Denso), 150A, OE-NO 6G9N-10300-UD, OPT ALT, (Denso), 150A, OE-NO 6G9N-10300-UD	
	06/07-	QYBA, KHBA	92	1753	<b>AP9045</b> <b>AP9046</b>	ALT, (Denso), 150A, OE-NO 6G9N-10300-UD, OPT ALT, (Denso), 150A, OE-NO 6G9N-10300-UD	<b>VD1039</b>
2.0 TDCi	03/07-	AZBA	96	1997	<b>AP9023</b>	ALT, (Bosch), 156A, OE-NO 6G9N 10300 ADA, 6G9N 10300 ADB, ALT-No: 0 121 615 021, 150A, OE-NO 7G9N 10300 EA, ALT-No: 0 121 615 028	
		QXBB, UFBA	103	1997	<b>AP9023</b>	ALT, (Bosch), 156A, OE-NO 6G9N 10300 ADA, 6G9N 10300 ADB, ALT-No: 0 121 615 021, 150A, OE-NO 7G9N 10300 EA, ALT-No: 0 121 615 028	
2.2 TDCi	11/07-	KLBA, LPBA, TYBA	85	1997	<b>AP9023</b>	ALT, (Bosch), 156A, OE-NO 6G9N 10300 ADA, 6G9N 10300 ADB, ALT-No: 0 121 615 021, 150A, OE-NO 7G9N 10300 EA, ALT-No: 0 121 615 028	
		03/08-	Q4BA	129	2179	<b>AP9023</b>	ALT, (Bosch), 156A, OE-NO 6G9N 10300 ADA, 6G9N 10300 ADB, ALT-No: 0 121 615 021

## MONDEO IV Turnier

1.8 TDCi	03/07-	FFBA	74	1753	<b>AP9045</b> <b>AP9046</b>	ALT, (Denso), 150A, OE-NO 6G9N-10300-UD, OPT ALT, (Denso), 150A, OE-NO 6G9N-10300-UD	
	06/07-	QYBA, KHBA	92	1753	<b>AP9045</b> <b>AP9046</b>	ALT, (Denso), 150A, OE-NO 6G9N-10300-UD, OPT ALT, (Denso), 150A, OE-NO 6G9N-10300-UD	<b>VD1039</b>
2.0 TDCi	03/07-	AZBA	96	1997	<b>AP9023</b>	ALT, (Bosch), 156A, OE-NO 6G9N 10300 ADA, 6G9N 10300 ADB, ALT-No: 0 121 615 021, 150A, OE-NO 7G9N 10300 EA, ALT-No: 0 121 615 028	
		QXBB, UFBA	103	1997	<b>AP9023</b>	ALT, (Bosch), 156A, OE-NO 6G9N 10300 ADA, 6G9N 10300 ADB, ALT-No: 0 121 615 021, 150A, OE-NO 7G9N 10300 EA, ALT-No: 0 121 615 028	
2.2 TDCi	11/07-	KLBA, LPBA, TYBA	85	1997	<b>AP9023</b>	ALT, (Bosch), 156A, OE-NO 6G9N 10300 ADA, 6G9N 10300 ADB, ALT-No: 0 121 615 021, 150A, OE-NO 7G9N 10300 EA, ALT-No: 0 121 615 028	
		03/08-	Q4BA	129	2179	<b>AP9023</b>	ALT, (Bosch), 156A, OE-NO 6G9N 10300 ADA, 6G9N 10300 ADB, ALT-No: 0 121 615 021

## S-MAX

1.8 TDCi	01/07-	FFWA	74	1753	<b>AP9045</b> <b>AP9046</b>	ALT, (Denso), 150A, OE-NO 6G9N-10300-UD, OPT ALT, (Denso), 150A, OE-NO 6G9N-10300-UD	
	05/06-	QYWA	92	1753	<b>AP9045</b>	ALT, (Denso), 150A, OE-NO 6G9N-10300-UD, OPT	

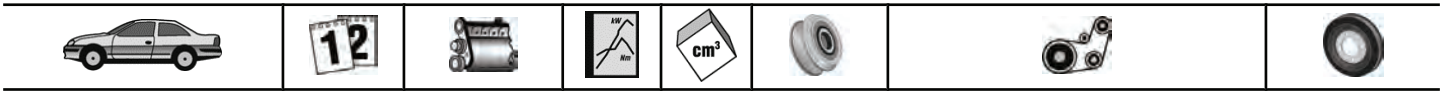

**FORD**

S-MAX							
					AP9046	ALT, (Denso), 150A, OE-NO 6G9N-10300-UD	VD1039
2.0 TDCi	05/06-	AZWA	96	1997	AP9023	ALT, (Bosch), 150A, OE-NO 6G9N-10300-XC	
		QXWA, QXWB, QXWC, UFWA	103	1997	AP9023	ALT, (Bosch), 150A, OE-NO 6G9N-10300-XC	
	11/07-	TYWA, KLWA	85	1997	AP9023	ALT, (Bosch), 150A, OE-NO 6G9N-10300-XC	
2.2 TDCi	03/08-	Q4WA	129	2179	AP9023	ALT, (Bosch), 156A, OE-NO 6G9N 10300 ADA, 6G9N 10300 ADB, ALT-No: 0 121 615 021	
TOURNEO CONNECT							
1.8 Di	06/02-	BHFA, P7PA, P7PB, R2PA	55	1753	AP9045	ALT, (Denso), 110A, OE-NO 2T1U-10300-CF, 120A, OE-NO 2T1U-10300-AL, R2T1U-10300-AJ, OPT	
					AP9046	ALT, (Denso), 110A, OE-NO 2T1U-10300-CF, 120A, OE-NO 2T1U-10300-AL, R2T1U-10300-AJ	
1.8 TDCi	08/06-	RWPA	81	1753	AP9045	ALT, (Denso), 110A, OE-NO 2T1U-10300-CF, 120A, OE-NO 2T1U-10300-AL, R2T1U-10300-AJ, OPT	
					AP9046	ALT, (Denso), 110A, OE-NO 2T1U-10300-CF, 120A, OE-NO 2T1U-10300-AL, R2T1U-10300-AJ	
1.8 Turbo Di	06/02-	HCPA, HCPB	66	1753	AP9045	ALT, (Denso), 110A, OE-NO 2T1U-10300-CF, 120A, OE-NO 2T1U-10300-AL, R2T1U-10300-AJ, OPT	
					AP9046	ALT, (Denso), 110A, OE-NO 2T1U-10300-CF, 120A, OE-NO 2T1U-10300-AL, R2T1U-10300-AJ	VD1039
TRANSIT Bus							
2.2 TDCi	07/06-	P8FA, P8FB	63	2198	AP9048	ALT, (Bosch), 156A	
		QVFA	81	2198	AP9048	ALT, (Bosch), 156A	
		QWFA	96	2198	AP9048	ALT, (Bosch), 156A	VD1098
	10/07-	PGFA, PGFB	103	2198	AP9048	ALT, (Bosch), 156A	
	10/08-	SRFA, SRFB, SRFC, SRFD, SRFE	85	2198			VD1098
2.4 TDCi	07/06-	PHFA, PHFC	74	2402		⇒10/2010	VD1099
		JXFA, JXFC	85	2402		⇒10/2010	VD1099
		H9FD	103	2402		⇒10/2010	VD1099
TRANSIT Bus (FD_, FB_, FS_, FZ_, FC_)							
2.0 DI (F_E_, F_F_, F_G_)	08/00-05/06	ABFA	74	1998			VD1110
2.0 TDCi (F_F_, F_E_, F_G_)	08/02-05/06	FIFA	92	1998			VD1110
2.4 DI (F_B_, F_C_, F_A_)	01/00-05/06	D2FA, D2FE, D2FB	66	2402	AP9053	ALT, (MAKO)	
2.4 DI [RWD] (F_B_, F_C_)	01/00-05/06	F4FA	55	2402	AP9053	ALT, (MAKO)	
2.4 DI [RWD] (F_B_, F_C_, F_A_)	01/00-05/06	D4FA	88	2402	AP9053	ALT, (MAKO)	
2.4 TDCi	03/04-05/06	H9FA	101	2402	AP9053	ALT, (MAKO)	
2.4 TDE	03/04-05/06	FXFA	85	2402	AP9053	ALT, (MAKO)	
2.4 TDE (F_C_, F_B_, F_A_)	07/01-05/06	DOFA	92	2402	AP9053	ALT, (MAKO)	
TRANSIT CONNECT (P65_, P70_, P80_)							
1.8 Di	06/02-	BHFA, P7PA, P7PB, R2PA	55	1753	AP9045	ALT, (Denso), 110A, OE-NO 2T1U-10300-CF, 120A, OE-NO 2T1U-10300-AL, R2T1U-10300-AJ, OPT	
					AP9046	ALT, (Denso), 110A, OE-NO 2T1U-10300-CF, 120A, OE-NO 2T1U-10300-AL, R2T1U-10300-AJ ⇒05/2006	VD1039
1.8 TDCi	06/02-	HCPA, HCPB	66	1753	AP9045	ALT, (Denso), 110A, OE-NO 2T1U-10300-CF, 120A, OE-NO 2T1U-10300-AL, OPT, OE-NO R2T1U-10300-AJ	
					AP9046	ALT, (Denso), 110A, OE-NO 2T1U-10300-CF, 120A, OE-NO	



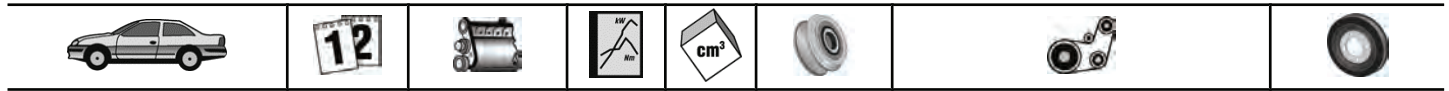

# FORD

## TRANSIT CONNECT (P65\_, P70\_, P80\_)

						2T1U-10300-AL, R2T1U-10300-AJ ⇒05/2006	VD1039
08/06-	RWPA	81	1753	AP9045	ALT, (Denso), 110A, OE-NO 2T1U-10300-CF, 120A, OE-NO 2T1U-10300-AL, R2T1U-10300-AJ, OPT		
				AP9046	ALT, (Denso), 110A, OE-NO 2T1U-10300-CF, 120A, OE-NO 2T1U-10300-AL, R2T1U-10300-AJ		

## TRANSIT Kasten

2.2 TDCi	07/06-	P8FA, P8FB	63	2198	AP9048	ALT, (Bosch), 156A	
		QVFA	81	2198	AP9048	ALT, (Bosch), 156A	
		QWFA	96	2198	AP9048	ALT, (Bosch), 156A	VD1098
	10/07-	PGFA, PGFB	103	2198	AP9048	ALT, (Bosch), 156A	
2.4 TDCi	07/06-	PHFA, PHFC	74	2402		⇒10/2010	VD1099
		JXFA, JXFC	85	2402		⇒10/2010	VD1099
		H9FD	103	2402		⇒10/2010	VD1099

## TRANSIT Kasten (FA\_)

2.0 DI (FAE_, FAF_, FAG_)	08/00-05/06	ABFA	74	1998			VD1110
2.0 TDCi	08/02-05/06	FIFA	92	1998			VD1110
2.4 DI (FAA_, FAB_, FAC_, FAD_)	01/00-05/06	D2FA, D2FE, D2FB	66	2402	AP9053	ALT, (MAKO)	
2.4 DI [RWD] (FAA_, FAB_, FAC_, FAD_)	01/00-05/06	F4FA	55	2402	AP9053	ALT, (MAKO)	
		D4FA	88	2402	AP9053	ALT, (MAKO)	
2.4 TDCi	03/04-05/06	H9FA	101	2402	AP9053	ALT, (MAKO)	
2.4 TDE	03/04-05/06	FXFA	85	2402	AP9053	ALT, (MAKO)	
	07/01-05/06	DOFA	92	2402	AP9053	ALT, (MAKO)	

## TRANSIT Pritsche/Fahrgestell

2.2 TDCi	07/06-	P8FA, P8FB	63	2198	AP9048	ALT, (Bosch), 156A	
		QVFA	81	2198	AP9048	ALT, (Bosch), 156A	
		QWFA	96	2198	AP9048	ALT, (Bosch), 156A	VD1098
	10/07-	PGFA, PGFB	103	2198	AP9048	ALT, (Bosch), 156A	
2.4 TDCi	07/06-	PHFA, PHFC	74	2402		⇒10/2010	VD1099
		JXFA, JXFC	85	2402		⇒10/2010	VD1099
		H9FD	103	2402		⇒10/2010	VD1099

## TRANSIT Pritsche/Fahrgestell (FM\_, FN\_)

2.0 DI (F_E_, F_F_)	08/00-05/06	ABFA	74	1998			VD1110
2.0 TDCi (F_E_, F_F_)	08/02-05/06	FIFA	92	1998			VD1110
2.4 DI (F_A_, F_B_, F_C_, F_D_)	01/00-05/06	F4FA	55	2402	AP9053	ALT, (MAKO)	
		D2FA, D2FE, D2FB	66	2402	AP9053	ALT, (MAKO)	
		D4FA	88	2402	AP9053	ALT, (MAKO)	
2.4 TDCi	03/04-05/06	H9FA	101	2402	AP9053	ALT, (MAKO)	
2.4 TDE	03/04-05/06	FXFA	85	2402	AP9053	ALT, (MAKO)	
	07/01-05/06	DOFA	92	2402	AP9053	ALT, (MAKO)	

## TRANSIT TOURNEO

2.2 TDCi	07/06-	QVFA	81	2198	AP9048	ALT, (Bosch), 156A	
		QWFA	96	2198	AP9048	ALT, (Bosch), 156A	VD1098
	10/07-	PGFA, PGFB	103	2198	AP9048	ALT, (Bosch), 156A	

# HYUNDAI

## ACCENT II (LC)

1.5 CRDi	04/02-	D3-EA	60	1493	AP9062	ALT, (Denso), 100A, OE-NO 37300-27502, 37300-27503, 37300-27504, 11/2002⇒, ⇒12/2006	
----------	--------	-------	----	------	--------	-------------------------------------------------------------------------------------------	--

## ACCENT III (MC)

1.5 CRDi GLS	11/05-	D4FA	81	1493	AP9062	ALT, (Denso), 100A, OE-NO 37300-27502, 37300-27503, 37300-27504, ⇒12/2006	
--------------	--------	------	----	------	--------	---------------------------------------------------------------------------------	--

## ACCENT Stufenheck (LC)

1.5 CRDi	01/02-	D3-EA	60	1493	AP9062	ALT, (Denso), 100A, OE-NO 37300-27502, 37300-27503, 37300-27504, 11/2002⇒, ⇒12/2006	
----------	--------	-------	----	------	--------	-------------------------------------------------------------------------------------------	--

## ACCENT Stufenheck (MC)

1.5 CRDi GLS	11/05-	D4FA	81	1493	AP9062	ALT, (Denso), 100A, OE-NO 37300-27502, 37300-27503, 37300-27504, ⇒12/2006	
--------------	--------	------	----	------	--------	---------------------------------------------------------------------------------	--

## GETZ (TB)

1.5 CRDi	03/03-	D3-EA	60	1493	AP9062	ALT, (Denso), 100A, OE-NO 37300-27601, 37300-27602, 07 /2003⇒, ⇒08/2005	
	08/05-		65	1493	AP9062	ALT, (Denso), 100A, OE-NO	



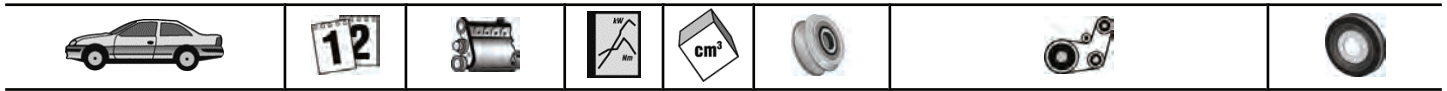

## HYUNDAI

### GETZ (TB)

						37300-27601, 37300-27602, 07/2003⇒, ⇒08/2005	
1.5 CRDi GLS	07/04-08/05	D4FA	75	1493	AP9062	ALT, (Denso), 100A, OE-NO 37300-27601, 37300-27602	
	08/05-	D4FA	81	1493	AP9062	ALT, (Denso), 100A, OE-NO 37300-27601, 37300-27602, 07/2003⇒, ⇒08/2005	

### MATRIX (FC)

1.5 CRDi	10/01-	D3-EA	60	1496	AP9062	ALT, (Denso), 100A, OE-NO 37300-27600, 37300-27601, ⇒05/2005	
	12/04-	D4FA	75	1493	AP9062	ALT, (Denso), 100A, OE-NO 37300-27600, 37300-27601, ⇒05/2005	
1.5 CRDi VGT	08/05-	D4FA	81	1493	AP9062	ALT, (Denso), 110A, OE-NO 37300-27600, 37300-27601, 37300-27602	

### TERRACAN (HP)

2.9 CRDi 4WD	11/03-	J3	120	2902	AP9061	ALT, (Mando), 110A, OE-NO 37300-4X500, 37300-4X501, 37300-4X502, 37300-4X503	
	12/01-		110	2902	AP9061	ALT, (Mando), 110A, OE-NO 37300-4X500, 37300-4X501, 37300-4X502, 37300-4X503	

## KIA

### CARNIVAL (UP)

2.9 TD	08/99-10/01		93	2903	AP9061	85A, (Denso)	
--------	-------------	--	----	------	--------	--------------	--

### CARNIVAL II (GQ)

2.9 CRDi	10/01-		106	2902	AP9061	ALT, (Mando), 110A, OE-NO 373004X000, 373004X001, 373004X002	
----------	--------	--	-----	------	--------	--------------------------------------------------------------	--

### SHUMA (FB)

1.5 i 16V	10/97-03/01		65	1498	AP9061	85A, (Denso)	
1.8 i 16V	10/97-03/01	T8	81	1793	AP9061	85A, (Denso)	

### SHUMA Stufenheck (FB)

1.5 i 16V	10/97-10/01		65	1498	AP9061	85A, (Denso)	
-----------	-------------	--	----	------	--------	--------------	--

## LANCIA

### DELTA III (844)

1.6 D Multijet	09/08-	198A2.000	88	1598		⇒12/2009, ⇒CH-NO 1063140, 1063853	VD1065
1.9 D Multijet	01/09-	844A1.000	140	1910	AP9017	ALT, (Denso), OE-NO 73501591, 140A	
						⇒12/2009, ⇒CH-NO 1063140, 1063853	VD1065
2.0 D Multijet	09/08-	198A5.000	121	1956		⇒12/2009, ⇒CH-NO 1063140, 1063853	VD1065

### KAPPA (838A)

2.4 JTD (838AL1AA)	06/98-10/01	838A8.000	100	2387	AP9058	ALT, (Magneti-Marelli), 100A	VD1064
2.4 T.DS (838AE1AA, 838AH1AA)	08/94-10/01	838A3.000, 838A7.000	91	2387		MTR-NO 0597297⇒	VD1064

### KAPPA SW (838B)

2.4 JTD (838BL1AA)	06/98-10/01	838A8.000	100	2387	AP9058	ALT, (Magneti-Marelli), 100A	VD1064
2.4 T.DS (838BH1AA)	07/96-10/01	838A3.000, 838A7.000	91	2387		MTR-NO 0597297⇒	VD1064

### LYBRA (839AX)

1.9 JTD	05/01-	937A2.000	85	1910	AP9017 AP9017	ALT, (Denso), OE-NO 46782213, 105A ALT, (Denso), OE-NO 46809068, 120A	VD1065
1.9 JTD (839AXD1A)	07/99-09/00	AR32302	77	1910	AP9058	ALT, MTR-NO 1611909⇒, (Magneti-Marelli), 100A, OE-NO 4654@4329	VD1065
1.9 JTD (839AXI1A)	09/00-05/01	AR37101	81	1910	AP9017 AP9017	ALT, (Denso), OE-NO 46782213, 105A ALT, (Denso), OE-NO 46809068, 120A	VD1065
2.4 JTD	05/02-	841C.000	110	2387		ALT, PS, AC	6PK1760D1 VD1064
2.4 JTD (839AXE1A)	07/99-09/00	839A5.000, AR32501	99	2387		ALT, (AC)	6PK1760D1 VD1064
2.4 JTD (839AXL1A)	09/00-05/02	839A6.000	103	2387		ALT, PS, AC	6PK1760D1 VD1064

### LYBRA SW (839BX)

1.9 JTD	05/01-	937A2.000	85	1910			VD1065
1.9 JTD (839BXD1A)	07/99-09/00	AR32302	77	1910	AP9058	ALT, MTR-NO 1611909⇒, (Magneti-Marelli), 100A, OE-NO 4654@4329	VD1065
1.9 JTD (839BXI1A)	09/00-05/01	AR37101	81	1910			VD1065





# LANCIA

## LYBRA SW (839BX)

2.4 JTD	05/02-	841C.000	110	2387		ALT, PS, AC	6PK1760D1 VD1064
2.4 JTD (839BXE1A)	10/99-09/00	839A5.000, AR32501	99	2387		ALT, (AC)	6PK1760D1 VD1064
2.4 JTD (839BXL1A)	09/00-	839A6.000	103	2387		ALT, PS, AC	6PK1760D1 VD1064

## MUSA (350)

1.3 D Multijet	09/06-	199A3.000	66	1248	AP9035	ALT, (AC), (Valeo), OE-NO 46823547, 90A, OE-NO 46835095, 105A	
	10/04-	188A9.000	51	1248	AP9035	ALT, (Valeo), OE-NO 46823547, 51784845, 90A, OE-NO 46835095, 51784846, 105A	
1.6 D Multijet	07/08-	350A2.000	88	1598			VD1065
1.9 D Multijet	10/04-	188B2.000	74	1910	AP9017 AP9017 AP9054	ALT, (Denso), OE-NO 46782213, 105A ALT, (Denso), OE-NO 46809068, 120A 90A, 120A	VD1065

## PHEDRA (179)

2.0 D Multijet	07/06-	RHR	100	1997	AP9013 AP9023 AP9040	ALT, (Valeo), OE-NO 71733552, 150A ALT, (Bosch), OE-NO 9646065480, 150A ALT, (Mitsubishi), 180A, OE-NO 9646065180, ALT-No: A004TJ0084	
	06/06-	RHK	88	1997	AP9013 AP9023 AP9040	ALT, (Valeo), OE-NO 71733552, 150A ALT, (Bosch), 150A, OE-NO 964065480 ALT, (Mitsubishi), 180A, OE-NO 9646065180, ALT-No: A004TJ0084	
		07/03-	RHM	79	1997	AP9013 AP9023 AP9031	ALT, (Valeo), OE-NO 71733552, 150A ALT, (Bosch), 150A, OE-NO 964065480 ALT, (Valeo), OE-NO 9640878780, 150A
2.0 JTD	09/02-	RHW (DW10ATED4)	80	1997	AP9013 AP9023 AP9031	ALT, (Valeo), OE-NO 71733552, 150A ALT, (Bosch), 150A, OE-NO 964065480 ALT, (Valeo), OE-NO 9640878780, 150A ALT, (AC), ⇨11/2004 ⇨11/2002, ⇨ORG-NO 09520 12/2002⇨, ORG-NO 09521⇨	6PK1740D1 VD1080 VD1095
2.0 JTD (179AXB1A)	09/02-	RHW (DW10ATED4)	80	1997	AP9013 AP9023 AP9031	ALT, (Valeo), OE-NO 71733552, 150A ALT, (Valeo), OE-NO 71748885, 150A ALT, (Valeo), OE-NO 9661544880, 180A ALT, (Bosch), OE-NO 9646065480, 150A, 12/2002⇨ ALT, (Valeo), OE-NO 9640878780, 150A ALT, (Mitsubishi), 180A, OE-NO 9646065180, ALT-No: A004TJ0084 ALT, (AC), ⇨11/2004 ⇨11/2004, ⇨ORG-NO 10248 11/2004⇨, ORG-NO 10249⇨	6PK1740D1 VD1080 VD1095
2.2 JTD (179AXC1A)	09/02-	4HW (DW12ATED4)	94	2179	AP9013 AP9013 AP9013 AP9023 AP9031 AP9040	ALT, (Valeo), OE-NO 71733552, 150A ALT, (Valeo), OE-NO 71748885, 150A ALT, (Valeo), OE-NO 9661544880, 180A ALT, (Bosch), OE-NO 9646065480, 150A, 12/2002⇨ ALT, (Valeo), OE-NO 9640878780, 150A ALT, (Mitsubishi), 180A, OE-NO 9646065180, ALT-No: A004TJ0084 ALT, (AC), ⇨11/2004 ⇨11/2004, ⇨ORG-NO 10248 11/2004⇨, ORG-NO 10249⇨	6PK1740D1 VD1080 VD1095

## THESIS (841AX)

2.4 D Multijet	04/06-	841P.000	136	2387			VD1064
2.4 JTD	05/03-	841G.000	129	2387	AP9017	ALT, (Denso), OE-NO 46823540, 140A	VD1064
2.4 JTD (841AXD1B02)	07/02-	841C.000	110	2387	AP9017 AP9017	ALT, (Denso), OE-NO 46774429, 140A ALT, (Denso), OE-NO 46823540, 140A	VD1064

## YPSILON (843)

1.3 D Multijet	05/07-	199A3.000	77	1248	AP9035	ALT, (AC), (Valeo), OE-NO 51718499, 75A	
	09/06-	199A2.000	55	1248	AP9035	ALT, (AC), (Valeo), OE-NO 51718499, 51784844, 75A	
		199A3.000	66	1248	AP9035	ALT, (AC), (Valeo), OE-NO 51718499, 75A	
1.3 JTD	10/03-	188A9.000	51	1248	AP9035	ALT, (AC), (Valeo), OE-NO 46823547, 51784845, 90A	

## ZETA (220)

2.0 JTD	04/00-09/02	RHZ	80	1997	AP9031	ALT, (Valeo), OE-NO 9640878780, 150A	
					AP9038	ALT, (Valeo), OE-NO 9621791480, 150A ALT, (-AC) ALT, (AC), (SANDEN) ALT, (AC), (DELPHI)	6PK1468D1 6PK1740D1 6PK1750D2 VD1080
2.0 JTD (220AN5)	09/99-09/02	RHW	80	1997	AP9031	ALT, (Valeo), OE-NO 9640878780,	





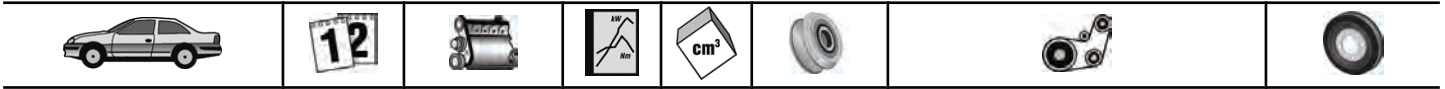

## LANCIA

### ZETA (220)

					<b>AP9038</b>	150A ALT, (Valeo), OE-NO 9621791480, 150A ALT, (-AC) ALT, (AC), (SANDEN) ALT, (AC), (DELPHI)	<b>6PK1468D1</b> <b>6PK1740D1</b> <b>6PK1750D2</b> <b>VD1080</b>
2.1 TD (220AJ5)	05/96-09/99	P8C	80	2088			<b>VD1088</b>

## LAND ROVER

### FREELANDER (LN)

2.0 Td4	11/00-		82	1951		MTR-CODE: M47	<b>VD1087</b>
	11/01-		80	1951		MTR-CODE: M47	<b>VD1087</b>

### FREELANDER 2 (FA\_)

2.2 TD4	01/07-	224DT	112	2179	<b>AP9023</b>	ALT, (Bosch), 156A, OE-NO LR002899, ALT-No: 0121 615 021, 180A, OE-NO LR001200, ALT-No: 0 121 715 024	
	10/06-	224DT	118	2179	<b>AP9023</b>	ALT, (Bosch), 156A, OE-NO LR002899, ALT-No: 0 121 615 021, 180A, OE-NO LR001200, ALT-No: 0 121 715 024	
2.2 TD4 4x4	10/06-		115	2179	<b>AP9023</b>	ALT, (Bosch), 156A, OE-NO LR002899, ALT-No: 0 121 615 021, 180A, OE-NO LR001200, ALT-No: 0 121 715 024	

## LOTUS

### EXIGE (SCC\_)

1.8 265 E	08/06-		197	1796	<b>AP9005</b>	ALT, (Bosch), 150A, OE-NO 1231 7 550 967, 1231 7 551 254, 180A, OE-NO 1231 7 551 256, 1231 7 555 926	
-----------	--------	--	-----	------	---------------	------------------------------------------------------------------------------------------------------------	--

## MAZDA

### 2 (DE)

1.4 MZR-CD	01/08-		50	1399	<b>AP9019</b>	ALT, (Valeo), 120A, OE-NO Y405-18-300, 150A, OE-NO Y406-18-300	<b>VD1094</b>
1.6 MZ-CD	10/08-		66	1560	<b>AP9019</b>	ALT, (Valeo), 120A, OE-NO Y405-18-300, 150A, OE-NO Y406-18-300	

### 2 (DY)

1.4 CD	04/03-	F6JA, F6JB	50	1399	<b>AP9031</b>	ALT, (Valeo), 150A, OE-NO Y402-18-300, ALT-No: SG15S019	<b>VD1094</b>
--------	--------	------------	----	------	---------------	------------------------------------------------------------	---------------

### 3 (BK)

1.6 DI Turbo	06/04-	Y601	80	1560	<b>AP9029</b>	ALT, (Denso), 120A, OE-NO Y601-18-300	<b>VD1094</b>
2.0 MZR-CD	12/06-	RF7J	105	1998	<b>AP9049</b>	ALT, (Mitsubishi), 90A, OE-NO RF7J-18-330A	

### 3 (BL)

1.6 MZR-CD	06/09-	Y601	80	1560	<b>AP9019</b>	ALT, (Valeo), 120A, OE-NO Y405-18-300, 150A, OE-NO Y406-18-300	
					<b>AP9029</b>	ALT, (Denso), 120A, OE-NO Y601-18-300	
2.2 MZR-CD	06/09-		110	2184	<b>AP9049</b>	ALT, (Mitsubishi), 110A, OE-NO R2AA-18-300A, R2AA-18-300B	
			136	2184	<b>AP9049</b>	ALT, (Mitsubishi), 110A, OE-NO R2AA-18-300A, R2AA-18-300B	

### 3 Stufenheck (BK)

1.6 DI Turbo	06/04-	Y601	80	1560	<b>AP9029</b>	ALT, (Denso), 120A, OE-NO Y601-18-300	<b>VD1094</b>
2.0 MZR-CD	12/06-	RF7J	105	1998	<b>AP9049</b>	ALT, (Mitsubishi), 90A, OE-NO RF7J-18-330A	

### 5 (CR19)

2.0 CD	03/05-		81	1998	<b>AP9049</b>	ALT, (Mitsubishi), 90A, OE-NO RF8G-18-300, RF8G-18-300A	
	06/05-	RF7J	105	1998	<b>AP9049</b>	ALT, (Mitsubishi), 90A, OE-NO RF8G-18-330, RF8G-18-300A	

### 6 (GG)

1.8	08/02-	L813	88	1798	<b>AP9047</b>	ALT, 120A, 150A	
2.0	03/05-	LFF7	108	1999	<b>AP9047</b>	ALT, 120A, 150A	
2.0 DI	06/02-	RF5C	100	1998	<b>AP9049</b>	ALT, (Mitsubishi), 90A, OE-NO RF8G-18-330	
	06/05-	RF7J	105	1998	<b>AP9049</b>	ALT, (Mitsubishi), 90A, OE-NO	



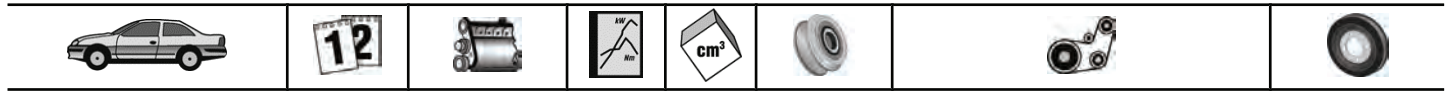

## MAZDA

<b>6 (GG)</b>							RF8G-18-330	
	08/02-	RF5C	89	1998	<b>AP9049</b>		ALT, (Mitsubishi), 90A, OE-NO RF8G-18-330	
<b>6 (GH)</b>								
2.2 MZR-CD	01/09-		92	2184	<b>AP9049</b>		ALT, (Mitsubishi), 110A, OE-NO R2AA-18-300A	
			120	2184	<b>AP9049</b>		ALT, (Mitsubishi), 110A, OE-NO R2AA-18-300A	
			136	2184	<b>AP9049</b>		ALT, (Mitsubishi), 110A, OE-NO R2AA-18-300A	
<b>6 Hatchback (GG)</b>								
1.8	08/02-	L813	88	1798	<b>AP9047</b>		ALT, 120A, 150A	
2.0	03/05-	LFF7	108	1999	<b>AP9047</b>		ALT, 120A, 150A	
	08/02-	LF17, LF18	104	1999	<b>AP9047</b>		ALT, 120A, 150A	
2.0 DI	06/05-	RF7J	105	1998	<b>AP9049</b>		ALT, (Mitsubishi), 90A, OE-NO RF8G-18-330	
	08/02-	RF5C	89	1998	<b>AP9049</b>		ALT, (Mitsubishi), 90A, OE-NO RF8G-18-330	
			100	1998	<b>AP9049</b>		ALT, (Mitsubishi), 90A, OE-NO RF8G-18-330	
2.3	08/02-	L3C1	122	2261	<b>AP9047</b>		ALT, 120A, 150A	
<b>6 Kombi (GH)</b>								
2.2 MZR-CD	01/09-		92	2184	<b>AP9049</b>		ALT, (Mitsubishi), 110A, OE-NO R2AA-18-300A	
			120	2184	<b>AP9049</b>		ALT, (Mitsubishi), 110A, OE-NO R2AA-18-300A	
			136	2184	<b>AP9049</b>		ALT, (Mitsubishi), 110A, OE-NO R2AA-18-300A	
<b>6 Schrägheck (GH)</b>								
2.2 MZR-CD	01/09-		92	2184	<b>AP9049</b>		ALT, (Mitsubishi), 110A, OE-NO R2AA-18-300A	
			120	2184	<b>AP9049</b>		ALT, (Mitsubishi), 110A, OE-NO R2AA-18-300A	
			136	2184	<b>AP9049</b>		ALT, (Mitsubishi), 110A, OE-NO R2AA-18-300A	
<b>6 Station Wagon (GY)</b>								
1.8	08/02-	L813	88	1798	<b>AP9047</b>		ALT, 120A, 150A	
2.0	03/05-	LFF7	108	1999	<b>AP9047</b>		ALT, 120A, 150A	
	08/02-	LF17, LF18	104	1999	<b>AP9047</b>		ALT, 120A, 150A	
2.0 CiTD 4x4	10/02-02/05	RF5C	100	1998	<b>AP9049</b>		ALT, (Mitsubishi), 90A, OE-NO RF8G-18-330	
2.0 DI	06/05-	RF7J	105	1998	<b>AP9049</b>		ALT, (Mitsubishi), 90A, OE-NO RF8G-18-330	
	08/02-	RF5C	89	1998	<b>AP9049</b>		ALT, (Mitsubishi), 90A, OE-NO RF8G-18-330	
			100	1998	<b>AP9049</b>		ALT, (Mitsubishi), 90A, OE-NO RF8G-18-330	
2.3	08/02-	L3C1	122	2261	<b>AP9047</b>		ALT, 120A, 150A	
2.3 AWD	11/02-	L3C1	119	2261	<b>AP9047</b>		ALT, 120A, 150A	
<b>MPV II (LW)</b>								
2.0 DI	07/02-	RF5C	100	1998	<b>AP9049</b>		ALT, (Mitsubishi), 90A, OE-NO RF8G-18-330	

## MERCEDES-BENZ

<b>A-CLASS (W168)</b>								
A 140 (168.031, 168.131)	01/01-08/04	M166.960	60	1598			MTR-CODE: M 166.960, (MANL)	<b>VD1093</b>
A 160 (168.033, 168.133)	07/97-08/04	M166.960	75	1598			MTR-CODE: M 166.960, (MANL)	<b>VD1093</b>
A 160 CDI (168.006)	02/01-08/04	OM668.940	55	1689	<b>AP9014</b>		ALT, (Valeo), OE-NO A 012 154 4402, ⇒CH-NO J 568589	
					<b>AP9036</b>		ALT, (Valeo), 90A, 100A	<b>VD1093</b>
A 160 CDI (168.007)	07/98-02/01	OM668.941	44	1689	<b>AP9014</b>		ALT, (Valeo), OE-NO A 012 154 4402, ⇒CH-NO J 568589	
					<b>AP9036</b>		ALT, (Valeo), 90A, 100A	<b>VD1093</b>
A 170 CDI (168.008)	07/98-02/01	OM668.940	66	1689	<b>AP9014</b>		ALT, (Valeo), OE-NO A 012 154 4402, ⇒CH-NO J 568589	
					<b>AP9036</b>		ALT, (Valeo), 90A, 100A	<b>VD1093</b>
A 170 CDI (168.009, 168.109)	02/01-08/04	OM668.942	70	1689	<b>AP9014</b>		ALT, (Valeo), OE-NO A 012 154 4402, ⇒CH-NO J 568589	
					<b>AP9036</b>		ALT, (Valeo), 90A, 100A	<b>VD1093</b>
A 190 (168.032, 168.132)	03/99-08/04	M166.990	92	1898	<b>AP9055</b>		ALT, (Valeo), 90A	<b>VD1093</b>





## MERCEDES-BENZ

### A-CLASS (W168)

 A 210 (168.035, 168.135)	03/02-08/04	M166.995	103	2084	<b>AP9055</b>	ALT, (Valeo), 90A	<b>VD1093</b>
-----------------------------------------------------------------------------------------------------------	-------------	----------	-----	------	---------------	-------------------	---------------

### A-CLASS (W169)

A 150 (169.031, 169.331)	09/04-	M266.920	70	1498	<b>AP9011</b>	ALT, (Valeo), 90A, OE-NO 266 154 1202, 115A, OE-NO 266 154 0902, 266 154 1302	
A 160 CDI (169.006, 169.306)	09/04-	OM640.942	60	1991	<b>AP9014</b>	ALT, (Valeo), 140A, OE-NO A 640 154 0502, CH-NO J 108540⇔	
A 170 (169.032, 169.332)	09/04-	M266.940	85	1699	<b>AP9011</b>	ALT, (Valeo), 90A, OE-NO 266 154 1202, 115A, OE-NO 266 154 0902, 266 154 1302	
A 180 CDI (169.007, 169.307)	09/04-	OM640.940	80	1991	<b>AP9014</b>	ALT, (Valeo), 140A, OE-NO A 640 154 0502, CH-NO J 108540⇔	
A 200 (169.033, 169.333)	09/04-	M266.960	100	2034	<b>AP9011</b>	ALT, (Valeo), 90A, OE-NO 266 154 1202, 115A, OE-NO 266 154 0902, 266 154 1302	
A 200 CDI (169.008, 169.308)	09/04-	OM640.941	103	1991	<b>AP9014</b>	ALT, (Valeo), 140A, OE-NO A 640 154 0502, CH-NO J 108540⇔	
A 200 TURBO (169.034, 169.334)	09/05-	M266.980	142	2034	<b>AP9011</b>	ALT, (Valeo), 90A, OE-NO 266 154 1202, 115A, OE-NO 266 154 0902, 266 154 1302	

### B-CLASS (W245)

B 150 (245.231)	03/05-	M266.920	70	1498	<b>AP9011</b>	ALT, (Valeo), 90A, OE-NO 266 154 1202, 115A, OE-NO 266 154 0902, 266 154 1302	
B 170 (245.232)	03/05-	M266.940	85	1699	<b>AP9011</b>	ALT, (Valeo), 90A, OE-NO 266 154 1202, 115A, OE-NO 266 154 0902, 266 154 1302	
B 170 NGT (245.233)	04/08-	M266.960	85	2034	<b>AP9011</b>	ALT, (Valeo), 90A, OE-NO 266 154 02 08, 266 154 12 02, 115A, OE-NO 266 154 0902, 266 154 13 02	
B 180 CDI (245.207)	03/05-	OM640.940	80	1991	<b>AP9014</b>	ALT, (Valeo), 140A, OE-NO A 640 154 0502, CH-NO J 000001⇔	
B 180 NGT (245.233)	04/08-	M266.960	85	2034	<b>AP9011</b>	ALT, (Valeo), 90A, OE-NO 266 154 02 08, 266 154 12 02, 115A, OE-NO 266 154 0902, 266 154 13 02	
B 200 (245.233)	03/05-	M266.960	100	2034	<b>AP9011</b>	ALT, (Valeo), 90A, OE-NO 266 154 1202, 115A, OE-NO 266 154 0902, 266 154 1302	
B 200 CDI (245.208)	03/05-	OM640.941	103	1991	<b>AP9014</b>	ALT, (Valeo), 140A, OE-NO A 640 154 0502, CH-NO J 000001⇔	
B 200 TURBO (245.234)	03/05-	M266.980	142	2034	<b>AP9011</b>	ALT, (Valeo), 90A, OE-NO 266 154 1202, 115A, OE-NO 266 154 0902, 266 154 1302	

### C CLASS (W204)

C 180 Kompressor (204.046)	01/07-	M271.952	115	1796	<b>AP9026</b> <b>AP9026</b>	ALT, (Valeo), OE-NO A 271 154 14 02, 120A ALT, (Valeo), OE-NO A 271 154 15 02, 150A	
C 200 CDI (204.007)	01/07-	OM646.811, OM646.812	100	2148		ALT	<b>6PK2260D3</b> <b>VD1042</b>
C 200 Kompressor (204.041)	01/07-	M271.950	135	1796	<b>AP9026</b> <b>AP9026</b>	ALT, (Valeo), OE-NO A 271 154 14 02, 120A ALT, (Valeo), OE-NO A 271 154 15 02, 150A	
C 220 CDI (204.008)	01/07-	OM646.811	125	2148		ALT	<b>6PK2260D3</b> <b>VD1042</b>
C 230 (204.052)	01/07-	M272.921	150	2496			<b>VD1072</b>
C 230 4-matic (204.085)	07/07-	M272.911	150	2496			<b>VD1072</b>
C 280 (204.054)	01/07-	M272.947	170	2996			<b>VD1072</b>
C 280 4-matic (204.081)	07/07-	M272.948	170	2996			<b>VD1072</b>
C 300 (204.054)	07/09-	M272.947	170	2996			<b>VD1072</b>
C 300 4-matic (204.081)	07/07-	M272.948	170	2996			<b>VD1072</b>
C 320 CDI (204.022)	01/07-	OM642.960	165	2987		ALT	<b>7PK2035D1</b> <b>VD1073</b>
C 320 CDI 4-matic (204.089)	07/07-	OM642.961	165	2987		ALT	<b>7PK2035D1</b> <b>VD1073</b>
C 350 CDI (204.025)	10/09-	OM642.830	170	2987		ALT	<b>7PK2035D1</b> <b>VD1073</b>
C 350 CDI 4-matic (204.092)	10/09-	OM642.832	170	2987		ALT	<b>7PK2035D1</b> <b>VD1073</b>

### C CLASS T-Model (S204)

C 200 CDI	08/07-	OM646.811	100	2148		ALT	<b>6PK2260D3</b> <b>VD1042</b>
-----------	--------	-----------	-----	------	--	-----	-----------------------------------



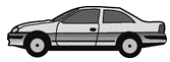

## MERCEDES-BENZ

### C CLASS T-Model (S204)

C 220 CDI	08/07-	OM646.811	125	2148		ALT	6PK2260D3 VD1042
C 230	08/07-	M272.921	150	2496			VD1072
C 280	08/07-	M272.947	170	2996			VD1072
C 320 CDI	08/07-	OM642.960	165	2987		ALT	7PK2035D1 VD1073
C 320 CDI 4-matic	08/07-	OM642.961	165	2987		ALT	7PK2035D1 VD1073
C 350 CDI (204.225)	10/09-	OM642.830	170	2987		ALT	7PK2035D1 VD1073
C 350 CDI 4-matic (204.292)	10/09-	OM642.832	170	2987		ALT	7PK2035D1 VD1073

### C-CLASS (W202)

C 200 CDI (202.134)	03/98-05/00	OM611.960	75	2151	AP9010 AP9015	ALT, (Bosch), OE-NO A 010 154 9502, A 012 154 2202, A 013 154 3602, 90A ALT, (Bosch), 115A, OE-NO 0111547802 ALT, (-AC), (LC) ALT, (-AC), (-LC) ALT, (AC), (LC) ALT, (AC), (-LC) OE-NO A611 030 10 03, A611 030 14 03, (Code: 170) OE-NO A611 030 02 03, A646 030 09 03, A611 030 05 03	6PK2160D1 6PK2196D1 6PK2241D1 6PK2271D2 VD1041 VD1042
C 200 D (202.122)	10/96-05/00	OM604.915	65	1997	AP9034	ALT	
C 220 CDI (202.133)	09/97-05/00	OM611.960	92	2151	AP9010 AP9015	ALT, (Bosch), OE-NO A 010 154 9502, A 012 154 2202, A 013 154 3602, 90A ALT, (Bosch), OE-NO A 010 154 9602, 90A, OE-NO A 011 154 7802, 115A ALT, (-AC), (LC) ALT, (-AC), (-LC) ALT, (AC), (LC) ALT, (AC), (-LC) OE-NO A611 030 10 03, A611 030 14 03, (Code: 170) OE-NO A611 030 02 03, A646 030 09 03, A611 030 05 03	6PK2160D1 6PK2196D1 6PK2241D1 6PK2271D2 VD1041 VD1042
C 220 D	07/96-05/00	OM604.910	55	2155	AP9034	ALT	
C 220 D (202.121)	08/93-05/00	OM604.910	70	2155	AP9034	ALT	
C 240 (202.026)	06/97-05/00	M112.910	125	2398		ALT, PS, (AC)	6PK2390D1 VD1070
C 280 (202.029)	06/97-05/00	M112.920	145	2799		ALT, PS, (AC)	6PK2390D1 VD1070
C 43 AMG (202.033)	08/97-05/00	M113.944	225	4266		ALT, PS, AC	6PK2390D1 VD1070

### C-CLASS (W203)

C 180 Kompressor (203.046)	05/02-	M271.946	105	1796	AP9020 AP9026	ALT, (Bosch), 120A ALT, (Valeo), OE-NO A 271 154 09 02, 120A, PROD.NO Valeo 2542582 D⇒	
C 200 CDI	02/01-	OM646.962	75	2148	AP9027	ALT, MTR-NO 30085732⇒, 06/2003⇒ ⇒06/2006, ⇒MTR-NO 30562087, ALT, (AC), (5-GEAR-AUTOM)	6PK2260D1 VD1036
C 200 CDI (203.004)	09/00-	OM611.962	85	2148	AP9024	ALT, 150A ALT, WP, PS, AC, (5-GEAR-AUTOM) (5-GEAR-AUTOM) (MANL)	6PK2260D1 VD1036 VD1042
C 200 CDI (203.007)	04/03-	OM646.962	90	2148	AP9027	ALT, MTR-NO 30085732⇒, 06/2003⇒ ⇒MTR-NO 30562087, ⇒06/2006, ALT, WP, PS, AC, (5-GEAR-AUTOM) MTR-NO 30562319⇒, 07/2006⇒, ALT, WP, PS, AC, (5-GEAR-AUTOM) (5-GEAR-AUTOM), MTR-NO 30085732⇒ (MANL)	6PK2260D1 6PK2260D3 VD1036 VD1042
C 200 CGI Kompressor (203.043)	07/03-	M271.942	125	1796	AP9020 AP9020 AP9026	ALT, (Bosch), OE-NO A 271 154 08 02, 120A ALT, (Valeo), OE-NO A 271 154 09 02, ⇒PROD.NO Valeo 2542582 C, 120A ALT, (Valeo), OE-NO A 271 0154 09 02, 120A, PROD.NO Valeo 2542582 D⇒	
C 200 Kompressor (203.042)	05/02-	M271.940	120	1796	AP9020 AP9020 AP9026	ALT, (Bosch), OE-NO A 271 154 08 02, 120A ALT, (Valeo), OE-NO A 271 154 09 02, ⇒PROD.NO Valeo 2542582 C, 120A ALT, (Valeo), OE-NO A 271 154 09 02, 120A, PROD.NO Valeo 2542582 D⇒	





## MERCEDES-BENZ

### C-CLASS (W203)

C 220 CDI (203.006)	05/00-	OM611.962	105	2148	<b>AP9024</b>	ALT, 150A ALT, WP, PS, AC, (5-GEAR-AUTOM) (5-GEAR-AUTOM) (MANL)	<b>6PK2260D1</b> <b>VD1036</b> <b>VD1042</b>
C 220 CDI (203.008)	02/04-	OM646.963	110	2148	<b>AP9027</b>	ALT ⇒06/2006, ⇒MTR-NO 30562087, ALT, WP, PS, AC, (5-GEAR-AUTOM) 07/2006⇒, MTR-NO 30562318⇒, ALT, WP, PS, AC, (5-GEAR-AUTOM) (5-GEAR-AUTOM), MTR-NO 30085732⇒ (MANL)	<b>6PK2260D1</b> <b>6PK2260D3</b>  <b>VD1036</b>  <b>VD1042</b>
C 230 (203.052)	01/05-	M272.920	150	2496		ALT, WP, PS, AC	<b>6PK2415D1</b> <b>VD1072</b>
C 230 Kompressor (203.040)	02/04-	M271.948	141	1796	<b>AP9020</b> <b>AP9020</b> <b>AP9026</b>	ALT, (Bosch), OE-NO A 271 154 08 02, 120A ALT, (Valeo), OE-NO A 271 154 09 02, ⇒PROD.NO Valeo 2542582 C, 120A ALT, (Valeo), OE-NO A 271 154 09 02, 120A, PROD.NO Valeo 2542582 D⇒	
C 240 (203.061)	05/00-	M112.912	125	2597		ALT, PS, AC, 03/2003⇒, CH-NO A 507496⇒ ALT, PS, AC, 03/2003⇒, CH-NO E 014992⇒ ALT, PS, AC, 03/2003⇒, CH-NO F 410069⇒ ALT, PS, AC, 05/2003⇒, CH-NO R 108313⇒ ALT, PS, AC, ⇒02/2003, ⇒CH-NO A 507495 ALT, PS, AC, ⇒02/2003, ⇒CH-NO E 014991 ALT, PS, AC, ⇒02/2003, ⇒CH-NO F 410068 ALT, PS, AC, ⇒04/2003, ⇒CH-NO R 108312	<b>6PK2380D1</b>  <b>6PK2380D1</b> <b>6PK2380D1</b> <b>6PK2380D1</b> <b>6PK2380D1</b> <b>6PK2390D1</b> <b>6PK2390D1</b> <b>6PK2390D1</b> <b>6PK2390D1</b> <b>6PK2390D1</b> <b>6PK2390D1</b> <b>6PK2390D1</b> <b>6PK2390D1</b>
C 240 4-matic (203.081)	07/02-	M112.916	125	2597		ALT, PS, AC, 03/2003⇒, CH-NO A 507496⇒ ALT, PS, AC, 03/2003⇒, CH-NO E 014992⇒ ALT, PS, AC, 03/2003⇒, CH-NO F 410069⇒ ALT, PS, AC, 05/2003⇒, CH-NO R 108313⇒ ALT, PS, AC, ⇒02/2003, ⇒CH-NO A 507495 ALT, PS, AC, ⇒02/2003, ⇒CH-NO E 014991 ALT, PS, AC, ⇒02/2003, ⇒CH-NO F 410068 ALT, PS, AC, ⇒04/2003, ⇒CH-NO R 108312	<b>6PK2380D1</b>  <b>6PK2380D1</b> <b>6PK2380D1</b> <b>6PK2380D1</b> <b>6PK2380D1</b> <b>6PK2390D1</b> <b>6PK2390D1</b> <b>6PK2390D1</b> <b>6PK2390D1</b> <b>6PK2390D1</b> <b>6PK2390D1</b> <b>6PK2390D1</b> <b>6PK2390D1</b> <b>6PK2390D1</b>
C 270 CDI (203.016)	12/00-	OM612.962	125	2685	<b>AP9024</b>	ALT, 150A ⇒MTR-NO 51184580, ALT, WP, PS, AC (5-GEAR-AUTOM), OE-NO A611 030 17 03	<b>6PK2260D1</b> <b>VD1036</b>
C 280 (203.054)	01/05-	M272.940	170	2996		ALT, WP, PS, AC	<b>6PK2415D1</b> <b>VD1072</b>
C 280 4-matic (203.092)	01/05-	M272.941	170	2996		ALT, WP, PS, AC	<b>6PK2415D1</b> <b>VD1072</b>
C 30 CDI AMG (203.018)	01/03-	OM612.990	170	2950	<b>AP9010</b>	ALT, (Bosch), 150A, OE-NO 012 154 1502, 013 154 1302	
C 320 (203.064)	05/00-	M112.946	160	3199		ALT, PS, AC, 03/2003⇒, CH-NO A 507496⇒ ALT, PS, AC, 03/2003⇒, CH-NO E 014992⇒ ALT, PS, AC, 03/2003⇒, CH-NO F 410069⇒ ALT, PS, AC, 05/2003⇒, CH-NO R 108313⇒ ALT, PS, AC, ⇒02/2003, ⇒CH-NO A 507495 ALT, PS, AC, ⇒02/2003, ⇒CH-NO E 014991 ALT, PS, AC, ⇒02/2003, ⇒CH-NO F 410068	<b>6PK2380D1</b>  <b>6PK2380D1</b> <b>6PK2380D1</b> <b>6PK2380D1</b> <b>6PK2380D1</b> <b>6PK2390D1</b> <b>6PK2390D1</b> <b>6PK2390D1</b> <b>6PK2390D1</b>





# MERCEDES-BENZ

## C-CLASS (W203)

						ALT, PS, AC, ⇒04/2003, ⇒CH-NO R 108312	<b>6PK2390D1</b> <b>VD1070</b>
C 320 4-matic (203.084)	07/02-	M112.953	160	3199		ALT, PS, AC, 03/2003⇒, CH-NO A 507496⇒ ALT, PS, AC, 03/2003⇒, CH-NO E 014992⇒ ALT, PS, AC, 03/2003⇒, CH-NO F 410069⇒ ALT, PS, AC, 05/2003⇒, CH-NO R 108313⇒ ALT, PS, AC, ⇒02/2003, ⇒CH-NO A 507495 ALT, PS, AC, ⇒02/2003, ⇒CH-NO E 014991 ALT, PS, AC, ⇒02/2003, ⇒CH-NO F 410068 ALT, PS, AC, ⇒04/2003, ⇒CH-NO R 108312	<b>6PK2380D1</b> <b>6PK2380D1</b> <b>6PK2380D1</b> <b>6PK2380D1</b> <b>6PK2390D1</b> <b>6PK2390D1</b> <b>6PK2390D1</b> <b>6PK2390D1</b>
C 320 CDI (203.020)	01/05-	OM642.910	165	2987		ALT, WP, PS, AC	<b>7PK2035D1</b> <b>VD1073</b>
<b>C-CLASS Coupe (CL203)</b>							
C 160 Kompressor (203.730)	05/02-	M271.921	90	1796	<b>AP9020</b> <b>AP9020</b> <b>AP9026</b>	ALT, (Bosch), OE-NO A 271 154 08 02, 120A ALT, (Valeo), OE-NO A 271 154 09 02, ⇒PROD.NO Valeo 2542582 C, 120A ALT, (Valeo), OE-NO A 271 154 09 02, 120A, PROD.NO Valeo 2542582 D⇒	
C 180 Kompressor (203.746)	05/02-	M271.946	105	1796	<b>AP9020</b> <b>AP9020</b> <b>AP9026</b>	ALT, (Bosch), OE-NO A 271 154 08 02, 120A ALT, (Valeo), OE-NO A 271 154 09 02, ⇒PROD.NO Valeo 2542582 C, 120A ALT, (Valeo), OE-NO A 271 154 09 02, 120A, PROD.NO Valeo 2542582 D⇒	
C 200 CDI (203.707)	03/03-	OM646.962	90	2148	<b>AP9027</b>	ALT, MTR-NO 30085732⇒ ⇒06/2006, ⇒MTR-NO 30562087, ALT, (AC), (5-GEAR-AUTOM) (5-GEAR-AUTOM), MTR-NO 30085732⇒ (MANL)	<b>6PK2260D1</b> <b>VD1036</b> <b>VD1042</b>
C 200 CGI Kompressor (203.743)	03/03-	M271.942	125	1796	<b>AP9020</b> <b>AP9020</b> <b>AP9026</b>	ALT, (Bosch), OE-NO A 271 154 08 02, 120A ALT, (Valeo), OE-NO A 271 154 09 02, ⇒PROD.NO Valeo 2542582 C, 120A ALT, (Valeo), OE-NO A 271 154 09 02, 120A, PROD.NO Valeo 2542582 D⇒	
C 200 Kompressor (203.742)	05/02-	M271.940	120	1796	<b>AP9020</b> <b>AP9020</b> <b>AP9026</b>	ALT, (Bosch), OE-NO A 271 154 08 02, 120A ALT, (Valeo), OE-NO A 271 154 09 02, ⇒PROD.NO Valeo 2542582 C, 120A ALT, (Valeo), OE-NO A 271 154 09 02, 120A, PROD.NO Valeo 2542582 D⇒	
C 220 CDI (203.706)	03/01-	OM611.962	105	2148	<b>AP9024</b>	ALT, 150A ALT, WP, PS, AC, (5-GEAR-AUTOM)	<b>6PK2260D1</b> <b>VD1036</b>
C 220 CDI (203.708)	02/04-	OM646.963	110	2148	<b>AP9027</b>	ALT ⇒06/2006, ⇒MTR-NO 30562087, ALT, (AC), (5-GEAR-AUTOM) (5-GEAR-AUTOM) (MANL)	<b>6PK2260D1</b> <b>VD1036</b> <b>VD1042</b>
C 230 (203.752)	01/05-	M272.920	150	2496		ALT, WP, PS, AC	<b>6PK2415D1</b> <b>VD1072</b>
C 230 Kompressor (203.740)	05/02-	M271.948	141	1796	<b>AP9020</b> <b>AP9020</b> <b>AP9026</b>	ALT, (Bosch), OE-NO A 271 154 08 02, 120A ALT, (Valeo), OE-NO A 271 154 09 02, ⇒PROD.NO Valeo 2542582 C, 120A ALT, (Valeo), OE-NO A 271 154 09 02, 120A, PROD.NO Valeo 2542582 D⇒	
C 30 CDI AMG (203.718)	09/02-	OM612.990	170	2950	<b>AP9010</b>	ALT, (Bosch), 150A, OE-NO 012 154 1502, 013 154 1302	
C 320 (203.764)	09/02-	M112.946	160	3199		ALT, PS, AC, 01/2007⇒, CH-NO E 020000⇒ ALT, PS, AC, 02/2003⇒, CH-NO A 507496⇒ ALT, PS, AC, ⇒CH-NO A 507495, ⇒02 /2003 ALT, PS, AC, ⇒CH-NO E 019999, ⇒12	<b>6PK2380D1</b> <b>6PK2380D1</b> <b>6PK2390D1</b> <b>6PK2390D1</b>



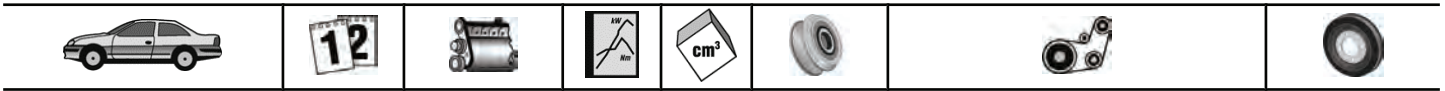

## MERCEDES-BENZ

### C-CLASS Coupe (CL203)

/2006

VD1070

### C-CLASS Kombi (S202)

C 200 T CDI (202.194)	03/98-03/01	OM611.960	75	2151	AP9010 AP9015	ALT, (Bosch), OE-NO A 010 154 9502, A 012 154 2202, A 013 154 3602, 90A ALT, (Bosch), OE-NO A 010 154 9602, 90A, OE-NO A 011 154 7802, 115A ALT, (-AC), (LC) ALT, (-AC), (-LC) ALT, (AC), (LC) ALT, (AC), (-LC) OE-NO A611 030 10 03, A611 030 14 03, (Code: 170) OE-NO A611 030 02 03, A646 030 09 03, A611 030 05 03	6PK2160D1 6PK2196D1 6PK2241D1 6PK2271D2 VD1041 VD1042
C 200 T D (202.180)	10/96-03/01	OM604.915	65	1997	AP9034	ALT	
C 220 T CDI (202.193)	09/97-03/01	OM611.960	92	2151	AP9010 AP9015	ALT, (Bosch), OE-NO A 010 154 9502, A 012 154 2202, A 013 154 3602, 90A ALT, (Bosch), OE-NO A 010 154 9602, 90A, OE-NO A 011 154 7802, 115A ALT, (-AC), (LC) ALT, (-AC), (-LC) ALT, (AC), (LC) ALT, (AC), (-LC) OE-NO A611 030 10 03, A611 030 14 03, (Code: 170) OE-NO A611 030 02 03, A646 030 09 03, A611 030 05 03	6PK2160D1 6PK2196D1 6PK2241D1 6PK2271D2 VD1041 VD1042
C 220 T D	06/96-03/01	OM604.910	55	2155	AP9034	ALT	
C 220 T D (202.182)	06/96-09/98	OM604.910	70	2155	AP9034	ALT	
C 240 T (202.086)	06/97-09/00	M112.910	125	2398		ALT, PS, (AC)	6PK2390D1 VD1070
C 240 T (202.088)	09/00-03/01	M112.915	125	2597		ALT, PS, (AC)	6PK2390D1 VD1070
C 280 T (202.089)	06/97-03/01	M112.920	145	2799		ALT, PS, (AC)	6PK2390D1 VD1070
C 43 AMG (202.093)	08/97-03/01	M113.944	225	4266		ALT, PS, AC	6PK2390D1 VD1070
<b>C-CLASS T-Model (S203)</b>							
C 180 Kompressor (203.246)	05/02-	M271.946	105	1796	AP9020	ALT, (Bosch), 120A	
C 200 CDI	03/01-	OM646.962	75	2148	AP9027	ALT, MTR-NO 30085732⇒, 06/2003⇒	
C 200 CDI (203.204)	03/01-	OM611.962	85	2148	AP9024	ALT, 150A ALT, WP, PS, AC, (5-GEAR-AUTOM) (5-GEAR-AUTOM) (MANL)	6PK2260D1 VD1036 VD1042
C 200 CDI (203.207)	04/03-	OM646.962	90	2148	AP9027	ALT, MTR-NO 30085732⇒, 06/2003⇒ ⇒03/2006, ⇒MTR-NO 30528520, ALT, WP, PS, AC, (5-GEAR-AUTOM) 07/2006⇒, MTR-NO 30562088⇒, ALT, WP, PS, AC, (5-GEAR-AUTOM) (5-GEAR-AUTOM), MTR-NO 30085732⇒ (MANL)	6PK2260D1 6PK2260D3 VD1036 VD1042
C 200 CGI Kompressor (203.243)	07/03-	M271.942	125	1796	AP9020	ALT, (Bosch), 120A	
C 200 Kompressor (203.242)	05/02-	M271.940	120	1796	AP9020	ALT, (Bosch), 120A	
C 220 CDI (203.206)	03/01-	OM611.962	105	2148	AP9024	ALT, 150A ALT, WP, PS, AC, (5-GEAR-AUTOM) (5-GEAR-AUTOM) (MANL)	6PK2260D1 VD1036 VD1042
C 220 CDI (203.208)	02/04-	OM646.963	110	2148	AP9027	ALT ⇒06/2006, ⇒MTR-NO 30562087, ALT, WP, PS, AC, (5-GEAR-AUTOM) 07/2006⇒, MTR-NO 30562319⇒, ALT, WP, PS, AC, (5-GEAR-AUTOM) (5-GEAR-AUTOM), MTR-NO 30085732⇒ (MANL)	6PK2260D1 6PK2260D3 VD1036 VD1042
C 230 (203.252)	01/05-	M272.920	150	2496		ALT, WP, PS, AC	6PK2415D1 VD1072
C 240 (203.261)	03/01-	M112.912	125	2597		ALT, PS, AC, 03/2003⇒, CH-NO F 410069⇒ ALT, PS, AC, ⇒02/2003, ⇒CH-NO F 410068	6PK2380D1 6PK2390D1 VD1070





## MERCEDES-BENZ

### C-CLASS T-Model (S203)

C 240 4-matic (203.281)	07/02-	M112.916	125	2597		ALT, PS, AC, 03/2003⇒, CH-NO F 410069⇒	<b>6PK2380D1</b>
						ALT, PS, AC, ⇒CH-NO F 410068, ⇒02/2003	<b>6PK2390D1</b>
							<b>VD1070</b>
C 270 CDI (203.216)	03/01-	OM612.962	125	2685	<b>AP9024</b>	ALT, 150A ⇒MTR-NO 51184580, ALT, WP, PS, AC (5-GEAR-AUTOM), OE-NO A611 030 17 03	<b>6PK2260D1</b>
							<b>VD1036</b>
C 280 (203.254)	01/05-	M272.940	170	2996		ALT, WP, PS, AC	<b>6PK2415D1</b>
							<b>VD1072</b>
C 280 4-matic (203.292)	01/05-	M272.941	170	2996		ALT, WP, PS, AC	<b>6PK2415D1</b>
							<b>VD1072</b>
C 30 CDI AMG (203.218)	01/03-	OM612.990	170	2950	<b>AP9010</b>	ALT, (Bosch), 150A, OE-NO 012 154 1502, 013 154 1302	
C 320 (203.264)	03/01-	M112.946	160	3199		ALT, PS, AC, 03/2003⇒, CH-NO F 410069⇒	<b>6PK2380D1</b>
						ALT, PS, AC, ⇒02/2003, ⇒CH-NO F 410068	<b>6PK2390D1</b>
							<b>VD1070</b>
C 320 4-matic (203.284)	07/02-	M112.953	160	3199		ALT, PS, AC, 03/2003⇒, CH-NO F 410069⇒	<b>6PK2380D1</b>
						ALT, PS, AC, ⇒02/2003, ⇒CH-NO F 410068	<b>6PK2390D1</b>
							<b>VD1070</b>
C 320 CDI (203.220)	06/05-	OM642.910	165	2987		ALT, WP, PS, AC	<b>7PK2035D1</b>
							<b>VD1073</b>

### CLC-CLASS

CLC 230 (203.752)	05/08-	M272.920	150	2496		ALT, AC	<b>6PK2415D1</b>
							<b>VD1072</b>

### CLK (C208)

320 (208.365)	06/97-06/02	M112.940	160	3199		ALT, PS, (AC)	<b>6PK2390D1</b>
							<b>VD1070</b>
430 (208.370)	07/98-06/02	M113.943	205	4266		ALT, PS, AC	<b>6PK2390D1</b>
							<b>VD1070</b>

### CLK (C209)

200 CGI (209.343)	07/03-	M271.942	125	1796	<b>AP9020</b>	ALT, (Bosch), OE-NO A 271 154 08 02, 120A	
					<b>AP9020</b>	ALT, (Valeo), OE-NO A 271 154 09 02, ⇒PROD.NO Valeo 2542582 C, 120A	
					<b>AP9026</b>	ALT, (Valeo), OE-NO A 271 154 09 02, 120A, PROD.NO Valeo 254 2582 D⇒	
200 Kompressor (209.342)	09/02-	M271.940	120	1796	<b>AP9020</b>	ALT, (Bosch), OE-NO A 271 154 08 02, 120A	
					<b>AP9020</b>	ALT, (Valeo), OE-NO A 271 154 09 02, ⇒PROD.NO Valeo 2542582 C, 120A	
					<b>AP9026</b>	ALT, (Valeo), OE-NO A 271 154 09 02, 120A, PROD.NO Valeo 2542582 D⇒	
220 CDI (209.308)	01/05-	OM646.966	110	2148	<b>AP9027</b>	ALT (5-GEAR-AUTOM), MTR-NO 30085732⇒ (MANL)	<b>VD1036</b>
							<b>VD1042</b>
240 (209.361)	06/02-	M112.912	125	2597		ALT, PS, (AC), 03/2003⇒, CH-NO F 050741⇒	<b>6PK2380D1</b>
						ALT, PS, (AC), ⇒02/2003, ⇒CH-NO F 050740	<b>6PK2390D1</b>
							<b>VD1070</b>
270 CDI (209.316)	10/02-	OM612.962, OM612.967	125	2685	<b>AP9024</b>	ALT, 150A (5-GEAR-AUTOM), OE-NO A611 030 17 03	<b>VD1036</b>
280 (209.354)	01/05-	M272.940	170	2996		ALT, WP, PS, AC	<b>6PK2415D1</b>
							<b>VD1072</b>
320 (209.365)	06/02-	M112.955	160	3199		ALT, PS, AC, 03/2003⇒, CH-NO F 050741⇒	<b>6PK2380D1</b>
						ALT, PS, AC, ⇒02/2003, ⇒CH-NO F 050740	<b>6PK2390D1</b>
							<b>VD1070</b>
320 CDI (209.320)	01/05-	OM642.910	165	2987		ALT, WP, PS, AC	<b>7PK2035D1</b>
							<b>VD1073</b>
500 (209.375)	06/02-	M113.968	225	4966		ALT, PS, AC	<b>6PK2380D1</b>
							<b>VD1070</b>

### CLK Cabriolet (A208)

320 (208.465)	03/98-03/02	M112.940	160	3199		ALT, PS, (AC)	<b>6PK2390D1</b>
							<b>VD1070</b>
430 (208.470)	09/98-03/02	M113.943	205	4266		ALT, PS, AC	<b>6PK2390D1</b>
							<b>VD1070</b>





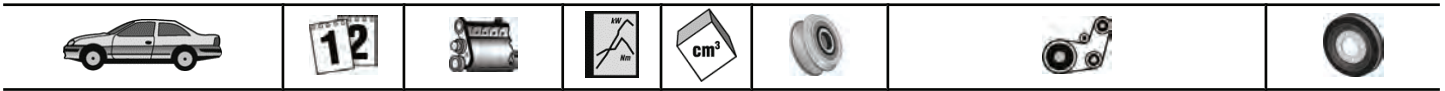

## MERCEDES-BENZ

### CLK Cabriolet (A209)

200 Kompressor (209.442)	02/03-	M271.940	120	1796	<b>AP9020</b>	ALT, (Bosch), OE-NO A 271 154 08 02, 120A	
					<b>AP9020</b>	ALT, (Valeo), OE-NO A 271 154 09 02, ⇒PROD.NO Valeo 2542582 C, 120A	
					<b>AP9026</b>	ALT, (Valeo), OE-NO A 271 154 09 02, 120A, PROD.NO Valeo 2542582 D⇒	
240 (209.461)	02/03-	M112.912	125	2597		ALT, PS, AC, 01/2004⇒, CH-NO F 103001⇒	<b>6PK2380D1</b>
						ALT, PS, AC, 03/2003⇒, CH-NO T 001364⇒	<b>6PK2380D1</b>
						ALT, PS, AC, ⇒03/2003, ⇒CH-NO T 001363	<b>6PK2390D1</b>
							<b>VD1070</b>
280 (209.454)	01/05-	M272.940	170	2996		ALT, WP, PS, AC	<b>6PK2415D1</b>
							<b>VD1072</b>
320 (209.465)	02/03-	M112.955	160	3199		ALT, PS, AC, 01/2004⇒, CH-NO F 103001⇒	<b>6PK2380D1</b>
						ALT, PS, AC, 03/2003⇒, CH-NO T 001364⇒	<b>6PK2380D1</b>
						ALT, PS, AC, ⇒03/2003, ⇒CH-NO T 001363	<b>6PK2390D1</b>
							<b>VD1070</b>
320 CDI (209.420)	03/05-	OM642.910	165	2987		ALT	<b>7PK2035D1</b>
							<b>VD1073</b>
500 (209.475)	02/03-	M113.968	225	4966		ALT, PS, AC	<b>6PK2380D1</b>
							<b>VD1070</b>

### CLS (C219)

280 (219.354)	07/08-	M272.943	170	2996			<b>VD1072</b>
300 (219.354)	04/09-	M272.943	170	2996			<b>VD1072</b>
320 CDI (219.322)	01/05-	OM642.910, OM642.920	165	2987		ALT	<b>7PK2035D1</b>
							<b>VD1073</b>
350 CDI (219.322)	04/09-	OM642.920	165	2987		ALT	<b>7PK2035D1</b>
							<b>VD1073</b>

### E-CLASS (W210)

E 200 CDI (210.007)	06/98-03/02	OM611.961	75	2151	<b>AP9015</b>	ALT, (Bosch), 115A, OE-NO 0111547802	
					<b>AP9024</b>	ALT, 150A, 01/2000⇒	
						ALT, PS, AC, (5-GEAR-AUTOM) (5-GEAR-AUTOM) (MANL)	<b>6PK2271D1</b>
							<b>VD1036</b>
							<b>VD1042</b>
	07/99-03/02	OM611.961	85	2148	<b>AP9015</b>	ALT, (Bosch), 115A, OE-NO 0111547802	
					<b>AP9024</b>	ALT, 150A, 01/2000⇒	
						ALT, PS, AC, (5-GEAR-AUTOM) (5-GEAR-AUTOM) (MANL)	<b>6PK2271D1</b>
							<b>VD1036</b>
							<b>VD1042</b>
E 200 D (210.003)	01/96-03/02	OM604.917	65	1997	<b>AP9034</b>	ALT	
E 220 CDI (210.006)	06/98-07/99	OM611.961	92	2151	<b>AP9015</b>	ALT, (Bosch), 115A, OE-NO 0111547802	
						ALT, PS, AC, (5-GEAR-AUTOM), MODEL '00⇒	<b>6PK2271D1</b>
						(5-GEAR-AUTOM), MODEL '00⇒ (MANL), ⇒MODEL '99	<b>VD1036</b>
							<b>VD1042</b>
	07/99-03/02	OM611.961	105	2148	<b>AP9015</b>	ALT, (Bosch), 115A, OE-NO 0111547802	
					<b>AP9024</b>	ALT, 150A, 01/2000⇒	
						ALT, PS, AC, (5-GEAR-AUTOM) (5-GEAR-AUTOM) (MANL)	<b>6PK2271D1</b>
							<b>VD1036</b>
							<b>VD1042</b>
E 220 D	05/96-03/02	OM604.912	55	2155	<b>AP9034</b>	ALT	
E 220 D (210.004)	06/95-07/99	OM604.912	70	2155	<b>AP9034</b>	ALT	
E 240 (210.061)	06/97-08/00	M112.911	125	2398		ALT, PS, (AC)	<b>6PK2390D1</b>
							<b>VD1070</b>
E 240 (210.062)	08/00-03/02	M112.914	125	2597		ALT, PS, (AC)	<b>6PK2390D1</b>
							<b>VD1070</b>
E 250 D (210.010)	06/95-07/99	OM605.912	83	2497	<b>AP9034</b>	ALT	
E 270 CDI (210.016)	07/99-03/02	OM612.961	125	2685	<b>AP9015</b>	ALT, (Bosch), 115A, OE-NO 0111547802	
					<b>AP9024</b>	ALT, 150A	
						⇒MTR-NO 51184580, ALT, PS, AC (5-GEAR-AUTOM) (MANL)	<b>6PK2271D1</b>
							<b>VD1036</b>
							<b>VD1042</b>
E 280 (210.063)	12/96-03/02	M112.921	150	2799		ALT, PS, (AC)	<b>6PK2390D1</b>
							<b>VD1070</b>
E 280 4-matic (210.081)	12/96-03/02	M112.921	150	2799		ALT, PS, (AC)	<b>6PK2390D1</b>
							<b>VD1070</b>
E 290 Turbo-D (210.017)	03/96-07/99	OM602.982	95	2874	<b>AP9034</b>	ALT	



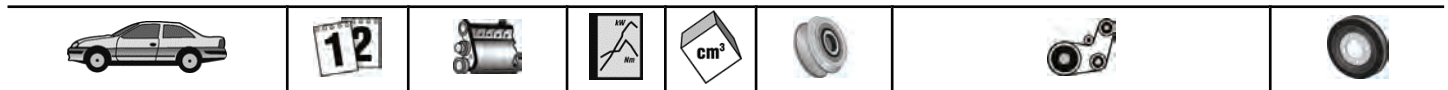

MERCEDES-BENZ

## MERCEDES-BENZ

E-CLASS (W210)							
E 300 D (210.020)	06/95-06/97	OM606.912	100	2996	AP9034	ALT, (Bosch), 90A, 120A	
E 300 Turbo-D (210.025)	12/96-07/99	OM606.962	130	2996	AP9034	ALT, (Bosch), 90A, 120A	
E 320 (210.065)	06/97-03/02	M112.941	165	3199		ALT, PS, AC	6PK2390D1 VD1070
E 320 4-matic (210.082)	06/97-03/02	M112.941	165	3199		ALT, PS, AC	6PK2390D1 VD1070
E 320 CDI (210.026)	07/99-03/02	OM613.961	145	3226	AP9024	ALT, 150A MTR-CODE: 613.961	VD1103
E 430 (210.070)	06/97-03/02	M113.940	205	4266		ALT, PS, (AC)	6PK2390D1 VD1070
E 430 4-matic (210.083)	05/99-03/02	M113.940	205	4266		ALT, PS, (AC)	6PK2390D1 VD1070
E-CLASS (W211)							
E 200 CDI (211.004)	07/02-	OM646.951	75	2148	AP9027	ALT, MTR-NO 30085732⇒, 06/2003⇒ 07/2003⇒, ⇒03/2006, CH-NO A348118⇒, X109212⇒, ⇒MTR-NO 30528520, ALT, (5-GEAR-AUTOM) MTR-NO 30562088⇒, 07/2006⇒, ALT, (5-GEAR-AUTOM), MTR-NO 30085732⇒ (MANL), MTR-NO 30085732⇒	6PK2260D1 6PK2260D3 VD1036 VD1042
			90	2148	AP9027	ALT, MTR-NO 30085732⇒, 06/2003⇒ 07/2003⇒, ⇒03/2006, CH-NO A348118⇒, X109212⇒, ⇒MTR-NO 30528520, ALT, (5-GEAR-AUTOM) MTR-NO 30562088⇒, 07/2006⇒, ALT, (5-GEAR-AUTOM), MTR-NO 30085732⇒ (MANL), MTR-NO 30085732⇒	6PK2260D1 6PK2260D3 VD1036 VD1042
E 200 CDI (211.007)	04/06-	OM646.820	100	2148			VD1042
E 200 Kompressor (211.042)	11/02-	M271.941	120	1796	AP9020	ALT, (Bosch), 150A	
E 220 CDI (211.006)	03/02-	OM646.961	100	2148		CH-NO A348118⇒, X109212⇒, ⇒MTR-NO 30562087, 07/2003⇒, ⇒06 /2006, ALT, (5-GEAR-AUTOM) MTR-NO 30562319⇒, 07/2006⇒, ALT, (5-GEAR-AUTOM)	6PK2260D1 6PK2260D3 VD1036
			110	2148	AP9027	ALT, MTR-NO 30085732⇒, 06/2003⇒ CH-NO A348118⇒, X109212⇒, ⇒MTR-NO 30562087, 07/2003⇒, ⇒06 /2006, ALT, (5-GEAR-AUTOM) MTR-NO 30562319⇒, 07/2006⇒, ALT, (5-GEAR-AUTOM), MTR-NO 30085732⇒ (MANL), MTR-NO 30085732⇒	6PK2260D1 6PK2260D3 VD1036 VD1042
E 220 CDI (211.008)	04/06-	OM646.821	125	2148			VD1042
E 230	09/07-	M272.922	150	2496			VD1072
E 240 (211.061)	03/02-	M112.917, M112.913	130	2597		ALT, PS, AC, 10/2002⇒, CH-NO A 135822⇒ ALT, PS, AC, 11/2002⇒, CH-NO X 095169⇒ ALT, PS, AC, ⇒09/2002, ⇒CH-NO A 135821 ALT, PS, AC, ⇒10/2002, ⇒CH-NO X 095168	6PK2380D1 6PK2380D1 6PK2390D1 6PK2390D1 VD1070
E 240 4-matic (211.080)	03/03-	M112.917	130	2597		ALT, PS, AC	6PK2380D1 VD1070
E 270 CDI (211.016)	03/02-	OM647.961	130	2685	AP9027	ALT, MTR-NO 30070144⇒, 07/2003⇒ 07/2003⇒, ⇒04/2006, CH-NO A348118⇒, X109212⇒, MTR-NO 30070144⇒, ⇒MTR-NO 30131767, ALT MTR-NO 30070144⇒, OE-NO A611 030 17 03	6PK2260D1 VD1036
E 280 (211.054)	03/05-	M272.943	170	2996		ALT, WP, PS, AC	6PK2415D1 VD1072
E 280 4-matic (211.092)	01/06-	M272.943	170	2996		ALT, WP, PS, AC	6PK2415D1 VD1072
E 280 CDI (211.020)	03/05-	OM642.920	140	2987		ALT, WP, PS, AC	7PK2035D1 VD1073
E 280 CDI (211.023)	05/04-	OM648.961	130	3222	AP9027	ALT MTR-CODE: 948.961	VD1103



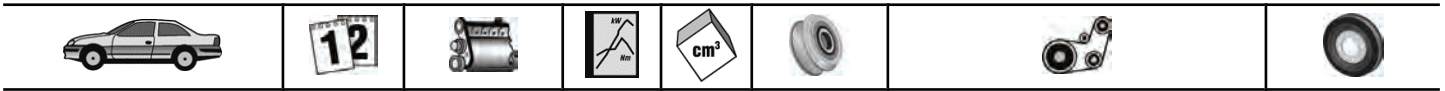

## MERCEDES-BENZ

### E-CLASS (W211)

 E 280 CDI 4-matic	03/05-	OM642.921	140	2987		ALT, PS, AC	7PK2035D1 VD1073
E 300 BLUETEC	09/07-	OM642.920	155	2987		ALT	7PK2035D1 VD1073
E 320 (211.065)	03/02-	M112.949	165	3199		ALT, PS, AC, 10/2002⇒, CH-NO A 135822⇒ ALT, PS, AC, 11/2002⇒, CH-NO X 095169⇒ ALT, PS, AC, ⇒09/2002, ⇒CH-NO A 135821 ALT, PS, AC, ⇒10/2002, ⇒CH-NO X 095168	6PK2380D1  6PK2380D1  6PK2390D1  6PK2390D1  VD1070
E 320 4-matic (211.082)	03/03-	M112.954	165	3199		ALT, PS, AC	6PK2380D1 VD1070
E 320 CDI (211.022)	03/05-	OM642.920	165	2987		ALT	7PK2035D1 VD1073
E 320 CDI (211.026)	11/02-	OM648.961	150	3222	AP9027	ALT MTR-CODE: 648.961	VD1103
E 320 CDI 4-matic	03/05-	OM642.910	165	2987		ALT	7PK2035D1 VD1073
E 500 (211.070)	03/02-	M113.967	225	4966		ALT, PS, AC, 10/2002⇒, CH-NO A 135822⇒ ALT, PS, AC, 11/2002⇒, CH-NO X 095169⇒ ALT, PS, AC, ⇒09/2002, ⇒CH-NO A 135821 ALT, PS, AC, ⇒10/2002, ⇒CH-NO X 095168	6PK2380D1  6PK2380D1  6PK2390D1  6PK2390D1  VD1070
E 500 4-matic (211.083)	10/03-	M113.969	225	4966		ALT, PS, AC	6PK2380D1 VD1070

### E-CLASS (W212)

E 350 BlueTEC (212.024)	01/09-	OM642.850	155	2987		ALT	7PK2035D1 VD1073
E 350 CDI (212.025)	01/09-	OM642.850	170	2987		ALT	7PK2035D1 VD1073
E 350 CDI 4-matic (212.089, 212.093)	09/09-	OM642.856, OM642.858	170	2987		ALT	7PK2035D1 VD1073

### E-CLASS Cabriolet (A207)

E 350 CDI (207.422)	01/10-	OM642.836	170	2987		ALT	7PK2035D1 VD1073
---------------------	--------	-----------	-----	------	--	-----	---------------------

### E-CLASS Kombi (S210)

E 220 T CDI (210.206)	06/98-07/99	OM611.961	92	2151	AP9015	ALT, (Bosch), 115A, OE-NO 0111547802 (5-GEAR-AUTOM) (MANL)	VD1036 VD1042
	07/99-03/03	OM611.961	105	2148	AP9015 AP9024	ALT, (Bosch), 115A, OE-NO 0111547802 ALT, 150A, 01/2000⇒ ALT, PS, AC, (5-GEAR-AUTOM) (5-GEAR-AUTOM) (MANL)	6PK2271D1 VD1036 VD1042
E 240 T (210.261)	06/97-03/03	M112.911	125	2398		ALT, PS, (AC)	6PK2390D1
E 240 T (210.262)	08/00-03/03	M112.914	125	2597		ALT, PS, AC	6PK2390D1
E 250 T D (210.210)	06/96-07/99	OM605.912	83	2497	AP9034	ALT	
E 270 T CDI (210.216)	07/99-03/03	OM612.961	125	2685	AP9024	ALT, 150A ⇒MTR-NO 51184580, ALT, PS, AC (5-GEAR-AUTOM), OE-NO A611 030 17 03	6PK2271D1 VD1036
E 280 T (210.263)	12/96-03/03	M112.921	150	2799		ALT, PS, (AC)	6PK2390D1
E 280 T 4-matic (210.281)	12/96-03/03	M112.921	150	2799		ALT, PS, (AC)	6PK2390D1
E 290 T Turbo-D (210.217)	06/96-07/99	OM602.982	95	2874	AP9034	ALT	
E 300 T Turbo-D (210.225)	12/96-07/99	OM606.962	130	2996	AP9034	ALT, (Bosch), 90A, 120A	
E 320 T (210.265)	12/96-03/03	M112.941	165	3199		ALT, PS, AC	6PK2390D1
E 320 T 4-matic (210.282)	12/96-03/03	M112.941	165	3199		ALT, PS, AC	6PK2390D1
E 320 T CDI (210.226)	07/99-03/03	OM613.961	145	3226	AP9024	ALT, 150A MTR-CODE: 613.961	VD1103
E 430 T (210.270)	06/97-03/03	M113.940	205	4266		ALT, PS, (AC)	6PK2390D1
E 430 T 4-matic (210.283)	05/99-03/03	M113.940	205	4266		ALT, PS, (AC)	6PK2390D1

### E-CLASS T-Model (S211)

E 200 CDI (211.207)	04/06-	OM646.821	100	2148			VD1042
---------------------	--------	-----------	-----	------	--	--	--------





## MERCEDES-BENZ

### E-CLASS T-Model (S211)

E 200 T Kompressor (211.242)	03/03-	M271.941	120	1796	<b>AP9020</b>	ALT, (Bosch), 150A	
E 220 CDI (211.206)	03/03-	OM646.961	100	2148		CH-NO A348118⇒, X109212⇒, ⇒MTR-NO 30562087, 07/2003⇒, ⇒06/2006, ALT, (5-GEAR-AUTOM) MTR-NO 30562319⇒, 07/2006⇒, ALT, (5-GEAR-AUTOM)	<b>6PK2260D1</b>  <b>6PK2260D3</b>  <b>VD1036</b>
E 220 T CDI (211.206)	03/03-	OM646.961	110	2148	<b>AP9027</b>	ALT, MTR-NO 30085732⇒, 06/2003⇒ 07/2003⇒, ⇒06/2006, CH-NO A348118⇒, X109212⇒, ⇒MTR-NO 30562087, ALT, (5-GEAR-AUTOM) MTR-NO 30562319⇒, 07/2006⇒, ALT, (5-GEAR-AUTOM), MTR-NO 30038201⇒ (MANL), MTR-NO 30038201⇒	<b>6PK2260D1</b>  <b>6PK2260D3</b>  <b>VD1036</b>  <b>VD1042</b>
E 220 T CDI (211.208)	04/06-	OM646.821	125	2148			<b>VD1042</b>
E 230 T	05/07-	M272.922	150	2496			<b>VD1072</b>
E 240 T (211.261)	03/03-	M112.913	130	2597		ALT, PS, AC	<b>6PK2380D1</b> <b>VD1070</b>
E 240 T 4-matic (211.280)	07/03-	M112.917	130	2597		ALT, PS, AC	<b>6PK2380D1</b> <b>VD1070</b>
E 270 T CDI (211.216)	03/03-	OM647.961	130	2685	<b>AP9027</b>	ALT, MTR-NO 30070144⇒, 07/2003⇒ 07/2003⇒, ⇒04/2006, CH-NO A348118⇒, X109212⇒, MTR-NO 30070144⇒, ⇒MTR-NO 30131767, ALT (5-GEAR-AUTOM), MTR-NO 30070144⇒	<b>6PK2260D1</b>  <b>VD1036</b>
E 280 T (211.254)	03/05-	M272.943	170	2996		ALT, WP, PS, AC	<b>6PK2415D1</b> <b>VD1072</b>
E 280 T 4-matic (211.292)	03/05-	M272.943	170	2996		ALT, WP, PS, AC	<b>6PK2415D1</b> <b>VD1072</b>
E 280 T CDI (211.220)	03/05-	OM642.920	140	2987		ALT	<b>7PK2035D1</b> <b>VD1073</b>
E 280 T CDI (211.223)	05/04-	OM648.961	130	3222	<b>AP9027</b>	ALT MTR-CODE: 648.961	<b>VD1103</b>
E 280 T CDI 4-matic	03/05-	OM642.921	140	2987		ALT, PS, AC	<b>7PK2035D1</b> <b>VD1073</b>
E 320 T (211.265)	03/03-	M112.949	165	3199		ALT, PS, AC	<b>6PK2380D1</b> <b>VD1070</b>
E 320 T 4-matic (211.282)	07/03-	M112.954	165	3199		ALT, PS, AC	<b>6PK2380D1</b> <b>VD1070</b>
E 320 T CDI (211.222)	03/05-	OM642.920	165	2987		ALT	<b>7PK2035D1</b> <b>VD1073</b>
E 320 T CDI (211.226)	03/03-	OM648.961	150	3222	<b>AP9027</b>	ALT MTR-CODE: 648.961	<b>VD1103</b>
E 320 T CDI 4-matic	03/05-	OM642.920	165	2987		ALT	<b>7PK2035D1</b> <b>VD1073</b>
E 500 T (211.270)	10/03-	M113.967	225	4966		ALT, PS, AC	<b>6PK2380D1</b> <b>VD1070</b>
E 500 T 4-matic (211.283)	10/03-	M113.969	225	4966		ALT, PS, AC	<b>6PK2380D1</b> <b>VD1070</b>
<b>E-CLASS T-Model (S212)</b>							
E 350 BlueTEC (212.224)	11/09-	OM642.850	155	2987		ALT	<b>7PK2035D1</b> <b>VD1073</b>
E 350 CDI (212.223, 212.225)	11/09-	OM642.850, OM642.852	170	2987		ALT	<b>7PK2035D1</b> <b>VD1073</b>
<b>G-CLASS (W461)</b>							
G 290 TD (461.335, 461.336)	07/97-	OM602.983	88	2874	<b>AP9034</b>	ALT, ⇒CH-NO 144225, 90A, 120A	
<b>G-CLASS (W463)</b>							
G 270 CDI (463.322, 463.323)	10/01-	OM612.965	115	2685	<b>AP9024</b>	ALT, 150A	
G 300 TD (463.330, 463.331)	08/96-	OM606.964	130	2996	<b>AP9034</b>	ALT	
<b>G-CLASS Cabrio (W463)</b>							
G 300 TD (463.308)	09/96-	OM606.964	130	2996	<b>AP9034</b>	ALT	
<b>GL-CLASS (X164)</b>							
GL 320 CDI (164.822)	09/06-05/09	OM642.940	165	2987		ALT, CH-NO A 390565⇒, 03/2008⇒ MTR-NO 40777760⇒	<b>7PK2035D1</b> <b>VD1073</b>
GL 350 CDI (164.822)	05/09-	OM642.940	165	2987		ALT	<b>7PK2035D1</b> <b>VD1073</b>
GL 350 CDI BlueTEC (164.824, 164.825)	12/09-	OM642.820	155	2987		ALT	<b>7PK2035D1</b> <b>VD1073</b>
<b>GLK-CLASS (X204)</b>							
280 4-matic (204.981)	06/08-06/09	M272.948	170	2996			<b>VD1072</b>



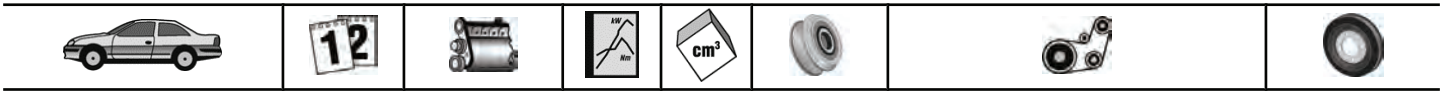

## MERCEDES-BENZ

### GLK-CLASS (X204)

300 4-matic (204.981)	07/09-	M272.948	170	2996			VD1072
320 CDI 4-matic (204.983)	06/08-	OM642.961	165	2987		ALT	7PK2035D1 VD1073
350 CDI 4-matic (204.992)	07/09-	OM642.832	165	2987		ALT	7PK2035D1 VD1073

### M-CLASS (W163)

ML 270 CDI (163.113)	12/99-06/05	OM612.963	120	2685	AP9024	ALT, 150A ⇒MTR-NO 51184580, ALT, WP, AC, PS (5-GEAR-AUTOM), OE-NO A611 030 17 03	6PK2271D1 VD1036
ML 320 (163.154)	02/98-08/02	M112.942	160	3199		ALT, PS, AC, ⇒CH-NO A 429265 ALT, PS, AC, ⇒CH-NO X 778320	6PK2390D1 6PK2390D1
ML 350 (163.157)	08/02-06/05	M112.970	180	3724		ALT, PS, AC, ⇒CH-NO A 429265 ALT, PS, AC, ⇒CH-NO X 778320	6PK2390D1 6PK2390D1
ML 430 (163.172)	02/98-06/05	M113.942	200	4266		ALT, PS, AC, ⇒CH-NO A 429265 ALT, PS, AC, ⇒CH-NO X 778320	6PK2390D1 6PK2390D1
ML 500 (163.175)	09/01-06/05	M113.964, M113.965	215	4966		ALT, PS, AC, ⇒CH-NO A 429265 ALT, PS, AC, ⇒CH-NO X 778320	6PK2390D1 6PK2390D1

### M-CLASS (W164)

ML 300 CDI 4-matic (164.120)	07/09-	OM642.940	140	2987		ALT	7PK2035D1 VD1073
ML 300 CDI 4-matic (164.121)	02/10-		150	2987		ALT	7PK2035D1 VD1073
ML 350 CDI 4-matic (164.122)	07/09-	OM642.940	165	2987		ALT	7PK2035D1 VD1073
ML 350 CDI 4-matic (164.125)	02/10-		170	2987		ALT	7PK2035D1 VD1073

### R-CLASS (W251, V251)

R 280 (251.054, 251.154)	01/07-	M272.945	170	2996		ALT	6PK2415D1
R 300 CDI 4-matic (251.020)	07/09-	OM642.950	140	2987		ALT	7PK2035D1 VD1073
R 350 BlueTEC 4-matic (251.124)	07/09-	OM642.950	155	2987		ALT	7PK2035D1 VD1073
R 350 CDI 4-matic (251.022, 251.122, 251.125)	07/09-	OM642.950	165	2987		ALT	7PK2035D1 VD1073

### S-CLASS (W140)

S 300 Turbo-D (140.135)	05/96-10/98	OM606.961	130	2996	AP9034	ALT	
-------------------------	-------------	-----------	-----	------	--------	-----	--

### S-CLASS (W220)

S 280 (220.063, 220.163)	10/98-08/05	M112.922	150	2799		ALT, PS, AC, ⇒CH-NO 220 A 190249	6PK2390D1
S 320 (220.065, 220.165)	10/98-08/05	M112.944	165	3199		ALT, PS, AC, ⇒CH-NO 220 A 190249	6PK2390D1
S 320 CDI (220.025, 220.125)	09/02-08/05	OM648.960	150	3222	AP9027	ALT MTR-CODE: 648.960	VD1103
S 320 CDI (220.026, 220.126)	08/99-09/02	OM613.960	145	3222	AP9024	ALT, 150A MTR-CODE: 613.960	VD1103
S 350 (220.067, 220.167)	09/02-08/05	M112.972	180	3724		ALT, PS, AC, 10/2002⇒, CH-NO A 316704⇒, (ABC-Federung) ALT, PS, AC, ⇒CH-NO A 316703, ⇒09 /2002, (ABC-Federung)	6PK2380D1 6PK2390D1 VD1070
S 350 4-matic (220.087, 220.187)	06/03-08/05	M112.975	180	3724		ALT, PS, AC, 10/2002⇒, CH-NO A 316704⇒, (ABC-Federung)	6PK2380D1 VD1070
S 430 (220.070, 220.170)	10/98-08/05	M113.941	205	4266		ALT, PS, AC	6PK2390D1
S 430 4-matic (220.083, 220.183)	09/02-08/05	M113.948	205	4266		ALT, PS, AC, 10/2002⇒, CH-NO A 316704⇒ ALT, PS, AC, ⇒CH-NO A 316703, ⇒09 /2002	6PK2380D1 6PK2390D1 VD1070
S 500 (220.075, 220.175, 220.875)	10/98-08/05	M113.960	225	4966		ALT, PS, AC	6PK2390D1
S 500 4-matic (220.084, 220.184)	09/02-08/05	M113.966	225	4966		ALT, PS, AC, 10/2002⇒, CH-NO A 316704⇒ ALT, PS, AC, ⇒CH-NO A 316703, ⇒09 /2002	6PK2380D1 6PK2390D1 VD1070

### S-CLASS Coupe (C215)

CL 500 (215.375)	03/99-03/06	M113.960	225	4966		ALT, PS, AC, 10/2002⇒, CH-NO A 031529⇒ ALT, PS, AC, ⇒09/2002, ⇒CH-NO A 031528	6PK2380D1 6PK2390D1 VD1070
------------------	-------------	----------	-----	------	--	----------------------------------------------------------------------------------	----------------------------------



**MERCEDES-BENZ**

SL (R129)							
↔ 280 (129.059)	05/98-10/01	M112.923, M112.925	150	2799		ALT, PS, AC	<b>6PK2390D1</b>
320 (129.064)	05/98-10/01	M112.943	165	3199		ALT, PS, AC	<b>6PK2390D1</b>
500 (129.068)	05/98-10/01	M113.961	225	4966		ALT, PS, AC	<b>6PK2390D1</b>
55 AMG (129.068)	03/00-10/01	M113.985	260	5439		ALT, PS, AC	<b>6PK2390D1</b>
SL (R230)							
280	03/08-	M272.949	170	2996		ALT	<b>6PK2415D1</b> <b>VD1072</b>
300	04/09-	M272.949	170	2996		ALT	<b>6PK2415D1</b> <b>VD1072</b>
350 (230.467)	03/03-	M112.973	180	3724		ALT, PS, AC	<b>6PK2380D1</b> <b>VD1070</b>
500 (230.475)	10/01-	M113.963	225	4966		ALT, PS, AC, 08/2002⇒, CH-NO F 011632⇒	<b>6PK2380D1</b>
						ALT, PS, AC, ⇒07/2002, ⇒CH-NO F 026959	<b>6PK2390D1</b> <b>VD1070</b>
SLK (R170)							
320 (170.465)	03/00-04/04	M112.947	160	3199		ALT, PS, AC	<b>6PK2390D1</b>
SLK (R171)							
200 Kompressor (171.442)	03/04-	M271.944	120	1795	<b>AP9020</b>	ALT, (Bosch), 120A, OE-NO A 271 154 08 02	
					<b>AP9026</b>	ALT, (Valeo), OE-NO A 271 154 09 02, 120A	
280 (171.454)	01/05-	M272.942	170	2996		ALT, WP, PS, AC	<b>6PK2415D1</b> <b>VD1072</b>
300 (171.454)	04/09-	M272.942	170	2996		ALT, WP, PS, AC	<b>6PK2415D1</b> <b>VD1072</b>
SPRINTER 2-t Bus (901, 902)							
208 CDI	04/00-05/06	OM611.987	60	2148	<b>AP9010</b>	ALT, (Bosch), OE-NO 012 154 2002, A 013 154 1702, 90A, OE-NO A 012 154 2402, 115A, OE-NO A 013 154 1502, 120A, OE-NO A 012 154 4602, A 013 154 1302, 150A, OE-NO A 013 154 1102, 200A	
					<b>AP9015</b>	ALT, (Bosch), OE-NO A 011 154 0602, 90A, OE-NO A 011 154 0902, 115A CH-NO R220798⇒, ALT, (-AC), (Abtrieb nicht vorn) ⇒MTR-NO 50185180, ALT, (AC), (Abtrieb vorn)	<b>6PK2264D1</b> <b>6PK2271D2</b>
						OE-NO A611 030 10 03, A611 030 14 03, (Code: 170)	<b>VD1041</b>
						OE-NO A611 030 02 03, A646 030 09 03, A611 030 05 03	<b>VD1042</b>
208 D	02/95-04/00	OM601.943	58	2299	<b>AP9034</b>	ALT	
210 D	03/97-04/00	OM602.980	75	2874	<b>AP9034</b>	ALT	
211 CDI	04/00-05/06	OM611.981	80	2148	<b>AP9010</b>	ALT, (Bosch), OE-NO 012 154 2002, A 013 154 1702, 90A, OE-NO A 012 154 2402, 115A, OE-NO A 013 154 1502, 120A, OE-NO A 012 154 4602, A 013 154 1302, 150A, OE-NO A 013 154 1102, 200A	
					<b>AP9015</b>	ALT, (Bosch), OE-NO A 011 154 0602, 90A, OE-NO A 011 154 0902, 115A CH-NO R220798⇒, ALT, (-AC), (Abtrieb nicht vorn) ⇒MTR-NO 50185180, ALT, (AC), (Abtrieb vorn)	<b>6PK2264D1</b> <b>6PK2271D2</b>
						OE-NO A611 030 10 03, A611 030 14 03, (Code: 170)	<b>VD1041</b>
						OE-NO A611 030 02 03, A646 030 09 03, A611 030 05 03	<b>VD1042</b>
212 D	02/95-04/00	OM602.980	90	2874	<b>AP9034</b>	ALT	
213 CDI	04/00-05/06	OM611.981	95	2148	<b>AP9010</b>	ALT, (Bosch), OE-NO 012 154 2002, A 013 154 1702, 90A, OE-NO A 012 154 2402, 115A, OE-NO A 013 154 1502, 120A, OE-NO A 012 154 4602, A 013 154 1302, 150A, OE-NO A 013 154 1102, 200A	
					<b>AP9015</b>	ALT, (Bosch), OE-NO A 011 154 0602, 90A, OE-NO A 011 154 0902, 115A CH-NO R220798⇒, ALT, (-AC), (Abtrieb nicht vorn) ⇒MTR-NO 50185180, ALT, (AC), (Abtrieb vorn)	<b>6PK2264D1</b> <b>6PK2271D2</b>
						OE-NO A611 030 10 03, A611 030 14 03, (Code: 170)	<b>VD1041</b>



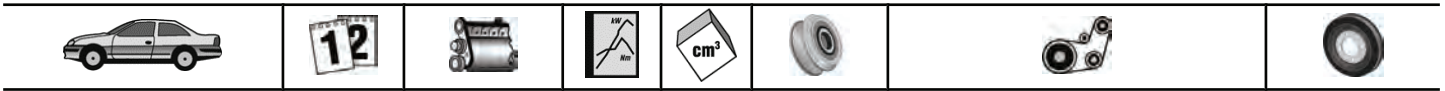

## MERCEDES-BENZ

### SPRINTER 2-t Bus (901, 902)

						OE-NO A611 030 02 03, A646 030 09 03, <b>VD1042</b> A611 030 05 03
216 CDI	04/00-05/06	OM612.981	115	2685	<b>AP9010</b>	ALT, (Bosch), OE-NO 012 154 2002, A 013 154 1702, 90A, OE-NO A 012 154 2402, 115A, OE-NO A 013 154 1502, 120A, OE-NO A 012 154 4602, A 013 154 1302, 150A, OE-NO A 013 154 1102, 200A
					<b>AP9015</b>	ALT, (Bosch), OE-NO A 011 154 0602, 90A, OE-NO A 011 154 0902, 115A (MANL), MTR-NO 50076683⇒ <b>VD1036</b>

### SPRINTER 2-t Kasten (901, 902)

208 CDI	04/00-05/06	OM611.987	60	2148	<b>AP9010</b>	ALT, (Bosch), OE-NO 012 154 2002, A 013 154 1702, 90A, OE-NO A 012 154 2402, 115A, OE-NO A 013 154 1502, 120A, OE-NO A 012 154 4602, A 013 154 1302, 150A, OE-NO A 013 154 1102, 200A
					<b>AP9015</b>	ALT, (Bosch), OE-NO A 011 154 0602, 90A, OE-NO A 011 154 0902, 115A CH-NO R220798⇒, ALT, (-AC), (Abtrieb nicht vorn) <b>6PK2264D1</b> ⇒MTR-NO 50185180, ALT, (AC), (Abtrieb vorn) <b>6PK2271D2</b> OE-NO A611 030 10 03, A611 030 14 03, <b>VD1041</b> (Code: 170) OE-NO A611 030 02 03, A646 030 09 03, <b>VD1042</b> A611 030 05 03
208 D	02/95-04/00	OM601.943	58	2299	<b>AP9034</b>	ALT
	10/96-04/00		60	2299	<b>AP9034</b>	ALT
210 D	01/97-04/00	OM602.980	75	2874	<b>AP9034</b>	ALT
211 CDI	04/00-05/06	OM611.981	80	2148	<b>AP9010</b>	ALT, (Bosch), OE-NO 012 154 2002, A 013 154 1702, 90A, OE-NO A 012 154 2402, 115A, OE-NO A 013 154 1502, 120A, OE-NO A 012 154 4602, A 013 154 1302, 150A, OE-NO A 013 154 1102, 200A
					<b>AP9015</b>	ALT, (Bosch), OE-NO A 011 154 0602, 90A, OE-NO A 011 154 0902, 115A OE-NO A611 030 10 03, A611 030 14 03, <b>VD1041</b> (Code: 170) OE-NO A611 030 02 03, A646 030 09 03, <b>VD1042</b> A611 030 05 03
212 D	02/95-04/00	OM602.980	90	2874	<b>AP9034</b>	ALT
213 CDI	04/00-05/06	OM611.981	95	2148	<b>AP9010</b>	ALT, (Bosch), OE-NO 012 154 2002, A 013 154 1702, 90A, OE-NO A 012 154 2402, 115A, OE-NO A 013 154 1502, 120A, OE-NO A 012 154 4602, A 013 154 1302, 150A, OE-NO A 013 154 1102, 200A
					<b>AP9015</b>	ALT, (Bosch), OE-NO A 011 154 0602, 90A, OE-NO A 011 154 0902, 115A CH-NO R220798⇒, ALT, (-AC), (Abtrieb nicht vorn) <b>6PK2264D1</b> ⇒MTR-NO 50185180, ALT, (AC), (Abtrieb vorn) <b>6PK2271D2</b> OE-NO A611 030 10 03, A611 030 14 03, <b>VD1041</b> (Code: 170) OE-NO A611 030 02 03, A646 030 09 03, <b>VD1042</b> A611 030 05 03
216 CDI	04/00-05/06	OM612.981	115	2685		(MANL), MTR-NO 50076683⇒ <b>VD1036</b>

### SPRINTER 2-t Pritsche/Fahrgestell (901, 902)

208 CDI	04/00-05/06	OM611.987	60	2148	<b>AP9010</b>	ALT, (Bosch), OE-NO 012 154 2002, A 013 154 1702, 90A, OE-NO A 012 154 2402, 115A, OE-NO A 013 154 1502, 120A, OE-NO A 012 154 4602, A 013 154 1302, 150A, OE-NO A 013 154 1102, 200A
					<b>AP9015</b>	ALT, (Bosch), OE-NO A 011 154 0602, 90A, OE-NO A 011 154 0902, 115A CH-NO R220798⇒, ALT, (-AC), (Abtrieb nicht vorn) <b>6PK2264D1</b> ⇒MTR-NO 50185180, ALT, (AC), (Abtrieb vorn) <b>6PK2271D2</b> OE-NO A611 030 10 03, A611 030 14 03, <b>VD1041</b> (Code: 170) OE-NO A611 030 02 03, A646 030 09 03, <b>VD1042</b> A611 030 05 03



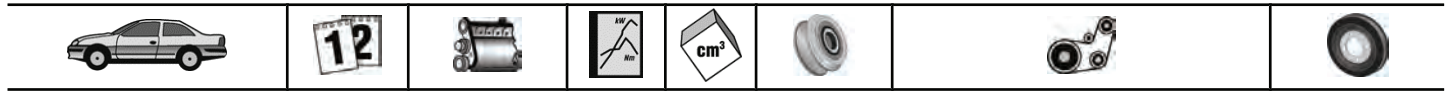

## MERCEDES-BENZ

SPRINTER 2-t Pritsche/Fahrgestell (901, 902)						
208 D	01/95-04/00	OM601.943	58	2299	AP9034	ALT
	09/96-04/00		60	2299	AP9034	ALT
210 D	01/97-04/00	OM602.980	75	2874	AP9034	ALT
211 CDI	04/00-05/06	OM611.981	80	2148	AP9010	ALT, (Bosch), OE-NO 012 154 2002, A 013 154 1702, 90A, OE-NO A 012 154 2402, 115A, OE-NO A 013 154 1502, 120A, OE-NO A 012 154 4602, A 013 154 1302, 150A, OE-NO A 013 154 1102, 200A
					AP9015	ALT, (Bosch), OE-NO A 011 154 0602, 90A, OE-NO A 011 154 0902, 115A CH-NO R220798⇒, ALT, (-AC), (Abtrieb nicht vorn) <b>6PK2264D1</b> ⇒MTR-NO 50185180, ALT, (AC), (Abtrieb vorn) <b>6PK2271D2</b> OE-NO A611 030 10 03, A611 030 14 03, <b>VD1041</b> (Code: 170) OE-NO A611 030 02 03, A646 030 09 03, <b>VD1042</b> A611 030 05 03
212 D	02/95-04/00	OM602.980	90	2874	AP9034	ALT
213 CDI	04/00-05/06	OM611.981	95	2148	AP9010	ALT, (Bosch), OE-NO 012 154 2002, A 013 154 1702, 90A, OE-NO A 012 154 2402, 115A, OE-NO A 013 154 1502, 120A, OE-NO A 012 154 4602, A 013 154 1302, 150A, OE-NO A 013 154 1102, 200A
					AP9015	ALT, (Bosch), OE-NO A 011 154 0602, 90A, OE-NO A 011 154 0902, 115A CH-NO R220798⇒, ALT, (-AC), (Abtrieb nicht vorn) <b>6PK2264D1</b> ⇒MTR-NO 50185180, ALT, (AC), (Abtrieb vorn) <b>6PK2271D2</b> OE-NO A611 030 10 03, A611 030 14 03, <b>VD1041</b> (Code: 170) OE-NO A611 030 02 03, A646 030 09 03, <b>VD1042</b> A611 030 05 03
216 CDI	04/00-05/06	OM612.981	115	2685	AP9010	ALT, (Bosch), OE-NO 012 154 2002, A 013 154 1702, 90A, OE-NO A 012 154 2402, 115A, OE-NO A 013 154 1502, 120A, OE-NO A 012 154 4602, A 013 154 1302, 150A, OE-NO A 013 154 1102, 200A
					AP9015	ALT, (Bosch), OE-NO A 011 154 0602, 90A, OE-NO A 011 154 0902, 115A (MANL), MTR-NO 50076683⇒ <b>VD1036</b>
SPRINTER 3,5 Pritsche/Fahrgestell (906)						
309 CDI	06/06-	OM646.984	65	2148	AP9050	ALT, (Valeo)
311 CDI	06/06-	OM646.985	80	2148	AP9050	ALT, (Valeo)
315 CDI	06/06-	OM646.990	110	2148	AP9050	ALT, (Valeo)
318 CDI	06/06-	OM642.992	135	2987	AP9050	ALT, (Valeo)
324	06/06-	M272.979	190	3498	AP9050	ALT, (Valeo)
SPRINTER 3,5-t Bus (906)						
311 CDI	06/06-	OM646.985	80	2148	AP9050	ALT, (Valeo)
315 CDI	06/06-	OM646.990	110	2148	AP9050	ALT, (Valeo)
324	06/06-	M272.979	190	3498	AP9050	ALT, (Valeo)
SPRINTER 3,5-t Kasten (906)						
309 CDI	06/06-	OM646.984	65	2148	AP9050	ALT, (Valeo)
311 CDI	06/06-	OM646.985	80	2148	AP9050	ALT, (Valeo)
315 CDI	06/06-	OM646.990	110	2148	AP9050	ALT, (Valeo)
318 CDI	06/06-	OM642.992	135	2987	AP9050	ALT, (Valeo)
324	06/06-	M272.979	190	3498	AP9050	ALT, (Valeo)
SPRINTER 3-t Bus (903)						
308 CDI	04/00-05/06	OM611.987	60	2148		CH-NO R220798⇒, ALT, (-AC), (Abtrieb nicht vorn) <b>6PK2264D1</b> ⇒MTR-NO 50185180, ALT, (AC), (Abtrieb vorn) <b>6PK2271D2</b> OE-NO A611 030 10 03, A611 030 14 03, <b>VD1041</b> (Code: 170) OE-NO A611 030 02 03, A646 030 09 03, <b>VD1042</b> A611 030 05 03
308 D	02/95-04/00	OM601.943	58	2299	AP9034	ALT
310 D 4x4	05/97-08/02	OM602.980	75	2874	AP9034	ALT
311 CDI	04/00-05/06	OM611.981	80	2148	AP9010	ALT, (Bosch), OE-NO 012 154 2002, A 013 154 1702, 90A, OE-NO A 012 154 2402, 115A, OE-NO A 013 154 1502, 120A, OE-NO A 012 154 4602, A 013 154 1302, 150A, OE-NO A 013 154 1102, 200A





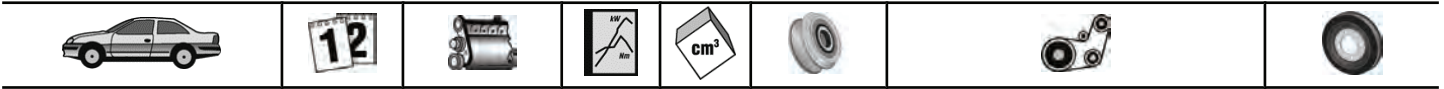

## MERCEDES-BENZ

### SPRINTER 3-t Bus (903)

					<b>AP9015</b>	ALT, (Bosch), OE-NO A 011 154 0602, 90A, OE-NO A 011 154 0902, 115A CH-NO R220798⇒, ALT, (-AC), (Abtrieb nicht vorn) ⇒MTR-NO 50185180, ALT, (AC), (Abtrieb vorn) OE-NO A611 030 10 03, A611 030 14 03, (Code: 170) OE-NO A611 030 02 03, A646 030 09 03, A611 030 05 03	<b>6PK2264D1</b> <b>6PK2271D2</b> <b>VD1041</b> <b>VD1042</b>
311 CDI 4x4	08/02-05/06	OM611.981	80	2148	<b>AP9010</b>	ALT, (Bosch), OE-NO 012 154 2002, A 013 154 1702, 90A, OE-NO A 012 154 2402, 115A, OE-NO A 013 154 1502, 120A, OE-NO A 012 154 4602, A 013 154 1302, 150A, OE-NO A 013 154 1102, 200A	
					<b>AP9015</b>	ALT, (Bosch), OE-NO A 011 154 0602, 90A, OE-NO A 011 154 0902, 115A CH-NO R220798⇒, ALT, (-AC), (Abtrieb nicht vorn) ⇒MTR-NO 50185180, ALT, (AC), (Abtrieb vorn) OE-NO A611 030 10 03, A611 030 14 03, (Code: 170) OE-NO A611 030 02 03, A646 030 09 03, A611 030 05 03	<b>6PK2264D1</b> <b>6PK2271D2</b> <b>VD1041</b> <b>VD1042</b>
313 CDI	04/00-05/06	OM611.981	95	2148	<b>AP9010</b>	ALT, (Bosch), OE-NO 012 154 2002, A 013 154 1702, 90A, OE-NO A 012 154 2402, 115A, OE-NO A 013 154 1502, 120A, OE-NO A 012 154 4602, A 013 154 1302, 150A, OE-NO A 013 154 1102, 200A	
					<b>AP9015</b>	ALT, (Bosch), OE-NO A 011 154 0602, 90A, OE-NO A 011 154 0902, 115A CH-NO R220798⇒, ALT, (-AC), (Abtrieb nicht vorn) ⇒MTR-NO 50185180, ALT, (AC), (Abtrieb vorn) OE-NO A611 030 02 03, A646 030 09 03, A611 030 05 03	<b>6PK2264D1</b> <b>6PK2271D2</b> <b>VD1042</b>
313 CDI 4x4	08/02-05/06	OM611.981	95	2148	<b>AP9010</b>	ALT, (Bosch), OE-NO 012 154 2002, A 013 154 1702, 90A, OE-NO A 012 154 2402, 115A, OE-NO A 013 154 1502, 120A, OE-NO A 012 154 4602, A 013 154 1302, 150A, OE-NO A 013 154 1102, 200A	
					<b>AP9015</b>	ALT, (Bosch), OE-NO A 011 154 0602, 90A, OE-NO A 011 154 0902, 115A CH-NO R220798⇒, ALT, (-AC), (Abtrieb nicht vorn) ⇒MTR-NO 50185180, ALT, (AC), (Abtrieb vorn) OE-NO A611 030 10 03, A611 030 14 03, (Code: 170) OE-NO A611 030 02 03, A646 030 09 03, A611 030 05 03	<b>6PK2264D1</b> <b>6PK2271D2</b> <b>VD1041</b> <b>VD1042</b>
316 CDI	04/00-05/06	OM612.981	115	2685	<b>AP9010</b>	ALT, (Bosch), OE-NO 012 154 2002, A 013 154 1702, 90A, OE-NO A 012 154 2402, 115A, OE-NO A 013 154 1502, 120A, OE-NO A 012 154 4602, A 013 154 1302, 150A, OE-NO A 013 154 1102, 200A	
					<b>AP9015</b>	ALT, (Bosch), OE-NO A 011 154 0602, 90A, OE-NO A 011 154 0902, 115A (MANL), MTR-NO 50076683⇒	<b>VD1036</b>
316 CDI 4x4	08/02-05/06	OM612.981	115	2685	<b>AP9010</b>	ALT, (Bosch), OE-NO 012 154 2002, A 013 154 1702, 90A, OE-NO A 012 154 2402, 115A, OE-NO A 013 154 1502, 120A, OE-NO A 012 154 4602, A 013 154 1302, 150A, OE-NO A 013 154 1102, 200A	
					<b>AP9015</b>	ALT, (Bosch), OE-NO A 011 154 0602, 90A, OE-NO A 011 154 0902, 115A (MANL), ⇒MTR-NO 50076683	<b>VD1036</b>
<b>SPRINTER 3-t Bus (906)</b>							
211 CDI	06/06-	OM646.985	80	2148	<b>AP9050</b>	ALT, (Valeo)	
215 CDI	06/06-	OM646.990	110	2148	<b>AP9050</b>	ALT, (Valeo)	
224	06/06-	M272.979	190	3498	<b>AP9050</b>	ALT, (Valeo)	





MERCEDES-BENZ

**MERCEDES-BENZ**

SPRINTER 3-t Kasten (903)  
↩ 308 CDI

	04/00-05/06	OM611.987	60	2148	<b>AP9010</b>	ALT, (Bosch), OE-NO 012 154 2002, A 013 154 1702, 90A, OE-NO A 012 154 2402, 115A, OE-NO A 013 154 1502, 120A, OE-NO A 012 154 4602, A 013 154 1302, 150A, OE-NO A 013 154 1102, 200A	
					<b>AP9015</b>	ALT, (Bosch), OE-NO A 011 154 0602, 90A, OE-NO A 011 154 0902, 115A CH-NO R220798⇒, ALT, (-AC), (Abtrieb nicht vorn) <b>6PK2264D1</b> ⇒MTR-NO 50185180, ALT, (AC), (Abtrieb vorn) <b>6PK2271D2</b> OE-NO A611 030 10 03, A611 030 14 03, <b>VD1041</b> (Code: 170) OE-NO A611 030 02 03, A646 030 09 03, <b>VD1042</b> A611 030 05 03	
308 D 2.3	02/95-04/00	OM601.943	58	2299	<b>AP9034</b>	ALT	
310 D 2.9	02/95-04/00	OM602.980	75	2874	<b>AP9034</b>	ALT	
311 CDI	04/00-05/06	OM611.981	80	2148	<b>AP9010</b>	ALT, (Bosch), OE-NO 012 154 2002, A 013 154 1702, 90A, OE-NO A 012 154 2402, 115A, OE-NO A 013 154 1502, 120A, OE-NO A 012 154 4602, A 013 154 1302, 150A, OE-NO A 013 154 1102, 200A	
					<b>AP9015</b>	ALT, (Bosch), OE-NO A 011 154 0602, 90A, OE-NO A 011 154 0902, 115A CH-NO R220798⇒, ALT, (-AC), (Abtrieb nicht vorn) <b>6PK2264D1</b> ⇒MTR-NO 50185180, ALT, (AC), (Abtrieb vorn) <b>6PK2271D2</b> OE-NO A611 030 10 03, A611 030 14 03, <b>VD1041</b> (Code: 170) OE-NO A611 030 02 03, A646 030 09 03, <b>VD1042</b> A611 030 05 03	
311 CDI 4x4	08/02-05/06	OM611.981	80	2148	<b>AP9010</b>	ALT, (Bosch), OE-NO 012 154 2002, A 013 154 1702, 90A, OE-NO A 012 154 2402, 115A, OE-NO A 013 154 1502, 120A, OE-NO A 012 154 4602, A 013 154 1302, 150A, OE-NO A 013 154 1102, 200A	
					<b>AP9015</b>	ALT, (Bosch), OE-NO A 011 154 0602, 90A, OE-NO A 011 154 0902, 115A CH-NO R220798⇒, ALT, (-AC), (Abtrieb nicht vorn) <b>6PK2264D1</b> ⇒MTR-NO 50185180, ALT, (AC), (Abtrieb vorn) <b>6PK2271D2</b> OE-NO A611 030 10 03, A611 030 14 03, <b>VD1041</b> (Code: 170) OE-NO A611 030 02 03, A646 030 09 03, <b>VD1042</b> A611 030 05 03	
313 CDI	04/00-05/06	OM611.981	95	2148	<b>AP9010</b>	ALT, (Bosch), OE-NO 012 154 2002, A 013 154 1702, 90A, OE-NO A 012 154 2402, 115A, OE-NO A 013 154 1502, 120A, OE-NO A 012 154 4602, A 013 154 1302, 150A, OE-NO A 013 154 1102, 200A	
					<b>AP9015</b>	ALT, (Bosch), OE-NO A 011 154 0602, 90A, OE-NO A 011 154 0902, 115A CH-NO R220798⇒, ALT, (-AC), (Abtrieb nicht vorn) <b>6PK2264D1</b> ⇒MTR-NO 50185180, ALT, (AC), (Abtrieb vorn) <b>6PK2271D2</b> OE-NO A611 030 10 03, A611 030 14 03, <b>VD1041</b> (Code: 170) OE-NO A611 030 02 03, A646 030 09 03, <b>VD1042</b> A611 030 05 03	
313 CDI 4x4	08/02-05/06	OM611.981	95	2148	<b>AP9010</b>	ALT, (Bosch), OE-NO 012 154 2002, A 013 154 1702, 90A, OE-NO A 012 154 2402, 115A, OE-NO A 013 154 1502, 120A, OE-NO A 012 154 4602, A 013 154 1302, 150A, OE-NO A 013 154 1102, 200A	
					<b>AP9015</b>	ALT, (Bosch), OE-NO A 011 154 0602, 90A, OE-NO A 011 154 0902, 115A CH-NO R220798⇒, ALT, (-AC), (Abtrieb nicht vorn) <b>6PK2264D1</b> ⇒MTR-NO 50185180, ALT, (AC), (Abtrieb vorn) <b>6PK2271D2</b>	



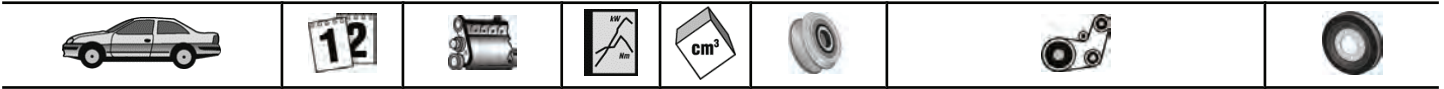

## MERCEDES-BENZ

### SPRINTER 3-t Kasten (903)

						OE-NO A611 030 10 03, A611 030 14 03, <b>VD1041</b> (Code: 170) OE-NO A611 030 02 03, A646 030 09 03, <b>VD1042</b> A611 030 05 03
316 CDI	04/00-05/06	OM612.981	115	2685	<b>AP9010</b>	ALT, (Bosch), OE-NO 012 154 2002, A 013 154 1702, 90A, OE-NO A 012 154 2402, 115A, OE-NO A 013 154 1502, 120A, OE-NO A 012 154 4602, A 013 154 1302, 150A, OE-NO A 013 154 1102, 200A
					<b>AP9015</b>	ALT, (Bosch), OE-NO A 011 154 0602, 90A, OE-NO A 011 154 0902, 115A (MANL), ⇨MTR-NO 50076683 <b>VD1036</b>
316 CDI 4x4	08/02-05/06	OM612.981	115	2685	<b>AP9010</b>	ALT, (Bosch), OE-NO 012 154 2002, A 013 154 1702, 90A, OE-NO A 012 154 2402, 115A, OE-NO A 013 154 1502, 120A, OE-NO A 012 154 4602, A 013 154 1302, 150A, OE-NO A 013 154 1102, 200A
					<b>AP9015</b>	ALT, (Bosch), OE-NO A 011 154 0602, 90A, OE-NO A 011 154 0902, 115A (MANL), ⇨MTR-NO 50076683 <b>VD1036</b>

### SPRINTER 3-t Kasten (906)

209 CDI	06/06-	OM646.984	65	2148	<b>AP9050</b>	ALT, (Valeo)
211 CDI	06/06-	OM646.985	80	2148	<b>AP9050</b>	ALT, (Valeo)
213 CDI	06/06-	OM646.986	95	2148	<b>AP9050</b>	ALT, (Valeo)
215 CDI	06/06-	OM646.990	110	2148	<b>AP9050</b>	ALT, (Valeo)
218 CDI	06/06-	OM642.992	135	2987	<b>AP9050</b>	ALT, (Valeo)
224	06/06-	M272.979	190	3498	<b>AP9050</b>	ALT, (Valeo)

### SPRINTER 3-t Pritsche/Fahrgestell (903)

308 CDI	04/00-05/06	OM611.987	60	2148	<b>AP9010</b>	ALT, (Bosch), OE-NO 012 154 2002, A 013 154 1702, 90A, OE-NO A 012 154 2402, 115A, OE-NO A 013 154 1502, 120A, OE-NO A 012 154 4602, A 013 154 1302, 150A, OE-NO A 013 154 1102, 200A
					<b>AP9015</b>	ALT, (Bosch), OE-NO A 011 154 0602, 90A, OE-NO A 011 154 0902, 115A CH-NO R220798⇨, ALT, (-AC), (Abtrieb nicht vorn) <b>6PK2264D1</b> ⇨MTR-NO 50185180, ALT, (AC), (Abtrieb vorn) <b>6PK2271D2</b> OE-NO A611 030 10 03, A611 030 14 03, <b>VD1041</b> (Code: 170) OE-NO A611 030 02 03, A646 030 09 03, <b>VD1042</b> A611 030 05 03
308 D 2.3	02/95-04/00	OM601.943	58	2299	<b>AP9034</b>	ALT
310 D 2.9	01/97-04/00	OM602.980	75	2874	<b>AP9034</b>	ALT
311 CDI	04/00-05/06	OM611.981	80	2148	<b>AP9010</b>	ALT, (Bosch), OE-NO 012 154 2002, A 013 154 1702, 90A, OE-NO A 012 154 2402, 115A, OE-NO A 013 154 1502, 120A, OE-NO A 012 154 4602, A 013 154 1302, 150A, OE-NO A 013 154 1102, 200A
					<b>AP9015</b>	ALT, (Bosch), OE-NO A 011 154 0602, 90A, OE-NO A 011 154 0902, 115A CH-NO R220798⇨, ALT, (-AC), (Abtrieb nicht vorn) <b>6PK2264D1</b> ⇨MTR-NO 50185180, ALT, (AC), (Abtrieb vorn) <b>6PK2271D2</b> OE-NO A611 030 10 03, A611 030 14 03, <b>VD1041</b> (Code: 170) OE-NO A611 030 02 03, A646 030 09 03, <b>VD1042</b> A611 030 05 03
311 CDI 4x4	08/02-05/06	OM611.981	80	2148	<b>AP9010</b>	ALT, (Bosch), OE-NO 012 154 2002, A 013 154 1702, 90A, OE-NO A 012 154 2402, 115A, OE-NO A 013 154 1502, 120A, OE-NO A 012 154 4602, A 013 154 1302, 150A, OE-NO A 013 154 1102, 200A
					<b>AP9015</b>	ALT, (Bosch), OE-NO A 011 154 0602, 90A, OE-NO A 011 154 0902, 115A OE-NO A611 030 10 03, A611 030 14 03, <b>VD1041</b> (Code: 170) OE-NO A611 030 02 03, A646 030 09 03, <b>VD1042</b> A611 030 05 03
313 CDI	04/00-05/06	OM611.981	95	2148	<b>AP9010</b>	ALT, (Bosch), OE-NO 012 154 2002, A 013 154 1702, 90A, OE-NO A 012 154

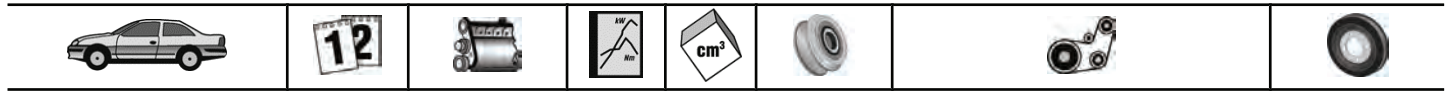
**MERCEDES-BENZ**
**SPRINTER 3-t Pritsche/Fahrgestell (903)**

					<b>AP9015</b>	2402, 115A, OE-NO A 013 154 1502, 120A, OE-NO A 012 154 4602, A 013 154 1302, 150A, OE-NO A 013 154 1102, 200A ALT, (Bosch), OE-NO A 011 154 0602, 90A, OE-NO A 011 154 0902, 115A CH-NO R220798⇒, ALT, (-AC), (Abtrieb nicht vorn) <b>6PK2264D1</b> ⇒MTR-NO 50185180, ALT, (AC), (Abtrieb vorn) <b>6PK2271D2</b> OE-NO A611 030 10 03, A611 030 14 03, <b>VD1041</b> (Code: 170) OE-NO A611 030 02 03, A646 030 09 03, <b>VD1042</b> A611 030 05 03
313 CDI 4x4	08/02-05/06	OM611.981	95	2148	<b>AP9010</b>	ALT, (Bosch), OE-NO 012 154 2002, A 013 154 1702, 90A, OE-NO A 012 154 2402, 115A, OE-NO A 013 154 1502, 120A, OE-NO A 012 154 4602, A 013 154 1302, 150A, OE-NO A 013 154 1102, 200A <b>AP9015</b> ALT, (Bosch), OE-NO A 011 154 0602, 90A, OE-NO A 011 154 0902, 115A CH-NO R220798⇒, ALT, (-AC), (Abtrieb nicht vorn) <b>6PK2264D1</b> ⇒MTR-NO 50185180, ALT, (AC), (Abtrieb vorn) <b>6PK2271D2</b> OE-NO A611 030 10 03, A611 030 14 03, <b>VD1041</b> (Code: 170) OE-NO A611 030 02 03, A646 030 09 03, <b>VD1042</b> A611 030 05 03
316 CDI	04/00-05/06	OM612.981	115	2685	<b>AP9010</b>	ALT, (Bosch), OE-NO 012 154 2002, A 013 154 1702, 90A, OE-NO A 012 154 2402, 115A, OE-NO A 013 154 1502, 120A, OE-NO A 012 154 4602, A 013 154 1302, 150A, OE-NO A 013 154 1102, 200A <b>AP9015</b> ALT, (Bosch), OE-NO A 011 154 0602, 90A, OE-NO A 011 154 0902, 115A (MANL), ⇒MTR-NO 50076683 <b>VD1036</b>
316 CDI 4x4	08/02-05/06	OM612.981	115	2685	<b>AP9010</b>	ALT, (Bosch), OE-NO 012 154 2002, A 013 154 1702, 90A, OE-NO A 012 154 2402, 115A, OE-NO A 013 154 1502, 120A, OE-NO A 012 154 4602, A 013 154 1302, 150A, OE-NO A 013 154 1102, 200A <b>AP9015</b> ALT, (Bosch), OE-NO A 011 154 0602, 90A, OE-NO A 011 154 0902, 115A (MANL), ⇒MTR-NO 50076683 <b>VD1036</b>

**SPRINTER 3-t Pritsche/Fahrgestell (906)**

209 CDI	06/06-	OM646.984	65	2148	<b>AP9050</b>	ALT, (Valeo)
211 CDI	06/06-	OM646.985	80	2148	<b>AP9050</b>	ALT, (Valeo)
213 CDI	06/06-	OM646.986	95	2148	<b>AP9050</b>	ALT, (Valeo)
215 CDI	06/06-	OM646.990	110	2148	<b>AP9050</b>	ALT, (Valeo)
218 CDI	06/06-	OM642.992	135	2987	<b>AP9050</b>	ALT, (Valeo)
224	06/06-	M272.979	190	3498	<b>AP9050</b>	ALT, (Valeo)

**SPRINTER 4-t Bus (904)**

408 CDI	04/00-05/06	OM611.987	60	2148	<b>AP9010</b>	ALT, (Bosch), OE-NO 012 154 2002, A 013 154 1702, 90A, OE-NO A 012 154 2402, 115A, OE-NO A 013 154 1502, 120A, OE-NO A 012 154 4602, A 013 154 1302, 150A, OE-NO A 013 154 1102, 200A <b>AP9015</b> ALT, (Bosch), OE-NO A 011 154 0602, 90A, OE-NO A 011 154 0902, 115A CH-NO R220798⇒, ALT, (-AC), (Abtrieb nicht vorn) <b>6PK2264D1</b> ⇒MTR-NO 50185180, ALT, (AC), (Abtrieb vorn) <b>6PK2271D2</b> OE-NO A611 030 10 03, A611 030 14 03, <b>VD1041</b> (Code: 170) OE-NO A611 030 02 03, A646 030 09 03, <b>VD1042</b> A611 030 05 03
411 CDI	04/00-05/06	OM611.981	80	2148	<b>AP9010</b>	ALT, (Bosch), OE-NO 012 154 2002, A 013 154 1702, 90A, OE-NO A 012 154 2402, 115A, OE-NO A 013 154 1502, 120A, OE-NO A 012 154 4602, A 013 154 1302, 150A, OE-NO A 013 154 1102, 200A



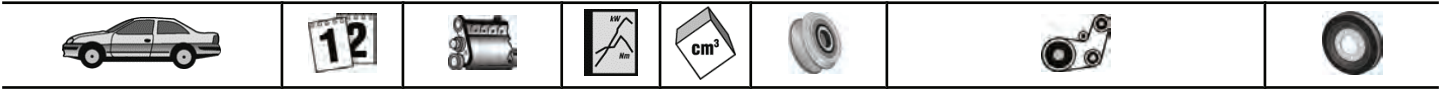

## MERCEDES-BENZ

### SPRINTER 4-t Bus (904)

					<b>AP9015</b>	ALT, (Bosch), OE-NO A 011 154 0602, 90A, OE-NO A 011 154 0902, 115A CH-NO R220798⇒, ALT, (-AC), (Abtrieb nicht vorn) <b>6PK2264D1</b> ⇒MTR-NO 50185180, ALT, (AC), (Abtrieb vorn) <b>6PK2271D2</b> OE-NO A611 030 10 03, A611 030 14 03, <b>VD1041</b> (Code: 170) OE-NO A611 030 02 03, A646 030 09 03, <b>VD1042</b> A611 030 05 03
413 CDI	04/00-05/06	OM611.981	95	2148	<b>AP9010</b>	ALT, (Bosch), OE-NO 012 154 2002, A 013 154 1702, 90A, OE-NO A 012 154 2402, 115A, OE-NO A 013 154 1502, 120A, OE-NO A 012 154 4602, A 013 154 1302, 150A, OE-NO A 013 154 1102, 200A
					<b>AP9015</b>	ALT, (Bosch), OE-NO A 011 154 0602, 90A, OE-NO A 011 154 0902, 115A CH-NO R220798⇒, ALT, (-AC), (Abtrieb nicht vorn) <b>6PK2264D1</b> ⇒MTR-NO 50185180, ALT, (AC), (Abtrieb vorn) <b>6PK2271D2</b> OE-NO A611 030 10 03, A611 030 14 03, <b>VD1041</b> (Code: 170) OE-NO A611 030 02 03, A646 030 09 03, <b>VD1042</b> A611 030 05 03
416 CDI	04/00-05/06	OM612.981	115	2685	<b>AP9010</b>	ALT, (Bosch), OE-NO 012 154 2002, A 013 154 1702, 90A, OE-NO A 012 154 2402, 115A, OE-NO A 013 154 1502, 120A, OE-NO A 012 154 4602, A 013 154 1302, 150A, OE-NO A 013 154 1102, 200A
					<b>AP9015</b>	ALT, (Bosch), OE-NO A 011 154 0602, 90A, OE-NO A 011 154 0902, 115A (MANL), ⇒MTR-NO 50076683 <b>VD1036</b>

### SPRINTER 4-t Kasten (904)

408 CDI	04/00-05/06	OM611.987	60	2148	<b>AP9010</b>	ALT, (Bosch), OE-NO 012 154 2002, A 013 154 1702, 90A, OE-NO A 012 154 2402, 115A, OE-NO A 013 154 1502, 120A, OE-NO A 012 154 4602, A 013 154 1302, 150A, OE-NO A 013 154 1102, 200A
					<b>AP9015</b>	ALT, (Bosch), OE-NO A 011 154 0602, 90A, OE-NO A 011 154 0902, 115A CH-NO R220798⇒, ALT, (-AC), (Abtrieb nicht vorn) <b>6PK2264D1</b> ⇒MTR-NO 50185180, ALT, (AC), (Abtrieb vorn) <b>6PK2271D2</b> OE-NO A611 030 10 03, A611 030 14 03, <b>VD1041</b> (Code: 170) OE-NO A611 030 02 03, A646 030 09 03, <b>VD1042</b> A611 030 05 03
408 D	02/96-05/06	OM601.943	58	2299	<b>AP9034</b>	ALT
411 CDI	04/00-05/06	OM611.981	80	2148	<b>AP9010</b>	ALT, (Bosch), OE-NO 012 154 2002, A 013 154 1702, 90A, OE-NO A 012 154 2402, 115A, OE-NO A 013 154 1502, 120A, OE-NO A 012 154 4602, A 013 154 1302, 150A, OE-NO A 013 154 1102, 200A
					<b>AP9015</b>	ALT, (Bosch), OE-NO A 011 154 0602, 90A, OE-NO A 011 154 0902, 115A CH-NO R220798⇒, ALT, (-AC), (Abtrieb nicht vorn) <b>6PK2264D1</b> ⇒MTR-NO 50185180, ALT, (AC), (Abtrieb vorn) <b>6PK2271D2</b> OE-NO A611 030 10 03, A611 030 14 03, <b>VD1041</b> (Code: 170) OE-NO A611 030 02 03, A646 030 09 03, <b>VD1042</b> A611 030 05 03
411 CDI 4x4	04/00-05/06	OM611.981	80	2148	<b>AP9010</b>	ALT, (Bosch), OE-NO 012 154 2002, A 013 154 1702, 90A, OE-NO A 012 154 2402, 115A, OE-NO A 013 154 1502, 120A, OE-NO A 012 154 4602, A 013 154 1302, 150A, OE-NO A 013 154 1102, 200A
					<b>AP9015</b>	ALT, (Bosch), OE-NO A 011 154 0602, 90A, OE-NO A 011 154 0902, 115A CH-NO R220798⇒, ALT, (-AC), (Abtrieb nicht vorn) <b>6PK2264D1</b>



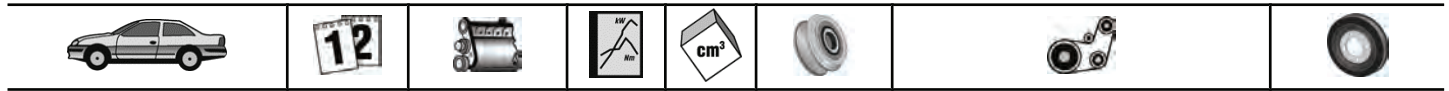

**MERCEDES-BENZ**
**SPRINTER 4-t Kasten (904)**

						nicht vorn) ⇒MTR-NO 50185180, ALT, (AC), <b>6PK2271D2</b> (Abtrieb vorn) OE-NO A611 030 10 03, A611 030 14 03, <b>VD1041</b> (Code: 170) OE-NO A611 030 02 03, A646 030 09 03, <b>VD1042</b> A611 030 05 03
413 CDI	04/00-05/06	OM611.981	95	2148	<b>AP9010</b>	ALT, (Bosch), OE-NO 012 154 2002, A 013 154 1702, 90A, OE-NO A 012 154 2402, 115A, OE-NO A 013 154 1502, 120A, OE-NO A 012 154 4602, A 013 154 1302, 150A, OE-NO A 013 154 1102, 200A
					<b>AP9015</b>	ALT, (Bosch), OE-NO A 011 154 0602, 90A, OE-NO A 011 154 0902, 115A CH-NO R220798⇒, ALT, (-AC), (Abtrieb nicht vorn) ⇒MTR-NO 50185180, ALT, (AC), <b>6PK2264D1</b> (Abtrieb vorn) ⇒MTR-NO 50185180, ALT, (AC), <b>6PK2271D2</b> (Abtrieb vorn) OE-NO A611 030 10 03, A611 030 14 03, <b>VD1041</b> (Code: 170) OE-NO A611 030 02 03, A646 030 09 03, <b>VD1042</b> A611 030 05 03
413 CDI 4x4	04/00-05/06	OM611.981	95	2148	<b>AP9010</b>	ALT, (Bosch), OE-NO 012 154 2002, A 013 154 1702, 90A, OE-NO A 012 154 2402, 115A, OE-NO A 013 154 1502, 120A, OE-NO A 012 154 4602, A 013 154 1302, 150A, OE-NO A 013 154 1102, 200A
					<b>AP9015</b>	ALT, (Bosch), OE-NO A 011 154 0602, 90A, OE-NO A 011 154 0902, 115A OE-NO A611 030 02 03, A646 030 09 03, <b>VD1042</b> A611 030 05 03
416 CDI	04/00-05/06	OM612.981	115	2685	<b>AP9010</b>	ALT, (Bosch), OE-NO 012 154 2002, A 013 154 1702, 90A, OE-NO A 012 154 2402, 115A, OE-NO A 013 154 1502, 120A, OE-NO A 012 154 4602, A 013 154 1302, 150A, OE-NO A 013 154 1102, 200A
					<b>AP9015</b>	ALT, (Bosch), OE-NO A 011 154 0602, 90A, OE-NO A 011 154 0902, 115A (MANL), ⇒MTR-NO 50076683 <b>VD1036</b>
416 CDI 4x4	04/00-05/06	OM612.981	115	2685	<b>AP9010</b>	ALT, (Bosch), OE-NO 012 154 2002, A 013 154 1702, 90A, OE-NO A 012 154 2402, 115A, OE-NO A 013 154 1502, 120A, OE-NO A 012 154 4602, A 013 154 1302, 150A, OE-NO A 013 154 1102, 200A
					<b>AP9015</b>	ALT, (Bosch), OE-NO A 011 154 0602, 90A, OE-NO A 011 154 0902, 115A (MANL), ⇒MTR-NO 50076683 <b>VD1036</b>

**SPRINTER 4-t Pritsche/Fahrgestell (904)**

408 CDI	04/00-05/06	OM611.987	60	2148	<b>AP9010</b>	ALT, (Bosch), OE-NO 012 154 2002, A 013 154 1702, 90A, OE-NO A 012 154 2402, 115A, OE-NO A 013 154 1502, 120A, OE-NO A 012 154 4602, A 013 154 1302, 150A, OE-NO A 013 154 1102, 200A
					<b>AP9015</b>	ALT, (Bosch), OE-NO A 011 154 0602, 90A, OE-NO A 011 154 0902, 115A CH-NO R220798⇒, ALT, (-AC), (Abtrieb nicht vorn) ⇒MTR-NO 50185180, ALT, (AC), <b>6PK2264D1</b> (Abtrieb vorn) ⇒MTR-NO 50185180, ALT, (AC), <b>6PK2271D2</b> (Abtrieb vorn) OE-NO A611 030 10 03, A611 030 14 03, <b>VD1041</b> (Code: 170) OE-NO A611 030 02 03, A646 030 09 03, <b>VD1042</b> A611 030 05 03
408 D	02/96-05/06	OM601.943	58	2299	<b>AP9034</b>	ALT
411 CDI	04/00-05/06	OM611.981	80	2148	<b>AP9010</b>	ALT, (Bosch), OE-NO 012 154 2002, A 013 154 1702, 90A, OE-NO A 012 154 2402, 115A, OE-NO A 013 154 1502, 120A, OE-NO A 012 154 4602, A 013 154 1302, 150A, OE-NO A 013 154 1102, 200A
					<b>AP9015</b>	ALT, (Bosch), OE-NO A 011 154 0602, 90A, OE-NO A 011 154 0902, 115A CH-NO R220798⇒, ALT, (-AC), (Abtrieb nicht vorn) ⇒MTR-NO 50185180, ALT, (AC), <b>6PK2264D1</b> (Abtrieb vorn) ⇒MTR-NO 50185180, ALT, (AC), <b>6PK2271D2</b> (Abtrieb vorn) OE-NO A611 030 10 03, A611 030 14 03, <b>VD1041</b> (Code: 170) OE-NO A611 030 02 03, A646 030 09 03, <b>VD1042</b> A611 030 05 03

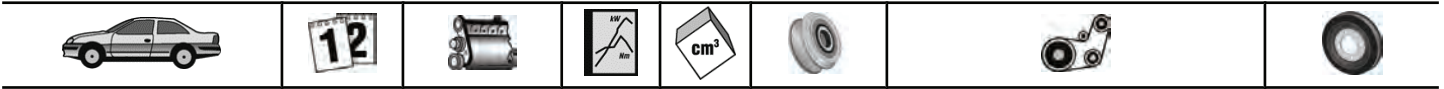



## MERCEDES-BENZ

### SPRINTER 4-t Pritsche/Fahrgestell (904)

						nicht vorn) ⇒MTR-NO 50185180, ALT, (AC), <b>6PK2271D2</b> (Abtrieb vorn) OE-NO A611 030 10 03, A611 030 14 03, <b>VD1041</b> (Code: 170) OE-NO A611 030 02 03, A646 030 09 03, <b>VD1042</b> A611 030 05 03
411 CDI 4x4	04/00-05/06	OM611.981	80	2148	<b>AP9010</b>	ALT, (Bosch), OE-NO 012 154 2002, A 013 154 1702, 90A, OE-NO A 012 154 2402, 115A, OE-NO A 013 154 1502, 120A, OE-NO A 012 154 4602, A 013 154 1302, 150A, OE-NO A 013 154 1102, 200A
					<b>AP9015</b>	ALT, (Bosch), OE-NO A 011 154 0602, 90A, OE-NO A 011 154 0902, 115A CH-NO R220798⇒, ALT, (-AC), (Abtrieb nicht vorn) ⇒MTR-NO 50185180, ALT, (AC), <b>6PK2264D1</b> (Abtrieb vorn) ⇒MTR-NO 50185180, ALT, (AC), <b>6PK2271D2</b> (Abtrieb vorn) OE-NO A611 030 10 03, A611 030 14 03, <b>VD1041</b> (Code: 170) OE-NO A611 030 02 03, A646 030 09 03, <b>VD1042</b> A611 030 05 03
413 CDI	04/00-05/06	OM611.981	95	2148	<b>AP9010</b>	ALT, (Bosch), OE-NO 012 154 2002, A 013 154 1702, 90A, OE-NO A 012 154 2402, 115A, OE-NO A 013 154 1502, 120A, OE-NO A 012 154 4602, A 013 154 1302, 150A, OE-NO A 013 154 1102, 200A
					<b>AP9015</b>	ALT, (Bosch), OE-NO A 011 154 0602, 90A, OE-NO A 011 154 0902, 115A CH-NO R220798⇒, ALT, (-AC), (Abtrieb nicht vorn) ⇒MTR-NO 50185180, ALT, (AC), <b>6PK2264D1</b> (Abtrieb vorn) ⇒MTR-NO 50185180, ALT, (AC), <b>6PK2271D2</b> (Abtrieb vorn) OE-NO A611 030 10 03, A611 030 14 03, <b>VD1041</b> (Code: 170) OE-NO A611 030 02 03, A646 030 09 03, <b>VD1042</b> A611 030 05 03
413 CDI 4x4	04/00-05/06	OM611.981	95	2148	<b>AP9010</b>	ALT, (Bosch), OE-NO 012 154 2002, A 013 154 1702, 90A, OE-NO A 012 154 2402, 115A, OE-NO A 013 154 1502, 120A, OE-NO A 012 154 4602, A 013 154 1302, 150A, OE-NO A 013 154 1102, 200A
					<b>AP9015</b>	ALT, (Bosch), OE-NO A 011 154 0602, 90A, OE-NO A 011 154 0902, 115A OE-NO A611 030 02 03, A646 030 09 03, <b>VD1042</b> A611 030 05 03
416 CDI	04/00-05/06	OM612.981	115	2685	<b>AP9010</b>	ALT, (Bosch), OE-NO 012 154 2002, A 013 154 1702, 90A, OE-NO A 012 154 2402, 115A, OE-NO A 013 154 1502, 120A, OE-NO A 012 154 4602, A 013 154 1302, 150A, OE-NO A 013 154 1102, 200A
					<b>AP9015</b>	ALT, (Bosch), OE-NO A 011 154 0602, 90A, OE-NO A 011 154 0902, 115A (MANL), ⇒MTR-NO 50076683 <b>VD1036</b>
416 CDI 4x4	04/00-05/06	OM612.981	115	2685	<b>AP9010</b>	ALT, (Bosch), OE-NO 012 154 2002, A 013 154 1702, 90A, OE-NO A 012 154 2402, 115A, OE-NO A 013 154 1502, 120A, OE-NO A 012 154 4602, A 013 154 1302, 150A, OE-NO A 013 154 1102, 200A
					<b>AP9015</b>	ALT, (Bosch), OE-NO A 011 154 0602, 90A, OE-NO A 011 154 0902, 115A (MANL), ⇒MTR-NO 50076683 <b>VD1036</b>
<b>SPRINTER 5-t Kasten (906)</b>						
509 CDI	06/06-	OM646.984	65	2148	<b>AP9050</b>	ALT, (Valeo)
511 CDI	06/06-	OM646.985	80	2148	<b>AP9050</b>	ALT, (Valeo)
515 CDI	06/06-	OM646.986	110	2148	<b>AP9050</b>	ALT, (Valeo)
518 CDI	06/06-	OM642.992	135	2987	<b>AP9050</b>	ALT, (Valeo)
<b>SPRINTER 5-t Pritsche/Fahrgestell (906)</b>						
509 CDI	06/06-	OM646.984	65	2148	<b>AP9050</b>	ALT, (Valeo)
511 CDI	06/06-	OM646.985	80	2148	<b>AP9050</b>	ALT, (Valeo)
515 CDI	06/06-	OM646.990	110	2148	<b>AP9050</b>	ALT, (Valeo)
518 CDI	06/06-	OM642.992	135	2987	<b>AP9050</b>	ALT, (Valeo)

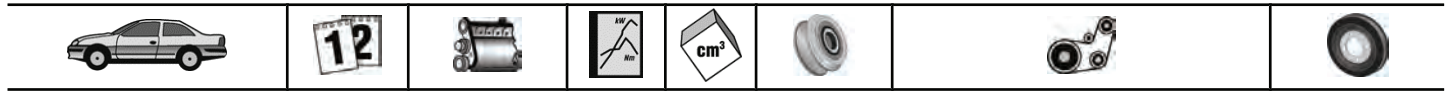

<b>MERCEDES-BENZ</b>							
<b>SPRINTER Kipper</b>							
↳ 616 CDI	04/01-	OM612.981	115	2685		(MANL), MTR-NO 50076683⇒	<b>VD1036</b>
<b>SPRINTER Pritsche/Fahrgestell</b>							
616 CDI	04/01-	OM612.981	115	2685		(MANL), MTR-NO 50076683⇒	<b>VD1036</b>
<b>VANEO (414)</b>							
1.6 (414.700)	02/02-	M166.961	60	1598	<b>AP9014</b>	ALT, (Valeo), 150A, OE-NO 668 154 01 02, 668 154 02 02, 668 154 03 02	<b>VD1093</b>
			75	1598	<b>AP9014</b>	ALT, (Valeo), 150A, OE-NO 668 154 01 02, 668 154 02 02, 668 154 03 02	
1.7 CDI (414.700)	02/02-	OM668.914	55	1689	<b>AP9014</b>	ALT, (Valeo), 150A, OE-NO 668 154 01 02, 668 154 02 02, 668 154 03 02	<b>VD1093</b>
			67	1689	<b>AP9014</b>	ALT, (Valeo), 150A, OE-NO 668 154 01 02, 668 154 02 02, 668 154 03 02	
1.9 (414.700)	02/02-	M166.991	92	1898	<b>AP9014</b>	ALT, (Valeo), 150A, OE-NO 668 154 01 02, 668 154 02 02, 668 154 03 02	<b>VD1093</b>
					<b>AP9055</b>	ALT, (Valeo), 90A, OE-NO 012 154 43 02	
<b>V-CLASS (638/2)</b>							
V 200 CDI (638.294)	03/99-07/03	OM611.980	75	2151	<b>AP9010</b>	ALT, (Bosch), OE-NO A 012 154 2202, 90A, OE-NO A 012 154 5402, 120A, OE-NO A 012 154 1702, 150A	<b>VD1041</b>
					<b>AP9015</b>	ALT, (Bosch), OE-NO A 010 154 9502, 90A, OE-NO A 010 154 9602, 120A, OE-NO A 011 154 7002, 150A	
						OE-NO A611 030 10 03, A611 030 14 03, (Code: 170)	<b>VD1042</b>
						OE-NO A611 030 02 03, A646 030 09 03, A611 030 05 03	
V 220 CDI (638.294)	03/99-07/03	OM611.980	90	2151	<b>AP9010</b>	ALT, (Bosch), OE-NO A 012 154 2202, 90A, OE-NO A 012 154 5402, 120A, OE-NO A 012 154 1702, 150A	<b>VD1041</b>
					<b>AP9015</b>	ALT, (Bosch), OE-NO A 010 154 9502, 90A, OE-NO A 010 154 9602, 120A, OE-NO A 011 154 7002, 150A	
						OE-NO A611 030 10 03, A611 030 14 03, (Code: 170)	<b>VD1042</b>
						OE-NO A611 030 02 03, A646 030 09 03, A611 030 05 03	
V 230 TD (638.274)	09/96-07/03	OM601.970	72	2299	<b>AP9060</b>	ALT, (Bosch)	
<b>VIANO (W639)</b>							
CDI 2.0	08/05-	OM646.982	85	2148	<b>AP9010</b>	ALT, (Bosch), OE-NO A 013 154 1002, 200A	<b>VD1041</b>
	09/03-	OM646.982	80	2148	<b>AP9010</b>	ALT, (Bosch), 200A, OE-NO 013 154 1002, 013 154 2102	
						ALT, (-PTO)	<b>6PK2260D3</b>
						⇒CH-NO 158569, ⇒MTR-NO 50	<b>6PK2271D2</b>
						222461, ALT, (PTO)	<b>VD1041</b>
						OE-NO A611 030 10 03, A611 030 14 03	<b>VD1042</b>
						OE-NO A611 030 02 03, A646 030 09 03, A611 030 05 03	
CDI 2.0 4-matic	07/05-	OM646.982	80	2148	<b>AP9010</b>	ALT, (Bosch), 200A, OE-NO 013 154 1002, 013 154 2102	<b>VD1041</b>
						ALT, (-PTO)	
						⇒CH-NO 158569, ⇒MTR-NO 50	<b>6PK2260D3</b>
						222461, ALT, (PTO)	<b>6PK2271D2</b>
						(PTO)	<b>VD1041</b>
						(-PTO)	<b>VD1042</b>
CDI 2.2	09/03-	OM646.982	110	2148	<b>AP9010</b>	ALT, (Bosch), 200A, OE-NO 013 154 1002, 013 154 2102	<b>VD1041</b>
						ALT, (-PTO)	
						⇒CH-NO 158569, ⇒MTR-NO 50	<b>6PK2260D3</b>
						222461, ALT, (PTO)	<b>6PK2271D2</b>
						OE-NO A611 030 10 03, A611 030 14 03	<b>VD1041</b>
						OE-NO A611 030 02 03, A646 030 09 03, A611 030 05 03	<b>VD1042</b>
CDI 2.2 4-matic	07/05-	OM646.982	110	2148	<b>AP9010</b>	ALT, (Bosch), 200A, OE-NO 013 154 1002, 013 154 2102	<b>VD1041</b>
						ALT, (-PTO)	
						⇒CH-NO 158569, ⇒MTR-NO 50	<b>6PK2260D3</b>
						222461, ALT, (PTO)	<b>6PK2271D2</b>
						(PTO)	<b>VD1041</b>







## MERCEDES-BENZ

VIANO (W639)

						(-PTO)	VD1042
<b>VITO / MIXTO Kasten (W639)</b>							
109 CDI	08/06-	OM646.981	70	2148	<b>AP9010</b>	ALT, (Bosch), OE-NO A 013 154 1002, 200A ALT, (-AC) ALT, (AC), ⇒CH-NO 158569, ⇒MTR-NO 50 222461 (AC) (-AC)	6PK2260D3 6PK2271D2 VD1041 VD1042
109 CDI	09/03-	OM646.983	65	2148	<b>AP9010</b>	ALT, (Bosch), 200A, OE-NO 013 154 1002, 013 154 2102 ALT, (-PTO) ⇒CH-NO 158569, ⇒MTR-NO 50 222462, ALT, (PTO) (PTO) (-PTO)	6PK2260D3 6PK2271D2 VD1041 VD1042
111 CDI	09/03-	OM646.982	80	2148	<b>AP9010</b>	ALT, (Bosch), 200A, OE-NO 013 154 1002, 013 154 2102 ALT, (-PTO) ⇒CH-NO 158569, ⇒MTR-NO 50 222461, ALT, (PTO) OE-NO A611 030 10 03, A611 030 14 03 OE-NO A611 030 02 03, A646 030 09 03, A611 030 05 03	6PK2260D3 6PK2271D2 VD1041 VD1042
	09/07-	OM646.982	85	2148	<b>AP9010</b>	ALT, (Bosch), 200A, OE-NO 013 154 1002, 013 154 2102 ALT, (-PTO) ⇒CH-NO 158569, ⇒MTR-NO 50 222461, ALT, (PTO) (PTO) (-PTO)	6PK2260D3 6PK2271D2 VD1041 VD1042
111 CDI 4x4	09/07-	OM646.982	80	2148	<b>AP9010</b>	ALT, (Bosch), 200A, OE-NO 013 154 1002, 013 154 2102 ALT, (-PTO) ⇒CH-NO 158569, ⇒MTR-NO 50 222461, ALT, (PTO) (PTO) (-PTO)	6PK2260D3 6PK2271D2 VD1041 VD1042
115 CDI	09/03-	OM646.982	110	2148	<b>AP9010</b>	ALT, (Bosch), 200A, OE-NO 013 154 1002, 013 154 2102 ALT, (-PTO) ⇒CH-NO 158569, ⇒MTR-NO 50 222461, ALT, (PTO) OE-NO A611 030 10 03, A611 030 14 03 OE-NO A611 030 02 03, A646 030 09 03, A611 030 05 03	6PK2260D3 6PK2271D2 VD1041 VD1042
115 CDI 4x4	09/07-	OM646.982	110	2148	<b>AP9010</b>	ALT, (Bosch), 200A, OE-NO 013 154 1002, 013 154 2102 ALT, (-PTO) ⇒CH-NO 158569, ⇒MTR-NO 50 222461, ALT, (PTO) (PTO) (-PTO)	6PK2260D3 6PK2271D2 VD1041 VD1042
<b>VITO Bus (638)</b>							
108 CDI 2.2 (638.194)	03/99-07/03	OM611A (60KWCDI)	60	2148	<b>AP9010</b>	ALT, (Bosch), OE-NO A 012 154 2202, 90A, OE-NO A 012 154 54023, 120A, OE-NO A 012 154 1702, 150A	
					<b>AP9015</b>	ALT, (Bosch), OE-NO A 010 154 9502, 90A, OE-NO A 010 154 9602, 120A, OE-NO A 011 154 7002, 150A	
108 D 2.3 (638.164)	02/96-07/03	OM601.942	58	2299	<b>AP9060</b>	ALT, (Bosch)	
110 CDI 2.2 (638.194)	03/99-07/03	OM611LA (75KWCDI)	75	2148	<b>AP9010</b>	ALT, (Bosch), OE-NO A 012 154 2202, 90A, OE-NO A 012 154 5402, 120A, OE-NO A 012 154 1702, 150A	
					<b>AP9015</b>	ALT, (Bosch), OE-NO A 010 154 9502, 90A, OE-NO A 010 154 9602, 120A, OE-NO A 011 154 7002, 150A	
110 TD 2.3 (638.174)	02/96-07/03	OM601.970	72	2299	<b>AP9060</b>	ALT, (Bosch)	
112 CDI 2.2 (638.194)	03/99-07/03	OM611.980	90	2151	<b>AP9015</b>	ALT, (Bosch), OE-NO A 010 154 9502, 90A, OE-NO A 010 154 9602, 120A, OE-NO A 011 154 7002, 150A OE-NO A611 030 10 03, A611 030 14 03, (Code: 170) OE-NO A611 030 02 03, A646 030 09 03, A611 030 05 03	VD1041 VD1042
<b>VITO Bus (W639)</b>							
109 CDI	09/03-	OM646.983	65	2148	<b>AP9010</b>	ALT, (Bosch), 200A, OE-NO 013 154 1002, 013 154 2102	



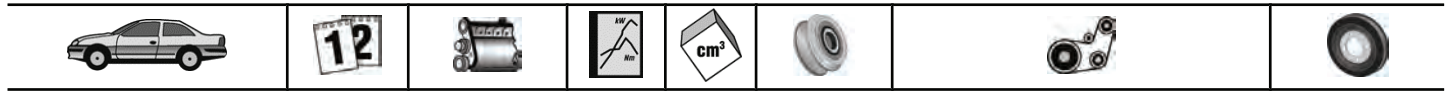

# MERCEDES-BENZ

## VITO Bus (W639)

						ALT, (-PTO) ⇒CH-NO 158569, ⇒MTR-NO 50 222462, ALT, (PTO) (PTO) (-PTO)	<b>6PK2260D3</b> <b>6PK2271D2</b>  <b>VD1041</b> <b>VD1042</b>
109 CDI 4x4	09/06- 09/07-	OM646.980 OM646.981	70 70	2148	<b>AP9010</b>	ALT, (Bosch), OE-NO A 013 154 1002, 200A ALT, (Bosch), OE-NO A 013 154 1002, 200A ALT, (-AC) ALT, (AC), ⇒CH-NO 158569, ⇒MTR-NO 50 222461 (AC) (-AC)	<b>6PK2260D3</b> <b>6PK2271D2</b>  <b>VD1041</b> <b>VD1042</b>
111 CDI	09/03-	OM646.982	80	2148	<b>AP9010</b>	ALT, (Bosch), 200A, OE-NO 013 154 1002, 013 154 2102 ALT, (-PTO) ⇒CH-NO 158569, ⇒MTR-NO 50 222461, ALT, (PTO) OE-NO A611 030 10 03, A611 030 14 03 OE-NO A611 030 02 03, A646 030 09 03, A611 030 05 03	<b>6PK2260D3</b> <b>6PK2271D2</b>  <b>VD1041</b> <b>VD1042</b>
111 CDI 4x4	09/07-	OM646.982	85	2148	<b>AP9010</b>	ALT, (Bosch), 200A, OE-NO 013 154 1002, 013 154 2102 ALT, (-PTO) ⇒CH-NO 158569, ⇒MTR-NO 50 222461, ALT, (PTO) (PTO) (-PTO)	<b>6PK2260D3</b> <b>6PK2271D2</b>  <b>VD1041</b> <b>VD1042</b>
115 CDI	09/03-	OM646.982	110	2148	<b>AP9010</b>	ALT, (Bosch), 200A, OE-NO 013 154 1002, 013 154 2102 ALT, (-PTO) ⇒CH-NO 158569, ⇒MTR-NO 50 222461, ALT, (PTO) OE-NO A611 030 10 03, A611 030 14 03 OE-NO A611 030 02 03, A646 030 09 03, A611 030 05 03	<b>6PK2260D3</b> <b>6PK2271D2</b>  <b>VD1041</b> <b>VD1042</b>
115 CDI 4x4	09/07-	OM646.982	110	2148	<b>AP9010</b>	ALT, (Bosch), OE-NO A 013 154 1002, 200A ALT, (-PTO) ⇒CH-NO 158569, ⇒MTR-NO 50 222461, ALT, (PTO) (PTO) (-PTO)	<b>6PK2260D3</b> <b>6PK2271D2</b>  <b>VD1041</b> <b>VD1042</b>

## VITO Kasten (638)

108 CDI 2.2 (638.094)	03/99-07/03	OM611A (60KWCDI)	60	2151	<b>AP9010</b>  <b>AP9015</b>	ALT, (Bosch), OE-NO A 012 154 2202, 90A, OE-NO A 012 154 5402, 120A, OE-NO A 012 154 1702, 150A ALT, (Bosch), OE-NO A 010 154 9502, 90A, OE-NO A 010 154 9602, 120A, OE-NO A 011 154 7002, 150A	
108 D 2.3 (638.064)	03/97-07/03	OM601.942	58	2299	<b>AP9060</b>	ALT, (Bosch)	
110 CDI 2.2 (638.094)	03/99-07/03	OM611LA (75KWCDI)	75	2151	<b>AP9010</b>  <b>AP9015</b>	ALT, (Bosch), OE-NO A 012 154 2202, 90A, OE-NO A 012 154 5402, 120A, OE-NO A 012 154 1702, 150A ALT, (Bosch), OE-NO A 010 154 9502, 90A, OE-NO A 010 154 9602, 120A, OE-NO A 011 154 7002, 150A	
110 D 2.3 (638.074)	03/97-07/03	OM601.970	72	2299	<b>AP9060</b>	ALT, (Bosch)	
112 CDI 2.2 (638.094)	03/99-07/03	OM611.980	90	2151	<b>AP9015</b>	ALT, (Bosch), OE-NO A 010 154 9502, 90A, OE-NO A 010 154 9602, 120A, OE-NO A 011 154 7002, 150A OE-NO A611 030 10 03, A611 030 14 03, (Code: 170) OE-NO A611 030 02 03, A646 030 09 03, A611 030 05 03	<b>VD1041</b> <b>VD1042</b>

## MG

### MG ZT

2.0 CDTi	06/02-09/03	204D2	85	1951		MTR-CODE: M47	<b>VD1087</b>
	11/02-	204D2	96	1951		MTR-CODE: M47	<b>VD1087</b>



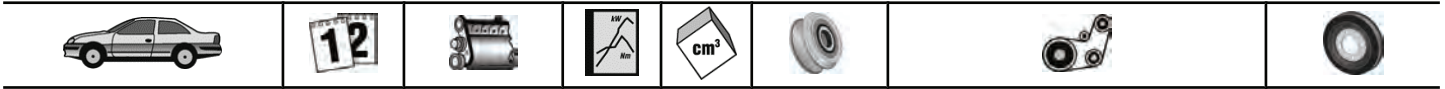

## MG

### MG ZT- T

↩ 2.0 CDTi	06/02-09/03	204D2	85	1951		MTR-CODE: M47	VD1087
	11/02-	204D2	96	1951		MTR-CODE: M47	VD1087

## MINI

### MINI (R56)

Cooper D	03/07-	9HZ (DV6TED4)	80	1560	AP9023	ALT, (Bosch), OE-NO 1231 7 794 970, 1231 7 806 779, 145A, ALT, (Bosch), 145A, OE-NO 1231 7 806 779	VD1096
One D	06/09-07/10		66	1560	AP9023	ALT, (Bosch), 145A, OE-NO 1231 7 806 779	

### MINI CLUBMAN (R55)

Cooper D	10/07-	9HZ (DV6TED4)	80	1560	AP9023	ALT, (Bosch), OE-NO 1231 7 794 970, 1231 7 806 779, 145A, ALT, (Bosch), 145A, OE-NO 1231 7 806 779	VD1096
----------	--------	------------------	----	------	--------	----------------------------------------------------------------------------------------------------------	--------

## MITSUBISHI

### CARISMA (DA\_)

1.9 DI-D	09/00-06/06	F9Q2	85	1870	AP9043 AP9052	ALT, (-AC) ALT, (AC)	
1.9 DI-D (DA5A)	09/00-06/06	F9Q1	75	1870	AP9043 AP9052	ALT, (-AC) ALT, (AC)	

### CARISMA Stufenheck (DA\_)

1.9 DI-D	09/00-06/06	F9Q2	85	1870	AP9043 AP9052	ALT, (-AC) ALT, (AC)	
1.9 DI-D (DA5A)	09/00-06/06	F9Q1	75	1870	AP9043 AP9052	ALT, (-AC) ALT, (AC)	

### COLT VI (Z\_)

1.5 DI-D	08/04-		50	1493	AP9014	ALT, OE-NO MN960266, 115A	
		OM639	70	1493	AP9014	ALT, OE-NO MN960266, 115A	

### SPACE STAR (DG0)

1.9 DI-D	10/02-	F9Q2	85	1870	AP9039 AP9043	ALT, (AC) ALT, (-AC)	
1.9 DI-D (DG4A)	02/01-	F9Q1	75	1870	AP9039 AP9043	ALT, (AC) ALT, (-AC)	

## NISSAN

### ALMERA II (N16)

1.5 dCi	01/03-	K9K722	60	1461	AP9025	ALT, (Bosch), 110A, OE-NO 23100-BN700, 23100-BN701, 23100-BN704	
---------	--------	--------	----	------	--------	-----------------------------------------------------------------------	--

### ALMERA II Hatchback (N16)

1.5 dCi	01/03-	K9K722	60	1461	AP9025	ALT, (Bosch), 110A, OE-NO 23100-BN700, 23100-BN701, 23100-BN704	
---------	--------	--------	----	------	--------	-----------------------------------------------------------------------	--

### INTERSTAR Bus (X70)

dCi 100	04/06-		74	2464	AP9039	ALT, (Valeo), 125A, OE-NO 23100-00QA7, 23100-00QAM, 23100-00QBE, 23100-00Q0A	
	11/03-		73	2463	AP9039	ALT, (Valeo), 125A, OE-NO 23100-00QA7, 23100-00QAM, 23100-00QBE, 23100-00Q0A	
dCi 120	07/02-	G9U720	84	2463	AP9039	ALT, (Valeo), 125A, OE-NO 23100-00QA7, 23100-00QAM, 23100-00QBE, 23100-00Q0A	
	09/06-	G9U650	88	2464	AP9039	ALT, (Valeo), 125A, OE-NO 23100-00QA7, 23100-00QAM, 23100-00QBE, 23100-00Q0A	
dCi 150	09/06-	G9U632	107	2464	AP9039	ALT, (Valeo), 125A, OE-NO 23100-00QA7, 23100-00QAM, 23100-00QBE, 23100-00Q0A	
dCi 80	07/02-	F9Q772	60	1870	AP9039	ALT, (Valeo), 125A, OE-NO 23100-00QA7, 23100-00QAM, 23100-00QBE, 23100-00Q0A	
dCi 90	07/02-	G9T722	66	2188	AP9043	ALT, (-AC)	
					AP9039	ALT, (Valeo), 125A, OE-NO 23100-00QA7, 23100-00QAM, 23100-00QBE, 23100-00Q0A	

### INTERSTAR Kasten (X70)

dCi 100	04/06-	G9U720	74	2464	AP9039	ALT, (Valeo), 125A, OE-NO 23100-00QA7, 23100-00QAM, 23100-00QBE, 23100-00Q0A	
dCi 120	07/02-	G9U720	84	2463	AP9039	ALT, (Valeo), 125A, OE-NO 23100-00QA7, 23100-00QAM, 23100-00QBE, 23100-00Q0A	





# NISSAN

## INTERSTAR Kasten (X70)

		G9U650	88	2464	<b>AP9039</b>	ALT, (Valeo), 125A, OE-NO 23100-00QA7, 23100-00QAM, 23100-00QBE, 23100-00Q0A
dCi 150	09/06-	G9U632	107	2464	<b>AP9039</b>	ALT, (Valeo), 125A, OE-NO 23100-00QA7, 23100-00QAM, 23100-00QBE, 23100-00Q0A
dCi 80	07/02-	F9Q772	60	1870	<b>AP9039</b>  <b>AP9043</b>	ALT, (Valeo), 125A, OE-NO 23100-00QA7, 23100-00QAM, 23100-00QBE, 23100-00Q0A ALT, (-AC)
dCi 90	07/02-	G9T722	66	2188	<b>AP9039</b>	ALT, (Valeo), 125A, OE-NO 23100-00QA7, 23100-00QAM, 23100-00QBE, 23100-00Q0A

## INTERSTAR Pritsche/Fahrgestell

dCi 100	02/04-		73	2463	<b>AP9039</b>	ALT, (Valeo), 125A, OE-NO 23100-00QA7, 23100-00QAM, 23100-00QBE, 23100-00Q0A
dCi 120	08/03-	G9U720	84	2463	<b>AP9039</b>	ALT, (Valeo), 125A, OE-NO 23100-00QA7, 23100-00QAM, 23100-00QBE, 23100-00Q0A
	08/06-		88	2464	<b>AP9039</b>	ALT, (Valeo), 125A, OE-NO 23100-00QA7, 23100-00QAM, 23100-00QBE, 23100-00Q0A
dCi 150	08/06-		107	2464	<b>AP9039</b>	ALT, (Valeo), 125A, OE-NO 23100-00QA7, 23100-00QAM, 23100-00QBE, 23100-00Q0A

## KUBISTAR (X76)

1.5 dCi	08/03-		42	1461	<b>AP9025</b> <b>AP9025</b> <b>AP9025</b>	ALT, (Bosch), 110A, OE-NO 23100-00QA9 ALT, (Mitsubishi), 110A, OE-NO A002TC0981 ALT, (Valeo), 125A, OE-NO 23100-00QHB, 23100-00QHD	
			K9K704	48	1461	<b>AP9025</b> <b>AP9025</b> <b>AP9025</b>	ALT, (Bosch), 110A, OE-NO 23100-00QA9 ALT, (Mitsubishi), 110A, OE-NO A002TC0981 ALT, (Valeo), 125A, OE-NO 23100-00QHB, 23100-00QHD
			K9K722	60	1461	<b>AP9025</b> <b>AP9025</b> <b>AP9025</b>	ALT, (Bosch), 110A, OE-NO 23100-00QA9 ALT, (Mitsubishi), 110A, OE-NO A002TC0981 ALT, (Valeo), 125A, OE-NO 23100-00QHB, 23100-00QHD
	1.5 dCi 70	04/06-	K9K700	50	1461	<b>AP9025</b> <b>AP9025</b> <b>AP9025</b>	ALT, (Bosch), 110A, OE-NO 23100-00QA9 ALT, (Mitsubishi), 110A, OE-NO A002TC0981 ALT, (Valeo), 125A, OE-NO 23100-00QHB, 23100-00QHD
				45	1461	<b>AP9025</b> <b>AP9025</b> <b>AP9025</b>	ALT, (Bosch), 110A, OE-NO 23100-00QA9 ALT, (Mitsubishi), 110A, OE-NO A002TC0981 ALT, (Valeo), 125A, OE-NO 23100-00QHB, 23100-00QHD
				62	1461	<b>AP9025</b> <b>AP9025</b> <b>AP9025</b>	ALT, (Bosch), 110A, OE-NO 23100-00QA9 ALT, (Mitsubishi), 110A, OE-NO A002TC0981 ALT, (Valeo), 125A, OE-NO 23100-00QHB, 23100-00QHD
	1.5 dCi 85	04/06-	K9K276	62	1461	<b>AP9025</b> <b>AP9025</b> <b>AP9025</b>	ALT, (Bosch), 110A, OE-NO 23100-00QA9 ALT, (Mitsubishi), 110A, OE-NO A002TC0981 ALT, (Valeo), 125A, OE-NO 23100-00QHB, 23100-00QHD

## KUBISTAR Kasten

1.5 dCi	08/03-	K9K704	48	1461	<b>AP9025</b> <b>AP9025</b> <b>AP9025</b>	ALT, (Bosch), 110A, OE-NO 23100-00QA9 ALT, (Mitsubishi), 110A, OE-NO A002TC0981 ALT, (Valeo), 125A, OE-NO 23100-00QHB, 23100-00QHD
		K9K722	60	1461	<b>AP9025</b> <b>AP9025</b> <b>AP9025</b>	ALT, (Bosch), 110A, OE-NO 23100-00QA9 ALT, (Mitsubishi), 110A, OE-NO A002TC0981 ALT, (Valeo), 125A, OE-NO 23100-00QHB, 23100-00QHD
	08/05-		45	1461	<b>AP9025</b>	ALT, (Bosch), 110A, OE-NO 23100-00QA9



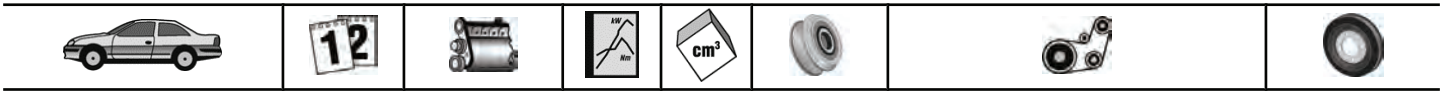

## NISSAN

### KUBISTAR Kasten

					AP9025	ALT, (Mitsubishi), 110A, OE-NO A002TC0981
					AP9025	ALT, (Valeo), 125A, OE-NO 23100-00QHB, 23100-00QHD

### MICRA III (K12)

1.5 dCi	01/03-	K9K704	48	1461	AP9025	ALT, (Bosch), 110A, OE-NO 23100-BN700, 120A, OE-NO 23100-00QAU
					AP9025	ALT, (Valeo), 110A, OE-NO 23100-00Q2H, 23100-00Q2C
	06/05-		50	1461	AP9025	ALT, (Bosch), 110A, OE-NO 23100-BN700, 120A, OE-NO 23100-00QAU
					AP9025	ALT, (Valeo), 110A, OE-NO 23100-00Q2H, 23100-00Q2C
	09/03-	K9K722	60	1461	AP9025	ALT, (Bosch), 110A, OE-NO 23100-BN700, 120A, OE-NO 23100-00QAU
					AP9025	ALT, (Valeo), 110A, OE-NO 23100-00Q2H, 23100-00Q2C

### NOTE (E11)

1.5 dCi	03/06-	K9K700	50	1461	AP9025	ALT, (Bosch), 110A, OE-NO 23100-BN700, 120A, OE-NO 23100-00QAU
					AP9025	ALT, (Valeo), 110A, OE-NO 23100-00Q2H, 23100-00Q2C
		K9K276	63	1461	AP9025	ALT, (Bosch), 110A, OE-NO 23100-BN700, 120A, OE-NO 23100-00QAU
					AP9025	ALT, (Valeo), 110A, OE-NO 23100-00Q2H, 23100-00Q2C
	07/08-	K9K292	76	1461	AP9025	ALT, (Bosch), 110A, OE-NO 23100-BN700, 120A, OE-NO 23100-00QAU
					AP9025	ALT, (Valeo), 110A, OE-NO 23100-00Q2H, 23100-00Q2C

### NV200 Bus

1.5 dci	02/10-		63	1461	AP9025	ALT, (Bosch), 110A, OE-NO 23100-BN700, 120A, OE-NO 23100-00QAU
					AP9025	ALT, (Valeo), 110A, OE-NO 23100-00Q2H, 23100-00Q2C

### NV200 Kasten

1.5 dci	02/10-		63	1461	AP9025	ALT, (Bosch), 110A, OE-NO 23100-BN700, 120A, OE-NO 23100-00QAU
					AP9025	ALT, (Valeo), 110A, OE-NO 23100-00Q2H, 23100-00Q2C

### PRIMASTAR Bus (X83)

dCi 100	03/01-	F9Q760	74	1870	AP9039	ALT, (Valeo), 125A, OE-NO 23100-00QA7, 23100-00QAM, 23100-00QBE, 23100-00Q0A
					AP9043	ALT, (-AC)
dCi 140	07/03-	G9U730	99	2463	AP9039	ALT, (Valeo), 125A, OE-NO 23100-00QA7, 23100-00QAM, 23100-00QBE, 23100-00Q0A
dCi 150	09/06-	G9U632	107	2464	AP9039	ALT, (Valeo), 125A, OE-NO 23100-00QA7, 23100-00QAM, 23100-00QBE, 23100-00Q0A
dCi 80	03/01-	F9Q762	60	1870	AP9039	ALT, (Valeo), 125A, OE-NO 23100-00QA7, 23100-00QAM, 23100-00QBE, 23100-00Q0A
					AP9043	ALT, (-AC)

### PRIMASTAR Kasten (X83)

dCi 100	09/02-	F9Q760	74	1870	AP9039	ALT, (Valeo), 125A, OE-NO 23100-00QA7, 23100-00QAM, 23100-00QBE, 23100-00Q0A
					AP9043	ALT, (-AC)
dCi 140	07/03-	G9U730	99	2463	AP9039	ALT, (Valeo), 125A, OE-NO 23100-00QA7, 23100-00QAM, 23100-00QBE, 23100-00Q0A
dCi 150	09/06-	G9U632	107	2464	AP9039	ALT, (Valeo), 125A, OE-NO 23100-00QA7, 23100-00QAM, 23100-00QBE, 23100-00Q0A
dCi 80	09/02-	F9Q762	60	1870	AP9039	ALT, (Valeo), 125A, OE-NO 23100-00QA7, 23100-00QAM, 23100-00QBE, 23100-00Q0A
					AP9043	ALT, (-AC)



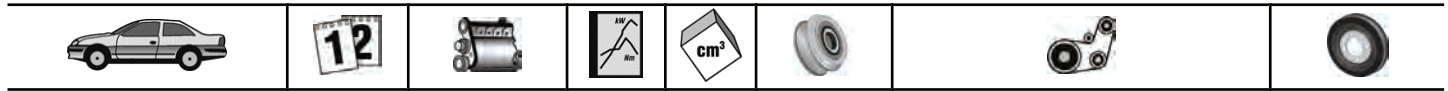

## NISSAN

PRIMERA (P12) 1.9 dCi	04/03-		88	1870			VD1104
	08/02-		85	1870			VD1104
PRIMERA Hatchback (P12) 1.9 dCi	04/03-		88	1870			VD1104
	08/02-		85	1870			VD1104
PRIMERA Kombi (WP12) 1.9 dCi	04/03-		88	1870			VD1104
	08/02-		85	1870			VD1104
TIIDA Schrägheck (C11X) 1.5 dCi	09/07-	K9K728	78	1461	AP9025	ALT, (Bosch), 110A, OE-NO 23100-BN700, 120A, OE-NO 23100-00QAU	
					AP9025	ALT, (Valeo), 110A, OE-NO 23100-00Q2H, 23100-00Q2C	
TIIDA Stufenheck (SC11X) 1.5 dCi	09/07-		78	1461	AP9025	ALT, (Bosch), 110A, OE-NO 23100-BN700, 120A, OE-NO 23100-00QAU	
					AP9025	ALT, (Valeo), 110A, OE-NO 23100-00Q2H, 23100-00Q2C	

## OPEL

AGILA (H00) 1.3 CDTI	08/03-	Z13DT	51	1248	AP9035	ALT, (Valeo), OE-NO 13117278, 70A, OE-NO 13117279, 100A	
ASTRA G Cabriolet	1.6	01/03-10/05	Z16XEP	76	1598		VD1106
	1.6 16V	03/01-10/05	Z16XE	74	1598	AP9003	ALT, (Bosch), 120A, OE-NO 9195336
	1.8 16V	03/01-10/05	Z18XE	92	1796	AP9003	ALT, (Bosch), 120A, OE-NO 9195336
ASTRA G Caravan (F35_)	1.4 16V	06/98-07/04	X14XE, Z14XE	66	1389	AP9003	ALT, (Bosch), 120A, OE-NO 9195336, CH-NO C 12257453⇒
	1.6	02/98-09/00	X16SZR	55	1598	AP9003	ALT, (Bosch), 120A, OE-NO 9195336, CH-NO C 15257664⇒
		09/00-07/04	Z16SE	62	1598	AP9003	ALT, (Bosch), 120A, OE-NO 9195336
	1.6 16V	12/02-07/04	Z16XEP	76	1598		VD1106
		02/98-07/04	X16XEL, Z16XE	74	1598	AP9003	ALT, (Bosch), 120A, OE-NO 9195336, MTR-CODE: X 16 XEL, CH-NO C 4G000001⇒
	1.6 16V	02/98-07/04	X16XEL, Z16XE	74	1598	AP9003	ALT, (Bosch), 120A, OE-NO 9195336, MTR-CODE: Z 16 XE
						AP9003	ALT, (Bosch), 120A, OE-NO 9195336, MTR-CODE: Z 16 XE
	1.6 CNG	03/03-07/04	Z16YNG	71	1598	AP9003	ALT, (Bosch), 120A, OE-NO 9195336
	1.7 CDTI	04/03-07/04	Z17DTL	59	1686	AP9044	ALT, (Delco Remy), 100A, 110A
						AP9044	ALT, (Hitachi), 100A, 110A
						ALT, (-AC), MTR-CODE: Z17DTL, MTR-NO 614509⇒	
1.8 16V	02/98-09/00	X18XE1	85	1796	AP9003	ALT, (Bosch), 120A, OE-NO 9195336	
	09/00-07/04	Z18XE	92	1796	AP9003	ALT, (Bosch), 120A, OE-NO 9195336	
2.0 16V	02/98-07/04	X20XEV	100	1998	AP9003	ALT, (Bosch), 120A, OE-NO 9195336	
2.0 DI	02/98-07/04	X20DTL, Y20DTL	60	1995		ALT	
						ALT, AC	
2.0 DTI 16V	08/99-07/04	X20DTH, Y20DTH	74	1995		ALT	
						ALT, AC	
ASTRA G CC (F48_, F08_)	1.4 16V	02/98-01/05	X14XE, Z14XE	66	1389	AP9003	ALT, (Bosch), 120A, OE-NO 9195336, CH-NO C 12257453⇒
	1.6	02/98-09/00	X16SZR	55	1598	AP9003	ALT, (Bosch), 120A, OE-NO 9195336, CH-NO C 15257664⇒
		09/00-01/05	Z16SE	62	1598	AP9003	ALT, (Bosch), 120A, OE-NO 9195336
		12/02-01/05	Z16XEP	76	1598		VD1106
	1.6 16V	02/98-01/05	X16XEL, Z16XE	74	1598	AP9003	ALT, (Bosch), 120A, OE-NO 9195336, MTR-CODE: X 16 XEL, CH-NO C 4G000001⇒
						AP9003	ALT, (Bosch), 120A, OE-NO 9195336, MTR-CODE: Z 16 XE
	1.7 CDTI	04/03-01/05	Z17DTL	59	1686	AP9044	ALT, (Delco Remy), 100A, 110A
						AP9044	ALT, (Hitachi), 100A, 110A
						ALT, (-AC), MTR-CODE: Z17DTL, MTR-NO 614509⇒	
						ALT, AC, MTR-CODE: Z17DTL, MTR-NO 614509⇒	
						MTR-NO 614509⇒	
						VD1068	



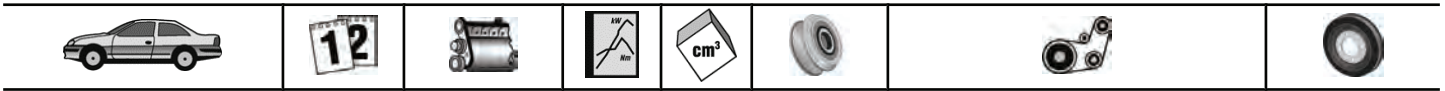

## OPEL

<b>ASTRA G CC (F48_, F08_)</b>							
↙ 1.8 16V	02/98-09/00	X18XE1	85	1796	<b>AP9003</b>	ALT, (Bosch), 120A, OE-NO 9195336	
	09/00-01/05	Z18XE	92	1796	<b>AP9003</b>	ALT, (Bosch), 120A, OE-NO 9195336	
2.0 16V	02/98-01/05	X20XE	100	1998	<b>AP9003</b>	ALT, (Bosch), 120A, OE-NO 9195336	
2.0 16V OPC	11/99-09/02	X20XER	118	1998	<b>AP9003</b>	ALT, (Bosch), 120A, OE-NO 9195336	
2.0 DI	02/98-01/05	X20DTL, Y20DTL	60	1995		ALT, PS ALT, AC	<b>6PK1800D1</b> <b>6PK1870D1</b> <b>VD1031</b>
2.0 DTI 16V	08/99-01/05	X20DTH, Y20DTH	74	1995		ALT ALT, AC	<b>6PK1800D1</b> <b>6PK1870D1</b> <b>VD1031</b>
<b>ASTRA G Coupe (F07_)</b>							
1.6 16V	03/00-05/05	Z16XEP	76	1598			<b>VD1106</b>
1.8 16V	03/00-10/00	X18XE1	85	1796	<b>AP9003</b>	ALT, (Bosch), 120A, OE-NO 9195336	
	09/00-05/05	Z18XE	92	1796	<b>AP9003</b>	ALT, (Bosch), 120A, OE-NO 9195336	
<b>ASTRA G Kasten (F70)</b>							
1.6	01/99-09/00	X16SZR	55	1598	<b>AP9003</b>	ALT, (Bosch), 120A, OE-NO 9195336, CH-NO C 15257664⇒	
	09/00-04/05	Z16SE	62	1598	<b>AP9003</b>	ALT, (Bosch), 120A, OE-NO 9195336	
<b>ASTRA G Stufenheck (F69_)</b>							
1.4 16V	09/98-01/05	X14XE, Z14XE	66	1389	<b>AP9003</b>	ALT, (Bosch), 120A, OE-NO 9195336, CH-NO C 12257453⇒	
	09/00-01/05	Z16SE	62	1598	<b>AP9003</b>	ALT, (Bosch), 120A, OE-NO 9195336	
1.6	09/98-09/00	X16SZR	55	1598	<b>AP9003</b>	ALT, (Bosch), 120A, OE-NO 9195336, CH-NO C 15257664⇒	
	12/02-01/05	Z16XEP	76	1598			<b>VD1106</b>
	09/98-01/05	X16XEL, Z16XE	74	1598	<b>AP9003</b>	ALT, (Bosch), 120A, OE-NO 9195336, MTR-CODE: X 16 XEL, CH-NO C 4G000001⇒	
1.6 16V	09/98-01/05				<b>AP9003</b>	ALT, (Bosch), 120A, OE-NO 9195336, MTR-CODE: Z 16 XE, ALT, (Bosch), 120A, OE-NO 9195336	
					<b>AP9003</b>	ALT, (Bosch), 120A, OE-NO 9195336, MTR-CODE: Z 16 XE, ALT, (Bosch), 120A, OE-NO 9195336	
1.7 CDTI	04/03-01/05	Z17DTL	59	1686	<b>AP9044</b> <b>AP9044</b>	ALT, (Delco Remy), 100A, 110A ALT, (Hitachi), 100A, 110A ALT, (-AC), MTR-CODE: Z17DTL, MTR-NO 614509⇒	<b>6PK1275D1</b> <b>6PK1623D1</b>
1.8 16V	09/00-01/05	Z18XE	92	1796	<b>AP9003</b>	ALT, (Bosch), 120A, OE-NO 9195336	
	09/98-09/00	X18XE1	85	1796	<b>AP9003</b>	ALT, (Bosch), 120A, OE-NO 9195336	
2.0 16V	09/98-01/05	X20XE	100	1998	<b>AP9003</b>	ALT, (Bosch), 120A, OE-NO 9195336	
2.0 DI	09/98-01/05	X20DTL, Y20DTL	60	1995		ALT ALT, AC	<b>6PK1800D1</b> <b>6PK1870D1</b> <b>VD1031</b>
2.0 DTI 16V	08/99-01/05	X20DTH, Y20DTH	74	1995			<b>VD1031</b>
<b>ASTRA H</b>							
1.3 CDTI	08/05-	Z13DTH	66	1248	<b>AP9035</b>	ALT, (Valeo), OE-NO 13117278, 13283343, 70A, OE-NO 13117279, 13283344, 100A	
1.6	03/04-	Z16XEP	77	1598			<b>VD1106</b>
	12/06-	Z16XER	85	1598			<b>VD1106</b>
1.6 Turbo	02/07-	Z16LET	132	1598			<b>VD1106</b>
1.7 CDTI	03/04-	Z17DTL	59	1686	<b>AP9044</b> <b>AP9044</b>	ALT, (Delco Remy), 100A, 110A ALT, (Hitachi), 100A, 110A ALT, (-AC) ALT, AC	<b>6PK1275D1</b> <b>6PK1623D1</b> <b>VD1068</b>
		Z17DTH	74	1686	<b>AP9044</b> <b>AP9044</b>	ALT, (Delco Remy), 100A, 110A ALT, (Hitachi), 100A, 110A ALT, (-AC) ALT, (AC)	<b>6PK1275D1</b> <b>6PK1623D1</b> <b>VD1068</b>
1.8	01/06-	Z18XER, A18XER	103	1796			<b>VD1106</b>
1.9 CDTI	06/04-	Z19DT	88	1910	<b>AP9017</b>  <b>AP9028</b>	ALT, (Denso), 100A, OE-NO 93180098, 120A, OE-NO 93180102, 130A, OE-NO 93180104 ALT, (Bosch), OE-NO 93191921, 120A, OE-NO 93191922, 140A ⇒CH-NO 5545149	<b>VD1065</b>
	09/04-	Z19DTH	110	1910	<b>AP9017</b>  <b>AP9028</b>	ALT, (Denso), 100A, OE-NO 93180098, 120A, OE-NO 93180102, 130A, OE-NO 93180104 ALT, (Bosch), OE-NO 93191921, 120A, OE-NO 93191922, 140A ALT, (-AC), CH-NO 72156709⇒,	<b>6PK1050D1</b>





# OPEL

## ASTRA H

						75189053⇒, 78104401⇒ ALT, (AC), MTR-NO 72156709⇒, 75189053⇒, 78104401⇒, OE-NO 93 185 361 ⇒CH-NO 72156708, 75189052, 78104400 CH-NO 72156709⇒, 75189053⇒, 78104401⇒, 8B000001⇒	<b>6PK1370D1</b>  <b>VD1065</b>  <b>VD1067</b>
	09/05-	Z19DTL	74	1910	<b>AP9017</b>  <b>AP9028</b>	ALT, (Denso), 100A, OE-NO 93180098, 120A, OE-NO 93180102, 130A, OE-NO 93180104 ALT, (Bosch), OE-NO 93191921, 120A, OE-NO 93191922, 140A ⇒CH-NO 5545149	  <b>VD1065</b>
1.9 CDTI 16V	04/04-	Z19DTJ	88	1910	<b>AP9017</b>  <b>AP9028</b>	ALT, (Denso), 100A, OE-NO 93180098, 120A, OE-NO 93180102, 130A, OE-NO 93180104 ALT, (Bosch), OE-NO 93191921, 120A, OE-NO 93191922, 140A ALT, (-AC), CH-NO 72156709⇒, 75189053⇒, 78104401⇒ ALT, (AC), CH-NO 72156709⇒, 75189053⇒, 78104401⇒, OE-NO 93 185 361 ⇒CH-NO 72156708, 75189052, 78104400 CH-NO 72156709⇒, 75189053⇒, 78104401⇒, 8B000001⇒	  <b>6PK1050D1</b>  <b>6PK1370D1</b>  <b>VD1065</b>  <b>VD1067</b>
<b>ASTRA H Caravan</b> 1.3 CDTI	08/05-	Z13DTH	66	1248	<b>AP9035</b>	ALT, (Valeo), OE-NO 13117278, 13283343, 70A, OE-NO 13117279, 13283344, 100A	
1.6	08/04-	Z16XEP	77	1598			<b>VD1106</b>
1.6 Turbo	02/07-	Z16LET	132	1598			<b>VD1106</b>
1.7 CDTI	08/04-	Z17DTL	59	1686	<b>AP9044</b> <b>AP9044</b>	ALT, (Delco Remy), 100A, 110A ALT, (Hitachi), 100A, 110A ALT, (-AC) ALT, AC	  <b>6PK1275D1</b> <b>6PK1623D1</b> <b>VD1068</b>
		Z17DTH	74	1686	<b>AP9044</b> <b>AP9044</b>	ALT, (Delco Remy), 100A, 110A ALT, (Hitachi), 100A, 110A ALT, (-AC) ALT, (AC)	  <b>6PK1275D1</b> <b>6PK1623D1</b> <b>VD1068</b>
1.8	08/05-	Z18XER, A18XER	103	1796			<b>VD1106</b>
1.9 CDTI	09/04-	Z19DTH	110	1910	<b>AP9017</b>  <b>AP9028</b>	ALT, (Denso), 100A, OE-NO 93180098, 120A, OE-NO 93180102, 130A, OE-NO 93180104 ALT, (Bosch), OE-NO 93191921, 120A, OE-NO 93191922, 140A ALT, (-AC), CH-NO 72156709⇒, 75189053⇒, 78104401⇒ ALT, (AC), MTR-NO 72156709⇒, 75189053⇒, 78104401⇒, OE-NO 93 185 361 ⇒CH-NO 72156708, 75189052, 78104400 CH-NO 72156709⇒, 75189053⇒, 78104401⇒, 8B000001⇒	  <b>6PK1050D1</b>  <b>6PK1370D1</b>  <b>VD1065</b>  <b>VD1067</b>
	09/05-	Z19DTL	74	1910	<b>AP9017</b>  <b>AP9028</b>	ALT, (Denso), 100A, OE-NO 93180098, 120A, OE-NO 93180102, 130A, OE-NO 93180104 ALT, (Bosch), OE-NO 93191921, 120A, OE-NO 93191922, 140A ⇒CH-NO 5545149	  <b>VD1065</b>
		Z19DT	88	1910	<b>AP9017</b>  <b>AP9028</b>	ALT, (Denso), 100A, OE-NO 93180098, 120A, OE-NO 93180102, 130A, OE-NO 93180104 ALT, (Bosch), OE-NO 93191921, 120A, OE-NO 93191922, 140A ⇒CH-NO 5545149	  <b>VD1065</b>
1.9 CDTI 16V	08/04-	Z19DTJ	88	1910	<b>AP9017</b>  <b>AP9028</b>	ALT, (Denso), 100A, OE-NO 93180098, 120A, OE-NO 93180102, 130A, OE-NO 93180104 ALT, (Bosch), OE-NO 93191921, 120A, OE-NO 93191922, 140A ALT, (-AC), CH-NO 72156709⇒,	  <b>6PK1050D1</b>







## OPEL

### ASTRA H Caravan

						75189053⇒, 78104401⇒ ALT, (AC), CH-NO 72156709⇒, 75189053⇒, 78104401⇒, OE-NO 93 185 361 ⇒CH-NO 72156708, 75189052, 78104400 CH-NO 72156709⇒, 71589053⇒, 78104401⇒, 8B000001⇒	<b>6PK1370D1</b>  <b>VD1065</b>  <b>VD1067</b>
--	--	--	--	--	--	---------------------------------------------------------------------------------------------------------------------------------------------------------------------------------------------------	------------------------------------------------------------

### ASTRA H GTC

1.3 CDTI	04/05-	Z13DTH	66	1248	<b>AP9035</b>	ALT, (Valeo), OE-NO 13117278, 13283343, 70A, OE-NO 13117279, 13283344, 100A	<b>VD1106</b>
1.6	03/05-	Z16XEP	77	1598			<b>VD1106</b>
	12/06-	Z16XER	85	1598			<b>VD1106</b>
1.6 Turbo	02/07-	Z16LET	132	1598			<b>VD1106</b>
1.7 CDTi	03/05-	Z17DTH	74	1686	<b>AP9044</b> <b>AP9044</b>	ALT, (Delco Remy), 100A, 110A ALT, (Hitachi), 100A, 110A ALT, (-AC) ALT, (AC)	<b>6PK1275D1</b> <b>6PK1623D1</b> <b>VD1068</b> <b>VD1106</b>
1.8	01/06-	Z18XER	103	1796			<b>VD1106</b>
1.9 CDTI	01/06-	Z19DTL	74	1910	<b>AP9017</b>  <b>AP9028</b>	ALT, (Denso), 100A, OE-NO 93180098, 120A, OE-NO 93180102, 130A, OE-NO 93180104 ALT, (Bosch), OE-NO 93191921, 120A, OE-NO 93191922, 140A	<b>VD1065</b>
1.9 CDTi	03/05-	Z19DTH	110	1910	<b>AP9017</b>  <b>AP9028</b>	ALT, (Denso), 100A, OE-NO 93180098, 120A, OE-NO 93180102, 130A, OE-NO 93180104 ALT, (Bosch), OE-NO 93191921, 120A, OE-NO 93191922, 140A ALT, (-AC), CH-NO 72156709⇒, 75189053⇒, 78104401⇒ ALT, (AC), CH-NO 72156709⇒, 75189053⇒, 78104401⇒, OE-NO 93 185 361 ⇒CH-NO 72156708, 75189052, 78104400 CH-NO 72156709⇒, 71589053⇒, 78104401⇒, 8B000001⇒	<b>6PK1050D1</b>  <b>6PK1370D1</b>  <b>VD1065</b>  <b>VD1067</b>
1.9 CDTI	09/05-	Z19DT	88	1910	<b>AP9017</b>  <b>AP9028</b>	ALT, (Denso), 100A, OE-NO 93180098, 120A, OE-NO 93180102, 130A, OE-NO 93180104 ALT, (Bosch), OE-NO 93191921, 120A, OE-NO 93191922, 140A ⇒CH-NO 5545149	<b>VD1065</b>
1.9 CDTi 16V	03/05-	Z19DTJ	88	1910	<b>AP9017</b>  <b>AP9028</b>	ALT, (Denso), 100A, OE-NO 93180098, 120A, OE-NO 93180102, 130A, OE-NO 93180104 ALT, (Bosch), OE-NO 93191921, 120A, OE-NO 93191922, 140A ALT, (-AC), CH-NO 72156709⇒, 75189053⇒, 78104401⇒ ALT, (AC), CH-NO 72156709⇒, 75189053⇒, 78104401⇒, OE-NO 93 185 361 ⇒CH-NO 72156708, 75189052, 78104400 CH-NO 72156709⇒, 71589053⇒, 78104401⇒, 8B000001⇒	<b>6PK1050D1</b>  <b>6PK1370D1</b>  <b>VD1065</b>  <b>VD1067</b>

### ASTRA H Stufenheck

1.3 CDTi	02/07-	Z13DTH	66	1248	<b>AP9035</b>	ALT, (Valeo), OE-NO 13117278, 13283343, 70A, OE-NO 1311279, 13283344, 100A	
1.7 CDTi	02/07-	Z17DTH	74	1686		ALT, (-AC) ALT, (AC)	<b>6PK1275D1</b> <b>6PK1623D1</b> <b>VD1068</b>

### ASTRA H TwinTop

1.6	09/05-	Z16XEP, Z16XE1	77	1598			<b>VD1106</b>
	12/06-	Z16XER	85	1598			<b>VD1106</b>
1.6 Turbo	02/07-	Z16LET	132	1598			<b>VD1106</b>
1.8	09/05-	Z18XER, A18XER	103	1796			<b>VD1106</b>
1.9 CDTi	09/05-	Z19DTH	110	1910	<b>AP9017</b>	ALT, (Denso), 100A, OE-NO 93180098, 120A, OE-NO 93180102, 130A, OE-NO 93180104	



**OPEL**
**OPEL**
**ASTRA H TwinTop**

					<b>AP9028</b>	ALT, (Bosch), OE-NO 93191921, 120A, OE-NO 93191922, 140A ALT, (-AC), CH-NO 72156709⇒, 75189053⇒, 78104401⇒ ALT, (AC), CH-NO 72156709⇒, 75189053⇒, 78104401⇒, OE-NO 93 185 361 ⇒CH-NO 72156708, 75189052, 78104400 CH-NO 72156709⇒, 75189053⇒, 78104401⇒, 8B000001⇒	<b>6PK1050D1</b> <b>6PK1370D1</b> <b>VD1065</b> <b>VD1067</b>
--	--	--	--	--	---------------	-----------------------------------------------------------------------------------------------------------------------------------------------------------------------------------------------------------------------------------------------------------------------------------------------	------------------------------------------------------------------------

**COMBO Kasten/Kombi**

1.3 CDTI 16V	08/05-	Z13DT	51	1248	<b>AP9035</b>	ALT, (Valeo), OE-NO 13117278, 13283343, 70A, OE-NO 13117279, 13283344, 100A	
	10/05-	Z13DTJ	55	1248	<b>AP9035</b>	ALT, (Valeo), OE-NO 13117278, 13283343, 70A, OE-NO 13117279, 13283344, 100A	
1.7 CDTI 16V	12/04-	Z17DTH	74	1686	<b>AP9044</b> <b>AP9044</b>	ALT, (Delco Remy), 100A, 110A ALT, (Hitachi), 100A, 110A ALT, PS, (-AC), MTR-CODE: Z17DTH ALT, PS, AC, MTR-CODE: Z17DTH	<b>6PK1275D1</b> <b>6PK1600D1</b> <b>VD1068</b>

**COMBO Tour**

1.3 CDTI 16V	10/04-	Z13DT, Y13DT	51	1248	<b>AP9035</b>	ALT, (Valeo), OE-NO 13117278, 13283343, 70A, OE-NO 13117279, 13283344, 100A	
	10/05-	Z13DTJ	55	1248	<b>AP9035</b>	ALT, (Valeo), OE-NO 13117278, 13283343, 70A, OE-NO 13117279, 13283344, 100A	
1.7 CDTI 16V	12/04-	Z17DTH	74	1686	<b>AP9044</b> <b>AP9044</b>	ALT, (Delco Remy), 100A, 110A ALT, (Hitachi), 100A, 110A ALT, PS, (-AC), MTR-CODE: Z17DTH ALT, PS, AC, MTR-CODE: Z17DTH	<b>6PK1275D1</b> <b>6PK1600D1</b> <b>VD1068</b>

**CORSA C (F08, F68)**

1.3 CDTI	06/03-	Z13DT	51	1248	<b>AP9035</b>	ALT, (Valeo), OE-NO 13117278, 13283343, 70A, OE-NO 13117279, 13283344, 100A	
1.4	09/00-	Z14XE	66	1389	<b>AP9003</b>	ALT, (Bosch), 120A, OE-NO 9195336, CH-NO C 12257453⇒	
1.7 CDTI	06/03-	Z17DTH	74	1686	<b>AP9044</b> <b>AP9044</b>	ALT, (Delco Remy), 100A, 110A ALT, (Hitachi), 100A, 110A ALT, PS, (-AC), MTR-CODE: Z17DTH ALT, PS, (AC), MTR-CODE: Z17DTH	<b>6PK1275D1</b> <b>6PK1600D1</b> <b>VD1068</b>
1.8	09/00-	Z18XE	92	1796	<b>AP9003</b>	ALT, (Bosch), 120A, OE-NO 9195336	

**CORSA C Kasten (F08, W5L)**

1.3 CDTI 16V	08/05-	Z13DT	51	1248	<b>AP9035</b>	ALT, (Valeo), OE-NO 13117278, 13283343, 70A, OE-NO 13117279, 13283344, 100A	
1.7 CDTi	08/03-	Z17DTH	74	1686	<b>AP9044</b> <b>AP9044</b>	ALT, (Delco Remy), 100A, 110A ALT, (Hitachi), 100A, 110A ALT, PS, (-AC), MTR-CODE: Z17DTH ALT, PS, (AC), MTR-CODE: Z17DTH	<b>6PK1275D1</b> <b>6PK1600D1</b> <b>VD1068</b>

**CORSA D**

1.6 Turbo	02/07-	Z16LEL, A16LEL	110	1598			<b>VD1106</b>
		Z16LER, A16LER	141	1598			<b>VD1106</b>









**FRONTERA B (6B\_)**

2.2 DTI (6B_ZC, 6B_VF, 6B_66, 6B_76)	10/98-09/02	X22DTH, Y22DTH	85	2171		ALT, AC	<b>6PK1900D1</b> <b>VD1031</b>
-----------------------------------------	-------------	-------------------	----	------	--	---------	-----------------------------------

**MERIVA**

1.3 CDTI	04/05-05/10	Z13DT, Y13DT	51	1248	<b>AP9035</b>	ALT, (Valeo), OE-NO 13117278, 13283343, 70A, OE-NO 13117279, 13283344, 100A	
	09/03-05/10	Z13DTJ	55	1248	<b>AP9035</b>	ALT, (Valeo), OE-NO 13117278, 13283343, 70A, OE-NO 13117279, 13283344, 100A	
1.6	01/06-05/10	Z16XEP	77	1598			<b>VD1106</b>
1.6 Turbo	09/05-05/10	Z16LET	132	1598			<b>VD1106</b>
1.7 CDTI	09/03-05/10	Z17DTH	74	1686	<b>AP9044</b> <b>AP9044</b>	ALT, (Delco Remy), 100A, 110A ALT, (Hitachi), 100A, 110A ALT, PS, (-AC), MTR-CODE: Z17DTH ALT, PS, AC, MTR-CODE: Z17DTH	<b>6PK1275D1</b> <b>6PK1600D1</b> <b>VD1068</b>



							
<b>OPEL</b>							
<b>MOVANO Combi (J9)</b> ↳ 1.9 DTI	09/00-10/01	F9Q770	59	1870	<b>AP9039</b>	ALT, (Valeo), 125A, OE-NO 9111540, 93160665, MTR-CODE: F9Q-772, (AC)	
	10/01-	F9Q774	60	1870	<b>AP9039</b> <b>AP9043</b>	ALT, (Valeo), 125A, OE-NO 93160665, 93161425, 93189523, (AC) ALT, (-AC)	<b>VD1101</b>
<b>MOVANO Kasten (F9)</b> 1.9 DTI	09/00-10/01	F9Q770	59	1870	<b>AP9039</b>	ALT, (Valeo), 125A, OE-NO 9111540, 93160665, MTR-CODE: F9Q-772, (AC)	
	10/01-	F9Q774, F9Q772	60	1870	<b>AP9039</b> <b>AP9043</b>	ALT, (Valeo), 125A, OE-NO 93160665, 93161425, 93189523, (AC) ALT, (-AC)	<b>VD1101</b>
<b>OMEGA B (25_, 26_, 27_)</b> 2.0 DTI 16V	09/97-09/00	X20DTH	74	1995		ALT, PS ALT, PS, AC	<b>6PK1800D1</b> <b>6PK1900D1</b> <b>VD1031</b>
2.2 DTI 16V	09/00-07/03	Y22DTH	81	2171		ALT, (-AC) ALT, (AC)	<b>6PK1800D1</b> <b>6PK1900D1</b>
			88	2171		ALT, (-AC) ALT, (AC)	<b>6PK1800D1</b> <b>6PK1900D1</b> <b>VD1031</b>
2.5 TD	04/94-07/03	25DT, X25DT, X25TD	96	2497		ALT	<b>5PK1815D1</b> <b>VD1025</b>
<b>OMEGA B Caravan (21_, 22_, 23_)</b> 2.0 DTI 16V	09/97-09/00	X20DTH	74	1995		ALT, PS ALT, PS, AC	<b>6PK1800D1</b> <b>6PK1900D1</b> <b>VD1031</b>
2.2 DTI 16V	09/00-07/03	Y22DTH	81	2171		ALT, (-AC) ALT, (AC)	<b>6PK1800D1</b> <b>6PK1900D1</b>
			88	2171		ALT, (-AC) ALT, (AC)	<b>6PK1800D1</b> <b>6PK1900D1</b> <b>VD1031</b>
2.5 TD	04/94-02/01	25DT, X25DT, X25TD	96	2497		ALT	<b>5PK1815D1</b> <b>VD1025</b>
<b>SIGNUM</b> 1.8	05/03- 09/05-	Z18XE Z18XER	90 103	1796 1796	<b>AP9003</b>	ALT, (Bosch), 120A, OE-NO 9195336	<b>VD1106</b>
1.9 CDTI	04/04-	Z19DT	88	1910	<b>AP9017</b> <b>AP9028</b>	ALT, (Denso), 100A, OE-NO 93180098, 120A, OE-NO 93180102, 130A, OE-NO 93180104 ALT, (Bosch), OE-NO 93191921, 120A, OE-NO 93191922, 140A ⇒CH-NO 5545149	<b>VD1065</b>
		Z19DTH	110	1910	<b>AP9017</b> <b>AP9028</b>	ALT, (Denso), 100A, OE-NO 93180098, 120A, OE-NO 93180102, 130A, OE-NO 93180104 ALT, (Bosch), OE-NO 93191921, 120A, OE-NO 93191922, 140A ALT, (-AC), CH-NO 71021892⇒ ALT, (AC), CH-NO 71021892⇒ ⇒CH-NO 71021891 CH-NO 71021892⇒	<b>6PK1050D1</b> <b>6PK1413D2</b> <b>VD1065</b> <b>VD1067</b>
	08/05-	Z19DT	74	1910	<b>AP9017</b> <b>AP9028</b>	ALT, (Denso), 100A, OE-NO 93180098, 120A, OE-NO 93180102, 130A, OE-NO 93180104 ALT, (Bosch), OE-NO 93191921, 120A, OE-NO 93191922, 140A ⇒CH-NO 5545149	<b>VD1065</b>
2.0 DTI	05/03-	Y20DTH	74	1994			<b>VD1031</b>
2.2 DTI	05/03-	Y22DTR	92	2171			<b>VD1031</b>
<b>SINTRA</b> 2.2 DTI	07/97-04/99	X22DTH	85	2171		ALT ALT, AC	<b>6PK1800D1</b> <b>6PK1900D1</b> <b>VD1031</b>
<b>TIGRA TwinTop</b> 1.3 CDTI	06/04-	Z13DT	51	1248	<b>AP9035</b>	ALT, (Valeo), OE-NO 13117279, 100A	
<b>VECTRA B (36_)</b> 2.0 DI 16V	11/96-04/02	X20DTL	60	1995		ALT ALT, AC	<b>6PK1800D1</b> <b>6PK1900D1</b> <b>VD1031</b>
2.0 DTI 16V	06/97-04/02	X20DTH, Y20DTH	74	1995		ALT ALT, AC	<b>6PK1800D1</b> <b>6PK1900D1</b> <b>VD1031</b>
2.2 DTI 16V	09/00-04/02	Y22DTR	92	2172		ALT ALT, AC	<b>6PK1800D1</b> <b>6PK1900D1</b> <b>VD1031</b>

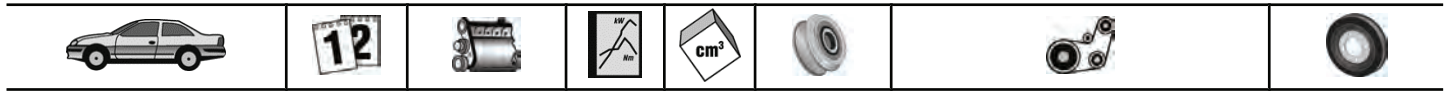

**OPEL**
**VECTRA B Caravan (31\_)**

↩ 2.0 DI 16V	11/96-06/00	X20DTL	60	1995		ALT ALT, AC	<b>6PK1800D1</b> <b>6PK1900D1</b> <b>VD1031</b>
2.0 DTI 16V	06/97-07/03	X20DTH, Y20DTH	74	1995		ALT ALT, AC	<b>6PK1800D1</b> <b>6PK1900D1</b> <b>VD1031</b>
2.2 DTI 16V	09/00-07/03	Y22DTR	92	2172		ALT ALT, AC	<b>6PK1800D1</b> <b>6PK1900D1</b> <b>VD1031</b>

**VECTRA B CC (38\_)**

2.0 DI 16V	11/96-06/00	X20DTL	60	1995		ALT, PS ALT, AC	<b>6PK1800D1</b> <b>6PK1900D1</b> <b>VD1031</b>
2.0 DTI 16V	06/97-07/03	X20DTH, Y20DTH	74	1995		ALT ALT, AC	<b>6PK1800D1</b> <b>6PK1900D1</b> <b>VD1031</b>
2.2 DTI 16V	09/00-07/03	Y22DTR	92	2172		ALT ALT, AC	<b>6PK1800D1</b> <b>6PK1900D1</b> <b>VD1031</b>

**VECTRA C**

1.6	01/06-	Z16XEP	77	1598			<b>VD1106</b>
1.6 16V	06/04-	Z16XE	74	1598	<b>AP9003</b>	ALT, (Bosch), 120A, OE-NO 9195336	
1.8	01/06-	Z18XER	103	1796			<b>VD1106</b>
	04/02-	Z18XEL	81	1796	<b>AP9003</b>	ALT, (Bosch), 120A, OE-NO 9195336	
1.8 16V	04/02-	Z18XE	90	1796	<b>AP9003</b>	ALT, (Bosch), 120A, OE-NO 9195336	
1.9 CDTI	04/04-	Z19DT	88	1910	<b>AP9017</b>	ALT, (Denso), 100A, OE-NO 93180098, 120A, OE-NO 93180102, 130A, OE-NO 93180104	
					<b>AP9028</b>	ALT, (Bosch), OE-NO 93191921, 120A, OE-NO 93191922, 140A ⇒CH-NO 5545149	<b>VD1065</b>
		Z19DTH	110	1910	<b>AP9017</b>	ALT, (Denso), 100A, OE-NO 93180098, 120A, OE-NO 93180102, 130A, OE-NO 93180104	
					<b>AP9028</b>	ALT, (Bosch), OE-NO 93191921, 120A, OE-NO 93191922, 140A ALT, (-AC), CH-NO 71021892⇒ ALT, AC, CH-NO 71021892⇒ ⇒CH-NO 71021891, 48999999 CH-NO 71021892⇒	<b>6PK1050D1</b> <b>6PK1413D2</b> <b>VD1065</b> <b>VD1067</b>
	10/05-	Z19DT	74	1910	<b>AP9017</b>	ALT, (Denso), 100A, OE-NO 93180098, 120A, OE-NO 93180102, 130A, OE-NO 93180104	
					<b>AP9028</b>	ALT, (Bosch), OE-NO 93191921, 120A, OE-NO 93191922, 140A ⇒CH-NO 5545149	<b>VD1065</b>
2.0 DTI 16V	04/02-	Y20DTH	74	1995			<b>VD1031</b>
2.2 DTI 16V	04/02-	Y22DTR	92	2172			<b>VD1031</b>

**VECTRA C Caravan**

1.6 16V	06/04-	Z16XE	74	1598	<b>AP9003</b>	ALT, (Bosch), 120A, OE-NO 9195336	
1.8	01/06-	Z18XER	103	1796			<b>VD1106</b>
	10/03-	Z18XE	90	1796	<b>AP9003</b>	ALT, (Bosch), 120A, OE-NO 9195336	
1.9 CDTI	04/04-	Z19DT	88	1910	<b>AP9017</b>	ALT, (Denso), 100A, OE-NO 93180098, 120A, OE-NO 93180102, 130A, OE-NO 93180104	
					<b>AP9028</b>	ALT, (Bosch), OE-NO 93191921, 120A, OE-NO 93191922, 140A ⇒CH-NO 5545149	<b>VD1065</b>
		Z19DTH	110	1910	<b>AP9017</b>	ALT, (Denso), 100A, OE-NO 93180098, 120A, OE-NO 93180102, 130A, OE-NO 93180104	
					<b>AP9028</b>	ALT, (Bosch), OE-NO 93191921, 120A, OE-NO 93191922, 140A ALT, (-AC), CH-NO 71021892⇒ ALT, AC, CH-NO 71021892⇒ ⇒CH-NO 71021891, 48999999 CH-NO 71021892⇒	<b>6PK1050D1</b> <b>6PK1413D2</b> <b>VD1065</b> <b>VD1067</b>
	10/05-	Z19DTL	74	1910	<b>AP9017</b>	ALT, (Denso), 100A, OE-NO 93180098, 120A, OE-NO 93180102, 130A, OE-NO 93180104	
					<b>AP9028</b>	ALT, (Bosch), OE-NO 93191921, 120A, OE-NO 93191922, 140A ⇒CH-NO 5545149	<b>VD1065</b>
2.0 DTI	10/03-	Y20DTH	74	1995			<b>VD1031</b>
2.2 DTI	10/03-	Y22DTR	92	2172			<b>VD1031</b>

**VECTRA C GTS**

1.6	01/06-	Z16XEP	77	1598			<b>VD1106</b>
-----	--------	--------	----	------	--	--	---------------



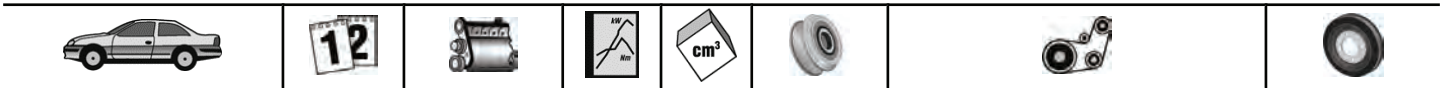

## OPEL

### VECTRA C GTS

	08/05-	Z16XE	74	1598	<b>AP9003</b>	ALT, (Bosch), 120A, OE-NO 9195336	
1.8	01/06-	Z18XER	103	1796			<b>VD1106</b>
1.8 16V	08/02-	Z18XE	90	1796	<b>AP9003</b>	ALT, (Bosch), 120A, OE-NO 9195336	
1.9 CDTI	04/04-	Z19DT	88	1910	<b>AP9017</b>	ALT, (Denso), 100A, OE-NO 93180098, 120A, OE-NO 93180102, 130A, OE-NO 93180104	
					<b>AP9028</b>	ALT, (Bosch), OE-NO 93191921, 120A, OE-NO 93191922, 140A ⇒CH-NO 5545149	<b>VD1065</b>
		Z19DTH	110	1910	<b>AP9017</b>	ALT, (Denso), 100A, OE-NO 93180098, 120A, OE-NO 93180102, 130A, OE-NO 93180104	
					<b>AP9028</b>	ALT, (Bosch), OE-NO 93191921, 120A, OE-NO 93191922, 140A ALT, (-AC), CH-NO 71021892⇒ ALT, AC, CH-NO 71021892⇒ ⇒CH-NO 71021891, 48999999 CH-NO 71021892⇒	<b>6PK1050D1</b> <b>6PK1413D2</b> <b>VD1065</b> <b>VD1067</b>
	10/05-	Z19DT	74	1910	<b>AP9017</b>	ALT, (Denso), 100A, OE-NO 93180098, 120A, OE-NO 93180102, 130A, OE-NO 93180104	
					<b>AP9028</b>	ALT, (Bosch), OE-NO 93191921, 120A, OE-NO 93191922, 140A ⇒CH-NO 5545149	<b>VD1065</b>
2.0 DTI 16V	08/02-	Y20DTH	74	1995			<b>VD1031</b>
2.2 DTI 16V	08/02-	Y22DTR	92	2172			<b>VD1031</b>

### VIVARO Combi (J7)

1.9 DI	08/01-	F9Q774	60	1870	<b>AP9039</b>	ALT, (Valeo), 125A, OE-NO 9111540, 93160665, 93161425, 93189523, MTR-CODE: F9Q-762	
					<b>AP9043</b>	ALT, (-AC)	<b>VD1101</b>
1.9 DTI	08/01-	F9Q760	74	1870	<b>AP9039</b>	ALT, (Valeo), 125A, OE-NO 9111540, 93160665, 93161425, 93189523	
					<b>AP9043</b>	ALT, (-AC)	<b>VD1101</b>
2.5 CDTI	08/06-	G9U630	84	2464	<b>AP9039</b>	ALT, (Valeo), 125A, OE-NO 91111540, 93160665, 93161425, 93189523	
			107	2463	<b>AP9039</b>	ALT, (Valeo), 125A, OE-NO 91111540, 93160665, 93161425, 93189523	
2.5 DTI	05/03-	G9U730	99	2463	<b>AP9039</b>	ALT, (Valeo), 125A, OE-NO 91111540, 93160665, 93161425, 93189523 ⇒CH-NO C069549, (AC)	<b>VD1109</b>

### VIVARO Kasten (F7)

1.9 DI	08/01-	F9Q762	60	1870	<b>AP9039</b>	ALT, (Valeo), 125A, OE-NO 9111540, 93160665, 93161425, 93189523	
					<b>AP9043</b>	ALT, (-AC)	<b>VD1101</b>
1.9 DTI	08/01-	F9Q760	74	1870	<b>AP9039</b>	ALT, (AC)	
					<b>AP9043</b>	ALT, (-AC)	<b>VD1101</b>
2.5 DTI	05/03-	G9U730	99	2463	<b>AP9039</b>	ALT, (Valeo), 125A, OE-NO 91111540, 93160665, 93161425, 93189523 ⇒CH-NO C069549, (AC)	<b>VD1109</b>

### VIVARO Pritsche/Fahrgestell (E7)

1.9 DTI	08/06-	F9Q760	74	1870	<b>AP9039</b>	ALT, (Valeo), 125A, OE-NO 91111540, 93160665, 93161425, 93189523	<b>VD1101</b>
2.5 CDTI	08/06-	G9U630	107	2463	<b>AP9039</b>	ALT, (Valeo), 125A, OE-NO 91111540, 93160665, 93161425, 93189523	

### ZAFIRA

1.6	01/06-	Z16YNG	69	1598	<b>AP9003</b>	ALT, (Bosch), 120A, OE-NO 9195336	
	01/08-	Z16XER, A16XER	85	1598			<b>VD1106</b>
	07/05-	Z16XEP, Z16XE1	77	1598			<b>VD1106</b>
1.9 CDTI	07/05-	Z19DTL	74	1910	<b>AP9017</b>	ALT, (Denso), 100A, OE-NO 93180098, 120A, OE-NO 93180102, 130A, OE-NO 93180104	
					<b>AP9028</b>	ALT, (Bosch), OE-NO 93191921, 120A, OE-NO 93191922, 140A ⇒CH-NO 5545149	<b>VD1065</b>
		Z19DT	88	1910	<b>AP9017</b>	ALT, (Denso), 100A, OE-NO 93180098, 120A, OE-NO 93180102, 130A, OE-NO 93180104	
					<b>AP9028</b>	ALT, (Bosch), OE-NO 93191921, 120A, OE-NO 93191922, 140A ⇒CH-NO 5545149	<b>VD1065</b>



**OPEL**
**ZAFIRA**

		Z19DTH	110	1910	<b>AP9017</b>	ALT, (Denso), 100A, OE-NO 93180098, 120A, OE-NO 93180102, 130A, OE-NO 93180104	
					<b>AP9028</b>	ALT, (Bosch), OE-NO 93191921, 120A, OE-NO 93191922, 140A	
						ALT, (-AC), CH-NO 72156709⇒, 7G150346⇒	<b>6PK1050D1</b>
						ALT, (AC), CH-NO 72156709⇒, 75189053⇒, 78104401⇒, OE-NO 93185361	<b>6PK1370D1</b>
						⇒CH-NO 72156708, 7G150345	<b>VD1065</b>
						CH-NO 72156709⇒, 7G150346⇒	<b>VD1067</b>

**ZAFIRA (F75\_)**

1.6	09/02-06/05	Z16YNG	70	1598	<b>AP9003</b>	ALT, (Bosch), 120A, OE-NO 9195336	
1.6 16V	04/99-06/05	X16XEL, Z16XE	74	1598	<b>AP9003</b>	ALT, (Bosch), 120A, OE-NO 9195336, MTR-CODE: X 16 XEL, CH-NO C4G000001⇒	
					<b>AP9003</b>	ALT, (Bosch), 120A, OE-NO 9195336, MTR-CODE: Z 16 XE, ALT, (Bosch), 120A, OE-NO 9195336	
1.6 CNG	09/01-06/05	Z16YNG	71	1598	<b>AP9003</b>	ALT, (Bosch), 120A, OE-NO 9195336	
1.8 16V	04/99-09/00	X18XE1	85	1796	<b>AP9003</b>	ALT, (Bosch), 120A, OE-NO 9195336	
	09/00-06/05	Z18XE	92	1796	<b>AP9003</b>	ALT, (Bosch), 120A, OE-NO 9195336	
2.0 DI 16V	10/99-06/05	X20DTL	60	1995		ALT, (-AC)	<b>6PK1800D1</b>
						ALT, (AC), ⇒CH-NO 2H019030, 22109974	<b>6PK1863D1</b>
						ALT, (AC), CH-NO 2H019031⇒, 22109975⇒	<b>6PK1870D1</b>
							<b>VD1031</b>
2.0 DTI 16V	09/00-06/05	Y20DTH	74	1995		ALT, (-AC)	<b>6PK1800D1</b>
						ALT, (AC), ⇒CH-NO 2H019030, 22109974	<b>6PK1863D1</b>
						ALT, (AC), CH-NO 2H019031⇒, 22109975⇒	<b>6PK1870D1</b>
							<b>VD1031</b>
2.2 DTI 16V	01/02-06/05	Y22DTR	92	2172			<b>VD1031</b>

**PEUGEOT**
**1007 (KM\_)**

1.4	04/05-	KFV (TU3JP)	54	1360			<b>VD1100</b>
1.4 16V	10/05-	KFU (ET3J4)	65	1360			<b>VD1100</b>
1.4 HDi	04/05-	8HX (DV4TD), 8HZ (DV4TD)	50	1398	<b>AP9013</b>	ALT, (Valeo), 150A, OE-NO 5702H4, 5705AS, 5705EY, ALT-No: TG15C020, TG15C028, TG15C053	
					<b>AP9019</b>	ALT, (Valeo), ALT-No: TG15C118, 150A, OE-NO 5705AS, 5705EY	<b>VD1094</b>
1.6 16V	04/05-	NFU (TU5JP4)	80	1587			<b>VD1100</b>
1.6 HDi	06/07-	9HZ (DV6TED4)	80	1560	<b>AP9013</b>	ALT, (Valeo), 150A, OE-NO 5702H4, 5705AS, 5705EY, ALT-No: TG15C020, TG15C028, TG15C053	
					<b>AP9019</b>	ALT, (Valeo), ALT-No: TG15C118, 150A, OE-NO 5705AS, 5705EY	<b>VD1096</b>

**106 I (1A, 1C)**

1.5 D	06/94-04/96	VJY (TUD5)	40	1527			<b>VD1085</b>
			43	1527			<b>VD1085</b>

**106 II (1)**

1.5 D	05/96-	VJY (TUD5)	40	1527			<b>VD1085</b>
	10/00-	VJX (TUD5)	42	1527			<b>VD1085</b>

**107**

1.4 HDi	06/05-	8HT (DV4TD)	40	1398	<b>AP9013</b>	ALT, (Valeo), 150A, OE-NO 5702H4, 5705AS, 5705EY, ALT-No: TG15C020, TG15C028, TG15C053	
					<b>AP9019</b>	ALT, (Valeo), ALT-No: TG15C118, 150A, OE-NO 5705AS, 5705EY	<b>VD1094</b>

**206 CC (2D)**

1.6 16V	09/00-	NFU (TU5JP4)	80	1587			<b>VD1100</b>
1.6 HDi 110	04/05-	9HZ (DV6TED4)	80	1560	<b>AP9013</b>	ALT, (Valeo), 150A, OE-NO 5702H4, 5705AS, 5705EY, ALT-No: TG15C020, TG15C028, TG15C053	
					<b>AP9019</b>	ALT, (Valeo), ALT-No: TG15C118, 150A, OE-NO 5705AS, 5705EY	<b>VD1094</b>
						⇒ORG-NO 10527	<b>VD1096</b>
						ORG-NO 10528⇒	<b>VD1096</b>



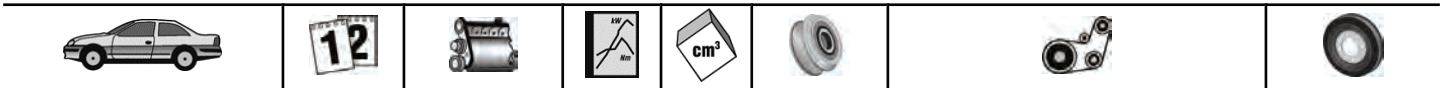

## PEUGEOT

### 206 Schrägheck (2A/C)

↳ 1.1 i	09/98-	HFZ (TU1JP), HFX (TU1JP)	44	1124		(-PS), (AC), ⇒ORG-NO 10191, MTR-CODE: TU1JP	VD1100
1.4 16V	10/03-	KFU (ET3J4)	65	1360		(PS), (-STRONIC), ⇒ORG-NO 10191	VD1100
1.4 HDi	09/02-02/07		51	1398	AP9013	ALT, (Valeo), 150A, OE-NO 5702H4, 5705AS, 5705EY, ALT-No: TG15C020, TG15C028, TG15C053	VD1100
					AP9019	ALT, (Valeo), ALT-No: TG15C118, 150A, OE-NO 5705AS, 5705EY	
1.4 HDi eco 70	09/01-	8HX (DV4TD), 8HZ (DV4TD)	50	1398	AP9013	ALT, (Valeo), 150A, OE-NO 5702H4, 5705AS, 5705EY, ALT-No: TG15C020, TG15C028, TG15C053	
					AP9019	ALT, (Valeo), ALT-No: TG15C118, 150A, OE-NO 5705AS, 5705EY ⇒ORG-NO 10527	VD1094
						ORG-NO 10528⇒	VD1096
1.4 i	09/98-	KFX (TU3JP), KFW (TU3JP)	55	1360		(-PS), (AC), ⇒ORG-NO 10191, MTR-CODE: TU3JP	VD1100
1.6 16V	12/00-	NFU (TU5JP4)	80	1587			VD1100
1.6 HDi 110	05/04-	9HY (DV6TED4), 9HZ (DV6TED4)	80	1560	AP9013	ALT, (Valeo), 150A, OE-NO 5702H4, 5705AS, 5705EY, ALT-No: TG15C020, TG15C028, TG15C053	
					AP9019	ALT, (Valeo), ALT-No: TG15C118, 150A, OE-NO 5705AS, 5705EY ⇒ORG-NO 10527	VD1094
						ORG-NO 10528⇒	VD1096
1.6 i	09/98-12/00	NFZ (TU5JP)	65	1587		(-PS), ⇒ORG-NO 10191	VD1100
1.9 D	09/98-11/01	WJZ (DW8)	51	1868		ORG-NO 09895⇒, (AC) ⇒ORG-NO 09894	VD1080
							VD1097
2.0 HDi 90	12/99-	RHY (DW10TD)	66	1997	AP9031	ORG-NO 09367⇒, ⇒ORG-NO 09519, ALT, (Valeo), 150A, OE-NO 5705 AA, 5705 ER	
					AP9038	⇒ORG-NO 09366, ALT, OE-NO 5705 4F, 5705 GC, (Valeo), (Mitsubishi), 150A	
					AP9042	ALT, (Bosch), ALT-No: 0124 615 027, 150A, OE-NO 5705AA, 5705ER ⇒ORG-NO 09360, ALT, (-AC)	6PK1468D1
						ALT, (AC), ⇒ORG-NO 09360	6PK1740D1
						⇒ORG-NO 09360	VD1080
						ORG-NO 09361⇒	VD1095

### 206 Stufenheck

1.4 HDi eco 70	09/08-	8HZ (DV4TD)	50	1398			VD1096
1.6 16V	03/07-	NFU (TU5JP4)	80	1587			VD1100

### 206 SW (2E/K)

1.4 16V	10/03-	KFU (ET3J4)	65	1360			VD1100
1.4 HDi	07/02-	8HX (DV4TD)	50	1398	AP9013	ALT, (Valeo), 150A, OE-NO 5702H4, 5705AS, 5705EY, ALT-No: TG15C020, TG15C028, TG15C053	
					AP9019	ALT, (Valeo), ALT-No: TG15C118, 150A, OE-NO 5705AS, 5705EY ⇒ORG-NO 10527	VD1094
						ORG-NO 10528⇒	VD1096
1.6 16V	07/02-	NFU (TU5JP4)	80	1587			VD1100
1.6 HDi 110	05/04-	9HZ (DV6TED4)	80	1560	AP9013	ALT, (Valeo), 150A, OE-NO 5702H4, 5705AS, 5705EY, ALT-No: TG15C020, TG15C028, TG15C053	
					AP9019	ALT, (Valeo), ALT-No: TG15C118, 150A, OE-NO 5705AS, 5705EY ⇒ORG-NO 10527	VD1094
						ORG-NO 10528⇒	VD1096
2.0 HDi	07/02-	RHY (DW10TD)	66	1997	AP9031	ALT, (Valeo), 150A, OE-NO 5705 AA, 5705ER	
					AP9038	⇒ORG-NO 09366, ALT, OE-NO 5705 4F, 5705 GC, (Valeo), (Mitsubishi), 150A	
					AP9042	ALT, (Bosch), ALT-No: 0124 615 027, 150A, OE-NO 5705AA, 5705ER	VD1095

### 206+ (T3E)

1.4 HDi eco 70	01/09-	8HX (DV4TD), 8HZ (DV4TD)	50	1398			VD1096
----------------	--------	-----------------------------	----	------	--	--	--------

### 207 (WA\_, WC\_)

1.4	02/06-	KFV (TU3A)	53	1360	AP9018	ALT, (Mitsubishi), 80A, OE-NO 5705KQ, 5702J3, ALT-No: A005TG0881ZE, 120A, OE-NO 5705KG, 5702J0, ALT-No: A003TG5281ZE	VD1100
1.4 16V	02/06-	KFU (ET3J4)	65	1360	AP9018	ALT, (Mitsubishi), 80A, OE-NO 5705KQ, 5702J3, ALT-No: A005TG0881ZE,	





## PEUGEOT

207 (WA\_, WC\_) ↩

						120A, OE-NO 5705KG, 5702J0, ALT-No: A003TG5281ZE	<b>VD1100</b>
	06/07-	EP3	70	1397	<b>AP9018</b>	ALT, (Mitsubishi), 80A, OE-NO 5705KQ, 5702J3, ALT-No: A005TG0881ZE, 120A, OE-NO 5705KG, 5702J0, ALT-No: A003TG5281ZE	
1.4 HDi	02/06-	8HZ (DV4TD), 8HR (DV4TD)	50	1398	<b>AP9013</b>  <b>AP9019</b>	ALT, (Valeo), 150A, OE-NO 5702H4, 5705AS, 5705EY, ALT-No: TG15C020, TG15C028, TG15C053 ALT, (Valeo), ALT-No: TG15C118, 150A, OE-NO 5705AS, 5705EY	<b>VD1096</b>
1.6 16V	02/06-	NFU (TU5JP4)	80	1587	<b>AP9018</b>	ALT, (Mitsubishi), 80A, OE-NO 5705KQ, 5702J3, ALT-No: A005TG0881ZE, 120A, OE-NO 5705KG, 5702J0, ALT-No: A003TG5281ZE	<b>VD1100</b>
1.6 16V RC	02/07-	5FY (EP6DTS)	128	1598	<b>AP9018</b>	ALT, (Mitsubishi), 80A, OE-NO 5705KQ, 5702J3, ALT-No: A005TG0881ZE, 120A, OE-NO 5705KG, 5702J0, ALT-No: A003TG5281ZE	
1.6 16V Turbo	02/06-	EP6DT	110	1598	<b>AP9018</b>	ALT, (Mitsubishi), 80A, OE-NO 5705KQ, 5702J3, ALT-No: A005TG0881ZE, 120A, OE-NO 5705KG, 5702J0, ALT-No: A003TG5281ZE	
1.6 16V VTi	02/07-	EP6, 5FS (EP6C)	88	1598	<b>AP9018</b>	ALT, (Mitsubishi), 80A, OE-NO 5705KQ, 5702J3, ALT-No: A005TG0881ZE, 120A, OE-NO 5705KG, 5702J0, ALT-No: A003TG5281ZE	
1.6 HDi	02/06-	9HX (DV6ATED4)	66	1560	<b>AP9013</b>  <b>AP9019</b>	ALT, (Valeo), 150A, OE-NO 5702H4, 5705AS, 5705EY, ALT-No: TG15C020, TG15C028, TG15C053 ALT, (Valeo), ALT-No: TG15C118, 150A, OE-NO 5705AS, 5705EY	<b>VD1096</b>
		9HY (DV6TED4), 9HZ (DV6TED4)	80	1560	<b>AP9013</b>  <b>AP9019</b>	ALT, (Valeo), 150A, OE-NO 5702H4, 5705AS, 5705EY, ALT-No: TG15C020, TG15C028, TG15C053 ALT, (Valeo), ALT-No: TG15C118, 150A, OE-NO 5705AS, 5705EY	<b>VD1096</b>
	11/09-		68	1560			<b>VD1096</b>
1.6 HDi 110	08/09-		82	1560			<b>VD1096</b>
<b>207 CC (WD_)</b>							
1.6 16V	02/07-	EP6	88	1598	<b>AP9018</b>	ALT, (Mitsubishi), 80A, OE-NO 5705KQ, 5702J3, ALT-No: A005TG0881ZE, 120A, OE-NO 5705KG, 5702J0, ALT-No: A003TG5281ZE	
1.6 16V Turbo	02/07-	EP6DT	110	1598	<b>AP9018</b>	ALT, (Mitsubishi), 80A, OE-NO 5705KQ, 5702J3, ALT-No: A005TG0881ZE, 120A, OE-NO 5705KG, 5702J0, ALT-No: A003TG5281ZE	
1.6 HDi	02/07-	9HZ (DV6TED4)	80	1560	<b>AP9013</b>  <b>AP9019</b>	ALT, (Valeo), 150A, OE-NO 5702H4, 5705AS, 5705EY, ALT-No: TG15C020, TG15C028, TG15C053 ALT, (Valeo), ALT-No: TG15C118, 150A, OE-NO 5705AS, 5705EY	<b>VD1096</b>
	08/09-		82	1560			<b>VD1096</b>
<b>207 SW (WK_)</b>							
1.4	06/07-	KFV (TU3A)	54	1360	<b>AP9018</b>	ALT, (Mitsubishi), 80A, OE-NO 5705KQ, 5702J3, ALT-No: A005TG0881ZE, 120A, OE-NO 5705KG, 5702J0, ALT-No: A003TG5281ZE	<b>VD1100</b>
1.4 16V	06/07-	EP3	70	1397	<b>AP9018</b>	ALT, (Mitsubishi), 80A, OE-NO 5705KQ, 5702J3, ALT-No: A005TG0881ZE, 120A, OE-NO 5705KG, 5702J0, ALT-No: A003TG5281ZE	
1.6 16V	06/07-	EP6	88	1598	<b>AP9018</b>	ALT, (Mitsubishi), 80A, OE-NO 5705KQ, 5702J3, ALT-No: A005TG0881ZE, 120A, OE-NO 5705KG, 5702J0, ALT-No: A003TG5281ZE	
1.6 16V RC	02/07-	5FY (EP6DTS)	128	1598	<b>AP9018</b>	ALT, (Mitsubishi), 80A, OE-NO 5705KQ, 5702J3, ALT-No: A005TG0881ZE, 120A, OE-NO 5705KG, 5702J0, ALT-No: A003TG5281ZE	







## PEUGEOT

207 SW (WK.)  
 ↩ 1.6 HDi

06/07-	9HX (DV6ATED4)	66	1560	AP9013	ALT, (Valeo), 150A, OE-NO 5702H4, 5705AS, 5705EY, ALT-No: TG15C020, TG15C028, TG15C053	
				AP9019	ALT, (Valeo), ALT-No: TG15C118, 150A, OE-NO 5705AS, 5705EY	VD1096
	9HZ (DV6TED4)	80	1560	AP9013	ALT, (Valeo), 150A, OE-NO 5702H4, 5705AS, 5705EY, ALT-No: TG15C020, TG15C028, TG15C053	
				AP9019	ALT, (Valeo), ALT-No: TG15C118, 150A, OE-NO 5705AS, 5705EY	VD1096
08/09-		82	1560			VD1096
11/09-		68	1560			VD1096

3008

1.6 HDi	06/09-	9HZ (DV6TED4)	80	1560	AP9013	ALT, (Valeo), 150A, OE-NO 5702H4, 5705AS, 5705EY, ALT-No: TG15C020, TG15C028, TG15C053	
					AP9019	ALT, (Valeo), ALT-No: TG15C118, 150A, OE-NO 5705AS, 5705EY	VD1096
	08/10-		82	1560			VD1096
1.6 THP	06/09-	5FX (EP6DT)	110	1598	AP9018	ALT, (Mitsubishi), 120A, OE-NO 5705KG, ALT-No: A003TG5281ZE	
		5FV (EP6DT)	115	1598	AP9018	ALT, (Mitsubishi), 120A, OE-NO 5705KG, ALT-No: A003TG5281ZE	
1.6 VTi	06/09-	EP6, 5FS (EP6C)	88	1598	AP9018	ALT, (Mitsubishi), 120A, OE-NO 5705KG, ALT-No: A003TG5281ZE	

306 (7B, N3, N5)

1.9 D	03/98-05/01	DHV (XUD9BSD)	55	1905			VD1086
	09/98-05/01	WJZ (DW8), WJY (DW8B)	51	1868		MTR-CODE: DW8B, ALT, (PS), (AC), ORG-NO 09520⇒	6PK1750D2
						MTR-CODE: DW8B, (AC), ORG-NO 09520⇒	VD1080
						MTR-CODE: DW8	VD1097
						MTR-CODE: DW8B, (-AC)	VD1097
						MTR-CODE: DW8B, (AC), ⇒ORG-NO 09519	VD1097
1.9 SLD	06/94-05/01	DJZ (XUD9Y)	47	1905			VD1086
		DJY (XUD9A)	50	1905			VD1086
1.9 SRDT	06/94-05/01	DHY (XUD9TE)	66	1905			VD1086
2.0 HDi 90	06/99-05/01	RHY (DW10TD)	66	1997	AP9023	ALT, (Bosch), ALT-No: 0124525035, 150A, OE-NO 5705AS, 5705EY	
					AP9038	ALT, (Valeo), (Mitsubishi), 150A	6PK1468D1
						MTR-CODE: DW10TD, ALT, (-AC)	6PK1750D2
						MTR-CODE: DW10TD, ALT, (AC)	VD1080

306 Break (7E, N3, N5)

1.9 D	03/97-04/02	DJY (XUD9A)	50	1905		MTR-CODE: XUD9A	VD1086
	03/98-04/02	DHV (XUD9BSD)	55	1905			VD1086
	09/98-04/02	WJZ (DW8), WJY (DW8B)	51	1868		MTR-CODE: DW8B, ALT, (PS), (AC), ORG-NO 09520⇒	6PK1750D2
						MTR-CODE: DW8B, (AC), ORG-NO 09520⇒	VD1080
						MTR-CODE: DW8	VD1097
						MTR-CODE: DW8B, (-AC)	VD1097
						MTR-CODE: DW8B, (AC), ⇒ORG-NO 09519	VD1097
1.9 TD	02/97-04/02	DHY (XUD9TE)	66	1905			VD1086
2.0 HDi 90	06/99-04/02	RHY (DW10TD)	66	1997	AP9023	ALT, (Bosch), ALT-No: 0124525035, 150A, OE-NO 5705AS, 5705EY	
					AP9038	ALT, (Valeo), (Mitsubishi), 150A	6PK1468D1
						MTR-CODE: DW10TD, ALT, (-AC)	6PK1750D2
						MTR-CODE: DW10TD, ALT, (AC)	VD1080

306 Schrägheck (7A, 7C, N3, N5)

1.8 D	05/93-05/01	A9A (XUD7)	43	1769			VD1086
1.9 D	03/98-05/01	DHV (XUD9BSD)	55	1905			VD1086
	05/93-05/01	DJZ (XUD9Y)	47	1905			VD1086
	06/94-05/01	DJY (XUD9A)	50	1905			VD1086
	09/98-05/01	WJZ (DW8), WJY (DW8B)	51	1868		MTR-CODE: DW8B, ALT, (PS), (AC), ORG-NO 09520⇒	6PK1750D2
						MTR-CODE: DW8B, (AC), ORG-NO 09520⇒	VD1080



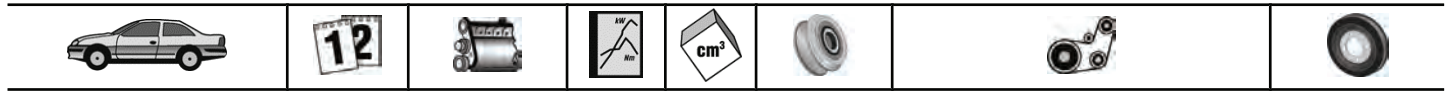

# PEUGEOT

## 306 Schrägheck (7A, 7C, N3, N5)

						MTR-CODE: DW8 MTR-CODE: DW8B, (-AC) MTR-CODE: DW8B, (AC), ⇨ORG-NO 09519	VD1097 VD1097 VD1097
1.9 DT	05/93-05/01	DHY (XUD9TE)	66	1905			VD1086
2.0 HDI 90	06/99-05/01	RHY (DW10TD)	66	1997	AP9023 AP9038	ALT, (Bosch), ALT-No: 0124525035, 150A, OE-NO 5705AS, 5705EY ALT, (Valeo), (Mitsubishi), 150A MTR-CODE: DW10TD, ALT, (-AC) MTR-CODE: DW10TD, ALT, (AC)	6PK1468D1 6PK1750D2 VD1080

## 307 (3A/C)

1.4	08/00-	KFW (TU3JP)	55	1360			VD1100
1.4 16V	11/03-	KFU (ET3J4)	65	1360			VD1100
1.4 HDi	10/01-	8HX (DV4TD), 8HZ (DV4TD)	50	1398	AP9013 AP9019	ALT, (Valeo), 150A, OE-NO 5702H4, 5705AS, 5705EY, ALT-No: TG15C020, TG15C028, TG15C053 ALT, (Valeo), ALT-No: TG15C118, 150A, OE-NO 5705AS, 5705EY	VD1094 VD1100
1.6 16V	08/00-	NFU (TU5JP4)	80	1587			VD1094 VD1100
1.6 HDi	04/05-	9HX (DV6ATED4)	66	1560	AP9013 AP9019	ALT, (Valeo), 150A, OE-NO 5702H4, 5705AS, 5705EY, ALT-No: TG15C020, TG15C028, TG15C053 ALT, (Valeo), ALT-No: TG15C118, 150A, OE-NO 5705AS, 5705EY ⇨ORG-NO 10556 ORG-NO 10557⇨	VD1094 VD1096
1.6 HDi 110	02/04-	9HY (DV6TED4), 9HZ (DV6TED4)	80	1560	AP9013 AP9019	ALT, (Valeo), 150A, OE-NO 5702H4, 5705AS, 5705EY, ALT-No: TG15C020, TG15C028, TG15C053 ALT, (Valeo), ALT-No: TG15C118, 150A, OE-NO 5705AS, 5705EY ⇨ORG-NO 10556 ORG-NO 10557⇨	VD1094 VD1096
2.0 HDi 110	08/00-	RHS (DW10ATED)	79	1997	AP9023 AP9031 AP9042	ALT, (Bosch), ALT-No: 0124525035, 150A, OE-NO 5705AS, 5705EY ALT, (Valeo), 150A, OE-NO 5705 AA, 5705 ER ALT, (Bosch), ALT-No: 0124 615 027, 150A, OE-NO 5705AA, 5705ER ⇨ORG-NO 09486 ORG-NO 09487⇨	VD1080 VD1095
2.0 HDi 90	08/00-	RHY (DW10TD)	66	1997	AP9023 AP9031 AP9042	ALT, (Bosch), ALT-No: 0124525035, 150A, OE-NO 5705AS, 5705EY ALT, (Valeo), 150A, OE-NO 5705 AA, 5705 ER ALT, (Bosch), ALT-No: 0124 615 027, 150A, OE-NO 5705AA, 5705ER ⇨ORG-NO 09216 ORG-NO 09217⇨	VD1080 VD1095

## 307 Break (3E)

1.4 16V	11/03-	KFU (ET3J4)	65	1360			VD1100
1.4 HDi	03/02-	8HZ (DV4TD)	50	1398	AP9013 AP9019	ALT, (Valeo), 150A, OE-NO 5702H4, 5705AS, 5705EY, ALT-No: TG15C020, TG15C028, TG15C053 ALT, (Valeo), ALT-No: TG15C118, 150A, OE-NO 5705AS, 5705EY	VD1100
1.6 16V	03/02-	NFU (TU5JP4)	80	1587			VD1100
1.6 HDi	04/05-	9HX (DV6ATED4)	66	1560	AP9013 AP9019	ALT, (Valeo), 150A, OE-NO 5702H4, 5705AS, 5705EY, ALT-No: TG15C020, TG15C028, TG15C053 ALT, (Valeo), ALT-No: TG15C118, 150A, OE-NO 5705AS, 5705EY ⇨ORG-NO 10556 ORG-NO 10557⇨	VD1094 VD1096
1.6 HDi 110	02/04-	9HY (DV6TED4), 9HZ (DV6TED4)	80	1560	AP9013 AP9019	ALT, (Valeo), 150A, OE-NO 5702H4, 5705AS, 5705EY, ALT-No: TG15C020, TG15C028, TG15C053 ALT, (Valeo), ALT-No: TG15C118, 150A, OE-NO 5705AS, 5705EY ⇨ORG-NO 10556 ORG-NO 10557⇨	VD1094 VD1096
2.0 HDi 110	03/02-	RHS (DW10ATED)	79	1997	AP9042	ALT, (Bosch), ALT-No: 0124 615 027, 150A, OE-NO 5705AA, 5705ER ⇨ORG-NO 09486 ORG-NO 09487⇨	VD1080 VD1095
2.0 HDi 90	03/02-	RHY (DW10TD)	66	1997	AP9023	ALT, (Bosch), ALT-No: 0124525035,	



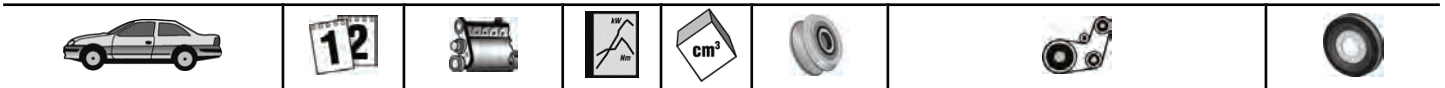

## PEUGEOT

### 307 Break (3E)

						<b>AP9031</b>	150A, OE-NO 5705AS, 5705EY ALT, (Valeo), 150A, OE-NO 5705 AA, 5705 ER	
						<b>AP9042</b>	ALT, (Bosch), ALT-No: 0124 615 027, 150A, OE-NO 5705AA, 5705ER	
								<b>VD1095</b>

### 307 CC (3B)

1.6 16V	03/05-	NFU (TU5JP4)	80	1587				<b>VD1100</b>
---------	--------	--------------	----	------	--	--	--	---------------

### 307 SW (3H)

1.4 16V	11/03-	KFU (ET3J4)	65	1360				<b>VD1100</b>
1.6 16V	03/02-	NFU (TU5JP4)	80	1587				<b>VD1100</b>

1.6 D	12/06-	9HX (DV6ATED4)	66	1560		<b>AP9013</b>	ALT, (Valeo), 150A, OE-NO 5702H4, 5705AS, 5705EY, ALT-No: TG15C020, TG15C028, TG15C053	
						<b>AP9019</b>	ALT, (Valeo), ALT-No: TG15C118, 150A, OE-NO 5705AS, 5705EY	
								<b>VD1096</b>

1.6 HDi 110	02/04-	9HY (DV6TED4), 9HZ (DV6TED4)	80	1560		<b>AP9013</b>	ALT, (Valeo), 150A, OE-NO 5702H4, 5705AS, 5705EY, ALT-No: TG15C020, TG15C028, TG15C053	
						<b>AP9019</b>	ALT, (Valeo), ALT-No: TG15C118, 150A, OE-NO 5705AS, 5705EY	
							⇒ORG-NO 10556 ORG-NO 10557⇒	<b>VD1094</b> <b>VD1096</b>

2.0 HDi 110	03/02-	RHS (DW10ATED)	79	1997		<b>AP9023</b>	ALT, (Bosch), ALT-No: 0124525035, 150A, OE-NO 5705AS, 5705EY	
						<b>AP9031</b>	ALT, (Valeo), 150A, OE-NO 5705 AA, 5705 ER	
						<b>AP9042</b>	ALT, (Bosch), ALT-No: 0124 615 027, 150A, OE-NO 5705AA, 5705ER	
							⇒ORG-NO 09486 ORG-NO 09487⇒	<b>VD1080</b> <b>VD1095</b>

2.0 HDi 90	03/02-	RHY (DW10TD)	66	1997		<b>AP9023</b>	ALT, (Bosch), ALT-No: 0124525035, 150A, OE-NO 5705AS, 5705EY	
						<b>AP9031</b>	ALT, (Valeo), 150A, OE-NO 5705 AA, 5705 ER	
						<b>AP9042</b>	ALT, (Bosch), ALT-No: 0124 615 027, 150A, OE-NO 5705AA, 5705ER	
								<b>VD1095</b>

### 308 (4A\_, 4C\_)

1.4 16V	09/07-	EP3	70	1397		<b>AP9018</b>	ALT, (Mitsubishi), 80A, OE-NO 5705KQ, 5702J3, ALT-No: A005TG0881ZE, 120A, OE-NO 5705KG, 5702J0, ALT-No: A003TG5281ZE	
---------	--------	-----	----	------	--	---------------	-------------------------------------------------------------------------------------------------------------------------------	--

1.6 16V	03/08-	EP6DTS	128	1598		<b>AP9018</b>	ALT, (Mitsubishi), 80A, OE-NO 5705KQ, 5702J3, ALT-No: A005TG0881ZE, 120A, OE-NO 5705KG, 5702J0, ALT-No: A003TG5281ZE	
---------	--------	--------	-----	------	--	---------------	-------------------------------------------------------------------------------------------------------------------------------	--

	09/07-	EP6	88	1598		<b>AP9018</b>	ALT, (Mitsubishi), 80A, OE-NO 5705KQ, 5702J3, ALT-No: A005TG0881ZE, 120A, OE-NO 5705KG, 5702J0, ALT-No: A003TG5281ZE	
--	--------	-----	----	------	--	---------------	-------------------------------------------------------------------------------------------------------------------------------	--

			103	1598		<b>AP9018</b>	ALT, (Mitsubishi), 80A, OE-NO 5705KQ, 5702J3, ALT-No: A005TG0881ZE, 120A, OE-NO 5705KG, 5702J0, ALT-No: A003TG5281ZE	
--	--	--	-----	------	--	---------------	-------------------------------------------------------------------------------------------------------------------------------	--

		EP6DT	110	1598		<b>AP9018</b>	ALT, (Mitsubishi), 80A, OE-NO 5705KQ, 5702J3, ALT-No: A005TG0881ZE, 120A, OE-NO 5705KG, 5702J0, ALT-No: A003TG5281ZE	
--	--	-------	-----	------	--	---------------	-------------------------------------------------------------------------------------------------------------------------------	--

1.6 HDi	09/07-		66	1560		<b>AP9013</b>	ALT, (Valeo), 150A, OE-NO 5702H4, 5705AS, 5705EY, ALT-No: TG15C020, TG15C028, TG15C053	
						<b>AP9019</b>	ALT, (Valeo), ALT-No: TG15C118, 150A, OE-NO 5705AS, 5705EY	
								<b>VD1096</b>

		9HZ (DV6TED4)	80	1560		<b>AP9013</b>	ALT, (Valeo), 150A, OE-NO 5702H4, 5705AS, 5705EY, ALT-No: TG15C020, TG15C028, TG15C053	
						<b>AP9019</b>	ALT, (Valeo), ALT-No: TG15C118, 150A, OE-NO 5705AS, 5705EY	
								<b>VD1096</b>

	11/09-		68	1560				<b>VD1096</b>
	12/09-		82	1560				<b>VD1096</b>

<b>308 CC</b>								
1.6 16V	06/09-	EP6	88	1598		<b>AP9018</b>	ALT, (Mitsubishi), 80A, OE-NO 5705KQ, 5702J3, ALT-No: A005TG0881ZE, 120A, OE-NO 5705KG, 5702J0,	





## PEUGEOT

**308 CC**

		5FT (EP6DT)	103	1598	<b>AP9018</b>	ALT-No: A003TG5281ZE ALT, (Mitsubishi), 80A, OE-NO 5705KQ, 5702J3, ALT-No: A005TG0881ZE, 120A, OE-NO 5705KG, 5702J0, ALT-No: A003TG5281ZE	
		EP6DT	110	1598	<b>AP9018</b>	ALT, (Mitsubishi), 80A, OE-NO 5705KQ, 5702J3, ALT-No: A005TG0881ZE, 120A, OE-NO 5705KG, 5702J0, ALT-No: A003TG5281ZE	
		EP6CDT	115	1598	<b>AP9018</b>	ALT, (Mitsubishi), 80A, OE-NO 5705KQ, 5702J3, ALT-No: A005TG0881ZE, 120A, OE-NO 5705KG, 5702J0, ALT-No: A003TG5281ZE	
1.6 HDi	06/09-		82	1560	<b>AP9013</b>  <b>AP9019</b>	ALT, (Valeo), 150A, OE-NO 5702H4, 5705AS, 5705EY, ALT-No: TG15C020, TG15C028, TG15C053 ALT, (Valeo), ALT-No: TG15C118, 150A, OE-NO 5705AS, 5705EY	<b>VD1096</b>

**308 SW**

1.4 16V	09/07-	8FS (EP3)	70	1397	<b>AP9018</b>	ALT, (Mitsubishi), 80A, OE-NO 5705KQ, 5702J3, ALT-No: A005TG0881ZE, 120A, OE-NO 5705KG, 5702J0, ALT-No: A003TG5281ZE	
	12/09-		72	1397	<b>AP9018</b>	ALT, (Mitsubishi), 80A, OE-NO 5705KQ, 5702J3, ALT-No: A005TG0881ZE, 120A, OE-NO 5705KG, 5702J0, ALT-No: A003TG5281ZE	
1.6 16V	03/08-	5FY (EP6DTS)	128	1598	<b>AP9018</b>	ALT, (Mitsubishi), 80A, OE-NO 5705KQ, 5702J3, ALT-No: A005TG0881ZE, 120A, OE-NO 5705KG, 5702J0, ALT-No: A003TG5281ZE	
	09/07-	EP6	88	1598	<b>AP9018</b>	ALT, (Mitsubishi), 80A, OE-NO 5705KQ, 5702J3, ALT-No: A005TG0881ZE, 120A, OE-NO 5705KG, 5702J0, ALT-No: A003TG5281ZE	
		5FT (EP6DT)	103	1598	<b>AP9018</b>	ALT, (Mitsubishi), 80A, OE-NO 5705KQ, 5702J3, ALT-No: A005TG0881ZE, 120A, OE-NO 5705KG, 5702J0, ALT-No: A003TG5281ZE	
1.6 HDi	09/07-	EP6DT	110	1598	<b>AP9018</b>	ALT, (Mitsubishi), 80A, OE-NO 5705KQ, 5702J3, ALT-No: A005TG0881ZE, 120A, OE-NO 5705KG, 5702J0, ALT-No: A003TG5281ZE	
		9HX (DV6ATED4), 9HV (DV6ATED4)	66	1560	<b>AP9013</b>  <b>AP9019</b>	ALT, (Valeo), 150A, OE-NO 5702H4, 5705AS, 5705EY, ALT-No: TG15C020, TG15C028, TG15C053 ALT, (Valeo), ALT-No: TG15C118, 150A, OE-NO 5705AS, 5705EY	<b>VD1096</b>
	9HZ (DV6TED4)	80	1560	<b>AP9013</b>  <b>AP9019</b>	ALT, (Valeo), 150A, OE-NO 5702H4, 5705AS, 5705EY, ALT-No: TG15C020, TG15C028, TG15C053 ALT, (Valeo), ALT-No: TG15C118, 150A, OE-NO 5705AS, 5705EY	<b>VD1096</b>	
	12/09-		82	1560	<b>AP9013</b>  <b>AP9019</b>	ALT, (Valeo), 150A, OE-NO 5702H4, 5705AS, 5705EY, ALT-No: TG15C020, TG15C028, TG15C053 ALT, (Valeo), ALT-No: TG15C118, 150A, OE-NO 5705AS, 5705EY	<b>VD1096</b>

**405 I (15B)**

1.8 Turbo Diesel	03/88-12/92	A8A (XUD7TE), AJZ (XUD7TEY)	66	1769		(-AC)	<b>VD1086</b>
1.9 Diesel	03/88-12/92	D9B (XUD9A)	51	1905		(PS), (-AC)	<b>VD1086</b>
	07/88-09/92	DJZ (XUD9Y)	47	1905		(PS), (-AC)	<b>VD1086</b>

**405 I Break (15E)**

1.8 TD	10/88-08/92	A8A (XUD7TE), AJZ (XUD7TEY)	66	1769		(-AC)	<b>VD1086</b>
1.9 D	10/88-08/92	DJZ (XUD9Y)	47	1905		(PS), (-AC)	<b>VD1086</b>
		D9B (XUD9A), DJY (XUD9A)	51	1905		(PS), (-AC)	<b>VD1086</b>

**405 II (4B)**

1.9 D	06/94-10/95	DJY (XUD9A)	50	1905			<b>VD1086</b>
	08/92-10/95	DJZ (XUD9Y)	47	1905			<b>VD1086</b>





## PEUGEOT

<b>405 II (4B)</b>							
↳ 1.9 TD	08/92-10/95	DHY (XUD9TE)	66	1905			VD1086
<b>405 II Break (4E)</b>							
1.9 D	06/94-10/96	DJY (XUD9A)	50	1905			VD1086
	08/92-10/96	DJZ (XUD9Y)	47	1905			VD1086
	09/93-12/95	XUD9	51	1905		MTR-CODE: XUD9A	VD1086
1.9 TD	08/92-10/96	DHY (XUD9TE)	66	1905			VD1086
<b>406 (8B)</b>							
1.9 TD	01/96-05/04	DHX (XUD9TE)	66	1905			VD1086
		DHY (XUD9TE)	68	1905			VD1086
2.0 HDi 110	06/98-08/01	RHZ (DW10ATED)	80	1997	AP9023	ALT, (Bosch), ALT-No: 0124525035, 150A, OE-NO 5705AS, 5705EY	
					AP9038	(AC), ALT, (Valeo), (Mitsubishi), 150A	
					AP9042	ALT, (Bosch), ALT-No: 0124 615 027, 150A, OE-NO 5705AA, 5705ER	
						ALT, (-AC), (AUTOM), ⇒ORG-NO 09365	6PK1468D1
						ALT, (-AC), (MANL), ⇒ORG-NO 09337	6PK1468D1
						ALT, (AC), (SANDEN), (AUTOM), ⇒ORG-NO 09365	6PK1740D1
						ALT, (AC), (SANDEN), (MANL), ⇒ORG-NO 09337	6PK1740D1
						ALT, (AC), (DELPHI), (AUTOM), ⇒ORG-NO 09365	6PK1750D2
						ALT, (AC), (DELPHI), (MANL), ⇒ORG-NO 09337	6PK1750D2
							VD1080
2.0 HDi 110	08/01-05/04	RHZ (DW10ATED), RHS (DW10ATED)	79	1997	AP9023	ALT, (Bosch), ALT-No: 0124525035, 150A, OE-NO 5705AS, 5705EY	
					AP9031	ALT, OE-NO 5705 AA, 5705 ER, (Valeo), 150A	
					AP9038	(AC), ALT, (Valeo), (Mitsubishi), 150A	
					AP9042	ALT, (Bosch), ALT-No: 0124 615 027, 150A, OE-NO 5705AA, 5705ER	
						ALT, (-AC), ⇒ORG-NO 09365	6PK1468D1
						ALT, (AC), (SANDEN), ⇒ORG-NO 09365	6PK1740D1
						ALT, (AC), (DELPHI), ⇒ORG-NO 09365	6PK1750D2
						⇒ORG-NO 09365	VD1080
						ORG-NO 09366⇒	VD1095
2.0 HDi 90	02/99-05/04	RHY (DW10TD)	66	1997	AP9023	ALT, (Bosch), ALT-No: 0124525035, 150A, OE-NO 5705AS, 5705EY	
					AP9031	ALT, OE-NO 5705 AA, 5705 ER, (Valeo), 150A	
					AP9038	(AC), ⇒ORG-NO 09338, ALT, OE-NO 5705 4F, 5705 GC, (Valeo), (Mitsubishi), 150A	
					AP9042	ALT, (Bosch), ALT-No: 0124 615 027, 150A, OE-NO 5705AA, 5705ER	
						ALT, (-AC), ⇒11/2002	6PK1468D1
						ALT, (AC), (SANDEN), ⇒11/2002	6PK1740D1
						ALT, (AC), (DELPHI), ⇒11/2002	6PK1750D2
						⇒ORG-NO 09337	VD1080
						ORG-NO 09338⇒	VD1095
2.1 TD 12V	01/96-05/04	P8C (XUD11BTE)	80	2088			VD1088
2.2 HDi	03/00-05/04	4HX (DW12TED4 /FAP)	98	2179	AP9031	⇒ORG-NO 09519, ALT, OE-NO 5705 AA, 5705 ER, (Valeo), 150A	
					AP9042	ALT, (Bosch), ALT-No: 0124 615 027, 150A, OE-NO 5705AA, 5705ER	
						ALT, (AC), (SANDEN), (MANL)	6PK1740D1
						ALT, (AC), (DELPHI), (MANL)	6PK1750D2
							VD1080
<b>406 Break (8E/F)</b>							
1.9 D	10/96-10/04	DHW (XUD9SD)	55	1905			VD1086
1.9 TD	10/96-10/04	DHX (XUD9TE)	66	1905			VD1086
2.0 HDi 110	02/99-04/04	RHZ (DW10ATED)	80	1997	AP9023	ALT, (Bosch), ALT-No: 0124525035, 150A, OE-NO 5705AS, 5705EY	
					AP9038	(AC), ALT, (Valeo), (Mitsubishi), 150A	
					AP9042	ALT, (Bosch), ALT-No: 0124 615 027, 150A, OE-NO 5705AA, 5705ER	
						ALT, (-AC), (AUTOM), ⇒ORG-NO 09365	6PK1468D1
						ALT, (-AC), (MANL), ⇒ORG-NO 09337	6PK1468D1
						ALT, (AC), (SANDEN), (AUTOM), ⇒ORG-NO 09365	6PK1740D1
						ALT, (AC), (SANDEN), (MANL), ⇒ORG-NO 09337	6PK1740D1





# PEUGEOT

## 406 Break (8E/F)

						ALT, (AC), (DELPHI), (AUTOM), ⇒ORG-NO 09365	<b>6PK1750D2</b>
						ALT, (AC), (DELPHI), (MANL), ⇒ORG-NO 09337 ⇒ORG-NO 09365 ORG-NO 09366⇒	<b>6PK1750D2</b> <b>VD1080</b> <b>VD1095</b>
2.0 HDi 110	08/01-10/04	RHZ (DW10ATED), RHS (DW10ATED)	79	1997	<b>AP9023</b> <b>AP9031</b> <b>AP9038</b> <b>AP9042</b>	ALT, (Bosch), ALT-No: 0124525035, 150A, OE-NO 5705AS, 5705EY ALT, (Valeo), OE-NO 5705 AA, 5705 ER, 150A (AC), ALT, (Valeo), (Mitsubishi), 150A ALT, (Bosch), ALT-No: 0124 615 027, 150A, OE-NO 5705AA, 5705ER ALT, (-AC), ⇒ORG-NO 09365 ALT, (AC), (SANDEN), ⇒ORG-NO 09365 ALT, (AC), (DELPHI), ⇒ORG-NO 09365 ⇒ORG-NO 09365 ORG-NO 09366⇒	<b>6PK1468D1</b> <b>6PK1740D1</b> <b>6PK1750D2</b> <b>VD1080</b> <b>VD1095</b>
2.0 HDI 90	02/99-10/04	RHY (DW10TD)	66	1997	<b>AP9023</b> <b>AP9031</b> <b>AP9038</b> <b>AP9042</b>	ALT, (Bosch), ALT-No: 0124525035, 150A, OE-NO 5705AS, 5705EY ALT, (Valeo), OE-NO 5705 AA, 5705 ER, 150A (AC), ⇒ORG-NO 09338, ALT, OE-NO 5705 4F, 5705 GC, (Valeo), (Mitsubishi), 150A ALT, (Bosch), ALT-No: 0124 615 027, 150A, OE-NO 5705AA, 5705ER ALT, (-AC), ⇒ORG-NO 09337 ALT, (AC), (SANDEN), ⇒ORG-NO 09337 ALT, (AC), (DELPHI), ⇒ORG-NO 09337 ⇒ORG-NO 09337 ORG-NO 09338⇒	<b>6PK1468D1</b> <b>6PK1740D1</b> <b>6PK1750D2</b> <b>VD1080</b> <b>VD1095</b>
2.1 TD 12V	10/96-10/04	P8C (XUD11BTE)	80	2088			<b>VD1088</b>
2.2 HDI	03/00-10/04	4HX (DW12TED4 /FAP)	98	2179	<b>AP9031</b> <b>AP9042</b>	ALT, (Valeo), 150A, OE-NO 5705 AA, 5705 ER ALT, (Bosch), ALT-No: 0124 615 027, 150A, OE-NO 5705AA, 5705ER ALT, (AC), (SANDEN), (MANL) ALT, (AC), (DELPHI), (MANL)	<b>6PK1740D1</b> <b>6PK1750D2</b> <b>VD1080</b>

## 406 Coupe (8C)

2.2 HDI	03/00-12/04	4HX (DW12TED4 /FAP)	98	2179	<b>AP9031</b> <b>AP9042</b>	⇒ORG-NO 09519, ALT, OE-NO 5705 AA, 5705 ER, (Valeo), 150A ALT, (Bosch), ALT-No: 0124 615 027, 150A, OE-NO 5705AA, 5705ER	
---------	-------------	---------------------------	----	------	--------------------------------	-----------------------------------------------------------------------------------------------------------------------------------	--

## 407 (6D\_)

1.6 HDi 110	05/04-	9HY (DV6TED4)	80	1560	<b>AP9013</b> <b>AP9019</b>	ALT, (Valeo), 150A, OE-NO 5702H4, 5705AS, 5705EY, ALT-No: TG15C020, TG15C028, TG15C053 ALT, (Valeo), ALT-No: TG15C118, 150A, OE-NO 5705AS, 5705EY ⇒ORG-NO 10556 ORG-NO 10557⇒	<b>VD1094</b> <b>VD1096</b>
2.0 HDi	08/08-		103	1997	<b>AP9013</b> <b>AP9013</b> <b>AP9040</b>	ALT, (Valeo), 150A, OE-NO 5702H4, 5705AS, 5705EY, ALT-No: TG15C020, TG15C028, TG15C053 ALT, (Valeo), 180A, OE-NO 5705AX, 5705EE, ALT-No: FG 18 S 017 ALT, (Mitsubishi), 180A, OE-NO 5705AX, 5705EE, ALT-No: A004TJ0084	
2.0 HDi 135	05/04-	RHR (DW10BTED4)	100	1997	<b>AP9013</b> <b>AP9013</b> <b>AP9040</b>	ALT, (Valeo), 150A, OE-NO 5702H4, 5705AS, 5705EY, ALT-No: TG15C020, TG15C028, TG15C053 ALT, (Valeo), 180A, OE-NO 5705AX, 5705EE, ALT-No: FG 18 S 017 ALT, (Mitsubishi), 180A, OE-NO 5705AX, 5705EE, ALT-No: A004TJ0084	
2.2 HDi	06/08-	4HP (DW12BTED4)	120	2179	<b>AP9013</b> <b>AP9013</b> <b>AP9040</b>	ALT, (Valeo), 150A, OE-NO 5702H4, 5705AS, 5705EY, ALT-No: TG15C020, TG15C028, TG15C053 ALT, (Valeo), 180A, OE-NO 5705AX, 5705EE, ALT-No: FG 18 S 017 ALT, (Mitsubishi), 180A, OE-NO	



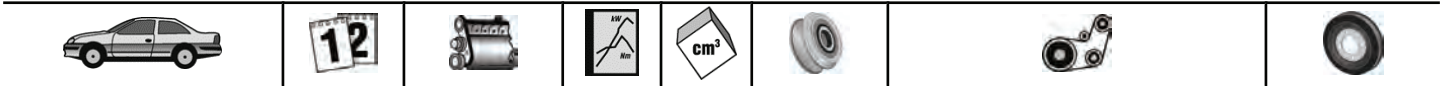

## PEUGEOT

### 407 (6D\_)

2.2 HDi 170	05/06-	4HT (DW12BTED4)	125	2179	AP9013  AP9013 AP9040	5705AX, 5705EE, ALT-No: A004TJ0084 ALT, (Valeo), 150A, OE-NO 5702H4, 5705AS, 5705EY, ALT-No: TG15C020, TG15C028, TG15C053 ALT, (Valeo), 180A, OE-NO 5705AX, 5705EE, ALT-No: FG 18 S 017 ALT, (Mitsubishi), 180A, OE-NO 5705AX, 5705EE, ALT-No: A004TJ0084	
-------------	--------	--------------------	-----	------	--------------------------------	--------------------------------------------------------------------------------------------------------------------------------------------------------------------------------------------------------------------------------------------------------------------------------------	--

### 407 SW (6E\_)

1.6 HDi 110	05/04-	9HY (DV6TED4)	80	1560	AP9013  AP9019	ALT, (Valeo), 150A, OE-NO 5702H4, 5705AS, 5705EY, ALT-No: TG15C020, TG15C028, TG15C053 ALT, (Valeo), ALT-No: TG15C118, 150A, OE-NO 5705AS, 5705EY ⇒ORG-NO 10556 ORG-NO 10557⇒	VD1094 VD1096
2.0 HDi	05/04-07/08		93	1997	AP9013  AP9013 AP9040	ALT, (Valeo), 150A, OE-NO 5702H4, 5705AS, 5705EY, ALT-No: TG15C020, TG15C028, TG15C053 ALT, (Valeo), 180A, OE-NO 5705AX, 5705EE, ALT-No: FG 18 S 017 ALT, (Mitsubishi), 180A, OE-NO 5705AX, 5705EE, ALT-No: A004TJ0084	
	08/08-		103	1997	AP9013  AP9013 AP9040	ALT, (Valeo), 150A, OE-NO 5702H4, 5705AS, 5705EY, ALT-No: TG15C020, TG15C028, TG15C053 ALT, (Valeo), 180A, OE-NO 5705AX, 5705EE, ALT-No: FG 18 S 017 ALT, (Mitsubishi), 180A, OE-NO 5705AX, 5705EE, ALT-No: A004TJ0084	
2.0 HDi 135	05/04-	RHR (DW10BTED4)	100	1997	AP9013  AP9013 AP9040	ALT, (Valeo), 150A, OE-NO 5702H4, 5705AS, 5705EY, ALT-No: TG15C020, TG15C028, TG15C053 ALT, (Valeo), 180A, OE-NO 5705AX, 5705EE, ALT-No: FG 18 S 017 ALT, (Mitsubishi), 180A, OE-NO 5705AX, 5705EE, ALT-No: A004TJ0084	
2.2 HDi	06/08-	4HP (DW12BTED4)	120	2179	AP9013  AP9013 AP9040	ALT, (Valeo), 150A, OE-NO 5702H4, 5705AS, 5705EY, ALT-No: TG15C020, TG15C028, TG15C053 ALT, (Valeo), 180A, OE-NO 5705AX, 5705EE, ALT-No: FG 18 S 017 ALT, (Mitsubishi), 180A, OE-NO 5705AX, 5705EE, ALT-No: A004TJ0084	
2.2 HDi 170	05/06-	4HT (DW12BTED4)	125	2179	AP9013  AP9013 AP9040	ALT, (Valeo), 150A, OE-NO 5702H4, 5705AS, 5705EY, ALT-No: TG15C020, TG15C028, TG15C053 ALT, (Valeo), 180A, OE-NO 5705AX, 5705EE, ALT-No: FG 18 S 017 ALT, (Mitsubishi), 180A, OE-NO 5705AX, 5705EE, ALT-No: A004TJ0084	

### 5008

1.6 16V	09/09-	EP6, 5FS (EP6C)	88	1598	AP9018	ALT, (Mitsubishi), 120A, OE-NO 5705KG, ALT-No: A003TG5281ZE, (-AC)	
		EP6CDT	115	1598	AP9018	ALT, (Mitsubishi), 120A, OE-NO 5705KG, ALT-No: A003TG5281ZE, (-AC)	
1.6 HDi	09/09-	9HZ (DV6TED4)	80	1560	AP9013  AP9019	ALT, (Valeo), 150A, OE-NO 5702H4, 5705AS, 5705EY, ALT-No: TG15C020, TG15C028, TG15C053 ALT, (Valeo), ALT-No: TG15C118, 150A, OE-NO 5705AS, 5705EY	VD1096

### 605 (6B)

2.1 TD 12V	08/94-09/99	P8C (XUD11BTE)	80	2088		MTR-CODE: XUD11ATE, (AUTOM), 06 /1995⇒, ⇒ORG-NO 07237 MTR-CODE: XUD11ATE, XUD11BTE, (MANL), 06/1995⇒	VD1088 VD1088
2.1 Turbo Diesel	06/89-09/99	PHZ	80	2088		MTR-CODE: XUD11BTE, (AUTOM) MTR-CODE: XUD11ATE, (AUTOM), 06	VD1088 VD1088



**PEUGEOT**

<b>605 (6B)</b>			(XUD11ATE)			/1995⇒, ⇒ORG-NO 07237 MTR-CODE: XUD11ATE, XUD11BTE, (MANL), 06/1995⇒ MTR-CODE: XUD11BTE, (AUTOM)	<b>VD1088</b> <b>VD1088</b>	
<b>607 (9D, 9U)</b> 2.0 HDi	03/01-07/04	RHS (DW10ATED)	79	1997	<b>AP9042</b>	ALT, (Bosch), ALT-No: 0124 615 027, 150A, OE-NO 5705AA, 5705ER ALT, (AC), ⇒ORG-NO 09337 ⇒ORG-NO 09337 ORG-NO 09338⇒	<b>6PK1740D1</b> <b>VD1080</b> <b>VD1095</b>	
	2.0 HDI	05/00-	RHZ (DW10ATED)	80	1997	<b>AP9031</b> <b>AP9038</b> <b>AP9042</b>	⇒ORG-NO 09519, ALT, OE-NO 5705 AA, 5705 ER, (Valeo), 150A ⇒ORG-NO 09519, ALT, OE-NO 5705 4F, 5705 GC, (Valeo), (Mitsubishi), 150A ALT, (Bosch), ALT-No: 0124 615 027, 150A, OE-NO 5705AA, 5705ER ALT, ⇒07/2004, ⇒ORG-NO 09337 ⇒ORG-NO 09337 ORG-NO 09338⇒	<b>6PK1740D1</b> <b>VD1080</b> <b>VD1095</b>
		09/05-	RHR (DW10BTED4)	100	1997	<b>AP9013</b> <b>AP9013</b> <b>AP9040</b>	ALT, (Valeo), 150A, OE-NO 5702H4, 5705AS, 5705EY, ALT-No: TG15C020, TG15C028, TG15C053 ALT, (Valeo), 180A, OE-NO 5705AX, 5705EE, ALT-No: FG 18 S 017 ALT, (Mitsubishi), 180A, OE-NO 5705AX, 5705EE, ALT-No: A004TJ0084	
	2.2 HDI	02/00-	4HX (DW12TED4 /FAP)	98	2179	<b>AP9013</b> <b>AP9013</b> <b>AP9031</b> <b>AP9038</b> <b>AP9040</b>	ALT, (Valeo), 150A, OE-NO 5702H4, 5705AS, 5705EY, ALT-No: TG15C020, TG15C028, TG15C053 ALT, (Valeo), 180A, OE-NO 5705AX, 5705EE, ALT-No: FG 18 S 017 ⇒ORG-NO 09519, ALT, OE-NO 5705 AA, 5705 ER, (Valeo), 150A ⇒ORG-NO 09519, ALT, OE-NO 5705 4F, 5705 GC, (Valeo), (Mitsubishi), 150A ALT, (Mitsubishi), 180A, OE-NO 5705AX, 5705EE, ALT-No: A004TJ0084 ALT, ⇒11/2004, ⇒ORG-NO 10247, (MANL) ⇒ORG-NO 10247 ORG-NO 10248⇒	<b>6PK1740D1</b> <b>VD1080</b> <b>VD1095</b>
<b>806 (221)</b>								
1.9 TD	05/97-08/02	DHY (XUD9TE)	68	1905			<b>VD1086</b>	
	07/95-08/02	DHX (XUD9TE)	66	1905			<b>VD1086</b>	
2.0 HDI	08/99-08/02	RHZ (DW10ATED)	80	1997	<b>AP9031</b> <b>AP9038</b> <b>AP9042</b>	ALT, OE-NO 5705 AA, 5705 ER, (Valeo), 150A (AC), ALT, OE-NO 5705 4F, 5705 GC, (Valeo), (Mitsubishi), 150A ALT, (Bosch), ALT-No: 0124 615 027, 150A, OE-NO 5705AA, 5705ER ALT, (-AC) ALT, (AC), (SANDEN) ALT, (AC), (DELPHI)	<b>6PK1468D1</b> <b>6PK1740D1</b> <b>6PK1750D2</b> <b>VD1080</b>	
2.0 HDI 16V	08/99-08/02	RHW (DW10ATED4)	80	1997	<b>AP9031</b> <b>AP9038</b> <b>AP9042</b>	ALT, OE-NO 5705 AA, 5705 ER, (Valeo), 150A (AC), ALT, OE-NO 5705 4F, 5705 GC, (Valeo), (Mitsubishi), 150A ALT, (Bosch), ALT-No: 0124 615 027, 150A, OE-NO 5705AA, 5705ER ALT, (-AC) ALT, (AC), (SANDEN) ALT, (AC), (DELPHI)	<b>6PK1468D1</b> <b>6PK1740D1</b> <b>6PK1750D2</b> <b>VD1080</b>	
2.1 td 12V	06/96-08/99	P8C (XUD11BTE)	80	2088			<b>VD1088</b>	
<b>807 (E)</b>								
2.0 HDi	04/04-05/06		80	1997			<b>VD1095</b>	
	06/02-	RHW (DW10ATED4), RHK (DW10UTED4), RHT (DW10ATED4), RHM (DW10ATED4)	79	1997	<b>AP9013</b> <b>AP9013</b> <b>AP9031</b>	ALT, (Valeo), 150A, OE-NO 5702H4, 5705AS, 5705EY, ALT-No: TG15C020, TG15C028, TG15C053 ALT, (Valeo), 180A, OE-NO 5705AX, 5705EE, ALT-No: FG 18 S 017 (-PARTCL-FILTER), ⇒ORG-NO 09519, ALT, OE-NO 5705 AA, 5705 ER, (Valeo), 150A		







## PEUGEOT

807 (E)					<b>AP9031</b>	(PARTCL-FILTER), ⇒ORG-NO 09551, ALT, OE-NO 5705 AA, 5705 ER, (Valeo), 150A	
					<b>AP9040</b>	ALT, (Mitsubishi), 180A, OE-NO 5705AX, 5705EE, ALT-No: A004TJ0084	
					<b>AP9042</b>	ALT, (Bosch), ALT-No: 0124 615 027, 150A, OE-NO 5705AA, 5705ER, MTR-CODE: RHM, RHT, RHW	
						ALT, (AC), ⇒ORG-NO 09519 ⇒ORG-NO 09519	<b>6PK1740D1</b> <b>VD1080</b> <b>VD1095</b>
2.0 HDI	06/06-	RHR (DW10BTED4)	100	1997	<b>AP9013</b>	ALT, (Valeo), 150A, OE-NO 5702H4, 5705AS, 5705EY, ALT-No: TG15C020, TG15C028, TG15C053	
					<b>AP9013</b>	ALT, (Valeo), 180A, OE-NO 5705AX, 5705EE, ALT-No: FG 18 S 017	
					<b>AP9040</b>	ALT, (Mitsubishi), 180A, OE-NO 5705AX, 5705EE, ALT-No: A004TJ0084	
2.0 HDi	11/06-	RHK (DW10UTED4)	88	1997	<b>AP9013</b>	ALT, (Valeo), 150A, OE-NO 5702H4, 5705AS, 5705EY, ALT-No: TG15C020, TG15C028, TG15C053	
					<b>AP9013</b>	ALT, (Valeo), 180A, OE-NO 5705AX, 5705EE, ALT-No: FG 18 S 017	
					<b>AP9040</b>	ALT, (Mitsubishi), 180A, OE-NO 5705AX, 5705EE, ALT-No: A004TJ0084	
2.2 HDi	06/02-	4HX (DW12TED4 /FAP)	94	2179	<b>AP9013</b>	ALT, (Valeo), 150A, OE-NO 5702H4, 5705AS, 5705EY, ALT-No: TG15C020, TG15C028, TG15C053	
					<b>AP9013</b>	ALT, (Valeo), 180A, OE-NO 5705AX, 5705EE, ALT-No: FG 18 S 017	
					<b>AP9031</b>	(-PARTCL-FILTER), ⇒ORG-NO 09519, ALT, OE-NO 5705 AA, 5705 ER, (Valeo), 150A	
					<b>AP9040</b>	ALT, (Mitsubishi), 180A, OE-NO 5705AX, 5705EE, ALT-No: A004TJ0084	
					<b>AP9042</b>	ALT, (Bosch), ALT-No: 0124 615 027, 150A, OE-NO 5705AA, 5705ER	
						ALT, (AC), ⇒ORG-NO 10247 ⇒ORG-NO 10247	<b>6PK1740D1</b> <b>VD1080</b> <b>VD1095</b>
						ORG-NO 10248⇒	
<b>BIPPER (AA_)</b>							
1.4	02/08-	KFV (TU3A)	54	1360			<b>VD1100</b>
1.4 HDi	02/08-	8HS (DV4TD)	50	1398	<b>AP9013</b>	ALT, (Valeo), 150A, OE-NO 5702H4, 5705AS, 5705EY, ALT-No: TG15C020, TG15C028, TG15C053	
					<b>AP9019</b>	ALT, (Valeo), ALT-No: TG15C118, 150A, OE-NO 5705AS, 5705EY	<b>VD1096</b>
<b>BIPPER Tepee</b>							
1.4 HDi	04/08-	8HS (DV4TD)	50	1398			<b>VD1096</b>
<b>BOXER Bus</b>							
2.2 HDi 100	04/06-	4HV	74	2198	<b>AP9048</b>	ALT, (Bosch), 156A	
2.2 HDi 120	04/06-	4HU	88	2198	<b>AP9048</b>	ALT, (Bosch), 156A	
						MTR-CODE: 22DT	<b>VD1098</b>
<b>BOXER Bus (230P)</b>							
1.9 D	03/94-04/02	D8C (XUD9AU)	51	1905		(-PS)	<b>VD1086</b>
1.9 TD	03/94-04/02	D8C (XUD9UTF)	68	1905		(-PS)	<b>VD1086</b>
	08/94-04/02	DHY (XUD9TE)	66	1905		(-PS)	<b>VD1086</b>
1.9 TD 4x4	07/96-04/02	D8C (XUD9UTF)	68	1905		(-PS)	<b>VD1086</b>
2.8 HDi	11/00-04/02	8140.43S (F28DTCR)	94	2798		(-AC)	<b>VD1062</b>
<b>BOXER Bus (244, Z_)</b>							
2.0 HDi	04/02-	RHV (DW10UTD), RHV (DW10TD)	62	1997	<b>AP9031</b>	ALT, (Valeo), 150A, OE-NO 5705 AA, 5705 ER	
					<b>AP9042</b>	ALT, (Bosch), ALT-No: 0124 615 027, 150A, OE-NO 5705AA, 5705ER	
						MTR-CODE: DW10TD, ⇒04/2004, ALT, PS, (-AC)	<b>6PK1468D1</b>
						(-AC)	<b>VD1080</b>
2.2 HDi	04/02-	4HY (DW12UTED)	74	2179	<b>AP9031</b>	(AC), ⇒05/2004, ALT, OE-NO 5705 AA, (Valeo), 150A	
						ALT, PS, (-AC)	<b>6PK1468D1</b>



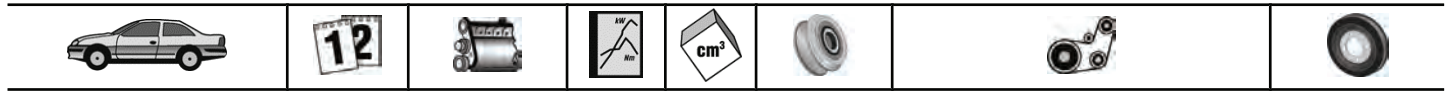

# PEUGEOT

## BOXER Bus (244, Z\_)

						(-AC)	VD1080
2.8 HDi	04/02-	8140.43S (F28DTCR)	94	2798		(-AC)	VD1062
	04/04-	8140.43N	107	2798		(-AC)	VD1062
2.8 HDi 4x4	04/02-	8140.43S (F28DTCR)	94	2798		(-AC)	VD1062

## BOXER Kasten

2.2 HDi 100	04/06-	4HV	74	2198	AP9048	ALT, (Bosch), 156A	
2.2 HDi 120	04/06-	4HU	88	2198	AP9048	ALT, (Bosch), 156A MTR-CODE: 22DT	VD1098

## BOXER Kasten (230L)

1.9 D	03/94-04/02	D8C (XUD9AU)	51	1905		(-PS)	VD1086
	07/99-04/02	DJY (XUD9A)	50	1905		(-PS)	VD1086
1.9 TD	03/94-04/02	D8C (XUD9UTF)	68	1905		(-PS)	VD1086
	07/99-04/02	XUD9TE	66	1905		(-PS)	VD1086
2.0 HDi	08/01-04/02	RHV (DW10UTD)	62	1997	AP9042	ALT, (Bosch), ALT-No: 0124 615 027, 150A, OE-NO 5705AA, 5705ER MTR-CODE: DW10TD, ALT, PS, (-AC)	6PK1468D1 VD1080
2.8 HDi	11/00-04/02	8140.43S (F28DTCR)	94	2798		(-AC)	VD1062

## BOXER Kasten (244)

2.0 HDi	04/02-	RHV (DW10UTD), RHV (DW10TD)	62	1997	AP9031 AP9042	ALT, (Valeo), 150A, OE-NO 5705 AA, 5705 ER ALT, (Bosch), ALT-No: 0124 615 027, 150A, OE-NO 5705AA, 5705ER ⇒04/2004, ALT, PS, (-AC)	6PK1468D1 VD1080
2.2 HDi	04/02-	4HY (DW12UTED)	74	2179	AP9031	(AC), ⇒05/2004, ALT, (Valeo), 150A, OE-NO 5705 AA ALT, PS, (-AC)	6PK1468D1 VD1080
2.8 HDi	04/02-	8140.43S (F28DTCR)	94	2798		(-AC)	VD1062
	04/04-	8140.43N	107	2798		(-AC)	VD1062
2.8 HDi 4x4	04/02-	8140.43S (F28DTCR)	94	2798		(-AC)	VD1062

## BOXER Pritsche/Fahrgestell

2.2 HDi 100	04/06-	4HV	74	2198	AP9048	ALT, (Bosch), 156A	
2.2 HDi 120	04/06-	4HU	88	2198	AP9048	ALT, (Bosch), 156A MTR-CODE: 22DT	VD1098

## BOXER Pritsche/Fahrgestell (244)

2.0 HDi	04/02-	RHV (DW10UTD), RHV (DW10TD)	62	1997	AP9031 AP9042	ALT, (Valeo), 150A, OE-NO 5705 AA, 5705 ER ALT, (Bosch), ALT-No: 0124 615 027, 150A, OE-NO 5705AA, 5705ER MTR-CODE: DW10TD, ⇒04/2004, ALT, PS, (-AC)	6PK1468D1 VD1080
2.2 HDi	04/02-	4HY (DW12UTED)	74	2179	AP9031	(AC), ⇒05/2004, ALT, (Valeo), 150A, OE-NO 5705 AA MTR-CODE: DW12TED, ALT, PS, (-AC)	6PK1468D1 VD1080
2.8 HDi	04/04-	8140.43N	107	2798		(-AC)	VD1062
2.8 HDi 4x4	04/02-	8140.43S (F28DTCR)	94	2798		(-AC)	VD1062

## BOXER Pritsche/Fahrgestell (ZCT\_)

1.9 TD	07/96-04/02	D8C (XUD9UTF)	68	1905		(-PS)	VD1086
	12/98-04/02	DHY (XUD9TE)	66	1905		(-PS)	VD1086
2.8 HDi	11/00-04/02	8140.43S (F28DTCR)	94	2798		(-AC)	VD1062

## EXPERT (224)

1.9 D	02/96-	D9B (XUD9AU)	51	1905			VD1086
1.9 TD	02/96-	DHX (XUD9TE)	66	1905			VD1086
		D8B (XUD9TE)	68	1905			VD1086
2.0 HDi	07/00-	RHW (DW10ATED4)	80	1997	AP9031 AP9038 AP9038	ALT, (Valeo), 150A, OE-NO 5705 AA, 5705 ER (AC), ⇒ORG-NO 09519, ALT, OE-NO 5705 4F, 5705 GC, (Valeo), (Mitsubishi), 150A (-AC), ORG-NO 09156⇒, ⇒ORG-NO 09627, ALT, OE-NO 5705 4F, 5705 GC, (Valeo), (Mitsubishi), 150A MTR-CODE: DW10ATED4, ALT, (-AC), ⇒ORG-NO 09519	6PK1468D1



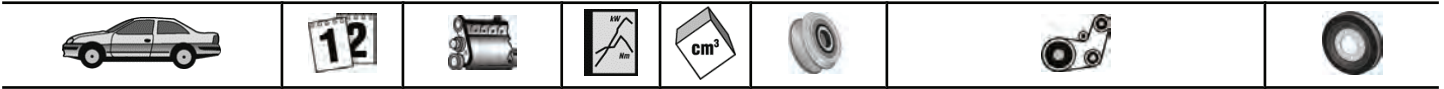

# PEUGEOT

## EXPERT (224)

						MTR-CODE: DW10ATED4, ALT, (AC), ⇒ORG-NO 09519 ⇒ORG-NO 09519 ORG-NO 09520⇒	<b>6PK1740D1</b> <b>VD1080</b> <b>VD1095</b>
		RHZ (DW10ATED)	80	1997	<b>AP9031</b> <b>AP9038</b> <b>AP9038</b> <b>AP9042</b>	ALT, (Valeo), 150A, OE-NO 5705 AA, 5705 ER (AC), ⇒ORG-NO 09519, ALT, OE-NO 5705 4F, 5705 GC, (Valeo), (Mitsubishi), 150A (-AC), ORG-NO 09156⇒, ⇒ORG-NO 09627, ALT, OE-NO 5705 4F, 5705 GC, (Valeo), (Mitsubishi), 150A ALT, (Bosch), ALT-No: 0124 615 027, 150A, OE-NO 5705AA, 5705ER ALT, (-AC), ⇒ORG-NO 09519 ALT, (AC), (SANDEN), ⇒ORG-NO 09519 ALT, (AC), (DELPHI), ⇒ORG-NO 09519 ⇒ORG-NO 09519 ORG-NO 09520⇒	<b>6PK1468D1</b> <b>6PK1740D1</b> <b>6PK1750D2</b> <b>VD1080</b> <b>VD1095</b>
2.0 HDi	10/00-11/03	RHX (DW10BTED)	69	1997	<b>AP9042</b>	ALT, (Bosch), ALT-No: 0124 615 027, 150A, OE-NO 5705AA, 5705ER ALT, (-AC), ⇒ORG-NO 09519 ALT, (AC), (SANDEN), ⇒ORG-NO 09519 ALT, (AC), (DELPHI), ⇒ORG-NO 09519 ⇒ORG-NO 09519 ORG-NO 09520⇒	<b>6PK1468D1</b> <b>6PK1740D1</b> <b>6PK1750D2</b> <b>VD1080</b> <b>VD1095</b>

## EXPERT Kasten (222)

1.9 D	02/96-	D9B (XUD9AU)	51	1905			<b>VD1086</b>
1.9 D 70	12/98-	WJZ (DW8), WJY (DW8B)	51	1868		MTR-CODE: DW8B, ALT, (PS), (AC), ⇒ORG-NO 10177, ⇒10/2002 (AC), ⇒ORG-NO 10177, MTR-CODE: DW8B (AC), ORG-NO 10178⇒, MTR-CODE: DW8B (-AC), ⇒ORG-NO 09894, MTR-CODE: DW8B MTR-CODE: DW8	<b>6PK1750D2</b> <b>VD1080</b> <b>VD1095</b> <b>VD1097</b> <b>VD1097</b>
1.9 TD	02/96-	DHX (XUD9TE)	66	1905			<b>VD1086</b>
		D8B (XUD9TE)	68	1905			<b>VD1086</b>
2.0 HDi	07/00-	RHX (DW10BTED)	69	1997	<b>AP9031</b> <b>AP9038</b> <b>AP9038</b> <b>AP9042</b>	⇒ORG-NO 09627, (Valeo), OE-NO 5705 AA, 5705 ER (AC), ⇒ORG-NO 09519, ALT, OE-NO 5705 4F, 5705 GC, (Valeo), (Mitsubishi), 150A (-AC), ORG-NO 09156⇒, ⇒ORG-NO 09627, ALT, OE-NO 5705 4F, 5705 GC, (Valeo), (Mitsubishi), 150A ALT, (Bosch), ALT-No: 0124 615 027, 150A, OE-NO 5705AA, 5705ER ALT, (-AC), ⇒ORG-NO 09519 ALT, (AC), (SANDEN), ⇒ORG-NO 09519 ALT, (AC), (DELPHI), ⇒ORG-NO 09519 ⇒ORG-NO 09519 ORG-NO 09520⇒	<b>6PK1468D1</b> <b>6PK1740D1</b> <b>6PK1750D2</b> <b>VD1080</b> <b>VD1095</b>
		RHW (DW10ATED4)	80	1997	<b>AP9031</b> <b>AP9038</b> <b>AP9038</b>	ALT, (Valeo), 150A, OE-NO 5705 AA, 5705 ER (AC), ⇒ORG-NO 09519, ALT, OE-NO 5705 4F, 5705 GC, (Valeo), (Mitsubishi), 150A (-AC), ORG-NO 09156⇒, ⇒ORG-NO 09627, ALT, OE-NO 5705 4F, 5705 GC, (Valeo), (Mitsubishi), 150A MTR-CODE: DW10ATED4, ALT, (-AC), ⇒ORG-NO 09519 MTR-CODE: DW10ATED4, ALT, (AC), ⇒ORG-NO 09519 ⇒ORG-NO 09519 ORG-NO 09520⇒	<b>6PK1468D1</b> <b>6PK1740D1</b> <b>VD1080</b> <b>VD1095</b>
		RHZ (DW10ATED)	80	1997	<b>AP9031</b> <b>AP9038</b> <b>AP9038</b>	ALT, (Valeo), 150A, OE-NO 5705 AA, 5705 ER (AC), ⇒ORG-NO 09519, ALT, OE-NO 5705 4F, 5705 GC, (Valeo), (Mitsubishi), 150A (-AC), ORG-NO 09156⇒, ⇒ORG-NO 09627, ALT, OE-NO 5705 4F, 5705 GC,	





# PEUGEOT

## EXPERT Kasten (222)

					<b>AP9042</b>	(Valeo), (Mitsubishi), 150A ALT, (Bosch), ALT-No: 0124 615 027, 150A, OE-NO 5705AA, 5705ER ALT, (-AC), ⇒ORG-NO 09519 ALT, (AC), (SANDEN), ⇒ORG-NO 09519 ALT, (AC), (DELPHI), ⇒ORG-NO 09519 ⇒ORG-NO 09519 ORG-NO 09520⇒	<b>6PK1468D1</b> <b>6PK1740D1</b> <b>6PK1750D2</b> <b>VD1080</b> <b>VD1095</b>
--	--	--	--	--	---------------	------------------------------------------------------------------------------------------------------------------------------------------------------------------------------------------------------------------------------------------------	--------------------------------------------------------------------------------------------

## EXPERT Kasten (VF3A\_, VF3U\_, VF3X\_)

1.6 HDi 90	01/07-	9HU (DV6UTED4)	66	1560	<b>AP9013</b>	ALT, (Valeo), 150A, OE-NO 5702H4, 5705AS, 5705EY, ALT-No: TG15C020, TG15C028, TG15C053	<b>VD1096</b>
					<b>AP9019</b>	ALT, (Valeo), ALT-No: TG15C118, 150A, OE-NO 5705AS, 5705EY	
2.0 HDi 120	01/07-	RHK (DW10UTED4)	88	1997	<b>AP9013</b>	ALT, (Valeo), 150A, OE-NO 5702H4, 5705AS, 5705EY, ALT-No: TG15C020, TG15C028, TG15C053	<b>VD1096</b>
					<b>AP9013</b>	ALT, (Valeo), 180A, OE-NO 5705AX, 5705EE, ALT-No: FG 18 S 017	
					<b>AP9040</b>	ALT, (Mitsubishi), 180A, OE-NO 5705AX, 5705EE, ALT-No: A004TJ0084	
2.0 HDi 140	01/07-	RHR (DW10BTED4)	100	1997	<b>AP9013</b>	ALT, (Valeo), 150A, OE-NO 5702H4, 5705AS, 5705EY, ALT-No: TG15C020, TG15C028, TG15C053	<b>VD1096</b>
					<b>AP9013</b>	ALT, (Valeo), 180A, OE-NO 5705AX, 5705EE, ALT-No: FG 18 S 017	
					<b>AP9040</b>	ALT, (Mitsubishi), 180A, OE-NO 5705AX, 5705EE, ALT-No: A004TJ0084	

## EXPERT Pritsche/Fahrgestell

1.6 HDi 90	01/07-		66	1560	<b>AP9013</b>	ALT, (Valeo), 150A, OE-NO 5702H4, 5705AS, 5705EY, ALT-No: TG15C020, TG15C028, TG15C053	<b>VD1086</b>
					<b>AP9019</b>	ALT, (Valeo), ALT-No: TG15C118, 150A, OE-NO 5705AS, 5705EY	
2.0 HDi 120	01/07-	RHK (DW10UTED4)	88	1997	<b>AP9013</b>	ALT, (Valeo), 150A, OE-NO 5702H4, 5705AS, 5705EY, ALT-No: TG15C020, TG15C028, TG15C053	<b>VD1086</b>
					<b>AP9013</b>	ALT, (Valeo), 180A, OE-NO 5705AX, 5705EE, ALT-No: FG 18 S 017	
					<b>AP9040</b>	ALT, (Mitsubishi), 180A, OE-NO 5705AX, 5705EE, ALT-No: A004TJ0084	
2.0 HDi 140	01/07-	RHR (DW10BTED4)	100	1997	<b>AP9013</b>	ALT, (Valeo), 150A, OE-NO 5702H4, 5705AS, 5705EY, ALT-No: TG15C020, TG15C028, TG15C053	<b>VD1086</b>
					<b>AP9013</b>	ALT, (Valeo), 180A, OE-NO 5705AX, 5705EE, ALT-No: FG 18 S 017	
					<b>AP9040</b>	ALT, (Mitsubishi), 180A, OE-NO 5705AX, 5705EE, ALT-No: A004TJ0084	

## EXPERT Pritsche/Fahrgestell (223)

1.9 D	02/96-	D9B (XUD9AU)	51	1905		<b>VD1086</b>
1.9 TD	02/96-	DHX (XUD9TE)	66	1905		<b>VD1086</b>
		D8B (XUD9TE)	68	1905		<b>VD1086</b>

## EXPERT Tepee (VF3V\_)

1.6 HDi 90	01/07-	9HU (DV6UTED4)	66	1560	<b>AP9013</b>	ALT, (Valeo), 150A, OE-NO 5702H4, 5705AS, 5705EY, ALT-No: TG15C020, TG15C028, TG15C053	<b>VD1096</b>
					<b>AP9019</b>	ALT, (Valeo), ALT-No: TG15C118, 150A, OE-NO 5705AS, 5705EY	
2.0 HDi 120	01/07-	RHK (DW10UTED4)	88	1997	<b>AP9013</b>	ALT, (Valeo), 150A, OE-NO 5702H4, 5705AS, 5705EY, ALT-No: TG15C020, TG15C028, TG15C053	<b>VD1096</b>
					<b>AP9013</b>	ALT, (Valeo), 180A, OE-NO 5705AX, 5705EE, ALT-No: FG 18 S 017	
					<b>AP9040</b>	ALT, (Mitsubishi), 180A, OE-NO 5705AX, 5705EE, ALT-No: A004TJ0084	
2.0 HDi 140	01/07-	RHR (DW10BTED4)	100	1997	<b>AP9013</b>	ALT, (Valeo), 150A, OE-NO 5702H4, 5705AS, 5705EY, ALT-No: TG15C020, TG15C028, TG15C053	<b>VD1096</b>
					<b>AP9013</b>	ALT, (Valeo), 180A, OE-NO 5705AX, 5705EE, ALT-No: FG 18 S 017	



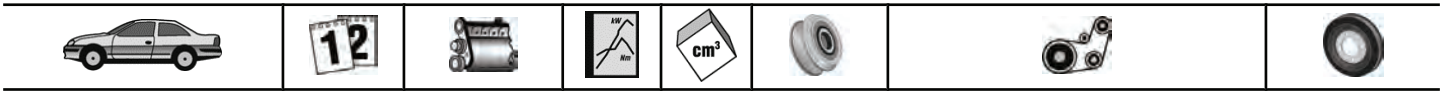

# PEUGEOT

## EXPERT Tepee (VF3V)

					<b>AP9040</b>	ALT, (Mitsubishi), 180A, OE-NO 5705AX, 5705EE, ALT-No: A004TJ0084	
--	--	--	--	--	---------------	-------------------------------------------------------------------	--

## PARTNER Combispace (5F)

1.1	06/96-	HDZ (TU1M), HFX (TU1JP)	44	1124			<b>VD1100</b>
1.4	06/96-	KFX (TU3JP), TU32, KFW (TU3JP)	55	1360			<b>VD1100</b>
1.6 16V	07/01-	NFU (TU5JP4)	80	1587			<b>VD1100</b>
1.6 HDi 75	02/06-	9HW (DV6BTED4)	55	1560	<b>AP9013</b> <b>AP9019</b>	ALT, (Valeo), 150A, OE-NO 5702H4, 5705AS, 5705EY, ALT-No: TG15C020, TG15C028, TG15C053 ALT, (Valeo), ALT-No: TG15C118, 150A, OE-NO 5705AS, 5705EY	<b>VD1096</b>
1.6 HDi 90	02/06-	9HX (DV6ATED4)	66	1560	<b>AP9013</b> <b>AP9019</b>	ALT, (Valeo), 150A, OE-NO 5702H4, 5705AS, 5705EY, ALT-No: TG15C020, TG15C028, TG15C053 ALT, (Valeo), ALT-No: TG15C118, 150A, OE-NO 5705AS, 5705EY	
1.9 D	05/96-12/98	XUD9	51	1905		MTR-CODE: XUD9A	<b>VD1086</b>
	06/96-	DJY (XUD9A)	50	1905		MTR-CODE: XUD9A	<b>VD1086</b>
	12/98-	WJZ (DW8), WJY (DW8B)	51	1868		MTR-CODE: DW8, ALT, (PS), (AC), ORG-NO 09377⇒, ⇒10/2002 MTR-CODE: DW8B, ALT, (PS), (AC), ⇒ORG-NO 10177, ⇒10/2002 (AC), (M59), ⇒ORG-NO 10177 (AC), ORG-NO 09154⇒, ⇒ORG-NO 11892 (AC), (M59), ORG-NO 10178⇒ (AC), ORG-NO 11893⇒ (-AC) ⇒ORG-NO 09154	<b>6PK1750D2</b> <b>6PK1750D2</b> <b>VD1080</b> <b>VD1080</b> <b>VD1095</b> <b>VD1095</b> <b>VD1097</b> <b>VD1097</b>
		1.9 D 4x4	04/04-08/05	WJY (DW8B)	51	1868	⇒ORG-NO 10177 ORG-NO 10178⇒
2.0 HDi	02/00-	RHY (DW10TD)	66	1997	<b>AP9038</b>	(M49), ALT, (Valeo), (Mitsubishi), 150A ALT, (-AC), ⇒ORG-NO 10179 ALT, (AC), CH-NO 11.2002⇒, ⇒ORG-NO 10179 ALT, (AC), ⇒10/2002 ⇒ORG-NO 10179 ORG-NO 10180⇒	<b>6PK1468D1</b> <b>6PK1740D1</b> <b>6PK1750D2</b> <b>VD1080</b> <b>VD1095</b>
2.0 HDi 4x4	04/04-08/05	RHY (DW10TD)	66	1997		ALT, (-AC), ⇒ORG-NO 10179 ALT, (AC), CH-NO 11.2002⇒, ⇒ORG-NO 10179 ⇒ORG-NO 10179 ORG-NO 10180⇒	<b>6PK1468D1</b> <b>6PK1740D1</b> <b>VD1080</b> <b>VD1095</b>

## PARTNER Kasten

1.6 HDi	04/08-	9HT (DV6BTED4)	55	1560	<b>AP9013</b> <b>AP9019</b> <b>AP9040</b>	ALT, (Valeo), 150A, OE-NO 5702H4, 5705AS, 5705EY, ALT-No: TG15C020, TG15C028, TG15C053 ALT, (Valeo), ALT-No: TG15C118, 150A, OE-NO 5705AS, 5705EY ALT, (Mitsubishi), 180A, OE-NO 5705AX, 5705EE, ALT-No: A004TJ0084	<b>VD1096</b>
		9HX (DV6ATED4)	66	1560	<b>AP9013</b> <b>AP9019</b> <b>AP9040</b>	ALT, (Valeo), 150A, OE-NO 5702H4, 5705AS, 5705EY, ALT-No: TG15C020, TG15C028, TG15C053 ALT, (Valeo), ALT-No: TG15C118, 150A, OE-NO 5705AS, 5705EY ALT, (Mitsubishi), 180A, OE-NO 5705AX, 5705EE, ALT-No: A004TJ0084	<b>VD1096</b>
			80	1560	<b>AP9013</b> <b>AP9019</b> <b>AP9040</b>	ALT, (Valeo), 150A, OE-NO 5702H4, 5705AS, 5705EY, ALT-No: TG15C020, TG15C028, TG15C053 ALT, (Valeo), ALT-No: TG15C118, 150A, OE-NO 5705AS, 5705EY ALT, (Mitsubishi), 180A, OE-NO 5705AX, 5705EE, ALT-No: A004TJ0084	<b>VD1096</b>

## PARTNER Kasten (5)

1.4	06/96-	KFX (TU3JP),	55	1360			<b>VD1100</b>
-----	--------	--------------	----	------	--	--	---------------



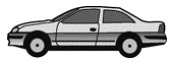

# PEUGEOT

## PARTNER Kasten (5)

1.6 HDi 75	02/06-	TU32 9HW (DV6BTED4)	55	1560	<b>AP9013</b>  <b>AP9019</b>	ALT, (Valeo), 150A, OE-NO 5702H4, 5705AS, 5705EY, ALT-No: TG15C020, TG15C028, TG15C053 ALT, (Valeo), ALT-No: TG15C118, 150A, OE-NO 5705AS, 5705EY	<b>VD1096</b>
1.6 HDi 90	02/06-	9HX (DV6ATED4)	66	1560	<b>AP9013</b>  <b>AP9019</b>	ALT, (Valeo), 150A, OE-NO 5702H4, 5705AS, 5705EY, ALT-No: TG15C020, TG15C028, TG15C053 ALT, (Valeo), ALT-No: TG15C118, 150A, OE-NO 5705AS, 5705EY	<b>VD1096</b>
1.8 D	06/96-	A9A (XUD7)	43	1769			<b>VD1086</b>
1.9 D	06/96-	WJZ (DW8), WJY (DW8B)	51	1868		MTR-CODE: DW8, ALT, (PS), (AC), ORG-NO 09377⇒, ⇒10/2002 MTR-CODE: DW8B, ALT, (PS), (AC), ⇒ORG-NO 10177, ⇒10/2002 (AC), (M59), ⇒ORG-NO 10177 (AC), ORG-NO 09154⇒, ⇒ORG-NO 11892 (AC), (M59), ORG-NO 10178⇒ (AC), ORG-NO 11893⇒ (-AC) (AC), ⇒ORG-NO 09154	<b>6PK1750D2</b>  <b>6PK1750D2</b>  <b>VD1080</b> <b>VD1080</b>  <b>VD1095</b> <b>VD1095</b> <b>VD1097</b> <b>VD1097</b>
1.9 D 4x4	04/04-	DJY (XUD9A) WJY (DW8B)	51	1905 1868		MTR-CODE: XUD9 ⇒ORG-NO 10177 ORG-NO 10178⇒	<b>VD1086</b> <b>VD1080</b> <b>VD1095</b>
2.0 HDi	04/00-	RHY (DW10TD)	66	1997	<b>AP9038</b>	(M49), ALT, (Valeo), (Mitsubishi), 150A ALT, (-AC), ⇒ORG-NO 10179 ALT, (AC), 11/2002⇒, ⇒ORG-NO 10179 ALT, (AC), ⇒10/2002 ⇒ORG-NO 10179 ORG-NO 10180⇒	<b>6PK1468D1</b> <b>6PK1740D1</b> <b>6PK1750D2</b> <b>VD1080</b> <b>VD1095</b>
2.0 HDi 4x4	04/04-	RHY (DW10TD)	66	1997	<b>AP9038</b>	(M49), ALT, (Valeo), (Mitsubishi), 150A	
<b>PARTNER Tepee</b>							
1.6	04/08-	NFR (TU5JP4B) NFU (TU5JP4)	66 80	1587 1587	<b>AP9018</b>  <b>AP9018</b>	ALT, (Mitsubishi), 80A, OE-NO 5705KQ, 5702J3, ALT-No: A005TG0881ZE, 120A, OE-NO 5705KG, 5702J0, ALT-No: A003TG5281ZE ALT, (Mitsubishi), 80A, OE-NO 5705KQ, 5702J3, ALT-No: A005TG0881ZE, 120A, OE-NO 5705KG, 5702J0, ALT-No: A003TG5281ZE	<b>VD1100</b>
1.6 HDi	04/08-	9HT (DV6BTED4)	55	1560	<b>AP9013</b>  <b>AP9019</b>  <b>AP9040</b>	ALT, (Valeo), 150A, OE-NO 5702H4, 5705AS, 5705EY, ALT-No: TG15C020, TG15C028, TG15C053 ALT, (Valeo), ALT-No: TG15C118, 150A, OE-NO 5705AS, 5705EY ALT, (Mitsubishi), 180A, OE-NO 5705AX, 5705EE, ALT-No: A004TJ0084	
		9HX (DV6ATED4)	66	1560	<b>AP9013</b>  <b>AP9019</b>  <b>AP9040</b>	ALT, (Valeo), 150A, OE-NO 5702H4, 5705AS, 5705EY, ALT-No: TG15C020, TG15C028, TG15C053 ALT, (Valeo), ALT-No: TG15C118, 150A, OE-NO 5705AS, 5705EY ALT, (Mitsubishi), 180A, OE-NO 5705AX, 5705EE, ALT-No: A004TJ0084	<b>VD1096</b>
		9HZ (DV6TED4)	80	1560	<b>AP9013</b>  <b>AP9019</b>  <b>AP9040</b>	ALT, (Valeo), 150A, OE-NO 5702H4, 5705AS, 5705EY, ALT-No: TG15C020, TG15C028, TG15C053 ALT, (Valeo), ALT-No: TG15C118, 150A, OE-NO 5705AS, 5705EY ALT, (Mitsubishi), 180A, OE-NO 5705AX, 5705EE, ALT-No: A004TJ0084	<b>VD1096</b>
	08/10-		82	1560			<b>VD1096</b>
<b>RCZ</b>							
1.6 16V	03/10-	EP6CDT	115	1598	<b>AP9018</b>	ALT, (Mitsubishi), 80A, OE-NO 5705KQ, ALT-No: A005TG0081ZE, 120A, OE-NO 5705KG, ALT-No: A003TG5281ZE	
	06/10-	EP6CDTX	147	1598	<b>AP9018</b>	ALT, (Mitsubishi), 80A, OE-NO 5705KQ,	



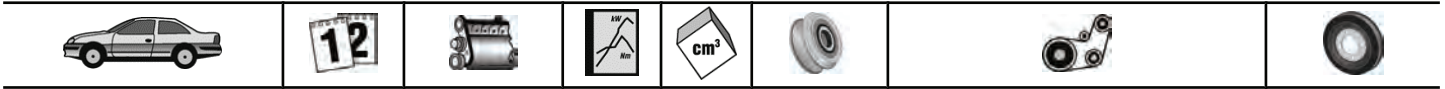

## PEUGEOT

RCZ  
↩

ALT-No: A005TG0881ZE, 120A,  
OE-NO 5705KG, ALT-No:  
A003TG5281ZE

## RENAULT

<b>19 I (B/C53_)</b> 1.9 D (B/C534, B/C53J)	09/88-04/92	F8Q706, F8Q742	47	1870			<b>VD1081</b>
<b>19 I Chamade (L53_)</b> 1.9 D (L534, L53J)	10/89-04/92	F8Q706, F8Q742	47	1870			<b>VD1081</b>
<b>19 II (B/C53_)</b> 1.9 D (B/C53J)	04/92-12/95	F8Q742	47	1870			<b>VD1081</b>
<b>19 II Chamade (L53_)</b> 1.9 D (L53J)	04/92-12/95	F8Q742	47	1870			<b>VD1081</b>
<b>AVANTIME (DE0_)</b> 2.2 dCi (DE01)	05/02-05/03	G9T712	110	2188			<b>VD1109</b>
<b>CLIO I (B/C57_, 5/357_)</b> 1.9 D (B/C/S576, B/C/S57L)	01/91-09/98	F8Q730, F8Q732	47	1870			<b>VD1081</b>
<b>CLIO II (BB0/1/2_, CB0/1/2_)</b> 1.4 16V (B/CB0L)	10/99-08/00	K4J712, K4J713	70	1390	<b>AP9025</b>	ALT, (Bosch), 98A, OE-NO 77 01 473 636, 77 01 477 694, 77 00 429 217	
1.4 16V (B/CB0P)	08/00-	K4J712, K4J713, K4J700, K4J711, K4J710	72	1390	<b>AP9025</b>	98A	
1.5 D	08/04-	K9K714	50	1461	<b>AP9025</b> <b>AP9025</b> <b>AP9025</b>	ALT, (Mitsubishi), 110A, ALT-No: A002TC0982 ALT, (Valeo), 110A, ALT-No: TG11C034, TG11C064, 125A, ALT-No: SG12B089, SG12B105 ALT, 110A, OE-NO 82 00 667 608, 125A, OE-NO 82 00 537 415	
1.5 dCi	01/04-	K9K712	74	1461	<b>AP9025</b> <b>AP9025</b> <b>AP9025</b> <b>AP9056</b> <b>AP9056</b>	ALT, (Bosch), 150A, OE-NO 77 01 476 808 ALT, (Valeo), 110A, ALT-No: TG11C034, TG11C064, TG11C011 ALT, 110A, OE-NO 82 00 667 608, 77 01 478 093 ALT, (Valeo), 120A, ALT-No: SG12B038, SG12B103 ALT, 120A, OE-NO 77 01 477 001	
1.5 dCi (B/CB03)	06/01-10/03	K9K702	59	1461	<b>AP9025</b> <b>AP9025</b> <b>AP9025</b> <b>AP9056</b> <b>AP9056</b>	ALT, (Mitsubishi), 110A, ALT-No: A002TC0982 ALT, (Valeo), 110A, ALT-No: TG11C034, TG11C064, 125A, ALT-No: SG12B089, SG12B105 ALT, 110A, OE-NO 82 00 667 608, 125A, OE-NO 82 00 537 415 ALT, (Valeo), 120A, ALT-No: SG12B038, SG12B103 ALT, 120A, OE-NO 77 01 477 001	
1.5 dCi (B/CB07)	06/01-	K9K700, K9K704	48	1461	<b>AP9025</b> <b>AP9025</b> <b>AP9025</b> <b>AP9056</b> <b>AP9056</b>	ALT, (Mitsubishi), 110A, ALT-No: A002TC0982 ALT, (Valeo), 110A, ALT-No: TG11C034, TG11C064, 125A, ALT-No: SG12B089, SG12B105 ALT, 110A, OE-NO 82 00 667 608, 125A, OE-NO 82 00 537 415 ALT, (Valeo), 120A, ALT-No: SG12B038, SG12B103 ALT, 120A, OE-NO 77 01 477 001	
1.5 dCi (B/CB08)	06/01-	K9K702	60	1461	<b>AP9025</b> <b>AP9025</b> <b>AP9025</b> <b>AP9056</b> <b>AP9056</b>	ALT, (Mitsubishi), 110A, ALT-No: A002TC0982 ALT, (Valeo), 110A, ALT-No: TG11C034, TG11C064, 125A, ALT-No: SG12B089, SG12B105 ALT, 110A, OE-NO 82 00 667 608, 125A, OE-NO 82 00 537 415 ALT, (Valeo), 120A, ALT-No: SG12B038, SG12B103 ALT, 120A, OE-NO 77 01 477 001	
1.5 dCi (B/CB3M)	06/05-	K9K740	47	1461	<b>AP9025</b> <b>AP9025</b>	ALT, (Mitsubishi), 110A, ALT-No: A002TC0982 ALT, (Valeo), 110A, ALT-No: TG11C034, TG11C064, 125A, ALT-No:	

↩



# RENAULT

## CLIO II (BB0/1/2\_, CB0/1/2\_)

					<b>AP9025</b>	SG12B089, SG12B105 ALT, 110A, OE-NO 82 00 667 608, 125A, OE-NO 82 00 537 415	
1.5 dCi (B/CB3N)	02/07-	K9K718	62	1461	<b>AP9025</b>	ALT, (Mitsubishi), 110A, ALT-No: A002TC0982	
					<b>AP9025</b>	ALT, (Valeo), 110A, ALT-No: TG11C034, TG11C064, 125A, ALT-No: SG12B089, SG12B105	
					<b>AP9025</b>	ALT, 110A, OE-NO 82 00 667 608, 125A, OE-NO 82 00 537 415	
					<b>AP9056</b>	ALT, (Valeo), 120A, ALT-No: SG12B038, SG12B103	
					<b>AP9056</b>	ALT, 120A, OE-NO 77 01 477 001	
1.6 16V (CB0T, CB0H)	09/98-	K4M748, K4M708, K4M744, K4M745	79	1598	<b>AP9025</b>	98A	
1.9 D (B/CB0E)	09/98-05/05	F8Q630	47	1870			<b>VD1081</b>
1.9 D (B/CB0J)	02/00-05/01	F8Q632	48	1870			<b>VD1081</b>
1.9 dTi (B/CB0U)	12/99-05/05	F9Q780	59	1870	<b>AP9052</b>	ALT, (AC)	<b>VD1063</b>

## CLIO II Kasten (SB0/1/2\_)

1.5 dCi (SB07)	06/01-	K9K700, K9K704	48	1461	<b>AP9025</b>	ALT, (Mitsubishi), 110A, ALT-No: A002TC0982	
					<b>AP9025</b>	ALT, (Valeo), 110A, ALT-No: TG11C034, TG11C064, 125A, ALT-No: SG12B089, SG12B105	
					<b>AP9025</b>	ALT, 110A, OE-NO 82 00 667 608, 125A, OE-NO 82 00 537 415	
					<b>AP9056</b>	ALT, (Valeo), 120A, ALT-No: SG12B038, SG12B103	
					<b>AP9056</b>	ALT, 120A, OE-NO 77 01 477 001	

## ESPACE III (JE0\_)

1.9 dTi (JE0M)	02/99-10/02	F9Q722	72	1870			<b>VD1063</b>
2.2 dCi (JE0K)	10/00-10/02	G9T710, G9T642	95	2188			<b>VD1109</b>

## GRAND SCÉNIC II (JM0/1\_)

1.9 dCi (JM12, JM0G)	04/04-	F9Q812	88	1870			<b>VD1104</b>
1.9 dCi (JM14)	05/05-	F9QJ803, F9QEE804, F9Q816, F9Q818	96	1870			<b>VD1104</b>
1.9 dCi (JM15)	05/05-	F9QE804	81	1870			<b>VD1104</b>
2.0 dCi (JM1K)	09/05-	M9R700, M9R721	110	1995	<b>AP9047</b>	ALT, 120A, 150A	

## KANGOO (KC0/1\_)

1.4 (KC0C, KCOH, KC0B, KC0M)	08/97-	E7J780, E7J634, E7J635, K7J700, K7J701	55	1390	<b>AP9025</b>	ALT, (Bosch), 87A, OE-NO 77 00 434 899, 77 01 473 637, 77 01 477 711	
1.5 dCi	06/05-	K9K714	50	1461	<b>AP9025</b>	ALT, (Mitsubishi), 110A, ALT-No: A002TC0982	
					<b>AP9025</b>	ALT, (Valeo), 110A, ALT-No: TG11C034, TG11C064, 125A, ALT-No: SG12B089, SG12B105	
					<b>AP9025</b>	ALT, 110A, OE-NO 82 00 667 608, 125A, OE-NO 82 00 537 415	
		K9K718	62	1461	<b>AP9025</b>	ALT, (Mitsubishi), 110A, ALT-No: A002TC0982	
					<b>AP9025</b>	ALT, (Valeo), 110A, ALT-No: TG11C034, TG11C064, 125A, ALT-No: SG12B089, SG12B105	
					<b>AP9025</b>	ALT, 110A, OE-NO 82 00 667 608, 125A, OE-NO 82 00 537 415	
					<b>AP9056</b>	ALT, (Valeo), 120A, ALT-No: SG12B038, SG12B103	
					<b>AP9056</b>	ALT, 120A, OE-NO 77 01 477 001	
	07/03-	K9K704	42	1461	<b>AP9025</b>	ALT, (Mitsubishi), 110A, ALT-No: A002TC0982	
					<b>AP9025</b>	ALT, (Valeo), 110A, ALT-No: TG11C034, TG11C064, 125A, ALT-No: SG12B089, SG12B105	
					<b>AP9025</b>	ALT, 110A, OE-NO 82 00 667 608, 125A, OE-NO 82 00 537 415	
					<b>AP9056</b>	ALT, (Valeo), 120A, ALT-No: SG12B038, SG12B103	
					<b>AP9056</b>	ALT, 120A, OE-NO 77 01 477 001	





## RENAULT

### KANGOO (KC0/1\_)

↩ 1.5 dCi (KC07)

1.5 dCi (KC07)	12/01-	K9K700, K9K704	48	1461	AP9025	ALT, (Mitsubishi), 110A, ALT-No: A002TC0982	
					AP9025	ALT, (Valeo), 110A, ALT-No: TG11C034, TG11C064, 125A, ALT-No: SG12B089, SG12B105	
					AP9025	ALT, 110A, OE-NO 82 00 667 608, 125A, OE-NO 82 00 537 415	
					AP9056	ALT, (Valeo), 120A, ALT-No: SG12B038, SG12B103	
					AP9056	ALT, 120A, OE-NO 77 01 477 001	
1.5 dCi (KC08, KC09)	07/02-	K9K702, K9K710	60	1461	AP9025	ALT, (Mitsubishi), 110A, ALT-No: A002TC0982	
					AP9025	ALT, (Valeo), 110A, ALT-No: TG11C034, TG11C064, 125A, ALT-No: SG12B089, SG12B105	
					AP9025	ALT, 110A, OE-NO 82 00 667 608, 125A, OE-NO 82 00 537 415	
					AP9056	ALT, (Valeo), 120A, ALT-No: SG12B038, SG12B103	
					AP9056	ALT, 120A, OE-NO 77 01 477 001	
1.6 16V	06/01-	K4M752, K4M750, K4M753	70	1598	AP9025	ALT, (Bosch), 98A, OE-NO 77 01 473 636, 77 01 477 694, 77 00 429 217	
1.6 16V 4x4 (KC0P, KC0S, KC0L)	10/01-	K4M752, K4M750, K4M753	70	1598	AP9025	ALT, (Bosch), 98A, OE-NO 77 01 473 636, 77 01 477 694, 77 00 429 217	
1.6 16V bivalent	06/05-		60	1598	AP9025	ALT, (Bosch), 98A, OE-NO 77 01 473 636, 77 01 477 694, 77 00 429 217	
1.9 dCi 4x4	10/03-	F9Q790	62	1870			VD1063
1.9 dCi 4x4 (KC0V)	10/01-	F9Q790, F9Q782	59	1870	AP9052	ALT, (AC), MTR-CODE: F9Q 790	VD1063
1.9 dTi (KC0U)	02/00-	F9Q780	59	1870	AP9052	ALT, (AC)	VD1063
D 55 1.9 (KC0D)	08/97-	F8Q662	40	1870			VD1081
D 65 1.9 (KC0E, KC02, KC0J, KC0N)	08/97-	F8Q630, F8Q632	47	1870			VD1081

### KANGOO Express (FC0/1\_)

1.4 (FC0C, FC0B, FC0H, FC0M)	08/97-	E7J780, E7J634, E7J635, K7J701	55	1390	AP9025	ALT, (Bosch), 87A, OE-NO 77 00 434 899, 77 01 473 637, 77 01 477 711	
1.5 dCi (FC07, FC1R)	12/01-	K9K700, K9K704	48	1461	AP9025	ALT, (Mitsubishi), 110A, ALT-No: A002TC0982	
					AP9025	ALT, (Valeo), 110A, ALT-No: TG11C034, TG11C064, 125A, ALT-No: SG12B089, SG12B105	
					AP9025	ALT, 110A, OE-NO 82 00 667 608, 125A, OE-NO 82 00 537 415	
					AP9056	ALT, (Valeo), 120A, ALT-No: SG12B038, SG12B103	
					AP9056	ALT, 120A, OE-NO 77 01 477 001	
1.5 dCi (FC08, FC09)	04/03-	K9K702, K9K710	60	1461	AP9025	ALT, (Mitsubishi), 110A, ALT-No: A002TC0982	
					AP9025	ALT, (Valeo), 110A, ALT-No: TG11C034, TG11C064, 125A, ALT-No: SG12B089, SG12B105	
					AP9025	ALT, 110A, OE-NO 82 00 667 608, 125A, OE-NO 82 00 537 415	
					AP9056	ALT, (Valeo), 120A, ALT-No: SG12B038, SG12B103	
					AP9056	ALT, 120A, OE-NO 77 01 477 001	
1.5 dCi (FC1E)	06/05-	K9K714	50	1461	AP9025	ALT, (Mitsubishi), 110A, ALT-No: A002TC0982	
					AP9025	ALT, (Valeo), 110A, ALT-No: TG11C034, TG11C064, 125A, ALT-No: SG12B089, SG12B105	
					AP9025	ALT, 110A, OE-NO 82 00 667 608, 125A, OE-NO 82 00 537 415	
1.5 dCi (FC1G)	06/05-	K9K718	62	1461	AP9025	ALT, (Mitsubishi), 110A, ALT-No: A002TC0982	
					AP9025	ALT, (Valeo), 110A, ALT-No: TG11C034, TG11C064, 125A, ALT-No: SG12B089, SG12B105	
					AP9025	ALT, 110A, OE-NO 82 00 667 608, 125A, OE-NO 82 00 537 415	
					AP9056	ALT, (Valeo), 120A, ALT-No: SG12B038, SG12B103	
					AP9056	ALT, 120A, OE-NO 77 01 477 001	



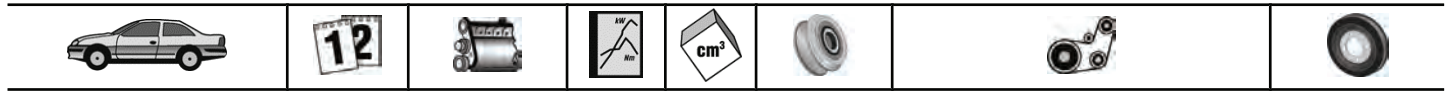

# RENAULT

Model	Year	Part No.	Weight	Volume	Code	Description	Code
<b>KANGOO Express (FC0/1_)</b>							
↩ 1.5 dCi (FC1R)	12/02-	K9K704	42	1461	<b>AP9025</b>	ALT, (Mitsubishi), 110A, ALT-No: A002TC0982	
					<b>AP9025</b>	ALT, (Valeo), 110A, ALT-No: TG11C034, TG11C064, 125A, ALT-No: SG12B089, SG12B105	
					<b>AP9025</b>	ALT, 110A, OE-NO 82 00 667 608, 125A, OE-NO 82 00 537 415	
					<b>AP9056</b>	ALT, (Valeo), 120A, ALT-No: SG12B038, SG12B103	
					<b>AP9056</b>	ALT, 120A, OE-NO 77 01 477 001	
1.6 16V	10/01-	K4M752	70	1598	<b>AP9025</b>	ALT, (Bosch), 98A, OE-NO 77 01 473 636, 77 01 477 694, 77 00 429 217	
1.6 16V 4x4 (FC0L, FC0P, FC0S)	10/01-	K4M752, K4M750, K4M753	70	1598	<b>AP9025</b>	ALT, (Bosch), 98A, OE-NO 77 01 473 636, 77 01 477 694, 77 00 429 217	
1.6 16V bivalent	06/05-		60	1598	<b>AP9025</b>	ALT, (Bosch), 98A, OE-NO 77 01 473 636, 77 01 477 694, 77 00 429 217	
1.9 D (FC0J)	09/99-06/03	F8Q632	48	1870			<b>VD1081</b>
1.9 dCi (FC0V)	07/03-	F9Q790	62	1870			<b>VD1063</b>
1.9 dCi 4x4 (FC0V)	07/03-	F9Q790	62	1870			<b>VD1063</b>
	10/01-	F9Q790, F9Q782	59	1870	<b>AP9052</b>	ALT, (AC), MTR-CODE: F9Q 790	<b>VD1063</b>
1.9 dTi (FC0U)	02/00-	F9Q780	59	1870	<b>AP9052</b>	ALT, (AC)	<b>VD1063</b>
D 55 1.9 (FC0D)	08/97-	F8Q662	40	1870			<b>VD1081</b>
D 65 1.9 (FC0E, FC02, FC0J, FC0N)	08/97-	F8Q630, F8Q632	47	1870			<b>VD1081</b>
<b>LAGUNA (B56_, 556_)</b>							
1.6 16V (B568, B561)	11/97-03/01	K4M720, K4M724	79	1598	<b>AP9025</b>	98A, ALT, (Bosch), 98A, OE-NO 77 01 473 636, 77 01 477 694, 77 00 429 217	
1.9 dCi (B56W)	09/99-03/01	F9Q718	79	1870	<b>AP9039</b> <b>AP9043</b>	ALT, (AC) ALT, (-AC)	<b>VD1101</b> <b>VD1063</b>
1.9 dTi (B56J)	10/97-03/01	F9Q710, F9Q716, F9Q717	72	1870			<b>VD1063</b>
<b>LAGUNA Grandtour (K56_)</b>							
1.6 16V (K568)	11/97-03/01	K4M720, K4M724	79	1598	<b>AP9025</b>	98A, ALT, (Bosch), 98A, OE-NO 77 01 473 636, 77 01 477 694, 77 00 429 217	
1.9 dCi (K56W)	09/99-03/01	F9Q718	79	1870	<b>AP9039</b> <b>AP9043</b>	ALT, (AC) ALT, (-AC)	<b>VD1101</b> <b>VD1063</b>
1.9 dTi (K56J)	10/97-03/01	F9Q710, F9Q716, F9Q717	72	1870			<b>VD1063</b>
<b>LAGUNA II (BG0/1_)</b>							
1.6 16V (BG0A, BG0L)	03/01-	K4M710, K4M711, K4M714	79	1598	<b>AP9025</b> <b>AP9025</b>	ALT, (Bosch), 98A, OE-NO 77 01 473 636, 77 01 477 694, 77 00 429 217 ALT, (Valeo), 120A, OE-NO 77 01 477 710, 82 00 019 706	
1.9 dCi (BG05)	03/04-	F9Q664	68	1870	<b>AP9047</b>	ALT, 120A, 150A	<b>VD1104</b>
1.9 dCi (BG0E)	06/01-	F9Q752	77	1870	<b>AP9039</b> <b>AP9043</b>	ALT, (AC) ALT, (-AC)	<b>VD1101</b>
1.9 dCi (BG0E, BG0R)	10/01-	F9Q754, F9Q752	74	1870	<b>AP9039</b> <b>AP9043</b>	ALT, (AC) ALT, (-AC)	<b>VD1101</b>
1.9 dCi (BG0G)	03/01-	F9Q750, F9Q756, F9Q670	88	1870	<b>AP9039</b> <b>AP9043</b>	ALT, (AC) ALT, (-AC)	<b>VD1101</b>
1.9 dCi (BG1A, BG1W)	01/05-	F9Q758, F9Q674	81	1870	<b>AP9047</b>	ALT, 120A, 150A	<b>VD1104</b>
1.9 dCi (BG1V)	05/05-	F9Q758, F9Q759	96	1870	<b>AP9047</b>	ALT, 120A, 150A	<b>VD1104</b>
2.2 dCi	05/05-	G9T600, G9T605, G9T706, G9T707	102	2188			<b>VD1109</b>
2.2 dCi (BG0F)	10/01-	G9T702, G9T700	110	2188			<b>VD1109</b>
<b>LAGUNA II Grandtour (KG0/1_)</b>							
1.6 16V (KG0A, KG0L)	03/01-	K4M710, K4M711, K4M714	79	1598	<b>AP9025</b> <b>AP9025</b>	ALT, (Bosch), 98A, OE-NO 77 01 473 636, 77 01 477 694, 77 00 429 217 ALT, (Valeo), 120A, OE-NO 77 01 477 710, 82 00 019 706	
1.9 dCi (KG05)	03/04-	F9Q664	68	1870	<b>AP9047</b>	ALT, 120A, 150A	





## RENAULT

### LAGUNA II Grandtour (KG0/1\_)

1.9 dCi (KG0E)	06/01-	F9Q752	77	1870	AP9039 AP9043	ALT, (AC) ALT, (-AC)	VD1104
1.9 dCi (KG0E, KG0R)	10/01-	F9Q754	74	1870	AP9039 AP9043	ALT, (AC) ALT, (-AC)	VD1101
1.9 dCi (KG0G)	03/01-	F9Q750, F9Q756, F9Q670	88	1870	AP9039 AP9043	ALT, (AC) ALT, (-AC)	VD1101
1.9 dCi (KG1A, KG1W)	01/05-	F9Q674	81	1870	AP9047	ALT, 120A, 150A	VD1104
1.9 dCi (KG1V)	05/05-	F9Q758, F9Q759	96	1870	AP9047	ALT, 120A, 150A	VD1104
2.2 dCi	05/05-	G9T600, G9T706, G9T707	102	2188			VD1109
2.2 dCi (KG0F)	10/01-	G9T702	110	2188			VD1109

### LOGAN (LS\_)

1.4	09/04-	K7J710	55	1390	AP9025	ALT, (Bosch), 98A, OE-NO 77 01 473 636, 77 01 477 694, 77 00 429 217	
1.5 dCi	04/07-		50	1461	AP9025  AP9025	ALT, (Valeo), 110A, ALT-No: TG11C034, TG11C064, 125A, ALT-No: SG12B089, SG12B105 ALT, 110A, OE-NO 82 00 667 608, 125A, OE-NO 82 00 537 415	
1.6	09/04-	K7M710	64	1598	AP9025	ALT, (Bosch), 98A, OE-NO 77 01 473 636, 77 01 477 694, 77 00 429 217	

### LOGAN Kombi (KS\_)

1.4	10/07-	K7J710	55	1390	AP9025	ALT, (Bosch), 98A, OE-NO 77 01 473 636, 77 01 477 694, 77 00 429 217	
1.5 dCi	04/07-	K9K792	50	1461	AP9025  AP9025	ALT, (Valeo), 110A, ALT-No: TG11C034, TG11C064, 125A, ALT-No: SG12B089, SG12B105 ALT, 110A, OE-NO 82 00 667 608, 125A, OE-NO 82 00 537 415	
1.6	04/07-	K7M710	64	1598	AP9025	ALT, (Bosch), 98A, OE-NO 77 01 473 636, 77 01 477 694, 77 00 429 217	

### MASTER II Bus (JD/ND)

1.9 dCi 80	11/01-	F9Q772, F9Q774	60	1870	AP9039 AP9043	ALT, (AC) ALT, (-AC)	
1.9 dTi	09/00-	F9Q770	59	1870			VD1063
2.2 dCi 90	09/00-	G9T720, G9T722, G9T750	66	2188		MTR-CODE: G9T 720, G9T 722	VD1109

### MASTER II Kasten (FD)

1.9 dCi 80	11/01-	F9Q772, F9Q774	60	1870	AP9039 AP9043	ALT, (AC) ALT, (-AC)	VD1101
1.9 dTi	09/00-	F9Q770	59	1870			VD1063
2.2 dCi 90	09/00-	G9T720, G9T722, G9T750	66	2188		MTR-CODE: G9T 720, G9T 722	VD1109

### MASTER II Pritsche/Fahrgestell (ED/HD/UD)

2.2 dCi 90	09/00-	G9T720, G9T722, G9T750	66	2188		MTR-CODE: G9T 720, G9T 722	VD1109
------------	--------	------------------------------	----	------	--	----------------------------	--------

### MEGANE CC (EZ0/1\_)

1.9 dCi (EZ0J, EZ1S)	06/10-	F9Q870	96	1870			VD1104
----------------------	--------	--------	----	------	--	--	--------

### MEGANE I (BA0/1\_)

1.4 16V (BA0D, BA1H, BA0W, BA10)	03/99-	K4J750, K4J714	70	1390	AP9025  AP9025	ALT, (Bosch), 87A, OE-NO 77 00 484 899, 77 01 473 637, 77 01 477 711, 98A, OE-NO 77 01 473 636, 77 01 477 694, 77 00429 217 ALT, (Valeo), 120A, OE-NO 77 01 477 710, 82 00 019 706	
1.4 e (BA0E, BA0V)	01/96-	E7J764, E7J626	55	1390	AP9025	ALT, (Bosch), 87A, OE-NO 77 00 434 899, 77 01 473 637, 77 01 477 711	
1.6 16V (BA11, BA04, BA0B, BA1J)	03/99-	K4M700, K4M701, K4M708, K4M704	79	1598	AP9025  AP9025	ALT, (Bosch), 87A, OE-NO 77 00 484 899, 77 01 473 637, 77 01 477 711, 98A, OE-NO 77 01 473 636, 77 01 477 694, 77 00429 217 ALT, (Valeo), 120A, OE-NO 77 01 477 710, 82 00 019 706	
1.9 D Eco (B/SA0U, BA0A)	01/96-	F8Q620, F8Q624	47	1870		ALT, (-AC) ALT, (AC)	6PK1138D2 6PK1642D2 VD1081



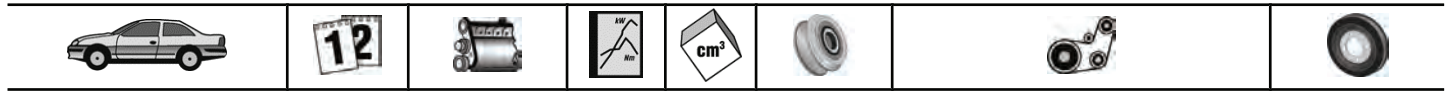

# RENAULT

## MEGANE I (BA0/1\_)

1.9 dCi	03/99-07/03	F9Q732, F9Q738	77	1870		ALT, (-AC), MTR-CODE: F9Q 731, F9Q 732, F9Q 733, F9Q 736, F9Q 744 ALT, (AC), MTR-CODE: F9Q 731, F9Q 732, F9Q 733, F9Q 736, F9Q 744	6PK1138D1 6PK1642D1
1.9 dCi (BA05, BA1F)	02/01-	F9Q732, F9Q733	75	1870	AP9052	ALT ALT, PS, (-AC), MTR-CODE: F9Q 731, F9Q 732, F9Q 733, F9Q 736, F9Q 744 ALT, PS, AC, MTR-CODE: F9Q 731, F9Q 732, F9Q 733, F9Q 736, F9Q 744, ⇒03/2001	6PK1138D1 6PK1642D1 VD1063
1.9 dT (B/SA0K, B/SA0Y)	01/96-	F8Q784, F8Q786	66	1870		ALT, (-AC) ALT, (AC)	6PK1138D2 6PK1642D2 VD1081
1.9 dTi (BA08, BA0N)	03/97-02/01	F9Q730, F9Q734, F9Q731, F9Q736	72	1870	AP9052	ALT, MTR-CODE: F9Q 731, F9Q 736 ALT, PS, (-AC), MTR-CODE: F9Q 731, F9Q 732, F9Q 733, F9Q 736, F9Q 744 ALT, PS, AC, MTR-CODE: F9Q 731, F9Q 732, F9Q 733, F9Q 736, F9Q 744 MTR-CODE: F9Q 731, F9Q 736 MTR-CODE: F9Q 734, 11/1997⇒	6PK1138D1 6PK1642D1 VD1063 VD1063
1.9 dTi (BA1U)	02/01-	F9Q744	59	1870	AP9052	ALT ALT, PS, (-AC), MTR-CODE: F9Q 731, F9Q 732, F9Q 733, F9Q 736, F9Q 744, ⇒03/2001 ALT, PS, AC, MTR-CODE: F9Q 731, F9Q 732, F9Q 733, F9Q 736, F9Q 744, ⇒03/2001	6PK1138D1 6PK1642D1 VD1063
1.9 TDI	09/96-	F8Q784	69	1870		ALT, (-AC) ALT, (AC)	6PK1138D2 6PK1642D2 VD1081

## MEGANE I Cabriolet (EA0/1\_)

1.4 16V (EA0D, EA1H, EA0W, EA10)	03/99-	K4J750, K4J714	70	1390	AP9025	ALT, (Bosch), 87A, OE-NO 77 00 484 899, 77 01 473 637, 77 01 477 711, 98A, OE-NO 77 01 473 636, 77 01 477 694, 77 00429 217	
					AP9025	ALT, (Valeo), 120A, OE-NO 77 01 477 710, 82 00 019 706	
1.6 16V (EA0B, EA04, EA11)	03/99-	K4M700, K4M701, K4M708	79	1598	AP9025	ALT, (Bosch), 87A, OE-NO 77 00 484 899, 77 01 473 637, 77 01 477 711, 98A, OE-NO 77 01 473 636, 77 01 477 694, 77 00429 217	
					AP9025	ALT, (Valeo), 120A, OE-NO 77 01 477 710, 82 00 019 706	

## MEGANE I Classic (LA0/1\_)

1.4 (LA0E, LA0V)	09/96-	E7J764, E7J626	55	1390	AP9025	ALT, (Bosch), 87A, OE-NO 77 00 434 899, 77 01 473 637, 77 01 477 711	
1.4 16V (LA0D, LA1H, IA0W, LA10)	03/99-	K4J750, K4J714	70	1390	AP9025	ALT, (Bosch), 87A, OE-NO 77 00 484 899, 77 01 473 637, 77 01 477 711, 98A, OE-NO 77 01 473 636, 77 01 477 694, 77 00429 217	
					AP9025	ALT, (Valeo), 120A, OE-NO 77 01 477 710, 82 00 019 706	
1.6 16V (La04, LA11, LA0B, LA1C, LA1J)	03/99-	K4M700, K4M701, K4M708	79	1598	AP9025	ALT, (Bosch), 87A, OE-NO 77 00 484 899, 77 01 473 637, 77 01 477 711, 98A, OE-NO 77 01 473 636, 77 01 477 694, 77 00429 217	
					AP9025	ALT, (Valeo), 120A, OE-NO 77 01 477 710, 82 00 019 706	
1.9 D (LA0A, LA0U)	09/96-	F8Q620, F8Q624	47	1870		ALT, (-AC) ALT, (AC)	6PK1138D2 6PK1642D2 VD1081
1.9 dCi (LA05, LA1F)	02/01-	F9Q732, F9Q733, F9Q738	75	1870	AP9052	ALT ALT, PS, (-AC), MTR-CODE: F9Q 731, F9Q 732, F9Q 733, F9Q 736, F9Q 744 ALT, PS, AC, MTR-CODE: F9Q 731, F9Q 732, F9Q 733, F9Q 736, F9Q 744, ⇒03/2001	6PK1138D1 6PK1642D1 VD1063
1.9 dT (LA0K, LA0Y)	09/96-	F8Q784, F8Q786	66	1870		ALT, (-AC) ALT, (AC)	6PK1138D2 6PK1642D2 VD1081
1.9 dTi (LA08, LA0N)	03/97-02/01	F9Q730, F9Q734, F9Q731, F9Q736	72	1870	AP9052	ALT, MTR-CODE: F9Q 731, F9Q 736 MTR-CODE: F9Q 731, F9Q 736 MTR-CODE: F9Q 734, 11/1997⇒	VD1063 VD1063
1.9 dTi (LA1U)	02/01-	F9Q744	59	1870	AP9052	ALT	



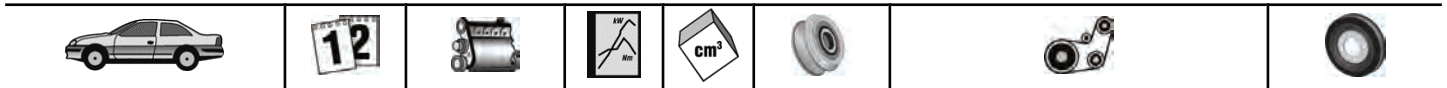

## RENAULT

### MEGANE I Classic (LA0/1\_)

						ALT, PS, MTR-CODE: F9Q 731, F9Q 732, F9Q 733, F9Q 736, F9Q 744	<b>6PK1138D1</b>
						ALT, PS, AC, MTR-CODE: F9Q 731, F9Q 732, F9Q 733, F9Q 736, F9Q 744	<b>6PK1642D1</b>
							<b>VD1063</b>
1.9 TDI	09/96-	F8Q784	69	1870		ALT, (-AC)	<b>6PK1138D2</b>
						ALT, (AC)	<b>6PK1642D2</b>
							<b>VD1081</b>

### MEGANE I Coach (DA0/1\_)

1.4 16V (DA0D, DA1H, DA0W, DA10)	03/99-08/03	K4J750, K4J714	70	1390	<b>AP9025</b>	ALT, (Bosch), 87A, OE-NO 77 00 484 899, 77 01 473 637, 77 01 477 711, 98A, OE-NO 77 01 473 636, 77 01 477 694, 77 00429 217	
					<b>AP9025</b>	ALT, (Valeo), 120A, OE-NO 77 01 477 710, 82 00 019 706	
1.6 16V (DA0B, DA04, DA11)	03/99-08/03	K4M700, K4M701, K4M708	79	1598	<b>AP9025</b>	ALT, (Bosch), 87A, OE-NO 77 00 484 899, 77 01 473 637, 77 01 477 711, 98A, OE-NO 77 01 473 636, 77 01 477 694, 77 00429 217	
					<b>AP9025</b>	ALT, (Valeo), 120A, OE-NO 77 01 477 710, 82 00 019 706	
1.9 DCi	03/99-09/00	F9Q732, F9Q738	77	1870		ALT, (-AC), MTR-CODE: F9Q 731, F9Q 732, F9Q 733, F9Q 736, F9Q 744	<b>6PK1138D1</b>
						ALT, (AC), MTR-CODE: F9Q 731, F9Q 732, F9Q 733, F9Q 736, F9Q 744	<b>6PK1642D1</b>
1.9 dCi (DA05, DA1F)	02/01-08/03	F9Q732, F9Q733	75	1870	<b>AP9052</b>	ALT	
						ALT, PS, (-AC), MTR-CODE: F9Q 731, F9Q 732, F9Q 733, F9Q 736, F9Q 744, ⇒03/2001	<b>6PK1138D1</b>
						ALT, PS, AC, MTR-CODE: F9Q 731, F9Q 732, F9Q 733, F9Q 736, F9Q 744, ⇒03/2001	<b>6PK1642D1</b>
							<b>VD1063</b>
1.9 dTi (DA0N)	03/97-02/01	F9Q734, F9Q731, F9Q736	72	1870	<b>AP9052</b>	ALT, MTR-CODE: F9Q 731, F9Q 736	
						ALT, PS, MTR-CODE: F9Q 731, F9Q 732, F9Q 733, F9Q 736, F9Q 744	<b>6PK1138D1</b>
						ALT, PS, AC, MTR-CODE: F9Q 731, F9Q 732, F9Q 733, F9Q 736, F9Q 744	<b>6PK1642D1</b>
							<b>VD1063</b>

### MEGANE I Grandtour (KA0/1\_)

1.4 16V (KA0D, KA1H, KA0W, KA10)	03/99-	K4J750, K4J714	70	1390	<b>AP9025</b>	ALT, (Bosch), 87A, OE-NO 77 00 484 899, 77 01 473 637, 77 01 477 711, 98A, OE-NO 77 01 473 636, 77 01 477 694, 77 00429 217	
					<b>AP9025</b>	ALT, (Valeo), 120A, OE-NO 77 01 477 710, 82 00 019 706	
1.4 e (KA0V)	03/99-	E7J626	55	1390	<b>AP9025</b>	ALT, (Bosch), 87A, OE-NO 77 00 434 899, 77 01 473 637, 77 01 477 711	
1.6 16V (KA0B, KA04, KA11)	03/99-	K4M700, K4M701, K4M708, K4M704	79	1598	<b>AP9025</b>	ALT, (Bosch), 87A, OE-NO 77 00 484 899, 77 01 473 637, 77 01 477 711, 98A, OE-NO 77 01 473 636, 77 01 477 694, 77 00429 217	
					<b>AP9025</b>	ALT, (Valeo), 120A, OE-NO 77 01 477 710, 82 00 019 706	
1.9 D (KA0J, KA0R)	04/99-	F8Q790, F8Q622	47	1870		ALT, (-AC)	<b>6PK1138D2</b>
						ALT, (AC)	<b>6PK1642D2</b>
							<b>VD1081</b>
1.9 dCi (KA05, KA1F)	02/01-	F9Q732, F9Q733, F9Q738	75	1870	<b>AP9052</b>	ALT	
						ALT, PS, (-AC), MTR-CODE: F9Q 731, F9Q 732, F9Q 733, F9Q 736, F9Q 744	<b>6PK1138D1</b>
						ALT, PS, AC, MTR-CODE: F9Q 731, F9Q 732, F9Q 733, F9Q 736, F9Q 744, ⇒03/2001	<b>6PK1642D1</b>
							<b>VD1063</b>
1.9 dTi (KA0N)	03/99-02/01	F9Q731, F9Q736	72	1870	<b>AP9025</b> <b>AP9052</b>	98A ALT	
						ALT, PS, MTR-CODE: F9Q 731, F9Q 732, F9Q 733, F9Q 736, F9Q 744	<b>6PK1138D1</b>
						ALT, PS, AC, MTR-CODE: F9Q 731, F9Q 732, F9Q 733, F9Q 736, F9Q 744	<b>6PK1642D1</b>
							<b>VD1063</b>
1.9 dTi (KA1U)	02/01-	F9Q744	59	1870	<b>AP9052</b>	ALT	
						ALT, PS, MTR-CODE: F9Q 731, F9Q 732, F9Q 733, F9Q 736, F9Q 744	<b>6PK1138D1</b>
						ALT, PS, AC, MTR-CODE: F9Q 731, F9Q 732, F9Q 733, F9Q 736, F9Q 744	<b>6PK1642D1</b>
							<b>VD1063</b>





# RENAULT

## MEGANE II (BM0/1\_, CM0/1\_)

1.9 dCi	03/04-	F9Q808	68	1870			VD1104
	05/05-	F9Q804, F9Q818	81	1870			VD1104
		F9Q803, F9Q816	96	1870			VD1104
	11/02-12/05	F9Q808	66	1870			VD1104
1.9 dCi (BM0G, CM0G)	11/02-	F9Q750	88	1870			VD1104
2.0 dCi (BM1K, CM1K)	09/05-	M9R700, M9R722	110	1995	AP9047	ALT, 120A, 150A	

## MEGANE II Coupé-Cabriolet (EM0/1\_)

1.9 dCi	05/05-	F9Q804, F9Q816, F9Q818	81	1870			VD1104
		F9Q803	96	1870			VD1104
	09/03-	F9Q804, F9Q816, F9Q818	85	1870			VD1104
2.0 dCi	09/05-	F9Q800	88	1870			VD1104
		M9R700, M9R722	110	1995	AP9047	ALT, 120A, 150A	

## MEGANE II Kombi (KM0/1\_)

1.9 dCi	03/04-	F9Q808	68	1870			VD1104
	04/04-12/05	F9Q808	66	1870			VD1104
	05/05-	F9Q804, F9Q818	81	1870			VD1104
		F9Q804, F9Q803	96	1870			VD1104
2.0 dCi	08/03-	F9Q800	88	1870			VD1104
	09/05-	M9R700, M9R722	110	1995	AP9047	ALT, 120A, 150A	

## MEGANE II Stufenheck (LM0/1\_)

1.9 dCi	03/04-	F9Q808	68	1870			VD1104
	05/05-	F9Q803	96	1870			VD1104
	09/03-12/05	F9Q808	66	1870			VD1104
1.9 dCi (LM0G, LM1G, LM2C)	09/03-	F9Q800	88	1870			VD1104
1.9 dCi (LM14, LM1D)	05/05-	F9Q804, F9Q818	81	1870			VD1104

## MEGANE III Kombi (KZ0/1)

1.9 dCi (KZ0N)	05/09-	F9Q872, F9Q870	96	1870			VD1104
----------------	--------	-------------------	----	------	--	--	--------

## MEGANE III Schrägheck (BZ0\_)

1.9 dCi (BZ0N, BZ0J)	11/08-	F9Q872, F9Q870	96	1870			VD1104
----------------------	--------	-------------------	----	------	--	--	--------

## MEGANE III Stufenheck

1.9 dCi	06/09-	F9Q872, F9Q870	96	1870			VD1104
---------	--------	-------------------	----	------	--	--	--------

## MEGANE Scenic (JA0/1\_)

1.9 D (JA0J)	03/97-09/99	F8Q790	47	1870		ALT, (-AC) ALT, (AC)	6PK1138D2 6PK1642D2 VD1081
1.9 dT (JA0K, JA0Y)	01/97-09/99	F8Q784, F8Q786	66	1870		ALT, (-AC) ALT, (AC)	6PK1138D2 6PK1642D2 VD1081
1.9 dTi (JA0N)	04/97-09/99	F9Q730, F9Q734	72	1870		ALT, (PS), (-AC), 11/1997⇒, MTR-CODE: F9Q 734	6PK1138D1
						ALT, (PS), (AC), 11/1997⇒, MTR-CODE: F9Q 734	6PK1642D1 VD1063

## RAPID Kasten (F40\_, G40\_)

1.9 D (F40P, F40N, F40E)	09/91-03/98	F8Q722, F8Q724, F8Q774, F8Q776	47	1870			VD1081
1.9 D (F40R)	09/94-03/98	F8Q640, F8Q682	40	1870			VD1081

## SCÉNIC I (JA0/1\_)

1.4 16V (JA0D, JA1H, Ja0W, JA10)	09/99-08/03	K4J750, K4J714	70	1390	AP9025	ALT, (Bosch), 87A, OE-NO 77 00 484 899, 77 01 473 637, 77 01 477 711, 98A, OE-NO 77 01 473 636, 77 01 477 694, 77 00429 217	
1.6 16V (JA0B, JA04, JA11)	09/99-08/03	K4M700, K4M701, K4M708, K4M704	79	1598	AP9025	ALT, (Valeo), 120A, OE-NO 77 01 477 710, 82 00 019 706	
					AP9025	ALT, (Bosch), 87A, OE-NO 77 00 484 899, 77 01 473 637, 77 01 477 711, 98A, OE-NO 77 01 473 636, 77 01 477 694, 77 00429 217	





## RENAULT

### SCÉNIC I (JA0/1\_)

					<b>AP9025</b>	ALT, (Valeo), 120A, OE-NO 77 01 477 710, 82 00 019 706	
1.9 dCi (JA05, JA1F)	09/99-08/03	F9Q732, F9Q733	75	1870	<b>AP9052</b>	ALT, (Valeo) ALT, PS, (-AC), MTR-CODE: F9Q 731, F9Q 732, F9Q 733, F9Q 736, F9Q 744 ALT, PS, AC, MTR-CODE: F9Q 731, F9Q 732, F9Q 733, F9Q 736, F9Q 744, ⇨03/2001	<b>6PK1138D1</b> <b>6PK1642D1</b> <b>VD1063</b>
1.9 dCi RX4	11/00-08/03	F9Q740	75	1870	<b>AP9052</b>	ALT, (Valeo)	<b>VD1063</b>
1.9 dTi (JA0N)	09/99-08/03	F9Q734, F9Q731, F9Q736	72	1870	<b>AP9052</b>	ALT, (Valeo), MTR-CODE: F9Q 734, F9Q 736 ALT, PS, (-AC), MTR-CODE: F9Q 731, F9Q 732, F9Q 733, F9Q 736, F9Q 744 ALT, PS, AC, MTR-CODE: F9Q 731, F9Q 732, F9Q 733, F9Q 736, F9Q 744, ⇨03/2001	<b>6PK1138D1</b> <b>6PK1642D1</b> <b>VD1063</b>
1.9 dTi (JA1U)	02/01-08/03	F9Q744	59	1870	<b>AP9052</b>	ALT, (Valeo) ALT, PS, (-AC), MTR-CODE: F9Q 731, F9Q 732, F9Q 733, F9Q 736, F9Q 744 ALT, PS, AC, MTR-CODE: F9Q 731, F9Q 732, F9Q 733, F9Q 736, F9Q 744, ⇨03/2001	<b>6PK1138D1</b> <b>6PK1642D1</b> <b>VD1063</b>

### SCÉNIC II (JM0/1\_)

1.9 D	06/06-	F9QJ803, F9Q812	85	1870			<b>VD1104</b>
1.9 dCi (JM12, JM0G)	06/03-	F9Q812	88	1870			<b>VD1104</b>
1.9 dCi (JM14)	05/05-	F9QJ803, F9Q804	96	1870			<b>VD1104</b>
1.9 dCi (JM15)	05/05-	F9QE804, F9Q803	81	1870			<b>VD1104</b>
2.0 dCi (JM1K)	09/05-	M9R700, M9R721	110	1995	<b>AP9047</b>	ALT, 120A, 150A	

### SCÉNIC III (JZ0/1\_)

1.9 dCi	02/09-	F9Q870	96	1870			<b>VD1104</b>
---------	--------	--------	----	------	--	--	---------------

### THALIA (LB0/1/2\_)

1.4	08/00-	K7J700	55	1390	<b>AP9025</b>	ALT, (Bosch), 87A, OE-NO 77 00 434 899, 77 01 473 637, 77 01 477 711	
1.4 16V	08/00-	K4J712	72	1390	<b>AP9025</b>	ALT, (Bosch), 98A, OE-NO 77 01 473 636, 77 01 477 694, 77 00 429 217	
1.5 dCi	02/03-		50	1461	<b>AP9025</b>	ALT, (Mitsubishi), 110A, ALT-No: A002TC0982	
					<b>AP9025</b>	ALT, (Valeo), 110A, ALT-No: TG11C034, TG11C064, 125A, ALT-No: SG12B089, SG12B105	
					<b>AP9025</b>	ALT, 110A, OE-NO 82 00 667 608, 125A, OE-NO 82 00 537 415	
	04/02-	K9K700	48	1461	<b>AP9025</b>	ALT, (Mitsubishi), 110A, ALT-No: A002TC0982	
					<b>AP9025</b>	ALT, (Valeo), 110A, ALT-No: TG11C034, TG11C064, 125A, ALT-No: SG12B089, SG12B105	
					<b>AP9025</b>	ALT, 110A, OE-NO 82 00 667 608, 125A, OE-NO 82 00 537 415	
					<b>AP9056</b>	ALT, (Valeo), 120A, ALT-No: SG12B038, SG12B103	
					<b>AP9056</b>	ALT, 120A, OE-NO 77 01 477 001	
	06/01-	K9K702	60	1461	<b>AP9025</b>	ALT, (Mitsubishi), 110A, ALT-No: A002TC0982	
					<b>AP9025</b>	ALT, (Valeo), 110A, ALT-No: TG11C034, TG11C064, 125A, ALT-No: SG12B089, SG12B105	
					<b>AP9025</b>	ALT, 110A, OE-NO 82 00 667 608, 125A, OE-NO 82 00 537 415	
					<b>AP9056</b>	ALT, (Valeo), 120A, ALT-No: SG12B038, SG12B103	
					<b>AP9056</b>	ALT, 120A, OE-NO 77 01 477 001	
	06/05-	K9K740	47	1461	<b>AP9025</b>	ALT, (Mitsubishi), 110A, ALT-No: A002TC0982	
					<b>AP9025</b>	ALT, (Valeo), 110A, ALT-No: TG11C034, TG11C064	
					<b>AP9025</b>	ALT, 110A, OE-NO 82 00 667 608	

### TRAFIC II Bus (JL)

1.9 dCi 100 (JLOC)	03/01-	F9Q760	74	1870	<b>AP9039</b> <b>AP9043</b>	ALT, (AC) ALT, (-AC)	
--------------------	--------	--------	----	------	--------------------------------	-------------------------	--





## RENAULT

### TRAFIC II Bus (JL)

1.9 dCi 80 (JL0B)	03/01-	F9Q762	60	1870	AP9039 AP9043	ALT, (AC) ALT, (-AC)	VD1101
2.5 dCi 135 (JL0D)	05/03-	G9U730	99	2464			VD1101 VD1109

### TRAFIC II Kasten (FL)

1.9 dCi 100 (FL0C)	03/01-	F9Q760	74	1870	AP9039 AP9043	ALT, (AC) ALT, (-AC)	VD1101
1.9 dCi 80 (FL0B)	03/01-	F9Q762	60	1870	AP9039 AP9043	ALT, (AC) ALT, (-AC)	VD1101
2.5 dCi 135 (FL0D)	05/03-	G9U730	99	2464			VD1109

### TRAFIC II Pritsche/Fahrgestell (EL)

1.9 dCi 100 (ELOC)	03/01-	F9Q760	74	1870	AP9039 AP9043	ALT, (AC) ALT, (-AC)	VD1101
1.9 dCi 80 (ELOB)	03/01-	F9Q762	60	1870	AP9039 AP9043	ALT, (AC) ALT, (-AC)	VD1101
2.5 dCi 135 (ELOC)	03/01-	G9U730	99	2463			VD1109

### TWINGO (CNO\_)

1.5 dCi (CNOE)	03/07-	K9K740	47	1461	AP9025 AP9025 AP9025	ALT, (Mitsubishi), 110A, ALT-No: A002TC0982 ALT, (Valeo), 110A, ALT-No: TG11C034, TG11C064, 125A, ALT-No: SG12B089, SG12B105 ALT, 110A, OE-NO 82 00 667 608, 125A, OE-NO 82 00 537 415	
1.5 dCi (CNOU)	04/08-	K9K718	62	1461	AP9025 AP9025 AP9025 AP9056 AP9056	ALT, (Mitsubishi), 110A, ALT-No: A002TC0982 ALT, (Valeo), 110A, ALT-No: TG11C034, TG11C064, 125A, ALT-No: SG12B089, SG12B105 ALT, 110A, OE-NO 82 00 667 608, 125A, OE-NO 82 00 537 415 ALT, (Valeo), 120A, ALT-No: SG12B038, SG12B103 ALT, 120A, OE-NO 77 01 477 001	
1.5 dCi 75	10/10-		55	1461	AP9025 AP9025 AP9025	ALT, (Mitsubishi), 110A, ALT-No: A002TC0982 ALT, (Valeo), 110A, ALT-No: TG11C034, TG11C064, 125A, ALT-No: SG12B089, SG12B105 ALT, 110A, OE-NO 82 00 667 608, 125A, OE-NO 82 00 537 415	
1.5 dCi 90	10/10-		63	1461	AP9025 AP9025 AP9025	ALT, (Mitsubishi), 110A, ALT-No: A002TC0982 ALT, (Valeo), 110A, ALT-No: TG11C034, TG11C064, 125A, ALT-No: SG12B089, SG12B105 ALT, 110A, OE-NO 82 00 667 608, 125A, OE-NO 82 00 537 415	

### VEL SATIS (BJ0\_)

2.2 dCi (BJ0E, BJ0F)	06/02-	G9T702, G9T703	110	2188			VD1109
2.2 dCi (BJ0G, BJ0H)	09/04-	G9T600, G9T700, G9T606	102	2188			VD1109
2.2 dCi (BJ0H)	04/04-	G9T600	85	2188			VD1109

## ROVER

### 75 (RJ)

2.0 CDT	02/99-	M47R	85	1950			VD1087
2.0 CDTi	02/03-	204D2	96	1951			VD1087

### 75 Tourer (RJ)

2.0 CDT	08/01-	M47R	85	1950			VD1087
2.0 CDTi	02/03-	204D2	96	1951			VD1087

## SAAB

### 9-3 (YS3D)

2.2 TiD	02/98-11/00	X22DTH, D223L	85	2171			VD1031
	11/00-09/02	D223L	92	2171			VD1031

### 9-3 (YS3F)

1.9 TiD	09/04-	Z19DT	88	1910	AP9017	ALT, (Denso), OE-NO 93 180 104, 130A, ⇒CH-NO 51024443	
---------	--------	-------	----	------	--------	----------------------------------------------------------	--







## SAAB

**9-3 (YS3F)**

					<b>AP9054</b>	ALT, (Denso), OE-NO 12 759 595, 140A, CH-NO 51024444⇒	
					Z19DTH	110	1910
1.9 TTiD	12/07-	Z19DTR, A19DTR	132	1910	<b>AP9054</b>	ALT, (Denso), OE-NO 12 759 595, 140A, CH-NO 51024444⇒	
					<b>AP9017</b>	ALT, (Denso), OE-NO 93 180 104, 130A, ⇒CH-NO 51024443	
2.2 TiD	09/02-	D223L	92	2171			<b>VD1065</b> <b>VD1031</b>

**9-3 Cabriolet (YS3F)**

1.9 TiD	01/06-	Z19DTH	110	1910	<b>AP9054</b>	ALT, (Denso), OE-NO 12 759 595, 140A, CH-NO 51024444⇒	
1.9 TTiD	12/07-	Z19DTR, A19DTR	132	1910	<b>AP9017</b>	ALT, (Denso), OE-NO 93 180 104, 130A, ⇒CH-NO 51024443	
					<b>AP9054</b>	ALT, (Denso), OE-NO 12 759 595, 140A, CH-NO 51024444⇒	<b>VD1065</b>

**9-3 Kombi**

1.9 TiD	03/05-		88	1910	<b>AP9017</b>	ALT, (Denso), OE-NO 93 180 104, 130A, ⇒CH-NO 51024443	
			Z19DTH	110	1910	<b>AP9017</b>	ALT, (Denso), OE-NO 93 180 104, 130A, ⇒CH-NO 51024443
1.9 TTiD	12/07-	Z19DTR	132	1910	<b>AP9054</b>	ALT, (Denso), OE-NO 12 759 595, 140A, CH-NO 51024444⇒	
					<b>AP9017</b>	ALT, (Denso), OE-NO 93 180 104, 130A, ⇒CH-NO 51024443	<b>VD1065</b>

**9-3X**

1.9 TTiD	02/09-	Z19DTR	132	1910	<b>AP9017</b>	ALT, (Denso), OE-NO 93 180 104, 130A, ⇒CH-NO 51024443	
					<b>AP9054</b>	ALT, (Denso), OE-NO 12 759 595, 140A, CH-NO 51024444⇒	<b>VD1065</b>

**9-5 (YS3E)**

1.9 TiD	01/06-	Z19DTH	110	1910	<b>AP9028</b>	ALT, (Bosch), OE-NO 93191921, 120A, OE-NO 93191922, 140A	
					<b>AP9054</b>	ALT, (Denso), OE-NO 12 759 595, 140A ALT, (-AC), MTR-NO 71021892⇒ ALT, AC, MTR-NO 71021892⇒ ⇒MTR-NO 71021891 MTR-NO 71021892⇒	<b>6PK1050D1</b> <b>6PK1413D2</b> <b>VD1065</b> <b>VD1067</b>
2.2 TiD	03/02-	D223L	88	2171			<b>VD1031</b>

**9-5 Kombi (YS3E)**

1.9 TiD	01/06-	Z19DTH	110	1910	<b>AP9028</b>	ALT, (Bosch), OE-NO 93191921, 120A, OE-NO 93191922, 140A	
					<b>AP9054</b>	ALT, (Denso), OE-NO 12 759 595, 140A, CH-NO 51024444⇒, ALT, (Denso), OE-NO 12 759 595, 140A ALT, (-AC), MTR-NO 71021892⇒ ALT, AC, MTR-NO 71021892⇒ ⇒MTR-NO 71021891 MTR-NO 71021892⇒	<b>6PK1050D1</b> <b>6PK1413D2</b> <b>VD1065</b> <b>VD1067</b>
2.2 TiD	03/02-	D223L	88	2171			<b>VD1031</b>

## SEAT

**ALHAMBRA (710)**

2.0 TDI	06/10-	CFFB	103	1968			<b>VD1111</b>
		CFGB	125	1968			<b>VD1111</b>

**ALHAMBRA (7V8, 7V9)**

1.8 T 20V	10/97-03/10	AWC, AJH	110	1781	<b>AP9001</b>	ALT, MTR-CODE: AJH, CH-NO 7M-X-517025⇒, (Bosch), 90A, 120A	
					<b>AP9001</b>	ALT, MTR-CODE: AWC, (Bosch), 90A, 120A	
					<b>AP9016</b>	ALT, MTR-CODE: AJH, ⇒CH-NO 7M-X-517024, (Bosch), 90A, 120A	<b>VD1107</b>
1.9 TDI	04/96-03/10	1Z, AHU, ANU	66	1896	<b>AP9001</b>	MTR-CODE: ANU, ALT, (Bosch), OE-NO 038903023L, 90A, OE-NO 028903028E, 120A	
					<b>AP9004</b>	ALT, MTR-CODE: 1Z, AHU, ⇒CH-NO	





# SEAT

## ALHAMBRA (7V8, 7V9)

						7M-X-517024, (Bosch), 90A, OE-NO 028 903 025 Q ALT, PS, (AC), CH-NO 7M-4-507 001⇒, MTR-CODE: ANU MTR-CODE: ANU, CH-NO 7M-4-507 001⇒ MTR-CODE: 1Z, AHU MTR-CODE: ANU, ⇒CH-NO 7M-4-507 000	<b>6DPK1195D1</b> <b>VD1076</b> <b>VD1084</b> <b>VD1091</b>
	05/05-05/07	ARL, BTB	110	1896	<b>AP9001</b>	ALT, (Bosch), 90A, 120A ALT, (AC)	<b>6DPK1195D1</b> <b>VD1076</b>
	06/00-03/10	AUY, BVK	85	1896	<b>AP9001</b>	MTR-CODE: BVK, ALT, (Bosch), OE-NO 038903023L, 90A ALT, (AC), CH-NO 7M-4-507 001⇒, ⇒CH-NO 7M-6-506 378 ALT, (AC), CH-NO 7M-6-506 379⇒ MTR-CODE: AUY, CH-NO 7M-4-507 001⇒ MTR-CODE: BVK MTR-CODE: AUY, ⇒CH-NO 7M-7-507 000	<b>6DPK1195D1</b> <b>6DPK1215D1</b> <b>VD1076</b> <b>VD1076</b> <b>VD1091</b>
	08/96-06/00	AFN, AVG	81	1896	<b>AP9001</b> <b>AP9004</b>	ALT, (Bosch), OE-NO 038903023L, 90A, OE-NO 028903028E, 120A ALT, CH-NO 7M-V-501501⇒, ⇒CH-NO 7M-X-517024, (Bosch), 90A, OE-NO 028 903 026 G, 120A, OE-NO 028 903 028 J MTR-CODE: AVG, AFN	<b>VD1084</b>
	11/02-11/08	ASZ	96	1896	<b>AP9001</b>	ALT, (Bosch), OE-NO 038903023L, 90A, OE-NO 028903023E, 120A ALT, (AC), CH-NO 7M-4-507 001⇒ CH-NO 7M-4-507 001⇒ ⇒CH-NO 7M-4-507 000	<b>6DPK1195D1</b> <b>VD1076</b> <b>VD1091</b>
1.9 TDI 4motion	06/00-03/10	AUY, BVK	85	1896	<b>AP9001</b>	ALT, (Bosch), OE-NO 038903023L, 90A, OE-NO 028903028E, 120A ALT, (AC), CH-NO 7M-4-507 001⇒, ⇒CH-NO 7M-6-506 378 ALT, (AC), CH-NO 7M-6-506 379⇒ MTR-CODE: AUY, CH-NO 7M-4-507 001⇒ MTR-CODE: BVK MTR-CODE: AUY, ⇒CH-NO 7M-7-507 000	<b>6DPK1195D1</b> <b>6DPK1215D1</b> <b>VD1076</b> <b>VD1091</b>
1.9 Tdi 4x4	06/05-11/08	ASZ	96	1896		ALT, (AC), CH-NO 7M-4-507 001⇒ CH-NO 7M-4-507 001⇒ ⇒CH-NO 7M-4-507 000	<b>6DPK1195D1</b> <b>VD1076</b> <b>VD1091</b>
2.0 i	04/96-03/10	ADY, ATM	85	1984	<b>AP9001</b> <b>AP9004</b>	ALT, MTR-CODE: ATM, (Bosch), 120A, 140A ALT, (AC), MTR-CODE: ADY, ⇒CH-NO 7M-X-517024, (Bosch), 90A, OE-NO 028 903 025 Q	<b>VD1107</b>
2.0 TDI	11/05-03/10	BRT	103	1968		ALT, PS, AC	<b>6DPK1215D1</b> <b>VD1076</b>
2.8 V6	06/00-03/10	AYL, AUE	150	2792	<b>AP9001</b>	ALT, (Bosch), 120A, 150A	
2.8 V6 4motion	06/00-03/10	AYL, AUE	150	2792	<b>AP9001</b>	ALT, (Bosch), 120A, 150A	
<b>ALTEA (5P1)</b>							
1.4 TSI	11/07-	CAXC	92	1390	<b>AP9001</b> <b>AP9012</b> <b>AP9012</b> <b>AP9012</b>	ALT, (Valeo), OE-NO 06J903023F, 140A (Bosch), OE-NO 03C 903 023 A, 140A (Valeo), OE-NO 03C 903 023 C, 140A ALT	
1.6	03/04-	BGU, BSE, BSF, CCSA, CMXA	75	1595	<b>AP9001</b>	ALT, (Bosch), OE-NO 06F903023F, 140A	
1.6 TDI	10/09-	CAYC	77	1598	<b>AP9012</b>	ALT, (Bosch), 140A, OE-NO 06F903023F MTR-CODE: CAYB, CAYC	<b>VD1111</b>
	11/10-	CAYB	66	1598		MTR-CODE: CAYB, CAYC	<b>VD1111</b>
1.8 TFSI	01/07-	BYT, BZB, CDAA	118	1798	<b>AP9009</b> <b>AP9009</b>	ALT, (Bosch), 140A, OE-NO 06B903016AB ALT, (Valeo), 140A, OE-NO 06D903016A, 06J903023C	
1.9 TDI	04/04-	BKC, BJB, BLS, BXE	77	1896	<b>AP9001</b>	ALT, (Bosch), OE-NO 06F903023F, 140A ALT, (AC)	<b>6PK1050D2</b> <b>VD1076</b>
	08/09-	BXF	66	1896		ALT, (AC)	<b>6PK1050D2</b>





## SEAT

### ALTEA (5P1)

↙ 2.0 FSI	05/04-03/09	BLR, BLY, BVY, BVZ	110	1984	AP9001	ALT, (Bosch), OE-NO 06F903023F, 140A	VD1107
2.0 TDI	03/04-05/09	AZV	100	1968	AP9001	ALT, (Bosch), OE-NO 06F903023F, 140A MTR-CODE: AZV, BKD, ALT, (AC)	6PK1050D2 VD1076
	03/06-	BMN, CEGA	125	1968	AP9001	ALT, (Bosch), OE-NO 06F903023F, 140A MTR-CODE: BMN, ALT, (AC)	6PK1050D2 VD1076
	11/05-	BMM	103	1968	AP9001	ALT, (Bosch), OE-NO 06F903023F, 140A ALT, PS, (AC)	6PK1050D2 VD1076
2.0 TDI 16V	03/04-	BKD, CFHC, CBDB	103	1968	AP9001	ALT, (Bosch), OE-NO 06F903023F, 140A MTR-CODE: AZV, BKD, ALT, (AC) MTR-CODE: BKD MTR-CODE: CFHC	6PK1050D2 VD1076 VD1111
2.0 TFSI	04/06-05/09	BWA	147	1984	AP9001	ALT, (Bosch), OE-NO 06F903023F, 140A	

### ALTEA XL (5P5, 5P8)

1.4 TSI	11/07-	CAXC	92	1390	AP9012 AP9012 AP9012	(Bosch), OE-NO 03C 903 023 A, 140A (Valeo), OE-NO 03C 903 023 C, 140A ALT	
1.6 TDI	10/09-	CAYC	77	1598	AP9012	ALT, (Bosch), 140A, OE-NO 06F903023F MTR-CODE: CAYB, CAYC	VD1111
	11/10-	CAYB	66	1598		MTR-CODE: CAYB, CAYC	VD1111
1.8 TFSI	01/07-	BYT, BZB, CDA	118	1798	AP9009 AP9009	ALT, (Bosch), 140A, OE-NO 06B903016AB ALT, (Valeo), 140A, OE-NO 06D903016A, 06J903023C	
1.9 TDI	08/09-	BXF	66	1896		ALT, (AC)	6PK1050D2
	10/06-	BLS, BXE	77	1896		ALT, (AC)	6PK1050D2 VD1076
2.0 FSI	10/06-03/09	BVY, BVZ	110	1984			VD1107
2.0 TDI	06/07-	BMN, CEGA	125	1968		MTR-CODE: BMN, ALT, (AC)	6PK1050D2 VD1076
	10/06-	BMM	103	1968		ALT, PS, (AC)	6PK1050D2 VD1076
	11/06-03/09	AZV	100	1968		MTR-CODE: AZV, BKD, ALT, (AC)	6PK1050D2 VD1076
2.0 TDI 4x4	06/07-	BMM	103	1968		ALT, PS, (AC)	6PK1050D2 VD1076
2.0 TDI 16V	10/06-	BKD, CFHC, CBDB	103	1968		MTR-CODE: AZV, BKD, ALT, (AC) MTR-CODE: BKD MTR-CODE: CFHC	6PK1050D2 VD1076 VD1111
2.0 TDI 4x4	06/07-	BMN, CEGA, CFJA	125	1968		MTR-CODE: BMN, ALT, (AC) MTR-CODE: BMN, CEGA MTR-CODE: CFJA	6PK1050D2 VD1076 VD1111

### AROSA (6H)

1.4 TDI	01/00-06/04	AMF	55	1422	AP9001	ALT, (Bosch), 70A, 90A, 120A	
1.7 SDI	08/97-06/04	AKU	44	1716	AP9057	ALT, CH-NO 6H-Y-000001↔, (Bosch), 70A, 90A	
					AP9059	ALT, ↔CH-NO 6H-X-046000, (Bosch), 70A, 90A	

### CORDOBA (6K2/C2)

1.9 D	01/96-08/96	1Y	47	1896	AP9001	ALT, (Bosch), 70A, 90A	VD1084
	02/93-08/96	1Y	50	1896	AP9001	ALT, (Bosch), 70A, 90A	VD1084
1.9 SDI	08/96-06/99	AEY	47	1896	AP9001	ALT, (Bosch), 70A, 90A	
					AP9004	ALT, (Bosch), 120A, OE-NO 028 903 026 G	
					AP9004	ALT, ↔CH-NO 6K-X-026679, (Bosch), 90A, OE-NO 028 903 028 J	VD1084
1.9 TD	02/93-08/96	AAZ	55	1896	AP9001	ALT, (Bosch), 70A, 90A	VD1084
1.9 TDI	03/97-06/99	AFN	81	1896	AP9001	ALT, (Bosch), 70A, 90A	
					AP9004	ALT, (Bosch), 120A, OE-NO 028 903 026 G	
					AP9004	ALT, ↔CH-NO 6K-X-026679, (Bosch), 90A, OE-NO 028 903 028 J MTR-CODE: AFN	VD1084
	08/96-06/99	1Z, AHU	66	1896	AP9001	ALT, (Bosch), 70A, 90A	





# SEAT

## CORDOBA (6K2/C2)

					<b>AP9004</b>	ALT, (Bosch), 120A, OE-NO 028 903 026G	
					<b>AP9004</b>	ALT, ⇒CH-NO 6K-X-026679, (Bosch), 90A, OE-NO 028 903 028 J	
						MTR-CODE: AHU, 1Z	<b>VD1084</b>

## CORDOBA (6L2)

1.2	10/02-06/06	AZQ, BME	47	1198	<b>AP9006</b>	ALT, (Valeo), 70A, OE-NO 03D903025D, 03D903025H, 90A, OE-NO 03D903025E, 03D903025J	
1.4 TDI	10/02-12/05	AMF	55	1422	<b>AP9001</b>	ALT, (Bosch), 70A, 90A	
1.9 SDI	09/02-	ASY	47	1896	<b>AP9001</b> <b>AP9001</b>	ALT, (Bosch,Valeo), 70A, 90A ALT, (Bosch,Valeo,Hitachi), 120A	<b>VD1111</b>
1.9 TDI	09/02-	ATD, AXR, BMT	74	1896	<b>AP9001</b> <b>AP9001</b>	ALT, (Bosch,Valeo), 70A, 90A ALT, (Bosch,Valeo,Hitachi), 120A	MTR-CODE: ATD, AXR, ALT, (AC)
							<b>6PK1180D1</b> <b>VD1076</b>
	10/02-	ASZ, BLT	96	1896	<b>AP9001</b> <b>AP9001</b>	ALT, (Bosch,Valeo), 70A, 90A ALT, (Bosch,Valeo,Hitachi), 120A	ALT, PS, (AC)
							<b>6PK1180D1</b> <b>VD1076</b>
2.0	09/02-11/09	AZL, BBX	85	1984			<b>VD1107</b>

## CORDOBA Schrägheck (6K2)

1.8 T 20V Cupra	07/00-10/02	AQX, AYP	115	1781			<b>VD1107</b>
1.9 SDI	06/99-10/02	AQM, AGP	50	1896	<b>AP9001</b>	ALT, (Bosch), 70A, 90A	<b>VD1089</b>
1.9 TDI	06/99-10/02	ALH, AGR	66	1896	<b>AP9001</b>	ALT, (Bosch), 70A, 90A	MTR-CODE: AGR, ALH
							<b>VD1089</b>
		ASV, ASK	81	1896		MTR-CODE: ASV	<b>VD1089</b>

## CORDOBA Vario (6K5)

1.9 SDI	06/99-12/02	AQM, AGP	50	1896	<b>AP9001</b>	ALT, (Bosch), 70A, 90A	<b>VD1089</b>
	09/96-06/99	AEY	47	1896	<b>AP9001</b> <b>AP9004</b> <b>AP9004</b>	ALT, (Bosch), 70A, 90A ALT, (Bosch), 120A, OE-NO 028 903 026 G ALT, ⇒CH-NO 6K-X-026679, (Bosch), 90A, OE-NO 028 903 028 J	MTR-CODE: AEY
							<b>VD1084</b>
1.9 TDI	06/99-12/02	ALH, AGR	66	1896	<b>AP9001</b>	ALT, (Bosch), 70A, 90A	<b>VD1089</b>
		ASV, ASK	81	1896		MTR-CODE: ASV	<b>VD1089</b>
	07/97-06/99	AFN	81	1896	<b>AP9001</b> <b>AP9004</b> <b>AP9004</b>	ALT, (Bosch), 70A, 90A ALT, (Bosch), 120A, OE-NO 028 903 026 G ALT, ⇒CH-NO 6K-X-026679, (Bosch), 90A, OE-NO 028 903 028 J	<b>VD1084</b>
	08/96-06/99	1Z, AHU	66	1896	<b>AP9001</b> <b>AP9004</b> <b>AP9004</b>	ALT, (Bosch), 70A, 90A ALT, (Bosch), 120A, OE-NO 028 903 026 G ALT, ⇒CH-NO 6K-X-026679, (Bosch), 90A, OE-NO 028 903 028 J	<b>VD1084</b>

## EXEO (3R2)

1.6	03/09-	ALZ	75	1595	<b>AP9009</b> <b>AP9009</b>	ALT, (Bosch), 120A, OE-NO 06B903016P, 140A, OE-NO 06B903016AB ALT, (Valeo), 120A, OE-NO 06B903016AE, 140A, OE-NO 06D903016A	
1.8 T	12/08-	CFMA	110	1781	<b>AP9009</b> <b>AP9009</b>	ALT, (Bosch), 120A, OE-NO 06B903016P, 140A, OE-NO 06B903016AB ALT, (Valeo), 120A, OE-NO 06B903016AE, 140A, OE-NO 06D903016A	<b>VD1107</b>
2.0 TDI	03/09-	CAGA	105	1968	<b>AP9022</b>	ALT, (Bosch), 140A, OE-NO 03G903016E	MTR-CODE: CAGA, CAGB, CAGC
		CAHA	125	1968	<b>AP9022</b>	ALT, (Bosch), 140A, OE-NO 03G903016E	MTR-CODE: CAHA, CAHB
							<b>VD1076</b>
	12/08-	CAGC	88	1968	<b>AP9022</b>	ALT, (Valeo), 150A, OE-NO 3R0903023	MTR-CODE: CAGA, CAGB, CAGC
							<b>VD1076</b>
2.0 TFSI	03/09-	BWE	147	1984	<b>AP9009</b>	ALT, (Bosch), 120A, OE-NO 06B903016P, 140A, OE-NO 06B903016AB	





## SEAT

EXEO (3R2)

					<b>AP9009</b>	ALT, (Valeo), 120A, OE-NO 06B903016AE, 140A, OE-NO 06D903016A	
<b>EXEO ST (3R5)</b>							
1.6	06/09-	ALZ	75	1595	<b>AP9009</b>	ALT, (Bosch), 120A, OE-NO 06B903016P, 140A, OE-NO 06B903016AB	
					<b>AP9009</b>	ALT, (Valeo), 120A, OE-NO 06B903016AE, 140A, OE-NO 06D903016A	
1.8 T	06/09-	CFMA	110	1781	<b>AP9009</b>	ALT, (Bosch), 120A, OE-NO 06B903016P, 140A, OE-NO 06B903016AB	
					<b>AP9009</b>	ALT, (Valeo), 120A, OE-NO 06B903016AE, 140A, OE-NO 06D903016A	<b>VD1107</b>
2.0 TDI	06/09-	CAGA	105	1968	<b>AP9022</b>	ALT, (Bosch), 140A, OE-NO 03G903016E	<b>VD1076</b>
		CAHA	125	1968	<b>AP9022</b>	ALT, (Bosch), 140A, OE-NO 03G903016E	<b>VD1076</b>
	08/09-	CAGC	88	1968	<b>AP9022</b>	ALT, (Valeo), 150A, OE-NO 3R0903023 MTR-CODE: CAGA, CAGB, CAGC	<b>VD1076</b>
2.0 TFSI	06/09-	BWE	147	1984	<b>AP9009</b>	ALT, (Bosch), 120A, OE-NO 06B903016P, 140A, OE-NO 06B903016AB	
					<b>AP9009</b>	ALT, (Valeo), 120A, OE-NO 06B903016AE, 140A, OE-NO 06D903016A	
<b>IBIZA II (6K1)</b>							
1.9 D	04/93-08/96	1Y	47	1896			<b>VD1084</b>
	10/94-08/96	1Y	50	1896			<b>VD1084</b>
1.9 SDI	08/96-08/99	AEY	47	1896	<b>AP9004</b>	ALT, (Bosch), 120A, OE-NO 028 903 026 G	
					<b>AP9004</b>	ALT, ⇨CH-NO 6K-X-026679, (Bosch), 90A, OE-NO 028 903 028 J	<b>VD1084</b>
1.9 TD	03/93-08/96	AAZ	55	1896			<b>VD1084</b>
1.9 TDI	02/97-08/99	AFN	81	1896	<b>AP9001</b>	ALT, (Bosch), 70A, 90A	
					<b>AP9004</b>	ALT, (Bosch), 120A, OE-NO 028 903 026 G	
					<b>AP9004</b>	ALT, ⇨CH-NO 6K-X-026679, (Bosch), 90A, OE-NO 028 903 028 J	<b>VD1084</b>
	08/96-08/99	1Z, AHU	66	1896	<b>AP9004</b>	ALT, (Bosch), 120A, OE-NO 028 903 026 G	
					<b>AP9004</b>	ALT, ⇨CH-NO 6K-X-026679, (Bosch), 90A, OE-NO 028 903 028 J	<b>VD1084</b>
<b>IBIZA III (6K1)</b>							
1.8 T 20V Cupra	07/00-02/02	AQX, AYP	115	1781			<b>VD1107</b>
1.9 SDI	08/99-02/02	AQM, AGP	50	1896	<b>AP9001</b>	ALT, (Bosch), 70A, 90A	<b>VD1089</b>
1.9 TDI	08/99-02/02	ALH, AGR	66	1896	<b>AP9001</b>	ALT, (Bosch), 70A, 90A	<b>VD1089</b>
		ASV, ASK	81	1896	<b>AP9001</b>	ALT, MTR-CODE: ASV, (Bosch), 70A, 90A	<b>VD1089</b>
						MTR-CODE: ASV	<b>VD1089</b>
<b>IBIZA IV (6L1)</b>							
1.2	02/02-06/06	AZQ, BME	47	1198	<b>AP9006</b>	ALT, (Valeo), 70A, OE-NO 03D903025D, 03D903025H, 90A, OE-NO 03D903025E, 03D903025J	
1.4 TDI	05/02-12/05	AMF	55	1422	<b>AP9001</b>	ALT, (Bosch), 70A, 90A	
	06/05-	BMS, BNV	59	1422	<b>AP9022</b>	ALT, (Bosch), 90A, OE-NO 045903023D, MTR-CODE: BMS	
1.8 T Cupra R	01/04-02/08	BBU, BLZ	132	1781			<b>VD1107</b>
1.8 T FR	12/03-05/08	BJX, BKV	110	1781			<b>VD1107</b>
1.9 SDI	02/02-12/05	ASY	47	1896	<b>AP9001</b>	ALT, (Bosch,Valeo), 70A, 90A, 120A	
					<b>AP9001</b>	ALT, (Hitachi), 120A	<b>VD1111</b>
1.9 TDI	02/02-	ATD, AXR, BMT	74	1896	<b>AP9001</b>	ALT, (Bosch,Hitachi), 120A	
					<b>AP9001</b>	ALT, (Bosch,Valeo), 70A, 90A MTR-CODE: ATD, AXR, ALT, (AC)	<b>6PK1180D1</b> <b>VD1076</b>
		ASZ, BLT	96	1896	<b>AP9001</b>	ALT, (Bosch,Hitachi), 120A	
					<b>AP9001</b>	ALT, (Bosch,Valeo), 70A, 90A	





# SEAT

## IBIZA IV (6L1)

						ALT, PS, (AC)	<b>6PK1180D1</b> <b>VD1076</b>
1.9 TDI Cupra R	03/04-02/08	BPX, BUK	118	1896		ALT, PS, (AC)	<b>6PK1180D1</b> <b>VD1076</b>
2.0	04/02-	AZL, BBX	85	1984			<b>VD1107</b>

## IBIZA V (6J5)

1.2	03/08-	BZG, CGPA	51	1198	<b>AP9022</b>	ALT, (Valeo), 70A, OE-NO 03D903025H, MTR-CODE: BZG	
1.2 TDI	05/10-	CFWA	55	1199		MTR-CODE: CFWA	<b>VD1111</b>
1.4 TDI	07/08-	BMS	59	1422	<b>AP9022</b>	ALT, (Bosch), 90A, OE-NO 045903023D	
1.4 TSI	06/09-	CAVF	110	1390	<b>AP9012</b>	ALT, (Bosch), 140A, OE-NO 03C903023A, 03C903025D	
1.6 TDI	05/09-	CAYB	66	1598	<b>AP9012</b>	ALT, (Bosch), 140A, OE-NO 06F903023F MTR-CODE: CAYB, CAYC, ⇨10/2009	<b>VD1076</b>
		CAYC, CLNA	77	1598	<b>AP9012</b>	ALT, (Bosch), 140A, OE-NO 06F903023F MTR-CODE: CAYB, CAYC, ⇨10/2009	<b>VD1076</b>
1.9 TDI	03/08-	BLS	77	1896	<b>AP9022</b>	ALT, (Bosch), 90A, OE-NO 045903023D	<b>VD1076</b>
	07/08-	BXJ	66	1896	<b>AP9022</b>	ALT, (Bosch), 90A, OE-NO 045903023D	<b>VD1076</b>
2.0 TDI	01/10-	CFHD	105	1968	<b>AP9012</b>	(Bosch), 140A, OE-NO 06F903023F	
					<b>AP9012</b>	(Valeo), 140A, OE-NO 03L903023F	
					<b>AP9012</b>	ALT	
						MTR-CODE: CFHD	<b>VD1111</b>

## IBIZA V SPORTCOUPE (6J1)

1.2	07/08-	BZG, CGPA	51	1198	<b>AP9022</b>	ALT, (Valeo), 70A, OE-NO 03D903025H, MTR-CODE: BZG	
1.2 TDI	05/10-	CFWA	55	1199		MTR-CODE: CFWA	<b>VD1111</b>
1.4 TDI	07/08-	BMS	59	1422	<b>AP9022</b>	ALT, (Bosch), 90A, OE-NO 045903023D	
1.6 TDI	05/09-	CAYB	66	1598	<b>AP9012</b>	ALT, (Bosch), 140A, OE-NO 06F903023F MTR-CODE: CAYB, CAYC, ⇨10/2009	<b>VD1076</b>
		CAYC, CLNA	77	1598		MTR-CODE: CAYB, CAYC, 11/2009⇨	<b>VD1111</b>
1.9 TDI	07/08-	BXJ	66	1896	<b>AP9022</b>	ALT, (Bosch), 90A, OE-NO 045903023D	<b>VD1076</b>
		BLS	77	1896	<b>AP9022</b>	ALT, (Bosch), 90A, OE-NO 045903023D	<b>VD1076</b>
2.0 TDI	01/10-	CFHD	105	1968	<b>AP9012</b>	(Bosch), 140A, OE-NO 06F903023F	
					<b>AP9012</b>	(Valeo), 140A, OE-NO 03L903023F	
					<b>AP9012</b>	ALT	
						MTR-CODE: CFHD	<b>VD1111</b>

## IBIZA V ST (6J8)

1.2 TDI	04/10-	CFWA	55	1199		MTR-CODE: CFWA	<b>VD1111</b>
1.6 TDI	03/10-	CAYB	66	1598		MTR-CODE: CAYB, CAYC, 11/2009⇨	<b>VD1111</b>
		CAYC, CLNA	77	1598		MTR-CODE: CAYB, CAYC, 11/2009⇨	<b>VD1111</b>

## INCA (6K9)

1.7 D	09/96-06/03	AHB	42	1716	<b>AP9004</b>	ALT, (Bosch), 120A, OE-NO 028 903 026 G	
					<b>AP9004</b>	ALT, ⇨CH-NO 9K-X-001745, (Bosch), 90A, OE-NO 028 903 028 J	
					<b>AP9004</b>	ALT, CH-NO 9K-X-001746⇨, (Bosch), 70A, OE-NO 6K0 903 028	<b>VD1084</b>
1.9 D	11/95-06/03	1Y	47	1896	<b>AP9004</b>	ALT, (Bosch), 90A, OE-NO 028 903 028 J	<b>VD1084</b>
1.9 SDI	11/95-06/03	AEY, AYQ	47	1896	<b>AP9001</b>	ALT, MTR-CODE: AYQ, (Bosch), 70A, 90A	
					<b>AP9004</b>	ALT, MTR-CODE: AEY, (Bosch), 120A, OE-NO 028 903 026 G	
					<b>AP9004</b>	ALT, MTR-CODE: AEY, ⇨CH-NO 9K-X-001745, (Bosch), 90A, OE-NO 028 903 028 J	
					<b>AP9004</b>	ALT, MTR-CODE: AEY, CH-NO 9K-X-001746⇨, (Bosch), 70A, OE-NO 6K0 903 028	





## SEAT

**INCA (6K9)**

						MTR-CODE: AYQ, MTR-NO 074 038⇒ MTR-CODE: AEY MTR-CODE: AYQ, ⇒MTR-NO 074 037	<b>VD1076</b> <b>VD1084</b> <b>VD1089</b>
1.9 TDI	09/96-06/03	ALH	66	1896	<b>AP9001</b>	ALT, (Bosch), 70A, 90A MTR-CODE: ALH, MTR-NO 896 340⇒ MTR-CODE: ALH, ⇒MTR-NO 896 339	<b>VD1076</b> <b>VD1089</b>

**LEON (1M1)**

1.6	11/99-06/06	AEH, AKL, APF	74	1595	<b>AP9001</b>	ALT, (Bosch,Valeo,Hitachi), 120A	
1.8 20V	11/99-06/06	AGN, APG	92	1781	<b>AP9001</b>	ALT, (Bosch,Valeo,Hitachi), 120A	<b>VD1107</b>
1.8 20V T	11/99-06/06	APP, AUQ	132	1781	<b>AP9001</b>	ALT, (Bosch,Valeo), 120A	<b>VD1107</b>
1.8 20V T 4	11/99-06/06	ARY, AJQ	132	1781	<b>AP9001</b>	ALT, (Bosch,Valeo,Hitachi), 120A	<b>VD1107</b>
1.8 T Cupra R	02/02-06/06	AMK	154	1781	<b>AP9001</b>	ALT, (Bosch), 120A	<b>VD1107</b>
	07/03-06/06	BAM	165	1781	<b>AP9001</b>	ALT, (Bosch)	<b>VD1107</b>
1.9 SDI	11/99-06/06	AQM	50	1896	<b>AP9001</b> <b>AP9001</b>	ALT, (Bosch,Valeo), 70A, 90A, 120A ALT, (Hitachi), 120A ALT, PS, (AC), CH-NO 1M-3R099 131⇒ CH-NO 1M-3R099 131⇒ ⇒CH-NO 1M-3R099 130	<b>6PK1660D1</b> <b>VD1076</b> <b>VD1089</b>
1.9 TDI	02/01-06/06	ARL	110	1896	<b>AP9001</b> <b>AP9001</b>	ALT, (Bosch,Valeo), (Hitachi), 120A ALT, (Bosch,Valeo), 90A	<b>VD1091</b>
	05/03-06/06	ASZ	96	1896		ALT, (AC), MTR-NO ASZ 435 001⇒ MTR-CODE: ASZ, MTR-NO 435 001⇒ MTR-CODE: ASZ, ⇒MTR-NO 435 000	<b>6DPK1195D2</b> <b>VD1076</b> <b>VD1091</b>
	10/05-06/06	AXR	74	1896		ALT, (AC)	<b>6DPK1195D1</b> <b>VD1076</b>
	11/99-06/06	ALH, AGR	66	1896	<b>AP9001</b> <b>AP9001</b> <b>AP9001</b>	ALT, (Bosch), 70A ALT, (Bosch,Valeo), 90A ALT, (Bosch,Valeo,Hitachi), 120A ALT, PS, (AC), CH-NO 1M-3R099 131⇒ CH-NO 1M-3R099 131⇒ ⇒CH-NO 1M-3R099 130	<b>6PK1660D1</b> <b>VD1076</b> <b>VD1089</b>
		AHF, ASV	81	1896	<b>AP9001</b> <b>AP9001</b> <b>AP9001</b>	ALT, (Bosch,Valeo), 90A ALT, (Bosch,Valeo,Hitachi), 120A ALT, MTR-CODE: AHF, (Bosch), 70A ALT, PS, (AC), CH-NO 1M-3R099 131⇒ CH-NO 1M-3R099 131⇒ ⇒CH-NO 1M-3R099 130	<b>6PK1660D1</b> <b>VD1076</b> <b>VD1089</b>
1.9 TDI Syncro	05/02-06/06	ARL	110	1896	<b>AP9001</b> <b>AP9001</b>	ALT, (Bosch,Valeo), 90A ALT, (Bosch,Valeo,Hitachi), 120A	<b>VD1091</b>
2.8 Cupra 4	02/01-06/06	AUE	150	2792	<b>AP9001</b> <b>AP9001</b>	ALT, (Bosch,Valeo), 90A ALT, (Bosch,Valeo,Hitachi), 120A	

**LEON (1P1)**

1.4 TSI	11/07-	CAXC	92	1390	<b>AP9012</b> <b>AP9012</b> <b>AP9012</b>	(Bosch), OE-NO 03C 903 023 A, 140A (Valeo), OE-NO 03C 903 023 C, 140A ALT	
1.6	07/05-	BSE, BSF, CCSA, CMXA	75	1595	<b>AP9001</b>	ALT, (Bosch), OE-NO 06F903023F, 140A	
1.6 TDI	02/10-	CAYC	77	1598		MTR-CODE: CAYB, CAYC	<b>VD1111</b>
	11/10-	CAYB	66	1598		MTR-CODE: CAYB, CAYC	<b>VD1111</b>
1.8 TSI	06/07-	BZB, CDAA	118	1798	<b>AP9001</b>	ALT, (Valeo), OE-NO 06J903023C, 140A	
					<b>AP9009</b>	ALT, (Bosch), 140A, OE-NO 06B903016AB	
					<b>AP9009</b>	ALT, (Valeo), 140A, OE-NO 06D903016A, 06J903023C	
1.9 TDI	06/07-	BXF	66	1896		ALT, (AC)	<b>6PK1050D2</b> <b>VD1076</b>
	07/05-	BKC, BLS, BXE	77	1896	<b>AP9001</b>	MTR-CODE: BLS, BXE, ALT, (Bosch), OE-NO 06F903023F, 140A ALT, (AC)	<b>6PK1050D2</b> <b>VD1076</b>
1.9 TDi	10/05-	ASV	81	1896	<b>AP9001</b> <b>AP9001</b> <b>AP9001</b>	ALT, (Bosch,Valeo), 90A ALT, (Bosch,Valeo,Hitachi), 120A ALT, MTR-CODE: AHF, (Bosch), 70A ALT, PS, (AC), CH-NO 1M-3R099 131⇒	<b>6PK1660D1</b>
2.0 FSI	07/05-05/10	BLR, BLY, BVY, BVZ	110	1984	<b>AP9001</b>	ALT, (Bosch), OE-NO 06F903023F, 140A	<b>VD1107</b>
2.0 TDI	05/06-	BMN, CEGA, CFJA	125	1968	<b>AP9001</b>	ALT, (Bosch), OE-NO 06F903023F, 140A	





# SEAT

## LEON (1P1)

						MTR-CODE: BMN, ALT, (AC) MTR-CODE: BMN, CEGA MTR-CODE: CFJA	6PK1050D2 VD1076 VD1111
	07/05-05/10	AZV	100	1968	AP9001	ALT, (Bosch), OE-NO 06F903023F, 140A MTR-CODE: AZV, BKD, ALT, (AC)	6PK1050D2 VD1076
	10/05-	BMM	103	1968	AP9001	ALT, (Bosch), OE-NO 06F903023F, 140A ALT, PS, (AC)	6PK1050D2 VD1076
2.0 TDI 16V	07/05-	BKD, CFHC	103	1968	AP9001	ALT, (Bosch), OE-NO 06F903023F, 140A MTR-CODE: AZV, BKD, ALT, (AC) MTR-CODE: BKD MTR-CODE: CFHC	6PK1050D2 VD1076 VD1111
2.0 TFSI	05/05-03/09	BWA	147	1984	AP9001	ALT, (Bosch), OE-NO 06F903023F, 140A	
	11/06-	BWJ, CDLD	177	1984	AP9001	ALT, (Bosch), OE-NO 06F903023F, 140A	

## TOLEDO I (1L)

1.9 D	05/91-03/99	1Y	50	1896			VD1084
	12/95-03/99	1Y	47	1896			VD1084
1.9 TD	05/91-03/99	AAZ	55	1896			VD1084
1.9 TDI	08/95-03/99	1Z, AHU	66	1896	AP9002 AP9004 AP9004 AP9004	ALT, (Valeo), 70A, 90A, 120A ALT, MTR-CODE: AHU, (Bosch), OE-NO 028 903 026 G, 120A ALT, MTR-CODE: AHU, ⇨CH-NO 1L-W-044486, (Bosch), OE-NO 028 903 028 J, 90A ALT, MTR-CODE: AHU, CH-NO 1L-W-044487⇨, (Bosch), OE-NO 6K0 903 028, 70A	VD1084
	11/96-03/99	AFN	81	1896	AP9004 AP9004 AP9004	ALT, (Bosch), OE-NO 028 903 026 G, 120A ALT, ⇨CH-NO 1L-W-044486, (Bosch), OE-NO 028 903 028 J, 90A ALT, CH-NO 1L-W-044487⇨, (Bosch), OE-NO 6K0 903 028, 70A	VD1084

## TOLEDO II (1M2)

1.6	04/99-09/00	AEH, AKL, APF	74	1595	AP9001	ALT, (Bosch,Valeo,Hitachi), 90A, 120A	
1.8 20V	04/99-05/06	AGN, APG	92	1781	AP9001	ALT, (Bosch,Valeo,Hitachi), 120A	VD1107
1.8 20VT	05/01-05/06	APP, AUQ	132	1781	AP9001	ALT, (Bosch,Valeo,Hitachi), 120A	VD1107
1.9 SDI	11/99-06/04	AQM	50	1896		CH-NO 1M-3R099 131⇨ ⇨CH-NO 1M-3R099 130	VD1076 VD1089
1.9 TDI	04/99-05/06	ALH, AGR	66	1896	AP9001 AP9001 AP9001	ALT, (Bosch), 70A, 90A, 120A ALT, (Hitachi), 120A ALT, (Valeo), 90A, 120A ALT, PS, (AC), CH-NO 1M-3R099 131⇨ CH-NO 1M-3R099 131⇨ ⇨CH-NO 1M-3R099 130	6PK1660D1 VD1076 VD1089
		AHF, ASV	81	1896	AP9001 AP9001 AP9001 AP9001	ALT, MTR-CODE: AHF, (Bosch), 70A, 90A, 120A ALT, MTR-CODE: AHF, (Valeo), 90A, 120A ALT, MTR-CODE: AHF, ASV, (Hitachi), 120A ALT, MTR-CODE: ASV, (Bosch,Valeo), 90A, 120A ALT, PS, (AC), CH-NO 1M-3R099 131⇨ CH-NO 1M-3R099 131⇨ ⇨CH-NO 1M-3R099 130	6PK1660D1 VD1076 VD1089
	05/03-05/06	ASZ	96	1896		ALT, PS, (AC), MTR-NO ASZ 435 001⇨ MTR-CODE: ASZ, MTR-NO 435 001⇨ MTR-CODE: ASZ, ⇨MTR-NO 435 000	6DPK1195D2 VD1076 VD1091
1.9 TDi	08/05-05/06	AXR	74	1896		ALT, (AC)	6DPK1195D1
1.9 TDI	10/00-05/06	ARL	110	1896	AP9001 AP9001	ALT, (Bosch,Valeo), 90A, 120A ALT, (Hitachi), 120A	VD1091
2.3 V5	04/99-05/01	AGZ	110	2324	AP9001 AP9001	ALT, (Bosch), 70A, 90A, 120A ALT, (Valeo), 90A, 120A	
2.3 V5 20V	05/01-05/06	AQN	125	2324	AP9001 AP9001 AP9001	ALT, (Bosch), 70A, 90A, 120A ALT, (Hitachi), 120A ALT, (Valeo), 90A, 120A	







## SEAT

### TOLEDO III (5P2)

1.6	10/04-05/09	BGU, BSE, BSF, CCSA	75	1595	AP9001	MTR-CODE: BSE, BSF, CCSA, ALT, (Bosch), OE-NO 06F903023F, 140A	
1.8 TFSI	01/07-	BYT, BZB, CDA	118	1798	AP9001 AP9009 AP9009 AP9009	ALT, (Valeo), OE-NO 06J903023C, 140A ALT, (Bosch), 140A, OE-NO 06B903016AB ALT, (Valeo), 140A, OE-NO 06D903016A MTR-CODE: BYT, BZB	
1.9 TDI	10/04-	BKC, BJB, BLS, BXE	77	1896	AP9001	MTR-CODE: BLS, BXE, ALT, (Bosch), OE-NO 06F903023F, 140A ALT, (AC)	6PK1050D2 VD1076
2.0 FSI	10/04-	BLR, BLY, BVY, BVZ	110	1984	AP9001	MTR-CODE: BVY, BVZ, ALT, (Bosch), OE-NO 06F903023F, 140A	VD1107
2.0 TDI	01/06-05/09	BMN, CEGA	125	1968	AP9001	ALT, (Bosch), OE-NO 06F903023F, 140A MTR-CODE: BMN, ALT, (AC)	6PK1050D2 VD1076
	09/04-05/09	AZV	100	1968	AP9001	ALT, (Bosch), OE-NO 06F903023F, 140A MTR-CODE: AZV, BKD, ALT, (AC)	6PK1050D2 VD1076
	11/05-05/09	BMM	103	1968	AP9001	ALT, (Bosch), OE-NO 06F903023F, 140A ALT, (AC)	6PK1050D2 VD1076
2.0 TDI 16V	04/04-05/09	BKD	103	1968	AP9001	ALT, (Bosch), OE-NO 06F903023F, 140A MTR-CODE: AZV, BKD, ALT, (AC)	6PK1050D2 VD1076
2.0 TFSI	11/05-05/09	BWA	147	1984	AP9001	ALT, (Bosch), OE-NO 06F903023F, 140A	

## SG AUTOMOTIVE

### DA CHAI SHEN Pick-up

2.2	07/07-	JM491Q-ME	76	2237	AP9025 AP9025	ALT, (Valeo), 110A, ALT-No: TG11C034, TG11C064, 125A, ALT-No: SG12B089, SG12B105 ALT, 110A, OE-NO 82 00 667 608, 125A, OE-NO 82 00 537 415	
-----	--------	-----------	----	------	------------------	-----------------------------------------------------------------------------------------------------------------------------------------------	--

## SKODA

<b>FABIA</b>							
1.2 TDI	05/10-	CFWA	55	1199		MTR-CODE: CAYA, CAYB, CAYC	VD1111
1.4 TDI	01/07-	BNV, BMS	59	1422	AP9001 AP9022	MTR-CODE: BNV, ALT, (Bosch), OE-NO 045903023, 90A ALT, (Bosch), 70A, OE-NO 045903023C, 90A, OE-NO 045903023D, 110A, OE-NO 045903023H	
	02/07-	BNM	51	1422	AP9001 AP9022	ALT, (Bosch), OE-NO 045903023, 90A ALT, (Bosch), 70A, OE-NO 045903023C, 90A, OE-NO 045903023D, 110A, OE-NO 045903023H	
1.6 TDI	03/10-	CAYB	66	1598		MTR-CODE: CAYA, CAYB, CAYC	VD1111
		CAYC	77	1598		MTR-CODE: CAYA, CAYB, CAYC	VD1111
	04/10-	CAYA	55	1598		MTR-CODE: CAYA, CAYB, CAYC	VD1111
1.9 TDI	04/07-	BLS, BSW	77	1896		ALT, (AC)	6PK1180D1 VD1076
<b>FABIA (6Y2)</b>							
1.2	01/03-03/08	AZQ, BME	47	1198	AP9006	ALT, MTR-CODE: AWY, ⇨CH-NO 6Y-3-725552, (Valeo), 70A, OE-NO 03D903025D, 90A, OE-NO 03D903025E	
	08/02-03/08	AWY, BMD	40	1198	AP9006	ALT, MTR-CODE: AWY, ⇨CH-NO 6Y-3-725552, (Valeo), 70A, OE-NO 03D903025D, 90A, OE-NO 03D903025E	
1.4 TDI	04/03-03/08	AMF	55	1422	AP9001	ALT, (Bosch), 70A, OE-NO 045903023B, 90A, OE-NO 045903023	
	10/05-03/08	BNM	51	1422	AP9022	ALT, (Bosch), 70A, OE-NO 045903023C, 90A, OE-NO 045903023D, 110A, OE-NO 045903023H	





# SKODA

## FABIA (6Y2)

		BNV	59	1422	<b>AP9022</b>	ALT, (Bosch), 70A, OE-NO 045903023C, 90A, OE-NO 045903023D, 110A, OE-NO 045903023H	
1.9 SDI	12/99-03/08	ASY	47	1896	<b>AP9001</b> <b>AP9001</b> <b>AP9001</b> <b>AP9001</b>	(Bosch), 70A, OE-NO 038903023K, 90A, OE-NO 038903023L, 120A, OE-NO 028903028E (Hitachi), 120A, OE-NO 028903029G (Valeo), 70A, OE-NO 038903023Q, 90A, OE-NO 038903023R, 120A, OE-NO 038903023S ALT	<b>VD1111</b>
1.9 TDI	01/00-03/08	ATD, AXR	74	1896	<b>AP9001</b> <b>AP9001</b> <b>AP9001</b> <b>AP9001</b> <b>AP9001</b> <b>AP9001</b> <b>AP9001</b> <b>AP9001</b>	(Bosch), 70A, OE-NO 038903023K, 90A, OE-NO 038903023L, 120A, OE-NO 028903028E (Hitachi), 120A, OE-NO 028903029G (Valeo), 70A, OE-NO 038903023Q, 90A, OE-NO 038903023R, 120A, OE-NO 038903023S ALT, (-AC), (Bosch), 70A ALT, (Bosch,Hitachi), 120A, ALT ALT, (Bosch,Valeo), 90A ALT, (Valeo), 70A ALT, (AC)	<b>6PK1180D1</b> <b>VD1076</b>
1.9 TDI RS	06/03-03/08	ASZ, BLT	96	1896	<b>AP9001</b> <b>AP9001</b> <b>AP9001</b>	(Bosch), 70A, OE-NO 038903023K, 90A, OE-NO 038903023L, 120A, OE-NO 028903028E (Hitachi), 120A, OE-NO 028903029G (Valeo), 70A, OE-NO 038903023Q, 90A, OE-NO 038903023R, 120A, OE-NO 038903023S ALT ALT, (AC)	<b>6PK1180D1</b> <b>VD1076</b>
2.0	12/99-03/08	AQY, AZL	85	1984			<b>VD1107</b>
<b>FABIA Combi</b>							
1.2 TDI	05/10-	CFWA	55	1199		MTR-CODE: CAYA, CAYB, CAYC	<b>VD1111</b>
1.4 TDI	10/07-	BNM	51	1422	<b>AP9001</b> <b>AP9022</b>	ALT, (Bosch), OE-NO 045903023, 90A ALT, (Bosch), 70A, OE-NO 045903023C, 90A, OE-NO 045903023D, 110A, OE-NO 045903023H	
		BNV, BMS	59	1422	<b>AP9001</b> <b>AP9022</b>	MTR-CODE: BNV, ALT, (Bosch), OE-NO 045903023, 90A ALT, (Bosch), 70A, OE-NO 045903023C, 90A, OE-NO 045903023D, 110A, OE-NO 045903023H	
1.6 TDI	03/10-	CAYB	66	1598		MTR-CODE: CAYA, CAYB, CAYC	<b>VD1111</b>
		CAYC	77	1598		MTR-CODE: CAYA, CAYB, CAYC	<b>VD1111</b>
1.9 TDI	04/10-	CAYA	55	1598		MTR-CODE: CAYA, CAYB, CAYC	<b>VD1111</b>
	10/07-	BLS, BSW	77	1896		ALT, (AC)	<b>6PK1180D1</b> <b>VD1076</b>
<b>FABIA Combi (6Y5)</b>							
1.2	01/03-12/07	AZQ, BME	47	1198	<b>AP9006</b>	ALT, MTR-CODE: AWY, ⇨CH-NO 6Y-3-725552, (Valeo), 70A, 90A	
	07/01-12/07	AWY, BMD	40	1198	<b>AP9006</b>	ALT, MTR-CODE: AWY, ⇨CH-NO 6Y-3-725552, (Valeo), 70A, OE-NO 03D903025D, 90A, OE-NO 03D903025E	
1.4 TDI	04/03-12/07	AMF	55	1422	<b>AP9001</b>	ALT, (Bosch), 70A, OE-NO 045903023B, 90A, OE-NO 045903023	
	10/05-12/07	BNM	51	1422	<b>AP9022</b>	ALT, (Bosch), 70A, OE-NO 045903023C, 90A, OE-NO 045903023D, 110A, OE-NO 045903023H	
		BNV	59	1422	<b>AP9022</b>	ALT, (Bosch), 70A, OE-NO 045903023C, 90A, OE-NO 045903023D, 110A, OE-NO 045903023H	
1.9 SDI	04/00-12/07	ASY	47	1896	<b>AP9001</b> <b>AP9001</b> <b>AP9001</b>	(Bosch), 70A, OE-NO 038903023K, 90A, OE-NO 038903023L, 120A, OE-NO 028903028E (Hitachi), 120A, OE-NO 028903029G (Valeo), 70A, OE-NO 038903023Q, 90A, OE-NO 038903023R, 120A,	





## SKODA

### FABIA Combi (6Y5)

					<b>AP9001</b>	OE-NO 038903023S ALT	<b>VD1111</b>
1.9 TDI	04/00-12/07	ATD, AXR	74	1896	<b>AP9001</b> <b>AP9001</b> <b>AP9001</b> <b>AP9001</b> <b>AP9001</b> <b>AP9001</b> <b>AP9001</b> <b>AP9001</b>	(Bosch), 70A, OE-NO 038903023K, 90A, OE-NO 038903023L, 120A, OE-NO 028903028E (Hitachi), 120A, OE-NO 028903029G (Valeo), 70A, OE-NO 038903023Q, 90A, OE-NO 038903023R, 120A, OE-NO 038903023S ALT, (-AC), (Bosch), 70A ALT, (Bosch,Hitachi), 120A, ALT ALT, (Bosch,Valeo), 90A ALT, (Valeo), 70A ALT, (AC)	<b>6PK1180D1</b> <b>VD1076</b> <b>VD1107</b>
2.0	04/00-12/07	AZL	85	1984			<b>VD1107</b>

### FABIA Praktik

1.2	01/03-12/07	AZQ, BME	47	1198	<b>AP9006</b>	ALT, MTR-CODE: AWY, ⇒CH-NO 6Y-3-725552, (Valeo), 70A, 90A	
	07/01-12/07	AWY, BMD	40	1198	<b>AP9006</b>	ALT, MTR-CODE: AWY, ⇒CH-NO 6Y-3-725552, (Valeo), 70A, OE-NO 03D903025D, 90A, OE-NO 03D903025E	
1.4 TDI	10/05-12/07	BNM	51	1422	<b>AP9022</b>	ALT, (Bosch), 70A, OE-NO 045903023C, 90A, OE-NO 045903023D, 110A, OE-NO 045903023H	
1.9 SDI	07/01-12/07	ASY	47	1896	<b>AP9001</b> <b>AP9001</b> <b>AP9001</b> <b>AP9001</b>	(Bosch), 70A, OE-NO 038903023K, 90A, OE-NO 038903023L, 120A, OE-NO 028903028E (Hitachi), 120A, OE-NO 028903029G (Valeo), 70A, OE-NO 038903023Q, 90A, OE-NO 038903023R, 120A, OE-NO 038903023S ALT	<b>VD1111</b>

### FABIA Stufenheck (6Y3)

1.2	01/03-12/07	AZQ, BME	47	1198	<b>AP9006</b>	ALT, MTR-CODE: AWY, ⇒CH-NO 6Y-3-725552, (Valeo), 70A, OE-NO 03D903025D, 90A, OE-NO 03D903025E	
	07/01-12/07	AWY, BMD	40	1198	<b>AP9006</b>	ALT, MTR-CODE: AWY, ⇒CH-NO 6Y-3-725552, (Valeo), 70A, OE-NO 03D903025H, 90A, OE-NO 03D903025E	
1.4 TDI	04/03-12/07	AMF	55	1422	<b>AP9001</b>	ALT, (Bosch), 70A, OE-NO 045903023B, 90A, OE-NO 045903023	
	10/05-12/07	BNM	51	1422	<b>AP9022</b>	ALT, (Bosch), 70A, OE-NO 045903023C, 90A, OE-NO 045903023D, 110A, OE-NO 045903023H	
		BNV	59	1422	<b>AP9022</b>	ALT, (Bosch), 70A, OE-NO 045903023C, 90A, OE-NO 045903023D, 110A, OE-NO 045903023H	
1.9 SDI	11/99-12/07	ASY	47	1896	<b>AP9001</b> <b>AP9001</b> <b>AP9001</b> <b>AP9001</b>	(Bosch), 70A, OE-NO 038903023K, 90A, OE-NO 038903023L, 120A, OE-NO 028903028E (Hitachi), 120A, OE-NO 028903029G (Valeo), 70A, OE-NO 038903023Q, 90A, OE-NO 038903023R, 120A, OE-NO 038903023S ALT	<b>VD1111</b>
1.9 TDI	01/00-12/07	ATD, AXR	74	1896	<b>AP9001</b> <b>AP9001</b> <b>AP9001</b> <b>AP9001</b> <b>AP9001</b> <b>AP9001</b> <b>AP9001</b>	(Bosch), 70A, OE-NO 038903023K, 90A, OE-NO 038903023L, 120A, OE-NO 028903028E (Hitachi), 120A, OE-NO 028903029G (Valeo), 70A, OE-NO 038903023Q, 90A, OE-NO 038903023R, 120A, OE-NO 038903023S ALT, (-AC), (Bosch), 70A ALT, (Bosch,Hitachi), 120A, ALT ALT, (Bosch,Valeo), 90A ALT, (Valeo), 70A ALT, (AC)	<b>6PK1180D1</b> <b>VD1076</b>



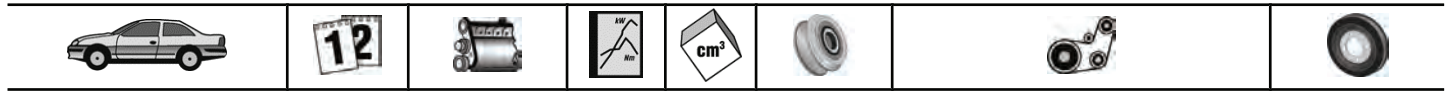

# SKODA

<b>FABIA Stufenheck (6Y3)</b>							
↔ 2.0	12/99-12/07	AZL	85	1984			<b>VD1107</b>
<b>FELICIA I (6U1)</b>							
1.6 LX	08/95-03/98	EA111, AEE	55	1598	<b>AP9004</b>	ALT, (Bosch), 90A, OE-NO 028 903 025 Q, 028 903 018 A, 028 903 018 AX	
<b>FELICIA I Fun (797)</b>							
1.6	06/97-	AEE	55	1598	<b>AP9004</b> <b>AP9004</b>	ALT, (Bosch), 70A, OE-NO 028 903 025 H, (PS) ALT, (Bosch), 90A, OE-NO 028 903 025 Q, (AC)	
<b>FELICIA I Kombi (6U5)</b>							
1.6 GLX	08/95-03/98	AEE	55	1598	<b>AP9004</b>	ALT, (Bosch), 90A, OE-NO 028 903 025 Q, 028 903 018 A, 028 903 018 AX	
<b>FELICIA II (6U1)</b>							
1.6	01/98-06/01	AEE	55	1598	<b>AP9004</b>	ALT, (Bosch), 90A, OE-NO 028 903 028 Q, 028 903 018 A, 028 903 018 AX	
<b>FELICIA II Kombi (6U5)</b>							
1.6	01/98-06/01	AEE	55	1598	<b>AP9004</b>	ALT, (Bosch), 90A, OE-NO 028 903 025 Q, 028 903 018 A, 028 903 018 AX	
<b>OCTAVIA (1U2)</b>							
1.6	02/97-	AEH, AKL	74	1595	<b>AP9001</b>	ALT, 08/2000⇒, (Bosch,Valeo,Hitachi), 120A	
	11/00-	AVU, BFQ	75	1595	<b>AP9001</b>	ALT, (Bosch,Valeo,Hitachi), 120A	
1.8	09/96-	AGN	92	1781			<b>VD1107</b>
1.8 T	08/97-	AGU, ARZ, ARX, AUM	110	1781	<b>AP9001</b>	ALT, MTR-CODE: AGU, ARX, AUM, 08/2000⇒, (Bosch,Valeo,Hitachi), 120A	<b>VD1107</b>
1.8 T 4x4	05/01-	AGU, ARX, AUM	110	1781	<b>AP9001</b>	ALT, MTR-CODE: AGU, ARX, AUM, (Bosch,Valeo,Hitachi), 120A	<b>VD1107</b>
1.9 SDI	06/97-	AQM, AGP	50	1896	<b>AP9001</b> <b>AP9001</b> <b>AP9001</b> <b>AP9001</b> <b>AP9001</b> <b>AP9016</b>	ALT, MTR-CODE: AGP, ⇒07/2000, (Valeo), 70A, 120A ALT, MTR-CODE: AGP, CH-NO 1U-W-113661⇒, ⇒07/2000, (Bosch), 70A, 90A, 120A ALT, MTR-CODE: AQM, 08/2000⇒, (Bosch), 70A, 90A ALT, MTR-CODE: AQM, 08/2000⇒, (Hitachi), 120A ALT, MTR-CODE: AQM, 08/2000⇒, (Valeo), 70A, 90A, 120A ALT, MTR-CODE: AGP, ⇒CH-NO 1U-W-113660, ⇒07/2000, (Bosch), 70A, 90A, 120A ALT, (AC), CH-NO 1U-3-726 897⇒, 1U-38684 073⇒ MTR-CODE: AQM, CH-NO 1U-3-726 897⇒, 1U-38684 073⇒ MTR-CODE: AGP MTR-CODE: AQM, ⇒CH-NO 1U-3-726 896, 1U-38684 072	<b>6PK1660D2</b> <b>VD1076</b> <b>VD1089</b> <b>VD1089</b>
1.9 TDI	01/03-	ASZ	96	1896	<b>AP9001</b> <b>AP9001</b>	ALT, (Bosch,Valeo), 70A, 90A, 120A ALT, (Hitachi), 120A	<b>VD1091</b>
	08/97-	ASV, AHF	81	1896	<b>AP9001</b> <b>AP9001</b> <b>AP9001</b> <b>AP9016</b>	ALT, (Hitachi), 120A ALT, (Valeo), 70A, 90A, 120A ALT, MTR-CODE: AHF, CH-NO 1U-W-113661⇒, (Bosch), 70A, 90A, 120A ALT, MTR-CODE: AHF, ⇒CH-NO 1U-W-113660, (Bosch), 70A, 90A, 120A ALT, PS, (AC), CH-NO 1U-3-726 897⇒, 1U-38684 073⇒ MTR-CODE: AHF, ASV, CH-NO 1U-3-726 897⇒, 1U-38684 073⇒ MTR-CODE: AHF, ASV, ⇒CH-NO 1U-3-726 896, 1U-38684 072	<b>6PK1660D2</b> <b>VD1076</b> <b>VD1089</b>
	09/96-	ALH, AGR	66	1896	<b>AP9001</b> <b>AP9001</b> <b>AP9001</b> <b>AP9016</b>	ALT, (Hitachi), 120A ALT, (Valeo), 70A, 90A, 120A ALT, CH-NO 1U-W-113661⇒, (Bosch), 70A, 90A, 120A ALT, MTR-CODE: AGR, ⇒CH-NO 1U-W-113660, (Bosch), 70A, 90A, 120A ALT, PS, (AC), CH-NO 1U-3-726 897⇒, 1U-38684 073⇒ MTR-CODE: AGR, ALH, CH-NO 1U-3-726 897⇒, 1U-38684 073⇒ MTR-CODE: AGR, ALH, ⇒CH-NO 1U-3-726 896, 1U-38684 072	<b>6PK1660D2</b> <b>VD1076</b> <b>VD1089</b>



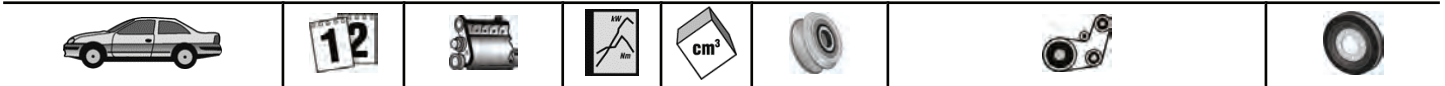

## SKODA

### OCTAVIA (1U2)

↩	10/05-	AXR	74	1896				<b>VD1091</b>
2.0	04/99-	AQY, APK, AZH, AEG	85	1984	<b>AP9001</b>	ALT, MTR-CODE: AQY, APK, AEG, (Bosch,Valeo), 120A		
					<b>AP9001</b>	ALT, MTR-CODE: AQY, APK, AZH, (Hitachi), 120A		<b>VD1107</b>
RS 1.8 T	05/01-	AUQ	132	1781	<b>AP9001</b>	ALT, (Bosch,Valeo,Hitachi), 120A		<b>VD1107</b>

### OCTAVIA (1Z3)

1.4 TSI	11/08-	CAXA	90	1390	<b>AP9012</b>	ALT, (Valeo), 110A, OE-NO 03C903023G, 140A, OE-NO 03C903023C, CH-NO 1Z-9-000001⇒		
1.6	06/04-	BGU, BSE, BSF, CCSA, CMXA	75	1595	<b>AP9001</b> <b>AP9001</b> <b>AP9001</b>	(Bosch), OE-NO 06F903023F, 140A (Valeo), OE-NO 06F903023C, 140A MTR-CODE: BSE, BSF, CCSA, ALT		
1.6 TDI	06/09-	CAYC	77	1598	<b>AP9012</b>	ALT, (Bosch), 140A, OE-NO 06F903023F MTR-CODE: CAYB, CAYC, ⇒10/2009 MTR-CODE: CAYB, CAYC, 11/2009⇒	<b>VD1076</b> <b>VD1111</b>	
1.8 TSI	06/07-	BZB, CDAA	118	1798	<b>AP9009</b> <b>AP9009</b>	ALT, (Bosch), 140A, OE-NO 06B903016AB ALT, (Valeo), 140A, OE-NO 06D903016A, 06J903023C		
1.9 TDI	06/04-12/10	BKC, BJB, BLS, BXE	77	1896	<b>AP9001</b> <b>AP9001</b> <b>AP9001</b> <b>AP9001</b> <b>AP9001</b>	(Bosch), OE-NO 06F903023D, 110A (Bosch), OE-NO 06F903023F, 140A (Valeo), OE-NO 06F903023C, 140A (Valeo), OE-NO 06F903023E, 110A MTR-CODE: BJB, ALT MTR-CODE: BLS, BJB, ALT ALT, (AC)	<b>6PK1050D2</b> <b>VD1076</b>	
2.0 FSI	11/04-	BLY, BLR, BVY, BVZ	110	1984				<b>VD1107</b>
2.0 RS	10/05-	BWA, CCZA	147	1984	<b>AP9009</b> <b>AP9009</b> <b>AP9009</b>	ALT, (Bosch), 140A, OE-NO 06B903016AB ALT, (Valeo), 140A, OE-NO 06D903016A, 06J903023C MTR-CODE: CCZA		<b>VD1107</b>
2.0 TDI	02/04-05/10	AZV	100	1968		MTR-CODE: AZV, BKD, ALT, (AC)	<b>6PK1050D2</b> <b>VD1076</b>	
	11/05-	BMM	103	1968		ALT, PS, (AC)	<b>6PK1050D2</b> <b>VD1076</b>	
2.0 TDI 16V	02/04-	BKD, CFHC, CLCB	103	1968		MTR-CODE: AZV, BKD, ALT, (AC) MTR-CODE: BKD MTR-CODE: CFHC, CLCA, CLCB	<b>6PK1050D2</b> <b>VD1076</b> <b>VD1111</b>	
2.0 TDI RS	04/06-	BMN, CEGA	125	1968		ALT, (-AC), MTR-CODE: BMN	<b>6PK1050D2</b> <b>VD1076</b>	

### OCTAVIA Combi (1U5)

1.6	07/98-	AEH, AKL	74	1595	<b>AP9001</b>	ALT, 08/2000⇒, (Bosch,Valeo,Hitachi), 120A		
	09/00-	AVU, BFQ	75	1595	<b>AP9001</b>	ALT, (Bosch,Valeo,Hitachi), 120A		
1.8 20V	07/98-	AGN	92	1781				<b>VD1107</b>
1.8 T	07/98-	AGU, ARZ, ARX, AUM	110	1781	<b>AP9001</b>	ALT, MTR-CODE: AGU, ARX, AUM, 08/2000⇒, (Bosch,Valeo,Hitachi), 120A		<b>VD1107</b>
1.8 T 4x4	05/01-	AGU, ARX, AUM	110	1781	<b>AP9001</b>	ALT, MTR-CODE: AGU, ARX, AUM, (Bosch,Valeo,Hitachi), 120A		<b>VD1107</b>
1.9 SDI	07/98-	AQM, AGP	50	1896	<b>AP9001</b> <b>AP9001</b> <b>AP9001</b> <b>AP9001</b> <b>AP9001</b> <b>AP9016</b>	ALT, MTR-CODE: AGP, ⇒07/2000, (Valeo), 70A, 120A ALT, MTR-CODE: AGP, CH-NO 1U-W-113661⇒, ⇒07/2000, (Bosch), 70A, 90A, 120A ALT, MTR-CODE: AQM, 08/2000⇒, (Bosch), 70A, 90A ALT, MTR-CODE: AQM, 08/2000⇒, (Hitachi), 120A ALT, MTR-CODE: AQM, 08/2000⇒, (Valeo), 70A, 90A, 120A ALT, MTR-CODE: AGP, ⇒CH-NO 1U-W-113660, ⇒07/2000, (Bosch), 70A, 90A, 120A ALT, (AC), CH-NO 1U-3-726 897⇒, 1U-38684 073⇒ MTR-CODE: AQM, CH-NO 1U-3-726 897⇒, 1U-38684 073⇒ MTR-CODE: AGP	<b>6PK1660D2</b> <b>VD1076</b> <b>VD1089</b>	





# SKODA

## OCTAVIA Combi (1U5)

						MTR-CODE: AQM, ⇒CH-NO 1U-3-726 896, 1U-38684 072	<b>VD1089</b>
1.9 TDI	01/03-	ASZ	96	1896	<b>AP9001</b> <b>AP9001</b>	ALT, (Bosch,Valeo), 70A, 90A, 120A ALT, (Hitachi), 120A	<b>VD1091</b>
	07/98-	ALH, AGR	66	1896	<b>AP9001</b> <b>AP9001</b> <b>AP9001</b> <b>AP9016</b>	ALT, (Hitachi), 120A ALT, (Valeo), 70A, 90A, 120A ALT, CH-NO 1U-W-113661⇒, (Bosch), 70A, 90A, 120A ALT, MTR-CODE: AGR, ⇒CH-NO 1U-W-113660, (Bosch), 70A, 90A, 120A ALT, PS, (AC), CH-NO 1U-3-726 897⇒, 1U-38684 073⇒	<b>6PK1660D2</b> <b>VD1076</b> <b>VD1089</b>
		ASV, AHF	81	1896	<b>AP9001</b> <b>AP9001</b> <b>AP9001</b> <b>AP9016</b>	ALT, (Hitachi), 120A ALT, (Valeo), 70A, 90A, 120A ALT, MTR-CODE: AHF, CH-NO 1U-W-113661⇒, (Bosch), 70A, 90A, 120A ALT, MTR-CODE: AHF, ⇒CH-NO 1U-W-113660, (Bosch), 70A, 90A, 120A ALT, PS, (AC), CH-NO 1U-3-726 897⇒, 1U-38684 073⇒ MTR-CODE: AHF, ASV, CH-NO 1U-3-726 897⇒, 1U-38684 073⇒ MTR-CODE: AHF, ASV, ⇒CH-NO 1U-3-726 896, 1U-38684 072	<b>6PK1660D2</b> <b>VD1076</b> <b>VD1089</b>
	08/00-	ATD, AXR	74	1896			<b>VD1091</b>
1.9 TDI 4x4	09/00-	ATD	74	1896	<b>AP9001</b> <b>AP9001</b>	ALT, (Bosch,Valeo), 70A, 90A, 120A ALT, (Hitachi), 120A	<b>VD1091</b>
	11/99-09/00	AGR	66	1896	<b>AP9001</b> <b>AP9001</b> <b>AP9001</b> <b>AP9016</b>	ALT, (Hitachi), 120A ALT, (Valeo), 70A, 90A, 120A ALT, CH-NO 1U-W-113661⇒, (Bosch), 70A, 90A, 120A ALT, MTR-CODE: AGR, ⇒CH-NO 1U-W-113660, (Bosch), 70A, 90A, 120A ALT, PS, (AC), CH-NO 1U-3-726 897⇒, 1U-38684 073⇒ MTR-CODE: AGR, ALH, CH-NO 1U-3-726 897⇒, 1U-38684 073⇒ MTR-CODE: AGR, ALH, ⇒CH-NO 1U-3-726 896, 1U-38684 072	<b>6PK1660D2</b> <b>VD1076</b> <b>VD1089</b>
2.0	04/99-	AQY, APK, AZH, AEG, AZJ	85	1984	<b>AP9001</b> <b>AP9001</b>	ALT, MTR-CODE: AQY, APK, AEG, (Bosch,Valeo), 120A ALT, MTR-CODE: AQY, APK, AZH, (Hitachi), 120A	<b>VD1107</b>
2.0 4x4	05/01-	AQY, AZH, AEG, AZJ	85	1984	<b>AP9001</b> <b>AP9001</b>	ALT, MTR-CODE: AEG, (Bosch,Valeo), 120A ALT, MTR-CODE: APK,AQY,AZH, (Bosch,Valeo,Hitachi), 120A	
RS 1.8 T	08/02-	AUQ	132	1781	<b>AP9001</b>	ALT, (Bosch,Valeo,Hitachi), 120A	<b>VD1107</b>
<b>OCTAVIA Combi (1Z5)</b>							
1.4 TSI	11/08-	CAXA	90	1390	<b>AP9012</b>	ALT, (Valeo), 110A, OE-NO 03C903023G, 140A, OE-NO 03C903023C, CH-NO 1Z-9-000001⇒	
1.6 TDI	06/09-	CAYC	77	1598	<b>AP9012</b>	ALT, (Bosch), 140A, OE-NO 06F903023F MTR-CODE: CAYB, CAYC, ⇒10/2009 MTR-CODE: CAYB, CAYC, 11/2009⇒	<b>VD1076</b> <b>VD1111</b>
1.6 TDI 4x4	06/09-	CAYC	77	1598	<b>AP9012</b>	ALT, (Bosch), 140A, OE-NO 06F903023F MTR-CODE: CAYB, CAYC, ⇒10/2009 MTR-CODE: CAYB, CAYC, 11/2009⇒	<b>VD1076</b> <b>VD1111</b>
1.8 TSI	06/07-	BZB, CDA A	118	1798	<b>AP9009</b> <b>AP9009</b>	ALT, (Bosch), 140A, OE-NO 06B903016AB ALT, (Valeo), 140A, OE-NO 06D903016A, 06J903023C	
1.8 TSI 4x4	11/08-	CDA A	118	1798	<b>AP9009</b> <b>AP9009</b>	ALT, (Bosch), 140A, OE-NO 06B903016AB ALT, (Valeo), 140A, OE-NO 06D903016A, 06J903023C	
1.9 TDI	09/04-12/10	BKC, BJB, BLS,	77	1896		ALT, (AC)	<b>6PK1050D2</b>





## SKODA

### OCTAVIA Combi (1Z5)

1.9 TDI 4x4	11/04-12/10	BXE	77	1896		ALT, (AC)	VD1076 6PK1050D2 VD1076
2.0 FSI	11/04-	BLY, BLR, BVY, BVZ	110	1984			VD1107
2.0 FSI 4x4	11/04-	BLX, BVX	110	1984			VD1107
2.0 RS	10/05-	BWA, CCZA	147	1984	AP9009 AP9009 AP9009	ALT, (Bosch), 140A, OE-NO 06B903016AB ALT, (Valeo), 140A, OE-NO 06D903016A, 06J903023C MTR-CODE: CCZA	VD1107
2.0 TDI	11/05-	BMM	103	1968		ALT, PS, (AC)	6PK1050D2 VD1076
2.0 TDI 4x4	07/06-	BMM	103	1968		ALT, (AC)	6PK1050D2 VD1076
2.0 TDI 16V	02/04-	BKD, CFHC, CLCB	103	1968		MTR-CODE: AZV, BKD, ALT, (AC) MTR-CODE: BKD MTR-CODE: CFHC, CLCA, CLCB	6PK1050D2 VD1076 VD1111
	02/04-05/10	AZV	100	1968		MTR-CODE: AZV, BKD, ALT, (AC)	6PK1050D2 VD1076
2.0 TDI 16V 4x4	05/10-	CFHC	103	1968		MTR-CODE: CFHC, CLCB	VD1111
2.0 TDI RS	04/06-	BMN, CEGA	125	1968		ALT, (AC), MTR-CODE: BMN	6PK1050D2 VD1076

### ROOMSTER (5J)

1.2 TDI	03/10-	CFWA	55	1199		MTR-CODE: CAYA, CAYB, CAYC	VD1111
1.4 TDI	07/06-	BNM	51	1422	AP9001	ALT, (Bosch), OE-NO 045903023C, 70A, OE-NO 045903023, 90A, OE-NO 045903023H, 110A, OE-NO 045903023A, 120A	
	09/06-	BNV, BMS	59	1422	AP9001	ALT, (Bosch), OE-NO 045903023C, 70A, OE-NO 045903023, 90A, OE-NO 045903023H, 110A, OE-NO 045903023A, 120A	
1.6 TDI	03/10-	CAYB	66	1598		MTR-CODE: CAYA, CAYB, CAYC	VD1111
		CAYC	77	1598		MTR-CODE: CAYA, CAYB, CAYC	VD1111
1.9 TDI	09/06-	BLS, BSW	77	1896	AP9001 AP9001 AP9001	(Valeo), OE-NO 038903023Q, 70A, OE-NO 038903023R, 90A MTR-CODE: BLS, ALT, (Bosch), OE-NO 045903023H, 110A MTR-CODE: BLS, BSW, ALT, (Bosch), OE-NO 038903023K, 70A, OE-NO 038903023L, 90A, OE-NO 028903028E, 120A	6PK1180D1 VD1076

### SUPERB (3T4)

1.4 TSI	07/08-	CAXC	92	1390	AP9012 AP9012 AP9012 AP9012	(Bosch), OE-NO 03C 903 023 A, 140A (Valeo), OE-NO 03C 903 023 C, 140A ALT MTR-CODE: CAXA, CAXC	
1.8 TSI	03/08-	BZB, CDAA	118	1798	AP9009 AP9009	ALT, (Bosch), 140A, OE-NO 06B903016AB ALT, (Valeo), 140A, OE-NO 06D903016A, 06J903023C	
1.8 TSI 4x4	11/08-	CDAA	118	1798	AP9009 AP9009	ALT, (Bosch), 140A, OE-NO 06B903016AB ALT, (Valeo), 140A, OE-NO 06D903016A, 06J903023C	
1.9 TDI	03/08-	BLS, BXE	77	1896	AP9022	ALT, (Bosch), 140A, OE-NO 06F903023N ALT	6PK1050D2 VD1076
2.0 TDI	03/08-	BMP	103	1968	AP9022 AP9022	ALT, (Bosch), 140A, OE-NO 06F903023N ALT, (Valeo), 140A, OE-NO 06F903023P ALT	6PK1050D2 VD1076
	07/08-	CBBB, CFGB	125	1968	AP9022 AP9022	ALT, (Bosch), 140A, OE-NO 06F903023N ALT, (Valeo), 140A, OE-NO 06F903023P MTR-CODE: CBBB MTR-CODE: CFGB	VD1076 VD1111
2.0 TDI 16V	01/09-	BKD, CFFB, CLJA	103	1968	AP9022 AP9022	ALT, (Bosch), 140A, OE-NO 06F903023N ALT, (Valeo), 140A, OE-NO	



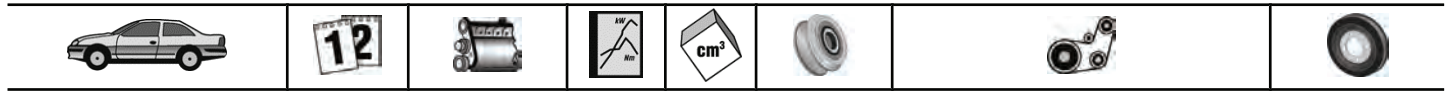

## SKODA

### SUPERB (3T4)

						06F903023P MTR-CODE: BKD MTR-CODE: CFFB, CLJA	VD1076 VD1111
2.0 TDI 4x4	09/08-	CBBB, CFGB	125	1968	AP9022	ALT, (Bosch), 140A, OE-NO 06F903023N ALT, (Valeo), 140A, OE-NO 06F903023P MTR-CODE: CBBB MTR-CODE: CFGB	VD1076 VD1111
3.6 V6 4x4	11/08-	CDVA	191	3580	AP9022 AP9022	ALT, (Bosch), 140A, OE-NO 06F903023N ALT, (Valeo), 140A, OE-NO 06F903023P	

### SUPERB (3U4)

1.8 T	02/02-03/08	AWT	110	1781	AP9002	ALT, (Valeo), 120A	
1.9 TDI	02/02-03/08	AWX, AVF	96	1896	AP9002	ALT, (Bosch,Valeo), 120A	VD1090
	08/02-10/05	AVB	74	1896	AP9002	ALT, (Bosch,Valeo), 120A	VD1090
2.0	02/02-03/08	AZM	85	1984	AP9002 AP9007	ALT, (Valeo), 120A ALT, (Bosch), 120A	
2.5 TDI	02/02-08/03	AYM	114	2496		ALT, PS, AC	6PK2404D1 VD1032
	06/03-03/08	BDG	120	2496		ALT, PS, AC	6PK2404D1 VD1032

### SUPERB Kombi (3T5)

1.4 TSI	10/09-	CAXC	92	1390	AP9012 AP9012 AP9012	(Bosch), 140A, OE-NO 03C903023A (Valeo), 140A, OE-NO 03C903023C ALT, CH-NO 3T-8-000001⇨, MTR-CODE: CAXA, CAXC	
2.0 TDI	10/09-	BMP	103	1968	AP9022 AP9022	ALT, (Bosch), 140A, OE-NO 06F903023N ALT, (Valeo), 140A, OE-NO 06F903023P ALT	6PK1050D2 VD1076
		CBBB, CFGB	125	1968	AP9022 AP9022	ALT, (Bosch), 140A, OE-NO 06F903023N ALT, (Valeo), 140A, OE-NO 06F903023P MTR-CODE: CBBB MTR-CODE: CFGB	VD1076 VD1111
2.0 TDI 16V	10/09-	BKD, CFFB, CLJA	103	1968	AP9022 AP9022	ALT, (Bosch), 140A, OE-NO 06F903023N, ALT, (Valeo), 140A, OE-NO 06F903023P MTR-CODE: BKD MTR-CODE: CFFB, CLJA	VD1076 VD1111
2.0 TDI 4x4	10/09-	CBBB, CFGB	125	1968	AP9022 AP9022	ALT, (Bosch), 140A, OE-NO 06F903023N ALT, (Valeo), 140A, OE-NO 06F903023P MTR-CODE: CBBB MTR-CODE: CFGB	VD1076 VD1111
3.6 V6 4x4	10/09-	CDVA	191	3580	AP9022 AP9022	ALT, (Bosch), 140A, OE-NO 06F903023N ALT, (Valeo), 140A, OE-NO 06F903023P	

### YETI

1.2 TSI	09/09-	CBZB	77	1197	AP9012 AP9012 AP9012	(Bosch), 140A, OE-NO 03F903023D (Valeo), 110A, OE-NO 03F903023E ALT	
1.8 TSI 4x4	05/09-	CDA A	118	1798	AP9009 AP9009	ALT, (Bosch), 140A, OE-NO 06B903016AB ALT, (Valeo), 140A, OE-NO 06D903016A, 06J903023C	
2.0 TDI	11/09-	CFHA, CLCA	81	1968			VD1111
2.0 TDI 4x4	05/09-	CBDB, CFHC, CLCB	103	1968		MTR-CODE: CBDB MTR-CODE: CFHC, CLCB	VD1076 VD1111
	11/09-	CFHF	81	1968			VD1111
		CEGA, CFJA	125	1968		MTR-CODE: CEGA MTR-CODE: CFJA	VD1076 VD1111

## SMART

### FORFOUR

1.5 CDI (454.000)	09/04-	OM639.939	50	1493	AP9014	ALT, (Valeo)	
1.5 CDI (454.001)	09/04-	OM639.939	70	1493	AP9014	ALT, (Valeo)	





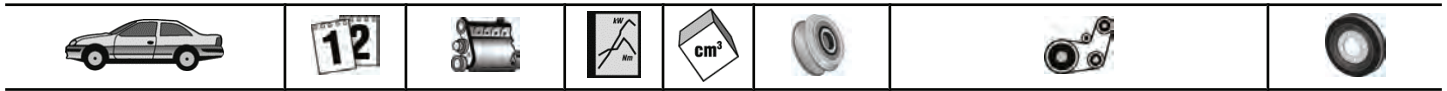

## SUZUKI

<b>GRAND VITARA (FT, GT)</b> ↩ 2.0 HDI 110 16V	07/01-	RHW	80	1997	<b>AP9031</b>	CH-NO JSAFTD82V00119469⇒, ALT, (Valeo), 150A, OE-NO 31400-68D01, 31400-68D02	
<b>IGNIS II</b> 1.3 DDiS	09/03-	Z13DT	51	1248	<b>AP9035</b>	ALT, (Valeo), OE-NO 31400-85E00-000, 100A	
<b>SPLASH</b> 1.3 CDTI	01/08-	D13A, Z13DTJ	55	1248	<b>AP9035</b>	ALT, (Valeo), OE-NO 31400-85E00-000, 100A	
<b>SWIFT III (SG)</b> 1.3 DDiS	08/05-	Z13DT	51	1248	<b>AP9035</b>	ALT, (Valeo), OE-NO 31400-85E00-000, 100A	
		D13A, Z13DTJ	55	1248	<b>AP9035</b>	ALT, (Valeo), OE-NO 31400-85E00-000, 100A	
<b>WAGON R+ (MM)</b> 1.3 DDiS	09/03-	Z13DT	51	1248	<b>AP9035</b>	ALT, (Valeo), OE-NO 31400-85E00-000, 100A	

## TOYOTA

<b>AURIS</b>							
1.4 VVTi	03/07-	4ZZ-FE	71	1398			<b>VD1079</b>
2.0 D-4D	03/07-	1AD-FTV	93	1998			<b>VD1078</b>
2.2 D	03/07-	2AD-FHV	130	2231			<b>VD1078</b>
<b>AVENSIS (_T22_)</b>							
1.6 VVT-i	10/00-02/03	3ZZ-FE	81	1598			<b>VD1079</b>
<b>AVENSIS (T25)</b>							
1.6 VVT-i	04/03-	3ZZ-FE	81	1598			<b>VD1079</b>
1.8	04/03-	1ZZ-FE	95	1794			<b>VD1079</b>
2.0 D-4D	03/06-	1AD-FTV	93	1998		ALT, (AC)	<b>7PK2000D1</b> <b>VD1078</b>
2.2 D-4D	10/05-	2AD-FTV	110	2231		ALT, (AC)	<b>7PK2000D1</b> <b>VD1078</b>
2.2 D-CAT	07/05-	2AD-FHV	130	2231		ALT, (AC)	<b>7PK2000D1</b> <b>VD1078</b>
<b>AVENSIS Kombi (T25)</b>							
1.6 VVT-i	04/03-	3ZZ-FE	81	1598			<b>VD1079</b>
1.8	04/03-	1ZZ-FE	95	1794			<b>VD1079</b>
2.0 D-4D	03/06-	1AD-FTV	93	1998		ALT, (AC)	<b>7PK2000D1</b> <b>VD1078</b>
2.2 D-4D	10/05-	2AD-FTV	110	2231		ALT, (AC)	<b>7PK2000D1</b> <b>VD1078</b>
2.2 D-CAT	07/05-	2AD-FHV	130	2231		ALT, (AC)	<b>7PK2000D1</b> <b>VD1078</b>
<b>AVENSIS Liftback (_T22_)</b>							
1.6 VVT-i	10/00-02/03	3ZZ-FE	81	1598			<b>VD1079</b>
<b>AVENSIS Station Wagon (_T22_)</b>							
1.6 VVT-i	10/00-02/03	3ZZ-FE	81	1598			<b>VD1079</b>
<b>AVENSIS Station Wagon (T27)</b>							
2.0 D-4D	02/09-	1AD-FTV	93	1998			<b>VD1078</b>
2.2 D-4D	02/09-	2AD-FHV,	110	2231			<b>VD1078</b>
		2AD-FTV	130	2231			<b>VD1078</b>
<b>AVENSIS Stufenheck (T25)</b>							
1.6 VVT-i	04/03-	3ZZ-FE	81	1598			<b>VD1079</b>
1.8	04/03-	1ZZ-FE	95	1794			<b>VD1079</b>
2.0 D-4D	03/06-	1AD-FTV	93	1998		ALT, (AC)	<b>7PK2000D1</b> <b>VD1078</b>
2.2 D-4D	10/05-	2AD-FTV	110	2231		ALT, (AC)	<b>7PK2000D1</b> <b>VD1078</b>
2.2 D-CAT	07/05-	2AD-FHV	130	2231		ALT, (AC)	<b>7PK2000D1</b> <b>VD1078</b>
<b>AVENSIS Stufenheck (T27)</b>							
2.0 D-4D	02/09-	1AD-FTV	93	1998			<b>VD1078</b>
2.2 D-4D	02/09-	2AD-FHV,	110	2231			<b>VD1078</b>
		2AD-FTV	130	2231			<b>VD1078</b>
<b>AYGO (B10)</b>							
1.4 HDi (WNB10)	07/05-	2WZ-TV	40	1398			<b>VD1094</b>
<b>COROLLA (_E12U_, _E12J_)</b>							
1.4 VVT-i	01/02-	4ZZ-FE	71	1398			<b>VD1079</b>
1.6 VVT-i	01/02-	3ZZ-FE	81	1598			<b>VD1079</b>
<b>COROLLA Kombi (_E12J_, _E12T_)</b>							
1.4 VVT-i	01/02-	4ZZ-FE	71	1398			<b>VD1079</b>
1.6 VVT-i	01/02-	3ZZ-FE	81	1598			<b>VD1079</b>
<b>COROLLA Stufenheck (_E12J_, _E12T_)</b>							
1.4 VVT-i	08/02-	4ZZ-FE	71	1398			<b>VD1079</b>



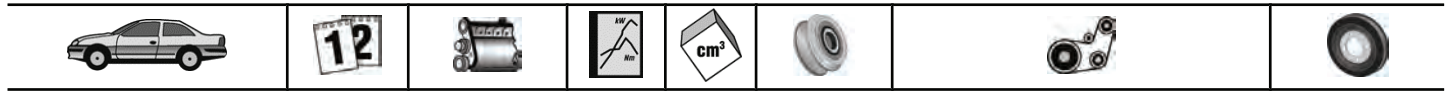

VAUXHALL

## TOYOTA

<b>COROLLA Stufenheck ( E12J, E12T )</b>						
1.6 VVT-i	08/02-	3ZZ-FE	81	1598		VD1079
<b>COROLLA Verso ( E12J )</b>						
1.6 VVT-i	01/02-05/04	3ZZ-FE	81	1598		VD1079
<b>COROLLA Verso ( ZER, ZZE )</b>						
1.6	04/04-	3ZZ-FE	81	1598	ALT, (AC)	6PK1870D2 VD1079
1.8	04/04-	1ZZ-FE	95	1794	ALT, (AC)	6PK1870D2 VD1079
2.2 D-4D	10/05-	2AD-FTV	100	2231	ALT, (AC)	7PK2000D1 VD1078
		2AD-FHV	130	2231	ALT, (AC)	7PK2000D1 VD1078
<b>RAV 4 III ( ACA, ACE, ALA )</b>						
2.2 D-4D	03/06-	2AD-FTV	100	2231		VD1078
	12/08-	2AD-FTV	110	2231		VD1078
2.2 D-CAT	03/06-	2AD-FHV	130	2231		VD1078
<b>VERSO</b>						
2.0 D-4D	04/09-	1AD-FTV	93	1998		VD1078
2.2 D-4D	04/09-	2AD-FHV	110	2231		VD1078
2.2 D-CAT	04/09-	2AD-FHV	130	2231		VD1078

## VAUXHALL

<b>ASTRA Mk III (F) Convertible</b>						
1.4 i 16V	01/96-03/01	X14XE	66	1389	AP9003	ALT, (Bosch), 120A, OE-NO 9195336, CH-NO C 12257453⇒
1.6 i	01/96-03/01	X16SZR	55	1598	AP9003	ALT, (Bosch), 120A, OE-NO 9195336, CH-NO C 15257664⇒
<b>ASTRA Mk IV (G)</b>						
1.4 16V	09/98-	X14XE, Z14XE	66	1389	AP9003	ALT, (Bosch), 120A, OE-NO 9195336, CH-NO C 12257453⇒
1.6	09/00-	Z16SE	62	1598	AP9003	ALT, (Bosch), 120A, OE-NO 9195336
1.6 16V	09/98-	X16XEL, Z16XE	74	1598	AP9003	ALT, (Bosch), 120A, OE-NO 9195336, MTR-CODE: X 16 XEL, CH-NO C 4G000001⇒
					AP9003	ALT, (Bosch), 120A, OE-NO 9195336, MTR-CODE: Z 16 XE
1.6 Dualfuel	09/02-	Z16XE	63	1598	AP9003	ALT, (Bosch), 120A, OE-NO 9195336
1.7 CDTI 16V	04/03-	Z17DTL	59	1686	AP9044	ALT, (Delco Remy), 100A, 110A
					AP9044	ALT, (Hitachi), 100A, 110A
						ALT, (-AC), MTR-NO 0614509⇒ ALT, AC, MTR-NO 0614509⇒ MTR-NO 0614509⇒
1.8 16V	02/98-07/04	X18XE1	85	1796	AP9003	ALT, (Bosch), 120A, OE-NO 9195336
1.8 16V Dualfuel	02/98-07/04	Z18XE	87	1796	AP9003	ALT, (Bosch), 120A, OE-NO 9195336
2.0 16V	09/98-	X20XE	100	1998	AP9003	ALT, (Bosch), 120A, OE-NO 9195336
2.0 DI	02/98-07/04	X20DTL, Y20DTL	60	1995		VD1031
2.0 DTI 16V	02/98-07/04	X20DTH, Y20DTH	74	1995		VD1031
<b>ASTRA Mk IV (G) CC</b>						
1.6	02/98-09/00	X16SZR	55	1598	AP9003	ALT, (Bosch), 120A, OE-NO 9195336, CH-NO C 15257664⇒
	09/00-	Z16SE	62	1598	AP9003	ALT, (Bosch), 120A, OE-NO 9195336
1.6 16V	02/98-	X16XEL, Z16XE	74	1598	AP9003	ALT, (Bosch), 120A, OE-NO 9195336, MTR-CODE: X 16 XEL, CH-NO C 4G000001⇒
					AP9003	ALT, (Bosch), 120A, OE-NO 9195336, MTR-CODE: Z 16 XE
1.6 Dualfuel	09/02-	Z16XE	63	1598	AP9003	ALT, (Bosch), 120A, OE-NO 9195336
1.7 CDTI 16V	04/03-	Z17DTL	59	1686	AP9044	ALT, (Delco Remy), 100A, 110A
					AP9044	ALT, (Hitachi), 100A, 110A
						ALT, (-AC), MTR-NO 0614509⇒ ALT, AC, MTR-NO 0614509⇒ MTR-NO 0614509⇒
1.8 16V	02/98-09/00	X18XE1	85	1796	AP9003	ALT, (Bosch), 120A, OE-NO 9195336
1.9	09/00-	Z18XE	92	1796	AP9003	ALT, (Bosch), 120A, OE-NO 9195336
	10/99-08/00	X20XER	118	1998	AP9003	ALT, (Bosch), 120A, OE-NO 9195336
2.0 16V	02/98-	X20XE	100	1998	AP9003	ALT, (Bosch), 120A, OE-NO 9195336
2.0 DI	02/98-	X20DTL, Y20DTL	60	1995		VD1031
2.0 DTI 16V	08/99-	X20DTH, Y20DTH	74	1995		VD1031
<b>ASTRA Mk IV (G) Convertible</b>						
1.6 16V	03/01-	Z16XE	74	1598	AP9003	ALT, (Bosch), 120A, OE-NO 9195336
1.8 16V	03/01-	Z18XE	92	1796	AP9003	ALT, (Bosch), 120A, OE-NO 9195336





## VAUXHALL

Model	Year Range	Engine	Power (kW)	Power (hp)	Part No.	Description	Accessories	
ASTRA Mk IV (G) Coupe ↳ 1.8 16V	03/00-10/00	X18XE1	85	1796	AP9003	ALT, (Bosch), 120A, OE-NO 9195336		
	09/00-	Z18XE	92	1796	AP9003	ALT, (Bosch), 120A, OE-NO 9195336		
	09/02-	Z18XE	87	1796	AP9003	ALT, (Bosch), 120A, OE-NO 9195336		
ASTRA Mk IV (G) Estate	1.4 16V	02/98-	X14XE, Z14XE	66	1389	AP9003	ALT, (Bosch), 120A, OE-NO 9195336, CH-NO C 12257453⇒	
	1.6	03/98-04/04	X16SZR	55	1598	AP9003	ALT, (Bosch), 120A, OE-NO 9195336, CH-NO C 15257664⇒	
			Z16SE	62	1598	AP9003	ALT, (Bosch), 120A, OE-NO 9195336	
	1.6 16V	03/98-04/04	X16XEL, Z16XE	74	1598	AP9003	ALT, (Bosch), 120A, OE-NO 9195336, MTR-CODE: X 16 XEL, CH-NO C 4G000001⇒	
						AP9003	ALT, (Bosch), 120A, OE-NO 9195336, MTR-CODE: Z 16 XE	
	1.6 Dualfuel	03/98-04/04	Z16XE	63	1598	AP9003	ALT, (Bosch), 120A, OE-NO 9195336	
	1.7 CDTI 16V	04/03-	Z17DTL	59	1686	AP9044	ALT, (Delco Remy), 100A, 110A	
						AP9044	ALT, (Hitachi), 100A, 110A	
							ALT, (-AC), MTR-NO 0614509⇒	6PK1275D1
							ALT, AC, MTR-NO 0614509⇒	6PK1623D1
						MTR-NO 0614509⇒	VD1068	
1.8 16V	02/98-08/00	X18XE1	85	1796	AP9003	ALT, (Bosch), 120A, OE-NO 9195336		
	09/00-	Z18XE	92	1796	AP9003	ALT, (Bosch), 120A, OE-NO 9195336		
2.0 16V	02/98-	X20XEV	100	1998	AP9003	ALT, (Bosch), 120A, OE-NO 9195336		
2.0 DI	03/98-04/04	X20DTL, Y20DTL	60	1995			VD1031	
2.0 DTI 16V	03/98-04/04	X20DTH, Y20DTH	74	1995			VD1031	
ASTRA Mk V (H) CC	1.6	01/04-05/09	Z16XEP	77	1598			VD1106
	1.7 CDTI	01/04-05/09	Z17DTL	59	1686	AP9044	ALT, (Delco Remy), 100A, 110A	
						AP9044	ALT, (Hitachi), 100A, 110A	
							ALT, (-AC)	6PK1275D1
							ALT, AC	6PK1623D1
								VD1068
			Z17DTH	74	1686		ALT, (-AC)	6PK1275D1
						ALT, (AC)	6PK1623D1	
							VD1068	
1.9 CDTI	01/04-05/09	Z19DT	88	1910	AP9017	ALT, (Denso), 100A, OE-NO 93180098, 120A, OE-NO 93180102, 130A, OE-NO 93180104		
					AP9028	ALT, (Bosch), OE-NO 93191921, 120A, OE-NO 93191922, 140A		
						⇒CH-NO 5545149	VD1065	
		Z19DTJ	88	1910	AP9017	ALT, (Denso), 100A, OE-NO 93180098, 120A, OE-NO 93180102, 130A, OE-NO 93180104		
					AP9028	ALT, (Bosch), OE-NO 93191921, 120A, OE-NO 93191922, 140A		
						⇒CH-NO 72156708, 75189052, 78104400	VD1065	
		Z19DTH	110	1910	AP9017	ALT, (Denso), 100A, OE-NO 93180098, 120A, OE-NO 93180102, 130A, OE-NO 93180104		
					AP9028	ALT, (Bosch), OE-NO 93191921, 120A, OE-NO 93191922, 140A		
						ALT, (-AC), CH-NO 72156709⇒, 75189053⇒, 78104401⇒	6PK1050D1	
						ALT, (AC), CH-NO 72156709⇒, 75189053⇒, 78104401⇒, OE-NO 93185361	6PK1370D1	
						⇒CH-NO 72156708, 75189052, 78104400	VD1065	
						CH-NO 72156709⇒, 75189053⇒, 78104401⇒, 8B000001⇒	VD1067	
ASTRA Mk V (H) Estate	1.6	08/04-03/09	Z16XEP	77	1598			VD1106
	1.7 CDTi	08/04-03/09	Z17DTH	74	1686		ALT, (-AC)	6PK1275D1
							ALT, (AC)	6PK1623D1
							VD1068	
1.9 CDTi	08/04-03/09	Z19DTL	74	1910	AP9017	ALT, (Denso), 100A, OE-NO 93180098, 120A, OE-NO 93180102, 130A, OE-NO 93180104		
					AP9028	ALT, (Bosch), OE-NO 93191921, 120A, OE-NO 93191922, 140A		
		Z19DT	88	1910	AP9017	ALT, (Denso), 100A, OE-NO 93180098, 120A, OE-NO 93180102, 130A, OE-NO 93180104		
					AP9017	ALT, (Denso), 100A, OE-NO 93180098,		





## VAUXHALL

### ASTRA Mk V (H) Estate

						120A, OE-NO 93180102, 130A, OE-NO 93180104 ALT, (Bosch), OE-NO 93191921, 120A, OE-NO 93191922, 140A ALT, (Bosch), OE-NO 93191921, 120A, OE-NO 93191922, 140A ⇒CH-NO 5545149 ⇒CH-NO 72156708, 75189052, 78104400	<b>VD1065</b> <b>VD1065</b>
		Z19DTH	110	1910	<b>AP9017</b> <b>AP9028</b>	ALT, (Denso), 100A, OE-NO 93180098, 120A, OE-NO 93180102, 130A, OE-NO 93180104 ALT, (Bosch), OE-NO 93191921, 120A, OE-NO 93191922, 140A ALT, (-AC), CH-NO 72156709⇒, 75189053⇒, 78104401⇒ ALT, (AC), CH-NO 72156709⇒, 75189053⇒, 78104401⇒, OE-NO 93185 361 ⇒CH-NO 72156708, 75189052, 78104400 CH-NO 72156709⇒, 71589053⇒, 78104401⇒, 8B000001⇒	<b>6PK1050D1</b> <b>6PK1370D1</b> <b>VD1065</b> <b>VD1067</b>

### ASTRA Mk V (H) Sport Hatch

1.6	02/05-	Z16XEP	77	1598			<b>VD1106</b>
1.7 CDTi	02/05-	Z17DTH	74	1686		ALT, (-AC) ALT, AC	<b>6PK1275D1</b> <b>6PK1623D1</b> <b>VD1068</b>
1.8	02/05-	Z18XE	92	1796	<b>AP9003</b>	ALT, (Bosch), 120A, OE-NO 9195336	
1.9 CDTi	02/05-	Z19DT	88	1910	<b>AP9017</b> <b>AP9028</b>	ALT, (Denso), 100A, OE-NO 93180098, 120A, OE-NO 93180102, 130A, OE-NO 93180104 ALT, (Bosch), OE-NO 93191921, 120A, OE-NO 93191922, 140A ⇒CH-NO 5545149	<b>VD1065</b>
		Z19DTH	110	1910	<b>AP9017</b> <b>AP9028</b>	ALT, (Denso), 100A, OE-NO 93180098, 120A, OE-NO 93180102, 130A, OE-NO 93180104 ALT, (Bosch), OE-NO 93191921, 120A, OE-NO 93191922, 140A ALT, (-AC), CH-NO 72156709⇒, 75189053⇒, 78104401⇒ ALT, (AC), CH-NO 72156709⇒, 75189053⇒, 78104401⇒, OE-NO 93185 361 ⇒CH-NO 72156708, 75189052, 78104400 CH-NO 72156709⇒, 71589053⇒, 78104401⇒, 8B000001⇒	<b>6PK1050D1</b> <b>6PK1370D1</b> <b>VD1065</b> <b>VD1067</b>
	08/05-	Z19DTL	74	1910	<b>AP9017</b> <b>AP9028</b>	ALT, (Denso), 100A, OE-NO 93180098, 120A, OE-NO 93180102, 130A, OE-NO 93180104 ALT, (Bosch), OE-NO 93191921, 120A, OE-NO 93191922, 140A	

### ASTRAVAN Mk IV (G)

1.6 i	08/98-09/00	X16SZR	55	1598	<b>AP9003</b>	ALT, (Bosch), 120A, OE-NO 9195336, CH-NO C 15257664⇒	
	09/00-	Z16SE	62	1598	<b>AP9003</b>	ALT, (Bosch), 120A, OE-NO 9195336	
1.7 CDTi	04/04-	Z17DTL	59	1686	<b>AP9044</b> <b>AP9044</b>	ALT, (Delco Remy), 100A, 110A ALT, (Hitachi), 100A, 110A ALT, (-AC), MTR-NO 0614509⇒ ALT, AC, MTR-NO 0614509⇒ MTR-NO 0614509⇒	<b>6PK1275D1</b> <b>6PK1623D1</b> <b>VD1068</b>

### ASTRAVAN Mk V (H)

1.9 CDTi	03/05-	Z19DTH	110	1910		ALT, (-AC), CH-NO 72156709⇒, 75189053⇒, 78104401⇒ ALT, (AC), CH-NO 72156709⇒, 75189053⇒, 78104401⇒, OE-NO 93185 361 ⇒CH-NO 72156708, 75189052, 78104400 CH-NO 72156709⇒, 75189053⇒, 78104401⇒, 8B000001⇒	<b>6PK1050D1</b> <b>6PK1370D1</b> <b>VD1065</b> <b>VD1067</b>
----------	--------	--------	-----	------	--	-------------------------------------------------------------------------------------------------------------------------------------------------------------------------------------------------------------------	------------------------------------------------------------------------

### COMBO Mk II (C)

1.7 CDTi 16V	12/04-	Z17DTH	74	1686	<b>AP9044</b> <b>AP9044</b>	ALT, (Delco Remy), 100A, 110A ALT, (Hitachi), 100A, 110A ALT, PS, (-AC), MTR-CODE: Z17DTH ALT, PS, AC, MTR-CODE: Z17DTH	<b>6PK1275D1</b> <b>6PK1600D1</b>
--------------	--------	--------	----	------	--------------------------------	----------------------------------------------------------------------------------------------------------------------------------	--------------------------------------





## VAUXHALL

<b>COMBO Mk II (C)</b>								<b>VD1068</b>
<b>CORSA Convertible</b> 1.4 i 16V	01/98-	X14XE	66	1389	<b>AP9003</b>	ALT, (Bosch), 120A, OE-NO 9195336, CH-NO C 12257453⇒		
<b>CORSA Mk III (C)</b> 1.7 CDTI 16V	08/00-09/06	Z17DTH	74	1686	<b>AP9044</b> <b>AP9044</b>	ALT, (Delco Remy), 100A, 110A ALT, (Hitachi), 100A, 110A ALT, PS, (-AC), MTR-CODE: Z17DTH ALT, PS, AC, MTR-CODE: Z17DTH	<b>6PK1275D1</b> <b>6PK1600D1</b> <b>VD1068</b>	
<b>CORSA Mk IV (D)</b> 1.6 16V Turbo	02/07-	Z16LER, A16LER	141	1598				<b>VD1106</b>
<b>FRONTERA Mk II (B)</b> 2.2 DTI	10/98-09/04	X22DTH, Y22DTH	85	2171				<b>VD1031</b>
<b>MERIVA Mk I (A)</b> 1.6 i 16V Twinport	01/03-10/09	Z16XEP	77	1598				<b>VD1106</b>
1.6 Turbo	05/06-	Z16LET	132	1598				<b>VD1106</b>
1.7 CDTI 16V	04/04-08/05	Z17DTH	74	1686	<b>AP9044</b> <b>AP9044</b>	ALT, (Delco Remy), 100A, 110A ALT, (Hitachi), 100A, 110A ALT, PS, (-AC), MTR-CODE: Z17DTH ALT, PS, AC, MTR-CODE: Z17DTH	<b>6PK1275D1</b> <b>6PK1600D1</b> <b>VD1068</b>	
<b>MOVANO Mk I (A) Combi (JD)</b> 1.9 DTI	10/01-	F9Q774	60	1870	<b>AP9039</b> <b>AP9043</b>	ALT, (Valeo), 125A, OE-NO 93160665, 93161425, 93189523, (AC) ALT, (-AC)		
<b>MOVANO Mk I (A) Van (FD)</b> 1.9 DTI	10/01-	F9Q774	60	1870	<b>AP9039</b> <b>AP9043</b>	ALT, (Valeo), 125A, OE-NO 93160665, 93161425, 93189523, (AC) ALT, (-AC)		<b>VD1101</b>
<b>OMEGA (B)</b> 2.0 DTI 16V	01/98-09/00	X20DTH	74	1995				<b>VD1031</b>
2.2 DTI 16V	08/00-03/04	Y22DTH	88	2171		ALT, (-AC) ALT, (AC)	<b>6PK1800D1</b> <b>6PK1900D1</b> <b>VD1031</b>	
2.5 TD	04/94-02/01	X25DT, 25DT	96	2497		ALT	<b>5PK1815D1</b> <b>VD1025</b>	
<b>OMEGA (B) Estate</b> 2.0 DTI 16V	01/98-09/00	X20DTH	74	1995				<b>VD1031</b>
2.2 DTI 16V	08/00-03/04	Y22DTH	88	2171		ALT, (-AC) ALT, (AC)	<b>6PK1800D1</b> <b>6PK1900D1</b> <b>VD1031</b>	
2.5 TD	04/94-02/01	X25DT, 25DT	96	2497		ALT	<b>5PK1815D1</b> <b>VD1025</b>	
<b>SIGNUM</b> 1.9 CDTI	04/04-03/08	Z19DT	88	1910	<b>AP9017</b> <b>AP9028</b>	ALT, (Denso), 100A, OE-NO 93180098, 120A, OE-NO 93180102, 130A, OE-NO 93180104 ALT, (Bosch), OE-NO 93191921, 120A, OE-NO 93191922, 140A ⇒CH-NO 5545149		<b>VD1065</b>
1.9 CDTI 16V	04/04-03/08	Z19DTH	110	1910	<b>AP9017</b> <b>AP9028</b>	ALT, (Denso), 100A, OE-NO 93180098, 120A, OE-NO 93180102, 130A, OE-NO 93180104 ALT, (Bosch), OE-NO 93191921, 120A, OE-NO 93191922, 140A ALT, (-AC), CH-NO 71021892⇒ ALT, (AC), CH-NO 71021892⇒ ⇒CH-NO 71021891 CH-NO 71021892⇒	<b>6PK1050D1</b> <b>6PK1413D2</b> <b>VD1065</b> <b>VD1067</b>	
2.0 DTI	05/03-	Y20DTH	74	1994				<b>VD1031</b>
2.2 DTI	05/03-	Y22DTR	92	2188				<b>VD1031</b>
<b>SINTRA</b> 2.2 DTI	07/97-04/99	X22DTH	85	2171				<b>VD1031</b>
<b>VECTRA (B)</b> 1.6 i 16V	08/95-10/01	X16XEL, Z16XE, Y16XE	74	1598	<b>AP9003</b> <b>AP9003</b>	ALT, (Bosch), 120A, OE-NO 9195336, MTR-CODE: X 16 XEL, CH-NO C 4G000001⇒ ALT, (Bosch), 120A, OE-NO 9195336, MTR-CODE: Z 16 XE		
2.0 DI 16V	08/95-10/01	X20DTL	60	1995				<b>VD1031</b>
2.0 DTI 16V	08/95-10/01	X20DTH, Y20DTH	74	1995				<b>VD1031</b>
2.2 DTI 16V	08/95-10/01	Y22DTR	92	2172				<b>VD1031</b>





# VAUXHALL

## VECTRA (B) CC

1.6 i 16V	08/95-10/01	X16XEL, Z16XE, Y16XE	74	1598	<b>AP9003</b>	ALT, (Bosch), 120A, OE-NO 9195336, MTR-CODE: X 16 XEL, CH-NO C 4G000001⇒	
					<b>AP9003</b>	ALT, (Bosch), 120A, OE-NO 9195336, MTR-CODE: Z 16 XE	
2.0 Di 16V	08/95-10/01	X20DTL	60	1995			<b>VD1031</b>
2.0 DTi 16V	06/97-10/01	X20DTH, Y20DTH	74	1995			<b>VD1031</b>
2.2 DTI 16V	08/95-10/01	Y22DTR	92	2172			<b>VD1031</b>

## VECTRA (B) Estate

1.6 i 16V	11/96-	X16XEL, Z16XE, Y16XE	74	1598	<b>AP9003</b>	ALT, (Bosch), 120A, OE-NO 9195336, MTR-CODE: X 16 XEL, CH-NO C 4G000001⇒	
					<b>AP9003</b>	ALT, (Bosch), 120A, OE-NO 9195336, MTR-CODE: Z 16 XE	
2.0 DI 16V	08/95-10/01	X20DTL	60	1995			<b>VD1031</b>
2.0 DTI 16V	08/95-10/01	X20DTH, Y20DTH	74	1995			<b>VD1031</b>
2.2 DTI 16V	08/95-10/01	Y22DTR	92	2172			<b>VD1031</b>

## VECTRA Mk II (C)

1.6	01/06-07/08	Z16XEP	77	1598			<b>VD1106</b>
1.6 16V	06/04-07/08	Z16XE	74	1598	<b>AP9003</b>	ALT, (Bosch), 120A, OE-NO 9195336	
1.8	01/06-07/08	Z18XER	103	1796			<b>VD1106</b>
1.8 16V	04/02-07/08	Z18XE	90	1796	<b>AP9003</b>	ALT, (Bosch), 120A, OE-NO 9195336	
1.8 16V Dualfuel	04/02-07/08	Z18XE	90	1796	<b>AP9003</b>	ALT, (Bosch), 120A, OE-NO 9195336	
1.9 CDTI	04/04-08/05	Z19DT	88	1910	<b>AP9017</b>	ALT, (Denso), 100A, OE-NO 93180098, 120A, OE-NO 93180102, 130A, OE-NO 93180104	
					<b>AP9028</b>	ALT, (Bosch), OE-NO 93191921, 120A, OE-NO 93191922, 140A ⇒CH-NO 5545149	<b>VD1065</b>
	10/05-07/08	Z19DTL	74	1910	<b>AP9017</b>	ALT, (Denso), 100A, OE-NO 93180098, 120A, OE-NO 93180102, 130A, OE-NO 93180104	
					<b>AP9028</b>	ALT, (Bosch), OE-NO 93191921, 120A, OE-NO 93191922, 140A ⇒CH-NO 5545149	<b>VD1065</b>
1.9 CDTI 16V	04/04-08/05	Z19DTH	110	1910	<b>AP9017</b>	ALT, (Denso), 100A, OE-NO 93180098, 120A, OE-NO 93180102, 130A, OE-NO 93180104	
					<b>AP9028</b>	ALT, (Bosch), OE-NO 93191921, 120A, OE-NO 93191922, 140A ALT, (-AC), CH-NO 71021892⇒ ALT, AC, CH-NO 71021892⇒ ⇒CH-NO 71021891, 48999999 CH-NO 71021892⇒	<b>6PK1050D1</b> <b>6PK1413D2</b> <b>VD1065</b> <b>VD1067</b>
2.0 DTI 16V	04/02-	Y20DTH	74	1995			<b>VD1031</b>
2.2 DTI 16V	04/02-	Y22DTR	92	2172			<b>VD1031</b>

## VECTRA Mk II (C) Estate

1.6 16V	06/04-07/08	Z16XE	74	1598	<b>AP9003</b>	ALT, (Bosch), 120A, OE-NO 9195336	
1.8	01/06-07/08	Z18XER	103	1796			<b>VD1106</b>
1.8 16V	10/03-08/05	Z18XE	90	1796	<b>AP9003</b>	ALT, (Bosch), 120A, OE-NO 9195336	
1.9 CDTI	04/04-08/05	Z19DT	88	1910	<b>AP9017</b>	ALT, (Denso), 100A, OE-NO 93180098, 120A, OE-NO 93180102, 130A, OE-NO 93180104	
					<b>AP9028</b>	ALT, (Bosch), OE-NO 93191921, 120A, OE-NO 93191922, 140A ⇒CH-NO 5545149	<b>VD1065</b>
	10/05-07/08	Z19DTL	74	1910	<b>AP9017</b>	ALT, (Denso), 100A, OE-NO 93180098, 120A, OE-NO 93180102, 130A, OE-NO 93180104	
					<b>AP9028</b>	ALT, (Bosch), OE-NO 93191921, 120A, OE-NO 93191922, 140A ⇒CH-NO 5545149	<b>VD1065</b>
1.9 CDTI 16V	04/04-08/05	Z19DTH	110	1910	<b>AP9017</b>	ALT, (Denso), 100A, OE-NO 93180098, 120A, OE-NO 93180102, 130A, OE-NO 93180104	
					<b>AP9028</b>	ALT, (Bosch), OE-NO 93191921, 120A, OE-NO 93191922, 140A ALT, (-AC), CH-NO 71021892⇒ ALT, AC, CH-NO 71021892⇒ ⇒CH-NO 71021891, 48999999 CH-NO 71021892⇒	<b>6PK1050D1</b> <b>6PK1413D2</b> <b>VD1065</b> <b>VD1067</b>
2.0 DTI 16V	10/03-07/08	Y20DTH	74	1995			<b>VD1031</b>
2.2 DTI 16V	10/03-07/08	Y22DTR	92	2172			<b>VD1031</b>

## VECTRA Mk II (C) GTS

1.6	01/06-07/08	Z16XEP	77	1598			<b>VD1106</b>
-----	-------------	--------	----	------	--	--	---------------



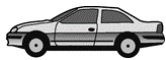

## VAUXHALL

### VECTRA Mk II (C) GTS

1.6 16V	06/04-07/08	Z16XE	74	1598	AP9003	ALT, (Bosch), 120A, OE-NO 9195336	
1.8	01/06-07/08	Z18XER	103	1796			VD1106
1.8 16V	08/02-07/08	Z18XE	90	1796	AP9003	ALT, (Bosch), 120A, OE-NO 9195336	
1.8 16V Dualfuel	08/02-07/08	Z18XE	90	1796	AP9003	ALT, (Bosch), 120A, OE-NO 9195336	
1.9 CDTI	04/04-08/05	Z19DT	88	1910	AP9017	ALT, (Denso), 100A, OE-NO 93180098, 120A, OE-NO 93180102, 130A, OE-NO 93180104	
					AP9028	ALT, (Bosch), OE-NO 93191921, 120A, OE-NO 93191922, 140A ⇒CH-NO 5545149	VD1065
	10/05-07/08	Z19DTL	74	1910	AP9017	ALT, (Denso), 100A, OE-NO 93180098, 120A, OE-NO 93180102, 130A, OE-NO 93180104	
					AP9028	ALT, (Bosch), OE-NO 93191921, 120A, OE-NO 93191922, 140A ⇒CH-NO 5545149	VD1065
1.9 CDTI 16V	04/04-08/05	Z19DTH	110	1910	AP9017	ALT, (Denso), 100A, OE-NO 93180098, 120A, OE-NO 93180102, 130A, OE-NO 93180104	
					AP9028	ALT, (Bosch), OE-NO 93191921, 120A, OE-NO 93191922, 140A ALT, (-AC), CH-NO 71021892⇒ ALT, AC, CH-NO 71021892⇒ ⇒CH-NO 71021891, 48999999 CH-NO 71021892⇒	6PK1050D1 6PK1413D2 VD1065 VD1067 VD1031
2.0 DTI 16V	08/02-07/08	Y20DTH	74	1995			VD1031
2.2 DTI 16V	08/02-07/08	Y22DTR	92	2172			VD1031

### VIVARO Combi

1.9 DI	08/01-		59	1900	AP9039 AP9043	ALT, (AC) ALT, (-AC)	
1.9 DTI	08/01-	F9Q760	74	1870	AP9039	ALT, (Valeo), 125A, OE-NO 9111540, 93160665, 93161425, 93189523	
					AP9043	ALT, (-AC)	
2.5 DTI	04/04-	G9U730	99	2463	AP9039	ALT, (Valeo), 125A, OE-NO 9111540, 93160665, 93161425, 93189523	

### VIVARO Kasten

1.9 DI	08/01-		59	1900	AP9039 AP9043	ALT, (AC) ALT, (-AC)	
1.9 DTI	08/01-	F9Q760	74	1870	AP9039	ALT, (Valeo), 125A, OE-NO 9111540, 93160665, 93161425, 93189523	
					AP9043	ALT, (-AC)	VD1101
2.5 DTI	04/04-	G9U730	99	2463	AP9039	ALT, (Valeo), 125A, OE-NO 9111540, 93160665, 93161425, 93189523	

### ZAFIRA Mk I (A)

1.6 16V	04/99-	X16XEL, Z16XE	74	1598	AP9003	ALT, (Bosch), 120A, OE-NO 9195336, MTR-CODE: X 16 XEL, CH-NO C 4G000001⇒	
					AP9003	ALT, (Bosch), 120A, OE-NO 9195336, MTR-CODE: Z 16 XE	
1.8 16V	05/99-08/00	X18XE1	85	1796	AP9003	ALT, (Bosch), 120A, OE-NO 9195336	
	09/00-08/05	Z18XE	92	1796	AP9003	ALT, (Bosch), 120A, OE-NO 9195336	
2.0 DI 16V	10/99-	X20DTL	60	1995		ALT, (-AC) ALT, (AC), ⇒CH-NO 2H019030, 22109974 ALT, (AC), CH-NO 2H019031⇒, 22109975⇒	6PK1800D1 6PK1863D1 6PK1870D1 VD1031
2.0 DTI 16V	04/99-08/05	Y20DTH	74	1995		ALT, (-AC) ALT, (AC), ⇒CH-NO 2H019030, 22109974 ALT, (AC), CH-NO 2H019031⇒, 22109975⇒	6PK1800D1 6PK1863D1 6PK1870D1 VD1031

### ZAFIRA Mk II (B)

1.6	07/05-	Z16XEP	77	1598			VD1106
1.9 CDTI	07/05-	Z19DT	88	1910	AP9017	ALT, (Denso), 100A, OE-NO 93180098, 120A, OE-NO 93180102, 130A, OE-NO 93180104	
					AP9028	ALT, (Bosch), OE-NO 93191921, 120A, OE-NO 93191922, 140A ⇒CH-NO 5545149	VD1065
		Z19DTH	110	1910	AP9017	ALT, (Denso), 100A, OE-NO 93180098, 120A, OE-NO 93180102, 130A, OE-NO 93180104	
					AP9028	ALT, (Bosch), OE-NO 93191921, 120A, OE-NO 93191922, 140A ALT, (-AC), CH-NO 72156709⇒,	6PK1050D1





## VAUXHALL

ZAFIRA Mk II (B)

						7G150346⇒ ALT, (AC), CH-NO 72156709⇒, 75189053⇒, 78104401⇒, OE-NO 93 185 361 ⇒CH-NO 72156708, 7G150345 CH-NO 72156709⇒, 7G150346⇒	<b>6PK1370D1</b>  <b>VD1065</b> <b>VD1067</b>
--	--	--	--	--	--	--------------------------------------------------------------------------------------------------------------------------------------------------	--------------------------------------------------------

## VOLVO

<b>850 (LS)</b>							
2.5 TDI	08/95-12/96	D5252T	103	2461			<b>VD1002</b>
<b>850 Kombi (LW)</b>							
2.5 TDI	08/95-12/96	D5252T	103	2461			<b>VD1002</b>
<b>C30</b>							
1.6 D	10/06-	D4164T	80	1560		⇒CH-NO 219999	<b>VD1094</b>
<b>C70 I Cabriolet</b>							
2.0 T	03/00-10/05	B5204T4	120	1984		01/2003⇒	<b>VD1102</b>
	03/98-10/05	B5204T3	166	1984		01/2003⇒	<b>VD1102</b>
2.3 T5	07/02-10/05	B5234T9	180	2319		01/2003⇒	<b>VD1102</b>
2.3 T-5	03/98-10/05	B5234T3	176	2319		01/2003⇒	<b>VD1102</b>
2.4 T	07/02-10/05	B5244T7	147	2435		01/2003⇒	<b>VD1102</b>
2.5 T	03/98-10/05	B5254T, B5244T	142	2435		01/2003⇒	<b>VD1102</b>
<b>S40 I (VS)</b>							
1.6	03/99-12/03	B4164S2	80	1587	<b>AP9051</b>	ALT, (Nippon Denso), 120A	
	09/95-08/99	B4164S	77	1588	<b>AP9051</b>	ALT, (Nippon Denso), 120A	
1.8	03/99-12/03	B4184S2, B4184S9	90	1783	<b>AP9051</b>	ALT, (Nippon Denso), 120A CH-NO CH920000⇒	<b>VD1102</b>
	07/95-08/99	B4184S, B4184S3	85	1731	<b>AP9051</b>	ALT, (Nippon Denso), 120A CH-NO CH920000⇒	<b>VD1102</b>
1.8 i	03/98-12/03	B4184SM	92	1834	<b>AP9051</b>	ALT, CH-NO 415000⇒, ⇒CH-NO 964074, (Nippon Denso), 120A	
	06/01-12/03	B4184SJ	90	1834	<b>AP9051</b>	ALT, CH-NO 415000⇒, ⇒CH-NO 964076, (Nippon Denso), 120A	
1.9 DI	03/99-07/00	D4192T2	70	1870	<b>AP9052</b>	ALT, (Valeo), OE-NO 8251638, 8251640, 80A, OE-NO 8251637, 8251646, 8602185, 110A, OE-NO 8251648, 120A	
	07/00-12/03	D4192T4	75	1870	<b>AP9039</b> <b>AP9052</b>	ALT, (Valeo), OE-NO 8251725, 125A, (AC) ALT, (Valeo), OE-NO 8251638, 8251640, 80A, OE-NO 8251637, 8251646, 8602185, 110A, OE-NO 8251648, 120A	
		D4192T3	85	1870	<b>AP9039</b> <b>AP9043</b> <b>AP9052</b>	ALT, (Valeo), OE-NO 8251725, 125A, (AC) ALT, (Valeo), OE-NO 36002231, 125A, (-AUTOM-AC) ALT, (Valeo), OE-NO 8251638, 8251640, 80A, OE-NO 8251637, 8251646, 8602185, 110A, OE-NO 8251648, 120A	
1.9 T4	05/97-07/00	B4194T, B4194T2	147	1855	<b>AP9051</b>	ALT, (Nippon Denso), 120A CH-NO CH920000⇒	<b>VD1102</b>
1.9 TD	07/95-08/99	D4192T	66	1870	<b>AP9052</b>	ALT, (Valeo), OE-NO 8251638, 8251640, 80A, OE-NO 8251637, 8251646, 8602185, 110A, OE-NO 8251648, 120A	
2.0	07/95-08/99	B4204S	103	1948	<b>AP9051</b>	ALT, (Nippon Denso), 120A CH-NO CH920000⇒	<b>VD1102</b>
	07/95-12/03	B4204S, B4204S2	100	1948	<b>AP9051</b>	ALT, (Nippon Denso), 120A CH-NO CH920000⇒	<b>VD1102</b>
2.0 T	06/01-12/03	B4204T3	120	1948	<b>AP9051</b>	ALT, (Nippon Denso), 120A CH-NO CH920000⇒	<b>VD1102</b>
	07/00-06/01	B4204T3	121	1948	<b>AP9051</b>	ALT, (Nippon Denso), 120A CH-NO CH920000⇒	<b>VD1102</b>
	10/97-07/00	B4204T	118	1948	<b>AP9051</b>	ALT, (Nippon Denso), 120A CH-NO CH920000⇒	<b>VD1102</b>
2.0 T4	07/00-12/03	B4204T5	147	1948	<b>AP9051</b>	ALT, (Nippon Denso), 120A CH-NO CH920000⇒	<b>VD1102</b>
<b>S40 II (MS)</b>							
1.6 D	01/05-	D4164T	81	1560			<b>VD1094</b>
<b>S60</b>							
2.0 T	09/01-	B5204T5	132	1984	<b>AP9041</b>	ALT, (Bosch), Ø 61 mm, 120A, 140A, 160A, ⇒07/2004 01/2003⇒	<b>VD1102</b>
2.3 T5	07/00-09/02	B5234T7	195	2319	<b>AP9041</b>	ALT, (Bosch), Ø 61 mm, 120A, 140A, 160A	







## VOLVO

**S60**

						ALT	<b>6DPK1841D1</b> <b>VD1077</b>
2.4	11/00-	B5244S2	103	2435	<b>AP9041</b>	ALT, (Bosch), Ø 61 mm, 120A, 140A, 160A, ⇨07/2004 01/2003⇨	<b>VD1102</b>
		B5244S	125	2435	<b>AP9041</b>	ALT, (Bosch), Ø 61 mm, 120A, 140A, 160A, ⇨07/2004 01/2003⇨	<b>VD1102</b>
2.4 AWD	02/04-	B5244T5	191	2401		ALT, MODEL '08⇨, ⇨CH-NO 545224 MODEL '08⇨, ⇨CH-NO 545224	<b>6DPK1841D1</b> <b>VD1077</b>
2.4 Bifuel	06/02-	B5244SG2	103	2435	<b>AP9041</b>	ALT, (Bosch), Ø 61 mm, 120A, 140A, 160A, ⇨07/2004 01/2003⇨	<b>VD1102</b>
2.4 D	09/05-	D5244T7	93	2401		ALT, PS, AC	<b>6DPK1841D1</b> <b>VD1077</b>
	12/01-	D5244T2	96	2401	<b>AP9033</b>	ALT, (Bosch), Ø 73 mm, 120A, 140A, 160A, ⇨06/2004 ALT, PS, AC	<b>6DPK1841D1</b> <b>VD1077</b>
2.4 D5	07/01-	D5244T	120	2401	<b>AP9033</b> <b>AP9041</b>	ALT, (Bosch), Ø 73 mm, 120A, 140A, 160A, ⇨06/2004 ALT, (Bosch), Ø 61 mm, 120A, 140A, 160A, ⇨07/2004 ALT	<b>6DPK1841D1</b> <b>VD1077</b>
	09/05-	D5244T4	136	2401		ALT	<b>6DPK1841D1</b> <b>VD1077</b>
2.4 T	11/00-	B5244T3	147	2435	<b>AP9041</b>	ALT, (Bosch), Ø 61 mm, 120A, 140A, 160A, ⇨07/2004 01/2003⇨	<b>VD1102</b>
2.4 T AWD	11/01-	B5244T3	147	2435	<b>AP9041</b>	ALT, (Bosch), Ø 61 mm, 120A, 140A, 160A, ⇨07/2004 01/2003⇨	<b>VD1102</b>
2.4 T5	04/04-	B5244T5	191	2401		MODEL '08⇨, ⇨CH-NO 545224	<b>VD1102</b>
2.5 T	02/04-	B5254T2	154	2521	<b>AP9033</b>	ALT, (Bosch), Ø 73 mm, 160A, ⇨06/2004	<b>VD1102</b>
2.5 T AWD	04/04-	B5254T2	154	2521	<b>AP9041</b>	ALT, (Bosch), Ø 61 mm, 120A, 140A, 160A, ⇨07/2004	<b>VD1102</b>
R 2.5 T AWD	03/03-	B5254T4	221	2521	<b>AP9033</b> <b>AP9041</b>	ALT, (Bosch), Ø 73 mm, 160A, ⇨06/2004 ALT, (Bosch), Ø 61 mm, 120A, 140A, 160A, ⇨07/2004	<b>VD1102</b>
T5	11/00-	B5234T3	184	2319	<b>AP9041</b>	ALT, (Bosch), Ø 61 mm, 120A, 140A, 160A, ⇨07/2004 01/2003⇨	<b>VD1102</b>

**S70 (P80 )**

2.5 TDi	01/97-11/00	D5252T	103	2461			<b>VD1002</b>
2.5 TDi AWD	10/99-09/00	D5252T	103	2460			<b>VD1002</b>

**S80 (TS, XY)**

2.0	06/98-07/06	B5204T4	120	1984	<b>AP9041</b>	ALT, (Bosch), Ø 61 mm, 120A, 140A, 160A 01/2003⇨	<b>VD1102</b>
2.0 T	06/98-07/06	B5204T3	166	1984	<b>AP9041</b>	ALT, (Bosch), Ø 61 mm, 120A, 140A, 160A 01/2003⇨	<b>VD1102</b>
	12/99-07/06	B5204T5	132	1984	<b>AP9041</b>	ALT, (Bosch), Ø 61 mm, 120A, 140A, 160A 01/2003⇨	<b>VD1102</b>
2.3 R	04/00-08/05	B5234T7	195	2319	<b>AP9041</b>	ALT, (Bosch), Ø 61 mm, 120A, 140A, 160A	
2.4	01/99-07/06	B5244S2	103	2435	<b>AP9041</b>	ALT, (Bosch), Ø 61 mm, 120A, 140A, 160A 01/2003⇨	<b>VD1102</b>
		B5244S	125	2435	<b>AP9041</b>	ALT, (Bosch), Ø 61 mm, 120A, 140A, 160A 01/2003⇨	<b>VD1102</b>
2.4 Bifuel	09/01-07/06	B5244SG2	103	2435	<b>AP9041</b>	ALT, (Bosch), Ø 61 mm, 120A, 140A, 160A 01/2003⇨	<b>VD1102</b>
2.4 D	10/01-07/06	D5244T2	96	2401	<b>AP9033</b> <b>AP9041</b>	ALT, (Bosch), Ø 73 mm, 120A, 140A, 160A ALT, (Bosch), Ø 61 mm, 120A, 140A, 160A, 01/2002⇨ ALT	<b>6DPK1841D1</b> <b>VD1077</b>
2.4 D5	08/01-07/06	D5244T	120	2401	<b>AP9033</b>	ALT, (Bosch), Ø 73 mm, 120A, 140A,	





# VOLVO

S80 (TS, XY)

					<b>AP9041</b>	160A ALT, (Bosch), Ø 61 mm, 120A, 140A, 160A, 01/2002⇒ ALT	<b>6DPK1841D1 VD1077</b>
2.4 T	06/00-07/06	B5244T3	147	2435	<b>AP9033</b> <b>AP9041</b>	ALT, (Bosch), Ø 73 mm, 120A, 140A, 160A ALT, (Bosch), Ø 61 mm, 120A, 140A, 160A 01/2003⇒	<b>VD1102</b>
2.4 T5 AWD	04/00-09/03	B5244T3	147	2435	<b>AP9033</b> <b>AP9041</b>	ALT, (Bosch), Ø 73 mm, 120A, 140A, 160A ALT, (Bosch), Ø 61 mm, 120A, 140A, 160A	
2.5 T	03/03-07/06	B5254T2	154	2521	<b>AP9041</b>	ALT, (Bosch), Ø 61 mm, 120A, 140A, 160A	<b>VD1102</b>
2.5 T AWD	07/03-07/06	B5254T2	154	2521	<b>AP9041</b>	ALT, (Bosch), Ø 61 mm, 120A, 140A, 160A	<b>VD1102</b>
2.5 TDI	01/99-07/06	D5252T	103	2461	<b>AP9033</b> <b>AP9041</b>	ALT, (Bosch), Ø 73 mm, 120A, 140A, 160A ALT, (Bosch), Ø 61 mm, 120A, 140A, 160A, 01/2002⇒	<b>VD1002</b>
2.8 T6	05/98-07/06	B6284T	200	2783	<b>AP9041</b>	ALT, (Bosch), Ø 61 mm, 120A, 140A, 160A	
2.9	03/99-07/06	B6294S	147	2922	<b>AP9041</b>	ALT, (Bosch), Ø 61 mm, 120A, 140A, 160A	
	05/98-07/06	B6304S3	150	2922	<b>AP9041</b>	ALT, (Bosch), Ø 61 mm, 120A, 140A, 160A	
<b>S80 II</b>							
1.6 D DRIVe	01/10-	D4164T	80	1560			<b>VD1094</b>
2.0 TDi	02/08-	D4204T	100	1997	<b>AP9023</b>	ALT, (Bosch), 150A, OE-NO 30795169, 36000798, ALT-No: 0 121 615 028	
2.4 D	03/06-	D5244T, D5244T5	120	2400	<b>AP9041</b>	ALT, (Bosch), Ø 61 mm, 120A, 140A, 160A	
<b>V40 Kombi (VW)</b>							
1.6	03/99-06/04	B4164S2	80	1587	<b>AP9051</b>	ALT, (Nippon Denso), 120A	
	12/95-08/99	B4164S	77	1588	<b>AP9051</b>	ALT, (Nippon Denso), 120A	
1.8	03/99-06/04	B4184S2, B4184S9	90	1783	<b>AP9051</b>	ALT, (Nippon Denso), 120A CH-NO CH920000⇒	<b>VD1102</b>
	07/95-08/99	B4184S, B4184S3	85	1731	<b>AP9051</b>	ALT, (Nippon Denso), 120A CH-NO CH920000⇒	<b>VD1102</b>
1.8 i	03/98-06/04	B4184SM	92	1834	<b>AP9051</b>	ALT, CH-NO 415000⇒, ⇒CH-NO 964074, (Nippon Denso), 120A	
	06/01-06/04	B4184SJ	90	1834	<b>AP9051</b>	ALT, CH-NO 415000⇒, ⇒CH-NO 964074, (Nippon Denso), 120A	
1.9 DI	03/99-07/00	D4192T2	70	1870	<b>AP9052</b>	ALT, (Valeo), OE-NO 8251638, 8251640, 80A, OE-NO 8251637, 8251646, 8602185, 110A, OE-NO 8251648, 120A	
	07/00-06/04	D4192T4	75	1870	<b>AP9052</b>	ALT, (Valeo), OE-NO 8251638, 8251640, 80A, OE-NO 8251637, 8251646, 8602185, 110A, OE-NO 8251648, 120A	
		D4192T3	85	1870	<b>AP9052</b>	ALT, (Valeo), OE-NO 8251638, 8251640, 80A, OE-NO 8251637, 8251646, 8602185, 110A, OE-NO 8251648, 120A	
1.9 T4	05/97-07/00	B4194T	147	1855	<b>AP9051</b>	ALT, (Nippon Denso), 120A CH-NO CH920000⇒	<b>VD1102</b>
1.9 TD	07/95-08/99	D4192T	66	1870	<b>AP9052</b>	ALT, (Valeo), OE-NO 8251638, 8251640, 80A, OE-NO 8251637, 8251646, 8602185, 110A, OE-NO 8251648, 120A	
2.0	07/95-06/04	B4204S	100	1948	<b>AP9051</b>	ALT, (Nippon Denso), 120A CH-NO CH920000⇒	<b>VD1102</b>
	07/95-08/99	B4204S	103	1948	<b>AP9051</b>	ALT, (Nippon Denso), 120A CH-NO CH920000⇒	<b>VD1102</b>
2.0 T	06/01-06/04	B4204T3	120	1948	<b>AP9051</b>	ALT, (Nippon Denso), 120A CH-NO CH920000⇒	<b>VD1102</b>
	07/99-06/01	B4204T2	121	1948	<b>AP9051</b>	ALT, (Nippon Denso), 120A CH-NO CH920000⇒	<b>VD1102</b>
	10/97-07/00	B4204T	118	1948	<b>AP9051</b>	ALT, (Nippon Denso), 120A CH-NO CH920000⇒	<b>VD1102</b>
2.0 T4	07/00-06/04	B4204T5	147	1948	<b>AP9051</b>	ALT, (Nippon Denso), 120A	



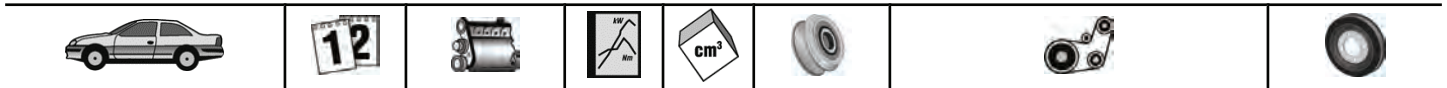

## VOLVO

VOLVO							
<b>V40 Kombi (VW)</b>							
						CH-NO CH920000⇒	<b>VD1102</b>
<b>V50 (MW)</b>							
1.6 D	01/05-	D4164T	81	1560			<b>VD1094</b>
<b>V70 I Kombi (P80_)</b>							
2.3 AWD	12/98-02/00	B5234T7, B5234T8	195	2319	<b>AP9041</b>	ALT, (Bosch), Ø 61 mm, 120A, 140A, 160A	
2.5 TDI	01/97-05/00	D5252T	103	2461			<b>VD1002</b>
2.5 TDi AWD	11/96-02/00	D5252T	103	2460			<b>VD1002</b>
<b>V70 II Kombi (P80_)</b>							
2.0 T	07/01-	B5204T5	132	1984	<b>AP9041</b>	ALT, (Bosch), Ø 61 mm, 120A, 140A, 160A, ⇒07/2004 01/2003⇒	<b>VD1102</b>
2.3	10/00-09/04	B5234T7	195	2319	<b>AP9041</b>	ALT, (Bosch), Ø 61 mm, 120A, 140A, 160A, ⇒07/2004	
2.3 AWD	10/00-09/04	B5234T7, B5234T8	195	2319	<b>AP9041</b>	ALT, (Bosch), Ø 61 mm, 120A, 140A, 160A, ⇒07/2004, MTR-CODE: B5234T7	
2.3 T5	03/00-	B5234T3, B5234T4	184	2319	<b>AP9041</b>	ALT, (Bosch), Ø 61 mm, 120A, 140A, 160A, ⇒07/2004, MTR-CODE: B5234T3 01/2003⇒	<b>VD1102</b>
2.4	03/00-	B5244S2	103	2435	<b>AP9041</b>	ALT, (Bosch), Ø 61 mm, 120A, 140A, 160A, ⇒07/2004 01/2003⇒	<b>VD1102</b>
		B5244S	125	2435	<b>AP9041</b>	ALT, (Bosch), Ø 61 mm, 120A, 140A, 160A, ⇒07/2004 01/2003⇒	<b>VD1102</b>
2.4 Bifuel	09/01-	B5244SG	103	2435	<b>AP9041</b>	ALT, (Bosch), Ø 61 mm, 120A, 140A, 160A, ⇒07/2004 01/2003⇒	<b>VD1102</b>
2.4 D	05/05-		93	2400			<b>VD1077</b>
	12/01-	D5244T2	96	2401	<b>AP9033</b>	ALT, (Bosch), Ø 73 mm, 120A, 140A, 160A, ⇒06/2004 ALT	<b>6DPK1841D1</b> <b>VD1077</b>
2.4 D5	08/01-		120	2401	<b>AP9033</b> <b>AP9041</b>	ALT, (Bosch), Ø 73 mm, 120A, 140A, 160A, ⇒06/2004 ALT, (Bosch), Ø 61 mm, 120A, 140A, 160A, ⇒07/2004 ALT, ⇒07/2007	<b>6DPK1841D1</b> <b>VD1077</b>
		12/05-	D5244T4	136	2401		ALT, ⇒07/2007
2.4 D5 AWD	03/03-	D5244T2	120	2401	<b>AP9033</b>	ALT, (Bosch), Ø 73 mm, 120A, 140A, 160A, ⇒06/2004 ALT, PS, AC	<b>6DPK1841D1</b> <b>VD1077</b>
	12/05-	D5244T4	136	2401		ALT, ⇒07/2007	<b>6DPK1841D1</b> <b>VD1077</b>
2.4 T	03/00-	B5244T3	147	2435	<b>AP9041</b>	ALT, (Bosch), Ø 61 mm, 120A, 140A, 160A, ⇒07/2004 01/2003⇒	<b>VD1102</b>
2.4 T AWD	09/01-	B5244T3	147	2435	<b>AP9041</b>	ALT, (Bosch), Ø 61 mm, 120A, 140A, 160A, ⇒07/2004	
2.4 T5	04/04-	B5244T5	191	2401			<b>VD1102</b>
2.5 T	04/04-	B5254T2	154	2521	<b>AP9033</b>	ALT, (Bosch), Ø 73 mm, 120A, 140A, 160A, ⇒06/2004	<b>VD1102</b>
2.5 T AWD	09/02-	B5254T2	154	2521	<b>AP9033</b>	ALT, (Bosch), Ø 73 mm, 120A, 140A, 160A, ⇒06/2004 01/2003⇒	<b>VD1102</b>
2.5 TDI	03/00-	D5252T	103	2461	<b>AP9033</b>	ALT, (Bosch), Ø 73 mm, 120A, 140A, 160A, ⇒06/2004	<b>VD1002</b>
R 2.5 T AWD	03/03-	B5254T4	221	2521	<b>AP9033</b> <b>AP9041</b>	ALT, (Bosch), Ø 73 mm, 160A, ⇒06/2004 ALT, (Bosch), Ø 61 mm, 120A, 140A, 160A, ⇒07/2004	<b>VD1102</b>
<b>V70 III Kombi</b>							
1.6 D	01/10-	D4164T	80	1560			<b>VD1094</b>
2.0 D	10/07-	D4204T	100	1997	<b>AP9023</b>	ALT, (Bosch), 150A, OE-NO 30795169, 36000798, ALT-No: 0 121 615 028	
<b>XC 90</b>							
2.5 T	10/02-	B5254T2	154	2521	<b>AP9041</b>	ALT, (Bosch), Ø 61 mm, 140A, 160A	<b>VD1102</b>
D5	04/09-	D5244T5	120	2400	<b>AP9041</b>	ALT, (Bosch), Ø 61 mm, 160A	<b>VD1077</b>





## VW VOLVO

XC 90							
	05/06-	D5244T4	136	2401	AP9041	ALT, (Bosch), Ø 61 mm, 160A ALT, ⇒CH-NO 288075	6DPK1841D1 VD1077
	10/02-	D5244T	120	2401	AP9041	ALT, (Bosch), Ø 61 mm, 140A, 160A ALT, ⇒CH-NO 288075	6DPK1841D1 VD1077
XC70 CROSS COUNTRY							
2.4 D5 AWD	12/05-	D5244T4	136	2401			VD1077
2.4 D5 XC AWD	09/02-	D5244T	120	2401	AP9033 AP9041	ALT, (Bosch), Ø 73 mm, 120A, 140A, 160A, ⇒06/2004 ALT, (Bosch), Ø 61 mm, 120A, 140A, 160A, ⇒07/2004	VD1077
2.4 T XC AWD	03/00-09/02	B5244T3	147	2435	AP9041	ALT, (Bosch), Ø 61 mm, 120A, 140A, 160A	
2.5 T XC AWD	09/02-	B5254T2	154	2521	AP9033 AP9041	ALT, (Bosch), Ø 73 mm, 160A, ⇒06/2004 ALT, (Bosch), Ø 61 mm, 120A, 140A, 160A, ⇒07/2004 01/2003⇒	VD1102

## VW

AMAROK							
2.0 BiTDI	09/10-	CDCA	120	1968		MTR-CODE: CDCA	VD1111
2.0 BiTDI 4motion	09/10-	CDCA	120	1968		MTR-CODE: CDCA	VD1111
BORA (1J2)							
1.6	08/00-05/05	AVU, BFQ, BJH	75	1595	AP9001 AP9001	ALT, (Bosch,Valeo), 120A ALT, MTR-CODE: AVU, (Hitachi), 120A	
	10/98-05/05	AEH, AKL, APF	74	1595	AP9001	MTR-CODE: AEH, AKL, ALT, (Valeo), 120A, OE-NO 038903023S	
1.8 4motion	02/99-05/05	AGN	92	1781			VD1107
1.8 T	03/02-05/05	AUQ	132	1781	AP9001	ALT, (Bosch,Valeo), (Hitachi), 120A	VD1107
	05/00-05/05	AGU, ARX, AUM, BAE	110	1781	AP9001	ALT, (Bosch,Valeo), (Hitachi), 120A	VD1107
1.9 SDI	10/98-05/05	AGP, AQM	50	1896	AP9001 AP9001	ALT, (Bosch), 70A, 90A, 120A ALT, MTR-CODE: AQM, (Valeo), 120A ALT, PS, (AC), CH-NO 1J-3D016 001⇒ ALT, PS, (AC), CH-NO 1J-3W350 001⇒ CH-NO 1J-3D016 001⇒, 1J-3W350 001⇒ ⇒CH-NO 1J-3D016 000, 1J-3W350 000	6PK1660D1 6PK1660D1 VD1076 VD1089
1.9 TDI	05/00-05/05	ARL	110	1896	AP9001 AP9001	(Valeo), OE-NO 028903023Q, 038903023C, 70A, OE-NO 038903023R, 038903024E, 90A, OE-NO 038903023S, 038903024G, 120A ALT, (Bosch), OE-NO 038903023K, 038903024B, 70A, OE-NO 038903023L, 038903024D, 90A, OE-NO 028903028E, 120A	VD1091
	09/00-05/05	ATD, AXR	74	1896	AP9001 AP9001	ALT, (Bosch), 70A, OE-NO 038903023K, 038903023B, 90A, OE-NO 038903023L, 038903024D, 120A, OE-NO 028903023E ALT, (Valeo), 70A, OE-NO 028903023Q, 038903024C, 90A, OE-NO 038903023R, 038903024E, 120A, OE-NO 03890023S, 038903024G	VD1091
	10/98-06/01	AGR, ALH	66	1896	AP9001 AP9001	ALT, (Bosch), 70A, OE-NO 038903023K, 038903023B, 90A, OE-NO 038903023L, 038903023D, 120A, OE-NO 028903028E ALT, (Valeo), 70A, OE-NO 028903023Q, 038903024C, 90A, OE-NO 038903023R, 038903024E, 120A, OE-NO 03890023S, 03890024G CH-NO 1J-3D016 001⇒, 1J-3W350 001⇒ ⇒CH-NO 1J-3D016 000, 1J-3W350 000	VD1076 VD1089
		AHF, ASV	81	1896	AP9001 AP9001	ALT, (Bosch), 70A, OE-NO 038903023K, 038903024B, 90A, OE-NO 038903023L, 038903024D, 120A, OE-NO 028903023E ALT, (Valeo), 70A, OE-NO	

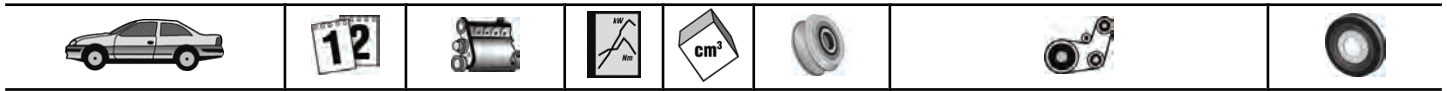

**VW**
**BORA (1J2)**

						028903023Q, 038903023C, 90A, OE-NO 038903023R, 038903023E, 120A, OE-NO 038903023S, 038903024G CH-NO 1J-3D016 001⇒, 1J-3W350 001⇒ ⇒CH-NO 1J-3D016 000, 1J-3W350 000	<b>VD1076</b> <b>VD1089</b>
	11/00-05/05	ASZ	96	1896	<b>AP9001</b>  <b>AP9001</b>	ALT, (Bosch), OE-NO 038903023K, 038903023B, 70A, OE-NO 038903023L, 038903023D, 90A, OE-NO 028903028E, 120A ALT, (Valeo), OE-NO 028903023Q, 038903024C, 70A, OE-NO 038903023R, 038903023E, 90A, OE-NO 038903023S, 038903023G, 120A MTR-CODE: ASZ, MTR-NO 435 001⇒ MTR-CODE: ASZ, ⇒MTR-NO 435 000	<b>VD1076</b> <b>VD1091</b>
	12/98-06/01	AJM, AUY	85	1896	<b>AP9001</b> <b>AP9001</b>	ALT, (Bosch,Valeo), 70A, 90A, 120A ALT, MTR-CODE: AUY, (Hitachi), 120A	<b>VD1091</b>
1.9 TDI 4motion	02/99-06/01	AGR	66	1896	<b>AP9001</b>  <b>AP9001</b>	ALT, (Bosch), 70A, OE-NO 038903023K, 038903023B, 90A, OE-NO 038903023L, 038903024D, 120A, OE-NO 028903028E ALT, (Valeo), 70A, OE-NO 028903023Q, 038903024C, 90A, OE-NO 038903023R, 038903024E, 120A, OE-NO 038903023S, 038903024G CH-NO 1J-3D016 001⇒, 1J-3W350 001⇒ ⇒CH-NO 1J-3D016 000, 1J-3W350 000	<b>VD1076</b> <b>VD1089</b>
		AJM, AUY	85	1896	<b>AP9001</b> <b>AP9001</b>	ALT, (Bosch,Valeo), 70A, 90A, 120A ALT, MTR-CODE: AUY, (Hitachi), 120A	<b>VD1091</b>
	05/00-05/05	ARL	110	1896	<b>AP9001</b>  <b>AP9001</b>	ALT, (Bosch), OE-NO 038903023K, 038903024B, 70A, OE-NO 038903023L, 038903023D, 90A, OE-NO 028903028E, 120A ALT, (Valeo), OE-NO 028903023Q, 038903023C, 70A, OE-NO 038903023R, 038903023E, 90A, OE-NO 038903023S, 038903023G, 120A	<b>VD1091</b>
	09/00-05/05	ATD	74	1896	<b>AP9001</b>  <b>AP9001</b>	ALT, (Bosch), 70A, OE-NO 038903023K, 038903023B, 90A, OE-NO 038903023L, 038903024D, 120A, OE-NO 028903028E ALT, (Valeo), 70A, OE-NO 028903023Q, 038903024C, 90A, OE-NO 038903023R, 038903024E, 120A, OE-NO 038903024G	<b>VD1091</b>
	11/00-05/05	ASZ	96	1896	<b>AP9001</b>  <b>AP9001</b>	ALT, (Bosch), OE-NO 038903023K, 038903024B, 70A, OE-NO 038903023L, 038903023D, 90A, OE-NO 028903023E, 120A ALT, (Valeo), OE-NO 028903023Q, 038903023C, 70A, OE-NO 038903023R, 038903023E, 90A, OE-NO 038903023S, 038903023G, 120A MTR-CODE: ASZ, MTR-NO 435 001⇒ MTR-CODE: ASZ, ⇒MTR-NO 435 000	<b>VD1076</b> <b>VD1091</b>
2.0	10/98-05/05	AQY, APK, AZG, AZH, AZJ, BBW	85	1984	<b>AP9001</b>	ALT, (Bosch,Valeo), (Hitachi), 120A	<b>VD1107</b>
2.0 4motion	04/00-05/05	AZH, AZJ	85	1984	<b>AP9001</b>	ALT, (Bosch,Valeo), (Hitachi), 120A	<b>VD1107</b>
2.3 V5	10/00-05/05	AQN	125	2324	<b>AP9001</b>  <b>AP9001</b>	ALT, (Bosch), 70A, OE-NO 038903023K, 038903024B, 90A, OE-NO 038903023L, 038903024D, 120A, OE-NO 028903028E ALT, (Valeo), 70A, OE-NO 028903023Q, 038903024C, 90A, OE-NO 038903023R, 038903024E,	

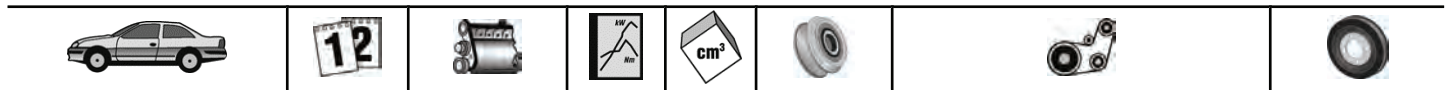

**VW**
**BORA (1J2)**

						120A, OE-NO 038903023S, 038903024G	
2.3 V5 4motion	10/98-10/00	AGZ	110	2324	AP9001	ALT, (Bosch,Valeo), 70A, 90A, 120A	
	10/00-05/05	AQN	125	2324	AP9001	ALT, (Bosch), 70A, OE-NO 038903023K, 038903024B, 90A, OE-NO 038903023L, 038903024D, 120A, OE-NO 028903028E	
					AP9001	ALT, (Valeo), 70A, OE-NO 028903023Q, 038903024C, 90A, OE-NO 038903023R, 038903024E, 120A, OE-NO 038903023S, 038903024G	
2.8 V6 4motion	12/98-10/00	AGZ	110	2324	AP9001	ALT, (Bosch,Valeo), 70A, 90A, 120A	
	03/99-05/05	AQP, AUE, BDE	150	2792	AP9001	ALT, MTR-CODE: AQP, (Valeo), 70A, 90A	
					AP9001	ALT, MTR-CODE: AUE, (Bosch), 120A	
					AP9001	ALT, MTR-CODE: AUE, (Bosch,Valeo), 70A, 90A	
					AP9001	ALT, MTR-CODE: BDE, (Bosch,Valeo), 70A, 90A, 120A	
					AP9001	ALT, MTR-CODE: BDE, (Hitachi), 120A	
<b>BORA Kombi (1J6)</b>							
1.6	05/99-05/05	AEH, AKL, APF	74	1595	AP9001	ALT, MTR-CODE: AEH, AKL, (Bosch,Valeo), (Hitachi), 120A	
1.8 4motion	05/99-05/05	AGN	92	1781			VD1107
1.8 T	05/00-05/05	AGU, ARX, AUM	110	1781	AP9001	ALT, MTR-CODE: AGU, AUM, (Bosch,Valeo), (Hitachi), 120A	
							VD1107
	05/02-05/05	AUQ	132	1781	AP9001	ALT, (Bosch,Valeo), (Hitachi), 120A	
							VD1107
1.9 TDI	05/01-05/05	ARL	110	1896	AP9001	ALT, (Bosch,Valeo), 70A, 90A, 120A	
					AP9001	ALT, (Hitachi), 120A	
							VD1091
	05/99-06/01	AHF, ASV	81	1896	AP9001	ALT, (Bosch,Valeo), 70A, 90A, 120A	
					AP9001	ALT, (Hitachi), 120A	
						CH-NO 1J-3D016 001⇒, 1J-3W350 001⇒	VD1076
						⇒CH-NO 1J-3D016 000, 1J-3W350 000	VD1089
		AJM, AUY	85	1896	AP9001	ALT, (Bosch,Valeo), 70A, 90A, 120A	
					AP9001	ALT, (Hitachi), 120A	
							VD1091
	07/04-05/05	AGR	66	1896	AP9001	ALT, (Bosch,Valeo), 70A, 90A, 120A	
					AP9001	ALT, (Hitachi), 120A	
	09/00-05/05	ATD, AXR	74	1896	AP9001	ALT, (Bosch,Valeo), 70A, 90A, 120A	
					AP9001	ALT, (Hitachi), 120A	
							VD1091
	11/00-05/05	ASZ	96	1896	AP9001	ALT, (Bosch,Valeo), 70A, 90A, 120A	
					AP9001	ALT, (Hitachi), 120A	
						MTR-CODE: ASZ, MTR-NO 435 001⇒	VD1076
						MTR-CODE: ASZ, ⇒MTR-NO 435 000	VD1091
1.9 TDI 4motion	05/01-05/05	ARL	110	1896	AP9001	ALT, (Bosch,Valeo), 70A, 90A, 120A	
					AP9001	ALT, (Hitachi), 120A	
							VD1091
	05/99-06/01	AJM, AUY	85	1896	AP9001	ALT, (Bosch,Valeo), 70A, 90A, 120A	
					AP9001	ALT, (Hitachi), 120A	
							VD1091
	09/00-05/05	ATD	74	1896	AP9001	ALT, (Bosch,Valeo), 70A, 90A, 120A	
					AP9001	ALT, (Hitachi), 120A	
							VD1091
	11/00-05/05	ASZ	96	1896	AP9001	ALT, (Bosch,Valeo), 70A, 90A, 120A	
					AP9001	ALT, (Hitachi), 120A	
						MTR-CODE: ASZ, MTR-NO 435 001⇒	VD1076
						MTR-CODE: ASZ, ⇒MTR-NO 435 000	VD1091
2.0	05/99-05/05	AQY, APK, AZG, AZH, AZJ	85	1984	AP9001	ALT, (Bosch,Valeo), (Hitachi), 120A	
2.0 4motion	04/00-05/05	AZH, AZJ	85	1984	AP9001	ALT, (Bosch,Valeo), (Hitachi), 120A	
							VD1107
2.3 V5	05/99-10/00	AGZ	110	2324	AP9001	ALT, (Bosch,Valeo), 70A, 90A, 120A	
	10/00-05/05	AQN	125	2324	AP9001	ALT, (Bosch,Valeo), 70A, 90A, 120A	
					AP9001	ALT, (Hitachi), 120A	
2.3 V5 4motion	05/99-10/00	AGZ	110	2324	AP9001	ALT, (Bosch,Valeo), 70A, 90A, 120A	
	10/00-05/05	AQN	125	2324	AP9001	ALT, (Bosch,Valeo), 70A, 90A, 120A	
					AP9001	ALT, (Hitachi), 120A	
2.8 V6 4motion	05/99-05/05	AQP, AUE, BDE	150	2792	AP9001	ALT, MTR-CODE: AUE, BDE, (Bosch,Valeo), 70A, 90A, 120A	
					AP9001	ALT, MTR-CODE: AUE, BDE, (Hitachi), 120A	



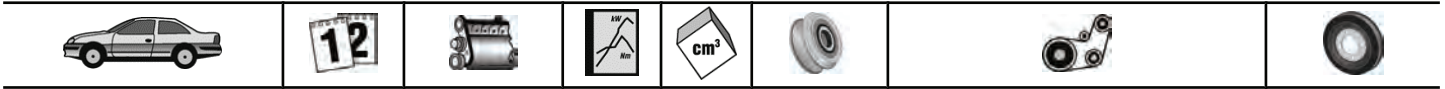

# VW

CADDY II Kasten (9K9A)							
↩ 1.7 SDI	07/96-09/00	AHB	42	1716	AP9004	ALT, (Bosch), 120A, OE-NO 028 903 026 G	
					AP9004	ALT, ⇒CH-NO 9K-X-505715, (Bosch), 90A, OE-NO 028 903 028 J	
					AP9004	ALT, CH-NO 9K-X-505716⇒, (Bosch), 70A, OE-NO 6K0 903 028	
1.9 D	11/95-01/04	1Y	47	1896		MTR-CODE: 1Y	VD1084
1.9 SDI	11/95-01/04	AEY, AYQ	47	1896	AP9001	MTR-CODE: AYQ, ALT, (Bosch), 70A, OE-NO 038903023K, 90A, OE-NO 038903023L, 120A, OE-NO 038903028E	
					AP9004	⇒CH-NO 9K-X-505715, (Bosch), 90A, OE-NO 028 903 028 J	
					AP9004	ALT, (Bosch), 120A, OE-NO 028 903 026 G	
					AP9004	ALT, CH-NO 9K-X-505716⇒, (Bosch), 70A, OE-NO 6K0 903 028	
					AP9004	ALT, MTR-CODE: AEY	
					MTR-CODE: AYQ, MTR-NO 074 038⇒	VD1076	
					MTR-CODE: AEY	VD1084	
					MTR-CODE: AYQ, ⇒MTR-NO 074 037	VD1089	
1.9 TDI	09/96-01/04	1Z, AHU, ALH	66	1896	AP9004	ALT, MTR-CODE: AHU, ALE, 1Z, (Bosch), 120A, OE-NO 028 903 026 G	
					AP9004	ALT, MTR-CODE: AHU, ALE, 1Z, CH-NO 9K-X-505716⇒, (Bosch), 70A, OE-NO 6K0 903 028	
					AP9004	ALT, MTR-CODE: AHU, ALE,, ⇒CH-NO 9K-X505715, (Bosch), 90A, OE-NO 028 903 028 J	
					MTR-CODE: ALH, MTR-NO 896 340⇒	VD1076	
					MTR-CODE: 1Z, AHU	VD1084	
					MTR-CODE: ALH, ⇒MTR-NO 896 339	VD1089	
CADDY II Kombi (9K9B)							
↩ 1.7 SDI	07/96-09/00	AHB	42	1716	AP9004	ALT, (Bosch), 120A, OE-NO 028 903 026 G	
					AP9004	ALT, ⇒CH-NO 9K-X505715, (Bosch), 90A, OE-NO 028 903 028 J	
					AP9004	ALT, CH-NO 9K-X-505716⇒, (Bosch), 70A, OE-NO 6K0 903 028	
1.9 D	11/95-01/04	1Y	47	1896		MTR-CODE: 1Y	VD1084
1.9 SDI	11/95-01/04	AEY, AYQ	47	1896	AP9001	MTR-CODE: AYQ, ALT, (Bosch), 70A, OE-NO 038903023K, 90A, OE-NO 038903023L, 120A, OE-NO 038903028E	
					AP9004	⇒CH-NO 9K-X505715, (Bosch), 90A, OE-NO 028 903 028 J	
					AP9004	ALT, (Bosch), 120A, OE-NO 028 903 026 G	
					AP9004	ALT, CH-NO 9K-X-505716⇒, (Bosch), 70A, OE-NO 6K0 903 028	
					AP9004	ALT, MTR-CODE: AEY	
					MTR-CODE: AYQ, MTR-NO 074 038⇒	VD1076	
					MTR-CODE: AEY	VD1084	
					MTR-CODE: AYQ, ⇒MTR-NO 074 037	VD1089	
1.9 TDI	10/96-01/04	AHU, ALH, ALE	66	1896	AP9004	ALT, MTR-CODE: AHU,ALE, (Bosch), 120A, OE-NO 028 903 026 G	
					AP9004	ALT, MTR-CODE: AHU,ALE, ⇒CH-NO 9K-X505715, (Bosch), 90A, OE-NO 028 903 028 J	
					AP9004	ALT, MTR-CODE: AHU,ALE, CH-NO 9K-X-505716⇒, (Bosch), 70A, OE-NO 6K0 903 028	
					MTR-CODE: ALH, MTR-NO 896 340⇒	VD1076	
					MTR-CODE: ALE, AHU	VD1084	
					MTR-CODE: ALH, ⇒MTR-NO 896 339	VD1089	
CADDY III Kasten (2KA, 2KH, 2CA, 2CH)							
1.6 TDI	08/10-	CAYE	55	1598			VD1111
		CAYD	75	1598			VD1111
1.9 TDI	04/04-	BJB, BLS	77	1896	AP9001	ALT, (Bosch), 110A, OE-NO 06F903023D, 140A, OE-NO 06F903023F	
					AP9001	ALT, (Valeo), 110A, OE-NO 06F903023E, 140A, OE-NO 06F903023C	
						ALT, (AC), (PS)	6DPK1215D1
					ALT, (AC), (STRONIC)	6PK1050D2	
	09/05-	BSU	55	1896	AP9001	ALT, (Bosch), 110A, OE-NO	VD1076





**VW**
**CADDY III Kasten (2KA, 2KH, 2CA, 2CH)**

					AP9001	06F903023D, 140A, OE-NO 06F903023F ALT, (Valeo), 110A, OE-NO 06F903023E, 140A, OE-NO 06F903023C ALT, (AC), (PS) ALT, (AC), (STRONIC)	6DPK1215D1 6PK1050D2 VD1076
2.0 EcoFuel	04/06-	BSX	80	1984	AP9001 AP9001	ALT, (Bosch), 140A, OE-NO 06F903023F ALT, (Valeo), 140A, OE-NO 06F903023C	VD1107
2.0 SDI	03/04-	BDJ, BST	51	1968	AP9001 AP9001	ALT, (Bosch), 110A, OE-NO 06F903023D, 140A, OE-NO 06F903023F ALT, (Valeo), 110A, OE-NO 06F903023E, 140A, OE-NO 06F903023C ALT, (AC), (PS) ALT, (AC), (STRONIC)	6DPK1215D1 6PK1050D2 VD1076
2.0 TDI	09/07-	BMM	103	1968	AP9001 AP9001	ALT, (Bosch), 110A, OE-NO 06F903023D, 140A, OE-NO 06F903023F ALT, (Valeo), 110A, OE-NO 06F903023E, 140A, OE-NO 06F903023C ALT, (AC), (PS) ALT, (AC), (STRONIC)	6DPK1215D1 6PK1050D2 VD1076
2.0 TDI 16V	11/10-	CFHC	103	1968			VD1111
2.0 TDI 4motion	10/10-	CFHF	81	1968			VD1111
<b>CADDY III Kombi (2KB, 2KJ)</b>							
1.6 TDI	08/10-	CAYE	55	1598			VD1111
		CAYD	75	1598			VD1111
1.9 TDI	04/04-	BJB, BLS	77	1896	AP9001 AP9001	ALT, (Bosch), 110A, OE-NO 06F903023D, 140A, OE-NO 06F903023F ALT, (Valeo), 110A, OE-NO 06F903023E, 140A, OE-NO 06F903023C ALT, (AC), (PS) ALT, (AC), (STRONIC)	6DPK1215D1 6PK1050D2 VD1076
	09/05-	BSU	55	1896	AP9001 AP9001	ALT, (Bosch), 110A, OE-NO 06F903023D, 140A, OE-NO 06F903023F ALT, (Valeo), 110A, OE-NO 06F903023E, 140A, OE-NO 06F903023C ALT, (AC), (PS) ALT, (AC), (STRONIC)	6DPK1215D1 6PK1050D2 VD1076
1.9 TDI 4motion	05/08-	BLS	77	1896		ALT, (AC), (PS) ALT, (AC), (STRONIC)	6DPK1215D1 6PK1050D2 VD1076
2.0 EcoFuel	04/06-	BSX	80	1984	AP9001 AP9001	ALT, (Bosch), 140A, OE-NO 06F903023F ALT, (Valeo), 140A, OE-NO 06F903023C	VD1107
2.0 SDI	03/04-	BDJ, BST	51	1968	AP9001 AP9001	ALT, (Bosch), 110A, OE-NO 06F903023D, 140A, OE-NO 06F903023F ALT, (Valeo), 110A, OE-NO 06F903023E, 140A, OE-NO 06F903023C ALT, (AC), (PS) ALT, (AC), (STRONIC)	6DPK1215D1 6PK1050D2 VD1076
2.0 TDI	09/07-	BMM	103	1968	AP9001 AP9001	ALT, (Bosch), 110A, OE-NO 06F903023D, 140A, OE-NO 06F903023F ALT, (Valeo), 110A, OE-NO 06F903023E, 140A, OE-NO 06F903023C ALT, (AC), (PS)	6DPK1215D1



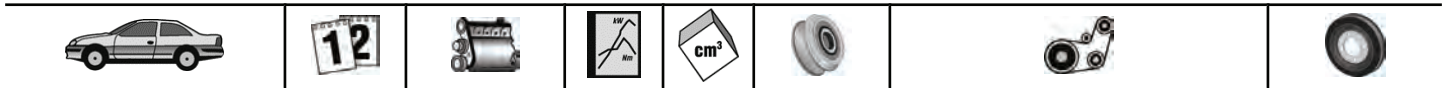



VW							
<b>CADDY III Kombi (2KB, 2KJ)</b>							
						ALT, (AC), (STRONIC)	6PK1050D2 VD1076
2.0 TDI 16V	11/10-	CFHC	103	1968			VD1111
2.0 TDI 4motion	10/10-	CFHF	81	1968			VD1111
<b>CRAFTER 30-35 Bus (2E_)</b>							
2.5 TDI	04/06-	BJJ, CEBA	65	2461	AP9001	ALT, (Bosch), 110A, OE-NO 06F903023D, 140A, OE-NO 06F903023F, 180A, OE-NO 03G903023	VD1002
		BJK, CEBB	80	2461	AP9001	ALT, (Bosch), 110A, OE-NO 06F903023D, 140A, OE-NO 06F903023F, 180A, OE-NO 03G903023	VD1002
		BJL, CECA	100	2461	AP9001	ALT, (Bosch), 110A, OE-NO 06F903023D, 140A, OE-NO 06F903023F, 180A, OE-NO 03G903023	VD1002
		BJM, CECB	120	2461	AP9001	ALT, (Bosch), 110A, OE-NO 06F903023D, 140A, OE-NO 06F903023F, 180A, OE-NO 03G903023	VD1002
<b>CRAFTER 30-50 Kasten (2E_)</b>							
2.5 TDI	04/06-	BJJ, CEBA	65	2461	AP9001	ALT, (Bosch), 110A, OE-NO 06F903023D, 140A, OE-NO 06F903023F, 180A, OE-NO 03G903023	VD1002
		BJK, CEBB	80	2461	AP9001	ALT, (Bosch), 110A, OE-NO 06F903023D, 140A, OE-NO 06F903023F, 180A, OE-NO 03G903023	VD1002
		BJL, CECA	100	2461	AP9001	ALT, (Bosch), 110A, OE-NO 06F903023D, 140A, OE-NO 06F903023F, 180A, OE-NO 03G903023	VD1002
		BJM, CECB	120	2461	AP9001	ALT, (Bosch), 110A, OE-NO 06F903023D, 140A, OE-NO 06F903023F, 180A, OE-NO 03G903023	VD1002
<b>CRAFTER 30-50 Pritsche/Fahrgestell (2F_)</b>							
2.5 TDI	04/06-	BJJ, CEBA	65	2461	AP9001	ALT, (Bosch), 110A, OE-NO 06F903023D, 140A, OE-NO 06F903023F, 180A, OE-NO 03G903023	VD1002
		BJK, CEBB	80	2461	AP9001	ALT, (Bosch), 110A, OE-NO 06F903023D, 140A, OE-NO 06F903023F, 180A, OE-NO 03G903023	VD1002
		BJL, CECA	100	2461	AP9001	ALT, (Bosch), 110A, OE-NO 06F903023D, 140A, OE-NO 06F903023F, 180A, OE-NO 03G903023	VD1002
		BJM, CECB	120	2461	AP9001	ALT, (Bosch), 110A, OE-NO 06F903023D, 140A, OE-NO 06F903023F, 180A, OE-NO 03G903023	VD1002
<b>EOS (1F7, 1F8)</b>							
1.4 TSI	05/08-	CAVD	118	1390	AP9012	ALT, (Bosch), 140A, OE-NO 03C903023A	
	11/07-	CAXA	90	1390	AP9012	(Bosch), 140A, OE-NO 03C903023A, 03C903023S	
					AP9012	(Valeo), 140A, OE-NO 03C903023C, 03C903023T	
					AP9012	ALT	
2.0 FSI	03/06-05/08	BVY, BVZ	110	1984	AP9001	ALT, (Valeo), 140A, OE-NO 06F903023C	
					AP9001	CH-NO 1F-7-030001⇒, MTR-CODE:	

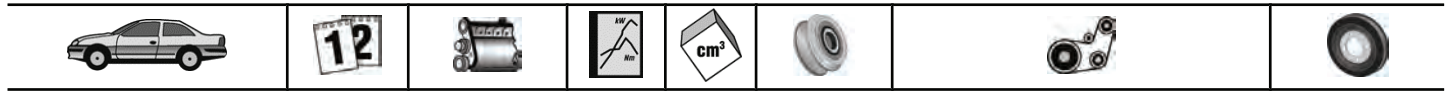

MM

**VW**

EOS (1F7, 1F8)

					AP9022	BVY, ALT, (Bosch), 140A, OE-NO 06F903023F	
					AP9022	ALT, (Bosch), 110A, OE-NO 06F903023L, 140A, OE-NO 06F903023N	
					AP9022	ALT, (Valeo), 110A, OE-NO 06F903023M, 140A, OE-NO 06F903023P CH-NO 1F-7-030001⇒	VD1107
2.0 TDI	06/06-05/08	BMM	103	1968	AP9001	ALT, (Valeo), 110A, OE-NO 06F903023E, 140A, OE-NO 06F903023C	
					AP9001	CH-NO 1F-7-030001⇒, ALT, (Bosch), 110A, OE-NO 06F903023D, 140A, OE-NO 06F903023F	
					AP9022	ALT, (Bosch), 110A, OE-NO 06F903023L, 140A, OE-NO 06F903023N	
					AP9022	ALT, (Valeo), 110A, OE-NO 06F903023M, 140A, OE-NO 06F903023P	
					AP9022	CH-NO 1F-7-030001⇒, MTR-CODE: BUB ALT, PS, (AC)	6PK1050D2 VD1076
2.0 TDI 16V	05/08-	CBAB, CFFB	103	1968		MTR-CODE: CBAA, CBAB, ⇒MODEL '10	VD1076
						MTR-CODE: CBAA, CBAB, MODEL '11⇒	VD1111
						MTR-CODE: CFFA, CFFB	VD1111
2.0 TFSI	03/06-	BWA, BPY, CAWB, CCTA, CBFA, CCZA	147	1984	AP9001	ALT, (Bosch), 140A, OE-NO 06F903023F	
					AP9001	ALT, (Valeo), 140A, OE-NO 06F903023C	
					AP9001	MTR-CODE: BWA, CH-NO 1F-7-030001⇒	
					AP9009	ALT, (Bosch), 140A, OE-NO 06B903016AB	
					AP9009	ALT, (Valeo), 140A, OE-NO 06D903016A, 06J903023C	
					AP9009	MTR-CODE: CAWB, CCTA, CCZA	
					AP9022	ALT, (Bosch), 110A, OE-NO 06F903023L, 140A, OE-NO 06F903023N	
					AP9022	ALT, (Valeo), 110A, OE-NO 06F903023M, 140A, OE-NO 06F903023P	
					AP9022	MTR-CODE: BWA, CH-NO 1F-7-030001⇒	
3.2 V6	06/06-	BUB, CBRA	184	3189	AP9022	ALT, (Bosch), 110A, OE-NO 06F903023L, 140A, OE-NO 06F903023F, 06F903023N	
					AP9022	ALT, (Valeo), 110A, OE-NO 06F903023M, 140A, OE-NO 06F903023P	
					AP9022	CH-NO 1F-7-030001⇒, MTR-CODE: BUB	
3.6 V6	05/09-	CDVA	191	3597	AP9022	ALT, (Bosch), 140A, OE-NO 06F903023N	
					AP9022	ALT, (Valeo), 140A, OE-NO 06F903023P	
FOX (5Z1, 5Z3) 1.2	04/05-	BMD, CHFB	40	1198	AP9006	(Valeo), 70A, OE-NO 03D903025H, 90A, OE-NO 03D903025J	
	09/10-	CHFA	44	1198	AP9006	ALT, MTR-CODE: BMD, CHFB	
					AP9006	ALT, (Bosch), 90A, OE-NO 03D 903 025J	
					AP9006	ALT, (Valeo), 70A, OE-NO 03D 903 025H	
1.4 TDI	04/05-	BNM	51	1422	AP9001	ALT, (Bosch), 70A, OE-NO 045903023B, 90A, OE-NO 038903018R, 045903023	
					AP9022	ALT, (Bosch), 70A, OE-NO 045903023C	
GOLF III (1H1) 1.9 D	11/91-08/97	1Y	48	1896	AP9004	ALT, (Bosch), 70A, OE-NO 028 903 025 H, 90A, OE-NO 028 903 025 Q, 028 903	



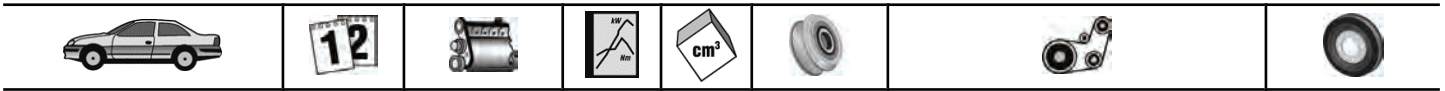

# VW

## GOLF III (1H1)

						028 J	
							<b>VD1084</b>
1.9 SDI	07/95-08/97	AEY	47	1896			<b>VD1084</b>
1.9 TD,GTD	11/91-08/97	AAZ	55	1896	<b>AP9004</b>	ALT, (Bosch), 70A, OE-NO 028 903 025 H, 90A, OE-NO 028 903 025 Q, 028 903 028 J	<b>VD1084</b>
1.9 TDI	04/96-08/97	AFN	81	1896	<b>AP9004</b>	ALT, (Bosch), 120A, OE-NO 028 903 026 G	<b>VD1084</b>
	09/93-08/97	1Z, AHU, ALE	66	1896	<b>AP9004</b>	ALT, (AC), MTR-CODE: AHU, ALE, (Bosch), 90A, OE-NO 028 903 028 J, 120A, OE-NO 028 903 026 G	<b>VD1084</b>
1.9 TDI Syncro (1HX1)	08/95-08/97	1Z, AHU, ALE	66	1896	<b>AP9004</b>	ALT, (AC), MTR-CODE: AHU, ALE, (Bosch), 90A, OE-NO 028 903 028 J, 120A, OE-NO 028 903 026 G	<b>VD1084</b>

## GOLF III Cabriolet (1E7)

1.9 TDI	07/96-05/98	AFN	81	1896	<b>AP9004</b>	ALT, (Bosch), 120A, OE-NO 028 903 026 G	<b>VD1084</b>
	08/95-05/98	1Z, AHU, ALE	66	1896	<b>AP9004</b>	ALT, (AC), MTR-CODE: AHU, ALE, (Bosch), 90A, OE-NO 028 903 028 J, 120A, OE-NO 028 903 026 G	<b>VD1084</b>

## GOLF III Variant (1H5)

1.9 D	07/93-04/99	1Y	48	1896	<b>AP9004</b>	ALT, (Bosch), 70A, OE-NO 028 903 025 H, 90A, OE-NO 028 903 025 Q, 028 903 028 J	<b>VD1084</b>
1.9 SDI	07/95-04/99	AEY	47	1896			<b>VD1084</b>
1.9 TD	07/93-04/99	AAZ	55	1896	<b>AP9004</b>	ALT, (Bosch), 70A, OE-NO 028 903 025 H, 90A, OE-NO 028 903 025 Q, 028 903 028 J	<b>VD1084</b>
1.9 TDI	03/94-04/99	1Z, AHU, ALE	66	1896	<b>AP9004</b>	ALT, (AC), MTR-CODE: AHU, ALE, (Bosch), 90A, OE-NO 028 903 028 J, 120A, OE-NO 028 903 026 G	<b>VD1084</b>
	04/96-04/99	AFN	81	1896	<b>AP9004</b>	ALT, (Bosch), 120A, OE-NO 028 903 026 G	<b>VD1084</b>
1.9 TDI Syncro	07/95-04/99	1Z, AHU, ALE	66	1896	<b>AP9004</b>	ALT, (Bosch), 90A, OE-NO 028 903 028 J, 120A, OE-NO 028 903 025 G	<b>VD1084</b>

## GOLF IV (1J1)

1.6	08/97-02/00	AEH, AKL, APF	74	1595	<b>AP9001</b>	ALT, (Bosch, Valeo), (Hitachi), 120A, MTR-CODE: AKL, AEH	
1.8	08/97-06/05	AGN, BAF	92	1781			<b>VD1107</b>
1.8 4motion	05/98-06/05	AGN	92	1781			<b>VD1107</b>
1.8 T	08/97-06/05	AGU, AUM, ARZ, AWD, AQA	110	1781			<b>VD1107</b>
1.8 T GTI	08/01-06/05	AUQ	132	1781	<b>AP9001</b>	ALT, (Bosch,Valeo), (Hitachi), 120A	<b>VD1107</b>
1.9 SDI	08/97-06/05	AGP, AQM	50	1896	<b>AP9001</b> <b>AP9001</b> <b>AP9001</b> <b>AP9001</b> <b>AP9016</b>	(Hitachi), 120A (Valeo), 70A, OE-NO 038903023Q, 038903024C, 90A, OE-NO 038903023R, 038903024E, 120A ALT, (Bosch), 70A, OE-NO 038903023K, 038903024B, 90A, OE-NO 038903023L, 038903024D, 120A CH-NO 1J-X-000 001⇒, MTR-CODE: AQM ALT, MTR-CODE: AGP, ⇒CH-NO 1J-W-200 000, (Bosch), 70A, 90A, 120A ALT, PS, (AC), CH-NO 1J-3B075 001⇒, 1J3D016 001⇒, 1J-3P066 001⇒, 1J-3U205 001⇒, 1J-3B350 001⇒, MTR-CODE: AQM CH-NO 1J-3B075 001⇒, 1J-3D016 001⇒, 1J-3P066 001⇒, 1J-3U205 001⇒, 1J-3W350 001⇒ ⇒CH-NO 1J-3B075 000, 1J-3D016 000, 1J-3P066 000, 1J-3U205 000, 1J-3W350 000	<b>6PK1660D1</b>           <b>VD1076</b>  <b>VD1089</b>
1.9 TDI	05/00-06/05	ARL	110	1896	<b>AP9001</b>	(Bosch), 70A, OE-NO 038903023K,	





VW

**VW**

GOLF IV (1J1)

				<p><b>AP9001</b> 038903024B, 90A, OE-NO 038903023L, 038903024D, 120A (Valeo), 70A, OE-NO 038903023Q, 038903024C, 90A, OE-NO 038903023R, 038903024E, 120A</p> <p><b>AP9001</b> ALT</p> <p><b>AP9001</b> ALT, (Hitachi), 120A</p>	<b>VD1091</b>
08/97-05/04	AHF, ASV	81	1896	<p><b>AP9001</b> (Bosch), 70A, OE-NO 038903023K, 038903024B, 90A, OE-NO 038903023L, 038903024D, 120A (Valeo), 70A, OE-NO 038903023Q, 038903024C, 90A, OE-NO 038903023R, 038903024E, 120A</p> <p><b>AP9001</b> ALT</p> <p><b>AP9001</b> ALT, (Hitachi), 120A</p> <p><b>AP9001</b> ALT, MTR-CODE: AHF, ⇒CH-NO 1J-W-200 000, (Bosch), 70A, 90A, 120A</p> <p><b>AP9016</b> ALT, PS, (AC), CH-NO 1J-3B075 001⇒, 1J3D016 001⇒, 1J-3P066 001⇒, 1J-3U205 001⇒, 1J-3B350 001⇒ CH-NO 1J-3B075 001⇒, 1J-3D016 001⇒, 1J-3P066 001⇒, 1J-3U205 001⇒, 1J-3W350 001⇒ ⇒CH-NO 1J-3B075 000, 1J-3D016 000, 1J-3P066 000, 1J-3U205 000, 1J-3W350 000</p>	<p><b>6PK1660D1</b></p> <p><b>VD1076</b></p> <p><b>VD1089</b></p>
09/00-06/05	ATD, AXR	74	1896	<p><b>AP9001</b> (Bosch), 70A, OE-NO 038903023K, 038903024B, 90A, OE-NO 038903023L, 038903024D, 120A (Valeo), 70A, OE-NO 038903023Q, 038903024C, 90A, OE-NO 038903023R, 038903024E, 120A</p> <p><b>AP9001</b> ALT</p> <p><b>AP9001</b> ALT, (Hitachi), 120A</p> <p><b>AP9001</b> ALT, PS, (AC), CH-NO 1J-6-005 001⇒ CH-NO 1J-6-005 001⇒ ⇒CH-NO 1J-6-005 000</p>	<p><b>6DPK1195D1</b></p> <p><b>VD1076</b></p> <p><b>VD1091</b></p>
10/97-05/04	AGR, ALH	66	1896	<p><b>AP9001</b> (Bosch), 70A, OE-NO 038903023K, 038903024B, 90A, OE-NO 038903023L, 038903024D, 120A (Valeo), 70A, OE-NO 038903023Q, 038903024C, 90A, OE-NO 038903023R, 038903024E, 120A</p> <p><b>AP9001</b> ALT, (Hitachi), 120A</p> <p><b>AP9001</b> ALT, CH-NO 1J-X-000 001⇒</p> <p><b>AP9001</b> ALT, ⇒CH-NO 1J-W-200 000, (Bosch), 70A, 90A, 120A</p> <p><b>AP9016</b> ALT, PS, (AC), CH-NO 1J-3B075 001⇒, 1J3D016 001⇒, 1J-3P066 001⇒, 1J-3U205 001⇒, 1J-3B350 001⇒ CH-NO 1J-3B075 001⇒, 1J-3D016 001⇒, 1J-3P066 001⇒, 1J-3U205 001⇒, 1J-3W350 001⇒ ⇒CH-NO 1J-3B075 000, 1J-3D016 000, 1J-3P066 000, 1J-3U205 000, 1J-3W350 000</p>	<p><b>6PK1660D1</b></p> <p><b>VD1076</b></p> <p><b>VD1089</b></p>
11/00-06/05	ASZ	96	1896	<p><b>AP9001</b> (Bosch), 70A, OE-NO 038903023K, 038903024B, 90A, OE-NO 038903023L, 038903024D, 120A (Valeo), 70A, OE-NO 038903023Q, 038903024C, 90A, OE-NO 038903023R, 038903024E, 120A</p> <p><b>AP9001</b> ALT</p> <p><b>AP9001</b> ALT, (Hitachi), 120A</p> <p><b>AP9001</b> ALT, PS, (AC), CH-NO 1J-4D008 312⇒, 1J-4U001 139⇒, 1J-4W040 232⇒</p> <p><b>AP9001</b> MTR-CODE: ASZ, CH-NO 1J-4D008 312⇒, 1J-4U001 139⇒, 1J-4W040 232⇒</p> <p><b>AP9001</b> MTR-CODE: ASZ, ⇒CH-NO 1J-4D008 311, 1J-4U001 138, 1J-4W040 231</p>	<p><b>6DPK1195D1</b></p> <p><b>VD1076</b></p> <p><b>VD1091</b></p>
12/98-06/01	AJM, AUY	85	1896	<p><b>AP9001</b> ALT, (Valeo), OE-NO 038903023Q, 70A, OE-NO 038903023R, 90A, OE-NO 038903023S, 120A</p> <p><b>AP9001</b> CH-NO 1J-X-000001⇒, ALT, (Bosch), OE-NO 038903023K, 70A, OE-NO 038903023L, 90A, OE-NO 028903028E, 120A</p>	



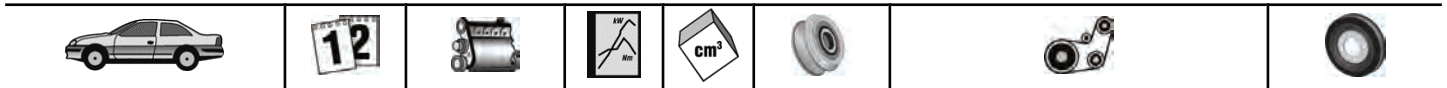

<b>VW</b>						
<b>GOLF IV (1J1)</b>						
					<b>AP9001</b>	MTR-CODE: AJM, ALT, (Valeo), OE-NO 038903023Q, 70A
					<b>AP9001</b>	MTR-CODE: AUJ, ALT, (Hitachi), OE-NO 028903029G, 120A
						<b>VD1091</b>
1.9 TDI 4motion	02/00-06/05	ARL	110	1896	<b>AP9001</b>	(Bosch), 70A, OE-NO 038903023K, 038903024B, 90A, OE-NO 038903023L, 038903024D, 120A
					<b>AP9001</b>	(Valeo), 70A, OE-NO 038903023Q, 038903024C, 90A, OE-NO 038903023R, 038903024E, 120A
					<b>AP9001</b>	ALT
					<b>AP9001</b>	ALT, (Hitachi), 120A
						<b>VD1091</b>
	07/98-04/02	AGR, ALH	66	1896	<b>AP9001</b>	(Bosch), 70A, OE-NO 038903023K, 038903024B, 90A, OE-NO 038903023L, 038903024D, 120A
					<b>AP9001</b>	(Valeo), 70A, OE-NO 038903023Q, 038903024C, 90A, OE-NO 038903023R, 038903024E, 120A
					<b>AP9001</b>	ALT
					<b>AP9001</b>	ALT, (Hitachi), 120A
					<b>AP9016</b>	ALT, ⇨CH-NO 1J-W-200 000, (Bosch), 70A, 90A, 120A
						ALT, PS, (AC), CH-NO 1J-3B075 001⇨, 1J3D016 001⇨, 1J-3P066 001⇨, 1J-3U205 001⇨, 1J-3B350 001⇨
						CH-NO 1J-3B075 001⇨, 1J-3D016 001⇨, 1J-3P066 001⇨, 1J-3U205 001⇨, 1J-3W350 001⇨
						⇨CH-NO 1J-3B075 000, 1J-3D016 000, 1J-3P066 000, 1J-3U205 000, 1J-3W350 000
						<b>6PK1660D1</b>
						<b>VD1076</b>
						<b>VD1089</b>
	09/00-06/05	ATD	74	1896	<b>AP9001</b>	(Bosch), 70A, OE-NO 038903023K, 038903024B, 90A, OE-NO 038903023L, 038903024D, 120A
					<b>AP9001</b>	(Valeo), 70A, OE-NO 038903023Q, 038903024C, 90A, OE-NO 038903023R, 038903024E, 120A
					<b>AP9001</b>	ALT
					<b>AP9001</b>	ALT, (Hitachi), 120A
						ALT, PS, (AC), CH-NO 1J-6-005 001⇨
						CH-NO 1J-6-005 001⇨
						⇨CH-NO 1J-6-005 000
						<b>6DPK1195D1</b>
						<b>VD1076</b>
						<b>VD1091</b>
	09/99-06/01	AJM, AUJ	85	1896	<b>AP9001</b>	ALT, (Valeo), OE-NO 038903023Q, 70A, OE-NO 038903023R, 90A, OE-NO 038903023S, 120A
					<b>AP9001</b>	CH-NO 1J-X-000001⇨, ALT, (Bosch), OE-NO 038903023K, 70A, OE-NO 038903023L, 90A, OE-NO 028903028E, 120A
					<b>AP9001</b>	MTR-CODE: AJM, ALT, (Valeo), OE-NO 038903023Q, 70A
					<b>AP9001</b>	MTR-CODE: AUJ, ALT, (Hitachi), OE-NO 028903029G, 120A
						<b>VD1091</b>
	11/00-06/05	ASZ	96	1896	<b>AP9001</b>	(Bosch), 70A, OE-NO 038903023K, 038903024B, 90A, OE-NO 038903023L, 038903024D, 120A
					<b>AP9001</b>	(Valeo), 70A, OE-NO 038903023Q, 038903024C, 90A, OE-NO 038903023R, 038903024E, 120A
					<b>AP9001</b>	ALT
					<b>AP9001</b>	ALT, (Hitachi), 120A
						ALT, PS, (AC), CH-NO 1J-4D008 312⇨, 1J-4U001 139⇨, 1J-4W040 232⇨
						MTR-CODE: ASZ, CH-NO 1J-4D008 312⇨, 1J-4U001 139⇨, 1J-4W040 232⇨
						MTR-CODE: ASZ, ⇨CH-NO 1J-4D008 311, 1J-4U001 138, 1J-4W040 231
						<b>6DPK1195D1</b>
						<b>VD1076</b>
						<b>VD1091</b>
2.0	07/98-06/05	AQY, APK, AZG, AZJ	85	1984		<b>VD1107</b>
2.0 4motion	10/00-06/05	AZH, AZJ	85	1984		<b>VD1107</b>
2.3 V5	08/97-10/00	AGZ	110	2324	<b>AP9016</b>	ALT, ⇨CH-NO 1J-W-200 000, (Bosch), 90A, 120A
	10/00-06/05	AQN	125	2324	<b>AP9001</b>	(Bosch), 70A, OE-NO 038903023K, 038903024B, 90A, OE-NO 038903023L, 038903024D, 120A





**VW**

**GOLF IV (1J1)**

2.3 V5 4motion	10/00-06/05	AQN	125	2324	AP9001	(Valeo), 70A, OE-NO 038903023Q, 038903024C, 90A, OE-NO 038903023R, 038903024E, 120A	
					AP9001 AP9001	ALT ALT, (Hitachi), 120A	
2.8 V6 4motion	12/98-10/00	AGZ	110	2324	AP9001	(Bosch), 70A, OE-NO 038903023K, 038903024B, 90A, OE-NO 038903023L, 038903024D, 120A	
					AP9001 AP9001 AP9001	(Valeo), 70A, OE-NO 038903023Q, 038903024C, 90A, OE-NO 038903023R, 038903024E, 120A ALT ALT, (Hitachi), 120A	
2.8 V6 4motion	03/99-06/05	AQP, AUE, BDE	150	2792	AP9016	ALT, ⇨CH-NO 1J-W-200 000, (Bosch), 90A, 120A	
					AP9001 AP9001 AP9001 AP9001	(Bosch), 70A, OE-NO 038903023K, 038903024B, 90A, OE-NO 038903023L, 038903024D, 120A (Valeo), 70A, OE-NO 038903023Q, 038903024C, 90A, OE-NO 038903023R, 038903024E, 120A ALT ALT, (Hitachi), 120A MTR-CODE: BDE	

**GOLF IV Cabriolet (1E7)**

1.9 TDI	06/98-06/02	AHU, ALE	66	1896	AP9004	ALT, (AC), (Bosch), 90A, OE-NO 028 903 028 J, 120A, OE-NO 028 903 026 G	VD1084
		AFN, AVG	81	1896	AP9004	ALT, (Bosch), 120A, OE-NO 028 903 026 G	VD1084

**GOLF IV Variant (1J5)**

1.6	05/99-02/00	AEH, AKL, APF	74	1595	AP9001 AP9001	ALT, (Bosch, Valeo), (Hitachi), 120A MTR-CODE: AKL, AEH	
1.8 4motion	05/99-06/06	AGN	92	1781			VD1107
1.8 T	05/00-06/06	AGU, AUM, ARZ, AWD, AQA	110	1781			VD1107
1.9 SDI	05/99-06/06	AGP, AQM	50	1896	AP9016	ALT, MTR-CODE: AGP, ⇨CH-NO 1J-W-200 000, (Bosch), 70A, 90A, 120A	6PK1660D1
						ALT, PS, (AC), CH-NO 1J-3B075 001⇨, 1J3D016 001⇨, 1J-3P066 001⇨, 1J-3U205 001⇨, 1J-3B350 001⇨, MTR-CODE: AQM CH-NO 1J-3B075 001⇨, 1J-3D016 001⇨, 1J-3P066 001⇨, 1J-3U205 001⇨, 1J-3W350 001⇨ ⇨CH-NO 1J-3B075 000, 1J-3D016 000, 1J-3P066 000, 1J-3U205 000, 1J-3W350 000	VD1076 VD1089
1.9 TDI	05/99-05/06	AGR, ALH	66	1896	AP9001 AP9001 AP9001 AP9016	(Bosch), 70A, OE-NO 038903023K, 038903024B, 90A, OE-NO 038903023L, 038903024D, 120A (Valeo), 70A, OE-NO 038903023Q, 038903024C, 90A, OE-NO 038903023R, 038903024E, 120A ALT ALT, (Hitachi), 120A ALT, ⇨CH-NO 1J-W-200 000, (Bosch), 70A, 90A, 120A	6PK1660D1
	05/99-06/01	AHF, ASV	81	1896	AP9001 AP9001 AP9001 AP9016	ALT, PS, (AC), CH-NO 1J-3B075 001⇨, 1J3D016 001⇨, 1J-3P066 001⇨, 1J-3U205 001⇨, 1J-3B350 001⇨ CH-NO 1J-3B075 001⇨, 1J-3D016 001⇨, 1J-3P066 001⇨, 1J-3U205 001⇨, 1J-3W350 001⇨ ⇨CH-NO 1J-3B075 000, 1J-3D016 000, 1J-3P066 000, 1J-3U205 000, 1J-3W350 000	VD1076 VD1089



**VW**
**GOLF IV Variant (1J5)**

					ALT, PS, (AC), CH-NO 1J-3B075 001⇒, 1J3D016 001⇒, 1J-3P066 001⇒, 1J-3U205 001⇒, 1J-3B350 001⇒ CH-NO 1J-3B075 001⇒, 1J-3D016 001⇒, 1J-3P066 001⇒, 1J-3U205 001⇒, 1J-3W350 001⇒ ⇒CH-NO 1J-3B075 000, 1J-3D016 000, 1J-3P066 000, 1J-3U205 000, 1J-3W350 000	<b>6PK1660D1</b>  <b>VD1076</b>  <b>VD1089</b>
08/99-06/01	AJM, AUY	85	1896			<b>VD1091</b>
09/00-06/06	ATD, AXR	74	1896	<b>AP9001</b>	(Bosch), 70A, OE-NO 038903023K, 038903024B, 90A, OE-NO 038903023L, 038903024D, 120A (Valeo), 70A, OE-NO 038903023Q, 038903024C, 90A, OE-NO 038903023R, 038903024E, 120A	
				<b>AP9001</b>	ALT	
				<b>AP9001</b>	ALT, (Hitachi), 120A	
				<b>AP9001</b>	ALT, PS, (AC), CH-NO 1J-6-005 001⇒	<b>6DPK1195D1</b>
					CH-NO 1J-6-005 001⇒	<b>VD1076</b>
					⇒CH-NO 1J-6-005 000	<b>VD1091</b>
11/00-06/06	ASZ	96	1896	<b>AP9001</b>	(Bosch), 70A, OE-NO 038903023K, 038903024B, 90A, OE-NO 038903023L, 038903024D, 120A (Valeo), 70A, OE-NO 038903023Q, 038903024C, 90A, OE-NO 038903023R, 038903024E, 120A	
				<b>AP9001</b>	ALT	
				<b>AP9001</b>	ALT, (Hitachi), 120A	
				<b>AP9001</b>	ALT, PS, (AC), CH-NO 1J-4D008 312⇒, 1J-4U001 139⇒, 1J-4W040 232⇒	<b>6DPK1195D1</b>
					MTR-CODE: ASZ, CH-NO 1J-4D008 312⇒, 1J-4U001 139⇒, 1J-4W040 232⇒	<b>VD1076</b>
					MTR-CODE: ASZ, ⇒CH-NO 1J-4D008 311, 1J-4U001 138, 1J-4W040 231	<b>VD1091</b>
1.9 TDI 4motion	05/99-04/02	AGR, ALH	66	1896	<b>AP9001</b>	
					(Bosch), 70A, OE-NO 038903023K, 038903024B, 90A, OE-NO 038903023L, 038903024D, 120A (Valeo), 70A, OE-NO 038903023Q, 038903024C, 90A, OE-NO 038903023R, 038903024E, 120A	
				<b>AP9001</b>	ALT	
				<b>AP9001</b>	ALT, (Hitachi), 120A	
				<b>AP9016</b>	ALT, ⇒CH-NO 1J-W-200 000, (Bosch), 70A, 90A, 120A	
					ALT, PS, (AC), CH-NO 1J-3B075 001⇒, 1J3D016 001⇒, 1J-3P066 001⇒, 1J-3U205 001⇒, 1J-3B350 001⇒, MTR-CODE: AQM	<b>6PK1660D1</b>
					CH-NO 1J-3B075 001⇒, 1J-3D016 001⇒, 1J-3P066 001⇒, 1J-3U205 001⇒, 1J-3W350 001⇒	<b>VD1076</b>
					⇒CH-NO 1J-3B075 000, 1J-3D016 000, 1J-3P066 000, 1J-3U205 000, 1J-3W350 000	<b>VD1089</b>
05/99-06/01	AJM	85	1896	<b>AP9001</b>	ALT, (Valeo), OE-NO 038903023Q, 70A, OE-NO 038903023R, 90A, OE-NO 038903023S, 120A	
				<b>AP9001</b>	CH-NO 1J-X-000001⇒, ALT, (Bosch), OE-NO 038903023K, 70A, OE-NO 038903023L, 90A, OE-NO 028903028E, 120A	<b>VD1091</b>
09/00-06/06	ATD	74	1896	<b>AP9001</b>	(Bosch), 70A, OE-NO 038903023K, 038903024B, 90A, OE-NO 038903023L, 038903024D, 120A (Valeo), 70A, OE-NO 038903023Q, 038903024C, 90A, OE-NO 038903023R, 038903024E, 120A	
				<b>AP9001</b>	ALT	
				<b>AP9001</b>	ALT, (Hitachi), 120A	
				<b>AP9001</b>	ALT, PS, (AC), CH-NO 1J-6-005 001⇒	<b>6DPK1195D1</b>
					CH-NO 1J-6-005 001⇒	<b>VD1076</b>
					⇒CH-NO 1J-6-005 000	<b>VD1091</b>
11/00-06/06	ASZ	96	1896	<b>AP9001</b>	(Bosch), 70A, OE-NO 038903023K, 038903024B, 90A, OE-NO 038903023L, 038903024D, 120A (Valeo), 70A, OE-NO 038903023Q,	
				<b>AP9001</b>		



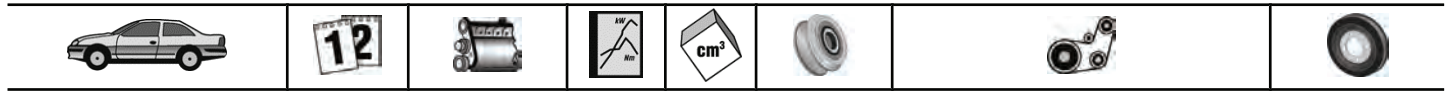

**VW**
**GOLF IV Variant (1J5)**

						038903024C, 90A, OE-NO 038903023R, 038903024E, 120A ALT ALT, (Hitachi), 120A ALT, PS, (AC), CH-NO 1J-4D008 312⇒, 1J-4U001 139⇒, 1J-4W040 232⇒ MTR-CODE: ASZ, CH-NO 1J-4D008 312⇒, 1J-4U001 139⇒, 1J-4W040 232⇒ MTR-CODE: ASZ, ⇒CH-NO 1J-4D008 311, 1J-4U001 138, 1J-4W040 231	<b>6DPK1195D1</b> <b>VD1076</b> <b>VD1091</b>
2.0	05/99-06/06	AQY, APK, AZJ	85	1984			<b>VD1107</b>
2.0 4motion	10/00-06/06	AZH, AZJ	85	1984			<b>VD1107</b>
2.0 Bi-Fuel	02/02-06/06	BEH	85	1984			<b>VD1107</b>
2.3 V5	05/99-06/06	AGZ	110	2324	<b>AP9016</b>	ALT, ⇒CH-NO 1J-W-200 000, (Bosch), 90A, 120A	
	10/00-06/06	AQN	125	2324	<b>AP9001</b> <b>AP9001</b> <b>AP9001</b> <b>AP9001</b>	(Bosch), 70A, OE-NO 038903023K, 038903024B, 90A, OE-NO 038903023L, 038903024D, 120A (Valeo), 70A, OE-NO 038903023Q, 038903024C, 90A, OE-NO 038903023R, 038903024E, 120A ALT ALT, (Hitachi), 120A	
2.3 V5 4motion	05/99-06/06	AGZ	110	2324	<b>AP9016</b>	ALT, ⇒CH-NO 1J-W-200 000, (Bosch), 90A, 120A	
	10/00-06/06	AQN	125	2324	<b>AP9001</b> <b>AP9001</b> <b>AP9001</b> <b>AP9001</b>	(Bosch), 70A, OE-NO 038903023K, 038903024B, 90A, OE-NO 038903023L, 038903024D, 120A (Valeo), 70A, OE-NO 038903023Q, 038903024C, 90A, OE-NO 038903023R, 038903024E, 120A ALT ALT, (Hitachi), 120A	
2.8 V6 4motion	05/99-06/06	AQP, AUE, BDE	150	2792	<b>AP9001</b> <b>AP9001</b> <b>AP9001</b> <b>AP9001</b>	(Bosch), 70A, OE-NO 038903023K, 038903024B, 90A, OE-NO 038903023L, 038903024D, 120A (Valeo), 70A, OE-NO 038903023Q, 038903024C, 90A, OE-NO 038903023R, 038903024E, 120A ALT ALT, (Hitachi), 120A MTR-CODE: BDE	
<b>GOLF PLUS (5M1, 521)</b>							
1.2 TSI	11/09-	CBZB	77	1197	<b>AP9012</b> <b>AP9012</b> <b>AP9012</b>	(Bosch), 140A, OE-NO 03F903023D, 03C903023F (Valeo), 110A, OE-NO 03F903023E ALT	
1.4 TSI	05/06-06/08	BMY	103	1390	<b>AP9012</b> <b>AP9012</b> <b>AP9012</b>	(Bosch), OE-NO 03C 903 023 A, 140A (Valeo), OE-NO 03C 903 023 G, 110A ALT	
		BLG	125	1390	<b>AP9012</b> <b>AP9012</b> <b>AP9012</b>	(Bosch), OE-NO 03C 903 023 A, 140A (Valeo), OE-NO 03C 903 023 G, 110A ALT	
	06/07-	CAXA	90	1390	<b>AP9012</b> <b>AP9012</b> <b>AP9012</b> <b>AP9012</b>	(Bosch), OE-NO 03C 903 023 A, 140A (Valeo), OE-NO 03C 903 023 C, 140A (Valeo), OE-NO 03C 903 023 G, 110A ALT	
	06/08-	CAVD, CNWA	118	1390	<b>AP9012</b> <b>AP9012</b> <b>AP9012</b> <b>AP9012</b>	(Bosch), OE-NO 03C 903 023 A, 140A (Valeo), OE-NO 03C 903 023 C, 140A (Valeo), OE-NO 03C 903 023 G, 110A ALT	
1.6	05/05-	BSE, BSF, CCSA, CMXA	75	1595	<b>AP9001</b> <b>AP9001</b>	ALT, (Bosch), 140A, OE-NO 06F903023F ALT, (Valeo), 140A, OE-NO 03L903023F	
1.6 MultiFuel	11/07-	CCSA, CHGA	75	1595	<b>AP9001</b> <b>AP9001</b>	ALT, (Bosch), 140A, OE-NO 06F903023F ALT, (Valeo), 140A, OE-NO 03L903023F	
1.6 TDI	02/09-	CAYB	66	1598		MTR-CODE: CAYB, CAYC, ⇒10/2009 MTR-CODE: CAYB, CAYC, 11/2009⇒	<b>VD1076</b> <b>VD1111</b>
	03/09-	CAYC	77	1598		MTR-CODE: CAYB, CAYC, ⇒10/2009 MTR-CODE: CAYB, CAYC, 11/2009⇒	<b>VD1076</b> <b>VD1111</b>
1.9 TDI	01/05-01/09	BKC, BLS, BXE	77	1896	<b>AP9001</b> <b>AP9001</b>	ALT, (Bosch), 110A, OE-NO 06F903023D, 140A, OE-NO 06F903023F ALT, (Valeo), 110A, OE-NO 06F903023E, 140A, OE-NO	



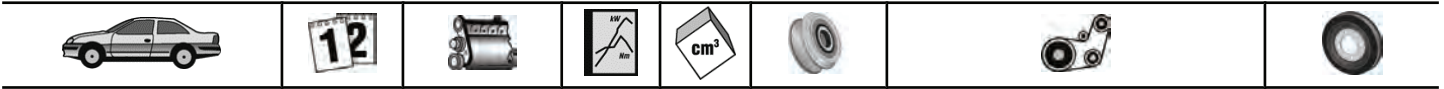



# VW

## GOLF PLUS (5M1, 521)

						06F903023C ALT, (AC)	6PK1050D2 VD1076
	05/05-12/08	BRU, BXF, BXJ	66	1896	AP9001	ALT, (Valeo), 110A, OE-NO 06F903023E, 140A, OE-NO 06F903023C	
					AP9001	MTR-CODE: BXF, BRU, ALT, (Bosch), 110A, OE-NO 06F903023D, 140A, OE-NO 06F903023F	6PK1050D2 VD1076
2.0 FSI	05/05-06/08	BLY, BLR, BVY, BVZ	110	1984	AP9001	ALT, 140A, (Bosch), (Valeo)	VD1107
2.0 TDI	01/09-	CBDC, CLCA	81	1968		MTR-CODE: CBDA, CBDB, CBDC MTR-CODE: CLCA	VD1076 VD1111
	05/05-	AZV, CBDA, CFHB	100	1968	AP9001	MTR-CODE: AZV, (Valeo), 110A, OE-NO 06F903023E	
					AP9001	MTR-CODE: AZV, ALT, (Bosch), 110A, OE-NO 06F903023D	
					AP9001	MTR-CODE: CBDA, (Valeo), 140A, OE-NO 03L903023F	
					AP9001	MTR-CODE: CBDA, ALT, (Bosch), 140A, OE-NO 06F903023F	6PK1050D2 VD1076
						MTR-CODE: AZV, BKD, ALT, (AC) MTR-CODE: AZV, BKD, CBDA, CBDB, CBDC	VD1111
	05/05-05/07	BEE	96	1968	AP9001	ALT, (Bosch), 110A, OE-NO 06F903023D, 140A, OE-NO 06F903023F	
					AP9001	ALT, (Valeo), 110A, OE-NO 06F903023E, 140A, OE-NO 06F903023C	
					AP9001	MTR-CODE: BVB	
	12/05-05/09	BMM	103	1968	AP9001	ALT, (Bosch), 110A, OE-NO 06F903023D, 140A, OE-NO 06F903023F	
					AP9001	ALT, (Valeo), 110A, OE-NO 06F903023E, 140A, OE-NO 06F903023C	6PK1050D2 VD1076
						ALT, PS, (AC)	VD1111
2.0 TDI 16V	01/05-	BKD, CBDB, CFHC	103	1968	AP9001	MTR-CODE: BKD, ALT, (Bosch), 110A, OE-NO 06F903023D, 140A, OE-NO 06F903023F	
					AP9001	MTR-CODE: BKD, ALT, (Valeo), 110A, OE-NO 06F903023E, 140A, OE-NO 06F903023C	
					AP9001	MTR-CODE: CBDB, ALT, (Bosch), 140A, OE-NO 06F903023F	
					AP9001	MTR-CODE: CBDB, ALT, (Valeo), 140A, OE-NO 03L903023F	6PK1050D2 VD1076
						MTR-CODE: AZV, BKD, ALT, (AC) MTR-CODE: AZV, BKD, CBDA, CBDB, CBDC	VD1111
						MTR-CODE: CFHB, CFHC	
<b>GOLF V (1K1)</b>							
1.4 TSI	05/06-	BMV	103	1390	AP9012	(Bosch), OE-NO 03C 903 023 A, 140A	
					AP9012	(Valeo), OE-NO 03C 903 023 G, 110A	
					AP9012	ALT	
	05/07-	CAXA	90	1390	AP9012	(Bosch), OE-NO 03C 903 023 A, 140A	
					AP9012	(Valeo), OE-NO 03C 903 023 C, 140A	
					AP9012	(Valeo), OE-NO 03C 903 023 G, 110A	
					AP9012	ALT	
	11/05-	BLG	125	1390	AP9012	(Bosch), OE-NO 03C 903 023 A, 140A	
					AP9012	(Valeo), OE-NO 03C 903 023 G, 110A	
					AP9012	ALT	
1.6	01/04-	BGU, BSE, BSF	75	1595	AP9001	ALT, (Bosch,Valeo), 140A	
1.9 TDI	05/04-	BRU, BXF, BXJ	66	1896	AP9001	ALT, (Bosch), 140A, OE-NO 06F903023F	
					AP9001	ALT, (Valeo), 110A, OE-NO 06F903023E, 140A, OE-NO 06F903023C	
					AP9001	MTR-CODE: BRU	6PK1050D2 VD1076
						ALT, (AC)	VD1111
	10/03-	BKC, BLS, BXE	77	1896		ALT, (AC)	6PK1050D2 VD1076



**VW**
**GOLF V (1K1)**

1.9 TDI 4motion	08/04-	BKC, BLS, BXE	77	1896	AP9001 AP9001	ALT, (Bosch), 140A ALT, (Valeo), 110A, 140A ALT, (AC)	6PK1050D2 VD1076
2.0 FSI	01/04-	AXW, BLX, BLY, BLR, BVY, BVZ, BVX	110	1984	AP9001	ALT, (Bosch,Valeo), 140A	VD1107
2.0 FSI 4motion	08/04-	BLX, BVX	110	1984	AP9001 AP9001	ALT, (Bosch,Valeo), 140A MTR-CODE: BVX	VD1107
2.0 GTI	10/04-	AXX, BWA, BPY, CAWB, CCTA, CBFA	147	1984	AP9001 AP9009  AP9009	ALT, (Bosch,Valeo), 140A ALT, (Bosch), 140A, OE-NO 06B903016AB ALT, (Valeo), 140A, OE-NO 06J903023C MTR-CODE: CCTA, CBFA	
2.0 SDI	01/04-	BDK	55	1968	AP9001 AP9001	ALT, (Bosch), 140A ALT, (Valeo), 110A, 140A ALT, (AC)	6PK1050D2 VD1076
2.0 TDI	10/03-	AZV, CBDA	100	1968		MTR-CODE: AZV, BKD, ALT, (AC)	6PK1050D2 VD1076
	11/05-	BMN	125	1968		MTR-CODE: BMN, ALT, PS, (AC)	6PK1050D2 VD1076
	12/04-	BMM	103	1968		ALT, PS, (AC)	6PK1050D2 VD1076
2.0 TDI 4motion	08/04-	BMM	103	1968		ALT, PS, (AC)	6PK1050D2 VD1076
2.0 TDI 16V	10/03-	BKD	103	1968	AP9001  AP9001	ALT, (Bosch), 110A, OE-NO 06F903023D, 140A, OE-NO 06F903023F ALT, (Valeo), 110A, OE-NO 06F903023E, 140A, OE-NO 06F903023C MTR-CODE: AZV, BKD, ALT, (AC)	6PK1050D2 VD1076
2.0 TDI 16V 4motion	08/04-	BKD	103	1968	AP9001 AP9001	(Bosch), 110A, OE-NO 06F903023D, 140A, OE-NO 06F903023F ALT, (Valeo), 110A, OE-NO 06F903023E, 140A, OE-NO 06F903023C MTR-CODE: AZV, BKD, ALT, (AC)	6PK1050D2 VD1076
3.2	09/05-	BUB	184	3189	AP9022	ALT, (Valeo), 140A, OE-NO 06F903023P, CH-NO 1K-7-120001⇒, ⇒CH-NO 1K-9-200000	
3.2 R32 4motion	11/05-	BUB, CBR, CBRA	184	3189	AP9022	ALT, (Valeo), 140A, OE-NO 06F903023P, CH-NO 1K-7-120001⇒, ⇒CH-NO 1K-9-200000, MTR-CODE: BUB	

**GOLF V Variant (1K5)**

1.9 TDI	06/07-	BKC, BLS, BXE	77	1896		ALT, (AC)	6PK1050D2 VD1076
1.9 TDI 4motion	01/08-	BLS	77	1896		ALT, (AC)	6PK1050D2 VD1076
2.0	06/07-	BWA, CAWB, CCTA	147	1984	AP9009 AP9009 AP9009	ALT, (Bosch), 140A, OE-NO 06B903016AB ALT, (Valeo), 140A, OE-NO 06J903023C MTR-CODE: CCTA	
2.0 TDI	06/07-	AZV	100	1968		MTR-CODE: AZV, BKD, ALT, (AC)	6PK1050D2 VD1076
		BMM	103	1968		ALT, PS, (AC)	6PK1050D2 VD1076
2.0 TDI 16V	06/07-	BKD, CBDB	103	1968	AP9001  AP9001	ALT, (Bosch), 110A, OE-NO 06F903023D, 140A, OE-NO 06F903023F ALT, (Valeo), 110A, OE-NO 06F903023E, 140A, OE-NO 06F903023C MTR-CODE: AZV, BKD, ALT, (AC)	6PK1050D2 VD1076
2.0 TDI 4motion	06/07-	AZV	100	1968		MTR-CODE: AZV, BKD, ALT, (AC)	6PK1050D2 VD1076

**GOLF VI (5K1)**

1.2 TSI	05/09-	CBZB	77	1197	AP9012 AP9012	(Bosch), 140A, OE-NO 03F903023D, 03C903025F (Valeo), 110A, OE-NO 03F903023F	
---------	--------	------	----	------	------------------	-----------------------------------------------------------------------------------	--

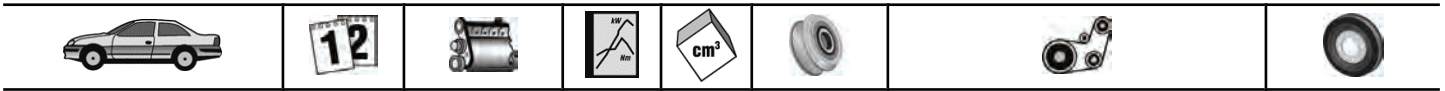

**VW**
**GOLF VI (5K1)**

1.4 TSI	10/08-	CAXA	90	1390	<b>AP9012</b> <b>AP9012</b> <b>AP9012</b> <b>AP9012</b>	ALT (Bosch), OE-NO 03C 903 023 A, 140A (Valeo), OE-NO 03C 903 023 C, 140A (Valeo), OE-NO 03C 903 023 G, 110A ALT	
		CAVD	118	1390	<b>AP9012</b> <b>AP9012</b> <b>AP9012</b> <b>AP9012</b>	(Bosch), OE-NO 03C 903 023 A, 140A (Valeo), OE-NO 03C 903 023 C, 140A (Valeo), OE-NO 03C 903 023 G, 110A ALT	
1.6	10/08-	BSE, BSF, CCSA, CMXA	75	1595	<b>AP9001</b> <b>AP9001</b>	ALT, (Bosch), 140A, OE-NO 06F903023F ALT, (Valeo), 140A, OE-NO 03L903023F	
1.6 BiFuel	03/09-	CHGA	75	1595	<b>AP9001</b> <b>AP9001</b>	ALT, (Bosch), 140A, OE-NO 06F903023F ALT, (Valeo), 140A, OE-NO 03L903023F	
1.6 TDI	02/09-	CAYB	66	1598		MTR-CODE: CAYB, CAYC, ⇨10/2009 MTR-CODE: CAYB, CAYC, 11/2009⇨	<b>VD1076</b> <b>VD1111</b>
		CAYC	77	1598		MTR-CODE: CAYB, CAYC, ⇨10/2009 MTR-CODE: CAYB, CAYC, 11/2009⇨	<b>VD1076</b> <b>VD1111</b>
2.0 TDI	04/09-	CBBB, CFGB	125	1968	<b>AP9001</b> <b>AP9001</b>	ALT, (Bosch), 140A, OE-NO 06F903023F ALT, (Valeo), 140A, OE-NO 03L903023F MTR-CODE: CBAB, CBBB MTR-CODE: CFGB	<b>VD1076</b> <b>VD1111</b>
	10/08-	CBDC, CLCA	81	1968	<b>AP9001</b> <b>AP9001</b>	ALT, (Bosch), 140A, OE-NO 06F903023F ALT, (Valeo), 140A, OE-NO 03L903023F MTR-CODE: CBDC MTR-CODE: CLCA	<b>VD1076</b> <b>VD1111</b>
		CBAA, CFFA	100	1968		MTR-CODE: CBAA, CBAB MTR-CODE: CFFA, CFFB	<b>VD1076</b> <b>VD1111</b>
		CBAB, CFFB, CJAA	103	1968	<b>AP9001</b> <b>AP9001</b>	ALT, (Bosch), 140A, OE-NO 06F903023F, 03L903023 ALT, (Valeo), 140A, OE-NO 03L903023F, 03L903023A MTR-CODE: CBAA, CBAB, CJAA MTR-CODE: CFFA, CFFB	<b>VD1076</b> <b>VD1111</b>
2.0 TDI 4motion	05/09-	CBAB, CFFB	103	1968		MTR-CODE: CBAA, CBAB, CJAA MTR-CODE: CFFA, CFFB	<b>VD1076</b> <b>VD1111</b>
2.0 TSI	04/09-	CCZB	155	1984	<b>AP9009</b> <b>AP9009</b>	ALT, (Bosch), 140A, OE-NO 06B903016AB ALT, (Valeo), 140A, OE-NO 06J903023C	

**GOLF VI Variant (AJ5)**

1.2 TSI	08/09-	CBZB	77	1197	<b>AP9012</b> <b>AP9012</b> <b>AP9012</b>	(Bosch), 140A, OE-NO 03F903023D, 03C903023F (Valeo), 110A, OE-NO 03F903023F ALT	
1.6 TDI	07/09-	CAYC	77	1598		MTR-CODE: CAYB, CAYC, ⇨10/2009 MTR-CODE: CAYB, CAYC, 11/2009⇨	<b>VD1076</b> <b>VD1111</b>
	12/09-	CAYB	66	1598		MTR-CODE: CAYB, CAYC, 11/2009⇨	<b>VD1111</b>
1.6 TDI 4motion	07/09-	CAYC	77	1598		MTR-CODE: CAYB, CAYC, ⇨10/2009 MTR-CODE: CAYB, CAYC, 11/2009⇨	<b>VD1076</b> <b>VD1111</b>
2.0 TDI	07/09-	CBDA, CFHB	100	1968		MTR-CODE: CBDA, CBDB MTR-CODE: CFHB, CFHC	<b>VD1076</b> <b>VD1111</b>
		BMM	103	1968			<b>VD1076</b>
2.0 TDI 16V	07/09-	CBDB, CFHC	103	1968		MTR-CODE: CBDA, CBDB MTR-CODE: CFHB, CFHC	<b>VD1076</b> <b>VD1111</b>

**JETTA III (1K2)**

1.4 TSI	05/07-	CAXA	90	1390	<b>AP9012</b> <b>AP9012</b> <b>AP9012</b>	(Bosch), OE-NO 03C 903 023 A, 140A (Valeo), OE-NO 03C 903 023 G, 110A ALT	
	07/06-	BMY	103	1390	<b>AP9012</b> <b>AP9012</b> <b>AP9012</b>	(Bosch), OE-NO 03C 903 023 A, 140A (Valeo), OE-NO 03C 903 023 G, 110A ALT	
		BLG	125	1390	<b>AP9012</b> <b>AP9012</b> <b>AP9012</b>	(Bosch), OE-NO 03C 903 023 A, 140A (Valeo), OE-NO 03C 903 023G, 110A ALT	
1.6	10/05-	BSE, BSF, CCSA	75	1595	<b>AP9001</b>	MTR-CODE: BSF, BSE, ALT, (Bosch), 140A, OE-NO 06F903023F	
1.6 TDI	06/09-	CAYC	77	1598		MTR-CODE: CAYB, CAYC, ⇨10/2009 MTR-CODE: CAYB, CAYC, 11/2009⇨	<b>VD1076</b> <b>VD1111</b>
1.9 TDI	08/05-	BKC, BLS, BXE	77	1896	<b>AP9001</b>	ALT, (Bosch), 140A	



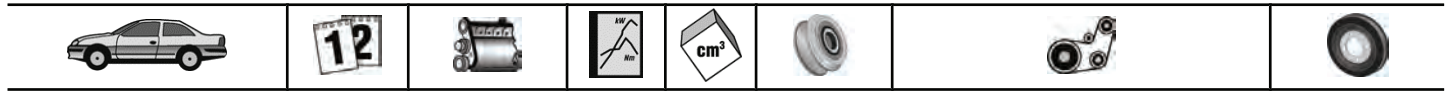

VW							
<b>JETTA III (1K2)</b>							
					<b>AP9001</b>	ALT, (Valeo), 110A	
					<b>AP9012</b>	(Bosch), OE-NO 03C 903 023 A, 140A	
					<b>AP9012</b>	(Valeo), OE-NO 03C 903 023 G, 110A	
					<b>AP9012</b>	MTR-CODE: BLZ, ALT	
						ALT, (AC)	<b>6PK1050D2</b>
2.0 FSI	08/05-	BLY, BLR, BVY, BVZ	110	1984	<b>AP9001</b>	ALT, (Bosch), 140A, OE-NO 06F903023F	<b>VD1076</b>
2.0 TDI	09/05-	AZV, CBDA	100	1968	<b>AP9001</b>	ALT, (Bosch), 140A, OE-NO 06F903023F	<b>VD1107</b>
					<b>AP9001</b>	ALT, (Valeo), 110A, OE-NO 06F903023E	
					<b>AP9001</b>	MTR-CODE: AZV	
						MTR-CODE: AZV, BKD, ALT, (AC)	<b>6PK1050D2</b>
						MTR-CODE: AZV, BKD, CBDA, CBDB	<b>VD1076</b>
	10/05-	BMM	103	1968	<b>AP9001</b>	ALT, (Bosch), 140A, OE-NO 06F903023F	
					<b>AP9001</b>	ALT, (Valeo), 110A, OE-NO 06F903023E	
						ALT, PS, (AC)	<b>6PK1050D2</b>
							<b>VD1076</b>
	10/06-	BMN, CEGA	125	1968	<b>AP9001</b>	ALT, (Bosch), 140A, OE-NO 06F903023F	
					<b>AP9001</b>	ALT, (Valeo), 110A, OE-NO 06F903023E	
						MTR-CODE: BMN, ALT, PS, (AC)	<b>6PK1050D2</b>
							<b>VD1076</b>
2.0 TDI 16V	08/05-	BKD, CBDB, CJAA	103	1968	<b>AP9001</b>	(Valeo), 110A, OE-NO 06F903023E	
					<b>AP9001</b>	ALT, (Bosch), 140A, OE-NO 06F903023F	
					<b>AP9001</b>	MTR-CODE: BKD	
						MTR-CODE: AZV, BKD, ALT, (AC)	<b>6PK1050D2</b>
						MTR-CODE: AZV, BKD, CBDA, CBDB, CJAA	<b>VD1076</b>
2.0 TFSI	10/05-	BWA, BPY, CAWB, CCTA, CBFA, CCZA	147	1984	<b>AP9001</b>	MTR-CODE: BWA, BPY, ALT, (Bosch), 140A, OE-NO 06F903023F	
<b>JETTA IV (162)</b>							
1.6 TDI	02/11-	CAYC	77	1598		MTR-CODE: CAYB, CAYC	<b>VD1111</b>
2.0 TDI	02/11-	CFFB, CJAA, CFHC, CLCB	103	1968		MTR-CODE: CJAA	<b>VD1076</b>
						MTR-CODE: CLCA, CLCB, CFHC, CFFB	<b>VD1111</b>
<b>LT 28-35 II Bus (2DM)</b>							
2.5 SDI	07/96-07/06	AGX	55	2461		ALT, (-AC), CH-NO 2D-Y-009 087⇒	<b>6PK1715D1</b>
						ALT, (-AC), ⇒CH-NO 2D-Y-009 086	<b>6PK1750D1</b>
2.5 TDI	05/01-07/06	BBE	61	2461		ALT, (-AC), CH-NO 2D-Y-009 087⇒	<b>6PK1715D1</b>
						ALT, (-AC), ⇒CH-NO 2D-Y-009 086	<b>6PK1750D1</b>
		BBF	70	2461		ALT, (-AC), CH-NO 2D-Y-009 087⇒	<b>6PK1715D1</b>
						ALT, (-AC), ⇒CH-NO 2D-Y-009 086	<b>6PK1750D1</b>
	05/96-08/99	AHD	75	2461		ALT, (-AC), CH-NO 2D-Y-009 087⇒	<b>6PK1715D1</b>
						ALT, (-AC), ⇒CH-NO 2D-Y-009 086	<b>6PK1750D1</b>
	05/99-07/06	APA	66	2461		ALT, (-AC), CH-NO 2D-Y-009 087⇒	<b>6PK1715D1</b>
						ALT, (-AC), ⇒CH-NO 2D-Y-009 086	<b>6PK1750D1</b>
		ANJ, AVR	80	2461		ALT, (-AC), CH-NO 2D-Y-009 087⇒	<b>6PK1715D1</b>
						ALT, (-AC), ⇒CH-NO 2D-Y-009 086	<b>6PK1750D1</b>
2.8 TDi	05/01-06/06	BCQ	116	2798	<b>AP9033</b>	ALT, (Bosch), ALT-No: 0 124 325 088, 90A, ALT-No: 0 124 515 110, 120A	
<b>LT 28-46 II Kasten (2DX0AE)</b>							
2.5 SDI	09/96-07/06	AGX	55	2461		ALT, (-AC), CH-NO 2D-Y-009 087⇒	<b>6PK1715D1</b>
						ALT, (-AC), ⇒CH-NO 2D-Y-009 086	<b>6PK1750D1</b>
2.5 TDI	05/01-07/06	BBE	61	2461		ALT, (-AC), CH-NO 2D-Y-009 087⇒	<b>6PK1715D1</b>
						ALT, (-AC), ⇒CH-NO 2D-Y-009 086	<b>6PK1750D1</b>
		BBF	70	2461		ALT, (-AC), CH-NO 2D-Y-009 087⇒	<b>6PK1715D1</b>
						ALT, (-AC), ⇒CH-NO 2D-Y-009 086	<b>6PK1750D1</b>
	05/96-08/99	AHD	75	2461		ALT, (-AC), CH-NO 2D-Y-009 087⇒	<b>6PK1715D1</b>
						ALT, (-AC), ⇒CH-NO 2D-Y-009 086	<b>6PK1750D1</b>
	05/99-07/06	APA	66	2461		ALT, (-AC), CH-NO 2D-Y-009 087⇒	<b>6PK1715D1</b>
						ALT, (-AC), ⇒CH-NO 2D-Y-009 086	<b>6PK1750D1</b>
		ANJ, AVR	80	2461		ALT, (-AC), CH-NO 2D-Y-009 087⇒	<b>6PK1715D1</b>
						ALT, (-AC), ⇒CH-NO 2D-Y-009 086	<b>6PK1750D1</b>
2.8 TDI	04/02-07/06	AUH, BCQ	116	2799	<b>AP9033</b>	ALT, (Bosch), ALT-No: 0 124 325 088, 90A, ALT-No: 0 124 515 110, 120A	

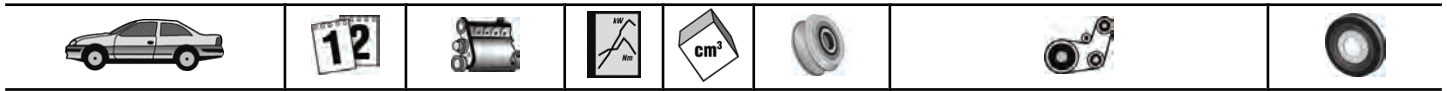

**VW**
**LT 28-46 II Pritsche/Fahrgestell (2DX0FE)**

↩ 2.5 SDI	09/96-07/06	AGX	55	2461		ALT, (-AC), CH-NO 2D-Y-009 087⇒ ALT, (-AC), ⇒CH-NO 2D-Y-009 086	<b>6PK1715D1</b> <b>6PK1750D1</b>
2.5 TDI	05/01-07/06	BBE	61	2461		ALT, (-AC), CH-NO 2D-Y-009 087⇒ ALT, (-AC), ⇒CH-NO 2D-Y-009 086	<b>6PK1715D1</b> <b>6PK1750D1</b> <b>VD1002</b>
		BBF	70	2461		ALT, (-AC), CH-NO 2D-Y-009 087⇒ ALT, (-AC), ⇒CH-NO 2D-Y-009 086	<b>6PK1715D1</b> <b>6PK1750D1</b> <b>VD1002</b>
	05/99-07/06	APA	66	2461		ALT, (-AC), CH-NO 2D-Y-009 087⇒ ALT, (-AC), ⇒CH-NO 2D-Y-009 086	<b>6PK1715D1</b> <b>6PK1750D1</b>
		ANJ, AVR	80	2461		ALT, (-AC), CH-NO 2D-Y-009 087⇒ ALT, (-AC), ⇒CH-NO 2D-Y-009 086	<b>6PK1715D1</b> <b>6PK1750D1</b>
	06/96-08/99	AHD	75	2461		ALT, (-AC), CH-NO 2D-Y-009 087⇒ ALT, (-AC), ⇒CH-NO 2D-Y-009 086	<b>6PK1715D1</b> <b>6PK1750D1</b>
2.8 TDI	04/02-07/06	AUH, BCQ	116	2799	<b>AP9033</b>	ALT, (Bosch), ALT-No: 0 124 325 088, 90A, ALT-No: 0 124 515 110, 120A	

**LUPO (6X1, 6E1)**

1.2 TDI 3L	07/99-07/05	ANY, AYZ	45	1191	<b>AP9001</b>	ALT, (Bosch), 70A, OE-NO 045903023B, 90A, OE-NO 045903023, 120A, OE-NO 045903023A	
1.4 TDI	01/99-07/05	AMF	55	1422	<b>AP9001</b>	ALT, (Bosch), 70A, OE-NO 045903023B, 90A, OE-NO 045903023, 120A, OE-NO 04590323A	
1.7 SDI	09/98-07/05	AKU	44	1716	<b>AP9057</b>	ALT, (Bosch), 70A, 90A	

**MULTIVAN V (7HM, 7HN, 7HF, 7EF, 7EM, 7EN)**

1.9 TDI	01/06-11/09	BRR	62	1896	<b>AP9001</b>	ALT, (Bosch), 90A, OE-NO 038903023L, 038903024D, 120A, OE-NO 028903028E, 038903024F, 140A, OE-NO 06F903023A, 06F903023J ALT, PS, (AC)	<b>6DPK1215D1</b> <b>VD1076</b>
		04/03-11/09	AXB	77	1896	<b>AP9001</b>	ALT, (Bosch), 90A, OE-NO 038903023L, 038903024D, 120A, OE-NO 028903028E, 038903024F, 140A, OE-NO 06F903023A, 06F903023J ALT, PS, (AC), CH-NO 7H-5-075 001⇒, ⇒CH-NO 7H-6H079 890, 7H-6X022 356 ALT, PS, (AC), CH-NO 7H-6H079 891⇒ ALT, PS, (AC), CH-NO 7H-6X022 357⇒ MTR-CODE: AXB, AXC, CH-NO 7J-5-022 001⇒ MTR-CODE: AXB, AXC, ⇒CH-NO 7J-5-022 000
	06/06-11/09	BRS	75	1896	<b>AP9001</b>	ALT, (Bosch), 90A, OE-NO 038903023L, 038903024D, 120A, OE-NO 028903028E, 038903024F, 140A, OE-NO 06F903023A, 06F903023J ALT, PS, (AC)	<b>6DPK1215D1</b> <b>VD1076</b> <b>VD1107</b>
2.0	11/03-	AXA	85	1984			<b>VD1107</b>
2.0 BITDI	09/09-	CFCA	132	1968	<b>AP9022</b>	ALT, (Bosch), 110A, OE-NO 06F903023L, 140A, OE-NO 06F903023N, 180A, OE-NO 03G903023F MTR-CODE: CAAA, CAAB, CAAC, CAAE, CCHA, CCHB, CFCA	<b>VD1111</b>
		CFCA	132	1968	<b>AP9022</b>	ALT, (Bosch), 110A, OE-NO 06F903023L, 140A, OE-NO 06F903023N, 180A, OE-NO 03G903023F MTR-CODE: CAAA, CAAB, CAAC, CAAE, CCHA, CCHB, CFCA	<b>VD1111</b>
2.0 TDI	05/10-	CAAE, CCHB	100	1968	<b>AP9022</b>	ALT, (Bosch), 110A, OE-NO 06F903023L, 140A, OE-NO 06F903023N, 180A, OE-NO 03G903023F MTR-CODE: CAAA, CAAB, CAAC, CAAE, CCHA, CCHB, CFCA	<b>VD1111</b>
	09/09-	CAAA	62	1968	<b>AP9022</b>	ALT, (Bosch), 110A, OE-NO 06F903023L, 140A, OE-NO 06F903023N, 180A, OE-NO 03G903023F MTR-CODE: CAAA, CAAB, CAAC, CAAE, CCHA, CCHB, CFCA	<b>VD1111</b>
		CAAB	75	1968	<b>AP9022</b>	ALT, (Bosch), 110A, OE-NO	



**VW**
**MULTIVAN V (7HM, 7HN, 7HF, 7EF, 7EM, 7EN)**

						06F903023L, 140A, OE-NO 06F903023N, 180A, OE-NO 03G903023F MTR-CODE: CAAA, CAAB, CAAC, CAAE, CCHA, CCHB, CFCA	<b>VD1111</b>
		CAAC, CCHA	103	1968	<b>AP9022</b>	ALT, (Bosch), 110A, OE-NO 06F903023L, 140A, OE-NO 06F903023N, 180A, OE-NO 03G903023F MTR-CODE: CAAA, CAAB, CAAC, CAAE, CCHA, CCHB, CFCA	<b>VD1111</b>
2.0 TDI 4motion	05/10-	CAAE, CCHB	100	1968		MTR-CODE: CAAA, CAAB, CAAC, CAAE, CCHA, CCHB, CFCA	<b>VD1111</b>
	09/09-	CAAC, CCHA	103	1968	<b>AP9022</b>	ALT, (Bosch), 110A, OE-NO 06F903023L, 140A, OE-NO 06F903023N, 180A, OE-NO 03G903023F MTR-CODE: CAAA, CAAB, CAAC, CAAE, CCHA, CCHB, CFCA	<b>VD1111</b>
2.5 TDI	04/03-11/09	AXD, BNZ	96	2461	<b>AP9030</b> <b>AP9030</b>	AC ALT, (Bosch), 150A, 180A	
		AXE, BPC	128	2461	<b>AP9030</b>	AC, CH-NO 7H-3-000 001⇨	
	11/03-11/09	BLJ	120	2461	<b>AP9030</b> <b>AP9030</b>	AC ALT, (Bosch), 150A, 180A	
2.5 TDI 4motion	07/04-11/09	AXD, BNZ	96	2461	<b>AP9030</b> <b>AP9030</b>	AC ALT, (Bosch), 150A, 180A	
		AXE, BPC	128	2461	<b>AP9030</b>	AC, CH-NO 7H-3-000 001⇨	

**NEW BEETLE (9C1, 1C1)**

1.6	06/00-	AYD, BFS	75	1595	<b>AP9001</b>	ALT, (Bosch,Valeo), (Hitachi), 120A	
	10/99-09/00	AWH	74	1595	<b>AP9001</b>	ALT, (Bosch), 120A	
1.8 T	10/99-	AGU, APH, AVC, AWU, AWV, BKF	110	1781	<b>AP9001</b>	ALT, (Hitachi), OE-NO 028903023G, 140A	
					<b>AP9001</b>	MTR-CODE: AWU, ALT, (Valeo), OE-NO 028903028E, 120A	<b>VD1107</b>
1.9 TDI	11/01-06/05	AWP, BNU	132	1781			<b>VD1107</b>
	01/98-06/04	ALH	66	1896	<b>AP9001</b> <b>AP9001</b>	ALT, (Hitachi), 120A ALT, CH-NO 1C-W-024 256⇨, (Bosch,Valeo), 70A, 90A, 120A	<b>VD1089</b>
					<b>AP9001</b> <b>AP9001</b>	ALT, (Bosch), OE-NO 038903023L, 90A MTR-CODE: BEW, ALT, (Valeo), OE-NO 028903028E, 120A, OE-NO 038903023R, 90A MTR-CODE: BEW MTR-CODE: ATD	<b>VD1076</b> <b>VD1091</b>
	07/05-	BSW	77	1896	<b>AP9001</b> <b>AP9001</b> <b>AP9001</b>	ALT, (Bosch), OE-NO 038903023L, 90A ALT, (Hitachi), OE-NO 028903029G, 120A ALT, (Valeo), OE-NO 038903023R, 90A	<b>VD1076</b>
2.0	01/98-	AQY, APK, AEG, AZG, AZJ, BER, BEV, AVH, BEJ, BHP, CBPA	85	1984	<b>AP9001</b>	ALT, (Hitachi), OE-NO 028903023G, 120A	
					<b>AP9001</b>	ALT, (Valeo), OE-NO 028903023E, 120A	
					<b>AP9001</b>	MTR-CODE: AZJ, BHP, BER	<b>VD1107</b>

**NEW BEETLE Cabriolet (1Y7)**

1.6	01/03-	BFS	75	1595	<b>AP9001</b>	ALT, (Hitachi), OE-NO 028903029G, 120A	
					<b>AP9001</b>	ALT, (Valeo), OE-NO 028903023E, 120A	
1.8 T	01/03-	AWU, AWV, BKF	110	1781	<b>AP9001</b>	ALT, (Hitachi), OE-NO 028903029G, 120A	
					<b>AP9001</b>	MTR-CODE: AWU, ALT, (Valeo), OE-NO 028903023E, 120A	<b>VD1107</b>
1.9 TDI	07/05-	BSW	77	1896	<b>AP9001</b>	(Hitachi), OE-NO 028903029G, 120A	
					<b>AP9001</b>	(Valeo), OE-NO 038903023R, 90A	
					<b>AP9001</b>	ALT, (Bosch), OE-NO 038903023L, 90A	<b>VD1076</b>
2.0	09/02-	AZJ, BDC, BGD, BEV	85	1984	<b>AP9001</b>	ALT, (Hitachi), OE-NO 028903029G, 120A	
					<b>AP9001</b>	MTR-CODE: AZJ, ALT, (Valeo), OE-NO 028903028E, 120A	<b>VD1107</b>

**PASSAT (3A2, 35I)**

1.6	10/94-08/96	AEK, AFT	74	1595	<b>AP9004</b>	ALT, (AC), (Bosch), 70A, 90A	
-----	-------------	----------	----	------	---------------	------------------------------	--



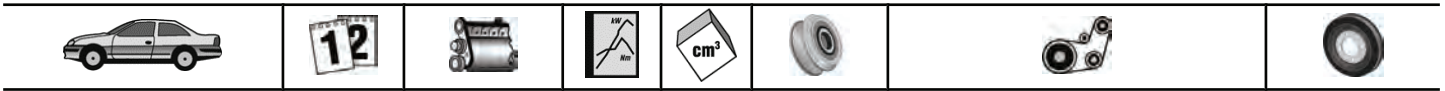

VW							
<b>PASSAT (3A2, 35I)</b>							
↩ 1.8	02/88-08/96	ABS, ADZ, RP	66	1781	AP9004	ALT, (AC), MTR-CODE: ABS, ADZ, (Bosch), 70A, 90A	
	08/90-08/96	AAM	55	1781	AP9004	ALT, (AC), (Bosch), 70A, 90A	
1.9 D	05/89-10/93	1Y	50	1896	AP9004	ALT, (Bosch), 90A, OE-NO 028 903 018 AX	
1.9 TD	03/91-08/96	AAZ	55	1896	AP9004	ALT, (AC), (Bosch), 70A, 90A	VD1084
1.9 TDI	03/96-08/96	AFN	81	1896	AP9004	ALT, (Bosch), 70A, 90A, 120A	VD1084
1.9 TDi	04/88-07/91	1Z	66	1896	AP9004	ALT, (Bosch), 70A, 90A MTR-CODE: 1Z, AHU	VD1084
1.9 TDI	10/93-08/96	1Z, AHU	66	1896	AP9004	ALT, (Bosch), 70A, 90A MTR-CODE: 1Z, AHU	VD1084
2.0	02/90-08/96	2E, ADY, AGG	85	1984	AP9004	ALT, (AC), (Bosch), 70A, 90A	
	03/95-08/96	AEP	79	1984	AP9004	ALT, (AC), (Bosch), 70A, 90A	
2.0 Syncro	10/90-08/96	2E, ADY, AGG	85	1984	AP9004	ALT, (AC), (Bosch), 70A, 90A	
2.0 16V	01/94-08/96	ABF	110	1984	AP9004	ALT, (Bosch), 70A, 90A	
<b>PASSAT (3B2)</b>							
1.6	10/96-11/00	AHL, ADP, ANA, ARM	74	1595	AP9002 AP9007	ALT, (Valeo), 120A ALT, (Bosch), 120A	
1.8 T	10/96-11/00	AEB, ANB, APU	110	1781	AP9002 AP9007	ALT, (Valeo), 120A ALT, (Bosch), 120A	
1.9 TDI	02/00-11/00	AVB	74	1896	AP9002	ALT, (Bosch), 90A, 120A ⇒CH-NO 3B-5E170 000, 3B-5-100 000	VD1090
	08/98-11/00	AJM, ATJ	85	1896	AP9002	ALT, CH-NO 3B-X-150 001⇒, ⇒CH-NO 3B-Y-060 488, (Bosch,Valeo), 90A, 120A	VD1090
	10/96-11/00	AHU, AHH	66	1896	AP9002 AP9002 AP9002 AP9032 AP9032 AP9032	ALT, CH-NO 3B-X-150 001⇒, (Bosch), 90A, 120A ALT, CH-NO 3B-X-150 001⇒, (Valeo), 120A ALT, CH-NO 3B-X-150 001⇒, ⇒CH-NO 3B-Y-060 488, (Valeo), 90A ALT, MTR-CODE: AHH, ⇒CH-NO 3B-X-150 000, (Bosch), 90A, 120A ALT, MTR-CODE: AHU, ⇒CH-NO 3B-X-150 000, (Bosch), 120A ALT, MTR-CODE: AHU, AHH, ⇒CH-NO 3B-X-150 000, (Bosch), 70A	
		AFN, AVG	81	1896	AP9002 AP9002 AP9002 AP9004 AP9032 AP9032	ALT, CH-NO 3B-X-150 001⇒, (Bosch), 90A, 120A ALT, CH-NO 3B-X-150 001⇒, (Valeo), 120A ALT, CH-NO 3B-X-150 001⇒, ⇒CH-NO 3B-Y-060 488, (Valeo), 90A ALT, (Bosch), 120A, OE-NO 028 903 026 G, MTR-CODE: AFN ALT, ⇒CH-NO 3B-X-150 000, (Bosch), 120A ALT, MTR-CODE: AFN, ⇒CH-NO 3B-X-150 000, (Bosch), 70A	
1.9 TDI 4motion	08/99-11/00	AJM, ATJ	85	1896	AP9002	ALT, CH-NO 3B-X-150 001⇒, ⇒CH-NO 3B-Y-060 488, (Bosch,Valeo), 90A, 120A	VD1090
1.9 TDI Syncro /4motion	10/96-11/00	AFN, AVG	81	1896	AP9002 AP9002 AP9002 AP9004 AP9032 AP9032	ALT, CH-NO 3B-X-150 001⇒, (Bosch), 90A, 120A ALT, CH-NO 3B-X-150 001⇒, (Valeo), 120A ALT, CH-NO 3B-X-150 001⇒, ⇒CH-NO 3B-Y-060 488, (Valeo), 90A ALT, (Bosch), 120A, OE-NO 028 903 026 G, MTR-CODE: AFN ALT, ⇒CH-NO 3B-X-150 000, (Bosch), 120A ALT, MTR-CODE: AFN, ⇒CH-NO 3B-X-150 000, (Bosch), 70A	
2.5 TDI	07/98-11/00	AKN, AFB	110	2496		ALT, AC	6PK2404D1 VD1032
2.5 TDI Syncro /4motion	12/98-11/00	AKN, AFB	110	2496		ALT, AC	6PK2404D1 VD1032
<b>PASSAT (3B3)</b>							
1.6	11/00-05/05	ALZ	75	1595	AP9002 AP9007	ALT, (Valeo), 120A ALT, (Bosch), 120A	
1.9 TDI	11/00-05/05	AVB	74	1896	AP9002	ALT, (Bosch), (Valeo), 90A, 120A ⇒CH-NO 3B-5E170 000, 3B-5-100 000	VD1090



**VW**
**PASSAT (3B3)**

		AVF, AWX	96	1896	<b>AP9002</b>	ALT, (Bosch), (Valeo), 90A, 120A ⇒CH-NO 3B-5E170 000, 3B-5-100 000	<b>VD1090</b>
1.9 TDI 4motion	11/00-05/05	AVF	96	1896	<b>AP9002</b>	ALT, (Bosch), (Valeo), 90A, 120A ⇒CH-NO 3B-5E170 000, 3B-5-100 000	<b>VD1090</b>
2.0	11/00-05/05	AZM, BFF	85	1984	<b>AP9002</b> <b>AP9007</b>	ALT, (Valeo), 120A ALT, (Bosch), 120A	
2.0 4motion	11/00-05/05	AZM	85	1984	<b>AP9002</b> <b>AP9007</b>	ALT, (Valeo), 120A ALT, (Bosch), 120A	
2.5 TDI	05/03-05/05	BDG	120	2496		ALT, AC	<b>6PK2404D1</b> <b>VD1032</b>
	11/00-05/05	AKN, AFB	110	2496		ALT, AC, MTR-CODE: AFB, AKN	<b>6PK2404D1</b> <b>VD1032</b>
2.5 TDI 4motion	01/03-05/05	BAU, BDH	132	2496		ALT, AC	<b>6PK2404D1</b> <b>VD1032</b>
	11/00-05/05	AKN, AFB	110	2496		ALT, AC, MTR-CODE: AFB, AKN	<b>6PK2404D1</b> <b>VD1032</b>

**PASSAT (3C2)**

1.4 TSI	05/07-	CAXA	90	1390	<b>AP9012</b> <b>AP9012</b> <b>AP9012</b> <b>AP9012</b>	(Bosch), OE-NO 03C 903 023 A, 140A (Valeo), OE-NO 03C 903 023 C, 140A (Valeo), OE-NO 03C 903 023 G, 110A ALT	
1.6	05/05-	BSE, BSF	75	1595	<b>AP9001</b>  <b>AP9001</b>	ALT, (Bosch), 140A, OE-NO 06F903023F ALT, (Valeo), 140A, OE-NO 06F903023C	
1.6 FSI	03/05-	BLF	85	1598	<b>AP9012</b> <b>AP9012</b> <b>AP9012</b>	(Bosch), OE-NO 03C 903 023 A, 140A (Valeo), OE-NO 03C 903 023 C, 140A ALT	
1.6 TDI	08/09-	CAYC	77	1598		MTR-CODE: CAYB, CAYC, ⇒10/2009 MTR-CODE: CAYB, CAYC, 11/2009⇒	<b>VD1076</b> <b>VD1111</b>
1.8 TSI	05/07-	BZB, CDAA	118	1798	<b>AP9009</b>  <b>AP9009</b>	ALT, (Bosch), 140A, OE-NO 06B903016AB ALT, (Valeo), 140A, OE-NO 06D903016A, 06J0903023C	
	11/09-	CDAB, CGYA	112	1798	<b>AP9009</b>  <b>AP9009</b>	ALT, (Bosch), 140A, OE-NO 06B903016AB ALT, (Valeo), 140A, OE-NO 06J903023C	
1.9 TDI	03/05-	BKC, BLS, BXE	77	1896	<b>AP9001</b>  <b>AP9001</b>	ALT, (Bosch), 140A, OE-NO 06F903023F ALT, (Valeo), 140A, OE-NO 06F903023C ALT, (AC)	<b>6PK1050D2</b> <b>VD1076</b>
2.0 BlueTDI	01/09-	CBAC	105	1968		MTR-CODE: CBAA, CBAB, CBAC	<b>VD1076</b>
2.0 FSI	03/05-	BLY, BLR, BVY, BVZ	110	1984	<b>AP9001</b>  <b>AP9001</b>	ALT, (Valeo), 140A, OE-NO 06F903023C MTR-CODE: BLY, BLR, BVY, ALT, (Bosch), 140A, OE-NO 06F903023F	<b>VD1107</b>
	07/05-	AXX, BWA, BPY, CAWB, CCTA, CBFA, CCZA	147	1984	<b>AP9001</b>  <b>AP9001</b>  <b>AP9009</b>  <b>AP9009</b>	ALT, (Bosch), 140A, OE-NO 06F903023F ALT, (Valeo), 140A, OE-NO 06F903023C ALT, (Bosch), 140A, OE-NO 06B903016AB ALT, (Valeo), 140A, OE-NO 06D903016A, 06J903023C MTR-CODE: CCTA, CAWB, CCZA	
	08/07-	CCTB	125	1984	<b>AP9009</b>  <b>AP9009</b>	ALT, (Bosch), 140A, OE-NO 06B903016AB ALT, (Valeo), 140A, OE-NO 06D903016A, 06J903023C	
	09/05-	BLX, BLY, BVX	110	1984	<b>AP9001</b>  <b>AP9001</b>	ALT, (Bosch), 140A, OE-NO 06F903023F ALT, (Valeo), 140A, OE-NO 06F903023C	<b>VD1107</b>
2.0 TDI	03/05-	BMA, CBAA	100	1968	<b>AP9001</b>  <b>AP9001</b>	ALT, (Bosch), 140A, OE-NO 06F903023F, 180A, OE-NO 03G903023 ALT, (Valeo), 140A, OE-NO 06F903023C, 180A, OE-NO 021903023L MTR-CODE: BMA, ALT, (AC) MTR-CODE: BMA, CBAA, CBAB, CBAC	<b>6PK1050D2</b> <b>VD1076</b>
		BMP	103	1968	<b>AP9001</b>	ALT, (Bosch), 140A, OE-NO 06F903023F, 180A, OE-NO	





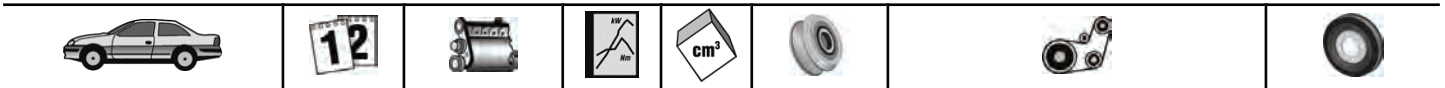

<b>VW</b>						
<b>PASSAT (3C2)</b>						
					<b>AP9001</b>	03G903023 ALT, (Valeo), 140A, OE-NO 06F903023C, 180A, OE-NO 021903023L ALT, AC MTR-CODE: BMP <b>6PK1050D2</b> <b>VD1076</b>
	08/05-	BUZ	120	1968		MTR-CODE: BUZ, ALT, (AC) <b>6PK1050D2</b>
		BMR, CBBB	125	1968		MTR-CODE: BMR, ALT, (AC) <b>6PK1050D2</b> <b>VD1076</b>
	08/05-07/06	BVE	90	1968		MTR-CODE: BVE, ALT, (AC) <b>6PK1050D2</b>
	11/05-	BWV	88	1968		MTR-CODE: BWV, ALT, (AC) <b>6PK1050D2</b> <b>VD1076</b>
	11/08-	CBDC	81	1968		MTR-CODE: CBDC <b>VD1076</b>
2.0 TDI 4motion	03/05-	BMP	103	1968	<b>AP9001</b>	ALT, (Bosch), 140A, OE-NO 06F903023F, 180A, OE-NO 03G903023 <b>AP9001</b> ALT, (Valeo), 140A, OE-NO 06F903023C, 180A, OE-NO 021903023L ALT, AC MTR-CODE: BMP <b>6PK1050D2</b> <b>VD1076</b>
2.0 TDI 16V	03/05-	BKP, CBAB	103	1968	<b>AP9001</b>	ALT, (Bosch), 140A, OE-NO 06F903023F, 180A, OE-NO 03G903023 <b>AP9001</b> ALT, (Valeo), 140A, OE-NO 06F903023C, 180A, OE-NO 021903023L MTR-CODE: BKP, ALT, (AC) MTR-CODE: BKP, CBAA, CBAB, CBAC <b>6PK1050D2</b> <b>VD1076</b>
2.0 TDI 16V 4motion	03/05-	BKP, CBAB	103	1968	<b>AP9001</b>	ALT, (Bosch), 140A, OE-NO 06F903023F, 180A, OE-NO 03G903023 <b>AP9001</b> ALT, (Valeo), 140A, OE-NO 06F903023C, 180A, OE-NO 021903023L MTR-CODE: BKP, ALT, (AC) MTR-CODE: BKP, CBAA, CBAB, CBAC <b>6PK1050D2</b> <b>VD1076</b>
2.0 TDI 4motion	05/09-	CBBB	125	1968		MTR-CODE: CBBB <b>VD1076</b>
3.2 FSI 4motion	11/05-	AXZ	184	3168	<b>AP9001</b>	ALT, (Bosch), 140A, OE-NO 06F903023F, 180A, OE-NO 03G903023 <b>AP9001</b> ALT, (Valeo), 140A, OE-NO 06F903023C, 180A, OE-NO 021903023L <b>AP9022</b> ALT, (Bosch), 180A, OE-NO 03G903023F <b>AP9022</b> ALT, (Valeo), 140A, OE-NO 06F903023P, 180A, OE-NO 03G903023G <b>AP9022</b> CH-NO 3C-7-140001⇨
3.6 FSI	06/05-07/07	BLV	206	3597	<b>AP9022</b>	ALT, (Bosch), 180A, OE-NO 03G903023F <b>AP9022</b> ALT, (Valeo), 140A, OE-NO 06F903023P, 180A, OE-NO 03G903023G <b>AP9022</b> CH-NO 3C-7-140001⇨
3.6 FSI 4motion	09/05-	BLV	206	3597	<b>AP9022</b>	ALT, (Bosch), 180A, OE-NO 03G903023F <b>AP9022</b> ALT, (Valeo), 140A, OE-NO 06F903023P, 180A, OE-NO 03G903023G <b>AP9022</b> CH-NO 3C-7-140001⇨
3.6 R36 4motion	04/07-	BWS	220	3597	<b>AP9022</b>	ALT, (Bosch), 180A, OE-NO 03G903023F <b>AP9022</b> ALT, (Valeo), 140A, OE-NO 06F903023P, 180A, OE-NO 03G903023G <b>AP9022</b> CH-NO 3C-7-140001⇨
<b>PASSAT CC</b>						
1.8 TSI	06/08-	BZB, CDAA	118	1798	<b>AP9009</b>	ALT, (Bosch), 140A, OE-NO 06B903016AB <b>AP9009</b> ALT, (Valeo), 140A, OE-NO 06D903016A, 06J903023C <b>AP9009</b> MTR-CODE: BZB
2.0 BlueTDI	05/09-	CBAC	105	1968	<b>AP9001</b>	ALT, (Bosch), 110A, OE-NO 06F903023D, 140A, OE-NO 06F903023F, 180A, OE-NO 03G903023





VW

**VW**

**PASSAT CC**

					<b>AP9001</b>	ALT, (Valeo), 110A, OE-NO 06F903023E, 140A, OE-NO 06F903023C, 180A, OE-NO 021903026L MTR-CODE: CBAA, CBAB, CBAC	<b>VD1076</b>
2.0 TDI	06/08-	CBAA	100	1968	<b>AP9001</b>	ALT, (Bosch), 110A, OE-NO 06F903023D, 140A, OE-NO 06F903023F, 180A, OE-NO 03G903023	
					<b>AP9001</b>	ALT, (Valeo), 110A, OE-NO 06F903023E, 140A, OE-NO 06F903023C, 180A, OE-NO 021903026L MTR-CODE: CBAA, CBAB, CBAC	<b>VD1076</b>
		CBAB, CFFB	103	1968	<b>AP9001</b>	ALT, (Bosch), 110A, OE-NO 06F903023D, 140A, OE-NO 06F903023F, 180A, OE-NO 03G903023	
					<b>AP9001</b>	ALT, (Valeo), 110A, OE-NO 06F903023E, 140A, OE-NO 06F903023C, 180A, OE-NO 021903026L MTR-CODE: CBAA, CBAB, CBAC MTR-CODE: CFFA, CFFB	<b>VD1076</b> <b>VD1111</b>
		CBBB, CFGB	125	1968	<b>AP9001</b>	ALT, (Bosch), 110A, OE-NO 06F903023D, 140A, OE-NO 06F903023F, 180A, OE-NO 03G903023	
					<b>AP9001</b>	ALT, (Valeo), 110A, OE-NO 06F903023E, 140A, OE-NO 06F903023C, 180A, OE-NO 021903026L MTR-CODE: CBBB MTR-CODE: CFGB	<b>VD1076</b> <b>VD1111</b>
2.0 TDI 4motion	08/09-	CBAB, CFFB	103	1968	<b>AP9001</b>	ALT, (Bosch), 110A, OE-NO 06F903023D, 140A, OE-NO 06F903023F, 180A, OE-NO 03G903023	
					<b>AP9001</b>	ALT, (Valeo), 110A, OE-NO 06F903023E, 140A, OE-NO 06F903023C, 180A, OE-NO 021903026L MTR-CODE: CBAA, CBAB, CBAC MTR-CODE: CFFA, CFFB	<b>VD1076</b> <b>VD1111</b>
2.0 TDI 4motion	11/09-	CBBB, CFGB	125	1968	<b>AP9001</b>	ALT, (Bosch), 110A, OE-NO 06F903023D, 140A, OE-NO 06F903023F, 180A, OE-NO 03G903023	
					<b>AP9001</b>	ALT, (Valeo), 110A, OE-NO 06F903023E, 140A, OE-NO 06F903023C, 180A, OE-NO 021903026L MTR-CODE: CBBB MTR-CODE: CFGB	<b>VD1076</b> <b>VD1111</b>
2.0 TSI	06/08-	CAWB, CCTA, CBFA, CCZA	147	1984	<b>AP9009</b>	ALT, (Bosch), 140A, OE-NO 06B903016AB	
					<b>AP9009</b>	ALT, (Valeo), 140A, OE-NO 06D903016A, 06J903023C	
					<b>AP9009</b>	MTR-CODE: CCTA, CAWB	
3.6 4motion	06/08-	BWS	220	3597	<b>AP9022</b>	ALT, (Bosch), 180A, OE-NO 03G903023F	
					<b>AP9022</b>	ALT, (Valeo), 140A, OE-NO 06F903023P, 180A, OE-NO 03G903023G	
					<b>AP9022</b>	CH-NO 3C-7-140001⇄	
<b>PASSAT Variant (3A5, 35I)</b>							
1.6	07/94-12/95	AEK, AFT	74	1595	<b>AP9004</b>	ALT, (AC), (Bosch), 70A, 90A	
1.8	02/88-05/97	ABS, ADZ, RP	66	1781	<b>AP9004</b>	ALT, (AC), MTR-CODE: ABS, ADZ, (Bosch), 70A, 90A	
	08/90-05/97	AAM	55	1781	<b>AP9004</b>	ALT, (AC), (Bosch), 70A, 90A	
1.9 D	05/89-10/93	1Y	50	1896	<b>AP9004</b>	ALT, (Bosch), 90A, OE-NO 028 903 018 AX	<b>VD1084</b>
1.9 TD	03/91-05/97	AAZ	55	1896	<b>AP9004</b>	ALT, (AC), (Bosch), 70A, 90A	<b>VD1084</b>
1.9 TDI	03/96-05/97	AFN	81	1896	<b>AP9004</b>	ALT, (Bosch), 120A, OE-NO 028 903 026 G	<b>VD1084</b>



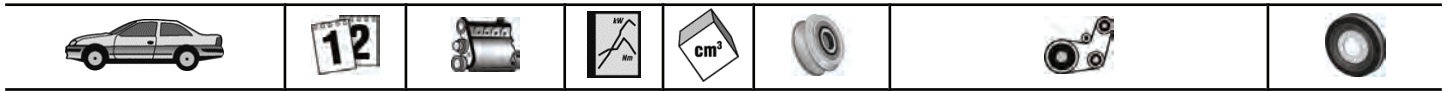

## VW

### PASSAT Variant (3A5, 35I)

1.9 TDi	04/88-07/91	1Z	66	1896	AP9004	ALT, (Bosch), 70A, 90A MTR-CODE: 1Z, AHU	VD1084
1.9 TDi	10/93-05/97	1Z, AHU	66	1896	AP9004	ALT, (Bosch), 70A, 90A MTR-CODE: 1Z, AHU	VD1084
2.0	02/90-05/97	2E, ADY, AGG	85	1984	AP9004	ALT, (AC), (Bosch), 70A, 90A	
	03/95-08/96	AEP	79	1984	AP9004	ALT, (AC), (Bosch), 70A, 90A	
2.0 Syncro	10/90-05/97	2E, ADY, AGG	85	1984	AP9004	ALT, (AC), (Bosch), 70A, 90A	
2.0 16V	01/94-05/97	ABF	110	1984	AP9004	ALT, (Bosch), 70A, 90A	

### PASSAT Variant (3B5)

1.6	06/97-11/00	AHL, ADP, ANA, ARM	74	1595	AP9002 AP9007	ALT, (Valeo), 120A ALT, (Bosch), 120A	
1.8 T	06/97-11/00	AEB, ANB, APU	110	1781	AP9002 AP9007	ALT, (Valeo), 120A ALT, (Bosch), 120A	
1.9 TDi	02/00-11/00	AVB	74	1896	AP9002	ALT, (Bosch), 90A, 120A ⇒CH-NO 3B-5E170 000, 3B-5-100 000	VD1090
	06/97-11/00	AHU, AHH	66	1896	AP9002 AP9002 AP9002 AP9032 AP9032 AP9032	ALT, CH-NO 3B-X-150 001⇒, (Bosch), 90A, 120A ALT, CH-NO 3B-X-150 001⇒, (Valeo), 120A ALT, CH-NO 3B-X-150 001⇒, ⇒CH-NO 3B-Y-060 488, (Valeo), 90A ALT, MTR-CODE: AHH, ⇒CH-NO 3B-X-150 000, (Bosch), 90A, 120A ALT, MTR-CODE: AHU, ⇒CH-NO 3B-X-150 000, (Bosch), 120A ALT, MTR-CODE: AHU, AHH, ⇒CH-NO 3B-X-150 000, (Bosch), 70A	
1.9 TDi 4motion	08/98-11/00	AFN, AVG	81	1896	AP9002 AP9002 AP9002 AP9032 AP9032	ALT, CH-NO 3B-X-150 001⇒, (Bosch), 90A, 120A ALT, CH-NO 3B-X-150 001⇒, (Valeo), 120A ALT, CH-NO 3B-X-150 001⇒, ⇒CH-NO 3B-Y-060 488, (Valeo), 90A ALT, ⇒CH-NO 3B-X-150 000, (Bosch), 120A ALT, MTR-CODE: AFN, ⇒CH-NO 3B-X-150 000, (Bosch), 70A	
		AJM, ATJ	85	1896	AP9002	ALT, CH-NO 3B-X-150 001⇒, ⇒CH-NO 3B-Y-060 488, (Bosch,Valeo), 90A, 120A	VD1090
1.9 TDi 4motion	08/99-11/00	ATJ	85	1896	AP9002	ALT, CH-NO 3B-X-150 001⇒, ⇒CH-NO 3B-Y-060 488, (Bosch,Valeo), 90A, 120A	VD1090
1.9 TDi Syncro /4motion	06/97-11/00	AFN, AVG	81	1896	AP9002 AP9002 AP9002 AP9032 AP9032	ALT, CH-NO 3B-X-150 001⇒, (Bosch), 90A, 120A ALT, CH-NO 3B-X-150 001⇒, (Valeo), 120A ALT, CH-NO 3B-X-150 001⇒, ⇒CH-NO 3B-Y-060 488, (Valeo), 90A ALT, ⇒CH-NO 3B-X-150 000, (Bosch), 120A ALT, MTR-CODE: AFN, ⇒CH-NO 3B-X-150 000, (Bosch), 70A	
2.5 TDi	07/98-11/00	AKN, AFB	110	2496		ALT, AC	6PK2404D1 VD1032
2.5 TDi Syncro /4motion	12/98-11/00	AKN, AFB	110	2496		ALT, AC	6PK2404D1 VD1032

### PASSAT Variant (3B6)

1.6	11/00-05/05	ALZ	75	1595	AP9002 AP9007	ALT, (Valeo), 120A ALT, (Bosch), 120A	
1.9 TDi	11/00-05/05	AVB	74	1896	AP9002	ALT, (Bosch), (Valeo), 90A, 120A ⇒CH-NO 3B-5E170 000, 3B-5-100 000	VD1090
		AVF, AWX	96	1896	AP9002	ALT, (Bosch), (Valeo), 90A, 120A ⇒CH-NO 3B-5E170 000, 3B-5-100 000	VD1090
1.9 TDi 4motion	11/00-05/05	AVF	96	1896	AP9002	ALT, (Bosch), (Valeo), 90A, 120A ⇒CH-NO 3B-5E170 000, 3B-5-100 000	VD1090
2.0	11/00-05/05	AZM	85	1984	AP9002 AP9007	ALT, (Valeo), 120A ALT, (Bosch), 120A	
2.0 4motion	11/00-05/05	AZM	85	1984	AP9002 AP9007	ALT, (Valeo), 120A ALT, (Bosch), 120A	
2.5 TDi	05/03-05/05	BDG	120	2496		ALT, AC	6PK2404D1 VD1032
	11/00-05/05	AKN, AFB	110	2496		ALT, AC, MTR-CODE: AFB, AKN	6PK2404D1 VD1032
2.5 TDi 4motion	01/03-05/05	BAU, BDH	132	2496		ALT, AC	6PK2404D1





**VW**
**PASSAT Variant (3B6)**

11/00-05/05	AKN, AFB	110	2496		ALT, AC, MTR-CODE: AFB, AKN	<b>VD1032</b> <b>6PK2404D1</b> <b>VD1032</b>
-------------	----------	-----	------	--	-----------------------------	----------------------------------------------------

**PASSAT Variant (3C5)**

1.4 TSI	05/07-	CAXA	90	1390	<b>AP9012</b> <b>AP9012</b> <b>AP9012</b> <b>AP9012</b>	(Bosch), OE-NO 03C 903 023 A, 140A (Valeo), OE-NO 03C 903 023 C, 140A (Valeo), OE-NO 03C 903 023 G, 110A ALT	
1.6	08/05-	BSE, BSF	75	1595	<b>AP9001</b>  <b>AP9001</b>	ALT, (Bosch), 140A, OE-NO 06F903023F ALT, (Valeo), 140A, OE-NO 06F903023C	
1.6 FSI	08/05-	BLF	85	1598	<b>AP9012</b> <b>AP9012</b> <b>AP9012</b>	(Bosch), OE-NO 03C 903 023 A, 140A (Valeo), OE-NO 03C 903 023 C, 140A ALT	
1.6 TDI	08/09-	CAYC	77	1598		MTR-CODE: CAYC, ⇨10/2009 MTR-CODE: CAYC, 11/2009⇨	<b>VD1076</b> <b>VD1111</b>
1.8 TSI	05/07-	BZB, CDAA	118	1798	<b>AP9009</b>  <b>AP9009</b>	ALT, (Bosch), 140A, OE-NO 06B903016AB ALT, (Valeo), 140A, OE-NO 06D903016A, 06J903023C	
	11/09-	CDAB, CGYA	112	1798	<b>AP9009</b>  <b>AP9009</b>	ALT, (Bosch), 140A, OE-NO 06B903016AB ALT, (Valeo), 140A, OE-NO 06J903023C	
1.9 TDI	08/05-	BKC, BLS, BXE	77	1896	<b>AP9001</b>  <b>AP9001</b>	ALT, (Bosch), 140A, OE-NO 06F903023F ALT, (Valeo), 140A, OE-NO 06F903023C ALT, (AC)	<b>6PK1050D2</b> <b>VD1076</b>
	01/09-	CBAC	105	1968		MTR-CODE: CBAA, CBAB, CBAC	<b>VD1076</b>
2.0 BlueTDI	08/05-	BLY, BLR, BVY, BVZ	110	1984	<b>AP9001</b>  <b>AP9001</b>	ALT, (Bosch), 140A, OE-NO 06F903023F ALT, (Valeo), 140A, OE-NO 06F903023C	<b>VD1107</b>
		AXX, BWA, BPY, CAWB, CCTA, CBFA, CCZA	147	1984	<b>AP9009</b>  <b>AP9009</b>  <b>AP9009</b>	ALT, (Bosch), 140A, OE-NO 06B903016AB ALT, (Valeo), 140A, OE-NO 06D903016A, 06J903023C MTR-CODE: CCTA, CAWB, CCZA	
	08/07-	CCTB	125	1984	<b>AP9009</b>  <b>AP9009</b>	ALT, (Bosch), 140A, OE-NO 06B903016AB ALT, (Valeo), 140A, OE-NO 06D903016A, 06J903023C	
2.0 FSI 4motion	09/05-	BLX, BLY, BVX	110	1984	<b>AP9001</b>	ALT, 140A, (Bosch), (Valeo)	<b>VD1107</b>
2.0 TDI	08/05-	BVE	90	1968	<b>AP9001</b>  <b>AP9001</b>  <b>AP9001</b>	ALT, (Bosch), 140A, OE-NO 06F903023F, 180A, OE-NO 03G903023 ALT, (Valeo), 140A, OE-NO 06F903023C, 180A, OE-NO 021903023L MTR-CODE: BVD MTR-CODE: BVE, ALT, (AC) MTR-CODE: BVE	<b>6PK1050D2</b> <b>VD1076</b>
		BMA, CBAA	100	1968	<b>AP9001</b>  <b>AP9001</b>	ALT, (Bosch), 140A, OE-NO 06F903023F, 180A, OE-NO 03G903023 ALT, (Valeo), 140A, OE-NO 06F903023C, 180A, OE-NO 021903023L MTR-CODE: BMA, ALT, (AC) MTR-CODE: BMA, CBAA, CBAB, CBAC	<b>6PK1050D2</b> <b>VD1076</b>
		BMP	103	1968	<b>AP9001</b>  <b>AP9001</b>	ALT, (Bosch), 140A, OE-NO 06F903023F, 180A, OE-NO 03G903023 ALT, (Valeo), 140A, OE-NO 06F903023C, 180A, OE-NO 021903023L ALT, (AC) MTR-CODE: BMP	<b>6PK1050D2</b> <b>VD1076</b>
2.0 TDi	08/05-	BUZ	120	1968		MTR-CODE: BUZ, ALT, (AC)	<b>6PK1050D2</b>
2.0 TDI	08/05-	BMR, CBBB	125	1968	<b>AP9001</b>  <b>AP9001</b>	ALT, (Bosch), 140A, OE-NO 06F903023F, 180A, OE-NO 03G903023 ALT, (Valeo), 140A, OE-NO	

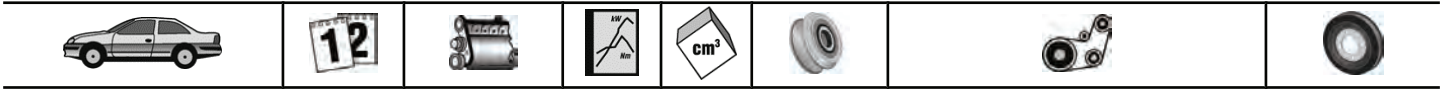



# VW

## PASSAT Variant (3C5)

						06F903023C, 180A, OE-NO 021903023L MTR-CODE: BMR, ALT, (AC) MTR-CODE: BMR, CBBB	6PK1050D2 VD1076
	11/05-	BWV	88	1968		MTR-CODE: BWV, ALT, (AC) MTR-CODE: BWV	6PK1050D2 VD1076
	11/08-	CBDC	81	1968		MTR-CODE: CBDC	VD1076
2.0 TDI 4motion	08/05-	BMP	103	1968	AP9001	ALT, (Bosch), 140A, OE-NO 06F903023F, 180A, OE-NO 03G903023	
					AP9001	ALT, (Valeo), 140A, OE-NO 06F903023C, 180A, OE-NO 021903023L ALT, AC MTR-CODE: BMP	6PK1050D2 VD1076
2.0 TDI 16V	08/05-	BKP, CBAB	103	1968	AP9001	ALT, (Bosch), 140A, OE-NO 06F903023F, 180A, OE-NO 03G903023	
					AP9001	ALT, (Valeo), 140A, OE-NO 06F903023C, 180A, OE-NO 021903023L MTR-CODE: BKP, ALT, (AC) MTR-CODE: BKP, CBAA, CBAB, CBAC	6PK1050D2 VD1076
2.0 TDI 16V 4motion	08/05-	BKP, CBAB	103	1968	AP9001	ALT, (Bosch), 140A, OE-NO 06F903023F, 180A, OE-NO 03G903023	
					AP9001	ALT, (Valeo), 140A, OE-NO 06F903023C, 180A, OE-NO 021903023L MTR-CODE: BKP, ALT, (AC) MTR-CODE: BKP, CBAA, CBAB, CBAC	6PK1050D2 VD1076
2.0 TDI 4motion	05/09-	CBBB	125	1968		MTR-CODE: CBBB	VD1076
3.2 FSI 4motion	11/05-	AXZ	184	3168	AP9001	ALT, (Bosch), 140A, OE-NO 06F903023F, 180A, OE-NO 03G903023	
					AP9001	ALT, (Valeo), 140A, OE-NO 06F903023C, 180A, OE-NO 021903023L	
					AP9022	ALT, (Bosch), 180A, OE-NO 03G903023F	
					AP9022	ALT, (Valeo), 140A, OE-NO 06F903023P, 180A, OE-NO 03G903023G	
					AP9022	CH-NO 3C-7-140001⇒	
3.6 FSI	09/05-	BLV	206	3597	AP9022	ALT, (Bosch), 180A, OE-NO 03G903023F	
					AP9022	ALT, (Valeo), 140A, OE-NO 06F903023P, 180A, OE-NO 03G903023G	
					AP9022	CH-NO 3C-7-140001⇒	
3.6 FSI 4motion	09/05-	BLV	206	3597	AP9022	ALT, (Bosch), 180A, OE-NO 03G903023F	
					AP9022	ALT, (Valeo), 140A, OE-NO 06F903023P, 180A, OE-NO 03G903023G	
					AP9022	CH-NO 3C-7-140001⇒	
3.6 R36 4motion	04/07-	BWS	220	3597	AP9022	ALT, (Bosch), 180A, OE-NO 03G903023F	
					AP9022	ALT, (Valeo), 140A, OE-NO 06F903023P, 180A, OE-NO 03G903023G	
					AP9022	CH-NO 3C-7-140001⇒	
<b>PHAETON (3D2)</b>							
3.0 V6 TDI 4motion	09/04-	BMK	165	2967		MTR-CODE: BMK	VD1033
5.0 V10 TDI 4motion	11/02-	AJS	230	4921	AP9030	AC	
					AP9030	ALT, (Delphi), 190A, OE-NO 07Z 903 021 C, 07Z 903 021 F	
<b>POLO (6N1)</b>							
60 1.7 SDI	08/97-10/99	AKU	44	1716	AP9057	ALT, (Bosch), 70A, OE-NO 038 903 025, 90A, OE-NO 038 903 025 A	
					AP9059	ALT, (Bosch), 70A, 90A	
64 1.9 D	10/94-10/99	AEF	47	1896	AP9057	ALT, (Bosch), 70A, OE-NO 038 903 023 P, 90A, OE-NO 038 903 023 T	
					AP9059	ALT, (Bosch), 70A, 90A	
64 1.9 SDI	07/96-10/99	AGD	47	1896	AP9057	ALT, (Bosch), 70A, OE-NO 038 903 025, 90A, OE-NO 038 903 025 A	
					AP9059	ALT, (Bosch), 70A, 90A	



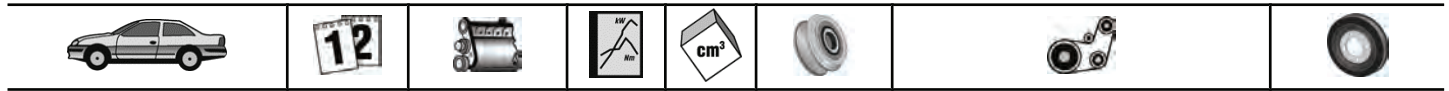

# VW

POLO (6N2)							
1.4 TDI	10/99-09/01	AMF	55	1422	AP9001	ALT, (Bosch), 70A, OE-NO 038903023K, 90A, OE-NO 038903023L	
1.7 SDI	10/99-09/01	AKU	44	1716	AP9001 AP9057	ALT, (Bosch), 70A, OE-NO 038903023K, 90A, OE-NO 038903023L	
1.9 D	10/99-09/01	AEF	47	1896	AP9001 AP9057	ALT, (Bosch), 70A, OE-NO 038903023K, 90A, OE-NO 038903023L ALT, (Bosch), 70A, 90A	
1.9 SDI	10/99-09/01	AGD, ASX	47	1896	AP9001 AP9057	ALT, (Bosch), 70A, OE-NO 038903023K, 90A, OE-NO 038903023L ALT, (Bosch), 70A, 90A	
POLO (6R_)							
1.2 TDI	10/09-	CFWA	55	1199			VD1111
1.2 TSI	11/09-	CBZB	77	1197	AP9012 AP9012 AP9012	(Bosch), 140A, OE-NO 03F903023D (Valeo), 110A, OE-NO 03F903023E ALT	
1.6 TDI	06/09-	CAYA	55	1598		MTR-CODE: CAYA, CAYB, CAYC, ⇌10 /2009 MTR-CODE: CAYA, CAYB, CAYC, 11 /2009⇌	VD1076 VD1111
		CAYB	66	1598		MTR-CODE: CAYA, CAYB, CAYC, ⇌10 /2009 MTR-CODE: CAYA, CAYB, CAYC, 11 /2009⇌	VD1076 VD1111
		CAYC	77	1598		MTR-CODE: CAYA, CAYB, CAYC, ⇌10 /2009 MTR-CODE: CAYA, CAYB, CAYC, 11 /2009⇌	VD1076 VD1111
POLO (9N_)							
1.2	01/02-05/07	AWY, BMD	40	1198	AP9006	ALT, (Valeo), 70A, OE-NO 03D903025D, 03D903025H, 90A, OE-NO 03D903025E, 03D903025J	
1.2 12V	10/01-07/07	AZQ, BME	47	1198	AP9006	ALT, (Valeo), 70A, OE-NO 03D903025D, 03D903025H, 90A, OE-NO 03D903025E, 03D903025J	
1.4 TDI	04/05-	BNM, BWB	51	1422	AP9022	ALT, (Bosch), 70A, OE-NO 045903023C, 90A, OE-NO 045903023D, 110A, OE-NO 045903023H	
		BMS, BNV	59	1422	AP9022	ALT, (Bosch), 70A, OE-NO 045903023C, 90A, OE-NO 045903023D, 110A, OE-NO 045903023H	
		10/01-06/05	AMF, BAY	55	1422	AP9001	ALT, (Bosch), 70A, OE-NO 045903023B, 90A, OE-NO 045903023A
1.8 GTI	09/05-	BJX	110	1781	AP9001	ALT, 120A, (Bosch), (Valeo)	VD1107
1.8 GTi Cup Edition	05/06-	BBU	132	1781	AP9001	ALT, 120A, (Bosch), (Valeo)	VD1107
1.9 SDI	10/01-	ASY	47	1896	AP9001	ALT, (Bosch), 70A, OE-NO 038903023K, 90A, OE-NO 038903023L, 120A, OE-NO 028903028E	
					AP9001	ALT, (Hitachi), 120A, OE-NO 028903029G	
					AP9001	ALT, (Valeo), 70A, OE-NO 038903023Q, 90A, OE-NO 038903023R, 120A, OE-NO 038903023S	
						MTR-CODE: ASY	VD1111
1.9 TDI	10/01-	ATD, AXR, BMT	74	1896	AP9001	ALT, (Bosch), 70A, OE-NO 038903023K, 90A, OE-NO 038903023L, 120A, OE-NO 028903028E	
					AP9001	ALT, (Hitachi), 120A, OE-NO 028903029G	
					AP9001	ALT, (Valeo), 70A, OE-NO 038903023Q, 90A, OE-NO 038903023R, 120A, OE-NO 038903023S	
					AP9001 AP9022	MTR-CODE: AXR, ATD ALT, (Bosch), 70A, OE-NO 045903023C, 90A, OE-NO 045903023D, 110A, OE-NO 045903023H, MTR-CODE: BMT	VD1076
					11/03-	ASZ, BLT	96



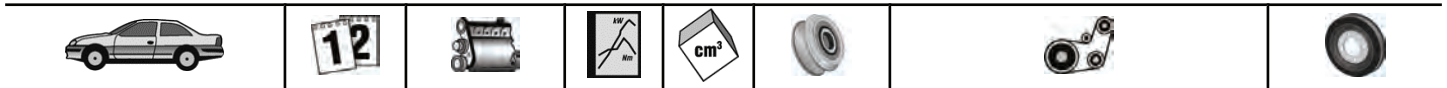

VW							
<b>POLO (9N )</b>							
						038903023K, 90A, OE-NO 038903023L, 120A, OE-NO 028903028E <b>AP9001</b> ALT, (Hitachi), 120A, OE-NO 028903029G <b>AP9001</b> ALT, (Valeo), 70A, OE-NO 038903023Q, 90A, OE-NO 038903023R, 120A, OE-NO 038903023S	
<b>VD1076</b>							
<b>POLO CLASSIC (6KV2)</b>							
110 1.9 TDI	06/98-09/01	AFN, ASV	81	1896	<b>AP9004</b> <b>AP9004</b>	ALT, MTR-CODE: AFN, (Bosch), 120A, OE-NO 028 903 026 G ALT, MTR-CODE: AFN, CH-NO 6K-X-507830⇒, (Bosch), 90A, OE-NO 028 903 028 J	<b>VD1089</b>
57 1.7 SDI	07/97-09/01	AKW	42	1716	<b>AP9004</b>	ALT, (Bosch), 120A	<b>VD1084</b>
64 1.9 SDI	12/95-08/99	AEY	47	1896	<b>AP9004</b> <b>AP9004</b>	ALT, (Bosch), 70A, OE-NO 028 903 018 X ALT, (Bosch), 90A, OE-NO 028 903 028 J, 120A, OE-NO 028 903 026 J, MTR-CODE: AEY	<b>VD1089</b>
68 1.9 SDI	08/99-09/01	AGP, AQM	50	1896			<b>VD1089</b>
90 1.9 TDI	09/96-09/01	AHU, AGR, ALH, ALE	66	1896	<b>AP9002</b> <b>AP9004</b> <b>AP9004</b>	ALT, (Valeo), 90A, 120A ALT, MTR-CODE: AHU, ALE, (Bosch), 120A, OE-NO 028 903 026 G ALT, MTR-CODE: AHU, ALE, CH-NO 6K0-X-507830⇒, (Bosch), 90A, OE-NO 028 903 028 J MTR-CODE: ALE, AHU MTR-CODE: ALH, AGR	<b>VD1084</b> <b>VD1089</b>
<b>POLO Kasten (6NF)</b>							
1.7 SDI	08/97-12/99	AKU	44	1716	<b>AP9057</b> <b>AP9059</b>	ALT, (Bosch), 70A, OE-NO 038 903 025, 90A, OE-NO 038 903 025 A ALT, (Bosch), 70A, 90A	
1.9 D	10/94-12/99	AEF	47	1896	<b>AP9057</b> <b>AP9059</b>	ALT, (Bosch), 70A, OE-NO 038 903 023 P, 90A, OE-NO 038 903 023 T ALT, (Bosch), 70A, 90A	
1.9 SDI	07/96-12/99	AGD	47	1896	<b>AP9057</b> <b>AP9059</b>	ALT, (Bosch), 70A, OE-NO 038 903 025, 90A, OE-NO 038 903 025 A ALT, (Bosch), 70A, 90A	
<b>POLO Stufenheck</b>							
1.4 TDI	07/03-	BAY	55	1422	<b>AP9001</b>	ALT, (Bosch), 70A, 90A, 120A	
1.9 SDI	09/02-	ASY	47	1896	<b>AP9001</b> <b>AP9001</b>	ALT, (Bosch,Valeo), 70A, 90A ALT, (Hitachi), 120A	<b>VD1076</b> <b>VD1111</b>
<b>POLO Variant (6KV5)</b>							
1.9 SDI	08/99-09/01	AGP, AQM	50	1896			<b>VD1089</b>
1.9 TDI	05/97-09/01	AHU, AGR, ALH, ALE	66	1896	<b>AP9002</b> <b>AP9004</b> <b>AP9004</b>	ALT, (Valeo), 90A, 120A ALT, (Bosch), 120A, OE-NO 028 903 026 G, MTR-CODE: AHU, ALE ALT, (Bosch), 90A, OE-NO 028 903 028 J, CH-NO 6K-X-507830⇒, MTR-CODE: AHU, ALE	<b>VD1089</b>
	06/98-09/01	AFN, ASV	81	1896	<b>AP9004</b> <b>AP9004</b>	ALT, MTR-CODE: AFN, (Bosch), 120A, OE-NO 028 903 026 G ALT, MTR-CODE: AFN, CH-NO 6K-X-507830⇒, (Bosch), 90A, OE-NO 028 903 028 J	
<b>SCIROCCO (137)</b>							
1.4 TSI	09/08-	CAXA	90	1390	<b>AP9012</b> <b>AP9012</b> <b>AP9012</b>	(Bosch), OE-NO 03C 903 023 A, 140A (Valeo), OE-NO 03C 903 023 C, 140A ALT	
		CAVD	118	1390	<b>AP9012</b> <b>AP9012</b> <b>AP9012</b>	(Bosch), OE-NO 03C 903 023 A, 140A (Valeo), OE-NO 03C 903 023 C, 140A ALT	
2.0 TDI	05/09-	CBBB, CFGB	125	1968	<b>AP9001</b> <b>AP9001</b>	ALT, (Bosch), 140A, OE-NO 06F903023F ALT, (Valeo), 140A, OE-NO 06F903023C MTR-CODE: CBBB MTR-CODE: CFGB	<b>VD1076</b> <b>VD1111</b>
	09/08-	CBDB, CFHC	103	1968	<b>AP9001</b>	ALT, (Bosch), 140A, OE-NO 06F903023F	

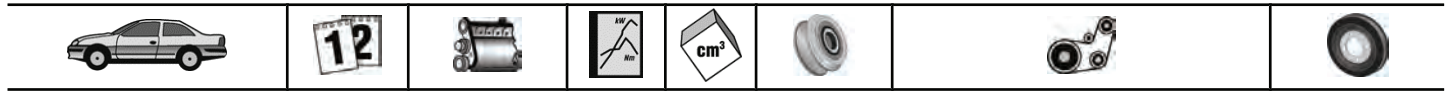

**VW**
**SCIROCCO (137)**

					<b>AP9001</b>	ALT, (Valeo), 140A, OE-NO 06F903023C MTR-CODE: CBDB MTR-CODE: CFHB, CFHC	<b>VD1076</b> <b>VD1111</b>
2.0 TSI	09/08-	CAWB	147	1984	<b>AP9009</b>	ALT, (Bosch), 140A, OE-NO 06B903016AB <b>AP9009</b> ALT, (Valeo), 140A, OE-NO 06D903016A	

**SHARAN (7M8, 7M9, 7M6)**  
1.8 T 20V

	09/97-	AJH, AWC	110	1781	<b>AP9001</b>	ALT, MTR-CODE: AJH, CH-NO 7M-X-055 001⇒, (Bosch), 90A, 120A	
					<b>AP9001</b>	ALT, MTR-CODE: AWC, (Bosch), 120A, 140A	
					<b>AP9016</b>	ALT, MTR-CODE: AJH, ⇒CH-NO 7M-X-055 000, (Bosch), 90A	
					<b>AP9016</b>	MTR-CODE: AJH, ⇒CH-NO 7M-X-025 000, (Bosch), 120A	<b>VD1107</b>
1.9 TDI	04/00-	AUY, BVK	85	1896	<b>AP9001</b>	ALT, MTR-CODE: AUY, (Bosch), 90A, OE-NO 038903023L, 120A, OE-NO 028903028E, 028903028A, 028903030A, 140A, OE-NO 06F903023J	
					<b>AP9001</b>	MTR-CODE: BVK, ALT, (Bosch), 120A, OE-NO 028903030A, 140A, OE-NO 06F903023J	
						ALT, PS, AC, CH-NO 7M-4-015 001⇒, ⇒CH-NO 7M-6-020 000	<b>6DPK1195D1</b>
						ALT, PS, AC, CH-NO 7M-6-020 001⇒	<b>6DPK1215D1</b>
						MTR-CODE: AUY, CH-NO 7M-4-015 001⇒	<b>VD1076</b>
						MTR-CODE: BVK	<b>VD1076</b>
						MTR-CODE: AUY, ⇒CH-NO 7M-4-015 000	<b>VD1091</b>
	06/05-	BTB	110	1896	<b>AP9001</b>	ALT, (Bosch), 120A, OE-NO 028903030A, 140A, OE-NO 06F903023J	
						ALT, PS, AC	<b>6DPK1195D1</b> <b>VD1076</b>
	09/95-	1Z, AHU, ANU	66	1896	<b>AP9001</b>	ALT, MTR-CODE: AHU, CH-NO 7M-X-055 001⇒, (Bosch), 90A, OE-NO 038903023L, 120A, OE-NO 028903028E	
					<b>AP9001</b>	ALT, MTR-CODE: ANU, (Bosch), 90A, OE-NO 038903023L, 120A, OE-NO 028903023E, 028903028A, 140A, OE-NO 06F903023J	
					<b>AP9004</b>	ALT, MTR-CODE: 1Z, AHU, ⇒CH-NO 7M-X-055 000, (Bosch), 90A, OE-NO 028 903 025 Q	
						ALT, PS, (AC), MTR-CODE: ANU, CH-NO 7M-4-015 001⇒	<b>6DPK1195D1</b>
						MTR-CODE: ANU, CH-NO 7M-4-015 001⇒	<b>VD1076</b>
						MTR-CODE: 1Z, AHU	<b>VD1084</b>
						MTR-CODE: ANU, ⇒CH-NO 7M-4-015 000	<b>VD1091</b>
	09/96-04/00	AFN, AVG	81	1896	<b>AP9001</b>	ALT, CH-NO 7M-X-055 001⇒, (Bosch), 90A, 120A	
					<b>AP9004</b>	ALT, CH-NO 7M-V-035000⇒, (Bosch), 90A, OE-NO 028 903 025 Q, (AC)	
					<b>AP9004</b>	ALT, CH-NO 7M-V-035001⇒, ⇒CH-NO 7M-X-055 000, (Bosch), 90A, OE-NO 028 903 028 J, 120A, OE-NO 028 903 026 G	
							<b>VD1084</b>
	11/02-	ASZ	96	1896	<b>AP9001</b>	ALT, (Bosch), 90A, OE-NO 038903024A, 120A, OE-NO 028903030, 028903030A, 140A, OE-NO 06F903023J	
						ALT, PS, AC, CH-NO 7M-4-015 001⇒	<b>6DPK1195D1</b>
						CH-NO 7M-4-015 001⇒	<b>VD1076</b>
						⇒CH-NO 7M-4-015 000	<b>VD1091</b>
1.9 TDI 4motion	04/00-	AUY, BVK	85	1896	<b>AP9001</b>	ALT, MTR-CODE: AUY, (Bosch), 90A, OE-NO 038903023L, 120A, OE-NO 028903028E, 028903028A, 028903030A, 140A, OE-NO 06F903023J	



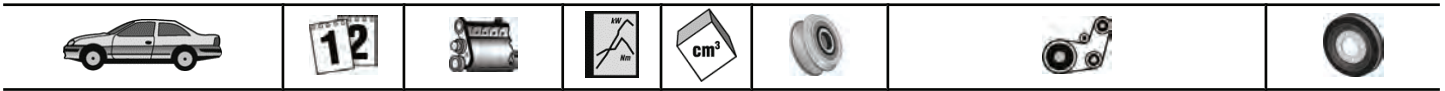

**VW**
**SHARAN (7M8, 7M9, 7M6)**

					<b>AP9001</b>	MTR-CODE: BVK, ALT, (Bosch), 120A, OE-NO 028903030A, 140A, OE-NO 06F903023J ALT, PS, AC, CH-NO 7M-4-015 001⇒, ⇒CH-NO 7M-6-020 000 ALT, PS, AC, CH-NO 7M-6-020 001⇒ MTR-CODE: AUYY, CH-NO 7M-4-015 001⇒ MTR-CODE: BVK MTR-CODE: AUYY, ⇒CH-NO 7M-4-015 000	<b>6DPK1195D1</b> <b>6DPK1215D1</b> <b>VD1076</b> <b>VD1076</b> <b>VD1091</b>
2.0	09/95-	ADY, ATM	85	1984	<b>AP9001</b> <b>AP9001</b> <b>AP9004</b>	ALT, MTR-CODE: ADY, CH-NO 7M-X-055001⇒, (Bosch), 120A, OE-NO 028903026H ALT, MTR-CODE: ATM, 120A, OE-NO 028903028E, 028903023A, 028903030A, 140A, OE-NO 06F903023J ALT, (AC), MTR-CODE: ADY, (Bosch), 90A	<b>VD1107</b>
2.0 LPG	05/08-	ATM	85	1984	<b>AP9001</b>	ALT, MTR-CODE: ATM, 140A, (Bosch)	<b>VD1107</b>
2.0 TDI	11/05-	BRT	103	1968	<b>AP9001</b>	ALT, (Bosch), 120A, OE-NO 028903030A, 140A, OE-NO 06F903023J	<b>VD1076</b>
2.8 V6 24V	04/00-	AYL	150	2792	<b>AP9001</b> <b>AP9001</b>	ALT, (Bosch), 120A, OE-NO 028903028E, 028903028A, 028903030, 140A, OE-NO 06F903023J, 150A, OE-NO 022903028A CH-NO 7M-1-035001⇒, ⇒CH-NO 7M-5-025000, ALT, (Bosch), 150A, OE-NO 021903026A	
2.8 V6 24V 4motion	04/00-	AYL	150	2792	<b>AP9001</b> <b>AP9001</b>	ALT, (Bosch), 120A, OE-NO 028903028E, 028903028A, 028903030, 140A, OE-NO 06F903023J, 150A, OE-NO 022903028A CH-NO 7M-1-035001⇒, ⇒CH-NO 7M-5-025000, ALT, (Bosch), 150A, OE-NO 021903026A	

**SHARAN (7N)**

2.0 TDI	05/10-	CFFA	100	1968		MTR-CODE: CFFA, CFFB	<b>VD1111</b>
		CFFB	103	1968		MTR-CODE: CFFA, CFFB	<b>VD1111</b>
	08/10-	CFGB	125	1968		MTR-CODE: CFGB	<b>VD1111</b>

**TIGUAN (5N\_)**

1.4 TSI	05/08-	BWK, CAVA	110	1390	<b>AP9012</b> <b>AP9012</b> <b>AP9012</b>	(Bosch), OE-NO 03C 903 023 A, 140A (Valeo), OE-NO 03C 903 023 C, 140A ALT	
1.4 TSI 4motion	09/07-	BWK, CAVA	110	1390	<b>AP9012</b> <b>AP9012</b> <b>AP9012</b>	(Bosch), OE-NO 03C 903 023 A, 140A (Valeo), OE-NO 03C 903 023 C, 140A ALT	
2.0 TDI	03/08-	CBAB, CFFB	103	1968	<b>AP9001</b> <b>AP9001</b>	ALT, (Bosch), 140A, OE-NO 06F903023F ALT, (Valeo), 140A, OE-NO 06F903023C MTR-CODE: CBAA, CBAB MTR-CODE: CFFA, CFFB	<b>VD1076</b> <b>VD1111</b>
	05/10-	CFFD	81	1968		MTR-CODE: CFFD	<b>VD1111</b>
2.0 TDI 4motion	09/07-	CBAB, CFFB, CLJA	103	1968	<b>AP9001</b> <b>AP9001</b>	ALT, (Bosch), 140A, OE-NO 06F903023F ALT, (Valeo), 140A, OE-NO 06F903023C MTR-CODE: CBAA, CBAB MTR-CODE: CFFA, CFFB, CLJA	<b>VD1076</b> <b>VD1111</b>
		CBAB, CFGB	125	1968	<b>AP9001</b> <b>AP9001</b>	ALT, (Bosch), 140A, OE-NO 06F903023F ALT, (Valeo), 140A, OE-NO 06F903023C MTR-CODE: CBAB MTR-CODE: CFGB	<b>VD1076</b> <b>VD1111</b>
	11/07-	CBAA, CFFA	100	1968	<b>AP9001</b> <b>AP9001</b>	ALT, (Bosch), 140A, OE-NO 06F903023F ALT, (Valeo), 140A, OE-NO 06F903023C MTR-CODE: CBAA, CBAB	<b>VD1076</b>



**VW**
**TIGUAN (5N.)**

						MTR-CODE: CFFA, CFFB	<b>VD1111</b>
2.0 TFSI 4motion	09/07-	CAWA, CCZC	125	1984	<b>AP9009</b>	ALT, (Bosch), 140A, OE-NO 06B903016AB	
					<b>AP9009</b>	ALT, (Valeo), 140A, OE-NO 06D903016A, 06J903023C	
		CAWB, CCTA, CCZA	147	1984	<b>AP9009</b>	ALT, (Bosch), 140A, OE-NO 06B903016AB	
					<b>AP9009</b>	ALT, (Valeo), 140A, OE-NO 06D903016A, 06J903023C	
					<b>AP9009</b>	MTR-CODE: CCTA, CAWB, CCZA	

**TOUAREG (7LA, 7L6, 7L7)**

2.5 R5 TDI	01/03-05/10	BAC, BPE	128	2461	<b>AP9030</b>	AC	
					<b>AP9030</b>	ALT, (Bosch), 150A, 180A	
	08/03-05/10	BLK, BPD	120	2461	<b>AP9030</b>	AC	
					<b>AP9030</b>	ALT, (Bosch), 150A, 180A	
3.0 TDI	12/06-05/10	BUN, CASB	155	2967		MTR-CODE: BUN	<b>VD1033</b>
3.0 V6 TDI	11/04-05/10	BKS, CATA	165	2967		ALT, PS, AC	<b>6PK2490D1</b>
						MTR-CODE: BKS	<b>VD1033</b>
5.0 R50 TDI	11/07-05/10	CBWA	257	4921	<b>AP9030</b>	AC	
					<b>AP9030</b>	ALT, (Hitachi), 190A	
5.0 V10 TDI	10/02-05/10	AYH, BLE, BWF	230	4921	<b>AP9030</b>	AC, MTR-CODE: AYH, BLE, CH-NO 7L-4-000001⇒	
					<b>AP9030</b>	ALT, (Delphi), 190A, MTR-CODE: AYH	
					<b>AP9030</b>	ALT, (Hitachi), 190A, MTR-CODE: BLE	

**TOURAN (1T1, 1T2, 1T3)**

1.4 TSI	02/06-	BMV, CAVC	103	1390	<b>AP9012</b>	(Bosch), OE-NO 03C 903 023 A, 140A (Valeo), OE-NO 03C0903 023 C, 140A	
					<b>AP9012</b>	ALT	
					<b>AP9012</b>		
1.6	07/03-05/10	BGU, BSE, BSF	75	1595	<b>AP9001</b>	ALT, (Bosch), 140A, OE-NO 06F903023F	
					<b>AP9001</b>	ALT, (Valeo), 140A, OE-NO 06F903023C	
					<b>AP9001</b>	MTR-CODE: BGU, BSF	
1.6 TDI	05/10-	CAYB	66	1598		MTR-CODE: CAYB, CAYC	<b>VD1111</b>
		CAYC	77	1598		MTR-CODE: CAYB, CAYC	<b>VD1111</b>
1.9 TDI	02/03-	AVQ	74	1896	<b>AP9001</b>	ALT, (Bosch), 110A, OE-NO 06F903023D, 140A, OE-NO 06F903023F	
					<b>AP9001</b>	ALT, (Valeo), 110A, OE-NO 06F903023E, 140A, OE-NO 06F903023C	
						ALT, (AC)	<b>6PK1050D2</b>
							<b>VD1076</b>
	08/03-	BKC, BLS, BXE	77	1896	<b>AP9001</b>	ALT, (Bosch), 110A, OE-NO 06F903023D, 140A, OE-NO 06F903023F	
					<b>AP9001</b>	ALT, (Valeo), 110A, OE-NO 06F903023E, 140A, OE-NO 06F903023C	
						ALT, (AC)	<b>6PK1050D2</b>
							<b>VD1076</b>
	11/04-	BRU, BXF, BXJ	66	1896	<b>AP9001</b>	ALT, (Bosch), 110A, OE-NO 06F903023D, 140A, OE-NO 06F903023F	
					<b>AP9001</b>	ALT, (Valeo), 110A, OE-NO 06F903023E, 140A, OE-NO 06F903023C	
					<b>AP9001</b>	MTR-CODE: BRU	
						ALT, (AC)	<b>6PK1050D2</b>
							<b>VD1076</b>
2.0 EcoFuel	02/06-05/09	BSX	80	1984	<b>AP9001</b>	ALT, (Bosch), 110A, OE-NO 06F903023D, 140A, OE-NO 06F903023F	
					<b>AP9001</b>	ALT, (Valeo), 110A, OE-NO 06F903023E, 140A, OE-NO 06F903023C	
							<b>VD1107</b>
2.0 FSI	10/03-	AXW, BLX, BLY, BLR, BVY, BVZ	110	1984	<b>AP9001</b>	ALT, (Bosch), 140A, OE-NO 06F903023F	
					<b>AP9001</b>	ALT, (Valeo), 140A, OE-NO 06F903023C	
							<b>VD1107</b>
2.0 TDI	02/03-	AZV	100	1968	<b>AP9001</b>	ALT, (Bosch), 110A, OE-NO 06F903023D, 140A, OE-NO 06F903023F	
					<b>AP9001</b>	ALT, (Valeo), 110A, OE-NO 06F903023E, 140A, OE-NO 06F903023C	



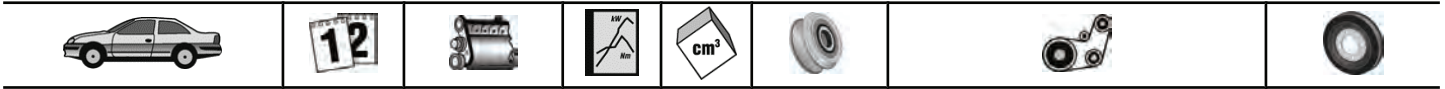

# VW

## TOURAN (1T1, 1T2, 1T3)

						MTR-CODE: AZV, BKD, ALT, (AC) MTR-CODE: AZV, BKD	6PK1050D2 VD1076
	12/05-	BMM	103	1968		ALT, PS, (AC) MTR-CODE: BMM	6PK1050D2 VD1076
		BMN, CFJA	125	1968	AP9001	ALT, (Bosch), 110A, OE-NO 06F903023D, 140A, OE-NO 06F903023F	
					AP9001	ALT, (Valeo), 110A, OE-NO 06F903023E, 140A, OE-NO 06F903023C	
						MTR-CODE: BMN, ALT, (AC) MTR-CODE: BMN	6PK1050D2 VD1076
						MTR-CODE: CFJA	VD1111
2.0 TDI 16V	08/03-	BKD, CFHC	103	1968	AP9001	ALT, (Bosch), 110A, OE-NO 06F903023D, 140A, OE-NO 06F903023F	
					AP9001	ALT, (Valeo), 110A, OE-NO 06F903023E, 140A, OE-NO 06F903023C	
						MTR-CODE: AZV, BKD, ALT, (AC) MTR-CODE: AZV, BKD	6PK1050D2 VD1076
						MTR-CODE: CFHC	VD1111
<b>TRANSPORTER IV Bus (70XB, 70XC, 7DB, 7DW)</b>							
1.9 D	09/90-04/03	1X	44	1896		MTR-CODE: 1X, CH-NO 70-P-085 001⇒	VD1084
1.9 TD	10/92-04/03	ABL	50	1896		MTR-CODE: ABL, CH-NO 70-P-085 001⇒	VD1084
2.0	09/90-04/03	AAC	62	1968	AP9004	ALT, (Bosch), 90A, OE-NO 028 903 025 Q, ⇒CH-NO 70-X-075000	
2.4 D	08/97-04/03	AJA	55	2370		ALT, PS, (PTO) ALT, PS, AC MTR-CODE: AJA	6PK1715D1 6PK2236D1 VD1002
	09/90-04/98	AAB	57	2370	AP9004	ALT, (Bosch), 90A, OE-NO 074 903 023 C, 074 903 025 C, 074 903 025 A, 100A, OE-NO 074 903 025 B, 074 903 025 D, ⇒CH-NO 70-S-071871	
						MTR-NO AAB 424606⇒, 01/1997⇒, ALT, (PTO)	6PK1715D1
						01/1995⇒, CH-NO 70S071873⇒, AC MTR-CODE: AAB, MTR-NO 320 127⇒	6PK2236D1 VD1002
2.4 D Syncro	10/92-09/98	AAB	57	2370	AP9004	ALT, (Bosch), 90A, OE-NO 074 903 023 C, 074 903 025 C, 074 903 025 A, 100A, OE-NO 074 903 025 B, 074 903 025 D, ⇒CH-NO 70-S-071871	
						MTR-NO AAB 424606⇒, 01/1997⇒, ALT, (PTO)	6PK1715D1
						01/1995⇒, CH-NO 70S071873⇒, AC MTR-CODE: AAB, MTR-NO 320 127⇒	6PK2236D1 VD1002
2.5 TDI	05/98-04/03	AJT, AYY	65	2461		ALT, (-AC), CH-NO 70-X-126 001⇒ ALT, (-AC), ⇒CH-NO 70-X-126 000 ALT, (AC), MTR-CODE: AJT, CH-NO 70-XH132 970⇒, 70-XX133 657⇒	6PK1750D1 6PK1767D1 6PK2215D1
						ALT, (AC), MTR-CODE: AYY ALT, (AC), ⇒CH-NO 70-XH132 969, 70-XX133 656, MTR-CODE: AJT	6PK2215D1 6PK2236D1
						MTR-CODE: AJT, AYY	VD1002
		AHY, AXG	111	2461		MTR-CODE: AHY, AXG	VD1002
	09/95-04/03	ACV, AUF, AYC, AXL	75	2461	AP9033	ALT, (Bosch), ALT-No: 0 124 615 006, 150A, CH-NO 70-1-200 001⇒	
						ALT, (-AC), MTR-CODE: AUF, CH-NO 70-Y-000 002⇒	6PK1750D1
						MTR-CODE: ACV, AYC, ⇒CH-NO 70-XH126 001, ALT, (-AC)	6PK1750D1
						⇒CH-NO 70-XH126 000, ALT, (-AC), MTR-CODE: ACV, AYC	6PK1767D1
						ALT, (AC), MTR-CODE: ACV, CH-NO 70-XH132 970⇒, 70-XH133 657⇒	6PK2215D1
						ALT, (AC), MTR-CODE: AUF, CH-NO 70-Y-000 002⇒	6PK2215D1
						MTR-CODE: ACV, ⇒CH-NO 70-XH132 969, 70-XX133 656, ALT, (AC)	6PK2236D1
						MTR-CODE: AYC, AUF, ACV	VD1002
2.5 TDI Syncro	01/96-04/03	ACV, AXL	75	2461	AP9033	ALT, MTR-CODE: ACV, CH-NO 70-1-200 001⇒, (Bosch), ALT-No: 0 124 615 006, 150A	
						MTR-CODE: ACV, ALT, (-AC), CH-NO 70-X-140 001⇒	6PK1750D1
						MTR-CODE: ACV, ⇒CH-NO 70-X-140	6PK1767D1



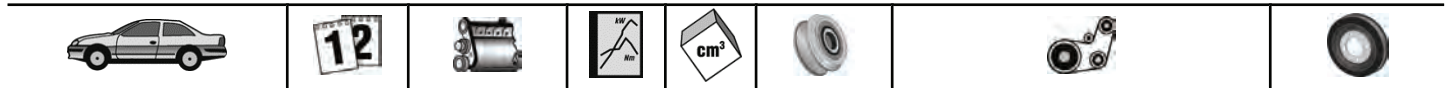

# VW

## TRANSPORTER IV Bus (70XB, 70XC, 7DB, 7DW)

						000, ALT, (-AC) ALT, (AC), MTR-CODE: ACV, CH-NO 70-X-140 001⇒ ALT, (AC), MTR-CODE: AXL MTR-CODE: ACV, ⇒CH-NO 70-X-140 000, ALT, (AC) MTR-CODE: AYC, AUF, ACV	<b>6PK2215D1</b> <b>6PK2215D1</b> <b>6PK2236D1</b> <b>VD1002</b>
--	--	--	--	--	--	-----------------------------------------------------------------------------------------------------------------------------------------------------------------------------	---------------------------------------------------------------------------

## TRANSPORTER IV Kasten (70XA)

1.9 D	07/90-04/03	1X	45	1896		MTR-CODE: 1X, CH-NO 70-P-085 001⇒	<b>VD1084</b>
1.9 TD	10/92-04/03	ABL	50	1896		MTR-CODE: ABL, CH-NO 70-P-085 001⇒	<b>VD1084</b>
2.0	07/90-04/03	AAC	62	1968	<b>AP9004</b>	ALT, (Bosch), 90A, OE-NO 028 903 025 Q, ⇒CH-NO 70-X-075000	
2.4 D	07/90-04/98	AAB	57	2370	<b>AP9004</b>	ALT, (Bosch), 90A, OE-NO 074 903 023 C, 074 903 025 C, 074 903 025 A, 100A, OE-NO 074 903 025 B, 074 903 025 D, ⇒CH-NO 70-S-071871 MTR-NO AAB 424606⇒, 01/1997⇒, ALT, (PTO) 01/1995⇒, CH-NO 70S071873⇒, AC MTR-CODE: AAB, MTR-NO 320 127⇒	<b>6PK1715D1</b> <b>6PK2236D1</b> <b>VD1002</b>
	08/97-04/03	AJA	55	2370		ALT, PS, (PTO) ALT, PS, AC MTR-CODE: AJA	<b>6PK1715D1</b> <b>6PK2236D1</b> <b>VD1002</b>
2.4 D Syncro	10/92-09/98	AAB	57	2370	<b>AP9004</b>	ALT, (Bosch), 90A, OE-NO 074 903 023 C, 074 903 025 C, 074 903 025 A, 100A, OE-NO 074 903 025 B, 074 903 025 D, ⇒CH-NO 70-S-071871 MTR-NO AAB 424606⇒, 01/1997⇒, ALT, (PTO) 01/1995⇒, CH-NO 70S071873⇒, AC MTR-CODE: AAB, MTR-NO 320 127⇒	<b>6PK1715D1</b> <b>6PK2236D1</b> <b>VD1002</b>
2.5 TDI	09/00-04/03	AXG	111	2461		MTR-CODE: AXG	<b>VD1002</b>
	09/95-04/03	ACV, AUF, AYC	75	2461	<b>AP9033</b>	ALT, CH-NO 70-1-200 001⇒, (Bosch), ALT-No: 0 124 615 006, 150A ALT, (-AC), MTR-CODE: AUF, CH-NO 70-Y-000 002⇒ MTR-CODE: ACV, AYC, ⇒CH-NO 70-XH126 001, ALT, (-AC) ⇒CH-NO 70-XH-126 000, ALT, (-AC), MTR-CODE: ACV, AYC ALT, (AC), MTR-CODE: ACV, CH-NO 70-XH-132 970⇒, 70-XH133 657⇒ ALT, (AC), MTR-CODE: AUF, CH-NO 70-Y-000 002⇒ MTR-CODE: ACV, ⇒CH-NO 70-XH-132 969, 70-XX-133 656, ALT, (AC) MTR-CODE: AYC, AUF, ACV	<b>6PK1750D1</b> <b>6PK1750D1</b> <b>6PK1767D1</b> <b>6PK2215D1</b> <b>6PK2215D1</b> <b>6PK2236D1</b> <b>VD1002</b>
2.5 TDI Syncro	12/98-04/03	AJT, AYY	65	2461		ALT, (-AC), CH-NO 70-X-126 001⇒ ALT, (-AC), ⇒CH-NO 70-X-126 000 ALT, (AC), MTR-CODE: AJT, CH-NO 70-XH132 970⇒, 70-XX133 657⇒ ALT, (AC), MTR-CODE: AYY ALT, (AC), ⇒CH-NO 70-XH132 969, 70-XX133 656, MTR-CODE: AJT MTR-CODE: AJT, AYY	<b>6PK1750D1</b> <b>6PK1767D1</b> <b>6PK2215D1</b> <b>6PK2215D1</b> <b>6PK2236D1</b> <b>VD1002</b>
	09/95-04/03	ACV, AXL	75	2461	<b>AP9033</b>	ALT, CH-NO 70-1-200 001⇒, (Bosch), ALT-No: 0 124 615 006, 150A, MTR-CODE: ACV MTR-CODE: ACV, ALT, (-AC), CH-NO 70-X-140 001⇒ MTR-CODE: ACV, ⇒CH-NO 70-X-140 000, ALT, (-AC) ALT, (AC), MTR-CODE: ACV, CH-NO 70-X-140 001⇒ ALT, (AC), MTR-CODE: AXL MTR-CODE: ACV, ⇒CH-NO 70-X-140 000, ALT, (AC) MTR-CODE: AYC, AUF, ACV	<b>6PK1750D1</b> <b>6PK1767D1</b> <b>6PK2215D1</b> <b>6PK2215D1</b> <b>6PK2236D1</b> <b>VD1002</b>

## TRANSPORTER IV Pritsche/Fahrgestell (70XD)

1.9 D	07/90-04/03	1X	45	1896		MTR-CODE: 1X, CH-NO 70-P-085 001⇒	<b>VD1084</b>
1.9 TD	10/92-04/03	ABL	50	1896		MTR-CODE: ABL, CH-NO 70-P-085 001⇒	<b>VD1084</b>
2.0	07/90-04/03	AAC	62	1968	<b>AP9004</b>	ALT, (Bosch), 90A, OE-NO 028 903 025 Q, ⇒CH-NO 70-X-075000	

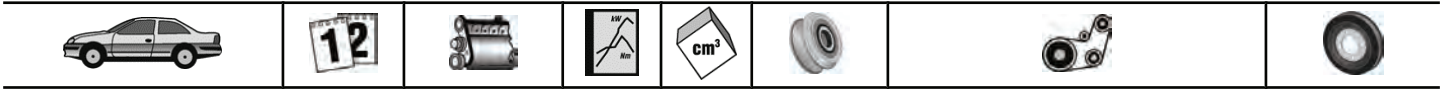

**VW**
**TRANSPORTER IV Pritsche/Fahrgestell (70XD)**

2.4 D	08/97-04/03	AJA	55	2370		ALT, PS, (PTO) ALT, PS, AC MTR-CODE: AJA	6PK1715D1 6PK2236D1 VD1002
	09/90-04/98	AAB	57	2370	AP9004	ALT, (Bosch), 90A, OE-NO 074 903 023 C, 074 903 025 C, 074 903 025 A, 100A, OE-NO 074 903 025 B, 074 903 025 D, ⇒CH-NO 70-S-071871 MTR-NO AAB 424606⇒, 01/1997⇒, ALT, (PTO) 01/1995⇒, CH-NO 70S071873⇒, AC MTR-CODE: AAB, MTR-NO 320 127⇒	6PK1715D1 6PK2236D1 VD1002
2.4 D Syncro	10/92-09/98	AAB	57	2370	AP9004	ALT, (Bosch), 90A, OE-NO 074 903 023 C, 074 903 025 C, 074 903 025 A, 100A, OE-NO 074 903 025 B, 074 903 025 D, ⇒CH-NO 70-S-071871 MTR-NO AAB 424606⇒, 01/1997⇒, ALT, (PTO) 01/1995⇒, CH-NO 70S071873⇒, AC MTR-CODE: AAB, MTR-NO 320 127⇒	6PK1715D1 6PK2236D1 VD1002
2.5 TDI	05/98-04/03	AJT, AYY	65	2461		ALT, (-AC), CH-NO 70-X-126 001⇒ ALT, (-AC), ⇒CH-NO 70-X-126 000 ALT, (AC), MTR-CODE: AJT, CH-NO 70-XH132 970⇒, 70-XX133 657⇒ ALT, (AC), MTR-CODE: AYY ALT, (AC), ⇒CH-NO 70-XH132 969, 70-XX133 656, MTR-CODE: AJT MTR-CODE: AJT, AYY	6PK1750D1 6PK1767D1 6PK2215D1 6PK2215D1 6PK2236D1 VD1002
	09/95-04/03	ACV, AUF, AYC	75	2461	AP9033	ALT, CH-NO 70-1-200 001⇒, (Bosch), ALT-No: 0 124 615 006, 150A ALT, (-AC), MTR-CODE: AUF, CH-NO 70-Y-000 002⇒ MTR-CODE: ACV, AYC, ⇒CH-NO 70-XH126 001, ALT, (-AC) ⇒CH-NO 70-XH-126 000, ALT, (-AC), MTR-CODE: ACV, AYC ALT, (AC), MTR-CODE: ACV, CH-NO 70-XH-132 970⇒, 70-XH133 657⇒ ALT, (AC), MTR-CODE: AUF, CH-NO 70-Y-000 002⇒ MTR-CODE: ACV, ⇒CH-NO 70-XH-132 969, 70-XX-133 656, ALT, (AC) MTR-CODE: AYC, AUF, ACV	6PK1750D1 6PK1750D1 6PK1767D1 6PK2215D1 6PK2215D1 6PK2236D1 VD1002
2.5 TDI Syncro	05/98-04/03	ACV, AXL	75	2461	AP9033	ALT, CH-NO 70-1-200 001⇒, (Bosch), ALT-No: 0 124 615 006, 150A MTR-CODE: ACV, ALT, (-AC), CH-NO 70-X-140 001⇒ MTR-CODE: ACV, ⇒CH-NO 70-X-140 000, ALT, (-AC) ALT, (AC), MTR-CODE: ACV, CH-NO 70-X-140 001⇒ ALT, (AC), MTR-CODE: AXL MTR-CODE: ACV, ⇒CH-NO 70-X-140 000, ALT, (AC) MTR-CODE: AYC, AUF, ACV	6PK1750D1 6PK1767D1 6PK2215D1 6PK2215D1 6PK2236D1 VD1002

**TRANSPORTER V Bus (7HB, 7HJ, 7EB, 7EJ)**

1.9 TDI	01/06-11/09	BRR	62	1896	AP9001	ALT, (Bosch), 90A, OE-NO 038903023L, 038903024D, 120A, OE-NO 028903028E, 038903024F, 140A, OE-NO 06F903023A, 06F903023J ALT, PS, (AC)	6DPK1215D1 VD1076
	04/03-11/09	AXC	63	1896	AP9001	ALT, (Bosch), 90A, OE-NO 038903023L, 038903024D, 120A, OE-NO 028903028E, 038903024F, 140A, OE-NO 06F903023A, 06F903023J ALT, PS, (AC), CH-NO 7H-5-075 001⇒, ⇒CH-NO 7H-6H079 890, 7H-6X022 356 ALT, PS, (AC), CH-NO 7H-6H079 891⇒ ALT, PS, (AC), CH-NO 7H-6X022 357⇒ MTR-CODE: AXB, AXC, CH-NO 7J-5-022 001⇒ MTR-CODE: AXB, AXC, ⇒CH-NO 7J-5-022 000	6DPK1195D1 6DPK1215D1 6DPK1215D1 VD1076 VD1091
		AXB	77	1896	AP9001	ALT, (Bosch), 90A, OE-NO 038903023L, 038903024D, 120A,	



**VW**
**TRANSPORTER V Bus (7HB, 7HJ, 7EB, 7EJ)**

						OE-NO 028903028E, 038903024F, 140A, OE-NO 06F903023A, 06F903023J ALT, PS, (AC), CH-NO 7H-5-075 001⇒, ⇒CH-NO 7H-6H079 890, 7H-6X022 356 ALT, PS, (AC), CH-NO 7H-6H079 891⇒ ALT, PS, (AC), CH-NO 7H-6X022 357⇒ MTR-CODE: AXB, AXC, CH-NO 7J-5-022 001⇒ MTR-CODE: AXB, AXC, ⇒CH-NO 7J-5-022 000	<b>6DPK1195D1</b> <b>6DPK1215D1</b> <b>6DPK1215D1</b> <b>VD1076</b> <b>VD1091</b>	
	06/06-11/09	BRS	75	1896	<b>AP9001</b>	ALT, (Bosch), 90A, OE-NO 038903023L, 038903024D, 120A, OE-NO 028903028E, 038903024F, 140A, OE-NO 06F903023A, 06F903023J ALT, PS, (AC)	<b>6DPK1215D1</b> <b>VD1076</b>	
2.0	11/03-	AXA	85	1984	<b>AP9001</b>	ALT, 140A, (Bosch)	<b>VD1107</b>	
2.0 BiTDI	09/09-	CFCA	132	1968	<b>AP9022</b>	ALT, (Bosch), 110A, OE-NO 06F903023L, 140A, OE-NO 06F903023N, 180A, OE-NO 03G903023F MTR-CODE: CAAA, CAAB, CAAC, CAAE, CCHA, CCHB, CFCA	<b>VD1111</b>	
2.0 BiTDI 4motion	09/09-	CFCA	132	1968	<b>AP9022</b>	ALT, (Bosch), 110A, OE-NO 06F903023L, 140A, OE-NO 06F903023N, 180A, OE-NO 03G903023F MTR-CODE: CAAA, CAAB, CAAC, CAAE, CCHA, CCHB, CFCA	<b>VD1111</b>	
2.0 TDI	05/10-	CAAE, CCHB	100	1968	<b>AP9022</b>	ALT, (Bosch), 110A, OE-NO 06F903023L, 140A, OE-NO 06F903023N, 180A, OE-NO 03G903023F MTR-CODE: CAAA, CAAB, CAAC, CAAE, CCHA, CCHB, CFCA	<b>VD1111</b>	
		09/09-	CAAA	62	1968	<b>AP9022</b>	ALT, (Bosch), 110A, OE-NO 06F903023L, 140A, OE-NO 06F903023N, 180A, OE-NO 03G903023F MTR-CODE: CAAA, CAAB, CAAC, CAAE, CCHA, CCHB, CFCA	<b>VD1111</b>
		CAAB	75	1968	<b>AP9022</b>	ALT, (Bosch), 110A, OE-NO 06F903023L, 140A, OE-NO 06F903023N, 180A, OE-NO 03G903023F MTR-CODE: CAAA, CAAB, CAAC, CAAE, CCHA, CCHB, CFCA	<b>VD1111</b>	
		CAAC, CCHA	103	1968	<b>AP9022</b>	ALT, (Bosch), 110A, OE-NO 06F903023L, 140A, OE-NO 06F903023N, 180A, OE-NO 03G903023F MTR-CODE: CAAA, CAAB, CAAC, CAAE, CCHA, CCHB, CFCA	<b>VD1111</b>	
2.0 TDI 4motion	05/10-	CAAE, CCHB	100	1968	<b>AP9022</b>	ALT, (Bosch), 110A, OE-NO 06F903023L, 140A, OE-NO 06F903023N, 180A, OE-NO 03G903023F MTR-CODE: CAAA, CAAB, CAAC, CAAE, CCHA, CCHB, CFCA	<b>VD1111</b>	
		09/09-	CAAC, CCHA	103	1968	<b>AP9022</b>	ALT, (Bosch), 110A, OE-NO 06F903023L, 140A, OE-NO 06F903023N, 180A, OE-NO 03G903023F MTR-CODE: CAAA, CAAB, CAAC, CAAE, CCHA, CCHB, CFCA	<b>VD1111</b>
2.5 TDI	04/03-11/09	AXD, BNZ	96	2461	<b>AP9030</b> <b>AP9030</b>	AC ALT, (Bosch), 150A, 180A		
		AXE, BPC	128	2461	<b>AP9030</b> <b>AP9030</b>	AC ALT, (Bosch), 150A, 180A		
2.5 TDi	11/03-11/09	BLJ	120	2461	<b>AP9030</b> <b>AP9030</b>	AC ALT, (Bosch), 150A, 180A		
2.5 TDI 4motion	07/04-11/09	AXD, BNZ	96	2461	<b>AP9030</b> <b>AP9030</b>	AC ALT, (Bosch), 150A, 180A		
		AXE, BPC	128	2461	<b>AP9030</b>	AC, CH-NO 7H-3-000 001⇒		

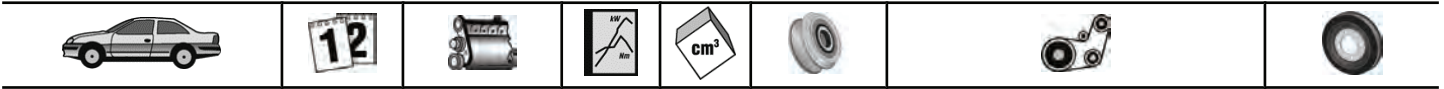

**VW**
**TRANSPORTER V Kasten (7HA, 7HH, 7EA, 7EH)**

↩ 1.9 TDI	01/06-11/09	BRR	62	1896	<b>AP9001</b>	ALT, (Bosch), 90A, OE-NO 038903023L, 038903024D, 120A, OE-NO 028903028E, 038903024F, 140A, OE-NO 06F903023A, 06F903023J ALT, PS, (AC)	<b>6DPK1215D1 VD1076</b>
	04/03-11/09	AXC	63	1896	<b>AP9001</b>	ALT, (Bosch), 90A, OE-NO 038903023L, 038903024D, 120A, OE-NO 028903028E, 038903024F, 140A, OE-NO 06F903023A, 06F903023J ALT, PS, (AC), CH-NO 7H-5-075 001⇒, ⇒CH-NO 7H-6H079 890, 7H-6X022 356 ALT, PS, (AC), CH-NO 7H-6H079 891⇒ ALT, PS, (AC), CH-NO 7H-6X022 357⇒ MTR-CODE: AXB, AXC, CH-NO 7J-5-022 001⇒ MTR-CODE: AXB, AXC, ⇒CH-NO 7J-5-022 000	<b>6DPK1195D1 6DPK1215D1 6DPK1215D1 VD1076 VD1091</b>
		AXB	77	1896	<b>AP9001</b>	ALT, (Bosch), 90A, OE-NO 038903023L, 038903024D, 120A, OE-NO 028903028E, 038903024F, 140A, OE-NO 06F903023A, 06F903023J ALT, PS, (AC), CH-NO 7H-5-075 001⇒, ⇒CH-NO 7H-6H079 890, 7H-6X022 356 ALT, PS, (AC), CH-NO 7H-6H079 891⇒ ALT, PS, (AC), CH-NO 7H-6X022 357⇒ MTR-CODE: AXB, AXC, CH-NO 7J-5-022 001⇒ MTR-CODE: AXB, AXC, ⇒CH-NO 7J-5-022 000	<b>6DPK1195D1 6DPK1215D1 6DPK1215D1 VD1076 VD1091</b>
	06/06-11/09	BRS	75	1896	<b>AP9001</b>	ALT, (Bosch), 90A, OE-NO 038903023L, 038903024D, 120A, OE-NO 028903028E, 038903024F, 140A, OE-NO 06F903023A, 06F903023J ALT, PS, (AC)	<b>6DPK1215D1 VD1076</b>
2.0	11/03-	AXA	85	1984	<b>AP9001</b>	ALT, 140A, (Bosch)	<b>VD1107</b>
2.0 BitDI	09/09-	CFCA	132	1968	<b>AP9022</b>	ALT, (Bosch), 110A, OE-NO 06F903023L, 140A, OE-NO 06F903023N, 180A, OE-NO 03G903023F MTR-CODE: CAAA, CAAB, CAAC, CAAE, CCHA, CCHB, CFCA	<b>VD1111</b>
2.0 BitDI 4motion	09/09-	CFCA	132	1968	<b>AP9022</b>	ALT, (Bosch), 110A, OE-NO 06F903023L, 140A, OE-NO 06F903023N, 180A, OE-NO 03G903023F MTR-CODE: CAAA, CAAB, CAAC, CAAE, CCHA, CCHB, CFCA	<b>VD1111</b>
2.0 TDI	09/09-	CAAA	62	1968	<b>AP9022</b>	ALT, (Bosch), 110A, OE-NO 06F903023L, 140A, OE-NO 06F903023N, 180A, OE-NO 03G903023F MTR-CODE: CAAA, CAAB, CAAC, CAAE, CCHA, CCHB, CFCA	<b>VD1111</b>
		CAAB	75	1968	<b>AP9022</b>	ALT, (Bosch), 110A, OE-NO 06F903023L, 140A, OE-NO 06F903023N, 180A, OE-NO 03G903023F MTR-CODE: CAAA, CAAB, CAAC, CAAE, CCHA, CCHB, CFCA	<b>VD1111</b>
		CAAC, CCHA	103	1968	<b>AP9022</b>	ALT, (Bosch), 110A, OE-NO 06F903023L, 140A, OE-NO 06F903023N, 180A, OE-NO 03G903023F MTR-CODE: CAAA, CAAB, CAAC, CAAE, CCHA, CCHB, CFCA	<b>VD1111</b>
2.0 TDI 4motion	09/09-	CAAC, CCHA	103	1968	<b>AP9022</b>	ALT, (Bosch), 110A, OE-NO 06F903023L, 140A, OE-NO 06F903023N, 180A, OE-NO 03G903023F MTR-CODE: CAAA, CAAB, CAAC, CAAE, CCHA, CCHB, CFCA	<b>VD1111</b>



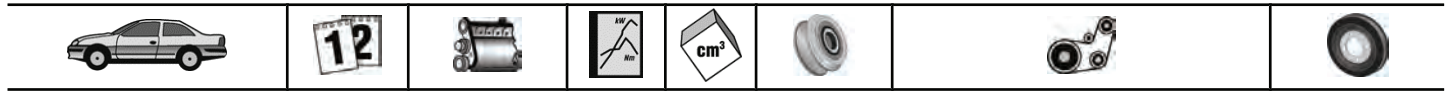

# VW

## TRANSPORTER V Kasten (7HA, 7HH, 7EA, 7EH)

2.5 TDI	04/03-11/09	AXD, BNZ	96	2461	AP9030	AC	
		AXE, BPC	128	2461	AP9030	ALT, (Bosch), 150A, 180A	
2.5 TDI 4motion	07/04-11/09	AXD, BNZ	96	2461	AP9030	AC	
		AXE, BPC	128	2461	AP9030	ALT, (Bosch), 150A, 180A	

## TRANSPORTER V Pritsche/Fahrgestell (7JD, 7JE, 7JL, 7JY, 7JZ,

1.9 TDI	01/06-11/09	BRR	62	1896	AP9001	ALT, (Bosch), 90A, OE-NO 038903023L, 038903024D, 120A, OE-NO 028903028E, 038903024F, 140A, OE-NO 06F903023A, 06F903023J ALT, PS, (AC)	6DPK1215D1 VD1076
		04/03-11/09	AXC	63	1896	AP9001	ALT, (Bosch), 90A, OE-NO 038903023L, 038903024D, 120A, OE-NO 028903028E, 038903024F, 140A, OE-NO 06F903023A, 06F903023J ALT, PS, (AC), CH-NO 7J-5-022 001⇒, ⇒CH-NO 7J-6-022 356 ALT, PS, (AC), CH-NO 7J-6-022 357⇒ MTR-CODE: AXB, AXC, CH-NO 7J-5-022 001⇒ MTR-CODE: AXB, AXC, ⇒CH-NO 7J-5-022 000
		AXB	77	1896	AP9001	ALT, (Bosch), 90A, OE-NO 038903023L, 038903024D, 120A, OE-NO 028903028E, 038903024F, 140A, OE-NO 06F903023A, 06F903023J ALT, PS, (AC), CH-NO 7H-5-075 001⇒, ⇒CH-NO 7H-6H079 890, 7H-6X022 356 ALT, PS, (AC), CH-NO 7H-6H079 891⇒ ALT, PS, (AC), CH-NO 7H-6X022 357⇒ MTR-CODE: AXB, AXC, CH-NO 7J-5-022 001⇒ MTR-CODE: AXB, AXC, ⇒CH-NO 7J-5-022 000	6DPK1195D1 6DPK1215D1 6DPK1215D1 VD1076 VD1091
	06/06-11/09	BRS	75	1896	AP9001	ALT, (Bosch), 90A, OE-NO 038903023L, 038903024D, 120A, OE-NO 028903028E, 038903024F, 140A, OE-NO 06F903023A, 06F903023J ALT, PS, (AC)	6DPK1215D1 VD1076
2.0	11/03-	AXA	85	1984	AP9001	ALT, 140A, (Bosch)	VD1107
2.0 BitDI	09/09-	CFCA	132	1968	AP9022	ALT, (Bosch), 110A, OE-NO 06F903023L, 140A, OE-NO 06F903023N, 180A, OE-NO 03G903023F MTR-CODE: CAAA, CAAB, CAAC, CAAE, CCHA, CCHB, CFCA	VD1111
2.0 BitDI 4motion	09/09-	CFCA	132	1968	AP9022	ALT, (Bosch), 110A, OE-NO 06F903023L, 140A, OE-NO 06F903023N, 180A, OE-NO 03G903023F MTR-CODE: CAAA, CAAB, CAAC, CAAE, CCHA, CCHB, CFCA	VD1111
2.0 TDI	09/09-	CAAA	62	1968	AP9022	ALT, (Bosch), 110A, OE-NO 06F903023L, 140A, OE-NO 06F903023N, 180A, OE-NO 03G903023F MTR-CODE: CAAA, CAAB, CAAC, CAAE, CCHA, CCHB, CFCA	VD1111
		CAAB	75	1968	AP9022	ALT, (Bosch), 110A, OE-NO 06F903023L, 140A, OE-NO 06F903023N, 180A, OE-NO 03G903023F MTR-CODE: CAAA, CAAB, CAAC, CAAE, CCHA, CCHB, CFCA	VD1111
		CAAC	103	1968	AP9022	ALT, (Bosch), 110A, OE-NO 06F903023L, 140A, OE-NO 06F903023N, 180A, OE-NO 03G903023F	





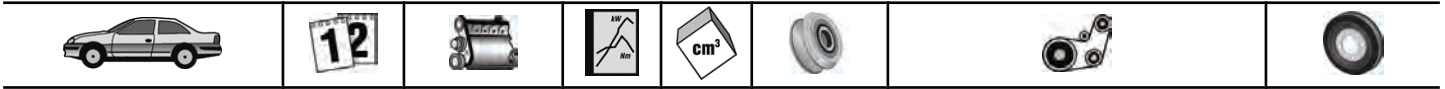

## VW

### TRANSPORTER V Pritsche/Fahrgestell (7JD, 7JE, 7JL, 7JY, 7JZ,

↔						MTR-CODE: CAAA, CAAB, CAAC, CAAE, CCHA, CCHB, CFCA	VD1111
2.0 TDI 4motion	09/09-	CAAC	103	1968	AP9022	ALT, (Bosch), 110A, OE-NO 06F903023L, 140A, OE-NO 06F903023N, 180A, OE-NO 03G903023F	
2.5 TDI	04/03-11/09	AXD, BNZ	96	2461	AP9030	AC	
					AP9030	ALT, (Bosch), 150A, 180A	
		AXE, BPC	128	2461	AP9030	AC, CH-NO 7H-3-000 001⇒	
2.5 TDI 4motion	04/04-11/09	AXE, BPC	128	2461	AP9030	AC	
					AP9030	ALT, (Bosch), 150A, 180A	
	07/04-11/09	AXD, BNZ	96	2461	AP9030	AC	
					AP9030	ALT, (Bosch), 150A, 180A	
<b>VENTO (1H2)</b>							
1.9 D	11/91-09/98	1Y	48	1896	AP9004	ALT, (Bosch), 70A, OE-NO 028 903 025 H, 90A, OE-NO 028 903 025 Q, 028 903 028 J	VD1084
1.9 SDI	04/97-09/98	AEY	47	1896			VD1084
1.9 TD	11/91-09/98	AAZ	55	1896	AP9004	ALT, (Bosch), 70A, OE-NO 028 903 025 H, 90A, OE-NO 028 903 025 Q, 028 903 028 J	VD1084
1.9 TDI	04/96-09/98	AFN	81	1896	AP9004	ALT, (Bosch), 120A, ALT, (Bosch), 120A, OE-NO 028 903 026 G	VD1084
	09/93-09/98	1Z, AHU, ALE	66	1896	AP9004	ALT, (Bosch), 90A, OE-NO 028 903 028 J, 120A, OE-NO 028 903 026 G, MTR-CODE: AHU, ALE	VD1084

M









Der Inhalt dieser Druckschrift ist unverbindlich und dient ausschließlich Informationszwecken. Die Informationen sind keine Angebote im Sinne der anwendbaren gesetzlichen Bestimmungen und begründen kein Vertragsverhältnis hinsichtlich der vorgestellten Produkte. Soweit nicht ausdrücklich anderweitig vereinbart, werden sie auch nicht Vertragsbestandteil bestehender oder künftiger Verträge mit der ContiTech AG.

Diese Druckschrift enthält keinerlei Garantien oder Beschaffensvereinbarungen der ContiTech AG für ihre Produkte, sei es ausdrücklich oder stillschweigend, auch nicht hinsichtlich der Aktualität, Korrektheit, Vollständigkeit und Qualität der Informationen sowie der Verfügbarkeit der Produkte. Die Informationen in dieser Druckschrift sowie die beschriebenen Produkte und Dienstleistungen können ohne vorherige Ankündigung von der ContiTech AG jederzeit geändert oder aktualisiert werden.

Die ContiTech AG übernimmt keine Haftung im Zusammenhang mit dieser Druckschrift. Eine Haftung für jegliche unmittelbaren oder mittelbaren Schäden, Schadensersatzforderungen, Folgeschäden gleich welcher Art und aus welchem Rechtsgrund, die durch die Verwendung der in dieser Druckschrift enthaltenen Informationen entstehen, ist, soweit rechtlich zulässig, ausgeschlossen.

Die gewerblichen Schutzrechte wie Marken (Logos) oder Patente, die in dieser Druckschrift dargestellt sind, sind Eigentum der Continental AG oder ihrer Tochtergesellschaften. Die Darstellung in dieser Druckschrift ist keine Gewährung von Lizenzen oder Nutzungsrechten. Ohne eine ausdrückliche schriftliche Einwilligung der Continental AG ist ihre Nutzung untersagt.

Alle Texte, Bilder, Grafiken und sonstigen Materialien, sowie deren Koordination und Anordnung in dieser Druckschrift sind urheberrechtlich für die Continental AG oder ihre Tochtergesellschaften geschützt und dürfen nicht zur kommerziellen Verwendung oder Verteilung modifiziert, kopiert oder anderweitig verwendet werden.

Copyright © 2011 ContiTech AG.  
Alle Rechte vorbehalten.

The content of this publication is provided for information only and without responsibility. ContiTech AG makes no representations about the accuracy, reliability, completeness or timeliness of the information in this publication. ContiTech AG may, in its sole discretion, revise the information contained herein at any time without notice.

ContiTech AG obligations and responsibilities regarding its products are governed solely by the agreements under which they are sold. Unless otherwise agreed in writing, the information contained herein does not become part of these agreements. This publication does not contain any guarantee or agreed quality of ContiTech AG products or any warranty of merchantability, fitness for a particular purpose and non-infringement. ContiTech AG may make changes in the products or services described at any time without notice.

This publication is provided on an "as is" basis. To the extent permitted by law, ContiTech AG makes no warranty, express or implied, and assumes no liability in connection with the use of the information contained in this publication. ContiTech AG is not liable for any direct, indirect, incidental, consequential or punitive damages arising out of the use of this publication. Information contained herein is not intended to announce product availability anywhere in the world.

The trademarks, service marks and logos (the Trademarks) displayed in this publication are the property of Continental AG and/or its affiliates. Nothing in this publication should be construed as granting any license or right to the Trademarks. Without the express written consent of Continental AG the use of the Trademarks is prohibited.

All text, images, graphics and other materials in this publication are subject to the copyright and other intellectual property rights of Continental AG and/or its affiliates. ContiTech AG owns the copyrights in the selection, coordination and arrangement of the materials in this publication. These materials may not be modified or copied for commercial use or distribution.

Copyright © 2011 ContiTech AG.  
All rights reserved.

Le contenu de la présente publication est donné exclusivement à titre informatif et n'engage pas la responsabilité de ContiTech AG. ContiTech AG ne peut être tenue pour responsable de l'exactitude, de la fiabilité, de l'intégralité ou de l'opportunité des informations reprises dans cette publication. ContiTech AG peut à sa seule discrétion modifier les informations contenues à tout moment et sans préavis.

Les devoirs et responsabilités de ContiTech AG à l'égard de ses produits ne sont régis que par les contrats de vente. En dehors de tout autre accord écrit, les informations ci-après ne peuvent devenir partie intégrante de ces contrats. La présente publication ne peut être interprétée comme valant clause de garantie, accord sur la qualité, garantie de disponibilité ou accord sur un usage particulier des produits de la ContiTech AG. ContiTech AG se réserve le droit de modifier les produits ou services décrits à tout moment sans préavis.

Ce document est remis à titre de base. Conformément aux dispositions législatives en vigueur, ContiTech AG, ne donne aucune garantie expresse ou tacite quant à l'utilisation des informations contenues dans cette publication. ContiTech AG décline toute responsabilité au titre de tout dommage direct, indirect ou consécutif, demande incidente, dommages et intérêts, dommage de quelque nature et à quelque titre juridique que ce soit pouvant naître de l'utilisation des informations contenues dans la présente publication. Les présentes informations ne peuvent être interprétées comme étant une annonce de disponibilité des produits au niveau mondial.

Les droits de propriété industrielle portant telles sur les marques (logos) et les brevets repris à la présente sont la propriété de la société Continental AG et/ou de ses filiales. La présente publication ne constitue ni une cession de licence ni un droit de jouissance desdits droits de propriété industrielle. Leur utilisation est interdite sans l'autorisation écrite expresse de la société Continental AG.

Les textes, photos, graphiques et autres représentations repris dans à la présente publication sont protégés par les droits de propriétés de Continental AG et/ou de ses filiales. ContiTech AG répond des droits d'auteur, de la sélection et de l'arrangement de cette publication laquelle ne peut en aucun cas être copiée ou modifiée à des fins d'utilisation ou de diffusion commerciales.

Copyright © 2011 ContiTech AG.  
Tous droits réservés.



El contenido de esta publicación no es obligatorio para ContiTech AG y solamente tiene fines informativos. La información contenida no significa ni debe entenderse en ningún sentido como una oferta formal de acuerdo con las disposiciones legales aplicables, por lo que no establece ninguna relación contractual con respecto a los productos presentados. En tanto no se haya acordado expresamente otra cosa, la información contenida de productos presentados, no serán parte integrante u objeto de contratos ya existentes o futuros con la ContiTech AG.

Esta publicación no incluye ni constituye de forma tácita o expresa ninguna clase de garantía o acuerdos de calidad de los productos de ContiTech AG, ni tampoco con respecto a la actualidad, corrección, integridad y calidad de la información contenida, así como de la disponibilidad de los mismos. ContiTech AG puede cambiar o actualizar en todo momento y sin previo aviso la información contenida en esta publicación así como los productos y servicios.

ContiTech AG no asume responsabilidad alguna en relación con esta publicación y no admite, responsabilidad alguna por daños directos o indirectos, reclamaciones de daños y perjuicios, daños consecuenciales de cualquier tipo y por cualquier motivo jurídico, que resulten o pudieran resultar del uso de la información incluida en esta publicación, cuando la misma no haya sido confirmada por escrito con ContiTech AG.

Los derechos de propiedad industrial tales como marcas (Logotipos) o patentes, mostrados en esta publicación, son propiedad de Continental AG y/o de sus filiales. Nada en esta publicación debe ser considerado como garantizando cualquier licencia o derecho de marca. El uso de la marca está prohibido sin el consentimiento escrito de Continental AG.

Todos los textos, figuras, gráficas y otros materiales en esta publicación están protegidos por los derechos de autor y otros derechos de propiedad intelectual de Continental AG y/o sus filiales. ContiTech AG es propietaria de los derechos de autor en la selección, coordinación y arreglo de los materiales en esta publicación. Estos materiales no pueden ser modificados o copiados para uso comercial o su distribución y cualquier violación a esta disposición puede derivar en responsabilidad civil y/o penal de conformidad con las leyes aplicables.

Copyright © 2011 ContiTech AG.  
Derechos reservados.

Il contenuto della presente pubblicazione non è vincolante; esso vuole essere solo di carattere informativo. Le informazioni non rappresentano un'offerta ai sensi delle disposizioni di legge applicabili e non giustificano quindi un rapporto contrattuale per i prodotti presentati. Se non espressamente concordato diversamente, esse non sono parte integrante dei contratti in essere o di quelli futuri stipulati dalla ContiTech AG.

La presente pubblicazione non riporta nessun tipo di garanzie o di accordi sulle caratteristiche della ContiTech AG per i suoi prodotti, né in maniera esplicita, né tacita, né per quanto riguarda l'attualità, la correttezza, la completezza e la qualità delle informazioni o la disponibilità dei prodotti. Le informazioni contenute nella presente pubblicazione e i prodotti e i servizi qui descritti, possono essere modificati o aggiornati in qualsiasi momento dalla ContiTech AG senza preannuncio.

La ContiTech AG non assume nessuna responsabilità per il contenuto della presente pubblicazione. Nella misura in cui legalmente ammissibile, si esclude qui qualsiasi responsabilità per danni diretti od indiretti, per richieste di risarcimento, per danni conseguenti di qualsiasi natura e motivazione giuridica derivanti dall'applicazione delle informazioni contenute nella presente pubblicazione.

I diritti di tutela industriale, come marchi (emblemi) o brevetti, riportati nella presente pubblicazione sono di proprietà della Continental AG o sue affiliate. La loro raffigurazione nella presente pubblicazione non sottintende il rilascio di licenze o diritti di sfruttamento. Il loro sfruttamento è pertanto interdetto senza un'espressa autorizzazione scritta da parte della Continental AG.

Tutti i testi, le immagini, le grafiche e tutti gli altri materiali, nonché la loro coordinazione e disposizione nella presente pubblicazione, sono protetti dai diritti d'autore della Continental AG o sue affiliate e non possono essere modificati o copiati a scopi commerciali, o utilizzati in qualsiasi altra maniera.

Copyright © 2011 ContiTech AG.  
Tutti i diritti riservati.

Sодержание данного издания не является окончательным и преследует лишь информационную цель. Информация не является предложением в юридическом смысле и не является основой для заключения соглашений по продукту. Если не оговорено специально, она не является также частью существующих или возможных в будущем контрактов с ContiTech AG.

Настоящее издание не содержит никаких гарантий или обещаний в отношении продукции ContiTech AG как явно, так и по умолчанию, а также в отношении актуальности, достоверности и качества информации и доступности продукта. Информация и описанные в издании продукты могут быть модернизированы или актуализированы в любое время без предварительного уведомления со стороны ContiTech AG.

ContiTech AG не несет ответственности в связи с данной публикацией. Ответственность за любой прямой или косвенный ущерб, требование компенсации за последующий возможный ущерб, независимо от их вида и юридического обоснования, возникшие в результате пользования данным изданием, исключаются, насколько это возможно юридически.



Использованные в издании марки, логотипы или патенты являются, согласно правам по защите промышленной деятельности, собственностью компании Continental AG или ее дочерних компаний. Публикация их в данной брошюре не дает права на дальнейшее их использование. Их использование без письменного согласия со Continental AG невозможно.

Все права на тексты, фотографии, рисунки и другие материалы данной брошюры, а также дизайн и верстку, которые не могут быть изменены, скопированы или иным способом употреблены в коммерческих целях, принадлежат Continental AG или ее дочерним компаниям.



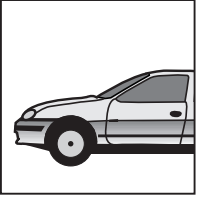

Copyright © 2011 ContiTech AG.  
Все права защищены

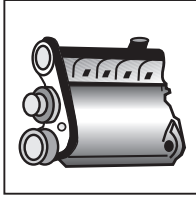
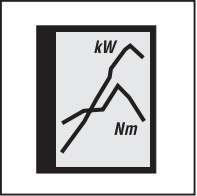
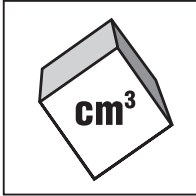
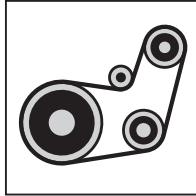
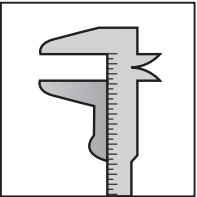
**Zeichenerklärung**  
**Key to symbols**  
**Signification des symboles**  
**Significado de símbolos**  
**Spiegazione de simboli**  
**Условное обозначение**

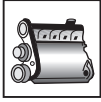
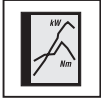
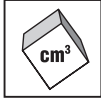

	Fahrzeugtyp Model Marque / Modèle Modelo Marca / Modello Марка автомобиля модель		Baujahr Year Année Año Anno Год выпуска		Motor Code Engine code Code moteur Código motor Codice motore Номер двигателя
	Leistung kW Output kW Puissance kW Potencia kW Potenza kW Мощность кВт		Hubraum cm <sup>3</sup> Capacity cm <sup>3</sup> Cylindrée en cm <sup>3</sup> Cilindrada cm <sup>3</sup> Cilindrata cm <sup>3</sup> Объем двигателя см <sup>3</sup>		Anwendungen Application Utilisation Aplicación Impiego Назначение
	Abmessung Size Dimension Dimensión Dimensione Размер				

**Anwendungsbeispiel**  
**Application examples**  
**Exemples d'utilisation**  
**Ejemplo de aplicación**  
**Esempio di applicazione**  
**Пример применения**

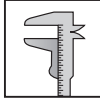
							
SKODA OCTAVIA (1U)	09/96	AEE	55	1598	CT 847 (137) CT 847 K1	ALT, PS ALT, PS, AC	6 PK 1080 6 PK 1548
1.6							

(137)\* = Zähnezahl / no of teeth / Nbre. dents / N° de dientes / No. di denti / Число зубьев

**Abkürzungsverzeichnis**  
**List of abbreviations**  
**Liste des abréviations**  
**Índice de abreviaturas**  
**Indice delle abbreviazioni**  
**Значение аббревиатуры**

	Deutsch	English	Français	Español	Italiano	Русский
XXXX->	ab	from	à partir de	desde	da	с
->XXXX	bis	up to	jusqu'à	hasta	a	до
(XXX)	für Fahrzeuge mit	for vehicles with	pour véhicules avec	Para vehiculos con	per veicoli con	Для транспортных средств с
(-XXX)	für Fahrzeuge ohne	for vehicles without	pour véhicules sans	Para vehiculos sin	per veicoli senza	Для транспортных средств без
ø 98 mm	Durchmesser	diameter	diamètre	diámetro	diametro	Диаметр
2X	2 Riemen	2 belts	2 courroies	2 correas	2 cinghie	2 ремня
2. FAN	2. Lüfter	2nd fan	2 <sup>e</sup> ventilateur	2 <sup>o</sup> ventilador	2 <sup>o</sup> ventilatore	2-ой вентилятор
4WD	Allradantrieb	Four-wheel drive	Transmission intégrale	Tracción a las cuatro ruedas	Trazione integrale	Полный привод
ABSP	ABS Pumpe	ABS pump	pompes ABS	bomba ABS	ABS pompa	насос ABS
AC	Klimaanlage	air conditioning unit	climatiseur	aire acondicionado	aria condizionata	КОНДИЦИОНЕР
ACT ST	Aktivlenkung	active steering system	sysème de direction active	sistema de dirección activa	sterzo attivo	активный рулевой механизм
AIRC	Luftpresse	air compressor	compresseur	compresor de aire	compressore d'aria	Воздушный компрессор
AIRF	Luftfilter	Air filter	Filtre à air	Filtro de aire	Filtro dell'aria	Воздушный фильтр
AIRP	Luftpumpe	air pump	pompe à air	bomba de aire	pompa dell'aria	Воздушный насос
ALT	Drehstrom-Lichtmaschine	alternator	alternateur	alternador	alternatore trifase	Генератор переменного тока
2. ALT	2. Drehstromlichtmaschine	second alternator	2 <sup>o</sup> alternateur	sinamo trifásica	secondo alternatore trifase	Второй генератор переменного тока
AUTOM	Automatic	automatic transmission	boîte automatique	automático	automático	АКПП
AUTOM-TP	automatische Spannrolle	automatic tension pulley	galet tendeur automatique	rodillo tensor automático	rullo tendicinghia automatico	Автоматический натяжной ролик
BORE-Ø	Bohrungsdurchmesser	bore diameter	diamètre d'alésage	diámetro de agujero	diametro del foro	диаметр вруба
BS	Ausgleichswelle	balance shaft	arbre de différentiel	árbol contrarrotante	albero del differenziale	Балансирный вал
CA	Nockenwelle	camshaft	arbre à cames	árbol de levas	albero a camme	Распределительный вал
CARB	Vergaser	carburetor	carburateur	carburator	carburatore	Карбюратор
CAT	Katalysator	catalytic converter	pot catalytique	catalizador	catalizzatore	Катализатор
CH-NO	Fahrgestell-Nr.	chassis no.	n° châssis	n° chasis	n° telaio	№ шасси
CHR	Lader	charger	suralimenteur	cargador	caricatore	турбоагнетатель
COMPR	Kompressor	compressor	compresseur	compresor	compressore	компрессор
CS	Kurbelwelle	crankshaft	vilebrequin	cigüeñal	albero motore	Коленчатый вал
CVH	Reihenmotor mit halbkugelförmigen Brennräumen	in-line engine with hemispherical combustion chambers	moteur en ligne à chambres de combustion hémisphériques	motor en línea con cámara de combustión semiesférica	motore in linea con camere di combustione semisferiche	Однорядный двигатель с полусферическими камерами сгорания
CVT-AUTOM	CVT-Automatikgetriebe	CVT automatic transmission	Boîte de vitesse automatique TVC	Transmisión automática CVT	Cambio automatico CVT	Бесступенчатая автоматическая коробка передач
DC-ALT	Gleichstromgenerator	DC generator	génératrice de courant continu	generator de corriente continua	generatore di corrente continua	Динамо
DIS	Zündverteiler	Ignition distributor	distributeur d'allumage	distribudor de encendido	distributore di accensione	распределитель зажигания
DOHC	Doppelte obenliegende Nockenwelle	double overhead camshaft	double arbre à cames en tête	doble árbol de levas superior	albero a camme doppio in testa	Верхний двойной распределительный вал
DYN	Lichtmaschine	dynamo	dynamo	dinamo	dinamo	Автомобильный генератор
ELECTR PS	Elektrische Servolenkung	Electrical power steering	Direction électrique assistée	Dirección asistida eléctrica	Servosterzo elettrico	Электрическое сервоуправление
ENGINE	Motor	engine	moteur	motor	motore	Двигатель
FAN	Lüfter	fan	ventilateur	ventilador	ventilatore	Вентилятор
FWD	Frontantrieb	Front-wheel drive	Traction avant	Tracción frontal	Trazione anteriore	Передний привод
G-COMPR	G-Lader	G-Lader	G-Lader	Compresor G-Lader	Compressore G	G образный нагнетатель
GP	Führungsrolle	guide pulley	galet de guidage	rodillo guía	galoppino	Направляющий ролик
HYDP	Hydraulikpumpe	hydraulic pump	pompe hydraulique	bomba hidráulica	pompa idraulica	Гидравлический насос
IDLER	Zwischenrolle	idler	galet intermédiaire	polea intermedia	puleggia intermedia	Промежуточный ролик



**Abkürzungsverzeichnis**  
**List of abbreviations**  
**Liste des abréviations**  
**Índice de abreviaturas**  
**Indice delle abbreviazioni**  
**Значение аббревиатуры**

	Deutsch	English	Français	Español	Italiano	Русский
INJ	Einspritzer	injection engine	injecteur	inyector	iniettore	Форсунка
INJP	Einspritzpumpe	injection pump	pompe à injection	bomba de inyección	pompa ad iniezione	насос–форсунка
JKR	je nach Keilriemen	depending on V-belt	svt. courroie trapézoïdale	según correa trapezial	a seconda della cinghia trapezoidale	Зависит от клинового ремня
JKRR	je nach Keilrippenriemen	depending on V-ribbed belt	svt. courroie striéee	según correa trapezial ranurada	a seconda della cinghia trapezoidale nervata	Зависит от поликлинного ремня
JP	Führungsrolle	jockey pulley	galet directeur	polea-guía	ruota di guida	Направляющий ролик
LC	Niveauregulierung	level control	correction assiette	control del nivel	controllo livello	Регулировка дорожного просвета
LH	Einbauseite links	left-hand installation	côté montage gauche	lado de montaje izquierdo	lato di montaggio destro	Установка слева
LHD	Linkslenkung	left hand drive	conduite à gauche	conducción a la izquierda	guida sinistra	Леворульный автомобиль
MANL	Handschaltung	manual transmission	changement de vitesses manuel	cambio manual	cambio manuale	Ручное переключение
MECH-TP	mechanische Spannrolle	mechanical tension pulley	galet tendeur mécanique	rodillo tensor mecánico	rullo tendicinghia meccanico	Механический натяжной ролик
MODEL	Modell	model	modèle	modelo	modello	модель
MTR-CODE	Motor Code	engine code	code moteur	código motor	codice motore	Код двигателя
MTR-NO	Motornummer	engine number	n° moteur	número del motor	numero motor	№ двигателя
OHC	obenliegende Nockenwelle	overhead camshaft	arbre à cames en tête	árbol de levas superior	albero a camme in testa	Верхний распределительный вал
OHV	obenliegende Ventile	overhead valves	soupapes en tête	válvulas superiores	valvole in testa	Верхние клапаны
OILC	Ölkühler	oil cooler	radiateur huile	radiador del aceite	radiatore olio	Масляный радиатор
OILP	Öpumpe	oil pump	pompe à huile	bomba aceite	pompa olio	Масляный насос
OPT	wahlweise	optional	en option	opcional	facoltativo	выборочно
ORG-NO	Werk-Nr.	organisation no.	n° usine	n° fábrica	n° fabbrica	№ завода
PETR INJ	Benzineinspritzung	Fuel injection	Injection d'essence	Inyección de gasolina	Iniezione a benzina	Система впрыскивания бензина
PS	Servolenkung	power steering	direction assistée	servodirección	servosterzo	сервоуправление
PTO	Nebenantrieb	power take off	prise de force	accionamiento auxiliar	presa di forza ausiliare	Вспомогательный привод
RAD	Heizung	radiator	radiateur	radiador	riscaldatore	система обогрева
REAR	hinten	rear	postérieur	posterior	posteriore	сзади
RICAMBI-NO	Ersatzteilnummer	spare-part number	n° pièces rechange	n° pieza de repuesto	numero ricambio	№ запчасти
RH	Einbauseite rechts	right-hand installation	côté montage droite	lado de montaje derecho	lato di montaggio sinistro	Установка справа
RHD	Rechtslenker	right hand drive	conduite à droite	conducción a la derecha	guida destra	Праворульный автомобиль
RWD	Heckantrieb	Rear-wheel drive	Traction arrière	Tracción trasera	Trazione posteriore	Задний привод
SP	Einzelpumpe	single pump	pompe simple	bomba individual	pompa singola	Одиночный насос
STRONIC	Servotronic-Lenkung	Servotronic steering	Direction Servotronic	Dirección servotronic	Sterzo Servotronic	Система усилителя рулевого управления Servotronic
TENS-DAMPER	Spanndämpfer	Tensioning damper	Amortisseur de tension	Amortiguadores de tensión	Pulegge	Демпфер натяжного ролика
THERMO	thermostatisch	thermostatic	thermostatique	termostático	termostatico	термостатический
TP	Spannrolle	tension pulley	galet-tendeur	rodillo tensor	rullo tenditore	натяжной ролик
TURBOC	Turbokühler	turbocooler	radiateur turbo	turborrefrigerador	turbocooler	охладитель турбины
VACP	Vakuumpumpe	vacuum pump	pompe à vide	bomba de vacío	pompa pervuoto	Вакуум–насос
WP	Wasserpumpe	water pump	pompe à eau extra	bomba de agua	pomba acqua	Водяной насос

[www.contitech.de/aam](http://www.contitech.de/aam)

Power Transmission Group

Market Segment  
Automotive Aftermarket

Contact Headquarter  
ContiTech Antriebssysteme GmbH  
Postfach 445  
D-30004 Hannover  
Phillipsbornstraße 1  
D-30165 Hannover  
Tel. +49 511 938 - 71  
Fax +49 511 938 - 5065  
aam@ptg.contitech.de

Your contact person:  
[www.contitech.de/contactlocator](http://www.contitech.de/contactlocator)



You need data, instructions and other info on a certain article? Use our Product Information Center.



Certified to



The content of this publication is not legally binding and is provided as information only. The trademarks displayed in this publication are the property of Continental AG and/or its affiliates. Copyright © 2011 ContiTech AG. All rights reserved.

For complete information go to:  
[www.contitech.de/discl\\_en](http://www.contitech.de/discl_en)

WT 7606 08.2011 (Rec) Printed with ContiTech offset printing blankets on bleached paper free of chlorine