



# BRAKE CATALOGUE



EUROPEAN APPLICATIONS



**2012  
2013**



**TecDoc**  
CERTIFIED DATA SUPPLIER

Oltre che sui cataloghi cartacei dei prodotti aftermarket di Ashika, è possibile trovare i prodotti Ashika anche in TecDoc, leader europeo nella produzione di catalogazione elettronica.

Ashika è "Fornitore di dati certificato" per TecDoc. Vale a dire che tutti i dati di Ashika presenti in TecDoc godono di ottima qualità, sono stati controllati e verificati da TecDoc, e supportati dagli specialisti di Ashika. I pezzi possono essere facilmente reperiti cliccando sul relativo veicolo e sul gruppo di prodotti. Quando vengono visualizzate le parti Ashika corrette, l'utente può visionare anche informazioni aggiuntive (ad es. dimensioni, caratteristiche o immagini).

*Beside the paper catalogues of the Ashika Aftermarket products, Ashika products can also be found in TecDoc, European leader of electronic cataloguing.*















*Ashika is a "certified Data Supplier" to TecDoc. This means that all Ashika data in TecDoc is of the highest quality, controlled and checked by TecDoc, and maintained by Japanparts' own specialists. Parts can easily be found just by clicking on the proper vehicle and product-group. When the correct Ashika part(s) is/are displayed, also additional information can be viewed (i.e. dimensions, remarks or pictures).*



























































# EUROPE Crossover

	KW			
<b>DACIA DUSTER</b> <i>i</i> <i>i</i>				
1.5 dCi	63	04.10 →	 <b>60-00-013</b>	NO ABS Imp. LUCAS
1.5 dCi	79	06.10 →		
1.5 dCi	66	10.10 →		
1.6 16V	77	04.10 →		
1.6 16V 4x4	77	06.10 →		
<b>FIAT SEDICI</b> <i>i</i> <i>i</i>				
1.6 16V 4x4	79	06.06 →	 <b>60-08-801</b>	Imp. TRW
1.9 D Multijet	88	06.06 →	 <b>60-08-819</b>	Made in Japan Imp. HITACHI
			 <b>60-08-820</b>	
				 <b>65-08-817</b>  <b>67-08-846</b>
<b>OPEL ANTARA</b> <i>i</i> <i>i</i>				
2.0 CDTI		03.07 →	 <b>60-0W-W10</b>	 <b>61-0W-W04</b>
2.0 CDTI		05.06 →	 <b>60-0W-W12</b>	 <b>61-0W-W05</b>
2.0 CDTI FWD		09.08 →		 <b>65-0W-W06</b>
2.4		05.06 →		
2.4 FWD		09.08 →		
3.2 V6		03.07 →		Parking Brake/Freno staz.

# EUROPE Vehicle



	KW			
<b>CITROEN C1</b>				
1.0	50	06.05 →	 <b>50-02-217</b>	 <b>55-02-212</b>
1.4 HDi	40	06.05 →	 <b>60-02-269</b>	 <b>56-02-203</b>
				 <b>67-02-207</b>
<b>OPEL ASTRA F (56_, 57_)</b>				
1.7 D	42	03.92 → 09.92	 <b>50-03-390</b>	 <b>55-03-395</b>
1.7 D	44	07.92 → 09.98	 <b>60-09-910</b>	 <b>56-W0-000</b>
1.7 TD	50	11.94 → 09.98		 <b>67-W0-000</b>
1.7 TDS	60	03.92 → 09.98		 <b>67-W0-001</b>
<b>OPEL ASTRA F Hatchback (53_, 54_, 58_, 5)</b>				
1.7 D	44	07.92 → 01.98	 <b>50-03-390</b>	 <b>55-03-395</b>
1.7 D	42	12.91 → 09.92	 <b>60-09-910</b>	 <b>56-W0-000</b>
1.7 TD	50	11.94 → 01.98		 <b>67-W0-000</b>
1.7 TDS	60	12.91 → 01.98		 <b>67-W0-001</b>
<b>OPEL ASTRA F Station wagon (51_, 52_)</b>				
1.7 D	44	07.92 → 01.98	 <b>50-03-390</b>	 <b>55-03-395</b>
1.7 D	42	12.91 → 09.92	 <b>60-09-910</b>	 <b>56-W0-000</b>
1.7 TD	50	11.94 → 01.98		 <b>67-W0-000</b>
1.7 TDS	60	12.91 → 01.98		 <b>67-W0-001</b>
<b>OPEL ASTRA J</b>				
1.3 CDTI ecoFLEX	70	12.09 →	 <b>50-0W-W12</b>  <b>50-0W-W13</b>	Rim Size\Diam Cerchio:15  <b>51-0W-W05</b> Rim Size\Diam Cerchio:16
1.4 ecoFLEX	64	12.09 →	 <b>50-0W-W12</b>	Rim Size\Diam Cerchio:15
1.4 ecoFLEX	74	12.09 →	 <b>50-0W-W13</b>	Rim Size\Diam Cerchio:16
1.4 Turbo	103	12.09 →	 <b>60-0W-W15</b>	Rim Size\Diam Cerchio:15
1.6	85	12.09 →	 <b>60-0W-W16</b>	Rim Size\Diam Cerchio:16
1.6 Turbo	132	12.09 →	 <b>50-0W-W13</b>	Rim Size\Diam Cerchio:16
1.7 CDTI	92	12.09 →	 <b>60-0W-W15</b>	Rim Size\Diam Cerchio:15
1.7 CDTI	81	12.09 →	 <b>60-0W-W16</b>	Rim Size\Diam Cerchio:16
2.0 CDTI	118	12.09 →		 <b>51-0W-W05</b>  <b>61-0W-W06</b>  <b>61-0W-W07</b>
<b>OPEL ASTRA Sports Tourer (J)</b>				
1.3 CDTI	70	10.10 →	 <b>50-0W-W12</b>	Rim Size\Diam Cerchio:15
1.4	74	10.10 →	 <b>50-0W-W13</b>	Rim Size\Diam Cerchio:16
1.4 Turbo	103	10.10 →	 <b>60-0W-W15</b>	Rim Size\Diam Cerchio:15
1.6	85	10.10 →	 <b>60-0W-W16</b>	Rim Size\Diam Cerchio:16
1.4 Turbo	88	10.10 →	 <b>50-0W-W12</b>	Rim Size\Diam Cerchio:15
			 <b>50-0W-W13</b>	Rim Size\Diam Cerchio:16
			 <b>60-0W-W16</b>	Rim Size\Diam Cerchio:16
1.6 Turbo	132	10.10 →	 <b>50-0W-W13</b>	Rim Size\Diam Cerchio:16
1.7 CDTI	92	10.10 →	 <b>60-0W-W15</b>	Rim Size\Diam Cerchio:15
1.7 CDTI	81	10.10 →	 <b>60-0W-W16</b>	Rim Size\Diam Cerchio:16
2.0 CDTI	118	10.10 →		 <b>51-0W-W05</b>  <b>61-0W-W06</b>  <b>61-0W-W07</b>





























































# EUROPE Vehicle

	KW			
<b>OPEL CAMPO (TF_)</b> <i>i</i> <i>i</i>				
2.6 D (TFR64)	56	08.91 → 06.94	<b>60-09-904</b>	Imp. AKEBONO
2.6 D 4x4 (TFS64)	56	08.91 → 06.94	<b>60-09-909</b>	
2.6 DTI	74	12.01 →		<b>61-09-900</b>
2.6 TD (TFR64)	56	07.94 →		<b>66-09-902</b>
2.6 TD 4x4 (TFS64)	56	07.94 →		<b>67-09-901</b>
<b>OPEL CORSA B (73_, 78_, 79_, F35_)</b> <i>i</i> <i>i</i>				
1.6 D	37	03.93 → 09.00	<b>60-03-390</b>	
1.6 TD	49	03.93 → 09.00	<b>60-09-904</b>	<b>66-09-996</b>
1.7 D	44	02.96 → 09.00	<b>60-09-911</b>	<b>67-W0-001</b>
<b>OPEL CORSA B Furgonato/Box (73_)</b> <i>i</i> <i>i</i>				
1.7 D	44	08.99 → 09.00	<b>60-03-390</b>	
			<b>60-09-904</b>	<b>66-09-996</b>
			<b>60-09-911</b>	<b>67-W0-001</b>
<b>OPEL FRONTERA A (6_MWL4)</b> <i>i</i> <i>i</i>				
2.3 TD (6JMWL4)	74	03.92 → 10.98	<b>60-09-904</b>	Imp. AKEBONO
			<b>60-09-909</b>	<b>66-09-991</b>
				<b>67-09-901</b>
<b>OPEL KADETT E (39_, 49_)</b> <i>i</i> <i>i</i>				
1.6 TD	53	07.88 → 08.91	<b>60-03-390</b>	
			<b>60-09-904</b>	<b>66-09-999</b>
			<b>60-09-911</b>	<b>66-W0-000</b>
				<b>67-W0-000</b>
<b>OPEL KADETT E Hatchback (33_, 34_, 43_)</b> <i>i</i> <i>i</i>				
1.6 TD	53	07.88 → 08.91	<b>60-03-390</b>	
			<b>60-09-904</b>	<b>66-09-999</b>
			<b>60-09-911</b>	<b>66-W0-000</b>
				<b>67-W0-000</b>
<b>OPEL KADETT E Station wagon (35_, 36_, 45_, 46_)</b> <i>i</i> <i>i</i>				
1.6 TD	53	07.88 → 08.91	<b>60-03-390</b>	
			<b>60-09-904</b>	<b>66-09-999</b>
			<b>60-09-911</b>	<b>66-W0-000</b>
				<b>67-W0-000</b>
<b>OPEL MONTEREY A (UBS_)</b> <i>i</i> <i>i</i>				
3.1 TD (UBS69_)	84	09.91 → 07.98	<b>60-09-904</b>	→12.95
3.2 (UBS25_)	130	06.92 → 07.98	<b>60-09-999</b>	Imp. AKEBONO
				01.96→
			<b>60-09-997</b>	Imp. SUMITOMO
				<b>61-09-900</b>
				<b>61-09-997</b>
<b>OPEL VECTRA A (86_, 87_)</b> <i>i</i> <i>i</i>				
1.7 D	44	07.92 → 11.95	<b>60-03-390</b>	
1.7 D	42	10.88 → 09.92	<b>60-09-910</b>	<b>66-09-999</b>
1.7 TD	60	03.90 → 11.95		<b>66-W0-000</b>
				<b>67-W0-001</b>
<b>OPEL VECTRA A Hatchback (88_, 89_)</b> <i>i</i> <i>i</i>				

# EUROPE Vehicle















































	KW			
<b>OPEL VECTRA A Hatchback (88_, 89_)</b> <i>i</i> <i>i</i>				
1.7 D	44	07.92 → 11.95	 <b>50-03-390</b>	 <b>55-09-999</b>
1.7 D	42	09.88 → 09.92	 <b>60-09-910</b>	 <b>56-W0-000</b>
1.7 TD	60	03.90 → 11.95		 <b>67-W0-001</b>
<b>OPEL VECTRA B (36_)</b> <i>i</i> <i>i</i>				
1.7 TD	60	10.95 → 12.98	 <b>50-03-390</b>	 <b>55-09-999</b>
			 <b>60-09-910</b>	 <b>67-W0-001</b>
<b>OPEL VECTRA B Hatchback (38_)</b> <i>i</i> <i>i</i>				
1.7 TD	60	10.95 → 12.98	 <b>50-03-390</b>	 <b>55-09-999</b>
			 <b>60-09-910</b>	 <b>67-W0-001</b>
<b>PEUGEOT 107</b> <i>i</i> <i>i</i>				
1.0	50	06.05 →	 <b>50-02-217</b>	 <b>55-02-212</b>
1.4 HDi	40	06.05 →	 <b>60-02-269</b>	 <b>56-02-203</b>
				 <b>67-02-207</b>
<b>ROVER 200 (RF)</b> <i>i</i> <i>i</i>				
211	44	01.98 → 03.00	 <b>50-04-429</b>	 <b>55-04-410</b>
214 i	55	11.95 → 03.00	 <b>60-04-411</b>	 <b>67-H0-013</b>
214 Si	76	11.95 → 03.00		 <b>67-H0-014</b>
216 Si	82	11.95 → 03.00	 <b>50-04-427</b>	 <b>51-04-404</b>
218 K Vi	107	11.95 → 03.00		 <b>61-04-402</b>
220 D/SD	63	11.95 → 03.00	 <b>50-04-430</b>	 <b>55-04-410</b>
220 SDi	77	11.95 → 03.00	 <b>60-04-498</b>	 <b>67-H0-013</b>
				 <b>67-H0-014</b>
<b>ROVER 200 (XH)</b> <i>i</i> <i>i</i>				
213 S	54	09.85 → 09.89	 <b>50-04-429</b>	 <b>55-04-403</b>
			 <b>60-04-411</b>	 <b>65-04-400</b> Right/Destra
216	61	03.85 → 09.89	 <b>50-04-430</b>	 <b>51-04-404</b>
216 Vitesse	75	03.85 → 09.89	 <b>60-04-498</b>	 <b>61-04-498</b>
				 <b>55-04-403</b> 03.85→
				 <b>67-04-450</b> →04.89
				 <b>67-04-451</b>
<b>ROVER 200 Coupe (XW)</b> <i>i</i> <i>i</i>				
216	90	10.92 → 06.99	 <b>50-04-427</b>	 <b>51-04-404</b> →12.96
			 <b>60-04-498</b>	 <b>61-04-498</b> →12.96
			 <b>50-04-430</b>	 <b>55-04-410</b>
			 <b>60-04-498</b>	
220 GSi	100	05.94 → 06.99	 <b>50-04-427</b>	 <b>51-04-404</b>
220 Turbo	147	10.92 → 06.99	 <b>50-04-430</b>	 <b>61-04-498</b>
			 <b>60-04-498</b>	

























































# EUROPE Vehicle

	KW					
<b>ROVER 200 Hatchback (XW)</b>						
<b>218 D</b>	52	09.91 → 10.95	 <b>50-04-427</b>	Imp. LUCAS	 <b>51-04-404</b>	
<b>218 TD</b>	65	09.91 → 10.95	 <b>60-04-498</b>		 <b>61-04-498</b>	
<b>220 GTi</b>	100	01.93 → 10.95			 <b>55-04-410</b>	
<b>220 GTi</b>	103	09.91 → 10.95			 <b>67-04-410</b>	
<b>220 Turbo</b>	147	01.93 → 10.95				
<b>214</b>	55	09.93 → 10.95	 <b>50-04-429</b>		 <b>55-04-410</b>	
<b>214 GSi/Si</b>	70	01.90 → 10.95	 <b>60-04-411</b>		 <b>67-04-410</b>	
<b>214 GSi/Si</b>	76	12.92 → 10.95				
<b>214 Si/Gsi</b>	66	10.89 → 10.95				
<b>216 GSi</b>	82	10.89 → 10.95	 <b>50-04-430</b>		 <b>51-04-404</b>	
<b>216 GSi</b>	85	10.89 → 10.95	 <b>60-04-498</b>		 <b>61-04-498</b>	
<b>216 GTi</b>	90	09.90 → 10.95			 <b>55-04-410</b>	
<b>216 GTi</b>	96	09.90 → 10.95			 <b>67-04-410</b>	
<b>ROVER 25 (RF)</b>						
<b>1.1 16V</b>	55	01.04 →	 <b>50-04-427</b>	Imp. LUCAS	 <b>51-04-404</b>	
<b>1.4 16V</b>	76	10.99 →	 <b>60-04-498</b>		 <b>61-04-402</b>	
<b>1.4 16V</b>	62	10.99 →			 <b>55-04-410</b>	
<b>1.6 16V</b>	80	10.99 →				
<b>1.8 16V</b>	107	02.00 →				
<b>1.8 16V</b>	85	10.99 →				
<b>2.0 iDT</b>	74	10.99 →				
<b>ROVER 400 (RT)</b>						
<b>414 Si</b>	76	05.95 → 03.00	 <b>50-04-427</b>	Imp. LUCAS	 <b>51-04-404</b>	
			 <b>60-04-498</b>		 <b>61-04-498</b>	
					 <b>55-04-410</b>	
<b>416 Si</b>	83	05.95 → 03.00	 <b>50-04-427</b>	01.97→	 <b>51-04-404</b>	→12.96
<b>416 Si</b>	82	05.95 → 03.00		Imp. LUCAS	 <b>61-04-498</b>	→12.96
<b>420 D</b>	63	11.95 → 03.00	 <b>50-04-430</b>	→12.96	 <b>55-04-410</b>	→12.96
<b>420 Di</b>	77	05.95 → 03.00	 <b>60-04-498</b>	→12.96		
<b>420 Si Lux</b>	100	12.95 → 03.00				
<b>ROVER 400 (XW)</b>						
<b>414</b>	70	01.93 → 04.95	 <b>50-04-430</b>		 <b>51-04-404</b>	
<b>414 GSI/SI</b>	66	04.90 → 04.95	 <b>60-04-498</b>		 <b>61-04-498</b>	
<b>414 GSI/SI Cat.</b>	76	01.93 → 04.95			 <b>55-04-410</b>	
<b>416 GSI</b>	82	04.90 → 04.95				
<b>416 GSI/GSE</b>	85	04.90 → 04.95				
<b>416 GTI</b>	90	04.90 → 04.95				
<b>416 GTI/GTE</b>	96	04.90 → 04.95				
<b>418 D</b>	49	09.91 → 04.95				
<b>418 TD</b>	65	09.91 → 04.95				
<b>420 GSI/SLI/GTI/Vite</b>	100	01.93 → 04.95	 <b>50-04-430</b>		 <b>51-04-404</b>	
<b>420 GTI/GSI/Vitesse</b>	103	02.92 → 04.95	 <b>60-04-498</b>		 <b>61-04-498</b>	
<b>420 Turbo</b>	147	01.93 → 04.95				
<b>ROVER 400 Hatchback (RT)</b>						

































# EUROPE Vehicle



	KW					
<b>ROVER 400 Hatchback (RT)</b>						
414 Si	76	05.95 → 03.00	 <b>50-04-427</b>	01.97→	 <b>51-04-404</b>	
416 Si	82	05.95 → 03.00		Imp. LUCAS	 <b>61-04-498</b>	
416 Si	83	06.95 → 03.00	 <b>50-04-430</b>	→12.96	 <b>55-04-410</b>	
			 <b>60-04-498</b>			
420 D	63	11.95 → 03.00	 <b>50-04-427</b>	Imp. LUCAS	 <b>51-04-404</b>	
			 <b>60-04-498</b>		 <b>61-04-498</b>	
					 <b>55-04-410</b>	
420 Di	77	05.95 → 03.00	 <b>50-04-427</b>	Imp. LUCAS	 <b>51-04-404</b>	
420 Si Lux	100	12.95 → 03.00	 <b>60-04-498</b>		 <b>61-04-498</b>	
<b>ROVER 400 Tourer (XW)</b>						
1.6 i	90	05.94 → 11.98	 <b>50-04-427</b>	Imp. LUCAS	 <b>51-04-404</b>	
1.6 i	82	05.94 → 11.98	 <b>60-04-498</b>		 <b>61-04-498</b>	
1.8 i	107	06.96 → 11.98			 <b>55-04-410</b>	
1.8 TD	65	09.93 → 11.98				
2.0 i	100	05.94 → 11.98				
<b>ROVER 45 (RT)</b>						
1.4	76	02.00 →	 <b>50-04-427</b>	Imp. LUCAS	 <b>51-04-404</b>	
1.6	80	02.00 →	 <b>60-04-426</b>		 <b>61-04-402</b>	
1.8	86	02.00 →			 <b>55-04-410</b>	
2.0 iDT	74	02.00 →				
2.0 V6	110	02.00 →				
<b>ROVER 45 Tre volumi/Saloon (RT)</b>						
1.4	76	02.00 →	 <b>50-04-427</b>	Imp. LUCAS	 <b>51-04-404</b>	
1.6	80	02.00 →	 <b>60-04-426</b>		 <b>61-04-402</b>	
1.8	86	02.00 →			 <b>55-04-410</b>	
2.0 iDT	74	02.00 →				
2.0 V6	110	02.00 →				
<b>ROVER 800</b>						
820 16V Turbo (RS)	132	01.92 → 02.99	 <b>50-04-427</b>	Imp. LUCAS	 <b>61-04-406</b>	
820 I/SI (RS)	100	01.92 → 02.99	 <b>60-04-421</b>			
825 D/SD (XS)	87	01.90 → 02.99				
825 Si Lux (RS)	129	04.96 → 02.99				
825 SI/Sterling (XS)	127	01.87 → 12.91				
825 SI/Sterling (XS)	123	10.86 → 10.88				
827 SI/Sterling (XS)	130	02.88 → 12.91	 <b>50-04-426</b>		 <b>51-04-405</b>	
827 SI/Sterling (XS)	124	02.88 → 02.99	 <b>60-04-421</b>		 <b>61-04-406</b>	
Cat.						
825 SI/Sterling (XS)	110	10.86 → 12.91	 <b>50-04-427</b>	Imp. LUCAS	 <b>51-04-406</b>	
Cat.			 <b>60-04-421</b>		 <b>61-04-406</b>	
<b>ROVER 800 Coupe</b>						
827 24V (RS)	124	08.92 → 02.99	 <b>50-04-426</b>		 <b>51-04-405</b>	
			 <b>60-04-421</b>		 <b>61-04-406</b>	
825 SD	87	09.93 → 02.99	 <b>50-04-427</b>	Imp. LUCAS	 <b>51-04-406</b>	
825 Si (RS)	129	04.96 → 02.99	 <b>60-04-421</b>		 <b>61-04-406</b>	



# EUROPE Vehicle

	KW			
<b>ROVER 800 Hatchback</b> <i>i</i> <i>i</i>				
827 24V I/SI (RS) Cat.	124	01.92 → 02.99	 <b>50-04-426</b>  <b>60-04-421</b>	 <b>51-04-405</b>  <b>61-04-406</b>
827 Vitesse (XS) Cat.	124	10.88 → 12.91		
827 Vitesse/SLI	130	10.88 → 12.91		
820 16V Turbo (RS)	132	01.92 → 02.99	 <b>50-04-427</b>  <b>60-04-421</b>	 <b>51-04-406</b>  <b>61-04-406</b>
825 D/SD (XS)	87	01.92 → 02.99		
820 I/SI (XS)	100	01.93 → 02.99	 <b>50-04-427</b>  <b>60-04-418</b>	 <b>51-04-406</b>  <b>61-04-406</b>
<b>ROVER CABRIOLET (XW)</b> <i>i</i> <i>i</i>				
214 1.4	66	01.92 → 11.99	 <b>50-04-427</b>  <b>60-04-498</b>	 <b>51-04-404</b>  <b>61-04-498</b>
214 1.4	70	04.90 → 09.92		
214 1.4i 16V	76	01.93 → 11.99		
216 1.6i	90	01.92 → 11.99		 <b>55-04-410</b>
216 1.6i 16V	82	01.96 → 11.99		
<b>ROVER CITYROVER</b> <i>i</i> <i>i</i>				
1.4	62	01.04 →	 <b>50-04-404</b>  <b>60-00-080</b>	 <b>51-04-404</b>  <b>61-04-402</b>
<b>ROVER COUPE</b> <i>i</i> <i>i</i>				
1.6 16 V	82	03.96 → 11.99	 <b>50-04-427</b>  <b>60-04-498</b>	 <b>51-04-404</b>  <b>61-04-402</b>
1.8 16 V	107	03.96 → 11.99		
<b>ROVER STREETWISE</b> <i>i</i> <i>i</i>				
1.4	76	08.03 →	 <b>50-04-427</b>  <b>60-04-498</b>	 <b>51-04-404</b>  <b>61-04-402</b>
1.4	62	08.03 →		
2.0 TD	74	08.03 →		





PICTURES BRAKE PADS FRONT  
ABBILDUNGEN BREMSKLÖTZE VORN  
FIGURAS PASTILLAS DE FRENO DELANTORES  
ILLUSTRATIONS PLAQUETTES DE FREI AVANT  
IMMAGINI PASTIGLIE FRENO ANTERIORI

<b>50-00-013</b>				<b>WVA</b>
<b>NISSAN - DACIA</b>	<b>L</b>	<b>H</b>	<b>Th</b>	
	116,4	52,6	16,2	<b>23973</b>

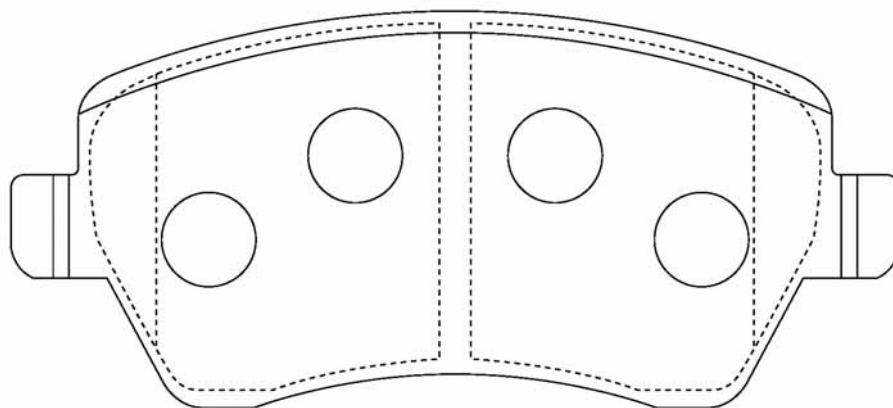

**X4**



PICTURES BRAKE PADS FRONT  
ABBILDUNGEN BREMSKLÖTZE VORN  
FIGURAS PASTILLAS DE FRENO DELANTORES  
ILLUSTRATIONS PLAQUETTES DE FREI AVANT  
IMMAGINI PASTIGLIE FRENO ANTERIORI

<b>50-02-217</b>				<b>WVA</b>
<b>CITROEN - TOYOTA - PEUGEOT</b>	<b>L</b>	<b>H</b>	<b>Th</b>	
	<b>123</b>	<b>47</b>	<b>17,4</b>	<b>23959</b>

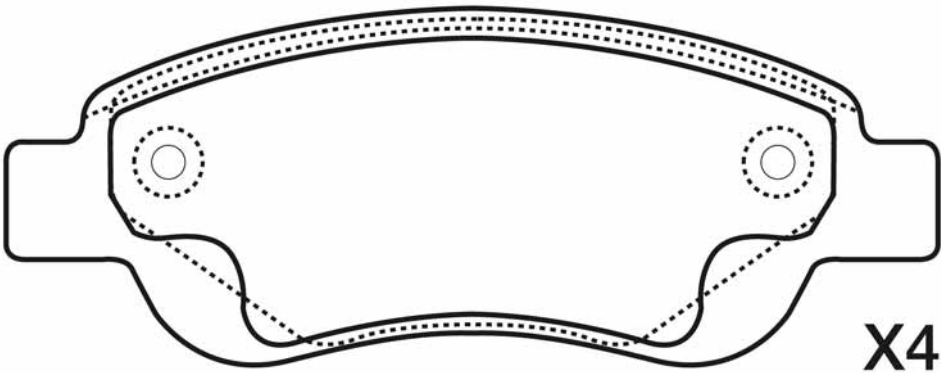



PICTURES BRAKE PADS FRONT  
ABBILDUNGEN BREMSKLÖTZE VORN  
FIGURAS PASTILLAS DE FRENO DELANTORES  
ILLUSTRATIONS PLAQUETTES DE FREI AVANT  
IMMAGINI PASTIGLIE FRENO ANTERIORI

<b>50-03-390</b> VAUXHALL - OPEL - DAEWOO				<b>WVA</b> <b>20547</b>
	<b>L</b> 140/141,5	<b>H</b> 58,8/48	<b>Th</b> 16,4	

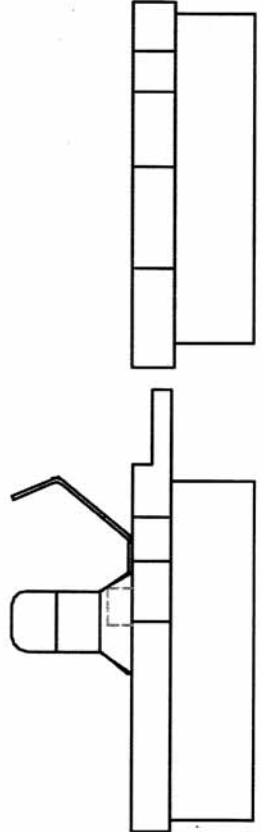
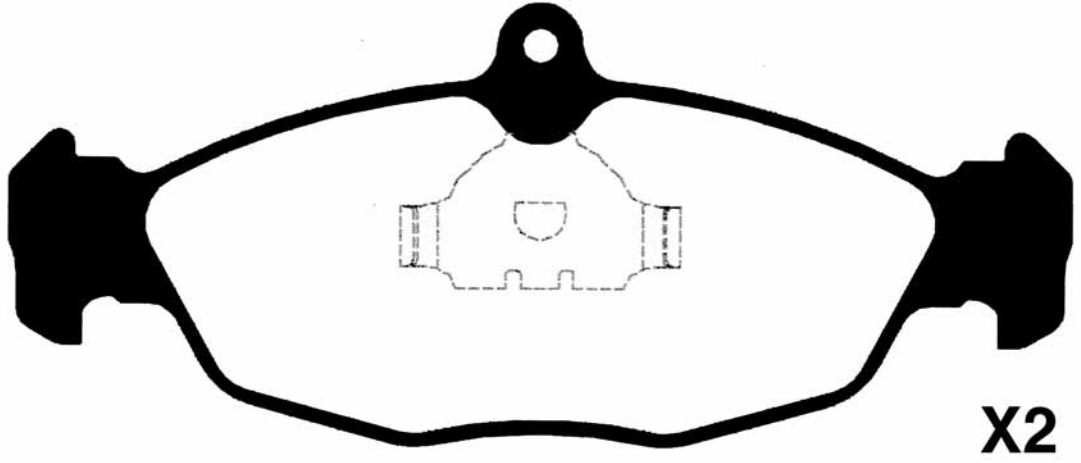
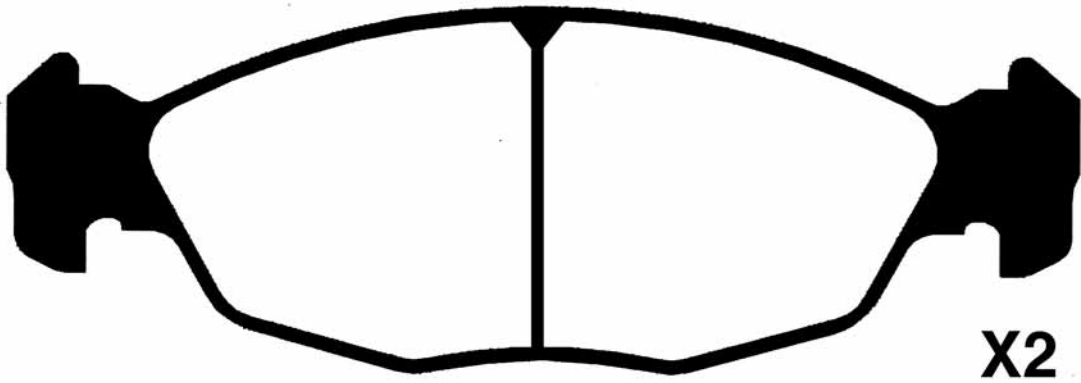



<b>50-04-404</b> <b>MARUTI - HONDA -</b> <b>BEDFORD - TRIUMPH -</b>				<b>WVA</b> <b>20731</b>
	<b>L</b> <b>119,4</b>	<b>H</b> <b>38,3</b>	<b>Th</b> <b>14,9</b>	

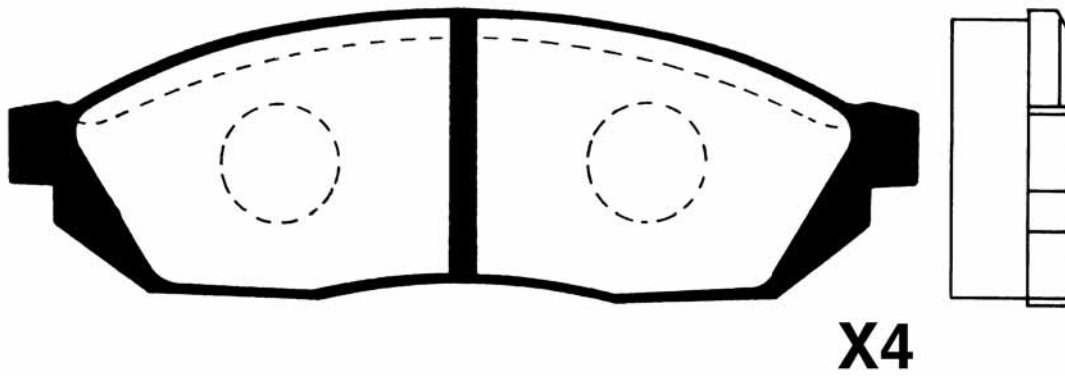





<b>50-04-426</b>				<b>WVA</b>
	<b>HONDA - ROVER</b>	<b>L</b>	<b>H</b>	<b>Th</b>
	129,1	53,3	17	21447

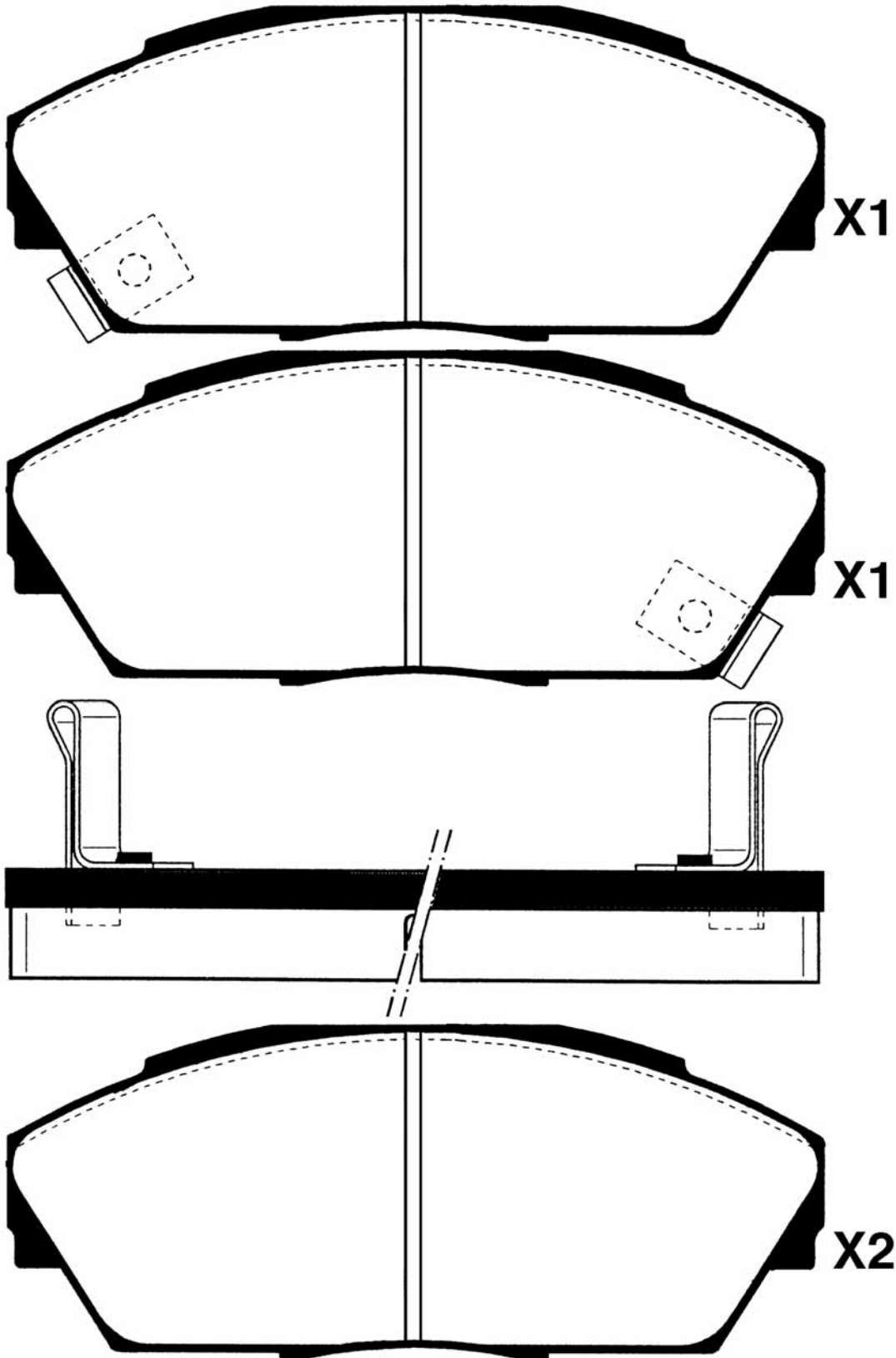



PICTURES BRAKE PADS FRONT  
ABBILDUNGEN BREMSKLÖTZE VORN  
FIGURAS PASTILLAS DE FRENO DELANTORES  
ILLUSTRATIONS PLAQUETTES DE FREI AVANT  
IMMAGINI PASTIGLIE FRENO ANTERIORI

**50-04-427**

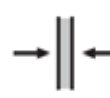

**WVA**

**HONDA - LAND ROVER -  
ROVER**

**L**

129,4

**H**

68,6

**Th**

17,6

21517

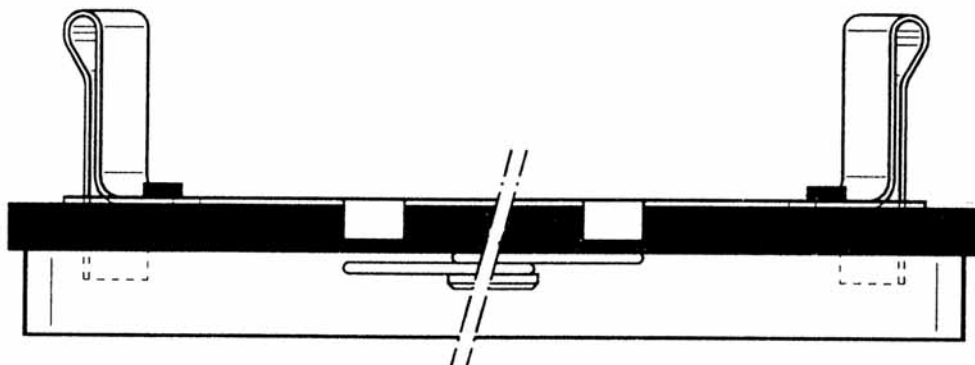
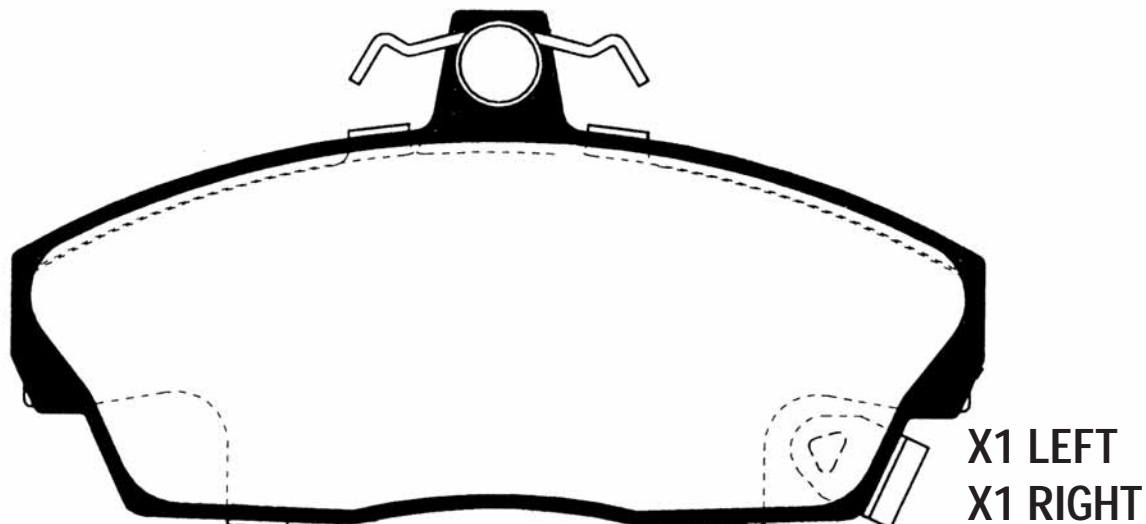
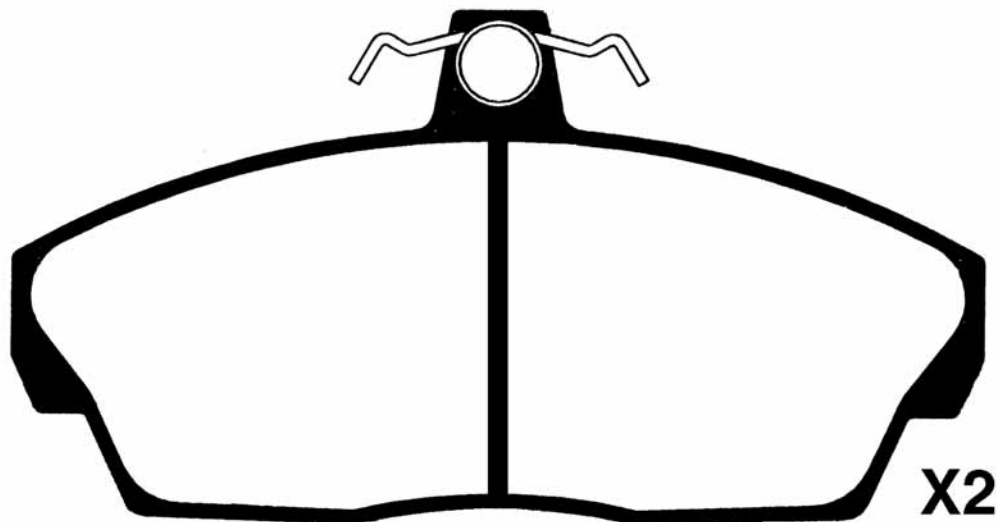



PICTURES BRAKE PADS FRONT  
ABBILDUNGEN BREMSKLÖTZE VORN  
FIGURAS PASTILLAS DE FRENO DELANTORES  
ILLUSTRATIONS PLAQUETTES DE FREI AVANT  
IMMAGINI PASTIGLIE FRENO ANTERIORI

<b>50-04-429</b>				<b>WVA</b>
<b>ROVER</b>	<b>L</b>	<b>H</b>	<b>Th</b>	
	107,6	45	14,8	23197

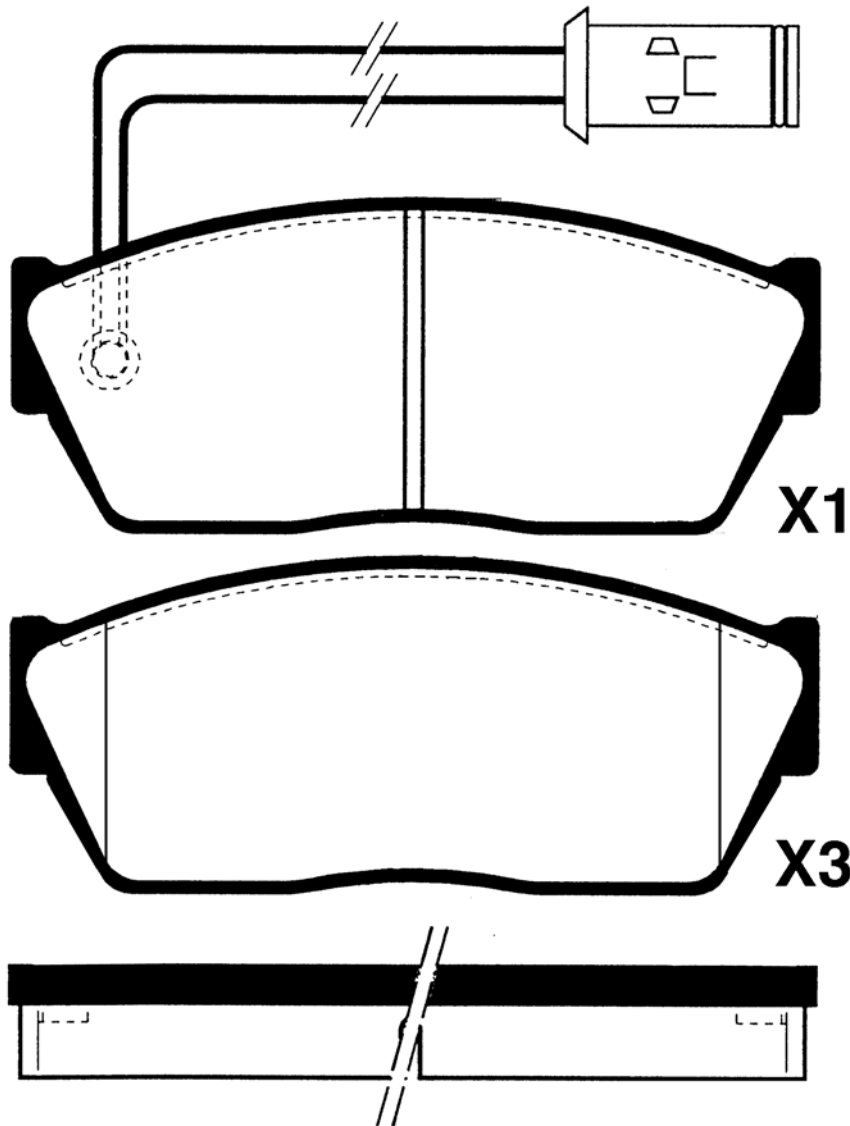



<b>50-04-430</b>				<b>WVA</b>
	<b>ROVER</b>	<b>L</b>	<b>H</b>	
	117,8	65,5	17	21520

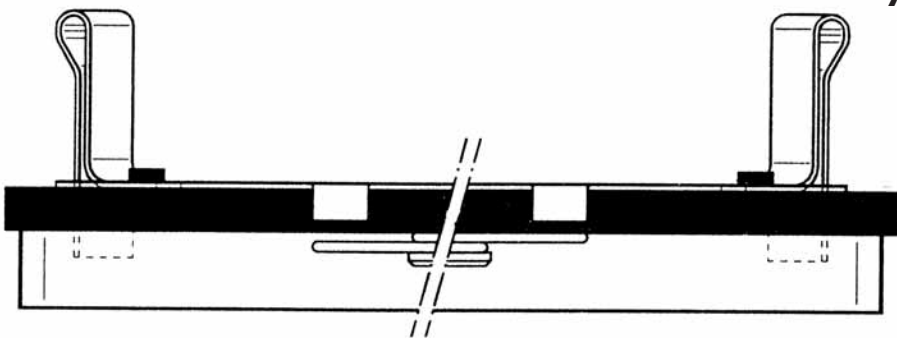
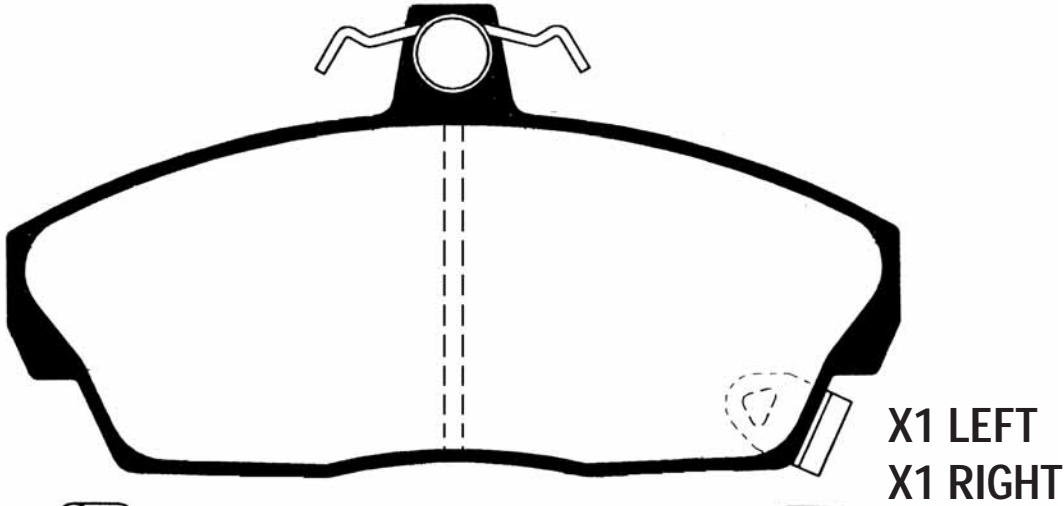
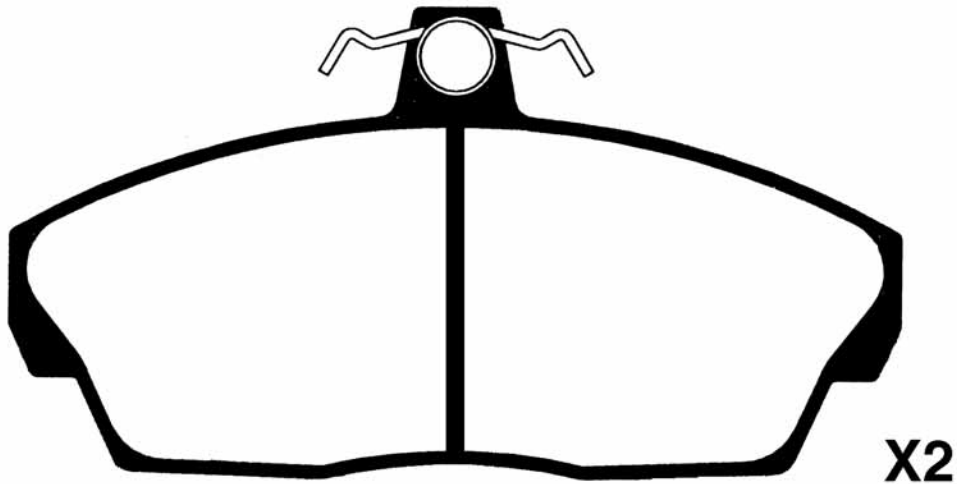



PICTURES BRAKE PADS FRONT  
ABBILDUNGEN BREMSKLÖTZE VORN  
FIGURAS PASTILLAS DE FRENO DELANTORES  
ILLUSTRATIONS PLAQUETTES DE FREI AVANT  
IMMAGINI PASTIGLIE FRENO ANTERIORI

**50-08-801**

**FIAT - SUZUKI**

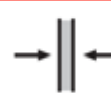

**WVA**

**L**

**131,2**

**H**

**57**

**Th**

**16**

**24391**

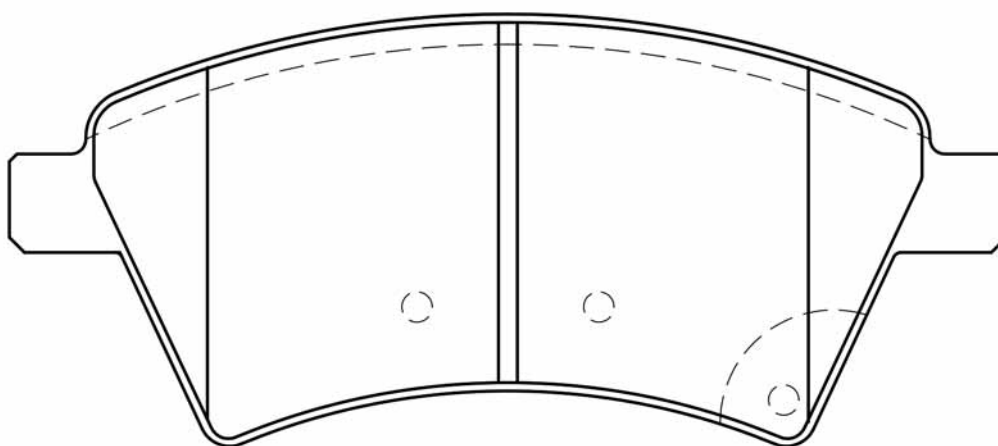
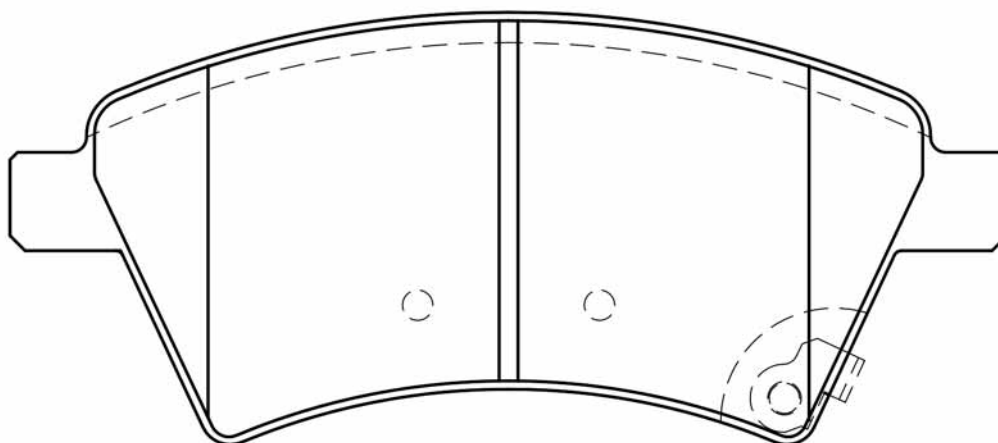

PICTURES BRAKE PADS FRONT  
 ABBILDUNGEN BREMSKLÖTZE VORN  
 FIGURAS PASTILLAS DE FRENO DELANTORES  
 ILLUSTRATIONS PLAQUETTES DE FREI AVANT  
 IMMAGINI PASTIGLIE FRENO ANTERIORI



<b>50-08-819</b>				<b>WVA</b>
	<b>FIAT - INFINITI - SUZUKI</b>	<b>L</b> 137	<b>H</b> 54	
				<b>24280</b>

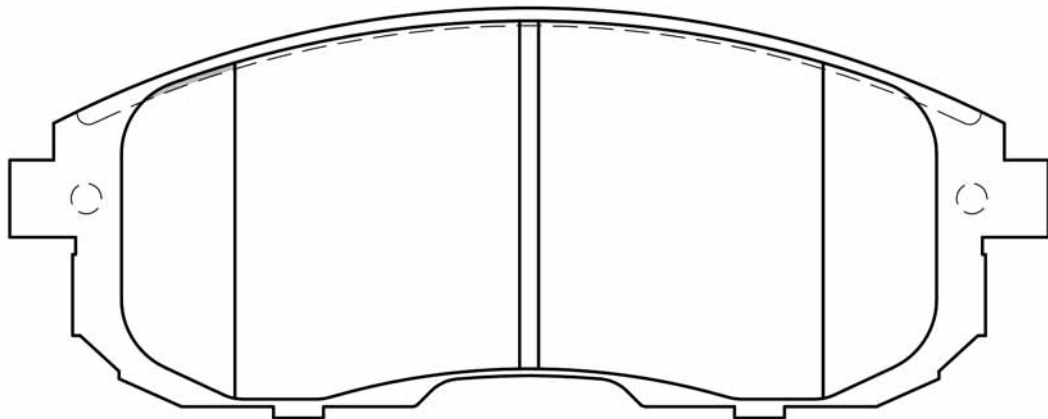
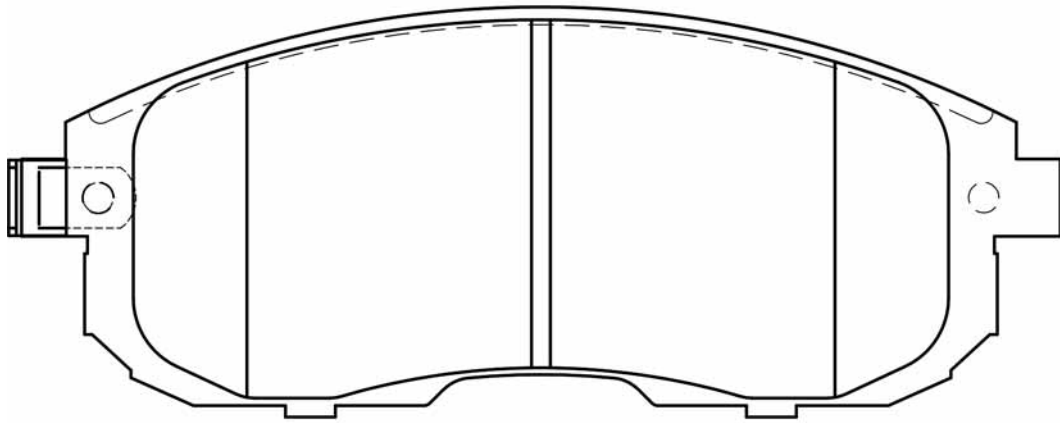



<b>50-09-904</b>				<b>WVA</b>
	<b>OPEL - ISUZU</b>	<b>L</b>	<b>H</b>	
	127	51,4	15,4	21467

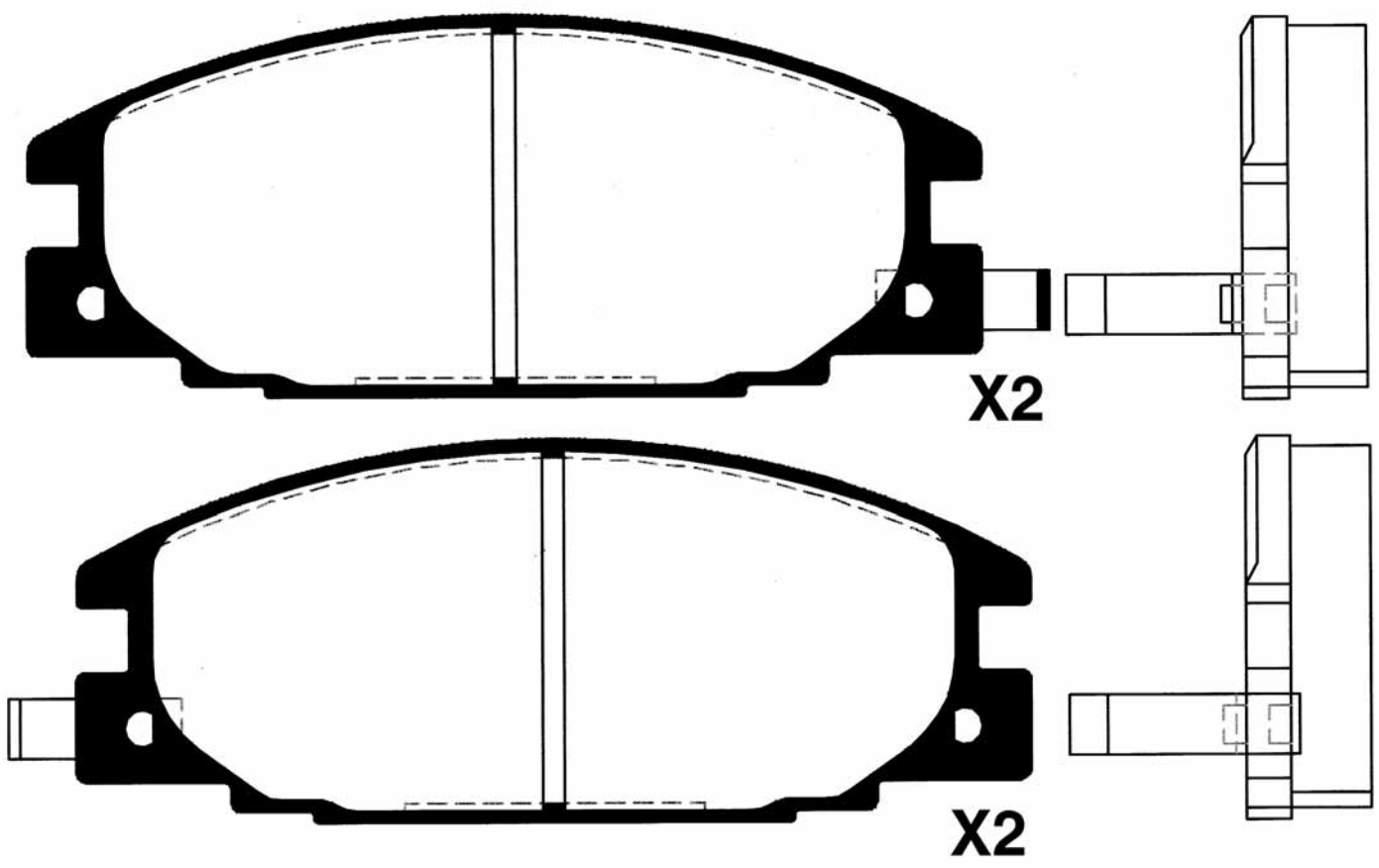



<b>50-09-999</b> <b>ISUZU - OPEL</b>				<b>WVA</b>
	<b>L</b> 137,8	<b>H</b> 58,3	<b>Th</b> 16	

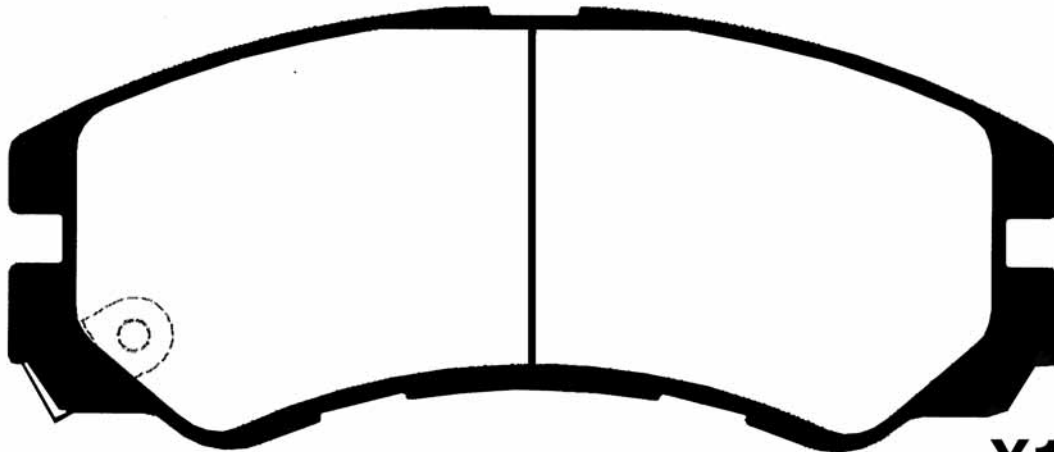

**X1**

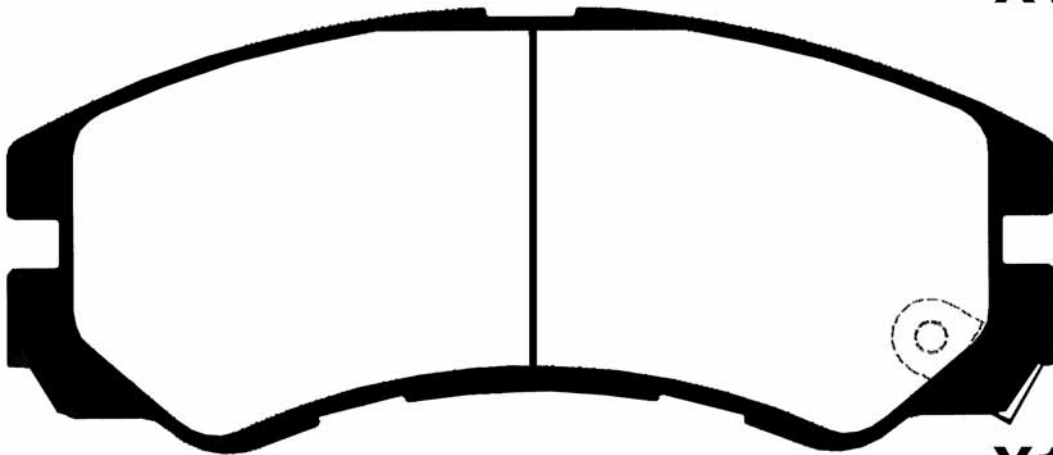

**X1**

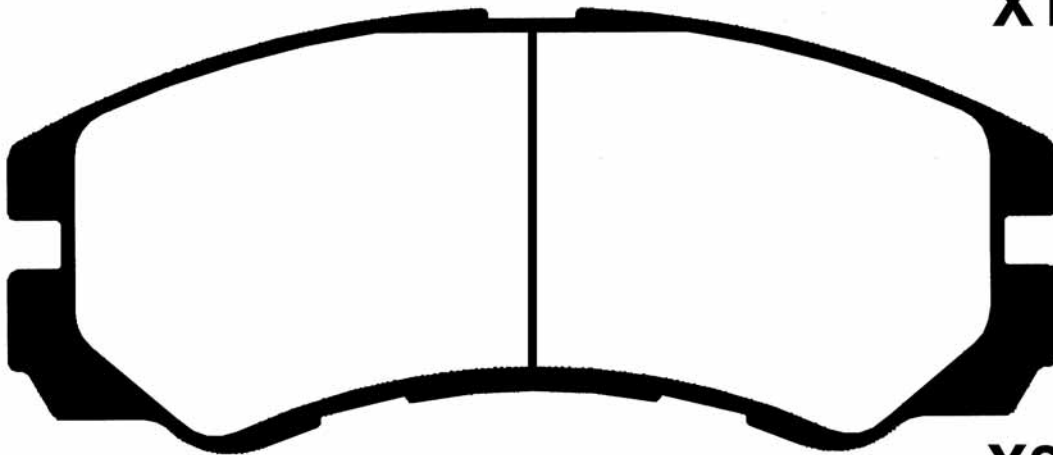

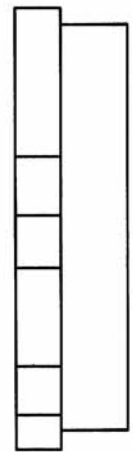
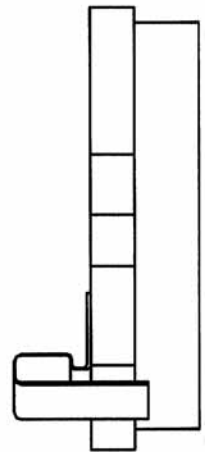

**X2**





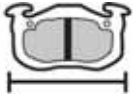

PICTURES BRAKE PADS FRONT  
ABBILDUNGEN BREMSKLÖTZE VORN  
FIGURAS PASTILLAS DE FRENO DELANTORES  
ILLUSTRATIONS PLAQUETTES DE FREI AVANT  
IMMAGINI PASTIGLIE FRENO ANTERIORI

<b>50-0W-W10</b>				<b>WVA</b>
<b>CHEVROLET</b>	<b>L</b>	<b>H</b>	<b>Th</b>	
	<b>148,5</b>	<b>62</b>	<b>17</b>	<b>24510</b>

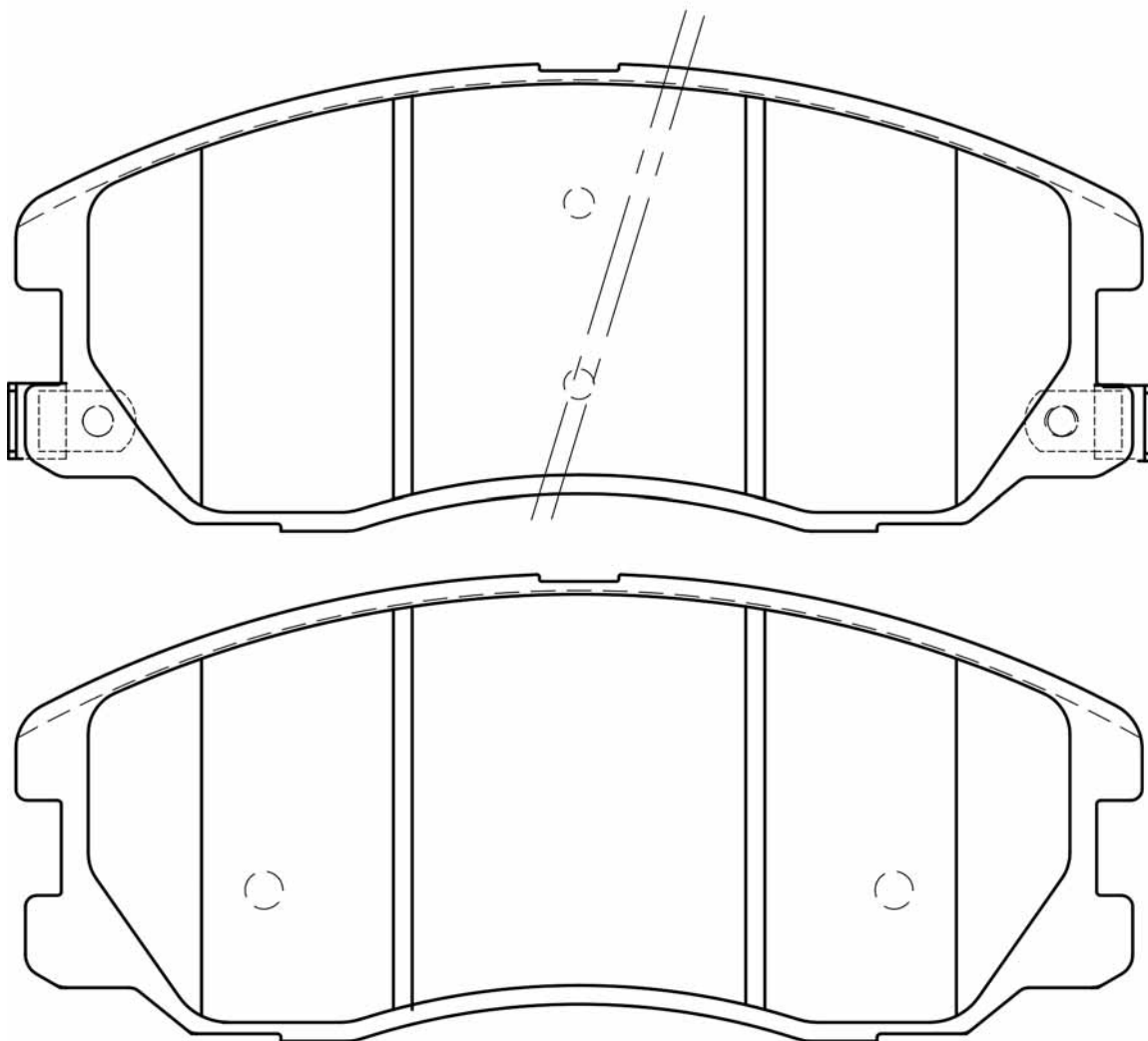

PICTURES BRAKE PADS FRONT  
 ABBILDUNGEN BREMSKLÖTZE VORN  
 FIGURAS PASTILLAS DE FRENO DELANTORES  
 ILLUSTRATIONS PLAQUETTES DE FREI AVANT  
 IMMAGINI PASTIGLIE FRENO ANTERIORI



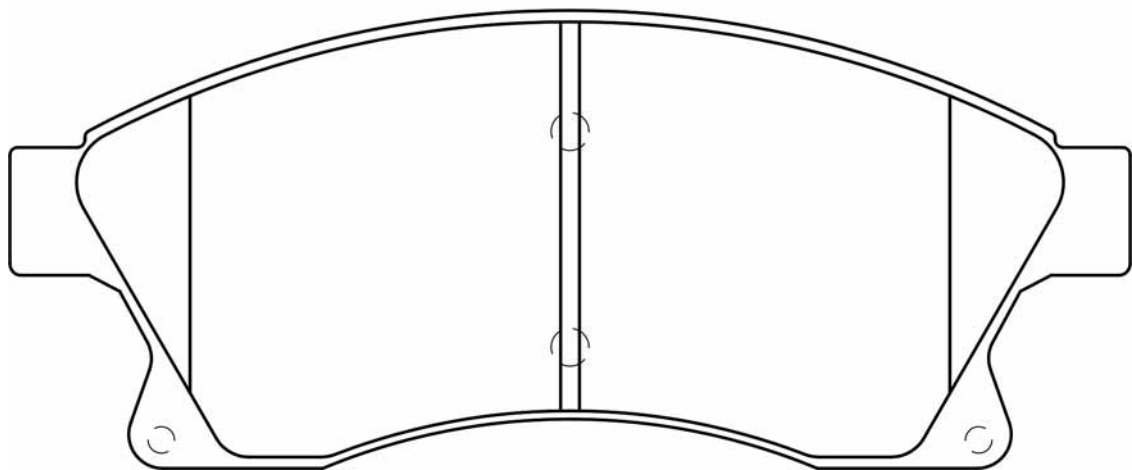
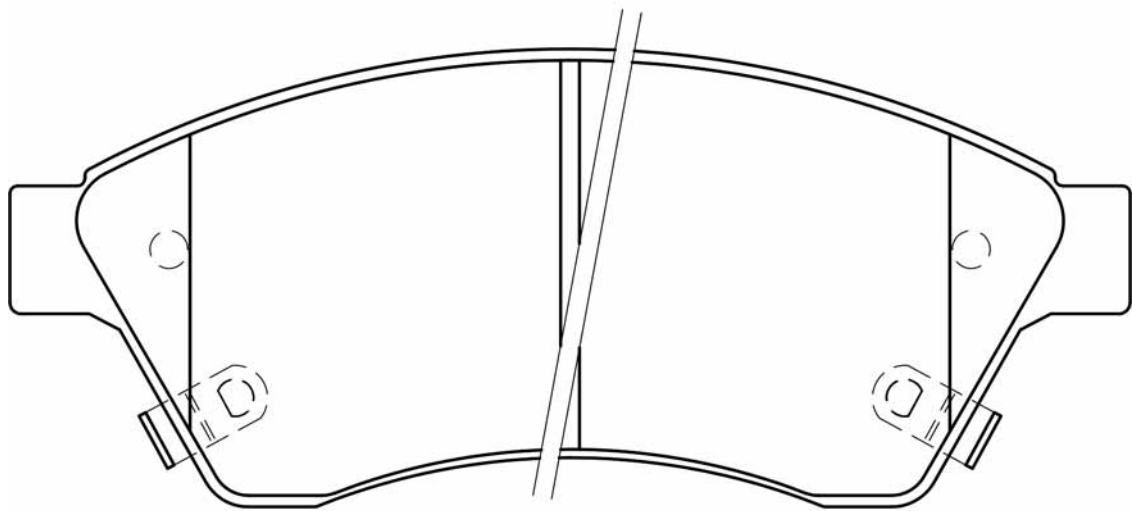

<b>50-0W-W12</b>				<b>WVA</b>
	<b>OPEL - CHEVROLET</b>	<b>L</b>	<b>H</b>	<b>Th</b>
	<b>148</b>	<b>61</b>	<b>19</b>	<b>25031</b>





PICTURES BRAKE PADS FRONT  
ABBILDUNGEN BREMSKLÖTZE VORN  
FIGURAS PASTILLAS DE FRENO DELANTORES  
ILLUSTRATIONS PLAQUETTES DE FREI AVANT  
IMMAGINI PASTIGLIE FRENO ANTERIORI

<b>50-0W-W13</b>				<b>WVA</b>
<b>OPEL - CHEVROLET</b>	<b>L</b>	<b>H</b>	<b>Th</b>	
	<b>148</b>	<b>62</b>	<b>19</b>	<b>25034</b>

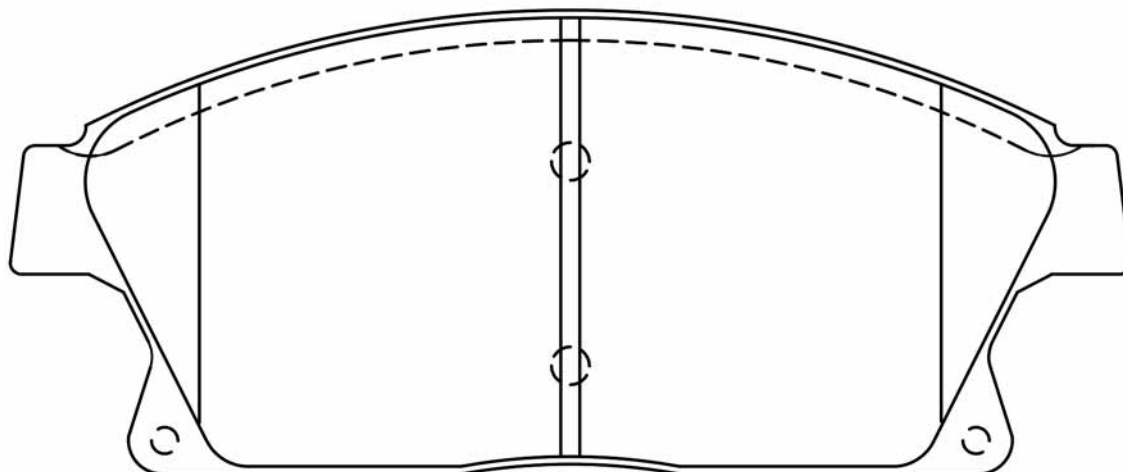
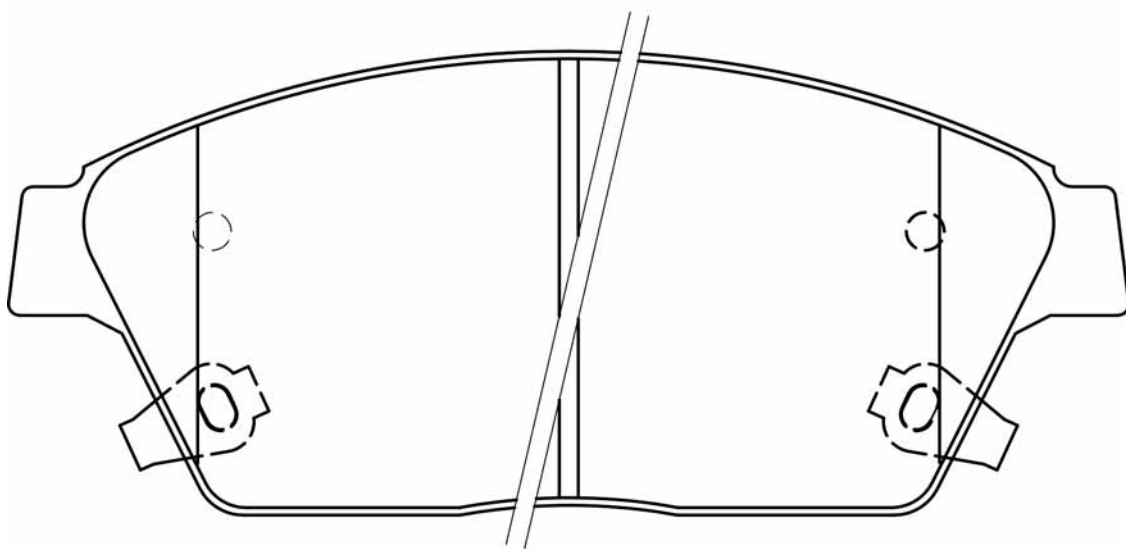



<b>51-04-404</b> <b>ROVER - HONDA</b>				<b>WVA</b>
	<b>L</b> 89	<b>H</b> 35,3	<b>Th</b> 12,4	21313

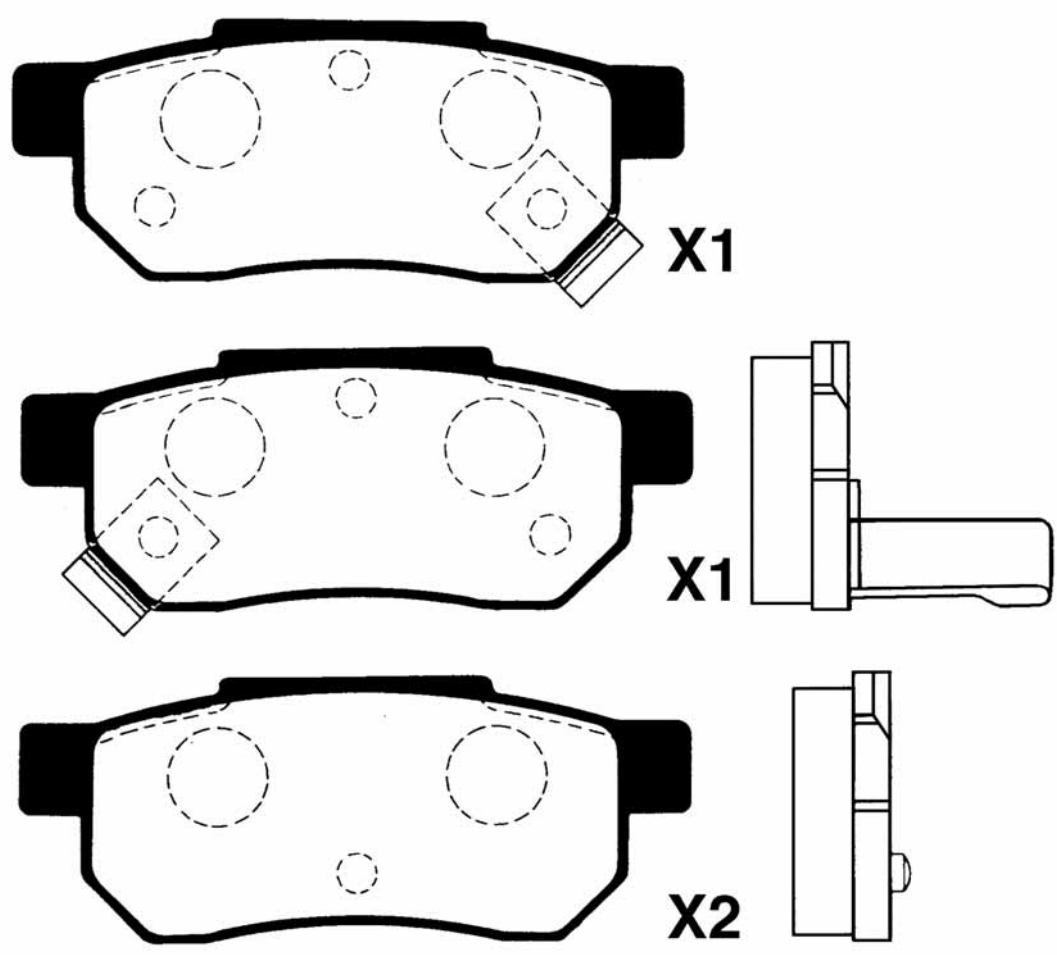



PICTURES BRAKE PADS REAR  
ABBILDUNGEN BREMSKLÖTZE HINTEN  
FIGURAS PASTILLAS DE FRENO POSTERIORES  
ILLUSTRATIONS PLAQUETTES DE FREI ARRIÈRE  
IMMAGINI PASTIGLIE FRENO POSTERIORI

<b>51-04-405</b>				<b>WVA</b>
<b>ROVER - HONDA</b>	<b>L</b>	<b>H</b>	<b>Th</b>	
	88,7	47,2	14	21721

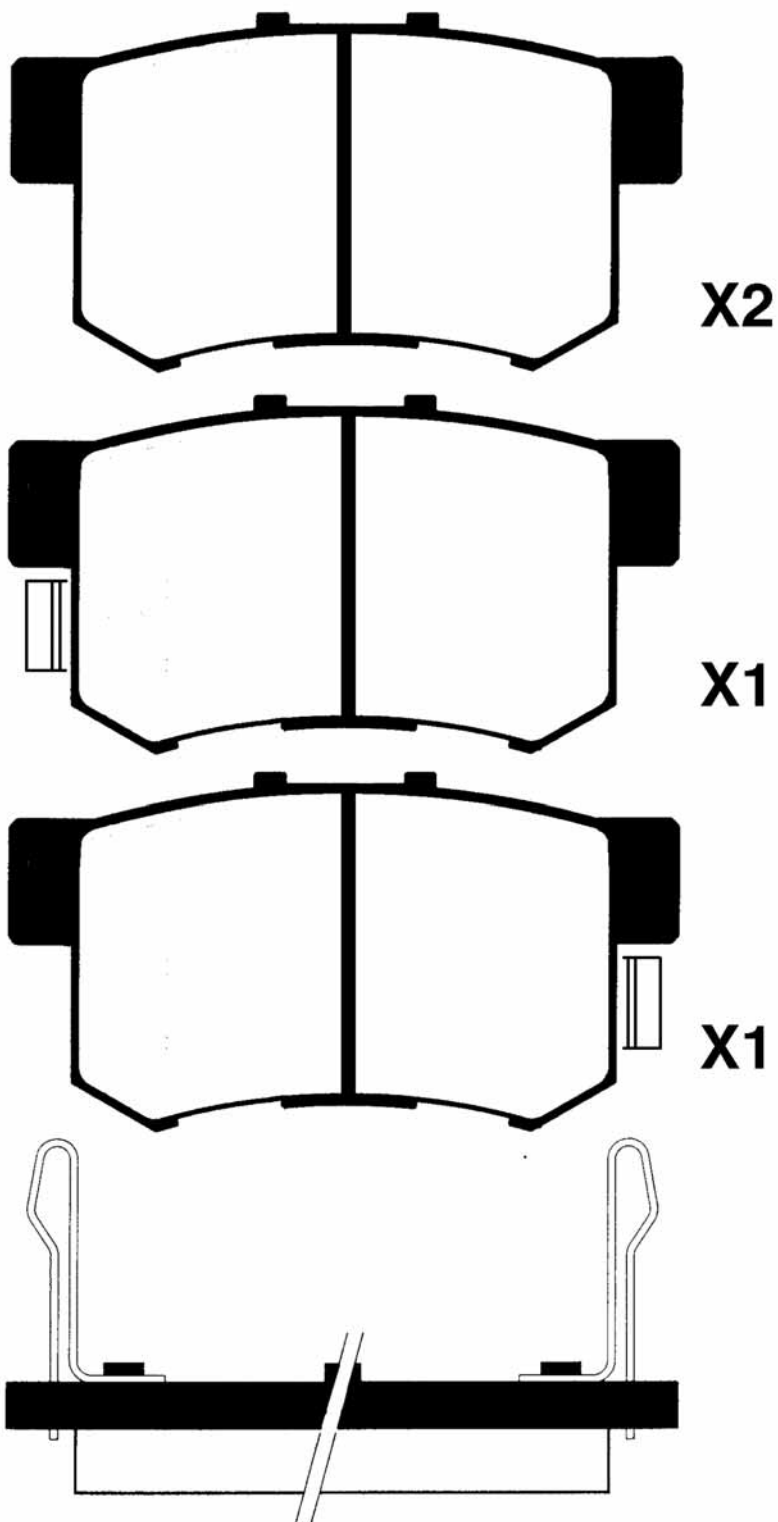



<b>51-04-406</b> <b>ROVER - HONDA</b>				<b>WVA</b>
	<b>L</b> 85,3	<b>H</b> 62	<b>Th</b> 13,7	20087

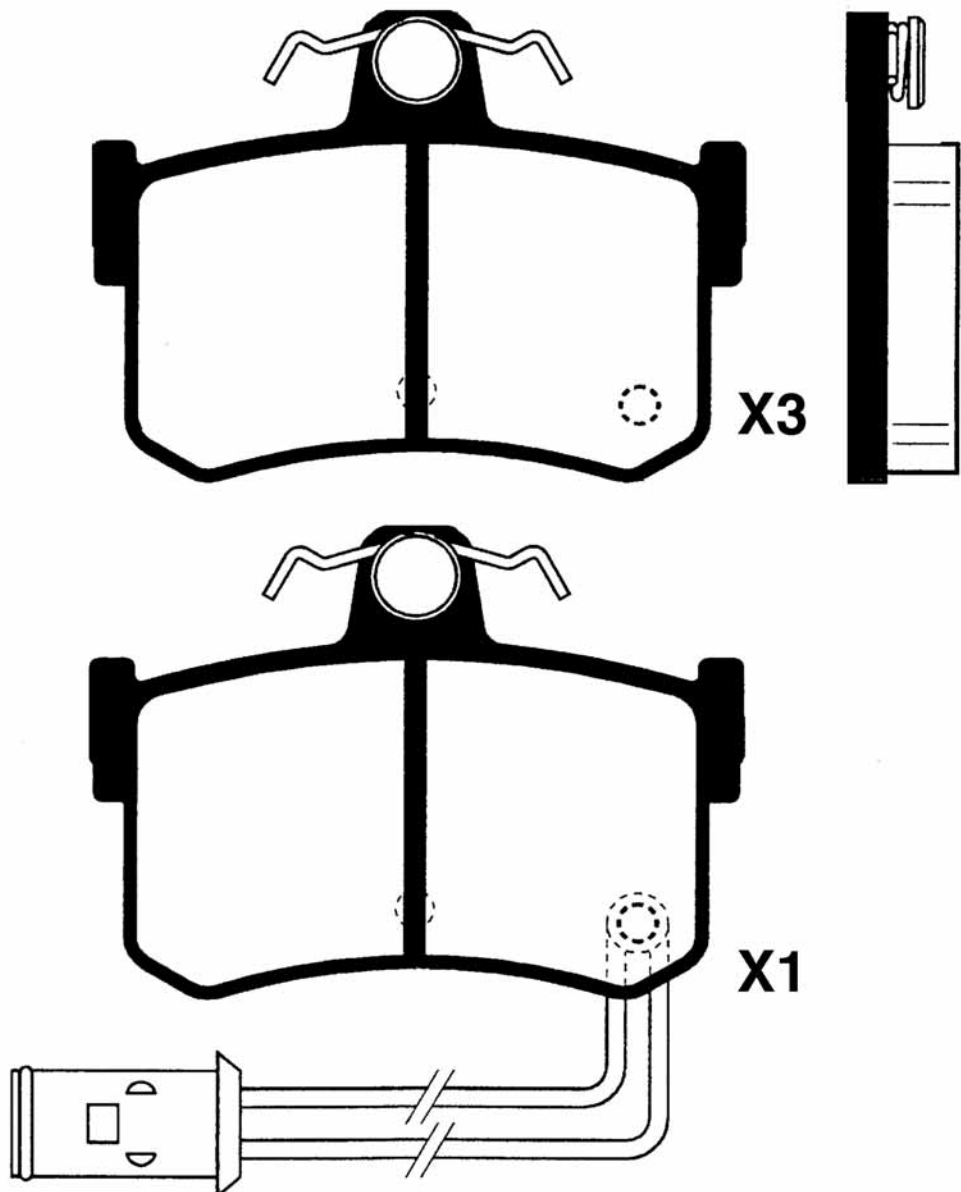



PICTURES BRAKE PADS REAR  
ABBILDUNGEN BREMSKLÖTZE HINTEN  
FIGURAS PASTILLAS DE FRENO POSTERIORES  
ILLUSTRATIONS PLAQUETTES DE FREI ARRIÈRE  
IMMAGINI PASTIGLIE FRENO POSTERIORI

<b>51-09-900</b>				<b>WVA</b>
<b>ISUZU - OPEL</b>	<b>L</b>	<b>H</b>	<b>Th</b>	
	131,5	41,8	12,8	21744

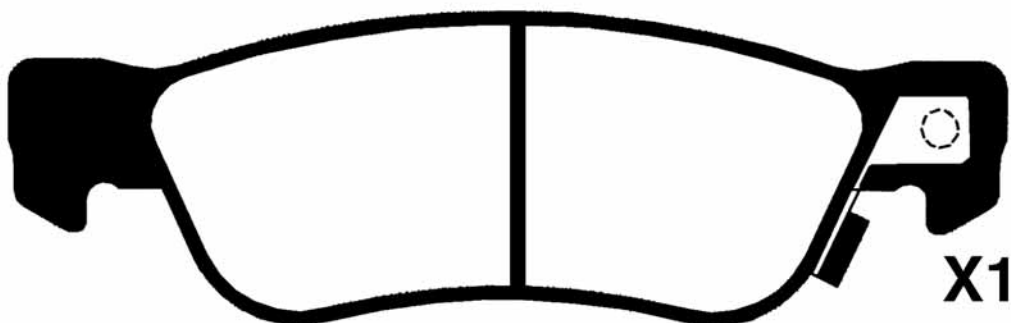
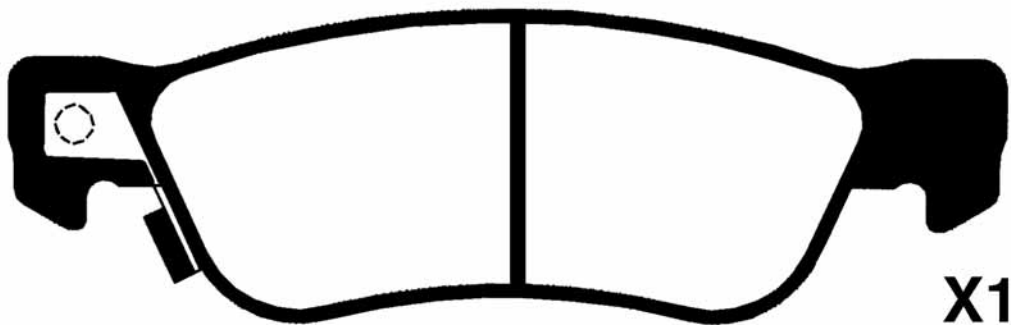
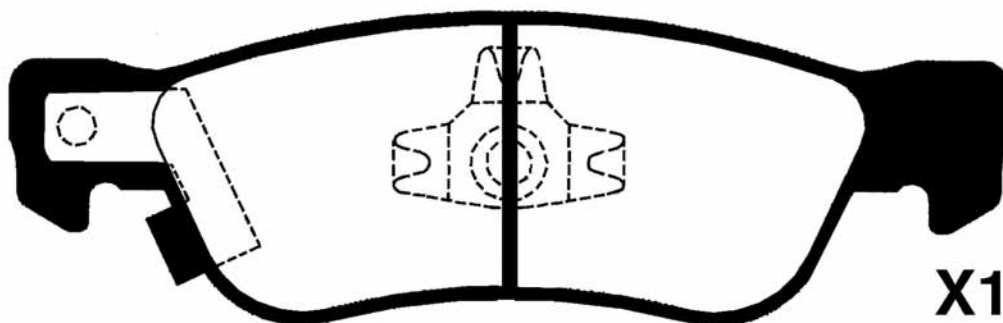
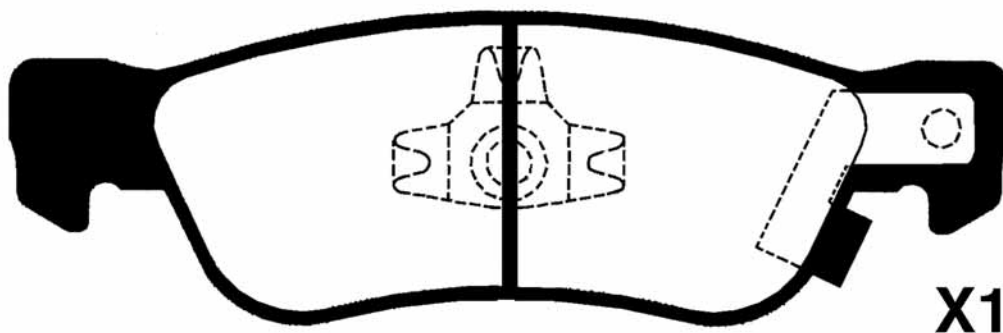



<b>51-0W-W04</b>				<b>WVA</b>
	<b>CHEVROLET</b>	<b>L</b>	<b>H</b>	
	110	46	15,2	24498

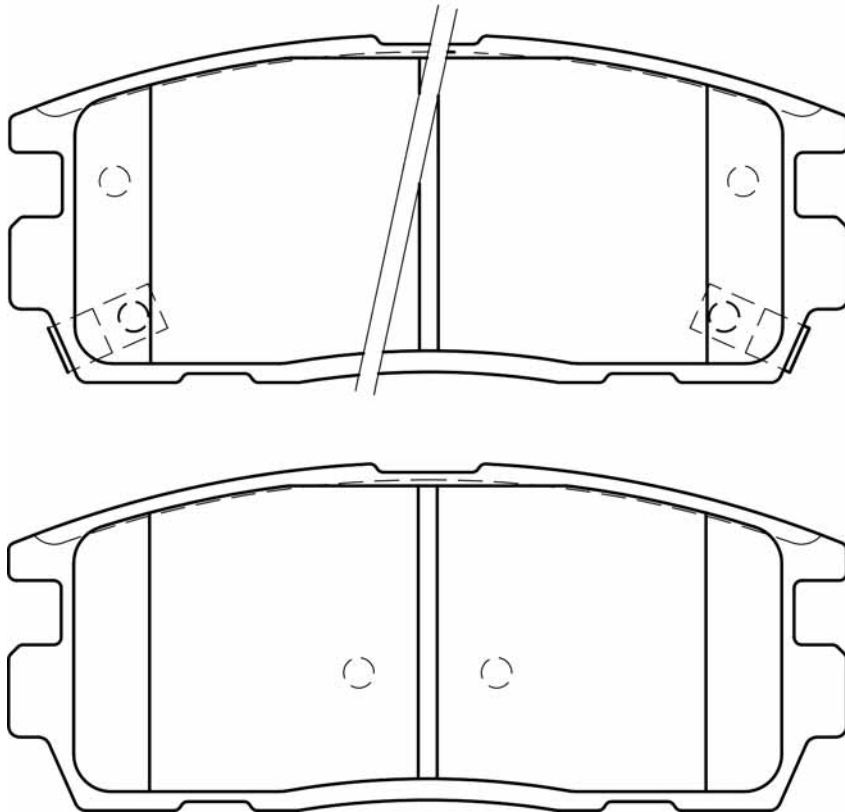





PICTURES BRAKE PADS REAR  
ABBILDUNGEN BREMSKLÖTZE HINTEN  
FIGURAS PASTILLAS DE FRENO POSTERIORES  
ILLUSTRATIONS PLAQUETTES DE FREI ARRIÈRE  
IMMAGINI PASTIGLIE FRENO POSTERIORI

**51-0W-W05**

**CHEVROLET - OPEL**

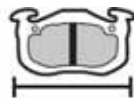

**WVA**

**L**

**117**

**H**

**43**

**Th**

**16**

**25096**

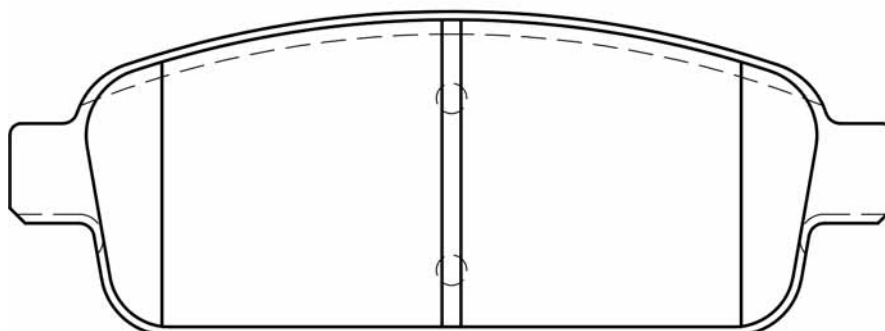
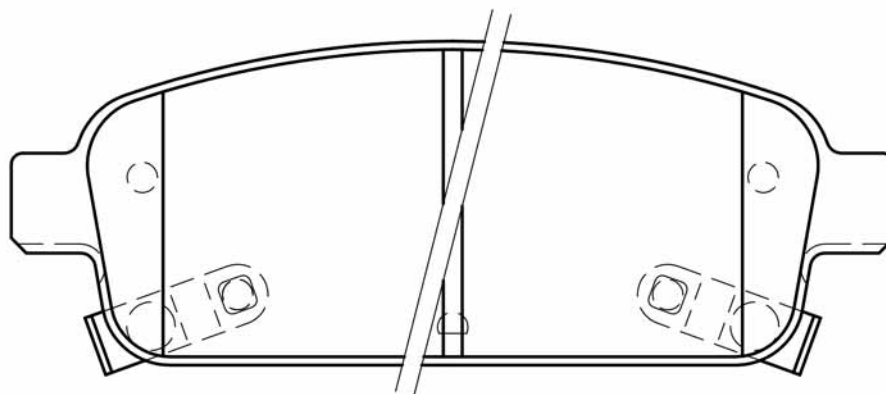



# Certificate of Registration



The Governing Board of  
Q.A. International Certification Limited  
hereby grants to:

**JAPANPARTS S.r.l.**

Registration No. : QAIC / IT / 90039 - A

*(hereinafter called the Registered Company) the right to be listed in the Directory of Registered Companies in respect of the services listed below. These services shall be offered by the Registered Company at or from only the address given below in accordance with the quality management system in compliance with ISO 9001:2008.*

Address to which this Certificate refers :

**Via Della Meccanica, 1/A 37139 VERONA - Italy**

Approved Scope to which this Certificate refers  
(Scopo della Certificazione cui il Certificato riferisce)

**Commercialisation of Automotive Parts and Accessories  
(Commercializzazione di Ricambi per Autoveicoli)**

(Further clarification regarding the Scope of this Certificate and the applicability of ISO 9001:2008 requirements may be obtained by consulting the organisation)

Signed for and on behalf of the Board

CHAIRMAN  
A. J. Duffield

SCHEME MANAGER  
A. Carter

**Certificate Issue Date : 9th February 2012 - Certificate Expiry Date : 24th January 2013**  
**Date of Initial Registration : 25th January 2000 - Re-assessment Date : 24th January 2015**  
This Certificate of Registration is granted subject to the Regulations approved by the Board.

**QA INTERNATIONAL**

Q.A. International Certification Ltd.  
Dudley Court  
Dudley Road  
Darlington  
Co. Durham  
DL1 4GG

Tel: +44 (0)1325 384272  
Fax: +44 (0)1325 480980  
www.qai.co.uk



The use of the Accreditation Mark indicates accreditation in respect of the activities covered by the accreditation certificate number 045.

# Rechtliche Hinweise - Disclaimer - Avvertenze Legali Information juridique - Advertencias/Juridische Informatie



**DE** Wir haben uns um die weitestgehende Richtigkeit der in diesem Katalog enthaltenen Angaben bemüht. Wir haften indes nicht für eventuelle Unrichtigkeiten. Dieser Katalog enthält Produkte, die dem Erstausstattungsstandard entsprechen. Wir behalten uns jederzeit technische Änderungen vor. Die im Katalog angeführten Originalnummern und Herstellernamen dienen ausschließlich der Identifizierung des Bauteils und sind nicht auf Lieferscheinen und Rechnungen verwendbar. Die vollständige und auch teilweise Reproduktion unserer Referenzangaben und unseres Katalogs ist verboten.

**EN** We have made every effort to ensure that the data in this catalogue are as accurate as possible. However, we decline all responsibility for any inaccuracies.  
This catalogue contains products of "initial equipment" quality. We reserve the right to make technical changes at any time. The original numbers and manufacturers' names mentioned in this catalogue are provided solely to allow identification of the component and may not be used on delivery notes and invoices.  
Even partial reproduction of our references and catalogue is forbidden.

**I** Ci siamo adoperati affinché i dati contenuti in questo catalogo siano i più esatti possibili. Tuttavia decliniamo ogni responsabilità per eventuali inesattezze.  
Questo catalogo contiene prodotti di qualità "primo equipaggiamento". Ci riserviamo il diritto di apportare modifiche tecniche in qualsiasi momento. I numeri originali e i nomi dei fabbricanti citati in questo catalogo servono esclusivamente a scopo identificativo del componente e non possono essere utilizzati sulle bolle di accompagnamento e fatture.  
La riproduzione, anche parziale dei nostri riferimenti e del nostro catalogo è vietata.

**FR** Nous avons fait tout notre possible pour que les données de ce catalogue soient exactes. Toutefois, nous déclinons toute responsabilité pour d'éventuelles inexactitudes.  
Ce catalogue contient des produits de qualité "équipement standard". Nous nous réservons le droit d'apporter à tout moment des modifications techniques. Les numéros originaux et les noms des fabricants cités dans ce catalogue servent exclusivement à identifier le composant et ne peuvent pas être utilisés sur les bulletins d'accompagnement et les factures.  
La reproduction, même partielle, de nos références et de notre catalogue est rigoureusement interdite.

**ES** Hemos procurado que los datos que figuran en este catálogo sean lo más exactos posible. No obstante declinamos toda responsabilidad por eventuales imprecisiones.  
Este catálogo incluye productos de calidad de "equipos de serie". Nos reservamos el derecho de introducir modificaciones técnicas en cualquier momento.  
Los números originales y los nombres de los fabricantes citados en este catálogo se ofrecen exclusivamente a efectos de identificación del componente y no podrán ser empleados en las cartas de porte ni en las facturas.  
Queda prohibida la reproducción total o parcial de nuestros códigos de referencia y nuestro catálogo.

**NL** Wij hebben ons ingespannen om ervoor te zorgen dat de gegevens in deze catalogus zo exact mogelijk zouden zijn. Wij kunnen echter niet aansprakelijk worden gesteld voor eventuele onnauwkeurigheden.  
Deze catalogus bevat producten van "standaarduitrusting" kwaliteit. Wij behouden ons het recht voor om op ieder gewenst ogenblik technische wijzigingen aan te brengen. De in deze catalogus genoemde oorspronkelijke nummers en namen van de fabrikanten dienen uitsluitend ter identificatie van de component en kunnen niet worden gebruikt op de geleidebrieven en facturen. De, ook gedeeltelijke, reproductie van ons referentiemateriaal en de catalogus is verboden.

# I NOSTRI CATALOGHI OUR CATALOGUES



**JA-GENERAL**  
2011  
Catalogo Generale  
General Catalogue



**JA-FILTRI**  
2012/2013  
FILTRI: carburante, aria, olio, abitacolo, ecologici (gamma completa)  
FILTERS: fuel, air, oil, cabin, ecological (complet range)



**JA-FRIZIONI**  
2007  
FRIZIONE: dischi, spingidisco, reggispinta, volani, kit con/senza volano, idraulica  
CLUTCHES: discs, covers, bearings, flywheel, kit, hydraulic parts



**JA-CINGHIE**  
2007  
Cinghie distribuzione, tendicinghia, guidacinghia, kit completi  
Timings belt, tensioners, guide, timings kit



**JA-CAT5D**  
2010/2011  
Motorini avviamento e alternatori  
Starters and alternators



**JA-GIUNTI**  
2008/2009  
Kit giunti omocinetici con cuffia fascette e grasso  
CV Joints kit, with casing, metal clips and grease



**JA-CAT7MM**  
2008/2009  
Ammortizzatori a gas, ammortizzatori sterzo  
Gas shock absorbers, steering dampers



**JJ-RADIATORI**  
2011/2012  
Radiatori, intercooler, elettroventole, compressori, condensatori, riscaldatori, evaporatori  
Radiators, intercooler, fans, compressors, condensers, heaters, evaporators



**JA-CAT11**  
2007  
Pompe acqua, termostati, giunti viscositatici, tappi radiatore  
Water pumps, thermostates, viscous coupling, radiator caps



**JA-CAT12**  
2008/2009  
Spazzole tergi universali, applicazioni Asiatiche ed Europee  
Universal wiper blades, Asian and European applications



**JA-FLAT**  
2008/2009  
Spazzole tergicristallo tipo Fiat universali  
Universal wiper blades, type Fiat



**JA-TIRANT**  
2010/2011  
Pari sterzo e sospensioni  
Steering and suspension parts



**JA-KITRUOTA**  
2008/2009  
Kit cuscinetti ruote  
Wheel bearings kit



**JA-CAT17**  
2007  
Candele Japanparts  
Glowplugs Japanparts



**JA-CUFFIE**  
2007  
Kit cuffie con fascette e grasso  
Boots kit with metal clips and grease



**JA-CROCIERE**  
2007  
Crociere trasmissione  
Universal joints



**JA-TAMA**  
2008/2009  
Valvole termostatiche TAMA  
Thermostatic valves TAMA



**JA-NSFILTRI**  
2012/2013  
Prontuario della gamma prodotti esclusi i filtri  
Handbook of the products range excluding filters



**JA-FAST MOVING**  
2009/2010  
Tutto il Fast Moving asiatico  
All the Asian Fast Moving



**JA-MMBOOT**  
2008/2009  
Kit parapolvere universali in gomma e uretano per ammortizzatori  
Bump rubber kit universal type



**JA-COMMERCIAL**  
2008/2009  
I nostri prodotti per veicoli commerciali  
Our products for commercial vehicles



**JA-MBL**  
2009  
Cinghie servizi MITSUBOSHI (Made in Japan)  
Automotive belts MITSUBOSHI (Made in Japan)



**JA-PAPREMIUM**  
2009  
Pastiglie freno PREMIUM alta qualità  
PREMIUM top quality brake pads



**JD-DENSO**  
2010/2011  
Candele, candele e candele Iridium DENSO  
DENSO spark plugs and glow plugs, Iridium spark plugs



**JD-DENSOSONDE**  
2010/2011  
Sonde lambda DENSO  
DENSO lambda sensors



**JD-SPAZZOLE**  
2010/2011  
Spazzole tergicristallo DENSO  
DENSO wiper blades



**JE-FRIZIONI**  
2012  
Frizioni sportive Racing EXEDY  
EXEDY racing clutches



**JJ-HKTA**  
2012  
Candele HKT applicazioni Asiatiche ed Europee  
HKT glowplugs for Asiatic and European applications



SCARICA I CATALOGHI IN PDF DAL NOSTRO SITO INTERNET

DOWNLOAD PDF CATALOGUES BY OUR WEB SITE

www.ashika.it



TOKYO · SINGAPORE · SYDNEY · ATLANTA · AMSTERDAM · FRANKFURT · WARSAW · SALZBURG · BRÜSSEL · VERONA · ZÜRICH · KOPENAGHEN

[www.ashika.eu](http://www.ashika.eu)

