



Transporter Lenkungs- und Fahrwerksteile



2008 / 2009

Index

Symbole	III
Allgemeine Information	IV
Produktinformation	V1-V3
Allgemeine Information	
Führungsgelenk	
Querlenker	V1
Spurstange	
Spurstangenendstück	
Traggelenk	V2
Lenkung	
Bauteile des Fahrzeugs	V3
Bemaßungsgrundlage	V4-V6
CITROËN	1-27
FIAT	28-55
FORD	56-79
HYUNDAI	80-81
IVECO	82-90
MERCEDES-BENZ	91-171
MITSUBISHI	172-177
NISSAN	178-187
OPEL	188-200
PEUGEOT	201-229
RENAULT	230-258
SEAT	259-262
SKODA	263-267
SUZUKI	268
TOYOTA	269-275
VOLKSWAGEN	276-323
Arithmetische Liste	324-333
Vergleichsliste	334-338
Neuaufnahmen	338-342
Geänderte Bestellnummer	342-342

Symbole

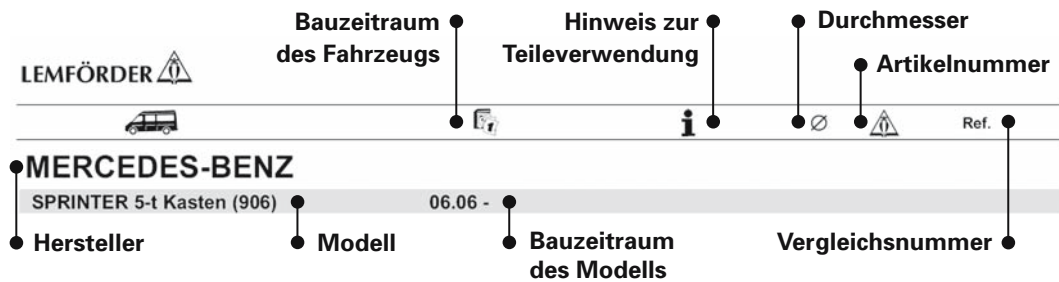

Baugruppe	
	Vorderachse
	Hinterachse
Einbauort	
	oben
	unten
	beidseitig
	links
	rechts
	mittig
	vorne
	vorne links
	vorne rechts
	hinten
	innen
	außen
	getriebeseitig

Fahrzeughinweise	
	für Linkslenker
	für Rechtslenker
	mit Servolenkung
	ohne Servolenkung
	Anzahl pro Achse
	bis Baujahr
	ab Baujahr
	Fahrgestellnummer
	bis Fahrgestellnummer
	ab Fahrgestellnummer
	bis Organisationsnummer
	ab Organisationsnummer
	bis VET-Nummer
	ab VET-Nummer
	Motorcode
Produktinweis	
	Auslaufartikel
	verstärkte Ausführung

Allgemeine Information

LEMFÖRDER Markenprodukte garantieren Ihnen höchste Präzision und einwandfreie Funktion. Verlangen Sie deshalb immer die Original-Teile von LEMFÖRDER.

Für Ihre Anforderungen benötigen wir die vollständige Bestellnummer, zum Beispiel:

LEMFÖRDER Spurstange 27756 01

In Zweifelsfällen geben Sie bitte auch Typenbezeichnung und Baujahr des Fahrzeugs an, für das der gewünschte Artikel bestimmt ist.

Bitte beachten Sie, dass wir die LEMFÖRDER Artikelnummern von fünf auf sieben Ziffern umgestellt haben. Die zwei zusätzlichen Zahlen fügen sich dabei hinter die bereits bekannten Nummern, so dass z. B. aus einer 12345 die 12345 01 wurde.

Alle Rechte vorbehalten. Vervielfältigungen oder die Mitbenutzung dieses Kataloges – auch auszugsweise – für die Erstellung eines Eigenkataloges sind ohne ausdrückliche Zustimmung unzulässig.

Ersatzteilenummern der Fahrzeughersteller dienen nur zu Vergleichszwecken. Eine Verwendung derartiger Angaben in Rechnungen an den Fahrzeugbesitzer ist nicht statthaft.

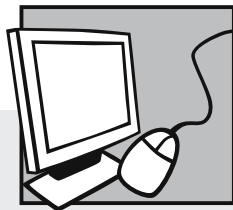

Elektronische Kataloge

WebCat

- Online-Katalog im Internet unter www.zf.com/de/trading/katalog

InCat

- Elektronischer Katalog auf DVD (Pkw und Nkw)

Allgemeine Produktinformation

Lenkungs- und Fahrwerkkomponenten sind Sicherheitsteile, die in Konstruktion, Fertigung und Montage einer besonderen Sorgfalt unterliegen. Sie müssen in allen Fahrsituationen des Fahrzeugs, die beeinflusst oder unbeeinflusst vom Fahrer auftreten können, ein Optimum an Fahrsicherheit bieten. Die ZF Trading GmbH ist durch ihre Verbindung mit ZF Lemförder und aufgrund von Qualität und Erfahrung in der Lage, allen Kunden diese Sicherheit zu garantieren.

Durch den Status „D-Teil“ (Sicherheitsteil) sind umfangreiche Prüfungen an den Produkten

vorgeschrieben, die detailliert dokumentiert sein müssen. Wir garantieren unseren Kunden die notwendige Sicherheit der Produkte mit unserem Logo.

Voraussetzung für die einwandfreie Funktion unserer Teile ist die Berücksichtigung der Montagevorschriften der OE-Hersteller.

Die notwendigen Einstellwerte sind den Herstellerangaben zu entnehmen. Falsche Einstellwerte und unsachgemäße Montage – auch mit nicht dafür vorgesehenen Werkzeugen – können im äußersten Fall zu schwerwie-

genden Folgen für Leib und Leben der Verkehrsteilnehmer führen. Sicherheitsmutter mit Nylonstop-Gewinde oder Quetschgewinde bei den Gelenken sind in jedem Fall durch neue zu ersetzen. Viele unserer Teile sind bereits mit diesen Muttern ausgestattet.

Beanstandungen, die aus unsachgemäßer Montage entstehen, können von der ZF Trading GmbH nicht anerkannt werden.

Sollten Sie Fragen zu diesem Thema haben, können Sie uns jederzeit kontaktieren:

ZF Trading GmbH

Tel.: +49 9721 4756-0
Fax: +49 9721 4755000
E-Mail: info.zf-trading@zf.com

Führungsgelenk



Das Führungsgelenk hat die Aufgabe, die Verbindung und damit die Abstützung zwischen Vorderachs-Querlenker und Achskörper (Achsschenkel) herzustellen. Seine Einbauposition ist immer die Dreieckspitze des Querlenkers. Es befindet sich damit gegenüber der Drehachse des Querlenkers. Stehend oder auch hängend eingebaute Führungsgelenke übertragen die Längs- und Seitenkräfte in dieser Verbindung. Die Höhenfixierung erfolgt über den Kugelzapfen. Er kann als Konus, mit kopfseitigem Gewindezapfen und Mutter, oder auch als Zylinderzapfen mit Klemmhalterung, Hohlkehle und

Durchgangsschraube ausgeführt sein. Im Abdichtbalg befindet sich eine Fett-Dauerfüllung.

Das Kugelgelenk sollte leicht beweglich, wenig nachgiebig, wartungsfrei und geräuschisolierend sein. Diese vier, einander teilweise widersprechenden Forderungen, werden z. B. durch Kunststoffschalen im K-Gelenk erfüllt. Konstruktiv unterscheiden sich Führungs- und Traggelenke nur unwesentlich voneinander.

Querlenker



Querlenker sollten leicht und unter Einwirkung von Seiten-, Anfahr- und Bremskräften knicksteif, biegesicher und dauerhaftbar sein.

Die beiden klassischen Herstellverfahren sind:

Ziehen aus Blech bzw. Band oder Schmieden aus Stahl bzw. einer aushärtbaren Aluminium-Knetlegierung, z. B. AlMgSi F 32. Gleichwertige Stahlkonstruktionen aus St 52-3 sind etwa dreimal so schwer.

Spurstange



Spurstangen werden gemäß ihrer Funktion in innere und äußere Spurstangen unterteilt.

Spurstangen oder auch Lenkzwischenstangen beeinflussen die Vorspur einer Lenkung. Spurstangen sind gleich lang und stellen über Kugelgelenke die kraftschlüssige Verbindung zum Spurhebel des Radträgers (Achsschenkels) einerseits und zur Lenkzwischenstange andererseits her. Die äußeren Spurstangen sind fast immer gekröpft, um bei voll eingeschlagener Lenkung eine Berührung mit dem Rad zu verhindern. Die

inneren Spurstangen-Axialgelenke sind an den Enden der Zahnstange befestigt und werden durch Faltenbälge abgedichtet. Die Zahnstange kann, wie im vorliegenden Beispiel, geteilt sein, so dass die effektive Länge stufenlos über eine Klemmschelle bzw. einen Gewindezapfen einstellbar ist.

Spurstangenendstück

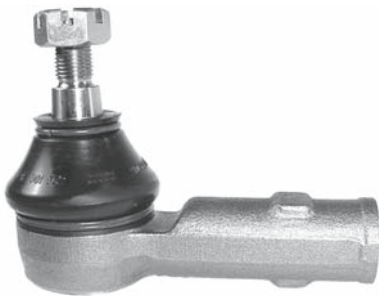

Spurstangenendstücke – besser Spurstangengelenke – sind fast immer Kugel-Winkelgelenke oder kardanische Winkelgelenke.

Die Ober- und Unterschale kann aus Stahl, Kunststoff oder einer Kombination aus beiden Werkstoffen sein. Kunststoffschalen sind z. B. aus Polyethylen gefertigt. Die Reibpaarung ergibt sich aus dem Schalenmaterial und der Kugeloberfläche. Aus der Reibpaarung leiten sich die Momente (Drehmoment, Bewegungsmoment, Losbrechmoment) und die Nachgiebigkeit, das Gelenkspiel oder besser die Einfederung ab. Stahlschalen-

Konstruktionen sorgen für eine äußerst geringe Nachgiebigkeit in radialer und axialer Richtung. Hochwertige Kunststoffschalen-Werkstoffe liefern ebenfalls eine geringe Nachgiebigkeit gepaart mit hervorragenden Gleiteigenschaften und sehr guter Dämpfung. Die Gelenkanschlüsse sind vielfältiger Art. Die Zeichnung zeigt einen Gelenkhals mit innenliegender Gewindebohrung. Das Gelenk ist durch einen Gummibalg geschützt.

Traggelenk



Auf der dem Führungsgelenk gegenüberliegenden Seite befindet sich, im Achsschenkel montiert, das Traggelenk. Es nimmt Kräfte in allen Richtungen auf. Traggelenke können hängend oder stehend eingebaut sein.

Die Kugel des Kugelzapfens gleitet zwischen vorgespannten, dauergeschmierten Schalen aus Kunststoff. Das Gehäuse wird meist im Lenker und der Kugelzapfen über seinen Kegel oder einen zylindrischen Zapfen im Achsschenkel befestigt. Diese Lagerung ist wartungsfrei. Der mit Spezialfett gefüllte Dichtbalg verhindert Schmutz- und Wassereintritt.

Lenkung

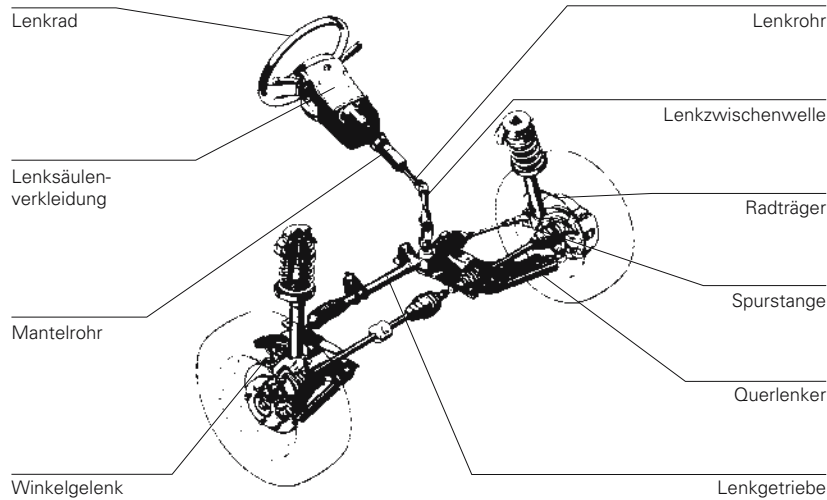

Zur Lenkanlage zählen die Teile, die dazu beitragen, die Drehbewegung des Lenkrades in die Lenkbewegung des Rades umzusetzen.

Bei einer manuellen Lenkung sind das die Komponenten, die den Kraftfluss vom Lenkrad zu den Radträgern weiterleiten. Bei einer Hilfskraftlenkung kommen noch die Aggregate für die Energieversorgung hinzu.

Die Abbildung zeigt eine manuelle Zahnstangenlenkung. Das Lenkgetriebe ist tief liegend an der Karosserie befestigt und liegt damit hinter der Achse. Die inneren Spurstangen-Axialgelenke sind an den Enden der Zahnstange befestigt und durch Gummi-Faltenbälge gegen Verunreinigung abgedichtet. Das Lenkrad überträgt das vom Fahrer aufgebrachte Betätigungsmoment über das Lenkrohr der Lenksäule zum Lenkgetriebe und ist damit das einzige Berührungselement des Fahrers mit der Lenkanlage. Die Achsrichtung der Lenksäule und die Lenkradneigung werden durch die Sitzposition des Fahrers vorgegeben. Über das Lenkgetriebe wird die Drehbewegung in eine Schiebbewegung der rechten und linken Spurstange

umgesetzt. Diese wiederum, in Kugelgelenken innen an der Zahnstange und außen am Spurhebel des Radträgers gelagert, sorgen für die Drehbewegung des Rades um die Lenkachse der Radaufhängung (king pin line).

Bauteile des Fahrwerks

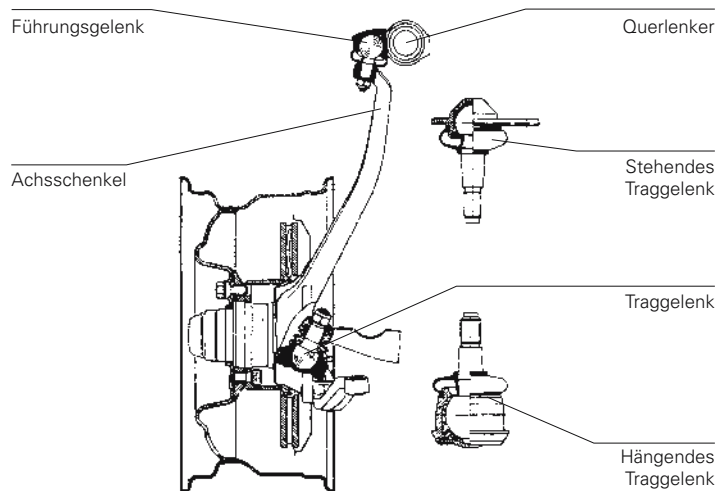

Zu den wichtigen Konstruktionselementen des Fahrwerks zählen die Federung (Federbeine), die Stoßdämpfer, die Gelenkstäbe, die Querlenker und die darin integrierten Querlenker-Lagerungen.

Gelenkstäbe und Lenker stellen die Verbindung zwischen dem eigentlichen Radlager (Schwenklager oder Achskörper) und dem Aufbau,

Rahmen bzw. Fahrschemel dar. Das Führungsgelenk übernimmt dabei die Abstützung auf dem Achskörper (Achsschenkel).

Erfordert die Art der Lagerung eine kardanische Beweglichkeit, so werden Kugelgelenke an den Achsschenkeln zum Einsatz gebracht. Das Gehäuse wird im Regelfall direkt im Querlenker

und der Kugelzapfen über einen 1:8-Kegel oder einen Zylinderzapfen im Achsschenkel befestigt. Traggelenke können hängend oder auch stehend die dynamischen Hochkräfte auffangen.

Querlenker können sowohl aus Blech oder Band gezogen als auch aus Stahl oder einer Aluminiumlegierung geschmiedet sein.

Im letzteren Fall spricht man von sogenannten Aluminium-Knetlegierungen, in die das Führungsgelenk direkt eingebaut ist. Im Gegensatz zum Traggelenk, das so eingebaut wird, dass sich die Kräfte immer über die Kugelfläche abstützen, spielt die Einbaulänge beim Führungsgelenk keine Rolle. Traggelenke können ggf. als Führungsgelenke Verwendung finden.

L, Ø und M zeigen die wichtigsten Abmessungen

- L Länge
- Ø Größter Konusdurchmesser
- M Gewindeabmessung

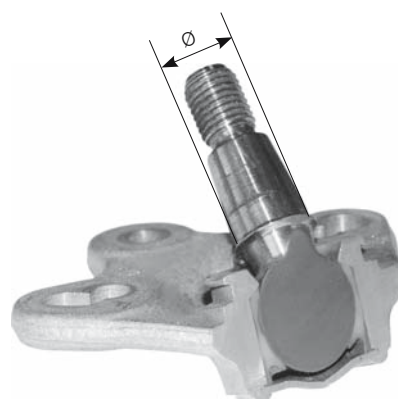
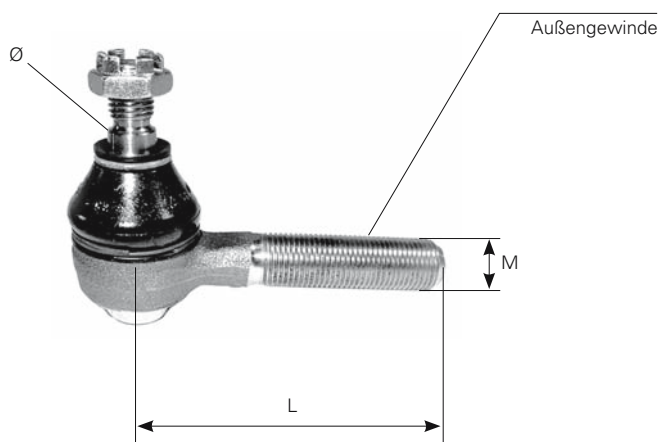
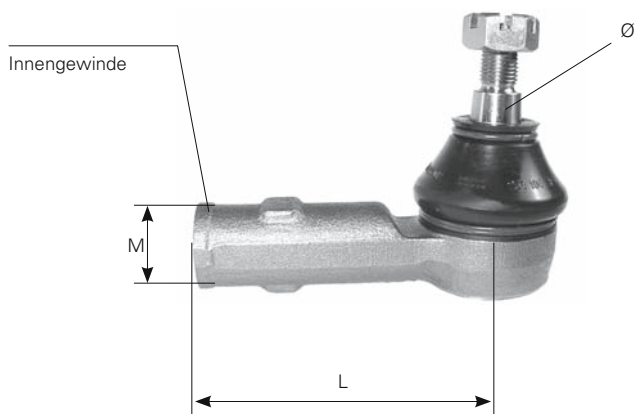

L, Ø, PØ und M zeigen die wichtigsten Abmessungen

- L Länge
- Ø Größter Konusdurchmesser
- PØ Rohrdurchmesser
- M Gewindeabmessung

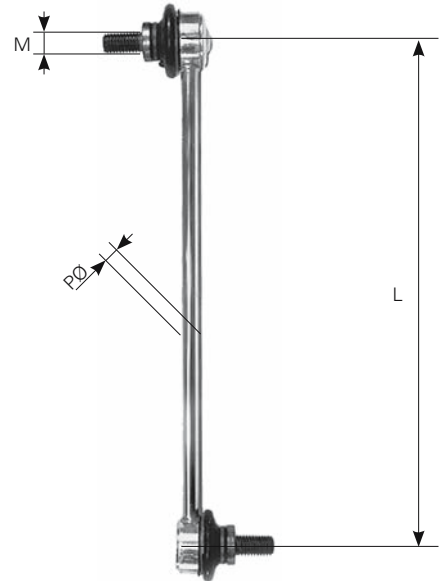
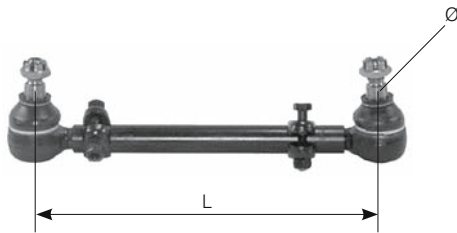

L, Ø und M zeigen die wichtigsten Abmessungen

- L Länge
- Ø Größter Konusdurchmesser
- M Gewindeabmessung

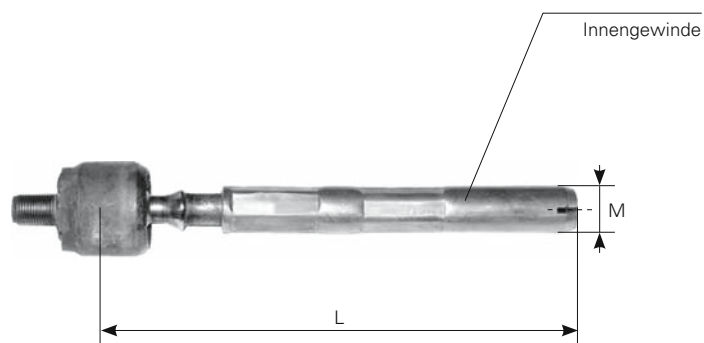
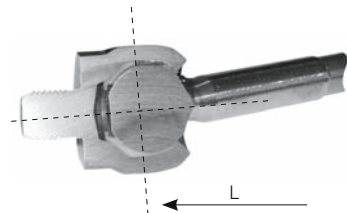
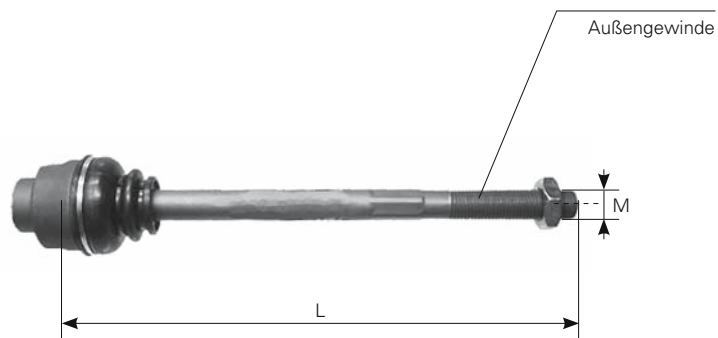
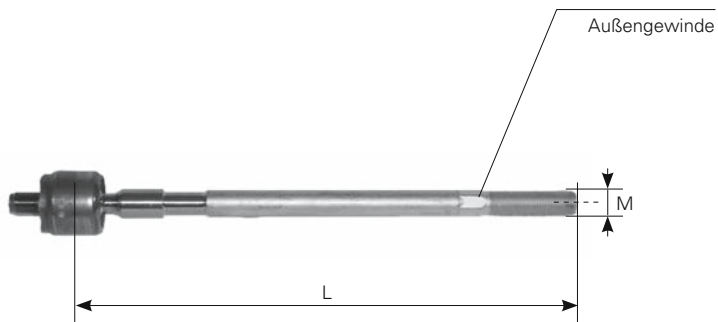











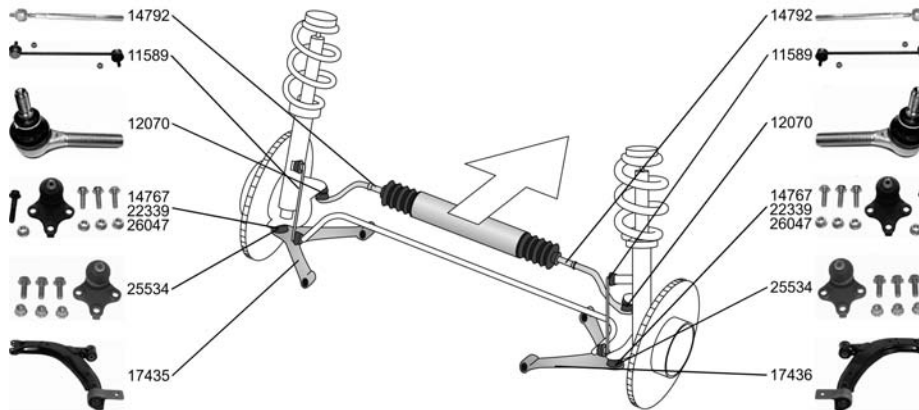

Ref.

CITROËN

BERLINGO (MF)

07.96 -

























<p>Spurstangenkopf mit Zubehör Gewindeart: mit Rechtsgewinde Gewindemaß: M14x1,5</p> <p>1.4 i bivalent 04.03 - 1.4 i (MFKFX) 07.96 - 1.6 16V (MFNFU) 10.00 - 1.8 i (MFLFX) 05.97 - 1.8 i 4WD (MFLFX) 04.97 - 1.8 D (MFA9A) 07.98 - 1.9 D (MFDJY) 07.96 - 1.9 D (MFWJZ) 07.98 - 1.9 D 4WD (MFWJZ) 07.98 - 2.0 HDI 90 (MFRHY) 12.99 - electrique 01.00 -</p>		<p>12070 04 3817 50</p> 
<p>Axialgelenk, Spurstange Gewindeart: mit Rechtsgewinde Gewindemaß: M14x1,5 mit Zubehör</p> <p>1.1 i (MFHDZ) 07.96 - 1.4 i bivalent 04.03 - 1.4 i (MFKFX) 07.96 - 1.6 16V (MFNFU) 10.00 - 1.8 i (MFLFX) 05.97 - 1.8 i 4WD (MFLFX) 04.97 - 1.8 D (MFA9A) 07.98 - 1.9 D (MFDJY) 07.96 - 1.9 D (MFWJZ) 07.98 - 1.9 D 4WD (MFWJZ) 07.98 - electrique 01.00 -</p>		<p>14792 01 3812 C0</p> 
<p>Lenker, Radaufhängung mit Gummilager ohne Trag-/Führungsgelenk</p> <p>1.1 i (MFHDZ) 07.96 - 1.4 i bivalent 04.03 - 1.4 i (MFKFX) 07.96 - 1.6 16V (MFNFU) 10.00 - 1.8 i (MFLFX) 05.97 - 1.8 i 4WD (MFLFX) 04.97 - 1.8 D (MFA9A) 07.98 - 1.9 D (MFDJY) 07.96 - 1.9 D (MFWJZ) 07.98 - 1.9 D 4WD (MFWJZ) 07.98 -</p>	 <p>separat bestellen nur in Verbindung mit:OE 3640 42 Konusmaß [mm]:16  ->Chass. O 07972</p> <p>nur in Verbindung mit:OE 3640 43 Konusmaß [mm]:16  ->Chass. O 07972</p> <p>nur in Verbindung mit:OE 3640 50 Konusmaß [mm]:18  Chass. O 07973-></p> <p>nur in Verbindung mit:OE 3640 51 Konusmaß [mm]:18  Chass. O 07973-></p>	<p>17435 01 3520.H5 27924 01</p> 



CITROËN

BERLINGO (MF)

07.96 -

 Lenker, Radaufhängung mit Gummilager ohne Trag-/Führungsgelenk		17436 01 3521.E5 27924 01																				
<table border="0"> <tr><td>1.1 i (MFHDZ)</td><td>07.96 -</td></tr> <tr><td>1.4 i bivalent</td><td>04.03 -</td></tr> <tr><td>1.4 i (MFKFX)</td><td>07.96 -</td></tr> <tr><td>1.6 16V (MFNFU)</td><td>10.00 -</td></tr> <tr><td>1.8 i (MFLFX)</td><td>05.97 -</td></tr> <tr><td>1.8 i 4WD (MFLFX)</td><td>04.97 -</td></tr> <tr><td>1.8 D (MFA9A)</td><td>07.98 -</td></tr> <tr><td>1.9 D (MFDJY)</td><td>07.96 -</td></tr> <tr><td>1.9 D (MFWJZ)</td><td>07.98 -</td></tr> <tr><td>1.9 D 4WD (MFWJZ)</td><td>07.98 -</td></tr> </table>	1.1 i (MFHDZ)	07.96 -	1.4 i bivalent	04.03 -	1.4 i (MFKFX)	07.96 -	1.6 16V (MFNFU)	10.00 -	1.8 i (MFLFX)	05.97 -	1.8 i 4WD (MFLFX)	04.97 -	1.8 D (MFA9A)	07.98 -	1.9 D (MFDJY)	07.96 -	1.9 D (MFWJZ)	07.98 -	1.9 D 4WD (MFWJZ)	07.98 -	separat bestellen nur in Verbindung mit:OE 3640 42 Konusmaß [mm]:16  ->Chass. O 07972 ----- nur in Verbindung mit:OE 3640 43 Konusmaß [mm]:16  ->Chass. O 07972 ----- nur in Verbindung mit:OE 3640 50 Konusmaß [mm]:18  Chass. O 07973-> ----- nur in Verbindung mit:OE 3640 51 Konusmaß [mm]:18  Chass. O 07973->	
1.1 i (MFHDZ)	07.96 -																					
1.4 i bivalent	04.03 -																					
1.4 i (MFKFX)	07.96 -																					
1.6 16V (MFNFU)	10.00 -																					
1.8 i (MFLFX)	05.97 -																					
1.8 i 4WD (MFLFX)	04.97 -																					
1.8 D (MFA9A)	07.98 -																					
1.9 D (MFDJY)	07.96 -																					
1.9 D (MFWJZ)	07.98 -																					
1.9 D 4WD (MFWJZ)	07.98 -																					
Lenker, Radaufhängung <table border="0"> <tr><td>1.9 D (MFWJZ)</td><td>07.98 -</td></tr> <tr><td>1.9 D 4WD (MFWJZ)</td><td>07.98 -</td></tr> <tr><td>2.0 HDI 90 (MFRHY)</td><td>12.99 -</td></tr> <tr><td>electrique</td><td>01.00 -</td></tr> </table>	1.9 D (MFWJZ)	07.98 -	1.9 D 4WD (MFWJZ)	07.98 -	2.0 HDI 90 (MFRHY)	12.99 -	electrique	01.00 -	  Chass. O 08365->	26714 02 3520 Q5 												
1.9 D (MFWJZ)	07.98 -																					
1.9 D 4WD (MFWJZ)	07.98 -																					
2.0 HDI 90 (MFRHY)	12.99 -																					
electrique	01.00 -																					
Lenker, Radaufhängung <table border="0"> <tr><td>1.9 D (MFWJZ)</td><td>07.98 -</td></tr> <tr><td>1.9 D 4WD (MFWJZ)</td><td>07.98 -</td></tr> <tr><td>2.0 HDI 90 (MFRHY)</td><td>12.99 -</td></tr> <tr><td>electrique</td><td>01.00 -</td></tr> </table>	1.9 D (MFWJZ)	07.98 -	1.9 D 4WD (MFWJZ)	07.98 -	2.0 HDI 90 (MFRHY)	12.99 -	electrique	01.00 -	  Chass. O 08365->	26715 02 3521 L6 												
1.9 D (MFWJZ)	07.98 -																					
1.9 D 4WD (MFWJZ)	07.98 -																					
2.0 HDI 90 (MFRHY)	12.99 -																					
electrique	01.00 -																					
Trag-/Führungsgelenk Konusmaß [mm]: 16 mit Zubehör	  ->Chass. O 07972	14767 04 3640 42 																				
Trag-/Führungsgelenk Konusmaß [mm]: 16 mit Zubehör	  ->Chass. O 07972	22339 04 3640 43 																				
Trag-/Führungsgelenk Konusmaß [mm]: 18	  Chass. O 07973->	26047 02 3640 50 																				



















Ref.

CITROËN

BERLINGO (MF)

07.96 -



















<p> Reparatursatz, Trag-/Führungsgelenk Konusmaß [mm]: 18</p> <table border="1"> <tr><td>1.1 i (MFHDZ)</td><td>07.96 -</td></tr> <tr><td>1.4 i (MFKFX)</td><td>07.96 -</td></tr> <tr><td>1.6 16V (MFNFU)</td><td>10.00 -</td></tr> <tr><td>1.8 i (MFLFX)</td><td>05.97 -</td></tr> <tr><td>1.8 i 4WD (MFLFX)</td><td>04.97 -</td></tr> <tr><td>1.8 D (MFA9A)</td><td>07.98 -</td></tr> <tr><td>1.9 D (MFDJY)</td><td>07.96 -</td></tr> <tr><td>1.9 D (MFWJZ)</td><td>07.98 -</td></tr> <tr><td>1.9 D 4WD (MFWJZ)</td><td>07.98 -</td></tr> </table>	1.1 i (MFHDZ)	07.96 -	1.4 i (MFKFX)	07.96 -	1.6 16V (MFNFU)	10.00 -	1.8 i (MFLFX)	05.97 -	1.8 i 4WD (MFLFX)	04.97 -	1.8 D (MFA9A)	07.98 -	1.9 D (MFDJY)	07.96 -	1.9 D (MFWJZ)	07.98 -	1.9 D 4WD (MFWJZ)	07.98 -	<p></p> <p> Chass. O 07973-></p>	<p>25534 02 3640 51</p> 										
1.1 i (MFHDZ)	07.96 -																													
1.4 i (MFKFX)	07.96 -																													
1.6 16V (MFNFU)	10.00 -																													
1.8 i (MFLFX)	05.97 -																													
1.8 i 4WD (MFLFX)	04.97 -																													
1.8 D (MFA9A)	07.98 -																													
1.9 D (MFDJY)	07.96 -																													
1.9 D (MFWJZ)	07.98 -																													
1.9 D 4WD (MFWJZ)	07.98 -																													
<p>Stange/Strebe, Stabilisator Pendelstange mit Zubehör</p> <table border="1"> <tr><td>1.1 i (MFHDZ)</td><td>07.96 -</td></tr> <tr><td>1.4 i bivalent</td><td>04.03 -</td></tr> <tr><td>1.4 i (MFKFX)</td><td>07.96 -</td></tr> <tr><td>1.6 16V (MFNFU)</td><td>10.00 -</td></tr> <tr><td>1.8 i (MFLFX)</td><td>05.97 -</td></tr> <tr><td>1.8 i 4WD (MFLFX)</td><td>04.97 -</td></tr> <tr><td>1.8 D (MFA9A)</td><td>07.98 -</td></tr> <tr><td>1.9 D (MFDJY)</td><td>07.96 -</td></tr> <tr><td>1.9 D (MFWJZ)</td><td>07.98 -</td></tr> <tr><td>1.9 D 4WD (MFWJZ)</td><td>07.98 -</td></tr> <tr><td>2.0 HDI 90 (MFRHY)</td><td>12.99 -</td></tr> <tr><td>electrique</td><td>01.00 -</td></tr> </table>	1.1 i (MFHDZ)	07.96 -	1.4 i bivalent	04.03 -	1.4 i (MFKFX)	07.96 -	1.6 16V (MFNFU)	10.00 -	1.8 i (MFLFX)	05.97 -	1.8 i 4WD (MFLFX)	04.97 -	1.8 D (MFA9A)	07.98 -	1.9 D (MFDJY)	07.96 -	1.9 D (MFWJZ)	07.98 -	1.9 D 4WD (MFWJZ)	07.98 -	2.0 HDI 90 (MFRHY)	12.99 -	electrique	01.00 -	<p></p>	<p>11589 02 5087 46</p> 				
1.1 i (MFHDZ)	07.96 -																													
1.4 i bivalent	04.03 -																													
1.4 i (MFKFX)	07.96 -																													
1.6 16V (MFNFU)	10.00 -																													
1.8 i (MFLFX)	05.97 -																													
1.8 i 4WD (MFLFX)	04.97 -																													
1.8 D (MFA9A)	07.98 -																													
1.9 D (MFDJY)	07.96 -																													
1.9 D (MFWJZ)	07.98 -																													
1.9 D 4WD (MFWJZ)	07.98 -																													
2.0 HDI 90 (MFRHY)	12.99 -																													
electrique	01.00 -																													
<p>Faltenbalg, Lenkung</p> <table border="1"> <tr><td>1.1 i (MFHDZ)</td><td>07.96 -</td></tr> <tr><td>1.4 i bivalent</td><td>04.03 -</td></tr> <tr><td>1.4 i (MFKFX)</td><td>07.96 -</td></tr> <tr><td>1.6 16V (MFNFU)</td><td>10.00 -</td></tr> <tr><td>1.8 i (MFLFX)</td><td>05.97 -</td></tr> <tr><td>1.8 i 4WD (MFLFX)</td><td>04.97 -</td></tr> <tr><td>1.8 D (MFA9A)</td><td>07.98 -</td></tr> <tr><td>1.9 D (MFDJY)</td><td>07.96 -</td></tr> <tr><td>1.9 D (MFWJZ)</td><td>07.98 -</td></tr> <tr><td>1.9 D 4WD (MFWJZ)</td><td>07.98 -</td></tr> <tr><td>electrique</td><td>01.00 -</td></tr> </table>	1.1 i (MFHDZ)	07.96 -	1.4 i bivalent	04.03 -	1.4 i (MFKFX)	07.96 -	1.6 16V (MFNFU)	10.00 -	1.8 i (MFLFX)	05.97 -	1.8 i 4WD (MFLFX)	04.97 -	1.8 D (MFA9A)	07.98 -	1.9 D (MFDJY)	07.96 -	1.9 D (MFWJZ)	07.98 -	1.9 D 4WD (MFWJZ)	07.98 -	electrique	01.00 -	<p></p> <p></p>	<p>15622 01 4066 22</p> 						
1.1 i (MFHDZ)	07.96 -																													
1.4 i bivalent	04.03 -																													
1.4 i (MFKFX)	07.96 -																													
1.6 16V (MFNFU)	10.00 -																													
1.8 i (MFLFX)	05.97 -																													
1.8 i 4WD (MFLFX)	04.97 -																													
1.8 D (MFA9A)	07.98 -																													
1.9 D (MFDJY)	07.96 -																													
1.9 D (MFWJZ)	07.98 -																													
1.9 D 4WD (MFWJZ)	07.98 -																													
electrique	01.00 -																													
<p>Faltenbalgsatz, Lenkung Innendurchmesser 1 [mm]: 10 Innendurchmesser 2 [mm]: 40</p> <table border="1"> <tr><td>1.1 i (MFHDZ)</td><td>07.96 -</td></tr> <tr><td>1.4 bivalent</td><td>11.02 -</td></tr> <tr><td>1.4 i bivalent</td><td>04.03 -</td></tr> <tr><td>1.4 i (MFKFX)</td><td>07.96 -</td></tr> <tr><td>1.6 16V (MFNFU)</td><td>10.00 -</td></tr> <tr><td>1.8 i (MFLFX)</td><td>05.97 -</td></tr> <tr><td>1.8 i 4WD (MFLFX)</td><td>04.97 -</td></tr> <tr><td>1.6 HDI 75</td><td>07.05 -</td></tr> <tr><td>1.6 HDI 90</td><td>07.05 -</td></tr> <tr><td>1.8 D (MFA9A)</td><td>07.98 -</td></tr> <tr><td>1.9 D (MFDJY)</td><td>07.96 -</td></tr> <tr><td>1.9 D (MFWJZ)</td><td>07.98 -</td></tr> <tr><td>1.9 D 4WD (MFWJZ)</td><td>07.98 -</td></tr> <tr><td>electrique</td><td>01.00 -</td></tr> </table>	1.1 i (MFHDZ)	07.96 -	1.4 bivalent	11.02 -	1.4 i bivalent	04.03 -	1.4 i (MFKFX)	07.96 -	1.6 16V (MFNFU)	10.00 -	1.8 i (MFLFX)	05.97 -	1.8 i 4WD (MFLFX)	04.97 -	1.6 HDI 75	07.05 -	1.6 HDI 90	07.05 -	1.8 D (MFA9A)	07.98 -	1.9 D (MFDJY)	07.96 -	1.9 D (MFWJZ)	07.98 -	1.9 D 4WD (MFWJZ)	07.98 -	electrique	01.00 -	<p>LHD  </p> <p>-----</p> <p>RHD </p>	<p>30114 01 4066 20</p> 
1.1 i (MFHDZ)	07.96 -																													
1.4 bivalent	11.02 -																													
1.4 i bivalent	04.03 -																													
1.4 i (MFKFX)	07.96 -																													
1.6 16V (MFNFU)	10.00 -																													
1.8 i (MFLFX)	05.97 -																													
1.8 i 4WD (MFLFX)	04.97 -																													
1.6 HDI 75	07.05 -																													
1.6 HDI 90	07.05 -																													
1.8 D (MFA9A)	07.98 -																													
1.9 D (MFDJY)	07.96 -																													
1.9 D (MFWJZ)	07.98 -																													
1.9 D 4WD (MFWJZ)	07.98 -																													
electrique	01.00 -																													
<p>Faltenbalgsatz, Lenkung Innendurchmesser 1 [mm]: 16,5 Innendurchmesser 2 [mm]: 43</p> <table border="1"> <tr><td>1.1 i (MFHDZ)</td><td>07.96 -</td></tr> <tr><td>1.4 bivalent</td><td>11.02 -</td></tr> <tr><td>1.4 i bivalent</td><td>04.03 -</td></tr> <tr><td>1.4 i (MFKFX)</td><td>07.96 -</td></tr> <tr><td>1.6 16V (MFNFU)</td><td>10.00 -</td></tr> <tr><td>1.8 i (MFLFX)</td><td>05.97 -</td></tr> <tr><td>1.8 i 4WD (MFLFX)</td><td>04.97 -</td></tr> <tr><td>1.6 HDI 75</td><td>07.05 -</td></tr> <tr><td>1.6 HDI 90</td><td>07.05 -</td></tr> <tr><td>1.8 D (MFA9A)</td><td>07.98 -</td></tr> <tr><td>1.9 D (MFDJY)</td><td>07.96 -</td></tr> <tr><td>1.9 D (MFWJZ)</td><td>07.98 -</td></tr> <tr><td>1.9 D 4WD (MFWJZ)</td><td>07.98 -</td></tr> <tr><td>electrique</td><td>01.00 -</td></tr> </table>	1.1 i (MFHDZ)	07.96 -	1.4 bivalent	11.02 -	1.4 i bivalent	04.03 -	1.4 i (MFKFX)	07.96 -	1.6 16V (MFNFU)	10.00 -	1.8 i (MFLFX)	05.97 -	1.8 i 4WD (MFLFX)	04.97 -	1.6 HDI 75	07.05 -	1.6 HDI 90	07.05 -	1.8 D (MFA9A)	07.98 -	1.9 D (MFDJY)	07.96 -	1.9 D (MFWJZ)	07.98 -	1.9 D 4WD (MFWJZ)	07.98 -	electrique	01.00 -	<p>LHD  </p> <p>-----</p> <p>RHD </p>	<p>30149 01</p> 
1.1 i (MFHDZ)	07.96 -																													
1.4 bivalent	11.02 -																													
1.4 i bivalent	04.03 -																													
1.4 i (MFKFX)	07.96 -																													
1.6 16V (MFNFU)	10.00 -																													
1.8 i (MFLFX)	05.97 -																													
1.8 i 4WD (MFLFX)	04.97 -																													
1.6 HDI 75	07.05 -																													
1.6 HDI 90	07.05 -																													
1.8 D (MFA9A)	07.98 -																													
1.9 D (MFDJY)	07.96 -																													
1.9 D (MFWJZ)	07.98 -																													
1.9 D 4WD (MFWJZ)	07.98 -																													
electrique	01.00 -																													



Ref.

CITROËN

BERLINGO Kasten/Box/Furgón/Van 07.96 - (M_)

 Axialgelenk, Spurstange Gewindeart: mit Rechtsgewinde Gewindemaß: M14x1,5 mit Zubehör		14792 01 3812 C0 
1.1 i (MAHDZ, MBHDZ) 07.96 - 1.4 i (MBKFX) 07.96 - 1.4 i bivalent 04.03 - 1.8 D (MBA9A, MCA9A) 07.96 - 1.9 D 07.96 - 1.9 D 70 4WD 07.98 - 1.9 D 70 (MBWJZ, MCWJZ) 04.99 -		
Lenker, Radaufhängung mit Gummilager ohne Trag-/Führungsgelenk		17435 01 3520.H5 27924 01 
1.1 i (MAHDZ, MBHDZ) 07.96 - 1.4 i (MBKFX) 07.96 - 1.4 i bivalent 04.03 - 1.8 D (MBA9A, MCA9A) 07.96 - 1.9 D 07.96 - 1.9 D 70 4WD 07.98 - 1.9 D 70 (MBWJZ, MCWJZ) 04.99 -	separat bestellen nur in Verbindung mit:OE 3640 42 Konusmaß [mm]:16  ->Chass. O 07972 ----- nur in Verbindung mit:OE 3640 43 Konusmaß [mm]:16  ->Chass. O 07972 ----- nur in Verbindung mit:OE 3640 50 Konusmaß [mm]:18  Chass. O 07973-> ----- nur in Verbindung mit:OE 3640 51 Konusmaß [mm]:18  Chass. O 07973->	
Lenker, Radaufhängung mit Gummilager ohne Trag-/Führungsgelenk		17436 01 3521.E5 27924 01 
1.1 i (MAHDZ, MBHDZ) 07.96 - 1.4 i (MBKFX) 07.96 - 1.4 i bivalent 04.03 - 1.8 D (MBA9A, MCA9A) 07.96 - 1.9 D 07.96 - 1.9 D 70 4WD 07.98 - 1.9 D 70 (MBWJZ, MCWJZ) 04.99 -	separat bestellen nur in Verbindung mit:OE 3640 42 Konusmaß [mm]:16  ->Chass. O 07972 ----- nur in Verbindung mit:OE 3640 43 Konusmaß [mm]:16  ->Chass. O 07972 ----- nur in Verbindung mit:OE 3640 50 Konusmaß [mm]:18  Chass. O 07973-> ----- nur in Verbindung mit:OE 3640 51 Konusmaß [mm]:18  Chass. O 07973->	
Lenker, Radaufhängung 1.9 D 70 4WD 07.98 - 1.9 D 70 (MBWJZ, MCWJZ) 04.99 - 2.0 HDI 90 (MBRHY, MCRHY) 12.99 -	  Chass. O 08365->	26714 02 3520 Q5 



























Ref.

CITROËN

BERLINGO Kasten/Box/Furgón/Van
(M)

07.96 -











<p> Lenker, Radaufhängung</p> <p>1.9 D 70 4WD 07.98 - 1.9 D 70 (MBWJZ, MCWJZ) 04.99 - 2.0 HDI 90 (MBRHY, MCRHY) 12.99 -</p>	<p></p> <p> Chass. O 08365-></p>	<p>26715 02 3521 L6</p> 
<p>Trag-/Führungsgelenk Konusmaß [mm]: 16 mit Zubehör</p> <p>1.1 i (MAHDZ, MBHDZ) 07.96 - 1.4 i (MBKFX) 07.96 - 1.8 D (MBA9A, MCA9A) 07.96 - 1.9 D 07.96 - 1.9 D 70 4WD 07.98 - 1.9 D 70 (MBWJZ, MCWJZ) 04.99 -</p>	<p></p> <p>->Chass. O 07972</p>	<p>14767 04 3640 42</p> 
<p>Trag-/Führungsgelenk Konusmaß [mm]: 16 mit Zubehör</p> <p>1.1 i (MAHDZ, MBHDZ) 07.96 - 1.4 i (MBKFX) 07.96 - 1.8 D (MBA9A, MCA9A) 07.96 - 1.9 D 07.96 - 1.9 D 70 4WD 07.98 - 1.9 D 70 (MBWJZ, MCWJZ) 04.99 -</p>	<p></p> <p>->Chass. O 07972</p>	<p>22339 04 3640 43</p> 
<p>Trag-/Führungsgelenk Konusmaß [mm]: 18</p> <p>1.1 i (MAHDZ, MBHDZ) 07.96 - 1.4 i (MBKFX) 07.96 - 1.8 D (MBA9A, MCA9A) 07.96 - 1.9 D 07.96 - 1.9 D 70 4WD 07.98 - 1.9 D 70 (MBWJZ, MCWJZ) 04.99 -</p>	<p></p> <p> Chass. O 07973-></p>	<p>26047 02 3640 50</p> 
<p>Reparatursatz, Trag-/Führungsgelenk Konusmaß [mm]: 18</p> <p>1.1 i (MAHDZ, MBHDZ) 07.96 - 1.4 i (MBKFX) 07.96 - 1.8 D (MBA9A, MCA9A) 07.96 - 1.9 D 07.96 - 1.9 D 70 4WD 07.98 - 1.9 D 70 (MBWJZ, MCWJZ) 04.99 -</p>	<p></p> <p> Chass. O 07973-></p>	<p>25534 02 3640 51</p> 
<p>Stange/Strebe, Stabilisator Pendelstange mit Zubehör</p> <p>1.1 i (MAHDZ, MBHDZ) 07.96 - 1.4 i (MBKFX) 07.96 - 1.4 i bivalent 04.03 - 1.8 D (MBA9A, MCA9A) 07.96 - 1.9 D 07.96 - 1.9 D 70 4WD 07.98 - 1.9 D 70 (MBWJZ, MCWJZ) 04.99 - 2.0 HDI 90 (MBRHY, MCRHY) 12.99 -</p>	<p></p>	<p>11589 02 5087 46</p> 
<p>Faltenbalg, Lenkung</p> <p>1.1 i (MAHDZ, MBHDZ) 07.96 - 1.4 i (MBKFX) 07.96 - 1.4 i bivalent 04.03 - 1.8 D (MBA9A, MCA9A) 07.96 - 1.9 D 07.96 - 1.9 D 70 4WD 07.98 - 1.9 D 70 (MBWJZ, MCWJZ) 04.99 -</p>	<p></p> <p></p>	<p>15622 01 4066 22</p> 
<p>Faltenbalgsatz, Lenkung Innendurchmesser 1 [mm]: 10 Innendurchmesser 2 [mm]: 40</p> <p>1.1 i (MAHDZ, MBHDZ) 07.96 - 1.4 bivalent 11.02 - 1.4 i (MBKFX) 07.96 - 1.4 i bivalent 04.03 - 1.8 i 08.99 - 10.02 1.8 D (MBA9A, MCA9A) 07.96 - 1.9 D 07.96 - 1.9 D 70 4WD 07.98 - 1.9 D 70 (MBWJZ, MCWJZ) 04.99 -</p>	<p> </p> <p>-----</p> <p></p>	<p>30114 01 4066 20</p> 













Ref.

CITROËN

BERLINGO Kasten/Box/Furgón/Van 07.96 - (M)

 Faltenbalgsatz, Lenkung Innendurchmesser 1 [mm]: 16,5 Innendurchmesser 2 [mm]: 43			30149 01 
	1.1 i (MAHDZ, MBHDZ) 07.96 - 1.4 bivalent 11.02 - 1.4 i (MBKFX) 07.96 - 1.4 i bivalent 04.03 - 1.8 i 08.99 - 10.02 1.8 D (MBA9A, MCA9A) 07.96 - 1.9 D 07.96 - 1.9 D 70 4WD 07.98 - 1.9 D 70 (MBWJZ, MCWJZ) 04.99 -	LHD  ----- RHD 	
Faltenbalgsatz, Lenkung Innendurchmesser 1 [mm]: 11 Innendurchmesser 2 [mm]: 42			30206 01 4066 44 
	1.1 i (MAHDZ, MBHDZ) 07.96 - 1.4 bivalent 11.02 - 1.4 i (MBKFX) 07.96 - 1.4 i bivalent 04.03 - 1.8 i 08.99 - 10.02 1.8 D (MBA9A, MCA9A) 07.96 - 1.9 D 07.96 - 1.9 D 70 4WD 07.98 - 1.9 D 70 (MBWJZ, MCWJZ) 04.99 -	 	
Faltenbalgsatz, Lenkung Innendurchmesser 1 [mm]: 11 Innendurchmesser 2 [mm]: 42			30207 01 4066 43 
	1.1 i (MAHDZ, MBHDZ) 07.96 - 1.4 bivalent 11.02 - 1.4 i (MBKFX) 07.96 - 1.4 i bivalent 04.03 - 1.8 i 08.99 - 10.02 1.8 D (MBA9A, MCA9A) 07.96 - 1.9 D 07.96 - 1.9 D 70 4WD 07.98 - 1.9 D 70 (MBWJZ, MCWJZ) 04.99 - 2.0 HDI 90 (MBRH, MCRHY) 12.99 -	  	

BERLINGO 04.08 -



 Lenker, Radaufhängung mit Gummilager ALL TYPES			30606 01 3520 S2 28898 01 28899 01 
			
Lenker, Radaufhängung mit Gummilager ALL TYPES			30607 01 3521 P3 28898 01 28899 01 
			
Trag-/Führungsgelenk mit Zubehör ALL TYPES			27299 02 3640 68 
			
Lagerung, Lenker ALL TYPES			28898 01 3523 91 
	 		













Ref.

CITROËN

BERLINGO 04.08 -

 Lagerung, Lenker ALL TYPES		28899 01 3523 92
		

BERLINGO Kasten 04.08 -

 Lenker, Radaufhängung mit Gummilager ALL TYPES		30606 01 3520 S2 28898 01 28899 01
		
Lenker, Radaufhängung mit Gummilager ALL TYPES		30607 01 3521 P3 28898 01 28899 01
		
Trag-/Führungsgelenk mit Zubehör ALL TYPES		27299 02 3640 68
		
Lagerung, Lenker ALL TYPES		28898 01 3523 91
		
Lagerung, Lenker ALL TYPES		28899 01 3523 92
		









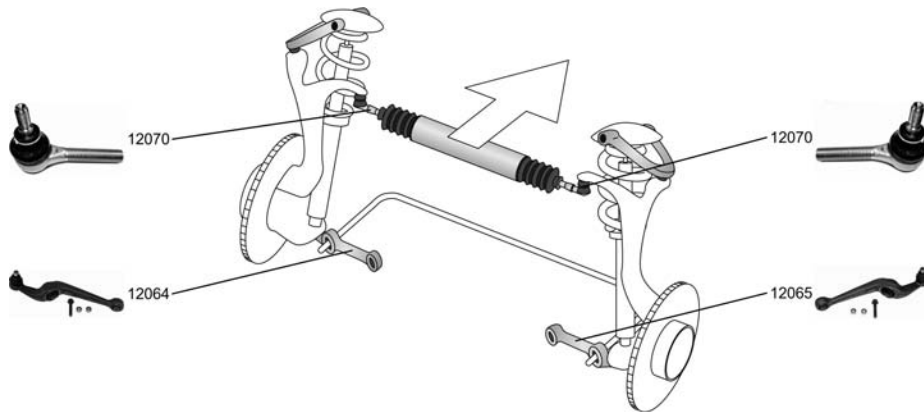

Ref.

CITROËN

C15 (VD-)

10.84 - 12.05



<p>Spurstangenkopf mit Zubehör Gewindeart: mit Rechtsgewinde Gewindemaß: M14x1,5</p> <table border="1"> <tr><td>1.0</td><td>10.84 - 12.97</td></tr> <tr><td>1.1, 35 kW</td><td>10.84 - 12.96</td></tr> <tr><td>1.1 i</td><td>07.88 - 12.96</td></tr> <tr><td>1.3, 47 kW</td><td>07.87 - 05.88</td></tr> <tr><td>1.4 E, 40 kW</td><td>07.87 - 12.96</td></tr> <tr><td>1.4 E, 44 kW</td><td>05.87 - 12.96</td></tr> <tr><td>1.4</td><td>07.87 - 12.96</td></tr> <tr><td>1.4 i</td><td>05.91 - 12.96</td></tr> <tr><td>1.8 D</td><td>07.86 - 12.00</td></tr> <tr><td>1.9 D</td><td>12.00 - 12.05</td></tr> </table>	1.0	10.84 - 12.97	1.1, 35 kW	10.84 - 12.96	1.1 i	07.88 - 12.96	1.3, 47 kW	07.87 - 05.88	1.4 E, 40 kW	07.87 - 12.96	1.4 E, 44 kW	05.87 - 12.96	1.4	07.87 - 12.96	1.4 i	05.91 - 12.96	1.8 D	07.86 - 12.00	1.9 D	12.00 - 12.05		<p>12070 04 3817 50</p> 
1.0	10.84 - 12.97																					
1.1, 35 kW	10.84 - 12.96																					
1.1 i	07.88 - 12.96																					
1.3, 47 kW	07.87 - 05.88																					
1.4 E, 40 kW	07.87 - 12.96																					
1.4 E, 44 kW	05.87 - 12.96																					
1.4	07.87 - 12.96																					
1.4 i	05.91 - 12.96																					
1.8 D	07.86 - 12.00																					
1.9 D	12.00 - 12.05																					
<p>Lenker, Radaufhängung mit Gummilager mit Zubehör</p> <table border="1"> <tr><td>1.1, 35 kW</td><td>10.84 - 12.96</td></tr> <tr><td>1.1 i</td><td>07.88 - 12.96</td></tr> <tr><td>1.3, 47 kW</td><td>07.87 - 05.88</td></tr> <tr><td>1.4 E, 40 kW</td><td>07.87 - 12.96</td></tr> <tr><td>1.4</td><td>07.87 - 12.96</td></tr> <tr><td>1.4 i</td><td>05.91 - 12.96</td></tr> <tr><td>1.8 D</td><td>07.86 - 12.00</td></tr> <tr><td>1.9 D</td><td>12.00 - 12.05</td></tr> <tr><td>1.4 E, 44 kW</td><td>05.87 - 12.96</td></tr> </table>	1.1, 35 kW	10.84 - 12.96	1.1 i	07.88 - 12.96	1.3, 47 kW	07.87 - 05.88	1.4 E, 40 kW	07.87 - 12.96	1.4	07.87 - 12.96	1.4 i	05.91 - 12.96	1.8 D	07.86 - 12.00	1.9 D	12.00 - 12.05	1.4 E, 44 kW	05.87 - 12.96		<p>12064 01 3520 51</p> 		
1.1, 35 kW	10.84 - 12.96																					
1.1 i	07.88 - 12.96																					
1.3, 47 kW	07.87 - 05.88																					
1.4 E, 40 kW	07.87 - 12.96																					
1.4	07.87 - 12.96																					
1.4 i	05.91 - 12.96																					
1.8 D	07.86 - 12.00																					
1.9 D	12.00 - 12.05																					
1.4 E, 44 kW	05.87 - 12.96																					
<p>Lenker, Radaufhängung mit Gummilager mit Zubehör</p> <table border="1"> <tr><td>1.1, 35 kW</td><td>10.84 - 12.96</td></tr> <tr><td>1.1 i</td><td>07.88 - 12.96</td></tr> <tr><td>1.3, 47 kW</td><td>07.87 - 05.88</td></tr> <tr><td>1.4 E, 40 kW</td><td>07.87 - 12.96</td></tr> <tr><td>1.4</td><td>07.87 - 12.96</td></tr> <tr><td>1.4 i</td><td>05.91 - 12.96</td></tr> <tr><td>1.8 D</td><td>07.86 - 12.00</td></tr> <tr><td>1.9 D</td><td>12.00 - 12.05</td></tr> <tr><td>1.4 E, 44 kW</td><td>05.87 - 12.96</td></tr> </table>	1.1, 35 kW	10.84 - 12.96	1.1 i	07.88 - 12.96	1.3, 47 kW	07.87 - 05.88	1.4 E, 40 kW	07.87 - 12.96	1.4	07.87 - 12.96	1.4 i	05.91 - 12.96	1.8 D	07.86 - 12.00	1.9 D	12.00 - 12.05	1.4 E, 44 kW	05.87 - 12.96		<p>12065 01 3521 34</p> 		
1.1, 35 kW	10.84 - 12.96																					
1.1 i	07.88 - 12.96																					
1.3, 47 kW	07.87 - 05.88																					
1.4 E, 40 kW	07.87 - 12.96																					
1.4	07.87 - 12.96																					
1.4 i	05.91 - 12.96																					
1.8 D	07.86 - 12.00																					
1.9 D	12.00 - 12.05																					
1.4 E, 44 kW	05.87 - 12.96																					
<p>Lagerung, Lenker</p> <table border="1"> <tr><td>1.0</td><td>10.84 - 12.97</td></tr> <tr><td>1.1, 35 kW</td><td>10.84 - 12.96</td></tr> <tr><td>1.3, 47 kW</td><td>07.87 - 05.88</td></tr> <tr><td>1.4 E, 44 kW</td><td>05.87 - 12.96</td></tr> <tr><td>1.4 i</td><td>05.91 - 12.96</td></tr> <tr><td>1.8 D</td><td>07.86 - 12.00</td></tr> </table>	1.0	10.84 - 12.97	1.1, 35 kW	10.84 - 12.96	1.3, 47 kW	07.87 - 05.88	1.4 E, 44 kW	05.87 - 12.96	1.4 i	05.91 - 12.96	1.8 D	07.86 - 12.00		<p>19247 01 3523 20</p> 								
1.0	10.84 - 12.97																					
1.1, 35 kW	10.84 - 12.96																					
1.3, 47 kW	07.87 - 05.88																					
1.4 E, 44 kW	05.87 - 12.96																					
1.4 i	05.91 - 12.96																					
1.8 D	07.86 - 12.00																					





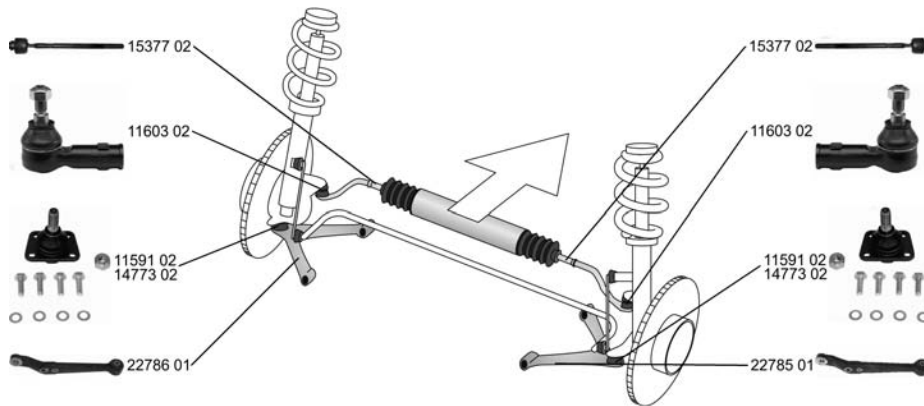

CITROËN

C25 Bus/Familial (280, 290)

07.81 - 02.94











<p>Spurstangenkopf Konusmaß [mm]: 16 Innengewinde [mm]: M16x1,5 Gewindeart: mit Rechtsgewinde Gewindemaß: M16x1,5 ALL TYPES</p>		<p>11603 02 3817 11</p> 																						
<p>Axialgelenk, Spurstange Gewindeart: mit Rechtsgewinde Gewindemaß: M16x1,5 ALL TYPES</p>		<p>15377 02 3812 27</p> 																						
<p>Lenker, Radaufhängung ohne Trag-/Führungsgelenk mit Gummilager nur in Verbindung mit: 11591 Nutzlast [kg]: 1000 Nutzlast [kg]: 1400</p> <table border="0" data-bbox="220 1238 874 1485"> <tr><td>1.8</td><td>11.81 - 01.94</td></tr> <tr><td>1.8 E</td><td>07.87 - 02.94</td></tr> <tr><td>2.0</td><td>02.91 - 02.94</td></tr> <tr><td>1.9 D</td><td>07.87 - 02.94</td></tr> <tr><td>1.9 TD</td><td>04.92 - 02.94</td></tr> <tr><td>2.5 D, 54 kW</td><td>10.85 - 02.94</td></tr> <tr><td>2.5 D 4x4</td><td>01.87 - 02.94</td></tr> <tr><td>2.5 D, 55 kW</td><td>11.81 - 01.94</td></tr> <tr><td>2.5 D Turbo</td><td>08.87 - 02.94</td></tr> <tr><td>2.5 D Turbo 4x4</td><td>08.87 - 02.94</td></tr> <tr><td>2.0 E</td><td>09.81 - 02.94</td></tr> </table>	1.8	11.81 - 01.94	1.8 E	07.87 - 02.94	2.0	02.91 - 02.94	1.9 D	07.87 - 02.94	1.9 TD	04.92 - 02.94	2.5 D, 54 kW	10.85 - 02.94	2.5 D 4x4	01.87 - 02.94	2.5 D, 55 kW	11.81 - 01.94	2.5 D Turbo	08.87 - 02.94	2.5 D Turbo 4x4	08.87 - 02.94	2.0 E	09.81 - 02.94		<p>22785 01 3521 52</p> 
1.8	11.81 - 01.94																							
1.8 E	07.87 - 02.94																							
2.0	02.91 - 02.94																							
1.9 D	07.87 - 02.94																							
1.9 TD	04.92 - 02.94																							
2.5 D, 54 kW	10.85 - 02.94																							
2.5 D 4x4	01.87 - 02.94																							
2.5 D, 55 kW	11.81 - 01.94																							
2.5 D Turbo	08.87 - 02.94																							
2.5 D Turbo 4x4	08.87 - 02.94																							
2.0 E	09.81 - 02.94																							
<p>Lenker, Radaufhängung ohne Trag-/Führungsgelenk mit Gummilager nur in Verbindung mit: 11591 Nutzlast [kg]: 1000 Nutzlast [kg]: 1400</p> <table border="0" data-bbox="220 1648 874 1895"> <tr><td>1.8</td><td>11.81 - 01.94</td></tr> <tr><td>1.8 E</td><td>07.87 - 02.94</td></tr> <tr><td>2.0</td><td>02.91 - 02.94</td></tr> <tr><td>1.9 D</td><td>07.87 - 02.94</td></tr> <tr><td>1.9 TD</td><td>04.92 - 02.94</td></tr> <tr><td>2.5 D, 54 kW</td><td>10.85 - 02.94</td></tr> <tr><td>2.5 D 4x4</td><td>01.87 - 02.94</td></tr> <tr><td>2.5 D, 55 kW</td><td>11.81 - 01.94</td></tr> <tr><td>2.5 D Turbo</td><td>08.87 - 02.94</td></tr> <tr><td>2.5 D Turbo 4x4</td><td>08.87 - 02.94</td></tr> <tr><td>2.0 E</td><td>09.81 - 02.94</td></tr> </table>	1.8	11.81 - 01.94	1.8 E	07.87 - 02.94	2.0	02.91 - 02.94	1.9 D	07.87 - 02.94	1.9 TD	04.92 - 02.94	2.5 D, 54 kW	10.85 - 02.94	2.5 D 4x4	01.87 - 02.94	2.5 D, 55 kW	11.81 - 01.94	2.5 D Turbo	08.87 - 02.94	2.5 D Turbo 4x4	08.87 - 02.94	2.0 E	09.81 - 02.94		<p>22786 01 3520 76</p> 
1.8	11.81 - 01.94																							
1.8 E	07.87 - 02.94																							
2.0	02.91 - 02.94																							
1.9 D	07.87 - 02.94																							
1.9 TD	04.92 - 02.94																							
2.5 D, 54 kW	10.85 - 02.94																							
2.5 D 4x4	01.87 - 02.94																							
2.5 D, 55 kW	11.81 - 01.94																							
2.5 D Turbo	08.87 - 02.94																							
2.5 D Turbo 4x4	08.87 - 02.94																							
2.0 E	09.81 - 02.94																							
<p>Trag-/Führungsgelenk mit Zubehör ALL TYPES</p>		<p>11591 02 3640 26</p> 																						
Chass. 289711->																								



Ref.





CITROËN

C25 Bus/Familial (280_, 290_) 07.81 - 02.94

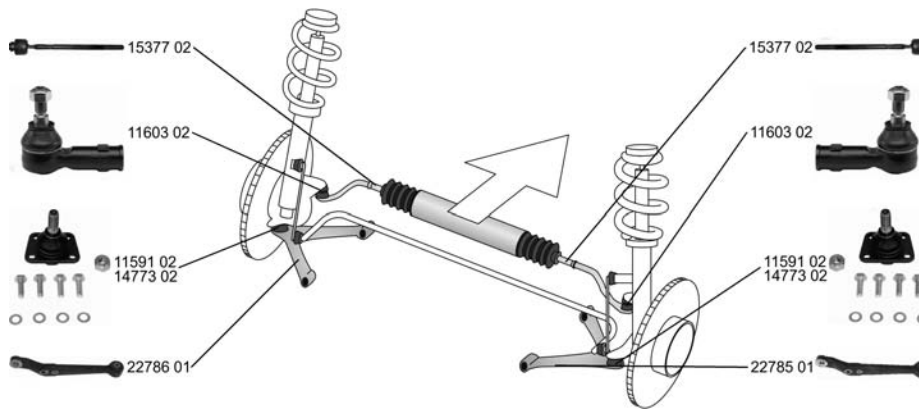
 Trag-/Führungsgelenk mit Zubehör ALL TYPES	 ->Chass. 00289710	14773 02 3640 17 
Faltenbalg, Lenkung ALL TYPES ausser : 1.8 11.81 - 01.94 2.5 D, 55 kW 11.81 - 01.94		15342 01 4066 19 
Faltenbalg, Lenkung ALL TYPES		30919 01 4066 18 
Faltenbalgsatz, Lenkung Innendurchmesser 1 [mm]: 11 Innendurchmesser 2 [mm]: 38 ALL TYPES		30132 01 4066 19 

C25 Kasten/Box/Furgón/Van (280_, 290_) 07.81 - 03.94

















Spurstangenkopf Konusmaß [mm]: 16 Innengewinde [mm]: M16x1,5 Gewindeart: mit Rechtsgewinde Gewindemaß: M16x1,5 ALL TYPES ausser : 2.5 D 11.81 - 02.94 2.5 TD 11.81 - 02.94		11603 02 3817 11 
Axialgelenk, Spurstange Gewindeart: mit Rechtsgewinde Gewindemaß: M16x1,5 ALL TYPES ausser : 2.5 D 11.81 - 02.94 2.5 TD 11.81 - 02.94	 	15377 02 3812 27 



CITROËN

**C25 Kasten/Box/Furgón/Van (280_,
290_)**

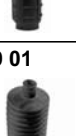
07.81 - 03.94

 Lenker, Radaufhängung ohne Trag-/Führungsgelenk mit Gummilager nur in Verbindung mit: 11591 Nutzlast [kg]: 1000 Nutzlast [kg]: 1400		22785 01 3521 52 																						
<table border="1"> <tr><td>2.0</td><td>02.91 - 03.94</td></tr> <tr><td>1.8</td><td>11.81 - 01.94</td></tr> <tr><td>2.0 E</td><td>09.81 - 03.94</td></tr> <tr><td>2.0 4x4</td><td>01.90 - 01.94</td></tr> <tr><td>1.9 D 1400</td><td>01.88 - 01.94</td></tr> <tr><td>1.9 D 4x4</td><td>01.88 - 01.94</td></tr> <tr><td>1.9 DT</td><td>10.91 - 01.94</td></tr> <tr><td>2.5 D</td><td>11.81 - 01.94</td></tr> <tr><td>2.5 D 4x4</td><td>11.83 - 12.86</td></tr> <tr><td>2.5 DT</td><td>08.91 - 01.94</td></tr> <tr><td>2.5 DT 4x4</td><td>08.91 - 01.94</td></tr> </table>	2.0	02.91 - 03.94	1.8	11.81 - 01.94	2.0 E	09.81 - 03.94	2.0 4x4	01.90 - 01.94	1.9 D 1400	01.88 - 01.94	1.9 D 4x4	01.88 - 01.94	1.9 DT	10.91 - 01.94	2.5 D	11.81 - 01.94	2.5 D 4x4	11.83 - 12.86	2.5 DT	08.91 - 01.94	2.5 DT 4x4	08.91 - 01.94	Chass. 00289711->	
2.0	02.91 - 03.94																							
1.8	11.81 - 01.94																							
2.0 E	09.81 - 03.94																							
2.0 4x4	01.90 - 01.94																							
1.9 D 1400	01.88 - 01.94																							
1.9 D 4x4	01.88 - 01.94																							
1.9 DT	10.91 - 01.94																							
2.5 D	11.81 - 01.94																							
2.5 D 4x4	11.83 - 12.86																							
2.5 DT	08.91 - 01.94																							
2.5 DT 4x4	08.91 - 01.94																							
Lenker, Radaufhängung ohne Trag-/Führungsgelenk mit Gummilager nur in Verbindung mit: 11591 Nutzlast [kg]: 1000 Nutzlast [kg]: 1400		22786 01 3520 76 																						
<table border="1"> <tr><td>2.0</td><td>02.91 - 03.94</td></tr> <tr><td>1.8</td><td>11.81 - 01.94</td></tr> <tr><td>2.0 E</td><td>09.81 - 03.94</td></tr> <tr><td>2.0 4x4</td><td>01.90 - 01.94</td></tr> <tr><td>1.9 D 1400</td><td>01.88 - 01.94</td></tr> <tr><td>1.9 D 4x4</td><td>01.88 - 01.94</td></tr> <tr><td>1.9 DT</td><td>10.91 - 01.94</td></tr> <tr><td>2.5 D</td><td>11.81 - 01.94</td></tr> <tr><td>2.5 D 4x4</td><td>11.83 - 12.86</td></tr> <tr><td>2.5 DT</td><td>08.91 - 01.94</td></tr> <tr><td>2.5 DT 4x4</td><td>08.91 - 01.94</td></tr> </table>	2.0	02.91 - 03.94	1.8	11.81 - 01.94	2.0 E	09.81 - 03.94	2.0 4x4	01.90 - 01.94	1.9 D 1400	01.88 - 01.94	1.9 D 4x4	01.88 - 01.94	1.9 DT	10.91 - 01.94	2.5 D	11.81 - 01.94	2.5 D 4x4	11.83 - 12.86	2.5 DT	08.91 - 01.94	2.5 DT 4x4	08.91 - 01.94	Chass. 00289711->	
2.0	02.91 - 03.94																							
1.8	11.81 - 01.94																							
2.0 E	09.81 - 03.94																							
2.0 4x4	01.90 - 01.94																							
1.9 D 1400	01.88 - 01.94																							
1.9 D 4x4	01.88 - 01.94																							
1.9 DT	10.91 - 01.94																							
2.5 D	11.81 - 01.94																							
2.5 D 4x4	11.83 - 12.86																							
2.5 DT	08.91 - 01.94																							
2.5 DT 4x4	08.91 - 01.94																							
Trag-/Führungsgelenk mit Zubehör		11591 02 3640 26 																						
<table border="1"> <tr><td colspan="2">ALL TYPES ausser :</td></tr> <tr><td>2.5 D</td><td>11.81 - 02.94</td></tr> <tr><td>2.5 TD</td><td>11.81 - 02.94</td></tr> </table>	ALL TYPES ausser :		2.5 D	11.81 - 02.94	2.5 TD	11.81 - 02.94	Chass. 289711->																	
ALL TYPES ausser :																								
2.5 D	11.81 - 02.94																							
2.5 TD	11.81 - 02.94																							
Trag-/Führungsgelenk mit Zubehör		14773 02 3640 17 																						
<table border="1"> <tr><td colspan="2">ALL TYPES ausser :</td></tr> <tr><td>2.5 D</td><td>11.81 - 02.94</td></tr> <tr><td>2.5 TD</td><td>11.81 - 02.94</td></tr> </table>	ALL TYPES ausser :		2.5 D	11.81 - 02.94	2.5 TD	11.81 - 02.94	->Chass. 00289710																	
ALL TYPES ausser :																								
2.5 D	11.81 - 02.94																							
2.5 TD	11.81 - 02.94																							
Faltenbalg, Lenkung <table border="1"> <tr><td>2.0 E</td><td>09.81 - 03.94</td></tr> <tr><td>2.0</td><td>02.91 - 03.94</td></tr> </table>	2.0 E	09.81 - 03.94	2.0	02.91 - 03.94		15342 01 4066 19 																		
2.0 E	09.81 - 03.94																							
2.0	02.91 - 03.94																							
Faltenbalg, Lenkung ALL TYPES ausser :		30919 01 4066 18 																						
<table border="1"> <tr><td>2.5 D</td><td>11.81 - 02.94</td></tr> <tr><td>2.5 TD</td><td>11.81 - 02.94</td></tr> </table>	2.5 D	11.81 - 02.94	2.5 TD	11.81 - 02.94																				
2.5 D	11.81 - 02.94																							
2.5 TD	11.81 - 02.94																							
Faltenbalgsatz, Lenkung Innendurchmesser 1 [mm]: 11 Innendurchmesser 2 [mm]: 38		30132 01 4066 19 																						
<table border="1"> <tr><td colspan="2">ALL TYPES ausser :</td></tr> <tr><td>2.5 D</td><td>11.81 - 02.94</td></tr> <tr><td>2.5 TD</td><td>11.81 - 02.94</td></tr> </table>	ALL TYPES ausser :		2.5 D	11.81 - 02.94	2.5 TD	11.81 - 02.94																		
ALL TYPES ausser :																								
2.5 D	11.81 - 02.94																							
2.5 TD	11.81 - 02.94																							









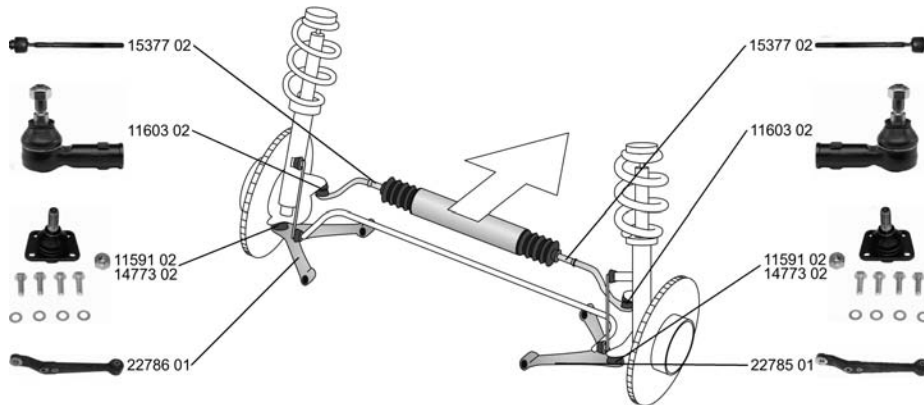













Ref.

CITROËN

C25 Pritsche, Fahrgestell / Flatbed, Chassis (280_, 290_) 07.81 - 03.94







<p>Spurstangenkopf Konusmaß [mm]: 16 Innengewinde [mm]: M16x1,5 Gewindeart: mit Rechtsgewinde Gewindemaß: M16x1,5</p> <p>ALL TYPES ausser : 2.5 D, TD</p>		<p>11603 02 3817 11</p> 
<p>Axialgelenk, Spurstange Gewindeart: mit Rechtsgewinde Gewindemaß: M16x1,5</p> <p>ALL TYPES ausser : 2.5 D, TD</p>	 	<p>15377 02 3812 27</p> 
<p>Lenker, Radaufhängung ohne Trag-/Führungsgelenk mit Gummilager nur in Verbindung mit: 11591 Nutzlast [kg]: 1000 Nutzlast [kg]: 1400</p> <p>ALL TYPES ausser : 2.5 D, TD</p>	 	<p>22785 01 3521 52</p> 
<p>Lenker, Radaufhängung ohne Trag-/Führungsgelenk mit Gummilager nur in Verbindung mit: 11591 Nutzlast [kg]: 1000 Nutzlast [kg]: 1400</p> <p>ALL TYPES ausser : 2.5 D, TD</p>	 	<p>22786 01 3520 76</p> 
<p>Trag-/Führungsgelenk mit Zubehör</p> <p>ALL TYPES ausser : 2.5 D, TD</p>	 	<p>11591 02 3640 26</p> 
<p>Trag-/Führungsgelenk mit Zubehör</p> <p>ALL TYPES ausser : 2.5 D, TD</p>	 	<p>14773 02 3640 17</p> 
<p>Faltenbalg, Lenkung</p> <p>2.0</p>	 	<p>15342 01 4066 19</p> 
<p>11.81 - 02.94</p>		









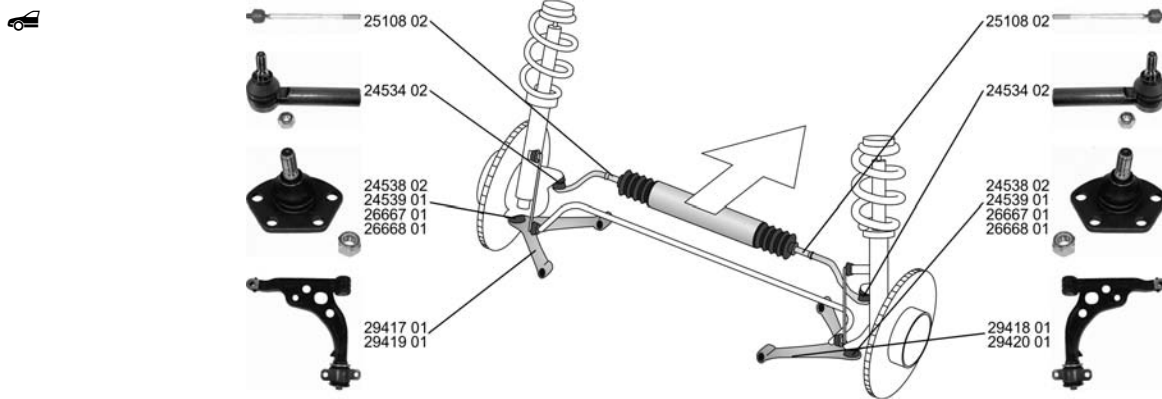

CITROËN

C25 Pritsche, Fahrgestell / Flatbed, Chassis (280_, 290_) 07.81 - 03.94

 Faltenbalg, Lenkung ALL TYPES ausser : 2.5 D, TD	11.81 - 02.94		30919 01  4066 18
Faltenbalgsatz, Lenkung Innendurchmesser 1 [mm]: 11 Innendurchmesser 2 [mm]: 38 ALL TYPES ausser : 2.5 D, TD	11.81 - 02.94		30132 01  4066 19

JUMPER Bus/Familial (230P) 02.94 - 04.02



Spurstangenkopf Gewindeart: mit Rechtsgewinde Gewindemaß: M16x1,5 ALL TYPES ausser : 2.8 TDi	01.98 -		24534 02  4018 A3
Axialgelenk, Spurstange ALL TYPES ausser : 2.8 TDi	01.98 -		25108 02  4018 A4
Lenker, Radaufhängung ALL TYPES ausser : 2.8 TDi	01.98 -		29417 01  3520 N3
Lenker, Radaufhängung 2.0 2.0 4x4 1.9 D 1.9 TD, 66 kW 1.9 TD 1.9 TD 4x4 2.5 D 2.5 D 4x4 2.5 TD 2.5 TD 4x4 2.5 TDi 2.8 HDi 2.8 HDi 4x4 2.5 TDi 4x4	02.94 - 04.02 08.96 - 04.02 01.99 - 04.02 08.94 - 04.02 02.94 - 04.02 08.96 - 04.02 08.94 - 04.02 08.96 - 04.02 08.94 - 04.02 08.96 - 04.02 08.94 - 04.02 12.96 - 11.00		29418 01  3521 J3











Ref.





CITROËN

JUMPER Bus/Familial (230P)

02.94 - 04.02

<p> Lenker, Radaufhängung ALL TYPES ausser : 2.8 TDi 01.98 -</p>	<p> zul. Gesamtgewicht [kg]:1800 ->Chass. 16194399 nur in Verbindung mit:OE 3640 54 ----- Chass. 16194400-> für Traggelenk ohne Einschränkung</p>	<p>29419 01 3520 N4 </p>																																																									
<p>Lenker, Radaufhängung ALL TYPES ausser : 2.8 TDi 01.98 -</p>	<p> zul. Gesamtgewicht [kg]:1800 ->Chass. 16194399 nur in Verbindung mit:OE 3640 54 ----- Chass. 16194400-> für Traggelenk ohne Einschränkung</p>	<p>29420 01 3521 J4 </p>																																																									
<p>Trag-/Führungsgelenk Gewindemaß: M16x1,5</p> <table border="0" style="width: 100%;"> <tr><td>2.0</td><td>02.94 - 04.02</td><td>->01.2001</td></tr> <tr><td>2.0 4x4</td><td>08.96 - 04.02</td><td>->Chass. 16194399</td></tr> <tr><td>1.9 D</td><td>01.99 - 04.02</td><td>nur in Verbindung mit:OE 3520 N3</td></tr> <tr><td>1.9 TD, 66 kW</td><td>08.94 - 04.02</td><td>nur in Verbindung mit:OE 3521 J3</td></tr> <tr><td>1.9 TD</td><td>02.94 - 04.02</td><td>Nutzlast [kg]:1000,1400</td></tr> <tr><td>1.9 TD 4x4</td><td>08.96 - 04.02</td><td>-----</td></tr> <tr><td>2.5 D</td><td>08.94 - 04.02</td><td>Chass. 16194400-></td></tr> <tr><td>2.5 D 4x4</td><td>08.96 - 04.02</td><td>ohne Einschränkung</td></tr> <tr><td>2.5 TD</td><td>08.94 - 04.02</td><td></td></tr> <tr><td>2.5 TD 4x4</td><td>08.96 - 04.02</td><td></td></tr> <tr><td>2.8 HDi</td><td>09.00 - 04.02</td><td></td></tr> <tr><td>2.8 HDi 4x4</td><td>09.00 - 04.02</td><td></td></tr> <tr><td>2.5 TDi</td><td>12.96 - 11.00</td><td>->Chass. 16194399</td></tr> <tr><td>2.5 TDi 4x4</td><td>12.96 - 11.00</td><td>nur in Verbindung mit:OE 3520 N3</td></tr> <tr><td></td><td></td><td>nur in Verbindung mit:OE 3521 J3</td></tr> <tr><td></td><td></td><td>Nutzlast [kg]:1000,1400</td></tr> <tr><td></td><td></td><td>-----</td></tr> <tr><td></td><td></td><td>Chass. 16194400-></td></tr> <tr><td></td><td></td><td>ohne Einschränkung</td></tr> </table>	2.0	02.94 - 04.02	->01.2001	2.0 4x4	08.96 - 04.02	->Chass. 16194399	1.9 D	01.99 - 04.02	nur in Verbindung mit:OE 3520 N3	1.9 TD, 66 kW	08.94 - 04.02	nur in Verbindung mit:OE 3521 J3	1.9 TD	02.94 - 04.02	Nutzlast [kg]:1000,1400	1.9 TD 4x4	08.96 - 04.02	-----	2.5 D	08.94 - 04.02	Chass. 16194400->	2.5 D 4x4	08.96 - 04.02	ohne Einschränkung	2.5 TD	08.94 - 04.02		2.5 TD 4x4	08.96 - 04.02		2.8 HDi	09.00 - 04.02		2.8 HDi 4x4	09.00 - 04.02		2.5 TDi	12.96 - 11.00	->Chass. 16194399	2.5 TDi 4x4	12.96 - 11.00	nur in Verbindung mit:OE 3520 N3			nur in Verbindung mit:OE 3521 J3			Nutzlast [kg]:1000,1400			-----			Chass. 16194400->			ohne Einschränkung	<p> ->01.2001 ->Chass. 16194399 nur in Verbindung mit:OE 3520 N3 nur in Verbindung mit:OE 3521 J3 Nutzlast [kg]:1000,1400 ----- Chass. 16194400-> ohne Einschränkung</p>	<p>24538 02 </p>
2.0	02.94 - 04.02	->01.2001																																																									
2.0 4x4	08.96 - 04.02	->Chass. 16194399																																																									
1.9 D	01.99 - 04.02	nur in Verbindung mit:OE 3520 N3																																																									
1.9 TD, 66 kW	08.94 - 04.02	nur in Verbindung mit:OE 3521 J3																																																									
1.9 TD	02.94 - 04.02	Nutzlast [kg]:1000,1400																																																									
1.9 TD 4x4	08.96 - 04.02	-----																																																									
2.5 D	08.94 - 04.02	Chass. 16194400->																																																									
2.5 D 4x4	08.96 - 04.02	ohne Einschränkung																																																									
2.5 TD	08.94 - 04.02																																																										
2.5 TD 4x4	08.96 - 04.02																																																										
2.8 HDi	09.00 - 04.02																																																										
2.8 HDi 4x4	09.00 - 04.02																																																										
2.5 TDi	12.96 - 11.00	->Chass. 16194399																																																									
2.5 TDi 4x4	12.96 - 11.00	nur in Verbindung mit:OE 3520 N3																																																									
		nur in Verbindung mit:OE 3521 J3																																																									
		Nutzlast [kg]:1000,1400																																																									

		Chass. 16194400->																																																									
		ohne Einschränkung																																																									
<p>Trag-/Führungsgelenk maximale Last [kg]: 1800 Gewindemaß: M18x1,5</p> <table border="0" style="width: 100%;"> <tr><td>2.0</td><td>02.94 - 04.02</td><td>->01.2001</td></tr> <tr><td>2.0 4x4</td><td>08.96 - 04.02</td><td>->Chass. 16194399</td></tr> <tr><td>1.9 D</td><td>01.99 - 04.02</td><td>nur in Verbindung mit:OE 3520 N4</td></tr> <tr><td>1.9 TD, 66 kW</td><td>08.94 - 04.02</td><td>nur in Verbindung mit:OE 3521 J4</td></tr> <tr><td>1.9 TD</td><td>02.94 - 04.02</td><td>Nutzlast [kg]:1800</td></tr> <tr><td>1.9 TD 4x4</td><td>08.96 - 04.02</td><td>-----</td></tr> <tr><td>2.5 D</td><td>08.94 - 04.02</td><td>Chass. 16194400-></td></tr> <tr><td>2.5 D 4x4</td><td>08.96 - 04.02</td><td>ohne Einschränkung</td></tr> <tr><td>2.5 TD</td><td>08.94 - 04.02</td><td></td></tr> <tr><td>2.5 TD 4x4</td><td>08.96 - 04.02</td><td></td></tr> <tr><td>2.8 HDi</td><td>09.00 - 04.02</td><td></td></tr> <tr><td>2.8 HDi 4x4</td><td>09.00 - 04.02</td><td></td></tr> <tr><td>2.5 TDi</td><td>12.96 - 11.00</td><td>->Chass. 16194399</td></tr> <tr><td>2.5 TDi 4x4</td><td>12.96 - 11.00</td><td>nur in Verbindung mit:OE 3520 N4</td></tr> <tr><td></td><td></td><td>nur in Verbindung mit:OE 3521 J4</td></tr> <tr><td></td><td></td><td>Nutzlast [kg]:1800</td></tr> <tr><td></td><td></td><td>-----</td></tr> <tr><td></td><td></td><td>Chass. 16194400-></td></tr> <tr><td></td><td></td><td>ohne Einschränkung</td></tr> </table>	2.0	02.94 - 04.02	->01.2001	2.0 4x4	08.96 - 04.02	->Chass. 16194399	1.9 D	01.99 - 04.02	nur in Verbindung mit:OE 3520 N4	1.9 TD, 66 kW	08.94 - 04.02	nur in Verbindung mit:OE 3521 J4	1.9 TD	02.94 - 04.02	Nutzlast [kg]:1800	1.9 TD 4x4	08.96 - 04.02	-----	2.5 D	08.94 - 04.02	Chass. 16194400->	2.5 D 4x4	08.96 - 04.02	ohne Einschränkung	2.5 TD	08.94 - 04.02		2.5 TD 4x4	08.96 - 04.02		2.8 HDi	09.00 - 04.02		2.8 HDi 4x4	09.00 - 04.02		2.5 TDi	12.96 - 11.00	->Chass. 16194399	2.5 TDi 4x4	12.96 - 11.00	nur in Verbindung mit:OE 3520 N4			nur in Verbindung mit:OE 3521 J4			Nutzlast [kg]:1800			-----			Chass. 16194400->			ohne Einschränkung	<p> ->01.2001 ->Chass. 16194399 nur in Verbindung mit:OE 3520 N4 nur in Verbindung mit:OE 3521 J4 Nutzlast [kg]:1800 ----- Chass. 16194400-> ohne Einschränkung</p>	<p>24539 01 3640 33 </p>
2.0	02.94 - 04.02	->01.2001																																																									
2.0 4x4	08.96 - 04.02	->Chass. 16194399																																																									
1.9 D	01.99 - 04.02	nur in Verbindung mit:OE 3520 N4																																																									
1.9 TD, 66 kW	08.94 - 04.02	nur in Verbindung mit:OE 3521 J4																																																									
1.9 TD	02.94 - 04.02	Nutzlast [kg]:1800																																																									
1.9 TD 4x4	08.96 - 04.02	-----																																																									
2.5 D	08.94 - 04.02	Chass. 16194400->																																																									
2.5 D 4x4	08.96 - 04.02	ohne Einschränkung																																																									
2.5 TD	08.94 - 04.02																																																										
2.5 TD 4x4	08.96 - 04.02																																																										
2.8 HDi	09.00 - 04.02																																																										
2.8 HDi 4x4	09.00 - 04.02																																																										
2.5 TDi	12.96 - 11.00	->Chass. 16194399																																																									
2.5 TDi 4x4	12.96 - 11.00	nur in Verbindung mit:OE 3520 N4																																																									
		nur in Verbindung mit:OE 3521 J4																																																									
		Nutzlast [kg]:1800																																																									









		Chass. 16194400->																																																									
		ohne Einschränkung																																																									
<p>Trag-/Führungsgelenk nur in Verbindung mit: 29417 nur in Verbindung mit: 29418 maximale Last [kg]: 1400 ALL TYPES ausser : 2.8 TDi 01.98 -</p>	<p> 02.2001-></p>	<p>26667 01 3640 55 </p>																																																									
<p>Trag-/Führungsgelenk nur in Verbindung mit: 29419 nur in Verbindung mit: 29420 maximale Last [kg]: 1800 mit Zubehör ALL TYPES ausser : 2.8 TDi 01.98 -</p>	<p> 02.2001-></p>	<p>26668 01 3640 54 </p>																																																									



CITROËN

JUMPER Bus/Familial (230P)



02.94 - 04.02

 Faltenbaldsatz, Lenkung 2.0 4x4 1.9 TD, 68 kW 1.9 TD 4x4 2.5 D 4x4 2.5 TD 4x4 2.5 TDi 4x4 2.8 HDi 4x4	08.96 - 04.02	 nur in Verbindung mit:LEMFÖRDER 30203	 30198 01	4006 22
	02.94 - 04.02			
1.9 TD, 66 kW 2.5 D 2.5 TD 2.5 TDi 2.8 HDi	02.94 - 04.02	 nur in Verbindung mit:Lemförder 30203	 30203 01	4006 22
	01.99 - 04.02			
Faltenbaldsatz, Lenkung 2.0 4x4 1.9 TD, 68 kW 1.9 TD 4x4 2.5 D 4x4 2.5 TD 4x4 2.5 TDi 4x4 2.8 HDi 4x4	08.96 - 04.02	 nur in Verbindung mit:LEMFÖRDER 30198	 30198	4006 22
	02.94 - 04.02			
1.9 D 1.9 TD, 66 kW 2.5 D 2.5 TD 2.5 TDi 2.8 HDi	02.94 - 04.02	 nur in Verbindung mit:Lemförder 30198	 30198	4006 22
	01.99 - 04.02			

JUMPER Kasten/Box/Furgón/Van (230L)

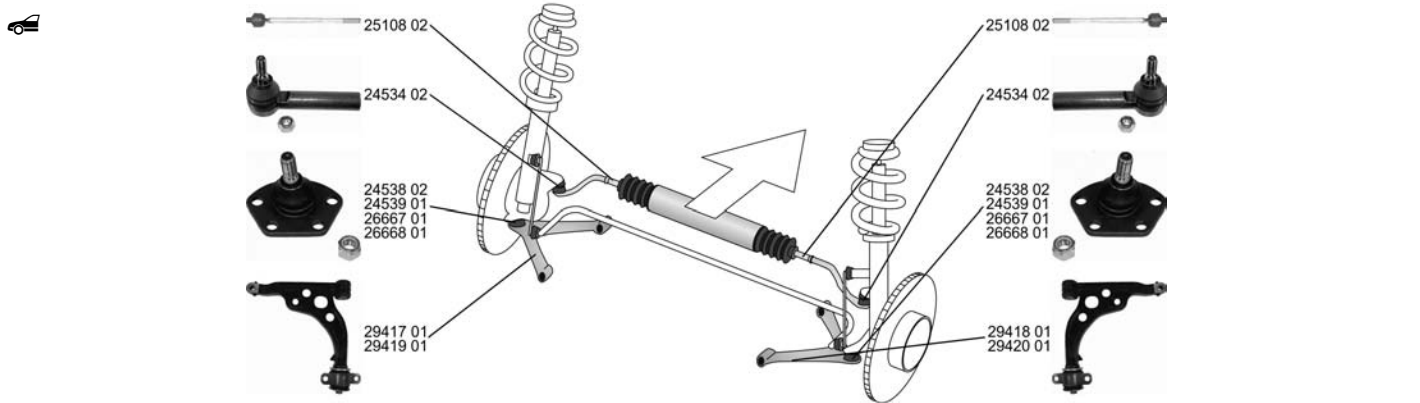
02.94 - 04.02



Spurstangenkopf Gewindeart: mit Rechtsgewinde Gewindemaß: M16x1,5 ALL TYPES	↔	 24534 02	4018 A3
Axialgelenk, Spurstange ALL TYPES	↔	 25108 02	4018 A4
Lenker, Radaufhängung ALL TYPES ausser : 2.5 D 4X4	03.00 - 04.02 zul. Gesamtgewicht [kg]:1000 zul. Gesamtgewicht [kg]:1400 ->Chass. 16194399 nur in Verbindung mit:OE 3640 55 ----- Chass. 16194400-> für Tragelenk ohne Einschränkung	 29417 01	3520 N3













Ref.

CITROËN

JUMPER Kasten/Box/Furgón/Van (230L)

02.94 - 04.02

<p> Lenker, Radaufhängung</p> <p>ALL TYPES ausser :</p> <table border="1"> <tr> <td>2.0 4x4</td> <td>10.96 - 01.02</td> </tr> <tr> <td>2.5 DT 4x4</td> <td>10.96 - 08.97</td> </tr> </table>	2.0 4x4	10.96 - 01.02	2.5 DT 4x4	10.96 - 08.97	<p></p> <p>zul. Gesamtgewicht [kg]:1000 zul. Gesamtgewicht [kg]:1400 ->Chass. 16194399 nur in Verbindung mit:OE 3640 55</p> <p>-----</p> <p>Chass. 16194400-> für Tragelenk ohne Einschränkung</p>	<p>29418 01 3521 J3</p> 																						
2.0 4x4	10.96 - 01.02																											
2.5 DT 4x4	10.96 - 08.97																											
<p>Lenker, Radaufhängung</p> <p>ALL TYPES ausser :</p> <table border="1"> <tr> <td>2.0 4x4</td> <td>10.96 - 01.02</td> </tr> <tr> <td>2.5 DT 4x4</td> <td>10.96 - 08.97</td> </tr> </table>	2.0 4x4	10.96 - 01.02	2.5 DT 4x4	10.96 - 08.97	<p></p> <p>zul. Gesamtgewicht [kg]:1800 ->Chass. 16194399 nur in Verbindung mit:OE 3640 54</p> <p>-----</p> <p>Chass. 16194400-> für Tragelenk ohne Einschränkung</p>	<p>29419 01 3520 N4</p> 																						
2.0 4x4	10.96 - 01.02																											
2.5 DT 4x4	10.96 - 08.97																											
<p>Lenker, Radaufhängung</p> <p>ALL TYPES</p>	<p></p> <p>zul. Gesamtgewicht [kg]:1800 ->Chass. 16194399 nur in Verbindung mit:OE 3640 54</p> <p>-----</p> <p>Chass. 16194400-> für Tragelenk ohne Einschränkung</p>	<p>29420 01 3521 J4</p> 																										
<p>Trag-/Führungsgelenk Gewindemaß: M16x1,5</p> <table border="1"> <tr> <td>2.0</td> <td>03.94 - 04.02</td> </tr> <tr> <td>1.9 D, 50 kW</td> <td>07.99 - 04.02</td> </tr> <tr> <td>2.0 4x4</td> <td>10.96 - 01.02</td> </tr> <tr> <td>1.9 D, 51 kW</td> <td>02.94 - 04.02</td> </tr> <tr> <td>1.9 TD, 66 kW</td> <td>03.94 - 04.02</td> </tr> <tr> <td>1.9 TD, 68 kW</td> <td>03.94 - 04.02</td> </tr> <tr> <td>2.0 HDi</td> <td>11.01 - 04.02</td> </tr> <tr> <td>2.5 D</td> <td>03.94 - 04.02</td> </tr> <tr> <td>2.5 D 4X4</td> <td>03.00 - 04.02</td> </tr> <tr> <td>2.5 TD</td> <td>03.94 - 04.02</td> </tr> <tr> <td>2.5 DT 4x4</td> <td>10.96 - 08.97</td> </tr> <tr> <td>2.8 HDi</td> <td>09.00 - 04.02</td> </tr> <tr> <td>2.8 HDi 4x4</td> <td>09.00 - 04.02</td> </tr> </table>	2.0	03.94 - 04.02	1.9 D, 50 kW	07.99 - 04.02	2.0 4x4	10.96 - 01.02	1.9 D, 51 kW	02.94 - 04.02	1.9 TD, 66 kW	03.94 - 04.02	1.9 TD, 68 kW	03.94 - 04.02	2.0 HDi	11.01 - 04.02	2.5 D	03.94 - 04.02	2.5 D 4X4	03.00 - 04.02	2.5 TD	03.94 - 04.02	2.5 DT 4x4	10.96 - 08.97	2.8 HDi	09.00 - 04.02	2.8 HDi 4x4	09.00 - 04.02	<p></p> <p>->01.2001 ->Chass. 16194399 nur in Verbindung mit:OE 3520 N3 nur in Verbindung mit:OE 3521 J3 Nutzlast [kg]:1000,1400</p> <p>-----</p> <p>Chass. 16194400-> ohne Einschränkung</p>	<p>24538 02</p> 
2.0	03.94 - 04.02																											
1.9 D, 50 kW	07.99 - 04.02																											
2.0 4x4	10.96 - 01.02																											
1.9 D, 51 kW	02.94 - 04.02																											
1.9 TD, 66 kW	03.94 - 04.02																											
1.9 TD, 68 kW	03.94 - 04.02																											
2.0 HDi	11.01 - 04.02																											
2.5 D	03.94 - 04.02																											
2.5 D 4X4	03.00 - 04.02																											
2.5 TD	03.94 - 04.02																											
2.5 DT 4x4	10.96 - 08.97																											
2.8 HDi	09.00 - 04.02																											
2.8 HDi 4x4	09.00 - 04.02																											
<p>Trag-/Führungsgelenk maximale Last [kg]: 1800 Gewindemaß: M18x1,5</p> <table border="1"> <tr> <td>2.0</td> <td>03.94 - 04.02</td> </tr> <tr> <td>1.9 D, 50 kW</td> <td>07.99 - 04.02</td> </tr> <tr> <td>2.0 4x4</td> <td>10.96 - 01.02</td> </tr> <tr> <td>1.9 D, 51 kW</td> <td>02.94 - 04.02</td> </tr> <tr> <td>1.9 TD, 66 kW</td> <td>03.94 - 04.02</td> </tr> <tr> <td>1.9 TD, 68 kW</td> <td>03.94 - 04.02</td> </tr> <tr> <td>2.0 HDi</td> <td>11.01 - 04.02</td> </tr> <tr> <td>2.5 D</td> <td>03.94 - 04.02</td> </tr> <tr> <td>2.5 D 4X4</td> <td>03.00 - 04.02</td> </tr> <tr> <td>2.5 TD</td> <td>03.94 - 04.02</td> </tr> <tr> <td>2.5 DT 4x4</td> <td>10.96 - 08.97</td> </tr> <tr> <td>2.8 HDi</td> <td>09.00 - 04.02</td> </tr> <tr> <td>2.8 HDi 4x4</td> <td>09.00 - 04.02</td> </tr> </table>	2.0	03.94 - 04.02	1.9 D, 50 kW	07.99 - 04.02	2.0 4x4	10.96 - 01.02	1.9 D, 51 kW	02.94 - 04.02	1.9 TD, 66 kW	03.94 - 04.02	1.9 TD, 68 kW	03.94 - 04.02	2.0 HDi	11.01 - 04.02	2.5 D	03.94 - 04.02	2.5 D 4X4	03.00 - 04.02	2.5 TD	03.94 - 04.02	2.5 DT 4x4	10.96 - 08.97	2.8 HDi	09.00 - 04.02	2.8 HDi 4x4	09.00 - 04.02	<p></p> <p>->01.2001 ->Chass. 16194399 nur in Verbindung mit:OE 3520 N4 nur in Verbindung mit:OE 3521 J4 Nutzlast [kg]:1800</p> <p>-----</p> <p>Chass. 16194400-> ohne Einschränkung</p>	<p>24539 01 3640 J3</p> 
2.0	03.94 - 04.02																											
1.9 D, 50 kW	07.99 - 04.02																											
2.0 4x4	10.96 - 01.02																											
1.9 D, 51 kW	02.94 - 04.02																											
1.9 TD, 66 kW	03.94 - 04.02																											
1.9 TD, 68 kW	03.94 - 04.02																											
2.0 HDi	11.01 - 04.02																											
2.5 D	03.94 - 04.02																											
2.5 D 4X4	03.00 - 04.02																											
2.5 TD	03.94 - 04.02																											
2.5 DT 4x4	10.96 - 08.97																											
2.8 HDi	09.00 - 04.02																											
2.8 HDi 4x4	09.00 - 04.02																											

















Ref.

CITROËN

JUMPER Pritsche, Fahrgestell / Flatbed, Chassis (230)

03.94 - 04.02







<p> Lenker, Radaufhängung ALL TYPES ausser : 2.8 HDi, 93 kW 10.00 - 01.02</p>	<p> zul. Gesamtgewicht [kg]:1000 zul. Gesamtgewicht [kg]:1400 ->Chass. 16194399 nur in Verbindung mit:OE 3640 55 ----- Chass. 16194400-> für Traggelenk ohne Einschränkung</p>	<p>29418 01 3521 J3 </p>
<p>Lenker, Radaufhängung ALL TYPES ausser : 2.8 HDi, 93 kW 10.00 - 01.02</p>	<p> zul. Gesamtgewicht [kg]:1800 ->Chass. 16194399 nur in Verbindung mit:OE 3640 54 ----- Chass. 16194400-> für Traggelenk ohne Einschränkung</p>	<p>29419 01 3520 N4 </p>
<p>Lenker, Radaufhängung ALL TYPES ausser : 2.8 HDi, 93 kW 10.00 - 01.02</p>	<p> zul. Gesamtgewicht [kg]:1800 ->Chass. 16194399 nur in Verbindung mit:OE 3640 54 ----- Chass. 16194400-> für Traggelenk ohne Einschränkung</p>	<p>29420 01 3521 J4 </p>
<p>Trag-/Führungsgelenk Gewindemaß: M16x1,5 ALL TYPES ausser : 2.8 HDi, 93 kW 10.00 - 01.02</p>	<p> ->01.2001 ->Chass. 16194399 nur in Verbindung mit:OE 3520 N3 nur in Verbindung mit:OE 3521 J3 Nutzlast [kg]:1000,1400 ----- Chass. 16194400-> ohne Einschränkung</p>	<p>24538 02 </p>
<p>Trag-/Führungsgelenk maximale Last [kg]: 1800 Gewindemaß: M18x1,5 ALL TYPES ausser : 2.8 HDi, 93 kW 10.00 - 01.02</p>	<p> ->01.2001 ->Chass. 16194399 nur in Verbindung mit:OE 3520 N4 nur in Verbindung mit:OE 3521 J4 Nutzlast [kg]:1800 ----- Chass. 16194400-> ohne Einschränkung</p>	<p>24539 01 3640 33 </p>
<p>Trag-/Führungsgelenk nur in Verbindung mit: 29417 nur in Verbindung mit: 29418 maximale Last [kg]: 1400 ALL TYPES ausser : 2.8 HDi, 93 kW 10.00 - 01.02</p>	<p> 02.2001-></p>	<p>26667 01 3640 55 </p>
<p>Trag-/Führungsgelenk nur in Verbindung mit: 29419 nur in Verbindung mit: 29420 maximale Last [kg]: 1800 mit Zubehör ALL TYPES ausser : 2.8 HDi, 93 kW 10.00 - 01.02</p>	<p> 02.2001-></p>	<p>26668 01 3640 54 </p>



CITROËN

JUMPER Pritsche,Fahrgestell / Flatbed,Chassis (230)





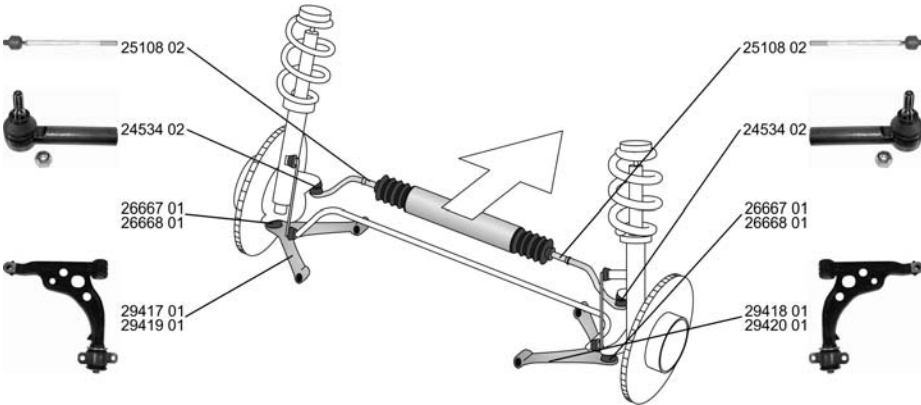

03.94 - 04.02

	Faltenbalgsatz, Lenkung		30198 01	4006 22
	2.5 D	03.94 - 04.02	 nur in Verbindung mit:LEMFÖRDER 30203	
	2.0	03.94 - 04.02	 nur in Verbindung mit:Lemförder 30203	
	1.9 TD, 66 kW	03.94 - 04.02		
	1.9 TD, 68 kW	03.94 - 04.02		
	2.5 D 4X4	03.00 - 04.02		
	2.5 TD	03.94 - 04.02		
	2.5 TDi	12.96 - 04.02		
	2.5 TDi 4X4	03.00 - 04.02		
	2.8 HDi, 93 kW	10.00 - 01.02		
	2.8 HDi, 94 kW	09.00 - 04.02		
	Faltenbalgsatz, Lenkung		30203 01	4006 22
	2.5 D	03.94 - 04.02	 nur in Verbindung mit:LEMFÖRDER 30198	
	2.0	03.94 - 04.02	 nur in Verbindung mit:Lemförder 30198	
	1.9 TD, 66 kW	03.94 - 04.02		
	1.9 TD, 68 kW	03.94 - 04.02		
	2.5 D 4X4	03.00 - 04.02		
	2.5 TD	03.94 - 04.02		
	2.5 TDi	12.96 - 04.02		
	2.5 TDi 4X4	03.00 - 04.02		
	2.8 HDi, 93 kW	10.00 - 01.02		
	2.8 HDi, 94 kW	09.00 - 04.02		

JUMPER Bus/Familial (244, Z_)

04.02 -



















Spurstangenkopf Gewindeart: mit Rechtsgewinde Gewindemaß: M16x1,5		24534 02	4018 A3
ALL TYPES	->12.2002		
Axialgelenk, Spurstange		25108 02	4018 A4
ALL TYPES			
Lenker, Radaufhängung		29417 01	3520 N3
ALL TYPES	zul. Gesamtgewicht [kg]:1000 zul. Gesamtgewicht [kg]:1400 ->Chass. 16194399 nur in Verbindung mit:OE 3640 55 Chass. 16194400-> für Tragelenk ohne Einschränkung		



Ref.

CITROËN

JUMPER Bus/Familial (244, Z_) 04.02 -

 Lenker, Radaufhängung ALL TYPES		29418 01 3521 J3
	zul. Gesamtgewicht [kg]:1000 zul. Gesamtgewicht [kg]:1400 ->Chass. 16194399 nur in Verbindung mit:OE 3640 55 ----- Chass. 16194400-> für Trag gelenk ohne Einschränkung	
Lenker, Radaufhängung ALL TYPES		29419 01 3520 N4
	zul. Gesamtgewicht [kg]:1800 ->Chass. 16194399 nur in Verbindung mit:OE 3640 54 ----- Chass. 16194400-> für Trag gelenk ohne Einschränkung	
Lenker, Radaufhängung ALL TYPES		29420 01 3521 J4
	zul. Gesamtgewicht [kg]:1800 ->Chass. 16194399 nur in Verbindung mit:OE 3640 54 ----- Chass. 16194400-> für Trag gelenk ohne Einschränkung	
Trag-/Führungsgelenk nur in Verbindung mit: 29417 nur in Verbindung mit: 29418 maximale Last [kg]: 1400 ALL TYPES		26667 01 3640 55 
Trag-/Führungsgelenk nur in Verbindung mit: 29419 nur in Verbindung mit: 29420 maximale Last [kg]: 1800 mit Zubehör ALL TYPES		26668 01 3640 54 
Faltenbalgsatz, Lenkung		30198 01 4006 22
2.0 04.02 - 2.0 HDi 04.02 - 2.0 bivalent 02.03 - 2.2 HDi 04.02 - 2.8 HDi 04.02 -	 nur in Verbindung mit:LEMFÖRDER 30203  nur in Verbindung mit:Lemförder 30203	
Faltenbalgsatz, Lenkung		30203 01 4006 22
2.0 04.02 - 2.0 HDi 04.02 - 2.0 bivalent 02.03 - 2.2 HDi 04.02 - 2.8 HDi 04.02 -	 nur in Verbindung mit:LEMFÖRDER 30198  nur in Verbindung mit:Lemförder 30198	







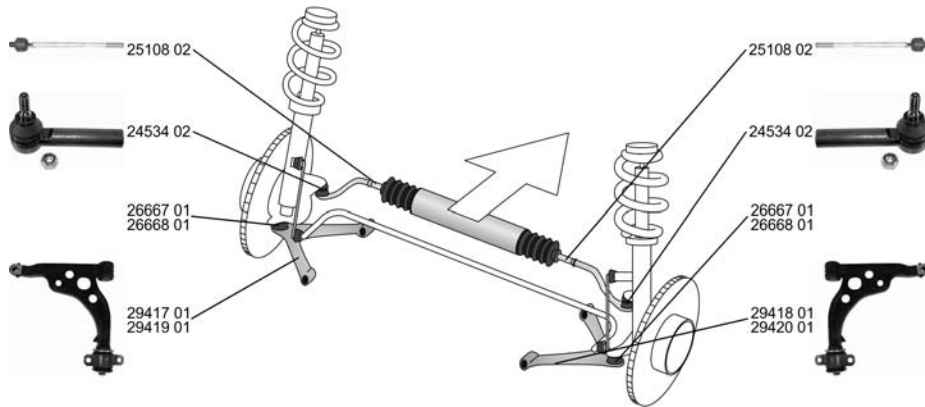

CITROËN

**JUMPER Kasten/Box/Furgón/Van
(244)**

04.02 -



<p>Spurstangenkopf Gewindeart: mit Rechtsgewinde Gewindemaß: M16x1,5</p> <p>ALL TYPES ausser : 2.0 bivalent 2.8 HDi, 107 kW</p>	<p>↔</p> <p>->12.2002</p>	<p>24534 02 4018 A3</p> 
<p>Axialgelenk, Spurstange ALL TYPES</p>	<p>↔</p>	<p>25108 02 4018 A4</p> 
<p>Lenker, Radaufhängung ALL TYPES</p>	<p>▽↻</p> <p>zul. Gesamtgewicht [kg]:1000 zul. Gesamtgewicht [kg]:1400 ->Chass. 16194399 nur in Verbindung mit:OE 3640 55</p> <p>----- Chass. 16194400-> für Tragelenk ohne Einschränkung</p>	<p>29417 01 3520 N3</p> 
<p>Lenker, Radaufhängung ALL TYPES</p>	<p>▽↻</p> <p>zul. Gesamtgewicht [kg]:1000 zul. Gesamtgewicht [kg]:1400 ->Chass. 16194399 nur in Verbindung mit:OE 3640 55</p> <p>----- Chass. 16194400-> für Tragelenk ohne Einschränkung</p>	<p>29418 01 3521 J3</p> 
<p>Lenker, Radaufhängung ALL TYPES</p>	<p>▽↻</p> <p>zul. Gesamtgewicht [kg]:1800 ->Chass. 16194399 nur in Verbindung mit:OE 3640 54</p> <p>----- Chass. 16194400-> für Tragelenk ohne Einschränkung</p>	<p>29419 01 3520 N4</p> 
<p>Lenker, Radaufhängung ALL TYPES</p>	<p>▽↻</p> <p>zul. Gesamtgewicht [kg]:1800 ->Chass. 16194399 nur in Verbindung mit:OE 3640 54</p> <p>----- Chass. 16194400-> für Tragelenk ohne Einschränkung</p>	<p>29420 01 3521 J4</p> 
<p>Trag-/Führungsgelenk nur in Verbindung mit: 29417 nur in Verbindung mit: 29418 maximale Last [kg]: 1400</p> <p>ALL TYPES</p>	<p>▽↻↔</p>	<p>26667 01 3640 55</p> 











Ref.

CITROËN











JUMPER Kasten/Box/Furgón/Van (244)

04.02 -

	Trag-/Führungsgelenk nur in Verbindung mit: 29419 nur in Verbindung mit: 29420 maximale Last [kg]: 1800 mit Zubehör		26668 01	3640 54
ALL TYPES				
	Faltenbalgsatz, Lenkung		30198 01	4006 22
2.0	04.02 -	 nur in Verbindung mit:LEMFÖRDER 30203		
2.0 HDi	04.02 -	 nur in Verbindung mit:Lemförder 30203		
2.0 bivalent	02.03 -			
2.2 HDi	04.02 -			
2.8 HDi, 94 kW	04.02 -			
2.8 HDi 4x4	04.02 -			
2.8 HDi, 107 kW	05.04 -			
	Faltenbalgsatz, Lenkung		30203 01	4006 22
2.0	04.02 -	 nur in Verbindung mit:LEMFÖRDER 30198		
2.0 HDi	04.02 -	 nur in Verbindung mit:Lemförder 30198		
2.0 bivalent	02.03 -			
2.2 HDi	04.02 -			
2.8 HDi, 94 kW	04.02 -			
2.8 HDi 4x4	04.02 -			
2.8 HDi, 107 kW	05.04 -			

JUMPER Pritsche,Fahrgestell / Flatbed,Chassis (244)

04.02 -

	Spurstangenkopf Gewindeart: mit Rechtsgewinde Gewindemaß: M16x1,5		24534 02	4018 A3
ALL TYPES		->12.2002		
	Axialgelenk, Spurstange			
ALL TYPES				
	Lenker, Radaufhängung			
ALL TYPES		zul. Gesamtgewicht [kg]:1000 zul. Gesamtgewicht [kg]:1400 ->Chass. 16194399 nur in Verbindung mit:OE 3640 55 ----- Chass. 16194400-> für Tragelenk ohne Einschränkung		
	Lenker, Radaufhängung			
ALL TYPES		zul. Gesamtgewicht [kg]:1000 zul. Gesamtgewicht [kg]:1400 ->Chass. 16194399 nur in Verbindung mit:OE 3640 55 ----- Chass. 16194400-> für Tragelenk ohne Einschränkung		
	Lenker, Radaufhängung			
ALL TYPES		zul. Gesamtgewicht [kg]:1800 ->Chass. 16194399 nur in Verbindung mit:OE 3640 54 ----- Chass. 16194400-> für Tragelenk ohne Einschränkung		



CITROËN

JUMPER Pritsche, Fahrgestell / Flatbed, Chassis (244)

04.02 -

	Lenker, Radaufhängung		29420 01	3521 J4
	ALL TYPES	zul. Gesamtgewicht [kg]: 1800 ->Chass. 16194399 nur in Verbindung mit: OE 3640 54 ----- Chass. 16194400-> für Tragelenk ohne Einschränkung		
	Trag-/Führungsgelenk nur in Verbindung mit: 29417 nur in Verbindung mit: 29418 maximale Last [kg]: 1400		26667 01	3640 55
	ALL TYPES			
	Trag-/Führungsgelenk nur in Verbindung mit: 29419 nur in Verbindung mit: 29420 maximale Last [kg]: 1800 mit Zubehör		26668 01	3640 54
	ALL TYPES			
	Faltenbalgsatz, Lenkung		30198 01	4006 22
	2.0 HDi 04.02 - 2.2 HDi 02.02 - 06.06 2.8 HDi 4x4 02.02 - 06.06 2.8 HDi, 107 kW 04.04 - 06.06		nur in Verbindung mit: LEMFÖRDER 30203	
	2.2 HDi 04.02 - 2.8 HDi, 94 kW 04.02 - 2.8 HDi, 107 kW 05.04 -		nur in Verbindung mit: Lemförder 30203	
	Faltenbalgsatz, Lenkung		30203 01	4006 22
	2.0 HDi 04.02 - 2.2 HDi 02.02 - 06.06 2.8 HDi 4x4 02.02 - 06.06 2.8 HDi, 107 kW 04.04 - 06.06		nur in Verbindung mit: LEMFÖRDER 30198	
	2.2 HDi 04.02 - 2.8 HDi, 94 kW 04.02 - 2.8 HDi, 107 kW 05.04 -		nur in Verbindung mit: Lemförder 30198	

JUMPER Bus

04.06 -

	Trag-/Führungsgelenk Konusmaß [mm]: 24		31196 01	3640 67
	ALL TYPES			
	Stange/Strebe, Stabilisator Pendelstange Rohr-Ø [mm]: 8 Gewindemaß: M10 x 1,5		31351 01	5170 F5
	ALL TYPES			

JUMPER Kasten

04.06 -



	Trag-/Führungsgelenk Konusmaß [mm]: 24		31196 01	3640 67
	ALL TYPES			







Ref.

CITROËN

JUMPER Kasten 04.06 -

 Stange/Strebe, Stabilisator Pendelstange Rohr-Ø [mm]: 8 Gewindemaß: M10 x 1,5 ALL TYPES		31351 01 5170 F5 
--	--	--

JUMPER Pritsche/Fahrgestell 04.06 -

 Trag-/Führungsgelenk Konusmaß [mm]: 24 ALL TYPES		31196 01 3640 67 
 Stange/Strebe, Stabilisator Pendelstange Rohr-Ø [mm]: 8 Gewindemaß: M10 x 1,5 ALL TYPES		31351 01 5170 F5 

JUMPY (U6U) 06.94 -

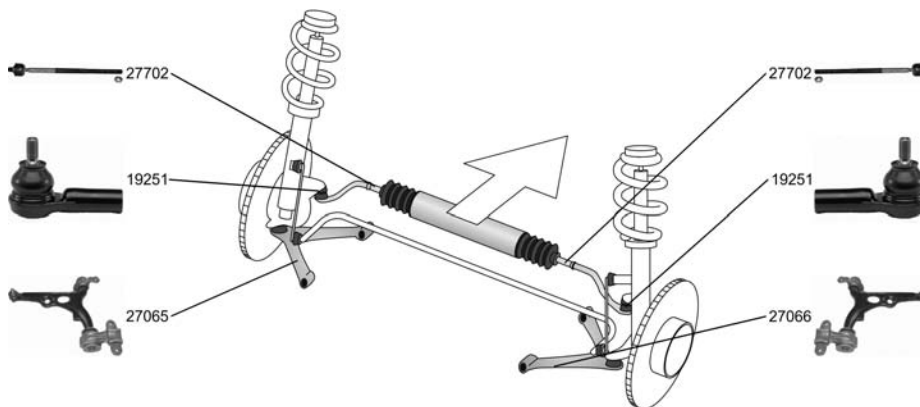



Spurstangenkopf Gewindeart: mit Rechtsgewinde Innengewinde [mm]: M14x1,5 mit Zubehör ALL TYPES ausser : 2.2 HDi 12.03 - 10.06	 ->Orga 09792	19251 03 4059 09 
Axialgelenk, Spurstange Aussengewinde [mm]: M14x1,5 ALL TYPES ausser : 2.2 HDi 12.03 - 10.06		27702 01 3812 A4 
Lenker, Radaufhängung mit Trag-/Führungsgelenk mit Gummilager mit Befestigungsmaterial ALL TYPES ausser : 2.2 HDi 12.03 - 10.06		27065 02 3520 P4 
Lenker, Radaufhängung mit Trag-/Führungsgelenk mit Gummilager mit Befestigungsmaterial ALL TYPES ausser : 2.2 HDi 12.03 - 10.06		27066 02 3521 K4 











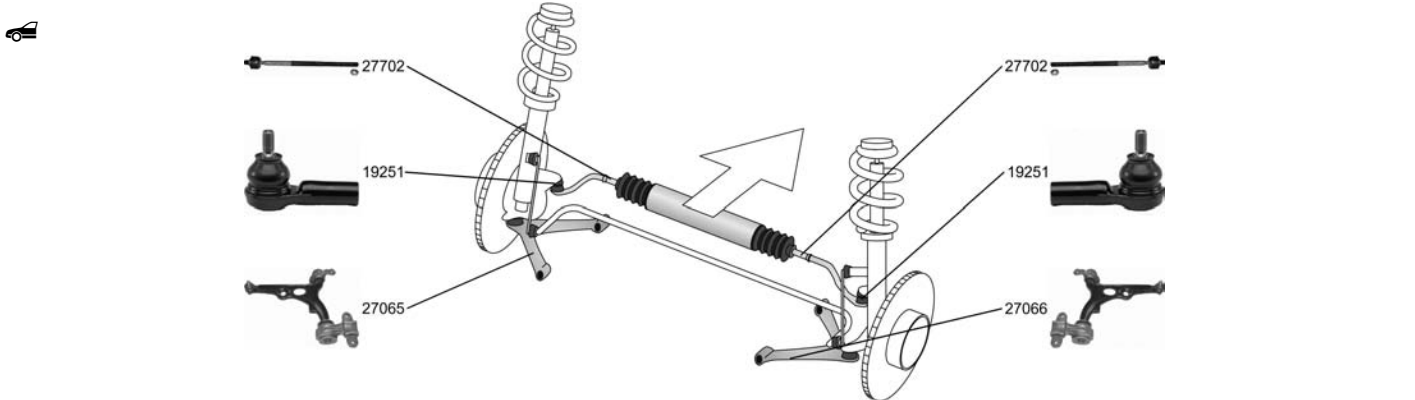

CITROËN

JUMPY (U6U) 06.94 -

	Achskörperlager	↔	26578 01	5152 61
	ALL TYPES ausser : 2.2 HDi		12.03 - 10.06	

JUMPY Kasten/Box/Furgón/Van 06.94 -











	Spurstangenkopf Gewindeart: mit Rechtsgewinde Innengewinde [mm]: M14x1,5 mit Zubehör	↔ ↻	19251 03	4059 09
	ALL TYPES		->Chass. 09792	
	Axialgelenk, Spurstange Aussengewinde [mm]: M14x1,5	↔ ↻	27702 01	3812 A4
	ALL TYPES ausser :			
	1.9 D 10.95 - 08.98 1.9 DT 10.95 - 08.00 2.2 HDi 12.03 - 10.06			
	Lenker, Radaufhängung mit Trag-/Führungsgelenk mit Gummilager mit Befestigungsmaterial	▽ ↻	27065 02	3520 P4
	ALL TYPES ausser :			
	1.9 D 10.95 - 08.98 1.9 DT 10.95 - 08.00 2.2 HDi 12.03 - 10.06			
	Lenker, Radaufhängung mit Trag-/Führungsgelenk mit Gummilager mit Befestigungsmaterial	▽ ↻	27066 02	3521 K4
	ALL TYPES ausser :			
	1.9 D 10.95 - 08.98 1.9 DT 10.95 - 08.00 2.2 HDi 12.03 - 10.06			
	Achskörperlager	↔	26578 01	5152 61
	ALL TYPES ausser : 1.9 D 10.95 - 08.98 1.9 DT 10.95 - 08.00 2.2 HDi 12.03 - 10.06			









Ref.

CITROËN







JUMPY Pritsche, Fahrgestell / Flatbed, Chassis 10.99 -

 Spurstangenkopf Gewindeart: mit Rechtsgewinde Innengewinde [mm]: M14x1,5 mit Zubehör			19251 03	4059 09	
	1.9 TD	10.99 -	->Chass. 09792		
	2.0	12.03 - 10.06			
	2.0 HDi 95	10.99 -			
2.0 HDi	12.03 - 10.06				
Axialgelenk, Spurstange Aussengewinde [mm]: M14x1,5			27702 01	3812 A4	
	1.9 TD	10.99 -			
2.0 HDi 95	10.99 -				
Lenker, Radaufhängung mit Trag-/Führungsgelenk mit Gummilager mit Befestigungsmaterial			27065 02	3520 P4	
	1.9 TD	10.99 -			
2.0 HDi 95	10.99 -				
Lenker, Radaufhängung mit Trag-/Führungsgelenk mit Gummilager mit Befestigungsmaterial			27066 02	3521 K4	
	1.9 TD	10.99 -			
2.0 HDi 95	10.99 -				

JUMPY 01.07 -

 Spurstangenkopf Konusmaß [mm]: 18 Gewindemaß: M14x1,5			31900 01	3817 73	
	ALL TYPES				
Axialgelenk, Spurstange Gewindemaß: M16x1,5 Gewindemaß: M14x1,5 radseitig			31899 01	3812 F0	
	ALL TYPES				
Stange/Strebe, Stabilisator Pendelstange Gewindemaß: M12x1,75			31898 01	5087 56	
	ALL TYPES				

JUMPY Kasten 01.07 -

 Spurstangenkopf Konusmaß [mm]: 18 Gewindemaß: M14x1,5			31900 01	3817 73	
	ALL TYPES				
Axialgelenk, Spurstange Gewindemaß: M16x1,5 Gewindemaß: M14x1,5 radseitig			31899 01	3812 F0	
	ALL TYPES				
Stange/Strebe, Stabilisator Pendelstange Gewindemaß: M12x1,75			31898 01	5087 56	
	ALL TYPES				









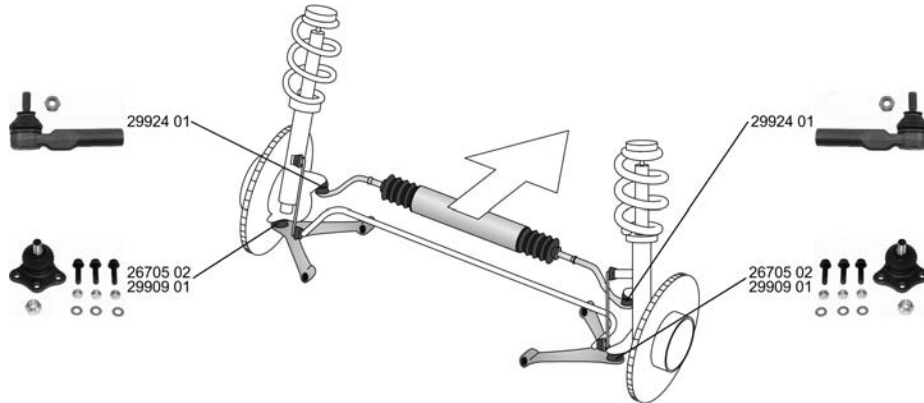



FIAT

DOBLO (119)

03.01 -



Spurstangenkopf 1.2 (223AXA1A) 03.01 - 1.6 16V (223AXD1A) 10.01 - 1.9 D (223AXB1A) 03.01 - 1.9 JTD (223AXE1A) 10.01 - 1.9 JTD 07.03 -	 ->Chass. 5120134	29924 01 98 845 030 
Axialgelenk, Spurstange Betriebsart: hydraulisch 1.2 (223AXA1A) 03.01 - 1.6 16V (223AXD1A) 10.01 - 1.6 Natural Power 09.02 - 1.9 D (223AXB1A) 03.01 - 1.9 JTD (223AXE1A) 10.01 - 1.9 JTD 07.03 -	 Chass. 5120134->	31301 01 98 845 026 
Trag-/Führungsgelenk mit Zubehör ALL TYPES	 Chass. VET 5023343->	26705 02 7 082 812 
Trag-/Führungsgelenk ALL TYPES	 ->Chass. VET 5023343	29909 01 46 543 045 
 Stange/Strebe, Stabilisator Koppelstange 1.2 (223AXA1A) 03.01 - 1.6 Natural Power 09.02 - 1.9 D (223AXB1A) 03.01 - 1.6 16V (223AXD1A) 10.01 - 1.9 JTD (223AXE1A) 10.01 - 1.9 JTD 07.03 -	 für: Panorama Elegant für: Panorama Malibu	29416 01 51 717 000 







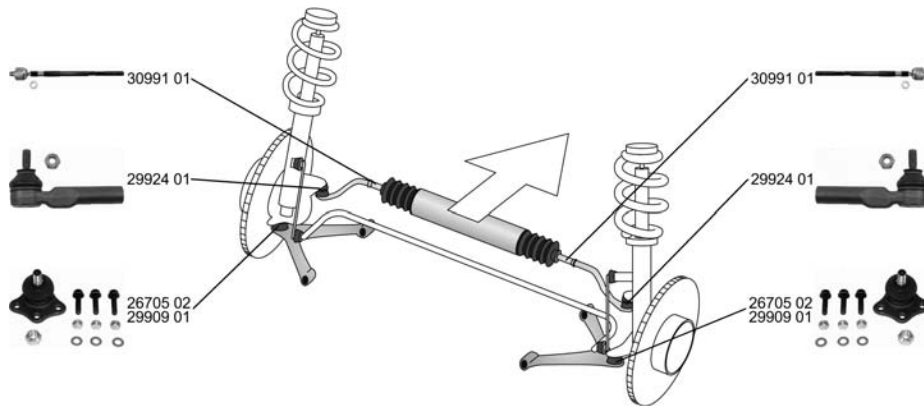

Ref.

FIAT

DOBLO Cargo (223)

03.01 -



<p>Spurstangenkopf ALL TYPES ausser : 1.4 10.05 - 1.3 D Multijet 10.05 -</p>	<p>↔ ->Chass. 5120134</p>	<p>29924 01 98 845 030 </p>
<p>Axialgelenk, Spurstange ALL TYPES</p>	<p>↔ ↻</p>	<p>30991 01 98 845 025 </p>
<p>Axialgelenk, Spurstange Betriebsart: hydraulisch 1.2 (223ZA1A) 03.01 - 1.6 16V (223XD1A) 10.01 - 1.3 JTD 16V 05.04 - 1.9 D (223XB1A) 03.01 - 1.6 Natural Power 09.02 - 1.9 JTD (223XE1A) 10.01 - 1.9 JTD 07.03 -</p>	<p>↔ ↻ Chass. 5120134-></p>	<p>31301 01 98 845 026 </p>
<p>Trag-/Führungsgelenk mit Zubehör ALL TYPES</p>	<p>↔ Chass. VET 5023343-></p>	<p>26705 02 7 082 812 </p>
<p>Trag-/Führungsgelenk ALL TYPES</p>	<p>↕ ↔ ->Chass. VET 5023343</p>	<p>29909 01 46 543 045 </p>









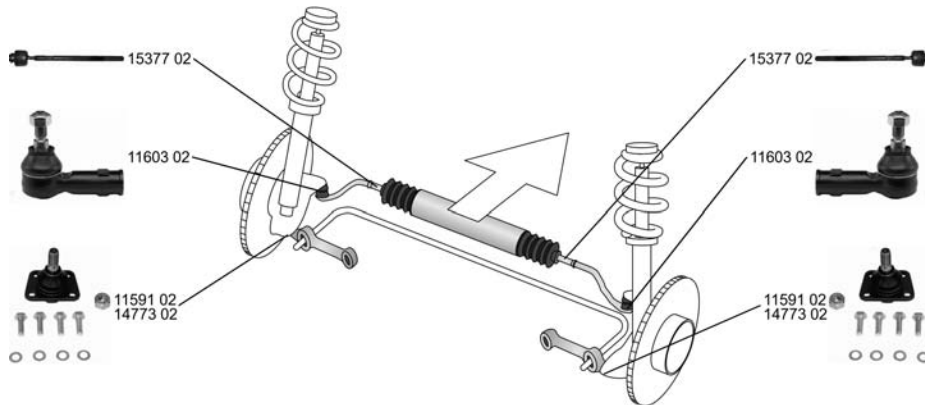









FIAT

**DUCATO Kasten/Box/Furgón/Van
(280)**

01.82 - 08.90





<p>Spurstangenkopf Konusmaß [mm]: 16 Innengewinde [mm]: M16x1,5 Gewindeart: mit Rechtsgewinde Gewindemaß: M16x1,5</p>		<p>11603 02 97 50 079 980</p> 
<p>1.8 2.0, 55 kW 2.0, 58 kW 2.0, 62 kW 1.9 D 1.9 TD 2.4 D 2.5 D 2.5 D 4x4</p>	<p>01.82 - 10.88 07.85 - 08.90 01.82 - 08.90 03.89 - 08.90 01.88 - 08.90 03.89 - 08.90 01.82 - 08.90 01.82 - 08.90 03.89 - 08.90</p> 	
<p>Axialgelenk, Spurstange Gewindeart: mit Rechtsgewinde Gewindemaß: M16x1,5</p>	 	<p>15377 02 97 90 002 680</p> 
<p>1.8 2.0, 55 kW 2.0, 58 kW 2.0, 62 kW 1.9 D 1.9 TD 2.4 D 2.5 D 2.5 D 4x4</p>	<p>01.82 - 10.88 07.85 - 08.90 01.82 - 08.90 03.89 - 08.90 01.88 - 08.90 03.89 - 08.90 01.82 - 08.90 01.82 - 08.90 03.89 - 08.90</p> 	
<p>Trag-/Führungsgelenk mit Zubehör</p>	 	<p>11591 02 7 567 284</p> 
<p>1.8 2.0, 55 kW 2.0, 58 kW 2.4 D 2.5 D 2.0, 62 kW 1.9 D 1.9 TD 2.5 D 4x4</p>	<p>01.82 - 10.88 07.85 - 08.90 01.82 - 08.90 01.82 - 08.90 01.82 - 08.90 03.89 - 08.90 01.88 - 08.90 03.89 - 08.90 03.89 - 08.90</p> <p>10.1985-></p>	
<p>Trag-/Führungsgelenk mit Zubehör</p>	 	<p>14773 02 4 388 159</p> 
<p>1.8 2.0, 58 kW 2.4 D 2.5 D</p>	<p>01.82 - 10.88 01.82 - 08.90 01.82 - 08.90 01.82 - 08.90</p> <p>->09.1985</p>	
<p>Faltenbalg, Lenkung</p>	 	<p>15342 01 97 50 000 380</p> 
<p>1.8 2.0, 55 kW 2.0, 58 kW 2.0, 62 kW 1.9 D 1.9 TD 2.4 D 2.5 D 2.5 D 4x4</p>	<p>01.82 - 10.88 07.85 - 08.90 01.82 - 08.90 03.89 - 08.90 01.88 - 08.90 03.89 - 08.90 01.82 - 08.90 01.82 - 08.90 03.89 - 08.90</p>	



Ref.









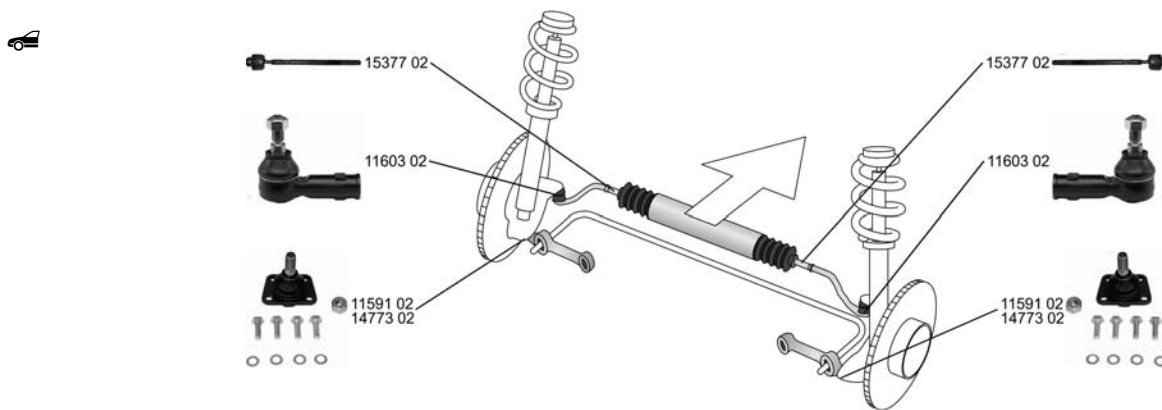

FIAT

DUCATO Kasten/Box/Furgón/Van (280) 01.82 - 08.90

 Faltenbaldsatz, Lenkung Innendurchmesser 1 [mm]: 11 Innendurchmesser 2 [mm]: 38		30132 01 97 50 000 380 

DUCATO Bus/Familial/Panorama (280) 07.82 - 08.90







Spurstangenkopf Konusmaß [mm]: 16 Innengewinde [mm]: M16x1,5 Gewindeart: mit Rechtsgewinde Gewindemaß: M16x1,5 ALL TYPES		11603 02 97 50 079 980 
Axialgelenk, Spurstange Gewindeart: mit Rechtsgewinde Gewindemaß: M16x1,5 ALL TYPES	 	15377 02 97 90 002 680 
Trag-/Führungsgelenk mit Zubehör	 	11591 02 7 567 284 
Trag-/Führungsgelenk mit Zubehör	 	14773 02 4 388 159 



FIAT

DUCATO Bus/Familial/Panorama (280)









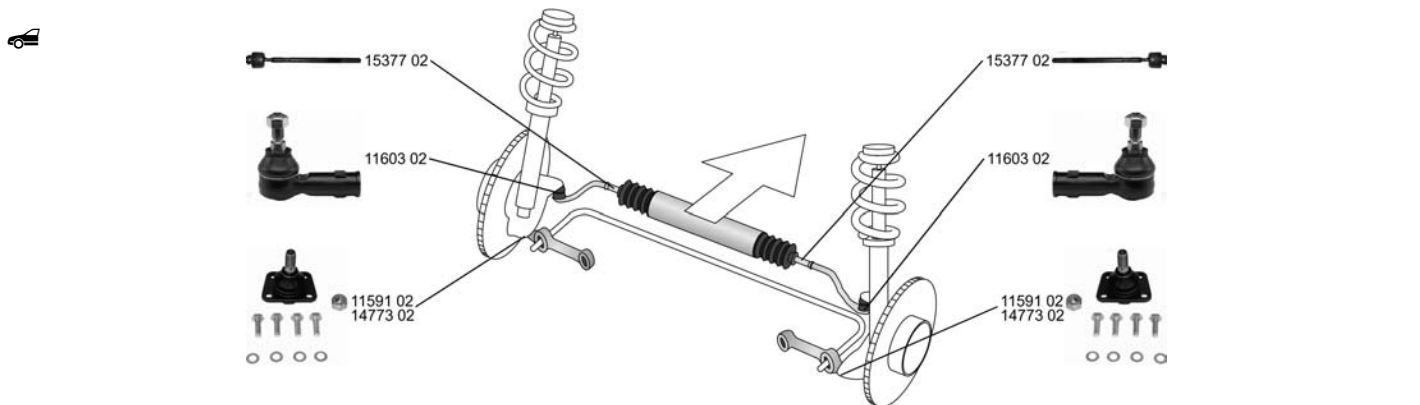

07.82 - 08.90

 Faltenbalg, Lenkung ALL TYPES		15342 01 97 50 000 380 
Faltenbalgsatz, Lenkung Innendurchmesser 1 [mm]: 11 Innendurchmesser 2 [mm]: 38 ALL TYPES		30132 01 97 50 000 380 

DUCATO Pritsche, Fahrgestell / Flatbed, Chassis (280)

07.82 - 08.90



Spurstangenkopf Konusmaß [mm]: 16 Innengewinde [mm]: M16x1,5 Gewindeart: mit Rechtsgewinde Gewindemaß: M16x1,5		11603 02 97 50 079 980 
ALL TYPES ausser : 2.5 TD 4x4		
Axialgelenk, Spurstange Gewindeart: mit Rechtsgewinde Gewindemaß: M16x1,5		15377 02 97 90 002 680 
ALL TYPES ausser : 2.5 TD 4x4		
Trag-/Führungsgelenk mit Zubehör		11591 02 7 567 284 
2.0, 62 kW		
1.9 D		
1.9 TD		
2.5 D 4x4		
2.5 TD		
2.0, 55 kW	10.1985->	
2.5 D		
Trag-/Führungsgelenk mit Zubehör		14773 02 4 388 159 
1.9 TD		











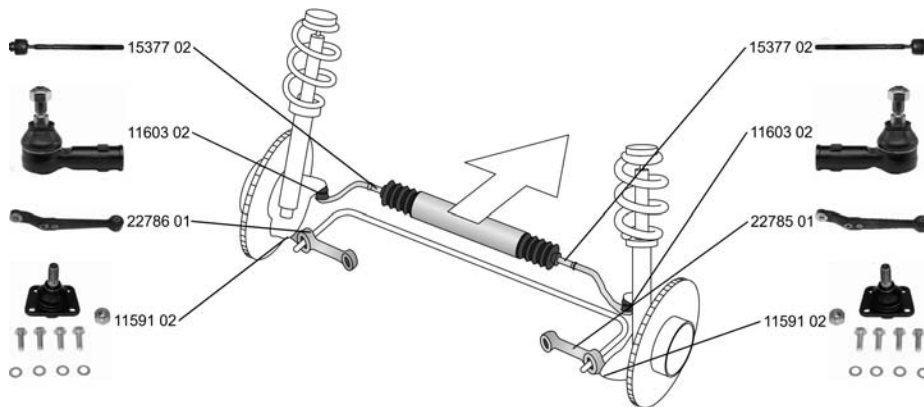





Ref.

FIAT

DUCATO Kasten/Box/Furgón/Van
(290)

03.89 - 03.94



<p>Spurstangenkopf Konusmaß [mm]: 16 Innengewinde [mm]: M16x1,5 Gewindeart: mit Rechtsgewinde Gewindemaß: M16x1,5 ALL TYPES</p>		<p>11603 02 97 50 079 980</p> 
<p>Axialgelenk, Spurstange Gewindeart: mit Rechtsgewinde Gewindemaß: M16x1,5 ALL TYPES</p>	 	<p>15377 02 97 90 002 680</p> 
<p>Lenker, Radaufhängung ohne Trag-/Führungsgelenk mit Gummilager nur in Verbindung mit: 11591 Nutzlast [kg]: 1000 Nutzlast [kg]: 1400 ALL TYPES</p>		<p>22785 01 7 695 190</p> 
<p>Lenker, Radaufhängung ohne Trag-/Führungsgelenk mit Gummilager nur in Verbindung mit: 11591 Nutzlast [kg]: 1000 Nutzlast [kg]: 1400 ALL TYPES</p>		<p>22786 01 7 695 191</p> 
<p>Trag-/Führungsgelenk mit Zubehör ALL TYPES</p>		<p>11591 02 7 567 284</p> 
<p>Faltenbalgsatz, Lenkung Innendurchmesser 1 [mm]: 15 Innendurchmesser 2 [mm]: 54 ALL TYPES ausser : 2.0 4x4 06.90 - 05.94 2.5 D 06.90 - 05.94</p>		<p>30172 01 9 943 623</p> 







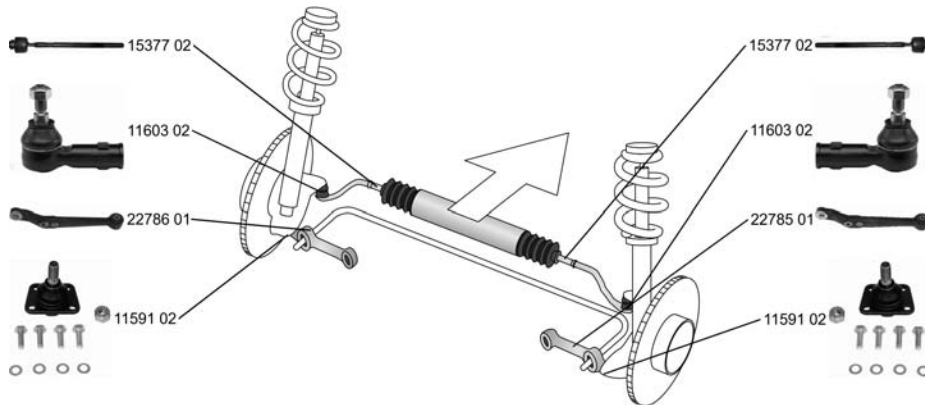

FIAT

**DUCATO Pritsche, Fahrgestell /
Flatbed, Chassis (290)**

03.89 - 03.94



<p>Spurstangenkopf Konusmaß [mm]: 16 Innengewinde [mm]: M16x1,5 Gewindeart: mit Rechtsgewinde Gewindemaß: M16x1,5 ALL TYPES</p>		<p>11603 02 97 50 079 980</p> 
<p>Axialgelenk, Spurstange Gewindeart: mit Rechtsgewinde Gewindemaß: M16x1,5 ALL TYPES</p>		<p>15377 02 97 90 002 680</p> 
<p>Lenker, Radaufhängung ohne Trag-/Führungsgelenk mit Gummilager nur in Verbindung mit: 11591 Nutzlast [kg]: 1000 Nutzlast [kg]: 1400 ALL TYPES</p>		<p>22785 01 7 695 190</p> 
<p>Lenker, Radaufhängung ohne Trag-/Führungsgelenk mit Gummilager nur in Verbindung mit: 11591 Nutzlast [kg]: 1000 Nutzlast [kg]: 1400 ALL TYPES</p>		<p>22786 01 7 695 191</p> 
<p>Trag-/Führungsgelenk mit Zubehör ALL TYPES ausser : 2.0 4x4 06.90 - 05.94</p>		<p>11591 02 7 567 284</p> 
<p>Faltenbalg, Lenkung 2.0 07.90 - 03.94 1.9 TD 03.89 - 03.94 2.5 D 07.90 - 03.94 2.5 TD 07.90 - 03.94</p>		<p>15342 01 97 50 000 380</p> 
<p>Faltenbalgsatz, Lenkung Innendurchmesser 1 [mm]: 11 Innendurchmesser 2 [mm]: 38 2.0 07.90 - 03.94 1.9 TD 03.89 - 03.94 2.5 D 07.90 - 03.94 2.5 TD 07.90 - 03.94</p>		<p>30132 01 97 50 000 380</p> 





Ref.

FIAT

DUCATO Pritsche, Fahrgestell / Flatbed, Chassis (290)









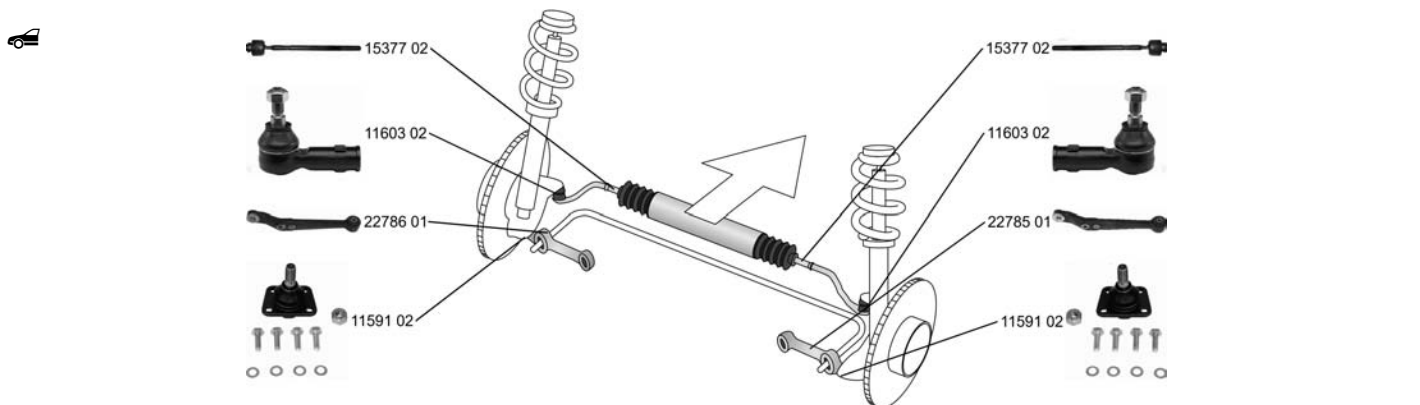

03.89 - 03.94

 Faltenbaldsatz, Lenkung Innendurchmesser 1 [mm]: 15 Innendurchmesser 2 [mm]: 54 ALL TYPES ausser : 2.0 4x4		30172 01 9 943 623 
06.90 - 05.94		

DUCATO Bus/Familial/Panorama (290)

01.90 - 03.94









Spurstangenkopf Konusmaß [mm]: 16 Innengewinde [mm]: M16x1,5 Gewindeart: mit Rechtsgewinde Gewindemaß: M16x1,5 ALL TYPES ausser : 1.8 - 12.94		11603 02 97 50 079 980 
Axialgelenk, Spurstange Gewindeart: mit Rechtsgewinde Gewindemaß: M16x1,5 ALL TYPES ausser : 1.8 - 12.94	 	15377 02 97 90 002 680 
Lenker, Radaufhängung ohne Trag-/Führungsgelenk mit Gummilager nur in Verbindung mit: 11591 Nutzlast [kg]: 1000 Nutzlast [kg]: 1400 ALL TYPES ausser : 1.8 - 12.94		22785 01 7 695 190 
Lenker, Radaufhängung ohne Trag-/Führungsgelenk mit Gummilager nur in Verbindung mit: 11591 Nutzlast [kg]: 1000 Nutzlast [kg]: 1400 ALL TYPES ausser : 1.8 - 12.94		22786 01 7 695 191 
Trag-/Führungsgelenk mit Zubehör 2.0, 62 kW 07.90 - 03.94 1.9 D 07.90 - 03.94 1.9 TD 07.90 - 03.94 2.5 D 07.90 - 03.94 2.5 D 4x4 07.90 - 03.94 2.5 TD 08.90 - 03.94 2.5 TD 4x4 01.91 - 03.94		11591 02 7 567 284 



FIAT





DUCATO Bus/Familial/Panorama (290)

01.90 - 03.94

 Faltenbalg, Lenkung 2.0, 62 kW 1.9 D 1.9 TD 2.5 D 2.5 D 4x4 2.5 TD 2.5 TD 4x4	07.90 - 03.94		15342 01  97 50 000 380
	07.90 - 03.94		
	07.90 - 03.94		
	07.90 - 03.94		
	07.90 - 03.94		
	07.90 - 03.94		
Faltenbalgsatz, Lenkung Innendurchmesser 1 [mm]: 11 Innendurchmesser 2 [mm]: 38 2.0, 62 kW 1.9 D 1.9 TD 2.5 D 2.5 D 4x4 2.5 TD 2.5 TD 4x4	07.90 - 03.94		30132 01  97 50 000 380
	07.90 - 03.94		
	07.90 - 03.94		
	07.90 - 03.94		
	07.90 - 03.94		
	07.90 - 03.94		
Faltenbalgsatz, Lenkung Innendurchmesser 1 [mm]: 15 Innendurchmesser 2 [mm]: 54 2.0, 62 kW 1.9 D 1.9 TD 2.5 D 2.5 D 4x4 2.5 TD 2.5 TD 4x4	07.90 - 03.94		30172 01  9 943 623
	07.90 - 03.94		
	07.90 - 03.94		
	07.90 - 03.94		
	07.90 - 03.94		
	07.90 - 03.94		

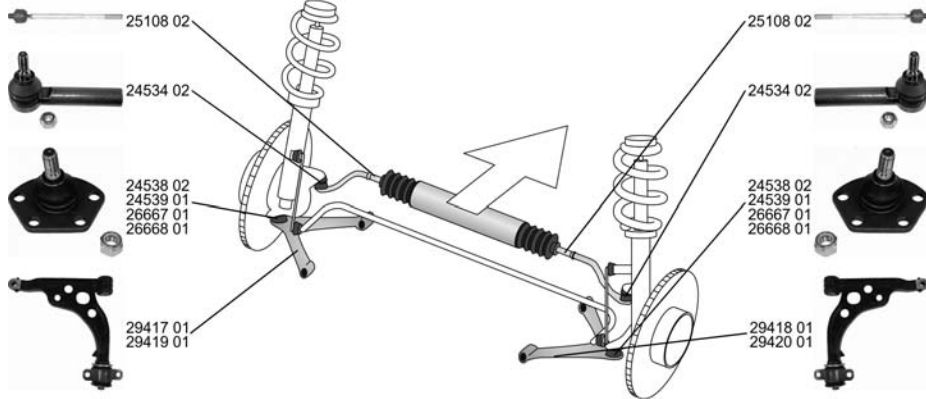
DUCATO Bus/Familial (230)

03.94 - 04.02

 		24534 02 13 06 716 080 
Axialgelenk, Spurstange ALL TYPES		25108 02 9 945 836 

















Ref.

FIAT

DUCATO Bus/Familial (230)

03.94 - 04.02





<p> Lenker, Radaufhängung ALL TYPES</p>	<p></p> <p>Nutzlast [kg]:1000 Nutzlast [kg]:1400 ->Chass. 6086766 ->Chass. 6087206 nur in Verbindung mit:OE 1331 640 080</p> <p>-----</p> <p>Chass. 6086767-> Chass. 6087207-> ohne Einschränkung</p>	<p>29417 01 1331 938 080</p> 
<p>Lenker, Radaufhängung ALL TYPES</p>	<p></p> <p>Nutzlast [kg]:1000 Nutzlast [kg]:1400 ->Chass. 6086766 ->Chass. 6087206 nur in Verbindung mit:OE 1331 640 080</p> <p>-----</p> <p>Chass. 6087207-> ohne Einschränkung</p>	<p>29418 01 1331 940 080</p> 
<p>Lenker, Radaufhängung ALL TYPES</p>	<p></p> <p>Nutzlast [kg]:1800 ->Chass. 6086766 ->Chass. 6087206 nur in Verbindung mit:OE 1331 641 080</p> <p>-----</p> <p>Chass. 6086767-> Chass. 6087207-> ohne Einschränkung</p>	<p>29419 01 1331 937 080</p> 
<p>Lenker, Radaufhängung ALL TYPES</p>	<p></p> <p>Nutzlast [kg]:1800 ->Chass. 6086766 ->Chass. 6087206 nur in Verbindung mit:OE 1331 641 080</p> <p>-----</p> <p>Chass. 6086767-> Chass. 6087207-> ohne Einschränkung</p>	<p>29420 01 1331 939 080</p> 
<p>Trag-/Führungsgelenk Gewindemaß: M16x1,5 ALL TYPES</p>	<p></p> <p>->Chass. 6015630 nur in Verbindung mit:OE 1331 938 080 nur in Verbindung mit:OE 1331 940 080 Nutzlast [kg]:1400</p> <p>-----</p> <p>Chass. 6015631-> ohne Einschränkung</p>	<p>24538 02</p> 
<p>Trag-/Führungsgelenk maximale Last [kg]: 1800 Gewindemaß: M18x1,5 ALL TYPES</p>	<p></p> <p>->Chass. 6015630 nur in Verbindung mit:OE 1331 937 080 nur in Verbindung mit:OE 1331 939 080</p> <p>-----</p> <p>Chass. 6015631-> nur in Verbindung mit:OE 1331 640 080 ohne Einschränkung</p>	<p>24539 01</p> 
<p>Trag-/Führungsgelenk nur in Verbindung mit: 29417 nur in Verbindung mit: 29418 maximale Last [kg]: 1400 ALL TYPES</p>	<p></p> <p>02.2001-></p>	<p>26667 01 13 31 640 080</p> 



FIAT

DUCATO Bus/Familial (230)





03.94 - 04.02

 Trag-/Führungsgelenk nur in Verbindung mit: 29419 nur in Verbindung mit: 29420 maximale Last [kg]: 1800 mit Zubehör		26668 01 13 31 641 080
ALL TYPES	02.2001->	
Faltenbalg, Lenkung 2.0 Panorama/Combinato 03.94 - 04.02 1.9 D, 50 kW 04.98 - 04.02 1.9 D Combinato 06.95 - 04.02 1.9 TD 04.98 - 04.02 1.9 TD Combinato 08.94 - 04.02 1.9 TD Panorama/Combinato 03.94 - 04.02 2.5 D Combinato 08.94 - 04.02 2.5 TDI 4x4 04.97 - 04.02 2.5 TDI Combinato 08.94 - 04.02 2.5 TDI Panorama/Combinato, 80 kW 07.94 - 04.02 2.5 TDI Panorama/Combinato, 85 kW 03.94 - 04.02 2.8 D 02.98 - 04.02 2.8 TDI 10.97 - 04.02		15342 01 97 50 000 380 
Faltenbalgsatz, Lenkung 2.0 Panorama/Combinato 03.94 - 04.02 1.9 D, 50 kW 04.98 - 04.02 1.9 D Combinato 06.95 - 04.02 1.9 TD 04.98 - 04.02 1.9 TD Combinato 08.94 - 04.02 1.9 TD Panorama/Combinato 03.94 - 04.02 2.0 JTD 10.01 - 04.02 2.5 D Combinato 08.94 - 04.02 2.5 TDI 4x4 04.97 - 04.02 2.5 TDI Combinato 08.94 - 04.02 2.5 TDI Panorama/Combinato, 80 kW 07.94 - 04.02 2.5 TDI Panorama/Combinato, 85 kW 03.94 - 04.02 2.8 D 02.98 - 04.02 2.8 JTD 11.00 - 04.02 2.8 JTD 4x4 11.00 - 04.02 2.8 TDI 10.97 - 04.02 2.8 TDI 4x4 07.99 - 04.02		30203 01 9 946 982 

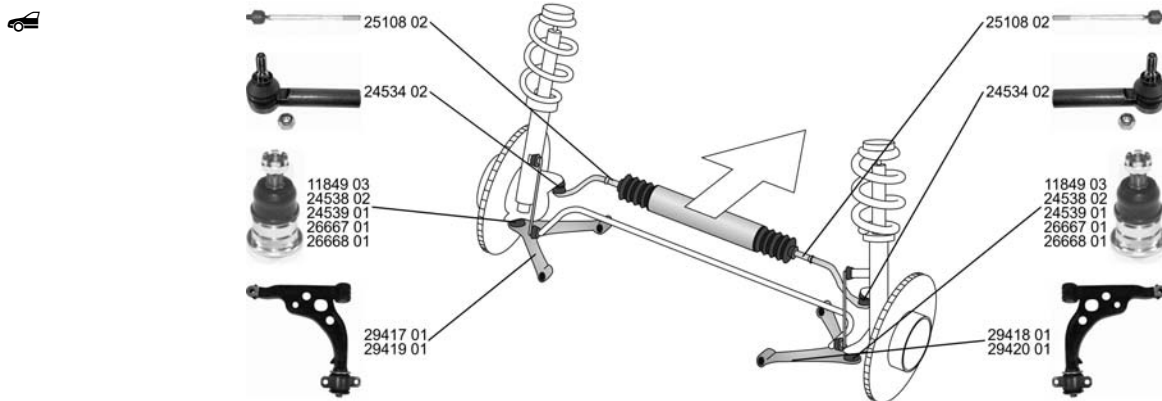
DUCATO Kasten/Box/Furgón/Van (230L)

03.94 - 04.02



Spurstangenkopf Gewindeart: mit Rechtsgewinde Gewindemaß: M16x1,5		24534 02 13 06 716 080 
ALL TYPES		
Axialgelenk, Spurstange		25108 02 9 945 836 
ALL TYPES		













Ref.

FIAT

**DUCATO Kasten/Box/Furgón/Van
(230L)**

03.94 - 04.02







<p> Lenker, Radaufhängung ALL TYPES</p>	<p></p> <p>Nutzlast [kg]:1000 Nutzlast [kg]:1400 ->Chass. 6086766 ->Chass. 6087206 nur in Verbindung mit:OE 1331 640 080</p> <p>-----</p> <p>Chass. 6086767-> Chass. 6087207-> ohne Einschränkung</p>	<p>29417 01 1331 938 080</p> 
<p>Lenker, Radaufhängung ALL TYPES</p>	<p></p> <p>Nutzlast [kg]:1000 Nutzlast [kg]:1400 ->Chass. 6086766 ->Chass. 6087206 nur in Verbindung mit:OE 1331 640 080</p> <p>-----</p> <p>Chass. 6087207-> ohne Einschränkung</p>	<p>29418 01 1331 940 080</p> 
<p>Lenker, Radaufhängung ALL TYPES</p>	<p></p> <p>Nutzlast [kg]:1800 ->Chass. 6086766 ->Chass. 6087206 nur in Verbindung mit:OE 1331 641 080</p> <p>-----</p> <p>Chass. 6086767-> Chass. 6087207-> ohne Einschränkung</p>	<p>29419 01 1331 937 080</p> 
<p>Lenker, Radaufhängung ALL TYPES</p>	<p></p> <p>Nutzlast [kg]:1800 ->Chass. 6086766 ->Chass. 6087206 nur in Verbindung mit:OE 1331 641 080</p> <p>-----</p> <p>Chass. 6086767-> Chass. 6087207-> ohne Einschränkung</p>	<p>29420 01 1331 939 080</p> 
<p>Trag-/Führungsgelenk Gewindemaß: M16x1,5</p>	<p></p>	<p>24538 02</p> 
<p>2.0 1.9 D, 50 kW 1.9 D, 51 kW 1.9 TD, 60 kW 1.9 TD, 66 kW 1.9 TD CAT 2.0 JTD 2.5 D 2.5 TDI 2.5 TDI Maxi 2.5 TDI 4x4 2.8 D 2.8 D 4x4 2.8 JTD 2.8 JTD 4x4 2.8 TDI 2.8 TDI 4x4</p>	<p>03.94 - 04.02 04.98 - 04.02 03.94 - 04.02 03.94 - 04.02 04.98 - 04.02 08.94 - 04.02 10.01 - 04.02 03.94 - 04.02 03.94 - 04.02 03.94 - 04.02 05.98 - 04.02 05.98 - 04.02 08.98 - 04.02 11.00 - 04.02 11.00 - 04.02 10.97 - 04.02 06.99 - 04.02</p>	<p>->Chass. 6015630 nur in Verbindung mit:OE 1331 938 080 nur in Verbindung mit:OE 1331 940 080 Nutzlast [kg]:1400</p> <p>-----</p> <p>Chass. 6015631-> ohne Einschränkung</p>



FIAT

**DUCATO Kasten/Box/Furgón/Van
(230L)**

03.94 - 04.02

<p> Trag-/Führungsgelenk maximale Last [kg]: 1800 Gewindemaß: M18x1,5</p> <table border="0"> <tr><td>2.0</td><td>03.94 - 04.02</td></tr> <tr><td>1.9 D, 50 kW</td><td>04.98 - 04.02</td></tr> <tr><td>1.9 D, 51 kW</td><td>03.94 - 04.02</td></tr> <tr><td>1.9 TD, 60 kW</td><td>03.94 - 04.02</td></tr> <tr><td>1.9 TD, 66 kW</td><td>04.98 - 04.02</td></tr> <tr><td>1.9 TD CAT</td><td>08.94 - 04.02</td></tr> <tr><td>2.0 JTD</td><td>10.01 - 04.02</td></tr> <tr><td>2.5 D</td><td>03.94 - 04.02</td></tr> <tr><td>2.5 TDI</td><td>03.94 - 04.02</td></tr> <tr><td>2.5 TDI Maxi</td><td>03.94 - 04.02</td></tr> <tr><td>2.5 TDI 4x4</td><td>05.98 - 04.02</td></tr> <tr><td>2.8 D</td><td>05.98 - 04.02</td></tr> <tr><td>2.8 D 4x4</td><td>08.98 - 04.02</td></tr> <tr><td>2.8 JTD</td><td>11.00 - 04.02</td></tr> <tr><td>2.8 JTD 4x4</td><td>11.00 - 04.02</td></tr> <tr><td>2.8 TDI</td><td>10.97 - 04.02</td></tr> <tr><td>2.8 TDI 4x4</td><td>06.99 - 04.02</td></tr> </table>	2.0	03.94 - 04.02	1.9 D, 50 kW	04.98 - 04.02	1.9 D, 51 kW	03.94 - 04.02	1.9 TD, 60 kW	03.94 - 04.02	1.9 TD, 66 kW	04.98 - 04.02	1.9 TD CAT	08.94 - 04.02	2.0 JTD	10.01 - 04.02	2.5 D	03.94 - 04.02	2.5 TDI	03.94 - 04.02	2.5 TDI Maxi	03.94 - 04.02	2.5 TDI 4x4	05.98 - 04.02	2.8 D	05.98 - 04.02	2.8 D 4x4	08.98 - 04.02	2.8 JTD	11.00 - 04.02	2.8 JTD 4x4	11.00 - 04.02	2.8 TDI	10.97 - 04.02	2.8 TDI 4x4	06.99 - 04.02	<p></p> <p>->Chass. 6015630 nur in Verbindung mit:OE 1331 937 080 nur in Verbindung mit:OE 1331 939 080 ----- Chass. 6015631-> nur in Verbindung mit:OE 1331 640 080 ohne Einschränkung</p>	<p>24539 01</p> 
2.0	03.94 - 04.02																																			
1.9 D, 50 kW	04.98 - 04.02																																			
1.9 D, 51 kW	03.94 - 04.02																																			
1.9 TD, 60 kW	03.94 - 04.02																																			
1.9 TD, 66 kW	04.98 - 04.02																																			
1.9 TD CAT	08.94 - 04.02																																			
2.0 JTD	10.01 - 04.02																																			
2.5 D	03.94 - 04.02																																			
2.5 TDI	03.94 - 04.02																																			
2.5 TDI Maxi	03.94 - 04.02																																			
2.5 TDI 4x4	05.98 - 04.02																																			
2.8 D	05.98 - 04.02																																			
2.8 D 4x4	08.98 - 04.02																																			
2.8 JTD	11.00 - 04.02																																			
2.8 JTD 4x4	11.00 - 04.02																																			
2.8 TDI	10.97 - 04.02																																			
2.8 TDI 4x4	06.99 - 04.02																																			
<p>Trag-/Führungsgelenk nur in Verbindung mit: 29417 nur in Verbindung mit: 29418 maximale Last [kg]: 1400</p> <table border="0"> <tr><td>2.0</td><td>03.94 - 04.02</td></tr> <tr><td>1.9 D, 50 kW</td><td>04.98 - 04.02</td></tr> <tr><td>1.9 D, 51 kW</td><td>03.94 - 04.02</td></tr> <tr><td>1.9 TD, 60 kW</td><td>03.94 - 04.02</td></tr> <tr><td>1.9 TD, 66 kW</td><td>04.98 - 04.02</td></tr> <tr><td>1.9 TD CAT</td><td>08.94 - 04.02</td></tr> <tr><td>2.0 JTD</td><td>10.01 - 04.02</td></tr> <tr><td>2.5 D</td><td>03.94 - 04.02</td></tr> <tr><td>2.5 TDI</td><td>03.94 - 04.02</td></tr> <tr><td>2.5 TDI Maxi</td><td>03.94 - 04.02</td></tr> <tr><td>2.5 TDI 4x4</td><td>05.98 - 04.02</td></tr> <tr><td>2.8 D</td><td>05.98 - 04.02</td></tr> <tr><td>2.8 D 4x4</td><td>08.98 - 04.02</td></tr> <tr><td>2.8 JTD</td><td>11.00 - 04.02</td></tr> <tr><td>2.8 JTD 4x4</td><td>11.00 - 04.02</td></tr> <tr><td>2.8 TDI</td><td>10.97 - 04.02</td></tr> <tr><td>2.8 TDI 4x4</td><td>06.99 - 04.02</td></tr> </table>	2.0	03.94 - 04.02	1.9 D, 50 kW	04.98 - 04.02	1.9 D, 51 kW	03.94 - 04.02	1.9 TD, 60 kW	03.94 - 04.02	1.9 TD, 66 kW	04.98 - 04.02	1.9 TD CAT	08.94 - 04.02	2.0 JTD	10.01 - 04.02	2.5 D	03.94 - 04.02	2.5 TDI	03.94 - 04.02	2.5 TDI Maxi	03.94 - 04.02	2.5 TDI 4x4	05.98 - 04.02	2.8 D	05.98 - 04.02	2.8 D 4x4	08.98 - 04.02	2.8 JTD	11.00 - 04.02	2.8 JTD 4x4	11.00 - 04.02	2.8 TDI	10.97 - 04.02	2.8 TDI 4x4	06.99 - 04.02	<p></p> <p>02.2001-></p>	<p>26667 01 13 31 640 080</p> 
2.0	03.94 - 04.02																																			
1.9 D, 50 kW	04.98 - 04.02																																			
1.9 D, 51 kW	03.94 - 04.02																																			
1.9 TD, 60 kW	03.94 - 04.02																																			
1.9 TD, 66 kW	04.98 - 04.02																																			
1.9 TD CAT	08.94 - 04.02																																			
2.0 JTD	10.01 - 04.02																																			
2.5 D	03.94 - 04.02																																			
2.5 TDI	03.94 - 04.02																																			
2.5 TDI Maxi	03.94 - 04.02																																			
2.5 TDI 4x4	05.98 - 04.02																																			
2.8 D	05.98 - 04.02																																			
2.8 D 4x4	08.98 - 04.02																																			
2.8 JTD	11.00 - 04.02																																			
2.8 JTD 4x4	11.00 - 04.02																																			
2.8 TDI	10.97 - 04.02																																			
2.8 TDI 4x4	06.99 - 04.02																																			
<p>Trag-/Führungsgelenk nur in Verbindung mit: 29419 nur in Verbindung mit: 29420 maximale Last [kg]: 1800 mit Zubehör</p> <table border="0"> <tr><td>2.0</td><td>03.94 - 04.02</td></tr> <tr><td>1.9 D, 50 kW</td><td>04.98 - 04.02</td></tr> <tr><td>1.9 D, 51 kW</td><td>03.94 - 04.02</td></tr> <tr><td>1.9 TD, 60 kW</td><td>03.94 - 04.02</td></tr> <tr><td>1.9 TD, 66 kW</td><td>04.98 - 04.02</td></tr> <tr><td>1.9 TD CAT</td><td>08.94 - 04.02</td></tr> <tr><td>2.0 JTD</td><td>10.01 - 04.02</td></tr> <tr><td>2.5 D</td><td>03.94 - 04.02</td></tr> <tr><td>2.5 TDI</td><td>03.94 - 04.02</td></tr> <tr><td>2.5 TDI Maxi</td><td>03.94 - 04.02</td></tr> <tr><td>2.5 TDI 4x4</td><td>05.98 - 04.02</td></tr> <tr><td>2.8 D</td><td>05.98 - 04.02</td></tr> <tr><td>2.8 D 4x4</td><td>08.98 - 04.02</td></tr> <tr><td>2.8 JTD</td><td>11.00 - 04.02</td></tr> <tr><td>2.8 JTD 4x4</td><td>11.00 - 04.02</td></tr> <tr><td>2.8 TDI</td><td>10.97 - 04.02</td></tr> <tr><td>2.8 TDI 4x4</td><td>06.99 - 04.02</td></tr> </table>	2.0	03.94 - 04.02	1.9 D, 50 kW	04.98 - 04.02	1.9 D, 51 kW	03.94 - 04.02	1.9 TD, 60 kW	03.94 - 04.02	1.9 TD, 66 kW	04.98 - 04.02	1.9 TD CAT	08.94 - 04.02	2.0 JTD	10.01 - 04.02	2.5 D	03.94 - 04.02	2.5 TDI	03.94 - 04.02	2.5 TDI Maxi	03.94 - 04.02	2.5 TDI 4x4	05.98 - 04.02	2.8 D	05.98 - 04.02	2.8 D 4x4	08.98 - 04.02	2.8 JTD	11.00 - 04.02	2.8 JTD 4x4	11.00 - 04.02	2.8 TDI	10.97 - 04.02	2.8 TDI 4x4	06.99 - 04.02	<p></p> <p>02.2001-></p>	<p>26668 01 13 31 641 080</p>
2.0	03.94 - 04.02																																			
1.9 D, 50 kW	04.98 - 04.02																																			
1.9 D, 51 kW	03.94 - 04.02																																			
1.9 TD, 60 kW	03.94 - 04.02																																			
1.9 TD, 66 kW	04.98 - 04.02																																			
1.9 TD CAT	08.94 - 04.02																																			
2.0 JTD	10.01 - 04.02																																			
2.5 D	03.94 - 04.02																																			
2.5 TDI	03.94 - 04.02																																			
2.5 TDI Maxi	03.94 - 04.02																																			
2.5 TDI 4x4	05.98 - 04.02																																			
2.8 D	05.98 - 04.02																																			
2.8 D 4x4	08.98 - 04.02																																			
2.8 JTD	11.00 - 04.02																																			
2.8 JTD 4x4	11.00 - 04.02																																			
2.8 TDI	10.97 - 04.02																																			
2.8 TDI 4x4	06.99 - 04.02																																			









Ref.

FIAT

**DUCATO Kasten/Box/Furgón/Van
(230L)**

03.94 - 04.02

 Faltenbalg, Lenkung 2.0 1.9 D, 50 kW 1.9 D, 51 kW 1.9 TD, 60 kW 1.9 TD, 66 kW 1.9 TD CAT 2.5 D 2.5 TDI 2.5 TDI Maxi 2.5 TDI 4x4 2.8 D 2.8 TDI 2.8 TDI 4x4	03.94 - 04.02 04.98 - 04.02 03.94 - 04.02 03.94 - 04.02 04.98 - 04.02 08.94 - 04.02 03.94 - 04.02 03.94 - 04.02 03.94 - 04.02 05.98 - 04.02 05.98 - 04.02 10.97 - 04.02 06.99 - 04.02		15342 01 97 50 000 380 
Faltenbalgsatz, Lenkung Innendurchmesser 1 [mm]: 11 Innendurchmesser 2 [mm]: 38 2.0 1.9 D, 50 kW 1.9 D, 51 kW 1.9 TD, 60 kW 1.9 TD, 66 kW 1.9 TD CAT 2.5 D 2.5 TDI 2.5 TDI Maxi 2.5 TDI 4x4 2.8 D 2.8 TDI 2.8 TDI 4x4	03.94 - 04.02 04.98 - 04.02 03.94 - 04.02 03.94 - 04.02 04.98 - 04.02 08.94 - 04.02 03.94 - 04.02 03.94 - 04.02 03.94 - 04.02 05.98 - 04.02 05.98 - 04.02 10.97 - 04.02 06.99 - 04.02		30132 01 97 50 000 380 
Faltenbalgsatz, Lenkung 2.0 1.9 D, 50 kW 1.9 D, 51 kW 1.9 TD, 60 kW 1.9 TD, 66 kW 1.9 TD CAT 2.0 JTD 2.5 D 2.5 TDI 2.5 TDI Maxi 2.5 TDI 4x4 2.8 D 2.8 D 4x4 2.8 JTD 2.8 JTD 4x4 2.8 TDI 2.8 TDI 4x4	03.94 - 04.02 04.98 - 04.02 03.94 - 04.02 03.94 - 04.02 04.98 - 04.02 08.94 - 04.02 10.01 - 04.02 03.94 - 04.02 03.94 - 04.02 03.94 - 04.02 05.98 - 04.02 05.98 - 04.02 08.98 - 04.02 11.00 - 04.02 11.00 - 04.02 10.97 - 04.02 06.99 - 04.02		30203 01 9 946 982 









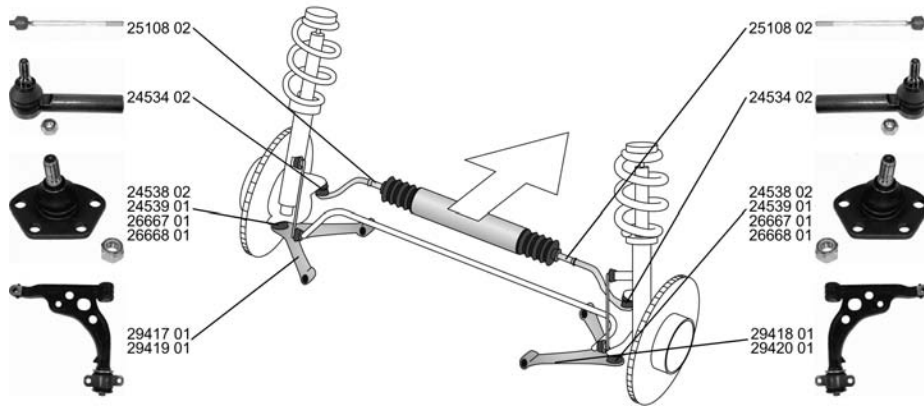

FIAT

DUCATO Pritsche, Fahrgestell / Flatbed, Chassis (230)

03.94 - 04.02



<p>Spurstangenkopf Gewindeart: mit Rechtsgewinde Gewindemaß: M16x1,5</p>		<p>24534 02 13 06 716 080</p> 
<p>ALL TYPES</p>		
<p>Axialgelenk, Spurstange</p>		<p>25108 02 9 945 836</p> 
<p>ALL TYPES</p>		
<p>Lenker, Radaufhängung</p>		<p>29417 01 1331 938 080</p> 
<p>ALL TYPES</p>	<p>Nutzlast [kg]:1000 Nutzlast [kg]:1400 ->Chass. 6086766 ->Chass. 6087206 nur in Verbindung mit:OE 1331 640 080</p> <p>----- Chass. 6086767-> Chass. 6087207-> ohne Einschränkung</p>	
<p>Lenker, Radaufhängung</p>		<p>29418 01 1331 940 080</p> 
<p>2.0 4x4 1.9 D, 50 kW 1.9 D, 51 kW 1.9 TD, 60 kW 1.9 TD, 66 kW 1.9 TD CAT 2.5 D 2.5 D 4x4 2.5 TDI, 80 kW 2.5 TDI, 85 kW 2.5 TDI 4x4 2.8 D 2.8 JTD, 94 kW 2.8 TDI 2.0</p>	<p>06.98 - 04.02 04.98 - 04.02 03.94 - 04.02 03.94 - 04.02 04.98 - 04.02 08.94 - 04.02 03.94 - 04.02 03.94 - 04.02 03.94 - 04.02 03.94 - 04.02 06.98 - 04.02 02.98 - 04.02 11.00 - 04.02 12.98 - 04.02 06.98 - 04.02</p>	<p>zul. Gesamtgewicht [kg]:1000 zul. Gesamtgewicht [kg]:1400 ->Chass. 6086766 ->Chass. 6087206 nur in Verbindung mit:OE 1331 640 080</p> <p>----- Chass. 6087207-> ohne Einschränkung</p>
	<p>Nutzlast [kg]:1000 Nutzlast [kg]:1400 ->Chass. 6086766 ->Chass. 6087206 nur in Verbindung mit:OE 1331 640 080</p> <p>----- Chass. 6087207-> ohne Einschränkung</p>	

















Ref.

FIAT

DUCATO Pritsche, Fahrgestell / Flatbed, Chassis (230)

03.94 - 04.02





<p> Lenker, Radaufhängung ALL TYPES</p>	<p></p> <p>Nutzlast [kg]:1800 ->Chass. 6086766 ->Chass. 6087206 nur in Verbindung mit:OE 1331 641 080</p> <p>-----</p> <p>Chass. 6086767-> Chass. 6087207-> ohne Einschränkung</p>	<p>29419 01 1331 937 080</p> 																						
<p>Lenker, Radaufhängung ALL TYPES</p>	<p></p> <p>Nutzlast [kg]:1800 ->Chass. 6086766 ->Chass. 6087206 nur in Verbindung mit:OE 1331 641 080</p> <p>-----</p> <p>Chass. 6086767-> Chass. 6087207-> ohne Einschränkung</p>	<p>29420 01 1331 939 080</p> 																						
<p>Trag-/Führungsgelenk Gewindemaß: M16x1,5 ALL TYPES</p>	<p></p> <p>->Chass. 6015630 nur in Verbindung mit:OE 1331 938 080 nur in Verbindung mit:OE 1331 940 080 Nutzlast [kg]:1400</p> <p>-----</p> <p>Chass. 6015631-> ohne Einschränkung</p>	<p>24538 02</p> 																						
<p>Trag-/Führungsgelenk maximale Last [kg]: 1800 Gewindemaß: M18x1,5 ALL TYPES</p>	<p></p> <p>->Chass. 6015630 nur in Verbindung mit:OE 1331 937 080 nur in Verbindung mit:OE 1331 939 080</p> <p>-----</p> <p>Chass. 6015631-> nur in Verbindung mit:OE 1331 640 080 ohne Einschränkung</p>	<p>24539 01</p> 																						
<p>Trag-/Führungsgelenk nur in Verbindung mit: 29417 nur in Verbindung mit: 29418 maximale Last [kg]: 1400 ALL TYPES</p>	<p></p> <p>02.2001-></p>	<p>26667 01 13 31 640 080</p> 																						
<p>Trag-/Führungsgelenk nur in Verbindung mit: 29419 nur in Verbindung mit: 29420 maximale Last [kg]: 1800 mit Zubehör ALL TYPES</p>	<p></p> <p>02.2001-></p>	<p>26668 01 13 31 641 080</p>																						
<p>Faltenbalg, Lenkung</p> <table border="0"> <tr> <td>2.0</td> <td>06.98 - 04.02</td> </tr> <tr> <td>1.9 D, 50 kW</td> <td>04.98 - 04.02</td> </tr> <tr> <td>1.9 D, 51 kW</td> <td>03.94 - 04.02</td> </tr> <tr> <td>1.9 TD, 60 kW</td> <td>03.94 - 04.02</td> </tr> <tr> <td>1.9 TD, 66 kW</td> <td>04.98 - 04.02</td> </tr> <tr> <td>1.9 TD CAT</td> <td>08.94 - 04.02</td> </tr> <tr> <td>2.5 D</td> <td>03.94 - 04.02</td> </tr> <tr> <td>2.5 TDI, 80 kW</td> <td>03.94 - 04.02</td> </tr> <tr> <td>2.5 TDI, 85 kW</td> <td>03.94 - 04.02</td> </tr> <tr> <td>2.8 D</td> <td>02.98 - 04.02</td> </tr> <tr> <td>2.8 TDI</td> <td>12.98 - 04.02</td> </tr> </table>	2.0	06.98 - 04.02	1.9 D, 50 kW	04.98 - 04.02	1.9 D, 51 kW	03.94 - 04.02	1.9 TD, 60 kW	03.94 - 04.02	1.9 TD, 66 kW	04.98 - 04.02	1.9 TD CAT	08.94 - 04.02	2.5 D	03.94 - 04.02	2.5 TDI, 80 kW	03.94 - 04.02	2.5 TDI, 85 kW	03.94 - 04.02	2.8 D	02.98 - 04.02	2.8 TDI	12.98 - 04.02	<p></p>	<p>15342 01 97 50 000 380</p> 
2.0	06.98 - 04.02																							
1.9 D, 50 kW	04.98 - 04.02																							
1.9 D, 51 kW	03.94 - 04.02																							
1.9 TD, 60 kW	03.94 - 04.02																							
1.9 TD, 66 kW	04.98 - 04.02																							
1.9 TD CAT	08.94 - 04.02																							
2.5 D	03.94 - 04.02																							
2.5 TDI, 80 kW	03.94 - 04.02																							
2.5 TDI, 85 kW	03.94 - 04.02																							
2.8 D	02.98 - 04.02																							
2.8 TDI	12.98 - 04.02																							



FIAT





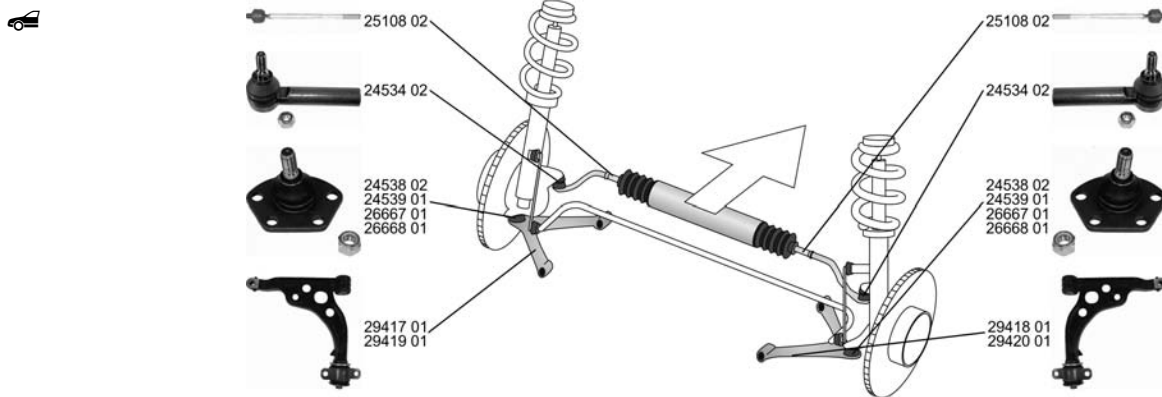

DUCATO Pritsche, Fahrgestell / Flatbed, Chassis (230)

03.94 - 04.02

 Faltenbaldsatz, Lenkung Innendurchmesser 1 [mm]: 11 Innendurchmesser 2 [mm]: 38			30132 01	97 50 000 380
	2.0	06.98 - 04.02		
	1.9 D, 50 kW	04.98 - 04.02		
	1.9 D, 51 kW	03.94 - 04.02		
	1.9 TD, 60 kW	03.94 - 04.02		
	1.9 TD, 66 kW	04.98 - 04.02		
	1.9 TD CAT	08.94 - 04.02		
	2.5 D	03.94 - 04.02		
	2.5 TDI, 80 kW	03.94 - 04.02		
	2.5 TDI, 85 kW	03.94 - 04.02		
	2.8 D	02.98 - 04.02		
2.8 TDI	12.98 - 04.02			
Faltenbaldsatz, Lenkung			30203 01	9 946 982
	2.0	06.98 - 04.02		
	2.0 4x4	06.98 - 04.02		
	1.9 D, 50 kW	04.98 - 04.02		
	1.9 D, 51 kW	03.94 - 04.02		
	1.9 TD, 60 kW	03.94 - 04.02		
	1.9 TD, 66 kW	04.98 - 04.02		
	1.9 TD CAT	08.94 - 04.02		
	2.5 D	03.94 - 04.02		
	2.5 D 4x4	03.94 - 04.02		
	2.5 TDI, 80 kW	03.94 - 04.02		
	2.5 TDI, 85 kW	03.94 - 04.02		
	2.5 TDI 4x4	06.98 - 04.02		
	2.8 D	02.98 - 04.02		
	2.8 JTD, 94 kW	11.00 - 04.02		
	2.8 TDI	12.98 - 04.02		

DUCATO Bus/Familial (244, Z_) 04.02 -



















 Spurstangenkopf Gewindeart: mit Rechtsgewinde Gewindemaß: M16x1,5			24534 02	13 06 716 080
	2.0	04.02 -		
	2.0 Bipower	11.02 -		
	2.0 JTD	04.02 -		
	2.3 JTD	04.02 -		
	2.0 4x4	05.02 - 07.06		
	2.8 JTD, 94 kW	04.02 -		
2.8 JTD 4x4	07.02 -			
Axialgelenk, Spurstange			25108 02	9 945 836
	2.0	04.02 -		
	2.0 Bipower	11.02 -		
	2.0 JTD	04.02 -		
	2.3 JTD	04.02 -		
	2.8 JTD, 94 kW	04.02 -		
	2.8 JTD 4x4	07.02 -		
	2.0 4x4	05.02 - 07.06		
2.8 TD	11.03 - 07.06			
2.8 TD 4x4	11.03 - 07.06			
2.8 JTD, 107 kW	04.04 - 07.06			



Ref.

FIAT

DUCATO Bus/Familial (244, Z_) 04.02 -

<p> Lenker, Radaufhängung ALL TYPES ausser : 2.8 TD</p>	<p> ->Chass. 7226522 Nutzlast [kg]:1100 Nutzlast [kg]:1500</p>	<p>29417 01 1331 938 080 </p>
<p>Lenker, Radaufhängung ALL TYPES</p>	<p> ->Chass. 7226522 Nutzlast [kg]:1100 Nutzlast [kg]:1500</p>	<p>29418 01 1331 940 080 </p>
<p>Lenker, Radaufhängung ALL TYPES ausser : 2.8 TD</p>	<p> ->Chass. 7226522 Nutzlast [kg]:1800</p>	<p>29419 01 1331 937 080 </p>
<p>Lenker, Radaufhängung ALL TYPES ausser : 2.8 TD</p>	<p> ->Chass. 7226522 Nutzlast [kg]:1800</p>	<p>29420 01 1331 939 080 </p>
<p>Trag-/Führungsgelenk Gewindemaß: M16x1,5 2.0</p>	<p> Nutzlast [kg]:1100 Nutzlast [kg]:1500</p>	<p>24538 02 </p>
<p>Trag-/Führungsgelenk maximale Last [kg]: 1800 Gewindemaß: M18x1,5 2.0</p>	<p></p>	<p>24539 01 </p>
<p>Trag-/Führungsgelenk nur in Verbindung mit: 29417 nur in Verbindung mit: 29418 maximale Last [kg]: 1400 ALL TYPES ausser : 2.8 TD</p>	<p></p>	<p>26667 01 13 31 640 080 </p>
<p>Trag-/Führungsgelenk nur in Verbindung mit: 29419 nur in Verbindung mit: 29420 maximale Last [kg]: 1800 mit Zubehör ALL TYPES ausser : 2.8 TD</p>	<p></p>	<p>26668 01 13 31 641 080 </p>







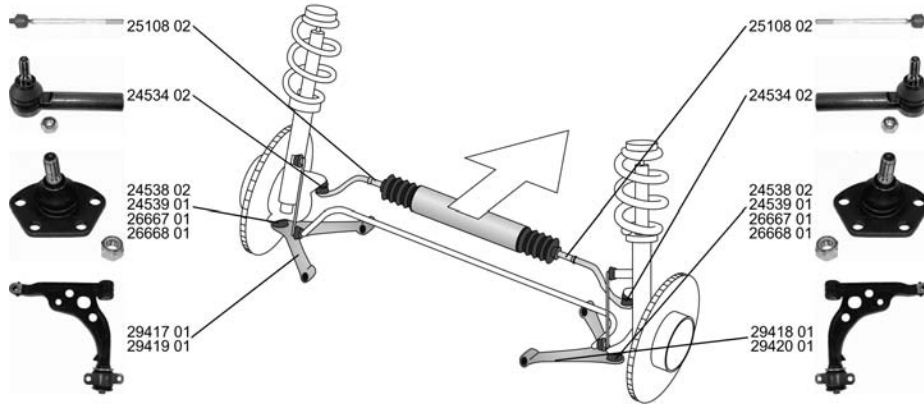

FIAT

DUCATO Kasten/Box/Furgón/Van (244)

04.02 -



Spurstangenkopf Gewindeart: mit Rechtsgewinde Gewindemaß: M16x1,5	↔	24534 02 13 06 716 080 
2.0 2.0 Bipower 2.0 JTD 2.3 JTD 2.0 4x4 2.8 JTD 2.8 JTD 4x4	04.02 - 11.02 - 04.02 - 04.02 - 05.02 - 07.06 04.02 - 07.02 -	->12.2002
Axialgelenk, Spurstange	↔	25108 02 9 945 836 
2.0 2.0 Bipower 2.0 JTD 2.3 JTD 2.8 JTD 2.8 JTD 4x4 2.0 4x4 2.8 JTD Power 2.8 TD 2.8 TD 4x4	04.02 - 11.02 - 04.02 - 04.02 - 04.02 - 07.02 - 05.02 - 07.06 05.04 - 11.03 - 07.06 11.03 - 07.06	
Lenker, Radaufhängung	↕↔	29417 01 1331 938 080 
ALL TYPES ausser : 2.8 TD	04.02 -	->Chass. 7226522 Nutzlast [kg]:1100 Nutzlast [kg]:1500
Lenker, Radaufhängung	↕↔	29418 01 1331 940 080 
ALL TYPES		->Chass. 7226522 Nutzlast [kg]:1100 Nutzlast [kg]:1500
Lenker, Radaufhängung	↕↔	29419 01 1331 937 080 
ALL TYPES ausser : 2.8 TD	04.02 -	->Chass. 7226522 Nutzlast [kg]:1800
Lenker, Radaufhängung	↕↔	29420 01 1331 939 080 
ALL TYPES ausser : 2.8 TD	04.02 -	->Chass. 7226522 Nutzlast [kg]:1800





Ref.

FIAT

DUCATO Kasten/Box/Furgón/Van (244)



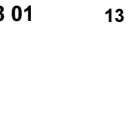

04.02 -

 Trag-/Führungsgelenk nur in Verbindung mit: 29417 nur in Verbindung mit: 29418 maximale Last [kg]: 1400 ALL TYPES ausser : 2.8 TD	04.02 -	▼↕	26667 01	13 31 640 080	
Trag-/Führungsgelenk nur in Verbindung mit: 29419 nur in Verbindung mit: 29420 maximale Last [kg]: 1800 mit Zubehör ALL TYPES ausser : 2.8 TD	04.02 -	▼↕	26668 01	13 31 641 080	

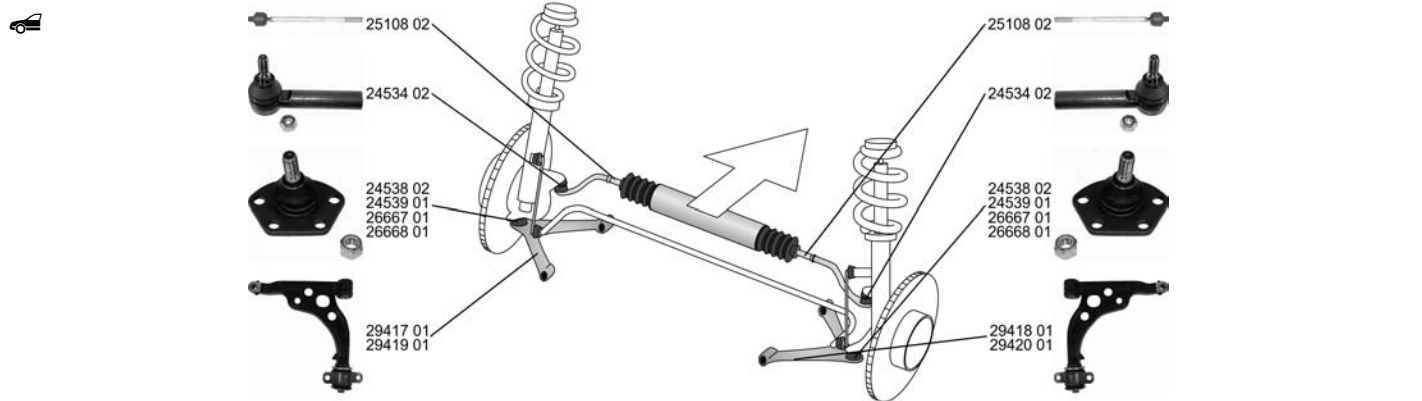
DUCATO Pritsche,Fahrgestell / Flatbed,Chassis (244)

04.02 -













Spurstangenkopf Gewindeart: mit Rechtsgewinde Gewindemaß: M16x1,5 2.0 JTD 2.3 JTD 2.8 JTD, 94 kW 2.8 JTD 4x4, 94 kW	04.02 -	↕	24534 02	13 06 716 080	
	04.02 -	->12.2002			
	04.02 -				
	10.02 -				
Axialgelenk, Spurstange 2.0 JTD 2.3 JTD 2.8 JTD, 94 kW 2.8 JTD 4x4, 94 kW 2.8 JTD Power 2.8 JTD, 90 kW 2.8 JTD 4x4, 90 kW	04.02 -	↕	25108 02	9 945 836	
	04.02 -				
	04.02 -				
	10.02 -				
	05.04 -	☰			
Lenker, Radaufhängung ALL TYPES ausser : 2.8 TD	04.02 -	▼↕	29417 01	1331 938 080	
		->Chass. 7226522 Nutzlast [kg]:1100 Nutzlast [kg]:1500			
Lenker, Radaufhängung 2.0 JTD 2.3 JTD 2.8 JTD, 94 kW 2.8 JTD 4x4, 94 kW	04.02 -	▼↕	29418 01	1331 940 080	
	04.02 -	->Chass. 7226522 Nutzlast [kg]:1100 Nutzlast [kg]:1500			
	04.02 -				
	10.02 -				
Lenker, Radaufhängung ALL TYPES ausser : 2.8 TD	04.02 -	▼↕	29419 01	1331 937 080	
		->Chass. 7226522 Nutzlast [kg]:1800			



FIAT





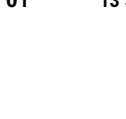

DUCATO Pritsche, Fahrgestell / Flatbed, Chassis (244)

04.02 -

 Lenker, Radaufhängung ALL TYPES ausser : 2.8 TD	04.02 -	 ->Chass. 7226522 Nutzlast [kg]:1800	29420 01 1331 939 080 
Trag-/Führungsgelenk Gewindemaß: M16x1,5 2.0 JTD	04.02 -	 Nutzlast [kg]:1100 Nutzlast [kg]:1500	24538 02 
Trag-/Führungsgelenk maximale Last [kg]: 1800 Gewindemaß: M18x1,5 2.0 JTD	04.02 -		24539 01 
Trag-/Führungsgelenk nur in Verbindung mit: 29417 nur in Verbindung mit: 29418 maximale Last [kg]: 1400 ALL TYPES ausser : 2.8 TD	04.02 -		26667 01 13 31 640 080 
Trag-/Führungsgelenk nur in Verbindung mit: 29419 nur in Verbindung mit: 29420 maximale Last [kg]: 1800 mit Zubehör ALL TYPES ausser : 2.8 TD	04.02 -		26668 01 13 31 641 080 







DUCATO Bus

07.06 -

 Trag-/Führungsgelenk Konusmaß [mm]: 24 ALL TYPES			31196 01 5070 5629 
 Stange/Strebe, Stabilisator Pendelstange Rohr-Ø [mm]: 8 Gewindemaß: M10 x 1,5 ALL TYPES			31351 01 

DUCATO Kasten

07.06 -







 Trag-/Führungsgelenk Konusmaß [mm]: 24 ALL TYPES			31196 01 5070 5629 
 Stange/Strebe, Stabilisator Pendelstange Rohr-Ø [mm]: 8 Gewindemaß: M10 x 1,5 ALL TYPES			31351 01 



Ref.









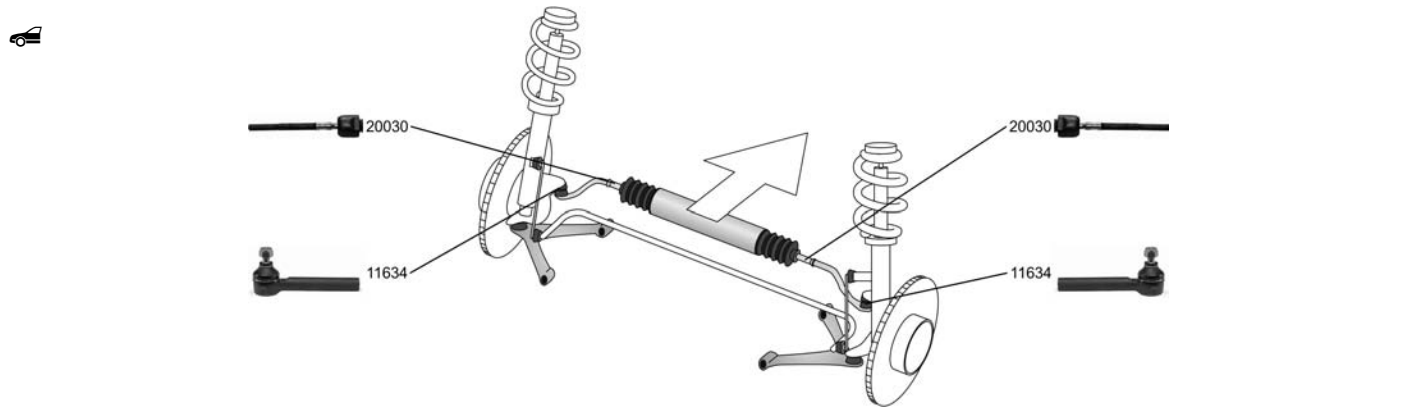



FIAT

DUCATO Pritsche/Fahrgestell 07.06 -





 Trag-/Führungsgelenk Konusmaß [mm]: 24 ALL TYPES		31196 01 5070 5629 
 Stange/Strebe, Stabilisator Pendelstange Rohr-Ø [mm]: 8 Gewindemaß: M10 x 1,5 ALL TYPES		31351 01 

FIORINO (147) 01.80 - 04.88



 Spurstangenkopf Gewindeart: mit Rechtsgewinde Gewindemaß: M10x1 ALL TYPES	 	11634 01 5 983 406 
Axialgelenk, Spurstange Gewindeart: mit Rechtsgewinde Gewindemaß: M12x1,5 ALL TYPES	   	20030 01 5 960 321 
Faltenbalgsatz, Lenkung Innendurchmesser 1 [mm]: 10 Innendurchmesser 2 [mm]: 42 ALL TYPES		30133 01 4 371 155 
Faltenbalgsatz, Lenkung Innendurchmesser 1 [mm]: 10 Innendurchmesser 2 [mm]: 26 ALL TYPES		30134 01 4 371 156 

FIORINO Pick up (147) 10.82 - 12.88

 Spurstangenkopf Gewindeart: mit Rechtsgewinde Gewindemaß: M10x1 ALL TYPES	 	11634 01 5 983 406 
---	---	--







Ref.

FIAT

FIORINO Pick up (147)





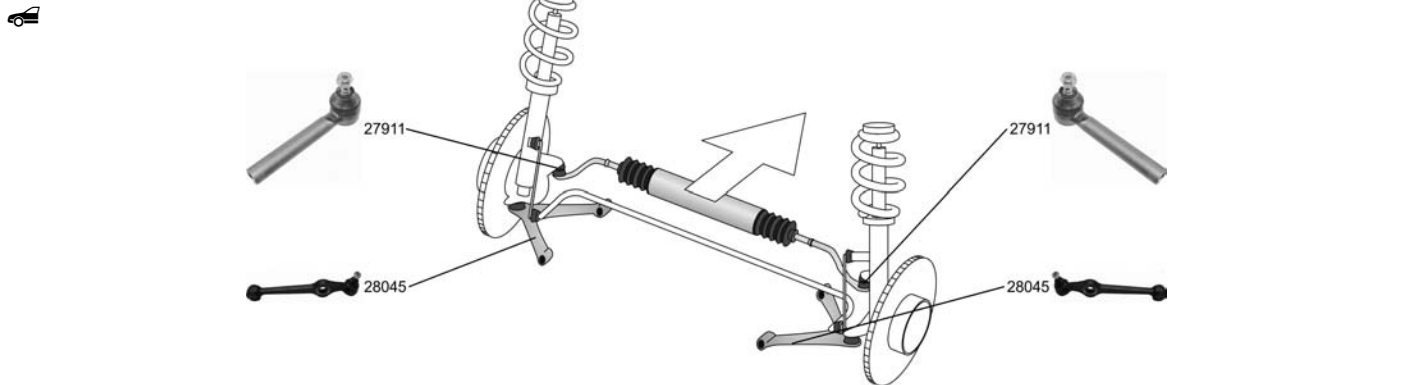

10.82 - 12.88

 Axialgelenk, Spurstange Gewindeart: mit Rechtsgewinde Gewindemaß: M12x1,5 ALL TYPES		20030 01 5 960 321 
		

FIORINO Kasten/Box/Furgón/Van (146 Uno)



05.88 - 05.01



Spurstangenkopf 60 1.1 05.88 - 12.93 70 1.3 01.88 - 12.94 75 i.e. 1.5 05.88 - 12.93 60 1.7 D, 42 kW 05.88 - 10.96	 12.1992->	27911 01 7 690 960 
Faltenbalgsatz, Lenkung Innendurchmesser 1 [mm]: 10 Innendurchmesser 2 [mm]: 42 60 1.1 05.88 - 12.93 70 1.3 01.88 - 12.94 70 i.e. 1.4 05.94 - 05.01 75 i.e. 1.5 05.88 - 12.93 75 i.e. 1.6 10.93 - 05.01 60 1.7 D, 42 kW 05.88 - 10.96 60 1.7 D, 44 kW 05.88 - 05.00 65 1.7 TD 01.97 - 05.01		30133 01 4 371 155 
Faltenbalgsatz, Lenkung Innendurchmesser 1 [mm]: 10 Innendurchmesser 2 [mm]: 26 60 1.1 05.88 - 12.93 70 1.3 01.88 - 12.94 70 i.e. 1.4 05.94 - 05.01 75 i.e. 1.5 05.88 - 12.93 75 i.e. 1.6 10.93 - 05.01 60 1.7 D, 42 kW 05.88 - 10.96 60 1.7 D, 44 kW 05.88 - 05.00 65 1.7 TD 01.97 - 05.01		30134 01 4 371 156 

FIORINO Pick up (146)

01.88 - 05.01

 Spurstangenkopf 1.3, 49 kW 01.88 - 12.94 1.7 D, 44 kW 05.88 - 10.99	 12.1992->	27911 01 7 690 960 
--	--	---











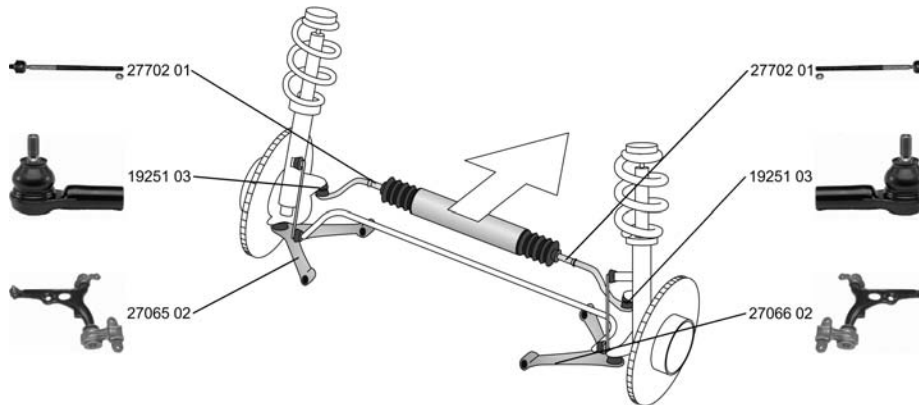

Ref.

FIAT

**SCUDO Combinato/Estate/Break
(220P)**

02.96 -



<p>Spurstangenkopf Gewindeart: mit Rechtsgewinde Innengewinde [mm]: M14x1,5 mit Zubehör</p>		<p>19251 03 13 06 003 080</p> 
<p>ALL TYPES ausser : 1.9 D, 1905 ccm 02.96 - 04.98 2.0 JTD, 69 kW 01.04 -</p>	<p>für Lenkgetriebe-ID:1 315 183 080 für Lenkgetriebe-ID:1 318 712 080</p>	
<p>Axialgelenk, Spurstange Aussengewinde [mm]: M14x1,5</p>		<p>27702 01 95 66 950 880</p> 
<p>ALL TYPES ausser : 2.0 JTD, 69 kW 01.04 -</p>	<p>für Lenkgetriebe-ID:13 15 183 080 für Lenkgetriebe-ID:13 18 712 080</p>	
<p>Lenker, Radaufhängung mit Trag-/Führungsgelenk mit Gummilager mit Befestigungsmaterial</p>		<p>27065 02 13 33 754 080</p> 
<p>ALL TYPES ausser : 2.0 JTD, 69 kW 01.04 -</p>		
<p>Lenker, Radaufhängung mit Trag-/Führungsgelenk mit Gummilager mit Befestigungsmaterial</p>		<p>27066 02 13 33 755 080</p> 
<p>ALL TYPES ausser : 2.0 JTD, 69 kW 01.04 -</p>		
<p>Achskörperlager</p>		<p>26578 01 1 479 759 080</p> 
<p>ALL TYPES ausser : 2.0 JTD, 69 kW 01.04 -</p>		











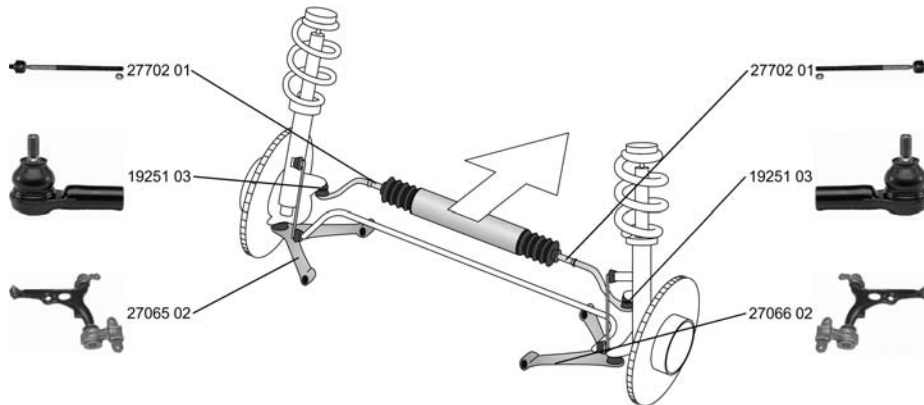



FIAT

**SCUDO Kasten/Box/Furgón/Van
(220L)**

02.96 -



<p>Spurstangenkopf Gewindeart: mit Rechtsgewinde Innengewinde [mm]: M14x1,5 mit Zubehör ALL TYPES</p>		<p>19251 03 13 06 003 080</p> 
<p>Axialgelenk, Spurstange Aussengewinde [mm]: M14x1,5 ALL TYPES</p>		<p>27702 01 95 66 950 880</p> 
<p>Lenker, Radaufhängung mit Trag-/Führungsgelenk mit Gummilager mit Befestigungsmaterial ALL TYPES</p>		<p>27065 02 13 33 754 080</p> 
<p>Lenker, Radaufhängung mit Trag-/Führungsgelenk mit Gummilager mit Befestigungsmaterial ALL TYPES</p>		<p>27066 02 13 33 755 080</p> 
<p>Achskörperlager ALL TYPES</p>		<p>26578 01 1 479 759 080</p> 







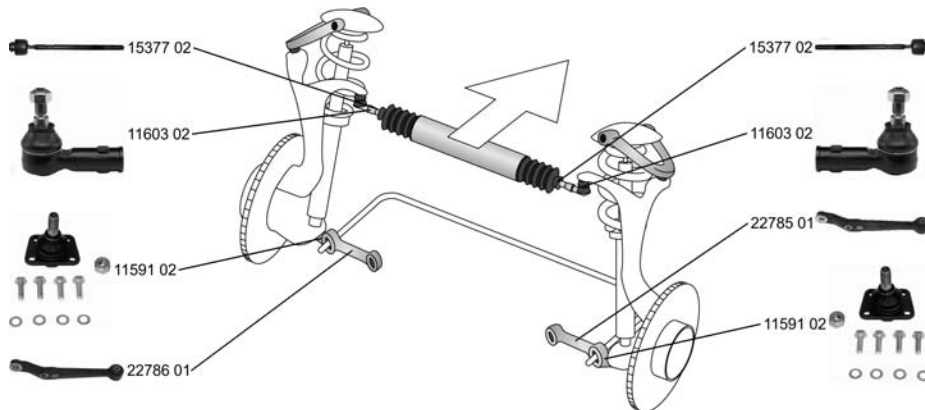

Ref.

FIAT

TALENTO Bus/Familial (290)

03.89 - 03.94



<p>Spurstangenkopf Konusmaß [mm]: 16 Innengewinde [mm]: M16x1,5 Gewindeart: mit Rechtsgewinde Gewindemaß: M16x1,5</p>		<p>11603 02 97 50 079 980</p> 
<p>ALL TYPES</p>		
<p>Axialgelenk, Spurstange Gewindeart: mit Rechtsgewinde Gewindemaß: M16x1,5</p>		<p>15377 02 97 90 002 680</p> 
<p>ALL TYPES</p>		
<p>Lenker, Radaufhängung ohne Trag-/Führungsgelenk mit Gummilager nur in Verbindung mit: 11591 Nutzlast [kg]: 1000 Nutzlast [kg]: 1400</p>		<p>22785 01 7 695 190</p> 
<p>ALL TYPES</p>		
<p>Lenker, Radaufhängung ohne Trag-/Führungsgelenk mit Gummilager nur in Verbindung mit: 11591 Nutzlast [kg]: 1000 Nutzlast [kg]: 1400</p>		<p>22786 01 7 695 191</p> 
<p>ALL TYPES</p>		
<p>Trag-/Führungsgelenk mit Zubehör</p>		<p>11591 02 7 567 284</p> 
<p>ALL TYPES</p>		









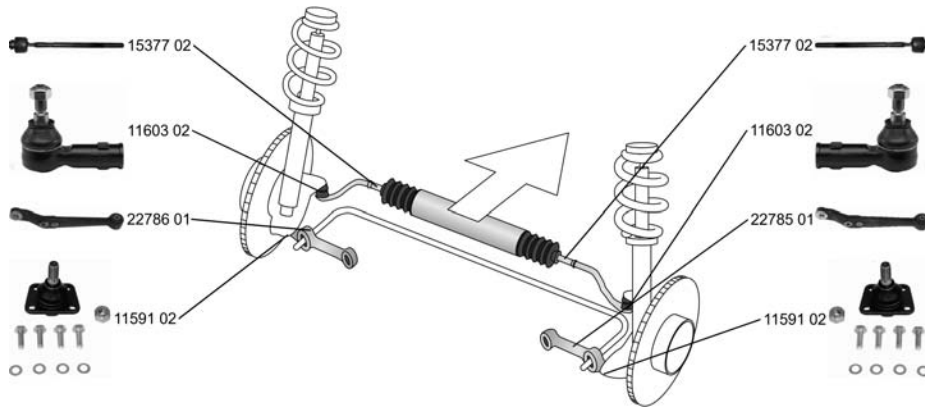









FIAT

**TALENTO Kasten/Box/Furgón/Van
(290)**

03.89 - 03.94



<p>Spurstangenkopf Konusmaß [mm]: 16 Innengewinde [mm]: M16x1,5 Gewindeart: mit Rechtsgewinde Gewindemaß: M16x1,5</p>		<p>11603 02 97 50 079 980</p> 
<p>ALL TYPES</p>		
<p>Axialgelenk, Spurstange Gewindeart: mit Rechtsgewinde Gewindemaß: M16x1,5</p>	 	<p>15377 02 97 90 002 680</p> 
<p>ALL TYPES</p>		
<p>Lenker, Radaufhängung ohne Trag-/Führungsgelenk mit Gummilager nur in Verbindung mit: 11591 Nutzlast [kg]: 1000 Nutzlast [kg]: 1400</p>	 	<p>22785 01 7 695 190</p> 
<p>ALL TYPES</p>		
<p>Lenker, Radaufhängung ohne Trag-/Führungsgelenk mit Gummilager nur in Verbindung mit: 11591 Nutzlast [kg]: 1000 Nutzlast [kg]: 1400</p>	 	<p>22786 01 7 695 191</p> 
<p>ALL TYPES</p>		
<p>Trag-/Führungsgelenk mit Zubehör</p>	 	<p>11591 02 7 567 284</p>
<p>ALL TYPES</p>		











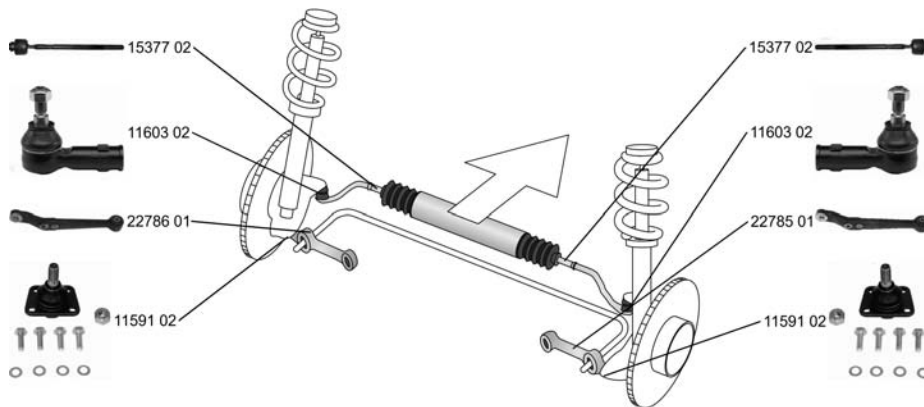



Ref.

FIAT

**TALENTO Pritsche/Fahrgestell /
Flatbed,Chassis (290)**

03.89 - 03.94



<p>Spurstangenkopf Konusmaß [mm]: 16 Innengewinde [mm]: M16x1,5 Gewindeart: mit Rechtsgewinde Gewindemaß: M16x1,5</p>		<p>11603 02 97 50 079 980</p> 
<p>ALL TYPES</p>		
<p>Axialgelenk, Spurstange Gewindeart: mit Rechtsgewinde Gewindemaß: M16x1,5</p>		<p>15377 02 97 90 002 680</p> 
<p>ALL TYPES</p>		
<p>Lenker, Radaufhängung ohne Trag-/Führungsgelenk mit Gummilager nur in Verbindung mit: 11591 Nutzlast [kg]: 1000 Nutzlast [kg]: 1400</p>		<p>22785 01 7 695 190</p> 
<p>ALL TYPES</p>		
<p>Lenker, Radaufhängung ohne Trag-/Führungsgelenk mit Gummilager nur in Verbindung mit: 11591 Nutzlast [kg]: 1000 Nutzlast [kg]: 1400</p>		<p>22786 01 7 695 191</p> 
<p>ALL TYPES</p>		
<p>Trag-/Führungsgelenk mit Zubehör</p>		<p>11591 02 7 567 284</p> 
<p>ALL TYPES</p>		











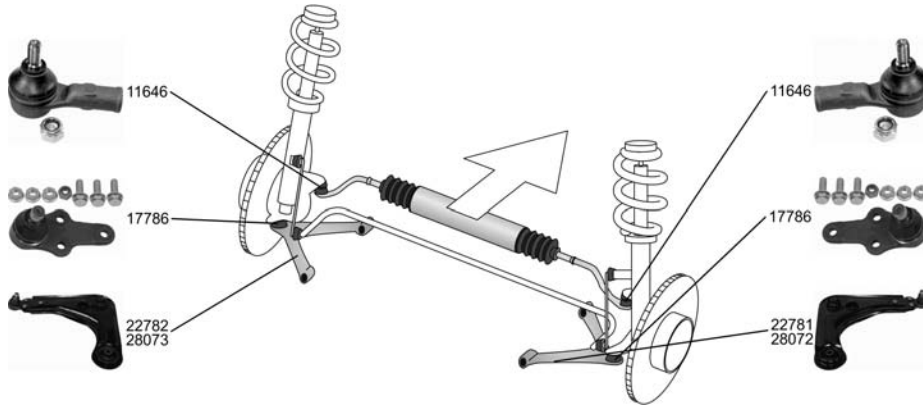





Ref.

FORD

**FIESTA Kasten/Box/Furgón/Van
(FVD)**

03.83 - 12.95



<p>Spurstangenkopf Gewindeart: mit Rechtsgewinde</p> <p>1.0 1.8 D (FVJ)</p>	<p></p>	<p>11646 03 5 021 410</p> 
<p>Lenker, Radaufhängung mit Trag-/Führungsgelenk mit Gummilager</p> <p>1.8 D (FVJ)</p>	<p></p> <p> 01.1994-></p>	<p>22781 01 1 111 410</p> 
<p>Lenker, Radaufhängung mit Trag-/Führungsgelenk mit Gummilager</p> <p>1.8 D (FVJ)</p>	<p></p> <p> 01.1994-></p>	<p>22782 01 1 111 412</p> 
<p>Trag-/Führungsgelenk mit Zubehör</p> <p>1.8 D (FVJ)</p>	<p></p> <p> 01.1994-></p>	<p>17786 03 1 047 797</p> 
<p>Lagerung, Lenker</p> <p>1.8 D (FVJ)</p>	<p></p>	<p>24548 01 1 000 445</p> 









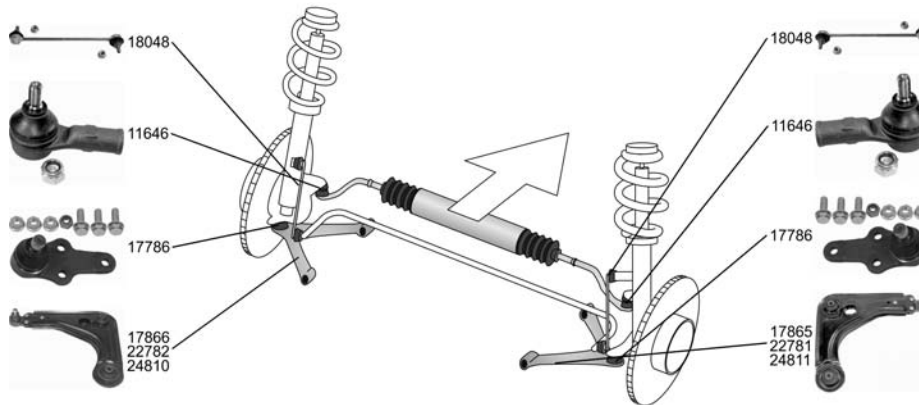















Ref.

FORD

FIESTA Box/Courier/Van (F3L, F5L) 07.91 - 02.96









Spurstangenkopf Gewindeart: mit Rechtsgewinde 1.3 1.8 D	09.91 - 02.96 09.91 - 02.96	 ->12.1993	11646 03 5 021 410 
Lenker, Radaufhängung mit Trag-/Führungsgelenk mit Gummilager 1.3 1.8 D	09.91 - 02.96 09.91 - 02.96	  10.1995->	17865 01 1 070 337 
Lenker, Radaufhängung mit Trag-/Führungsgelenk mit Gummilager 1.3 1.8 D	09.91 - 02.96 09.91 - 02.96	  10.1995->	17866 01 1 070 338 
Lenker, Radaufhängung mit Trag-/Führungsgelenk mit Gummilager 1.3 1.8 D	09.91 - 02.96 09.91 - 02.96	  01.1994->	22781 01 1 111 410 
Lenker, Radaufhängung mit Trag-/Führungsgelenk mit Gummilager 1.3 1.8 D	09.91 - 02.96 09.91 - 02.96	  01.1994->	22782 01 1 111 412 
Lenker, Radaufhängung mit Trag-/Führungsgelenk mit Gummilager 1.3 1.8 D	09.91 - 02.96 09.91 - 02.96	  ->01.1994	24810 01 1 111 413 
Lenker, Radaufhängung mit Trag-/Führungsgelenk mit Gummilager 1.3 1.8 D	09.91 - 02.96 09.91 - 02.96	  ->01.1994	24811 01 1 111 411 
Trag-/Führungsgelenk mit Zubehör 1.3 1.8 D	09.91 - 02.96 09.91 - 02.96	  01.1994->	17786 03 1 047 797 



Ref.



FORD

FIESTA Box/Courier/Van (F3L, F5L) 07.91 - 02.96

	Lagerung, Lenker		▼↕	24548 01	1 000 445
	1.3 1.8 D	09.91 - 02.96 09.91 - 02.96			
	Lagerung, Lenker		▼↕	25176 01	1 035 929
	1.3 1.8 D	09.91 - 02.96 09.91 - 02.96			
	Stange/Strebe, Stabilisator Pendelstange mit Zubehör		↔	18048 02	1 130 273
	1.3 1.8 D	09.91 - 02.96 09.91 - 02.96			
	Faltenbalgsatz, Lenkung Innendurchmesser 1 [mm]: 14 Innendurchmesser 2 [mm]: 37		↔	30168 01	6 935 233
	1.3 1.8 D	09.91 - 02.96 09.91 - 02.96	↕		
	Achskörperlager		↔	29518 01	7 320 351
	1.3 1.8 D	09.91 - 02.96 09.91 - 02.96			

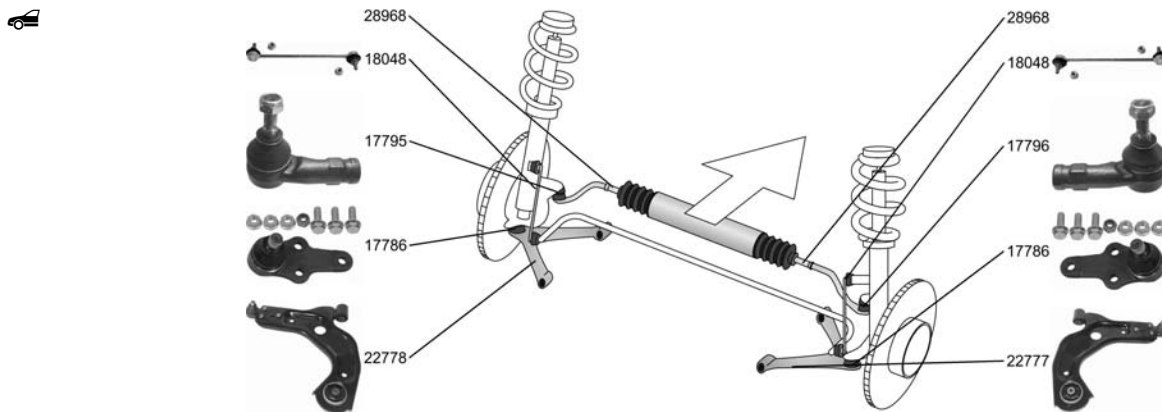
FIESTA Box/Courier/Van (J5_, J3_) 02.96 -



	Spurstangenkopf Gewindeart: mit Rechtsgewinde Gewindemaß: M10x1,5		↕	17795 01	1 020 175
	1.3 1.4 i 1.8 D 1.8 DI	02.96 - 04.96 - 10.99 02.96 - 09.00 -			
	Spurstangenkopf Gewindeart: mit Rechtsgewinde Gewindemaß: M10x1,5		↕	17796 01	1 020 174
	1.3 1.4 i 1.8 D 1.8 DI	02.96 - 04.96 - 10.99 02.96 - 09.00 -			



Ref.

FORD

FIESTA Box/Courier/Van (J5 , J3) 02.96 -

 Axialgelenk, Spurstange Gewindemaß: M16x1,5 radseitig Aussengewinde [mm]: 16			28968 01	1 044 014
	1.3	02.96 -		
	1.4 i	04.96 - 10.99		
	1.8 D	02.96 -		
1.8 DI	09.00 -			
Lenker, Radaufhängung mit Trag-/Führungsgelenk mit Gummilager			22777 01	1 330 238
	1.3	02.96 -		
	1.4 i	04.96 - 10.99		
	1.8 D	02.96 -		
1.8 DI	09.00 -			
Lenker, Radaufhängung mit Trag-/Führungsgelenk mit Gummilager			22778 01	1 330 239
	1.3	02.96 -		
	1.4 i	04.96 - 10.99		
	1.8 D	02.96 -		
1.8 DI	09.00 -			
Trag-/Führungsgelenk mit Zubehör			17786 03	1 047 797
	1.3	02.96 -		
	1.4 i	04.96 - 10.99		
	1.8 D	02.96 -		
1.8 DI	09.00 -			
Lagerung, Lenker			27308 01	1 063 372
	1.3	02.96 -		
	1.4 i	04.96 - 10.99		
	1.8 D	02.96 -		
1.8 DI	09.00 -			
Lagerung, Lenker			27408 01	1 055 191
	1.3	02.96 -		
	1.4 i	04.96 - 10.99		
	1.8 D	02.96 -		
1.8 DI	09.00 -			
Stange/Strebe, Stabilisator Pendelstange mit Zubehör			18048 02	1 130 273
	1.3	02.96 -		
	1.4 i	04.96 - 10.99		
	1.8 D	02.96 -		
1.8 DI	09.00 -			
 Achskörperlager			27869 01	1 016 439
	1.3	02.96 -		
	1.4 i	04.96 - 10.99		
	1.8 D	02.96 -		
1.8 DI	09.00 -			
Achskörperlager			29518 01	7 320 351
	1.3	02.96 -		
	1.4 i	04.96 - 10.99		
	1.8 D	02.96 -		
1.8 DI	09.00 -			



FORD

FIESTA Kasten/Box/Courier/Van
(JV_)

05.98 -

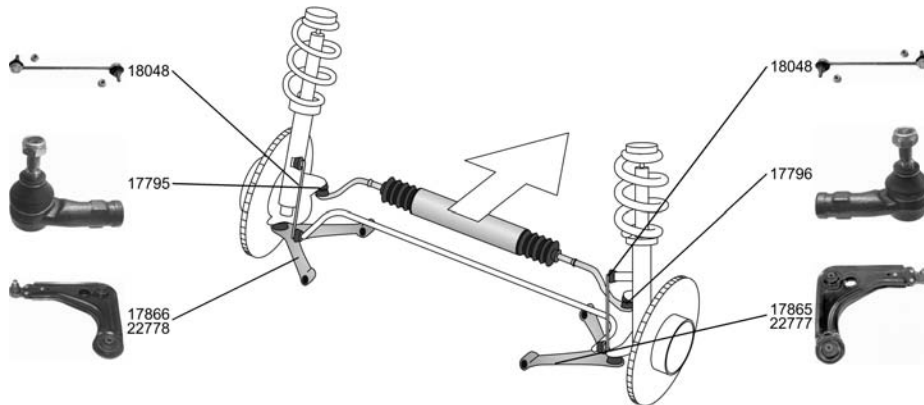







<p>Spurstangenkopf Gewindeart: mit Rechtsgewinde Gewindemaß: M10x1,5 D 1.8</p>		<p>17795 01 1 020 175</p> 
<p>Spurstangenkopf Gewindeart: mit Rechtsgewinde Gewindemaß: M10x1,5 D 1.8</p>		<p>17796 01 1 020 174</p> 
<p>Lenker, Radaufhängung mit Trag-/Führungsgelenk mit Gummilager D 1.8</p>	 	<p>17865 01 1 070 337</p> 
<p>Lenker, Radaufhängung mit Trag-/Führungsgelenk mit Gummilager D 1.8</p>	 	<p>17866 01 1 070 338</p> 
<p>Lenker, Radaufhängung mit Trag-/Führungsgelenk mit Gummilager D 1.8</p>	 	<p>22777 01 1 330 238</p> 
<p>Lenker, Radaufhängung mit Trag-/Führungsgelenk mit Gummilager D 1.8</p>	 	<p>22778 01 1 330 239</p> 
<p>Lagerung, Lenker ALL TYPES</p>	 	<p>27308 01 1 063 372</p> 
<p>Lagerung, Lenker ALL TYPES</p>	 	<p>27408 01 1 055 191</p> 



Ref.









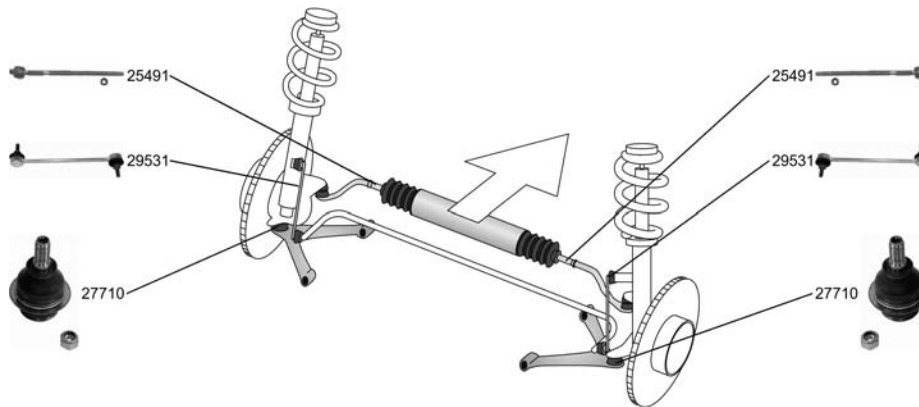

FORD

FIESTA Kasten/Box/Courier/Van 05.98 - (JV_)

 Stange/Strebe, Stabilisator Pendelstange mit Zubehör D 1.8		18048 02 1 130 273 
	05.98 -	
 Achskörperlager ALL TYPES		27869 01 1 016 439 

TOURNEO CONNECT 06.02 -







Spurstangenkopf Konusmaß [mm]: 15,9 mit Anbaumaterial 1.8 16V 1.8 Di 1.8 Turbo Di		28325 02 4 381 840 
	06.02 -	
Axialgelenk, Spurstange radseitig Gewindemaß: M14x1,5 Gewindemaß: M14x2,0 1.8 16V 1.8 Di 1.8 Turbo Di		25491 01 1 085 520 
	06.02 -	
Trag-/Führungsgelenk mit Zubehör 1.8 16V 1.8 Di 1.8 Turbo Di		27710 01 4 386 870 4 616 978 
	06.02 -	
Lagerung, Lenker 1.8 16V 1.8 Di 1.8 Turbo Di		29943 01 4 366 976 
	06.02 -	
Stange/Strebe, Stabilisator Pendelstange Länge innen [mm]: 237,5 1.8 16V 1.8 Di 1.8 Turbo Di		29531 02 1 332 453 
	06.02 -	



Ref.





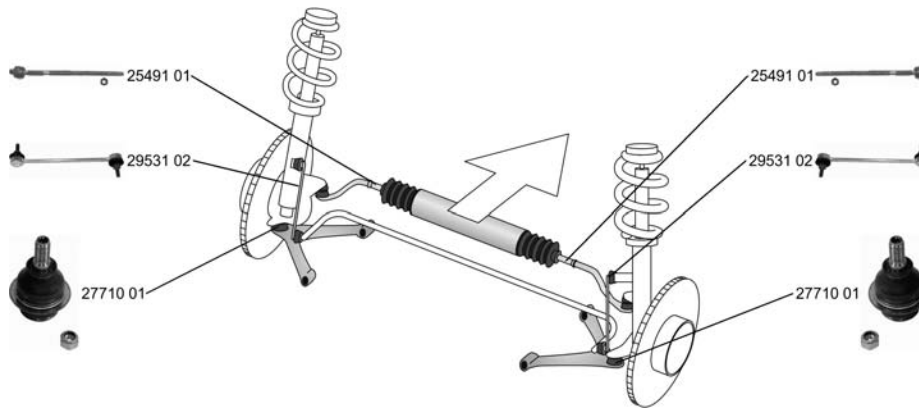

FORD

TOURNEO CONNECT 06.02 -

Stabilisatorlager 1.8 16V 1.8 Di 1.8 Turbo Di	06.02 -		29945 01 4 419 559
	06.02 -		
	06.02 -		
Stange/Strebe, Stabilisator Länge innen [mm]: 133,0 Koppelstange 1.8 16V 1.8 Di 1.8 Turbo Di	06.02 -		29532 01 1 332 463
	06.02 -		
	06.02 -		
Stabilisatorlager für Fahrzeuge ohne Hochdach 1.8 16V 1.8 Di 1.8 Turbo Di	06.02 -		29946 01 4 419 557
	06.02 -		
	06.02 -		
Stabilisatorlager für Fahrzeuge mit Hochdach 1.8 16V 1.8 Di 1.8 Turbo Di	06.02 -		29947 01 4 419 558
	06.02 -		
	06.02 -		

TRANSIT CONNECT (P65_, P70_, P80_) 06.02 -











Spurstangenkopf Konusmaß [mm]: 15,9 mit Anbaumaterial ALL TYPES			28325 02 4 381 840
			
Axialgelenk, Spurstange radseitig Gewindemaß: M14x1,5 Gewindemaß: M14x2,0 ALL TYPES	  		25491 01 1 085 520
			
Trag-/Führungsgelenk mit Zubehör ALL TYPES			27710 01 4 386 870 4 616 978
			





Ref.

FORD



TRANSIT CONNECT (P65_, P70_, P80_) 06.02 -

	Lagerung, Lenker ALL TYPES	↔ ↑	29943 01 4 366 976	
	Stange/Strebe, Stabilisator Pendelstange Länge innen [mm]: 237,5 ALL TYPES	↔	29531 02 1 332 453	
	Stabilisatorlager ALL TYPES		29945 01 4 419 559	
	Stange/Strebe, Stabilisator Länge innen [mm]: 133,0 Koppelstange ALL TYPES	↔	29532 01 1 332 463	
	Stabilisatorlager für Fahrzeuge ohne Hochdach ALL TYPES		22 29946 01 4 419 557	
	Stabilisatorlager für Fahrzeuge mit Hochdach ALL TYPES		24 29947 01 4 419 558	

TRANSIT Bus/Familial (V_ _) 11.77 - 09.92

	Spurstangenkopf Gewindeart: mit Rechtsgewinde Gewindemaß: M20x1,5 ALL TYPES ausser : 2.9 i V6 04.89 - 05.92 3.0 01.86 - 12.94	↻ ♂	17842 01 5 021 443	
	Spurstangenkopf Gewindeart: mit Linksgewinde Gewindemaß: M20x1,5 ALL TYPES ausser : 2.9 i V6 04.89 - 05.92 3.0 01.86 - 12.94	↻ ♂	18483 01 5 021 444	



TRANSIT Kasten/Box/Furgón/Van (V_ _) 01.77 - 10.89

	Spurstangenkopf Gewindeart: mit Rechtsgewinde Gewindemaß: M20x1,5 ALL TYPES	↻ ♂	17842 01 5 021 443	
---	---	-----	---------------------------	---







FORD

TRANSIT Kasten/Box/Furgón/Van (V_) 01.77 - 10.89









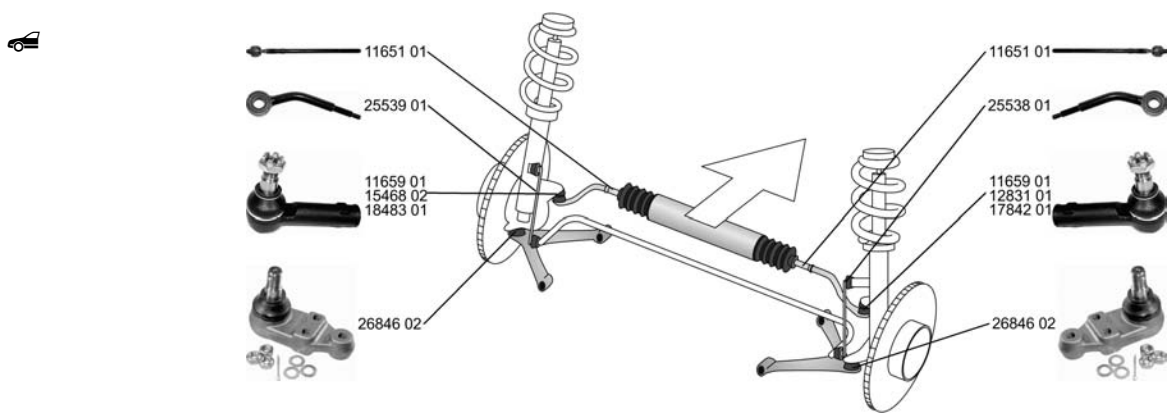



 Spurstangenkopf Gewindeart: mit Linksgewinde Gewindemaß: M20x1,5 ALL TYPES		18483 01 5 021 444 
--	---	--

TRANSIT Pritsche,Fahrgestell / Flatbed,Chassis (V_) 11.77 - 10.86

 Spurstangenkopf Gewindeart: mit Rechtsgewinde Gewindemaß: M20x1,5 ALL TYPES		17842 01 5 021 443 
Spurstangenkopf Gewindeart: mit Linksgewinde Gewindemaß: M20x1,5 ALL TYPES		18483 01 5 021 444 

TRANSIT Bus/Familial (T_) 02.77 - 09.92



















Spurstangenkopf Schubstange Gewindeart: mit Linksgewinde Gewindemaß: M16x1,5		11654 01 5 021 445 
1.6 (TBL, TES) 12.85 - 01.89 1.6 10.86 - 07.87 2.0 L 10.85 - 03.91 2.0 10.85 - 03.91 2.5 D (TBS, TCL, TCS, TEL, TES) 12.85 - 01.89 2.5 D (TBS, TEL, TES) 09.88 - 09.92		
2.0 (TBS, TCL, TCS, TEL, TES) 11.85 - 09.92		
2.0 (TBS, TCL, TCS) KAT 12.85 - 09.92	 12.1985 - 08.1991 ->08.1991	
Spurstangenkopf mit Zubehör Gewindeart: mit Rechtsgewinde Gewindemaß: M16x1,5		11659 01 5 021 442 
ALL TYPES ausser : 2.5 TD 08.89 - 08.91 2.5 TD 11.85 - 08.91		



Ref.

FORD





TRANSIT Bus/Familial (T_) 02.77 - 09.92

<p> Spurstangenkopf Gewindeart: mit Rechtsgewinde</p> <table border="1"> <tr><td>1.6 (TBL, TES)</td><td>12.85 - 01.89</td><td>für:190,190A</td></tr> <tr><td>1.6</td><td>10.86 - 07.87</td><td>für:100L,130,160,</td></tr> <tr><td>2.0 L</td><td>10.85 - 03.91</td><td></td></tr> <tr><td>2.0</td><td>10.85 - 03.91</td><td></td></tr> <tr><td>2.5 D (TBS, TCL, TCS, TEL, TES)</td><td>12.85 - 01.89</td><td></td></tr> <tr><td>2.5 D (TBS, TEL, TES)</td><td>09.88 - 09.92</td><td></td></tr> <tr><td>2.0 (TBS, TCL, TCS, TEL, TES)</td><td>11.85 - 09.92</td><td>für:190,190A</td></tr> <tr><td>2.0 (TBS, TCL, TCS) KAT</td><td>12.85 - 09.92</td><td>für:100L,130,160, 08.1987 - 08.1991</td></tr> </table>	1.6 (TBL, TES)	12.85 - 01.89	für:190,190A	1.6	10.86 - 07.87	für:100L,130,160,	2.0 L	10.85 - 03.91		2.0	10.85 - 03.91		2.5 D (TBS, TCL, TCS, TEL, TES)	12.85 - 01.89		2.5 D (TBS, TEL, TES)	09.88 - 09.92		2.0 (TBS, TCL, TCS, TEL, TES)	11.85 - 09.92	für:190,190A	2.0 (TBS, TCL, TCS) KAT	12.85 - 09.92	für:100L,130,160, 08.1987 - 08.1991		<p>12831 01 5 021 446</p> 			
1.6 (TBL, TES)	12.85 - 01.89	für:190,190A																											
1.6	10.86 - 07.87	für:100L,130,160,																											
2.0 L	10.85 - 03.91																												
2.0	10.85 - 03.91																												
2.5 D (TBS, TCL, TCS, TEL, TES)	12.85 - 01.89																												
2.5 D (TBS, TEL, TES)	09.88 - 09.92																												
2.0 (TBS, TCL, TCS, TEL, TES)	11.85 - 09.92	für:190,190A																											
2.0 (TBS, TCL, TCS) KAT	12.85 - 09.92	für:100L,130,160, 08.1987 - 08.1991																											
<p>Spurstangenkopf Gewindeart: mit Linksgewinde</p> <table border="1"> <tr><td>1.6 (TBL, TES)</td><td>12.85 - 01.89</td><td>für:190,190A</td></tr> <tr><td>1.6</td><td>10.86 - 07.87</td><td>für:100L,130,160,</td></tr> <tr><td>2.0 L</td><td>10.85 - 03.91</td><td></td></tr> <tr><td>2.0</td><td>10.85 - 03.91</td><td></td></tr> <tr><td>2.5 D (TBS, TCL, TCS, TEL, TES)</td><td>12.85 - 01.89</td><td></td></tr> <tr><td>2.5 D (TBS, TEL, TES)</td><td>09.88 - 09.92</td><td></td></tr> <tr><td>2.0 (TBS, TCL, TCS, TEL, TES)</td><td>11.85 - 09.92</td><td>für:100L,130,160,</td></tr> <tr><td>2.0 (TBS, TCL, TCS) KAT</td><td>12.85 - 09.92</td><td>für:190,190A 08.1987 - 08.1991</td></tr> </table>	1.6 (TBL, TES)	12.85 - 01.89	für:190,190A	1.6	10.86 - 07.87	für:100L,130,160,	2.0 L	10.85 - 03.91		2.0	10.85 - 03.91		2.5 D (TBS, TCL, TCS, TEL, TES)	12.85 - 01.89		2.5 D (TBS, TEL, TES)	09.88 - 09.92		2.0 (TBS, TCL, TCS, TEL, TES)	11.85 - 09.92	für:100L,130,160,	2.0 (TBS, TCL, TCS) KAT	12.85 - 09.92	für:190,190A 08.1987 - 08.1991		<p>15468 02 5 021 447</p> 			
1.6 (TBL, TES)	12.85 - 01.89	für:190,190A																											
1.6	10.86 - 07.87	für:100L,130,160,																											
2.0 L	10.85 - 03.91																												
2.0	10.85 - 03.91																												
2.5 D (TBS, TCL, TCS, TEL, TES)	12.85 - 01.89																												
2.5 D (TBS, TEL, TES)	09.88 - 09.92																												
2.0 (TBS, TCL, TCS, TEL, TES)	11.85 - 09.92	für:100L,130,160,																											
2.0 (TBS, TCL, TCS) KAT	12.85 - 09.92	für:190,190A 08.1987 - 08.1991																											
<p>Spurstangenkopf Gewindeart: mit Rechtsgewinde Gewindemaß: M20x1,5</p> <table border="1"> <tr><td>1.6 (TBL, TES)</td><td>12.85 - 01.89</td><td>für:190A</td></tr> <tr><td>1.6</td><td>10.86 - 07.87</td><td>für:100L,130,160,190</td></tr> <tr><td>2.0 L</td><td>10.85 - 03.91</td><td>->08.1987</td></tr> <tr><td>2.0 (TBS, TCL, TCS) KAT</td><td>12.85 - 09.92</td><td></td></tr> <tr><td>2.0</td><td>10.85 - 03.91</td><td></td></tr> <tr><td>2.5 D (TBS, TCL, TCS, TEL, TES)</td><td>12.85 - 01.89</td><td></td></tr> </table>	1.6 (TBL, TES)	12.85 - 01.89	für:190A	1.6	10.86 - 07.87	für:100L,130,160,190	2.0 L	10.85 - 03.91	->08.1987	2.0 (TBS, TCL, TCS) KAT	12.85 - 09.92		2.0	10.85 - 03.91		2.5 D (TBS, TCL, TCS, TEL, TES)	12.85 - 01.89			<p>17842 01 5 021 443</p> 									
1.6 (TBL, TES)	12.85 - 01.89	für:190A																											
1.6	10.86 - 07.87	für:100L,130,160,190																											
2.0 L	10.85 - 03.91	->08.1987																											
2.0 (TBS, TCL, TCS) KAT	12.85 - 09.92																												
2.0	10.85 - 03.91																												
2.5 D (TBS, TCL, TCS, TEL, TES)	12.85 - 01.89																												
<p>Spurstangenkopf Schubstange Gewindeart: mit Linksgewinde</p> <table border="1"> <tr><td>1.6 (TBL, TES)</td><td>12.85 - 01.89</td><td></td></tr> <tr><td>1.6</td><td>10.86 - 07.87</td><td></td></tr> <tr><td>2.0 L</td><td>10.85 - 03.91</td><td></td></tr> <tr><td>2.0 (TBS, TCL, TCS, TEL, TES)</td><td>11.85 - 09.92</td><td></td></tr> <tr><td>2.0 (TBS, TCL, TCS) KAT</td><td>12.85 - 09.92</td><td></td></tr> <tr><td>2.0</td><td>10.85 - 03.91</td><td></td></tr> <tr><td>2.5 D (TBS, TCL, TCS, TEL, TES)</td><td>12.85 - 01.89</td><td></td></tr> <tr><td>2.5 D (TBS, TEL, TES)</td><td>09.88 - 09.92</td><td></td></tr> </table>	1.6 (TBL, TES)	12.85 - 01.89		1.6	10.86 - 07.87		2.0 L	10.85 - 03.91		2.0 (TBS, TCL, TCS, TEL, TES)	11.85 - 09.92		2.0 (TBS, TCL, TCS) KAT	12.85 - 09.92		2.0	10.85 - 03.91		2.5 D (TBS, TCL, TCS, TEL, TES)	12.85 - 01.89		2.5 D (TBS, TEL, TES)	09.88 - 09.92		  09.1987->	<p>17861 02 5 025 558</p> 			
1.6 (TBL, TES)	12.85 - 01.89																												
1.6	10.86 - 07.87																												
2.0 L	10.85 - 03.91																												
2.0 (TBS, TCL, TCS, TEL, TES)	11.85 - 09.92																												
2.0 (TBS, TCL, TCS) KAT	12.85 - 09.92																												
2.0	10.85 - 03.91																												
2.5 D (TBS, TCL, TCS, TEL, TES)	12.85 - 01.89																												
2.5 D (TBS, TEL, TES)	09.88 - 09.92																												
<p>Spurstangenkopf Gewindeart: mit Linksgewinde Gewindemaß: M20x1,5</p> <table border="1"> <tr><td>ALL TYPES ausser :</td><td></td><td>für:100L,130,160,190</td></tr> <tr><td>2.5 TD</td><td>08.89 - 08.91</td><td>für:190A</td></tr> <tr><td>2.5 TD</td><td>11.85 - 08.91</td><td>->08.1987</td></tr> <tr><td>2.5 D (TBS, TEL, TES)</td><td>09.88 - 09.92</td><td></td></tr> </table>	ALL TYPES ausser :		für:100L,130,160,190	2.5 TD	08.89 - 08.91	für:190A	2.5 TD	11.85 - 08.91	->08.1987	2.5 D (TBS, TEL, TES)	09.88 - 09.92			<p>18483 01 5 021 444</p> 															
ALL TYPES ausser :		für:100L,130,160,190																											
2.5 TD	08.89 - 08.91	für:190A																											
2.5 TD	11.85 - 08.91	->08.1987																											
2.5 D (TBS, TEL, TES)	09.88 - 09.92																												
<p>Spurstangenkopf Schubstange für Fahrzeuge mit Stabilisator Gewindeart: mit Rechtsgewinde</p> <table border="1"> <tr><td>1.6 (TBL, TES)</td><td>12.85 - 01.89</td><td>für:190,190A</td></tr> <tr><td>1.6</td><td>10.86 - 07.87</td><td>für:100L,130,160,</td></tr> <tr><td>2.0 L</td><td>10.85 - 03.91</td><td>09.1987-></td></tr> <tr><td>2.0 (TBS, TCL, TCS, TEL, TES)</td><td>11.85 - 09.92</td><td></td></tr> <tr><td>2.0 (TBS, TCL, TCS) KAT</td><td>12.85 - 09.92</td><td></td></tr> <tr><td>2.0</td><td>10.85 - 03.91</td><td></td></tr> <tr><td>2.5 D (TBS, TCL, TCS, TEL, TES)</td><td>12.85 - 01.89</td><td></td></tr> <tr><td>2.5 D (TBS, TEL, TES)</td><td>09.88 - 09.92</td><td>für:190,190A</td></tr> <tr><td></td><td></td><td>für:100L,130,160,</td></tr> </table>	1.6 (TBL, TES)	12.85 - 01.89	für:190,190A	1.6	10.86 - 07.87	für:100L,130,160,	2.0 L	10.85 - 03.91	09.1987->	2.0 (TBS, TCL, TCS, TEL, TES)	11.85 - 09.92		2.0 (TBS, TCL, TCS) KAT	12.85 - 09.92		2.0	10.85 - 03.91		2.5 D (TBS, TCL, TCS, TEL, TES)	12.85 - 01.89		2.5 D (TBS, TEL, TES)	09.88 - 09.92	für:190,190A			für:100L,130,160,		<p>19130 01 5 025 557</p> 
1.6 (TBL, TES)	12.85 - 01.89	für:190,190A																											
1.6	10.86 - 07.87	für:100L,130,160,																											
2.0 L	10.85 - 03.91	09.1987->																											
2.0 (TBS, TCL, TCS, TEL, TES)	11.85 - 09.92																												
2.0 (TBS, TCL, TCS) KAT	12.85 - 09.92																												
2.0	10.85 - 03.91																												
2.5 D (TBS, TCL, TCS, TEL, TES)	12.85 - 01.89																												
2.5 D (TBS, TEL, TES)	09.88 - 09.92	für:190,190A																											
		für:100L,130,160,																											
<p>Axialgelenk, Spurstange Gewindeart: mit Rechtsgewinde Gewindemaß: M16x1,5</p> <table border="1"> <tr><td>ALL TYPES ausser :</td><td></td><td></td></tr> <tr><td>2.5 TD</td><td>08.89 - 08.91</td><td></td></tr> <tr><td>2.5 TD</td><td>11.85 - 08.91</td><td></td></tr> </table>	ALL TYPES ausser :			2.5 TD	08.89 - 08.91		2.5 TD	11.85 - 08.91			<p>11651 01 6 869 951</p> 																		
ALL TYPES ausser :																													
2.5 TD	08.89 - 08.91																												
2.5 TD	11.85 - 08.91																												





FORD

TRANSIT Bus/Familial (T_) 02.77 - 09.92

<p> Trag-/Führungsgelenk mit Zubehör ALL TYPES ausser : 2.5 TD 08.89 - 08.91 2.5 TD 11.85 - 08.91</p>	<p>▼↕</p>	<p>26846 02 5 021 430</p> 
<p>Stange/Strebe, Stabilisator Pendelstange ALL TYPES ausser : 2.5 TD 08.89 - 08.91 2.5 TD 11.85 - 08.91</p>	<p>↻</p>	<p>25538 01 6 150 970</p> 
<p>Stange/Strebe, Stabilisator Pendelstange ALL TYPES ausser : 2.5 TD 08.89 - 08.91 2.5 TD 11.85 - 08.91</p>	<p>↻</p>	<p>25539 01 6 150 971</p> 
<p>Faltenbalgsatz, Lenkung Innendurchmesser 1 [mm]: 15 Innendurchmesser 2 [mm]: 49 ALL TYPES ausser : 2.5 TD 08.89 - 08.91 2.5 TD 11.85 - 08.91</p>	<p>↔ für:80-120</p>	<p>30189 01 6 160 070</p> 

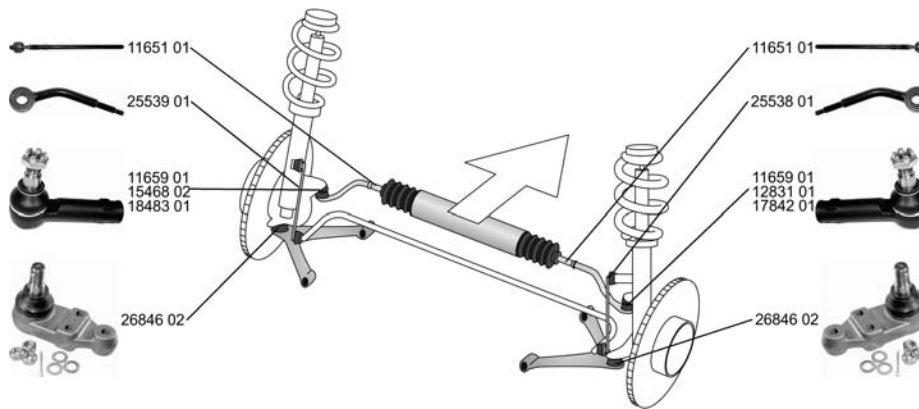
TRANSIT Kasten/Box/Furgón/Van (T_) 09.85 - 09.92



<p>Spurstangenkopf Schubstange Gewindeart: mit Linksgewinde Gewindemaß: M16x1,5 ALL TYPES ausser : 2.5 TD 08.89 - 09.92 2.5 TD 11.85 - 08.91</p>	<p>↓ ↻ ->08.1991</p>	<p>11654 01 5 021 445</p> 
<p>Spurstangenkopf mit Zubehör Gewindeart: mit Rechtsgewinde Gewindemaß: M16x1,5 ALL TYPES ausser : 2.5 TD 08.89 - 09.92 2.5 TD 11.85 - 08.91</p>	<p>↔↻</p>	<p>11659 01 5 021 442</p> 



















Ref.

FORD

TRANSIT Kasten/Box/Furgón/Van
(T_)

09.85 - 09.92







<p> Spurstangenkopf Gewindeart: mit Rechtsgewinde</p> <table border="1"> <tr> <td>1.6</td> <td>10.85 - 07.87</td> <td>für:190,190A</td> </tr> <tr> <td>2.0, 56 kW</td> <td>10.85 - 03.91</td> <td>für:100L,130,160,</td> </tr> <tr> <td>2.0, 60 kW</td> <td>10.85 - 03.91</td> <td></td> </tr> <tr> <td>2.5 D (TAL, TAS, TGL, TWS), 52 kW</td> <td>10.88 - 09.91</td> <td></td> </tr> <tr> <td>1.6 (TAS)</td> <td>09.85 - 09.92</td> <td>für:190,190A</td> </tr> <tr> <td>2.0 (TAL, TAS, TGL, TWS)</td> <td>09.85 - 09.92</td> <td>für:100L,130,160, 08.1987 - 08.1991</td> </tr> <tr> <td>2.5 D (TAL, TAS, TGL, TWS), 50 kW</td> <td>01.86 - 09.91</td> <td>für:190,190A für:100L,130,160, ->08.1991</td> </tr> </table>	1.6	10.85 - 07.87	für:190,190A	2.0, 56 kW	10.85 - 03.91	für:100L,130,160,	2.0, 60 kW	10.85 - 03.91		2.5 D (TAL, TAS, TGL, TWS), 52 kW	10.88 - 09.91		1.6 (TAS)	09.85 - 09.92	für:190,190A	2.0 (TAL, TAS, TGL, TWS)	09.85 - 09.92	für:100L,130,160, 08.1987 - 08.1991	2.5 D (TAL, TAS, TGL, TWS), 50 kW	01.86 - 09.91	für:190,190A für:100L,130,160, ->08.1991		<p>12831 01 5 021 446</p> 
1.6	10.85 - 07.87	für:190,190A																					
2.0, 56 kW	10.85 - 03.91	für:100L,130,160,																					
2.0, 60 kW	10.85 - 03.91																						
2.5 D (TAL, TAS, TGL, TWS), 52 kW	10.88 - 09.91																						
1.6 (TAS)	09.85 - 09.92	für:190,190A																					
2.0 (TAL, TAS, TGL, TWS)	09.85 - 09.92	für:100L,130,160, 08.1987 - 08.1991																					
2.5 D (TAL, TAS, TGL, TWS), 50 kW	01.86 - 09.91	für:190,190A für:100L,130,160, ->08.1991																					
<p>Spurstangenkopf Gewindeart: mit Linksgewinde</p> <table border="1"> <tr> <td>2.5 D (TAL, TAS, TGL, TWS), 52 kW</td> <td>10.88 - 09.91</td> <td>für:190,190A für:100L,130,160,</td> </tr> <tr> <td>1.6 (TAS)</td> <td>09.85 - 09.92</td> <td>für:190,190A</td> </tr> <tr> <td>1.6</td> <td>10.85 - 07.87</td> <td>für:100L,130,160,</td> </tr> <tr> <td>2.0 (TAL, TAS, TGL, TWS)</td> <td>09.85 - 09.92</td> <td>08.1987 - 08.1991</td> </tr> <tr> <td>2.0, 56 kW</td> <td>10.85 - 03.91</td> <td></td> </tr> <tr> <td>2.0, 60 kW</td> <td>10.85 - 03.91</td> <td></td> </tr> <tr> <td>2.5 D (TAL, TAS, TGL, TWS), 50 kW</td> <td>01.86 - 09.91</td> <td>für:190,190A für:100L,130,160, ->08.1991</td> </tr> </table>	2.5 D (TAL, TAS, TGL, TWS), 52 kW	10.88 - 09.91	für:190,190A für:100L,130,160,	1.6 (TAS)	09.85 - 09.92	für:190,190A	1.6	10.85 - 07.87	für:100L,130,160,	2.0 (TAL, TAS, TGL, TWS)	09.85 - 09.92	08.1987 - 08.1991	2.0, 56 kW	10.85 - 03.91		2.0, 60 kW	10.85 - 03.91		2.5 D (TAL, TAS, TGL, TWS), 50 kW	01.86 - 09.91	für:190,190A für:100L,130,160, ->08.1991		<p>15468 02 5 021 447</p> 
2.5 D (TAL, TAS, TGL, TWS), 52 kW	10.88 - 09.91	für:190,190A für:100L,130,160,																					
1.6 (TAS)	09.85 - 09.92	für:190,190A																					
1.6	10.85 - 07.87	für:100L,130,160,																					
2.0 (TAL, TAS, TGL, TWS)	09.85 - 09.92	08.1987 - 08.1991																					
2.0, 56 kW	10.85 - 03.91																						
2.0, 60 kW	10.85 - 03.91																						
2.5 D (TAL, TAS, TGL, TWS), 50 kW	01.86 - 09.91	für:190,190A für:100L,130,160, ->08.1991																					
<p>Spurstangenkopf Gewindeart: mit Rechtsgewinde Gewindemaß: M20x1,5</p> <table border="1"> <tr> <td>ALL TYPES ausser :</td> <td></td> <td>für:100L,130,160,190</td> </tr> <tr> <td>2.5 TD</td> <td>08.89 - 09.92</td> <td>für:190A</td> </tr> <tr> <td>2.5 TD</td> <td>11.85 - 08.91</td> <td>->08.1987</td> </tr> <tr> <td>2.5 D (TAL, TAS, TGL, TWS), 52 kW</td> <td>10.88 - 09.91</td> <td></td> </tr> </table>	ALL TYPES ausser :		für:100L,130,160,190	2.5 TD	08.89 - 09.92	für:190A	2.5 TD	11.85 - 08.91	->08.1987	2.5 D (TAL, TAS, TGL, TWS), 52 kW	10.88 - 09.91			<p>17842 01 5 021 443</p> 									
ALL TYPES ausser :		für:100L,130,160,190																					
2.5 TD	08.89 - 09.92	für:190A																					
2.5 TD	11.85 - 08.91	->08.1987																					
2.5 D (TAL, TAS, TGL, TWS), 52 kW	10.88 - 09.91																						
<p>Spurstangenkopf Schubstange Gewindeart: mit Linksgewinde</p> <table border="1"> <tr> <td>ALL TYPES ausser :</td> <td></td> <td></td> </tr> <tr> <td>2.5 TD</td> <td>08.89 - 09.92</td> <td></td> </tr> <tr> <td>2.5 TD</td> <td>11.85 - 08.91</td> <td>09.1987-></td> </tr> <tr> <td>2.5 D (TAL, TAS, TGL, TWS), 52 kW</td> <td>10.88 - 09.91</td> <td></td> </tr> </table>	ALL TYPES ausser :			2.5 TD	08.89 - 09.92		2.5 TD	11.85 - 08.91	09.1987->	2.5 D (TAL, TAS, TGL, TWS), 52 kW	10.88 - 09.91			<p>17861 02 5 025 558</p> 									
ALL TYPES ausser :																							
2.5 TD	08.89 - 09.92																						
2.5 TD	11.85 - 08.91	09.1987->																					
2.5 D (TAL, TAS, TGL, TWS), 52 kW	10.88 - 09.91																						
<p>Spurstangenkopf Gewindeart: mit Linksgewinde Gewindemaß: M20x1,5</p> <table border="1"> <tr> <td>ALL TYPES ausser :</td> <td></td> <td>für:100L,130,160,190</td> </tr> <tr> <td>2.5 TD</td> <td>08.89 - 09.92</td> <td>für:190A</td> </tr> <tr> <td>2.5 TD</td> <td>11.85 - 08.91</td> <td>->08.1987</td> </tr> <tr> <td>2.5 D (TAL, TAS, TGL, TWS), 52 kW</td> <td>10.88 - 09.91</td> <td></td> </tr> </table>	ALL TYPES ausser :		für:100L,130,160,190	2.5 TD	08.89 - 09.92	für:190A	2.5 TD	11.85 - 08.91	->08.1987	2.5 D (TAL, TAS, TGL, TWS), 52 kW	10.88 - 09.91			<p>18483 01 5 021 444</p> 									
ALL TYPES ausser :		für:100L,130,160,190																					
2.5 TD	08.89 - 09.92	für:190A																					
2.5 TD	11.85 - 08.91	->08.1987																					
2.5 D (TAL, TAS, TGL, TWS), 52 kW	10.88 - 09.91																						
<p>Spurstangenkopf Schubstange für Fahrzeuge mit Stabilisator Gewindeart: mit Rechtsgewinde</p> <table border="1"> <tr> <td>2.5 D (TAL, TAS, TGL, TWS), 52 kW</td> <td>10.88 - 09.91</td> <td>für:190,190A für:100L,130,160,</td> </tr> <tr> <td>1.6 (TAS)</td> <td>09.85 - 09.92</td> <td>für:190,190A</td> </tr> <tr> <td>1.6</td> <td>10.85 - 07.87</td> <td>für:100L,130,160,</td> </tr> <tr> <td>2.0 (TAL, TAS, TGL, TWS)</td> <td>09.85 - 09.92</td> <td>09.1987-></td> </tr> <tr> <td>2.0, 56 kW</td> <td>10.85 - 03.91</td> <td></td> </tr> <tr> <td>2.5 D (TAL, TAS, TGL, TWS), 50 kW</td> <td>01.86 - 09.91</td> <td></td> </tr> <tr> <td>2.0, 60 kW</td> <td>10.85 - 03.91</td> <td></td> </tr> </table>	2.5 D (TAL, TAS, TGL, TWS), 52 kW	10.88 - 09.91	für:190,190A für:100L,130,160,	1.6 (TAS)	09.85 - 09.92	für:190,190A	1.6	10.85 - 07.87	für:100L,130,160,	2.0 (TAL, TAS, TGL, TWS)	09.85 - 09.92	09.1987->	2.0, 56 kW	10.85 - 03.91		2.5 D (TAL, TAS, TGL, TWS), 50 kW	01.86 - 09.91		2.0, 60 kW	10.85 - 03.91			<p>19130 01 5 025 557</p> 
2.5 D (TAL, TAS, TGL, TWS), 52 kW	10.88 - 09.91	für:190,190A für:100L,130,160,																					
1.6 (TAS)	09.85 - 09.92	für:190,190A																					
1.6	10.85 - 07.87	für:100L,130,160,																					
2.0 (TAL, TAS, TGL, TWS)	09.85 - 09.92	09.1987->																					
2.0, 56 kW	10.85 - 03.91																						
2.5 D (TAL, TAS, TGL, TWS), 50 kW	01.86 - 09.91																						
2.0, 60 kW	10.85 - 03.91																						
<p>Axialgelenk, Spurstange Gewindeart: mit Rechtsgewinde Gewindemaß: M16x1,5</p> <table border="1"> <tr> <td>ALL TYPES ausser :</td> <td></td> <td></td> </tr> <tr> <td>2.5 TD</td> <td>08.89 - 09.92</td> <td></td> </tr> <tr> <td>2.5 TD</td> <td>11.85 - 08.91</td> <td></td> </tr> </table>	ALL TYPES ausser :			2.5 TD	08.89 - 09.92		2.5 TD	11.85 - 08.91			<p>11651 01 6 869 951</p> 												
ALL TYPES ausser :																							
2.5 TD	08.89 - 09.92																						
2.5 TD	11.85 - 08.91																						
<p>Trag-/Führungsgelenk mit Zubehör</p> <table border="1"> <tr> <td>ALL TYPES ausser :</td> <td></td> <td></td> </tr> <tr> <td>2.5 TD</td> <td>08.89 - 09.92</td> <td></td> </tr> <tr> <td>2.5 TD</td> <td>11.85 - 08.91</td> <td></td> </tr> </table>	ALL TYPES ausser :			2.5 TD	08.89 - 09.92		2.5 TD	11.85 - 08.91			<p>26846 02 5 021 430</p> 												
ALL TYPES ausser :																							
2.5 TD	08.89 - 09.92																						
2.5 TD	11.85 - 08.91																						



FORD

TRANSIT Kasten/Box/Furgón/Van (T_)







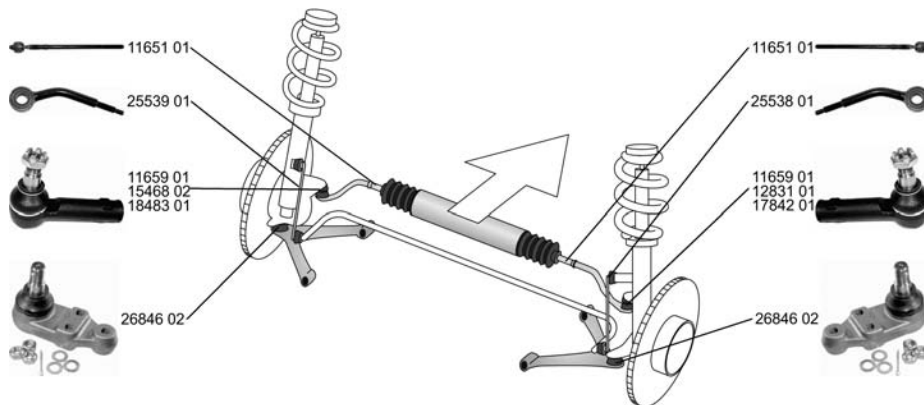

09.85 - 09.92

 Stange/Strebe, Stabilisator Pendelstange ALL TYPES ausser : 2.5 TD 08.89 - 09.92 2.5 TD 11.85 - 08.91		25538 01 6 150 970 
		Stange/Strebe, Stabilisator Pendelstange ALL TYPES ausser : 2.5 TD 08.89 - 09.92 2.5 TD 11.85 - 08.91
Faltenbalgsatz, Lenkung Innendurchmesser 1 [mm]: 15 Innendurchmesser 2 [mm]: 49 ALL TYPES ausser : 2.5 TD 08.89 - 09.92 2.5 TD 11.85 - 08.91	  für:80-120	30189 01 6 160 070 

TRANSIT Pritsche,Fahrgestell / Flatbed,Chassis (T_)

11.77 - 09.92



Spurstangenkopf Schubstange Gewindeart: mit Linksgewinde Gewindemaß: M16x1,5 2.0 (TTE, TTL, TTS) 01.86 - 09.92 2.0 (TUL) KAT 11.85 - 09.92 2.5 DI (TTE, TTL, TTS, TUL) 09.88 - 09.92 1.6 01.78 - 12.88 2.5 D (TTL, TTS, TUL, TUS, TTE) KAT 01.86 - 01.89	  ->08.1991 	11654 01 5 021 445 				
		Spurstangenkopf mit Zubehör Gewindeart: mit Rechtsgewinde Gewindemaß: M16x1,5 ALL TYPES ausser : 1.6 11.85 - 08.91 2.5 TD 11.85 - 08.91 2.5 TD 08.89 - 09.92		11659 01 5 021 442 		
				Spurstangenkopf Gewindeart: mit Rechtsgewinde 1.6 01.78 - 12.88 2.5 D (TTL, TTS, TUL, TUS, TTE) KAT 01.86 - 01.89 2.5 DI (TTE, TTL, TTS, TUL) 09.88 - 09.92 2.0 (TTE, TTL, TTS) 01.86 - 09.92 2.0 (TUL) KAT 11.85 - 09.92		12831 01 5 021 446 
						für:190,190A für:100L,130,160, 08.1987 - 08.1991





















Ref.

FORD

**TRANSIT Pritsche, Fahrgestell /
Flatbed, Chassis (T_ _)**

11.77 - 09.92

 Spurstangenkopf Gewindeart: mit Linksgewinde			15468 02	5 021 447
	1.6	01.78 - 12.88	für: 190, 190A	
	2.5 D (TTL, TTS, TUL, TUS, TTE) KAT	01.86 - 01.89	für: 100L, 130, 160,	
	2.5 DI (TTE, TTL, TTS, TUL)	09.88 - 09.92		
2.0 (TTE, TTL, TTS)	01.86 - 09.92	für: 190, 190A		
2.0 (TUL) KAT	11.85 - 09.92	für: 100L, 130, 160, 08.1987 - 08.1991		
Spurstangenkopf Gewindeart: mit Rechtsgewinde Gewindemaß: M20x1,5			17842 01	5 021 443
	1.6	01.78 - 12.88	für: 100L, 130, 160, 190	
	2.0 (TTE, TTL, TTS)	01.86 - 09.92	für: 190A	
	2.0 (TUL) KAT	11.85 - 09.92	->08.1987	
	2.5 D (TTL, TTS, TUL, TUS, TTE) KAT	01.86 - 01.89		
Spurstangenkopf Schubstange Gewindeart: mit Linksgewinde			17861 02	5 025 558
	1.6	01.78 - 12.88		
	2.0 (TTE, TTL, TTS)	01.86 - 09.92		
	2.0 (TUL) KAT	11.85 - 09.92		
	2.5 D (TTL, TTS, TUL, TUS, TTE) KAT	01.86 - 01.89		
Spurstangenkopf Gewindeart: mit Linksgewinde Gewindemaß: M20x1,5			18483 01	5 021 444
	1.6	01.78 - 12.88	für: 100L, 130, 160, 190	
	2.0 (TTE, TTL, TTS)	01.86 - 09.92	für: 190A	
	2.0 (TUL) KAT	11.85 - 09.92	->08.1987	
	2.5 D (TTL, TTS, TUL, TUS, TTE) KAT	01.86 - 01.89		
Spurstangenkopf Schubstange für Fahrzeuge mit Stabilisator Gewindeart: mit Rechtsgewinde			19130 01	5 025 557
	2.5 DI (TTE, TTL, TTS, TUL)	09.88 - 09.92	für: 190, 190A für: 100L, 130, 160,	
	1.6	01.78 - 12.88	für: 190, 190A	
	2.0 (TTE, TTL, TTS)	01.86 - 09.92	für: 100L, 130, 160,	
	2.0 (TUL) KAT	11.85 - 09.92	09.1987->	
	2.5 D (TTL, TTS, TUL, TUS, TTE) KAT	01.86 - 01.89		
Axialgelenk, Spurstange Gewindeart: mit Rechtsgewinde Gewindemaß: M16x1,5			11651 01	6 869 951
	ALL TYPES ausser :			
	1.6	11.85 - 08.91		
	2.5 TD	11.85 - 08.91		
2.5 TD	08.89 - 09.92			
Trag-/Führungsgelenk mit Zubehör			26846 02	5 021 430
	ALL TYPES ausser :			
	1.6	11.85 - 08.91		
	2.5 TD	11.85 - 08.91		
	2.5 TD	08.89 - 09.92		
Stange/Strebe, Stabilisator Pendelstange			25538 01	6 150 970
	ALL TYPES ausser :			
	1.6	11.85 - 08.91		
	2.5 TD	11.85 - 08.91		
2.5 TD	08.89 - 09.92			
Stange/Strebe, Stabilisator Pendelstange			25539 01	6 150 971
	ALL TYPES ausser :			
	1.6	11.85 - 08.91		
	2.5 TD	11.85 - 08.91		
2.5 TD	08.89 - 09.92			











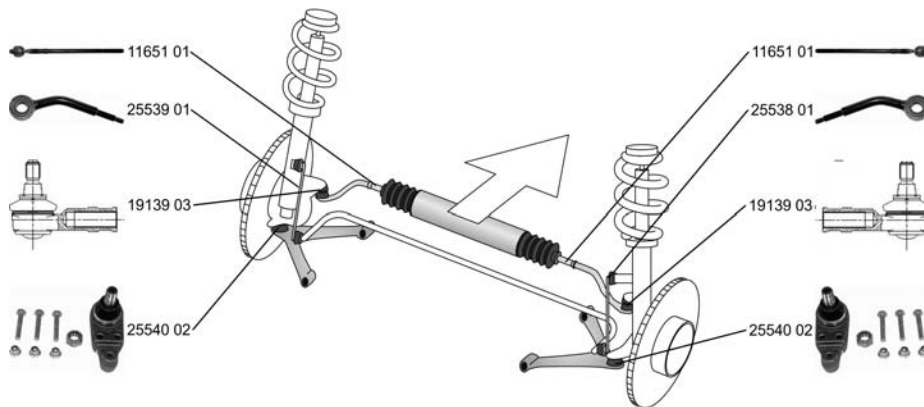



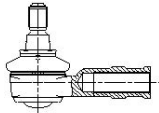

Ref.

FORD

TRANSIT Kasten/Box/Furgón/Van
(E_)

05.91 - 06.94



<p>Spurstangenkopf Gewindemaß: M16x1,5</p> <p>ALL TYPES ausser : 2.9 V6</p> <p>09.91 - 08.94</p>		<p>19139 03 1 047 145</p> 
<p>Axialgelenk, Spurstange Gewindeart: mit Rechtsgewinde Gewindemaß: M16x1,5</p> <p>ALL TYPES ausser : 2.9 V6</p> <p>09.91 - 08.94</p>		<p>11651 01 6 869 951</p> 
<p>Trag-/Führungsgelenk Konusmaß [mm]: 24</p> <p>ALL TYPES ausser : 2.9 V6</p> <p>09.91 - 08.94</p>		<p>25540 02 1 055 194</p> 
<p>Stange/Strebe, Stabilisator Pendelstange</p> <p>ALL TYPES ausser : 2.9 V6</p> <p>09.91 - 08.94</p>		<p>25538 01 6 150 970</p> 
<p>Stange/Strebe, Stabilisator Pendelstange</p> <p>ALL TYPES ausser : 2.9 V6</p> <p>09.91 - 08.94</p>		<p>25539 01 6 150 971</p> 
<p>Faltenbalgsatz, Lenkung Innendurchmesser 1 [mm]: 15 Innendurchmesser 2 [mm]: 49</p> <p>ALL TYPES ausser : 2.9 V6</p> <p>09.91 - 08.94</p>	  für:80-120	<p>30189 01 6 160 070</p> 









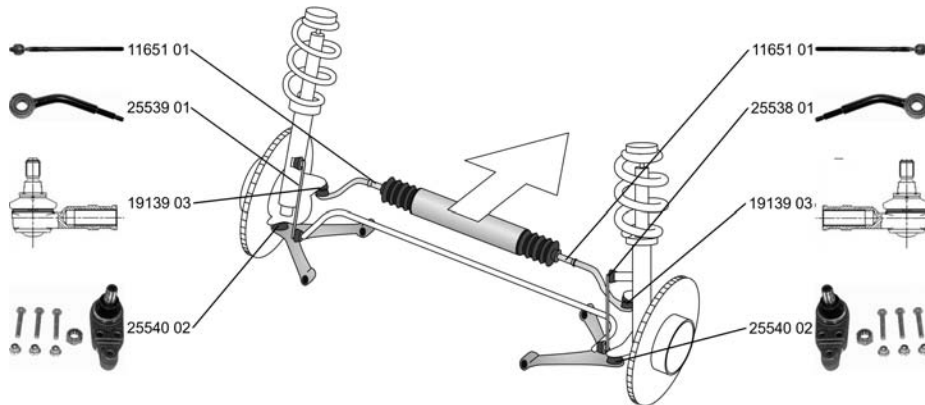

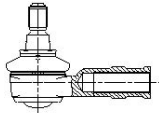



FORD

**TRANSIT Pritsche, Fahrgestell /
Flatbed, Chassis (E_)**

09.91 - 08.94



<p>Spurstangenkopf Gewindemaß: M16x1,5</p> <p>ALL TYPES ausser : 2.9 V6</p> <p>09.91 - 08.94</p>		<p>19139 03 1 047 145</p> 
<p>Axialgelenk, Spurstange Gewindeart: mit Rechtsgewinde Gewindemaß: M16x1,5</p> <p>ALL TYPES ausser : 2.9 V6</p> <p>09.91 - 08.94</p>		<p>11651 01 6 869 951</p> 
<p>Trag-/Führungsgelenk Konusmaß [mm]: 24</p> <p>ALL TYPES ausser : 2.9 V6</p> <p>09.91 - 08.94</p>		<p>25540 02 1 055 194</p> 
<p>Stange/Strebe, Stabilisator Pendelstange</p> <p>ALL TYPES ausser : 2.9 V6</p> <p>09.91 - 08.94</p>		<p>25538 01 6 150 970</p> 
<p>Stange/Strebe, Stabilisator Pendelstange</p> <p>ALL TYPES ausser : 2.9 V6</p> <p>09.91 - 08.94</p>		<p>25539 01 6 150 971</p> 
<p>Faltenbaldsatz, Lenkung Innendurchmesser 1 [mm]: 15 Innendurchmesser 2 [mm]: 49</p> <p>ALL TYPES ausser : 2.9 V6</p> <p>09.91 - 08.94</p>	  für:80-120	<p>30189 01 6 160 070</p> 







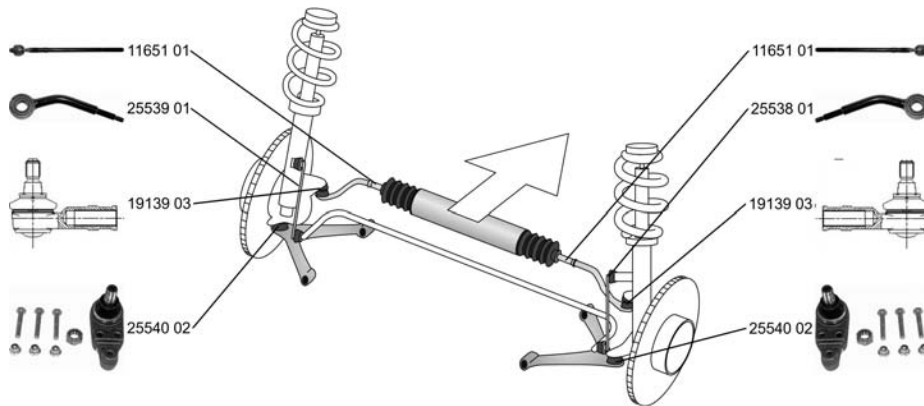

Ref.

FORD

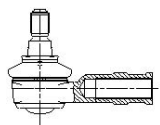
TRANSIT Bus/Familial (E_)

06.94 - 06.00



<p>Spurstangenkopf Gewindemaß: M16x1,5</p> <p>ALL TYPES ausser : 2.9 i V6</p> <p style="text-align: right;">08.94 -</p>	↔	<p>19139 03 1 047 145</p> 
<p>Axialgelenk, Spurstange Gewindeart: mit Rechtsgewinde Gewindemaß: M16x1,5</p> <p>ALL TYPES ausser : 2.9 i V6</p> <p style="text-align: right;">08.94 -</p>	↔ ↗	<p>11651 01 6 869 951</p> 
<p>Trag-/Führungsgelenk Konusmaß [mm]: 24</p> <p>ALL TYPES ausser : 2.9 i V6</p> <p style="text-align: right;">08.94 -</p>	▽ ↔	<p>25540 02 1 055 194</p> 
<p>Stange/Strebe, Stabilisator Pendelstange</p> <p>ALL TYPES ausser : 2.9 i V6</p> <p style="text-align: right;">08.94 -</p>	↻	<p>25538 01 6 150 970</p> 
<p>Stange/Strebe, Stabilisator Pendelstange</p> <p>ALL TYPES ausser : 2.9 i V6</p> <p style="text-align: right;">08.94 -</p>	↻	<p>25539 01 6 150 971</p> 
<p>Faltenbalgsatz, Lenkung Innendurchmesser 1 [mm]: 15 Innendurchmesser 2 [mm]: 49</p> <p>ALL TYPES ausser : 2.9 i V6</p> <p style="text-align: right;">08.94 -</p>	↔	<p>30189 01 6 160 070</p> 











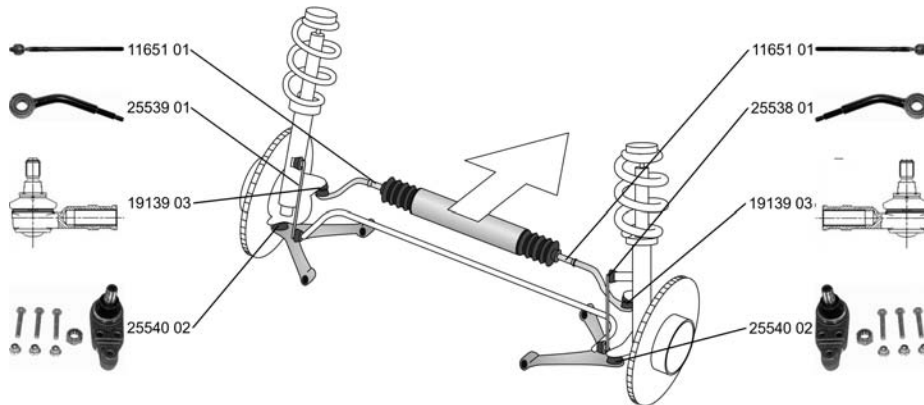



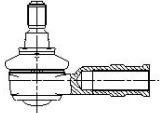

Ref.

FORD

TRANSIT Kasten/Box/Furgón/Van
(E_)

06.94 - 03.00



Spurstangenkopf Gewindemaß: M16x1,5 ALL TYPES		19139 03 1 047 145 
Axialgelenk, Spurstange Gewindeart: mit Rechtsgewinde Gewindemaß: M16x1,5 ALL TYPES		11651 01 6 869 951 
Trag-/Führungsgelenk Konusmaß [mm]: 24 ALL TYPES		25540 02 1 055 194 
Stange/Strebe, Stabilisator Pendelstange ALL TYPES		25538 01 6 150 970 
Stange/Strebe, Stabilisator Pendelstange ALL TYPES		25539 01 6 150 971 
Faltenbalgsatz, Lenkung Innendurchmesser 1 [mm]: 15 Innendurchmesser 2 [mm]: 49 ALL TYPES		30189 01 6 160 070 
	 für:80-120	







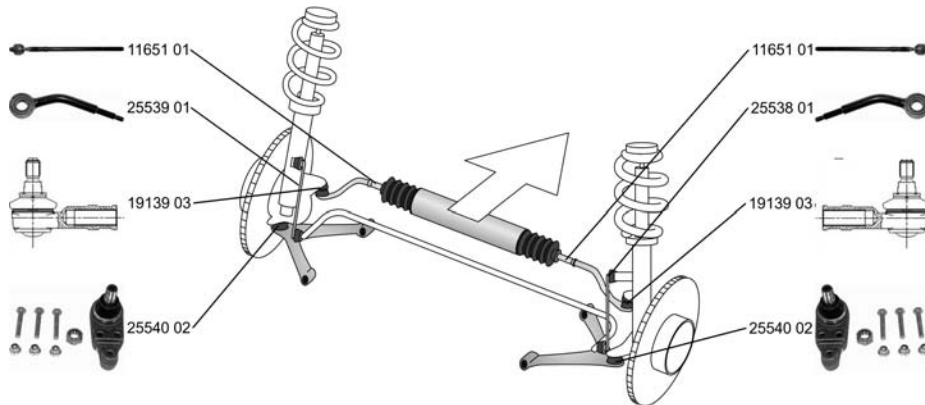

Ref.

FORD

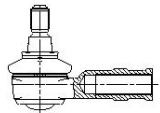
**TRANSIT Pritsche, Fahrgestell /
Flatbed, Chassis (E_)**

08.94 - 03.00



Spurstangenkopf Gewindemaß: M16x1,5 ALL TYPES		19139 03 1 047 145 
Axialgelenk, Spurstange Gewindeart: mit Rechtsgewinde Gewindemaß: M16x1,5 ALL TYPES		11651 01 6 869 951 
Trag-/Führungsgelenk Konusmaß [mm]: 24 ALL TYPES		25540 02 1 055 194 
Stange/Strebe, Stabilisator Pendelstange ALL TYPES		25538 01 6 150 970 
Stange/Strebe, Stabilisator Pendelstange ALL TYPES		25539 01 6 150 971 
Faltenbaldsatz, Lenkung Innendurchmesser 1 [mm]: 15 Innendurchmesser 2 [mm]: 49 ALL TYPES		30189 01 6 160 070 
	 für:80-120	









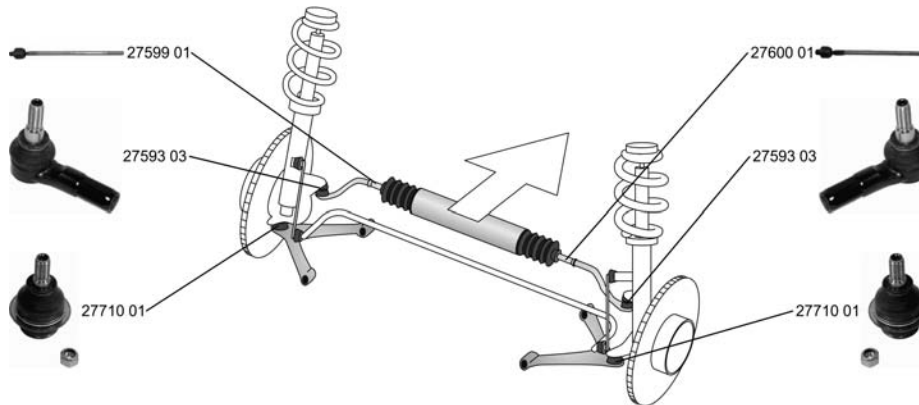

FORD

TRANSIT Bus / Familial (FD_Y,
FB_Y, FS_Y, FZ_Y, FC_Y)

01.00 -



<p>Spurstangenkopf ALL TYPES</p>		<p>27593 03 1 138 275</p> 
<p>Axialgelenk, Spurstange radseitig Gewindemaß: M16 Aussengewinde [mm]: M16x1,5 ALL TYPES</p>		<p>27599 01 4 602 028</p> 
<p>Axialgelenk, Spurstange radseitig Gewindemaß: M20 Aussengewinde [mm]: M16x1,5 ALL TYPES</p>		<p>27600 01 4 577 976</p> 
<p>Trag-/Führungsgelenk mit Zubehör ALL TYPES</p>		<p>27710 01 4 386 870 4 616 978</p> 









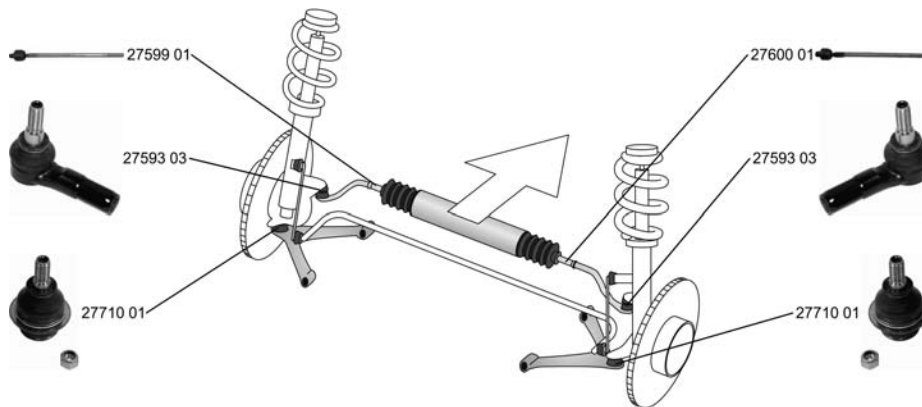

Ref.

FORD

**TRANSIT Kasten/Box/Furgón/Van
(FA_Y)**

01.00 -



<p>Spurstangenkopf ALL TYPES</p>		<p>27593 03 1 138 275</p> 
<p>Axialgelenk, Spurstange radseitig Gewindemaß: M16 Aussengewinde [mm]: M16x1,5 ALL TYPES</p>		<p>27599 01 4 602 028</p> 
<p>Axialgelenk, Spurstange radseitig Gewindemaß: M20 Aussengewinde [mm]: M16x1,5 ALL TYPES</p>		<p>27600 01 4 577 976</p> 
<p>Trag-/Führungsgelenk mit Zubehör ALL TYPES</p>		<p>27710 01 4 386 870 4 616 978</p> 





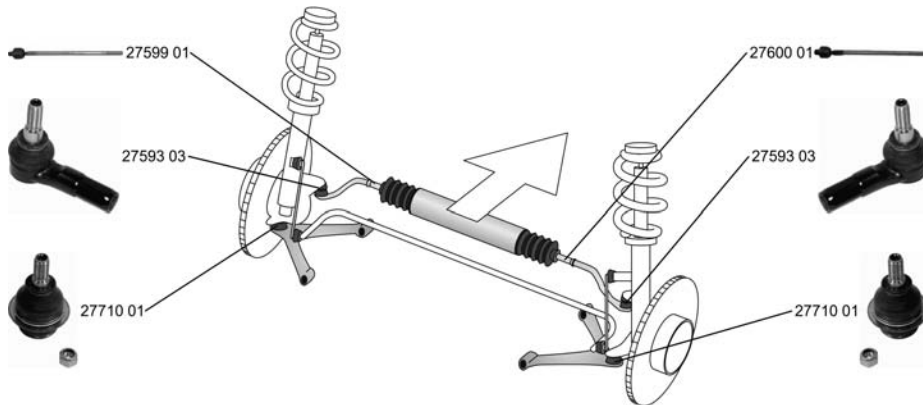

FORD

TRANSIT Pritsche, Fahrgestell / Flatbed Chassis (FM_Y, FN_Y)

01.00 -



Spurstangenkopf ALL TYPES		27593 03 1 138 275 
Axialgelenk, Spurstange radseitig Gewindemaß: M16 Aussengewinde [mm]: M16x1,5 ALL TYPES		27599 01 4 602 028 
Axialgelenk, Spurstange radseitig Gewindemaß: M20 Aussengewinde [mm]: M16x1,5 ALL TYPES		27600 01 4 577 976 
Trag-/Führungsgelenk mit Zubehör ALL TYPES		27710 01 4 386 870 4 616 978 

TRANSIT TOURNEO

07.06 -

Trag-/Führungsgelenk Gewindemaß: M16x1,5 ohne Zubehör ALL TYPES		29626 01 1 417 352 
---	--	--

TRANSIT Bus

07.06 -



Trag-/Führungsgelenk Gewindemaß: M16x1,5 ohne Zubehör ALL TYPES		29626 01 1 417 352 
---	--	--



Ref.

FORD

TRANSIT Kasten 07.06 -

 Trag-/Führungsgelenk Gewindemaß: M16x1,5 ohne Zubehör		29626 01 1 417 352
ALL TYPES		

TRANSIT Pritsche/Fahrgestell 07.06 -

 Trag-/Führungsgelenk Gewindemaß: M16x1,5 ohne Zubehör		29626 01 1 417 352
ALL TYPES		





Ref.

HYUNDAI

H100 Bus/Familial (P)

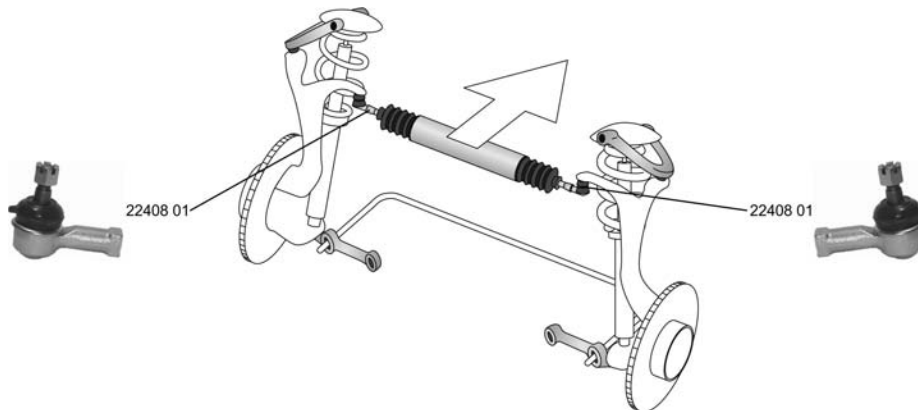
07.93 -





Spurstangenkopf			22408 01	56872-43000	
	2.4, 84 kW				01.97 - 03.00
	2.4, 90 kW				07.93 - 03.00
	2.5 D, 55 kW				07.93 - 12.94
	2.5 D				12.94 - 03.00

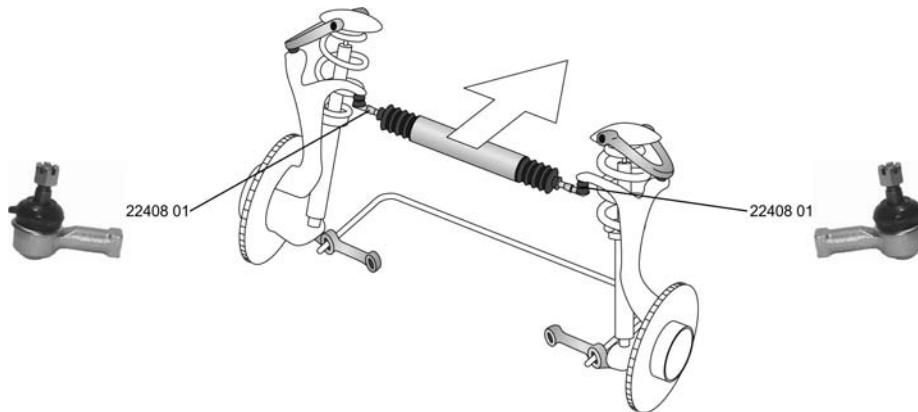

H100 Kasten/Box/Furgón/Panel Van

07.93 -



Spurstangenkopf			22408 01	56872-43000	
	2.5 D, 55 kW				07.93 - 12.94
	2.5 D				12.94 - 03.00









Ref.

HYUNDAI

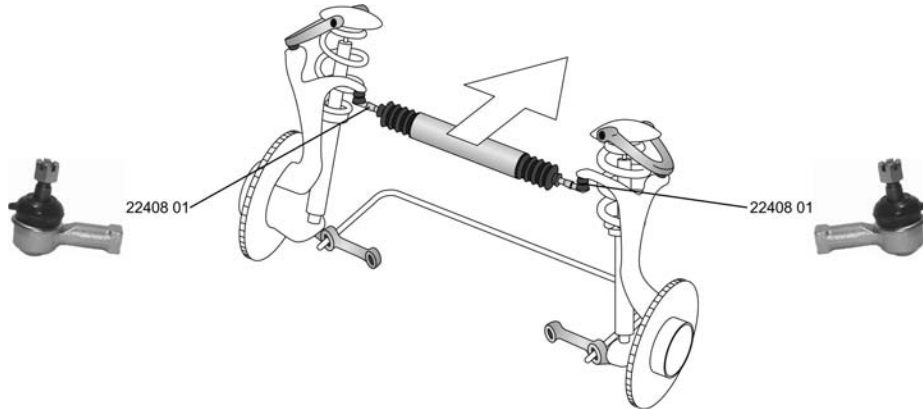
H-1 Starex/Bus/Familial

10.97 -





Spurstangenkopf 2.4, 82 kW 2.5 TD, 59 kW 2.5 TD, 73 kW	10.97 -		22408 01 56872-43000 
	10.97 -		
	10.99 - 11.01		
Trag-/Führungsgelenk 2.4, 82 kW 2.4 4WD 2.5 D 2.5 TD, 59 kW 2.5 TD 2.5 TD, 74 kW	10.97 -		31250 01 54530-4AA00 
	10.97 -		
	10.97 -		
	10.97 -		
	10.99 - 11.01		
	11.01 -		

H-1 Kasten/Box/Furgón/Van

03.00 -



Trag-/Führungsgelenk ALL TYPES ausser : 2.4, 107 kW 2.5 CRDi, 81 kW	11.01 -		31250 01 54530-4AA00 
	01.07 -		





Ref.













IVECO

Daily III

05.06 -

	Lagerung, Lenker		129/A52	31103 01	9380 7640
	35C10, 35C10 D, 35S10, 35S10 D	05.06 -			
	35C10 K, 35C10 DK	05.06 -			
	35C10 V, 35S10 V	05.06 -			
	35C12, 35C12 /P, 35S12, 35S12 /P, 35S12 D, 35S12 D/P	05.06 -			
	35C12 K, 35C12 DK	05.06 -			
	35C12V, 35C12 V/P, 35S12 V, 35S12 V/P	05.06 -			
	35C15, 35C15 /P, 35C15 D, 35C15 D/P	05.06 -			
	35C18, 35C18 /P, 35C18 D, 35C18 D/P, 35S18, 35S18 /P	05.06 -			
	40C15, 40C15 /P, 40C15 D, 40C15 D/P	05.06 -			
	40C15 V, 40C15 V/P	05.06 -			
	40C18, 40C18 /P, 40C18 D, 40C18 D/P	05.06 -			
	40C18 V, 40C18 V/P	05.06 -			
	50C15, 50C15 /P, 50C15 D, 50C15 D/P, 50C15 CCS, 50C15 CCS/P	05.06 -			
	50C15 V, 50C15 V/P	05.06 -			

Daily 20...







	Spurstangenkopf Gewindeart: mit Rechtsgewinde Innengewinde [mm]: M16x1,5 mit Zubehör Konusmaß [mm]: 20 Aussengewinde [mm]: M14x1,5			22817 01	4253 4911
	29 L 9	05.99 -			
	29 L 9 V	05.99 -			
	29 L 11	05.99 -			
	29 L 11 V	05.99 -			
	Spurstangenkopf Gewindeart: Innengewinde Gewindemaß: M20x1,5 für Führungsstange mit Zubehör mit Kronenmutter			31146 01	500 337 201
	29 L 10	09.02 -			
	29 L 10 V	09.02 -			
	29 L 11	05.99 -			
	29 L 11 V	05.99 -			
	29 L 12	09.02 -			
	29 L 12 V	09.02 -			
	29 L 13	11.01 -			
	29 L 13 V	05.01 -			
	Axialgelenk, Spurstange Gewindeart: mit Rechtsgewinde Betriebsart: manuell für OE-Nummer 5003 06763 Gewindemaß: M16/M18x1,5			22818 01	5003 06763
	29 L 9	05.99 -			
	29 L 9 V	05.99 -			
	29 L 11	05.99 -			
	29 L 11 V	05.99 -			
	Trag-/Führungsgelenk Konusmaß [mm]: 20 Gewindeart: mit Außengewinde Gewindemaß: M16 x 1,5			31005 01	500 379 801
	ALL TYPES ausser : 29L14, 29L14 /P, 29L14 D, 29L14 D/P	05.06 -			
	29L14 C, 29L14 C/P, 29L14 V, 29L14 V/P	05.06 -			
	Trag-/Führungsgelenk Konusmaß [mm]: 23 Gewindeart: mit Außengewinde Gewindemaß: M18 x 1,5 mit Zubehör			31006 01	500 334 716
	ALL TYPES ausser : 29L14, 29L14 /P, 29L14 D, 29L14 D/P	05.06 -			
	29L14 C, 29L14 C/P, 29L14 V, 29L14 V/P	05.06 -			



Ref.

IVECO







Daily 30...

<p> Spurstangenkopf mit Zubehör</p> <p>30-8 02.83 - 10.87 30-8, 55-60 kW 01.92 - 08.98 30-8, 60 kW 01.96 - 08.98 30-8, 62 kW, 2,8 t 09.98 - 30-8, 62 kW, 3,17 t 09.98 - 30-8 V 09.98 - 30-8 V,30-8 C, 53 kW 01.78 - 12.89 30-8 V,30-8 C, 55-60 kW 01.89 - 08.98 30-8 V,30-8 C, 60 kW 01.96 - 08.98 30-8 V,30-8 C, 62 kW 09.98 - 30-10 01.98 - 30-10 C, 2,8 t 01.98 - 30-10 C, 3 t 01.97 - 30-10 V,30-10 C 01.97 - 35-8, 53 kW 01.78 - 12.89 35-8, 55-60 kW 01.89 - 08.98 35-8, 62 kW 09.98 - 35-8 K 09.98 - 35-8 V,35-8 C, 53 kW 01.78 - 12.89 35-8 V,35-8 C, 55-60 kW 01.91 - 08.98 35-8 V,35-8 C, 62 kW 09.98 - 35-10, 68 kW 01.85 - 12.89 35-10, 68-76 kW 01.89 - 12.96 35-10, 76 kW 01.96 - 35-10 K 01.97 - 35-10 V,35-10 C, 68 kW, 2445 ccm 01.85 - 12.89 35-10 V,35-10 C, 76 kW 01.96 - 35-10 V,35-10 C, 76-80 kW 01.89 - 08.98 35-12, 85 kW 01.90 - 04.96 35-12, 90 kW 05.96 - 35-12 K 09.96 - 08.98 35-12 V,35-12 C 01.90 - 04.96</p>		<p>11637 02 9380 0662</p> 
<p>Spurstangenkopf an Achslenker</p> <p>35-8, 62 kW 09.98 - 35-8 K 09.98 - 35-10, 76 kW 01.96 - 35-10 K 01.97 - 35-10 V,35-10 C, 68 kW, 2499 ccm 09.96 - 08.98 35-10 V,35-10 C, 76 kW 01.96 - 35-12, 90 kW 05.96 - 35-12 K 09.96 - 08.98</p>		<p>22714 01 500 310 933</p> 
<p>Spurstangenkopf Gewindeart: mit Rechtsgewinde Innengewinde [mm]: M16x1,5 mit Zubehör Konusmaß [mm]: 20 Aussengewinde [mm]: M14x1,5</p> <p>35 S 9,35 C 9 05.99 - 35 S 9 V,35 C 9 V 05.99 - 35 S 11 V,35 C 11 V 05.99 - 35 S 11,35 C 11 05.99 - 35 S 13 V,35 C 13 V 05.99 - 35 S 13,35 C 13 05.99 -</p>		<p>22817 01 4253 4911</p> 
<p>Spurstangenkopf Gewindeart: Innengewinde Gewindemaß: M20x1,5 für Führungsstange mit Zubehör mit Kronenmutter</p> <p>35 C 10 , 35 S 10 09.02 - 35 C 10 V , 35 S 10 V 09.02 - 35 C 12 , 35 S 12 09.02 - 35 C 12 V , 35 S 12 V 09.02 - 35 S 9,35 C 9 05.99 - 35 S 9 V,35 C 9 V 05.99 - 35 S 15 V , 35 C 15 V 11.02 -</p>		<p>31146 01 500 337 201</p> 



IVECO

Daily 30...







<p> Axialgelenk, Spurstange Gewindeart: mit Rechtsgewinde Gewindemaß: M16x1,5</p> <table border="1"> <tr><td>30-8</td><td>02.83 - 10.87</td></tr> <tr><td>30-8, 55-60 kW</td><td>01.92 - 08.98</td></tr> <tr><td>30-8, 60 kW</td><td>01.96 - 08.98</td></tr> <tr><td>30-8, 62 kW, 2,8 t</td><td>09.98 -</td></tr> <tr><td>30-8, 62 kW, 3,17 t</td><td>09.98 -</td></tr> <tr><td>30-8 V</td><td>09.98 -</td></tr> <tr><td>30-8 V,30-8 C, 53 kW</td><td>01.78 - 12.89</td></tr> <tr><td>30-8 V,30-8 C, 55-60 kW</td><td>01.89 - 08.98</td></tr> <tr><td>30-8 V,30-8 C, 60 kW</td><td>01.96 - 08.98</td></tr> <tr><td>30-8 V,30-8 C, 62 kW</td><td>09.98 -</td></tr> <tr><td>30-10</td><td>01.98 -</td></tr> <tr><td>30-10 C, 2,8 t</td><td>01.98 -</td></tr> <tr><td>30-10 C, 3 t</td><td>01.97 -</td></tr> <tr><td>30-10 V,30-10 C</td><td>01.97 -</td></tr> <tr><td>35-8, 53 kW</td><td>01.78 - 12.89</td></tr> <tr><td>35-8, 55-60 kW</td><td>01.89 - 08.98</td></tr> <tr><td>35-8, 62 kW</td><td>09.98 -</td></tr> <tr><td>35-8 K</td><td>09.98 -</td></tr> <tr><td>35-8 V,35-8 C, 53 kW</td><td>01.78 - 12.89</td></tr> <tr><td>35-8 V,35-8 C, 55-60 kW</td><td>01.91 - 08.98</td></tr> <tr><td>35-8 V,35-8 C, 62 kW</td><td>09.98 -</td></tr> <tr><td>35-10, 68 kW</td><td>01.85 - 12.89</td></tr> <tr><td>35-10, 68-76 kW</td><td>01.89 - 12.96</td></tr> <tr><td>35-10, 76 kW</td><td>01.96 -</td></tr> <tr><td>35-10 K</td><td>01.97 -</td></tr> <tr><td>35-10 V,35-10 C, 68 kW, 2445 ccm</td><td>01.85 - 12.89</td></tr> <tr><td>35-10 V,35-10 C, 76 kW</td><td>01.96 -</td></tr> <tr><td>35-10 V,35-10 C, 76-80 kW</td><td>01.89 - 08.98</td></tr> <tr><td>35-12, 85 kW</td><td>01.90 - 04.96</td></tr> <tr><td>35-12, 90 kW</td><td>05.96 -</td></tr> <tr><td>35-12 K</td><td>09.96 - 08.98</td></tr> <tr><td>35-12 V,35-12 C</td><td>01.90 - 04.96</td></tr> </table>	30-8	02.83 - 10.87	30-8, 55-60 kW	01.92 - 08.98	30-8, 60 kW	01.96 - 08.98	30-8, 62 kW, 2,8 t	09.98 -	30-8, 62 kW, 3,17 t	09.98 -	30-8 V	09.98 -	30-8 V,30-8 C, 53 kW	01.78 - 12.89	30-8 V,30-8 C, 55-60 kW	01.89 - 08.98	30-8 V,30-8 C, 60 kW	01.96 - 08.98	30-8 V,30-8 C, 62 kW	09.98 -	30-10	01.98 -	30-10 C, 2,8 t	01.98 -	30-10 C, 3 t	01.97 -	30-10 V,30-10 C	01.97 -	35-8, 53 kW	01.78 - 12.89	35-8, 55-60 kW	01.89 - 08.98	35-8, 62 kW	09.98 -	35-8 K	09.98 -	35-8 V,35-8 C, 53 kW	01.78 - 12.89	35-8 V,35-8 C, 55-60 kW	01.91 - 08.98	35-8 V,35-8 C, 62 kW	09.98 -	35-10, 68 kW	01.85 - 12.89	35-10, 68-76 kW	01.89 - 12.96	35-10, 76 kW	01.96 -	35-10 K	01.97 -	35-10 V,35-10 C, 68 kW, 2445 ccm	01.85 - 12.89	35-10 V,35-10 C, 76 kW	01.96 -	35-10 V,35-10 C, 76-80 kW	01.89 - 08.98	35-12, 85 kW	01.90 - 04.96	35-12, 90 kW	05.96 -	35-12 K	09.96 - 08.98	35-12 V,35-12 C	01.90 - 04.96		<p>20345 01</p> 
30-8	02.83 - 10.87																																																																	
30-8, 55-60 kW	01.92 - 08.98																																																																	
30-8, 60 kW	01.96 - 08.98																																																																	
30-8, 62 kW, 2,8 t	09.98 -																																																																	
30-8, 62 kW, 3,17 t	09.98 -																																																																	
30-8 V	09.98 -																																																																	
30-8 V,30-8 C, 53 kW	01.78 - 12.89																																																																	
30-8 V,30-8 C, 55-60 kW	01.89 - 08.98																																																																	
30-8 V,30-8 C, 60 kW	01.96 - 08.98																																																																	
30-8 V,30-8 C, 62 kW	09.98 -																																																																	
30-10	01.98 -																																																																	
30-10 C, 2,8 t	01.98 -																																																																	
30-10 C, 3 t	01.97 -																																																																	
30-10 V,30-10 C	01.97 -																																																																	
35-8, 53 kW	01.78 - 12.89																																																																	
35-8, 55-60 kW	01.89 - 08.98																																																																	
35-8, 62 kW	09.98 -																																																																	
35-8 K	09.98 -																																																																	
35-8 V,35-8 C, 53 kW	01.78 - 12.89																																																																	
35-8 V,35-8 C, 55-60 kW	01.91 - 08.98																																																																	
35-8 V,35-8 C, 62 kW	09.98 -																																																																	
35-10, 68 kW	01.85 - 12.89																																																																	
35-10, 68-76 kW	01.89 - 12.96																																																																	
35-10, 76 kW	01.96 -																																																																	
35-10 K	01.97 -																																																																	
35-10 V,35-10 C, 68 kW, 2445 ccm	01.85 - 12.89																																																																	
35-10 V,35-10 C, 76 kW	01.96 -																																																																	
35-10 V,35-10 C, 76-80 kW	01.89 - 08.98																																																																	
35-12, 85 kW	01.90 - 04.96																																																																	
35-12, 90 kW	05.96 -																																																																	
35-12 K	09.96 - 08.98																																																																	
35-12 V,35-12 C	01.90 - 04.96																																																																	
<p>Axialgelenk, Spurstange Gewindeart: mit Rechtsgewinde Betriebsart: manuell für OE-Nummer 5003 06763 Gewindemaß: M16/M18x1,5</p> <table border="1"> <tr><td>35 S 9,35 C 9</td><td>05.99 -</td></tr> <tr><td>35 S 9 V,35 C 9 V</td><td>05.99 -</td></tr> <tr><td>35 S 11 V,35 C 11 V</td><td>05.99 -</td></tr> <tr><td>35 S 11,35 C 11</td><td>05.99 -</td></tr> <tr><td>35 S 13 V,35 C 13 V</td><td>05.99 -</td></tr> <tr><td>35 S 13,35 C 13</td><td>05.99 -</td></tr> </table>	35 S 9,35 C 9	05.99 -	35 S 9 V,35 C 9 V	05.99 -	35 S 11 V,35 C 11 V	05.99 -	35 S 11,35 C 11	05.99 -	35 S 13 V,35 C 13 V	05.99 -	35 S 13,35 C 13	05.99 -		<p>22818 01 5003 06763</p> 																																																				
35 S 9,35 C 9	05.99 -																																																																	
35 S 9 V,35 C 9 V	05.99 -																																																																	
35 S 11 V,35 C 11 V	05.99 -																																																																	
35 S 11,35 C 11	05.99 -																																																																	
35 S 13 V,35 C 13 V	05.99 -																																																																	
35 S 13,35 C 13	05.99 -																																																																	
<p>Trag-/Führungsgelenk mit Zubehör Gewindeart: mit Rechtsgewinde</p> <table border="1"> <tr><td>30-8</td><td>02.83 - 10.87</td></tr> <tr><td>30-8, 55-60 kW</td><td>01.92 - 08.98</td></tr> <tr><td>30-8, 60 kW</td><td>01.96 - 08.98</td></tr> <tr><td>30-8, 62 kW, 2,8 t</td><td>09.98 -</td></tr> <tr><td>30-8, 62 kW, 3,17 t</td><td>09.98 -</td></tr> <tr><td>30-8 V</td><td>09.98 -</td></tr> <tr><td>30-8 V,30-8 C, 53 kW</td><td>01.78 - 12.89</td></tr> <tr><td>30-8 V,30-8 C, 55-60 kW</td><td>01.89 - 08.98</td></tr> <tr><td>30-8 V,30-8 C, 60 kW</td><td>01.96 - 08.98</td></tr> <tr><td>30-8 V,30-8 C, 62 kW</td><td>09.98 -</td></tr> <tr><td>30-10</td><td>01.98 -</td></tr> <tr><td>30-10 C, 2,8 t</td><td>01.98 -</td></tr> <tr><td>30-10 C, 3 t</td><td>01.97 -</td></tr> <tr><td>30-10 V,30-10 C</td><td>01.97 -</td></tr> <tr><td>35-8, 55-60 kW</td><td>01.89 - 08.98</td></tr> <tr><td>35-8, 62 kW</td><td>09.98 -</td></tr> <tr><td>35-8 K</td><td>09.98 -</td></tr> <tr><td>35-8 V,35-8 C, 55-60 kW</td><td>01.91 - 08.98</td></tr> <tr><td>35-8 V,35-8 C, 62 kW</td><td>09.98 -</td></tr> <tr><td>35-10, 68-76 kW</td><td>01.89 - 12.96</td></tr> <tr><td>35-10, 76 kW</td><td>01.96 -</td></tr> <tr><td>35-10 K</td><td>01.97 -</td></tr> <tr><td>35-10 V,35-10 C, 76 kW</td><td>01.96 -</td></tr> <tr><td>35-10 V,35-10 C, 76-80 kW</td><td>01.89 - 08.98</td></tr> <tr><td>35-12, 85 kW</td><td>01.90 - 04.96</td></tr> <tr><td>35-12, 90 kW</td><td>05.96 -</td></tr> <tr><td>35-12 K</td><td>09.96 - 08.98</td></tr> <tr><td>35-12 V,35-12 C</td><td>01.90 - 04.96</td></tr> </table>	30-8	02.83 - 10.87	30-8, 55-60 kW	01.92 - 08.98	30-8, 60 kW	01.96 - 08.98	30-8, 62 kW, 2,8 t	09.98 -	30-8, 62 kW, 3,17 t	09.98 -	30-8 V	09.98 -	30-8 V,30-8 C, 53 kW	01.78 - 12.89	30-8 V,30-8 C, 55-60 kW	01.89 - 08.98	30-8 V,30-8 C, 60 kW	01.96 - 08.98	30-8 V,30-8 C, 62 kW	09.98 -	30-10	01.98 -	30-10 C, 2,8 t	01.98 -	30-10 C, 3 t	01.97 -	30-10 V,30-10 C	01.97 -	35-8, 55-60 kW	01.89 - 08.98	35-8, 62 kW	09.98 -	35-8 K	09.98 -	35-8 V,35-8 C, 55-60 kW	01.91 - 08.98	35-8 V,35-8 C, 62 kW	09.98 -	35-10, 68-76 kW	01.89 - 12.96	35-10, 76 kW	01.96 -	35-10 K	01.97 -	35-10 V,35-10 C, 76 kW	01.96 -	35-10 V,35-10 C, 76-80 kW	01.89 - 08.98	35-12, 85 kW	01.90 - 04.96	35-12, 90 kW	05.96 -	35-12 K	09.96 - 08.98	35-12 V,35-12 C	01.90 - 04.96		<p>11638 02 93 802 209</p> 								
30-8	02.83 - 10.87																																																																	
30-8, 55-60 kW	01.92 - 08.98																																																																	
30-8, 60 kW	01.96 - 08.98																																																																	
30-8, 62 kW, 2,8 t	09.98 -																																																																	
30-8, 62 kW, 3,17 t	09.98 -																																																																	
30-8 V	09.98 -																																																																	
30-8 V,30-8 C, 53 kW	01.78 - 12.89																																																																	
30-8 V,30-8 C, 55-60 kW	01.89 - 08.98																																																																	
30-8 V,30-8 C, 60 kW	01.96 - 08.98																																																																	
30-8 V,30-8 C, 62 kW	09.98 -																																																																	
30-10	01.98 -																																																																	
30-10 C, 2,8 t	01.98 -																																																																	
30-10 C, 3 t	01.97 -																																																																	
30-10 V,30-10 C	01.97 -																																																																	
35-8, 55-60 kW	01.89 - 08.98																																																																	
35-8, 62 kW	09.98 -																																																																	
35-8 K	09.98 -																																																																	
35-8 V,35-8 C, 55-60 kW	01.91 - 08.98																																																																	
35-8 V,35-8 C, 62 kW	09.98 -																																																																	
35-10, 68-76 kW	01.89 - 12.96																																																																	
35-10, 76 kW	01.96 -																																																																	
35-10 K	01.97 -																																																																	
35-10 V,35-10 C, 76 kW	01.96 -																																																																	
35-10 V,35-10 C, 76-80 kW	01.89 - 08.98																																																																	
35-12, 85 kW	01.90 - 04.96																																																																	
35-12, 90 kW	05.96 -																																																																	
35-12 K	09.96 - 08.98																																																																	
35-12 V,35-12 C	01.90 - 04.96																																																																	



Ref.

IVECO



Daily 30...

<p> Trag-/Führungsgelenk mit Zubehör Gewindemaß 1: M20x1,5 Gewindemaß 2: M18x1,5</p> <table border="0"> <tr><td>30-8</td><td>02.83 - 10.87</td></tr> <tr><td>30-8, 55-60 kW</td><td>01.92 - 08.98</td></tr> <tr><td>30-8, 60 kW</td><td>01.96 - 08.98</td></tr> <tr><td>30-8, 62 kW, 2,8 t</td><td>09.98 -</td></tr> <tr><td>30-8, 62 kW, 3,17 t</td><td>09.98 -</td></tr> <tr><td>30-8 V</td><td>09.98 -</td></tr> <tr><td>30-8 V,30-8 C, 53 kW</td><td>01.78 - 12.89</td></tr> <tr><td>30-8 V,30-8 C, 55-60 kW</td><td>01.89 - 08.98</td></tr> <tr><td>30-8 V,30-8 C, 60 kW</td><td>01.96 - 08.98</td></tr> <tr><td>30-8 V,30-8 C, 62 kW</td><td>09.98 -</td></tr> <tr><td>30-10</td><td>01.98 -</td></tr> <tr><td>30-10 C, 2,8 t</td><td>01.98 -</td></tr> <tr><td>30-10 C, 3 t</td><td>01.97 -</td></tr> <tr><td>30-10 V,30-10 C</td><td>01.97 -</td></tr> <tr><td>35-8, 53 kW</td><td>01.78 - 12.89</td></tr> <tr><td>35-8, 55-60 kW</td><td>01.89 - 08.98</td></tr> <tr><td>35-8, 62 kW</td><td>09.98 -</td></tr> <tr><td>35-8 K</td><td>09.98 -</td></tr> <tr><td>35-8 V,35-8 C, 53 kW</td><td>01.78 - 12.89</td></tr> <tr><td>35-8 V,35-8 C, 55-60 kW</td><td>01.91 - 08.98</td></tr> <tr><td>35-8 V,35-8 C, 62 kW</td><td>09.98 -</td></tr> <tr><td>35-10, 68 kW</td><td>01.85 - 12.89</td></tr> <tr><td>35-10, 68-76 kW</td><td>01.89 - 12.96</td></tr> <tr><td>35-10, 76 kW</td><td>01.96 -</td></tr> <tr><td>35-10 K</td><td>01.97 -</td></tr> <tr><td>35-10 V,35-10 C, 68 kW, 2445 ccm</td><td>01.85 - 12.89</td></tr> <tr><td>35-10 V,35-10 C, 76 kW</td><td>01.96 -</td></tr> <tr><td>35-10 V,35-10 C, 76-80 kW</td><td>01.89 - 08.98</td></tr> <tr><td>35-12, 85 kW</td><td>01.90 - 04.96</td></tr> <tr><td>35-12, 90 kW</td><td>05.96 -</td></tr> <tr><td>35-12 K</td><td>09.96 - 08.98</td></tr> <tr><td>35-12 V,35-12 C</td><td>01.90 - 04.96</td></tr> </table>	30-8	02.83 - 10.87	30-8, 55-60 kW	01.92 - 08.98	30-8, 60 kW	01.96 - 08.98	30-8, 62 kW, 2,8 t	09.98 -	30-8, 62 kW, 3,17 t	09.98 -	30-8 V	09.98 -	30-8 V,30-8 C, 53 kW	01.78 - 12.89	30-8 V,30-8 C, 55-60 kW	01.89 - 08.98	30-8 V,30-8 C, 60 kW	01.96 - 08.98	30-8 V,30-8 C, 62 kW	09.98 -	30-10	01.98 -	30-10 C, 2,8 t	01.98 -	30-10 C, 3 t	01.97 -	30-10 V,30-10 C	01.97 -	35-8, 53 kW	01.78 - 12.89	35-8, 55-60 kW	01.89 - 08.98	35-8, 62 kW	09.98 -	35-8 K	09.98 -	35-8 V,35-8 C, 53 kW	01.78 - 12.89	35-8 V,35-8 C, 55-60 kW	01.91 - 08.98	35-8 V,35-8 C, 62 kW	09.98 -	35-10, 68 kW	01.85 - 12.89	35-10, 68-76 kW	01.89 - 12.96	35-10, 76 kW	01.96 -	35-10 K	01.97 -	35-10 V,35-10 C, 68 kW, 2445 ccm	01.85 - 12.89	35-10 V,35-10 C, 76 kW	01.96 -	35-10 V,35-10 C, 76-80 kW	01.89 - 08.98	35-12, 85 kW	01.90 - 04.96	35-12, 90 kW	05.96 -	35-12 K	09.96 - 08.98	35-12 V,35-12 C	01.90 - 04.96		<p>11639 01 93 807 545</p> 
30-8	02.83 - 10.87																																																																	
30-8, 55-60 kW	01.92 - 08.98																																																																	
30-8, 60 kW	01.96 - 08.98																																																																	
30-8, 62 kW, 2,8 t	09.98 -																																																																	
30-8, 62 kW, 3,17 t	09.98 -																																																																	
30-8 V	09.98 -																																																																	
30-8 V,30-8 C, 53 kW	01.78 - 12.89																																																																	
30-8 V,30-8 C, 55-60 kW	01.89 - 08.98																																																																	
30-8 V,30-8 C, 60 kW	01.96 - 08.98																																																																	
30-8 V,30-8 C, 62 kW	09.98 -																																																																	
30-10	01.98 -																																																																	
30-10 C, 2,8 t	01.98 -																																																																	
30-10 C, 3 t	01.97 -																																																																	
30-10 V,30-10 C	01.97 -																																																																	
35-8, 53 kW	01.78 - 12.89																																																																	
35-8, 55-60 kW	01.89 - 08.98																																																																	
35-8, 62 kW	09.98 -																																																																	
35-8 K	09.98 -																																																																	
35-8 V,35-8 C, 53 kW	01.78 - 12.89																																																																	
35-8 V,35-8 C, 55-60 kW	01.91 - 08.98																																																																	
35-8 V,35-8 C, 62 kW	09.98 -																																																																	
35-10, 68 kW	01.85 - 12.89																																																																	
35-10, 68-76 kW	01.89 - 12.96																																																																	
35-10, 76 kW	01.96 -																																																																	
35-10 K	01.97 -																																																																	
35-10 V,35-10 C, 68 kW, 2445 ccm	01.85 - 12.89																																																																	
35-10 V,35-10 C, 76 kW	01.96 -																																																																	
35-10 V,35-10 C, 76-80 kW	01.89 - 08.98																																																																	
35-12, 85 kW	01.90 - 04.96																																																																	
35-12, 90 kW	05.96 -																																																																	
35-12 K	09.96 - 08.98																																																																	
35-12 V,35-12 C	01.90 - 04.96																																																																	
<p>Trag-/Führungsgelenk Konusmaß [mm]: 20 Gewindeart: mit Außengewinde Gewindemaß: M16 x 1,5</p> <table border="0"> <tr><td>35 C 10 , 35 S 10</td><td>09.02 -</td></tr> <tr><td>35 C 10 V , 35 S 10 V</td><td>09.02 -</td></tr> <tr><td>35 C 12 , 35 S 12</td><td>09.02 -</td></tr> <tr><td>35 C 12 V , 35 S 12 V</td><td>09.02 -</td></tr> <tr><td>35 S 9,35 C 9</td><td>05.99 -</td></tr> <tr><td>35 S 9 V,35 C 9 V</td><td>05.99 -</td></tr> <tr><td>35 S 11 V,35 C 11 V</td><td>05.99 -</td></tr> <tr><td>35 S 11,35 C 11</td><td>05.99 -</td></tr> <tr><td>35 S 13 V,35 C 13 V</td><td>05.99 -</td></tr> <tr><td>35 S 13,35 C 13</td><td>05.99 -</td></tr> <tr><td>35 S 15 V , 35 C 15 V</td><td>11.02 -</td></tr> <tr><td>35 S 15 , 35 C 15</td><td>11.01 -</td></tr> </table>	35 C 10 , 35 S 10	09.02 -	35 C 10 V , 35 S 10 V	09.02 -	35 C 12 , 35 S 12	09.02 -	35 C 12 V , 35 S 12 V	09.02 -	35 S 9,35 C 9	05.99 -	35 S 9 V,35 C 9 V	05.99 -	35 S 11 V,35 C 11 V	05.99 -	35 S 11,35 C 11	05.99 -	35 S 13 V,35 C 13 V	05.99 -	35 S 13,35 C 13	05.99 -	35 S 15 V , 35 C 15 V	11.02 -	35 S 15 , 35 C 15	11.01 -		<p>31005 01 500 379 801</p> 																																								
35 C 10 , 35 S 10	09.02 -																																																																	
35 C 10 V , 35 S 10 V	09.02 -																																																																	
35 C 12 , 35 S 12	09.02 -																																																																	
35 C 12 V , 35 S 12 V	09.02 -																																																																	
35 S 9,35 C 9	05.99 -																																																																	
35 S 9 V,35 C 9 V	05.99 -																																																																	
35 S 11 V,35 C 11 V	05.99 -																																																																	
35 S 11,35 C 11	05.99 -																																																																	
35 S 13 V,35 C 13 V	05.99 -																																																																	
35 S 13,35 C 13	05.99 -																																																																	
35 S 15 V , 35 C 15 V	11.02 -																																																																	
35 S 15 , 35 C 15	11.01 -																																																																	
<p>Trag-/Führungsgelenk Konusmaß [mm]: 23 Gewindeart: mit Außengewinde Gewindemaß: M18 x 1,5 mit Zubehör</p> <table border="0"> <tr><td>35 C 10 , 35 S 10</td><td>09.02 -</td></tr> <tr><td>35 C 10 V , 35 S 10 V</td><td>09.02 -</td></tr> <tr><td>35 C 12 , 35 S 12</td><td>09.02 -</td></tr> <tr><td>35 C 12 V , 35 S 12 V</td><td>09.02 -</td></tr> <tr><td>35 S 9,35 C 9</td><td>05.99 -</td></tr> <tr><td>35 S 9 V,35 C 9 V</td><td>05.99 -</td></tr> <tr><td>35 S 11 V,35 C 11 V</td><td>05.99 -</td></tr> <tr><td>35 S 11,35 C 11</td><td>05.99 -</td></tr> <tr><td>35 S 13 V,35 C 13 V</td><td>05.99 -</td></tr> <tr><td>35 S 13,35 C 13</td><td>05.99 -</td></tr> <tr><td>35 S 15 V , 35 C 15 V</td><td>11.02 -</td></tr> <tr><td>35 S 15 , 35 C 15</td><td>11.01 -</td></tr> </table>	35 C 10 , 35 S 10	09.02 -	35 C 10 V , 35 S 10 V	09.02 -	35 C 12 , 35 S 12	09.02 -	35 C 12 V , 35 S 12 V	09.02 -	35 S 9,35 C 9	05.99 -	35 S 9 V,35 C 9 V	05.99 -	35 S 11 V,35 C 11 V	05.99 -	35 S 11,35 C 11	05.99 -	35 S 13 V,35 C 13 V	05.99 -	35 S 13,35 C 13	05.99 -	35 S 15 V , 35 C 15 V	11.02 -	35 S 15 , 35 C 15	11.01 -		<p>31006 01 500 334 716</p> 																																								
35 C 10 , 35 S 10	09.02 -																																																																	
35 C 10 V , 35 S 10 V	09.02 -																																																																	
35 C 12 , 35 S 12	09.02 -																																																																	
35 C 12 V , 35 S 12 V	09.02 -																																																																	
35 S 9,35 C 9	05.99 -																																																																	
35 S 9 V,35 C 9 V	05.99 -																																																																	
35 S 11 V,35 C 11 V	05.99 -																																																																	
35 S 11,35 C 11	05.99 -																																																																	
35 S 13 V,35 C 13 V	05.99 -																																																																	
35 S 13,35 C 13	05.99 -																																																																	
35 S 15 V , 35 C 15 V	11.02 -																																																																	
35 S 15 , 35 C 15	11.01 -																																																																	





IVECO

Daily 30...

 Lagerung, Lenker		I29/A52	31103 01	9380 7640
30-8	02.83 - 10.87			
30-8, 55-60 kW	01.92 - 08.98			
30-8, 60 kW	01.96 - 08.98			
30-8, 62 kW, 2,8 t	09.98 -			
30-8, 62 kW, 3,17 t	09.98 -			
30-8 V	09.98 -			
30-8 V,30-8 C, 53 kW	01.78 - 12.89			
30-8 V,30-8 C, 55-60 kW	01.89 - 08.98			
30-8 V,30-8 C, 60 kW	01.96 - 08.98			
30-8 V,30-8 C, 62 kW	09.98 -			
35-8, 53 kW	01.78 - 12.89			
35-8, 55-60 kW	01.89 - 08.98			
35-8, 62 kW	09.98 -			
35-8 K	09.98 -			
35-8 V,35-8 C, 53 kW	01.78 - 12.89			
35-8 V,35-8 C, 55-60 kW	01.91 - 08.98			
35-8 V,35-8 C, 62 kW	09.98 -			
35-12, 85 kW	01.90 - 04.96			
35-12, 90 kW	05.96 -			
35-12 K	09.96 - 08.98			
35-12 V,35-12 C	01.90 - 04.96			

Daily 40...





 Spurstangenkopf mit Zubehör			11637 02	9380 0662
A 40-10, 2499 ccm	01.91 - 12.96			
A 40-10, 2798 ccm	09.96 -			
A 40-12	05.96 -			
A 45-10, 2499 ccm	01.91 - 04.96			
A 45-10, 2798 ccm	05.96 -			
A 45-12, 85 kW	06.90 - 04.96			
A 45-12, 90 kW	05.96 -			
40-8	01.83 - 06.89			
40-8 V	01.83 - 06.89			
40-10	01.85 - 12.89			
40-10 V, 68 kW	01.85 - 12.89			
40-10 V, 76 kW	01.90 - 04.96			
40-10 W	01.97 -			
40-10 WV,40-10 WC	01.97 -			
40-12	10.90 - 04.96			
40-12 V	10.90 - 04.96			
45-10, 76 kW, Pritsche/Fahrgestell	01.89 - 04.96			
45-10, 76 kW, Kipper	01.92 - 04.96			
45-10 V, 76 kW	01.89 - 04.96			
49-10, 76 kW, 2798 ccm	05.96 -			
49-10 K, 2499 ccm	01.89 - 04.96			
49-10 K, 2798 ccm	05.96 -			
49-10 V, 76 kW	01.89 - 04.96			
49-12, 85 kW	06.90 - 04.96			
49-12, 90 kW	05.96 -			
49-12 K, 85 kW	06.90 - 04.96			
49-12 K, 90 kW	05.96 -			
49-12 V, 85 kW	06.90 - 04.96			
49-12 V, 90 kW	05.96 -			



Ref.

IVECO





Daily 40...

 Axialgelenk, Spurstange Gewindeart: mit Rechtsgewinde Gewindemaß: M16x1,5		20345 01 
A 40-10, 2499 ccm A 40-10, 2798 ccm A 40-12 A 45-10, 2499 ccm A 45-10, 2798 ccm A 45-12, 85 kW A 45-12, 90 kW 40-8 40-8 V 40-10 40-10 V, 68 kW 40-10 V, 76 kW 40-10 W 40-10 WV,40-10 WC 40-12 40-12 V 45-10, 68 kW 45-10, 76 kW, Pritsche/Fahrgestell 45-10, 76 kW, Kipper 45-10 V, 68 kW 45-10 V, 76 kW 49-10, 68 kW 49-10, 76 kW, 2499 ccm 49-10, 76 kW, 2798 ccm 49-10 K, 2499 ccm 49-10 K, 2798 ccm 49-10 V, 68 kW 49-10 V, 76 kW 49-12, 85 kW 49-12, 90 kW 49-12 K, 85 kW 49-12 K, 90 kW 49-12 V, 85 kW 49-12 V, 90 kW	01.91 - 12.96 09.96 - 05.96 - 01.91 - 04.96 05.96 - 06.90 - 04.96 05.96 - 01.83 - 06.89 01.83 - 06.89 01.85 - 12.89 01.85 - 12.89 01.90 - 04.96 01.97 - 01.97 - 10.90 - 04.96 10.90 - 04.96 01.85 - 12.89 01.89 - 04.96 01.92 - 04.96 01.85 - 12.89 01.89 - 04.96 01.85 - 12.89 01.89 - 04.96 01.89 - 04.96 05.96 - 01.89 - 04.96 05.96 - 01.85 - 12.89 01.89 - 04.96 06.90 - 04.96 05.96 - 06.90 - 04.96 05.96 - 06.90 - 04.96 05.96 - 06.90 - 04.96	
Trag-/Führungsgelenk mit Zubehör Gewindeart: mit Rechtsgewinde		11638 02 93 802 209 
A 45-10, 2499 ccm A 45-10, 2798 ccm A 45-12, 85 kW A 45-12, 90 kW 45-10, 76 kW, Pritsche/Fahrgestell 45-10, 76 kW, Kipper 45-10 V, 76 kW 49-10, 76 kW, 2798 ccm 49-10 K, 2499 ccm 49-10 K, 2798 ccm 49-10 V, 76 kW 49-12, 85 kW 49-12, 90 kW 49-12 K, 85 kW 49-12 K, 90 kW 49-12 V, 85 kW 49-12 V, 90 kW	01.91 - 04.96 05.96 - 06.90 - 04.96 05.96 - 01.89 - 04.96 01.92 - 04.96 01.89 - 04.96 05.96 - 01.89 - 04.96 05.96 - 01.89 - 04.96 06.90 - 04.96 05.96 - 06.90 - 04.96 05.96 - 06.90 - 04.96 05.96 - 06.90 - 04.96 05.96 - 06.90 - 04.96	







IVECO

Daily 40...

 Trag-/Führungsgelenk mit Zubehör Gewindemaß 1: M20x1,5 Gewindemaß 2: M18x1,5		11639 01 93 807 545 
A 40-10, 2499 ccm 01.91 - 12.96 A 40-10, 2798 ccm 09.96 - A 40-12 05.96 - A 45-10, 2499 ccm 01.91 - 04.96 A 45-10, 2798 ccm 05.96 - A 45-12, 85 kW 06.90 - 04.96 A 45-12, 90 kW 05.96 - 40-8 01.83 - 06.89 40-8 V 01.83 - 06.89 40-10 01.85 - 12.89 40-10 V, 68 kW 01.85 - 12.89 40-10 V, 76 kW 01.90 - 04.96 40-10 W 01.97 - 40-10 WV,40-10 WC 01.97 - 40-12 10.90 - 04.96 40-12 V 10.90 - 04.96 45-10, 68 kW 01.85 - 12.89 45-10, 76 kW, Pritsche/Fahrgestell 01.89 - 04.96 45-10, 76 kW, Kipper 01.92 - 04.96 45-10 V, 68 kW 01.85 - 12.89 45-10 V, 76 kW 01.89 - 04.96 49-10, 68 kW 01.85 - 12.89 49-10, 76 kW, 2499 ccm 01.89 - 04.96 49-10, 76 kW, 2798 ccm 05.96 - 49-10 K, 2499 ccm 01.89 - 04.96 49-10 K, 2798 ccm 05.96 - 49-10 V, 68 kW 01.85 - 12.89 49-10 V, 76 kW 01.89 - 04.96 49-12, 85 kW 06.90 - 04.96 49-12, 90 kW 05.96 - 49-12 K, 85 kW 06.90 - 04.96 49-12 K, 90 kW 05.96 - 49-12 V, 85 kW 06.90 - 04.96 49-12 V, 90 kW 05.96 -		
Lagerung, Lenker 40C10, 40C10 D, 40S10 05.06 - 40C10 V 05.06 - 40C12, 40C12 /P, 40C12 D, 40C12 D/P 05.06 - 45-10, 76 kW, Pritsche/Fahrgestell 01.89 - 04.96 45-10, 76 kW, Kipper 01.92 - 04.96 45-10 V, 76 kW 01.89 - 04.96 49-10, 76 kW, 2798 ccm 05.96 - 49-10 K, 2798 ccm 05.96 - 49-12, 85 kW 06.90 - 04.96 49-12, 90 kW 05.96 - 49-12 K, 85 kW 06.90 - 04.96 49-12 K, 90 kW 05.96 - 49-12 V, 85 kW 06.90 - 04.96 49-12 V, 90 kW 05.96 -	 I29/A52	31103 01 9380 7640 

Daily 50...













 Spurstangenkopf mit Zubehör 59-12 04.89 - 05.92 59-12, 90 kW 05.96 - 59-12 K, 85 kW 05.91 - 04.96 59-12 K, 90 kW 05.96 - 59-12 V, 85 kW 05.91 - 04.96 59-12 V, 90 kW 05.96 -		11637 02 9380 0662 
Spurstangenkopf Gewindeart: mit Rechtsgewinde Innengewinde [mm]: M16x1,5 mit Zubehör Konusmaß [mm]: 20 Aussengewinde [mm]: M14x1,5 50 C 11 10.81 - 12.81 50 C 11, Kasten/Kombi 05.99 - 50 C 13, Pritsche/Fahrgestell 05.99 - 50 C 13, Kasten/Kombi 05.99 -		22817 01 4253 4911 



Ref.

IVECO

Daily 50...



 Spurstangenkopf Gewindeart: Innengewinde Gewindemaß: M20x1,5 für Führungsstange mit Zubehör mit Kronenmutter		31146 01 500 337 201 
50 C 11, Pritsche/Fahrgestell 05.99 - 50 C 11, Kasten/Kombi 05.99 - 50 C 13, Pritsche/Fahrgestell 05.99 - 50 C 13, Kasten/Kombi 05.99 - 50 C 15 01.01 - 59-12 04.89 - 05.92 59-12, 90 kW 05.96 - 59-12 K, 85 kW 05.91 - 04.96 59-12 K, 90 kW 05.96 - 59-12 V, 85 kW 05.91 - 04.96 59-12 V, 90 kW 05.96 -		
Axialgelenk, Spurstange Gewindeart: mit Rechtsgewinde Gewindemaß: M16x1,5		20345 01 
59-12 04.89 - 05.92 59-12, 90 kW 05.96 - 59-12 K, 85 kW 05.91 - 04.96 59-12 K, 90 kW 05.96 - 59-12 V, 85 kW 05.91 - 04.96 59-12 V, 90 kW 05.96 -		
Axialgelenk, Spurstange Gewindeart: mit Rechtsgewinde Betriebsart: manuell für OE-Nummer 5003 06763 Gewindemaß: M16/M18x1,5		22818 01 5003 06763 
50 C 11 10.81 - 12.81 50 C 11, Kasten/Kombi 05.99 - 50 C 13, Pritsche/Fahrgestell 05.99 - 50 C 13, Kasten/Kombi 05.99 -		
Trag-/Führungsgelenk mit Zubehör Gewindeart: mit Rechtsgewinde		11638 02 93 802 209 
59-12 04.89 - 05.92 59-12, 90 kW 05.96 - 59-12 K, 85 kW 05.91 - 04.96 59-12 K, 90 kW 05.96 - 59-12 V, 85 kW 05.91 - 04.96 59-12 V, 90 kW 05.96 -		
Trag-/Führungsgelenk mit Zubehör Gewindemaß 1: M20x1,5 Gewindemaß 2: M18x1,5		11639 01 93 807 545 
59-12 04.89 - 05.92 59-12, 90 kW 05.96 - 59-12 K, 85 kW 05.91 - 04.96 59-12 K, 90 kW 05.96 - 59-12 V, 85 kW 05.91 - 04.96 59-12 V, 90 kW 05.96 -		
Trag-/Führungsgelenk Konusmaß [mm]: 20 Gewindeart: mit Außengewinde Gewindemaß: M16 x 1,5		31005 01 500 379 801 
50 C 11 10.81 - 12.81 50 C 11, Kasten/Kombi 05.99 - 50 C 13, Pritsche/Fahrgestell 05.99 - 50 C 13, Kasten/Kombi 05.99 - 50 C 15 01.01 -		
Trag-/Führungsgelenk Konusmaß [mm]: 23 Gewindeart: mit Außengewinde Gewindemaß: M18 x 1,5 mit Zubehör		31006 01 500 334 716 
50 C 11 10.81 - 12.81 50 C 11, Kasten/Kombi 05.99 - 50 C 13, Pritsche/Fahrgestell 05.99 - 50 C 13, Kasten/Kombi 05.99 - 50 C 15 01.01 -		









Ref.

IVECO

Daily 50...

 Lagerung, Lenker			I29/A52	31103 01	9380 7640
	59-12, 85 kW 59-12 K, 85 kW	05.91 - 04.96 05.91 - 04.96			

Daily 60...

 Spurstangenkopf Gewindeart: Innengewinde Gewindemaß: M20x1,5 für Führungsstange mit Zubehör mit Kronenmutter				31146 01	500 337 201
	65 C 15	11.01 -			
Trag-/Führungsgelenk Konusmaß [mm]: 20 Gewindeart: mit Außengewinde Gewindemaß: M16 x 1,5				31005 01	500 379 801
	65 C 15	11.01 -			
Trag-/Führungsgelenk Konusmaß [mm]: 23 Gewindeart: mit Außengewinde Gewindemaß: M18 x 1,5 mit Zubehör				31006 01	500 334 716
	65 C 15	11.01 -			











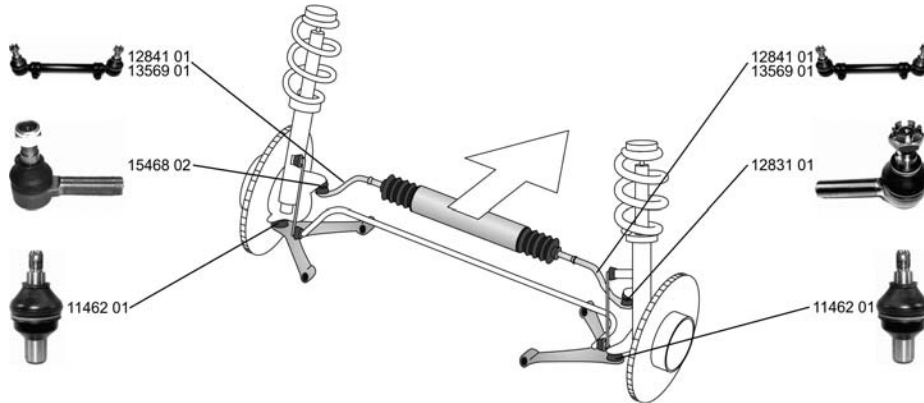

Ref.

MERCEDES-BENZ

100 Bus/Familial (631)

02.88 - 02.96



















<p>Spurstange Konusmaß [mm]: 20 Rohr-Ø [mm]: 26 mit Zubehör</p>		<p>12841 01 631 330 07 03 ▲-12831 01 ▲-12838 01</p>
<p>ALL TYPES</p>	<p>Chass. 013458-> Chass. 013458-> für OE-Nummer 631 330 07 03 Chass. 013548-> für OE-Nummer 631 330 04 03 ->Chass. 013547 für OE-Nummer 631 330 07 03 für OE-Nummer = 12841 01 Chass. 013548-> ----- für OE-Nummer 631 330 04 03 für OE-Nummer = 12842 01 ->Chass. 013547</p>	
<p>Spurstange</p>		<p>12842 01 631 330 04 03 ▲-12838 01 ▲-12831 01</p>
<p>ALL TYPES</p>	<p>->Chass. 013547</p>	
<p>Spurstange</p>		<p>12843 01 631 330 06 03 ▲-12844 01</p>
<p>ALL TYPES</p>	<p>Chass. 013458-></p>	
<p>Spurstange Konusmaß [mm]: 18 Rohr-Ø [mm]: 22</p>		<p>13569 01 631 330 03 03 ▲-12839 01 ▲-12840 01</p>
<p>ALL TYPES</p>	<p>->Chass. 013457</p>	
<p>Spurstangenkopf Gewindeart: mit Rechtsgewinde</p>		<p>12831 01 001 330 48 35</p>
<p>ALL TYPES</p>	<p>für OE-Nummer 631 330 07 03 für OE-Nummer = 12841 01 Chass. 013548-> ----- für OE-Nummer 631 330 04 03 für OE-Nummer = 12842 01 ->Chass. 013547</p>	



MERCEDES-BENZ

100 Bus/Familial (631)

02.88 - 02.96

<p> Spurstangenkopf Konusmaß [mm]: 20 Gewindemaß: M20x1,5 Gewindeart: mit Linksgewinde mit Zubehör</p>		<p>12838 01 631 330 04 35</p> 
<p>ALL TYPES</p>	<p>für OE-Nummer 631 330 07 03 für OE-Nummer = 12841 01 Chass. 013548-></p> <hr/> <p>für OE-Nummer 631 330 04 03 für OE-Nummer = 12842 01 ->Chass. 013547</p>	
<p>Spurstangenkopf Gewindemaß: M18x1,5 Gewindeart: mit Rechtsgewinde Aussengewinde [mm]: M18x1,5</p>		<p>12839 01 631 338 03 10</p> 
<p>ALL TYPES</p>	<p>->Chass. 013457</p>	
<p>Spurstangenkopf Konusmaß [mm]: 18 Gewindemaß: M18x1,5 Gewindeart: mit Linksgewinde Aussengewinde [mm]: M18x1,5</p>		<p>12840 01 631 338 04 10</p> 
<p>ALL TYPES</p>	<p>->Chass. 013457</p>	
<p>Spurstangenkopf für OE-Nummer 631 330 06 03 Gewindemaß: M24x1,5 Gewindeart: mit Rechtsgewinde</p>		<p>12844 01 631 330 05 35</p> 
<p>ALL TYPES</p>	<p>Chass. 013458-></p>	
<p>Spurstangenkopf Gewindeart: mit Linksgewinde</p>		<p>15468 02 000 460 73 48</p> 
<p>D (631.333, 631.343, 631.334, 631.344) 02.88 - 05.92 D (631.333, 631.343, 631.334, 631.344), 55 kW 12.90 - 02.96</p>	<p>Chass. 013458-></p>	
<p>Lenkstange Schubstange Konusmaß [mm]: 18 Rohr-Ø [mm]: 35</p>		<p>12845 01 631 460 07 05 ▲-13606 01</p> 
<p>ALL TYPES</p>	<p>Chass. 013458-> für OE-Nummer 631 330 07 03 Chass. 013548-> für OE-Nummer 631 330 04 03 ->Chass. 013547 für OE-Nummer 631 330 07 03 für OE-Nummer = 12841 01 Chass. 013548-></p> <hr/> <p>für OE-Nummer 631 330 04 03 für OE-Nummer = 12842 01 ->Chass. 013547</p>	
<p>Winkelgelenk, Lenkschubstange Gewindemaß: M18x1,5 Gewindeart: mit Rechtsgewinde</p>		<p>13606 01 000 460 65 48</p>
<p>ALL TYPES</p>		
<p>Trag-/Führungsgelenk</p>		<p>11462 01 631 320 00 28</p> 
<p>ALL TYPES</p>	<p>(x4)</p> 	<p>26573 01 631 330 00 75</p> 
<p>ALL TYPES</p>		











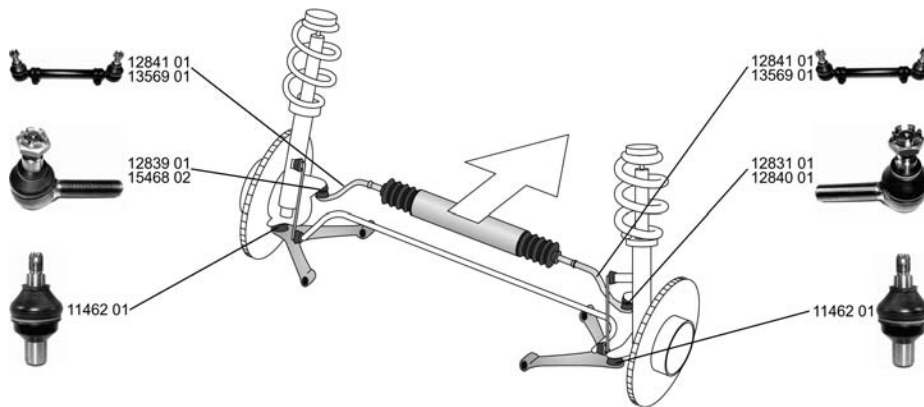

Ref.

MERCEDES-BENZ

100 Kasten/Box/Furgón/Van (631)

02.88 - 02.96



















<p>Spurstange Konusmaß [mm]: 20 Rohr-Ø [mm]: 26 mit Zubehör</p>		<p>12841 01 631 330 07 03 ▲12831 01 ▲12838 01</p>
<p>ALL TYPES</p>	<p>Chass. 013458-> Chass. 013458-> für OE-Nummer 631 330 07 03 Chass. 013548-> für OE-Nummer 631 330 04 03 ->Chass. 013547 für OE-Nummer 631 330 07 03 für OE-Nummer = 12841 01 Chass. 013548-> ----- für OE-Nummer 631 330 04 03 für OE-Nummer = 12842 01 ->Chass. 013547</p>	
<p>Spurstange</p>		<p>12842 01 631 330 04 03 ▲12838 01 ▲12831 01</p>
<p>ALL TYPES</p>	<p>->Chass. 013547</p>	
<p>Spurstange</p>		<p>12843 01 631 330 06 03 ▲12844 01</p>
<p>ALL TYPES</p>	<p>Chass. 013458-></p>	
<p>Spurstange Konusmaß [mm]: 18 Rohr-Ø [mm]: 22</p>		<p>13569 01 631 330 03 03 ▲12839 01 ▲12840 01</p>
<p>ALL TYPES</p>	<p>->Chass. 013457</p>	
<p>Spurstangenkopf Gewindeart: mit Rechtsgewinde</p>		<p>12831 01 001 330 48 35</p>
<p>ALL TYPES</p>	<p>für OE-Nummer 631 330 07 03 für OE-Nummer = 12841 01 Chass. 013548-> ----- für OE-Nummer 631 330 04 03 für OE-Nummer = 12842 01 ->Chass. 013547</p>	



MERCEDES-BENZ

100 Kasten/Box/Furgón/Van (631)

02.88 - 02.96

<p> Spurstangenkopf Konusmaß [mm]: 20 Gewindemaß: M20x1,5 Gewindeart: mit Linksgewinde mit Zubehör</p>		<p>12838 01 631 330 04 35</p> 
<p>ALL TYPES</p>	<p>für OE-Nummer 631 330 07 03 für OE-Nummer = 12841 01 Chass. 013548-></p> <hr/> <p>für OE-Nummer 631 330 04 03 für OE-Nummer = 12842 01 ->Chass. 013547</p>	
<p>Spurstangenkopf Gewindemaß: M18x1,5 Gewindeart: mit Rechtsgewinde Aussengewinde [mm]: M18x1,5</p>		<p>12839 01 631 338 03 10</p> 
<p>ALL TYPES</p>	<p>->Chass. 013457</p>	
<p>Spurstangenkopf Konusmaß [mm]: 18 Gewindemaß: M18x1,5 Gewindeart: mit Linksgewinde Aussengewinde [mm]: M18x1,5</p>		<p>12840 01 631 338 04 10</p> 
<p>ALL TYPES</p>	<p>->Chass. 013457</p>	
<p>Spurstangenkopf für OE-Nummer 631 330 06 03 Gewindemaß: M24x1,5 Gewindeart: mit Rechtsgewinde</p>		<p>12844 01 631 330 05 35</p> 
<p>ALL TYPES</p>	<p>Chass. 013458-></p>	
<p>Spurstangenkopf Gewindeart: mit Linksgewinde</p>		<p>15468 02 000 460 73 48</p> 
<p>D (631.332, 631.342) 02.88 - 05.92 D (631.332, 631.342), 55 kW 12.90 - 02.96</p>	<p>Chass. 013458-></p>	
<p>Lenkstange Schubstange Konusmaß [mm]: 18 Rohr-Ø [mm]: 35</p>		<p>12845 01 631 460 07 05 ▲-13606 01</p> 
<p>ALL TYPES</p>	<p>Chass. 013458-> für OE-Nummer 631 330 07 03 Chass. 013548-> für OE-Nummer 631 330 04 03 ->Chass. 013547 für OE-Nummer 631 330 07 03 für OE-Nummer = 12841 01 Chass. 013548-></p> <hr/> <p>für OE-Nummer 631 330 04 03 für OE-Nummer = 12842 01 ->Chass. 013547</p>	
<p>Winkelgelenk, Lenkschubstange Gewindemaß: M18x1,5 Gewindeart: mit Rechtsgewinde</p>		<p>13606 01 000 460 65 48</p>
<p>ALL TYPES</p>		
<p>Trag-/Führungsgelenk</p>		<p>11462 01 631 320 00 28</p> 
<p>ALL TYPES</p>		
<p>Lagerung, Lenker</p>	<p>(x4)</p> 	<p>26573 01 631 330 00 75</p> 
<p>ALL TYPES</p>		











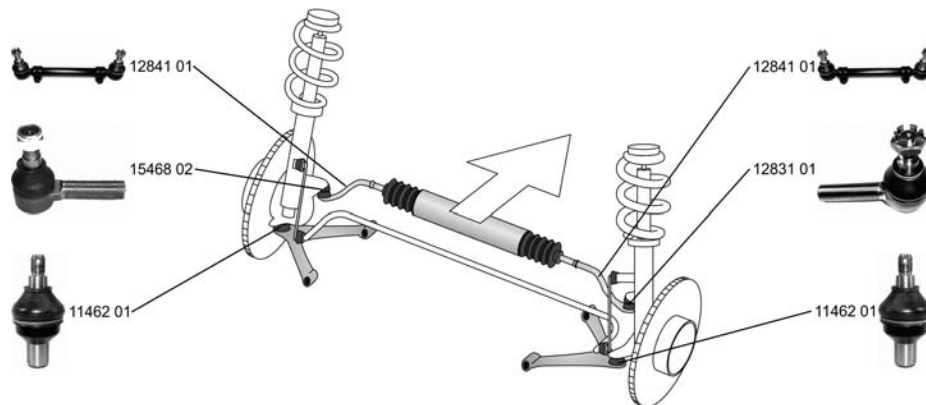

Ref.

MERCEDES-BENZ

100 Pritsche/Fahrgestell (631)

02.88 - 02.96





















<p>Spurstange Konusmaß [mm]: 20 Rohr-Ø [mm]: 26 mit Zubehör</p>		<p>12841 01 631 330 07 03 ▲12831 01 ▲12838 01</p>
<p>ALL TYPES</p>	<p>Chass. 013458-> Chass. 013458-> für OE-Nummer 631 330 07 03 Chass. 013548-> für OE-Nummer 631 330 04 03 ->Chass. 013547 für OE-Nummer 631 330 07 03 für OE-Nummer = 12841 01 Chass. 013548-> ----- für OE-Nummer 631 330 04 03 für OE-Nummer = 12842 01 ->Chass. 013547</p>	
<p>Spurstange</p>		<p>12842 01 631 330 04 03 ▲12838 01 ▲12831 01</p>
<p>ALL TYPES</p>	<p>->Chass. 013547</p>	
<p>Spurstange</p>		<p>12843 01 631 330 06 03 ▲12844 01</p>
<p>ALL TYPES</p>	<p>Chass. 013458-></p>	
<p>Spurstange Konusmaß [mm]: 18 Rohr-Ø [mm]: 22</p>		<p>13569 01 631 330 03 03 ▲12839 01 ▲12840 01</p>
<p>ALL TYPES</p>	<p>->Chass. 013457</p>	
<p>Spurstangenkopf Gewindeart: mit Rechtsgewinde</p>		<p>12831 01 001 330 48 35</p>
<p>ALL TYPES</p>	<p>für OE-Nummer 631 330 07 03 für OE-Nummer = 12841 01 Chass. 013548-> ----- für OE-Nummer 631 330 04 03 für OE-Nummer = 12842 01 ->Chass. 013547</p>	

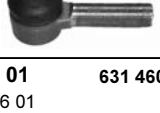

MERCEDES-BENZ

100 Pritsche/Fahrgestell (631)

02.88 - 02.96

<p> Spurstangenkopf Konusmaß [mm]: 20 Gewindemaß: M20x1,5 Gewindeart: mit Linksgewinde mit Zubehör</p>		<p>12838 01 631 330 04 35</p> 
<p>ALL TYPES</p>	<p>für OE-Nummer 631 330 07 03 für OE-Nummer = 12841 01 Chass. 013548-></p> <hr/> <p>für OE-Nummer 631 330 04 03 für OE-Nummer = 12842 01 ->Chass. 013547</p>	
<p>Spurstangenkopf Gewindemaß: M18x1,5 Gewindeart: mit Rechtsgewinde Aussengewinde [mm]: M18x1,5</p>		<p>12839 01 631 338 03 10</p> 
<p>ALL TYPES</p>	<p>->Chass. 013457</p>	
<p>Spurstangenkopf Konusmaß [mm]: 18 Gewindemaß: M18x1,5 Gewindeart: mit Linksgewinde Aussengewinde [mm]: M18x1,5</p>		<p>12840 01 631 338 04 10</p> 
<p>ALL TYPES</p>	<p>->Chass. 013457</p>	
<p>Spurstangenkopf für OE-Nummer 631 330 06 03 Gewindemaß: M24x1,5 Gewindeart: mit Rechtsgewinde</p>		<p>12844 01 631 330 05 35</p> 
<p>ALL TYPES</p>	<p>Chass. 013458-></p>	
<p>Spurstangenkopf Gewindeart: mit Linksgewinde</p>		<p>15468 02 000 460 73 48</p> 
<p>ALL TYPES</p>		
<p>Lenkstange Schubstange Konusmaß [mm]: 18 Rohr-Ø [mm]: 35</p>		<p>12845 01 631 460 07 05</p> <p> 13606 01</p> 
<p>ALL TYPES</p>	<p>Chass. 013458-> für OE-Nummer 631 330 07 03 Chass. 013548-> für OE-Nummer 631 330 04 03 ->Chass. 013547 für OE-Nummer 631 330 07 03 für OE-Nummer = 12841 01 Chass. 013548-></p> <hr/> <p>für OE-Nummer 631 330 04 03 für OE-Nummer = 12842 01 ->Chass. 013547</p>	
<p>Winkelgelenk, Lenkschubstange Gewindemaß: M18x1,5 Gewindeart: mit Rechtsgewinde</p>		<p>13606 01 000 460 65 48</p>
<p>ALL TYPES</p>		
<p>Trag-/Führungsgelenk</p>		<p>11462 01 631 320 00 28</p> 
<p>ALL TYPES</p>	<p>(x4)</p> 	<p>26573 01 631 330 00 75</p> 
<p>ALL TYPES</p>		









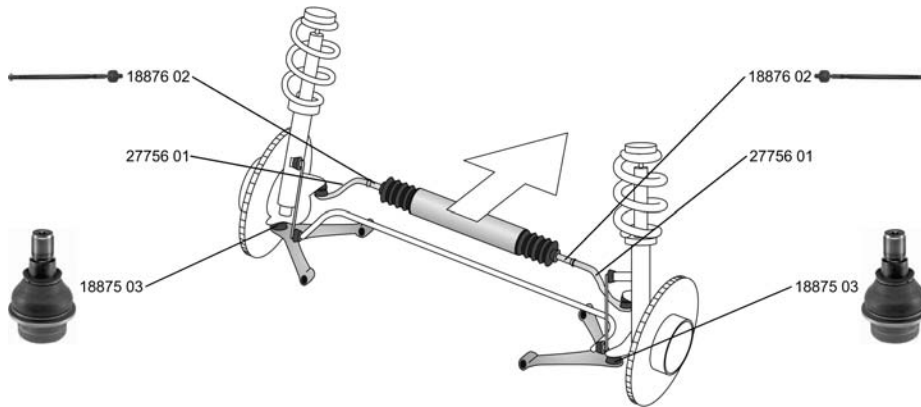

Ref.

MERCEDES-BENZ

SPRINTER 2-t Bus/Familial (901, 902)

01.95 - 05.06



<p>Spurstange mit Zubehör nicht für Felgenreöße [Zoll]: 16 nicht für Tiefbettfelge ALL TYPES</p>	↔	<p>27756 01 901 460 02 05 18876 02 ▲19719 02</p> 
<p>Spurstangenkopf mit Zubehör nicht für Felgenreöße [Zoll]: 16 ALL TYPES</p>	↔	<p>19719 02 901 460 01 48</p> 
<p>Axialgelenk, Spurstange mit Zubehör nicht für Felgenreöße [Zoll]: 16 ALL TYPES</p>	↔	<p>18876 02 901 460 04 55</p> 
<p>Trag-/Führungsgelenk Durchmesser 1/Durchmesser 2 [mm]: 45,2 / 62 Konusmaß [mm]: 26 ALL TYPES</p>	▼↔	<p>18875 03 901 333 12 27</p> 
<p>Lagerung, Lenker ALL TYPES</p>	↔	<p>24636 02 901 333 02 14</p> 
<p>Stange/Strebe, Stabilisator Koppelstange ALL TYPES</p>	↻	<p>25800 01 901 320 02 89</p> 
<p>Stange/Strebe, Stabilisator Koppelstange ALL TYPES</p>	↻	<p>25801 01 901 320 03 89</p> 









Ref.

MERCEDES-BENZ

SPRINTER 2-t Bus/Familial (901, 902)

01.95 - 05.06







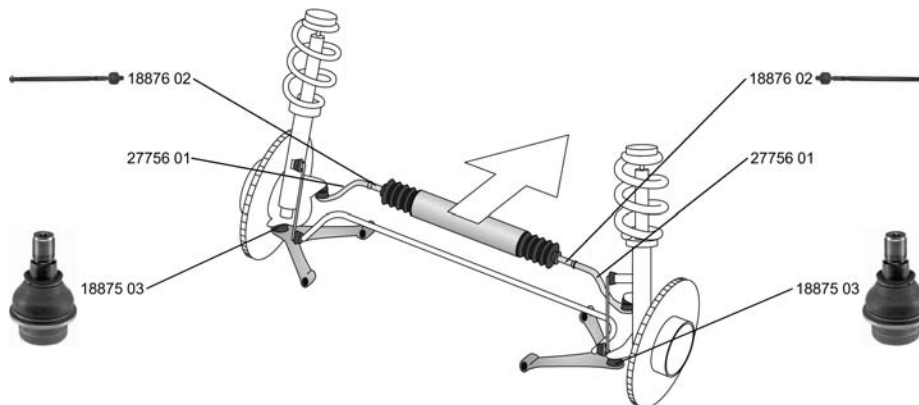

	Stabilisatorlager	(x2)	112	12871 01	601 321 03 50
	214	02.95 - 05.06	↓		
	208 D	02.95 - 04.00			
	210 D	03.97 - 04.00			
212 D	02.95 - 04.00				
	Stange/Strebe, Stabilisator	↔		25802 01	901 320 00 89
	Koppelstange ALL TYPES				
	Stabilisatorlager	↔		27440 01	901 326 01 81
	ALL TYPES ausser :		für Fahrzeuge mit verstärktem Stabilisator Chass. R 337662-> Chass. A 901274->		
	210 D	03.97 - 04.00			
	212 D	02.95 - 04.00			

SPRINTER 2-t

01.95 - 05.06

Kasten/Box/Furgón/Van (901, 902)











	Spurstange mit Zubehör nicht für Felgenreöße [Zoll]: 16 nicht für Tiefbettfelge ALL TYPES	↔		27756 01	901 460 02 05
				18876 02 ▲19719 02	
	Spurstangenkopf mit Zubehör nicht für Felgenreöße [Zoll]: 16 ALL TYPES	↔		19719 02	901 460 01 48
					
	Axialgelenk, Spurstange mit Zubehör nicht für Felgenreöße [Zoll]: 16 ALL TYPES	↔		18876 02	901 460 04 55
					
	Trag-/Führungsgelenk Durchmesser 1/Durchmesser 2 [mm]: 45,2 / 62 Konusmaß [mm]: 26 ALL TYPES	▽↔		18875 03	901 333 12 27
					



Ref.

MERCEDES-BENZ

SPRINTER 2-t 01.95 - 05.06 Kasten/Box/Furgón/Van (901, 902)

	Lagerung, Lenker			24636 02	901 333 02 14
	ALL TYPES				
	Stange/Strebe, Stabilisator			25800 01	901 320 02 89
	Koppelstange				
	ALL TYPES				
	Stange/Strebe, Stabilisator			25801 01	901 320 03 89
	Koppelstange				
	ALL TYPES				
	Stabilisatorlager	(x2)	112	12871 01	601 321 03 50
	214	02.95 - 05.06			
	208 D, 58 kW	02.95 - 04.00			
	208 D, 60 kW	10.96 - 04.00			
	210 D	01.97 - 04.00			
	212 D	02.95 - 04.00			
	Stange/Strebe, Stabilisator			25802 01	901 320 00 89
	Koppelstange				
	ALL TYPES				
	Stabilisatorlager		123/A35	27439 01	901 326 00 81
	210 D	01.97 - 04.00	Mot. OM 602-.986		
	214	02.95 - 05.06			
	208 D	02.95 - 04.00			
	208 D, 60 kW	10.96 - 04.00			
	212 D	02.95 - 04.00			
	Stabilisatorlager			27440 01	901 326 01 81
	214	02.95 - 05.06	für Fahrzeuge mit verstärktem Stabilisator		
	214 NGT	04.00 - 05.06	Chass. R 337662->		
	208 CDI	04.00 - 05.06	Chass. A 901274->		
	211 CDI	04.00 - 05.06			
	213 CDI	04.00 - 05.06			
	216 CDI	04.00 - 05.06			







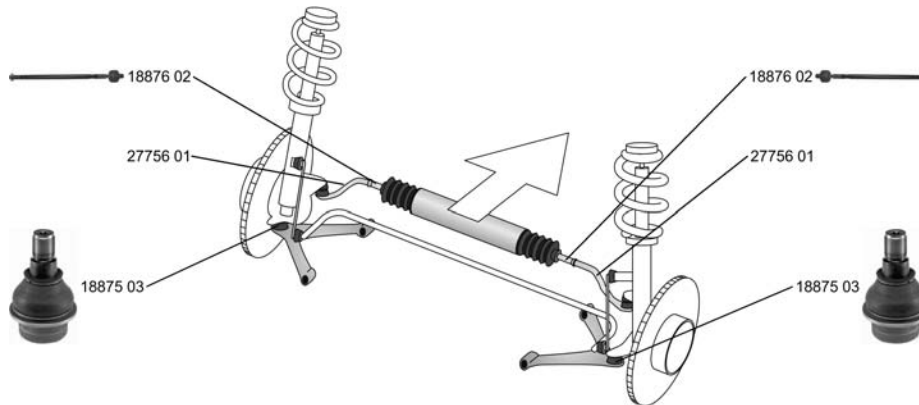

MERCEDES-BENZ

**SPRINTER 2-t Pritsche,Fahrgestell /
Flatbed,Chassis (901, 902)**

01.95 - 05.06









<p>Spurstange mit Zubehör nicht für Felgenreöße [Zoll]: 16 nicht für Tiefbettfelge ALL TYPES</p>	↔	<p>27756 01 901 460 02 05 18876 02 ▲19719 02</p> 
<p>Spurstangenkopf mit Zubehör nicht für Felgenreöße [Zoll]: 16 ALL TYPES</p>	↔	<p>19719 02 901 460 01 48</p> 
<p>Axialgelenk, Spurstange mit Zubehör nicht für Felgenreöße [Zoll]: 16 ALL TYPES</p>	↔	<p>18876 02 901 460 04 55</p> 
<p>Trag-/Führungsgelenk Durchmesser 1/Durchmesser 2 [mm]: 45,2 / 62 Konusmaß [mm]: 26 ALL TYPES</p>	▼↔	<p>18875 03 901 333 12 27</p> 
<p>Lagerung, Lenker ALL TYPES</p>	↔	<p>24636 02 901 333 02 14</p> 
<p>Stange/Strebe, Stabilisator Koppelstange ALL TYPES</p>	↻	<p>25800 01 901 320 02 89</p> 
<p>Stange/Strebe, Stabilisator Koppelstange ALL TYPES</p>	↻	<p>25801 01 901 320 03 89</p> 







Ref.

MERCEDES-BENZ

SPRINTER 2-t Pritsche, Fahrgestell / Flatbed, Chassis (901, 902) 01.95 - 05.06

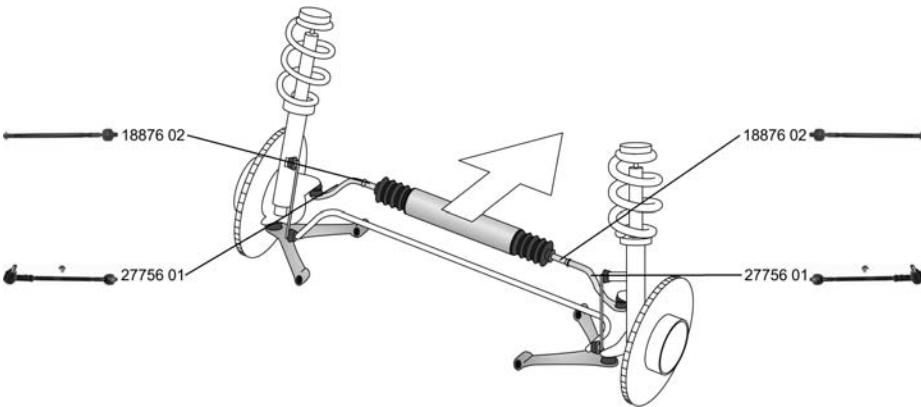
	Stabilisatorlager	(x2)	112	12871 01	601 321 03 50
	214	02.95 - 05.06	↓		
	208 D, 58 kW	01.95 - 04.00			
	208 D, 60 kW	09.96 - 04.00			
	210 D	01.97 - 04.00			
	212 D	02.95 - 04.00			
	Stange/Strebe, Stabilisator Koppelstange	↔		25802 01	901 320 00 89
	ALL TYPES				
	Stabilisatorlager		123/A35	27439 01	901 326 00 81
	214	02.95 - 05.06			
	208 D, 58 kW	01.95 - 04.00			
	212 D	02.95 - 04.00			
	210 D	01.97 - 04.00	Mot. OM 602-.986		
	Stabilisatorlager	↔		27440 01	901 326 01 81
	214	02.95 - 05.06	für Fahrzeuge mit verstärktem Stabilisator		
	214 NGT	04.00 - 05.06	Chass. R 337662->		
	208 CDI	04.00 - 05.06	Chass. A 901274->		
	211 CDI	04.00 - 05.06			
	213 CDI	04.00 - 05.06			
	216 CDI	04.00 - 05.06			

SPRINTER 3-t Bus/Familial (903) 01.95 - 05.06

					
	Spurstange mit Zubehör nicht für Felgengröße [Zoll]: 16 nicht für Tiefbettfelge	↔		27756 01	901 460 02 05
	ALL TYPES				
	Spurstangenkopf mit Zubehör nicht für Felgengröße [Zoll]: 16	↔		19719 02	901 460 01 48
	ALL TYPES				
	Axialgelenk, Spurstange mit Zubehör nicht für Felgengröße [Zoll]: 16	↔		18876 02	901 460 04 55
	ALL TYPES				



Ref.

MERCEDES-BENZ

SPRINTER 3-t Bus/Familial (903)

01.95 - 05.06

<p> Trag-/Führungsgelenk Durchmesser 1/Durchmesser 2 [mm]: 45,2 / 62 Konusmaß [mm]: 26</p> <table border="1"> <tr><td>308 E (903.372)</td><td>04.00 - 05.06</td></tr> <tr><td>314</td><td>02.95 - 05.06</td></tr> <tr><td>314 NGT</td><td>04.00 - 05.06</td></tr> <tr><td>308 CDI</td><td>04.00 - 05.06</td></tr> <tr><td>308 D</td><td>02.95 - 04.00</td></tr> <tr><td>311 CDI</td><td>04.00 - 05.06</td></tr> <tr><td>312 D 2.9</td><td>02.95 - 04.00</td></tr> <tr><td>313 CDI</td><td>04.00 - 05.06</td></tr> <tr><td>316 CDI</td><td>04.00 - 05.06</td></tr> <tr><td>2.9 TDi</td><td>01.97 - 12.99</td></tr> </table>	308 E (903.372)	04.00 - 05.06	314	02.95 - 05.06	314 NGT	04.00 - 05.06	308 CDI	04.00 - 05.06	308 D	02.95 - 04.00	311 CDI	04.00 - 05.06	312 D 2.9	02.95 - 04.00	313 CDI	04.00 - 05.06	316 CDI	04.00 - 05.06	2.9 TDi	01.97 - 12.99	<p>▼↕</p>	<p>18875 03 901 333 12 27</p> 		
308 E (903.372)	04.00 - 05.06																							
314	02.95 - 05.06																							
314 NGT	04.00 - 05.06																							
308 CDI	04.00 - 05.06																							
308 D	02.95 - 04.00																							
311 CDI	04.00 - 05.06																							
312 D 2.9	02.95 - 04.00																							
313 CDI	04.00 - 05.06																							
316 CDI	04.00 - 05.06																							
2.9 TDi	01.97 - 12.99																							
<p>Lagerung, Lenker ALL TYPES</p>	<p>↔</p>	<p>24636 02 901 333 02 14</p> 																						
<p>Stange/Strebe, Stabilisator Koppelstange ALL TYPES</p>	<p>↻</p>	<p>25800 01 901 320 02 89</p> 																						
<p>Stange/Strebe, Stabilisator Koppelstange ALL TYPES</p>	<p>↻</p>	<p>25801 01 901 320 03 89</p> 																						
<p>Stabilisatorlager</p> <table border="1"> <tr><td>314</td><td>02.95 - 05.06</td></tr> <tr><td>308 D</td><td>02.95 - 04.00</td></tr> <tr><td>310 D 4x4</td><td>05.97 - 08.02</td></tr> <tr><td>312 D 2.9</td><td>02.95 - 04.00</td></tr> </table>	314	02.95 - 05.06	308 D	02.95 - 04.00	310 D 4x4	05.97 - 08.02	312 D 2.9	02.95 - 04.00	<p>(x2) 112 ↓</p>	<p>12871 01 601 321 03 50</p> 														
314	02.95 - 05.06																							
308 D	02.95 - 04.00																							
310 D 4x4	05.97 - 08.02																							
312 D 2.9	02.95 - 04.00																							
<p> Stange/Strebe, Stabilisator Koppelstange</p> <table border="1"> <tr><td>308 E (903.372)</td><td>04.00 - 05.06</td></tr> <tr><td>314</td><td>02.95 - 05.06</td></tr> <tr><td>314 NGT</td><td>04.00 - 05.06</td></tr> <tr><td>308 CDI</td><td>04.00 - 05.06</td></tr> <tr><td>308 D</td><td>02.95 - 04.00</td></tr> <tr><td>311 CDI</td><td>04.00 - 05.06</td></tr> <tr><td>312 D 2.9</td><td>02.95 - 04.00</td></tr> <tr><td>313 CDI</td><td>04.00 - 05.06</td></tr> <tr><td>2.3 D 4x4</td><td>06.97 - 12.99</td></tr> <tr><td>316 CDI</td><td>04.00 - 05.06</td></tr> <tr><td>2.9 TDi</td><td>01.97 - 12.99</td></tr> </table>	308 E (903.372)	04.00 - 05.06	314	02.95 - 05.06	314 NGT	04.00 - 05.06	308 CDI	04.00 - 05.06	308 D	02.95 - 04.00	311 CDI	04.00 - 05.06	312 D 2.9	02.95 - 04.00	313 CDI	04.00 - 05.06	2.3 D 4x4	06.97 - 12.99	316 CDI	04.00 - 05.06	2.9 TDi	01.97 - 12.99	<p>↔</p>	<p>25802 01 901 320 00 89</p> 
308 E (903.372)	04.00 - 05.06																							
314	02.95 - 05.06																							
314 NGT	04.00 - 05.06																							
308 CDI	04.00 - 05.06																							
308 D	02.95 - 04.00																							
311 CDI	04.00 - 05.06																							
312 D 2.9	02.95 - 04.00																							
313 CDI	04.00 - 05.06																							
2.3 D 4x4	06.97 - 12.99																							
316 CDI	04.00 - 05.06																							
2.9 TDi	01.97 - 12.99																							
<p>Stabilisatorlager</p> <table border="1"> <tr><td>308 E (903.372)</td><td>04.00 - 05.06</td></tr> <tr><td>314</td><td>02.95 - 05.06</td></tr> <tr><td>314 NGT</td><td>04.00 - 05.06</td></tr> <tr><td>308 CDI</td><td>04.00 - 05.06</td></tr> <tr><td>308 D</td><td>02.95 - 04.00</td></tr> <tr><td>311 CDI</td><td>04.00 - 05.06</td></tr> <tr><td>312 D 2.9</td><td>02.95 - 04.00</td></tr> <tr><td>313 CDI</td><td>04.00 - 05.06</td></tr> <tr><td>316 CDI</td><td>04.00 - 05.06</td></tr> </table>	308 E (903.372)	04.00 - 05.06	314	02.95 - 05.06	314 NGT	04.00 - 05.06	308 CDI	04.00 - 05.06	308 D	02.95 - 04.00	311 CDI	04.00 - 05.06	312 D 2.9	02.95 - 04.00	313 CDI	04.00 - 05.06	316 CDI	04.00 - 05.06	<p>↔ für Fahrzeuge mit verstärktem Stabilisator</p>	<p>27440 01 901 326 01 81</p> 				
308 E (903.372)	04.00 - 05.06																							
314	02.95 - 05.06																							
314 NGT	04.00 - 05.06																							
308 CDI	04.00 - 05.06																							
308 D	02.95 - 04.00																							
311 CDI	04.00 - 05.06																							
312 D 2.9	02.95 - 04.00																							
313 CDI	04.00 - 05.06																							
316 CDI	04.00 - 05.06																							







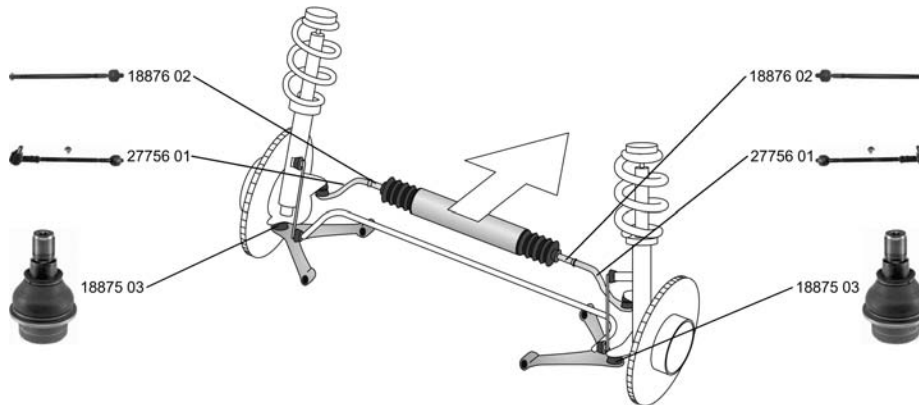

Ref.

MERCEDES-BENZ

SPRINTER 3-t
Kasten/Box/Furgón/Van (903)

01.95 - 05.06



<p>Spurstange mit Zubehör nicht für Felgenreöße [Zoll]: 16 nicht für Tiefbettfelge ALL TYPES</p>	↔	<p>27756 01 901 460 02 05 18876 02 ▲19719 02</p> 																				
<p>Spurstangenkopf mit Zubehör nicht für Felgenreöße [Zoll]: 16 ALL TYPES</p>	↔	<p>19719 02 901 460 01 48</p> 																				
<p>Axialgelenk, Spurstange mit Zubehör nicht für Felgenreöße [Zoll]: 16 ALL TYPES</p>	↔	<p>18876 02 901 460 04 55</p> 																				
<p>Trag-/Führungsgelenk Durchmesser 1/Durchmesser 2 [mm]: 45,2 / 62 Konusmaß [mm]: 26</p> <table border="0" style="width: 100%;"> <tr><td>314</td><td>02.95 - 05.06</td></tr> <tr><td>314 NGT</td><td>04.00 - 05.06</td></tr> <tr><td>308 CDI</td><td>04.00 - 05.06</td></tr> <tr><td>308 D 2.3</td><td>02.95 - 04.00</td></tr> <tr><td>308 D 2.3, 60 kW</td><td>02.95 - 04.00</td></tr> <tr><td>310 D 2.9</td><td>02.95 - 04.00</td></tr> <tr><td>311 CDI</td><td>04.00 - 05.06</td></tr> <tr><td>312 D 2.9</td><td>02.95 - 04.00</td></tr> <tr><td>313 CDI</td><td>04.00 - 05.06</td></tr> <tr><td>316 CDI</td><td>04.00 - 05.06</td></tr> </table>	314	02.95 - 05.06	314 NGT	04.00 - 05.06	308 CDI	04.00 - 05.06	308 D 2.3	02.95 - 04.00	308 D 2.3, 60 kW	02.95 - 04.00	310 D 2.9	02.95 - 04.00	311 CDI	04.00 - 05.06	312 D 2.9	02.95 - 04.00	313 CDI	04.00 - 05.06	316 CDI	04.00 - 05.06	▼↔	<p>18875 03 901 333 12 27</p> 
314	02.95 - 05.06																					
314 NGT	04.00 - 05.06																					
308 CDI	04.00 - 05.06																					
308 D 2.3	02.95 - 04.00																					
308 D 2.3, 60 kW	02.95 - 04.00																					
310 D 2.9	02.95 - 04.00																					
311 CDI	04.00 - 05.06																					
312 D 2.9	02.95 - 04.00																					
313 CDI	04.00 - 05.06																					
316 CDI	04.00 - 05.06																					
<p>Lagerung, Lenker ALL TYPES</p>	↔	<p>24636 02 901 333 02 14</p> 																				
<p>Stange/Strebe, Stabilisator Koppelstange ALL TYPES</p>	↶	<p>25800 01 901 320 02 89</p> 																				







Ref.

MERCEDES-BENZ

SPRINTER 3-t

01.95 - 05.06

Kasten/Box/Furgón/Van (903)

 Stange/Strebe, Stabilisator Koppelstange ALL TYPES			25801 01 901 320 03 89 	
Stabilisatorlager 314 308 D 2.3, 58 kW 310 D 2.9 312 D 2.9		(x2)	12871 01 601 321 03 50 	
 Stange/Strebe, Stabilisator Koppelstange 314 314 NGT 308 CDI 308 D 2.3 308 D 2.3, 60 kW 310 D 2.9 311 CDI 312 D 2.9 313 CDI 316 CDI			25802 01 901 320 00 89 	
Stabilisatorlager 314 308 D 2.3, 58 kW 312 D 2.9 310 D 2.9			27439 01 901 326 00 81 	
Stabilisatorlager 314 314 NGT 308 CDI 308 D 2.3 308 D 2.3, 60 kW 310 D 2.9 311 CDI 312 D 2.9 313 CDI 316 CDI			27440 01 901 326 01 81 	







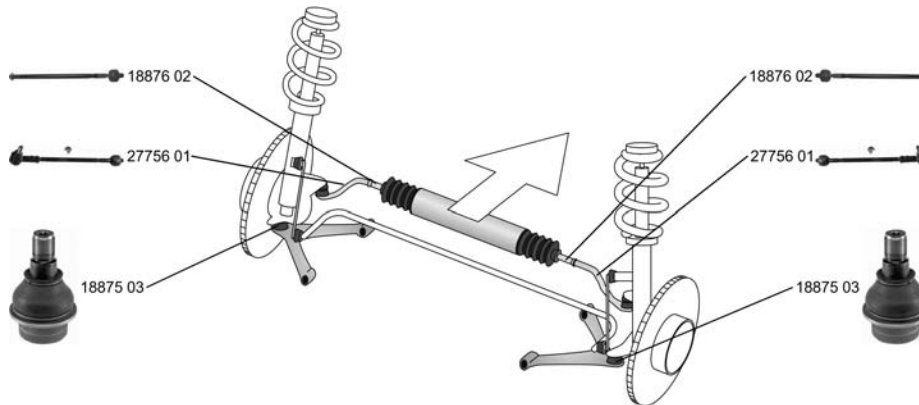

Ref.

MERCEDES-BENZ

**SPRINTER 3-t Pritsche, Fahrgestell / 01.95 - 05.06
Flatbed, Chassis (903)**



<p>Spurstange mit Zubehör nicht für Felgenreöße [Zoll]: 16 nicht für Tiefbettfelge ALL TYPES</p>	↔	<p>27756 01 901 460 02 05 18876 02 ▲19719 02</p> 																				
<p>Spurstangenkopf mit Zubehör nicht für Felgenreöße [Zoll]: 16 ALL TYPES</p>	↔	<p>19719 02 901 460 01 48</p> 																				
<p>Axialgelenk, Spurstange mit Zubehör nicht für Felgenreöße [Zoll]: 16 ALL TYPES</p>	↔	<p>18876 02 901 460 04 55</p> 																				
<p>Trag-/Führungsgelenk Durchmesser 1/Durchmesser 2 [mm]: 45,2 / 62 Konusmaß [mm]: 26</p> <table border="0" style="width: 100%;"> <tr><td>314</td><td>02.95 - 05.06</td></tr> <tr><td>314 NGT</td><td>04.00 - 05.06</td></tr> <tr><td>308 CDI</td><td>04.00 - 05.06</td></tr> <tr><td>308 D 2.3</td><td>02.95 - 04.00</td></tr> <tr><td>308 D 2.3, 60 kW</td><td>11.96 - 04.00</td></tr> <tr><td>310 D 2.9</td><td>01.97 - 04.00</td></tr> <tr><td>311 CDI</td><td>04.00 - 05.06</td></tr> <tr><td>312 D 2.9</td><td>02.95 - 04.00</td></tr> <tr><td>313 CDI</td><td>04.00 - 05.06</td></tr> <tr><td>316 CDI</td><td>04.00 - 05.06</td></tr> </table>	314	02.95 - 05.06	314 NGT	04.00 - 05.06	308 CDI	04.00 - 05.06	308 D 2.3	02.95 - 04.00	308 D 2.3, 60 kW	11.96 - 04.00	310 D 2.9	01.97 - 04.00	311 CDI	04.00 - 05.06	312 D 2.9	02.95 - 04.00	313 CDI	04.00 - 05.06	316 CDI	04.00 - 05.06	▼↔	<p>18875 03 901 333 12 27</p> 
314	02.95 - 05.06																					
314 NGT	04.00 - 05.06																					
308 CDI	04.00 - 05.06																					
308 D 2.3	02.95 - 04.00																					
308 D 2.3, 60 kW	11.96 - 04.00																					
310 D 2.9	01.97 - 04.00																					
311 CDI	04.00 - 05.06																					
312 D 2.9	02.95 - 04.00																					
313 CDI	04.00 - 05.06																					
316 CDI	04.00 - 05.06																					
<p>Lagerung, Lenker ALL TYPES</p>	↔	<p>24636 02 901 333 02 14</p> 																				
<p>Stange/Strebe, Stabilisator Koppelstange ALL TYPES</p>	↺	<p>25800 01 901 320 02 89</p> 																				









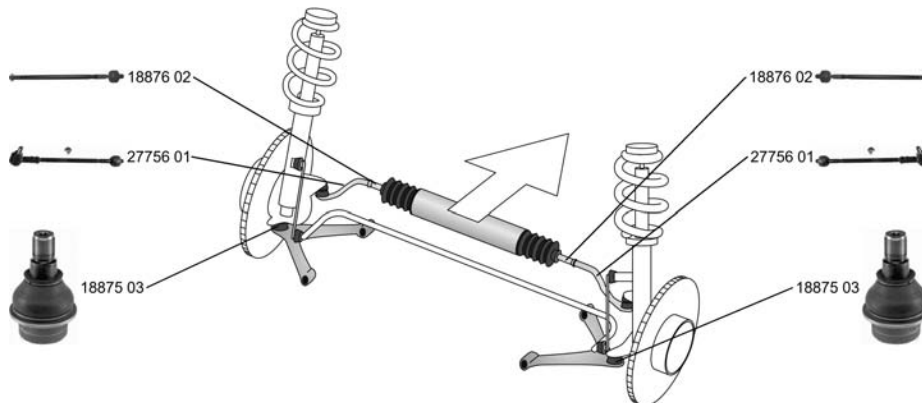

Ref.

MERCEDES-BENZ

SPRINTER 4-t Bus/Familial (904)

02.96 - 05.06







<p>Spurstange mit Zubehör nicht für Felgenreöße [Zoll]: 16 nicht für Tiefbettfelge ALL TYPES</p>	↔	<p>27756 01 901 460 02 05 18876 02 ▲19719 02</p> 
<p>Spurstangenkopf mit Zubehör nicht für Felgenreöße [Zoll]: 16 ALL TYPES</p>	↔	<p>19719 02 901 460 01 48</p> 
<p>Axialgelenk, Spurstange mit Zubehör nicht für Felgenreöße [Zoll]: 16 ALL TYPES</p>	↔	<p>18876 02 901 460 04 55</p> 
<p>Trag-/Führungsgelenk Durchmesser 1/Durchmesser 2 [mm]: 45,2 / 62 Konusmaß [mm]: 26 ALL TYPES</p>	↕↔	<p>18875 03 901 333 12 27</p> 
<p>Lagerung, Lenker ALL TYPES</p>	↔	<p>24636 02 901 333 02 14</p> 
<p>Stange/Strebe, Stabilisator Koppelstange ALL TYPES</p>	↶	<p>25800 01 901 320 02 89</p> 
<p>Stange/Strebe, Stabilisator Koppelstange ALL TYPES</p>	↷	<p>25801 01 901 320 03 89</p> 



Ref.

MERCEDES-BENZ

SPRINTER 4-t 02.96 - 05.06 Kasten/Box/Furgón/Van (904)

	Lagerung, Lenker ALL TYPES	↔	24636 02 901 333 02 14																			
	Stange/Strebe, Stabilisator Koppelstange ALL TYPES	↻	25800 01 901 320 02 89																			
	Stange/Strebe, Stabilisator Koppelstange ALL TYPES	↻	25801 01 901 320 03 89																			
	Stange/Strebe, Stabilisator Koppelstange	↔	25802 01 901 320 00 89																			
	<table border="0"> <tr><td>414</td><td>02.96 - 05.06</td></tr> <tr><td>408 CDI</td><td>04.00 - 05.06</td></tr> <tr><td>408 D</td><td>02.96 - 05.06</td></tr> <tr><td>410 D</td><td>02.96 - 05.06</td></tr> <tr><td>411 CDI</td><td>04.00 - 05.06</td></tr> <tr><td>412 D, 85 kW</td><td>02.96 - 05.06</td></tr> <tr><td>412 D, 90 kW</td><td>02.96 - 05.06</td></tr> <tr><td>413 CDI</td><td>04.00 - 05.06</td></tr> <tr><td>416 CDI</td><td>04.00 - 05.06</td></tr> </table>	414	02.96 - 05.06	408 CDI	04.00 - 05.06	408 D	02.96 - 05.06	410 D	02.96 - 05.06	411 CDI	04.00 - 05.06	412 D, 85 kW	02.96 - 05.06	412 D, 90 kW	02.96 - 05.06	413 CDI	04.00 - 05.06	416 CDI	04.00 - 05.06			
414	02.96 - 05.06																					
408 CDI	04.00 - 05.06																					
408 D	02.96 - 05.06																					
410 D	02.96 - 05.06																					
411 CDI	04.00 - 05.06																					
412 D, 85 kW	02.96 - 05.06																					
412 D, 90 kW	02.96 - 05.06																					
413 CDI	04.00 - 05.06																					
416 CDI	04.00 - 05.06																					
	Stabilisatorlager ALL TYPES ausser : 2.3 D 4x4 06.97 - 12.99	↔	27 20965 01 904 326 08 81																			

SPRINTER 4-t Pritsche,Fahrgestell / 02.96 - 05.06 Flatbed,Chassis (904)

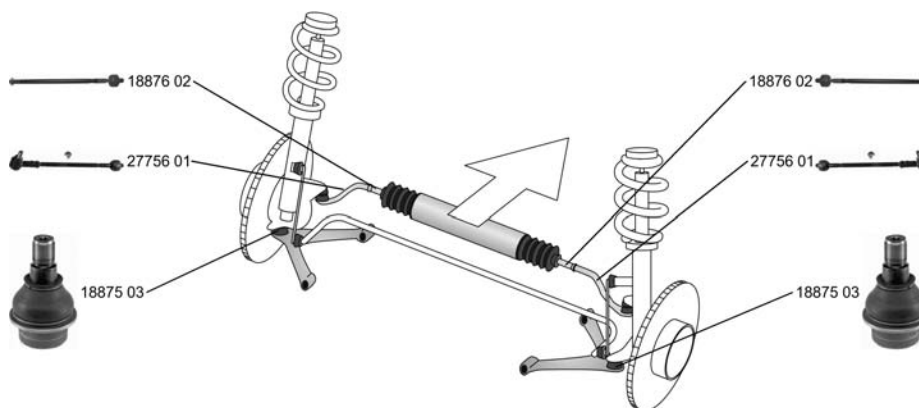



Spurstange mit Zubehör nicht für Felgengröße [Zoll]: 16 nicht für Tiefbettfelge ALL TYPES	↔	27756 01 901 460 02 05 18876 02 19719 02	
--	---	--	---





Ref.

MERCEDES-BENZ



SPRINTER 3-t Kasten (906) 06.06 -

 Spurstangenkopf Innengewinde [mm]: M16x1,5 mit Zubehör ALL TYPES		31148 01 906 460 00 48 
	↔	
Axialgelenk, Spurstange radseitig Aussengewinde [mm]: M16x1,5 Gewindemaß: M18x1,5 mit Zubehör ALL TYPES	△	31147 01 906 460 00 55 
	↔	



SPRINTER 3-t Pritsche/Fahrgestell (906) 06.06 -

 Spurstangenkopf Innengewinde [mm]: M16x1,5 mit Zubehör ALL TYPES		31148 01 906 460 00 48 
	↔	
Axialgelenk, Spurstange radseitig Aussengewinde [mm]: M16x1,5 Gewindemaß: M18x1,5 mit Zubehör ALL TYPES	△	31147 01 906 460 00 55 
	↔	

SPRINTER 3,5-t Bus (906) 06.06 -

 Spurstangenkopf Innengewinde [mm]: M16x1,5 mit Zubehör ALL TYPES		31148 01 906 460 00 48 
	↔	
Axialgelenk, Spurstange radseitig Aussengewinde [mm]: M16x1,5 Gewindemaß: M18x1,5 mit Zubehör ALL TYPES	△	31147 01 906 460 00 55 
	↔	







SPRINTER 3,5-t Kasten (906) 06.06 -

 Spurstangenkopf Innengewinde [mm]: M16x1,5 mit Zubehör ALL TYPES		31148 01 906 460 00 48 
	↔	
Axialgelenk, Spurstange radseitig Aussengewinde [mm]: M16x1,5 Gewindemaß: M18x1,5 mit Zubehör ALL TYPES	△	31147 01 906 460 00 55 
	↔	









MERCEDES-BENZ







SPRINTER 3,5 Pritsche/Fahrgestell (906) 06.06 -

 Spurstangenkopf Innengewinde [mm]: M16x1,5 mit Zubehör		31148 01 906 460 00 48 
ALL TYPES		
Axialgelenk, Spurstange radseitig Aussengewinde [mm]: M16x1,5 Gewindemaß: M18x1,5 mit Zubehör		31147 01 906 460 00 55 
ALL TYPES		

SPRINTER 5-t Kasten (906) 06.06 -

 Spurstangenkopf Innengewinde [mm]: M16x1,5 mit Zubehör		31148 01 906 460 00 48 
ALL TYPES		
Axialgelenk, Spurstange radseitig Aussengewinde [mm]: M16x1,5 Gewindemaß: M18x1,5 mit Zubehör		31147 01 906 460 00 55 
ALL TYPES		

SPRINTER 5-t Pritsche/Fahrgestell (906) 06.06 -

 Spurstangenkopf Innengewinde [mm]: M16x1,5 mit Zubehör		31148 01 906 460 00 48 
ALL TYPES		
Axialgelenk, Spurstange radseitig Aussengewinde [mm]: M16x1,5 Gewindemaß: M18x1,5 mit Zubehör		31147 01 906 460 00 55 
ALL TYPES		







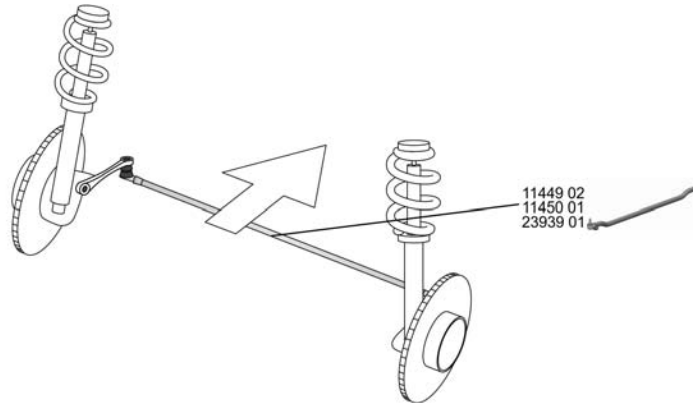

Ref.

MERCEDES-BENZ

T1 Bus/Familial (601)

05.77 - 02.96















<p>Spurstange Konusmaß [mm]: 18 verstellbar Rohr-Ø [mm]: 32</p> <p>ALL TYPES ausser : 207 D 2.4, 53 kW</p>	<p>⊕</p> <p>Vorderachsnummer:730.404 Vorderachsnummer:730.446</p>	<p>11449 02 602 330 04 03 ▲11446 01</p> 
<p>Spurstange Konusmaß [mm]: 18 Rohr-Ø [mm]: 30 beidseitig verstellbar Mit gekröpften Kugelgelenken</p> <p>ALL TYPES ausser : 207 D 2.4, 53 kW</p>	<p>⊕</p> <p>Vorderachsnummer:730.403 Vorderachsnummer:730.445</p>	<p>11450 01 602 330 09 03 ▲11451 01 ▲11452 01</p> 
<p>Spurstange Konusmaß [mm]: 14 Rohr-Ø [mm]: 20 nicht verstellbar</p> <p>207 D 2.4, 53 kW</p>	<p>⊕</p>	<p>13566 01 608 330 04 03</p> 
<p>Spurstange Konusmaß [mm]: 14 Rohr-Ø [mm]: 22 beidseitig verstellbar</p> <p>207 D 2.4, 53 kW</p>	<p>▲⊕</p> <p>07.82 - 01.90</p>	<p>23939 01 608 330 03 03</p> 
<p>Spurstangenkopf Konusmaß [mm]: 18 Gewindemaß: M20x1,5 Gewindeart: mit Rechtsgewinde mit Zubehör Aussengewinde [mm]: M20x1,5</p> <p>ALL TYPES ausser : 207 D 2.4, 53 kW</p>	<p>Vorderachsnummer:730.403 ----- Vorderachsnummer:730.445</p>	<p>11446 01 601 330 04 35</p> 
<p>Spurstangenkopf Konusmaß [mm]: 18 Gewindemaß: M20x1,5 Gewindeart: mit Linksgewinde mit Zubehör Aussengewinde [mm]: M20x1,5</p> <p>ALL TYPES ausser : 207 D 2.4, 53 kW</p>	<p>Vorderachsnummer:730.403 ----- Vorderachsnummer:730.445</p>	<p>11447 01 601 330 05 35</p> 



MERCEDES-BENZ

T1 Bus/Familial (601) 05.77 - 02.96





<p> Spurstangenkopf Konusmaß [mm]: 18 Gewindemaß: M24x1,5 Gewindeart: mit Linksgewinde mit Zubehör Aussengewinde [mm]: M24x1,5</p>		<p>11451 01 602 330 57 35</p> 
<p>ALL TYPES ausser : 207 D 2.4, 53 kW 07.82 - 01.90</p>	<p>Vorderachsnummer:730.404 ----- Vorderachsnummer:730.446</p>	
<p>Spurstangenkopf Konusmaß [mm]: 18 Gewindemaß: M24x1,5 Gewindeart: mit Rechtsgewinde mit Zubehör Aussengewinde [mm]: M24x1,5</p>		<p>11452 01 602 330 58 35</p> 
<p>ALL TYPES ausser : 207 D 2.4, 53 kW 07.82 - 01.90</p>	<p>Vorderachsnummer:730.404 ----- Vorderachsnummer:730.446</p>	
<p>Lenkstange fahrerseitig Konusmaß [mm]: 18 Rohr-Ø [mm]: 26 Schubstange beidseitig verstellbar</p>		<p>11448 01 601 460 15 05 ▲11395 01</p> 
<p>210 2.3 07.82 - 01.90 210 2.3, 77 kW 05.89 - 02.96 207 D 2.4, 48 kW 05.77 - 12.82 208 D 2.3, 58 kW 10.88 - 02.96 208 D 2.3, 60 kW 10.88 - 02.96</p>	<p> Chass. 152684-> -----  Chass. 152920-></p>	
<p>208 2.3 05.77 - 12.82 209 D 2.9 12.82 - 01.90 210 D 2.8, 70 kW 11.88 - 02.96 210 D 2.8, 72 kW 11.88 - 02.96 207 D 2.4, 53 kW 07.82 - 01.90</p>		
<p>LHD</p>		
<p>Lenkstange fahrerseitig Konusmaß [mm]: 18 Rohr-Ø [mm]: 26 Schubstange verstellbar mit Zubehör</p>		<p>30908 01 ▲11391 01</p>
<p>210 2.3 07.82 - 01.90 210 2.3, 77 kW 05.89 - 02.96 207 D 2.4, 48 kW 05.77 - 12.82 208 D 2.3, 58 kW 10.88 - 02.96 208 D 2.3, 60 kW 10.88 - 02.96</p>	<p>LHD  ->Chass. 152683 ----- RHD  ->Chass. 166248 ----- LHD  ->Chass. 152919 ----- RHD  ->Chass. 166248</p>	
<p>207 D 2.4, 53 kW 07.82 - 01.90</p>		
<p>Winkelgelenk, Lenkschubstange Konusmaß [mm]: 18 Gewindemaß: M22x1,5 Gewindeart: mit Rechtsgewinde mit Zubehör Aussengewinde [mm]: M22x1,5</p>		<p>11391 01 000 460 85 48</p> 
<p>ALL TYPES ausser : 207 D 2.4, 53 kW 07.82 - 01.90</p>		
<p>Winkelgelenk, Lenkschubstange Konusmaß [mm]: 18 Gewindemaß: M22x1,5 Gewindeart: mit Linksgewinde Aussengewinde [mm]: M22x1,5</p>		<p>11395 01 000 460 86 48</p> 
<p>ALL TYPES ausser : 207 D 2.4, 53 kW 07.82 - 01.90</p>		



Ref.



MERCEDES-BENZ

T1 Bus/Familial (601) 05.77 - 02.96

 Trag-/Führungsgelenk 207 D 2.4, 53 kW 07.82 - 01.90	▲▼⊕ 	11462 01 631 320 00 28 
Stabilisatorlager ALL TYPES	(x2) 112 ↓	12871 01 601 321 03 50 
Stabilisatorlager ALL TYPES	⊕⊖(x2) 116	18852 01 602 321 02 50 

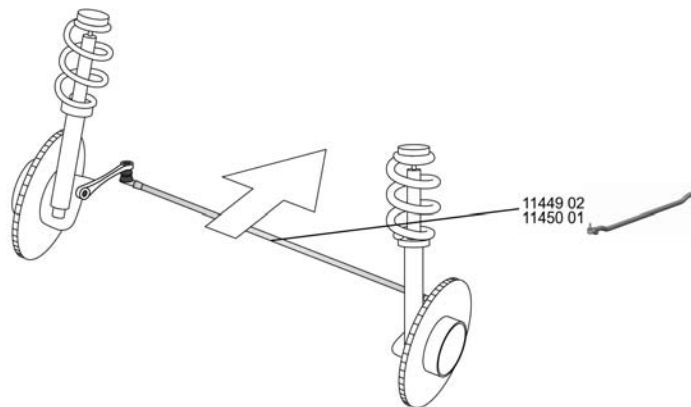
T1 Kasten/Box/Furgón/Van (601) 05.77 - 02.96















Spurstange Konusmaß [mm]: 18 verstellbar Rohr-Ø [mm]: 32 ALL TYPES	⊕ Vorderachsnummer:730.404 Vorderachsnummer:730.446	11449 02 602 330 04 03 ▲-11446 01 
Spurstange Konusmaß [mm]: 18 Rohr-Ø [mm]: 30 beidseitig verstellbar Mit gekröpften Kugelgelenken ALL TYPES	⊕ Vorderachsnummer:730.403 Vorderachsnummer:730.445	11450 01 602 330 09 03 ▲-11451 01 ▲-11452 01 
Spurstangenkopf Konusmaß [mm]: 18 Gewindemaß: M20x1,5 Gewindeart: mit Rechtsgewinde mit Zubehör Aussengewinde [mm]: M20x1,5 ALL TYPES	Vorderachsnummer:730.403 Vorderachsnummer:730.445	11446 01 601 330 04 35 



MERCEDES-BENZ

T1 Kasten/Box/Furgón/Van (601) 05.77 - 02.96









 Spurstangenkopf Konusmaß [mm]: 18 Gewindemaß: M20x1,5 Gewindeart: mit Linksgewinde mit Zubehör Aussengewinde [mm]: M20x1,5		11447 01 601 330 05 35 
ALL TYPES	Vorderachsnr.:730.403 ----- Vorderachsnr.:730.445	
Spurstangenkopf Konusmaß [mm]: 18 Gewindemaß: M24x1,5 Gewindeart: mit Linksgewinde mit Zubehör Aussengewinde [mm]: M24x1,5		11451 01 602 330 57 35 
ALL TYPES	Vorderachsnr.:730.404 ----- Vorderachsnr.:730.446	
Spurstangenkopf Konusmaß [mm]: 18 Gewindemaß: M24x1,5 Gewindeart: mit Rechtsgewinde mit Zubehör Aussengewinde [mm]: M24x1,5		11452 01 602 330 58 35 
ALL TYPES	Vorderachsnr.:730.404 ----- Vorderachsnr.:730.446	
Lenkstange fahrerseitig Konusmaß [mm]: 18 Rohr-Ø [mm]: 26 Schubstange beidseitig verstellbar		11448 01 601 460 15 05 
210 2.3, 77 kW 05.89 - 02.96 207 D 2.4 06.82 - 01.90 208 D 2.3, 58 kW 11.88 - 02.96 208 D 2.3, 60 kW 10.88 - 02.96	 Chass. 152684-> -----  Chass. 152920->	
209 D 2.9 12.82 - 01.90 210 D 2.8 10.88 - 02.96 210 D 2.8, 72 kW 10.88 - 02.96 210 2.3, 70 kW 07.82 - 02.96	LHD	
Lenkstange fahrerseitig Konusmaß [mm]: 18 Rohr-Ø [mm]: 26 Schubstange verstellbar mit Zubehör		30908 01 
210 2.3, 77 kW 05.89 - 02.96 207 D 2.4 06.82 - 01.90 208 D 2.3, 58 kW 11.88 - 02.96 208 D 2.3, 60 kW 10.88 - 02.96	LHD  ->Chass. 152683 ----- RHD  ->Chass. 166248 ----- LHD  ->Chass. 152919 ----- RHD  ->Chass. 166248	
210 2.3, 70 kW 07.82 - 02.96		
Winkelgelenk, Lenkschubstange Konusmaß [mm]: 18 Gewindemaß: M22x1,5 Gewindeart: mit Rechtsgewinde mit Zubehör Aussengewinde [mm]: M22x1,5		11391 01 000 460 85 48 
ALL TYPES		



Ref.





MERCEDES-BENZ

T1 Kasten/Box/Furgón/Van (601) 05.77 - 02.96

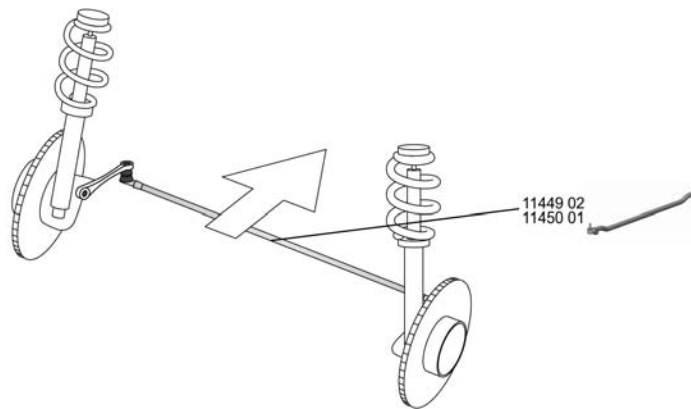
 Winkelgelenk, Lenkschubstange Konusmaß [mm]: 18 Gewindemaß: M22x1,5 Gewindeart: mit Linksgewinde Aussengewinde [mm]: M22x1,5 ALL TYPES		11395 01 000 460 86 48 
Stabilisatorlager ALL TYPES	(x2) 112 	12871 01 601 321 03 50 
Stabilisatorlager ALL TYPES	 (x2) 116	18852 01 602 321 02 50 
Stabilisatorlager 209 D 2.9 210 D 2.8, 70 kW	 130 12.82 - 01.90 10.88 - 02.96	21107 01 602 326 04 82 

T1 Pritsche,Fahrgestell / Flatbed,Chassis (601) 01.77 - 02.96











Spurstange Konusmaß [mm]: 18 verstellbar Rohr-Ø [mm]: 32 ALL TYPES		11449 02 602 330 04 03 
ALL TYPES	Vorderachsnnummer:730.404 Vorderachsnnummer:730.446	
Spurstange Konusmaß [mm]: 18 Rohr-Ø [mm]: 30 beidseitig verstellbar Mit gekröpften Kugelgelenken ALL TYPES		11450 01 602 330 09 03 
ALL TYPES	Vorderachsnnummer:730.403 Vorderachsnnummer:730.445	



MERCEDES-BENZ

T1 Pritsche, Fahrgestell /
Flatbed, Chassis (601)

01.77 - 02.96

 Spurstangenkopf Konusmaß [mm]: 18 Gewindemaß: M20x1,5 Gewindeart: mit Rechtsgewinde mit Zubehör Aussengewinde [mm]: M20x1,5		11446 01 601 330 04 35 
ALL TYPES	Vorderachsnnummer:730.403 ----- Vorderachsnnummer:730.445	
Spurstangenkopf Konusmaß [mm]: 18 Gewindemaß: M20x1,5 Gewindeart: mit Linksgewinde mit Zubehör Aussengewinde [mm]: M20x1,5		11447 01 601 330 05 35 
ALL TYPES	Vorderachsnnummer:730.403 ----- Vorderachsnnummer:730.445	
Spurstangenkopf Konusmaß [mm]: 18 Gewindemaß: M24x1,5 Gewindeart: mit Linksgewinde mit Zubehör Aussengewinde [mm]: M24x1,5		11451 01 602 330 57 35 
ALL TYPES	Vorderachsnnummer:730.404 ----- Vorderachsnnummer:730.446	
Spurstangenkopf Konusmaß [mm]: 18 Gewindemaß: M24x1,5 Gewindeart: mit Rechtsgewinde mit Zubehör Aussengewinde [mm]: M24x1,5		11452 01 602 330 58 35 
ALL TYPES	Vorderachsnnummer:730.404 ----- Vorderachsnnummer:730.446	
Lenkstange fahrerseitig Konusmaß [mm]: 18 Rohr-Ø [mm]: 26 Schubstange beidseitig verstellbar		11448 01 601 460 15 05  11395 01 
210 2.3, 63 kW 04.77 - 10.89 210 2.3, 70 kW 04.77 - 10.89 207 D 2.4, 48 kW 04.77 - 12.82 207 D 2.4, 53 kW 12.77 - 10.89 208 D 2.3, 58 kW 11.88 - 02.96 208 D 2.3 06.89 - 02.96	 Chass. 152684-> -----  Chass. 152920->	
209 D 2.9 12.82 - 01.90 210 D 2.8 11.88 - 02.96 210 D 2.9 11.88 - 02.96		



















Ref.

MERCEDES-BENZ

**T1 Pritsche, Fahrgestell /
Flatbed, Chassis (601)**

01.77 - 02.96

 Lenkstange fahrerseitig Konusmaß [mm]: 18 Rohr-Ø [mm]: 26 Schubstange verstellbar mit Zubehör		30908 01  11391 01
210 2.3, 63 kW 207 D 2.4, 48 kW 207 D 2.4, 53 kW 208 D 2.3, 58 kW 208 D 2.3	04.77 - 10.89 04.77 - 12.82 12.77 - 10.89 11.88 - 02.96 06.89 - 02.96 LHD  ->Chass. 152683 ----- RHD  ->Chass. 166248 ----- LHD  ->Chass. 152919 ----- RHD  ->Chass. 166248	
Winkelgelenk, Lenkschubstange Konusmaß [mm]: 18 Gewindemaß: M22x1,5 Gewindeart: mit Rechtsgewinde mit Zubehör Aussengewinde [mm]: M22x1,5 ALL TYPES		11391 01 000 460 85 48 
Winkelgelenk, Lenkschubstange Konusmaß [mm]: 18 Gewindemaß: M22x1,5 Gewindeart: mit Linksgewinde Aussengewinde [mm]: M22x1,5 ALL TYPES		11395 01 000 460 86 48 
Stabilisatorlager ALL TYPES	(x2) 112 	12871 01 601 321 03 50 
Stabilisatorlager ALL TYPES	  (x2) 116	18852 01 602 321 02 50 
Stabilisatorlager ALL TYPES ausser : 210 2.3, 63 kW 208 D 2.3, 60 kW 210 D 2.8	  130 04.77 - 10.89 06.89 - 02.96 11.88 - 02.96	21107 01 602 326 04 82 







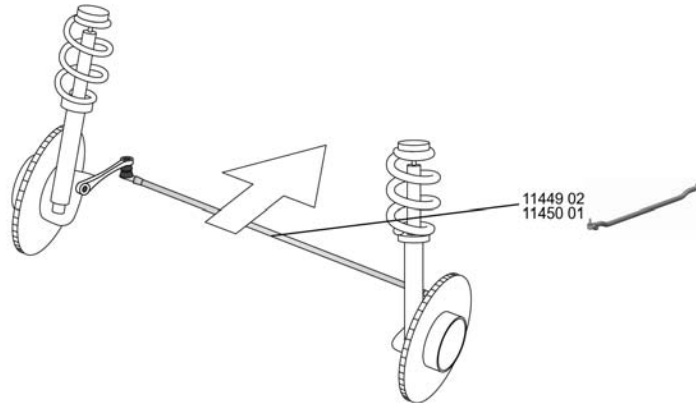

MERCEDES-BENZ

T1 Bus/Familial (602)

04.77 - 02.96















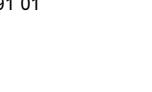

<p>Spurstange Konusmaß [mm]: 18 verstellbar Rohr-Ø [mm]: 32</p> <p>ALL TYPES</p>	<p>⊕</p> <p>Vorderachsnummer:730.404 Vorderachsnummer:730.446</p>	<p>11449 02 602 330 04 03 ▲11446 01</p> 
<p>Spurstange Konusmaß [mm]: 18 Rohr-Ø [mm]: 30 beidseitig verstellbar Mit gekröpften Kugelgelenken</p> <p>ALL TYPES</p>	<p>⊕</p> <p>Vorderachsnummer:730.403 Vorderachsnummer:730.445</p>	<p>11450 01 602 330 09 03 ▲11451 01 ▲11452 01</p> 
<p>Spurstangenkopf Konusmaß [mm]: 18 Gewindemaß: M20x1,5 Gewindeart: mit Rechtsgewinde mit Zubehör Aussengewinde [mm]: M20x1,5</p> <p>ALL TYPES</p>	<p>Vorderachsnummer:730.403 Vorderachsnummer:730.445</p>	<p>11446 01 601 330 04 35</p> 
<p>Spurstangenkopf Konusmaß [mm]: 18 Gewindemaß: M20x1,5 Gewindeart: mit Linksgewinde mit Zubehör Aussengewinde [mm]: M20x1,5</p> <p>ALL TYPES</p>	<p>Vorderachsnummer:730.403 Vorderachsnummer:730.445</p>	<p>11447 01 601 330 05 35</p> 
<p>Spurstangenkopf Konusmaß [mm]: 18 Gewindemaß: M24x1,5 Gewindeart: mit Linksgewinde mit Zubehör Aussengewinde [mm]: M24x1,5</p> <p>ALL TYPES</p>	<p>Vorderachsnummer:730.404 Vorderachsnummer:730.446</p>	<p>11451 01 602 330 57 35</p> 
<p>Spurstangenkopf Konusmaß [mm]: 18 Gewindemaß: M24x1,5 Gewindeart: mit Rechtsgewinde mit Zubehör Aussengewinde [mm]: M24x1,5</p> <p>ALL TYPES</p>	<p>Vorderachsnummer:730.404 Vorderachsnummer:730.446</p>	<p>11452 01 602 330 58 35</p> 



Ref.

MERCEDES-BENZ

T1 Bus/Familial (602) 04.77 - 02.96

 Lenkstange fahrerseitig Konusmaß [mm]: 18 Rohr-Ø [mm]: 26 Schubstange beidseitig verstellbar		11448 01 601 460 15 05 
308 D 2.3, 60 kW 06.89 - 02.96 310 D 2.9, 72 kW 06.90 - 02.96	 Chass. 152684->	
	 Chass. 152920->	
Lenkstange fahrerseitig Konusmaß [mm]: 18 Rohr-Ø [mm]: 26 Schubstange verstellbar mit Zubehör		30908 01 601 460 15 05 
308 D 2.3, 60 kW 06.89 - 02.96 310 D 2.9, 72 kW 06.90 - 02.96	 ->Chass. 152683	
	 ->Chass. 166248	
	 ->Chass. 152919	
	 ->Chass. 166248	
Winkelgelenk, Lenkschubstange Konusmaß [mm]: 18 Gewindemaß: M22x1,5 Gewindeart: mit Rechtsgewinde mit Zubehör Aussengewinde [mm]: M22x1,5 ALL TYPES		11391 01 000 460 85 48 
Winkelgelenk, Lenkschubstange Konusmaß [mm]: 18 Gewindemaß: M22x1,5 Gewindeart: mit Linksgewinde Aussengewinde [mm]: M22x1,5 ALL TYPES		11395 01 000 460 86 48 
Stabilisatorlager ALL TYPES	(x2) 112 	12871 01 601 321 03 50 
Stabilisatorlager ALL TYPES	 (x2) 116	18852 01 602 321 02 50 







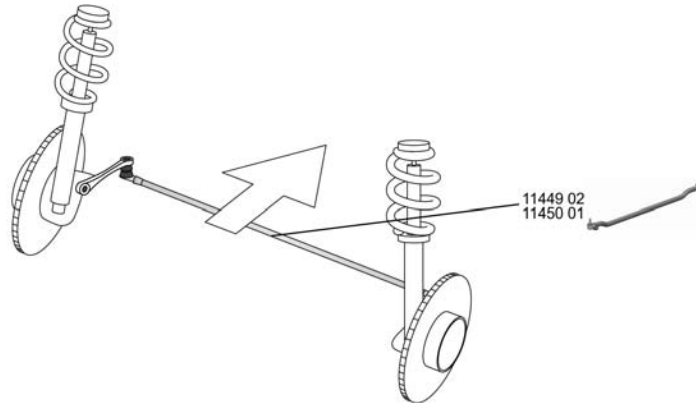

MERCEDES-BENZ

T1 Kasten/Box/Furgón/Van (602)

10.82 - 02.96

















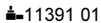



<p>Spurstange Konusmaß [mm]: 18 verstellbar Rohr-Ø [mm]: 32</p> <p>ALL TYPES</p>	<p>⊕</p> <p>Vorderachsnummer:730.404 Vorderachsnummer:730.446</p>	<p>11449 02 602 330 04 03 ▲11446 01</p> 
<p>Spurstange Konusmaß [mm]: 18 Rohr-Ø [mm]: 30 beidseitig verstellbar Mit gekrüppften Kugelgelenken</p> <p>ALL TYPES</p>	<p>⊕</p> <p>Vorderachsnummer:730.403 Vorderachsnummer:730.445</p>	<p>11450 01 602 330 09 03 ▲11451 01 ▲11452 01</p> 
<p>Spurstangenkopf Konusmaß [mm]: 18 Gewindemaß: M20x1,5 Gewindeart: mit Rechtsgewinde mit Zubehör Aussengewinde [mm]: M20x1,5</p> <p>ALL TYPES</p>	<p>Vorderachsnummer:730.403 Vorderachsnummer:730.445</p>	<p>11446 01 601 330 04 35</p> 
<p>Spurstangenkopf Konusmaß [mm]: 18 Gewindemaß: M20x1,5 Gewindeart: mit Linksgewinde mit Zubehör Aussengewinde [mm]: M20x1,5</p> <p>ALL TYPES</p>	<p>Vorderachsnummer:730.403 Vorderachsnummer:730.445</p>	<p>11447 01 601 330 05 35</p> 
<p>Spurstangenkopf Konusmaß [mm]: 18 Gewindemaß: M24x1,5 Gewindeart: mit Linksgewinde mit Zubehör Aussengewinde [mm]: M24x1,5</p> <p>ALL TYPES</p>	<p>Vorderachsnummer:730.404 Vorderachsnummer:730.446</p>	<p>11451 01 602 330 57 35</p> 
<p>Spurstangenkopf Konusmaß [mm]: 18 Gewindemaß: M24x1,5 Gewindeart: mit Rechtsgewinde mit Zubehör Aussengewinde [mm]: M24x1,5</p> <p>ALL TYPES</p>	<p>Vorderachsnummer:730.404 Vorderachsnummer:730.446</p>	<p>11452 01 602 330 58 35</p> 



Ref.

MERCEDES-BENZ

T1 Kasten/Box/Furgón/Van (602) 10.82 - 02.96

<p> Lenkstange fahrerseitig Konusmaß [mm]: 18 Rohr-Ø [mm]: 26 Schubstange beidseitig verstellbar</p>		<p>11448 01 601 460 15 05 </p>
<p>308 D 2.3, 58 kW 11.88 - 02.96 308 D 2.3, 60 kW 06.89 - 02.96 310 D 2.9, 70 kW 06.89 - 02.96 310 D 2.9 06.89 - 02.96</p>	<p> Chass. 152684-> -----  Chass. 152920-></p>	
<p>307 D 2.4 10.82 - 01.90 309 D 3.0 10.82 - 01.90</p>	<p> LHD</p>	
<p>Lenkstange fahrerseitig Konusmaß [mm]: 18 Rohr-Ø [mm]: 26 Schubstange verstellbar mit Zubehör</p>		<p>30908 01 </p>
<p>308 D 2.3, 58 kW 11.88 - 02.96 308 D 2.3, 60 kW 06.89 - 02.96 310 D 2.9, 70 kW 06.89 - 02.96 310 D 2.9 06.89 - 02.96</p>	<p> LHD ->Chass. 152683 -----  RHD ->Chass. 166248 -----  LHD  ->Chass. 152919 -----  RHD  ->Chass. 166248</p>	
<p>Winkelgelenk, Lenkschubstange Konusmaß [mm]: 18 Gewindemaß: M22x1,5 Gewindeart: mit Rechtsgewinde mit Zubehör Aussengewinde [mm]: M22x1,5 ALL TYPES</p>		<p>11391 01 000 460 85 48 </p>
<p>Winkelgelenk, Lenkschubstange Konusmaß [mm]: 18 Gewindemaß: M22x1,5 Gewindeart: mit Linksgewinde Aussengewinde [mm]: M22x1,5 ALL TYPES</p>		<p>11395 01 000 460 86 48 </p>
<p>Stabilisatorlager ALL TYPES</p>	<p>(x2) 112 </p>	<p>12871 01 601 321 03 50 </p>
<p>Stabilisatorlager ALL TYPES</p>	<p>  (x2) 116</p>	<p>18852 01 602 321 02 50 </p>







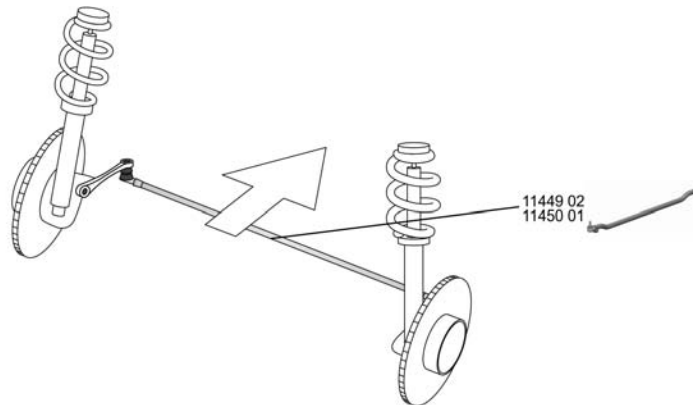

MERCEDES-BENZ

T1 Pritsche, Fahrgestell /
Flatbed, Chassis (602)

04.77 - 02.96

















<p>Spurstange Konusmaß [mm]: 18 verstellbar Rohr-Ø [mm]: 32 ALL TYPES</p>	<p>⊕</p> <p>Vorderachsnummer:730.404 Vorderachsnummer:730.446</p>	<p>11449 02 602 330 04 03 ▲-11446 01</p> 
<p>Spurstange Konusmaß [mm]: 18 Rohr-Ø [mm]: 30 beidseitig verstellbar Mit gekröpften Kugelgelenken ALL TYPES</p>	<p>⊕</p> <p>Vorderachsnummer:730.403 Vorderachsnummer:730.445</p>	<p>11450 01 602 330 09 03 ▲-11451 01 ▲-11452 01</p> 
<p>Spurstangenkopf Konusmaß [mm]: 18 Gewindemaß: M20x1,5 Gewindeart: mit Rechtsgewinde mit Zubehör Aussengewinde [mm]: M20x1,5 ALL TYPES</p>	<p>Vorderachsnummer:730.403 Vorderachsnummer:730.445</p>	<p>11446 01 601 330 04 35</p> 
<p>Spurstangenkopf Konusmaß [mm]: 18 Gewindemaß: M20x1,5 Gewindeart: mit Linksgewinde mit Zubehör Aussengewinde [mm]: M20x1,5 ALL TYPES</p>	<p>Vorderachsnummer:730.403 Vorderachsnummer:730.445</p>	<p>11447 01 601 330 05 35</p> 
<p>Spurstangenkopf Konusmaß [mm]: 18 Gewindemaß: M24x1,5 Gewindeart: mit Linksgewinde mit Zubehör Aussengewinde [mm]: M24x1,5 ALL TYPES</p>	<p>Vorderachsnummer:730.404 Vorderachsnummer:730.446</p>	<p>11451 01 602 330 57 35</p> 
<p>Spurstangenkopf Konusmaß [mm]: 18 Gewindemaß: M24x1,5 Gewindeart: mit Rechtsgewinde mit Zubehör Aussengewinde [mm]: M24x1,5 ALL TYPES</p>	<p>Vorderachsnummer:730.404 Vorderachsnummer:730.446</p>	<p>11452 01 602 330 58 35</p> 



Ref.

MERCEDES-BENZ

T1 Pritsche, Fahrgestell / 04.77 - 02.96 Flatbed, Chassis (602)

 Lenkstange fahrerseitig Konusmaß [mm]: 18 Rohr-Ø [mm]: 26 Schubstange beidseitig verstellbar		11448 01 601 460 15 05 ▲11395 01 
307 D 2.4, 53 kW 06.82 - 01.90 308 D 2.3 06.89 - 02.96 308 D 2.3, 60 kW 06.89 - 02.96 310 D 2.9, 70 kW 06.89 - 02.96 310 D 2.9, 72 kW 06.89 - 02.96 309 D 3.0 10.82 - 01.90	 Chass. 152684-> <hr/>  Chass. 152920->	
307 D 2.4, 48 kW 04.77 - 01.83		
Lenkstange fahrerseitig Konusmaß [mm]: 18 Rohr-Ø [mm]: 26 Schubstange verstellbar mit Zubehör		30908 01 ▲11391 01
ALL TYPES ausser : 307 D 2.4, 48 kW 04.77 - 01.83	 ->Chass. 152683	
	 ->Chass. 166248	
	 ->Chass. 152919	
	 ->Chass. 166248	
Winkelgelenk, Lenkschubstange Konusmaß [mm]: 18 Gewindemaß: M22x1,5 Gewindeart: mit Rechtsgewinde mit Zubehör Aussengewinde [mm]: M22x1,5		11391 01 000 460 85 48 
ALL TYPES		
Winkelgelenk, Lenkschubstange Konusmaß [mm]: 18 Gewindemaß: M22x1,5 Gewindeart: mit Linksgewinde Aussengewinde [mm]: M22x1,5		11395 01 000 460 86 48 
ALL TYPES		
Stabilisatorlager ALL TYPES	(x2) 112 	12871 01 601 321 03 50 
Stabilisatorlager ALL TYPES	 (x2) 116	18852 01 602 321 02 50 









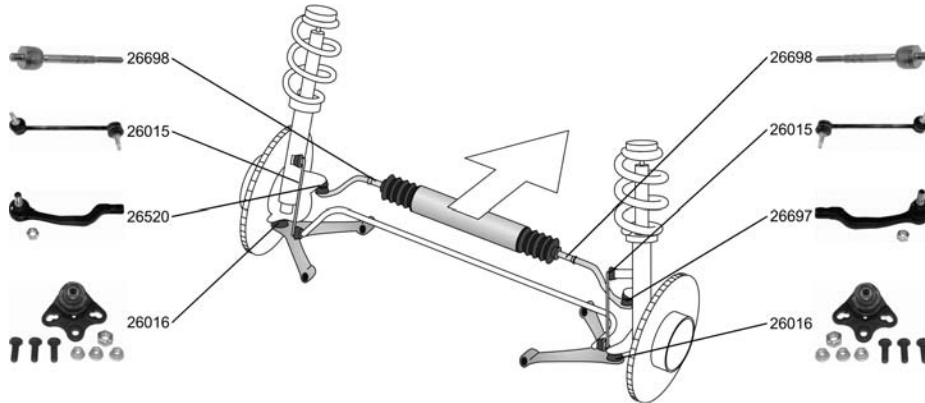





MERCEDES-BENZ

VANEO (414)

02.02 -



Spurstangenkopf mit Zubehör ALL TYPES		26520 02 414 460 00 05 
Spurstangenkopf mit Zubehör ALL TYPES		26697 02 414 460 01 05 
Axialgelenk, Spurstange ALL TYPES		26698 01 414 460 02 05 
Trag-/Führungsgelenk mit Zubehör ALL TYPES		26016 02 414 333 02 27 
Stange/Strebe, Stabilisator Pendelstange ALL TYPES		26015 02 414 320 03 89 
 Achsträgerlager ALL TYPES		29973 01 414 351 00 42 









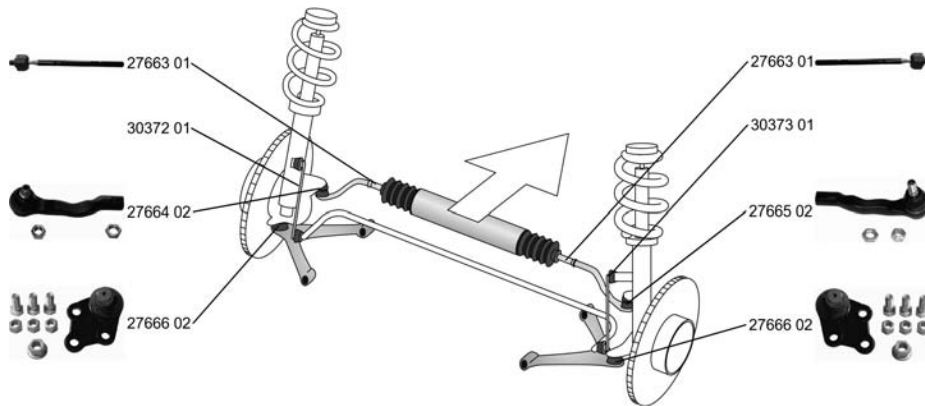

Ref.

MERCEDES-BENZ

VIANO (W639)

09.03 -





















Spurstangenkopf mit Zubehör ALL TYPES		27664 02 639 460 00 48 
Spurstangenkopf mit Zubehör ALL TYPES		27665 02 639 460 03 48 
Axialgelenk, Spurstange Gewindemaß: M16x1,5 ALL TYPES		27663 01 639 460 00 55 
Trag-/Führungsgelenk mit Zubehör ALL TYPES		22 27666 02 639 330 04 10 639 330 05 10 639 333 02 27 
Lagerung, Lenker ALL TYPES		26574 01 638 333 08 14 
Lagerung, Lenker ALL TYPES		26614 01 638 333 00 14 
Stange/Strebe, Stabilisator Pendelstange ALL TYPES		30372 01 639 320 02 89 
Stange/Strebe, Stabilisator Pendelstange ALL TYPES		30373 01 639 320 03 89 



Ref.

MERCEDES-BENZ

VITO Bus/Familial (638) 02.96 - 07.03























 Spurstange ALL TYPES		25459 01 638 460 02 05 19722 01 ▲18874 01 
Spurstangenkopf Achslast [kg]: 1500 Innengewinde [mm]: M16x1,5 Gewindeart: mit Rechtsgewinde mit Zubehör ALL TYPES		18874 03 638 460 00 48 
Axialgelenk, Spurstange Gewindeart: mit Rechtsgewinde ALL TYPES		19722 01 638 460 02 05 
Lenker, Radaufhängung ALL TYPES		29636 01 638 330 00 10 22394 01 26574 01 26614 01 
Lenker, Radaufhängung ALL TYPES		29637 01 638 330 01 10 22394 01 26574 01 26614 01 
Reparatursatz, Trag-/Führungsgelenk ALL TYPES		22394 02 638 330 00 27 
Lagerung, Lenker ALL TYPES		26574 01 638 333 08 14 
Lagerung, Lenker ALL TYPES		26614 01 638 333 00 14 
Stange/Strebe, Stabilisator Pendelstange mit Zubehör Aussengewinde [mm]: M10x1,5 113 2.0 (638.114) 02.96 - 07.03 114 2.3 (638.134) 12.96 - 07.03 108 D 2.3 (638.164) 02.96 - 07.03 110 TD 2.3 (638.174) 02.96 - 07.03		22088 02 638 323 02 68 



Ref.

MERCEDES-BENZ

VITO Bus/Familial (638) 02.96 - 07.03

 Stange/Strebe, Stabilisator Pendelstange mit Zubehör 113 2.0 (638.114) 02.96 - 07.03 114 2.3 (638.134) 12.96 - 07.03 108 D 2.3 (638.164) 02.96 - 07.03 110 TD 2.3 (638.174) 02.96 - 07.03		22089 02 638 323 03 68 
Stange/Strebe, Stabilisator Pendelstange mit Zubehör 108 CDI 2.2 03.99 - 07.03 110 CDI 2.2 03.99 - 07.03 112 CDI 2.2 03.99 - 07.03		25344 02 638 323 04 68 
Stange/Strebe, Stabilisator Pendelstange mit Zubehör 108 CDI 2.2 03.99 - 07.03 110 CDI 2.2 03.99 - 07.03 112 CDI 2.2 03.99 - 07.03		25345 02 638 323 05 68 
Achskörperlager ALL TYPES		22934 01 638 317 02 12 
Achskörperlager ALL TYPES		23067 01 638 317 04 12 
Achskörperlager ALL TYPES		24597 01 638 317 09 12 
Stabilisatorlager ALL TYPES		22214 01 638 323 02 85 
Faltenbalgsatz, Lenkung ALL TYPES		30243 01 901 462 00 96 
 Lagerung, Lenker 113 2.0 (638.114) 02.96 - 07.03 114 2.3 (638.134) 12.96 - 07.03 108 D 2.3 (638.164) 02.96 - 07.03 110 TD 2.3 (638.174) 02.96 - 07.03	(x2) 	26593 01 638 352 04 50 638 352 06 50 639 353 00 50 
Stange/Strebe, Stabilisator Pendelstange ALL TYPES		24724 01 638 326 01 16 



Ref.

MERCEDES-BENZ









VITO Bus/Familial (638)

02.96 - 07.03

	Stabilisatorlager		24725 01	638 326 02 81
	ALL TYPES			

VITO Kasten/Box/Furgón/Van (638)

03.97 - 07.03























	Spurstange	↔	25459 01	638 460 02 05
	ALL TYPES		19722 01	
			18874 01	
				
	Spurstangenkopf	↔ ↗	18874 03	638 460 00 48
	Achslast [kg]: 1500 Innengewinde [mm]: M16x1,5 Gewindeart: mit Rechtsgewinde mit Zubehör			
	ALL TYPES			
	Axialgelenk, Spurstange	↔ ↗	19722 01	638 460 02 05
	Gewindeart: mit Rechtsgewinde			
	ALL TYPES			
	Lenker, Radaufhängung	▽ ↗	29636 01	638 330 00 10
	ALL TYPES		22394 01	
			26574 01	
			26614 01	
				
	Lenker, Radaufhängung	▽ ↗	29637 01	638 330 01 10
	ALL TYPES		22394 01	
			26574 01	
			26614 01	
				
	Reparatursatz, Trag-/Führungsgelenk	▽ ↔	22394 02	638 330 00 27
	ALL TYPES			
	Lagerung, Lenker	▽ ↓	26574 01	638 333 08 14
	ALL TYPES			
	Lagerung, Lenker	▽ ↑	26614 01	638 333 00 14
	ALL TYPES			



Ref.

MERCEDES-BENZ

VITO Kasten/Box/Furgón/Van (638) 03.97 - 07.03







 Stange/Strebe, Stabilisator Pendelstange mit Zubehör Aussengewinde [mm]: M10x1,5 113 2.0 (638.014) 03.97 - 07.03 114 2.3 (638.034) 03.97 - 07.03 108 D 2.3 (638.064) 03.97 - 07.03 110 D 2.3 (638.074) 03.97 - 07.03		22088 02 638 323 02 68 
Stange/Strebe, Stabilisator Pendelstange mit Zubehör 113 2.0 (638.014) 03.97 - 07.03 114 2.3 (638.034) 03.97 - 07.03 108 D 2.3 (638.064) 03.97 - 07.03 110 D 2.3 (638.074) 03.97 - 07.03		22089 02 638 323 03 68 
Stange/Strebe, Stabilisator Pendelstange mit Zubehör 108 CDI 2.2 03.99 - 07.03 110 CDI 2.2 03.99 - 07.03 112 CDI 2.2 03.99 - 07.03		25344 02 638 323 04 68 
Stange/Strebe, Stabilisator Pendelstange mit Zubehör 108 CDI 2.2 03.99 - 07.03 110 CDI 2.2 03.99 - 07.03 112 CDI 2.2 03.99 - 07.03		25345 02 638 323 05 68 
Achskörperlager ALL TYPES		22934 01 638 317 02 12 
Achskörperlager ALL TYPES		23067 01 638 317 04 12 
Achskörperlager ALL TYPES		24597 01 638 317 09 12 
Stabilisatorlager ALL TYPES		22214 01 638 323 02 85 
Faltenbalsatz, Lenkung ALL TYPES		30243 01 901 462 00 96 
 Lagerung, Lenker ALL TYPES	(x2) 	26593 01 638 352 04 50 638 352 06 50 639 353 00 50 



Ref.





MERCEDES-BENZ

VITO Bus (W639) 09.03 -

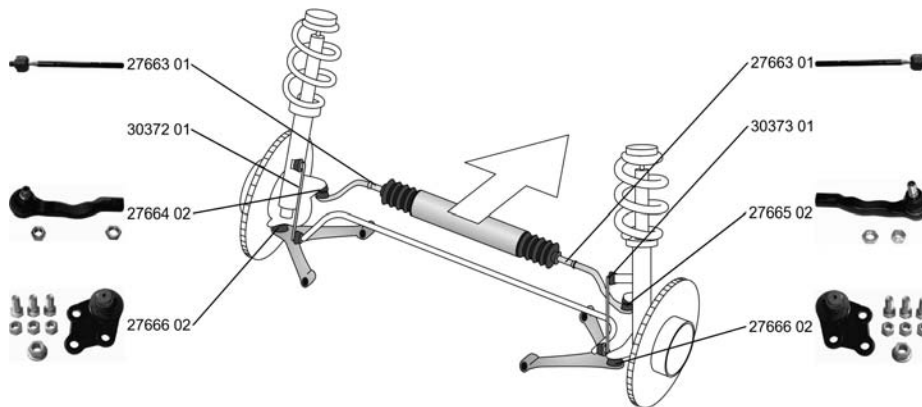
 Lagerung, Lenker ALL TYPES		26614 01 638 333 00 14 
Stange/Strebe, Stabilisator Pendelstange ALL TYPES		30372 01 639 320 02 89 
Stange/Strebe, Stabilisator Pendelstange ALL TYPES		30373 01 639 320 03 89 

VITO Kasten (W639) 09.03 -







Spurstangenkopf mit Zubehör ALL TYPES		27664 02 639 460 00 48 
Spurstangenkopf mit Zubehör ALL TYPES		27665 02 639 460 03 48 
Axialgelenk, Spurstange Gewindemaß: M16x1,5 ALL TYPES		27663 01 639 460 00 55 
Trag-/Führungsgelenk mit Zubehör ALL TYPES		22 27666 02 639 330 04 10 639 330 05 10 639 333 02 27 



MERCEDES-BENZ





VITO Kasten (W639)

09.03 -

 Lagerung, Lenker ALL TYPES	▼⬇	26574 01 638 333 08 14	
Lagerung, Lenker ALL TYPES	▼⬆	26614 01 638 333 00 14	
Stange/Strebe, Stabilisator Pendelstange ALL TYPES	↻	30372 01 639 320 02 89	
Stange/Strebe, Stabilisator Pendelstange ALL TYPES	↻	30373 01 639 320 03 89	

VARIO

09.96 -

 Spurstange Konusmaß [mm]: 22 Rohr-Ø [mm]: 36	⊕	12877 01 670 330 02 03 ▲11380 01 ▲11381 01	
	512 D 12.71 - 09.72 512 D, Kasten/Kombi 09.96 - 612 D, Kipper 09.96 - 613 D, 614 D, Kipper 09.96 - 615 D, 616 D, Kipper 09.98 -	Achsausführung:730.604	
612 D, Pritsche/Fahrgestell 09.96 - 612 D, Kasten/Kombi 09.96 - 613 D, 614 D, Pritsche/Fahrgestell 09.96 - 613 D, 614 D, Kasten/Kombi 09.96 - 615 D, 616 D, Pritsche/Fahrgestell 09.98 - 615 D, 616 D, Kasten/Kombi 09.98 -		Achsausführung:730.604-605	
	812 D, Pritsche/Fahrgestell 09.96 - 812 D, Kasten/Kombi 09.96 - 813 D, 814 D, Pritsche/Fahrgestell 09.96 - 813 D, 814 D, Kasten/Kombi 09.96 - 815 D, 816 D, Pritsche/Fahrgestell 09.96 - 815 D, 816 D, Kasten/Kombi 09.96 -	Achsausführung:730.604-605/712	
Spurstange Konusmaß [mm]: 18 Rohr-Ø [mm]: 36 beidseitig verstellbar	⊕	20898 01 667 330 06 03 ▲11446 01 ▲11447 01	
	512 D 12.71 - 09.72 512 D, Kasten/Kombi 09.96 -	Achsausführung:730.412	
Spurstange Konusmaß [mm]: 22 Rohr-Ø [mm]: 44	⊕	23962 01 669 330 06 03 ▲11378 01 ▲11378 01	
	813 DA, 814 DA 09.68 - 09.73 813 DA, 814 DA, Kasten/Kombi 09.96 - 813 DA, 814 DA, Kipper 09.96 - 815 DA, 816 DA, Pritsche/Fahrgestell 09.96 - 815 DA, 816 DA, Kasten/Kombi 09.96 - 815 DA, 816 DA, Kipper 09.96 -	Achsausführung:730.354	









Ref.

MERCEDES-BENZ

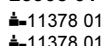
VARIO

09.96 -





 Spurstange Konusmaß [mm]: 22 Rohr-Ø [mm]: 40		23965 01 669 330 08 03 
810 DT 04.62 - 06.69 810 DT, 100 kW 09.96 - 810 DT, 112 kW 09.96 -	Achsausführung:730.353	
Spurstangenkopf Gewindemaß: M28x1,5 Gewindeart: mit Rechtsgewinde Konusmaß [mm]: 22 Aussengewinde [mm]: M28x1,5 mit Zubehör		11378 01 000 330 93 35 
813 DA, 814 DA, Pritsche/Fahrgestell 09.96 - 813 DA, 814 DA, Kipper 09.96 - 815 DA, 816 DA, Pritsche/Fahrgestell 09.96 - 815 DA, 816 DA, Kipper 09.96 -	Achsausführung:730.354	
813 DA, 814 DA, Kasten/Kombi 09.96 - 815 DA, 816 DA, Kasten/Kombi 09.96 - 810 DT 04.62 - 06.69 810 DT, 100 kW 09.96 - 810 DT, 112 kW 09.96 -	Achsausführung:730.354 Achsausführung:730.353	
Spurstangenkopf Konusmaß [mm]: 22 Aussengewinde [mm]: M24x1,5 Gewindeart: mit Rechtsgewinde		11380 01 000 330 97 35 
512 D 12.71 - 09.72 512 D, Kasten/Kombi 09.96 - 612 D, Kipper 09.96 - 613 D, 614 D, Kipper 09.96 - 615 D, 616 D, Kipper 09.98 -	Achsausführung:730.604	
612 D, Pritsche/Fahrgestell 09.96 - 612 D, Kasten/Kombi 09.96 - 613 D, 614 D, Pritsche/Fahrgestell 09.96 - 613 D, 614 D, Kasten/Kombi 09.96 - 615 D, 616 D, Pritsche/Fahrgestell 09.98 - 615 D, 616 D, Kasten/Kombi 09.98 -	----- Achsausführung:730.604/604-605	
812 D, Pritsche/Fahrgestell 09.96 - 812 D, Kasten/Kombi 09.96 - 813 D, 814 D, Pritsche/Fahrgestell 09.96 - 813 D, 814 D, Kasten/Kombi 09.96 - 815 D, 816 D, Pritsche/Fahrgestell 09.96 - 815 D, 816 D, Kasten/Kombi 09.96 -	----- Achsausführung:730.604/604-605/712	
812 D, Kipper 09.96 - 813 D, 814 D, Kipper 09.96 - 815 D, 816 D, Kipper 09.96 -	Achsausführung:730.605/712	
Spurstangenkopf Konusmaß [mm]: 22 Aussengewinde [mm]: M24x1,5 Gewindeart: mit Linksgewinde		11381 01 000 330 98 35 
512 D 12.71 - 09.72 512 D, Kasten/Kombi 09.96 - 612 D, Kipper 09.96 - 613 D, 614 D, Kipper 09.96 - 615 D, 616 D, Kipper 09.98 -	Achsausführung:730.604	
612 D, Pritsche/Fahrgestell 09.96 - 612 D, Kasten/Kombi 09.96 - 613 D, 614 D, Pritsche/Fahrgestell 09.96 - 613 D, 614 D, Kasten/Kombi 09.96 - 615 D, 616 D, Pritsche/Fahrgestell 09.98 - 615 D, 616 D, Kasten/Kombi 09.98 -	----- Achsausführung:730.604/604-605	
812 D, Pritsche/Fahrgestell 09.96 - 812 D, Kasten/Kombi 09.96 - 813 D, 814 D, Pritsche/Fahrgestell 09.96 - 813 D, 814 D, Kasten/Kombi 09.96 - 815 D, 816 D, Pritsche/Fahrgestell 09.96 - 815 D, 816 D, Kasten/Kombi 09.96 -	----- Achsausführung:730.604/604-605/712	
812 D, Kipper 09.96 - 813 D, 814 D, Kipper 09.96 - 815 D, 816 D, Kipper 09.96 -	Achsausführung:730.605/712	



MERCEDES-BENZ

VARIO

09.96 -

 Spurstangenkopf Konusmaß [mm]: 18 Aussengewinde [mm]: M24x1,5 Gewindeart: mit Rechtsgewinde			11407 01 001 330 14 35 	
	512 D, Pritsche/Fahrgestell	09.96 -		667.321-322-323
	512 D, Kasten/Kombi	09.96 -		667.351-352-353
Spurstangenkopf Form: gekröpft Konusmaß [mm]: 18 Aussengewinde [mm]: M22x1,5 Gewindeart: mit Linksgewinde			12825 01 000 330 08 35 	
	512 D, Pritsche/Fahrgestell	09.96 -		667.321-322-323 ab Achsnummer:0 002 774
	512 D, Kasten/Kombi	09.96 -		667.351-352-353 ab Achsnummer:0 002 774
Winkelgelenk, Lenkschubstange Gewindemaß: M28x1,5 Gewindeart: mit Rechtsgewinde Konusmaß [mm]: 22 Aussengewinde [mm]: M28x1,5 mit Zubehör			11378 01 000 330 93 35 	
	512 D, Pritsche/Fahrgestell	09.96 -		Lenkstange an Lenkstockhebel ----- 667.321-322-323 ->Chass. 859207 ----- Fahrerhaus-ID:669.899
	512 D, Kasten/Kombi	09.96 -		Lenkstange an Lenkstockhebel ----- 667.351-352-353 ->Chass. 859207 ----- Fahrerhaus-ID:669.599
	612 D, Pritsche/Fahrgestell	09.96 -		Lenkstange an Lenkstockhebel
	613 D, 614 D, Pritsche/Fahrgestell	09.96 -		-----
	615 D, 616 D, Pritsche/Fahrgestell	09.98 -		668.321-322-323 ----- Fahrerhaus-ID:669.899
	612 D, Kasten/Kombi	09.96 -		Lenkstange an Lenkstockhebel
	613 D, 614 D, Kasten/Kombi	09.96 -		-----
	615 D, 616 D, Kasten/Kombi	09.98 -		668.351-352-353 ----- Fahrerhaus-ID:669.599
	612 D, Kipper	09.96 -		Lenkstange an Lenkstockhebel
	613 D, 614 D, Kipper	09.96 -		-----
	615 D, 616 D, Kipper	09.98 -		668.331-332 ----- Fahrerhaus-ID:669.899
	812 D, Pritsche/Fahrgestell	09.96 -		Lenkstange an Lenkstockhebel
	813 D, 814 D, Pritsche/Fahrgestell	09.96 -		-----
	815 D, 816 D, Pritsche/Fahrgestell	09.96 -		Fahrerhaus-ID:669.899 ----- 670.321-322-323-324
	812 D, Kasten/Kombi	09.96 -		Lenkstange an Lenkstockhebel
	813 D, 814 D, Kasten/Kombi	09.96 -		-----
815 D, 816 D, Kasten/Kombi	09.96 -	Fahrerhaus-ID:669.599 ----- 670.351-352-353		
812 D, Kipper	09.96 -	Lenkstange an Lenkstockhebel		
813 D, 814 D, Kipper	09.96 -	-----		
815 D, 816 D, Kipper	09.96 -	Fahrerhaus-ID:669.899 ----- 670.331-332		
813 DA, 814 DA, Pritsche/Fahrgestell	09.96 -	Lenkstange an Lenkstockhebel		
813 DA, 814 DA, Kipper	09.96 -	-----		
815 DA, 816 DA, Pritsche/Fahrgestell	09.96 -	Fahrerhaus-ID:669.899		
815 DA, 816 DA, Kipper	09.96 -	-----		
813 DA, 814 DA, Kasten/Kombi	09.96 -	Lenkstange an Lenkstockhebel		
815 DA, 816 DA, Kasten/Kombi	09.96 -	----- Fahrerhaus-ID:669.599		
810 DT	04.62 - 06.69	Lenkstange an Lenkstockhebel		
810 DT, 100 kW	09.96 -	-----		
810 DT, 112 kW	09.96 -	Fahrerhaus-ID:669.899		



Ref.

MERCEDES-BENZ

VARIO

09.96 -



Winkelgelenk, Lenkschubstange

Konusmaß [mm]: 18
 Aussengewinde [mm]: M24x1,5
 Gewindeart: mit Rechtsgewinde

512 D, Pritsche/Fahrgestell

09.96 -

Lenkstange an Lenkstockhebel

 667.321-322-323

512 D, Kasten/Kombi

09.96 -

Lenkstange an Lenkstockhebel

 667.351-352-353

11407 01

001 330 14 35





MERCEDES-BENZ

VARIO 09.96 -

Stabilisatorlager		I12/A32	12876 01	667 320 00 73
512 D, Pritsche/Fahrgestell	09.96 -	Drehstab an Verbindungsstange 1.VA ----- 667.321-322-323 für:(50,32) 514142/06 ----- Fahrerhaus-ID:669.899 für:(32) 514140/03 für:(50,32) 514142/04 für:(50,32) 514142/06 ----- Verbindungsstange an Konsole ----- Fahrerhaus-ID:669.899 für:(32) 514140/03 für:(50,32) 514142/04 für:(50,32) 514142/06 benötigte Stückzahl:2		
	09.96 -	Drehstab an Verbindungsstange 1.VA ----- 667.351-352-353 für:(50,32) 514142/06 ----- Fahrerhaus-ID:669.599 für:(32) 514140/03 für:(50,32) 514142/04 für:(50,32) 514142/06 ----- Verbindungsstange an Konsole ----- Fahrerhaus-ID:669.599 für:(32) 514140/03 für:(50,32) 514142/04 für:(50,32) 514142/06 benötigte Stückzahl:2		
612 D, Pritsche/Fahrgestell	09.96 -	Drehstab an Verbindungsstange 1.VA ----- Fahrerhaus-ID:669.899 für:(32) 514140/03 für:(50,32) 514142/04 für:(50,32) 514142/06 ----- Verbindungsstange an Konsole ----- Fahrerhaus-ID:669.899 für:(32) 514140/03 für:(50,32) 514142/04 für:(50,32) 514142/06 benötigte Stückzahl:2		
612 D, Kipper	09.96 -			
613 D, 614 D, Pritsche/Fahrgestell	09.96 -			
613 D, 614 D, Kipper	09.96 -			
615 D, 616 D, Pritsche/Fahrgestell	09.98 -			
615 D, 616 D, Kipper	09.98 -			
612 D, Kasten/Kombi	09.96 -	Drehstab an Verbindungsstange 1.VA ----- 668.351-352 für:(50,32) 514142/06 ----- Fahrerhaus-ID:669.599 für:(32) 514140/03 für:(50,32) 514142/04 für:(50,32) 514142/06 ----- Verbindungsstange an Konsole ----- Fahrerhaus-ID:669.599 für:(32) 514140/03 für:(50,32) 514142/04 für:(50,32) 514142/06 benötigte Stückzahl:2		
613 D, 614 D, Kasten/Kombi	09.96 -			
615 D, 616 D, Kasten/Kombi	09.98 -			



Ref.

MERCEDES-BENZ

VARIO

09.96 -



Stabilisatorlager		I12/A32	12876 01	667 320 00 73
812 D, Pritsche/Fahrgestell	09.96 -	Drehstab an Verbindungsstange 1.VA Fahrerhaus-ID:669.899 für:(32) 514140/03 für:(50,32) 514142/04 für:(50,32) 514142/06 670.321-322-323-324 für:(50,32) 514142/06 Verbindungsstange an Konsole Fahrerhaus-ID:669.899 für:(32) 514140/03 für:(50,32) 514142/04 für:(50,32) 514142/06 benötigte Stückzahl:2		
813 D, 814 D, Pritsche/Fahrgestell	09.96 -			
815 D, 816 D, Pritsche/Fahrgestell	09.96 -			
812 D, Kasten/Kombi	09.96 -	Drehstab an Verbindungsstange 1.VA Fahrerhaus-ID:669.599 für:(32) 514140/03 für:(50,32) 514142/04 für:(50,32) 514142/06 670.351-352-353 für:(50,32) 514142/06 Verbindungsstange an Konsole Fahrerhaus-ID:669.599 für:(32) 514140/03 für:(50,32) 514142/04 für:(50,32) 514142/06 benötigte Stückzahl:2		
813 D, 814 D, Kasten/Kombi	09.96 -			
815 D, 816 D, Kasten/Kombi	09.96 -			
812 D, Kipper	09.96 -	Drehstab an Verbindungsstange 1.VA Fahrerhaus-ID:669.899 für:(32) 514140/03 für:(50,32) 514142/04 für:(50,32) 514142/06 670.331-332 für:(50,32) 514142/06 Verbindungsstange an Konsole Fahrerhaus-ID:669.899 für:(32) 514140/03 für:(50,32) 514142/04 für:(50,32) 514142/06 benötigte Stückzahl:2		
813 D, 814 D, Kipper	09.96 -			
815 D, 816 D, Kipper	09.96 -			
813 DA, 814 DA, Pritsche/Fahrgestell	09.96 -	Drehstab an Verbindungsstange 1.VA Fahrerhaus-ID:669.899 für:(32) 514140/03 für:(50,32) 514142/04 für:(50,32) 514142/06 für:(32) 514140/03 für:(50,32) 514142/04 Verbindungsstange an Konsole Fahrerhaus-ID:669.899 für:(32) 514140/03 für:(50,32) 514142/04 für:(50,32) 514142/06 670.421-422-423/421-422-423 für:(32) 514140/03 für:(50,32) 514142/04 benötigte Stückzahl:2		
815 DA, 816 DA, Pritsche/Fahrgestell	09.96 -			



MERCEDES-BENZ

VARIO

09.96 -

 Stabilisatorlager		I12/A32	12876 01	667 320 00 73
813 DA, 814 DA, Kasten/Kombi	09.96 -	Drehstab an Verbindungsstange 1.VA Fahrerhaus-ID:669.599 für:(32) 514140/03 für:(50,32) 514142/04 für:(50,32) 514142/06 für:(32) 514140/03 für:(50,32) 514142/04 Verbindungsstange an Konsole Fahrerhaus-ID:669.599 für:(32) 514140/03 für:(50,32) 514142/04 für:(50,32) 514142/06 670.451-452-453/451-452-453 für:(32) 514140/03 für:(50,32) 514142/04 benötigte Stückzahl:2		
815 DA, 816 DA, Kasten/Kombi	09.96 -			
813 DA, 814 DA, Kipper	09.96 -			
815 DA, 816 DA, Kipper	09.96 -	Drehstab an Verbindungsstange 1.VA Fahrerhaus-ID:669.899 für:(32) 514140/03 für:(50,32) 514142/04 für:(50,32) 514142/06 für:(32) 514140/03 für:(50,32) 514142/04 Verbindungsstange an Konsole Fahrerhaus-ID:669.899 für:(32) 514140/03 für:(50,32) 514142/04 für:(50,32) 514142/06 670.431-432/431-432 für:(32) 514140/03 für:(50,32) 514142/04 benötigte Stückzahl:2		
810 DT	04.62 - 06.69			
810 DT, 100 kW	09.96 -			
810 DT, 112 kW	09.96 -	Drehstab an Verbindungsstange 1.VA Fahrerhaus-ID:669.899 für:(32) 514140/03 für:(50,32) 514142/04 für:(50,32) 514142/06 für:(32) 514140/03 für:(50,32) 514142/04 Verbindungsstange an Konsole Fahrerhaus-ID:669.899 für:(32) 514140/03 für:(50,32) 514142/04 für:(50,32) 514142/06 670.398/398 für:(32) 514140/03 für:(50,32) 514142/04 benötigte Stückzahl:2		



Ref.

MERCEDES-BENZ

VARIO

09.96 -

	Stabilisatorlager		▲	18441 01	667 323 04 85
	512 D, Pritsche/Fahrgestell	09.96 -			
	810 DT, 75 kW	09.96 -	Vorderachse beidseitig		
	810 DT, 100 kW	09.96 -	1.VA		
	810 DT, 112 kW	09.96 -	-----		
	812 D, Pritsche/Fahrgestell	09.96 -	Fahrerhaus-ID:669.899		
	812 D, Kipper	09.96 -	für:(32) 514131/02		
	813 D, 814 D, Pritsche/Fahrgestell	09.96 -	für:(32) 514131/08		
	813 D, 814 D, Kipper	09.96 -	benötigte Stückzahl:2		
	813 DA, 814 DA, Pritsche/Fahrgestell	09.96 -			
	813 DA, 814 DA, Kipper	09.96 -			
	815 D, 816 D, Pritsche/Fahrgestell	09.96 -			
	815 D, 816 D, Kipper	09.96 -			
	815 DA, 816 DA, Pritsche/Fahrgestell	09.96 -			
	815 DA, 816 DA, Kipper	09.96 -			
	512 D, Kasten/Kombi	09.96 -	Vorderachse beidseitig		
	812 D, Kasten/Kombi	09.96 -	1.VA		
	813 D, 814 D, Kasten/Kombi	09.96 -	-----		
	813 DA, 814 DA, Kasten/Kombi	09.96 -	Fahrerhaus-ID:669.599		
	815 D, 816 D, Kasten/Kombi	09.96 -	für:(32) 514131/02		
	815 DA, 816 DA, Kasten/Kombi	09.96 -	für:(32) 514131/08		
			benötigte Stückzahl:2		
	612 D, Pritsche/Fahrgestell	09.96 -	Vorderachse beidseitig		
	613 D, 614 D, Pritsche/Fahrgestell	09.96 -	1.VA		
	615 D, 616 D, Pritsche/Fahrgestell	09.98 -	-----		
			für:(32) 514131/02		

			668.321-322-323/322-323		
			für:(32) 514131/08		

			Fahrerhaus-ID:669.899		
			für:(32) 514131/02		
			für:(32) 514131/08		
			benötigte Stückzahl:2		
	612 D, Kasten/Kombi	09.96 -	Vorderachse beidseitig		
	613 D, 614 D, Kasten/Kombi	09.96 -	1.VA		
	615 D, 616 D, Kasten/Kombi	09.98 -	-----		
			für:(32) 514131/02		

			668.351-352-353/352-353		
			für:(32) 514131/08		

			Fahrerhaus-ID:669.599		
			für:(32) 514131/02		
			für:(32) 514131/08		
			benötigte Stückzahl:2		
	612 D, Kipper	09.96 -	Vorderachse beidseitig		
	613 D, 614 D, Kipper	09.96 -	1.VA		
	615 D, 616 D, Kipper	09.98 -	-----		
			668.331-332		
			für:(32) 514131/02		



			Fahrerhaus-ID:669.899		
			für:(32) 514131/02		
			für:(32) 514131/08		
			benötigte Stückzahl:2		



MERCEDES-BENZ

VARIO

09.96 -

 Stabilisatorlager			26101 01	318 320 00 73
512 D, Pritsche/Fahrgestell	09.96 -	Verbindungsstange an Konsole 1.VA ----- Fahrerhaus-ID:669.899 für:(32) 514140/02 für:(50,32) 514142/03 benötigte Stückzahl:2		
612 D, Pritsche/Fahrgestell	09.96 -			
612 D, Kipper	09.96 -			
613 D, 614 D, Pritsche/Fahrgestell	09.96 -			
613 D, 614 D, Kipper	09.96 -			
615 D, 616 D, Pritsche/Fahrgestell	09.98 -			
615 D, 616 D, Kipper	09.98 -			
812 D, Pritsche/Fahrgestell	09.96 -			
812 D, Kipper	09.96 -			
813 D, 814 D, Pritsche/Fahrgestell	09.96 -			
813 D, 814 D, Kipper	09.96 -			
813 DA, 814 DA, Pritsche/Fahrgestell	09.96 -			
813 DA, 814 DA, Kipper	09.96 -			
815 D, 816 D, Pritsche/Fahrgestell	09.96 -			
815 D, 816 D, Kipper	09.96 -			
815 DA, 816 DA, Pritsche/Fahrgestell	09.96 -			
815 DA, 816 DA, Kipper	09.96 -			
512 D, Kasten/Kombi	09.96 -			
612 D, Kasten/Kombi	09.96 -			
613 D, 614 D, Kasten/Kombi	09.96 -			
615 D, 616 D, Kasten/Kombi	09.98 -			
812 D, Kasten/Kombi	09.96 -			
813 D, 814 D, Kasten/Kombi	09.96 -			
813 DA, 814 DA, Kasten/Kombi	09.96 -			
815 D, 816 D, Kasten/Kombi	09.96 -			
815 DA, 816 DA, Kasten/Kombi	09.96 -			
810 DT	04.62 - 06.69	Verbindungsstange an Konsole 1.VA ----- Fahrerhaus-ID:669.899 für:(32) 514140/02 für:(50,32) 514142/03 ----- Baumuster:670.398 für:(32) 514140/02 für:(50,32) 514142/03 benötigte Stückzahl:2		
810 DT, 100 kW	09.96 -			
810 DT, 112 kW	09.96 -			





Ref.

MERCEDES-BENZ

VARIO

09.96 -



 Stabilisatorlager		▲	26940 01	670 323 03 85
512 D, Pritsche/Fahrgestell	09.96 -	Vorderachse beidseitig 1.VA ----- Fahrerhaus-ID:669.899 für:(32) 514131/05 benötigte Stückzahl:2		
612 D, Pritsche/Fahrgestell	09.96 -			
612 D, Kipper	09.96 -			
613 D, 614 D, Pritsche/Fahrgestell	09.96 -			
613 D, 614 D, Kipper	09.96 -			
615 D, 616 D, Pritsche/Fahrgestell	09.98 -			
615 D, 616 D, Kipper	09.98 -			
812 D, Pritsche/Fahrgestell	09.96 -			
812 D, Kipper	09.96 -			
813 D, 814 D, Pritsche/Fahrgestell	09.96 -			
813 D, 814 D, Kipper	09.96 -			
815 D, 816 D, Pritsche/Fahrgestell	09.96 -			
815 D, 816 D, Kipper	09.96 -			
512 D, Kasten/Kombi	09.96 -	Vorderachse beidseitig 1.VA ----- Fahrerhaus-ID:669.599 für:(32) 514131/05 benötigte Stückzahl:2		
612 D, Kasten/Kombi	09.96 -			
613 D, 614 D, Kasten/Kombi	09.96 -			
615 D, 616 D, Kasten/Kombi	09.98 -			
812 D, Kasten/Kombi	09.96 -			
813 D, 814 D, Kasten/Kombi	09.96 -			
815 D, 816 D, Kasten/Kombi	09.96 -			
813 DA, 814 DA, Pritsche/Fahrgestell	09.96 -	Vorderachse beidseitig 1.VA ----- Fahrerhaus-ID:669.899 für:(32) 514131/05 ----- 670.421-422-423 für:(32) 514131/05 benötigte Stückzahl:2		
815 DA, 816 DA, Pritsche/Fahrgestell	09.96 -			
813 DA, 814 DA, Kasten/Kombi	09.96 -	Vorderachse beidseitig 1.VA ----- Fahrerhaus-ID:669.599 für:(32) 514131/05 ----- 670.451-452-453 für:(32) 514131/05 benötigte Stückzahl:2		
815 DA, 816 DA, Kasten/Kombi	09.96 -			
813 DA, 814 DA, Kipper	09.96 -	Vorderachse beidseitig 1.VA ----- Fahrerhaus-ID:669.899 für:(32) 514131/05 ----- 670.431-432 für:(32) 514131/05 benötigte Stückzahl:2		
815 DA, 816 DA, Kipper	09.96 -			
810 DT	04.62 - 06.69	Vorderachse beidseitig 1.VA ----- Fahrerhaus-ID:669.899 für:(32) 514131/05 ----- Baumuster:670.398 für:(32) 514131/05 benötigte Stückzahl:2		
810 DT, 100 kW	09.96 -			
810 DT, 112 kW	09.96 -			



MERCEDES-BENZ

VARIO

09.96 -



 Stabilisatorlager			27749 01	667 323 06 85
512 D, Pritsche/Fahrgestell	09.96 -	Vorderachse beidseitig 1.VA ----- 667.321-322-323 für:(32) 514131/07 ----- Fahrerhaus-ID:669.899 für:(32) 514131/07 für:(32) 514131/10 benötigte Stückzahl:2		
512 D, Kasten/Kombi	09.96 -	Vorderachse beidseitig 1.VA ----- 667.351-352-353 für:(32) 514131/07 ----- Fahrerhaus-ID:669.599 für:(32) 514131/07 für:(32) 514131/10 benötigte Stückzahl:2		
612 D, Pritsche/Fahrgestell	09.96 -	Vorderachse beidseitig 1.VA ----- Fahrerhaus-ID:669.899 für:(32) 514131/07 für:(32) 514131/10 benötigte Stückzahl:2		
612 D, Kipper	09.96 -			
613 D, 614 D, Pritsche/Fahrgestell	09.96 -			
613 D, 614 D, Kipper	09.96 -			
615 D, 616 D, Pritsche/Fahrgestell	09.98 -			
615 D, 616 D, Kipper	09.98 -			
810 DT, 75 kW	09.96 -			
810 DT, 100 kW	09.96 -			
810 DT, 112 kW	09.96 -			
813 DA, 814 DA, Pritsche/Fahrgestell	09.96 -			
813 DA, 814 DA, Kipper	09.96 -			
815 DA, 816 DA, Pritsche/Fahrgestell	09.96 -			
815 DA, 816 DA, Kipper	09.96 -			
612 D, Kasten/Kombi	09.96 -	Vorderachse beidseitig 1.VA ----- für:(32) 514131/07 ----- 668.351-352/352 für:(32) 514131/10 ----- Fahrerhaus-ID:669.599 für:(32) 514131/07 für:(32) 514131/10 benötigte Stückzahl:2		
613 D, 614 D, Kasten/Kombi	09.96 -			
615 D, 616 D, Kasten/Kombi	09.98 -			
812 D, Pritsche/Fahrgestell	09.96 -	Vorderachse beidseitig 1.VA ----- Fahrerhaus-ID:669.899 für:(32) 514131/07 für:(32) 514131/10 benötigte Stückzahl:2		
813 D, 814 D, Pritsche/Fahrgestell	09.96 -			
815 D, 816 D, Pritsche/Fahrgestell	09.96 -			
812 D, Kasten/Kombi	09.96 -	Vorderachse beidseitig 1.VA ----- Fahrerhaus-ID:669.599 für:(32) 514131/07 für:(32) 514131/10 benötigte Stückzahl:2		
813 D, 814 D, Kasten/Kombi	09.96 -			
815 D, 816 D, Kasten/Kombi	09.96 -			
812 D, Kipper	09.96 -	Vorderachse beidseitig 1.VA ----- Fahrerhaus-ID:669.899 für:(32) 514131/07 für:(32) 514131/10 benötigte Stückzahl:2		
813 D, 814 D, Kipper	09.96 -			
815 D, 816 D, Kipper	09.96 -			



Ref.

MERCEDES-BENZ











VARIO **09.96 -**

 Stabilisatorlager 813 DA, 814 DA, Kasten/Kombi 815 DA, 816 DA, Kasten/Kombi	09.96 -	Vorderachse beidseitig 1.VA <hr/> Fahrerhaus-ID:669.599 für:(32) 514131/07 für:(32) 514131/10 benötigte Stückzahl:2	27749 01 667 323 06 85 
	09.96 -		



MERCEDES-BENZ

VARIO 09.96 -



Achsstrebenlager		26920 01	601 322 00 85
512 D, Pritsche/Fahrgestell	09.96 -		
		667.321-322-323 für:(32) 514151/01	
		Fahrerhaus-ID:669.899 für:(32) 514151/01 benötigte Stückzahl:2	
512 D, Kasten/Kombi	09.96 -		
		667.351-352-353 für:(32) 514151/01	
		Fahrerhaus-ID:669.599 für:(32) 514151/01 benötigte Stückzahl:2	
612 D, Pritsche/Fahrgestell	09.96 -		
613 D, 614 D, Pritsche/Fahrgestell	09.96 -		
615 D, 616 D, Pritsche/Fahrgestell	09.98 -		
		668.321-322-323 für:(32) 514151/01	
		Fahrerhaus-ID:669.899 für:(32) 514151/01 benötigte Stückzahl:2	
612 D, Kasten/Kombi	09.96 -		
613 D, 614 D, Kasten/Kombi	09.96 -		
615 D, 616 D, Kasten/Kombi	09.98 -		
		668.351-352-353 für:(32) 514151/01	
		Fahrerhaus-ID:669.599 für:(32) 514151/01 benötigte Stückzahl:2	
612 D, Kipper	09.96 -		
613 D, 614 D, Kipper	09.96 -		
615 D, 616 D, Kipper	09.98 -		
		668.331-332 für:(32) 514151/01	
		Fahrerhaus-ID:669.899 für:(32) 514151/01 benötigte Stückzahl:2	
812 D, Pritsche/Fahrgestell	09.96 -		
813 D, 814 D, Pritsche/Fahrgestell	09.96 -		
815 D, 816 D, Pritsche/Fahrgestell	09.96 -		
		Fahrerhaus-ID:669.899 für:(32) 514151/01	
		670.321-322-323-324 für:(32) 514151/01 benötigte Stückzahl:2	
812 D, Kasten/Kombi	09.96 -		
813 D, 814 D, Kasten/Kombi	09.96 -		
815 D, 816 D, Kasten/Kombi	09.96 -		
		Fahrerhaus-ID:669.599 für:(32) 514151/01	
		670.351-352-353 für:(32) 514151/01 benötigte Stückzahl:2	
812 D, Kipper	09.96 -		
813 D, 814 D, Kipper	09.96 -		
815 D, 816 D, Kipper	09.96 -		
		Fahrerhaus-ID:669.899 für:(32) 514151/01	
		670.331-332 für:(32) 514151/01 benötigte Stückzahl:2	
810 DT, 75 kW	09.96 -		
810 DT, 100 kW	09.96 -		
810 DT, 112 kW	09.96 -		
813 DA, 814 DA, Pritsche/Fahrgestell	09.96 -		
813 DA, 814 DA, Kipper	09.96 -		
815 DA, 816 DA, Pritsche/Fahrgestell	09.96 -		
815 DA, 816 DA, Kipper	09.96 -		
			Fahrerhaus-ID:669.899 für:(32) 514151/01 benötigte Stückzahl:2



Ref.

MERCEDES-BENZ

VARIO 09.96 -

 Achsstrebenlager 813 DA, 814 DA, Kasten/Kombi 815 DA, 816 DA, Kasten/Kombi	09.96 -	 ----- Fahrerhaus-ID:669.599 für:(32) 514151/01 benötigte Stückzahl:2	26920 01	601 322 00 85
	09.96 -			



MERCEDES-BENZ

VARIO

09.96 -

	Stabilisatorlager	I12/A30	12834 01	309 320 00 73
	512 D, Pritsche/Fahrgestell	09.96 -		
Drehstab an Verbindungsstange 1.VA				
für:(32) 514140/01 für:(32) 514144/02 für:(50,32) 514142/01 für:(50,32) 514142/05				
Fahrerhaus-ID:669.899 für:(32) 514140/01 für:(32) 514144/02 für:(50,32) 514142/01 für:(50,32) 514142/02 für:(50,32) 514142/05				
Verbindungsstange an Konsole				
für:(32) 514140/01 für:(32) 514144/02 für:(50,32) 514142/01 für:(50,32) 514142/05				
Fahrerhaus-ID:669.899 für:(32) 514140/01 für:(32) 514144/02 für:(50,32) 514142/01 für:(50,32) 514142/02 für:(50,32) 514142/05				
Drehstab an Verbindungsstange 1.HA				
667.321-322-323/321-322-323/321- 322-323 für:(32) 514140/01 für:(32) 514144/02 für:(50,32) 514142/01 für:(50,32) 514142/05				
Fahrerhaus-ID:669.899 für:(32) 514140/01 für:(32) 514144/02 für:(50,32) 514142/01 für:(50,32) 514142/02 für:(50,32) 514142/05 benötigte Stückzahl:2				



Ref.

MERCEDES-BENZ

VARIO 09.96 -

	Stabilisatorlager	I12/A30	12834 01	309 320 00 73
	512 D, Kasten/Kombi	09.96 -		
			Drehstab an Verbindungsstange 1.VA	
			für:(32) 514140/01 für:(32) 514144/02 für:(50,32) 514142/01 für:(50,32) 514142/05	
			Fahrerhaus-ID:669.599 für:(32) 514140/01 für:(32) 514144/02 für:(50,32) 514142/01 für:(50,32) 514142/02 für:(50,32) 514142/05	
			Verbindungsstange an Konsole	
			für:(32) 514140/01 für:(32) 514144/02 für:(50,32) 514142/01 für:(50,32) 514142/05	
			Fahrerhaus-ID:669.599 für:(32) 514140/01 für:(32) 514144/02 für:(50,32) 514142/01 für:(50,32) 514142/02 für:(50,32) 514142/05	
			Drehstab an Verbindungsstange 1.HA	
			667.351-352-353/351-352-353/351- 352-353 für:(32) 514140/01 für:(32) 514144/02 für:(50,32) 514142/01 für:(50,32) 514142/05	
			Fahrerhaus-ID:669.599 für:(32) 514140/01 für:(32) 514144/02 für:(50,32) 514142/01 für:(50,32) 514142/02 für:(50,32) 514142/05 benötigte Stückzahl:2	



MERCEDES-BENZ

VARIO

09.96 -

Stabilisatorlager		I12/A30	12834 01	309 320 00 73
612 D, Pritsche/Fahrgestell	09.96 -	Drehstab an Verbindungsstange 1.VA		
613 D, 614 D, Pritsche/Fahrgestell	09.96 -			
615 D, 616 D, Pritsche/Fahrgestell	09.98 -	für:(32) 514140/01 für:(50,32) 514142/01 für:(50,32) 514142/02		
		Fahrerhaus-ID:669.899 für:(32) 514140/01 für:(32) 514144/02 für:(50,32) 514142/01 für:(50,32) 514142/02 für:(50,32) 514142/05		
		Verbindungsstange an Konsole		
		668.321-322-323/321-322-323 für:(32) 514140/01 für:(50,32) 514142/01 für:(50,32) 514142/02		
		Fahrerhaus-ID:669.899 für:(32) 514140/01 für:(32) 514144/02 für:(50,32) 514142/01 für:(50,32) 514142/02 für:(50,32) 514142/05		
		Drehstab an Verbindungsstange 1.HA		
		Fahrerhaus-ID:669.899 für:(32) 514140/01 für:(32) 514144/02 für:(50,32) 514142/01 für:(50,32) 514142/02 für:(50,32) 514142/05 benötigte Stückzahl:2		
612 D, Kasten/Kombi	09.96 -	Drehstab an Verbindungsstange 1.VA		
613 D, 614 D, Kasten/Kombi	09.96 -			
615 D, 616 D, Kasten/Kombi	09.98 -	für:(32) 514140/01 für:(50,32) 514142/01 für:(50,32) 514142/02		
		Fahrerhaus-ID:669.599 für:(32) 514140/01 für:(32) 514144/02 für:(50,32) 514142/01 für:(50,32) 514142/02 für:(50,32) 514142/05		
		Verbindungsstange an Konsole		
		668.351-352-353/351-352-353 für:(32) 514140/01 für:(50,32) 514142/01 für:(50,32) 514142/02		
		Fahrerhaus-ID:669.599 für:(32) 514140/01 für:(32) 514144/02 für:(50,32) 514142/01 für:(50,32) 514142/02 für:(50,32) 514142/05		
		Drehstab an Verbindungsstange 1.HA		
		Fahrerhaus-ID:669.599 für:(32) 514140/01 für:(32) 514144/02 für:(50,32) 514142/01 für:(50,32) 514142/02 für:(50,32) 514142/05 benötigte Stückzahl:2		



Ref.

MERCEDES-BENZ

VARIO

09.96 -



Stabilisatorlager		I12/A30	12834 01	309 320 00 73
612 D, Kipper	09.96 -	Drehstab an Verbindungsstange 1.VA ----- für:(32) 514140/01 für:(50,32) 514142/01 für:(50,32) 514142/02 ----- Fahrerhaus-ID:669.899 für:(32) 514140/01 für:(32) 514144/02 für:(50,32) 514142/01 für:(50,32) 514142/02 für:(50,32) 514142/05 ----- Verbindungsstange an Konsole ----- 668.331-332/331-332 für:(32) 514140/01 für:(50,32) 514142/01 für:(50,32) 514142/02 ----- Fahrerhaus-ID:669.899 für:(32) 514140/01 für:(32) 514144/02 für:(50,32) 514142/01 für:(50,32) 514142/02 für:(50,32) 514142/05 ----- Drehstab an Verbindungsstange 1.HA ----- Fahrerhaus-ID:669.899 für:(32) 514140/01 für:(32) 514144/02 für:(50,32) 514142/01 für:(50,32) 514142/02 für:(50,32) 514142/05 benötigte Stückzahl:2		
613 D, 614 D, Kipper	09.96 -			
615 D, 616 D, Kipper	09.98 -			
812 D, Pritsche/Fahrgestell	09.96 -	Drehstab an Verbindungsstange 1.VA ----- Fahrerhaus-ID:669.899 für:(32) 514140/01 für:(32) 514144/02 für:(50,32) 514142/01 für:(50,32) 514142/02 für:(50,32) 514142/05 ----- für:(32) 514140/01 für:(50,32) 514142/02 ----- Verbindungsstange an Konsole ----- Fahrerhaus-ID:669.899 für:(32) 514140/01 für:(32) 514144/02 für:(50,32) 514142/01 für:(50,32) 514142/02 für:(50,32) 514142/05 ----- 670.321-322-323-324/321-322-323- 324 für:(32) 514140/01 für:(50,32) 514142/02 ----- Drehstab an Verbindungsstange 1.HA ----- Fahrerhaus-ID:669.899 für:(32) 514140/01 für:(32) 514144/02 für:(50,32) 514142/01 für:(50,32) 514142/02 für:(50,32) 514142/05 benötigte Stückzahl:2		
813 D, 814 D, Pritsche/Fahrgestell	09.96 -			
815 D, 816 D, Pritsche/Fahrgestell	09.96 -			



MERCEDES-BENZ

VARIO

09.96 -

 Stabilisatorlager		I12/A30	12834 01	309 320 00 73
812 D, Kasten/Kombi	09.96 -	Drehstab an Verbindungsstange 1.VA		
813 D, 814 D, Kasten/Kombi	09.96 -	Fahrerhaus-ID:669.599 für:(32) 514140/01 für:(32) 514144/02 für:(50,32) 514142/01 für:(50,32) 514142/02 für:(50,32) 514142/05		
815 D, 816 D, Kasten/Kombi	09.96 -	für:(32) 514140/01 für:(50,32) 514142/02		
		Verbindungsstange an Konsole		
		Fahrerhaus-ID:669.599 für:(32) 514140/01 für:(32) 514144/02 für:(50,32) 514142/01 für:(50,32) 514142/02 für:(50,32) 514142/05		
		670.351-352-353/351-352-353 für:(32) 514140/01 für:(50,32) 514142/02		
		Drehstab an Verbindungsstange 1.HA		
		Fahrerhaus-ID:669.599 für:(32) 514140/01 für:(32) 514144/02 für:(50,32) 514142/01 für:(50,32) 514142/02 für:(50,32) 514142/05 benötigte Stückzahl:2		
812 D, Kipper	09.96 -	Drehstab an Verbindungsstange 1.VA		
813 D, 814 D, Kipper	09.96 -	Fahrerhaus-ID:669.899 für:(32) 514140/01 für:(32) 514144/02 für:(50,32) 514142/01 für:(50,32) 514142/02 für:(50,32) 514142/05		
815 D, 816 D, Kipper	09.96 -	für:(32) 514140/01 für:(50,32) 514142/02		
		Verbindungsstange an Konsole		
		Fahrerhaus-ID:669.899 für:(32) 514140/01 für:(32) 514144/02 für:(50,32) 514142/01 für:(50,32) 514142/02 für:(50,32) 514142/05		
		670.331-332/331-332 für:(32) 514140/01 für:(50,32) 514142/02		
		Drehstab an Verbindungsstange 1.HA		
		Fahrerhaus-ID:669.899 für:(32) 514140/01 für:(32) 514144/02 für:(50,32) 514142/01 für:(50,32) 514142/02 für:(50,32) 514142/05 benötigte Stückzahl:2		



Ref.

MERCEDES-BENZ

VARIO



09.96 -

Stabilisatorlager		I12/A30	12834 01	309 320 00 73
810 DT, 75 kW	09.96 -	Drehstab an Verbindungsstange 1.VA		
810 DT, 100 kW	09.96 -			
810 DT, 112 kW	09.96 -			
813 DA, 814 DA, Pritsche/Fahrgestell	09.96 -	Fahrerhaus-ID:669.899		
813 DA, 814 DA, Kipper	09.96 -	für:(32) 514140/01		
815 DA, 816 DA, Pritsche/Fahrgestell	09.96 -	für:(32) 514144/02		
815 DA, 816 DA, Kipper	09.96 -	für:(50,32) 514142/01		
		für:(50,32) 514142/02		
		für:(50,32) 514142/05		
		Verbindungsstange an Konsole		
		Fahrerhaus-ID:669.899		
		für:(32) 514140/01		
		für:(32) 514144/02		
		für:(50,32) 514142/01		
		für:(50,32) 514142/02		
		für:(50,32) 514142/05		
		Drehstab an Verbindungsstange 1.HA		
		Fahrerhaus-ID:669.899		
		für:(32) 514140/01		
		für:(32) 514144/02		
		für:(50,32) 514142/01		
		für:(50,32) 514142/02		
		für:(50,32) 514142/05		
		benötigte Stückzahl:2		
813 DA, 814 DA, Kasten/Kombi	09.96 -	Drehstab an Verbindungsstange 1.VA		
815 DA, 816 DA, Kasten/Kombi	09.96 -			
		Fahrerhaus-ID:669.599		
		für:(32) 514140/01		
		für:(32) 514144/02		
		für:(50,32) 514142/01		
		für:(50,32) 514142/02		
		für:(50,32) 514142/05		
		Verbindungsstange an Konsole		
		Fahrerhaus-ID:669.599		
		für:(32) 514140/01		
		für:(32) 514144/02		
		für:(50,32) 514142/01		
		für:(50,32) 514142/02		
		für:(50,32) 514142/05		
		Drehstab an Verbindungsstange 1.HA		
		Fahrerhaus-ID:669.599		
		für:(32) 514140/01		
		für:(32) 514144/02		
		für:(50,32) 514142/01		
		für:(50,32) 514142/02		
		für:(50,32) 514142/05		
		benötigte Stückzahl:2		



MERCEDES-BENZ

VARIO 09.96 -

 Stabilisatorlager		▲	150/A68	21790 01	669 326 00 81
512 D, Pritsche/Fahrgestell	09.96 -	1.HA			
612 D, Pritsche/Fahrgestell	09.96 -	-----			
612 D, Kipper	09.96 -	Fahrerhaus-ID:669.899			
613 D, 614 D, Pritsche/Fahrgestell	09.96 -	für:(32) 514132/05			
613 D, 614 D, Kipper	09.96 -				
615 D, 616 D, Pritsche/Fahrgestell	09.98 -				
615 D, 616 D, Kipper	09.98 -				
810 DT, 75 kW	09.96 -				
810 DT, 100 kW	09.96 -				
810 DT, 112 kW	09.96 -				
812 D, Pritsche/Fahrgestell	09.96 -				
812 D, Kipper	09.96 -				
813 D, 814 D, Pritsche/Fahrgestell	09.96 -				
813 D, 814 D, Kipper	09.96 -				
815 D, 816 D, Pritsche/Fahrgestell	09.96 -				
815 D, 816 D, Kipper	09.96 -				
512 D, Kasten/Kombi	09.96 -	1.HA			
612 D, Kasten/Kombi	09.96 -	-----			
613 D, 614 D, Kasten/Kombi	09.96 -	Fahrerhaus-ID:669.599			
615 D, 616 D, Kasten/Kombi	09.98 -	für:(32) 514132/05			
812 D, Kasten/Kombi	09.96 -				
813 D, 814 D, Kasten/Kombi	09.96 -				
815 D, 816 D, Kasten/Kombi	09.96 -				
813 DA, 814 DA, Pritsche/Fahrgestell	09.96 -	1.HA			
815 DA, 816 DA, Pritsche/Fahrgestell	09.96 -	-----			
		Fahrerhaus-ID:669.899			
		für:(32) 514132/05			

		670.421-422			
		für:(32) 514132/05			
813 DA, 814 DA, Kasten/Kombi	09.96 -	1.HA			
815 DA, 816 DA, Kasten/Kombi	09.96 -	-----			
		Fahrerhaus-ID:669.599			
		für:(32) 514132/05			

		670.451-452			
		für:(32) 514132/05			
813 DA, 814 DA, Kipper	09.96 -	1.HA			
815 DA, 816 DA, Kipper	09.96 -	-----			
		Fahrerhaus-ID:669.899			
		für:(32) 514132/05			

		670.431-432			
		für:(32) 514132/05			



Ref.

MERCEDES-BENZ

VARIO 09.96 -



	Stabilisatorlager	26109 01	667 320 00 44
512 D, Pritsche/Fahrgestell	09.96 -		
512 D, Pritsche/Fahrgestell	09.96 -	<p>↔↔</p> <p>für:(32) 044101/02 für:(32) 514121/07 für:(32) 514121/09 für:(32) 514122/02</p> <p>-----</p> <p>667.321-322-323/321 ->Chass. N 071 238 für:(32) 044101/02 für:(32) 514121/07 für:(32) 514121/09 für:(32) 514122/02</p> <p>-----</p> <p>Fahrerhaus-ID:669.899 für:(32) 514121/02 für:(32) 514121/07 für:(32) 514121/08 für:(32) 514121/09 für:(32) 514121/10 für:(32) 514121/13 für:(32) 514122/02</p> <p>-----</p> <p>Fahrerhaus-ID:669.899 ->Chass. N 071 238 für:(32) 514121/02 für:(32) 514121/07 für:(32) 514121/08 für:(32) 514121/09 für:(32) 514121/10 für:(32) 514121/13 für:(32) 514122/02 benötigte Stückzahl:2</p>	
512 D, Pritsche/Fahrgestell	09.96 -	<p>↓</p> <p>links oben rechts oben</p> <p>-----</p> <p>667.321-322-323 für:(32) 044101/02 für:(32) 514121/07 für:(32) 514121/09 für:(32) 514122/02</p> <p>-----</p> <p>Fahrerhaus-ID:669.899 für:(32) 514121/02 für:(32) 514121/07 für:(32) 514121/08 für:(32) 514121/09 für:(32) 514121/10 für:(32) 514121/13 für:(32) 514122/02 benötigte Stückzahl:2</p>	



MERCEDES-BENZ

VARIO

09.96 -



 Stabilisatorlager		26109 01 667 320 00 44
512 D, Kasten/Kombi 09.96 -	<p>↔ ↔</p> <p>-----</p> <p>für:(32) 044101/02 für:(32) 514121/07 für:(32) 514121/09 für:(32) 514122/02</p> <p>-----</p> <p>667.351-352-353/351 ->Chass. N 071 238 für:(32) 044101/02 für:(32) 514121/07 für:(32) 514121/09 für:(32) 514122/02</p> <p>-----</p> <p>Fahrerhaus-ID:669.599 für:(32) 514121/02 für:(32) 514121/07 für:(32) 514121/08 für:(32) 514121/09 für:(32) 514121/10 für:(32) 514121/13 für:(32) 514122/02</p> <p>-----</p> <p>Fahrerhaus-ID:669.599 ->Chass. N 071 238 für:(32) 514121/02 für:(32) 514121/07 für:(32) 514121/08 für:(32) 514121/09 für:(32) 514121/10 für:(32) 514121/13 für:(32) 514122/02 benötigte Stückzahl:2</p>	
512 D, Kasten/Kombi 09.96 -	<p>↓</p> <p>links oben rechts oben</p> <p>-----</p> <p>667.351-352-353 für:(32) 044101/02 für:(32) 514121/07 für:(32) 514121/09 für:(32) 514122/02</p> <p>-----</p> <p>Fahrerhaus-ID:669.599 für:(32) 514121/02 für:(32) 514121/07 für:(32) 514121/08 für:(32) 514121/09 für:(32) 514121/10 für:(32) 514121/13 für:(32) 514122/02 benötigte Stückzahl:2</p>	



Ref.

MERCEDES-BENZ

VARIO 09.96 -





Stabilisatorlager			26109 01	667 320 00 44
612 D, Pritsche/Fahrgestell	09.96 -			
613 D, 614 D, Pritsche/Fahrgestell	09.96 -			
615 D, 616 D, Pritsche/Fahrgestell	09.98 -			
		für:(32) 514121/02 für:(32) 514121/07 für:(32) 514121/08 für:(32) 514121/09 für:(32) 514121/10 für:(32) 514121/13 für:(32) 514122/02		
		668.321-322-323/321 ->Chass. N 071 238 für:(32) 514121/02 für:(32) 514121/07 für:(32) 514121/08 für:(32) 514121/09 für:(32) 514121/10 für:(32) 514121/13 für:(32) 514122/02		
		Fahrerhaus-ID:669.899 für:(32) 514121/02 für:(32) 514121/07 für:(32) 514121/08 für:(32) 514121/09 für:(32) 514121/10 für:(32) 514121/13 für:(32) 514122/02		
		Fahrerhaus-ID:669.899 ->Chass. N 071 238 für:(32) 514121/02 für:(32) 514121/07 für:(32) 514121/08 für:(32) 514121/09 für:(32) 514121/10 für:(32) 514121/13 für:(32) 514122/02 benötigte Stückzahl:2		
612 D, Pritsche/Fahrgestell	09.96 -			
613 D, 614 D, Pritsche/Fahrgestell	09.96 -			
615 D, 616 D, Pritsche/Fahrgestell	09.98 -			
		links oben rechts oben		
		668.321-322-323 für:(32) 514121/02 für:(32) 514121/07 für:(32) 514121/08 für:(32) 514121/09 für:(32) 514121/10 für:(32) 514121/13 für:(32) 514122/02		
		Fahrerhaus-ID:669.899 für:(32) 514121/02 für:(32) 514121/07 für:(32) 514121/08 für:(32) 514121/09 für:(32) 514121/10 für:(32) 514121/13 für:(32) 514122/02 benötigte Stückzahl:2		



MERCEDES-BENZ

VARIO

09.96 -





 Stabilisatorlager			26109 01	667 320 00 44
612 D, Kasten/Kombi	09.96 -	 für:(32) 514121/02 für:(32) 514121/07 für:(32) 514121/08 für:(32) 514121/09 für:(32) 514121/10 für:(32) 514121/13 für:(32) 514122/02		
613 D, 614 D, Kasten/Kombi	09.96 -			
615 D, 616 D, Kasten/Kombi	09.98 -			
		668.351-352-353/351 ->Chass. N 071 238 für:(32) 514121/02 für:(32) 514121/07 für:(32) 514121/08 für:(32) 514121/09 für:(32) 514121/10 für:(32) 514121/13 für:(32) 514122/02		
		Fahrerhaus-ID:669.599 für:(32) 514121/02 für:(32) 514121/07 für:(32) 514121/08 für:(32) 514121/09 für:(32) 514121/10 für:(32) 514121/13 für:(32) 514122/02		
		Fahrerhaus-ID:669.599 ->Chass. N 071 238 für:(32) 514121/02 für:(32) 514121/07 für:(32) 514121/08 für:(32) 514121/09 für:(32) 514121/10 für:(32) 514121/13 für:(32) 514122/02 benötigte Stückzahl:2		
612 D, Kasten/Kombi	09.96 -	 links oben rechts oben		
613 D, 614 D, Kasten/Kombi	09.96 -			
615 D, 616 D, Kasten/Kombi	09.98 -			
		668.351-352-353 für:(32) 514121/02 für:(32) 514121/07 für:(32) 514121/08 für:(32) 514121/09 für:(32) 514121/10 für:(32) 514121/13 für:(32) 514122/02		
		Fahrerhaus-ID:669.599 für:(32) 514121/02 für:(32) 514121/07 für:(32) 514121/08 für:(32) 514121/09 für:(32) 514121/10 für:(32) 514121/13 für:(32) 514122/02 benötigte Stückzahl:2		



Ref.

MERCEDES-BENZ

VARIO 09.96 -

Stabilisatorlager			26109 01	667 320 00 44
612 D, Kipper	09.96 -	 ----- 668.331-332 ->Chass. N 071 238 für:(32) 514121/02 für:(32) 514121/08 für:(32) 514122/02 ----- Fahrerhaus-ID:669.899 für:(32) 514121/02 für:(32) 514121/07 für:(32) 514121/08 für:(32) 514121/09 für:(32) 514121/10 für:(32) 514121/13 für:(32) 514122/02 ----- Fahrerhaus-ID:669.899 ->Chass. N 071 238 für:(32) 514121/02 für:(32) 514121/07 für:(32) 514121/08 für:(32) 514121/09 für:(32) 514121/10 für:(32) 514121/13 für:(32) 514122/02 benötigte Stückzahl:2		
613 D, 614 D, Kipper	09.96 -			
615 D, 616 D, Kipper	09.98 -			
612 D, Kipper	09.96 -	 links oben rechts oben ----- 668.331-332 für:(32) 514121/02 für:(32) 514121/08 für:(32) 514122/02 ----- Fahrerhaus-ID:669.899 für:(32) 514121/02 für:(32) 514121/07 für:(32) 514121/08 für:(32) 514121/09 für:(32) 514121/10 für:(32) 514121/13 für:(32) 514122/02 benötigte Stückzahl:2		
613 D, 614 D, Kipper	09.96 -			
615 D, 616 D, Kipper	09.98 -			
812 D, Pritsche/Fahrgestell	09.96 -	 ----- Fahrerhaus-ID:669.899 für:(32) 514121/02 für:(32) 514121/07 für:(32) 514121/08 für:(32) 514121/09 für:(32) 514121/10 für:(32) 514121/13 für:(32) 514122/02 ----- Fahrerhaus-ID:669.899 ->Chass. N 071 238 für:(32) 514121/02 für:(32) 514121/07 für:(32) 514121/08 für:(32) 514121/09 für:(32) 514121/10 für:(32) 514121/13 für:(32) 514122/02 ----- 670.321-322-323-324 ->Chass. N 071 238 für:(32) 514121/02 für:(32) 514121/08 für:(32) 514121/10 für:(32) 514122/02 benötigte Stückzahl:2		
813 D, 814 D, Pritsche/Fahrgestell	09.96 -			
815 D, 816 D, Pritsche/Fahrgestell	09.96 -			







MERCEDES-BENZ

VARIO

09.96 -

26109 01

667 320 00 44

Stabilisatorlager			
812 D, Pritsche/Fahrgestell	09.96 -	 links oben rechts oben	
813 D, 814 D, Pritsche/Fahrgestell	09.96 -		
815 D, 816 D, Pritsche/Fahrgestell	09.96 -		
		Fahrerhaus-ID:669.899 für:(32) 514121/02 für:(32) 514121/07 für:(32) 514121/08 für:(32) 514121/09 für:(32) 514121/10 für:(32) 514121/13 für:(32) 514122/02	
		670.321-322-323-324 für:(32) 514121/02 für:(32) 514121/08 für:(32) 514121/10 für:(32) 514122/02 benötigte Stückzahl:2	
812 D, Kasten/Kombi	09.96 -		
813 D, 814 D, Kasten/Kombi	09.96 -		
815 D, 816 D, Kasten/Kombi	09.96 -		
		Fahrerhaus-ID:669.599 für:(32) 514121/02 für:(32) 514121/07 für:(32) 514121/08 für:(32) 514121/09 für:(32) 514121/10 für:(32) 514121/13 für:(32) 514122/02	
		Fahrerhaus-ID:669.599 ->Chass. N 071 238 für:(32) 514121/02 für:(32) 514121/07 für:(32) 514121/08 für:(32) 514121/09 für:(32) 514121/10 für:(32) 514121/13 für:(32) 514122/02	
		670.351-352-353 ->Chass. N 071 238 für:(32) 514121/02 für:(32) 514121/08 für:(32) 514121/10 für:(32) 514122/02 benötigte Stückzahl:2	
812 D, Kasten/Kombi	09.96 -	 links oben rechts oben	
813 D, 814 D, Kasten/Kombi	09.96 -		
815 D, 816 D, Kasten/Kombi	09.96 -		
		Fahrerhaus-ID:669.599 für:(32) 514121/02 für:(32) 514121/07 für:(32) 514121/08 für:(32) 514121/09 für:(32) 514121/10 für:(32) 514121/13 für:(32) 514122/02	
		670.351-352-353 für:(32) 514121/02 für:(32) 514121/08 für:(32) 514121/10 für:(32) 514122/02 benötigte Stückzahl:2	





Ref.

MERCEDES-BENZ

VARIO

09.96 -

		26109 01	667 320 00 44
	Stabilisatorlager		
	812 D, Kipper	09.96 -	
	813 D, 814 D, Kipper	09.96 -	
815 D, 816 D, Kipper	09.96 -		
		<p>⊕ ⊗</p> <p>-----</p> <p>Fahrerhaus-ID:669.899 für:(32) 514121/02 für:(32) 514121/07 für:(32) 514121/08 für:(32) 514121/09 für:(32) 514121/10 für:(32) 514121/13 für:(32) 514122/02</p> <p>-----</p> <p>Fahrerhaus-ID:669.899 ->Chass. N 071 238 für:(32) 514121/02 für:(32) 514121/07 für:(32) 514121/08 für:(32) 514121/09 für:(32) 514121/10 für:(32) 514121/13 für:(32) 514122/02</p> <p>-----</p> <p>670.331-332 ->Chass. N 071 238 für:(32) 514121/02 für:(32) 514121/08 für:(32) 514121/10 für:(32) 514122/02 benötigte Stückzahl:2</p>	
		<p>⬇</p> <p>links oben rechts oben</p> <p>-----</p> <p>Fahrerhaus-ID:669.899 für:(32) 514121/02 für:(32) 514121/07 für:(32) 514121/08 für:(32) 514121/09 für:(32) 514121/10 für:(32) 514121/13 für:(32) 514122/02</p> <p>-----</p> <p>670.331-332 für:(32) 514121/02 für:(32) 514121/08 für:(32) 514121/10 für:(32) 514122/02 benötigte Stückzahl:2</p>	
		<p>⊕ ⊗</p> <p>-----</p> <p>Fahrerhaus-ID:669.899 für:(32) 514121/02 für:(32) 514121/07 für:(32) 514121/08 für:(32) 514121/09 für:(32) 514121/10 für:(32) 514121/13 für:(32) 514122/02</p> <p>-----</p> <p>Fahrerhaus-ID:669.899 ->Chass. N 071 238 für:(32) 514121/02 für:(32) 514121/07 für:(32) 514121/08 für:(32) 514121/09 für:(32) 514121/10 für:(32) 514121/13 für:(32) 514122/02 benötigte Stückzahl:2</p>	
		<p>⊕ ⊗</p> <p>-----</p> <p>Fahrerhaus-ID:669.899 für:(32) 514121/02 für:(32) 514121/07 für:(32) 514121/08 für:(32) 514121/09 für:(32) 514121/10 für:(32) 514121/13 für:(32) 514122/02</p> <p>-----</p> <p>Fahrerhaus-ID:669.899 ->Chass. N 071 238 für:(32) 514121/02 für:(32) 514121/07 für:(32) 514121/08 für:(32) 514121/09 für:(32) 514121/10 für:(32) 514121/13 für:(32) 514122/02 benötigte Stückzahl:2</p>	
		<p>⊕ ⊗</p> <p>-----</p> <p>Fahrerhaus-ID:669.899 für:(32) 514121/02 für:(32) 514121/07 für:(32) 514121/08 für:(32) 514121/09 für:(32) 514121/10 für:(32) 514121/13 für:(32) 514122/02</p> <p>-----</p> <p>Fahrerhaus-ID:669.899 ->Chass. N 071 238 für:(32) 514121/02 für:(32) 514121/07 für:(32) 514121/08 für:(32) 514121/09 für:(32) 514121/10 für:(32) 514121/13 für:(32) 514122/02 benötigte Stückzahl:2</p>	
		<p>⊕ ⊗</p> <p>-----</p> <p>Fahrerhaus-ID:669.899 für:(32) 514121/02 für:(32) 514121/07 für:(32) 514121/08 für:(32) 514121/09 für:(32) 514121/10 für:(32) 514121/13 für:(32) 514122/02</p> <p>-----</p> <p>Fahrerhaus-ID:669.899 ->Chass. N 071 238 für:(32) 514121/02 für:(32) 514121/07 für:(32) 514121/08 für:(32) 514121/09 für:(32) 514121/10 für:(32) 514121/13 für:(32) 514122/02 benötigte Stückzahl:2</p>	







MERCEDES-BENZ

VARIO

09.96 -

26109 01 **667 320 00 44**

	Stabilisatorlager		 links oben rechts oben	
813 DA, 814 DA, Pritsche/Fahrgestell	09.96 -	Fahrerhaus-ID:669.899 für:(32) 514121/02 für:(32) 514121/07 für:(32) 514121/08 für:(32) 514121/09 für:(32) 514121/10 für:(32) 514121/13 für:(32) 514122/02		
815 DA, 816 DA, Pritsche/Fahrgestell	09.96 -	670.421-422-423 für:(32) 514122/02 benötigte Stückzahl:2		
813 DA, 814 DA, Kasten/Kombi	09.96 -	 Fahrerhaus-ID:669.599 für:(32) 514121/02 für:(32) 514121/07 für:(32) 514121/08 für:(32) 514121/09 für:(32) 514121/10 für:(32) 514121/13 für:(32) 514122/02		
815 DA, 816 DA, Kasten/Kombi	09.96 -	Fahrerhaus-ID:669.599 ->Chass. N 071 238 für:(32) 514121/02 für:(32) 514121/07 für:(32) 514121/08 für:(32) 514121/09 für:(32) 514121/10 für:(32) 514121/13 für:(32) 514122/02 benötigte Stückzahl:2		
813 DA, 814 DA, Kasten/Kombi	09.96 -	 links oben rechts oben Fahrerhaus-ID:669.599 für:(32) 514121/02 für:(32) 514121/07 für:(32) 514121/08 für:(32) 514121/09 für:(32) 514121/10 für:(32) 514121/13 für:(32) 514122/02		
815 DA, 816 DA, Kasten/Kombi	09.96 -	670.451-452-453 für:(32) 514122/02 benötigte Stückzahl:2		
813 DA, 814 DA, Kipper	09.96 -	 Fahrerhaus-ID:669.899 für:(32) 514121/02 für:(32) 514121/07 für:(32) 514121/08 für:(32) 514121/09 für:(32) 514121/10 für:(32) 514121/13 für:(32) 514122/02		
815 DA, 816 DA, Kipper	09.96 -	Fahrerhaus-ID:669.899 ->Chass. N 071 238 für:(32) 514121/02 für:(32) 514121/07 für:(32) 514121/08 für:(32) 514121/09 für:(32) 514121/10 für:(32) 514121/13 für:(32) 514122/02 benötigte Stückzahl:2		



Ref.

MERCEDES-BENZ

VARIO 09.96 -

Stabilisatorlager			26109 01	667 320 00 44
813 DA, 814 DA, Kipper 815 DA, 816 DA, Kipper	09.96 - 09.96 -	↓ links oben rechts oben		
		Fahrerhaus-ID:669.899 für:(32) 514121/02 für:(32) 514121/07 für:(32) 514121/08 für:(32) 514121/09 für:(32) 514121/10 für:(32) 514121/13 für:(32) 514122/02		
		670.431-432 für:(32) 514122/02 benötigte Stückzahl:2		
810 DT 810 DT, 100 kW 810 DT, 112 kW	04.62 - 06.69 09.96 - 09.96 -	↕		
		Fahrerhaus-ID:669.899 für:(32) 514121/02 für:(32) 514121/07 für:(32) 514121/08 für:(32) 514121/09 für:(32) 514121/10 für:(32) 514121/13 für:(32) 514122/02		
		Fahrerhaus-ID:669.899 ->Chass. N 071 238 für:(32) 514121/02 für:(32) 514121/07 für:(32) 514121/08 für:(32) 514121/09 für:(32) 514121/10 für:(32) 514121/13 für:(32) 514122/02 benötigte Stückzahl:2		
810 DT 810 DT, 100 kW 810 DT, 112 kW	04.62 - 06.69 09.96 - 09.96 -	↓ links oben rechts oben		
		Fahrerhaus-ID:669.899 für:(32) 514121/02 für:(32) 514121/07 für:(32) 514121/08 für:(32) 514121/09 für:(32) 514121/10 für:(32) 514121/13 für:(32) 514122/02 benötigte Stückzahl:2		



MERCEDES-BENZ

VARIO

09.96 -

26928 01 **667 326 06 81**



Stabilisatorlager		▲
512 D, Pritsche/Fahrgestell	09.96 -	1.HA ----- Fahrerhaus-ID:669.899 für:(32) 514132/02 für:(32) 514132/07 ----- Hinterachse beidseitig 667.321-322-323 für:(32) 514132/07 ----- Fahrerhaus-ID:669.899 für:(32) 514132/02 für:(32) 514132/07 benötigte Stückzahl:2
512 D, Kasten/Kombi	09.96 -	1.HA ----- Fahrerhaus-ID:669.599 für:(32) 514132/02 für:(32) 514132/07 ----- Hinterachse beidseitig 667.351-352-353 für:(32) 514132/07 ----- Fahrerhaus-ID:669.599 für:(32) 514132/02 für:(32) 514132/07 benötigte Stückzahl:2
612 D, Pritsche/Fahrgestell	09.96 -	1.HA ----- Fahrerhaus-ID:669.899 für:(32) 514132/02 für:(32) 514132/07 ----- Hinterachse beidseitig Fahrerhaus-ID:669.899 für:(32) 514132/02 für:(32) 514132/07 benötigte Stückzahl:2
612 D, Kipper	09.96 -	
613 D, 614 D, Pritsche/Fahrgestell	09.96 -	
613 D, 614 D, Kipper	09.96 -	
615 D, 616 D, Pritsche/Fahrgestell	09.98 -	
615 D, 616 D, Kipper	09.98 -	
810 DT, 75 kW	09.96 -	
810 DT, 100 kW	09.96 -	
810 DT, 112 kW	09.96 -	
812 D, Pritsche/Fahrgestell	09.96 -	
812 D, Kipper	09.96 -	
813 D, 814 D, Pritsche/Fahrgestell	09.96 -	
813 D, 814 D, Kipper	09.96 -	
815 D, 816 D, Pritsche/Fahrgestell	09.96 -	
815 D, 816 D, Kipper	09.96 -	
612 D, Kasten/Kombi	09.96 -	1.HA ----- Fahrerhaus-ID:669.599 für:(32) 514132/02 für:(32) 514132/07 ----- Hinterachse beidseitig Fahrerhaus-ID:669.599 für:(32) 514132/02 für:(32) 514132/07 benötigte Stückzahl:2
613 D, 614 D, Kasten/Kombi	09.96 -	
615 D, 616 D, Kasten/Kombi	09.98 -	
812 D, Kasten/Kombi	09.96 -	
813 D, 814 D, Kasten/Kombi	09.96 -	
815 D, 816 D, Kasten/Kombi	09.96 -	
813 DA, 814 DA, Pritsche/Fahrgestell	09.96 -	1.HA ----- Fahrerhaus-ID:669.899 für:(32) 514132/02 für:(32) 514132/07 ----- 670.421-422 für:(32) 514132/02 ----- Hinterachse beidseitig Fahrerhaus-ID:669.899 für:(32) 514132/02 für:(32) 514132/07 benötigte Stückzahl:2
815 DA, 816 DA, Pritsche/Fahrgestell	09.96 -	



Ref.

MERCEDES-BENZ

VARIO

09.96 -

	Stabilisatorlager	09.96 - 09.96 -	▲	26928 01	667 326 06 81
	813 DA, 814 DA, Kasten/Kombi 815 DA, 816 DA, Kasten/Kombi		1.HA ----- Fahrerhaus-ID:669.599 für:(32) 514132/02 für:(32) 514132/07 ----- 670.451-452 für:(32) 514132/02 ----- Hinterachse beidseitig Fahrerhaus-ID:669.599 für:(32) 514132/02 für:(32) 514132/07 benötigte Stückzahl:2		
	813 DA, 814 DA, Kipper 815 DA, 816 DA, Kipper	09.96 - 09.96 -	1.HA ----- Fahrerhaus-ID:669.899 für:(32) 514132/02 für:(32) 514132/07 ----- 670.431-432 für:(32) 514132/02 ----- Hinterachse beidseitig Fahrerhaus-ID:669.899 für:(32) 514132/02 für:(32) 514132/07 benötigte Stückzahl:2		



MERCEDES-BENZ

VARIO 09.96 -

Stabilisatorlager		▲	26941 01	670 326 01 81
512 D, Pritsche/Fahrgestell	09.96 -	1.HA		
810 DT, 75 kW	09.96 -	-----		
810 DT, 100 kW	09.96 -	Fahrerhaus-ID:669.899		
810 DT, 112 kW	09.96 -	für:(32) 514132/02		
		für:(32) 514132/03		

		Hinterachse beidseitig		
		Fahrerhaus-ID:669.899		
		für:(32) 514132/02		
		für:(32) 514132/03		
		benötigte Stückzahl:2		
512 D, Kasten/Kombi	09.96 -	1.HA		

		Fahrerhaus-ID:669.599		
		für:(32) 514132/02		
		für:(32) 514132/03		

		Hinterachse beidseitig		
		Fahrerhaus-ID:669.599		
		für:(32) 514132/02		
		für:(32) 514132/03		
		benötigte Stückzahl:2		
612 D, Pritsche/Fahrgestell	09.96 -	1.HA		
613 D, 614 D, Pritsche/Fahrgestell	09.96 -	-----		
615 D, 616 D, Pritsche/Fahrgestell	09.98 -	Fahrerhaus-ID:669.899		
		für:(32) 514132/02		
		für:(32) 514132/03		

		Hinterachse beidseitig		
		668.321-322-323		
		für:(32) 514132/03		

		Fahrerhaus-ID:669.899		
		für:(32) 514132/02		
		für:(32) 514132/03		
		benötigte Stückzahl:2		
612 D, Kasten/Kombi	09.96 -	1.HA		
613 D, 614 D, Kasten/Kombi	09.96 -	-----		
615 D, 616 D, Kasten/Kombi	09.98 -	Fahrerhaus-ID:669.599		
		für:(32) 514132/02		
		für:(32) 514132/03		

		Hinterachse beidseitig		
		668.351-352-353		
		für:(32) 514132/03		

		Fahrerhaus-ID:669.599		
		für:(32) 514132/02		
		für:(32) 514132/03		
		benötigte Stückzahl:2		
612 D, Kipper	09.96 -	1.HA		
613 D, 614 D, Kipper	09.96 -	-----		
615 D, 616 D, Kipper	09.98 -	Fahrerhaus-ID:669.899		
		für:(32) 514132/02		
		für:(32) 514132/03		

		Hinterachse beidseitig		
		668.331-332		
		für:(32) 514132/03		

		Fahrerhaus-ID:669.899		
		für:(32) 514132/02		
		für:(32) 514132/03		
		benötigte Stückzahl:2		
812 D, Pritsche/Fahrgestell	09.96 -	1.HA		
813 D, 814 D, Pritsche/Fahrgestell	09.96 -	-----		
815 D, 816 D, Pritsche/Fahrgestell	09.96 -	Fahrerhaus-ID:669.899		
		für:(32) 514132/02		
		für:(32) 514132/03		

		Hinterachse beidseitig		
		Fahrerhaus-ID:669.899		
		für:(32) 514132/02		
		für:(32) 514132/03		

		670.321-322-323-324		
		für:(32) 514132/03		
		benötigte Stückzahl:2		



Ref.

MERCEDES-BENZ

VARIO 09.96 -

Stabilisatorlager		▲	26941 01	670 326 01 81
812 D, Kasten/Kombi	09.96 -	1.HA		
813 D, 814 D, Kasten/Kombi	09.96 -	Fahrerhaus-ID:669.599 für:(32) 514132/02 für:(32) 514132/03		
815 D, 816 D, Kasten/Kombi	09.96 -	Hinterachse beidseitig Fahrerhaus-ID:669.599 für:(32) 514132/02 für:(32) 514132/03		
		670.351-352-353 für:(32) 514132/03 benötigte Stückzahl:2		
812 D, Kipper	09.96 -	1.HA		
813 D, 814 D, Kipper	09.96 -	Fahrerhaus-ID:669.899 für:(32) 514132/02 für:(32) 514132/03		
815 D, 816 D, Kipper	09.96 -	Hinterachse beidseitig Fahrerhaus-ID:669.899 für:(32) 514132/02 für:(32) 514132/03		
		670.331-332 für:(32) 514132/03 benötigte Stückzahl:2		
813 DA, 814 DA, Pritsche/Fahrgestell	09.96 -	1.HA		
815 DA, 816 DA, Pritsche/Fahrgestell	09.96 -	Fahrerhaus-ID:669.899 für:(32) 514132/02 für:(32) 514132/03		
		für:(32) 514132/02		
		Hinterachse beidseitig Fahrerhaus-ID:669.899 für:(32) 514132/02 für:(32) 514132/03		
		670.421-422/422-423 für:(32) 514132/03 benötigte Stückzahl:2		
813 DA, 814 DA, Kasten/Kombi	09.96 -	1.HA		
815 DA, 816 DA, Kasten/Kombi	09.96 -	Fahrerhaus-ID:669.599 für:(32) 514132/02 für:(32) 514132/03		
		für:(32) 514132/02		
		Hinterachse beidseitig Fahrerhaus-ID:669.599 für:(32) 514132/02 für:(32) 514132/03		
		670.451-452/452-453 für:(32) 514132/03 benötigte Stückzahl:2		
813 DA, 814 DA, Kipper	09.96 -	1.HA		
815 DA, 816 DA, Kipper	09.96 -	Fahrerhaus-ID:669.899 für:(32) 514132/02 für:(32) 514132/03		
		für:(32) 514132/02		
		Hinterachse beidseitig Fahrerhaus-ID:669.899 für:(32) 514132/02 für:(32) 514132/03		
		670.431-432/432 für:(32) 514132/03 benötigte Stückzahl:2		



MERCEDES-BENZ

VARIO

09.96 -



	Lagerbuchse, Blattfeder	09.96 -	▲	26110 01	670 320 03 44
	512 D, Pritsche/Fahrgestell				
			Fahrerhaus-ID:669.899 für:(32) 514121/03 für:(32) 514121/04 für:(32) 514121/05 für:(32) 514121/11 für:(32) 514121/14		
			Fahrerhaus-ID:669.899 ->Chass. N 071 238 für:(32) 514121/03 für:(32) 514121/04 für:(32) 514121/05 für:(32) 514121/11 für:(32) 514121/14 benötigte Stückzahl:2		
	512 D, Kasten/Kombi				
			Fahrerhaus-ID:669.599 für:(32) 514121/03 für:(32) 514121/04 für:(32) 514121/05 für:(32) 514121/11 für:(32) 514121/14		
			Fahrerhaus-ID:669.599 ->Chass. N 071 238 für:(32) 514121/03 für:(32) 514121/04 für:(32) 514121/05 für:(32) 514121/11 für:(32) 514121/14 benötigte Stückzahl:2		
	612 D, Pritsche/Fahrgestell 613 D, 614 D, Pritsche/Fahrgestell 615 D, 616 D, Pritsche/Fahrgestell	09.96 - 09.96 - 09.98 -			
			für:(32) 514121/05 für:(32) 514121/11		
			668.321-322-323/321 ->Chass. N 071 238 für:(32) 514121/05 für:(32) 514121/11		
			Fahrerhaus-ID:669.899 für:(32) 514121/03 für:(32) 514121/04 für:(32) 514121/05 für:(32) 514121/11 für:(32) 514121/14		
			Fahrerhaus-ID:669.899 ->Chass. N 071 238 für:(32) 514121/03 für:(32) 514121/04 für:(32) 514121/05 für:(32) 514121/11 für:(32) 514121/14 benötigte Stückzahl:2		



Ref.

MERCEDES-BENZ

VARIO 09.96 -

		▲	26110 01	670 320 03 44
	Lagerbuchse, Blattfeder			
	612 D, Kasten/Kombi	09.96 -		
	613 D, 614 D, Kasten/Kombi	09.96 -		
615 D, 616 D, Kasten/Kombi	09.98 -			
		<p>⊕ ⊖</p> <p>-----</p> <p>668.351-352-353 ->Chass. N 071 238 für:(32) 514121/11</p> <p>-----</p> <p>Fahrerhaus-ID:669.599 für:(32) 514121/03 für:(32) 514121/04 für:(32) 514121/05 für:(32) 514121/11 für:(32) 514121/14</p> <p>-----</p> <p>Fahrerhaus-ID:669.599 ->Chass. N 071 238 für:(32) 514121/03 für:(32) 514121/04 für:(32) 514121/05 für:(32) 514121/11 für:(32) 514121/14 benötigte Stückzahl:2</p>		
		<p>⊕ ⊖</p> <p>-----</p> <p>668.331-332 ->Chass. N 071 238 für:(32) 514121/11</p> <p>-----</p> <p>Fahrerhaus-ID:669.899 für:(32) 514121/03 für:(32) 514121/04 für:(32) 514121/05 für:(32) 514121/11 für:(32) 514121/14</p> <p>-----</p> <p>Fahrerhaus-ID:669.899 ->Chass. N 071 238 für:(32) 514121/03 für:(32) 514121/04 für:(32) 514121/05 für:(32) 514121/11 für:(32) 514121/14 benötigte Stückzahl:2</p>		
		<p>⊕ ⊖</p> <p>-----</p> <p>Fahrerhaus-ID:669.899 für:(32) 514121/03 für:(32) 514121/04 für:(32) 514121/05 für:(32) 514121/11 für:(32) 514121/14</p> <p>-----</p> <p>Fahrerhaus-ID:669.899 ->Chass. N 071 238 für:(32) 514121/03 für:(32) 514121/04 für:(32) 514121/05 für:(32) 514121/11 für:(32) 514121/14</p> <p>-----</p> <p>für:(32) 514121/05</p> <p>-----</p> <p>für:(32) 044101/05 für:(32) 514121/03 für:(32) 514121/11 für:(32) 514121/14</p> <p>-----</p> <p>670.321-322-323/321-322-323-324/321 ->Chass. N 071 238 für:(32) 044101/05 für:(32) 514121/03 für:(32) 514121/11 für:(32) 514121/14 benötigte Stückzahl:2</p>		
	812 D, Pritsche/Fahrgestell	09.96 -		
	813 D, 814 D, Pritsche/Fahrgestell	09.96 -		
	815 D, 816 D, Pritsche/Fahrgestell	09.96 -		





MERCEDES-BENZ

VARIO

09.96 -

26110 01

670 320 03 44

 Lagerbuchse, Blattfeder	▲	
812 D, Kasten/Kombi 09.96 - 813 D, 814 D, Kasten/Kombi 09.96 - 815 D, 816 D, Kasten/Kombi 09.96 -	Ⓡ Ⓢ ----- Fahrerhaus-ID:669.599 für:(32) 514121/03 für:(32) 514121/04 für:(32) 514121/05 für:(32) 514121/11 für:(32) 514121/14 ----- Fahrerhaus-ID:669.599 ->Chass. N 071 238 für:(32) 514121/03 für:(32) 514121/04 für:(32) 514121/05 für:(32) 514121/11 für:(32) 514121/14 ----- für:(32) 044101/05 für:(32) 514121/03 für:(32) 514121/11 für:(32) 514121/14 ----- 670.351-352-353/351 ->Chass. N 071 238 für:(32) 044101/05 für:(32) 514121/03 für:(32) 514121/11 für:(32) 514121/14 benötigte Stückzahl:2	
812 D, Kipper 09.96 - 813 D, 814 D, Kipper 09.96 - 815 D, 816 D, Kipper 09.96 -	Ⓡ Ⓢ ----- Fahrerhaus-ID:669.899 für:(32) 514121/03 für:(32) 514121/04 für:(32) 514121/05 für:(32) 514121/11 für:(32) 514121/14 ----- Fahrerhaus-ID:669.899 ->Chass. N 071 238 für:(32) 514121/03 für:(32) 514121/04 für:(32) 514121/05 für:(32) 514121/11 für:(32) 514121/14 ----- für:(32) 044101/05 für:(32) 514121/03 für:(32) 514121/11 ----- 670.331-332/331 ->Chass. N 071 238 für:(32) 044101/05 für:(32) 514121/03 für:(32) 514121/11 benötigte Stückzahl:2	
813 DA, 814 DA, Pritsche/Fahrgestell 09.96 - 815 DA, 816 DA, Pritsche/Fahrgestell 09.96 -	Ⓡ Ⓢ ----- Fahrerhaus-ID:669.899 für:(32) 514121/03 für:(32) 514121/04 für:(32) 514121/05 für:(32) 514121/11 für:(32) 514121/14 ----- Fahrerhaus-ID:669.899 ->Chass. N 071 238 für:(32) 514121/03 für:(32) 514121/04 für:(32) 514121/05 für:(32) 514121/11 für:(32) 514121/14 ----- 670.421-422-423 ->Chass. N 071 238 für:(32) 514121/04 benötigte Stückzahl:2	



Ref.

MERCEDES-BENZ

VARIO

09.96 -

	Lagerbuchse, Blattfeder		▲	26110 01	670 320 03 44		
	813 DA, 814 DA, Kasten/Kombi 815 DA, 816 DA, Kasten/Kombi	09.96 - 09.96 -					
			Fahrerhaus-ID:669.599 für:(32) 514121/03 für:(32) 514121/04 für:(32) 514121/05 für:(32) 514121/11 für:(32) 514121/14				
			Fahrerhaus-ID:669.599 ->Chass. N 071 238 für:(32) 514121/03 für:(32) 514121/04 für:(32) 514121/05 für:(32) 514121/11 für:(32) 514121/14				
			670.451-452-453 ->Chass. N 071 238 für:(32) 514121/04 benötigte Stückzahl:2				
	813 DA, 814 DA, Kipper 815 DA, 816 DA, Kipper	09.96 - 09.96 -					
			Fahrerhaus-ID:669.899 für:(32) 514121/03 für:(32) 514121/04 für:(32) 514121/05 für:(32) 514121/11 für:(32) 514121/14				
			Fahrerhaus-ID:669.899 ->Chass. N 071 238 für:(32) 514121/03 für:(32) 514121/04 für:(32) 514121/05 für:(32) 514121/11 für:(32) 514121/14				
			670.431-432 ->Chass. N 071 238 für:(32) 514121/04 benötigte Stückzahl:2				
	810 DT 810 DT, 100 kW 810 DT, 112 kW	04.62 - 06.69 09.96 - 09.96 -					
			Fahrerhaus-ID:669.899 für:(32) 514121/03 für:(32) 514121/04 für:(32) 514121/05 für:(32) 514121/11 für:(32) 514121/14				
			Fahrerhaus-ID:669.899 ->Chass. N 071 238 für:(32) 514121/03 für:(32) 514121/04 für:(32) 514121/05 für:(32) 514121/11 für:(32) 514121/14				
			Baumuster:670.398 für:(32) 044101/05 benötigte Stückzahl:2				







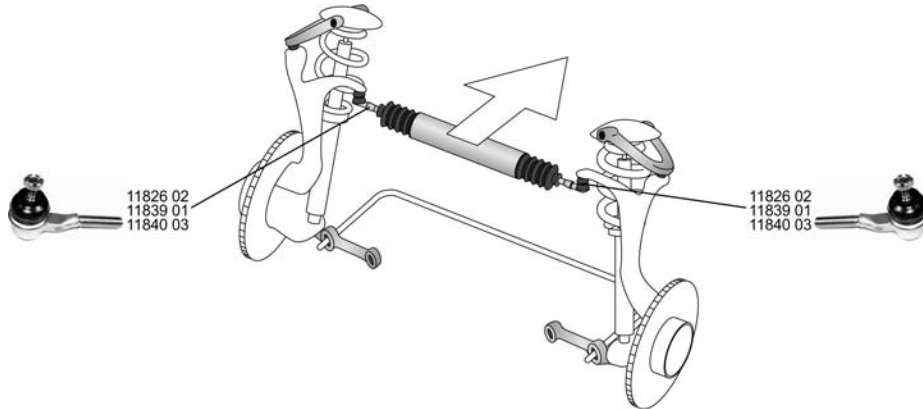

MITSUBISHI

L 200 Pick-Up (K_4T)

11.86 - 08.96











Spurstangenkopf Gewindeart: mit Linksgewinde Gewindemaß: M14x1,5 2.5 D (K14T)	11.86 - 08.96		11826 02 MB 378704 
Spurstangenkopf Gewindeart: mit Linksgewinde Aussengewinde [mm]: M16x1,5 2.5 D 4WD (K24T) 2.5 TD 4WD (K34T)	12.87 - 05.93		11839 01 MB 315775 
	11.92 - 08.96		
Spurstangenkopf Gewindeart: mit Rechtsgewinde Aussengewinde [mm]: M16x1,5 2.5 D 4WD (K24T) 2.5 TD 4WD (K34T)	12.87 - 05.93		11840 03 MB 315776 
	11.92 - 08.96		

L 300 Bus/Familial (LO3_P/G, LO_2P)

05.80 - 02.87















Spurstangenkopf Gewindeart: mit Rechtsgewinde Innengewinde [mm]: M14x1,5 Gewindemaß: M10x1,25 1.6 (L032P, L062P), 48 kW 2.3 D (L038P)	09.81 - 10.86		11841 01 MB 912519 	
	04.83 - 10.86			01.1982->
Spurstangenkopf Gewindeart: mit Rechtsgewinde Innengewinde [mm]: M14x1,5 1.6 (L032P, L062P), 51 kW 1.8 4x4 (L035G) 2.0 4x4 (L037G)	11.84 - 02.87		11842 02 MB 864164 	
	08.84 - 02.87			
	11.86 - 02.87			
Spurstangenkopf Gewindeart: mit Rechtsgewinde 1.6 (L032P, L062P), 48 kW	09.81 - 10.86		15450 01 MB 315629 	
				->12.1981
Spurstangenkopf Gewindemaß: M14x1,5 Gewindeart: mit Linksgewinde 1.6 (L032P, L062P), 48 kW 2.3 D (L038P)	09.81 - 10.86		15562 02 MB 288119 	
	04.83 - 10.86			01.1982->



Ref.



MITSUBISHI

L 300 Bus/Familial (LO3_P/G, LO_2P) 05.80 - 02.87

 Axialgelenk, Spurstange Gewindeart: mit Rechtsgewinde Gewindemaß: M14x1,5		15566 02 MB 532971 
1.6 (L032P, L062P), 51 kW 1.8 4x4 (L035G) 2.0 4x4 (L037G)	11.84 - 02.87 08.84 - 02.87 11.86 - 02.87 	
Trag-/Führungsgelenk		11847 01 MB 175544
1.6 (L032P, L062P), 48 kW 2.3 D (L038P)	09.81 - 10.86 04.83 - 10.86 ->10.1983	
Trag-/Führungsgelenk Konusmaß [mm]: 15,9		11849 03 MB 176309
1.6 (L032P, L062P), 48 kW 2.3 D (L038P)	09.81 - 10.86 04.83 - 10.86 11.1983->	
Trag-/Führungsgelenk		11852 01 MB 527350
1.6 (L032P, L062P), 51 kW 1.8 4x4 (L035G) 2.0 4x4 (L037G)	11.84 - 02.87 08.84 - 02.87 11.86 - 02.87	
Trag-/Führungsgelenk		11853 03 MB 527383-01
1.6 (L032P, L062P), 51 kW 2.0 4x4 (L037G) 1.8 4x4 (L035G)	11.84 - 02.87 11.86 - 02.87 08.84 - 02.87 01.1986->	

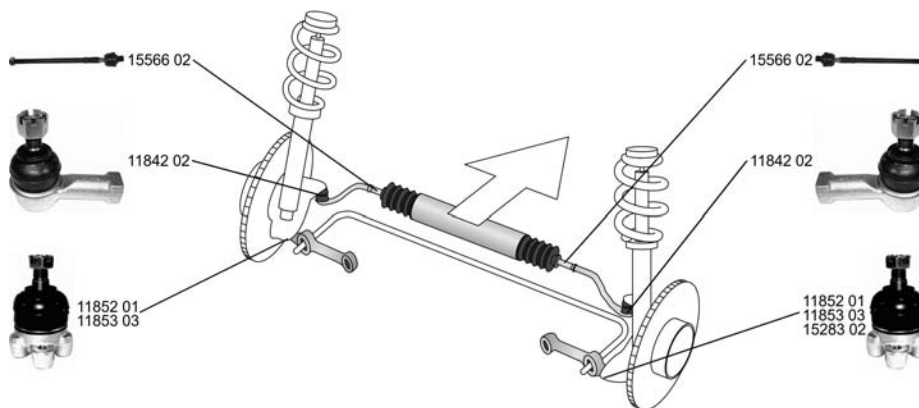
L 300 Bus/Familial (P0_W, P1_W, P2_W) 11.86 -













Spurstangenkopf Gewindeart: mit Rechtsgewinde Innengewinde [mm]: M14x1,5		11842 02 MB 864164 
1.6 (P02V, P12V) 2.0 (P03W) 2.0 4WD (P23V, P23W) 2.0 (P03W, P03V, P13V) 2.0 4WD (P23W) 2.0 (P00W) 2.4 4WD (P24W, P24V), 80 kW 2.4 4WD (P24W, P24V), 82 kW 2.4 (P04W, P14V, P04V) 2.5 D (P05W, P05V, P15V) 2.5 TD 4WD (P25W, P25V)	11.86 - 11.86 - 12.86 - 11.86 - 11.86 - 07.96 - 11.86 - 12.90 11.90 - 11.90 - 11.86 - 11.88 -	



Ref.



MITSUBISHI

L 300 Bus/Familial (P0_W, P1_W, P2_W) 11.86 -

 Axialgelenk, Spurstange Gewindeart: mit Rechtsgewinde Gewindemaß: M14x1,5		15566 02 MB 532971 
1.6 (P02V, P12V) 11.86 - 2.0 (P03W) 11.86 - 2.0 4WD (P23V, P23W) 12.86 - 2.0 (P03W, P03V, P13V) 11.86 - 2.0 4WD (P23W) 11.86 - 2.0 (P00W) 07.96 - 2.4 4WD (P24W, P24V), 80 kW 11.86 - 12.90 2.4 4WD (P24W, P24V), 82 kW 11.90 - 2.4 (P04W, P14V, P04V) 11.90 - 2.5 D (P05W, P05V, P15V) 11.86 - 2.5 TD 4WD (P25W, P25V) 11.88 -		
Trag-/Führungsgelenk 1.6 (P02V, P12V) 11.86 - 2.0 (P03W) 11.86 - 2.0 4WD (P23V, P23W) 12.86 - 2.0 (P03W, P03V, P13V) 11.86 - 2.0 4WD (P23W) 11.86 - 2.4 4WD (P24W, P24V), 80 kW 11.86 - 12.90 2.4 4WD (P24W, P24V), 82 kW 11.90 - 2.4 (P04W, P14V, P04V) 11.90 - 2.5 D (P05W, P05V, P15V) 11.86 - 2.5 TD 4WD (P25W, P25V) 11.88 -		11852 01 MB 527350 
Trag-/Führungsgelenk 1.6 (P02V, P12V) 11.86 - 2.0 (P03W) 11.86 - 2.0 4WD (P23V, P23W) 12.86 - 2.0 (P03W, P03V, P13V) 11.86 - 2.0 4WD (P23W) 11.86 - 2.4 4WD (P24W, P24V), 80 kW 11.86 - 12.90 2.4 4WD (P24W, P24V), 82 kW 11.90 - 2.4 (P04W, P14V, P04V) 11.90 - 2.5 D (P05W, P05V, P15V) 11.86 - 2.5 TD 4WD (P25W, P25V) 11.88 -		11853 03 MB 527383-01 
Trag-/Führungsgelenk 2.0 4WD (P23V, P23W) 12.86 - 2.0 4WD (P23W) 11.86 - 2.4 4WD (P24W, P24V), 80 kW 11.86 - 12.90 2.4 4WD (P24W, P24V), 82 kW 11.90 - 2.5 TD 4WD (P25W, P25V) 11.88 -		15283 02 MB 527352 

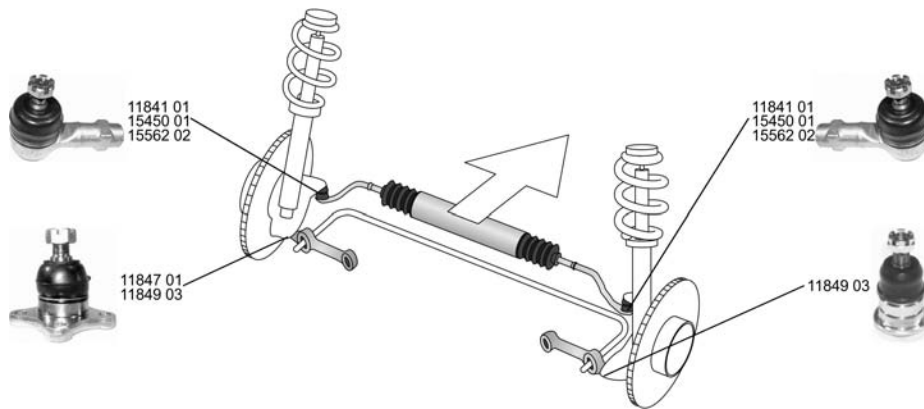
L 300 Kasten/Box/Furgón/Van (L03_P) 05.80 - 02.87







Spurstangenkopf Gewindeart: mit Rechtsgewinde Innengewinde [mm]: M14x1,5 Gewindemaß: M10x1,25		11841 01 MB 912519 
2.3 D (L038P, L068P) 09.83 - 10.86		



Ref.



MITSUBISHI

L 300 Kasten/Box/Furgón/Van 05.80 - 02.87 (L03_P)

 Spurstangenkopf Gewindeart: mit Rechtsgewinde 1.6 (L032P, L062P)	05.80 - 10.86	->12.1981	 15450 01 MB 315629
Spurstangenkopf Gewindemaß: M14x1,5 Gewindeart: mit Linksgewinde 2.3 D (L038P, L068P)	09.83 - 10.86		 15562 02 MB 288119
Trag-/Führungsgelenk 1.6 (L032P, L062P)	05.80 - 10.86	->10.1983	 11847 01 MB 175544
Trag-/Führungsgelenk Konusmaß [mm]: 15,9 1.6 (L032P, L062P) 2.3 D (L038P, L068P)	05.80 - 10.86	11.1983->	 11849 03 MB 176309
	09.83 - 10.86		

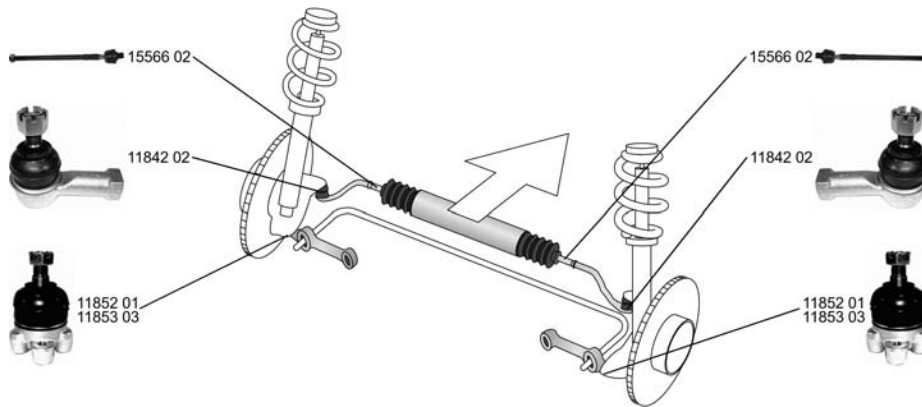
L 300 Kasten/Box/Furgón/Van 11.86 - (P0_W, P1_W)





Spurstangenkopf Gewindeart: mit Rechtsgewinde Innengewinde [mm]: M14x1,5 1.6 (P12V, P02V) 2.0 (P03V, P13V) 2.5 D (P05V, P05W, P15V)	11.86 - 05.94		 11842 02 MB 864164
	11.86 -		
	11.86 -		
Axialgelenk, Spurstange Gewindeart: mit Rechtsgewinde Gewindemaß: M14x1,5 1.6 (P12V, P02V) 2.0 (P03V, P13V) 2.5 D (P05V, P05W, P15V)	11.86 - 05.94		 15566 02 MB 532971
	11.86 -		
	11.86 -		
Trag-/Führungsgelenk 1.6 (P12V, P02V) 2.0 (P03V, P13V) 2.5 D (P05V, P05W, P15V)	11.86 - 05.94		 11852 01 MB 527350
	11.86 -		
	11.86 -		







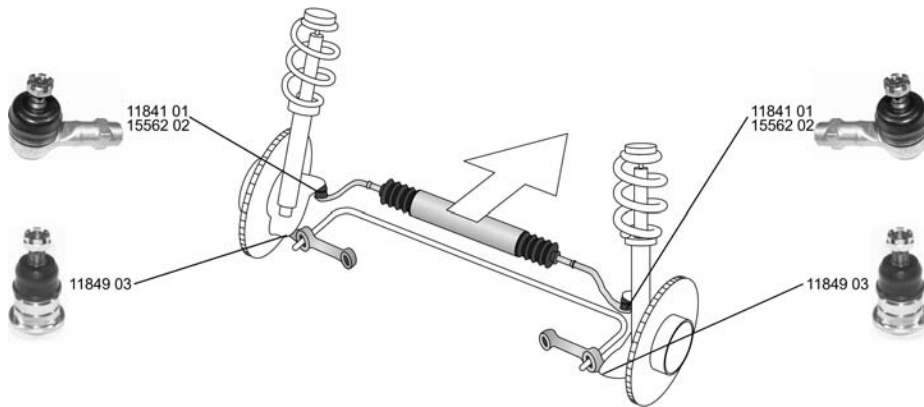

MITSUBISHI

L 300 Kasten/Box/Furgón/Van 11.86 - (P0_W, P1_W)

	Trag-/Führungsgelenk			11853 03	MB 527383-01
	1.6 (P12V, P02V)	11.86 - 05.94			
	2.0 (P03V, P13V)	11.86 -			
	2.5 D (P05V, P05W, P15V)	11.86 -			

L 300 Pritsche, Fahrgestell / Flatbed, Chassis (L03_P) 05.80 - 04.94



Spurstangenkopf Gewindeart: mit Rechtsgewinde Innengewinde [mm]: M14x1,5 Gewindemaß: M10x1,25 ALL TYPES		11841 01	MB 912519
			
Spurstangenkopf Gewindemaß: M14x1,5 Gewindeart: mit Linksgewinde ALL TYPES		15562 02	MB 288119
			
Trag-/Führungsgelenk Konusmaß [mm]: 15,9 ALL TYPES		11849 03	MB 176309
			







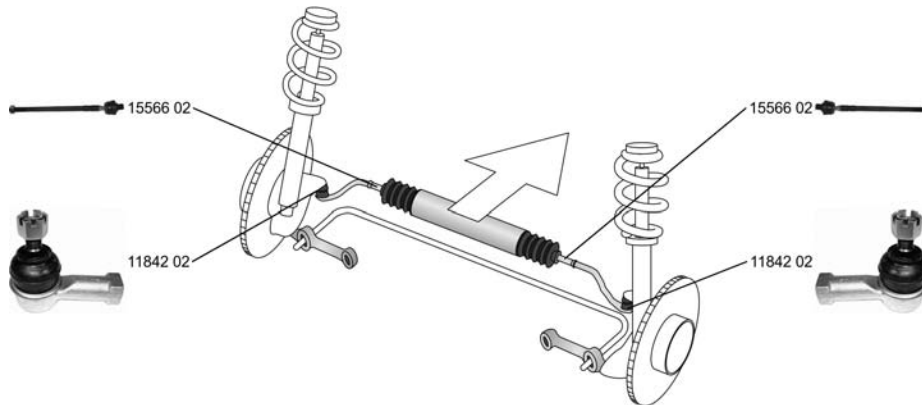

Ref.

MITSUBISHI

**L 300 Pritsche, Fahrgestell /
Flatbed, Chassis (P1_T)**

04.94 -



<p>Spurstangenkopf Gewindeart: mit Rechtsgewinde Innengewinde [mm]: M14x1,5</p>		<p>11842 02 MB 864164</p> 
<p>2.0 (P13T) 07.94 - 2.5 D (P15T) 11.94 -</p>		<p>15566 02 MB 532971</p> 
<p>Axialgelenk, Spurstange Gewindeart: mit Rechtsgewinde Gewindemaß: M14x1,5</p>	 	
<p>2.0 (P13T) 07.94 - 2.5 D (P15T) 11.94 -</p>		









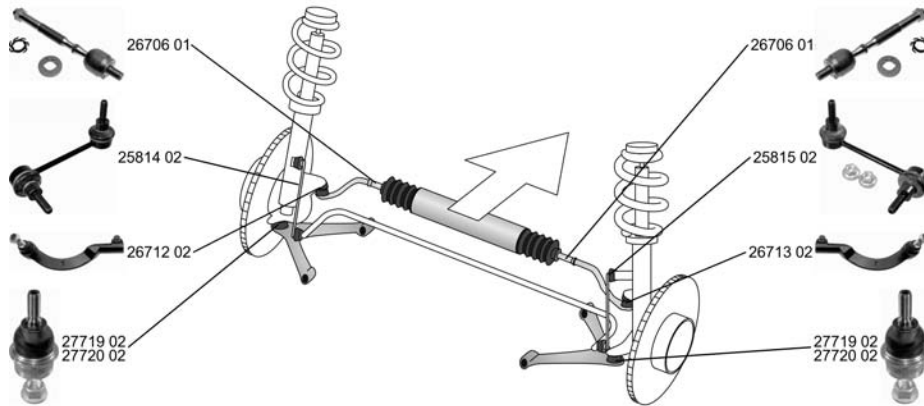







NISSAN

INTERSTAR Bus (X70)

07.02 -



Spurstangenkopf ALL TYPES		26712 02 48520-00QAH 
Spurstangenkopf ALL TYPES		26713 02 48520-00QAJ 
Axialgelenk, Spurstange Gewindemaß: M14x1,5 Gewindemaß: M16x1,5 mit Zubehör ALL TYPES		26706 01 48521-00QAF 
Trag-/Führungsgelenk mit Zubehör ALL TYPES		27719 02 40160-00QAB 
Trag-/Führungsgelenk mit Zubehör ALL TYPES	 ->09.2007	27720 02 40160-00QAD 
Stange/Strebe, Stabilisator Pendelstange mit Zubehör ALL TYPES ausser : dCi 100, 74 kW 04.06 - dCi 120, 88 kW 09.06 - dCi 150 09.06 -		25814 02 54616- 00QAB 
Stange/Strebe, Stabilisator Pendelstange mit Zubehör ALL TYPES ausser : dCi 100, 74 kW 04.06 - dCi 120, 88 kW 09.06 - dCi 150 09.06 -		25815 02 54618-00QAA 



Ref.

NISSAN

INTERSTAR Kasten (X70)

07.02 -

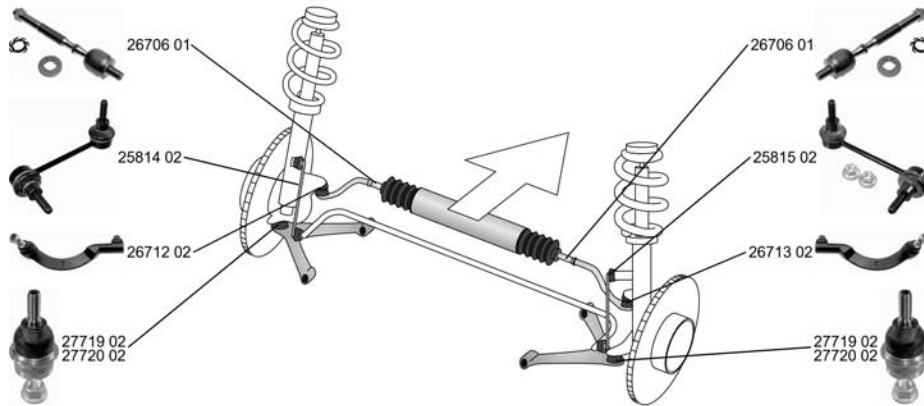

Spurstangenkopf ALL TYPES		26712 02 48520-00QAH
Spurstangenkopf ALL TYPES		26713 02 48520-00QAJ
Axialgelenk, Spurstange Gewindemaß: M14x1,5 Gewindemaß: M16x1,5 mit Zubehör ALL TYPES		26706 01 48521-00QAF
Trag-/Führungsgelenk mit Zubehör ALL TYPES		27719 02 40160-00QAB
Trag-/Führungsgelenk mit Zubehör ALL TYPES		27720 02 40160-00QAD
Stange/Strebe, Stabilisator Pendelstange mit Zubehör ALL TYPES ausser : dCi 100, 74 kW 04.06 - dCi 120, 88 kW 07.02 - dCi 150 09.06 -		25814 02 54616- 00QAB
Stange/Strebe, Stabilisator Pendelstange mit Zubehör ALL TYPES ausser : dCi 100, 74 kW 04.06 - dCi 120, 88 kW 07.02 - dCi 150 09.06 -		25815 02 54618-00QAA









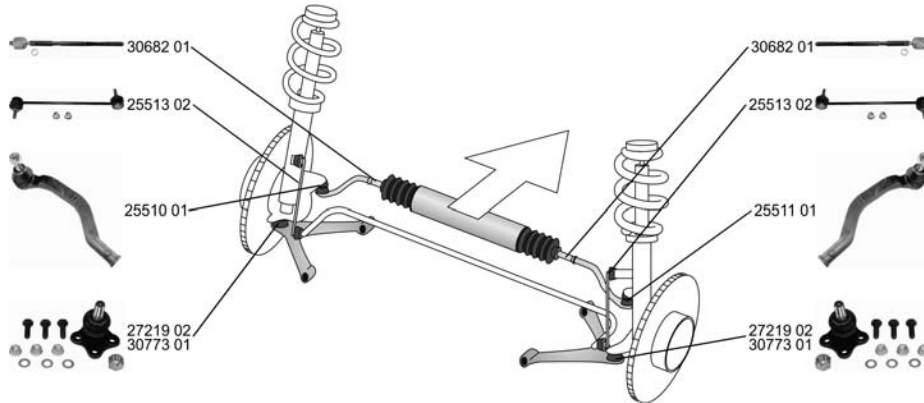







NISSAN

PRIMASTAR Bus (X83)

09.02 -



Spurstangenkopf 2.0 dCi 80 dCi 100 dCi 140	03.01 - 03.01 - 03.01 - 09.03 -		25510 01  48520-00QAK
Spurstangenkopf 2.0 dCi 80 dCi 100 dCi 140	03.01 - 03.01 - 03.01 - 09.03 -		25511 01  48520-00QAL
Axialgelenk, Spurstange radseitig Gewindemaß: M12x1,0 Gewindemaß: M14x1,5 2.0 dCi 80 dCi 100 dCi 140	03.01 - 03.01 - 03.01 - 09.03 -		30682 01  48520-00QAM
Trag-/Führungsgelenk Konusmaß [mm]: 19,55 Bohrung-Ø [mm]: 10 mit Zubehör 2.0 dCi 80 dCi 100 dCi 140	03.01 - 03.01 - 03.01 - 09.03 -	 ->10.2006	27219 02 
Trag-/Führungsgelenk Konusmaß [mm]: 19,55 Bohrung-Ø [mm]: 12 mit Zubehör 2.0 dCi 80 dCi 100 dCi 140	03.01 - 03.01 - 03.01 - 09.03 -	 10.2006->	30773 01  40160-00Q0A
Lagerung, Lenker 2.0 dCi 80 dCi 100 dCi 140	03.01 - 03.01 - 03.01 - 09.03 -		26938 01 
Lagerung, Lenker 2.0 dCi 80 dCi 100 dCi 140	03.01 - 03.01 - 03.01 - 09.03 -		26939 01 





Ref.

NISSAN

PRIMASTAR Bus (X83)





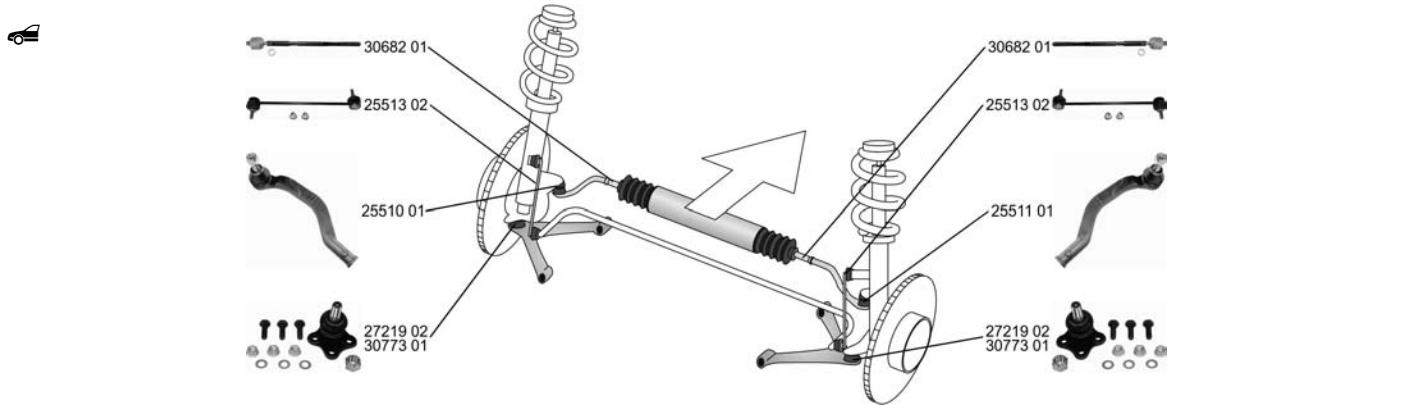

09.02 -

 Stange/Strebe, Stabilisator Pendelstange mit Zubehör			25513 02	54616-00QAC	
	2.0		03.01 -		
	dCi 80		03.01 -		
	dCi 100		03.01 -		
dCi 140	09.03 -				

PRIMASTAR Kasten (X83)

09.02 -







Spurstangenkopf 2.0 dCi 80 dCi 100 dCi 140	02.03 -		25510 01	48520-00QAK
	09.02 -			
	09.02 -			
	09.03 -			
Spurstangenkopf 2.0 dCi 80 dCi 100 dCi 140	02.03 -		25511 01	48520-00QAL
	09.02 -			
	09.02 -			
	09.03 -			
Axialgelenk, Spurstange radseitig Gewindemaß: M12x1,0 Gewindemaß: M14x1,5 2.0 dCi 80 dCi 100 dCi 140	02.03 -		30682 01	48520-00QAM
	09.02 -			
	09.02 -			
	09.03 -			
Trag-/Führungsgelenk Konusmaß [mm]: 19,55 Bohrung-Ø [mm]: 10 mit Zubehör 2.0 dCi 80 dCi 100 dCi 140	02.03 -		27219 02	
	09.02 -		->10.2006	
	09.02 -			
	09.03 -			
Trag-/Führungsgelenk Konusmaß [mm]: 19,55 Bohrung-Ø [mm]: 12 mit Zubehör 2.0 dCi 80 dCi 100 dCi 140	02.03 -		30773 01	40160-00Q0A
	09.02 -		10.2006->	
	09.02 -			
	09.03 -			
Lagerung, Lenker 2.0 dCi 80 dCi 100 dCi 140	02.03 -		26938 01	
	09.02 -			
	09.02 -			
	09.03 -			



NISSAN





PRIMASTAR Kasten (X83)

09.02 -

	Lagerung, Lenker			26939 01	
	2.0	02.03 -			
	dCi 80	09.02 -			
	dCi 100	09.02 -			
	dCi 140	09.03 -			
	Stange/Strebe, Stabilisator			25513 02	
	Pendelstange mit Zubehör			54616-00QAC	
	2.0	02.03 -			
	dCi 80	09.02 -			
	dCi 100	09.02 -			
	dCi 140	09.03 -			





URVAN Bus/Familial (E23)

07.80 - 11.88

	Trag-/Führungsgelenk			11860 02	
	1.8	04.82 - 02.87			
	2.0 (E23B)	12.82 - 11.88			
	2.3 D (E23B)	04.85 - 11.88			
	Trag-/Führungsgelenk			11873 03	
	1.8	04.82 - 02.87			
	2.0 (E23B)	12.82 - 11.88			
	2.3 D (E23B)	04.85 - 11.88			







URVAN Kasten/Box/Furgón/Van (E23)

07.80 - 05.87

	Trag-/Führungsgelenk			11860 02	
	ALL TYPES				
	Trag-/Führungsgelenk			11873 03	
	ALL TYPES				

URVAN Bus/Familial (E24)

11.86 - 04.97

	Spurstange			16284 01	
	2.0, 65 kW	06.86 - 09.94			
	2.4 i	05.89 - 09.93			
	2.5 D	05.89 - 10.96			
	Spurstangenkopf			16304 01	
	Gewindemaß: M14x1,5 Gewindeart: mit Rechtsgewinde				
	2.0, 65 kW	06.86 - 09.94			
	2.4 i	05.89 - 09.93			
	2.5 D	05.89 - 10.96			
	Spurstangenkopf			16307 02	
	Gewindeart: mit Rechtsgewinde Gewindemaß: M16x1,5				
	2.4 i	05.89 - 09.93			
	2.5 D	05.89 - 10.96			











Ref.

NISSAN











URVAN Bus/Familial (E24)

11.86 - 04.97

 Spurstangenkopf Gewindeart: mit Linksgewinde Gewindemaß: M16x1,5			16308 02 48641-01N25 
	2.4 i	05.89 - 09.93	
2.5 D	05.89 - 10.96		
Axialgelenk, Spurstange			16296 01 48521-27N25 
2.4 i	05.89 - 09.93		
2.5 D	05.89 - 10.96		
Trag-/Führungsgelenk			11860 02 40110-01G26 
2.0, 65 kW	06.86 - 09.94		
2.4 i	05.89 - 09.93		
2.5 D	05.89 - 10.96		
Trag-/Führungsgelenk			11863 02 40160-01N25 
2.4 i	05.89 - 09.93		
2.5 D	05.89 - 10.96		

URVAN Kasten/Box/Furgón/Van (E24)

05.87 - 05.97

 Spurstange			16284 01 48510-01N25 	
	2.0			05.87 - 05.97
	2.0, 65 kW			06.86 - 09.94
	2.3 D			01.88 - 05.97
	2.4, 72 kW			10.93 - 05.97
	2.5 D			12.88 - 05.97
	2.4, 74 kW			02.92 - 04.97
Spurstangenkopf Gewindemaß: M14x1,5 Gewindeart: mit Rechtsgewinde			16304 01 48520-27N25 	
2.0	05.87 - 05.97			
2.0, 65 kW	06.86 - 09.94			
2.3 D	01.88 - 05.97			
2.4, 72 kW	10.93 - 05.97			
2.5 D	12.88 - 05.97			
2.4, 74 kW	02.92 - 04.97			
Spurstangenkopf Gewindeart: mit Rechtsgewinde Gewindemaß: M16x1,5			16307 02 48640-01N25 	
2.0, 64 kW	05.87 - 05.97			
2.3 D	01.88 - 05.97			
2.5 D	12.88 - 05.97			
Spurstangenkopf Gewindeart: mit Linksgewinde Gewindemaß: M16x1,5			16308 02 48641-01N25 	
2.0, 64 kW	05.87 - 05.97			
2.3 D	01.88 - 05.97			
2.5 D	12.88 - 05.97			
Axialgelenk, Spurstange			16296 01 48521-27N25 	
2.0, 64 kW	05.87 - 05.97	10.1988->		
2.3 D	01.88 - 05.97			
2.5 D	12.88 - 05.97			



Ref.

NISSAN

URVAN Kasten/Box/Furgón/Van (E24)

05.87 - 05.97

	Trag-/Führungsgelenk			11860 02	40110-01G26
	2.0	05.87 - 05.97			
	2.0, 65 kW	06.86 - 09.94			
	2.3 D	01.88 - 05.97			
	2.4, 72 kW	10.93 - 05.97			
	2.5 D	12.88 - 05.97			
2.4, 74 kW	02.92 - 04.97				
Trag-/Führungsgelenk				11863 02	40160-01N25
	2.0, 64 kW	05.87 - 05.97			
	2.3 D	01.88 - 05.97			
	2.5 D	12.88 - 05.97			

VANETTE Bus/Familial (KC120)

06.81 - 12.87

	Trag-/Führungsgelenk			11868 03	40160-G5400
	Konusmaß [mm]: 13,5				
1.5	01.83 - 12.87				
Trag-/Führungsgelenk				15577 01	40110-G5110
	1.5	01.83 - 12.87			

VANETTE Bus/Familial (C22)

10.86 - 12.95









	Spurstangenkopf			15595 01	48641-G5125
	Gewindeart: mit Linksgewinde				
	Gewindemaß: M14x1,5				
	2.4 i (SLC22)	10.86 - 12.95			
	2.4 i (SLC22), 77 kW	10.86 - 12.95			
2.0 D (ULC22), 47 kW	10.86 - 12.95				
2.0 D (ULC22), 49 kW	10.86 - 12.95				
Spurstangenkopf				16315 02	48521-G5125
	Gewindeart: mit Rechtsgewinde				
	Gewindemaß: M14x1,5				
	2.4 i (SLC22)	10.86 - 12.95			
	2.4 i (SLC22), 77 kW	10.86 - 12.95			
	2.0 D (ULC22), 47 kW	10.86 - 12.95			
2.0 D (ULC22), 49 kW	10.86 - 12.95				



Ref.





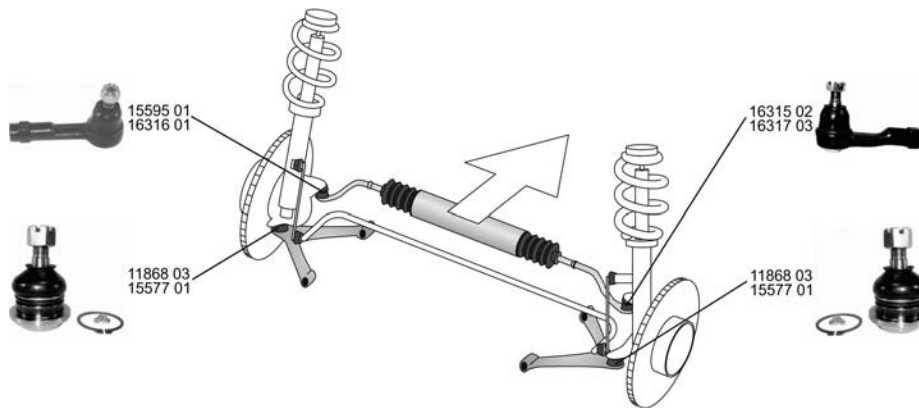

NISSAN

VANETTE Bus/Familial (C22) 10.86 - 12.95

<p>Spurstangenkopf Gewindeart: mit Rechtsgewinde Innengewinde [mm]: M14x1,5</p> <p>2.4 i (SLC22) 10.86 - 12.95 2.4 i (SLC22), 77 kW 10.86 - 12.95 2.0 D (ULC22), 47 kW 10.86 - 12.95 2.0 D (ULC22), 49 kW 10.86 - 12.95</p>		<p>16316 01 48640-G5125</p> 
<p>Spurstangenkopf Gewindeart: mit Linksgewinde Innengewinde [mm]: M14x1,5</p> <p>2.4 i (SLC22) 10.86 - 12.95 2.4 i (SLC22), 77 kW 10.86 - 12.95 2.0 D (ULC22), 47 kW 10.86 - 12.95 2.0 D (ULC22), 49 kW 10.86 - 12.95</p>		<p>16317 03 48520-G5125</p> 
<p>Trag-/Führungsgelenk Konusmaß [mm]: 13,5</p> <p>ALL TYPES ausser : 1.5 (APLC 22) 09.86 - 04.93 2.0 (WRLC 22) 09.86 - 04.93</p>		<p>11868 03 40160-G5400</p> 
<p>Trag-/Führungsgelenk</p> <p>ALL TYPES ausser : 1.5 (APLC 22) 09.86 - 04.93 2.0 (WRLC 22) 09.86 - 04.93</p>		<p>15577 01 40110-G5110</p> 

VANETTE Kasten/Box/Furgón/Van (C22) 10.86 - 01.95



<p>Spurstangenkopf Gewindeart: mit Linksgewinde Gewindemaß: M14x1,5</p> <p>2.0 D 07.91 - 01.95</p>		<p>15595 01 48641-G5125</p> 
<p>Spurstangenkopf Gewindeart: mit Rechtsgewinde Gewindemaß: M14x1,5</p> <p>2.0 D 07.91 - 01.95</p>		<p>16315 02 48521-G5125</p> 
<p>Spurstangenkopf Gewindeart: mit Rechtsgewinde Innengewinde [mm]: M14x1,5</p> <p>2.0 D 07.91 - 01.95</p>		<p>16316 01 48640-G5125</p> 









Ref.

NISSAN

VANETTE Kasten/Box/Furgón/Van (C22)







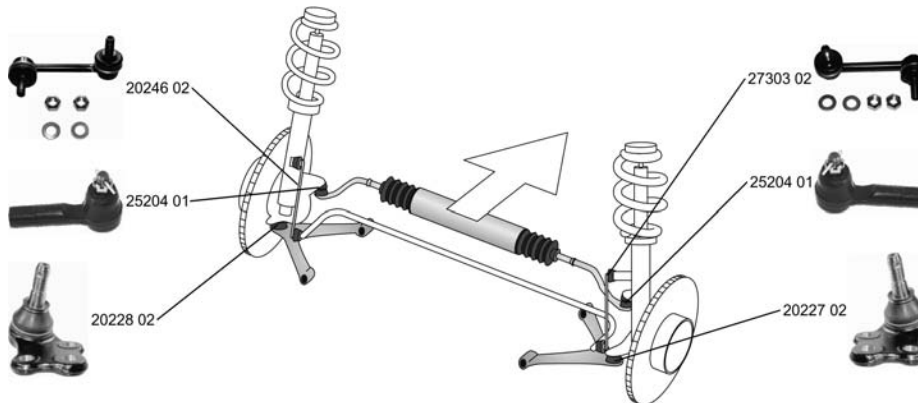

10.86 - 01.95

 Spurstangenkopf Gewindeart: mit Linksgewinde Innengewinde [mm]: M14x1,5 2.0 D 07.91 - 01.95		16317 03 48520-G5125 
Trag-/Führungsgelenk Konusmaß [mm]: 13,5 ALL TYPES		11868 03 40160-G5400 
Trag-/Führungsgelenk ALL TYPES		15577 01 40110-G5110 

VANETTE CARGO Kasten/Box/Furgón/Van (HC 23)

01.95 -





Spurstangenkopf Gewindemaß: M12x1,25 Innengewinde [mm]: M12x1,25 1.6 i 2.0 D 2.3 D 01.95 - 01.95 - 01.95 -		25204 01 48520-73J25 
Trag-/Führungsgelenk mit Zubehör 1.6 i 2.0 D 2.3 D 01.95 - 01.95 - 01.95 -		20227 02 40160-9C500 
Trag-/Führungsgelenk mit Zubehör 1.6 i 2.0 D 2.3 D 01.95 - 01.95 - 01.95 -		20228 02 40161-9C500 
Stange/Strebe, Stabilisator Pendelstange 1.6 i 2.0 D 2.3 D 01.95 - 01.95 - 01.95 -		20246 02 54668-9C000 



Ref.









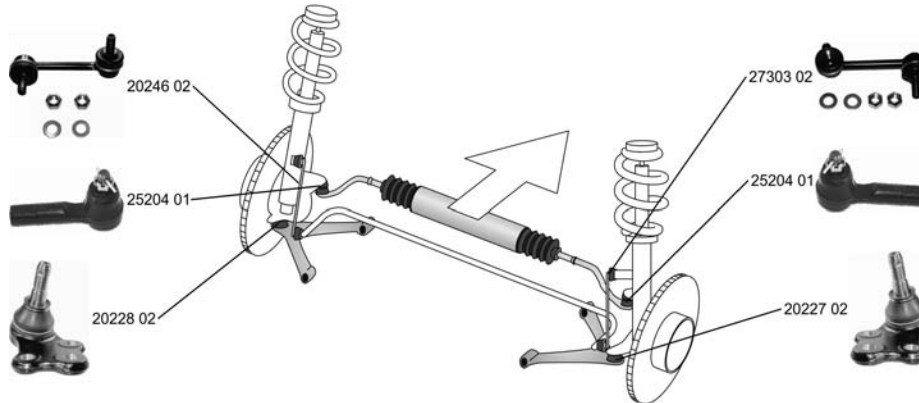

NISSAN

VANETTE CARGO 01.95 -
Kasten/Box/Furgón/Van (HC 23)

 Stange/Strebe, Stabilisator Pendelstange mit Zubehör		27303 02 54618-9C002		
		1.6 i		01.95 -
		2.0 D		01.95 -
2.3 D	01.95 -			

VANETTE CARGO Bus (HC 23) 01.96 -



Spurstangenkopf Gewindemaß: M12x1,25 Innengewinde [mm]: M12x1,25 ALL TYPES		25204 01 48520-73J25	
Trag-/Führungsgelenk mit Zubehör ALL TYPES		20227 02 40160-9C500	
Trag-/Führungsgelenk mit Zubehör ALL TYPES		20228 02 40161-9C500	
Stange/Strebe, Stabilisator Pendelstange ALL TYPES		20246 02 54668-9C000	
Stange/Strebe, Stabilisator Pendelstange mit Zubehör ALL TYPES		27303 02 54618-9C002	





Ref.

OPEL

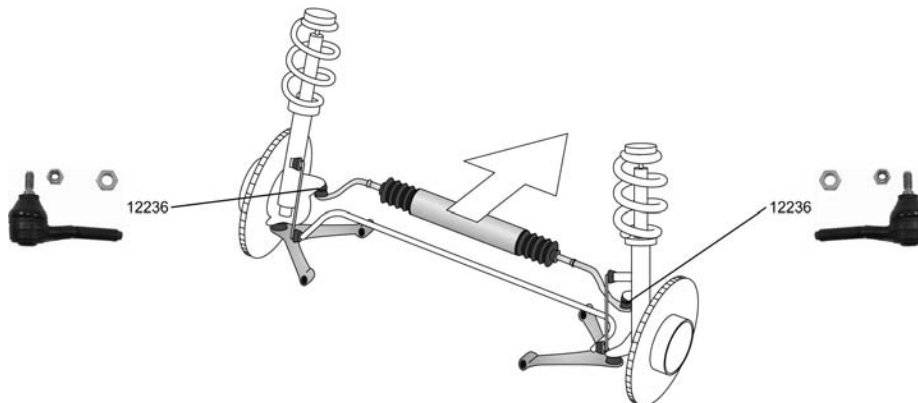

ARENA Combi/Bus/Familial (THB) 03.98 - 08.01

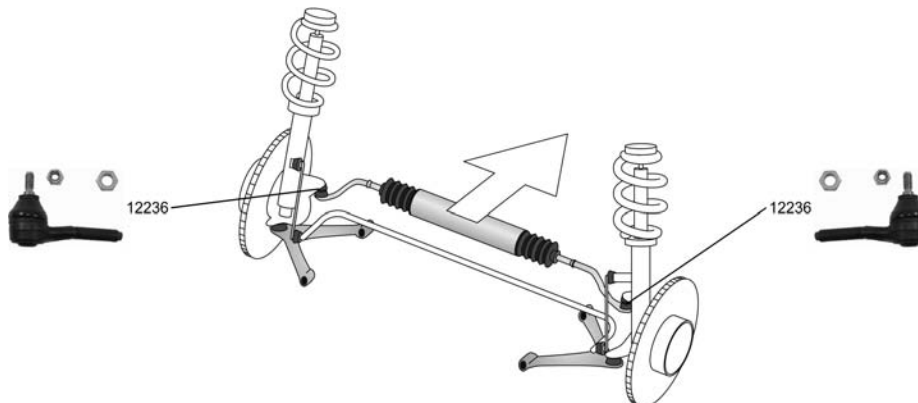

<p>Spurstangenkopf Gewindeart: mit Rechtsgewinde Aussengewinde [mm]: M14x1,5</p>		<p>12236 02</p>
<p>ALL TYPES</p>		

ARENA Kasten/Box/Furgón/Van (TB, TF) 03.98 - 08.01



<p>Spurstangenkopf Gewindeart: mit Rechtsgewinde Aussengewinde [mm]: M14x1,5</p>		<p>12236 02</p>
<p>ALL TYPES</p>		











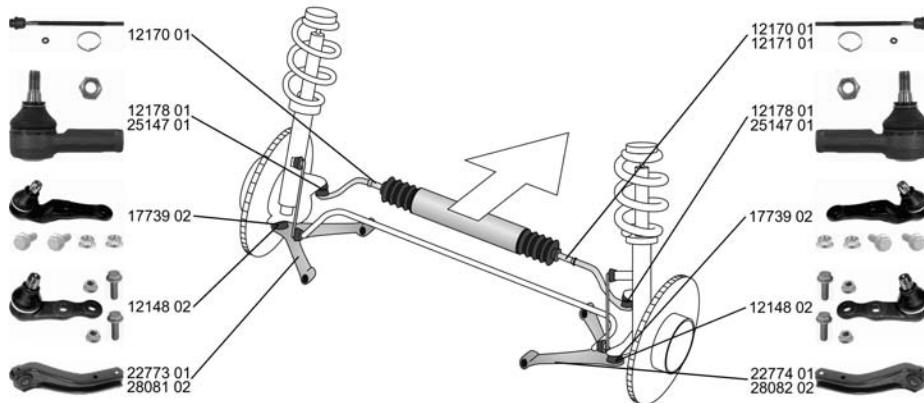







Ref.

OPEL

COMBO (71_)

07.94 - 10.01





















Spurstangenkopf Gewindeart: mit Rechtsgewinde Innengewinde [mm]: M12x1,5		12178 01 3 24 050	
1.2	07.94 - 10.01	->Chass. V 6 066279	
1.4, 44 kW	07.94 - 10.01	->Chass. V 3 023597	
1.4, 60 kW	07.94 - 10.01	->Chass. V 4 166925	
1.4 16V	08.99 - 10.01		
1.7 D	07.94 - 10.01	->Chass. V 4 166925 ->Chass. V 3 023597	
Spurstangenkopf mit Zubehör Gewindeart: mit Rechtsgewinde Innengewinde [mm]: M12x1,5		25147 01 3 24 066	
1.2	07.94 - 10.01	Chass. V6066280->	
1.4, 44 kW	07.94 - 10.01	Chass. V3023598->	
1.4, 60 kW	07.94 - 10.01	Chass. V4166926->	
1.7 D	07.94 - 10.01		
1.4 16V	08.99 - 10.01		
Axialgelenk, Spurstange mit Zubehör Gewindeart: mit Rechtsgewinde Aussengewinde [mm]: M12x1,5 Innengewinde [mm]: M14x1,5		12170 01 3 22 155	
ALL TYPES			
Axialgelenk, Spurstange Gewindeart: mit Rechtsgewinde		12171 01 3 22 158	
ALL TYPES			
Lenker, Radaufhängung ohne Trag-/Führungsgelenk mit Gummilager		22773 01 53 52 011	
ALL TYPES		Chass. V6066280-> Chass. V4166926-> Chass. V3023598->	
Lenker, Radaufhängung ohne Trag-/Führungsgelenk mit Gummilager		22774 01 53 52 012	
ALL TYPES		Chass. V6066280-> Chass. V3023598-> Chass. V4166926->	
Lenker, Radaufhängung mit Gummilager mit Befestigungsmaterial		28081 02 3 52 003	
1.2	07.94 - 10.01	->Chass. V6 066279	
1.4, 44 kW	07.94 - 10.01	->Chass. V4 166925	
1.4, 60 kW	07.94 - 10.01	->Chass. V3 023597	
1.7 D	07.94 - 10.01		





Ref.

OPEL

COMBO (71_) 07.94 - 10.01

 Lenker, Radaufhängung mit Gummilager mit Befestigungsmaterial 1.2 1.4, 44 kW 1.4, 60 kW 1.7 D	 07.94 - 10.01 07.94 - 10.01 07.94 - 10.01 07.94 - 10.01 ->Chass. V6 066279 ->Chass. V3 023597 ->Chass. V4 166925	28082 02 3 52 002 
Trag-/Führungsgelenk 1.2 1.4, 44 kW 1.4, 60 kW 1.7 D 1.2 1.4, 44 kW 1.4, 60 kW 1.7 D	 Chass. V3023598-> Chass. V6066280->	17739 02 16 03 202 
Reparatursatz, Trag-/Führungsgelenk mit Befestigungsmaterial ALL TYPES	 ->Chass. V3023597	12148 02 16 03 187 
Lagerung, Lenker 1.2 1.4, 44 kW 1.4, 60 kW 1.7 D	 07.94 - 10.01 07.94 - 10.01 07.94 - 10.01 07.94 - 10.01	16056 02 352 301 90 445 097 
Lagerung, Lenker Zugstange ALL TYPES	 Chass. V3 023598 - Chass. V3 037203	26604 01 3 53 562 
Stabilisatorlager ALL TYPES		23711 01 3 50 127 
Faltenbalsatz, Lenkung Innendurchmesser 1 [mm]: 12 Innendurchmesser 2 [mm]: 50 ALL TYPES	  Betriebsart:elektrisch	30130 01 9 02 827 
Faltenbalsatz, Lenkung Innendurchmesser 1 [mm]: 12 Innendurchmesser 2 [mm]: 49 ALL TYPES	 	30161 01 16 09 087 

COMBO Kasten/Kombi/Box 10.01 - Body/Van/Estate/Break

 Axialgelenk, Spurstange 1.6 1.7 DI 16V 1.7 DTI 16V	 10.01 - 10.01 - 10.01 - ->Chass. 36999999 ->Chass. 33999999 ->Chass. 34999999	29938 01 16 03 008 
--	---	---









Ref.

OPEL

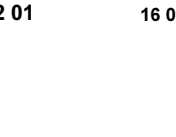

**COMBO Kasten/Kombi/Box
Body/Van/Estate/Break**

10.01 -

 Trag-/Führungsgelenk 1.6 1.7 DI 16V 1.7 DTI 16V	10.01 -	↔	26501 02 3 52 803 
	10.01 -		
	10.01 -		
	10.01 -		
Lagerung, Lenker 1.6 1.7 DI 16V 1.7 DTI 16V	10.01 -	↔ ↓	26580 01 3 52 320 
	10.01 -		
	10.01 -		
	10.01 -		
Lagerung, Lenker mit Zubehör 1.6 1.7 DI 16V 1.7 DTI 16V	10.01 -	↔ ↑	112,1/A60,1 26581 02 3 52 309 9 199 576 
	10.01 -		
	10.01 -		
	10.01 -		
Faltenbalsatz, Lenkung Innendurchmesser 1 [mm]: 12 Innendurchmesser 2 [mm]: 50 ALL TYPES ausser : 1.6 16V 1.6 CNG 1.7 CDTI 16V	06.06 -	↔	30252 01 16 09 121 
	04.05 -		
	12.04 -		
 Achskörperlager 1.6 1.7 DI 16V 1.7 DTI 16V	10.01 -	↔	26582 01 4 02 644 
	10.01 -		
	10.01 -		
	10.01 -		

COMBO Tour

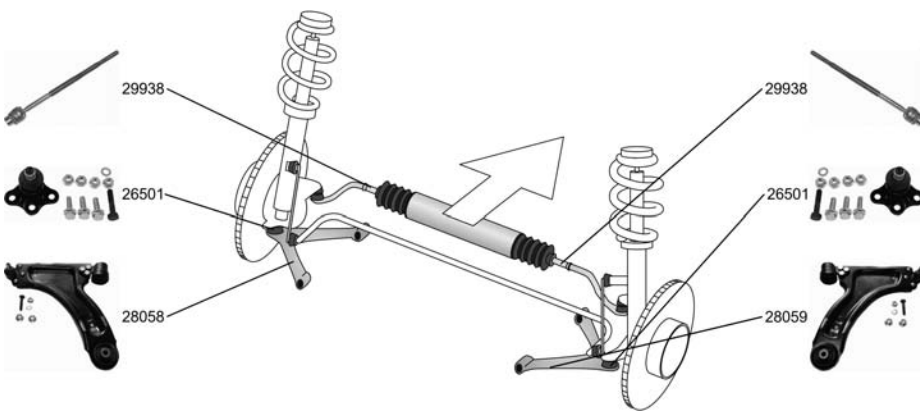
10.01 -

			29938 01 16 03 008 		
	Axialgelenk, Spurstange 1.4 1.6, 64 kW 1.3 CDTI 16V, 51 kW 1.7 DI 16V 1.7 DTI 16V	10.04 -		↔	
		10.01 -			->Chass. 36999999
		10.04 -			->Chass. 34999999
		10.01 -			->Chass. 33999999
10.01 -					



OPEL

COMBO Tour

10.01 -

 Lenker, Radaufhängung mit Gummilager mit Befestigungsmaterial			28058 02 3 52 041
	1.6, 64 kW	10.01 -	für Fahrzeuge ohne Schlechtwegeausführung
	1.7 DI 16V	10.01 -	
1.7 DTI 16V	10.01 -		
			26501 01 26580 01 26581 02 
Lenker, Radaufhängung mit Gummilager mit Befestigungsmaterial			28059 02 3 52 042
	1.6, 64 kW	10.01 -	für Fahrzeuge ohne Schlechtwegeausführung
	1.7 DI 16V	10.01 -	
1.7 DTI 16V	10.01 -		
			26501 01 26580 01 26581 02 
Trag-/Führungsgelenk			26501 02 3 52 803
	1.6, 64 kW	10.01 -	
	1.7 DI 16V	10.01 -	
1.7 DTI 16V	10.01 -		
			
Lagerung, Lenker			26580 01 3 52 320
	1.6, 64 kW	10.01 -	
	1.7 DI 16V	10.01 -	
1.7 DTI 16V	10.01 -		
			
Lagerung, Lenker mit Zubehör		 	112,1/A60,1 26581 02 3 52 309 9 199 576
	1.6, 64 kW	10.01 -	
	1.7 DI 16V	10.01 -	
1.7 DTI 16V	10.01 -		
			
Faltenbalgsatz, Lenkung Innendurchmesser 1 [mm]: 12 Innendurchmesser 2 [mm]: 50			30252 01 16 09 121
	1.4	10.04 -	
	1.6, 64 kW	10.01 -	
	1.3 CDTI 16V, 51 kW	10.04 -	
	1.3 CDTI 16V, 55 kW	10.05 -	
	1.7 DI 16V	10.01 -	
1.7 DTI 16V	10.01 -		
 Achskörperlager			26582 01 4 02 644
	1.6, 64 kW	10.01 -	
	1.7 DI 16V	10.01 -	
1.7 DTI 16V	10.01 -		
			



Ref.

OPEL

MOVANO Combi/Bus/Familial (J9) 07.98 -

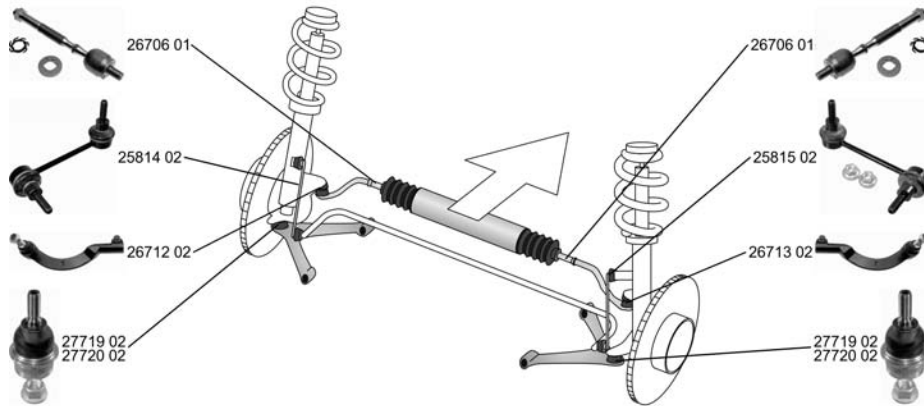







Spurstangenkopf ALL TYPES		26712 02	45 01 262	
Spurstangenkopf ALL TYPES		26713 02	45 01 263	
Axialgelenk, Spurstange Gewindemaß: M14x1,5 Gewindemaß: M16x1,5 mit Zubehör ALL TYPES		26706 01	45 01 261	
Trag-/Führungsgelenk mit Zubehör ALL TYPES		27719 02	45 00 254	
Trag-/Führungsgelenk mit Zubehör		27720 02	44 01 909	
1.9 DTI, 59 kW 2.5 D 2.8 DTI	09.00 - 10.01 07.98 - 09.00 07.98 - 10.01			
1.9 DTI, 60 kW 2.2 DTI 2.5 CDTI, 88 kW 2.5 CDTI, 107 kW 2.5 DTI 3.0 DTI	10.01 - 09.00 - 08.06 - 08.06 - 10.01 - 10.03 -	->09.2007		
Lagerung, Lenker ALL TYPES		30721 01	45 00 094	
Lagerung, Lenker ALL TYPES		30722 01	45 00 095	



Ref.







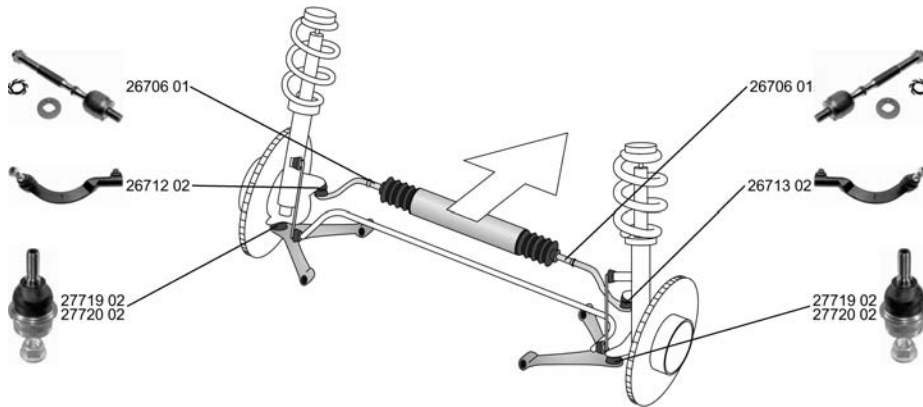

OPEL

MOVANO Combi/Bus/Familial (J9) 07.98 -

 Stange/Strebe, Stabilisator Pendelstange mit Zubehör ALL TYPES		25814 02 45 00 198 
Stange/Strebe, Stabilisator Pendelstange mit Zubehör ALL TYPES		25815 02 45 00 199 
Faltenbalgsatz, Lenkung Innendurchmesser 1 [mm]: 9,5 Innendurchmesser 2 [mm]: 42 ALL TYPES ausser :		30212 01 45 01 260 
2.5 CDTI, 88 kW 08.06 - 2.5 CDTI, 107 kW 08.06 - 3.0 DTI 10.03 -		

MOVANO Pritsche,Fahrgestell / Flatbed,Chassis (U9, E9) 07.98 -











Spurstangenkopf ALL TYPES		26712 02 45 01 262 
Spurstangenkopf ALL TYPES		26713 02 45 01 263 
Axialgelenk, Spurstange Gewindemaß: M14x1,5 Gewindemaß: M16x1,5 mit Zubehör ALL TYPES		26706 01 45 01 261 
Trag-/Führungsgelenk mit Zubehör ALL TYPES		27719 02 45 00 254 



Ref.





OPEL

MOVANO Pritsche, Fahrgestell / Flatbed, Chassis (U9, E9) 07.98 -

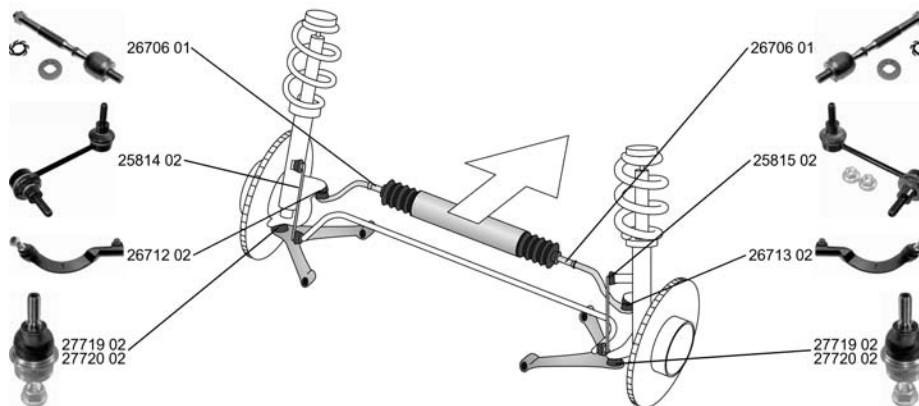
<p> Trag-/Führungsgelenk mit Zubehör</p> <p>2.5 CDTI, 88 kW 08.06 - 2.5 CDTI, 107 kW 08.06 - 2.5 D 07.98 - 09.00 2.5 DTi 10.03 - 2.5 CDTI, 74 kW 08.06 - 2.8 DTi 07.98 - 10.01 3.0 DTi 10.03 - 2.2 DTi 09.00 - 2.5 DTi 10.01 -</p>	<p></p> <p>->09.2007</p>	<p>27720 02 44 01 909</p> 
<p>Lagerung, Lenker ALL TYPES</p>	<p></p>	<p>30721 01 45 00 094</p> 
<p>Lagerung, Lenker ALL TYPES</p>	<p></p>	<p>30722 01 45 00 095</p> 
<p>Faltenbalgsatz, Lenkung Innendurchmesser 1 [mm]: 9,5 Innendurchmesser 2 [mm]: 42</p> <p>2.2 DTi 09.00 - 2.5 D 07.98 - 09.00 2.5 DTi 10.01 - 2.8 DTi 07.98 - 10.01</p>	<p></p>	<p>30212 01 45 01 260</p> 

MOVANO Kasten/Box/Furgón/Van (F9) 01.99 -



<p>Spurstangenkopf ALL TYPES</p>	<p></p>	<p>26712 02 45 01 262</p> 
<p>Spurstangenkopf ALL TYPES</p>	<p></p>	<p>26713 02 45 01 263</p> 



















Ref.

OPEL

MOVANO Kasten/Box/Furgón/Van
(F9)

01.99 -







 Axialgelenk, Spurstange Gewindemaß: M14x1,5 Gewindemaß: M16x1,5 mit Zubehör ALL TYPES		26706 01 45 01 261 
Trag-/Führungsgelenk mit Zubehör ALL TYPES		27719 02 45 00 254 
Trag-/Führungsgelenk mit Zubehör 1.9 DTI, 60 kW 10.01 - 2.2 DTI 09.00 - 2.5 CDTI, 88 kW 08.06 - 2.5 CDTI, 107 kW 08.06 - 2.5 D 01.99 - 09.00 2.5 DTi 10.03 - 2.5 DTI 10.01 - 2.5 CDTI, 74 kW 08.06 - 3.0 DTI 10.03 - 1.9 DTI, 59 kW 09.00 - 10.01 2.8 DTI 01.99 - 10.01	 ->09.2007	27720 02 44 01 909 
Lagerung, Lenker ALL TYPES		30721 01 45 00 094 
Lagerung, Lenker ALL TYPES		30722 01 45 00 095 
Stange/Strebe, Stabilisator Pendelstange mit Zubehör ALL TYPES		25814 02 45 00 198 
Stange/Strebe, Stabilisator Pendelstange mit Zubehör ALL TYPES		25815 02 45 00 199 
Faltenbalgsatz, Lenkung Innendurchmesser 1 [mm]: 9,5 Innendurchmesser 2 [mm]: 42 1.9 DTI, 59 kW 09.00 - 10.01 1.9 DTI, 60 kW 10.01 - 2.2 DTI 09.00 - 2.5 D 01.99 - 09.00 2.5 DTI 10.01 - 2.8 DTI 01.99 - 10.01		30212 01 45 01 260 



Ref.









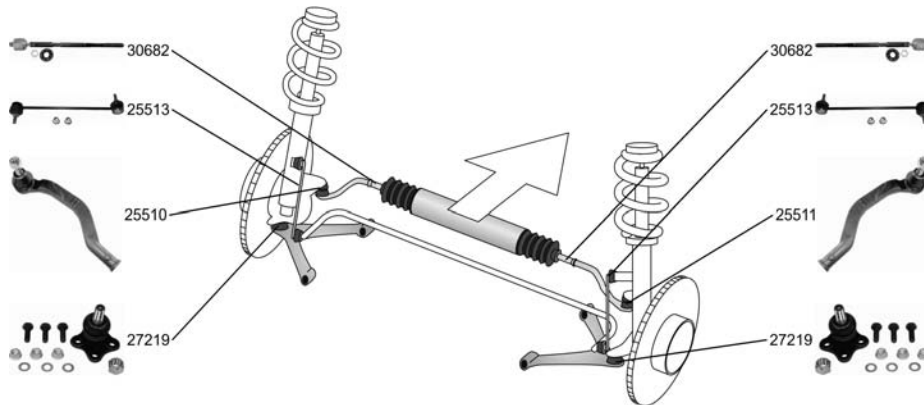

OPEL

MOVANO Kipper/Dumptruck (H9) 01.99 -

 Stange/Strebe, Stabilisator Pendelstange mit Zubehör ALL TYPES		25814 02	45 00 198				
Stange/Strebe, Stabilisator Pendelstange mit Zubehör ALL TYPES		25815 02	45 00 199				
Faltenbalgsatz, Lenkung Innendurchmesser 1 [mm]: 9,5 Innendurchmesser 2 [mm]: 42 2.2 DTI 2.5 D 2.8 DTI				30212 01	45 01 260		
							09.00 -
							01.99 - 09.00 01.99 - 10.01

VIVARO Combi/Estate/Break 08.01 -















Spurstangenkopf 2.0 16V 1.9 DI 1.9 DTI 2.5 DTI	08.01 - 08.01 - 08.01 - 05.03 -			25510 01	44 08 510	
Spurstangenkopf 2.0 16V 1.9 DI 1.9 DTI 2.5 DTI	08.01 - 08.01 - 08.01 - 05.03 -			25511 01	44 08 511	
Axialgelenk, Spurstange radseitig Gewindemaß: M12x1,0 Gewindemaß: M14x1,5 2.0 16V 1.9 DI 1.9 DTI 2.5 DTI	08.01 - 08.01 - 08.01 - 05.03 -	  		30682 01	44 08 474	
Trag-/Führungsgelenk Konusmaß [mm]: 19,55 Bohrung-Ø [mm]: 10 mit Zubehör 2.0 16V 1.9 DI 1.9 DTI 2.5 DTI	08.01 - 08.01 - 08.01 - 05.03 -	 		27219 02		



Ref.





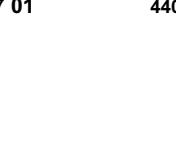



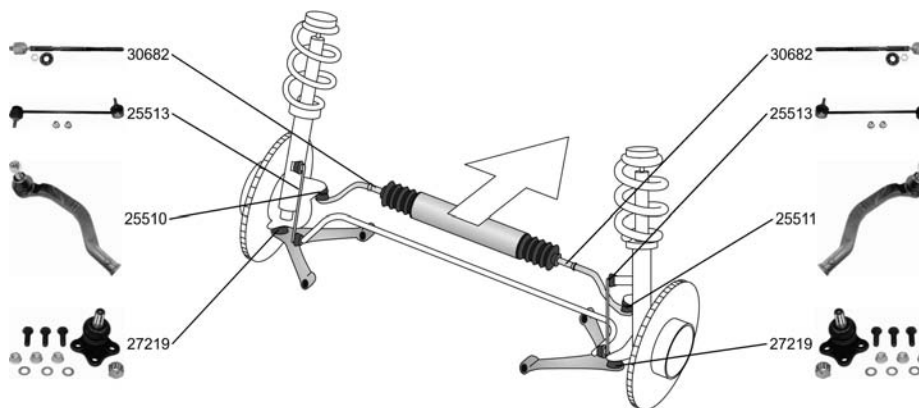

OPEL

VIVARO Combi/Estate/Break 08.01 -

 Lagerung, Lenker 2.0 16V 1.9 DI 1.9 DTI 2.5 DTI	08.01 -	  	26938 01 
	08.01 -		
	08.01 -		
	08.01 -		
	05.03 -		
Lagerung, Lenker 2.0 16V 1.9 DI 1.9 DTI 2.5 DTI	08.01 -	  	26939 01 
	08.01 -		
	08.01 -		
	08.01 -		
	05.03 -		
Stange/Strebe, Stabilisator Pendelstange mit Zubehör 2.0 16V 1.9 DI 1.9 DTI 2.5 DTI	08.01 -		25513 02 44 08 904 
	08.01 -		
	08.01 -		
	08.01 -		
	05.03 -		
Faltenbalgsatz, Lenkung Innendurchmesser 1 [mm]: 13 Innendurchmesser 2 [mm]: 54 2.0 16V 1.9 DI 1.9 DTI 2.5 DTI	08.01 -		30257 01 4408476 
	08.01 -		
	08.01 -		
	08.01 -		
	05.03 -		

VIVARO Kasten (F7) 08.01 -













Spurstangenkopf 2.0 16V 1.9 DI 1.9 DTI 2.5 DTI	08.01 -	 	25510 01 44 08 510 
	08.01 -		
	08.01 -		
	08.01 -		
	05.03 -		
Spurstangenkopf 2.0 16V 1.9 DI 1.9 DTI 2.5 DTI	08.01 -	 	25511 01 44 08 511 
	08.01 -		
	08.01 -		
	08.01 -		
	05.03 -		
Axialgelenk, Spurstange radseitig Gewindemaß: M12x1,0 Gewindemaß: M14x1,5 2.0 16V 1.9 DI 1.9 DTI 2.5 DTI	08.01 -	  	30682 01 44 08 474 
	08.01 -		
	08.01 -		
	08.01 -		
	05.03 -		



OPEL

VIVARO Kasten (F7) 08.01 -

<p> Trag-/Führungsgelenk Konusmaß [mm]: 19,55 Bohrung-Ø [mm]: 10 mit Zubehör</p> <p>2.0 16V 08.01 - 1.9 DI 08.01 - 1.9 DTI 08.01 - 2.5 DTI 05.03 -</p>		<p>27219 02</p> 
<p>Lagerung, Lenker</p> <p>2.0 16V 08.01 - 1.9 DI 08.01 - 1.9 DTI 08.01 - 2.5 DTI 05.03 -</p>		<p>26938 01</p> 
<p>Lagerung, Lenker</p> <p>2.0 16V 08.01 - 1.9 DI 08.01 - 1.9 DTI 08.01 - 2.5 DTI 05.03 -</p>		<p>26939 01</p> 
<p>Stange/Strebe, Stabilisator Pendelstange mit Zubehör</p> <p>2.0 16V 08.01 - 1.9 DI 08.01 - 1.9 DTI 08.01 - 2.5 DTI 05.03 -</p>		<p>25513 02 44 08 904</p> 
<p>Faltenbalgsatz, Lenkung Innendurchmesser 1 [mm]: 13 Innendurchmesser 2 [mm]: 54</p> <p>2.0 16V 08.01 - 1.9 DI 08.01 - 1.9 DTI 08.01 - 2.5 DTI 05.03 -</p>		<p>30257 01 4408476</p>







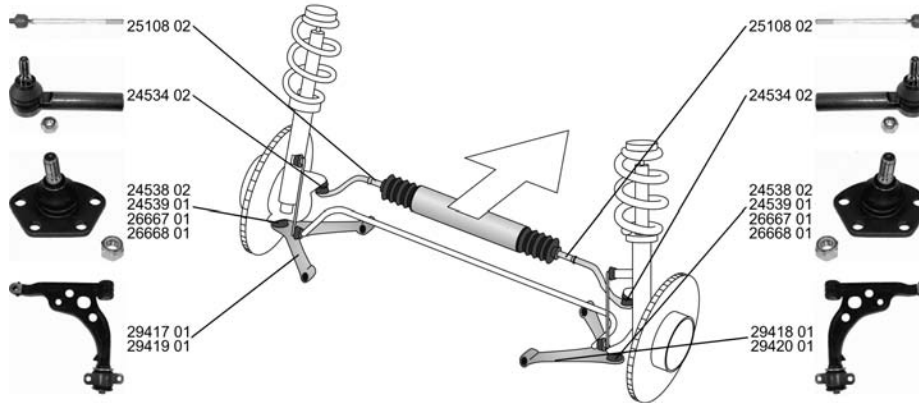

Ref.

PEUGEOT

BOXER Bus/Familial (230P)

03.94 - 04.02





















<p>Spurstangenkopf Gewindeart: mit Rechtsgewinde Gewindemaß: M16x1,5</p> <p>ALL TYPES ausser : 2.0</p> <p>03.94 - 04.02</p>	<p>↻</p>	<p>24534 02 4018 A3</p> 
<p>Axialgelenk, Spurstange</p> <p>ALL TYPES ausser : 2.0</p> <p>03.94 - 04.02</p>	<p>↻</p>	<p>25108 02 4018 A4</p> 
<p>Lenker, Radaufhängung</p> <p>ALL TYPES ausser : 2.0</p> <p>03.94 - 04.02</p>	<p>▽ ↻</p> <p>zul. Gesamtgewicht [kg]:1000 zul. Gesamtgewicht [kg]:1400 ->Chass. 16194399 nur in Verbindung mit:OE 3640 55</p> <p>Chass. 16194400-> für Tragelenk ohne Einschränkung</p>	<p>29417 01 3520 N3</p> 
<p>Lenker, Radaufhängung</p> <p>ALL TYPES ausser : 2.0</p> <p>03.94 - 04.02</p>	<p>▽ ↻</p> <p>zul. Gesamtgewicht [kg]:1000 zul. Gesamtgewicht [kg]:1400 ->Chass. 16194399 nur in Verbindung mit:OE 3640 55</p> <p>Chass. 16194400-> für Tragelenk ohne Einschränkung</p>	<p>29418 01 3521 J3</p> 
<p>Lenker, Radaufhängung</p> <p>ALL TYPES ausser : 2.0</p> <p>03.94 - 04.02</p>	<p>▽ ↻</p> <p>zul. Gesamtgewicht [kg]:1800 ->Chass. 16194399 nur in Verbindung mit:OE 3640 54</p> <p>Chass. 16194400-> für Tragelenk ohne Einschränkung</p>	<p>29419 01 3520 N4</p> 
<p>Lenker, Radaufhängung</p> <p>ALL TYPES ausser : 2.0</p> <p>03.94 - 04.02</p>	<p>▽ ↻</p> <p>zul. Gesamtgewicht [kg]:1800 ->Chass. 16194399 nur in Verbindung mit:OE 3640 54</p> <p>Chass. 16194400-> für Tragelenk ohne Einschränkung</p>	<p>29420 01 3521 J4</p> 



PEUGEOT

BOXER Bus/Familial (230P)

03.94 - 04.02

 Trag-/Führungsgelenk Gewindemaß: M16x1,5		24538 02 
ALL TYPES ausser : 2.0 03.94 - 04.02	->01.2001 ->Chass. 16194399 nur in Verbindung mit:OE 3520 N3 nur in Verbindung mit:OE 3521 J3 Nutzlast [kg]:1000,1400 ----- Chass. 16194400-> ohne Einschränkung	
Trag-/Führungsgelenk maximale Last [kg]: 1800 Gewindemaß: M18x1,5		24539 01 3640 33 
ALL TYPES ausser : 2.0 03.94 - 04.02	->01.2001 ->Chass. 16194399 nur in Verbindung mit:OE 3520 N4 nur in Verbindung mit:OE 3521 J4 Nutzlast [kg]:1800 ----- Chass. 16194400-> ohne Einschränkung	
Trag-/Führungsgelenk nur in Verbindung mit: 29417 nur in Verbindung mit: 29418 maximale Last [kg]: 1400		26667 01 3640 55 
ALL TYPES ausser : 2.0 03.94 - 04.02	02.2001->	
Trag-/Führungsgelenk nur in Verbindung mit: 29419 nur in Verbindung mit: 29420 maximale Last [kg]: 1800 mit Zubehör		26668 01 3640 54
ALL TYPES ausser : 2.0 03.94 - 04.02	02.2001->	
Faltenbalsatz, Lenkung 2.0 i 03.94 - 04.02 2.0 i 4x4 08.96 - 04.02 1.9 TD 4x4 07.96 - 04.02 2.5 D 4x4 07.96 - 04.02 2.5 TD 4x4 07.96 - 04.02 2.5 TDI 4x4 01.97 - 04.02 2.5 DT 10.97 - 11.01	  nur in Verbindung mit:LEMFÖRDER 30203	30198 01 4006 22 
1.9 D 03.94 - 04.02 1.9 TD, 66 kW 08.94 - 04.02 1.9 TD, 68 kW 03.94 - 04.02 2.5 D 08.94 - 04.02 2.5 TD 07.94 - 04.02 2.5 TDI 01.97 - 04.02 2.8 HDI 11.00 - 04.02	  nur in Verbindung mit:Lemförder 30203	
Faltenbalsatz, Lenkung 2.0 i 03.94 - 04.02 2.0 i 4x4 08.96 - 04.02 1.9 TD 4x4 07.96 - 04.02 2.5 D 4x4 07.96 - 04.02 2.5 TD 4x4 07.96 - 04.02 2.5 TDI 4x4 01.97 - 04.02 2.5 DT 10.97 - 11.01	  nur in Verbindung mit:LEMFÖRDER 30198	30203 01 4006 22 
1.9 D 03.94 - 04.02 1.9 TD, 66 kW 08.94 - 04.02 1.9 TD, 68 kW 03.94 - 04.02 2.5 D 08.94 - 04.02 2.5 TD 07.94 - 04.02 2.5 TDI 01.97 - 04.02 2.8 HDI 11.00 - 04.02	  nur in Verbindung mit:Lemförder 30198	







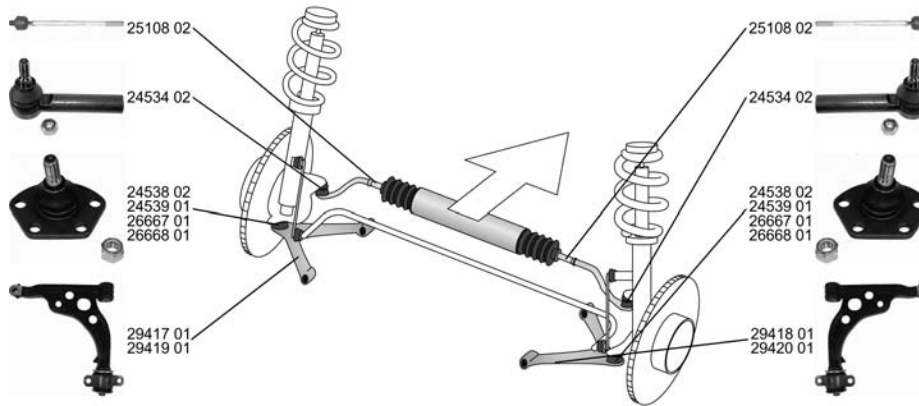

Ref.

PEUGEOT

BOXER Kasten/Box/Furgón/Van (230L)

03.94 - 04.02

















<p>Spurstangenkopf Gewindeart: mit Rechtsgewinde Gewindemaß: M16x1,5</p> <p>ALL TYPES ausser : 2.0</p> <p>03.94 - 04.02</p>	<p>↔</p>	<p>24534 02 4018 A3</p> 
<p>Axialgelenk, Spurstange</p> <p>ALL TYPES ausser : 2.0</p> <p>03.94 - 04.02</p>	<p>↔</p>	<p>25108 02 4018 A4</p> 
<p>Lenker, Radaufhängung</p> <p>ALL TYPES ausser : 2.0</p> <p>03.94 - 04.02</p>	<p>▽↺</p> <p>zul. Gesamtgewicht [kg]:1000 zul. Gesamtgewicht [kg]:1400 ->Chass. 16194399 nur in Verbindung mit:OE 3640 55</p> <p>Chass. 16194400-> für Tragelenk ohne Einschränkung</p>	<p>29417 01 3520 N3</p> 
<p>Lenker, Radaufhängung</p> <p>ALL TYPES ausser : 2.0</p> <p>03.94 - 04.02</p>	<p>▽↻</p> <p>zul. Gesamtgewicht [kg]:1000 zul. Gesamtgewicht [kg]:1400 ->Chass. 16194399 nur in Verbindung mit:OE 3640 55</p> <p>Chass. 16194400-> für Tragelenk ohne Einschränkung</p>	<p>29418 01 3521 J3</p> 
<p>Lenker, Radaufhängung</p> <p>ALL TYPES ausser : 2.0</p> <p>03.94 - 04.02</p>	<p>▽↺</p> <p>zul. Gesamtgewicht [kg]:1800 ->Chass. 16194399 nur in Verbindung mit:OE 3640 54</p> <p>Chass. 16194400-> für Tragelenk ohne Einschränkung</p>	<p>29419 01 3520 N4</p> 
<p>Lenker, Radaufhängung</p> <p>ALL TYPES ausser : 2.0</p> <p>03.94 - 04.02</p>	<p>▽↻</p> <p>zul. Gesamtgewicht [kg]:1800 ->Chass. 16194399 nur in Verbindung mit:OE 3640 54</p> <p>Chass. 16194400-> für Tragelenk ohne Einschränkung</p>	<p>29420 01 3521 J4</p> 



PEUGEOT

**BOXER Kasten/Box/Furgón/Van
(230L)**

03.94 - 04.02

<p> Trag-/Führungsgelenk Gewindemaß: M16x1,5</p> <p>ALL TYPES ausser : 2.0 03.94 - 04.02</p>	<p></p> <p>->01.2001 ->Chass. 16194399 nur in Verbindung mit:OE 3520 N3 nur in Verbindung mit:OE 3521 J3 Nutzlast [kg]:1000,1400</p> <p>----- Chass. 16194400-> ohne Einschränkung</p>	<p>24538 02</p> 																														
<p>Trag-/Führungsgelenk maximale Last [kg]: 1800 Gewindemaß: M18x1,5</p> <p>ALL TYPES ausser : 2.0 03.94 - 04.02</p>	<p></p> <p>->01.2001 ->Chass. 16194399 nur in Verbindung mit:OE 3520 N4 nur in Verbindung mit:OE 3521 J4 Nutzlast [kg]:1800</p> <p>----- Chass. 16194400-> ohne Einschränkung</p>	<p>24539 01 3640 33</p> 																														
<p>Trag-/Führungsgelenk nur in Verbindung mit: 29417 nur in Verbindung mit: 29418 maximale Last [kg]: 1400</p> <p>ALL TYPES ausser : 2.0 03.94 - 04.02</p>	<p></p> <p>02.2001-></p>	<p>26667 01 3640 55</p> 																														
<p>Trag-/Führungsgelenk nur in Verbindung mit: 29419 nur in Verbindung mit: 29420 maximale Last [kg]: 1800 mit Zubehör</p> <p>ALL TYPES ausser : 2.0 03.94 - 04.02</p>	<p></p> <p>02.2001-></p>	<p>26668 01 3640 54</p>																														
<p>Faltenbalsatz, Lenkung</p> <table border="0"> <tr><td>2.0 4x4</td><td>03.96 - 09.98</td></tr> <tr><td>1.9 D, 51 kW</td><td>03.94 - 04.02</td></tr> <tr><td>1.9 DT 4x4</td><td>03.96 - 09.98</td></tr> <tr><td>2.5 D 4x4</td><td>07.99 - 04.02</td></tr> <tr><td>2.5 TDI 4x4</td><td>07.99 - 04.02</td></tr> <tr><td>2.5 DT</td><td>10.97 - 11.01</td></tr> </table> <p>2.0 i</p> <table border="0"> <tr><td>1.9 D, 50 kW</td><td>06.94 - 04.02</td></tr> <tr><td>1.9 TD, 66 kW</td><td>07.99 - 04.02</td></tr> <tr><td>1.9 TD</td><td>07.99 - 04.02</td></tr> <tr><td>2.0 HDI</td><td>03.94 - 04.02</td></tr> <tr><td>2.0 HDI</td><td>08.01 - 04.02</td></tr> <tr><td>2.5 D</td><td>03.94 - 04.02</td></tr> <tr><td>2.5 TD</td><td>03.94 - 04.02</td></tr> <tr><td>2.5 TDI</td><td>01.97 - 04.02</td></tr> <tr><td>2.8 HDI</td><td>11.00 - 04.02</td></tr> </table>	2.0 4x4	03.96 - 09.98	1.9 D, 51 kW	03.94 - 04.02	1.9 DT 4x4	03.96 - 09.98	2.5 D 4x4	07.99 - 04.02	2.5 TDI 4x4	07.99 - 04.02	2.5 DT	10.97 - 11.01	1.9 D, 50 kW	06.94 - 04.02	1.9 TD, 66 kW	07.99 - 04.02	1.9 TD	07.99 - 04.02	2.0 HDI	03.94 - 04.02	2.0 HDI	08.01 - 04.02	2.5 D	03.94 - 04.02	2.5 TD	03.94 - 04.02	2.5 TDI	01.97 - 04.02	2.8 HDI	11.00 - 04.02	<p></p> <p>nur in Verbindung mit:LEMFÖRDER 30203</p> <p></p> <p>nur in Verbindung mit:Lemförder 30203</p>	<p>30198 01 4006 22</p> 
2.0 4x4	03.96 - 09.98																															
1.9 D, 51 kW	03.94 - 04.02																															
1.9 DT 4x4	03.96 - 09.98																															
2.5 D 4x4	07.99 - 04.02																															
2.5 TDI 4x4	07.99 - 04.02																															
2.5 DT	10.97 - 11.01																															
1.9 D, 50 kW	06.94 - 04.02																															
1.9 TD, 66 kW	07.99 - 04.02																															
1.9 TD	07.99 - 04.02																															
2.0 HDI	03.94 - 04.02																															
2.0 HDI	08.01 - 04.02																															
2.5 D	03.94 - 04.02																															
2.5 TD	03.94 - 04.02																															
2.5 TDI	01.97 - 04.02																															
2.8 HDI	11.00 - 04.02																															
<p>Faltenbalsatz, Lenkung</p> <table border="0"> <tr><td>2.0 4x4</td><td>03.96 - 09.98</td></tr> <tr><td>1.9 D, 51 kW</td><td>03.94 - 04.02</td></tr> <tr><td>1.9 DT 4x4</td><td>03.96 - 09.98</td></tr> <tr><td>2.5 D 4x4</td><td>07.99 - 04.02</td></tr> <tr><td>2.5 TDI 4x4</td><td>07.99 - 04.02</td></tr> <tr><td>2.5 DT</td><td>10.97 - 11.01</td></tr> </table> <p>2.0 i</p> <table border="0"> <tr><td>1.9 D, 50 kW</td><td>06.94 - 04.02</td></tr> <tr><td>1.9 TD, 66 kW</td><td>07.99 - 04.02</td></tr> <tr><td>1.9 TD</td><td>07.99 - 04.02</td></tr> <tr><td>2.0 HDI</td><td>03.94 - 04.02</td></tr> <tr><td>2.0 HDI</td><td>08.01 - 04.02</td></tr> <tr><td>2.5 D</td><td>03.94 - 04.02</td></tr> <tr><td>2.5 TD</td><td>03.94 - 04.02</td></tr> <tr><td>2.5 TDI</td><td>01.97 - 04.02</td></tr> <tr><td>2.8 HDI</td><td>11.00 - 04.02</td></tr> </table>	2.0 4x4	03.96 - 09.98	1.9 D, 51 kW	03.94 - 04.02	1.9 DT 4x4	03.96 - 09.98	2.5 D 4x4	07.99 - 04.02	2.5 TDI 4x4	07.99 - 04.02	2.5 DT	10.97 - 11.01	1.9 D, 50 kW	06.94 - 04.02	1.9 TD, 66 kW	07.99 - 04.02	1.9 TD	07.99 - 04.02	2.0 HDI	03.94 - 04.02	2.0 HDI	08.01 - 04.02	2.5 D	03.94 - 04.02	2.5 TD	03.94 - 04.02	2.5 TDI	01.97 - 04.02	2.8 HDI	11.00 - 04.02	<p></p> <p>nur in Verbindung mit:LEMFÖRDER 30198</p> <p></p> <p>nur in Verbindung mit:Lemförder 30198</p>	<p>30203 01 4006 22</p> 
2.0 4x4	03.96 - 09.98																															
1.9 D, 51 kW	03.94 - 04.02																															
1.9 DT 4x4	03.96 - 09.98																															
2.5 D 4x4	07.99 - 04.02																															
2.5 TDI 4x4	07.99 - 04.02																															
2.5 DT	10.97 - 11.01																															
1.9 D, 50 kW	06.94 - 04.02																															
1.9 TD, 66 kW	07.99 - 04.02																															
1.9 TD	07.99 - 04.02																															
2.0 HDI	03.94 - 04.02																															
2.0 HDI	08.01 - 04.02																															
2.5 D	03.94 - 04.02																															
2.5 TD	03.94 - 04.02																															
2.5 TDI	01.97 - 04.02																															
2.8 HDI	11.00 - 04.02																															







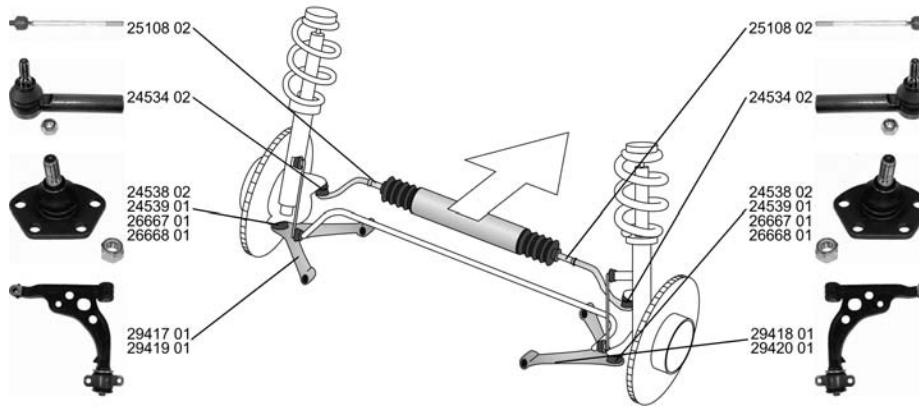

Ref.

PEUGEOT

**BOXER Pritsche, Fahrgestell /
Flatbed, Chassis/Van**

03.94 - 04.02

















<p>Spurstangenkopf Gewindeart: mit Rechtsgewinde Gewindemaß: M16x1,5</p> <p>ALL TYPES ausser : 2.0</p> <p>03.94 - 04.02</p>	<p>↔</p>	<p>24534 02 4018 A3</p> 
<p>Axialgelenk, Spurstange</p> <p>ALL TYPES ausser : 2.0</p> <p>03.94 - 04.02</p>	<p>↔</p>	<p>25108 02 4018 A4</p> 
<p>Lenker, Radaufhängung</p> <p>ALL TYPES ausser : 2.0</p> <p>03.94 - 04.02</p>	<p>▽↺</p> <p>zul. Gesamtgewicht [kg]:1000 zul. Gesamtgewicht [kg]:1400 ->Chass. 16194399 nur in Verbindung mit:OE 3640 55</p> <p>Chass. 16194400-> für Tragelenk ohne Einschränkung</p>	<p>29417 01 3520 N3</p> 
<p>Lenker, Radaufhängung</p> <p>ALL TYPES ausser : 2.0</p> <p>03.94 - 04.02</p>	<p>▽↻</p> <p>zul. Gesamtgewicht [kg]:1000 zul. Gesamtgewicht [kg]:1400 ->Chass. 16194399 nur in Verbindung mit:OE 3640 55</p> <p>Chass. 16194400-> für Tragelenk ohne Einschränkung</p>	<p>29418 01 3521 J3</p> 
<p>Lenker, Radaufhängung</p> <p>ALL TYPES ausser : 2.0</p> <p>03.94 - 04.02</p>	<p>▽↺</p> <p>zul. Gesamtgewicht [kg]:1800 ->Chass. 16194399 nur in Verbindung mit:OE 3640 54</p> <p>Chass. 16194400-> für Tragelenk ohne Einschränkung</p>	<p>29419 01 3520 N4</p> 
<p>Lenker, Radaufhängung</p> <p>ALL TYPES ausser : 2.0 2.0</p> <p>03.94 - 04.02 12.01 -</p>	<p>▽↻</p> <p>zul. Gesamtgewicht [kg]:1800 ->Chass. 16194399 nur in Verbindung mit:OE 3640 54</p> <p>Chass. 16194400-> für Tragelenk ohne Einschränkung</p>	<p>29420 01 3521 J4</p> 



PEUGEOT

**BOXER Pritsche, Fahrgestell /
Flatbed, Chassis/Van**











03.94 - 04.02

<p> Trag-/Führungsgelenk Gewindemaß: M16x1,5</p> <p>ALL TYPES ausser : 2.0 03.94 - 04.02</p>	<p></p> <p>->01.2001 ->Chass. 16194399 nur in Verbindung mit:OE 3520 N3 nur in Verbindung mit:OE 3521 J3 Nutzlast [kg]:1000,1400</p> <p>----- Chass. 16194400-> ohne Einschränkung</p>	<p>24538 02</p> 
<p>Trag-/Führungsgelenk maximale Last [kg]: 1800 Gewindemaß: M18x1,5</p> <p>ALL TYPES ausser : 2.0 03.94 - 04.02</p>	<p></p> <p>->01.2001 ->Chass. 16194399 nur in Verbindung mit:OE 3520 N4 nur in Verbindung mit:OE 3521 J4 Nutzlast [kg]:1800</p> <p>----- Chass. 16194400-> ohne Einschränkung</p>	<p>24539 01 3640 33</p> 
<p>Trag-/Führungsgelenk nur in Verbindung mit: 29417 nur in Verbindung mit: 29418 maximale Last [kg]: 1400</p> <p>ALL TYPES ausser : 2.0 03.94 - 04.02</p>	<p></p> <p>02.2001-></p>	<p>26667 01 3640 55</p> 
<p>Trag-/Führungsgelenk nur in Verbindung mit: 29419 nur in Verbindung mit: 29420 maximale Last [kg]: 1800 mit Zubehör</p> <p>2.0 12.01 - 2.5 D 03.94 - 04.02 2.0 i 06.94 - 04.02 1.9 TD, 66 kW 12.98 - 04.02 1.9 TD, 68 kW 07.96 - 04.02 2.5 D 4x4 07.99 - 04.02 2.5 TD 03.94 - 04.02 2.5 TDI 01.97 - 04.02 2.5 TDI 4x4 07.99 - 04.02 2.8 HDI 11.00 - 04.02</p>	<p></p> <p>02.2001-></p>	<p>26668 01 3640 54</p> 
<p>Faltenbalsatz, Lenkung</p> <p>2.0 12.01 - 2.5 D 03.94 - 04.02 2.5 D 4x4 07.99 - 04.02 2.5 TDI 4x4 07.99 - 04.02 2.0 i 06.94 - 04.02 1.9 TD, 66 kW 12.98 - 04.02 1.9 TD, 68 kW 07.96 - 04.02 2.5 TD 03.94 - 04.02 2.5 TDI 01.97 - 04.02 2.8 HDI 11.00 - 04.02</p>	<p></p> <p>nur in Verbindung mit:LEMFÖRDER 30203</p> <p></p> <p>nur in Verbindung mit:Lemförder 30203</p>	<p>30198 01 4006 22</p> 
<p>Faltenbalsatz, Lenkung</p> <p>2.0 12.01 - 2.5 D 03.94 - 04.02 2.5 D 4x4 07.99 - 04.02 2.5 TDI 4x4 07.99 - 04.02 2.0 i 06.94 - 04.02 1.9 TD, 66 kW 12.98 - 04.02 1.9 TD, 68 kW 07.96 - 04.02 2.5 TD 03.94 - 04.02 2.5 TDI 01.97 - 04.02 2.8 HDI 11.00 - 04.02</p>	<p></p> <p>nur in Verbindung mit:LEMFÖRDER 30198</p> <p></p> <p>nur in Verbindung mit:Lemförder 30198</p>	<p>30203 01 4006 22</p> 







PEUGEOT

BOXER Bus/Familial (244, Z_) 04.02 -

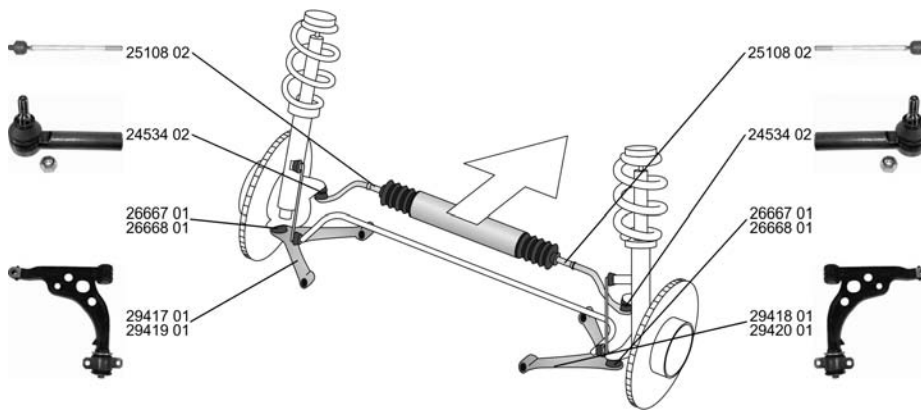
 Trag-/Führungsgelenk nur in Verbindung mit: 29417 nur in Verbindung mit: 29418 maximale Last [kg]: 1400 ALL TYPES		26667 01 3640 55 
Trag-/Führungsgelenk nur in Verbindung mit: 29419 nur in Verbindung mit: 29420 maximale Last [kg]: 1800 mit Zubehör ALL TYPES		26668 01 3640 54
Faltenbalgsatz, Lenkung 2.0 04.02 - 2.8 HDi, 107 kW 04.04 -	 nur in Verbindung mit: LEMFÖRDER 30203	30198 01 4006 22 
2.0 HDi 04.02 - 2.2 HDi 04.02 - 2.8 HDi, 94 kW 04.02 - 2.8 HDi 4x4 04.02 -	 nur in Verbindung mit: Lemförder 30203	
Faltenbalgsatz, Lenkung 2.0 04.02 - 2.8 HDi, 107 kW 04.04 -	 nur in Verbindung mit: LEMFÖRDER 30198	30203 01 4006 22 
2.0 HDi 04.02 - 2.2 HDi 04.02 - 2.8 HDi, 94 kW 04.02 - 2.8 HDi 4x4 04.02 -	 nur in Verbindung mit: Lemförder 30198	

BOXER Kasten/Box/Furgón/Van (244) 04.02 -



Spurstangenkopf Gewindeart: mit Rechtsgewinde Gewindemaß: M16x1,5 2.0 04.02 - 2.0 HDi 04.02 - 2.2 HDi 04.02 - 2.8 HDi, 94 kW 04.02 - 2.8 HDi 4x4 04.02 - 2.8 HDi, 107 kW 04.04 -	 ->12.2002	24534 02 4018 A3 
Axialgelenk, Spurstange ALL TYPES		25108 02 4018 A4 





















Ref.

PEUGEOT

BOXER Kasten/Box/Furgón/Van (244)

04.02 -

 Lenker, Radaufhängung ALL TYPES	 <p>zul. Gesamtgewicht [kg]:1000 zul. Gesamtgewicht [kg]:1400 ->Chass. 16194399 nur in Verbindung mit:OE 3640 55</p> <p>Chass. 16194400-> für Trag gelenk ohne Einschränkung</p>	<p>29417 01 3520 N3</p> 
Lenker, Radaufhängung ALL TYPES	 <p>zul. Gesamtgewicht [kg]:1000 zul. Gesamtgewicht [kg]:1400 ->Chass. 16194399 nur in Verbindung mit:OE 3640 55</p> <p>Chass. 16194400-> für Trag gelenk ohne Einschränkung</p>	<p>29418 01 3521 J3</p> 
Lenker, Radaufhängung ALL TYPES	 <p>zul. Gesamtgewicht [kg]:1800 ->Chass. 16194399 nur in Verbindung mit:OE 3640 54</p> <p>Chass. 16194400-> für Trag gelenk ohne Einschränkung</p>	<p>29419 01 3520 N4</p> 
Lenker, Radaufhängung ALL TYPES	 <p>zul. Gesamtgewicht [kg]:1800 ->Chass. 16194399 nur in Verbindung mit:OE 3640 54</p> <p>Chass. 16194400-> für Trag gelenk ohne Einschränkung</p>	<p>29420 01 3521 J4</p> 
Trag-/Führungsgelenk nur in Verbindung mit: 29417 nur in Verbindung mit: 29418 maximale Last [kg]: 1400 ALL TYPES		<p>26667 01 3640 55</p> 
Trag-/Führungsgelenk nur in Verbindung mit: 29419 nur in Verbindung mit: 29420 maximale Last [kg]: 1800 mit Zubehör ALL TYPES		<p>26668 01 3640 54</p> 
Faltenbalgsatz, Lenkung 2.0 HDi 04.02 - 2.8 HDi, 107 kW 04.04 - 2.0 04.02 - 2.2 HDi 04.02 - 2.8 HDi, 94 kW 04.02 - 2.8 HDi 4x4 04.02 -	 <p>nur in Verbindung mit:LEMFÖRDER 30203</p>  <p>nur in Verbindung mit:Lemförder 30203</p>	<p>30198 01 4006 22</p> 
Faltenbalgsatz, Lenkung 2.0 HDi 04.02 - 2.8 HDi, 107 kW 04.04 - 2.0 04.02 - 2.2 HDi 04.02 - 2.8 HDi, 94 kW 04.02 - 2.8 HDi 4x4 04.02 -	 <p>nur in Verbindung mit:LEMFÖRDER 30198</p>  <p>nur in Verbindung mit:Lemförder 30198</p>	<p>30203 01 4006 22</p> 







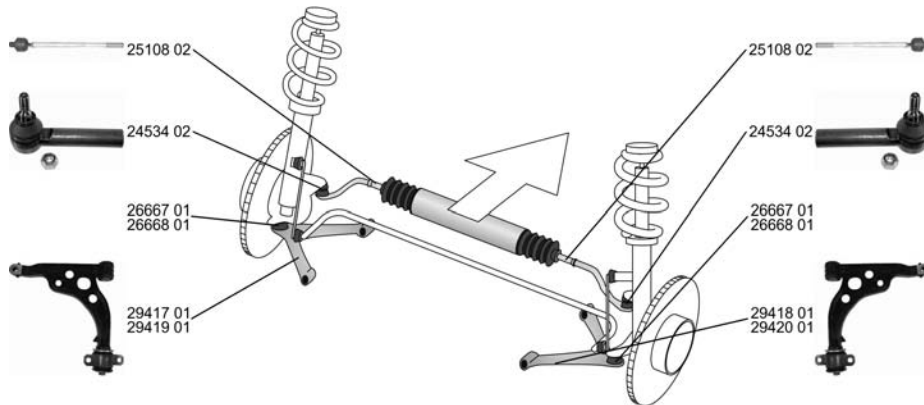

PEUGEOT

**BOXER Pritsche, Fahrgestell /
Flatbed, Chassis (244)**

04.02 -



<p>Spurstangenkopf Gewindeart: mit Rechtsgewinde Gewindemaß: M16x1,5</p> <p>2.0 HDi 04.02 - 2.2 HDi 04.02 - 2.8 HDi, 94 kW 04.02 - 2.8 HDi 4x4 04.02 -</p>		<p>24534 02 4018 A3</p> 
<p>Axialgelenk, Spurstange ALL TYPES</p>		<p>25108 02 4018 A4</p> 
<p>Lenker, Radaufhängung ALL TYPES</p>		<p>29417 01 3520 N3</p> 
<p>Lenker, Radaufhängung ALL TYPES</p>		<p>29418 01 3521 J3</p> 
<p>Lenker, Radaufhängung ALL TYPES</p>		<p>29419 01 3520 N4</p> 
<p>Lenker, Radaufhängung ALL TYPES</p>		<p>29420 01 3521 J4</p> 











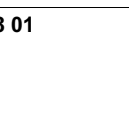

Ref.

PEUGEOT







BOXER Pritsche, Fahrgestell / Flatbed, Chassis (244)

04.02 -

 Trag-/Führungsgelenk nur in Verbindung mit: 29417 nur in Verbindung mit: 29418 maximale Last [kg]: 1400 ALL TYPES		26667 01 3640 55 
Trag-/Führungsgelenk nur in Verbindung mit: 29419 nur in Verbindung mit: 29420 maximale Last [kg]: 1800 mit Zubehör ALL TYPES		26668 01 3640 54 
Faltenbalgsatz, Lenkung 2.0 HDi 04.02 - 2.8 HDi, 107 kW 04.04 - 2.2 HDi 04.02 - 2.8 HDi, 94 kW 04.02 - 2.8 HDi 4x4 04.02 -	 nur in Verbindung mit: LEMFÖRDER 30203  nur in Verbindung mit: Lemförder 30203	30198 01 4006 22 
Faltenbalgsatz, Lenkung 2.0 HDi 04.02 - 2.8 HDi, 107 kW 04.04 - 2.2 HDi 04.02 - 2.8 HDi, 94 kW 04.02 - 2.8 HDi 4x4 04.02 -	 nur in Verbindung mit: LEMFÖRDER 30198  nur in Verbindung mit: Lemförder 30198	30203 01 4006 22 







BOXER Bus

04.06 -

 Trag-/Führungsgelenk Konusmaß [mm]: 24 ALL TYPES		31196 01 3640 67 
 Stange/Strebe, Stabilisator Pendelstange Rohr-Ø [mm]: 8 Gewindemaß: M10 x 1,5 ALL TYPES		31351 01 5170 F5 

BOXER Kasten

04.06 -







 Trag-/Führungsgelenk Konusmaß [mm]: 24 ALL TYPES		31196 01 3640 67 
 Stange/Strebe, Stabilisator Pendelstange Rohr-Ø [mm]: 8 Gewindemaß: M10 x 1,5 ALL TYPES		31351 01 5170 F5 



Ref.







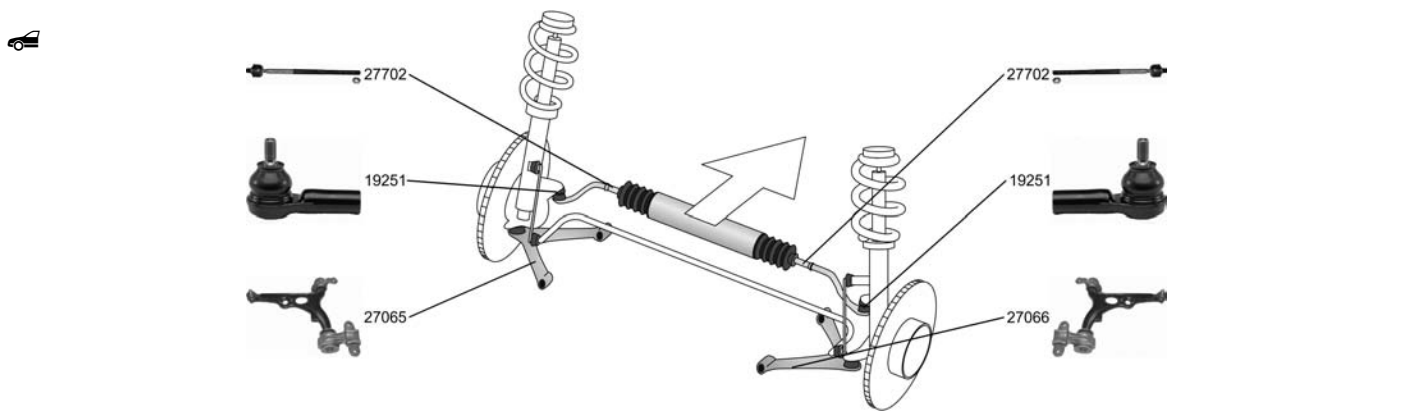

PEUGEOT

BOXER Pritsche/Fahrgestell 04.06 -

 Trag-/Führungsgelenk Konusmaß [mm]: 24 ALL TYPES		31196 01 3640 67 
 Stange/Strebe, Stabilisator Pendelstange Rohr-Ø [mm]: 8 Gewindemaß: M10 x 1,5 ALL TYPES		31351 01 5170 F5 

EXPERT Kasten/Box/Furgón/Van (222) 07.95 -



 Spurstangenkopf Gewindeart: mit Rechtsgewinde Innengewinde [mm]: M14x1,5 mit Zubehör ALL TYPES	 ->Orga 09792	19251 03 4059 09 
Axialgelenk, Spurstange Aussengewinde [mm]: M14x1,5 ALL TYPES ausser : 1.8 10.96 - 09.00 1.9 D 70 12.98 - 2.0 HDI, 80 kW 07.00 -		27702 01 3812 A4 
Lenker, Radaufhängung mit Trag-/Führungsgelenk mit Gummilager mit Befestigungsmaterial ALL TYPES ausser : 1.8 10.96 - 09.00 1.9 D 70 12.98 - 2.0 HDI, 80 kW 07.00 -		27065 02 3520 P4 
Lenker, Radaufhängung mit Trag-/Führungsgelenk mit Gummilager mit Befestigungsmaterial ALL TYPES ausser : 1.8 10.96 - 09.00 1.9 D 70 12.98 - 2.0 HDI, 80 kW 07.00 -		27066 02 3521 K4 





Ref.

PEUGEOT

EXPERT Kasten/Box/Furgón/Van (222)





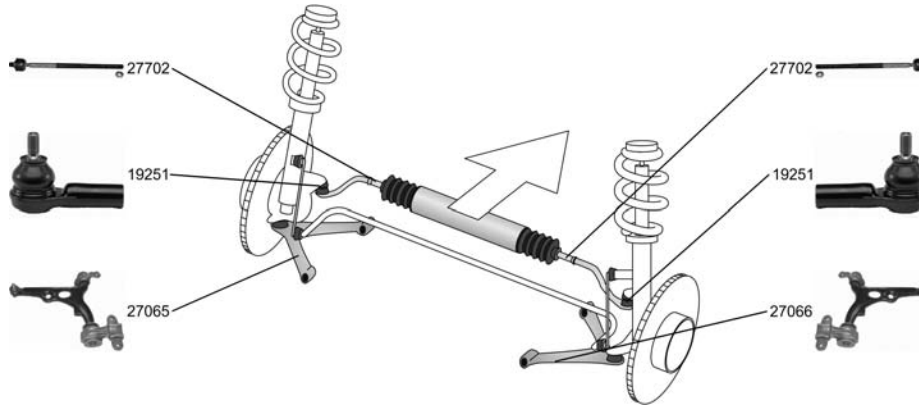

07.95 -

	Achskörperlager		↔	26578 01	5152 61
	1.6	02.96 -			
	2.0	09.02 -			
	1.9 TD, 66 kW	02.96 -			
	1.9 TD, 68 kW	02.96 -			
	2.0 HDI, 69 kW	07.00 -			
2.0 HDI, 80 kW	07.00 -				

EXPERT (224)

12.95 -



	Spurstangenkopf Gewindeart: mit Rechtsgewinde Innengewinde [mm]: M14x1,5 mit Zubehör		↔	19251 03	4059 09
	ALL TYPES ausser : 1.8 i	11.95 -	-->Orga 09792		
	Axialgelenk, Spurstange Aussengewinde [mm]: M14x1,5		↔	27702 01	3812 A4
	1.6	02.96 -			
	2.0	07.00 -			
	1.9 D, 51 kW	02.96 -			
	1.9 TD, 66 kW	02.96 -			
	1.9 TD	02.96 -			
	2.0 HDI	07.00 -			
	Lenker, Radaufhängung mit Trag-/Führungsgelenk mit Gummilager mit Befestigungsmaterial		↔	27065 02	3520 P4
	1.6	02.96 -			
	2.0	07.00 -			
	1.9 D, 51 kW	02.96 -			
	1.9 TD, 66 kW	02.96 -			
	1.9 TD	02.96 -			
	2.0 HDI	07.00 -			
	Lenker, Radaufhängung mit Trag-/Führungsgelenk mit Gummilager mit Befestigungsmaterial		↔	27066 02	3521 K4
	1.6	02.96 -			
	2.0	07.00 -			
	1.9 D, 51 kW	02.96 -			
	1.9 TD, 66 kW	02.96 -			
	1.9 TD	02.96 -			
	2.0 HDI	07.00 -			
	Achskörperlager		↔	26578 01	5152 61
	1.6	02.96 -			
	2.0	07.00 -			
	1.9 D, 51 kW	02.96 -			
	1.9 TD, 66 kW	02.96 -			
	1.9 TD	02.96 -			
	2.0 HDI	07.00 -			









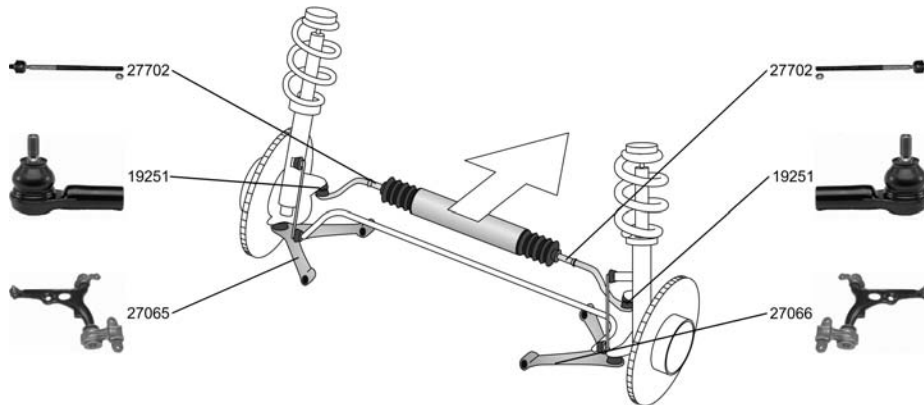



PEUGEOT

EXPERT Pritsche, Fahrgestell / Flatbed, Chassis/ Van (223)

12.95 -





<p>Spurstangenkopf Gewindeart: mit Rechtsgewinde Innengewinde [mm]: M14x1,5 mit Zubehör</p>		<p>19251 03 4059 09</p> 
<p>ALL TYPES ausser : 2.0 16V 02.96 - 1.9 D, 1868 ccm 02.96 - 2.0 HDI 07.00 -</p>	<p>->Orga 09792</p>	
<p>Axialgelenk, Spurstange Aussengewinde [mm]: M14x1,5</p>		<p>27702 01 3812 A4</p> 
<p>1.6 02.96 - 1.9 D, 1905 ccm 02.96 - 1.9 TD, 66 kW 02.96 - 1.9 TD, 68 kW 02.96 -</p>		
<p>Lenker, Radaufhängung mit Trag-/Führungsgelenk mit Gummilager mit Befestigungsmaterial</p>		<p>27065 02 3520 P4</p> 
<p>1.6 02.96 - 1.9 D, 1905 ccm 02.96 - 1.9 TD, 66 kW 02.96 - 1.9 TD, 68 kW 02.96 -</p>		
<p>Lenker, Radaufhängung mit Trag-/Führungsgelenk mit Gummilager mit Befestigungsmaterial</p>		<p>27066 02 3521 K4</p> 
<p>1.6 02.96 - 1.9 D, 1905 ccm 02.96 - 1.9 TD, 66 kW 02.96 - 1.9 TD, 68 kW 02.96 -</p>		
<p>Achskörperlager</p> <p>1.6 02.96 - 1.9 D, 1905 ccm 02.96 - 1.9 TD, 66 kW 02.96 - 1.9 TD, 68 kW 02.96 -</p>		<p>26578 01 5152 61</p> 

EXPERT Tepee (VF3V_)

01.07 -



<p>Spurstangenkopf Konusmaß [mm]: 18 Gewindemaß: M14x1,5</p>		<p>31900 01</p> 
<p>ALL TYPES</p>		







Ref.

PEUGEOT







EXPERT Tepee (VF3V_)

01.07 -

 Axialgelenk, Spurstange Gewindemaß: M16x1,5 Gewindemaß: M14x1,5 radseitig ALL TYPES		31899 01 
Stange/Strebe, Stabilisator Pendelstange Gewindemaß: M12x1,75 ALL TYPES		31898 01 5087 56







EXPERT Kasten (VF3A_, VF3U_, VF3X_)

01.07 -

 Spurstangenkopf Konusmaß [mm]: 18 Gewindemaß: M14x1,5 ALL TYPES		31900 01 
Axialgelenk, Spurstange Gewindemaß: M16x1,5 Gewindemaß: M14x1,5 radseitig ALL TYPES		31899 01 
Stange/Strebe, Stabilisator Pendelstange Gewindemaß: M12x1,75 ALL TYPES		31898 01 5087 56



EXPERT Pritsche/Fahrgestell

01.07 -

 Spurstangenkopf Konusmaß [mm]: 18 Gewindemaß: M14x1,5 1.6 HDi 90 01.07 - 2.0 HDi 120 01.07 - 2.0 HDi 140 01.07 -		31900 01 
Axialgelenk, Spurstange Gewindemaß: M16x1,5 Gewindemaß: M14x1,5 radseitig 1.6 HDi 90 01.07 - 2.0 HDi 120 01.07 - 2.0 HDi 140 01.07 -		31899 01 
Stange/Strebe, Stabilisator Pendelstange Gewindemaß: M12x1,75 1.6 HDi 90 01.07 - 2.0 HDi 120 01.07 - 2.0 HDi 140 01.07 -		31898 01 5087 56

J5 Bus/Familial (280P)

09.81 - 09.90



















 Spurstangenkopf Konusmaß [mm]: 16 Innengewinde [mm]: M16x1,5 Gewindeart: mit Rechtsgewinde Gewindemaß: M16x1,5 2.0, 55 kW 09.81 - 09.90 2.0, 58 kW 01.83 - 09.90 2.0 Super 4x4 09.81 - 08.90 2.5 D 09.81 - 09.90		11603 02 3817 11 
---	---	--





Ref.

PEUGEOT

J5 Bus/Familial (280P) 09.81 - 09.90

<p> Axialgelenk, Spurstange Gewindeart: mit Rechtsgewinde Gewindemaß: M16x1,5</p> <p>2.0, 55 kW 09.81 - 09.90 2.0, 58 kW 01.83 - 09.90 2.0 Super 4x4 09.81 - 08.90 2.5 D 09.81 - 09.90</p>	<p></p> <p></p>	<p>15377 02 3812 27</p> 
<p>Lenker, Radaufhängung ohne Trag-/Führungsgelenk mit Gummilager nur in Verbindung mit: 11591 Nutzlast [kg]: 1000 Nutzlast [kg]: 1400</p> <p>2.0, 55 kW 09.81 - 09.90 2.0, 58 kW 01.83 - 09.90 2.0 Super 4x4 09.81 - 08.90 2.5 D 09.81 - 09.90</p>	<p></p> <p>10.1985-></p>	<p>22785 01 3521 52</p> 
<p>Lenker, Radaufhängung ohne Trag-/Führungsgelenk mit Gummilager nur in Verbindung mit: 11591 Nutzlast [kg]: 1000 Nutzlast [kg]: 1400</p> <p>2.0, 55 kW 09.81 - 09.90 2.0, 58 kW 01.83 - 09.90 2.0 Super 4x4 09.81 - 08.90 2.5 D 09.81 - 09.90</p>	<p></p> <p>10.1985-></p>	<p>22786 01 3520 76</p> 
<p>Trag-/Führungsgelenk mit Zubehör</p> <p>2.0, 55 kW 09.81 - 09.90 2.0, 58 kW 01.83 - 09.90 2.0 Super 4x4 09.81 - 08.90 2.5 D 09.81 - 09.90</p>	<p></p> <p>10.1985-></p>	<p>11591 02 3640 26</p> 
<p>Trag-/Führungsgelenk mit Zubehör</p> <p>2.0, 55 kW 09.81 - 09.90 2.0, 58 kW 01.83 - 09.90 2.0 Super 4x4 09.81 - 08.90 2.5 D 09.81 - 09.90</p>	<p></p> <p>->09.1985</p>	<p>14773 02 3640 17</p> 
<p>Faltenbalg, Lenkung</p> <p>2.0, 55 kW 09.81 - 09.90 2.0, 58 kW 01.83 - 09.90 2.5 D 09.81 - 09.90</p>	<p></p>	<p>15342 01 4066 19</p> 
<p>Faltenbalg, Lenkung</p> <p>2.0, 55 kW 09.81 - 09.90 2.0, 58 kW 01.83 - 09.90 2.0 Super 4x4 09.81 - 08.90 2.5 D 09.81 - 09.90</p>	<p></p>	<p>30919 01 4066 18</p> 
<p>Faltenbalgsatz, Lenkung Innendurchmesser 1 [mm]: 11 Innendurchmesser 2 [mm]: 38</p> <p>2.0, 55 kW 09.81 - 09.90 2.0, 58 kW 01.83 - 09.90 2.0 Super 4x4 09.81 - 08.90 2.5 D 09.81 - 09.90</p>	<p></p>	<p>30132 01 4066 19</p> 

J5 Kasten/Box/Furgón/Van (280L) 09.81 - 09.90

<p> Spurstangenkopf Konusmaß [mm]: 16 Innengewinde [mm]: M16x1,5 Gewindeart: mit Rechtsgewinde Gewindemaß: M16x1,5</p> <p>ALL TYPES</p>	<p></p>	<p>11603 02 3817 11</p> 
---	--	---





















Ref.

PEUGEOT



J5 Kasten/Box/Furgón/Van (280L)

09.81 - 09.90

 Axialgelenk, Spurstange Gewindeart: mit Rechtsgewinde Gewindemaß: M16x1,5		15377 02 3812 27 
ALL TYPES		
Lenker, Radaufhängung ohne Trag-/Führungsgelenk mit Gummilager nur in Verbindung mit: 11591 Nutzlast [kg]: 1000 Nutzlast [kg]: 1400		22785 01 3521 52 
ALL TYPES	10.1985->	
Lenker, Radaufhängung ohne Trag-/Führungsgelenk mit Gummilager nur in Verbindung mit: 11591 Nutzlast [kg]: 1000 Nutzlast [kg]: 1400		22786 01 3520 76 
ALL TYPES	10.1985->	
Trag-/Führungsgelenk mit Zubehör		11591 02 3640 26 
ALL TYPES	10.1985->	
Trag-/Führungsgelenk mit Zubehör		14773 02 3640 17 
ALL TYPES	->09.1985	
Faltenbalg, Lenkung 1.8		15342 01 4066 19 
01.83 - 11.88		
Faltenbalg, Lenkung		30919 01 4066 18 
ALL TYPES		
Faltenbalgsatz, Lenkung Innendurchmesser 1 [mm]: 11 Innendurchmesser 2 [mm]: 38		30132 01 4066 19 
ALL TYPES		

J5 Pritsche,Fahrgestell / Flatbed,Chassis/Van (280L)

09.81 - 09.90



















 Spurstangenkopf Konusmaß [mm]: 16 Innengewinde [mm]: M16x1,5 Gewindeart: mit Rechtsgewinde Gewindemaß: M16x1,5		11603 02 3817 11 
ALL TYPES ausser : 2.5 TD 01.88 - 09.90		



PEUGEOT

**J5 Pritsche, Fahrgestell /
Flatbed, Chassis/Van (280L)**

09.81 - 09.90























 Axialgelenk, Spurstange Gewindeart: mit Rechtsgewinde Gewindemaß: M16x1,5		15377 02 3812 27 
ALL TYPES ausser : 2.5 TD 01.88 - 09.90		
Lenker, Radaufhängung ohne Trag-/Führungsgelenk mit Gummilager nur in Verbindung mit: 11591 Nutzlast [kg]: 1000 Nutzlast [kg]: 1400		22785 01 3521 52 
1.8 09.81 - 08.90 2.0, 58 kW 01.83 - 11.88 2.5 D 09.81 - 09.90 2.5 D 4x4 09.81 - 08.90 2.5 DT 09.81 - 08.90 2.5 DT 4x4 09.81 - 08.90 2.0, 55 kW 01.86 - 11.88	10.1985->	
Lenker, Radaufhängung ohne Trag-/Führungsgelenk mit Gummilager nur in Verbindung mit: 11591 Nutzlast [kg]: 1000 Nutzlast [kg]: 1400		22786 01 3520 76 
1.8 09.81 - 08.90 2.0, 58 kW 01.83 - 11.88 2.5 D 09.81 - 09.90 2.5 D 4x4 09.81 - 08.90 2.5 DT 09.81 - 08.90 2.5 DT 4x4 09.81 - 08.90 2.0, 55 kW 01.86 - 11.88	10.1985->	
Trag-/Führungsgelenk mit Zubehör		11591 02 3640 26 
1.8 09.81 - 08.90 2.0, 58 kW 01.83 - 11.88 2.5 D 09.81 - 09.90 2.5 D 4x4 09.81 - 08.90 2.5 DT 09.81 - 08.90 2.5 DT 4x4 09.81 - 08.90 2.0, 55 kW 01.86 - 11.88	10.1985->	
Trag-/Führungsgelenk mit Zubehör		14773 02 3640 17 
ALL TYPES ausser : 2.5 TD 01.88 - 09.90	->09.1985	
Faltenbalg, Lenkung		15342 01 4066 19 
2.0, 55 kW 01.86 - 11.88 2.0, 58 kW 01.83 - 11.88 2.5 D 09.81 - 09.90		
Faltenbalg, Lenkung		30919 01 4066 18 
ALL TYPES ausser : 2.5 TD 01.88 - 09.90		
Faltenbalgsatz, Lenkung Innendurchmesser 1 [mm]: 11 Innendurchmesser 2 [mm]: 38		30132 01 4066 19 
ALL TYPES ausser : 2.5 TD 01.88 - 09.90		









Ref.

PEUGEOT

J5 Bus/Familial (290P) 09.90 - 03.94

 Spurstangenkopf Konusmaß [mm]: 16 Innengewinde [mm]: M16x1,5 Gewindeart: mit Rechtsgewinde Gewindemaß: M16x1,5 ALL TYPES		11603 02 3817 11 
Axialgelenk, Spurstange Gewindeart: mit Rechtsgewinde Gewindemaß: M16x1,5 ALL TYPES	 	15377 02 3812 27 
Lenker, Radaufhängung ohne Trag-/Führungsgelenk mit Gummilager nur in Verbindung mit: 11591 Nutzlast [kg]: 1000 Nutzlast [kg]: 1400 ALL TYPES	 	22785 01 3521 52 
Lenker, Radaufhängung ohne Trag-/Führungsgelenk mit Gummilager nur in Verbindung mit: 11591 Nutzlast [kg]: 1000 Nutzlast [kg]: 1400 ALL TYPES	 	22786 01 3520 76 
Trag-/Führungsgelenk mit Zubehör ALL TYPES	 	11591 02 3640 26 
Faltenbalg, Lenkung ALL TYPES	 	15342 01 4066 19 
Faltenbalg, Lenkung ALL TYPES		30919 01 4066 18 
Faltenbalgsatz, Lenkung Innendurchmesser 1 [mm]: 11 Innendurchmesser 2 [mm]: 38 ALL TYPES		30132 01 4066 19 

J5 Kasten/Box/Furgón/Van (290L) 09.90 - 03.94













 Spurstangenkopf Konusmaß [mm]: 16 Innengewinde [mm]: M16x1,5 Gewindeart: mit Rechtsgewinde Gewindemaß: M16x1,5 ALL TYPES		11603 02 3817 11 
Axialgelenk, Spurstange Gewindeart: mit Rechtsgewinde Gewindemaß: M16x1,5 ALL TYPES	 	15377 02 3812 27 
ALL TYPES		



PEUGEOT









J5 Kasten/Box/Furgón/Van (290L)

09.90 - 03.94

<p> Lenker, Radaufhängung ohne Trag-/Führungsgelenk mit Gummilager nur in Verbindung mit: 11591 Nutzlast [kg]: 1000 Nutzlast [kg]: 1400</p>	<p></p>	<p>22785 01 3521 52 </p>
<p>ALL TYPES</p>	<p>->05.1994</p>	
<p>Lenker, Radaufhängung ohne Trag-/Führungsgelenk mit Gummilager nur in Verbindung mit: 11591 Nutzlast [kg]: 1000 Nutzlast [kg]: 1400</p>	<p></p>	<p>22786 01 3520 76 </p>
<p>ALL TYPES</p>	<p>->05.1994</p>	
<p>Trag-/Führungsgelenk mit Zubehör</p>	<p></p>	<p>11591 02 3640 26 </p>
<p>ALL TYPES</p>		
<p>Faltenbalg, Lenkung 1.9 D 10.90 - 2.5 D 4x4 10.90 - 2.5 TD 4x4 10.90 -</p>	<p></p>	<p>15342 01 4066 19 </p>
<p>Faltenbalg, Lenkung</p>	<p></p>	<p>30919 01 4066 18 </p>
<p>ALL TYPES</p>		
<p>Faltenbalgsatz, Lenkung Innendurchmesser 1 [mm]: 11 Innendurchmesser 2 [mm]: 38</p>	<p></p>	<p>30132 01 4066 19 </p>
<p>ALL TYPES</p>		

J5 Pritsche,Fahrgestell / Flatbed,Chassis/Van (290L)

09.90 - 03.94











<p> Spurstangenkopf Konusmaß [mm]: 16 Innengewinde [mm]: M16x1,5 Gewindeart: mit Rechtsgewinde Gewindemaß: M16x1,5</p>	<p></p>	<p>11603 02 3817 11 </p>
<p>ALL TYPES</p>		
<p>Axialgelenk, Spurstange Gewindeart: mit Rechtsgewinde Gewindemaß: M16x1,5</p>	<p> </p>	<p>15377 02 3812 27 </p>
<p>ALL TYPES</p>	<p></p>	
<p>Lenker, Radaufhängung ohne Trag-/Führungsgelenk mit Gummilager nur in Verbindung mit: 11591 Nutzlast [kg]: 1000 Nutzlast [kg]: 1400</p>	<p></p>	<p>22785 01 3521 52 </p>
<p>ALL TYPES</p>	<p>->05.1994</p>	





Ref.

PEUGEOT



J5 Pritsche,Fahrgestell / Flatbed,Chassis/Van (290L) 09.90 - 03.94

 Lenker, Radaufhängung ohne Trag-/Führungsgelenk mit Gummilager nur in Verbindung mit: 11591 Nutzlast [kg]: 1000 Nutzlast [kg]: 1400		22786 01 3520 76 
ALL TYPES	->05.1994	
Trag-/Führungsgelenk mit Zubehör		11591 02 3640 26 
ALL TYPES		
Faltenbalg, Lenkung 2.0, 62 kW 10.90 - 1.9 D 10.90 - 2.5 D 10.90 - 2.5 D 4x4 10.90 - 2.5 TD 10.90 - 2.5 TD 4x4 10.90 -		15342 01 4066 19 
Faltenbalg, Lenkung ALL TYPES		30919 01 4066 18 
ALL TYPES		
Faltenbalgsatz, Lenkung Innendurchmesser 1 [mm]: 11 Innendurchmesser 2 [mm]: 38		30132 01 4066 19 
ALL TYPES		



J9 Bus/Familial 03.80 - 06.87

 Trag-/Führungsgelenk mit Zubehör Gewindemaß 1: M20x1,5 Gewindemaß 2: M18x1,5		11639 01 3608 28 
ALL TYPES		

J9 Kasten/Box/Furgón/Van 03.80 - 06.87

 Trag-/Führungsgelenk mit Zubehör Gewindemaß 1: M20x1,5 Gewindemaß 2: M18x1,5		11639 01 3608 28 
ALL TYPES		

J9 Pritsche,Fahrgestell / Flatbed,Chassis/Van 03.80 - 06.87

 Trag-/Führungsgelenk mit Zubehör Gewindemaß 1: M20x1,5 Gewindemaß 2: M18x1,5		11639 01 3608 28 
ALL TYPES		









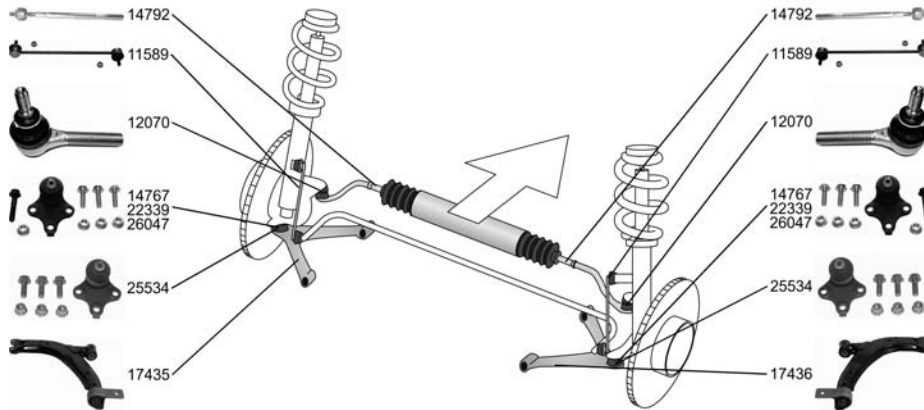



PEUGEOT

PARTNER Kasten/Box/Furgón/Van
(5)

06.96 -

























<p>Spurstangenkopf mit Zubehör Gewindeart: mit Rechtsgewinde Gewindemaß: M14x1,5</p> <p>1.1 06.96 - 1.4, 55 kW 06.96 - 1.4 BiFuel 04.03 - 1.8 D, 43 kW 06.96 - 1.9 D, 51 kW 06.96 - 2.0 HDi 04.00 -</p>		<p>12070 04 3817 50</p> 
<p>Axialgelenk, Spurstange Gewindeart: mit Rechtsgewinde Gewindemaß: M14x1,5 mit Zubehör</p> <p>1.1 06.96 - 1.4, 55 kW 06.96 - 1.4 BiFuel 04.03 - 1.8 D, 43 kW 06.96 - 1.9 D, 51 kW 06.96 -</p>		<p>14792 01 3812 C0</p> 
<p>Lenker, Radaufhängung mit Gummilager ohne Trag-/Führungsgelenk</p> <p>1.1 06.96 - 1.4, 55 kW 06.96 - 1.4 BiFuel 04.03 - 1.8 D, 43 kW 06.96 - 1.9 D, 51 kW 06.96 - 2.0 HDi 04.00 -</p>	 <p>separat bestellen nur in Verbindung mit:OE 3640 42 Konusmaß [mm]:16 ->Chass. O 07972</p> <p>nur in Verbindung mit:OE 3640 43 Konusmaß [mm]:16 ->Chass. O 07972</p> <p>nur in Verbindung mit:OE 3640 50 Konusmaß [mm]:18 Chass. O 07973-></p> <p>nur in Verbindung mit:OE 3640 51 Konusmaß [mm]:18 Chass. O 07973-></p>	<p>17435 01 3520 H5 27924 01</p> 



Ref.

PEUGEOT

PARTNER Kasten/Box/Furgón/Van 06.96 - (5)







 Lenker, Radaufhängung mit Gummilager ohne Trag-/Führungsgelenk		17436 01 3521 E5 27924 01	
1.1 06.96 - 1.4, 55 kW 06.96 - 1.4 BiFuel 04.03 - 1.8 D, 43 kW 06.96 - 1.9 D, 51 kW 06.96 - 2.0 HDi 04.00 -	separat bestellen nur in Verbindung mit:OE 3640 42 Konusmaß [mm]:16  ->Chass. O 07972 ----- nur in Verbindung mit:OE 3640 43 Konusmaß [mm]:16  ->Chass. O 07972 ----- nur in Verbindung mit:OE 3640 50 Konusmaß [mm]:18  Chass. O 07973-> ----- nur in Verbindung mit:OE 3640 51 Konusmaß [mm]:18  Chass. O 07973->		26714 02 3520 Q5 
Lenker, Radaufhängung 2.0 HDi 04.00 -	  Chass. O 08365->		26715 02 3521 L6 
Trag-/Führungsgelenk Konusmaß [mm]: 16 mit Zubehör 1.1 06.96 - 1.4, 55 kW 06.96 - 1.8 D, 43 kW 06.96 - 1.9 D, 51 kW 06.96 -	  ->Chass. O 07972	14767 04 3640 42 	22339 04 3640 43 
Trag-/Führungsgelenk Konusmaß [mm]: 16 mit Zubehör 1.1 06.96 - 1.4, 55 kW 06.96 - 1.8 D, 43 kW 06.96 - 1.9 D, 51 kW 06.96 -	  ->Chass. O 07972		26047 02 3640 50 
Trag-/Führungsgelenk Konusmaß [mm]: 18 1.1 06.96 - 1.4, 55 kW 06.96 - 1.8 D, 43 kW 06.96 - 1.9 D, 51 kW 06.96 -	  Chass. O 07973->		25534 02 3640 51 
Reparatursatz, Trag-/Führungsgelenk Konusmaß [mm]: 18 1.1 06.96 - 1.4, 55 kW 06.96 - 1.8 D, 43 kW 06.96 - 1.9 D, 51 kW 06.96 -	  Chass. O 07973->		



Ref.

PEUGEOT

PARTNER Kasten/Box/Furgón/Van 06.96 -
(5)





	Lagerung, Lenker		▼↕↓	27924 01	3523 75	
	1.1	06.96 -				
	1.4, 55 kW	06.96 -				
	1.4 BiFuel	04.03 -				
	1.8 D, 43 kW	06.96 -				
	1.9 D, 51 kW	06.96 -				
	2.0 HDi	04.00 -				
	Stange/Strebe, Stabilisator		↔	11589 02	5087 46	
	Pendelstange mit Zubehör					
	1.1	06.96 -				
	1.4, 55 kW	06.96 -				
	1.4 BiFuel	04.03 -				
	1.8 D, 43 kW	06.96 -				
	1.9 D, 51 kW	06.96 -				
	2.0 HDi	04.00 -				
	Stabilisatorlager		↔	26577 01	5094 65	
	1.1	06.96 -				
	1.4, 55 kW	06.96 -				
	1.8 D, 43 kW	06.96 -				
	1.9 D, 51 kW	06.96 -				
	Faltenbaldsatz, Lenkung			30114 01		
	Innendurchmesser 1 [mm]: 10 Innendurchmesser 2 [mm]: 40					
	1.1	06.96 -				
	1.4, 55 kW	06.96 -	LHD ↻			
	1.4 BiFuel	04.03 -				
	1.8 D, 43 kW	06.96 -				
	1.9 D, 51 kW	06.96 -	RHD ↻			
	1.9 D 4x4	04.04 -				
	1.9 D, 51 kW	06.96 -				
	Faltenbaldsatz, Lenkung		↻	30122 01	4066 16	
	Innendurchmesser 1 [mm]: 39 Innendurchmesser 2 [mm]: 11					
	1.1	06.96 -				
	1.4, 55 kW	06.96 -				
	1.4 BiFuel	04.03 -				
	1.8 D, 43 kW	06.96 -				
	1.9 D, 51 kW	06.96 -				
	1.9 D 4x4	04.04 -				
	1.9 D, 51 kW	06.96 -				
	Faltenbaldsatz, Lenkung			30149 01	4066 22	
	Innendurchmesser 1 [mm]: 16,5 Innendurchmesser 2 [mm]: 43					
	1.1	06.96 -				
	1.4, 55 kW	06.96 -	LHD ↻			
	1.4 BiFuel	04.03 -				
	1.8 D, 43 kW	06.96 -				
	1.9 D, 51 kW	06.96 -	RHD ↻			
	1.9 D 4x4	04.04 -				
	1.9 D, 51 kW	06.96 -				
	Faltenbaldsatz, Lenkung		↻	30206 01	4066 44	
	Innendurchmesser 1 [mm]: 11 Innendurchmesser 2 [mm]: 42					
	1.1	06.96 -				
	1.4, 55 kW	06.96 -	⊗			
	1.4 BiFuel	04.03 -				
	1.8 D, 43 kW	06.96 -				
	1.9 D, 51 kW	06.96 -				
	1.9 D 4x4	04.04 -				
	1.9 D, 51 kW	06.96 -				



Ref.



PEUGEOT

PARTNER Kasten/Box/Furgón/Van (5) 06.96 -

 Faltenbaldsatz, Lenkung Innendurchmesser 1 [mm]: 11 Innendurchmesser 2 [mm]: 42			30207 01 4066 43
	1.1 06.96 - 1.4, 55 kW 06.96 - 1.4 BiFuel 04.03 - 1.8 D, 43 kW 06.96 - 1.9 D, 51 kW 06.96 - 1.9 D 4x4 04.04 - 1.9 D, 51 kW 06.96 -		
Faltenbaldsatz, Lenkung Innendurchmesser 1 [mm]: 36 Innendurchmesser 2 [mm]: 11			30248 01 4066 21
	2.0 HDi 04.00 - 2.0 HDi 4x4 04.04 -		

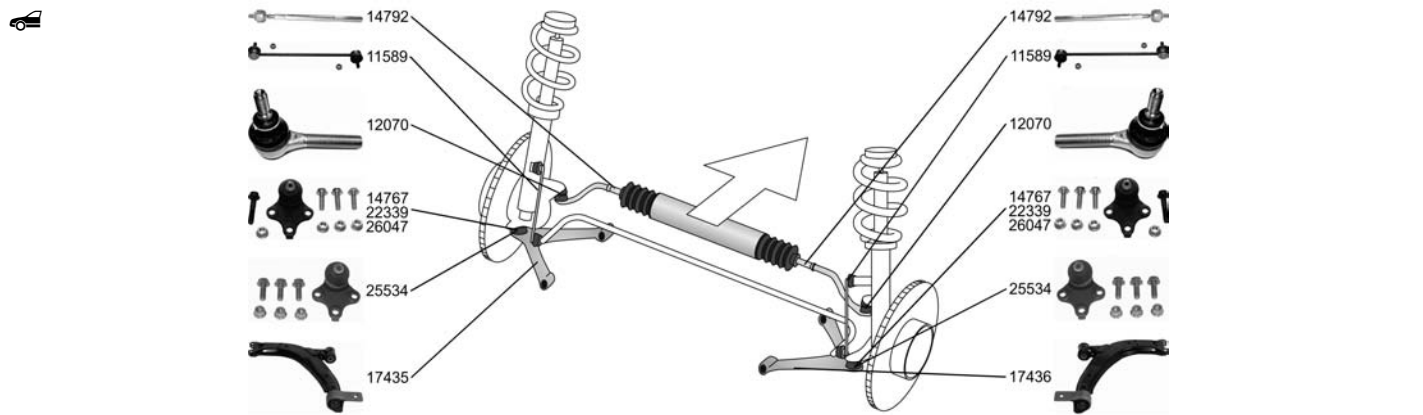
PARTNER Combispace/MPV (5F) 06.96 -









































Spurstangenkopf mit Zubehör Gewindeart: mit Rechtsgewinde Gewindemaß: M14x1,5			12070 04 3817 50
	1.1 06.96 - 1.4, 55 kW 06.96 - 1.6 16V 07.01 - 1.8 05.97 - 1.9 D, 50 kW 06.96 - 1.9 D, 51 kW 12.98 - 2.0 HDI 02.00 -		
Axialgelenk, Spurstange Gewindeart: mit Rechtsgewinde Gewindemaß: M14x1,5 mit Zubehör			14792 01 3812 C0
	1.1 06.96 - 1.4, 55 kW 06.96 - 1.6 16V 07.01 - 1.8 05.97 - 1.9 D, 50 kW 06.96 - 1.9 D, 51 kW 12.98 -		



PEUGEOT

PARTNER Combispace/MPV (5F)

06.96 -

 Lenker, Radaufhängung mit Gummilager ohne Trag-/Führungsgelenk		17435 01 3520 H5 27924 01																					
<table border="0"> <tr> <td>1.1</td> <td>06.96 -</td> <td rowspan="5"> separat bestellen nur in Verbindung mit:OE 3640 42 Konusmaß [mm]:16  ->Chass. O 07972 </td> </tr> <tr> <td>1.4, 55 kW</td> <td>06.96 -</td> </tr> <tr> <td>1.6 16V</td> <td>07.01 -</td> </tr> <tr> <td>1.8</td> <td>05.97 -</td> </tr> <tr> <td>1.9 D, 50 kW</td> <td>06.96 -</td> </tr> <tr> <td>1.9 D, 51 kW</td> <td>12.98 -</td> <td> ----- nur in Verbindung mit:OE 3640 43 Konusmaß [mm]:16  ->Chass. O 07972 </td> </tr> <tr> <td></td> <td></td> <td> ----- nur in Verbindung mit:OE 3640 50 Konusmaß [mm]:18  Chass. O 07973-> </td> </tr> <tr> <td></td> <td></td> <td> ----- nur in Verbindung mit:OE 3640 51 Konusmaß [mm]:18  Chass. O 07973-> </td> </tr> </table>	1.1	06.96 -	separat bestellen nur in Verbindung mit:OE 3640 42 Konusmaß [mm]:16  ->Chass. O 07972	1.4, 55 kW	06.96 -	1.6 16V	07.01 -	1.8	05.97 -	1.9 D, 50 kW	06.96 -	1.9 D, 51 kW	12.98 -	----- nur in Verbindung mit:OE 3640 43 Konusmaß [mm]:16  ->Chass. O 07972			----- nur in Verbindung mit:OE 3640 50 Konusmaß [mm]:18  Chass. O 07973->			----- nur in Verbindung mit:OE 3640 51 Konusmaß [mm]:18  Chass. O 07973->			
1.1	06.96 -	separat bestellen nur in Verbindung mit:OE 3640 42 Konusmaß [mm]:16  ->Chass. O 07972																					
1.4, 55 kW	06.96 -																						
1.6 16V	07.01 -																						
1.8	05.97 -																						
1.9 D, 50 kW	06.96 -																						
1.9 D, 51 kW	12.98 -	----- nur in Verbindung mit:OE 3640 43 Konusmaß [mm]:16  ->Chass. O 07972																					
		----- nur in Verbindung mit:OE 3640 50 Konusmaß [mm]:18  Chass. O 07973->																					
		----- nur in Verbindung mit:OE 3640 51 Konusmaß [mm]:18  Chass. O 07973->																					
Lenker, Radaufhängung mit Gummilager ohne Trag-/Führungsgelenk		17436 01 3521 E5 27924 01																					
<table border="0"> <tr> <td>1.1</td> <td>06.96 -</td> <td rowspan="5"> separat bestellen nur in Verbindung mit:OE 3640 42 Konusmaß [mm]:16  ->Chass. O 07972 </td> </tr> <tr> <td>1.4, 55 kW</td> <td>06.96 -</td> </tr> <tr> <td>1.6 16V</td> <td>07.01 -</td> </tr> <tr> <td>1.8</td> <td>05.97 -</td> </tr> <tr> <td>1.9 D, 50 kW</td> <td>06.96 -</td> </tr> <tr> <td>1.9 D, 51 kW</td> <td>12.98 -</td> <td> ----- nur in Verbindung mit:OE 3640 43 Konusmaß [mm]:16  ->Chass. O 07972 </td> </tr> <tr> <td></td> <td></td> <td> ----- nur in Verbindung mit:OE 3640 50 Konusmaß [mm]:18  Chass. O 07973-> </td> </tr> <tr> <td></td> <td></td> <td> ----- nur in Verbindung mit:OE 3640 51 Konusmaß [mm]:18  Chass. O 07973-> </td> </tr> </table>	1.1	06.96 -	separat bestellen nur in Verbindung mit:OE 3640 42 Konusmaß [mm]:16  ->Chass. O 07972	1.4, 55 kW	06.96 -	1.6 16V	07.01 -	1.8	05.97 -	1.9 D, 50 kW	06.96 -	1.9 D, 51 kW	12.98 -	----- nur in Verbindung mit:OE 3640 43 Konusmaß [mm]:16  ->Chass. O 07972			----- nur in Verbindung mit:OE 3640 50 Konusmaß [mm]:18  Chass. O 07973->			----- nur in Verbindung mit:OE 3640 51 Konusmaß [mm]:18  Chass. O 07973->			
1.1	06.96 -	separat bestellen nur in Verbindung mit:OE 3640 42 Konusmaß [mm]:16  ->Chass. O 07972																					
1.4, 55 kW	06.96 -																						
1.6 16V	07.01 -																						
1.8	05.97 -																						
1.9 D, 50 kW	06.96 -																						
1.9 D, 51 kW	12.98 -	----- nur in Verbindung mit:OE 3640 43 Konusmaß [mm]:16  ->Chass. O 07972																					
		----- nur in Verbindung mit:OE 3640 50 Konusmaß [mm]:18  Chass. O 07973->																					
		----- nur in Verbindung mit:OE 3640 51 Konusmaß [mm]:18  Chass. O 07973->																					
Lenker, Radaufhängung 2.0 HDI		26714 02 3520 Q5																					
Lenker, Radaufhängung 2.0 HDI		26715 02 3521 L6																					
Trag-/Führungsgelenk Konusmaß [mm]: 16 mit Zubehör		14767 04 3640 42																					
<table border="0"> <tr> <td>1.1</td> <td>06.96 -</td> <td rowspan="5">  ->Chass. O 07972 </td> </tr> <tr> <td>1.4, 55 kW</td> <td>06.96 -</td> </tr> <tr> <td>1.8</td> <td>05.97 -</td> </tr> <tr> <td>1.9 D, 50 kW</td> <td>06.96 -</td> </tr> <tr> <td>1.9 D, 51 kW</td> <td>12.98 -</td> </tr> </table>	1.1	06.96 -	 ->Chass. O 07972	1.4, 55 kW	06.96 -	1.8	05.97 -	1.9 D, 50 kW	06.96 -	1.9 D, 51 kW	12.98 -												
1.1	06.96 -	 ->Chass. O 07972																					
1.4, 55 kW	06.96 -																						
1.8	05.97 -																						
1.9 D, 50 kW	06.96 -																						
1.9 D, 51 kW	12.98 -																						

















Ref.

PEUGEOT

PARTNER Combispace/MPV (5F)

06.96 -

 Trag-/Führungsgelenk Konusmaß [mm]: 16 mit Zubehör			22339 04 3640 43
	1.1 06.96 - 1.4, 55 kW 06.96 - 1.8 05.97 - 1.9 D, 50 kW 06.96 -		 ->Chass. O 07972
Trag-/Führungsgelenk Konusmaß [mm]: 18			26047 02 3640 50
	1.1 06.96 - 1.4, 55 kW 06.96 - 1.6 16V 07.01 - 1.8 05.97 - 1.9 D, 50 kW 06.96 - 1.9 D, 51 kW 12.98 -		 Chass. O 07973->
Reparatursatz, Trag-/Führungsgelenk Konusmaß [mm]: 18			25534 02 3640 51
	1.1 06.96 - 1.4, 55 kW 06.96 - 1.6 16V 07.01 - 1.8 05.97 - 1.9 D, 50 kW 06.96 - 1.9 D, 51 kW 12.98 -		 Chass. O 07973->
Lagerung, Lenker			27924 01 3523 75
	1.1 06.96 - 1.4, 55 kW 06.96 - 1.6 16V 07.01 - 1.8 05.97 - 1.9 D, 50 kW 06.96 - 1.9 D, 51 kW 12.98 - 2.0 HDI 02.00 -		
Stange/Strebe, Stabilisator Pendelstange mit Zubehör			11589 02 5087 46
	1.1 06.96 - 1.4, 55 kW 06.96 - 1.6 16V 07.01 - 1.8 05.97 - 1.9 D, 50 kW 06.96 - 1.9 D, 51 kW 12.98 - 2.0 HDI 02.00 -		
Stabilisatorlager			21 26577 01 5094 65
	1.1 06.96 - 1.4, 55 kW 06.96 - 1.8 05.97 - 1.9 D, 50 kW 06.96 - 1.9 D, 51 kW 12.98 - 2.0 HDI 02.00 -		
Faltenbalgsatz, Lenkung Innendurchmesser 1 [mm]: 10 Innendurchmesser 2 [mm]: 40			30114 01
	1.1 06.96 - 1.4, 55 kW 06.96 - 1.6 16V 07.01 - 1.8 05.97 - 1.9 D, 50 kW 06.96 - 1.9 D, 51 kW 12.98 -		LHD   ----- RHD  
Faltenbalgsatz, Lenkung Innendurchmesser 1 [mm]: 39 Innendurchmesser 2 [mm]: 11			30122 01 4066 16
	1.1 06.96 - 1.4, 55 kW 06.96 - 1.6 16V 07.01 - 1.8 05.97 - 1.9 D, 50 kW 06.96 - 1.9 D, 51 kW 12.98 -		















Ref.

PEUGEOT

PARTNER Combispace/MPV (5F)

06.96 -

 Faltenbalgsatz, Lenkung Innendurchmesser 1 [mm]: 16,5 Innendurchmesser 2 [mm]: 43			30149 01	4066 22
	1.1 1.4, 55 kW 1.6 16V 1.8 1.9 D, 50 kW 1.9 D, 51 kW	06.96 - 06.96 - 07.01 - 05.97 - 06.96 - 12.98 -	LHD  ----- RHD 	
Faltenbalgsatz, Lenkung Innendurchmesser 1 [mm]: 11 Innendurchmesser 2 [mm]: 42			30206 01	4066 44
	1.1 1.4, 55 kW 1.6 16V 1.8 1.9 D, 50 kW 1.9 D, 51 kW 2.0 HDI	06.96 - 06.96 - 07.01 - 05.97 - 06.96 - 12.98 - 02.00 -		
Faltenbalgsatz, Lenkung Innendurchmesser 1 [mm]: 21 Innendurchmesser 2 [mm]: 42			30207 01	4066 43
	1.1 1.4, 55 kW 1.6 16V 1.8 1.9 D, 50 kW 1.9 D, 51 kW 2.0 HDI	06.96 - 06.96 - 07.01 - 05.97 - 06.96 - 12.98 - 02.00 -		
Faltenbalgsatz, Lenkung Innendurchmesser 1 [mm]: 36 Innendurchmesser 2 [mm]: 11			30248 01	4066 21
	2.0 HDI	02.00 -		

PARTNER Kasten

04.08 -

 Lenker, Radaufhängung mit Gummilager ALL TYPES			30606 01	3520 S2
			28898 01 28899 01	
Lenker, Radaufhängung mit Gummilager ALL TYPES			30607 01	3521 P3
			28898 01 28899 01	
Trag-/Führungsgelenk mit Zubehör ALL TYPES			27299 02	3640 68
				
Lagerung, Lenker ALL TYPES			28898 01	3523 91
				



Ref.

PEUGEOT

PARTNER Kasten

04.08 -



Lagerung, Lenker

ALL TYPES



28899 01

3523 92







RENAULT

KANGOO (KC0/1)

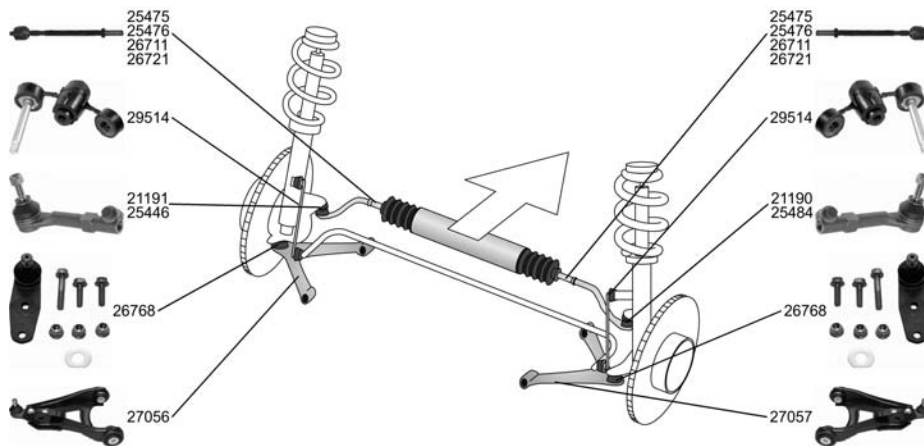
03.98 -



Spurstangenkopf			21190 01	77 01 470 766
1.2 (KC0A, KC0K, KC0F, KC01)	03.98 -	->02.1999 		
1.4 (KC0C, KC0H, KC0B, KC0M)	03.98 -	02.1999-> FC0A KC0A 		
D 55 1.9 (KC0D)	03.98 -	 ->02.1999		
D 65 1.9 (KC0E, KC02, KC0J, KC0N)	03.98 -	 KC0E/ ->02.1999		
Spurstangenkopf			21191 01	77 01 470 765
1.2 (KC0A, KC0K, KC0F, KC01)	03.98 -	->02.1999 		
1.4 (KC0C, KC0H, KC0B, KC0M)	03.98 -	->02.1999 FC0A KC0A 		
D 55 1.9 (KC0D)	03.98 -	 ->02.1999		
D 65 1.9 (KC0E, KC02, KC0J, KC0N)	03.98 -	 KC0E/ ->02.1999		



Ref.

RENAULT

KANGOO (KC0/1_)

03.98 -































	Spurstangenkopf		25446 02	77 01 474 492
	mit Zubehör Konusmaß [mm]: 14,6 Gewindemaß: M10x1,25 Innengewinde [mm]: M14x1,5			
	1.2 (KC0A, KC0K, KC0F, KC01)	03.98 -		
			->03.2001	
			02.1999-> KC0K KC0F/KC01 KC0A/	
	1.4 (KC0C, KC0H, KC0B, KC0M)	03.98 -	02.1999->	
			KC0C/KC0H KC0B/KC0M	
	1.5 dCi (KC07) 1.5 dCi (KC08, KC09) D 55 1.9 (KC0D) 1.9 dTi (KC0U) 1.9 dCi 4x4 (KC0V)	12.01 - 07.02 - 03.98 - 02.00 - 10.01 -		
	D 65 1.9 (KC0E, KC02, KC0J, KC0N)	03.98 -	02.1999->	
			KC0E KC02/KC0J/KC0N	
	1.6 16V 4x4 (KC0P, KC0S, KC0L)	10.01 -		
			KC0P/KC0S/KC0L	
	1.2 16V (KC03, KC05, KC06, KC0T, KC0W)	06.01 -		
			KC05/KC06/KC0T/KC0W	



RENAULT

KANGOO (KC0/1)

03.98 -











 Spurstangenkopf mit Zubehör Konusmaß [mm]: 14,6 Gewindemaß: M10x1,25 Innengewinde [mm]: M14x1,5		25484 02 77 01 474 493 
1.2 (KC0A, KC0K, KC0F, KC01) 03.98 -	 ----- ->03.2001  ----- 02.1999->  ----- KC0K KC0F/KC01 KC0A KC0F 	
1.4 (KC0C, KC0H, KC0B, KC0M) 03.98 -	02.1999->  ----- KC0C/KC0H KC0B/KC0M 	
1.5 dCi (KC07) 1.5 dCi (KC08, KC09) D 55 1.9 (KC0D) 1.9 dTi (KC0U) 1.9 dCi 4x4 (KC0V) D 65 1.9 (KC0E, KC02, KC0J, KC0N)	    	
1.6 16V 4x4 (KC0P, KC0S, KC0L) 10.01 -	02.1999->  ----- KC0E KC02/KC0J/KC0N 	
1.2 16V (KC03, KC05, KC06, KC0T, KC0W) 06.01 -	  ----- KC05/KC06/KC0T/KC0W 	
Axialgelenk, Spurstange		25475 01 77 01 470 764 
1.2 (KC0A, KC0K, KC0F, KC01) 03.98 -	 KC0A/ ->03.1999	
1.4 (KC0C, KC0H, KC0B, KC0M) 03.98 -	 KC0C/KC0H/ ->03.1999	
D 55 1.9 (KC0D) 03.98 -	 ----- ->03.1999	
D 65 1.9 (KC0E, KC02, KC0J, KC0N) 03.98 -	 ----- KC0E/ ->03.1999	
Axialgelenk, Spurstange mit Zubehör		25476 01 77 01 470 763 
1.2 (KC0A, KC0K, KC0F, KC01) 03.98 -	 KC0A/ ->03.1999	
1.4 (KC0C, KC0H, KC0B, KC0M) 03.98 -	 KC0C/KC0H ->03.1999	
D 55 1.9 (KC0D) 03.98 -	 ----- ->03.1999	
D 65 1.9 (KC0E, KC02, KC0J, KC0N) 03.98 -	 ----- KC0E/ ->03.1999	



RENAULT

KANGOO (KC0/1 _)

03.98 -

 Lenker, Radaufhängung mit Trag-/Führungsgelenk mit Gummilager			27056 01 82 00 197 179 29516 01	
	1.2 (KC0A, KC0K, KC0F, KC01)	03.98 -	Baumuster:KC0A ->03.1999	
	1.4 (KC0C, KC0H, KC0B, KC0M)	03.98 -	Baumuster:KC0C ->03.1999	
	1.2 16V (KC03, KC05, KC06, KC0T, KC0W)	06.01 -		
	1.6 16V	06.01 -		
	1.5 dCi (KC08, KC09)	07.02 -		
	D 55 1.9 (KC0D)	03.98 -		
	1.9 dTi (KC0U)	02.00 -		
D 65 1.9 (KC0E, KC02, KC0J, KC0N)	03.98 -	Baumuster:KC0E,KC0J,KC0N, ->03.2001		
Lenker, Radaufhängung mit Trag-/Führungsgelenk mit Gummilager			27057 01 82 00 197 187 29516 01	
	1.2 (KC0A, KC0K, KC0F, KC01)	03.98 -	Baumuster:KC0A ->03.1999	
	1.4 (KC0C, KC0H, KC0B, KC0M)	03.98 -	Baumuster:KC0C ->03.1999	
	1.2 16V (KC03, KC05, KC06, KC0T, KC0W)	06.01 -		
	1.6 16V	06.01 -		
	1.5 dCi (KC08, KC09)	07.02 -		
	D 55 1.9 (KC0D)	03.98 -		
	1.9 dTi (KC0U)	02.00 -		
D 65 1.9 (KC0E, KC02, KC0J, KC0N)	03.98 -	Baumuster:KC0E,KC0J,KC0N, ->03.2001		
Trag-/Führungsgelenk Konusmaß [mm]: 16 mit Befestigungsmaterial Gewindemaß: M10			26768 01 77 01 472 038	
	1.2 (KC0A, KC0K, KC0F, KC01)	03.98 -	Baumuster:KC0A,KC0F, ->09.2002	
	1.4 (KC0C, KC0H, KC0B, KC0M)	03.98 -	->09.2002	
	1.5 dCi (KC07)	12.01 -		
	1.5 dCi (KC08, KC09)	07.02 -		
	D 55 1.9 (KC0D)	03.98 -		
	D 65 1.9 (KC0E, KC02, KC0J, KC0N)	03.98 -	Baumuster:KC0E,KC0J,KC0N, ->09.2002	
	1.6 16V 4x4 (KC0P, KC0S, KC0L)	10.01 -	Frontantrieb	
1.9 dCi 4x4 (KC0V)	10.01 -	->09.2002		
1.2 16V (KC03, KC05, KC06, KC0T, KC0W)	06.01 -	Baumuster:KC05 ->09.2002		
Lagerung, Lenker			29516 01 82 00 651 161	
	1.2 (KC0A, KC0K, KC0F, KC01)	03.98 -	Baumuster:KC0A ->03.1999	
	1.4 (KC0C, KC0H, KC0B, KC0M)	03.98 -	Baumuster:KC0C ->03.1999	
	D 55 1.9 (KC0D)	03.98 -	Baumuster:KC0E ->03.1999	
	1.5 dCi (KC07)	12.01 -	->03.1999	
	1.5 dCi (KC08, KC09)	07.02 -		
	D 65 1.9 (KC0E, KC02, KC0J, KC0N)	03.98 -		
1.9 dTi (KC0U)	02.00 -			
1.9 dCi 4x4 (KC0V)	10.01 -			
Stange/Strebe, Stabilisator Koppelstange			29514 01 77 00 799 404	
	1.2 (KC0A, KC0K, KC0F, KC01)	03.98 -		
	1.2 16V (KC03, KC05, KC06, KC0T, KC0W)	06.01 -		
	1.4 (KC0C, KC0H, KC0B, KC0M)	03.98 -		
	D 55 1.9 (KC0D)	03.98 -		
	D 65 1.9 (KC0E, KC02, KC0J, KC0N)	03.98 -		
1.9 dTi (KC0U)	02.00 -			







Ref.

RENAULT





KANGOO (KC0/1_)

03.98 -

<p> Faltenbaldsatz, Lenkung Innendurchmesser 1 [mm]: 9 Innendurchmesser 2 [mm]: 39</p> <p>1.2 (KC0A, KC0K, KC0F, KC01) 03.98 - 1.2 16V (KC03, KC05, KC06, KC0T, KC0W) 06.01 - 1.4 (KC0C, KC0H, KC0B, KC0M) 03.98 - 1.6 16V 06.01 - 1.6 16V bivalent 06.05 - 1.6 16V 4x4 (KC0P, KC0S, KC0L) 10.01 - 1.5 dCi (KC07) 12.01 - 1.5 dCi, 42 kW 07.03 - 1.5 dCi (KC08, KC09) 07.02 - D 55 1.9 (KC0D) 03.98 - 1.5 dCi, 50 kW 06.05 - D 65 1.9 (KC0E, KC02, KC0J, KC0N) 03.98 - 1.9 dTi (KC0U) 02.00 - 1.5 dCi, 62 kW 06.05 - 1.9 dCi 4x4 (KC0V) 10.01 - 1.9 dCi 4x4 10.03 -</p>		<p>30183 01 77 01 469 496</p> 
<p>Faltenbaldsatz, Lenkung Innendurchmesser 1 [mm]: 9 Innendurchmesser 2 [mm]: 38</p> <p>1.2 (KC0A, KC0K, KC0F, KC01) 03.98 - 1.2 16V (KC03, KC05, KC06, KC0T, KC0W) 06.01 - 1.4 (KC0C, KC0H, KC0B, KC0M) 03.98 - 1.6 16V 06.01 - 1.6 16V bivalent 06.05 - 1.6 16V 4x4 (KC0P, KC0S, KC0L) 10.01 - 1.5 dCi (KC07) 12.01 - 1.5 dCi, 42 kW 07.03 - 1.5 dCi (KC08, KC09) 07.02 - D 55 1.9 (KC0D) 03.98 - 1.5 dCi, 50 kW 06.05 - D 65 1.9 (KC0E, KC02, KC0J, KC0N) 03.98 - 1.9 dTi (KC0U) 02.00 - 1.5 dCi, 62 kW 06.05 - 1.9 dCi 4x4 (KC0V) 10.01 - 1.9 dCi 4x4 10.03 -</p>		<p>30214 01 77 01 470 753</p> 

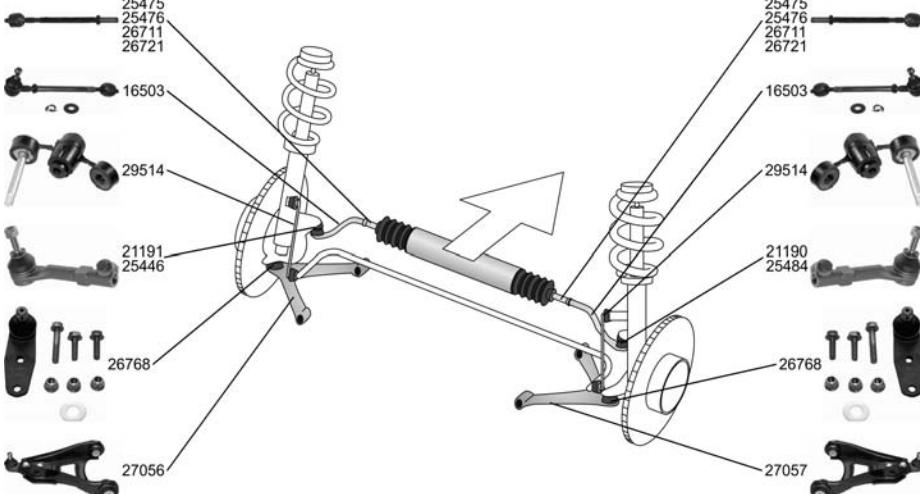
KANGOO Rapid/Express/Van (FC0_)























03.98 -

<p></p> 		<p>16503 03 77 01 463 025</p> 
<p>Spurstange 1.2 16V (FC05) 10.01 -</p>		<p>16503 03 77 01 463 025</p> 



RENAULT

KANGOO Rapid/Express/Van 03.98 - (FC0_)

 Spurstangenkopf 1.2 (FC01, FC0A, FC0F)	03.98 -	  Baumuster:FC0A ->02.1999	21190 01 77 01 470 766 	
	1.4 (FC0C, FC0B, FC0H, FC0M)	03.98 -		 FC0C/FC0H/ ->02.1999
	D 55 1.9 (FC0D)	03.98 -		 ->02.1999
	D 65 1.9 (FC0E, FC02, FC0J, FC0N)	03.98 -		 FC0E/ ->02.1999
	Spurstangenkopf 1.2 (FC01, FC0A, FC0F)			
03.98 -	  Baumuster:FC0A ->02.1999	21191 01 77 01 470 765 		
1.4 (FC0C, FC0B, FC0H, FC0M)	03.98 -		 FC0C/FC0H/ ->02.1999	
D 55 1.9 (FC0D)	03.98 -		 ->02.1999	
D 65 1.9 (FC0E, FC02, FC0J, FC0N)	03.98 -		 FC0E/ ->02.1999	
Spurstangenkopf mit Zubehör Konusmaß [mm]: 14,6 Gewindemaß: M10x1,25 Innengewinde [mm]: M14x1,5				
1.2 (FC01, FC0A, FC0F)	03.98 -	 ----- 02.1999-> FC01 FC0A/FC0F 	25446 02 77 01 474 492 	
1.4 (FC0C, FC0B, FC0H, FC0M)	03.98 -	02.1999->  ----- FC0C/FC0H FC0B/FC0M 		
D 55 1.9 (FC0D)	03.98 -	 ->02.1999		
D 65 1.9 (FC0E, FC02, FC0J, FC0N)	03.98 -	->02.1999  ----- FC0E/FC02 FC0J/FC0N 		
1.2 16V (FC05)	10.01 -			
1.6 16V 4x4 (FC0L, FC0P, FC0S)	10.01 -			
1.5 dCi (FC07)	12.01 -			
1.9 dTi (FC0U)	02.00 -			
1.9 dCi 4x4 (FC0V)	10.01 -			

























Ref.

RENAULT

KANGOO Rapid/Express/Van (FC0_)

03.98 -

 Spurstangenkopf mit Zubehör Konusmaß [mm]: 14,6 Gewindemaß: M10x1,25 Innengewinde [mm]: M14x1,5		25484 02 77 01 474 493 
1.2 (FC01, FC0A, FC0F) 03.98 -	 ----- 02.1999-> FC01 FC0A/FC0F 	
1.4 (FC0C, FC0B, FC0H, FC0M) 03.98 -	02.1999->  ----- FC0C/FC0H FC0B/FC0M 	
D 55 1.9 (FC0D) 03.98 -	 ->02.1999	
D 65 1.9 (FC0E, FC02, FC0J, FC0N) 03.98 -	->02.1999  ----- FC0E/FC02 FC0J/FC0N 	
1.2 16V (FC05) 10.01 - 1.6 16V 4x4 (FC0L, FC0P, FC0S) 10.01 - 1.5 dCi (FC07) 12.01 - 1.9 dTi (FC0U) 02.00 - 1.9 dCi 4x4 (FC0V) 10.01 -		
Axialgelenk, Spurstange		25475 01 77 01 470 764
1.2 (FC01, FC0A, FC0F) 03.98 -	 Baumuster:FC0A ->03.1999	
1.4 (FC0C, FC0B, FC0H, FC0M) 03.98 -	 FC0C/FC0H ->03.1999	
D 55 1.9 (FC0D) 03.98 -	 ->03.1999	
D 65 1.9 (FC0E, FC02, FC0J, FC0N) 03.98 -	 FC0E/ ->03.1999	
Axialgelenk, Spurstange mit Zubehör		25476 01 77 01 470 763
1.2 (FC01, FC0A, FC0F) 03.98 -	 Baumuster:FC0A ->03.1999	
1.4 (FC0C, FC0B, FC0H, FC0M) 03.98 -	 FC0C/FC0H ->03.1999	
D 55 1.9 (FC0D) 03.98 -	 ->03.1999	
D 65 1.9 (FC0E, FC02, FC0J, FC0N) 03.98 -	 FC0E/ ->03.1999	



RENAULT

KANGOO Rapid/Express/Van 03.98 - (FC0_)

	Axialgelenk, Spurstange radseitig Gewindemaß: M12x1,0 Gewindemaß: M14x1,5 mit Zubehör		26711 01 77 01 472 120	
	1.2 (FC01, FC0A, FC0F) 03.98 -		12.1999->	
	1.4 (FC0C, FC0B, FC0H, FC0M) 03.98 -		für Lenkgetriebe-ID:SMI	
	D 55 1.9 (FC0D) 03.98 -			
	D 65 1.9 (FC0E, FC02, FC0J, FC0N) 03.98 -			
	1.2 16V (FC05) 10.01 -		für Lenkgetriebe-ID:SMI	
	1.6 16V 10.01 -			
	1.5 dCi, 42 kW 12.02 -			
	1.5 dCi (FC07) 12.01 -			
	1.5 dCi (FC08, FC09) 04.03 -			
	1.5 dCi, 62 kW 06.05 -			
	1.9 dTi (FC0U) 02.00 -			
	1.9 dCi 07.03 -			
	1.6 16V 4x4 (FC0L, FC0P, FC0S) 10.01 -		für Lenkgetriebe-ID:SMI Baumuster:KC0L,KC0P,KC0S Frontantrieb	
	1.9 dCi 4x4 (FC0V) 10.01 -		für Lenkgetriebe-ID:SMI Baumuster:KC0V Frontantrieb	
	Axialgelenk, Spurstange Aussengewinde [mm]: M12x1,0 Aussengewinde [mm]: M14x1,5 mit Zubehör		26721 01 77 01 472 113	
	1.2 (FC01, FC0A, FC0F) 03.98 -		04.1999->	
	1.4 (FC0C, FC0B, FC0H, FC0M) 03.98 -		03.1998-> FC0A FC01/FC0F	
	D 55 1.9 (FC0D) 03.98 -		04.1999->	
	D 65 1.9 (FC0E, FC02, FC0J, FC0N) 03.98 -		04.1999->	
	1.2 16V (FC05) 10.01 -		FC0E/ FC02/FC0J/FC0N	
	1.6 16V 10.01 -			
	1.6 16V 4x4 (FC0L, FC0P, FC0S) 10.01 -			
	1.5 dCi, 42 kW 12.02 -			
	1.5 dCi (FC07) 12.01 -			
	1.5 dCi (FC08, FC09) 04.03 -			
	1.5 dCi, 62 kW 06.05 -			
	1.9 dTi (FC0U) 02.00 -			
	1.9 dCi 4x4 (FC0V) 10.01 -			
	1.9 dCi 07.03 -			
	1.9 dCi 4x4 07.03 -			
	Lenker, Radaufhängung mit Trag-/Führungsgelenk mit Gummilager		27056 01 82 00 197 179	29516 01
	1.2 (FC01, FC0A, FC0F) 03.98 -		Baumuster:FC0A ->03.1999	
	1.4 (FC0C, FC0B, FC0H, FC0M) 03.98 -		Baumuster:FC0C ->03.1999	
	1.2 16V (FC05) 10.01 -			
	1.6 16V 10.01 -			
	1.5 dCi, 42 kW 12.02 -			
	1.5 dCi (FC08, FC09) 04.03 -			
	D 55 1.9 (FC0D) 03.98 -			
	1.9 dTi (FC0U) 02.00 -			
	D 65 1.9 (FC0E, FC02, FC0J, FC0N) 03.98 -		Baumuster:FC0E,FC0J,FC0N ->03.2001	











Ref.

RENAULT







KANGOO Rapid/Express/Van (FC0_)

03.98 -

 Lenker, Radaufhängung mit Trag-/Führungsgelenk mit Gummilager			27057 01 82 00 197 187 29516 01	
	1.2 (FC01, FC0A, FC0F)	03.98 -	Baumuster:FC0A ->03.1999	
	1.4 (FC0C, FC0B, FC0H, FC0M)	03.98 -	Baumuster:FC0C ->03.1999	
	1.2 16V (FC05) 1.6 16V 1.5 dCi, 42 kW 1.5 dCi (FC08, FC09) D 55 1.9 (FC0D) 1.9 dTi (FC0U) D 65 1.9 (FC0E, FC02, FC0J, FC0N)	10.01 - 10.01 - 12.02 - 04.03 - 03.98 - 02.00 - 03.98 -		
Trag-/Führungsgelenk Konusmaß [mm]: 16 mit Befestigungsmaterial Gewindemaß: M10			26768 01 77 01 472 038	
	1.2 (FC01, FC0A, FC0F)	03.98 -	->09.2002	
	1.2 16V (FC05) 1.4 (FC0C, FC0B, FC0H, FC0M) 1.5 dCi (FC08, FC09) D 55 1.9 (FC0D) D 65 1.9 (FC0E, FC02, FC0J, FC0N)	10.01 - 03.98 - 04.03 - 03.98 - 03.98 -		
	1.6 16V 4x4 (FC0L, FC0P, FC0S) 1.9 dCi 4x4 (FC0V)	10.01 - 10.01 -	Baumuster:FC0E,FC0J, ->09.2002 Frontantrieb ->09.2002	
Lagerung, Lenker			29516 01 82 00 651 161	
	1.2 (FC01, FC0A, FC0F)	03.98 -	Baumuster:FC0A ->03.1999	
	1.4 (FC0C, FC0B, FC0H, FC0M)	03.98 -	Baumuster:FC0C ->03.1999	
	1.2 16V (FC05) 1.5 dCi (FC07) D 55 1.9 (FC0D) D 65 1.9 (FC0E, FC02, FC0J, FC0N)	10.01 - 12.01 - 03.98 - 03.98 -	->03.1999	
Stange/Strebe, Stabilisator Koppelstange			29514 01 77 00 799 404	
	1.2 (FC01, FC0A, FC0F)	03.98 -		
	1.2 16V (FC05) 1.4 (FC0C, FC0B, FC0H, FC0M) 1.5 dCi (FC07) D 55 1.9 (FC0D) D 65 1.9 (FC0E, FC02, FC0J, FC0N) 1.9 dTi (FC0U)	10.01 - 03.98 - 03.98 - 03.98 - 03.98 - 02.00 -		

KANGOO

02.08 -

 Spurstangenkopf Innengewinde [mm]: M14x1,5 Aussengewinde [mm]: M10x1,25 ALL TYPES ausser : 1.9 RXED			32011 01 77 01 478 407
	09.99 - 06.01		
Spurstangenkopf Innengewinde [mm]: M14x1,5 Aussengewinde [mm]: M10x1,25 ALL TYPES ausser : 1.9 RXED			32012 01 77 01 478 408
	09.99 - 06.01		
Lagerung, Lenker ALL TYPES ausser : 1.9 RXED			31989 01 82 00 586 564
	09.99 - 06.01		
Lagerung, Lenker ALL TYPES ausser : 1.9 RXED			31990 01 82 00 586 570
	09.99 - 06.01		





Ref.

RENAULT





KANGOO

02.08 -

	Stange/Strebe, Stabilisator Pendelstange mit Zubehör	↔	28334 02	82 00 669 065	
	ALL TYPES ausser : 1.9 RXED				
	Achskörperlager	↔ ↑	31991 01	82 00 380 965	
	ALL TYPES ausser : 1.9 RXED				

KANGOO Express

02.08 -

	Spurstangenkopf Innengewinde [mm]: M14x1,5 Aussengewinde [mm]: M10x1,25	↻	32011 01	77 01 478 407	
	ALL TYPES				
	Spurstangenkopf Innengewinde [mm]: M14x1,5 Aussengewinde [mm]: M10x1,25	↻	32012 01	77 01 478 408	
	ALL TYPES				
	Lagerung, Lenker	↔ ↑	31989 01	82 00 586 564	
	ALL TYPES				
	Lagerung, Lenker	↔ ↓	31990 01	82 00 586 570	
	ALL TYPES				
	Stange/Strebe, Stabilisator Pendelstange mit Zubehör	↔	28334 02	82 00 669 065	
	ALL TYPES				
	Achskörperlager	↔ ↑	31991 01	82 00 380 965	
	ALL TYPES				











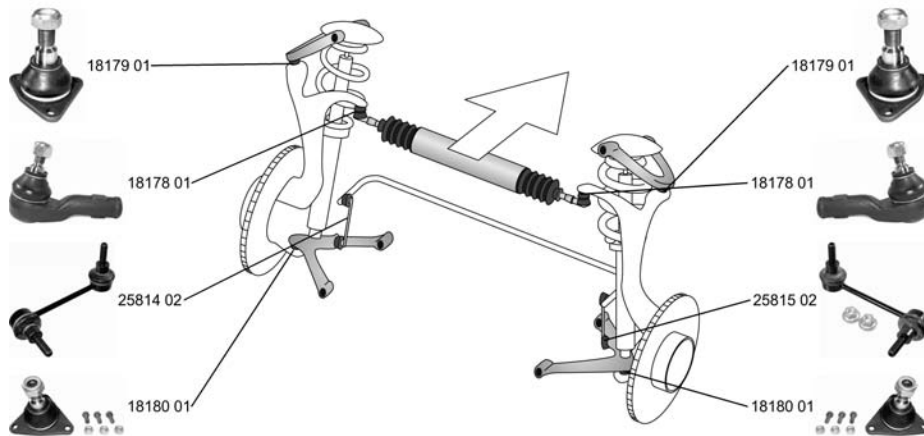



Ref.

RENAULT

MASTER I Bus/Familial (T_)

08.80 - 07.98



Spurstangenkopf Gewindeart: mit Rechtsgewinde Innengewinde [mm]: M16x1,5 ALL TYPES		18178 01 77 01 462 427 
Trag-/Führungsgelenk ALL TYPES		18179 01 77 01 462 692 
Trag-/Führungsgelenk ALL TYPES		18180 01 77 01 462 693 
Lagerung, Lenker ALL TYPES		24503 01 77 00 734 714 
Stange/Strebe, Stabilisator Pendelstange mit Zubehör ALL TYPES		25814 02 82 00 713 522 
Stange/Strebe, Stabilisator Pendelstange mit Zubehör ALL TYPES		25815 02 82 00 713 523 









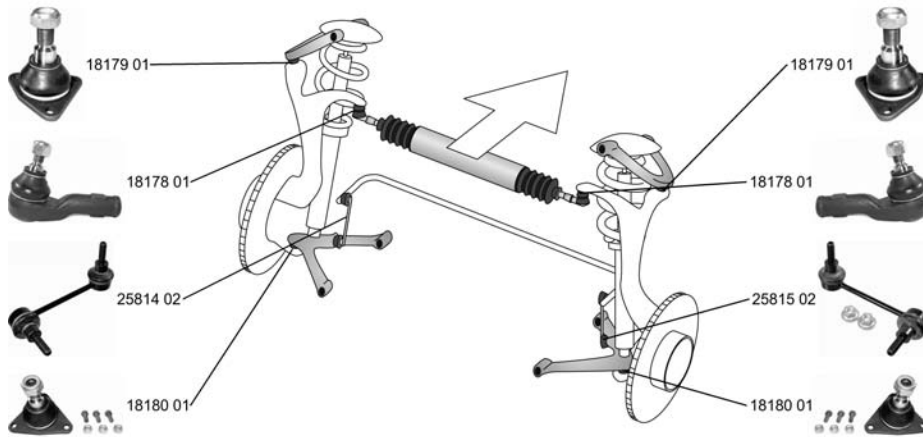





RENAULT

MASTER I Kasten/Box/Furgón/Van
(T₁)

08.80 - 07.98



<p>Spurstangenkopf Gewindeart: mit Rechtsgewinde Innengewinde [mm]: M16x1,5 ALL TYPES</p>		<p>18178 01 77 01 462 427</p> 
<p>Trag-/Führungsgelenk ALL TYPES</p>		<p>18179 01 77 01 462 692</p> 
<p>Trag-/Führungsgelenk ALL TYPES</p>		<p>18180 01 77 01 462 693</p> 
<p>Lagerung, Lenker ALL TYPES</p>		<p>24503 01 77 00 734 714</p> 
<p>Stange/Strebe, Stabilisator Pendelstange mit Zubehör ALL TYPES</p>		<p>25814 02 82 00 713 522</p> 
<p>Stange/Strebe, Stabilisator Pendelstange mit Zubehör ALL TYPES</p>		<p>25815 02 82 00 713 523</p> 











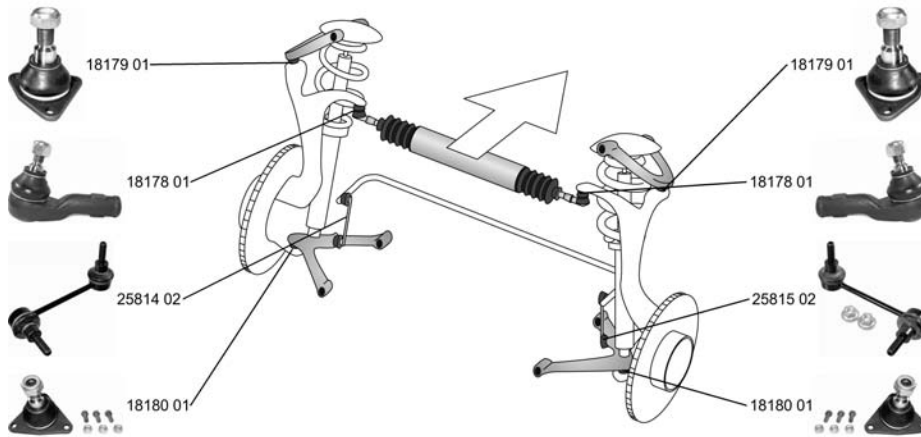



Ref.

RENAULT

**MASTER I Pritsche, Fahrgestell /
Flatbed, Chassis Cab (P_)**

08.80 - 07.98



<p>Spurstangenkopf Gewindeart: mit Rechtsgewinde Innengewinde [mm]: M16x1,5 ALL TYPES</p>		<p>18178 01 77 01 462 427</p> 
<p>Trag-/Führungsgelenk ALL TYPES</p>		<p>18179 01 77 01 462 692</p> 
<p>Trag-/Führungsgelenk ALL TYPES</p>		<p>18180 01 77 01 462 693</p> 
<p>Lagerung, Lenker ALL TYPES</p>		<p>24503 01 77 00 734 714</p> 
<p>Stange/Strebe, Stabilisator Pendelstange mit Zubehör ALL TYPES</p>		<p>25814 02 82 00 713 522</p> 
<p>Stange/Strebe, Stabilisator Pendelstange mit Zubehör ALL TYPES</p>		<p>25815 02 82 00 713 523</p> 







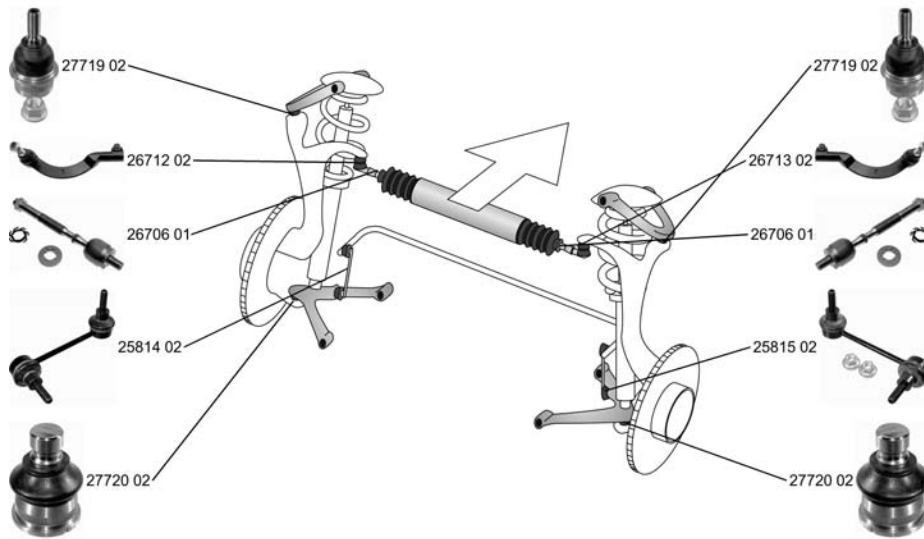

RENAULT

MASTER II Bus/Familial (JD/ND)

07.98 -













Spurstangenkopf ALL TYPES		26712 02 77 01 470 363
		
Spurstangenkopf ALL TYPES		26713 02 77 01 470 364
		
Axialgelenk, Spurstange Gewindemaß: M14x1,5 Gewindemaß: M16x1,5 mit Zubehör ALL TYPES		26706 01 77 01 470 362
		
Trag-/Führungsgelenk mit Zubehör ALL TYPES		27719 02 77 00 312 851
		
Trag-/Führungsgelenk mit Zubehör 2.5 D 07.98 - 01.01 2.8 dTI 07.98 - 10.01 1.9 dTI 09.00 - 1.9 dCi 80 11.01 - 2.2 dCi 90 09.00 - 2.5 dCi 120 10.01 -		27720 02 77 01 056 969
		
Lagerung, Lenker ALL TYPES		30721 01 77 00 302 122
		
Lagerung, Lenker ALL TYPES		30722 01 77 00 302 123
		





RENAULT

MASTER II Kasten/Box/Furgón/Van 07.98 - (FD)

 Trag-/Führungsgelenk mit Zubehör 2.5 D 07.98 - 01.01 2.8 dTI 07.98 - 10.01 1.9 dCi 80 11.01 - 1.9 dTI 09.00 - 2.2 dCi 90 09.00 - 2.5 dCi 120 10.01 -	 ->09.2007	27720 02 77 01 056 969 
Lagerung, Lenker ALL TYPES		30721 01 77 00 302 122 
Lagerung, Lenker ALL TYPES		30722 01 77 00 302 123 
Stange/Strebe, Stabilisator Pendelstange mit Zubehör ALL TYPES		25814 02 82 00 713 522 
Stange/Strebe, Stabilisator Pendelstange mit Zubehör ALL TYPES		25815 02 82 00 713 523 

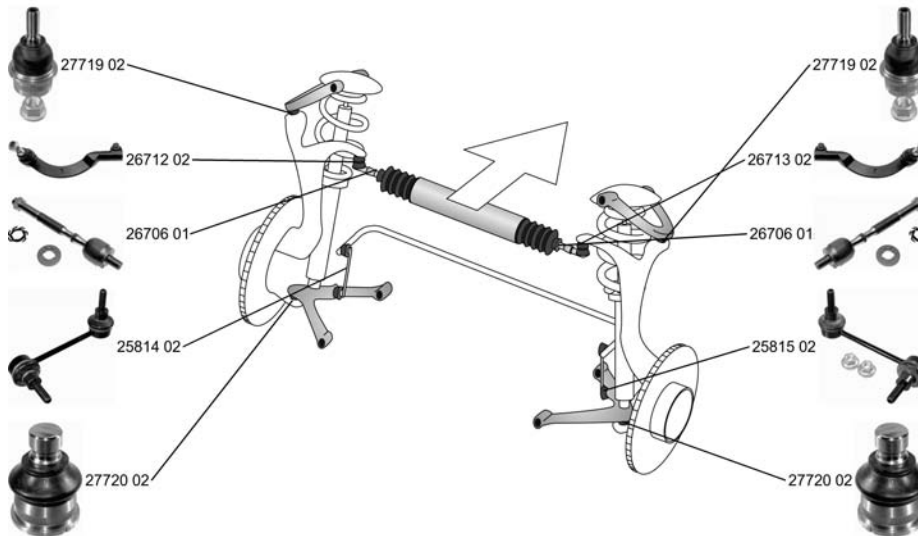
MASTER II Pritsche, Fahrgestell / Flatbed, Chassis/Cab (ED/HD/UD) 07.98 -



















Spurstangenkopf ALL TYPES		26712 02 77 01 470 363 
-------------------------------------	---	--







Ref.

RENAULT

MASTER II Pritsche, Fahrgestell / Flatbed, Chassis/Cab (ED/HD/UD) 07.98 -

	Spurstangenkopf ALL TYPES		26713 02 77 01 470 364	
	Axialgelenk, Spurstange Gewindemaß: M14x1,5 Gewindemaß: M16x1,5 mit Zubehör ALL TYPES		26706 01 77 01 470 362	
	Trag-/Führungsgelenk mit Zubehör ALL TYPES		27719 02 77 00 312 851	
	Trag-/Führungsgelenk mit Zubehör		27720 02 77 01 056 969	
	2.5 D 07.98 - 01.01			
	2.8 dTI 07.98 - 10.01			
	2.2 dCi 90 09.00 -	->09.2007		
	2.5 dCi 120 10.01 -			
	Lagerung, Lenker ALL TYPES		30721 01 77 00 302 122	
	Lagerung, Lenker ALL TYPES		30722 01 77 00 302 123	
	Stange/Strebe, Stabilisator Pendelstange mit Zubehör ALL TYPES		25814 02 82 00 713 522	
	Stange/Strebe, Stabilisator Pendelstange mit Zubehör ALL TYPES		25815 02 82 00 713 523	

MASTER III Bus (JD) 10.03 -









	Trag-/Führungsgelenk mit Zubehör 3.0 dCi 140 (JD0T) 10.03 -		27719 02 77 00 312 851	
	Trag-/Führungsgelenk mit Zubehör ALL TYPES		27720 02 77 01 056 969	
		->09.2007		



RENAULT













MASTER III Bus (JD)

10.03 -

 Lagerung, Lenker ALL TYPES		30721 01 77 00 302 122 
Lagerung, Lenker ALL TYPES		30722 01 77 00 302 123 
Stange/Strebe, Stabilisator Pendelstange mit Zubehör ALL TYPES		25814 02 82 00 713 522 
Stange/Strebe, Stabilisator Pendelstange mit Zubehör ALL TYPES		25815 02 82 00 713 523 

MASTER III Kasten (HD, FD)

10.03 -

 Trag-/Führungsgelenk mit Zubehör 2.5 dCi 100 (HD0U, FD0U, HD0V, FD0V) 10.03 - 3.0 dCi 140 (HD0S, FD0S, HD1S) 10.03 -		27719 02 77 00 312 851 
Trag-/Führungsgelenk mit Zubehör ALL TYPES	 ->09.2007	27720 02 77 01 056 969 
Lagerung, Lenker ALL TYPES		30721 01 77 00 302 122 
Lagerung, Lenker ALL TYPES		30722 01 77 00 302 123 
Stange/Strebe, Stabilisator Pendelstange mit Zubehör ALL TYPES		25814 02 82 00 713 522 
Stange/Strebe, Stabilisator Pendelstange mit Zubehör ALL TYPES		25815 02 82 00 713 523 















Ref.

RENAULT

MASTER III Pritsche/Fahrgestell (ED, UD)

10.03 -

 Trag-/Führungsgelenk mit Zubehör 2.5 dCi 100 (ED4V, ED8V) 10.03 - 3.0 dCi 140 (ED0S, UD0S) 10.03 -		27719 02 77 00 312 851 
Trag-/Führungsgelenk mit Zubehör ALL TYPES	 ->09.2007	27720 02 77 01 056 969 
Lagerung, Lenker ALL TYPES		30721 01 77 00 302 122 
Lagerung, Lenker ALL TYPES		30722 01 77 00 302 123 
Stange/Strebe, Stabilisator Pendelstange mit Zubehör ALL TYPES		25814 02 82 00 713 522 
Stange/Strebe, Stabilisator Pendelstange mit Zubehör ALL TYPES		25815 02 82 00 713 523 







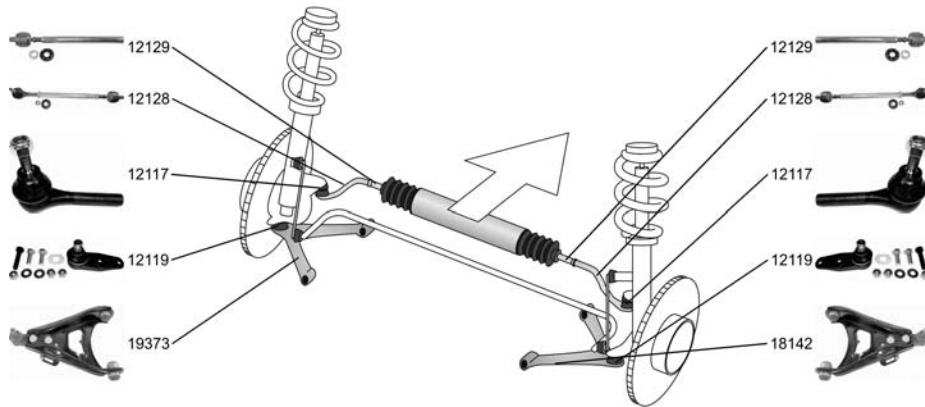

RENAULT

**RAPID Kasten/Box/Express/Van
(F40_, G40_)**

07.85 - 03.98



Spurstange mit Zubehör			12128 01 77 01 463 346 
1.0 1.1 (F40H) 1.1 (F401) 1.2 (F406, G40A) 1.4 (F402) 1.4 (F407) KAT 1.4 (F40M) 1.4 (F40U, F40V) 1.4 (F40D) 1.6 D (F404) 1.9 D (F40R) 1.9 D (F40P, F40N, F40E)	02.86 - 05.92 06.87 - 09.91 07.85 - 04.95 09.91 - 03.98 07.85 - 08.91 08.88 - 03.98 03.86 - 08.91 09.91 - 03.98 01.94 - 03.98 03.86 - 08.98 09.94 - 03.98 09.91 - 03.98		12117 02 12129 02 
Spurstangenkopf mit Zubehör Gewindeart: mit Rechtsgewinde Aussengewinde 1 [mm]: M14x1,5 Aussengewinde [mm]: M10x1,5			12117 02 77 01 469 231 
1.0 1.1 (F40H) 1.1 (F401) 1.2 (F406, G40A) 1.4 (F402) 1.4 (F407) KAT 1.4 (F40M) 1.4 (F40U, F40V) 1.4 (F40D) 1.6 D (F404) 1.9 D (F40R) 1.9 D (F40P, F40N, F40E)	02.86 - 05.92 06.87 - 09.91 07.85 - 04.95 09.91 - 03.98 07.85 - 08.91 08.88 - 03.98 03.86 - 08.91 09.91 - 03.98 01.94 - 03.98 03.86 - 08.98 09.94 - 03.98 09.91 - 03.98		
Axialgelenk, Spurstange mit Zubehör für OE-Nummer 77 01 465 915			12129 01 77 01 465 915 
1.0 1.1 (F40H) 1.1 (F401) 1.2 (F406, G40A) 1.4 (F402) 1.4 (F407) KAT 1.4 RN 1.4 (F40M) 1.4 (F40U, F40V) 1.4 (F40D) 1.6 D (F404) 1.9 D (F40R) 1.9 D (F40P, F40N, F40E)	02.86 - 05.92 06.87 - 09.91 07.85 - 04.95 09.91 - 03.98 07.85 - 08.91 08.88 - 03.98 09.91 - 08.93 03.86 - 08.91 09.91 - 03.98 01.94 - 03.98 03.86 - 08.98 09.94 - 03.98 09.91 - 03.98		









Ref.

RENAULT







RAPID Kasten/Box/Express/Van (F40_, G40_)

07.85 - 03.98

 Lenker, Radaufhängung mit Gummilager 1.0 1.1 (F40H) 1.1 (F401) 1.2 (F406, G40A) 1.4 (F402) 1.4 (F407) KAT 1.4 (F40M) 1.4 (F40U, F40V) 1.4 (F40D) 1.6 D (F404) 1.9 D (F40R) 1.9 D (F40P, F40N, F40E)		18142 01 77 00 783 456 
Lenker, Radaufhängung mit Gummilager 1.0 1.1 (F40H) 1.1 (F401) 1.2 (F406, G40A) 1.4 (F402) 1.4 (F407) KAT 1.4 (F40M) 1.4 (F40U, F40V) 1.4 (F40D) 1.6 D (F404) 1.9 D (F40R) 1.9 D (F40P, F40N, F40E)		19373 01 77 00 783 455 
Reparatursatz, Trag-/Führungsgelenk mit Zubehör mit Befestigungsmaterial Gewindemaß: M10 1.0 1.1 (F40H) 1.1 (F401) 1.2 (F406, G40A) 1.4 (F402) 1.4 (F407) KAT 1.4 (F40M) 1.4 (F40U, F40V) 1.4 (F40D) 1.6 D (F404) 1.9 D (F40R) 1.9 D (F40P, F40N, F40E)		A16 12119 03 77 01 468 883 

TRAFIC Bus/Familial (T5, T6, T7)

03.80 - 04.89



 Spurstange mit Zubehör ALL TYPES		12125 01 77 01 463 035 12236 01 22726 01 
Spurstangenkopf Gewindeart: mit Rechtsgewinde Aussengewinde [mm]: M14x1,5 ALL TYPES		12236 02 77 01 461 770 
Axialgelenk, Spurstange radseitig Gewindemaß: M12x1,0 Innengewinde [mm]: M14x1,5 mit Zubehör ALL TYPES		22726 02 











Ref.

RENAULT







TRAFIC Bus/Familial (T5, T6, T7) 03.80 - 04.89

 Lagerung, Lenker ALL TYPES		22491 01 77 01 349 064 
--	---	--

TRAFIC Kasten/Box/Furgón/Van (T1, T3, T4) 03.80 - 04.89

 Spurstange mit Zubehör ALL TYPES		12125 01 77 01 463 035 ▲12236 01 22726 01 
Spurstangenkopf Gewindeart: mit Rechtsgewinde Aussengewinde [mm]: M14x1,5 ALL TYPES		12236 02 77 01 461 770 
Axialgelenk, Spurstange radseitig Gewindemaß: M12x1,0 Innengewinde [mm]: M14x1,5 mit Zubehör ALL TYPES		22726 02 
Lagerung, Lenker ALL TYPES		22491 01 77 01 349 064 

TRAFIC Pritsche,Fahrgestell / Flatbed,Chassis Cab (P6) 03.80 - 04.89



 Spurstange mit Zubehör ALL TYPES		12125 01 77 01 463 035 ▲12236 01 22726 01 
Spurstangenkopf Gewindeart: mit Rechtsgewinde Aussengewinde [mm]: M14x1,5 ALL TYPES		12236 02 77 01 461 770 
Axialgelenk, Spurstange radseitig Gewindemaß: M12x1,0 Innengewinde [mm]: M14x1,5 mit Zubehör ALL TYPES		22726 02 



Ref.









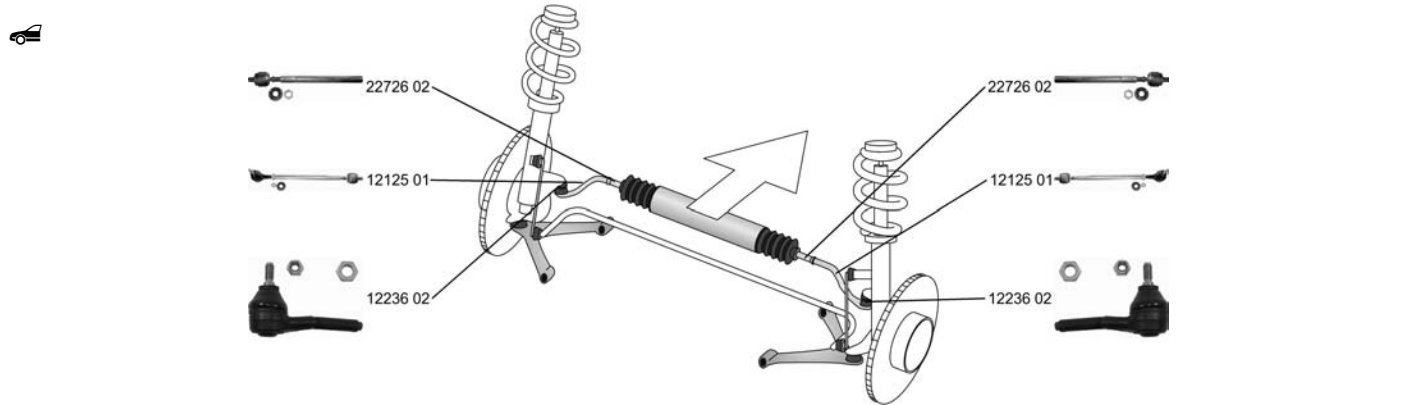



RENAULT

TRAFIC Pritsche, Fahrgestell / Flatbed, Chassis Cab (P6) 03.80 - 04.89

 Lagerung, Lenker ALL TYPES		22491 01 77 01 349 064 
--	--	--

TRAFIC Bus/Familial (TXW) 03.89 - 03.01





Spurstange mit Zubehör ALL TYPES		12125 01 77 01 463 035 12236 01 22726 01 
Spurstangenkopf Gewindeart: mit Rechtsgewinde Aussengewinde [mm]: M14x1,5 ALL TYPES		12236 02 77 01 461 770 
Axialgelenk, Spurstange radseitig Gewindemaß: M12x1,0 Innengewinde [mm]: M14x1,5 mit Zubehör ALL TYPES		22726 02 
Lagerung, Lenker ALL TYPES		22491 01 77 01 349 064 
Faltenbalgsatz, Lenkung Innendurchmesser 1 [mm]: 10 Innendurchmesser 2 [mm]: 26 ALL TYPES	 	30134 01 77 00 774 566 
Faltenbalgsatz, Lenkung Innendurchmesser 1 [mm]: 10 Innendurchmesser 2 [mm]: 33 ALL TYPES		30153 01 77 00 680 852 



Ref.









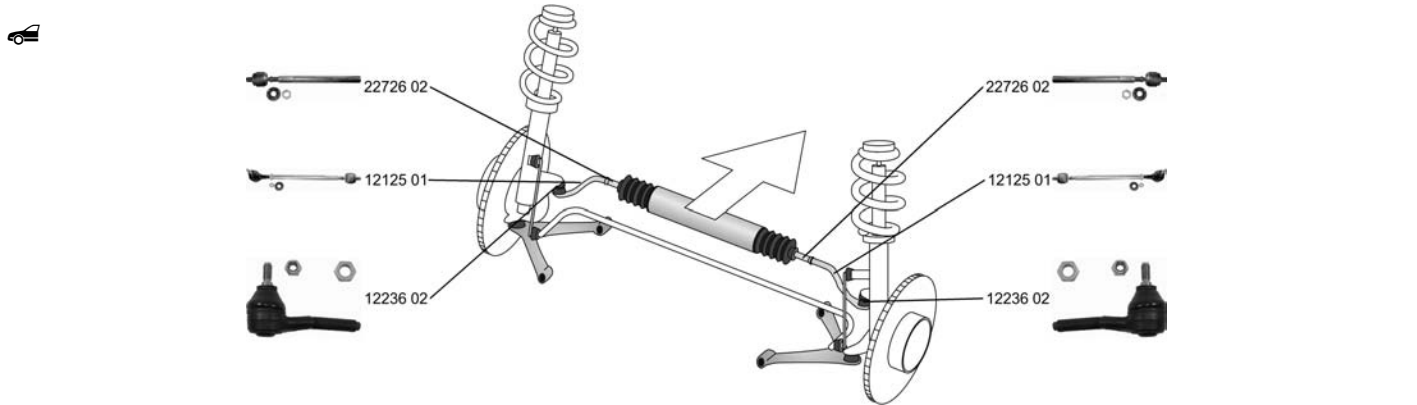









RENAULT

TRAFIC Bus/Familial (TXW) 03.89 - 03.01

 Faltenbalgsatz, Lenkung Innendurchmesser 1 [mm]: 10 Innendurchmesser 2 [mm]: 40 ALL TYPES		30154 01 77 01 469 617 
		

TRAFIC Kasten/Box/Furgón/Van (TXX) 05.89 - 03.01



 Spurstange mit Zubehör ALL TYPES		12125 01 77 01 463 035 ▲ 12236 01 22726 01 
Spurstangenkopf Gewindeart: mit Rechtsgewinde Aussengewinde [mm]: M14x1,5 ALL TYPES		12236 02 77 01 461 770 
Axialgelenk, Spurstange radseitig Gewindemaß: M12x1,0 Innengewinde [mm]: M14x1,5 mit Zubehör ALL TYPES	 	22726 02 
Lagerung, Lenker ALL TYPES	    TB12/TB22/TB32 P313/T422/T7B2/T7C2	22491 01 77 01 349 064 
Faltenbalgsatz, Lenkung Innendurchmesser 1 [mm]: 10 Innendurchmesser 2 [mm]: 26 ALL TYPES		30134 01 77 00 774 566 
Faltenbalgsatz, Lenkung Innendurchmesser 1 [mm]: 10 Innendurchmesser 2 [mm]: 33 ALL TYPES	 	30153 01 77 00 680 852 



Ref.

RENAULT

TRAFIC Kasten/Box/Furgón/Van (TXX)









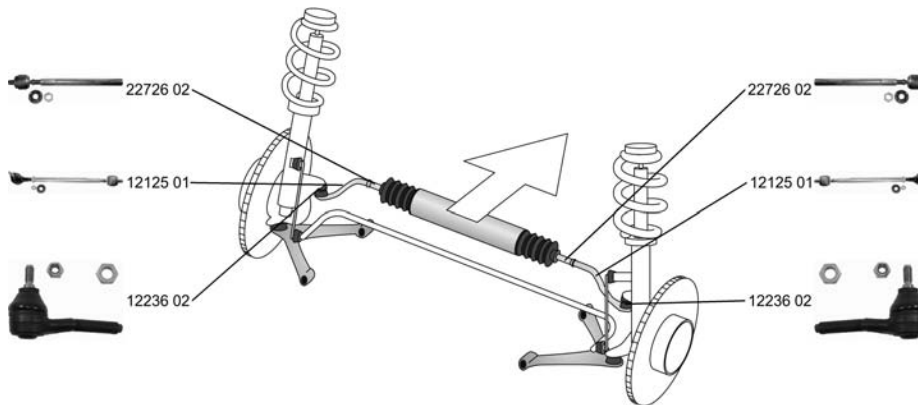



05.89 - 03.01

 Faltenbalgsatz, Lenkung Innendurchmesser 1 [mm]: 10 Innendurchmesser 2 [mm]: 40 ALL TYPES		30154 01 77 01 469 617 
---	---	--

TRAFIC Pritsche,Fahrgestell / Flatbed,Chassis/Cab (PXX)

05.89 - 03.01





Spurstange mit Zubehör ALL TYPES		12125 01 77 01 463 035 
Spurstangenkopf Gewindeart: mit Rechtsgewinde Aussengewinde [mm]: M14x1,5 ALL TYPES		12236 02 77 01 461 770 
Axialgelenk, Spurstange radseitig Gewindemaß: M12x1,0 Innengewinde [mm]: M14x1,5 mit Zubehör ALL TYPES		22726 02 
Lagerung, Lenker ALL TYPES		22491 01 77 01 349 064 
Faltenbalgsatz, Lenkung Innendurchmesser 1 [mm]: 10 Innendurchmesser 2 [mm]: 26 ALL TYPES		30134 01 77 00 774 566 
Faltenbalgsatz, Lenkung Innendurchmesser 1 [mm]: 10 Innendurchmesser 2 [mm]: 33 ALL TYPES		30153 01 77 00 680 852 



RENAULT

**TRAFIC Pritsche, Fahrgestell /
Flatbed, Chassis/Cab (PXX)**

05.89 - 03.01

 Faltenbaldsatz, Lenkung Innendurchmesser 1 [mm]: 10 Innendurchmesser 2 [mm]: 40 ALL TYPES		30154 01 77 01 469 617 
		

TRAFIC II Bus (JL)

03.01 -

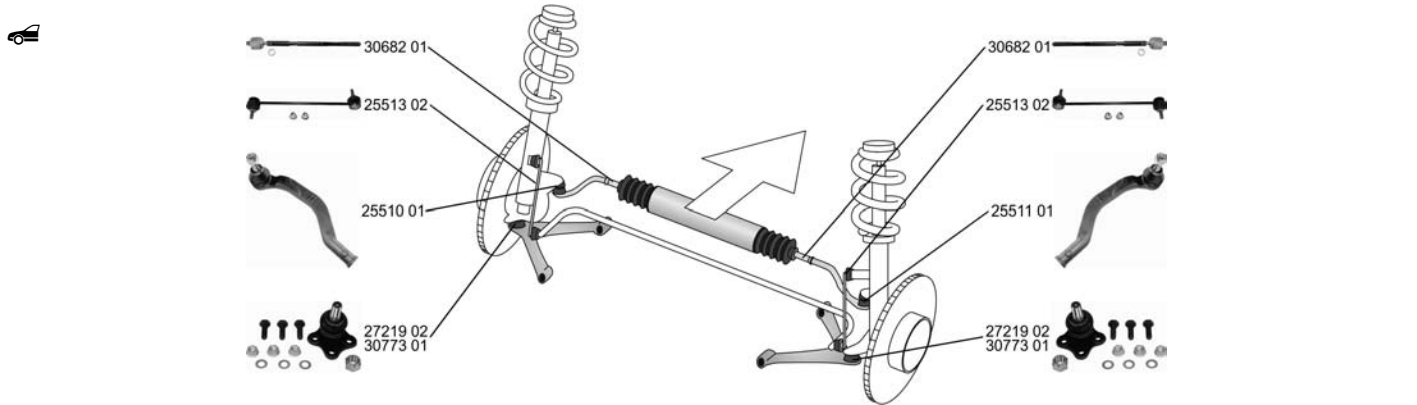





Spurstangenkopf ALL TYPES		25510 01 77 01 049 282 
Spurstangenkopf ALL TYPES		25511 01 77 01 049 283 
Axialgelenk, Spurstange radseitig Gewindemaß: M12x1,0 Gewindemaß: M14x1,5 ALL TYPES		30682 01 77 01 473 333 
Trag-/Führungsgelenk Konusmaß [mm]: 19,55 Bohrung-Ø [mm]: 10 mit Zubehör ALL TYPES	 ->10.2006	27219 02 77 01 478 029 
Trag-/Führungsgelenk Konusmaß [mm]: 19,55 Bohrung-Ø [mm]: 12 mit Zubehör ALL TYPES	 10.2006->	30773 01 77 01 477 385 
Lagerung, Lenker ALL TYPES		26938 01 82 00 002 869 



Ref.









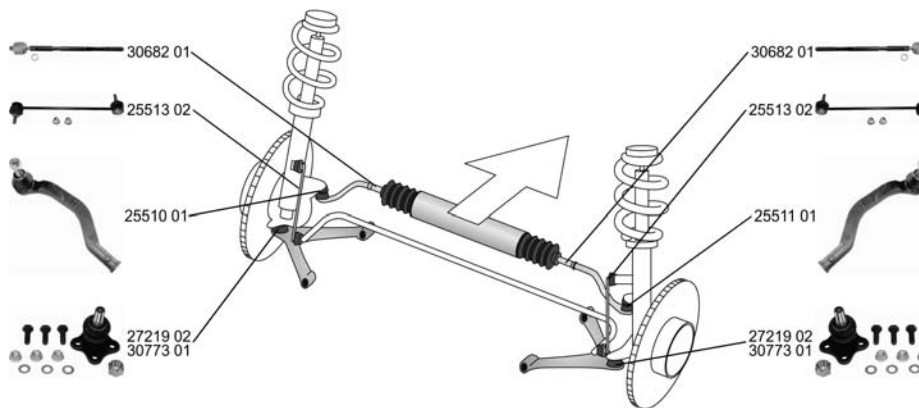

RENAULT

TRAFIC II Bus (JL) 03.01 -

 Lagerung, Lenker ALL TYPES		26939 01 82 00 049 624 
Stange/Strebe, Stabilisator Pendelstange mit Zubehör ALL TYPES		25513 02 82 00 661 217 

TRAFIC II Kasten (FL) 03.01 -









Spurstangenkopf ALL TYPES		25510 01 77 01 049 282 
Spurstangenkopf ALL TYPES		25511 01 77 01 049 283 
Axialgelenk, Spurstange radseitig Gewindemaß: M12x1,0 Gewindemaß: M14x1,5 ALL TYPES		30682 01 77 01 473 333 
Trag-/Führungsgelenk Konusmaß [mm]: 19,55 Bohrung-Ø [mm]: 10 mit Zubehör ALL TYPES	 ->10.2006	27219 02 77 01 478 029 
Trag-/Führungsgelenk Konusmaß [mm]: 19,55 Bohrung-Ø [mm]: 12 mit Zubehör ALL TYPES	 10.2006->	30773 01 77 01 477 385 









Ref.

RENAULT

TRAFIC II Kasten (FL) 03.01 -

 Lagerung, Lenker ALL TYPES		26938 01 82 00 002 869 
Lagerung, Lenker ALL TYPES		26939 01 82 00 049 624 
Stange/Strebe, Stabilisator Pendelstange mit Zubehör ALL TYPES		25513 02 82 00 661 217 

TRAFIC II Pritsche/Fahrgestell (EL) 03.01 -

 Axialgelenk, Spurstange radseitig Gewindemaß: M12x1,0 Gewindemaß: M14x1,5 ALL TYPES ausser : 2.0 dCi 90 08.06 - 2.0 dCi 115 08.06 - 2.5 dCi 145 08.06 -		30682 01 77 01 473 333 
Trag-/Führungsgelenk Konusmaß [mm]: 19,55 Bohrung-Ø [mm]: 10 mit Zubehör ALL TYPES	 ->10.2006	27219 02 77 01 478 029 
Trag-/Führungsgelenk Konusmaß [mm]: 19,55 Bohrung-Ø [mm]: 12 mit Zubehör ALL TYPES	 10.2006->	30773 01 77 01 477 385 











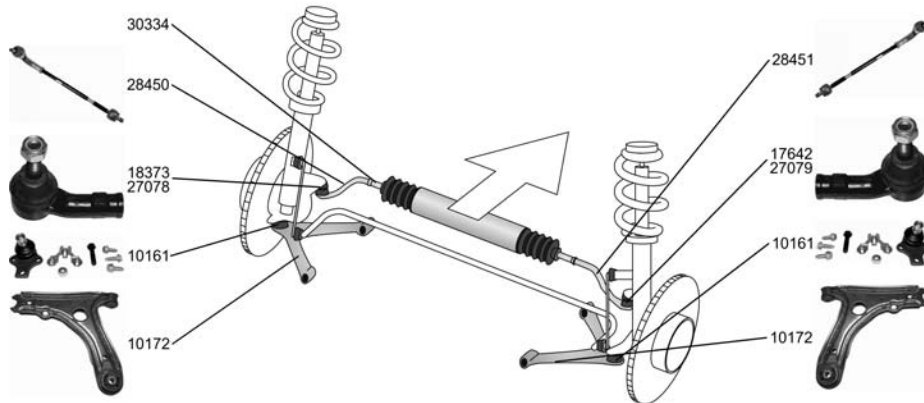

















Ref.

SEAT

INCA (6K9)

11.95 -



<p>Spurstange ALL TYPES ausser : 1.6 08.99 - 04.02</p>	 	<p>28450 02 6K0 422 803 D</p> 
<p>Spurstange ALL TYPES ausser : 1.6 08.99 - 04.02</p>	 	<p>28451 02 6K0 422 804 D</p> 
<p>Spurstangenkopf Gewindeart: mit Rechtsgewinde mit Zubehör ALL TYPES ausser : 1.6 08.99 - 04.02</p>	   ->Chass. 9K-1-013 000	<p>17642 04 3A0 422 812</p> 
<p>Spurstangenkopf Gewindeart: mit Rechtsgewinde mit Zubehör ALL TYPES ausser : 1.6 08.99 - 04.02</p>	  ->Chass. 9K-1-013 000	<p>18373 04 3A0 422 811</p> 
<p>Spurstangenkopf mit Zubehör ALL TYPES ausser : 1.6 08.99 - 04.02</p>	  Chass. 9K-1-013 001->	<p>27078 02 6K0 422 811</p> 
<p>Spurstangenkopf mit Zubehör ALL TYPES ausser : 1.6 08.99 - 04.02</p>	  Chass. 9K-1-013 001->	<p>27079 02 6K0 422 812</p> 
<p>Axialgelenk, Spurstange ALL TYPES ausser : 1.6 08.99 - 04.02</p>	 	<p>30334 01 6K0 422 807 D</p>
<p>Lenker, Radaufhängung ohne Trag-/Führungsgelenk mit Gummilager nur in Verbindung mit: 10169 nur in Verbindung mit: 10161 ALL TYPES ausser : 1.6 08.99 - 04.02</p>	  	<p>10172 01 191 407 151 B</p> 



Ref.

SEAT

INCA (6K9)

11.95 -

<p> Reparatursatz, Trag-/Führungsgelenk mit Zubehör für OE-Nummer 191 407 151 B</p> <p>ALL TYPES ausser : 1.6 08.99 - 04.02</p>	<p>↔</p>	<p>10161 07 357 407 365</p> 
<p>Lagerung, Lenker</p> <p>ALL TYPES ausser : 1.6 08.99 - 04.02</p>	<p>↔ ↕ (x2) 112/A33</p>	<p>10203 02 357 408 182</p> 
<p>Lagerung, Lenker</p> <p>1.4 i 11.95 - 1.6 i 11.95 - 05.98 1.9 D 11.95 - 1.9 SDI 11.95 -</p>	<p>↔ ↕ (x2)</p>	<p>10205 02 191 407 181 E</p> 
<p>Lagerung, Lenker</p> <p>1.4 i 11.95 - 1.6 i 11.95 - 05.98 1.9 D 11.95 - 1.9 SDI 11.95 -</p>	<p>↔ ↕ (x2) HD</p>	<p>31480 01 191 407 181 SP</p> 
<p>Reparatursatz, Lenker mit Montagehülsen</p> <p>ALL TYPES ausser : 1.6 08.99 - 04.02</p>	<p>↔ ↕ (x2)</p>	<p>25352 01 191 407 181 E</p> 
<p>Lagerung, Stabilisator-koppelstange</p> <p>ALL TYPES ausser : 1.4 16V 04.00 - 1.6 08.99 - 04.02</p>	<p>↔ ->Chass. 9K-V-012 500</p>	<p>17400 02 191 411 327</p> 
<p>Faltenbalsatz, Lenkung</p> <p>ALL TYPES ausser : 1.6 08.99 - 04.02</p>	<p>↕</p>	<p>30111 01 1H0 422 831 B</p> 











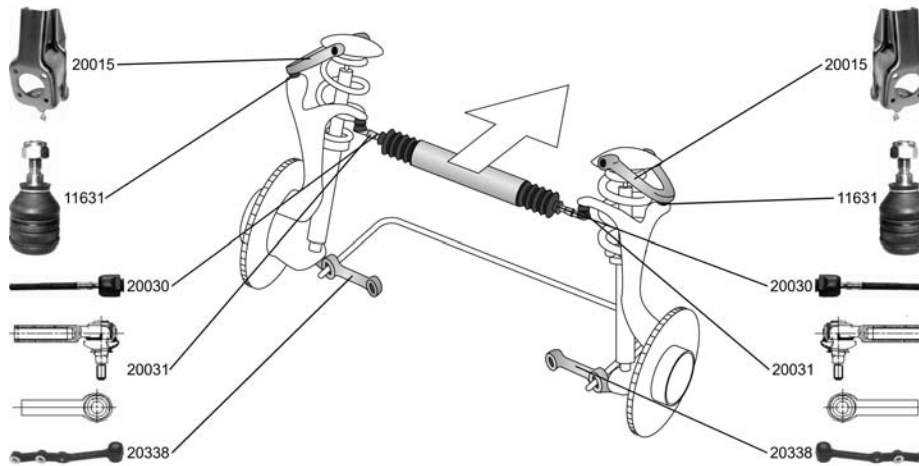



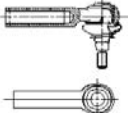

Ref.

SEAT

MARBELLA
Kasten/Box/Furgón/Van (028A)

11.86 - 12.93



<p>Spurstangenkopf ALL TYPES</p>		<p>20031 02 5 960 835 SE 141162410 A</p> 
<p>Axialgelenk, Spurstange Gewindeart: mit Rechtsgewinde Gewindemaß: M12x1,5 ALL TYPES</p>	 	<p>20030 01 5 960 321</p> 
<p>Lenker, Radaufhängung ALL TYPES</p>		<p>20015 01 5 995 503</p> 
<p>Lenker, Radaufhängung ALL TYPES</p>		<p>20338 03 7 601 261</p> 
<p>Trag-/Führungsgelenk ALL TYPES</p>		<p>11631 02 4 402 649</p> 
<p>Faltenbalgsatz, Lenkung Innendurchmesser 1 [mm]: 10 Innendurchmesser 2 [mm]: 42 ALL TYPES</p>		<p>30133 01 SE 138 162 131 A</p>
<p>Faltenbalgsatz, Lenkung Innendurchmesser 1 [mm]: 10 Innendurchmesser 2 [mm]: 26 ALL TYPES</p>		<p>30134 01 SE 138 162 132 A</p> 





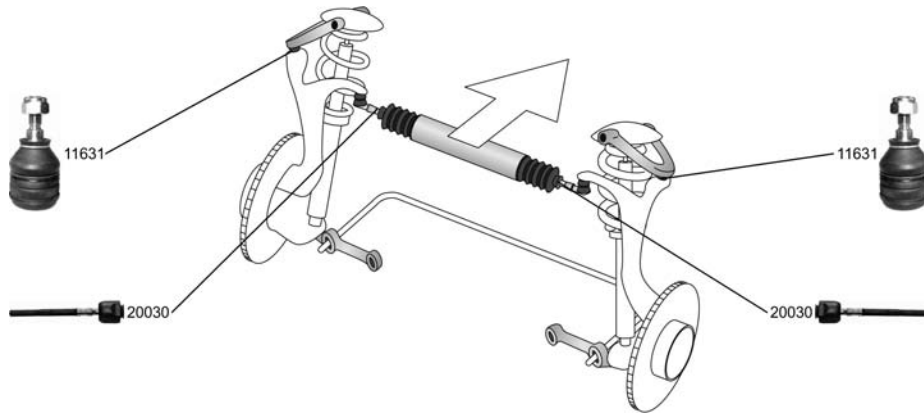

SEAT

**TERRA Kasten/Box/Furgón/Van
(024A)**

01.87 - 02.96



Axialgelenk, Spurstange Gewindeart: mit Rechtsgewinde Gewindemaß: M12x1,5		20030 01 5 960 321 
ALL TYPES		
Trag-/Führungsgelenk		11631 02 4 402 649
ALL TYPES		











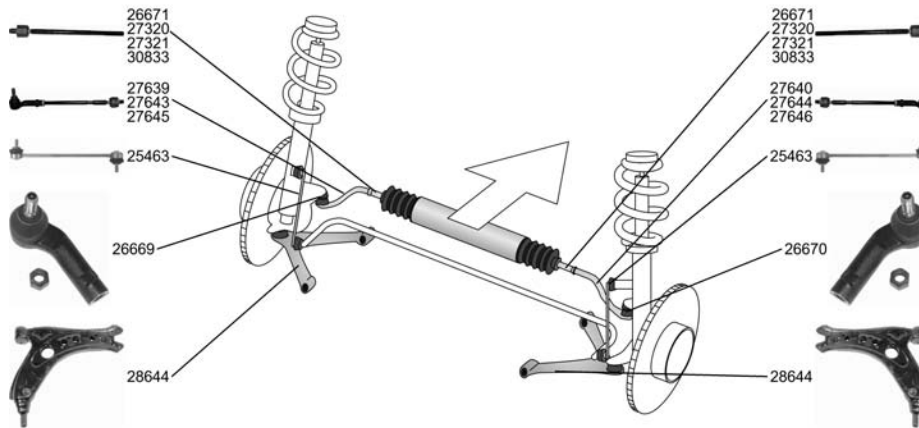



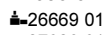
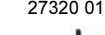



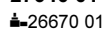
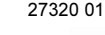



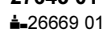

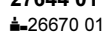

Ref.

SKODA

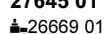
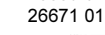
FABIA Praktik

04.02 -

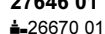
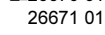

<p>Spurstange mit Zubehör</p> <p>1.2, 47 kW 1.9 SDI</p>	<p>01.03 - 04.02 -</p>	<p></p> <p></p>	<p>27639 01 6Q0 419 803 D</p> <p> </p> <p></p>
<p>Spurstange mit Zubehör</p> <p>1.2, 47 kW 1.9 SDI</p>	<p>01.03 - 04.02 -</p>	<p></p> <p></p>	<p>27640 01 6Q0 419 804 D</p> <p> </p> <p></p>
<p>Spurstange für Lenkgetriebe-ID: TRW Betriebsart: elektrisch-hydraulisch mit Zubehör</p> <p>1.2, 47 kW 1.9 SDI</p>	<p>01.03 - 04.02 -</p>	<p></p> <p></p>	<p>27643 01 6Q0 423 803 E</p> <p></p> <p></p>
<p>Spurstange für Lenkgetriebe-ID: TRW Betriebsart: elektrisch-hydraulisch mit Zubehör</p> <p>1.2, 47 kW 1.9 SDI</p>	<p>01.03 - 04.02 -</p>	<p></p> <p></p>	<p>27644 01 6Q0 423 804 E</p> <p></p> <p></p>
<p>Spurstange für Lenkgetriebe-ID: SMI-Koyo für: KOYO Betriebsart: elektrisch-hydraulisch mit Zubehör</p> <p>1.2, 47 kW 1.9 SDI</p>	<p>01.03 - 04.02 -</p>	<p></p> <p></p>	<p>27645 01 6Q0 423 803 G</p> <p> </p> <p></p>
<p>Spurstange für Lenkgetriebe-ID: SMI-Koyo für: KOYO Betriebsart: elektrisch-hydraulisch mit Zubehör</p> <p>1.2, 47 kW 1.9 SDI</p>	<p>01.03 - 04.02 -</p>	<p></p> <p></p>	<p>27646 01 6Q0 423 804 G</p> <p> </p> <p></p>





















Ref.

SKODA

FABIA Praktik

04.02 -

 Spurstangenkopf ALL TYPES		26669 02 6Q0 423 811 C 
Spurstangenkopf ALL TYPES		26670 02 6Q0 423 812 C 
Axialgelenk, Spurstange radseitig Betriebsart: elektrisch-hydraulisch für Lenkgetriebe-ID: SMI-Koyo Aussengewinde [mm]: M14x1,5 Gewindemaß: M16x1,5 1.2, 47 kW 1.9 SDI		26671 01 
Axialgelenk, Spurstange radseitig Aussengewinde [mm]: M14x1,5 Gewindemaß: M14x1,5 mit Zubehör 1.2, 47 kW 1.9 SDI		27320 01 6Q0 419 807 D 
Axialgelenk, Spurstange radseitig Gewindemaß 1: M14x1,5 Gewindemaß 2: M14x1,5 1.9 SDI 1.4		27321 01 6Q0 423 810 B 
Axialgelenk, Spurstange radseitig für Lenkgetriebe-ID: TRW Aussengewinde [mm]: M14x1,5 Gewindemaß: M14 x1,5 mit Zubehör 1.2 1.2, 40 kW 1.4 TDI 1.9 SDI 1.4		30833 01 6Q0 423 810 E 
Lenker, Radaufhängung mit Gummilager 1.2, 47 kW 1.9 SDI		28644 01 6Q0 407 151 E 29709 01 
Reparatursatz, Trag-/Führungsgelenk 1.2, 47 kW 1.9 SDI		25524 02 6Q0 407 365 M 
Reparatursatz, Trag-/Führungsgelenk 1.2, 47 kW 1.9 SDI		25525 02 6Q0 407 366 A 











Ref.

SKODA



FABIA Praktik

04.02 -

	Lagerung, Lenker	↔ ↑	29709 01	6Q0 407 182 A	
	1.2, 47 kW 1.9 SDI	01.03 - 04.02 -			
	Lagerung, Lenker	↔ ↓	29710 01	6Q0 407 183 A	
	1.2, 47 kW 1.9 SDI	01.03 - 04.02 -			
	Stange/Strebe, Stabilisator Pendelstange	↔	25463 02	6Q0 411 315 J	
	1.2, 47 kW 1.9 SDI	01.03 - 04.02 -			
	Faltenbalgsatz, Lenkung	↔	30235 01	6E0 419 831	
	1.2, 47 kW 1.9 SDI	01.03 - 04.02 -	 für: TRW ->Chass. 6Y-3-736 552		
	Achskörperlager Hydrolager paarweise durch konventionelles Lager ersetzen.	↔	A71,40	21236 01	1J0 501 541 C
	1.2, 47 kW 1.9 SDI	01.03 - 04.02 -			
	Achskörperlager	↔		26814 01	6Q0 501 541 E
	1.2, 47 kW 1.9 SDI	01.03 - 04.02 -	für Fahrzeuge mit verstärktem Fahrwerk 		
	Reparatursatz, Achskörper mit Zubehör	↔	27627 01	1J0 501 541 C	
	1.2, 47 kW 1.9 SDI	01.03 - 04.02 -	21236 01		

PRAKTIK

06.07 -

	Spurstangenkopf ALL TYPES	↻ ♂	26669 02	6Q0 423 811 C
				
	Spurstangenkopf ALL TYPES	↻ ♂	26670 02	6Q0 423 812 C
				





















Ref.

SKODA

ROOMSTER (5J)

09.06 -

 Axialgelenk, Spurstange radseitig für Lenkgetriebe-ID: TRW Aussengewinde [mm]: M14x1,5 Gewindemaß: M14 x1,5 mit Zubehör		30833 01 6Q0 423 810 E 
ALL TYPES		
Lenker, Radaufhängung mit Gummilager		28644 01 6Q0 407 151 E 29709 01 
ALL TYPES ausser : 1.2, 51 kW 01.07 -		
Reparatursatz, Trag-/Führungsgelenk		25524 02 6Q0 407 365 M 
ALL TYPES ausser : 1.2, 51 kW 01.07 -		
Reparatursatz, Trag-/Führungsgelenk		25525 02 6Q0 407 366 A 
ALL TYPES ausser : 1.2, 51 kW 01.07 -		
Stange/Strebe, Stabilisator Pendelstange		25463 02 6Q0 411 315 J 
ALL TYPES ausser : 1.2, 51 kW 01.07 -		
 Achskörperlager Hydrolager paarweise durch konventionelles Lager ersetzen.		A71,40 21236 01 1J0 501 541 C 
ALL TYPES		
Reparatursatz, Achskörper mit Zubehör		27627 01 1J0 501 541 C 21236 01 
ALL TYPES		





Ref.

SUZUKI

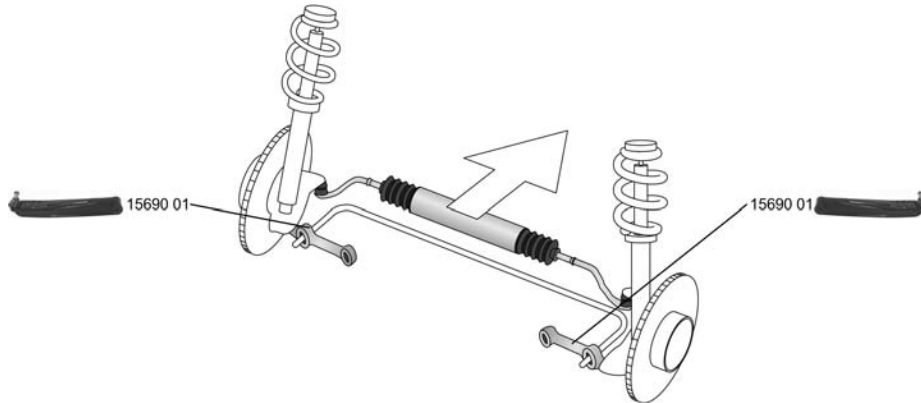
SUPER CARRY Bus/Familial (ED) 10.85 - 03.99









Lenker, Radaufhängung			15690 01	45200-77500
1.0, 30 kW	09.94 - 03.99			
1.0, 31 kW	10.92 - 03.99			
1.0, 33 kW	10.85 - 03.99	10.1991->		









Ref.

TOYOTA

HIACE II Kasten/Box/Furgón/Van 03.83 - 11.89 (H5_)

 Spurstangenkopf Gewindeart: mit Linksgewinde Gewindemaß: M17x1,5 Aussengewinde [mm]: M17x1,5		11907 02 45046-39235 
		ALL TYPES ausser : 2.2 09.87 - 08.89 2.4 D 4x4 04.84 - 07.87
Spurstangenkopf Gewindeart: mit Rechtsgewinde Gewindemaß: M17x1,5		16361 02 45406-29145 
		ALL TYPES ausser : 2.2 09.87 - 08.89 2.4 D 4x4 04.84 - 07.87
Trag-/Führungsgelenk Konusmaß [mm]: 17,2		11905 02 43350-29056 
		1.8 03.83 - 11.89
		2.0 01.84 - 11.89
		2.2 D 03.83 - 11.89
2.4 D 05.84 - 11.89		

HIACE II Wagon/Bus/Familial (H5_) 03.83 - 11.89

 Spurstangenkopf Gewindeart: mit Linksgewinde Gewindemaß: M17x1,5 Aussengewinde [mm]: M17x1,5		11907 02 45046-39235 
		ALL TYPES ausser : 2.0 4x4 08.87 - 07.89 2.2 09.87 - 08.89
Spurstangenkopf Gewindeart: mit Rechtsgewinde Gewindemaß: M17x1,5		16361 02 45406-29145 
		ALL TYPES ausser : 2.0 4x4 08.87 - 07.89 2.2 09.87 - 08.89
Trag-/Führungsgelenk Konusmaß [mm]: 17,2		11905 02 43350-29056 
		ALL TYPES ausser :
		2.0 4x4 08.87 - 07.89
2.2 09.87 - 08.89		





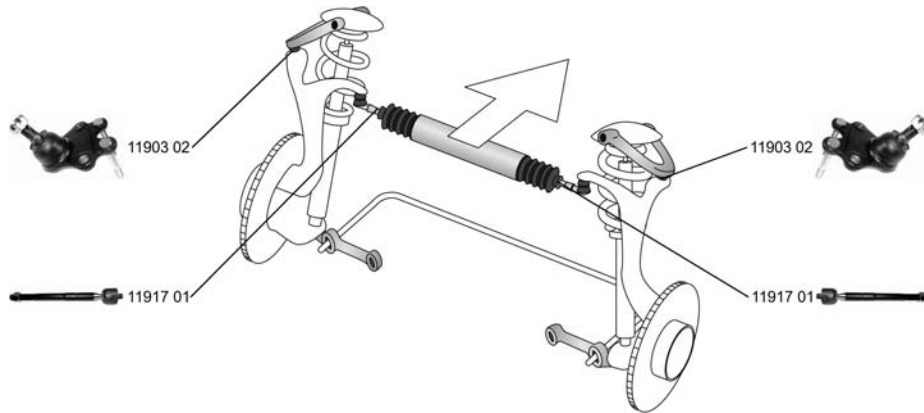

TOYOTA

HIACE III Kasten/Box/Furgón/Van (_H10_)

08.89 - 08.95





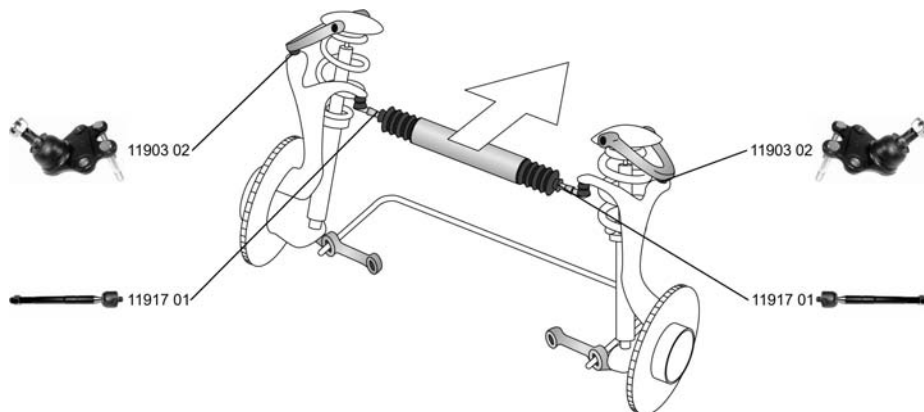

Axialgelenk, Spurstange ohne Zubehör			11917 01 45503-29255 	
	2.0			02.90 - 08.95
	2.4			08.89 - 08.95
	2.4 Diesel			02.90 - 08.95
Trag-/Führungsgelenk Konusmaß [mm]: 17,2			11903 02 43350-29065 	
	2.0			02.90 - 08.95
	2.4			08.89 - 08.95
	2.4 4WD			08.89 - 08.95
	2.4 Diesel			02.90 - 08.95

HIACE III Wagon/Bus/Familial (_H10_)

08.89 - 08.95



Axialgelenk, Spurstange ohne Zubehör			11917 01 45503-29255 	
	2.0 (RZH102)			08.89 - 08.95
	2.4 (RZH103)			08.89 - 08.95
	2.4 D (LH102)			08.89 - 08.95
	2.4 D			10.93 - 08.95
Trag-/Führungsgelenk Konusmaß [mm]: 17,2			11903 02 43350-29065 	
	ALL TYPES ausser :			
	2.4 D 4WD			08.89 - 08.95
2.8 D	08.89 - 08.95			





Ref.

TOYOTA

**HIACE IV Kasten/Box/Furgón/Van
(_H1_, _H2_)**

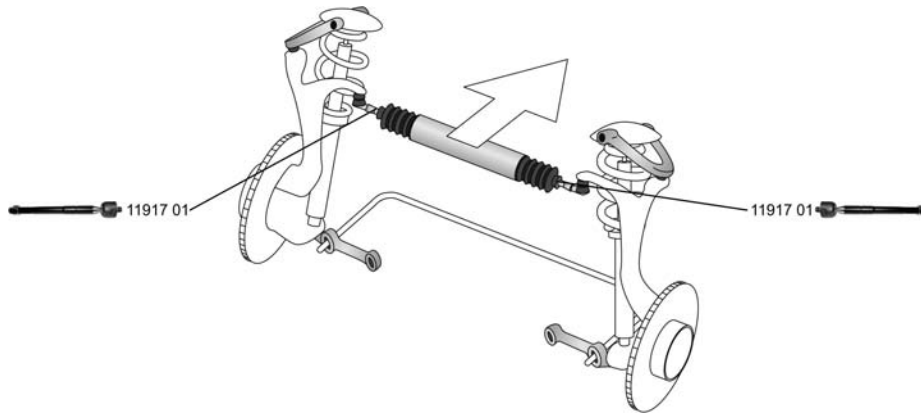
08.95 -



Axialgelenk, Spurstange ohne Zubehör		11917 01	45503-29255
2.4 (RCH12_, RCH22_)	08.95 - 04.98		
2.4 D (LXH12_, LXH22_)	08.95 -		
2.4 TD (LXH12_, LXH22_)	08.95 -		

**HIACE IV Wagon/Bus/Familial
(_H1_, _H2_)**

08.95 -

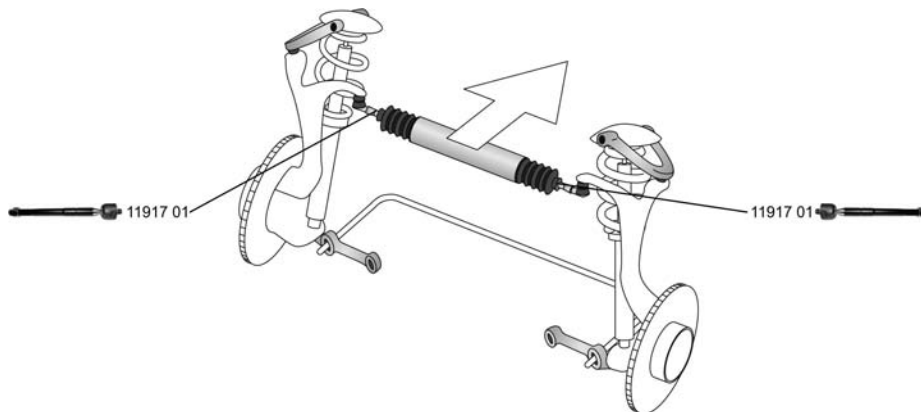

Axialgelenk, Spurstange ohne Zubehör		11917 01	45503-29255
2.4 (RCH12_, RCH22_)	08.95 - 04.98		
2.4 D, 58 kW	08.95 -		
2.4 TD (LXH12_, LXH22_)	08.95 -		









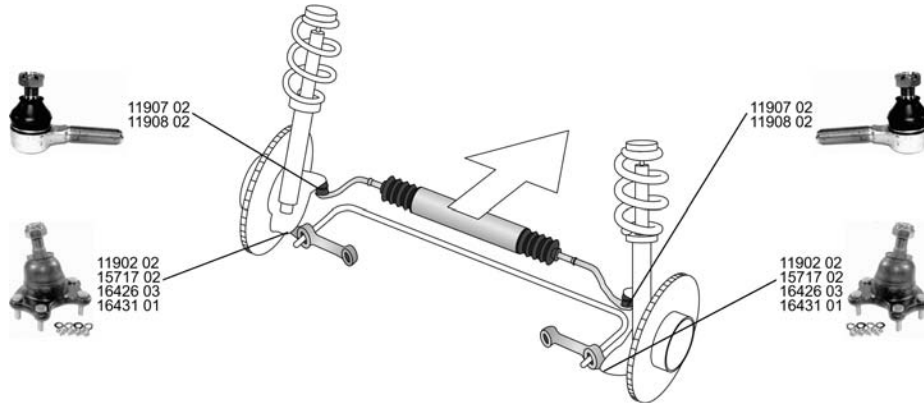



TOYOTA

HILUX Pickup (N)

01.84 -



<p>Spurstangenkopf Gewindeart: mit Linksgewinde Gewindemaß: M17x1,5 Aussengewinde [mm]: M17x1,5</p>		<p>11907 02 45046-39235</p> 
<p>1.8 (YN85_, YN90_) 08.88 - 07.94 2.0, 65 kW 01.84 - 12.86 2.2 4WD (YN106_, YN110_) 01.87 - 12.89 2.4 i 4WD, 84 kW, 2366 ccm 06.89 - 2.4 i 4WD, 84 kW, 2355 ccm 06.89 - 2.4 i 4WD, 103 kW 08.97 - 2.4 D, 55 kW 07.98 - 01.02 2.4 D, 58 kW 03.95 - 2.4 D 4WD, 58 kW 01.94 - 2.4 D 01.92 - 2.4 D, 61 kW 08.88 - 2.4 D 4WD, 61 kW 08.88 - 2.4 TD 4WD 08.98 - 01.02</p>		
<p>Spurstangenkopf Gewindeart: mit Rechtsgewinde Gewindemaß: M17x1,5 Aussengewinde [mm]: M17x1,5</p>		<p>11908 02 45406-39155</p> 
<p>1.8 (YN85_, YN90_) 08.88 - 07.94 2.0, 65 kW 01.84 - 12.86 2.4 i 4WD, 84 kW, 2366 ccm 06.89 - 2.4 i 4WD, 84 kW, 2355 ccm 06.89 - 2.4 i 4WD, 103 kW 08.97 - 2.4 D, 55 kW 07.98 - 01.02 2.4 D, 58 kW 03.95 - 2.4 D 4WD, 58 kW 01.94 - 2.4 D 01.92 - 2.4 D, 61 kW 08.88 - 2.4 TD 4WD 08.98 - 01.02</p>		
<p>Trag-/Führungsgelenk Konusmaß [mm]: 18,2</p>		<p>11902 02 43330-39295</p> 
<p>1.8 (YN85_, YN90_) 08.88 - 07.94 2.0, 65 kW 01.84 - 12.86 2.4 D, 58 kW 03.95 - 2.4 D, 59 kW 01.92 - 2.4 D, 61 kW 08.88 -</p>		
<p>Trag-/Führungsgelenk Konusmaß [mm]: 17,1</p>		<p>15717 02 43360-39085</p> 
<p>2.2 4WD (YN106_, YN110_) 01.87 - 12.89 2.4 i 4WD, 84 kW, 2355 ccm 06.89 - 2.4 i 4WD, 103 kW 08.97 - 2.4 D 4WD, 58 kW 01.94 - 2.4 D 4WD, 61 kW 08.88 - 2.4 TD 4WD 08.98 - 01.02</p>		
<p>Trag-/Führungsgelenk</p>		<p>16426 03 43350-39115</p> 
<p>1.8 (YN85_, YN90_) 08.88 - 07.94 2.0, 65 kW 01.84 - 12.86 2.4 D, 55 kW 07.98 - 01.02 2.4 D, 58 kW 03.95 - 2.4 D 01.92 - 2.4 D, 61 kW 08.88 -</p>		



Ref.

TOYOTA

HILUX Pickup (N)

01.84 -

Trag-/Führungsgelenk 2.4 i 4WD 2.4 i 4WD, 84 kW, 2355 ccm 2.4 i 4WD, 103 kW 2.4 D 4WD, 58 kW 2.4 TD 4WD 2.2 4WD (YN106_, YN110_) 2.4 D 4WD, 61 kW	06.89 - .		16431 01 43330-39265
	06.89 -		
	08.97 -		
	01.94 -		
	08.98 - 01.02		
	01.87 - 12.89	04.1989->	
08.88 -			

LITEACE Kasten/Box/Furgón/Van (M2_V)

10.79 - 10.86

Spurstangenkopf Gewindeart: mit Linksgewinde Gewindemaß: M14x1,5 1.3	10.79 - 10.86		15719 03 45046-29155
Trag-/Führungsgelenk 1.3	10.79 - 10.86		11898 02 43330-29245
Trag-/Führungsgelenk 1.3	10.79 - 10.86		11904 01 43350-29036

LITEACE Bus/Familial (CM30_G, KM30_G)

10.85 - 01.92

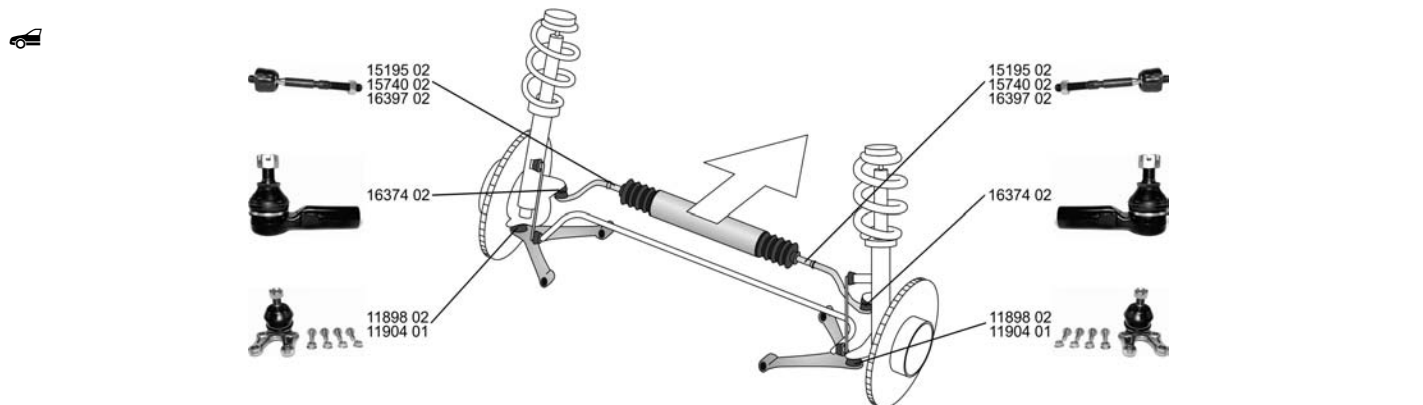











Spurstangenkopf 1.5 (KM30LG), 52 kW	07.89 - 01.92		16374 02 45046-29186
Axialgelenk, Spurstange Gewindemaß: M14x1,5 Gewindeart: mit Rechtsgewinde 1.5 (KM30LG), 51 kW 2.0 D (CM30LG) 1.5 (KM30LG), 52 kW	10.85 - 08.89		15195 02 45503-29125
	08.88 - 01.92		
	07.89 - 01.92		



TOYOTA

LITEACE Bus/Familial (CM30_G, KM30_G)





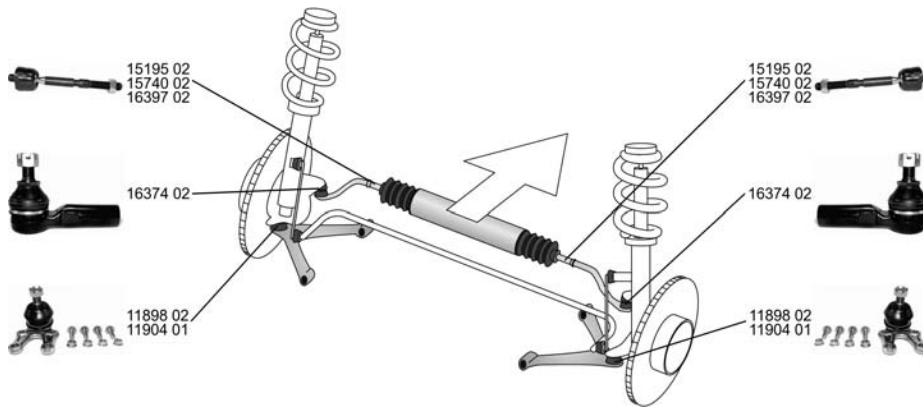

10.85 - 01.92

 Axialgelenk, Spurstange Gewindeart: mit Rechtsgewinde Gewindemaß: M14x1,5 1.5 (KM30LG), 51 kW	 10.85 - 08.89	15740 02 45503-29135 
	 ->08.1988	
Axialgelenk, Spurstange 1.5 (KM30LG), 52 kW	 07.89 - 01.92	16397 02 45503-29215 
Trag-/Führungsgelenk 1.5 (KM30LG) 1.5 (KM30LG), 52 kW	 10.85 - 08.89 07.89 - 01.92	11898 02 43330-29245 
Trag-/Führungsgelenk 1.5 (KM30LG) 1.5 (KM30LG), 52 kW	 10.85 - 08.89 07.89 - 01.92	11904 01 43350-29036 

LITEACE Kasten/Box/Furgón/Van (CM3_V, KM3_V)

10.85 - 01.92









Spurstangenkopf 1.5 (KM31_V, KM36_V)	 05.86 - 09.91 08.1988->	16374 02 45046-29186 
Axialgelenk, Spurstange Gewindemaß: M14x1,5 Gewindeart: mit Rechtsgewinde 1.5 (KM31_V, KM36_V) 1.8 D (CM35_V) 2.0 D (CM36_V)	 05.86 - 09.91 10.85 - 08.88 08.88 - 01.92	15195 02 45503-29125 
Axialgelenk, Spurstange Gewindeart: mit Rechtsgewinde Gewindemaß: M14x1,5 1.5 (KM31_V, KM36_V)	 05.86 - 09.91  ->08.1988	15740 02 45503-29135 



Ref.

TOYOTA

LITEACE Kasten/Box/Furgón/Van 10.85 - 01.92 (CM3_V, KM3_V)

 Axialgelenk, Spurstange 1.5 (KM31_V, KM36_V) 05.86 - 09.91		16397 02 45503-29215 
Trag-/Führungsgelenk 1.5 (KM31_V, KM36_V) 05.86 - 09.91		11898 02 43330-29245 
Trag-/Führungsgelenk 1.5 (KM31_V, KM36_V) 05.86 - 09.91		11904 01 43350-29036 









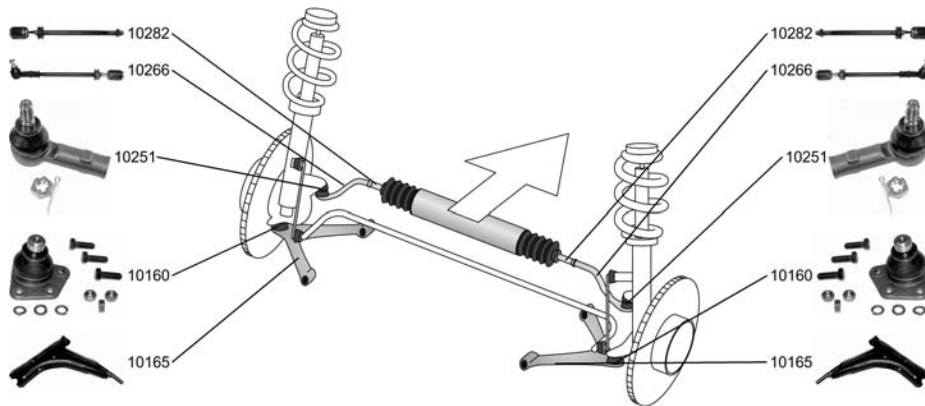









VOLKSWAGEN

CADDY I (14)

08.82 - 07.92







Spurstange Konusmaß [mm]: 14 Rohr-Ø [mm]: 14		10266 01	
1.5 1.6 1.8 1.6 D	08.82 - 07.83 01.83 - 07.92 08.85 - 07.92 08.82 - 07.92		
Spurstangenkopf Konusmaß [mm]: 14 Innengewinde [mm]: M14x1,5 Gewindeart: mit Rechtsgewinde mit Zubehör Gewindemaß: M14x1,5		10251 02 171 419 812	
1.5 1.6 1.8 1.6 D	08.82 - 07.83 01.83 - 07.92 08.85 - 07.92 08.82 - 07.92		
Axialgelenk, Spurstange Gewindemaß: M22x1,5 Gewindeart: mit Rechtsgewinde für OE-Nummer 025 390 045 617		10282 01 171 419 807 A	
1.5 1.6 1.8 1.6 D	08.82 - 07.83 01.83 - 07.92 08.85 - 07.92 08.82 - 07.92		
Lenker, Radaufhängung ohne Trag-/Führungsgelenk ohne Gummilager		10165 01 171 407 153 D	
1.5 1.6 1.8 1.6 D	08.82 - 07.83 01.83 - 07.92 08.85 - 07.92 08.82 - 07.92		
Reparatursatz, Trag-/Führungsgelenk		A17 10160 04 171 407 365 F	
1.5 1.6 1.8 1.6 D	08.82 - 07.83 01.83 - 07.92 08.85 - 07.92 08.82 - 07.92		
Lagerung, Lenker		10202 01 171 407 182 D	
1.5 1.6 1.8 1.6 D	08.82 - 07.83 01.83 - 07.92 08.85 - 07.92 08.82 - 07.92		
Faltenbalgsatz, Lenkung		30112 01 191 419 831	
1.5 1.6 1.8 1.6 D	08.82 - 07.83 01.83 - 07.92 08.85 - 07.92 08.82 - 07.92		



Ref.









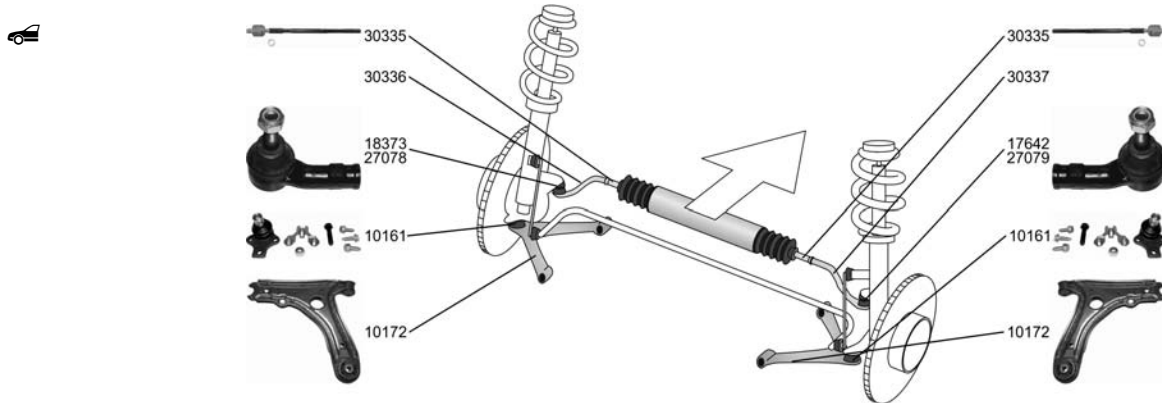





VOLKSWAGEN

CADDY I (14) 08.82 - 07.92

	Faltenbaldsatz, Lenkung			30117 01	171 419 832 C/S
	1.5	08.82 - 07.83			
	1.6	01.83 - 07.92			
	1.8	08.85 - 07.92			
1.6 D	08.82 - 07.92				

CADDY II Kasten/Box/Furgón/Van (9K9) 11.95 - 01.04













Spurstange ALL TYPES		30336 01	6K0 422 803 E
		Reifenabmessung:185/60 R14 H	
Spurstange ALL TYPES		30337 01	6K0 422 804 E
		Reifenabmessung:185/60 R14 H	
Spurstangenkopf Gewindeart: mit Rechtsgewinde mit Zubehör		17642 04	3A0 422 812
ALL TYPES ausser : 75 1.6	11.95 - 05.97		->Chass. 9K-1-523 000
Spurstangenkopf Gewindeart: mit Rechtsgewinde mit Zubehör		18373 04	3A0 422 811
ALL TYPES ausser : 75 1.6	11.95 - 05.97		->Chass. 9K-1-523 000
Spurstangenkopf mit Zubehör		27078 02	6K0 422 811
ALL TYPES ausser : 75 1.6	11.95 - 05.97		Chass. 9K-1-523 001->
Spurstangenkopf mit Zubehör		27079 02	6K0 422 812
ALL TYPES ausser : 75 1.6	11.95 - 05.97		Chass. 9K-1-523 001->
Axialgelenk, Spurstange Gewindemaß: M14x1,5		30335 01	6K0 422 804 F 6K0 422 807 F
ALL TYPES		Reifenabmessung:185/60 R14 H	



VOLKSWAGEN

**CADDY II Kasten/Box/Furgón/Van
(9K9)**

11.95 - 01.04

<p> Lenker, Radaufhängung ohne Trag-/Führungsgelenk mit Gummilager nur in Verbindung mit: 10169 nur in Verbindung mit: 10161</p> <p>ALL TYPES ausser : 75 1.6</p>	<p>▼↕</p>	<p>10172 01 191 407 151 B</p> 
<p>Reparatursatz, Trag-/Führungsgelenk mit Zubehör für OE-Nummer 191 407 151 B</p> <p>ALL TYPES ausser : 75 1.6</p>	<p>↕</p>	<p>10161 07 357 407 365</p> 
<p>Lagerung, Lenker ALL TYPES</p>	<p>↕↕(x2) I12/A33</p>	<p>10203 02 357 407 182</p> 
<p>Lagerung, Lenker 60 1.4 75 1.6 1.9 SDI 1.9 TDI</p>	<p>↕↕(x2)</p>	<p>10205 02 191 407 181 E</p> 
<p>Lagerung, Lenker 60 1.4 75 1.6 1.9 SDI 1.9 TDI</p>	<p>↕↕(x2) ↻HD</p>	<p>31480 01 191 407 181 SP</p> 
<p>Reparatursatz, Lenker mit Montagehülsen ALL TYPES</p>	<p>↕↕(x2)</p>	<p>25352 01 191 407 181 E</p> 
<p>Stabilisatorlager 60 1.4 1.9 D 1.9 SDI 75 1.6 1.9 TDI 1.4</p>	<p>↕↻ I19</p> <p>Mot. AUD 01.1997-> Chass. 9K-V-525 701-> Durchmesser Stabilisator [mm]:20</p> <p>01.1997-> Chass. 9K-V-525 701-> Durchmesser Stabilisator [mm]:20</p> <p>Mot. 1F 01.1997-> Chass. 9K-V-525 701-> Durchmesser Stabilisator [mm]:20</p> <p>Mot. 1Z 01.1997-> Chass. 9K-V-525 701-> Durchmesser Stabilisator [mm]:20</p> <p>08.00 - 01.04 Chass. 9K-V-525 701-> Durchmesser Stabilisator [mm]:20</p>	<p>27461 01 1H0 411 314</p> 
<p>Lagerung, Stabilisatorkoppelstange ALL TYPES ausser : 1.4 75 1.6</p>	<p>↕ ->Chass. 9K-V-525 700</p>	<p>17400 02 191 411 327</p> 
<p>Faltenbalgsatz, Lenkung ALL TYPES</p>	<p>↻ ⊞</p>	<p>30111 01 1H0 422 831 B</p> 







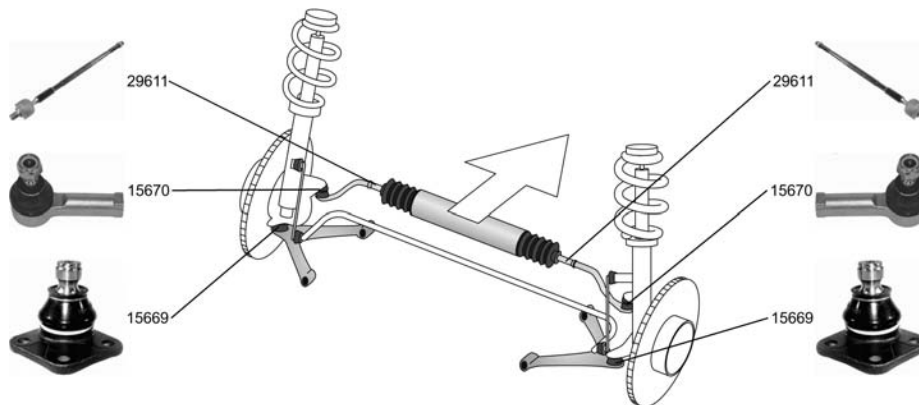

Ref.

VOLKSWAGEN



CADDY II Pickup (9U7) 10.97 - 12.00

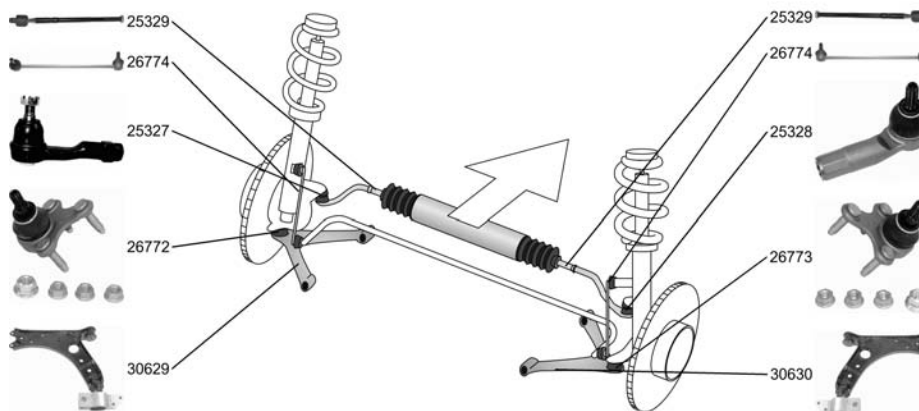

Spurstangenkopf Innengewinde [mm]: M12x1 Gewindeart: mit Rechtsgewinde ALL TYPES		15670 02 6U0 422 811 
Axialgelenk, Spurstange Aussengewinde [mm]: M12x1 ALL TYPES	 	29611 01 6U0 422 807 
Trag-/Führungsgelenk mit Zubehör ALL TYPES		15669 02 

CADDY III Kasten/Box/Furgón/Van (2KA) 03.04 -























Spurstangenkopf 1.4 1.6 1.9 TDI, 77 kW 2.0 SDI	 03.04 - 04.04 - 04.04 - 03.04 -	25327 01 1K0 423 811 G 
---	---	--



VOLKSWAGEN

**CADDY III Kasten/Box/Furgón/Van
(2KA)**

03.04 -

	Spurstangenkopf			25328 01	1K0 423 812 G	
	1.4	03.04 -				
	1.6	04.04 -				
	1.9 TDI, 77 kW	04.04 -				
	2.0 SDI	03.04 -				
	Axialgelenk, Spurstange			25329 02	1K0 423 810 A	
	Gewindeart: mit Rechtsgewinde					
	Gewindemaß: M16x1,5					
	Betriebsart: elektrisch					
	1.4	03.04 -				
	1.6	04.04 -				
	1.9 TDI, 77 kW	04.04 -				
	2.0 SDI	03.04 -				
	Lenker, Radaufhängung			30629 01	1K0 407 151 P	
	1.4	03.04 -				
	1.6	04.04 -				
	1.9 TDI, 77 kW	04.04 -				
	2.0 SDI	03.04 -				
	Lenker, Radaufhängung			30630 01	1K0 407 152 P	
	1.4	03.04 -				
	1.6	04.04 -				
	1.9 TDI, 77 kW	04.04 -				
	2.0 SDI	03.04 -				
	Trag-/Führungsgelenk			26772 02	1K0 407 365 C	
	1.4	03.04 -				
	1.6	04.04 -				
	1.9 TDI, 77 kW	04.04 -				
	2.0 SDI	03.04 -				
	Trag-/Führungsgelenk			26773 02	1K0 407 366 C	
	1.4	03.04 -				
	1.6	04.04 -				
	1.9 TDI, 77 kW	04.04 -				
	2.0 SDI	03.04 -				
	Lagerung, Lenker			29916 01	1K0 407 182	
	1.4	03.04 -				
	1.6	04.04 -				
	1.9 TDI, 77 kW	04.04 -				
	2.0 SDI	03.04 -				
	Stange/Strebe, Stabilisator			26774 01	1K0 411 315 J	
	Pendelstange					
	ALL TYPES ausser :					
	1.9 TDI, 55 kW	09.05 -				
	2.0 TDI	09.07 -				
	Stange/Strebe, Stabilisator			27872 01	2K0 505 465 B	
	Pendelstange					
	1.4	03.04 -				
	1.6	04.04 -				
	1.9 TDI, 77 kW	04.04 -				
	2.0 SDI	03.04 -				







Ref.

VOLKSWAGEN





CRAFTER 30-35 Bus (2E)

04.06 -

 Spurstangenkopf Innengewinde [mm]: M16x1,5 mit Zubehör ALL TYPES		31148 01 2E0 713 501 
	↔	
Axialgelenk, Spurstange radseitig Aussengewinde [mm]: M16x1,5 Gewindemaß: M18x1,5 mit Zubehör ALL TYPES	△	31147 01 2E0 713 491 
	↔	
Stange/Strebe, Stabilisator Pendelstange Rohr-Ø [mm]: 10 ALL TYPES	↻	30665 01 2E0 411 317 C 
Stange/Strebe, Stabilisator Pendelstange ALL TYPES	↻	30666 01 2E0 411 318 C 

CRAFTER 30-50 Kasten (2E)



04.06 -

 Spurstangenkopf Innengewinde [mm]: M16x1,5 mit Zubehör ALL TYPES		31148 01 2E0 713 501 
	↔	
Axialgelenk, Spurstange radseitig Aussengewinde [mm]: M16x1,5 Gewindemaß: M18x1,5 mit Zubehör ALL TYPES	△	31147 01 2E0 713 491 
	↔	
Stange/Strebe, Stabilisator Pendelstange Rohr-Ø [mm]: 10 ALL TYPES	↻	30665 01 2E0 411 317 C 
Stange/Strebe, Stabilisator Pendelstange ALL TYPES	↻	30666 01 2E0 411 318 C 

CRAFTER 30-50

04.06 -









Pritsche/Fahrgestell (2E)

 Spurstangenkopf Innengewinde [mm]: M16x1,5 mit Zubehör ALL TYPES		31148 01 2E0 713 501 
	↔	









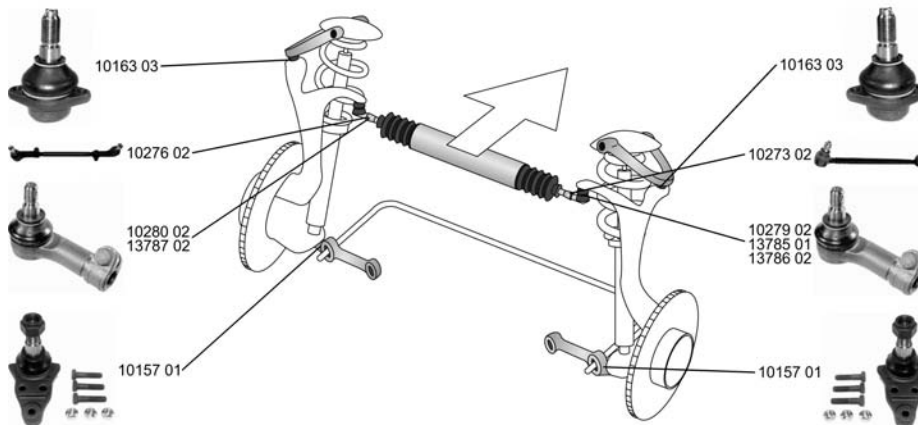

VOLKSWAGEN

CRAFTER 30-50 04.06 - Pritsche/Fahrgestell (2E)

 Axialgelenk, Spurstange radseitig Aussengewinde [mm]: M16x1,5 Gewindemaß: M18x1,5 mit Zubehör		31147 01 2E0 713 491 
ALL TYPES		
Stange/Strebe, Stabilisator Pendelstange Rohr-Ø [mm]: 10		30665 01 2E0 411 317 C 
ALL TYPES		
Stange/Strebe, Stabilisator Pendelstange		30666 01 2E0 411 318 C 
ALL TYPES		

LT 28 | Bus/Familial (281-363) 04.75 - 06.96







Spurstange für Fahrzeuge mit Schraubenfederung		10247 01 281 415 303 B 
ALL TYPES		
Spurstange für Fahrzeuge mit Blattfederung		10273 02 281 415 802 A 
ALL TYPES		
Spurstange für Fahrzeuge mit Schraubenfederung		10276 02 281 415 801 D 
ALL TYPES		
Spurstangenkopf für Fahrzeuge mit Schraubenfederung Gewindeart: mit Linksgewinde		10279 02 281 415 801 D 
ALL TYPES		



Ref.





VOLKSWAGEN

LT 28 I Bus/Familial (281-363) 04.75 - 06.96

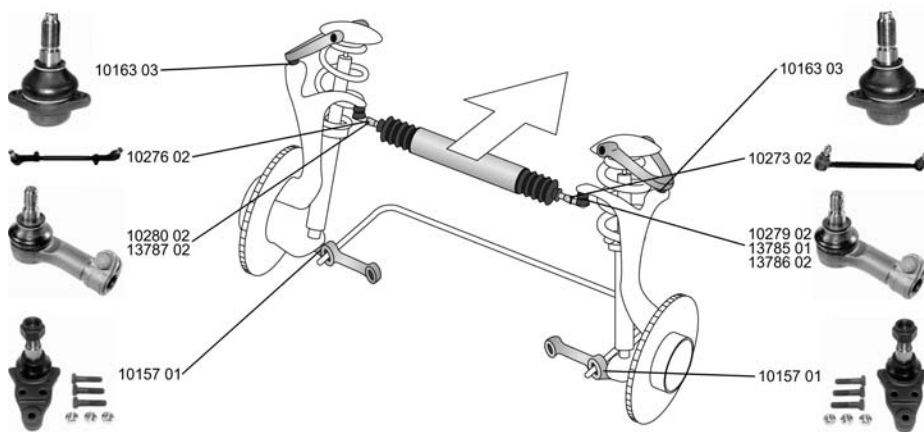
 Lagerung, Lenker ALL TYPES	(↑↓)(x2)	10208 01 281 407 179 
Lagerung, Lenker ALL TYPES	▼↔	14383 01 281 407 183 C 
Stabilisatorlager ALL TYPES	↔↑(x4)	112 16612 01 291 411 045 

LT 28-35 I Kasten/Box/Furgón/Van (281-363) 04.75 - 06.96







Spurstange für Fahrzeuge mit Schraubenfederung ALL TYPES	⊕	10247 01 281 415 303 B 
Spurstange für Fahrzeuge mit Blattfederung ALL TYPES	↻♂	10273 02 281 415 802 A 
Spurstange für Fahrzeuge mit Schraubenfederung ALL TYPES	↻♂	10276 02 281 415 801 D 
Spurstangenkopf für Fahrzeuge mit Schraubenfederung Gewindeart: mit Linksgewinde ALL TYPES	↻♂	10279 02 281 415 801 D 



VOLKSWAGEN



**LT 28-35 | Kasten/Box/Furgón/Van
(281-363)**

04.75 - 06.96

 Lagerung, Lenker		▼↓(x2)	10207 01	281 407 180	
	2.0	04.75 - 09.83			
	2.4 i	03.94 - 06.96			
	2.4 TD Syncro	08.92 - 04.96			
	2.7 D	11.75 - 01.80			
	2.4	12.82 - 07.92			12.1982->
	2.4 D, 51 kW	07.90 - 05.96			
	2.4 D, 55 kW	01.79 - 07.92			
	2.4 TD, 68 kW	08.88 - 08.92			
	2.4 TD, 70 kW	06.92 - 05.96			
2.4 TD, 75 kW	02.86 - 08.92				
Lagerung, Lenker		↑↓(x2)	10208 01	281 407 179	
2.0	04.75 - 09.83				
2.4 i	03.94 - 06.96				
2.4 TD Syncro	08.92 - 04.96				
2.7 D	11.75 - 01.80				
2.4	12.82 - 07.92			12.1982->	
2.4 D, 51 kW	07.90 - 05.96				
2.4 D, 55 kW	01.79 - 07.92				
2.4 TD, 68 kW	08.88 - 08.92				
2.4 TD, 70 kW	06.92 - 05.96				
2.4 TD, 75 kW	02.86 - 08.92				
Lagerung, Lenker		▼↔	14383 01	281 407 183 C	
ALL TYPES					
Stabilisatorlager		↔↑(x4)	16612 01	291 411 045	
ALL TYPES					

**LT 28-35 | Pritsche,Fahrgestell /
Flatbed,Chassis Cab (281-363)**

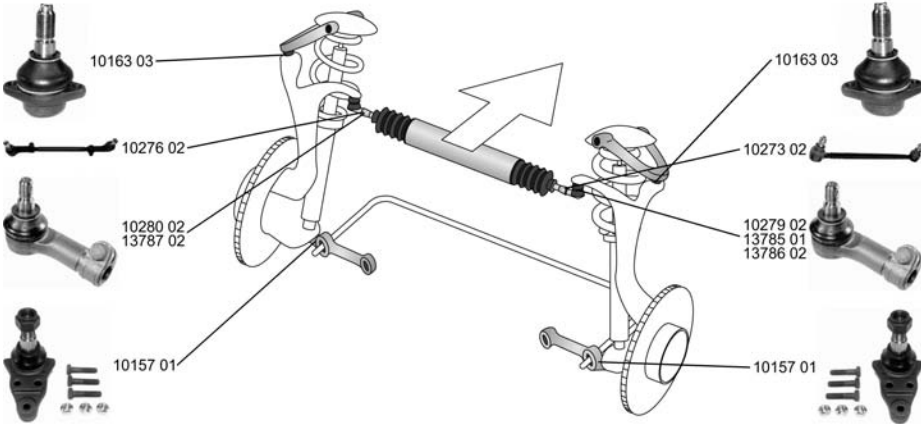
04.75 - 06.96

			10247 01	281 415 303 B
	Spurstange für Fahrzeuge mit Schraubenfederung		⊕	
ALL TYPES ausser :				
2.0	04.75 - 09.83			

















Ref.

VOLKSWAGEN

**LT 28-35 | Pritsche, Fahrgestell /
Flatbed, Chassis Cab (281-363)**

04.75 - 06.96









<p> Spurstange für Fahrzeuge mit Blattfederung</p> <p>ALL TYPES ausser : 2.0 04.75 - 09.83</p>		<p>10273 02 281 415 802 A</p> 
<p>Spurstange für Fahrzeuge mit Schraubenfederung</p> <p>ALL TYPES ausser : 2.0 04.75 - 09.83</p>		<p>10276 02 281 415 801 D</p> 
<p>Spurstangenkopf für Fahrzeuge mit Schraubenfederung Gewindeart: mit Linksgewinde</p> <p>ALL TYPES</p>		<p>10279 02 281 415 801 D</p> 
<p>Spurstangenkopf für Fahrzeuge mit Schraubenfederung Gewindeart: mit Rechtsgewinde</p> <p>ALL TYPES</p>		<p>10280 02 281 415 801 D</p> 
<p>Spurstangenkopf für Fahrzeuge mit Schraubenfederung Gewindeart: mit Linksgewinde</p> <p>2.0 04.75 - 09.83 2.4 12.82 - 07.92 2.4 Syncro, 66 kW 08.91 - 07.92 2.4 D, 55 kW 12.78 - 02.91 2.4 Syncro, 70 kW 08.92 - 07.94 2.4 TD, 68 kW 08.88 - 07.89 2.4 TD, 75 kW 12.82 - 09.93 2.7 D 11.75 - 01.80 2.4 TD Syncro 08.92 - 04.96 2.4 D Syncro, 51 kW 08.91 - 07.92 2.4 D Syncro, 55 kW 08.91 - 07.92</p>	 <p>->Chass. 28-D-004508</p>	<p>13786 02 281 415 811</p> 
<p>Spurstangenkopf für Fahrzeuge mit Schraubenfederung Konusmaß [mm]: 16 Gewindemaß: M14x1,5 Gewindeart: mit Rechtsgewinde</p> <p>2.0 04.75 - 09.83 2.4 12.82 - 07.92 2.4 Syncro, 66 kW 08.91 - 07.92 2.4 D, 55 kW 12.78 - 02.91 2.4 Syncro, 70 kW 08.92 - 07.94 2.4 TD, 68 kW 08.88 - 07.89 2.4 TD, 75 kW 12.82 - 09.93 2.7 D 11.75 - 01.80 2.4 TD Syncro 08.92 - 04.96 2.4 D Syncro, 51 kW 08.91 - 07.92 2.4 D Syncro, 55 kW 08.91 - 07.92</p>	 <p>->Chass. 28-D-004508</p>	<p>13787 02 281 415 812</p> 
<p>Lenkstange längs Schubstange für Fahrzeuge mit Schraubenfederung</p> <p>2.0 04.75 - 09.83 2.4 12.82 - 07.92 2.4 i 03.94 - 06.96 2.4 D, 51 kW 08.90 - 06.96 2.4 D, 55 kW 12.78 - 02.91 2.4 TD, 68 kW 08.90 - 08.92 2.4 TD, 70 kW 08.92 - 06.96 2.4 TD, 75 kW 12.82 - 09.93 2.7 D 11.75 - 01.80</p>		<p>10281 02 281 415 701 E</p> 



VOLKSWAGEN

LT 28-35 | Pritsche, Fahrgestell /
Flatbed, Chassis Cab (281-363)

04.75 - 06.96

<p> Winkelgelenk, Lenkschubstange Konusmaß [mm]: 16 Gewindemaß: M16x1,5 Gewindeart: mit Rechtsgewinde Aussengewinde [mm]: M16x1,5 Schubstange</p> <p>ALL TYPES ausser : 2.0 04.75 - 09.83</p>		<p>13785 01 281 415 711 A</p> 
<p>Trag-/Führungsgelenk mit Zubehör</p> <p>ALL TYPES ausser : 2.0 04.75 - 09.83</p>		<p>10157 01 281 407 187 B</p> 
<p>Trag-/Führungsgelenk</p> <p>ALL TYPES ausser : 2.0 04.75 - 09.83</p>		<p>10163 03 281 407 361</p> 
<p>Lagerung, Lenker</p> <p>ALL TYPES ausser : 2.0 04.75 - 09.83</p>		<p>10175 01 281 407 077</p> 
<p>Lagerung, Lenker</p> <p>ALL TYPES ausser : 2.0 04.75 - 09.83</p>		<p>10207 01 281 407 180</p> 
<p>Lagerung, Lenker</p> <p>ALL TYPES ausser : 2.0 04.75 - 09.83</p>		<p>10208 01 281 407 179</p> 
<p>Lagerung, Lenker</p> <p>ALL TYPES ausser : 2.0 04.75 - 09.83</p>		<p>14383 01 281 407 183 C</p> 
<p>Stabilisatorlager ALL TYPES</p>		<p>16612 01 291 411 045</p> 









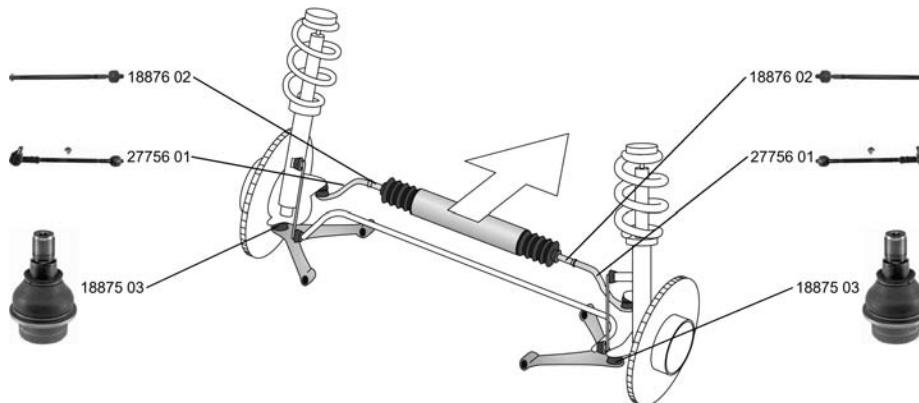

Ref.

VOLKSWAGEN

LT 28-35 II Bus/Familial (2DM)

04.96 -



<p>Spurstange mit Zubehör nicht für Felgenreöße [Zoll]: 16 nicht für Tiefbettfelge ALL TYPES</p>	↔	<p>27756 01 2D0 422 803 18876 02 ▲19719 02</p> 
<p>Spurstangenkopf mit Zubehör nicht für Felgenreöße [Zoll]: 16 ALL TYPES</p>	↔	<p>19719 02 2D0 422 811</p> 
<p>Axialgelenk, Spurstange mit Zubehör nicht für Felgenreöße [Zoll]: 16 ALL TYPES</p>	↔	<p>18876 02 2D0 422 803</p> 
<p>Trag-/Führungsgelenk Durchmesser 1/Durchmesser 2 [mm]: 45,2 / 62 Konusmaß [mm]: 26 ALL TYPES ausser : 2.8 TDI, 92 kW 07.97 - 09.98 2.8 TDI, 96 kW 01.99 - 01.02 2.8 TDI, 116 kW 02.02 -</p>	↕↔	<p>18875 03 2D0 407 361 A</p> 
<p>Stange/Strebe, Stabilisator Koppelstange ALL TYPES</p>	↻	<p>25800 01 2D0 411 051</p> 
<p>Stange/Strebe, Stabilisator Koppelstange ALL TYPES</p>	↻	<p>25801 01 2D0 411 052</p> 
<p>Stange/Strebe, Stabilisator Koppelstange ALL TYPES ausser : 2.8 TDI, 92 kW 07.97 - 09.98 2.8 TDI, 96 kW 01.99 - 01.02 2.8 TDI, 116 kW 02.02 -</p>	↔	<p>25802 01 2D0 511 329</p> 











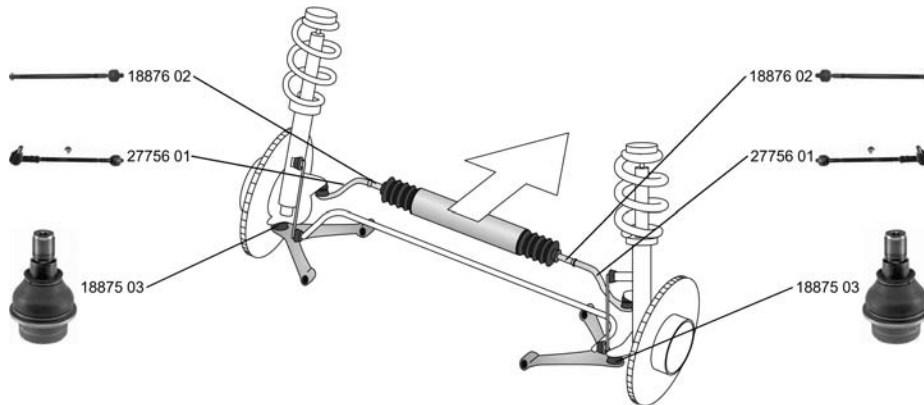

VOLKSWAGEN

LT 28-46 II Kasten/Box/Furgón/Van
(2DX0AE)

04.96 -





<p>Spurstange mit Zubehör nicht für Felgenreöße [Zoll]: 16 nicht für Tiefbettfelge ALL TYPES</p>	↔	<p>27756 01 2D0 422 803 18876 02 ▲ 19719 02</p> 
<p>Spurstangenkopf mit Zubehör nicht für Felgenreöße [Zoll]: 16 ALL TYPES</p>	↔	<p>19719 02 2D0 422 811</p> 
<p>Axialgelenk, Spurstange mit Zubehör nicht für Felgenreöße [Zoll]: 16 ALL TYPES</p>	↔	<p>18876 02 2D0 422 803</p> 
<p>Trag-/Führungsgelenk Durchmesser 1/Durchmesser 2 [mm]: 45,2 / 62 Konusmaß [mm]: 26 ALL TYPES</p>	▼ ↔	<p>18875 03 2D0 407 361 A</p> 
<p>Stange/Strebe, Stabilisator Koppelstange ALL TYPES</p>	↻	<p>25800 01 2D0 411 051</p> 
<p>Stange/Strebe, Stabilisator Koppelstange ALL TYPES</p>	↻	<p>25801 01 2D0 411 052</p> 
<p>Stange/Strebe, Stabilisator Koppelstange ALL TYPES</p>	↔	<p>25802 01 2D0 511 329</p> 
	Baumuster:LT28, LT35	



Ref.









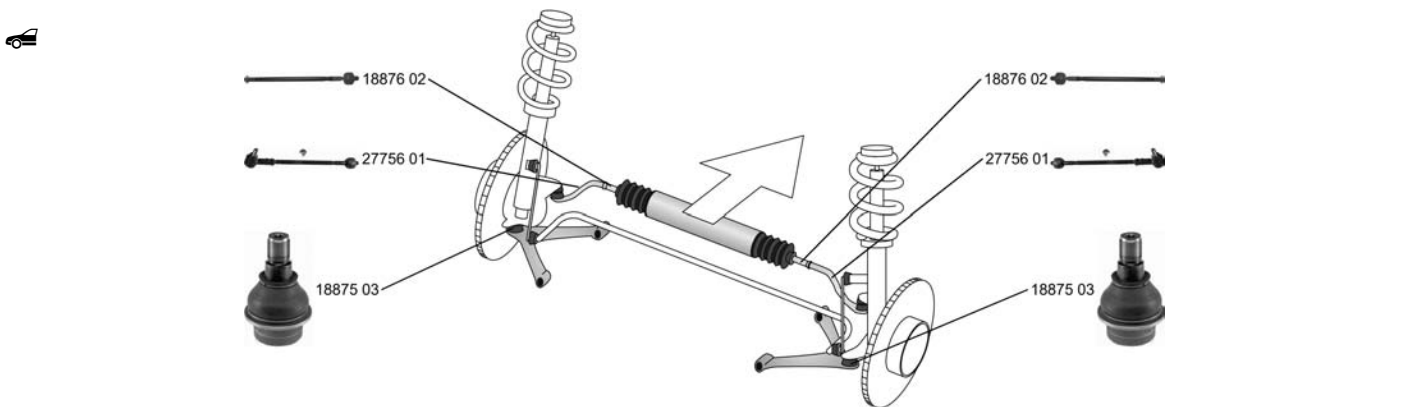



VOLKSWAGEN

LT 28-46 II Kasten/Box/Furgón/Van 04.96 - (2DX0AE)

 Stabilisatorlager ALL TYPES	 27	20965 01 2D0 511 413 B
	zul. Gesamtgewicht [kg]:4600	

LT 28-46 II Pritsche,Fahrgestell / Flatbed,Chassis Cab (2DX0FE)



Spurstange mit Zubehör nicht für Felgenreöße [Zoll]: 16 nicht für Tiefbettfelge ALL TYPES		27756 01 2D0 422 803 18876 02 ▲19719 02
		
Spurstangenkopf mit Zubehör nicht für Felgenreöße [Zoll]: 16 ALL TYPES		19719 02 2D0 422 811
		
Axialgelenk, Spurstange mit Zubehör nicht für Felgenreöße [Zoll]: 16 ALL TYPES		18876 02 2D0 422 803
		
Trag-/Führungsgelenk Durchmesser 1/Durchmesser 2 [mm]: 45,2 / 62 Konusmaß [mm]: 26 ALL TYPES	 	18875 03 2D0 407 361 A
		
Stange/Strebe, Stabilisator Koppelstange ALL TYPES		25800 01 2D0 411 051
		
Stange/Strebe, Stabilisator Koppelstange ALL TYPES		25801 01 2D0 411 052
		







Ref.

VOLKSWAGEN

**LT 40-55 | Pritsche, Fahrgestell /
Flatbed, Chassis Cab (293-909)**









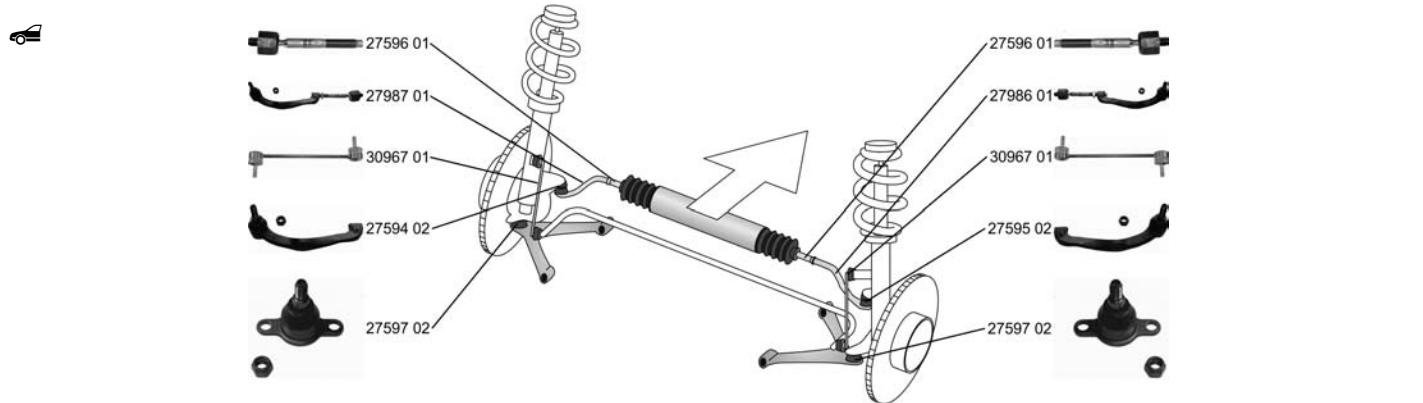

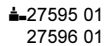

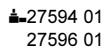
04.75 - 06.96

 Stabilisatorlager ALL TYPES ausser : 2.7 D	  (x4)	112	16612 01	291 411 045
	01.76 - 11.82			

MULTIVAN T5 (7HM)

04.03 -



Spurstange Konusmaß [mm]: 20 mit Befestigungsmaterial ALL TYPES		27986 01 7H0 419 804 D  ▲27595 01 27596 01
Spurstange Konusmaß [mm]: 20 mit Befestigungsmaterial ALL TYPES		27987 01 7H0 419 803 D  ▲27594 01 27596 01
Spurstangenkopf Konusmaß [mm]: 20 ALL TYPES	 	27594 02 7H0 422 817 C 
Spurstangenkopf Konusmaß [mm]: 20 ALL TYPES	 	27595 02 7H0 422 818 C 
Axialgelenk, Spurstange ALL TYPES	 	27596 01 7H0 422 817 C 7H0 422 818 C 











Ref.

VOLKSWAGEN

MULTIVAN T5 (7HM)





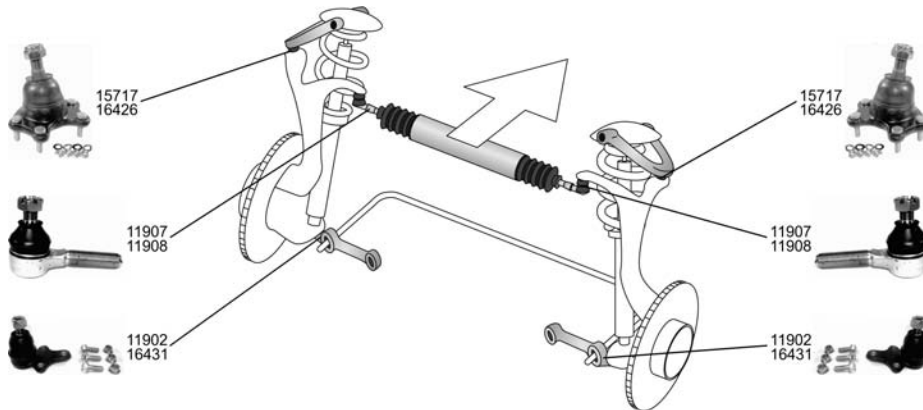

04.03 -

 Trag-/Führungsgelenk ALL TYPES		26936 01 7H0 407 182 A 
Trag-/Führungsgelenk Konusmaß [mm]: 22 ALL TYPES		27597 02 7H0 407 361 
Lagerung, Lenker ALL TYPES		26937 01 7H0 407 183 
Stange/Strebe, Stabilisator Pendelstange ALL TYPES ausser : 3.2 4motion 11.03 - 06.06		30967 01 7H5 411 317 A 

TARO

04.89 - 03.97









Spurstangenkopf Gewindeart: mit Linksgewinde Gewindemaß: M17x1,5 Aussengewinde [mm]: M17x1,5 ALL TYPES ausser : 2.4 D 4x4, 61 kW 04.89 - 03.97		11907 02 
Spurstangenkopf Gewindeart: mit Rechtsgewinde Gewindemaß: M17x1,5 Aussengewinde [mm]: M17x1,5 ALL TYPES ausser : 2.4 D 4x4, 61 kW 04.89 - 03.97		11908 02 J45 406 391 15 
Trag-/Führungsgelenk Konusmaß [mm]: 18,2 ALL TYPES ausser : 2.4 D 4x4, 61 kW 04.89 - 03.97 2.4 i 4x4 06.89 - 03.97 2.4 D 4x4, 58 kW 07.94 - 03.97		11902 02 J43 330 392 95 



Ref.







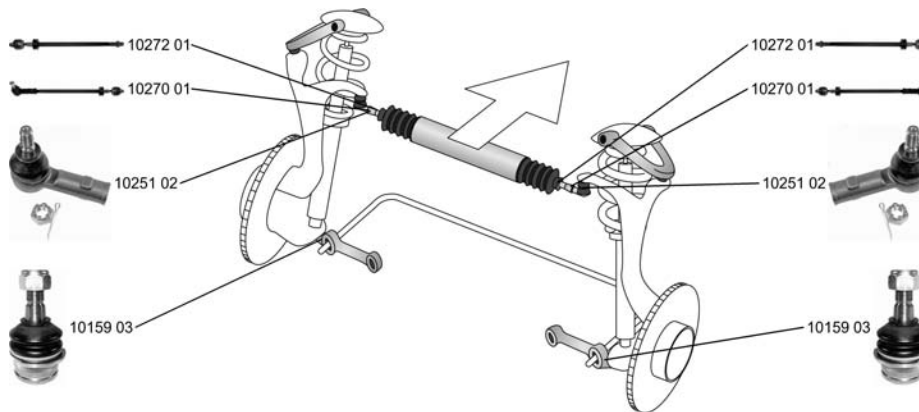

VOLKSWAGEN

TARO 04.89 - 03.97

<p>Trag-/Führungsgelenk Konusmaß [mm]: 17,1</p> <p>2.4 i 4x4 06.89 - 03.97 2.4 D 4x4, 58 kW 07.94 - 03.97</p>		<p>15717 02 J43 350 390 75</p> 
<p>Trag-/Führungsgelenk</p> <p>ALL TYPES ausser : 2.4 D 4x4, 61 kW 04.89 - 03.97 2.4 i 4x4 06.89 - 03.97 2.4 D 4x4, 58 kW 07.94 - 03.97</p>		<p>16426 03 J43 350 390 75</p> 
<p>Trag-/Führungsgelenk</p> <p>2.4 i 4x4 06.89 - 03.97 2.4 D 4x4, 58 kW 07.94 - 03.97</p>		<p>16431 01 J43 340 392 45</p> 

TRANSPORTER T3 Bus/Familial 05.79 - 07.92









<p>Spurstange Konusmaß [mm]: 14 Rohr-Ø [mm]: 14</p> <p>ALL TYPES ausser : 1900 08.85 - 12.92</p>		<p>10270 01 251 419 803</p> 
<p>Spurstangenkopf Konusmaß [mm]: 14 Innengewinde [mm]: M14x1,5 Gewindeart: mit Rechtsgewinde mit Zubehör Gewindemaß: M14x1,5</p> <p>ALL TYPES ausser : 1900 08.85 - 12.92</p>		<p>10251 02 171 419 812</p> 
<p>Axialgelenk, Spurstange Gewindemaß: M14x1,5 Gewindeart: mit Rechtsgewinde mit Zubehör für OE-Nummer 025 390 036 617</p> <p>ALL TYPES ausser : 1900 08.85 - 12.92</p>		<p>10272 01 251 419 807 A</p> 
<p>Trag-/Führungsgelenk mit Zubehör Standardmaß</p> <p>ALL TYPES ausser : 1900 08.85 - 12.92</p>		<p>48,3 10159 03 251 407 187</p> 



VOLKSWAGEN



TRANSPORTER T3 Bus/Familial 05.79 - 07.92

 Reparaturatz, Trag-/Führungsgelenk ALL TYPES ausser : 1900	08.85 - 12.92			10162 02	251 407 361	
Reparaturatz, Trag-/Führungsgelenk 1. Übermaß ALL TYPES ausser : 1900	08.85 - 12.92		A48,6	13784 02	251 407 187 C	
Lagerung, Lenker ALL TYPES ausser : 1900	08.85 - 12.92			10174 01	251 407 077	
Stabilisatorlager ALL TYPES ausser : 1900	08.85 - 12.92		126/A66	14378 01	251 407 175	
Faltenbalgsatz, Lenkung ALL TYPES ausser : 1900	08.85 - 12.92			30121 01	251 419 831 A	
 Achskörperlager ALL TYPES ausser : 1900	08.85 - 12.92		112/A47	10197 01	251 501 131 A	

TRANSPORTER T3 05.79 - 07.92 Kasten/Box/Furgón/Van

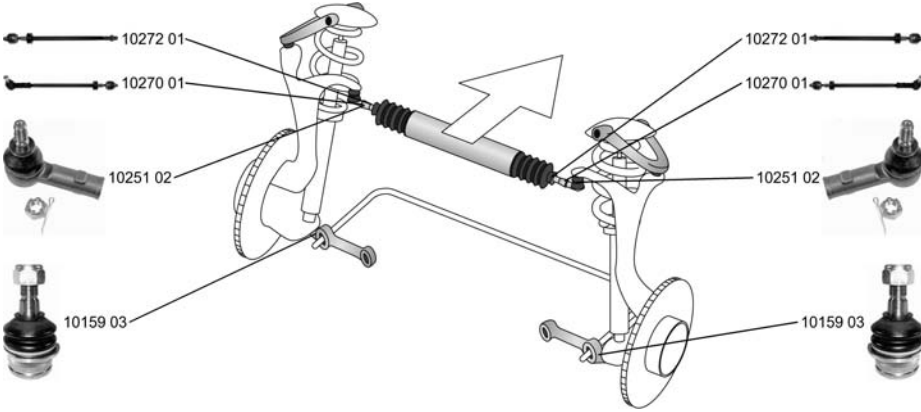



Spurstange Konusmaß [mm]: 14 Rohr-Ø [mm]: 14 ALL TYPES ausser : 1.7 D 1900	08.85 - 07.87 08.85 - 12.92			10270 01	251 419 803	





















Ref.

VOLKSWAGEN

TRANSPORTER T3 Kasten/Box/Furgón/Van

05.79 - 07.92

	Spurstangenkopf Konusmaß [mm]: 14 Innengewinde [mm]: M14x1,5 Gewindeart: mit Rechtsgewinde mit Zubehör Gewindemaß: M14x1,5 ALL TYPES ausser : 1900 08.85 - 12.92		10251 02 171 419 812 
	Axialgelenk, Spurstange Gewindemaß: M14x1,5 Gewindeart: mit Rechtsgewinde mit Zubehör für OE-Nummer 025 390 036 617 ALL TYPES ausser : 1900 08.85 - 12.92		10272 01 251 419 807 A 
	Trag-/Führungsgelenk mit Zubehör Standardmaß ALL TYPES ausser : 1900 08.85 - 12.92	 48,3	10159 03 251 407 187 
	Reparatursatz, Trag-/Führungsgelenk ALL TYPES ausser : 1900 08.85 - 12.92		10162 02 251 407 361 
	Reparatursatz, Trag-/Führungsgelenk 1. Übermaß ALL TYPES ausser : 1900 08.85 - 12.92	 A48,6	13784 02 251 407 187 C 
	Lagerung, Lenker ALL TYPES ausser : 1900 08.85 - 12.92		10174 01 251 407 077 
	Stabilisatorlager ALL TYPES ausser : 1900 08.85 - 12.92	 126/A66	14378 01 251 407 175 
	Faltenbaldsatz, Lenkung ALL TYPES ausser : 1900 08.85 - 12.92		30121 01 251 419 831 A 
	Achskörperlager ALL TYPES ausser : 1900 08.85 - 12.92	 112/A47	10197 01 251 501 131 A 









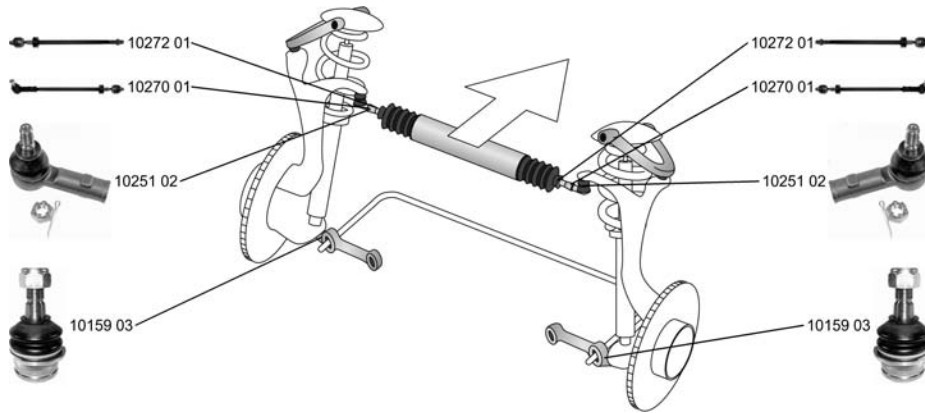







VOLKSWAGEN

TRANSPORTER T3
Pritsche, Fahrgestell /
Flatbed, Chassis Cab

05.79 - 07.92











<p>Spurstange Konusmaß [mm]: 14 Rohr-Ø [mm]: 14 ALL TYPES</p>		<p>10270 01 251 419 803</p> 
<p>Spurstangenkopf Konusmaß [mm]: 14 Innengewinde [mm]: M14x1,5 Gewindeart: mit Rechtsgewinde mit Zubehör Gewindemaß: M14x1,5 ALL TYPES</p>		<p>10251 02 171 419 812</p> 
<p>Axialgelenk, Spurstange Gewindemaß: M14x1,5 Gewindeart: mit Rechtsgewinde mit Zubehör für OE-Nummer 025 390 036 617 ALL TYPES</p>		<p>10272 01 251 419 807 A</p> 
<p>Trag-/Führungsgelenk mit Zubehör Standardmaß ALL TYPES</p>		<p>10159 03 251 407 187</p> 
<p>Reparatursatz, Trag-/Führungsgelenk ALL TYPES</p>		<p>10162 02 251 407 361</p> 
<p>Reparatursatz, Trag-/Führungsgelenk 1. Übermaß ALL TYPES</p>		<p>13784 02 251 407 187 C</p> 
<p>Lagerung, Lenker ALL TYPES ausser : 1.9, 61 kW 10.84 - 02.89</p>		<p>10174 01 251 407 077</p> 



Ref.



VOLKSWAGEN

TRANSPORTER T3 05.79 - 07.92 Pritsche, Fahrgestell / Flatbed, Chassis Cab

 Stabilisatorlager ALL TYPES		126/A66	14378 01	251 407 175	
Faltenbalgsatz, Lenkung ALL TYPES			30121 01	251 419 831 A	
 Achskörperlager ALL TYPES		112/A47	10197 01	251 501 131 A	

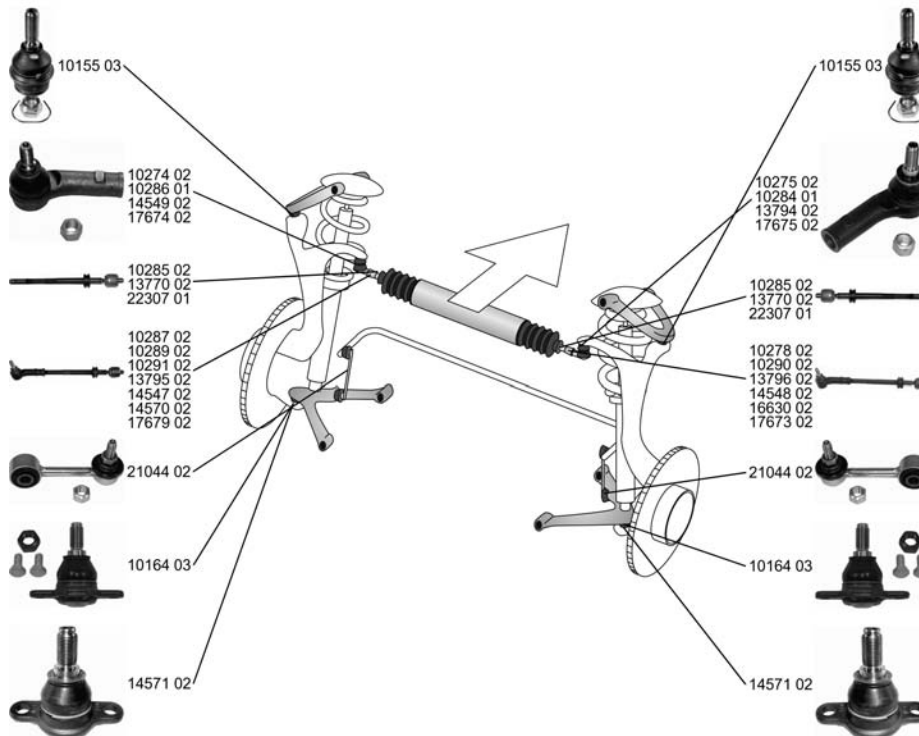
TRANSPORTER T4 Bus/Familial 09.90 - 04.03 (70XB, 70XC, 7DB, 7DW)





















Spurstange Konusmaß [mm]: 16 Rohr-Ø [mm]: 16		10278 02	701 419 804 D	
2.5 Syncro, 81 kW	11.92 - 04.03	->Chass. 70-S-002 791		
1.9 TD	10.92 - 04.03			
2.4 D Syncro	10.92 - 09.98			
1.8	12.90 - 07.92	Chass. 70-M-096 449 - Chass. 70-S-002 791		
2.0	09.90 - 04.03			
2.5, 81 kW	11.90 - 04.03			
1.9 D	09.90 - 04.03			
2.4 D, 57 kW	09.90 - 04.98			



VOLKSWAGEN

**TRANSPORTER T4 Bus/Familial
(70XB, 70XC, 7DB, 7DW)**

09.90 - 04.03

 Spurstange Konusmaß [mm]: 16 Rohr-Ø [mm]: 16 mit Zubehör				10287 02 702 419 803 B 
	2.4 D Syncro	10.92 - 09.98	RHD 	->Chass. 70-S-002 791
	2.4 D Syncro	10.92 - 09.98	LHD  RHD 	->Chass. 70-S-002 791
	2.5 Syncro, 81 kW 1.9 TD	11.92 - 04.03 10.92 - 04.03	RHD 	->Chass. 70-S-002 791
	1.8 2.0 2.5, 81 kW 1.9 D 2.4 D, 57 kW	12.90 - 07.92 09.90 - 04.03 11.90 - 04.03 09.90 - 04.03 09.90 - 04.98	RHD  Chass. 70-M-096 449 - Chass. 70-S-002 791 RHD  LHD 	->Chass. 70-S-002 791 Chass. 70-M-096 449 - Chass. 70-S-002 791
Spurstange Konusmaß [mm]: 16 mit Zubehör	2.5 Syncro, 81 kW 1.9 TD	11.92 - 04.03 10.92 - 04.03	LHD 	->Chass. 70-S-002 791
	2.4 D Syncro	10.92 - 09.98		
	1.8 2.0 2.5, 81 kW 1.9 D 2.4 D, 57 kW	12.90 - 07.92 09.90 - 04.03 11.90 - 04.03 09.90 - 04.03 09.90 - 04.98	LHD  Chass. 70-M-096 449 - Chass. 70-S-002 791	
Spurstange Konusmaß [mm]: 14 mit Zubehör	1.8 2.0 2.5, 81 kW 1.9 D 2.4 D, 57 kW	12.90 - 07.92 09.90 - 04.03 11.90 - 04.03 09.90 - 04.03 09.90 - 04.98	LHD 	->Chass. 70-M-096 448
Spurstange Konusmaß [mm]: 14	1.8 2.0 2.5, 81 kW 1.9 D 2.4 D, 57 kW	12.90 - 07.92 09.90 - 04.03 11.90 - 04.03 09.90 - 04.03 09.90 - 04.98	LHD 	->Chass. 70-M-096 448
Spurstange Konusmaß [mm]: 14 Rohr-Ø [mm]: 16 mit Zubehör	1.8 2.0 2.5, 81 kW 1.9 D 2.4 D, 57 kW	12.90 - 07.92 09.90 - 04.03 11.90 - 04.03 09.90 - 04.03 09.90 - 04.98	RHD  ->Chass. 70-M-096 448 RHD  LHD 	->Chass. 70-M-096 448 ->Chass. 70-M-096 448
Spurstange Konusmaß [mm]: 16	2.5 Syncro, 81 kW 1.9 TD 2.4 D Syncro	11.92 - 04.03 10.92 - 04.03 10.92 - 09.98	RHD 	->Chass. 70-S-002 791
	1.8 2.0 2.5, 81 kW 1.9 D 2.4 D, 57 kW	12.90 - 07.92 09.90 - 04.03 11.90 - 04.03 09.90 - 04.03 09.90 - 04.98	RHD  Chass. 70-M-096 449 - Chass. 70-S-002 791	

















Ref.

VOLKSWAGEN

TRANSPORTER T4 Bus/Familial (70XB, 70XC, 7DB, 7DW)

09.90 - 04.03















 Spurstange Konusmaß [mm]: 18 Rohr-Ø [mm]: 16		14547 02 701 419 803 E 
1.8 2.0 2.5, 81 kW 2.5 Syncro, 81 kW 1.9 D 1.9 TD 2.4 D, 57 kW 2.4 D Syncro	12.90 - 07.92 09.90 - 04.03 11.90 - 04.03 11.92 - 04.03 09.90 - 04.03 10.92 - 04.03 09.90 - 04.98 10.92 - 09.98	LHD Chass. 70-S-002 792 - Chass. 70-T-199 999
Spurstange Konusmaß [mm]: 18 1.8 2.0 2.5, 81 kW 2.5 Syncro, 81 kW 1.9 D 1.9 TD 2.4 D, 57 kW 2.4 D Syncro		14548 02 701 419 804 E 
Spurstange Konusmaß [mm]: 18 2.4 D Syncro		14570 02 702 419 803 C 
1.8 2.0 2.5, 81 kW 2.5 Syncro, 81 kW 1.9 D 1.9 TD 2.4 D, 57 kW	12.90 - 07.92 09.90 - 04.03 11.90 - 04.03 11.92 - 04.03 09.90 - 04.03 10.92 - 04.03 09.90 - 04.98	RHD  Chass. 70-S-002 792 - Chass. 70-T-199 999 ----- RHD LHD  ->Chass. 70-S-002 792 ->Chass. 70-T-199 999
Spurstange Konusmaß [mm]: 18 2.4 D Syncro		16630 02 702 419 804 C 
1.8 2.0 2.5, 81 kW 2.5 Syncro, 81 kW 1.9 D 1.9 TD 2.4 D, 57 kW	12.90 - 07.92 09.90 - 04.03 11.90 - 04.03 11.92 - 04.03 09.90 - 04.03 10.92 - 04.03 09.90 - 04.98	RHD  Chass. 70-S-002 792 - Chass. 70-T-199 999 ----- RHD LHD  ->Chass. 70-S-002 792 ->Chass. 70-T-199 999 ----- RHD LHD  Chass. 70-S-002 792 - Chass. 70-T-199 999



VOLKSWAGEN

**TRANSPORTER T4 Bus/Familial
(70XB, 70XC, 7DB, 7DW)**

09.90 - 04.03

 Spurstange Konusmaß [mm]: 18 mit Zubehör		17673 02 701 419 804 F 
1.8 2.0 2.5, 81 kW 2.5 Syncro, 81 kW 1.9 D 1.9 TD 2.4 D, 57 kW 2.4 D Syncro 2.5 TDI, 75 kW	12.90 - 07.92 09.90 - 04.03 11.90 - 04.03 11.92 - 04.03 09.90 - 04.03 10.92 - 04.03 09.90 - 04.98 10.92 - 09.98 09.95 - 04.03	 Chass. 70-T-200 000->
2.5, 85 kW 2.5 Syncro, 85 kW 2.8 VR 6 2.8 V6 2.4 D, 55 kW 2.5 TDI, 65 kW 2.5 TDI Syncro 2.5 TDI, 111 kW	08.96 - 04.03 07.96 - 04.03 11.95 - 04.00 04.00 - 04.03 08.97 - 04.03 05.98 - 04.03 01.96 - 04.03 05.98 - 04.03	
Spurstange Konusmaß [mm]: 18 Rohr-Ø [mm]: 16,5 mit Zubehör		17679 02 702 419 803 D 
1.8 2.0 2.5, 81 kW 2.5 Syncro, 81 kW 1.9 D 1.9 TD 2.4 D, 57 kW 2.4 D Syncro 2.5 TDI, 75 kW	12.90 - 07.92 09.90 - 04.03 11.90 - 04.03 11.92 - 04.03 09.90 - 04.03 10.92 - 04.03 09.90 - 04.98 10.92 - 09.98 09.95 - 04.03	 Chass. 70-T-200 000->
2.5, 85 kW 2.5 Syncro, 85 kW 2.8 VR 6 2.8 V6 2.4 D, 55 kW 2.5 TDI, 65 kW 2.5 TDI Syncro 2.5 TDI, 111 kW	08.96 - 04.03 07.96 - 04.03 11.95 - 04.00 04.00 - 04.03 08.97 - 04.03 05.98 - 04.03 01.96 - 04.03 05.98 - 04.03	
Spurstangenkopf 2.5 Syncro, 81 kW 1.9 TD 2.4 D Syncro	 ->Chass. 70-S-002 791	10274 02 701 419 811 B 
1.8 2.0 2.5, 81 kW 1.9 D 2.4 D, 57 kW	12.90 - 07.92 09.90 - 04.03 11.90 - 04.03 09.90 - 04.03 09.90 - 04.98	Chass. 70-M-096 449 - Chass. 70-S-002 791
Spurstangenkopf Konusmaß [mm]: 18 Gewindeart: mit Rechtsgewinde		10275 02 701 419 812 B 
1.8 2.0 2.5, 81 kW 2.5 Syncro, 81 kW 1.9 D 1.9 TD 2.4 D, 57 kW 2.4 D Syncro	12.90 - 07.92 09.90 - 04.03 11.90 - 04.03 11.92 - 04.03 09.90 - 04.03 10.92 - 04.03 09.90 - 04.98 10.92 - 09.98	Chass. 70-S-002 792 - Chass. 70-T-199 999
Spurstangenkopf Konusmaß [mm]: 14 Gewindeart: mit Rechtsgewinde		10284 01 701 419 812 
1.8 2.0 2.5, 81 kW 1.9 D 2.4 D, 57 kW	12.90 - 07.92 09.90 - 04.03 11.90 - 04.03 09.90 - 04.03 09.90 - 04.98	->Chass. 70-M-096 448













Ref.

VOLKSWAGEN

TRANSPORTER T4 Bus/Familial (70XB, 70XC, 7DB, 7DW)

09.90 - 04.03















 Spurstangenkopf Konusmaß [mm]: 14 Gewindeart: mit Rechtsgewinde		10286 01 701 419 811 A
1.8 2.0 2.5, 81 kW 1.9 D 2.4 D, 57 kW	12.90 - 07.92 09.90 - 04.03 11.90 - 04.03 09.90 - 04.03 09.90 - 04.98	->Chass. 70-M-096 448 
Spurstangenkopf 2.5 Syncro, 81 kW 1.9 TD 2.4 D Syncro		13794 02 701 419 812 A
1.8 2.0 2.5, 81 kW 1.9 D 2.4 D, 57 kW	11.92 - 04.03 10.92 - 04.03 10.92 - 09.98 12.90 - 07.92 09.90 - 04.03 11.90 - 04.03 09.90 - 04.03 09.90 - 04.98	->Chass. 70-S-002 791 Chass. 70-M-096 449 - Chass. 70-S-002 791 
Spurstangenkopf Konusmaß [mm]: 18 Gewindeart: mit Rechtsgewinde		14549 02 701 419 811 C
1.8 2.0 2.5, 81 kW 2.5 Syncro, 81 kW 1.9 D 1.9 TD 2.4 D, 57 kW 2.4 D Syncro	12.90 - 07.92 09.90 - 04.03 11.90 - 04.03 11.92 - 04.03 09.90 - 04.03 10.92 - 04.03 09.90 - 04.98 10.92 - 09.98	Chass. 70-S-002 792 - Chass. 70-T-199 999 
Spurstangenkopf Konusmaß [mm]: 18 Gewindeart: mit Rechtsgewinde mit Zubehör		17674 02 701 419 811 E
1.8 2.0 2.5, 81 kW 2.5 Syncro, 81 kW 1.9 D 1.9 TD 2.4 D, 57 kW 2.4 D Syncro 2.5 TDI, 75 kW 2.5, 85 kW 2.5 Syncro, 85 kW 2.8 VR 6 2.8 V6 2.4 D, 55 kW 2.5 TDI, 65 kW 2.5 TDI Syncro 2.5 TDI, 111 kW	12.90 - 07.92 09.90 - 04.03 11.90 - 04.03 11.92 - 04.03 09.90 - 04.03 10.92 - 04.03 09.90 - 04.98 10.92 - 09.98 09.95 - 04.03 08.96 - 04.03 07.96 - 04.03 11.95 - 04.00 04.00 - 04.03 08.97 - 04.03 05.98 - 04.03 01.96 - 04.03 05.98 - 04.03	Chass. 70-T-200 000-> 
Spurstangenkopf Konusmaß [mm]: 18 Gewindeart: mit Rechtsgewinde mit Zubehör		17675 02 701 419 812 D
1.8 2.0 2.5, 81 kW 2.5 Syncro, 81 kW 1.9 D 1.9 TD 2.4 D, 57 kW 2.4 D Syncro 2.5 TDI, 75 kW 2.5, 85 kW 2.5 Syncro, 85 kW 2.8 VR 6 2.8 V6 2.4 D, 55 kW 2.5 TDI, 65 kW 2.5 TDI Syncro 2.5 TDI, 111 kW	12.90 - 07.92 09.90 - 04.03 11.90 - 04.03 11.92 - 04.03 09.90 - 04.03 10.92 - 04.03 09.90 - 04.98 10.92 - 09.98 09.95 - 04.03 08.96 - 04.03 07.96 - 04.03 11.95 - 04.00 04.00 - 04.03 08.97 - 04.03 05.98 - 04.03 01.96 - 04.03 05.98 - 04.03	Chass. 70-T-200 000-> 



VOLKSWAGEN

**TRANSPORTER T4 Bus/Familial
(70XB, 70XC, 7DB, 7DW)**

09.90 - 04.03













 Axialgelenk, Spurstange Gewindemaß: M14x1,5 Gewindeart: mit Rechtsgewinde für OE-Nummer 025 390 091/092 617		10285 02 701 419 810 A 
2.0 09.90 - 04.03 2.5, 81 kW 11.90 - 04.03 1.9 D 09.90 - 04.03 1.9 TD 10.92 - 04.03 2.4 D, 57 kW 09.90 - 04.98 2.4 D Syncro 10.92 - 09.98 2.5 TDI, 75 kW 09.95 - 04.03 2.5 Syncro, 81 kW 11.92 - 04.03	-->Chass. 70-T-199 999	
1.8 12.90 - 07.92 2.5 Syncro, 85 kW 07.96 - 04.03 2.8 VR 6 11.95 - 04.00 2.8 V6 04.00 - 04.03 2.5 TDI, 65 kW 05.98 - 04.03		
Axialgelenk, Spurstange Gewindeart: mit Rechtsgewinde für OE-Nummer 025 390 090/093 617		13770 02 701 419 810 
2.0 09.90 - 04.03 2.5, 81 kW 11.90 - 04.03 1.9 D 09.90 - 04.03 1.9 TD 10.92 - 04.03 2.4 D, 57 kW 09.90 - 04.98 2.4 D Syncro 10.92 - 09.98 1.8 12.90 - 07.92	-->Chass. 70-T-199 999	
Axialgelenk, Spurstange für OE-Nummer 025 390 123 617 LH		22307 01 701 419 804 F 701 419 810 B 702 419 803 D 
2.4 D Syncro 10.92 - 09.98 2.5 TDI, 75 kW 09.95 - 04.03 2.0 09.90 - 04.03 2.5, 81 kW 11.90 - 04.03 2.5 Syncro, 85 kW 07.96 - 04.03 2.8 VR 6 11.95 - 04.00 2.8 V6 04.00 - 04.03 1.9 D 09.90 - 04.03 1.9 TD 10.92 - 04.03 2.4 D, 57 kW 09.90 - 04.98 2.5 TDI, 65 kW 05.98 - 04.03 2.5 TDI Syncro 01.96 - 04.03 2.5 TDI, 111 kW 05.98 - 04.03 2.5, 85 kW 08.96 - 04.03 2.4 D, 55 kW 08.97 - 04.03	Chass. 70-T-200 000->  Chass. 70-T-200 000-> 	
Trag-/Führungsgelenk ALL TYPES ausser : 2.8 Syncro 01.96 - 04.96		10155 03 701 407 187 B 
Trag-/Führungsgelenk Lochabstand 1/Lochabstand 2: 80 mit Zubehör		10164 03 701 407 361 B 
1.8 12.90 - 07.92 2.0 09.90 - 04.03 2.5, 81 kW 11.90 - 04.03 2.5 Syncro, 81 kW 11.92 - 04.03 1.9 D 09.90 - 04.03 1.9 TD 10.92 - 04.03 2.4 D, 57 kW 09.90 - 04.98 2.4 D Syncro 10.92 - 09.98	-->Chass. 70-T-199 999	



Ref.

VOLKSWAGEN

TRANSPORTER T4 Bus/Familial 09.90 - 04.03 (70XB, 70XC, 7DB, 7DW)









 Reparatursatz, Trag-/Führungsgelenk Lochabstand 1/Lochabstand 2: 80		14571 02 7D0 407 361
1.8 12.90 - 07.92 2.0 09.90 - 04.03 2.5, 81 kW 11.90 - 04.03 2.8 VR 6 11.95 - 04.00 1.9 D 09.90 - 04.03 1.9 TD 10.92 - 04.03 2.4 D, 57 kW 09.90 - 04.98 2.4 D Syncro 10.92 - 09.98 2.5 TDI, 75 kW 09.95 - 04.03	Chass. 70-T-2-000 001->	
2.5, 85 kW 08.96 - 04.03 2.5 Syncro, 85 kW 07.96 - 04.03 2.8 V6 04.00 - 04.03 2.4 D, 55 kW 08.97 - 04.03 2.5 TDI, 65 kW 05.98 - 04.03 2.5 TDI Syncro 01.96 - 04.03 2.5 TDI, 111 kW 05.98 - 04.03		
Lagerung, Lenker		14555 03 7D0 407 140 A
2.5 Syncro, 81 kW 11.92 - 04.03 2.5, 85 kW 08.96 - 04.03 2.5 Syncro, 85 kW 07.96 - 04.03 2.8 VR 6 11.95 - 04.00 2.8 V6 04.00 - 04.03 1.9 TD 10.92 - 04.03 2.4 D, 55 kW 08.97 - 04.03 2.4 D Syncro 10.92 - 09.98 2.5 TDI, 65 kW 05.98 - 04.03 2.5 TDI, 75 kW 09.95 - 04.03 2.5 TDI Syncro 01.96 - 04.03 2.5 TDI, 111 kW 05.98 - 04.03		
1.8 12.90 - 07.92 2.0 09.90 - 04.03 2.5, 81 kW 11.90 - 04.03 2.4 D, 57 kW 09.90 - 04.98 1.9 D 09.90 - 04.03	Chass. 70-M-083 343->	
1.9 D 09.90 - 04.03	->Chass. 70-M-083 342	
Lagerung, Lenker		17681 01 7D0 407 183
1.8 12.90 - 07.92 2.0 09.90 - 04.03 2.5, 81 kW 11.90 - 04.03 2.5 Syncro, 81 kW 11.92 - 04.03 1.9 D 09.90 - 04.03 1.9 TD 10.92 - 04.03 2.4 D, 57 kW 09.90 - 04.98 2.4 D Syncro 10.92 - 09.98 2.5 TDI, 75 kW 09.95 - 04.03	Chass. 70-T-200 000->	
2.5, 85 kW 08.96 - 04.03 2.5 Syncro, 85 kW 07.96 - 04.03 2.8 VR 6 11.95 - 04.00 2.8 V6 04.00 - 04.03 2.4 D, 55 kW 08.97 - 04.03 2.5 TDI, 65 kW 05.98 - 04.03 2.5 TDI Syncro 01.96 - 04.03 2.5 TDI, 111 kW 05.98 - 04.03		
Lagerung, Lenker		25931 01 701 407 077 A
ALL TYPES ausser : 2.8 Syncro 01.96 - 04.96		
Stange/Strebe, Stabilisator		21044 02 701 411 049 B
Pendelstange Gewindemaß: M12x1,5 Durchmesser Stabilisator [mm]: 27		
ALL TYPES ausser : 2.8 Syncro 01.96 - 04.96		
Stabilisatorlager		17682 02 7D0 411 045
ALL TYPES ausser : 2.8 Syncro 01.96 - 04.96		



VOLKSWAGEN

**TRANSPORTER T4 Bus/Familial
(70XB, 70XC, 7DB, 7DW)**

09.90 - 04.03



 Stabilisatorlager 1.8 2.0 2.5, 81 kW 2.5 Syncro, 81 kW 1.9 D 1.9 TD 2.4 D, 57 kW 2.4 D Syncro	12.90 - 07.92	 ->Chass. 70-T-199 999	19129 01 701 411 041 
	09.90 - 04.03		
	11.90 - 04.03		
	11.92 - 04.03		
	09.90 - 04.03		
	10.92 - 04.03		
	09.90 - 04.98		
10.92 - 09.98			
Faltenbalgsatz, Lenkung ALL TYPES ausser : 2.8 Syncro	01.96 - 04.96		30127 01 7D0 419 831 
 Achsträgerlager 2.5 Syncro, 81 kW 2.5 Syncro, 85 kW 2.4 D Syncro 2.5 TDI Syncro	11.92 - 04.03		26572 01 701 599 381 
	07.96 - 04.03		
	10.92 - 09.98		
	01.96 - 04.03		

TRANSPORTER T4

07.90 - 04.03

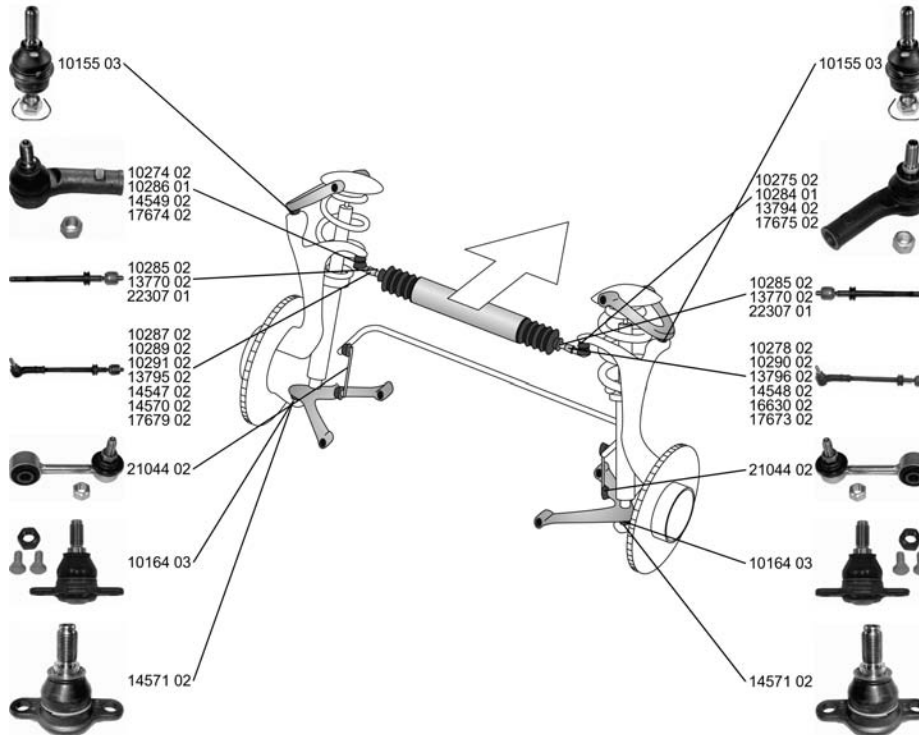
Kasten/Box/Furgón/Van (70XA)



Spurstange Konusmaß [mm]: 16 Rohr-Ø [mm]: 16 2.0 2.5, 81 kW 1.9 D 2.4 D, 57 kW 2.5 Syncro, 81 kW 1.9 TD 2.4 D Syncro	07.90 - 04.03	 Chass. 70-M-096 449 - Chass. 70-S-002 791 ->Chass. 70-S-002 791	10278 02 701 419 804 D 
	11.90 - 04.03		
	07.90 - 04.03		
	07.90 - 04.98		
	10.92 - 04.03		
	10.92 - 04.03		
	10.92 - 09.98		































Ref.

VOLKSWAGEN

TRANSPORTER T4 Kasten/Box/Furgón/Van (70XA)













07.90 - 04.03

 Spurstange Konusmaß [mm]: 16 Rohr-Ø [mm]: 16 mit Zubehör				10287 02 702 419 803 B 	
	2.0 07.90 - 04.03 2.5, 81 kW 11.90 - 04.03 1.9 D 07.90 - 04.03 2.4 D, 57 kW 07.90 - 04.98		Chass. 70-M-096 449 - Chass. 70-S-002 791		
				Chass. 70-M-096 449 - Chass. 70-S-002 791	
2.5 Syncro, 81 kW 1.9 TD 2.4 D Syncro	10.92 - 04.03 10.92 - 04.03 10.92 - 09.98		->Chass. 70-S-002 791		
				->Chass. 70-S-002 791	
Spurstange Konusmaß [mm]: 16 mit Zubehör				10289 02 701 419 803 D 	
	2.0 07.90 - 04.03 2.5, 81 kW 11.90 - 04.03 1.9 D 07.90 - 04.03 2.4 D, 57 kW 07.90 - 04.98		Chass. 70-M-096 449 - Chass. 70-S-002 791		
				->Chass. 70-S-002 791	
2.5 Syncro, 81 kW 1.9 TD 2.4 D Syncro	10.92 - 04.03 10.92 - 04.03 10.92 - 09.98				
Spurstange Konusmaß [mm]: 14 mit Zubehör				10290 02 701 419 804 C 	
	2.0 07.90 - 04.03 2.5, 81 kW 11.90 - 04.03 1.9 D 07.90 - 04.03 2.4 D, 57 kW 07.90 - 04.98		->Chass. 70-M-096 448		
Spurstange Konusmaß [mm]: 14				10291 02 701 419 803 C 	
	2.0 07.90 - 04.03 2.5, 81 kW 11.90 - 04.03 1.9 D 07.90 - 04.03 2.4 D, 57 kW 07.90 - 04.98		->Chass. 70-M-096 448		
Spurstange Konusmaß [mm]: 14 Rohr-Ø [mm]: 16 mit Zubehör				13795 02 702 419 803 A 	
	2.0 07.90 - 04.03 2.5, 81 kW 11.90 - 04.03 1.9 D 07.90 - 04.03 2.4 D, 57 kW 07.90 - 04.98		->Chass. 70-M-096 448		
				->Chass. 70-M-096 448	
Spurstange Konusmaß [mm]: 16				13796 02 702 419 804 B 	
	2.0 07.90 - 04.03 2.5, 81 kW 11.90 - 04.03 1.9 D 07.90 - 04.03 2.4 D, 57 kW 07.90 - 04.98		Chass. 70-M-096 449 - Chass. 70-S-002 791		
				->Chass. 70-S-002 791	
2.5 Syncro, 81 kW 1.9 TD 2.4 D Syncro	10.92 - 04.03 10.92 - 04.03 10.92 - 09.98				
Spurstange Konusmaß [mm]: 18 Rohr-Ø [mm]: 16				14547 02 701 419 803 E 	
	2.0 07.90 - 04.03 2.5, 81 kW 11.90 - 04.03 2.5 Syncro, 81 kW 10.92 - 04.03 1.9 D 07.90 - 04.03 1.9 TD 10.92 - 04.03 2.4 D, 57 kW 07.90 - 04.98 2.4 D Syncro 10.92 - 09.98		Chass. 70-S-002 792 - Chass. 70-T-199 999		



VOLKSWAGEN

TRANSPORTER T4 07.90 - 04.03 Kasten/Box/Furgón/Van (70XA)

<p> Spurstange Konusmaß [mm]: 18</p> <table border="1"> <tr><td>2.0</td><td>07.90 - 04.03</td></tr> <tr><td>2.5, 81 kW</td><td>11.90 - 04.03</td></tr> <tr><td>2.5 Syncro, 81 kW</td><td>10.92 - 04.03</td></tr> <tr><td>1.9 D</td><td>07.90 - 04.03</td></tr> <tr><td>1.9 TD</td><td>10.92 - 04.03</td></tr> <tr><td>2.4 D, 57 kW</td><td>07.90 - 04.98</td></tr> <tr><td>2.4 D Syncro</td><td>10.92 - 09.98</td></tr> </table>	2.0	07.90 - 04.03	2.5, 81 kW	11.90 - 04.03	2.5 Syncro, 81 kW	10.92 - 04.03	1.9 D	07.90 - 04.03	1.9 TD	10.92 - 04.03	2.4 D, 57 kW	07.90 - 04.98	2.4 D Syncro	10.92 - 09.98	<p></p> <p>LHD Chass. 70-S-002 792 - Chass. 70-T-199 999</p>	<p>14548 02 701 419 804 E</p> 														
2.0	07.90 - 04.03																													
2.5, 81 kW	11.90 - 04.03																													
2.5 Syncro, 81 kW	10.92 - 04.03																													
1.9 D	07.90 - 04.03																													
1.9 TD	10.92 - 04.03																													
2.4 D, 57 kW	07.90 - 04.98																													
2.4 D Syncro	10.92 - 09.98																													
<p>Spurstange Konusmaß [mm]: 18</p> <table border="1"> <tr><td>2.0</td><td>07.90 - 04.03</td></tr> <tr><td>2.5, 81 kW</td><td>11.90 - 04.03</td></tr> <tr><td>2.5 Syncro, 81 kW</td><td>10.92 - 04.03</td></tr> <tr><td>1.9 D</td><td>07.90 - 04.03</td></tr> <tr><td>1.9 TD</td><td>10.92 - 04.03</td></tr> <tr><td>2.4 D, 57 kW</td><td>07.90 - 04.98</td></tr> <tr><td>2.4 D Syncro</td><td>10.92 - 09.98</td></tr> </table>	2.0	07.90 - 04.03	2.5, 81 kW	11.90 - 04.03	2.5 Syncro, 81 kW	10.92 - 04.03	1.9 D	07.90 - 04.03	1.9 TD	10.92 - 04.03	2.4 D, 57 kW	07.90 - 04.98	2.4 D Syncro	10.92 - 09.98	<p></p> <p>RHD Chass. 70-S-002 792 - Chass. 70-T-199 999</p> <p>-----</p> <p>RHD LHD Chass. 70-S-002 792 - Chass. 70-T-199 999</p>	<p>14570 02 702 419 803 C</p> 														
2.0	07.90 - 04.03																													
2.5, 81 kW	11.90 - 04.03																													
2.5 Syncro, 81 kW	10.92 - 04.03																													
1.9 D	07.90 - 04.03																													
1.9 TD	10.92 - 04.03																													
2.4 D, 57 kW	07.90 - 04.98																													
2.4 D Syncro	10.92 - 09.98																													
<p>Spurstange Konusmaß [mm]: 18</p> <table border="1"> <tr><td>2.0</td><td>07.90 - 04.03</td></tr> <tr><td>2.5, 81 kW</td><td>11.90 - 04.03</td></tr> <tr><td>2.5 Syncro, 81 kW</td><td>10.92 - 04.03</td></tr> <tr><td>1.9 D</td><td>07.90 - 04.03</td></tr> <tr><td>1.9 TD</td><td>10.92 - 04.03</td></tr> <tr><td>2.4 D, 57 kW</td><td>07.90 - 04.98</td></tr> <tr><td>2.4 D Syncro</td><td>10.92 - 09.98</td></tr> </table>	2.0	07.90 - 04.03	2.5, 81 kW	11.90 - 04.03	2.5 Syncro, 81 kW	10.92 - 04.03	1.9 D	07.90 - 04.03	1.9 TD	10.92 - 04.03	2.4 D, 57 kW	07.90 - 04.98	2.4 D Syncro	10.92 - 09.98	<p></p> <p>RHD Chass. 70-S-002 792 - Chass. 70-T-199 999</p> <p>-----</p> <p>RHD LHD Chass. 70-S-002 792 - Chass. 70-T-199 999</p>	<p>16630 02 702 419 804 C</p> 														
2.0	07.90 - 04.03																													
2.5, 81 kW	11.90 - 04.03																													
2.5 Syncro, 81 kW	10.92 - 04.03																													
1.9 D	07.90 - 04.03																													
1.9 TD	10.92 - 04.03																													
2.4 D, 57 kW	07.90 - 04.98																													
2.4 D Syncro	10.92 - 09.98																													
<p>Spurstange Konusmaß [mm]: 18 mit Zubehör</p> <table border="1"> <tr><td>2.0</td><td>07.90 - 04.03</td></tr> <tr><td>2.5, 81 kW</td><td>11.90 - 04.03</td></tr> <tr><td>2.5 Syncro, 81 kW</td><td>10.92 - 04.03</td></tr> <tr><td>1.9 D</td><td>07.90 - 04.03</td></tr> <tr><td>1.9 TD</td><td>10.92 - 04.03</td></tr> <tr><td>2.4 D, 57 kW</td><td>07.90 - 04.98</td></tr> <tr><td>2.4 D Syncro</td><td>10.92 - 09.98</td></tr> <tr><td>2.5 TDI, 75 kW</td><td>09.95 - 04.03</td></tr> <tr><td>2.5 TDI Syncro</td><td>09.95 - 04.03</td></tr> <tr><td>2.5, 85 kW</td><td>08.96 - 04.03</td></tr> <tr><td>2.5 Syncro, 85 kW</td><td>08.96 - 04.03</td></tr> <tr><td>2.4 D, 55 kW</td><td>08.97 - 04.03</td></tr> <tr><td>2.5 TDI, 65 kW</td><td>12.98 - 04.03</td></tr> <tr><td>2.5 TDI, 111 kW</td><td>09.00 - 04.03</td></tr> </table>	2.0	07.90 - 04.03	2.5, 81 kW	11.90 - 04.03	2.5 Syncro, 81 kW	10.92 - 04.03	1.9 D	07.90 - 04.03	1.9 TD	10.92 - 04.03	2.4 D, 57 kW	07.90 - 04.98	2.4 D Syncro	10.92 - 09.98	2.5 TDI, 75 kW	09.95 - 04.03	2.5 TDI Syncro	09.95 - 04.03	2.5, 85 kW	08.96 - 04.03	2.5 Syncro, 85 kW	08.96 - 04.03	2.4 D, 55 kW	08.97 - 04.03	2.5 TDI, 65 kW	12.98 - 04.03	2.5 TDI, 111 kW	09.00 - 04.03	<p></p> <p>RHD Chass. 70-T-200 000-></p> <p>-----</p> <p>RHD LHD Chass. 70-T-200 000-></p>	<p>17673 02 701 419 804 F</p> 
2.0	07.90 - 04.03																													
2.5, 81 kW	11.90 - 04.03																													
2.5 Syncro, 81 kW	10.92 - 04.03																													
1.9 D	07.90 - 04.03																													
1.9 TD	10.92 - 04.03																													
2.4 D, 57 kW	07.90 - 04.98																													
2.4 D Syncro	10.92 - 09.98																													
2.5 TDI, 75 kW	09.95 - 04.03																													
2.5 TDI Syncro	09.95 - 04.03																													
2.5, 85 kW	08.96 - 04.03																													
2.5 Syncro, 85 kW	08.96 - 04.03																													
2.4 D, 55 kW	08.97 - 04.03																													
2.5 TDI, 65 kW	12.98 - 04.03																													
2.5 TDI, 111 kW	09.00 - 04.03																													
<p>Spurstange Konusmaß [mm]: 18 Rohr-Ø [mm]: 16,5 mit Zubehör</p> <table border="1"> <tr><td>2.0</td><td>07.90 - 04.03</td></tr> <tr><td>2.5, 81 kW</td><td>11.90 - 04.03</td></tr> <tr><td>2.5 Syncro, 81 kW</td><td>10.92 - 04.03</td></tr> <tr><td>1.9 D</td><td>07.90 - 04.03</td></tr> <tr><td>1.9 TD</td><td>10.92 - 04.03</td></tr> <tr><td>2.4 D, 57 kW</td><td>07.90 - 04.98</td></tr> <tr><td>2.4 D Syncro</td><td>10.92 - 09.98</td></tr> <tr><td>2.5 TDI, 75 kW</td><td>09.95 - 04.03</td></tr> <tr><td>2.5 TDI Syncro</td><td>09.95 - 04.03</td></tr> <tr><td>2.5, 85 kW</td><td>08.96 - 04.03</td></tr> <tr><td>2.5 Syncro, 85 kW</td><td>08.96 - 04.03</td></tr> <tr><td>2.4 D, 55 kW</td><td>08.97 - 04.03</td></tr> <tr><td>2.5 TDI, 65 kW</td><td>12.98 - 04.03</td></tr> <tr><td>2.5 TDI, 111 kW</td><td>09.00 - 04.03</td></tr> </table>	2.0	07.90 - 04.03	2.5, 81 kW	11.90 - 04.03	2.5 Syncro, 81 kW	10.92 - 04.03	1.9 D	07.90 - 04.03	1.9 TD	10.92 - 04.03	2.4 D, 57 kW	07.90 - 04.98	2.4 D Syncro	10.92 - 09.98	2.5 TDI, 75 kW	09.95 - 04.03	2.5 TDI Syncro	09.95 - 04.03	2.5, 85 kW	08.96 - 04.03	2.5 Syncro, 85 kW	08.96 - 04.03	2.4 D, 55 kW	08.97 - 04.03	2.5 TDI, 65 kW	12.98 - 04.03	2.5 TDI, 111 kW	09.00 - 04.03	<p></p> <p>RHD Chass. 70-T-200 000-></p> <p>-----</p> <p>RHD LHD Chass. 70-T-200 000-></p>	<p>17679 02 702 419 803 D</p> 
2.0	07.90 - 04.03																													
2.5, 81 kW	11.90 - 04.03																													
2.5 Syncro, 81 kW	10.92 - 04.03																													
1.9 D	07.90 - 04.03																													
1.9 TD	10.92 - 04.03																													
2.4 D, 57 kW	07.90 - 04.98																													
2.4 D Syncro	10.92 - 09.98																													
2.5 TDI, 75 kW	09.95 - 04.03																													
2.5 TDI Syncro	09.95 - 04.03																													
2.5, 85 kW	08.96 - 04.03																													
2.5 Syncro, 85 kW	08.96 - 04.03																													
2.4 D, 55 kW	08.97 - 04.03																													
2.5 TDI, 65 kW	12.98 - 04.03																													
2.5 TDI, 111 kW	09.00 - 04.03																													
<p>Spurstangenkopf</p> <table border="1"> <tr><td>2.0</td><td>07.90 - 04.03</td></tr> <tr><td>2.5, 81 kW</td><td>11.90 - 04.03</td></tr> <tr><td>1.9 D</td><td>07.90 - 04.03</td></tr> <tr><td>2.4 D, 57 kW</td><td>07.90 - 04.98</td></tr> <tr><td>2.5 Syncro, 81 kW</td><td>10.92 - 04.03</td></tr> <tr><td>1.9 TD</td><td>10.92 - 04.03</td></tr> <tr><td>2.4 D Syncro</td><td>10.92 - 09.98</td></tr> </table>	2.0	07.90 - 04.03	2.5, 81 kW	11.90 - 04.03	1.9 D	07.90 - 04.03	2.4 D, 57 kW	07.90 - 04.98	2.5 Syncro, 81 kW	10.92 - 04.03	1.9 TD	10.92 - 04.03	2.4 D Syncro	10.92 - 09.98	<p></p> <p>Chass. 70-M-096 449 - Chass. 70-S-002 791</p> <p>->Chass. 70-S-002 791</p>	<p>10274 02 701 419 811 B</p> 														
2.0	07.90 - 04.03																													
2.5, 81 kW	11.90 - 04.03																													
1.9 D	07.90 - 04.03																													
2.4 D, 57 kW	07.90 - 04.98																													
2.5 Syncro, 81 kW	10.92 - 04.03																													
1.9 TD	10.92 - 04.03																													
2.4 D Syncro	10.92 - 09.98																													















Ref.

VOLKSWAGEN

TRANSPORTER T4 Kasten/Box/Furgón/Van (70XA)

07.90 - 04.03

 Spurstangenkopf Konusmaß [mm]: 18 Gewindeart: mit Rechtsgewinde		10275 02 701 419 812 B 
2.0 2.5, 81 kW 2.5 Syncro, 81 kW 1.9 D 1.9 TD 2.4 D, 57 kW 2.4 D Syncro	07.90 - 04.03 11.90 - 04.03 10.92 - 04.03 07.90 - 04.03 10.92 - 04.03 07.90 - 04.98 10.92 - 09.98	Chass. 70-S-002 792 - Chass. 70-T-199 999
Spurstangenkopf Konusmaß [mm]: 14 Gewindeart: mit Rechtsgewinde		10284 01 701 419 812 
2.0 2.5, 81 kW 1.9 D 2.4 D, 57 kW	07.90 - 04.03 11.90 - 04.03 07.90 - 04.03 07.90 - 04.98	->Chass. 70-M-096 448
Spurstangenkopf Konusmaß [mm]: 14 Gewindeart: mit Rechtsgewinde		10286 01 701 419 811 A 
2.0 2.5, 81 kW 1.9 D 2.4 D, 57 kW	07.90 - 04.03 11.90 - 04.03 07.90 - 04.03 07.90 - 04.98	->Chass. 70-M-096 448
Spurstangenkopf		13794 02 701 419 812 A 
2.0 2.5, 81 kW 1.9 D 2.4 D, 57 kW 2.5 Syncro, 81 kW 1.9 TD 2.4 D Syncro	07.90 - 04.03 11.90 - 04.03 07.90 - 04.03 07.90 - 04.98 10.92 - 04.03 10.92 - 04.03 10.92 - 09.98	Chass. 70-M-096 449 - Chass. 70-S-002 791 ->Chass. 70-S-002 791
Spurstangenkopf Konusmaß [mm]: 18 Gewindeart: mit Rechtsgewinde		14549 02 701 419 811 C 
2.0 2.5, 81 kW 2.5 Syncro, 81 kW 1.9 D 1.9 TD 2.4 D, 57 kW 2.4 D Syncro	07.90 - 04.03 11.90 - 04.03 10.92 - 04.03 07.90 - 04.03 10.92 - 04.03 07.90 - 04.98 10.92 - 09.98	Chass. 70-S-002 792 - Chass. 70-T-199 999
Spurstangenkopf Konusmaß [mm]: 18 Gewindeart: mit Rechtsgewinde mit Zubehör		17674 02 701 419 811 E 
2.0 2.5, 81 kW 2.5 Syncro, 81 kW 1.9 D 1.9 TD 2.4 D, 57 kW 2.4 D Syncro 2.5 TDI, 75 kW 2.5 TDI Syncro 2.5, 85 kW 2.5 Syncro, 85 kW 2.4 D, 55 kW 2.5 TDI, 65 kW 2.5 TDI, 111 kW	07.90 - 04.03 11.90 - 04.03 10.92 - 04.03 07.90 - 04.03 10.92 - 04.03 07.90 - 04.98 10.92 - 09.98 09.95 - 04.03 09.95 - 04.03 08.96 - 04.03 08.96 - 04.03 08.97 - 04.03 12.98 - 04.03 09.00 - 04.03	Chass. 70-T-200 000->















VOLKSWAGEN

TRANSPORTER T4

07.90 - 04.03

Kasten/Box/Furgón/Van (70XA)

 Spurstangenkopf Konusmaß [mm]: 18 Gewindeart: mit Rechtsgewinde mit Zubehör		17675 02 701 419 812 D 
2.0 07.90 - 04.03 2.5, 81 kW 11.90 - 04.03 2.5 Syncro, 81 kW 10.92 - 04.03 1.9 D 07.90 - 04.03 1.9 TD 10.92 - 04.03 2.4 D, 57 kW 07.90 - 04.98 2.4 D Syncro 10.92 - 09.98 2.5 TDI, 75 kW 09.95 - 04.03 2.5 TDI Syncro 09.95 - 04.03	Chass. 70-T-200 000->	
2.5, 85 kW 08.96 - 04.03 2.5 Syncro, 85 kW 08.96 - 04.03 2.4 D, 55 kW 08.97 - 04.03 2.5 TDI, 65 kW 12.98 - 04.03 2.5 TDI, 111 kW 09.00 - 04.03		
Axialgelenk, Spurstange Gewindemaß: M14x1,5 Gewindeart: mit Rechtsgewinde für OE-Nummer 025 390 091/092 617		10285 02 701 419 810 A 
2.0 07.90 - 04.03 2.5, 81 kW 11.90 - 04.03 2.5 Syncro, 81 kW 10.92 - 04.03 1.9 D 07.90 - 04.03 1.9 TD 10.92 - 04.03 2.4 D, 57 kW 07.90 - 04.98 2.4 D Syncro 10.92 - 09.98 2.5 TDI Syncro 09.95 - 04.03	->Chass. 70-T-199 999	
2.5 Syncro, 85 kW 08.96 - 04.03 2.5 TDI, 65 kW 12.98 - 04.03 2.5 TDI, 75 kW 09.95 - 04.03		
Axialgelenk, Spurstange Gewindeart: mit Rechtsgewinde für OE-Nummer 025 390 090/093 617		13770 02 701 419 810 
2.0 07.90 - 04.03 2.5, 81 kW 11.90 - 04.03 2.5 Syncro, 81 kW 10.92 - 04.03 1.9 D 07.90 - 04.03 1.9 TD 10.92 - 04.03 2.4 D, 57 kW 07.90 - 04.98 2.4 D Syncro 10.92 - 09.98	->Chass. 70-T-199 999	
Axialgelenk, Spurstange für OE-Nummer 025 390 123 617 LH		22307 01 701 419 804 F 701 419 810 B 702 419 803 D 
2.0 07.90 - 04.03 2.5, 81 kW 11.90 - 04.03 2.5 Syncro, 85 kW 08.96 - 04.03 1.9 D 07.90 - 04.03 2.4 D, 57 kW 07.90 - 04.98 2.5 TDI, 65 kW 12.98 - 04.03 2.5 TDI, 75 kW 09.95 - 04.03	 Chass. 70-T-200 000->	
2.5 Syncro, 81 kW 10.92 - 04.03 1.9 TD 10.92 - 04.03 2.4 D Syncro 10.92 - 09.98 2.5 TDI Syncro 09.95 - 04.03 2.5, 85 kW 08.96 - 04.03 2.4 D, 55 kW 08.97 - 04.03	Chass. 70-T-200 000->	
Trag-/Führungsgelenk ALL TYPES ausser : 1.6 08.92 - 07.99 2.8 VR6, 103 kW 05.96 - 05.00 2.8 VR6, 150 kW 06.00 - 04.03		10155 03 701 407 187 B 





Ref.

VOLKSWAGEN

TRANSPORTER T4 Kasten/Box/Furgón/Van (70XA)











07.90 - 04.03

 Trag-/Führungsgelenk Lochabstand 1/Lochabstand 2: 80 mit Zubehör		10164 03 701 407 361 B 
2.0 2.5, 81 kW 2.5 Syncro, 81 kW 1.9 D 1.9 TD 2.4 D, 57 kW 2.4 D Syncro	07.90 - 04.03 11.90 - 04.03 10.92 - 04.03 07.90 - 04.03 10.92 - 04.03 07.90 - 04.98 10.92 - 09.98 ->Chass. 70-T-199 999	
Reparatursatz,Trag-/Führungsgelenk Lochabstand 1/Lochabstand 2: 80		14571 02 7D0 407 361 
2.0 2.5, 81 kW 2.5 Syncro, 81 kW 1.9 D 1.9 TD 2.4 D, 57 kW 2.4 D Syncro 2.5 TDI, 75 kW 2.5 TDI Syncro 2.5, 85 kW 2.5 Syncro, 85 kW 2.4 D, 55 kW 2.5 TDI, 65 kW	07.90 - 04.03 11.90 - 04.03 10.92 - 04.03 07.90 - 04.03 10.92 - 04.03 07.90 - 04.98 10.92 - 09.98 09.95 - 04.03 09.95 - 04.03 08.96 - 04.03 08.96 - 04.03 08.97 - 04.03 12.98 - 04.03 Chass. 70-T-2-000 001->	
Lagerung, Lenker		14555 03 7D0 407 140 A 
2.0 2.5, 81 kW 1.9 D 2.4 D, 57 kW 2.5 Syncro, 81 kW 2.5, 85 kW 2.5 Syncro, 85 kW 1.9 TD 2.4 D, 55 kW 2.4 D Syncro 2.5 TDI, 65 kW 2.5 TDI, 75 kW 2.5 TDI Syncro 2.5 TDI, 111 kW	07.90 - 04.03 11.90 - 04.03 07.90 - 04.03 07.90 - 04.98 10.92 - 04.03 08.96 - 04.03 08.96 - 04.03 10.92 - 04.03 08.97 - 04.03 10.92 - 09.98 12.98 - 04.03 09.95 - 04.03 09.95 - 04.03 09.00 - 04.03 Chass. 70-M-083 343->	
Lagerung, Lenker		17681 01 7D0 407 183 
2.0 2.5, 81 kW 2.5 Syncro, 81 kW 1.9 D 1.9 TD 2.4 D, 57 kW 2.4 D Syncro 2.5 TDI, 75 kW 2.5 TDI Syncro 2.5, 85 kW 2.5 Syncro, 85 kW 2.4 D, 55 kW 2.5 TDI, 65 kW 2.5 TDI, 111 kW	07.90 - 04.03 11.90 - 04.03 10.92 - 04.03 07.90 - 04.03 10.92 - 04.03 07.90 - 04.98 10.92 - 09.98 09.95 - 04.03 09.95 - 04.03 08.96 - 04.03 08.96 - 04.03 08.97 - 04.03 12.98 - 04.03 09.00 - 04.03 Chass. 70-T-200 000->	
Lagerung, Lenker		25931 01 701 407 077 A 
ALL TYPES ausser : 1.6 2.8 VR6, 103 kW 2.8 VR6, 150 kW	08.92 - 07.99 05.96 - 05.00 06.00 - 04.03	
Stange/Strebe, Stabilisator		21044 02 701 411 049 B 
Pendelstange Gewindemaß: M12x1,5 Durchmesser Stabilisator [mm]: 27 ALL TYPES ausser : 1.6 2.8 VR6, 103 kW 2.8 VR6, 150 kW	08.92 - 07.99 05.96 - 05.00 06.00 - 04.03	



VOLKSWAGEN

TRANSPORTER T4 07.90 - 04.03
Kasten/Box/Furgón/Van (70XA)

 Stabilisatorlager ALL TYPES ausser : 1.6 08.92 - 07.99 2.8 VR6, 103 kW 05.96 - 05.00 2.8 VR6, 150 kW 06.00 - 04.03		17682 02 7D0 411 045 
Stabilisatorlager 2.0 07.90 - 04.03 2.5, 81 kW 11.90 - 04.03 2.5 Syncro, 81 kW 10.92 - 04.03 1.9 D 07.90 - 04.03 1.9 TD 10.92 - 04.03 2.4 D, 57 kW 07.90 - 04.98 2.4 D Syncro 10.92 - 09.98	 ->Chass. 70-T-199 999	19129 01 701 411 041 
Faltenbalsatz, Lenkung ALL TYPES ausser : 1.6 08.92 - 07.99 2.8 VR6, 103 kW 05.96 - 05.00 2.8 VR6, 150 kW 06.00 - 04.03		30127 01 7D0 419 831 
 Achsträgerlager 2.5 Syncro 10.92 - 04.03 2.5 Syncro, 85 kW 08.96 - 04.03 2.4 D Syncro 10.92 - 09.98 2.5 TDI Syncro 09.95 - 04.03		26572 01 701 599 381 











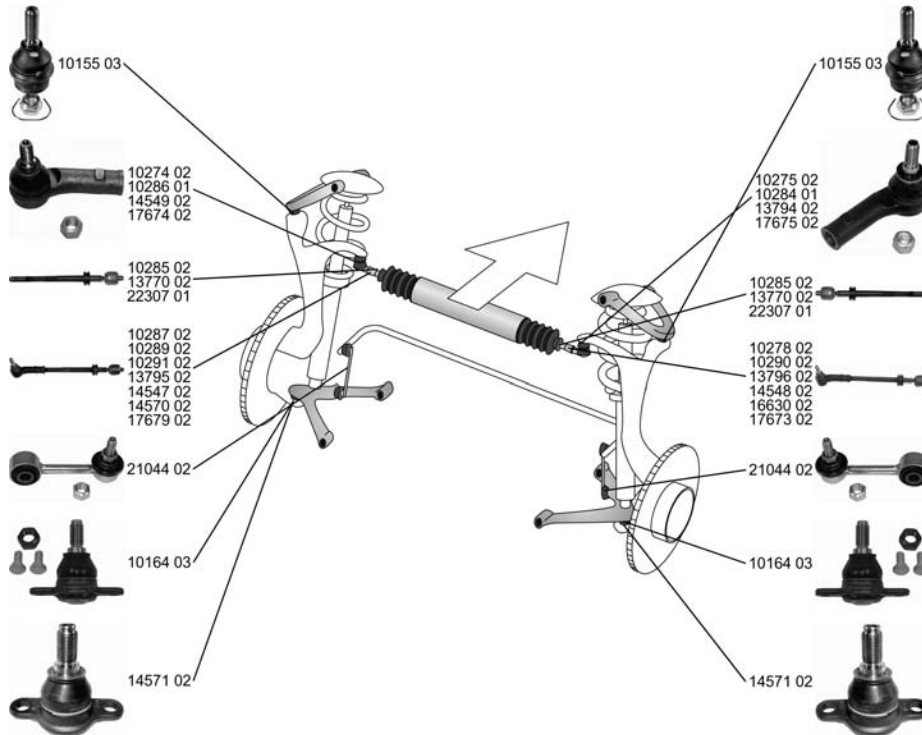



Ref.

VOLKSWAGEN

TRANSPORTER T4
Pritsche, Fahrgestell /
Flatbed, Chassis Cab (70XD)

07.90 - 04.03

















Spurstange Konusmaß [mm]: 16 Rohr-Ø [mm]: 16			10278 02 701 419 804 D 
2.0 2.5, 81 kW 1.9 D 2.4 D, 57 kW	07.90 - 04.03 11.90 - 04.03 07.90 - 04.03 09.90 - 04.98	Chass. 70-M-096 449 - Chass. 70-S-002 791	
2.5 Syncro, 81 kW 1.9 TD 2.4 D Syncro	10.92 - 04.03 10.92 - 04.03 10.92 - 09.98	->Chass. 70-S-002 791	
Spurstange Konusmaß [mm]: 16 Rohr-Ø [mm]: 16 mit Zubehör			10287 02 702 419 803 B 
2.0 2.5, 81 kW 1.9 D 2.4 D, 57 kW	07.90 - 04.03 11.90 - 04.03 07.90 - 04.03 09.90 - 04.98	RHD  Chass. 70-M-096 449 - Chass. 70-S-002 791	
		RHD LHD  Chass. 70-M-096 449 - Chass. 70-S-002 791	
2.5 Syncro, 81 kW 1.9 TD 2.4 D Syncro	10.92 - 04.03 10.92 - 04.03 10.92 - 09.98	RHD  ->Chass. 70-S-002 791	
		RHD LHD  ->Chass. 70-S-002 791	
Spurstange Konusmaß [mm]: 16 mit Zubehör			10289 02 701 419 803 D 
2.0 2.5, 81 kW 1.9 D 2.4 D, 57 kW	07.90 - 04.03 11.90 - 04.03 07.90 - 04.03 09.90 - 04.98	LHD  Chass. 70-M-096 449 - Chass. 70-S-002 791	
2.5 Syncro, 81 kW 1.9 TD 2.4 D Syncro	10.92 - 04.03 10.92 - 04.03 10.92 - 09.98	LHD  ->Chass. 70-S-002 791	



VOLKSWAGEN

TRANSPORTER T4
Pritsche, Fahrgestell /
Flatbed, Chassis Cab (70XD)

07.90 - 04.03

 Spurstange Konusmaß [mm]: 14 mit Zubehör			10290 02	701 419 804 C	
	2.0	07.90 - 04.03			
	2.5, 81 kW	11.90 - 04.03	LHD		
	1.9 D	07.90 - 04.03	->Chass. 70-M-096 448		
	2.4 D, 57 kW	09.90 - 04.98			
Spurstange Konusmaß [mm]: 14			10291 02	701 419 803 C	
	2.0	07.90 - 04.03			
	2.5, 81 kW	11.90 - 04.03	LHD 		
	1.9 D	07.90 - 04.03	->Chass. 70-M-096 448		
	2.4 D, 57 kW	09.90 - 04.98			
Spurstange Konusmaß [mm]: 14 Rohr-Ø [mm]: 16 mit Zubehör			13795 02	702 419 803 A	
	2.0	07.90 - 04.03			
	2.5, 81 kW	11.90 - 04.03	RHD 		
	1.9 D	07.90 - 04.03	->Chass. 70-M-096 448		
	2.4 D, 57 kW	09.90 - 04.98			
Spurstange Konusmaß [mm]: 16			13796 02	702 419 804 B	
	2.0	07.90 - 04.03			
	2.5, 81 kW	11.90 - 04.03	RHD 		
	1.9 D	07.90 - 04.03	Chass. 70-M-096 449 - Chass. 70-S-002 791		
	2.4 D, 57 kW	09.90 - 04.98			
Spurstange Konusmaß [mm]: 18 Rohr-Ø [mm]: 16			14547 02	701 419 803 E	
	2.0	07.90 - 04.03			
	2.5, 81 kW	11.90 - 04.03	LHD		
	2.5 Syncro, 81 kW	10.92 - 04.03	Chass. 70-S-002 792 - Chass. 70-T-199 999		
	1.9 D	07.90 - 04.03			
Spurstange Konusmaß [mm]: 18			14548 02	701 419 804 E	
	2.0	07.90 - 04.03			
	2.5, 81 kW	11.90 - 04.03	LHD		
	2.5 Syncro, 81 kW	10.92 - 04.03	Chass. 70-S-002 792 - Chass. 70-T-199 999		
	1.9 D	07.90 - 04.03			
Spurstange Konusmaß [mm]: 18			14570 02	702 419 803 C	
	2.0	07.90 - 04.03			
	2.5, 81 kW	11.90 - 04.03	RHD 		
	2.5 Syncro, 81 kW	10.92 - 04.03	Chass. 70-S-002 792 - Chass. 70-T-199 999		
	1.9 D	07.90 - 04.03			
2.4 D, 57 kW					
	1.9 TD	10.92 - 04.03			
	2.4 D Syncro	10.92 - 09.98			
	2.4 D, 57 kW	09.90 - 04.98	RHD LHD 		
			Chass. 70-S-002 792 - Chass. 70-T-199 999		
2.4 D Syncro					
	10.92 - 09.98				
			RHD 		
			Chass. 70-S-002 792 - Chass. 70-T-199 999		
		RHD LHD 			
		->Chass. 70-S-002 792			
		->Chass. 70-T-199 999			





















Ref.

VOLKSWAGEN

TRANSPORTER T4 Pritsche, Fahrgestell / Flatbed, Chassis Cab (70XD)













07.90 - 04.03

Spurstange Konusmaß [mm]: 18 2.0 2.5, 81 kW 2.5 Syncro, 81 kW 1.9 D 1.9 TD 2.4 D, 57 kW	  Chass. 70-S-002 792 - Chass. 70-T-199 999 -----  Chass. 70-S-002 792 - Chass. 70-T-199 999	16630 02 702 419 804 C 
2.4 D Syncro	 Chass. 70-S-002 792 - Chass. 70-T-199 999 -----  ->Chass. 70-S-002 792 ->Chass. 70-T-199 999	
Spurstange Konusmaß [mm]: 18 mit Zubehör 2.0 2.5, 81 kW 2.5 Syncro, 81 kW 1.9 D 1.9 TD 2.4 D Syncro 2.4 D, 57 kW 2.5 TDI, 75 kW	  Chass. 70-T-200 000->	17673 02 701 419 804 F 
2.5, 85 kW 2.5 Syncro, 85 kW 2.4 D, 55 kW 2.5 TDI Syncro 2.5 TDI, 65 kW 2.5 TDI Syncro	 08.96 - 04.03 08.96 - 04.03 08.97 - 04.03 05.98 - 05.98 - 04.03 05.98 - 04.03	
Spurstange Konusmaß [mm]: 18 Rohr-Ø [mm]: 16,5 mit Zubehör		17679 02 702 419 803 D 
2.0 2.5, 81 kW 2.5 Syncro, 81 kW 1.9 D 1.9 TD 2.4 D Syncro 2.4 D, 57 kW 2.5 TDI, 75 kW	 Chass. 70-T-200 000->	
2.5, 85 kW 2.5 Syncro, 85 kW 2.4 D, 55 kW 2.5 TDI Syncro 2.5 TDI, 65 kW 2.5 TDI Syncro	 08.96 - 04.03 08.96 - 04.03 08.97 - 04.03 05.98 - 05.98 - 04.03 05.98 - 04.03	
Spurstangenkopf 2.0 2.5, 81 kW 1.9 D 2.4 D, 57 kW 2.5 Syncro, 81 kW 1.9 TD 2.4 D Syncro	 Chass. 70-M-096 449 - Chass. 70-S-002 791 ----- ->Chass. 70-S-002 791	10274 02 701 419 811 B 
Spurstangenkopf Konusmaß [mm]: 18 Gewindeart: mit Rechtsgewinde 2.0 2.5, 81 kW 2.5 Syncro, 81 kW 1.9 D 1.9 TD 2.4 D Syncro 2.4 D, 57 kW	 Chass. 70-S-002 792 - Chass. 70-T-199 999	10275 02 701 419 812 B 



VOLKSWAGEN

TRANSPORTER T4 **07.90 - 04.03**
Pritsche, Fahrgestell /
Flatbed, Chassis Cab (70XD)















 Spurstangenkopf Konusmaß [mm]: 14 Gewindeart: mit Rechtsgewinde			10284 01 701 419 812		
	2.0	07.90 - 04.03	->Chass. 70-M-096 448		
	2.5, 81 kW	11.90 - 04.03			
	1.9 D	07.90 - 04.03			
2.4 D, 57 kW	09.90 - 04.98				
Spurstangenkopf Konusmaß [mm]: 14 Gewindeart: mit Rechtsgewinde			10286 01 701 419 811 A		
	2.0	07.90 - 04.03	->Chass. 70-M-096 448		
	2.5, 81 kW	11.90 - 04.03			
	1.9 D	07.90 - 04.03			
2.4 D, 57 kW	09.90 - 04.98				
Spurstangenkopf Konusmaß [mm]: 14 Gewindeart: mit Rechtsgewinde			13794 02 701 419 812 A		
	2.0	07.90 - 04.03	Chass. 70-M-096 449 - Chass. 70-S-002 791		
	2.5, 81 kW	11.90 - 04.03			
	1.9 D	07.90 - 04.03			
	2.4 D, 57 kW	09.90 - 04.98			
	2.5 Syncro, 81 kW	10.92 - 04.03			->Chass. 70-S-002 791
1.9 TD	10.92 - 04.03				
2.4 D Syncro	10.92 - 09.98				
Spurstangenkopf Konusmaß [mm]: 18 Gewindeart: mit Rechtsgewinde			14549 02 701 419 811 C		
	2.0	07.90 - 04.03	Chass. 70-S-002 792 - Chass. 70-T-199 999		
	2.5, 81 kW	11.90 - 04.03			
	2.5 Syncro, 81 kW	10.92 - 04.03			
	1.9 D	07.90 - 04.03			
	1.9 TD	10.92 - 04.03			
	2.4 D Syncro	10.92 - 09.98			
	2.4 D, 57 kW	09.90 - 04.98			
2.5 TDI, 75 kW	09.95 - 04.03				
Spurstangenkopf Konusmaß [mm]: 18 Gewindeart: mit Rechtsgewinde mit Zubehör			17674 02 701 419 811 E		
	2.0	07.90 - 04.03	Chass. 70-T-200 000->		
	2.5, 81 kW	11.90 - 04.03			
	2.5 Syncro, 81 kW	10.92 - 04.03			
	1.9 D	07.90 - 04.03			
	1.9 TD	10.92 - 04.03			
	2.4 D Syncro	10.92 - 09.98			
	2.4 D, 57 kW	09.90 - 04.98			
	2.5 TDI, 75 kW	09.95 - 04.03			
	2.5, 85 kW	08.96 - 04.03			
	2.5 Syncro, 85 kW	08.96 - 04.03			
	2.4 D, 55 kW	08.97 - 04.03			
2.5 TDI Syncro	05.98 -				
2.5 TDI, 65 kW	05.98 - 04.03				
2.5 TDI Syncro	05.98 - 04.03				
Spurstangenkopf Konusmaß [mm]: 18 Gewindeart: mit Rechtsgewinde mit Zubehör			17675 02 701 419 812 D		
	2.0	07.90 - 04.03	Chass. 70-T-200 000->		
	2.5, 81 kW	11.90 - 04.03			
	2.5 Syncro, 81 kW	10.92 - 04.03			
	1.9 D	07.90 - 04.03			
	1.9 TD	10.92 - 04.03			
	2.4 D Syncro	10.92 - 09.98			
	2.4 D, 57 kW	09.90 - 04.98			
	2.5 TDI, 75 kW	09.95 - 04.03			
	2.5, 85 kW	08.96 - 04.03			
	2.5 Syncro, 85 kW	08.96 - 04.03			
	2.4 D, 55 kW	08.97 - 04.03			
2.5 TDI Syncro	05.98 -				
2.5 TDI, 65 kW	05.98 - 04.03				
2.5 TDI Syncro	05.98 - 04.03				



Ref.

VOLKSWAGEN

TRANSPORTER T4 07.90 - 04.03 Pritsche, Fahrgestell / Flatbed, Chassis Cab (70XD)













 Axialgelenk, Spurstange Gewindemaß: M14x1,5 Gewindeart: mit Rechtsgewinde für OE-Nummer 025 390 091/092 617		10285 02 701 419 810 A 
2.0 07.90 - 04.03 2.5, 81 kW 11.90 - 04.03 2.5 Syncro, 81 kW 10.92 - 04.03 1.9 D 07.90 - 04.03 1.9 TD 10.92 - 04.03 2.4 D Syncro 10.92 - 09.98 2.4 D, 57 kW 09.90 - 04.98 2.5 TDI, 75 kW 09.95 - 04.03	->Chass. 70-T-199999	
2.5 TDI Syncro 05.98 - 2.5 TDI, 65 kW 05.98 - 04.03		
Axialgelenk, Spurstange Gewindeart: mit Rechtsgewinde für OE-Nummer 025 390 090/093 617		13770 02 701 419 810 
2.0 07.90 - 04.03 2.5, 81 kW 11.90 - 04.03 2.5 Syncro, 81 kW 10.92 - 04.03 1.9 D 07.90 - 04.03 1.9 TD 10.92 - 04.03 2.4 D Syncro 10.92 - 09.98 2.4 D, 57 kW 09.90 - 04.98	->Chass. 70-T-199999	
Axialgelenk, Spurstange für OE-Nummer 025 390 123 617 LH		22307 01 701 419 804 F 701 419 810 B 702 419 803 D 
2.0 07.90 - 04.03 2.5, 81 kW 11.90 - 04.03 1.9 D 07.90 - 04.03 2.4 D, 57 kW 09.90 - 04.98 2.5 TDI Syncro 05.98 - 2.5 TDI, 65 kW 05.98 - 04.03	 Chass. 70-T-200000->	
2.5 Syncro, 81 kW 10.92 - 04.03 1.9 TD 10.92 - 04.03 2.4 D Syncro 10.92 - 09.98 2.5 TDI, 75 kW 09.95 - 04.03 2.5, 85 kW 08.96 - 04.03 2.5 Syncro, 85 kW 08.96 - 04.03 2.4 D, 55 kW 08.97 - 04.03	Chass. 70-T-200000->	
Trag-/Führungsgelenk ALL TYPES ausser :		10155 03 701 407 187 B 
1.8 12.90 - 07.92 2.8 05.96 - 05.00		
Trag-/Führungsgelenk Lochabstand 1/Lochabstand 2: 80 mit Zubehör		10164 03 701 407 361 B 
2.0 07.90 - 04.03 2.5, 81 kW 11.90 - 04.03 2.5 Syncro, 81 kW 10.92 - 04.03 1.9 D 07.90 - 04.03 1.9 TD 10.92 - 04.03 2.4 D Syncro 10.92 - 09.98 2.4 D, 57 kW 09.90 - 04.98	->Chass. 70-T-199 999	
2.5 TDI, 75 kW 09.95 - 04.03 2.5, 85 kW 08.96 - 04.03 2.5 Syncro, 85 kW 08.96 - 04.03 2.4 D, 55 kW 08.97 - 04.03 2.5 TDI Syncro 05.98 - 2.5 TDI, 65 kW 05.98 - 04.03		14571 02 7D0 407 361 
	Chass. 70-T-2-000 001->	



VOLKSWAGEN

TRANSPORTER T4
Pritsche, Fahrgestell /
Flatbed, Chassis Cab (70XD)

07.90 - 04.03



<p> Lagerung, Lenker</p> <table border="1"> <tr><td>2.0</td><td>07.90 - 04.03</td></tr> <tr><td>2.5, 81 kW</td><td>11.90 - 04.03</td></tr> <tr><td>1.9 D</td><td>07.90 - 04.03</td></tr> <tr><td>2.4 D, 57 kW</td><td>09.90 - 04.98</td></tr> <tr><td>2.5 Syncro, 81 kW</td><td>10.92 - 04.03</td></tr> <tr><td>2.5, 85 kW</td><td>08.96 - 04.03</td></tr> <tr><td>2.5 Syncro, 85 kW</td><td>08.96 - 04.03</td></tr> <tr><td>1.9 TD</td><td>10.92 - 04.03</td></tr> <tr><td>2.4 D, 55 kW</td><td>08.97 - 04.03</td></tr> <tr><td>2.4 D Syncro</td><td>10.92 - 09.98</td></tr> <tr><td>2.5 TDI Syncro</td><td>05.98 -</td></tr> <tr><td>2.5 TDI, 65 kW</td><td>05.98 - 04.03</td></tr> <tr><td>2.5 TDI, 75 kW</td><td>09.95 - 04.03</td></tr> <tr><td>2.5 TDI Syncro</td><td>05.98 - 04.03</td></tr> </table>	2.0	07.90 - 04.03	2.5, 81 kW	11.90 - 04.03	1.9 D	07.90 - 04.03	2.4 D, 57 kW	09.90 - 04.98	2.5 Syncro, 81 kW	10.92 - 04.03	2.5, 85 kW	08.96 - 04.03	2.5 Syncro, 85 kW	08.96 - 04.03	1.9 TD	10.92 - 04.03	2.4 D, 55 kW	08.97 - 04.03	2.4 D Syncro	10.92 - 09.98	2.5 TDI Syncro	05.98 -	2.5 TDI, 65 kW	05.98 - 04.03	2.5 TDI, 75 kW	09.95 - 04.03	2.5 TDI Syncro	05.98 - 04.03	<p></p> <p>Chass. 70-M-083 343-></p>	<p>14555 03 7D0 407 140 A</p> 
2.0	07.90 - 04.03																													
2.5, 81 kW	11.90 - 04.03																													
1.9 D	07.90 - 04.03																													
2.4 D, 57 kW	09.90 - 04.98																													
2.5 Syncro, 81 kW	10.92 - 04.03																													
2.5, 85 kW	08.96 - 04.03																													
2.5 Syncro, 85 kW	08.96 - 04.03																													
1.9 TD	10.92 - 04.03																													
2.4 D, 55 kW	08.97 - 04.03																													
2.4 D Syncro	10.92 - 09.98																													
2.5 TDI Syncro	05.98 -																													
2.5 TDI, 65 kW	05.98 - 04.03																													
2.5 TDI, 75 kW	09.95 - 04.03																													
2.5 TDI Syncro	05.98 - 04.03																													
<p>Lagerung, Lenker</p> <table border="1"> <tr><td>2.0</td><td>07.90 - 04.03</td></tr> <tr><td>2.5, 81 kW</td><td>11.90 - 04.03</td></tr> <tr><td>2.5 Syncro, 81 kW</td><td>10.92 - 04.03</td></tr> <tr><td>1.9 D</td><td>07.90 - 04.03</td></tr> <tr><td>1.9 TD</td><td>10.92 - 04.03</td></tr> <tr><td>2.4 D Syncro</td><td>10.92 - 09.98</td></tr> <tr><td>2.4 D, 57 kW</td><td>09.90 - 04.98</td></tr> <tr><td>2.5 TDI, 75 kW</td><td>09.95 - 04.03</td></tr> <tr><td>2.5, 85 kW</td><td>08.96 - 04.03</td></tr> <tr><td>2.5 Syncro, 85 kW</td><td>08.96 - 04.03</td></tr> <tr><td>2.4 D, 55 kW</td><td>08.97 - 04.03</td></tr> <tr><td>2.5 TDI Syncro</td><td>05.98 -</td></tr> <tr><td>2.5 TDI, 65 kW</td><td>05.98 - 04.03</td></tr> <tr><td>2.5 TDI Syncro</td><td>05.98 - 04.03</td></tr> </table>	2.0	07.90 - 04.03	2.5, 81 kW	11.90 - 04.03	2.5 Syncro, 81 kW	10.92 - 04.03	1.9 D	07.90 - 04.03	1.9 TD	10.92 - 04.03	2.4 D Syncro	10.92 - 09.98	2.4 D, 57 kW	09.90 - 04.98	2.5 TDI, 75 kW	09.95 - 04.03	2.5, 85 kW	08.96 - 04.03	2.5 Syncro, 85 kW	08.96 - 04.03	2.4 D, 55 kW	08.97 - 04.03	2.5 TDI Syncro	05.98 -	2.5 TDI, 65 kW	05.98 - 04.03	2.5 TDI Syncro	05.98 - 04.03	<p> I40/A60</p> <p>Chass. 70-T-200 000-></p>	<p>17681 01 7D0 407 183</p> 
2.0	07.90 - 04.03																													
2.5, 81 kW	11.90 - 04.03																													
2.5 Syncro, 81 kW	10.92 - 04.03																													
1.9 D	07.90 - 04.03																													
1.9 TD	10.92 - 04.03																													
2.4 D Syncro	10.92 - 09.98																													
2.4 D, 57 kW	09.90 - 04.98																													
2.5 TDI, 75 kW	09.95 - 04.03																													
2.5, 85 kW	08.96 - 04.03																													
2.5 Syncro, 85 kW	08.96 - 04.03																													
2.4 D, 55 kW	08.97 - 04.03																													
2.5 TDI Syncro	05.98 -																													
2.5 TDI, 65 kW	05.98 - 04.03																													
2.5 TDI Syncro	05.98 - 04.03																													
<p>Lagerung, Lenker</p> <table border="1"> <tr><td>ALL TYPES ausser :</td><td></td></tr> <tr><td>1.8</td><td>12.90 - 07.92</td></tr> <tr><td>2.8</td><td>05.96 - 05.00</td></tr> </table>	ALL TYPES ausser :		1.8	12.90 - 07.92	2.8	05.96 - 05.00	<p> I12/A39</p>	<p>25931 01 701 407 077 A</p> 																						
ALL TYPES ausser :																														
1.8	12.90 - 07.92																													
2.8	05.96 - 05.00																													
<p>Stange/Strebe, Stabilisator Pendelstange Gewindemaß: M12x1,5 Durchmesser Stabilisator [mm]: 27</p> <table border="1"> <tr><td>ALL TYPES ausser :</td><td></td></tr> <tr><td>1.8</td><td>12.90 - 07.92</td></tr> <tr><td>2.8</td><td>05.96 - 05.00</td></tr> </table>	ALL TYPES ausser :		1.8	12.90 - 07.92	2.8	05.96 - 05.00	<p></p>	<p>21044 02 701 411 049 B</p> 																						
ALL TYPES ausser :																														
1.8	12.90 - 07.92																													
2.8	05.96 - 05.00																													
<p>Stabilisatorlager</p> <table border="1"> <tr><td>ALL TYPES ausser :</td><td></td></tr> <tr><td>1.8</td><td>12.90 - 07.92</td></tr> <tr><td>2.8</td><td>05.96 - 05.00</td></tr> </table>	ALL TYPES ausser :		1.8	12.90 - 07.92	2.8	05.96 - 05.00	<p></p>	<p>17682 02 7D0 411 045</p> 																						
ALL TYPES ausser :																														
1.8	12.90 - 07.92																													
2.8	05.96 - 05.00																													
<p>Stabilisatorlager</p> <table border="1"> <tr><td>2.0</td><td>07.90 - 04.03</td></tr> <tr><td>2.5, 81 kW</td><td>11.90 - 04.03</td></tr> <tr><td>2.5 Syncro, 81 kW</td><td>10.92 - 04.03</td></tr> <tr><td>1.9 D</td><td>07.90 - 04.03</td></tr> <tr><td>1.9 TD</td><td>10.92 - 04.03</td></tr> <tr><td>2.4 D Syncro</td><td>10.92 - 09.98</td></tr> <tr><td>2.4 D, 57 kW</td><td>09.90 - 04.98</td></tr> </table>	2.0	07.90 - 04.03	2.5, 81 kW	11.90 - 04.03	2.5 Syncro, 81 kW	10.92 - 04.03	1.9 D	07.90 - 04.03	1.9 TD	10.92 - 04.03	2.4 D Syncro	10.92 - 09.98	2.4 D, 57 kW	09.90 - 04.98	<p> ->Chass. 70-T-199 999</p>	<p>19129 01 701 411 041</p> 														
2.0	07.90 - 04.03																													
2.5, 81 kW	11.90 - 04.03																													
2.5 Syncro, 81 kW	10.92 - 04.03																													
1.9 D	07.90 - 04.03																													
1.9 TD	10.92 - 04.03																													
2.4 D Syncro	10.92 - 09.98																													
2.4 D, 57 kW	09.90 - 04.98																													
<p>Faltenbalsatz, Lenkung</p> <table border="1"> <tr><td>ALL TYPES ausser :</td><td></td></tr> <tr><td>1.8</td><td>12.90 - 07.92</td></tr> <tr><td>2.8</td><td>05.96 - 05.00</td></tr> </table>	ALL TYPES ausser :		1.8	12.90 - 07.92	2.8	05.96 - 05.00	<p></p>	<p>30127 01 7D0 419 831</p> 																						
ALL TYPES ausser :																														
1.8	12.90 - 07.92																													
2.8	05.96 - 05.00																													



Ref.









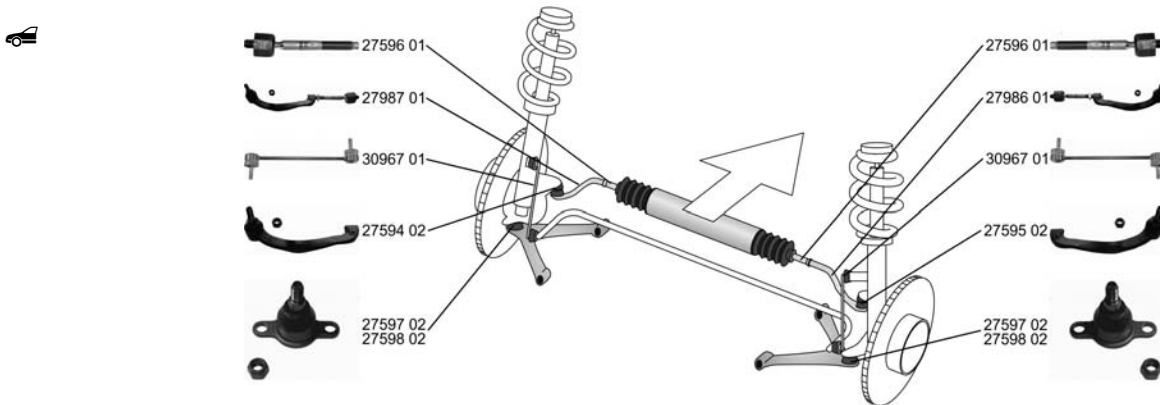

VOLKSWAGEN

TRANSPORTER T4 07.90 - 04.03 Pritsche, Fahrgestell / Flatbed, Chassis Cab (70XD)

 Achsträgerlager 2.5 Syncro 2.5 Syncro, 85 kW 2.4 D Syncro 2.5 TDI Syncro	10.92 - 04.03		26572 01 701 599 381 
	08.96 - 04.03 10.92 - 09.98 05.98 -		

TRANSPORTER T5 Bus/Familial 03.04 - (7HB, 7HJ)















Spurstange Konusmaß [mm]: 20 mit Befestigungsmaterial ALL TYPES		27986 01 7H0 419 804 D ▲27595 01 27596 01 
Spurstange Konusmaß [mm]: 20 mit Befestigungsmaterial ALL TYPES		27987 01 7H0 419 803 D ▲27594 01 27596 01 
Spurstangenkopf Konusmaß [mm]: 20 ALL TYPES		27594 02 7H0 422 817 C 
Spurstangenkopf Konusmaß [mm]: 20 ALL TYPES		27595 02 7H0 422 818 C 
Axialgelenk, Spurstange ALL TYPES	 	27596 01 7H0 422 817 C 7H0 422 818 C 



VOLKSWAGEN

**TRANSPORTER T5 Bus/Familial
(7HB, 7HJ)**



03.04 -

 Trag-/Führungsgelenk ALL TYPES	 zul. Gesamtgewicht [kg]:3200	26935 01 7H0 407 182 
Trag-/Führungsgelenk ALL TYPES	 zul. Gesamtgewicht [kg]:2600 zul. Gesamtgewicht [kg]:2800 zul. Gesamtgewicht [kg]:2850 zul. Gesamtgewicht [kg]:3000	26936 01 7H0 407 182 A 
Trag-/Führungsgelenk Konusmaß [mm]: 22 ALL TYPES	 zul. Gesamtgewicht [kg]:2600 zul. Gesamtgewicht [kg]:2800 zul. Gesamtgewicht [kg]:2850 zul. Gesamtgewicht [kg]:3000	27597 02 7H0 407 361 
Trag-/Führungsgelenk Konusmaß [mm]: 22 ALL TYPES	 zul. Gesamtgewicht [kg]:3200	27598 02 7H8 407 361 A 
Lagerung, Lenker ALL TYPES		26937 01 7H0 407 183 
Stange/Strebe, Stabilisator Pendelstange ALL TYPES		30967 01 7H5 411 317 A 

**TRANSPORTER T5
Kasten/Box/Furgón/Van (7HA, 7HH)**

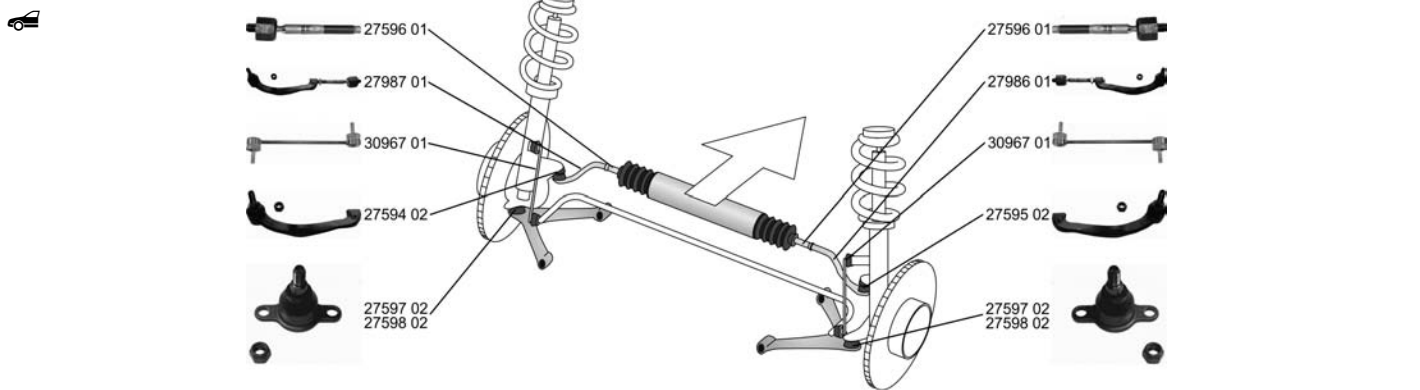
03.04 -

























Spurstange Konusmaß [mm]: 20 mit Befestigungsmaterial ALL TYPES		27986 01 7H0 419 804 D  ▲27595 01 27596 01
---	---	---



Ref.

VOLKSWAGEN

TRANSPORTER T5 03.04 - Kasten/Box/Furgón/Van (7HA, 7HH)

 Spurstange Konusmaß [mm]: 20 mit Befestigungsmaterial ALL TYPES		27987 01 7H0 419 803 D  27594 01 27596 01
		
Spurstangenkopf Konusmaß [mm]: 20 ALL TYPES		27594 02 7H0 422 817 C 
Spurstangenkopf Konusmaß [mm]: 20 ALL TYPES		27595 02 7H0 422 818 C 
Axialgelenk, Spurstange ALL TYPES		27596 01 7H0 422 817 C 7H0 422 818 C 
		
Trag-/Führungsgelenk ALL TYPES		26935 01 7H0 407 182 
	zul. Gesamtgewicht [kg]:3200	
Trag-/Führungsgelenk ALL TYPES		26936 01 7H0 407 182 A 
	zul. Gesamtgewicht [kg]:2600 zul. Gesamtgewicht [kg]:2800 zul. Gesamtgewicht [kg]:2850 zul. Gesamtgewicht [kg]:3000	
Trag-/Führungsgelenk Konusmaß [mm]: 22 ALL TYPES		27597 02 7H0 407 361 
	zul. Gesamtgewicht [kg]:2600 zul. Gesamtgewicht [kg]:2800 zul. Gesamtgewicht [kg]:2850 zul. Gesamtgewicht [kg]:3000	
Trag-/Führungsgelenk Konusmaß [mm]: 22 ALL TYPES		27598 02 7H8 407 361 A 
	zul. Gesamtgewicht [kg]:3200	
Lagerung, Lenker ALL TYPES		26937 01 7H0 407 183 
Stange/Strebe, Stabilisator Pendelstange ALL TYPES		30967 01 7H5 411 317 A 









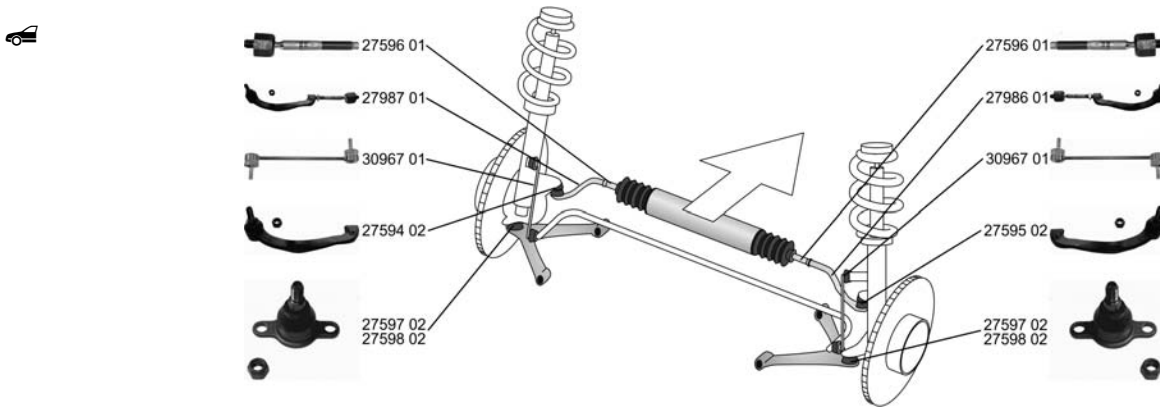







VOLKSWAGEN

TRANSPORTER T5
Pritsche/Fahrg./Flatbed, Chassis
(7JD,7JE,7JL)

03.04 -



<p>Spurstange Konusmaß [mm]: 20 mit Befestigungsmaterial ALL TYPES</p>		<p>27986 01 7H0 419 804 D ▲27595 01 27596 01</p> 
<p>Spurstange Konusmaß [mm]: 20 mit Befestigungsmaterial ALL TYPES</p>		<p>27987 01 7H0 419 803 D ▲27594 01 27596 01</p> 
<p>Spurstangenkopf Konusmaß [mm]: 20 ALL TYPES</p>		<p>27594 02 7H0 422 817 C</p> 
<p>Spurstangenkopf Konusmaß [mm]: 20 ALL TYPES</p>		<p>27595 02 7H0 422 818 C</p> 
<p>Axialgelenk, Spurstange ALL TYPES</p>	 	<p>27596 01 7H0 422 817 C 7H0 422 818 C</p> 
<p>Trag-/Führungsgelenk ALL TYPES</p>	 für Fahrzeuge mit Einfachkabine zul. Gesamtgewicht [kg]:3000	<p>26935 01 7H0 407 182</p> 
<p>Trag-/Führungsgelenk ALL TYPES</p>	 für Fahrzeuge mit Doppelkabine	<p>26936 01 7H0 407 182 A</p> 











Ref.

VOLKSWAGEN

TRANSPORTER T5 Pritsche/Fahrg./Flatbed, Chassis (7JD,7JE,7JL)

03.04 -

 Trag-/Führungsgelenk Konusmaß [mm]: 22 ALL TYPES	 für Fahrzeuge mit Doppelkabine	27597 02 7H0 407 361 
Trag-/Führungsgelenk Konusmaß [mm]: 22 ALL TYPES	 für Fahrzeuge mit Einfachkabine zul. Gesamtgewicht [kg]:3000	27598 02 7H8 407 361 A 
Lagerung, Lenker ALL TYPES		26937 01 7H0 407 183 
Stange/Strebe, Stabilisator Pendelstange ALL TYPES		30967 01 7H5 411 317 A 



















































Arithmetische Liste

Artikelnummer	Seite	Hersteller	Artikelnummer	Seite	Hersteller
10155 03	304 310 317	VOLKSWAGEN	10281 02	283 285 287	VOLKSWAGEN
Trag-/Führungsgelenk			Lenkstange		
10157 01	283 285 288	VOLKSWAGEN	10282 01	276	VOLKSWAGEN
Trag-/Führungsgelenk			Axialgelenk, Spurstange		
10159 03	295 297 298	VOLKSWAGEN	10284 01	302 309 316	VOLKSWAGEN
Trag-/Führungsgelenk			Spurstangenkopf		
10160 04	276	VOLKSWAGEN	10285 02	304 310 317	VOLKSWAGEN
Reparatursatz, Trag- /Führungsgelenk			Axialgelenk, Spurstange		
10161 07	260	SEAT	10286 01	303 309 316	VOLKSWAGEN
Reparatursatz, Trag- /Führungsgelenk	278	VOLKSWAGEN	Spurstangenkopf		
10162 02	296 297 298	VOLKSWAGEN	10287 02	300 307 313	VOLKSWAGEN
Reparatursatz, Trag- /Führungsgelenk			Spurstange		
10163 03	283 285 288	VOLKSWAGEN	10289 02	300 307 313	VOLKSWAGEN
Trag-/Führungsgelenk			Spurstange		
10164 03	304 311 317	VOLKSWAGEN	10290 02	300 307 314	VOLKSWAGEN
Trag-/Führungsgelenk			10291 02	300 307 314	VOLKSWAGEN
10165 01	276	VOLKSWAGEN	Spurstange		
Lenker, Radaufhängung			11378 01	136	MERCEDES-BENZ
10172 01	259	SEAT	Winkelgelenk, Lenkschubstange		
Lenker, Radaufhängung	278	VOLKSWAGEN	11380 01	135	MERCEDES-BENZ
10174 01	296 297 298	VOLKSWAGEN	Spurstangenkopf		
Lagerung, Lenker			11381 01	135	MERCEDES-BENZ
10175 01	283 285 288	VOLKSWAGEN	Spurstangenkopf		
Lagerung, Lenker			11391 01	114 114 116	MERCEDES-BENZ
10197 01	296 297 299	VOLKSWAGEN	Winkelgelenk, Lenkschubstange	116 119 119	
Achskörperlager				121 121 123	
10202 01	276	VOLKSWAGEN		123 125 125	
Lagerung, Lenker			11395 01	114 114 117	MERCEDES-BENZ
10203 02	260	SEAT	Winkelgelenk, Lenkschubstange	119 121 121	
Lagerung, Lenker	278	VOLKSWAGEN		123 123 125	
10205 02	260	SEAT		125	
Lagerung, Lenker	278	VOLKSWAGEN	11407 01	137	MERCEDES-BENZ
10207 01	283 286 288	VOLKSWAGEN	Winkelgelenk, Lenkschubstange		
Lagerung, Lenker			11446 01	113 113 115	MERCEDES-BENZ
10208 01	284 286 288	VOLKSWAGEN	Spurstangenkopf	115 118 120	
Lagerung, Lenker				120 122 122	
10247 01	282 284 286	VOLKSWAGEN		124 124 134	
Spurstange			11447 01	113 116 118	MERCEDES-BENZ
10251 02	276 295 297	VOLKSWAGEN	Spurstangenkopf	120 122 124	
Spurstangenkopf	298			134	
10259 01	292	VOLKSWAGEN	11448 01	114 116 118	MERCEDES-BENZ
Lenkstange			Lenkstange	121 123 125	
10266 01	276	VOLKSWAGEN	11449 02	113 115 117	MERCEDES-BENZ
Spurstange			Spurstange	120 122 124	
10270 01	295 296 298	VOLKSWAGEN	11450 01	113 115 117	MERCEDES-BENZ
Spurstange			Spurstange	120 122 124	
10272 01	295 297 298	VOLKSWAGEN	11451 01	114 116 118	MERCEDES-BENZ
Axialgelenk, Spurstange			Spurstangenkopf	120 120 122	
10273 02	282 284 287	VOLKSWAGEN		122 124 124	
Spurstange			11452 01	114 116 118	MERCEDES-BENZ
10274 02	302 308 315	VOLKSWAGEN	Spurstangenkopf	120 120 122	
Spurstangenkopf				122 124 124	
10275 02	302 309 315	VOLKSWAGEN	11462 01	92 94 96	MERCEDES-BENZ
Spurstangenkopf			Trag-/Führungsgelenk	115	
10276 02	282 284 287	VOLKSWAGEN	11589 02	3 6	CITROËN
Spurstange			Stange/Strebe, Stabilisator	224 227	PEUGEOT
10278 02	299 306 313	VOLKSWAGEN	11591 02	10 12 13	CITROËN
Spurstange			Trag-/Führungsgelenk	30 31 32	FIAT
10279 02	282 284 287	VOLKSWAGEN		33 34 35	
Spurstangenkopf				53 54 55	
10280 02	283 285 287	VOLKSWAGEN			
Spurstangenkopf					













































Artikelnummer	Seite	Hersteller	Artikelnummer	Seite	Hersteller
11603 02 ☉	10 11 13	CITROËN	11917 01 ☉☿	270 271	TOYOTA
Spurstangenkopf	30 31 32	FIAT	Axialgelenk, Spurstange		
	33 34 35		12064 01 ▼☉	9	CITROËN
	53 54 55		Lenker, Radaufhängung		
	215 216 217	PEUGEOT	12065 01 ▼☉	9	CITROËN
	219 220		Lenker, Radaufhängung		
11631 02 ▲☉	261 262	SEAT	12070 04 ☉☿	1 4 9	CITROËN
Trag-/Führungsgelenk			Spurstangenkopf	222 225	PEUGEOT
11634 01 ☉☿	49	FIAT	12117 02 ☉☿	250 250	RENAULT
Spurstangenkopf			Spurstangenkopf		
11637 02 ☉	83 86 88	IVECO	12119 03 ▼☉	251	RENAULT
Spurstangenkopf			Reparatursatz,Trag- /Führungsgelenk		
11638 02 ▲▼☉	84 87 89	IVECO	12125 01 ☉	251 252 253	RENAULT
Trag-/Führungsgelenk			Spurstange	254 255	
11639 01 ▲▼☉	85 88 89	IVECO	12128 01 ☉☿	250	RENAULT
Trag-/Führungsgelenk	221	PEUGEOT	Spurstange		
11646 03 ☉☿	56 57	FORD	12129 01 ☉	250	RENAULT
Spurstangenkopf			Axialgelenk, Spurstange		
11651 01 ☉☿	65 67 69	FORD	12129 02	250	RENAULT
Axialgelenk, Spurstange	70 71 72		12148 02 ▼☉☿	190	OPEL
11654 01 Ⓡ	64 66 68	FORD	Reparatursatz,Trag- /Führungsgelenk		
Spurstangenkopf			12170 01 ☉☿	189	OPEL
11659 01 ☉☿	64 66 68	FORD	Axialgelenk, Spurstange		
Spurstangenkopf			12171 01 ☉☿	189	OPEL
11826 02 ▲☉☿	172	MITSUBISHI	Axialgelenk, Spurstange		
Spurstangenkopf			12178 01 ☉☿	189	OPEL
11839 01 ▲☉☿	172	MITSUBISHI	Spurstangenkopf		
Spurstangenkopf			12236 01	251 252 253	RENAULT
11840 03 ☉☿	172	MITSUBISHI		254 255	
Spurstangenkopf			12236 02 ☉☿	188	OPEL
11841 01 ☉☿	172 174 176	MITSUBISHI	Spurstangenkopf	251 252 253	RENAULT
Spurstangenkopf				254 255	
11842 02 ☉☿	172 173 175	MITSUBISHI	12825 01	136	MERCEDES-BENZ
Spurstangenkopf	177		Spurstangenkopf		
11847 01 ▲▼☉☿	173 175	MITSUBISHI	12831 01 ☉☿	65 67 68	FORD
Trag-/Führungsgelenk			Spurstangenkopf	91 91 93	MERCEDES-BENZ
11849 03 ▲☉	173 175 176	MITSUBISHI		93 95 95	
Trag-/Führungsgelenk			12834 01	148 149 150	MERCEDES-BENZ
11852 01 ▲☉☿	173 174 175	MITSUBISHI	Stabilisatorlager	151 152 153	
Trag-/Führungsgelenk			12838 01 ☉	92 94 96	MERCEDES-BENZ
11853 03 ▼☉☿	173 174 176	MITSUBISHI	Spurstangenkopf		
Trag-/Führungsgelenk			12839 01 ☉☿	92 94 96	MERCEDES-BENZ
11860 02 ▲☉☿	182 183 184	NISSAN	Spurstangenkopf		
Trag-/Führungsgelenk			12840 01 ☉☿	92 94 96	MERCEDES-BENZ
11863 02 ▼☉☿	183 184	NISSAN	Spurstangenkopf		
Trag-/Führungsgelenk			12841 01 ☉☿	91 93 95	MERCEDES-BENZ
11868 03 ▼☉☿	184 185 186	NISSAN	Spurstange		
Trag-/Führungsgelenk			12842 01 ☉	91 93 95	MERCEDES-BENZ
11873 03 ▼☉☿	182	NISSAN	Spurstange		
Trag-/Führungsgelenk			12843 01 ☉	91 93 95	MERCEDES-BENZ
11898 02 ▼☉☿	273 274 275	TOYOTA	Spurstange		
Trag-/Führungsgelenk			12844 01 ☉☉	92 94 96	MERCEDES-BENZ
11902 02 ▼☉☿	272	TOYOTA	Spurstangenkopf		
Trag-/Führungsgelenk	294	VOLKSWAGEN	12845 01 ☉	92 94 96	MERCEDES-BENZ
11903 02 ▲☉☿	270	TOYOTA	Lenkstange		
Trag-/Führungsgelenk			12871 01 (x2)	98 99 101	MERCEDES-BENZ
11904 01 ▲☉☿	273 274 275	TOYOTA	Stabilisatorlager	102 104 106	
Trag-/Führungsgelenk				115 117 119	
11905 02 ▲☉☿	269	TOYOTA			
Trag-/Führungsgelenk					
11907 02 ☉☿	269 272	TOYOTA			
Spurstangenkopf	294	VOLKSWAGEN			
11908 02 ☉☿	272	TOYOTA			
Spurstangenkopf	294	VOLKSWAGEN			

Arithmetische Liste

Artikelnummer	Seite	Hersteller	Artikelnummer	Seite	Hersteller
12876 01	138 139 140	MERCEDES-BENZ	15377 02	10 11 13	CITROËN
Stabilisatorlager			Axialgelenk,	30 31 32	FIAT
12877 01	134	MERCEDES-BENZ	Spurstange	33 34 35	
Spurstange				53 54 55	
13566 01	113	MERCEDES-BENZ		216 217 218	PEUGEOT
Spurstange				219 220	
13569 01	91 93 95	MERCEDES-BENZ	15450 01	172 175	MITSUBISHI
Spurstange			Spurstangenkopf		
13606 01	92 92 94	MERCEDES-BENZ	15468 02	65 67 69	FORD
Winkelgelenk,	94 96 96		Spurstangenkopf	92 94 96	MERCEDES-BENZ
Lenkschubstange			15562 02	172 175 176	MITSUBISHI
13770 02	304 310 317	VOLKSWAGEN	Spurstangenkopf		
Axialgelenk,			15566 02	173 174 175	MITSUBISHI
Spurstange			Axialgelenk,	177	
13784 02	296 297 298	VOLKSWAGEN	Spurstange		
Reparatursatz, Trag-			15577 01	184 185 186	NISSAN
/Führungsgelenk			Trag-/Führungsgelenk		
13785 01	283 285 288	VOLKSWAGEN	15595 01	184 185	NISSAN
Winkelgelenk,			Spurstangenkopf		
Lenkschubstange			15622 01	3 6	CITROËN
13786 02	283 285 287	VOLKSWAGEN	Faltenbalg, Lenkung		
Spurstangenkopf			15669 02	279	VOLKSWAGEN
13787 02	283 285 287	VOLKSWAGEN	Trag-/Führungsgelenk		
Spurstangenkopf			15670 02	279	VOLKSWAGEN
13794 02	303 309 316	VOLKSWAGEN	Spurstangenkopf		
Spurstangenkopf			15690 01	268	SUZUKI
13795 02	300 307 314	VOLKSWAGEN	Lenker,		
Spurstange			Radaufhängung		
13796 02	300 307 314	VOLKSWAGEN	15717 02	272	TOYOTA
Spurstange			Trag-/Führungsgelenk	295	VOLKSWAGEN
14378 01	296 297 299	VOLKSWAGEN	15719 03	273	TOYOTA
Stabilisatorlager			Spurstangenkopf		
14383 01	284 286 288	VOLKSWAGEN	15740 02	274	TOYOTA
Lagerung, Lenker			Axialgelenk,		
14496 01	292	VOLKSWAGEN	Spurstange		
Winkelgelenk,			16056 02	190	OPEL
Lenkschubstange			Lagerung, Lenker		
14547 02	301 307 314	VOLKSWAGEN	16284 01	182 183	NISSAN
Spurstange			Spurstange		
14548 02	301 308 314	VOLKSWAGEN	16296 01	183	NISSAN
Spurstange			Axialgelenk,		
14549 02	303 309 316	VOLKSWAGEN	Spurstange		
Spurstangenkopf			16304 01	182 183	NISSAN
14555 03	305 311 318	VOLKSWAGEN	Spurstangenkopf		
Lagerung, Lenker			16307 02	182 183	NISSAN
14570 02	301 308 314	VOLKSWAGEN	Spurstangenkopf		
Spurstange			16308 02	183	NISSAN
14571 02	305 311 317	VOLKSWAGEN	Spurstangenkopf		
Reparatursatz, Trag-			16315 02	184 185	NISSAN
/Führungsgelenk			Spurstangenkopf		
14767 04	2 6	CITROËN	16316 01	185	NISSAN
Trag-/Führungsgelenk	223 226	PEUGEOT	Spurstangenkopf		
14773 02	11 12 13	CITROËN	16317 03	185 186	NISSAN
Trag-/Führungsgelenk	30 31 32	FIAT	Spurstangenkopf		
	216 217 218	PEUGEOT	16361 02	269	TOYOTA
14792 01	1 5	CITROËN	Spurstangenkopf		
Axialgelenk,	222 225	PEUGEOT	16374 02	273 274	TOYOTA
Spurstange			Spurstangenkopf		
15195 02	273 274	TOYOTA	16397 02	274 275	TOYOTA
Axialgelenk,			Axialgelenk,		
Spurstange			Spurstange		
15283 02	174	MITSUBISHI	16426 03	272	TOYOTA
Trag-/Führungsgelenk			Trag-/Führungsgelenk	295	VOLKSWAGEN
15342 01	11 12 13	CITROËN	16431 01	273	TOYOTA
Faltenbalg, Lenkung	30 32 34	FIAT	Trag-/Führungsgelenk	295	VOLKSWAGEN
	36 38 41		16503 03	235	RENAULT
	43		Spurstange		
	216 217 218	PEUGEOT			

Artikelnummer	Seite	Hersteller	Artikelnummer	Seite	Hersteller
16612 01  (x4)	284 286 288	VOLKSWAGEN	18874 03 	128 130	MERCEDES-BENZ
Stabilisatorlager	292 293		Spurstangenkopf		
16630 02 	301 308 315	VOLKSWAGEN	18875 03 	97 98 100	MERCEDES-BENZ
Spurstange			Trag-/Führungsgelenk	102 103 105	
17400 02 	260	SEAT		107 108	
Lagerung,	278	VOLKSWAGEN		289 290 291	VOLKSWAGEN
Stabilisator-koppelstan- ge			18876 02 	97 97 98	MERCEDES-BENZ
17435 01 	1 5	CITROËN	Axialgelenk,	98 100 100	
Lenker,	222 226	PEUGEOT	Spurstange	101 101 103	
Radaufhängung				103 105 105	
17436 01 	2 5	CITROËN		107 107 108	
Lenker,	223 226	PEUGEOT		108 110	
Radaufhängung				289 289 290	VOLKSWAGEN
17642 04 	259	SEAT		290 291 291	
Spurstangenkopf	277	VOLKSWAGEN	19129 01 	306 312 318	VOLKSWAGEN
17673 02 	302 308 315	VOLKSWAGEN	Stabilisatorlager		
Spurstange			19130 01 	65 67 69	FORD
17674 02 	303 309 316	VOLKSWAGEN	Spurstangenkopf		
Spurstangenkopf			19139 03 	70 71 72	FORD
17675 02 	303 310 316	VOLKSWAGEN	Spurstangenkopf	73 74 75	
Spurstangenkopf			19247 01 	9	CITROËN
17679 02 	302 308 315	VOLKSWAGEN	Lagerung, Lenker		
Spurstange			19251 03 	25 26 27	CITROËN
17681 01 	305 311 318	VOLKSWAGEN	Spurstangenkopf	51 52	FIAT
Lagerung, Lenker				212 213 214	PEUGEOT
17682 02 	305 312 318	VOLKSWAGEN	19373 01 	251	RENAULT
Stabilisatorlager			Lenker,		
17739 02 	190	OPEL	Radaufhängung		
Trag-/Führungsgelenk			19719 02 	97 97 98	MERCEDES-BENZ
17786 03 	56 57 59	FORD	Spurstangenkopf	98 100 100	
Trag-/Führungsgelenk				101 101 103	
17795 01 	58 60	FORD		103 105 105	
Spurstangenkopf				107 107 108	
17796 01 	58 60	FORD		108 110	
Spurstangenkopf				289 289 290	VOLKSWAGEN
17842 01 	63 64 65	FORD		290 291 291	
Spurstangenkopf	67 69		19722 01 	128 128 130	MERCEDES-BENZ
17861 02 	65 67 69	FORD	Axialgelenk,	130	
Spurstangenkopf			Spurstange		
17865 01 	57 60	FORD	20015 01 	261	SEAT
Lenker,			Lenker,		
Radaufhängung			Radaufhängung		
17866 01 	57 60	FORD	20030 01 	49 50	FIAT
Lenker,			Axialgelenk,	261 262	SEAT
Radaufhängung			Spurstange		
18048 02 	58 59 61	FORD	20031 02 	261	SEAT
Stange/Strebe,			Spurstangenkopf		
Stabilisator			20227 02 	186 187	NISSAN
18142 01 	251	RENAULT	Trag-/Führungsgelenk		
Lenker,			20228 02 	186 187	NISSAN
Radaufhängung			Trag-/Führungsgelenk		
18178 01 	241 242 243	RENAULT	20246 02 	186 187	NISSAN
Spurstangenkopf			Stange/Strebe,		
18179 01 	241 242 243	RENAULT	Stabilisator		
Trag-/Führungsgelenk			20338 03 	261	SEAT
18180 01 	241 242 243	RENAULT	Lenker,		
Trag-/Führungsgelenk			Radaufhängung		
18373 04 	259	SEAT	20345 01 	84 87 89	IVECO
Spurstangenkopf	277	VOLKSWAGEN	Axialgelenk,		
18441 01 	141	MERCEDES-BENZ	Spurstange		
Stabilisatorlager			20898 01 	134	MERCEDES-BENZ
18483 01 	63 64 65	FORD	Spurstange		
Spurstangenkopf	67 69		20965 01 	108 109 110	MERCEDES-BENZ
18852 01 	115 117 119	MERCEDES-BENZ	Stabilisatorlager	291 292	VOLKSWAGEN
Stabilisatorlager	121 123 125		21044 02 	305 311 318	VOLKSWAGEN
18874 01	128 130	MERCEDES-BENZ	Stange/Strebe,		
			Stabilisator		

Arithmetische Liste

Artikelnummer	Seite	Hersteller	Artikelnummer	Seite	Hersteller
21107 01 	117 119	MERCEDES-BENZ	22817 01	82 83 88	IVECO
Stabilisatorlager			Spurstangenkopf		
21190 01 	230 236	RENAULT	22818 01	82 84 89	IVECO
Spurstangenkopf			Axialgelenk, Spurstange		
21191 01 	230 236	RENAULT	22934 01 	129 131	MERCEDES-BENZ
Spurstangenkopf			Achskörperlager		
21236 01 	265 265 267	SKODA	23067 01 	129 131	MERCEDES-BENZ
Achskörperlager	267		Achskörperlager		
21790 01 	154	MERCEDES-BENZ	23711 01 	190	OPEL
Stabilisatorlager			Stabilisatorlager		
22088 02 	128 131	MERCEDES-BENZ	23939 01 	113	MERCEDES-BENZ
Stange/Strebe, Stabilisator			Spurstange		
22089 02 	129 131	MERCEDES-BENZ	23962 01 	134	MERCEDES-BENZ
Stange/Strebe, Stabilisator			Spurstange		
22214 01 	129 131	MERCEDES-BENZ	23965 01 	135	MERCEDES-BENZ
Stabilisatorlager			Spurstange		
22307 01 	304 310 317	VOLKSWAGEN	24503 01 	241 242 243	RENAULT
Axialgelenk, Spurstange			Lagerung, Lenker		
22313 01 	292	VOLKSWAGEN	24534 02 	14 16 18	CITROËN
Lenkstange			Spurstangenkopf		
22339 04 	2 6	CITROËN		20 22 23	FIAT
Trag-/Führungsgelenk	223 227	PEUGEOT		36 38 42	FIAT
22394 01	128 130	MERCEDES-BENZ		44 46 47	PEUGEOT
				201 203 205	PEUGEOT
				207 208 210	
22394 02 	128 130	MERCEDES-BENZ	24538 02 	15 17 19	CITROËN
Reparatursatz, Trag- /Führungsgelenk			Trag-/Führungsgelenk		FIAT
22408 01 	80 81	HYUNDAI		37 39 43	
Spurstangenkopf				45 48	PEUGEOT
22491 01 	252 253 254	RENAULT		202 204 206	PEUGEOT
Lagerung, Lenker	255		24539 01 	15 17 19	CITROËN
22714 01	83	IVECO	Trag-/Führungsgelenk		FIAT
Spurstangenkopf				37 40 43	
22726 01	251 252 253	RENAULT		45 48	PEUGEOT
	254 255			202 204 206	PEUGEOT
22726 02 	251 252 253	RENAULT	24548 01 	56 58	FORD
Axialgelenk, Spurstange	254 255		Lagerung, Lenker		
22773 01 	189	OPEL	24597 01 	129 131	MERCEDES-BENZ
Lenker, Radaufhängung			Achskörperlager		
22774 01 	189	OPEL	24636 02 	97 99 100	MERCEDES-BENZ
Lenker, Radaufhängung			Lagerung, Lenker		
22777 01 	59 60	FORD		102 103 105	
Lenker, Radaufhängung				107 109 110	
22778 01 	59 60	FORD	24724 01 	129 132	MERCEDES-BENZ
Lenker, Radaufhängung			Stange/Strebe, Stabilisator		
22781 01 	56 57	FORD	24725 01	130 132	MERCEDES-BENZ
Lenker, Radaufhängung			Stabilisatorlager		
22782 01 	56 57	FORD	24810 01 	57	FORD
Lenker, Radaufhängung			Lenker, Radaufhängung		
22785 01 	10 12 13	CITROËN	24811 01 	57	FORD
Lenker,	33 34 35	FIAT	Lenker, Radaufhängung		
Radaufhängung	53 54 55		25108 02 	14 16 18	CITROËN
	216 217 218	PEUGEOT	Axialgelenk, Spurstange		
	219 220			20 22 23	FIAT
22786 01 	10 12 13	CITROËN		36 38 42	FIAT
Lenker,	33 34 35	FIAT		44 46 47	PEUGEOT
Radaufhängung	53 54 55			201 203 205	PEUGEOT
	216 217 218	PEUGEOT		207 208 210	
			25147 01 	189	OPEL
			Spurstangenkopf		
			25176 01	58	FORD
			Lagerung, Lenker		
			25204 01 	186 187	NISSAN
			Spurstangenkopf		
			25327 01 	279	VOLKSWAGEN
			Spurstangenkopf		
			25328 01 	280	VOLKSWAGEN
			Spurstangenkopf		

Artikelnummer	Seite	Hersteller	Artikelnummer	Seite	Hersteller
25329 02 ☉☉	280	VOLKSWAGEN	25814 02 ☉	178 179	NISSAN
Axialgelenk, Spurstange			Stange/Strebe, Stabilisator	194 196 198 241 242 243 245 246 247 248 249	OPEL RENAULT
25344 02 ☉	129 131	MERCEDES-BENZ	25815 02 ☉	178 179	NISSAN
Stange/Strebe, Stabilisator			Stange/Strebe, Stabilisator	194 196 198 241 242 243 245 246 247 248 249	OPEL RENAULT
25345 02 ☉	129 131	MERCEDES-BENZ	25931 01 ▲☉☉	305 311 318	VOLKSWAGEN
25352 01 ☉☉(x2)	260	SEAT	Lagerung, Lenker		
Reparaturatz, Lenker	278	VOLKSWAGEN	26015 02 ☉	126	MERCEDES-BENZ
25446 02 ☉☉	231 236	RENAULT	Stange/Strebe, Stabilisator		
Spurstangenkopf			26016 02 ▼☉	126	MERCEDES-BENZ
25459 01 ☉	128 130	MERCEDES-BENZ	Trag-/Führungsgelenk		
Spurstange			26047 02 ▼☉	2 6	CITROËN
25463 02 ☉	265 267	SKODA	Trag-/Führungsgelenk	223 227	PEUGEOT
Stange/Strebe, Stabilisator			26101 01	142	MERCEDES-BENZ
25475 01 ☉	232 237	RENAULT	Stabilisatorlager		
Axialgelenk, Spurstange			26109 01	155 156 157	MERCEDES-BENZ
25476 01 ☉	232 237	RENAULT	Stabilisatorlager	158 159 160 161 162 163	
Axialgelenk, Spurstange			26110 01 ▲	168 169 170	MERCEDES-BENZ
25484 02 ☉☉	232 237	RENAULT	Lagerbuchse, Blattfeder	171	
Spurstangenkopf			26501 01	192	OPEL
25491 01 ☉☉△	61 62	FORD	26501 02 ☉	191 192	OPEL
Axialgelenk, Spurstange			Trag-/Führungsgelenk		
25510 01 ☉☉	180 181	NISSAN	26520 02 ☉☉	126	MERCEDES-BENZ
Spurstangenkopf	198 199 256 257	OPEL RENAULT	Spurstangenkopf		
25511 01 ☉☉	180 181	NISSAN	26572 01 ☉	306 312 319	VOLKSWAGEN
Spurstangenkopf	198 199 256 257	OPEL RENAULT	Achsträgerlager		
25513 02 ☉	181 182	NISSAN	26573 01 (x4)	92 94 96	MERCEDES-BENZ
Stange/Strebe, Stabilisator	199 200 257 258	OPEL RENAULT	Lagerung, Lenker		
25524 02 ▼☉	264 267	SKODA	26574 01 ▼☉	127 128 128 130 130 132 134	MERCEDES-BENZ
Reparaturatz, Trag- /Führungsgelenk			Lagerung, Lenker		
25525 02 ▼☉	264 267	SKODA	26577 01 ☉	224 227	PEUGEOT
Reparaturatz, Trag- /Führungsgelenk			Stabilisatorlager		
25534 02 ▼☉	3 6	CITROËN	26578 01 ☉	26	CITROËN
Reparaturatz, Trag- /Führungsgelenk	223 227	PEUGEOT	Achskörperlager	51 52 213 214	FIAT PEUGEOT
25538 01 ☉	66 68 69	FORD	26580 01 ☉☉	191 192 192	OPEL
Stange/Strebe, Stabilisator	71 72 73 74 75		Lagerung, Lenker		
25539 01 ☉	66 68 69	FORD	26581 02 ☉☉	191 192 192	OPEL
Stange/Strebe, Stabilisator	71 72 73 74 75		Lagerung, Lenker		
25540 02 ▼☉	70 71 72	FORD	26582 01 ☉	191 192	OPEL
Trag-/Führungsgelenk	73 74 75		Achskörperlager		
25800 01 ☉	97 99 100	MERCEDES-BENZ	26593 01 (x2)	129 131	MERCEDES-BENZ
Stange/Strebe, Stabilisator	102 103 105 107 109 110 289 290 291	VOLKSWAGEN	Lagerung, Lenker		
25801 01 ☉	97 99 100	MERCEDES-BENZ	26604 01 ☉	190	OPEL
Stange/Strebe, Stabilisator	102 104 106 107 109 110 289 290 291	VOLKSWAGEN	Lagerung, Lenker		
25802 01 ☉	98 99 101	MERCEDES-BENZ	26614 01 ▼☉	127 128 128 130 130 133 134	MERCEDES-BENZ
Stange/Strebe, Stabilisator	102 104 106 108 109 110 289 290 292	VOLKSWAGEN	Lagerung, Lenker		
			26667 01 ▼☉	15 18 19 21 22 24 37 40 43 45 47 48 202 204 206 208 209 211	CITROËN FIAT PEUGEOT
			26668 01 ▼☉	15 18 19	CITROËN
			Trag-/Führungsgelenk	21 23 24	



































Arithmetische Liste

Artikelnummer	Seite	Hersteller	Artikelnummer	Seite	Hersteller
26669 01	263 266	SKODA	26939 01 ▾⊕⊖	180 182	NISSAN
26669 02 ♂	264 265 266	SKODA	Lagerung, Lenker	199 200	OPEL
Spurstangenkopf				257 258	RENAULT
26670 01	263 266	SKODA	26940 01 ▲	143	MERCEDES-BENZ
26670 02 ♂	264 265 266	SKODA	Stabilisatorlager		
Spurstangenkopf			26941 01 ▲	166 167	MERCEDES-BENZ
26671 01 ⊕⊖△	264 266 266	SKODA	Stabilisatorlager		
Axialgelenk, Spurstange			27056 01 ▾⊕	234 238	RENAULT
26697 02 ♂	126	MERCEDES-BENZ	Lenker, Radaufhängung		
Spurstangenkopf			27057 01 ▾⊕	234 239	RENAULT
26698 01 ⊕⊖	126	MERCEDES-BENZ	Lenker, Radaufhängung		
Axialgelenk, Spurstange			27065 02 ▾⊕	25 26 27	CITROËN
26705 02 ⊕	28 29	FIAT	Lenker, Radaufhängung	51 52	FIAT
Trag-/Führungsgelenk				212 213 214	PEUGEOT
26706 01 ⊕⊖	178 179	NISSAN	27066 02 ▾⊕	25 26 27	CITROËN
Axialgelenk, Spurstange	193 194 196	OPEL	Lenker, Radaufhängung	51 52	FIAT
	197			212 213 214	PEUGEOT
	244 245 247	RENAULT	27078 02 ♂	259	SEAT
26711 01 ⊕⊖△	233 238	RENAULT	Spurstangenkopf	277	VOLKSWAGEN
Axialgelenk, Spurstange			27079 02 ♂	259	SEAT
26712 02 ♂	178 179	NISSAN	Spurstangenkopf	277	VOLKSWAGEN
Spurstangenkopf	193 194 195	OPEL	27219 02 ▾⊕	180 181	NISSAN
	197		Trag-/Führungsgelenk	198 200	OPEL
	244 245 246	RENAULT		256 257 258	RENAULT
26713 02 ♂	178 179	NISSAN	27299 02 ▾⊕	7 8	CITROËN
Spurstangenkopf	193 194 195	OPEL	Trag-/Führungsgelenk	228	PEUGEOT
	197		27303 02 ⊕	187	NISSAN
	244 245 247	RENAULT	Stange/Strebe, Stabilisator		
26714 02 ▾⊕	2 5	CITROËN	27308 01 ▾⊕⊖	59 60	FORD
Lenker, Radaufhängung	223 226	PEUGEOT	Lagerung, Lenker		
26715 02 ▾⊕	2 6	CITROËN	27320 01 ⊕△	264	SKODA
Lenker, Radaufhängung	223 226	PEUGEOT	Axialgelenk, Spurstange		
26721 01 ⊕	233 238	RENAULT	27321 01 ⊕⊖△	264	SKODA
Axialgelenk, Spurstange			Axialgelenk, Spurstange		
26768 01 ⊕	234 239	RENAULT	27408 01 ⊕⊖	59 60	FORD
Trag-/Führungsgelenk			Lagerung, Lenker		
26772 02 ▾⊕	280	VOLKSWAGEN	27439 01	99 101 104	MERCEDES-BENZ
Trag-/Führungsgelenk			Stabilisatorlager	106	
26773 02 ▾⊕	280	VOLKSWAGEN	27440 01 ⊕	98 99 101	MERCEDES-BENZ
Trag-/Führungsgelenk			Stabilisatorlager	102 104 106	
26774 01 ⊕	280	VOLKSWAGEN	27461 01 ⊕⊖	278	VOLKSWAGEN
Stange/Strebe, Stabilisator			Stabilisatorlager		
26814 01 ⊕	265	SKODA	27593 03 ♂	76 77 78	FORD
Achskörperlager			Spurstangenkopf		
26846 02 ▾⊕	66 67 69	FORD	27594 01	293 319 321	VOLKSWAGEN
Trag-/Führungsgelenk				322	
26920 01	146 147	MERCEDES-BENZ	27594 02 ♂	293 319 321	VOLKSWAGEN
Achsstrebenlager			Spurstangenkopf	322	
26928 01 ▲	164 165	MERCEDES-BENZ	27595 01	293 319 320	VOLKSWAGEN
Stabilisatorlager				322	
26935 01 ⊕⊖	320 321 322	VOLKSWAGEN	27595 02 ♂	293 319 321	VOLKSWAGEN
Trag-/Führungsgelenk			Spurstangenkopf	322	
26936 01 ⊕⊖	294 320 321	VOLKSWAGEN	27596 01 ⊕	293 293 319	VOLKSWAGEN
Trag-/Führungsgelenk	322		Axialgelenk, Spurstange	319 321 321	
26937 01 ⊕⊖	294 320 321	VOLKSWAGEN		322 322	
Lagerung, Lenker	323		27597 02 ▾⊕	294 320 321	VOLKSWAGEN
26938 01 ▾⊕⊖	180 181	NISSAN	Trag-/Führungsgelenk	323	
Lagerung, Lenker	199 200	OPEL	27598 02 ▾⊕	320 321 323	VOLKSWAGEN
			Trag-/Führungsgelenk		

Artikelnummer	Seite	Hersteller	Artikelnummer	Seite	Hersteller
27599 01	76 77 78	FORD	28059 02	192	OPEL
Axialgelenk, Spurstange			Lenker, Radaufhängung		
27600 01	76 77 78	FORD	28081 02	189	OPEL
Axialgelenk, Spurstange			Lenker, Radaufhängung		
27627 01	265 267	SKODA	28082 02	190	OPEL
Reparatursatz, Achskörper			Lenker, Radaufhängung		
27639 01	263	SKODA	28325 02	61 62	FORD
Spurstange			Spurstangenkopf		
27640 01	263	SKODA	28334 02	240	RENAULT
Spurstange			Stange/Strebe, Stabilisator		
27643 01	263 266	SKODA	28450 02	259	SEAT
Spurstange			Spurstange		
27644 01	263 266	SKODA	28451 02	259	SEAT
Spurstange			Spurstange		
27645 01	263 266	SKODA	28644 01	264 267	SKODA
Spurstange			Lenker, Radaufhängung		
27646 01	263 266	SKODA	28898 01	7 7 8	CITROËN
27663 01	127 132 133	MERCEDES-BENZ	Lagerung, Lenker	8	
Axialgelenk, Spurstange				228 228	PEUGEOT
27664 02	127 132 133	MERCEDES-BENZ	28899 01	8 8	CITROËN
Spurstangenkopf			Lagerung, Lenker	229	PEUGEOT
27665 02	127 132 133	MERCEDES-BENZ	28968 01	59	FORD
Spurstangenkopf			Axialgelenk, Spurstange		
27666 02	127 132 133	MERCEDES-BENZ	29416 01	28	FIAT
Trag-/Führungsgelenk			Stange/Strebe, Stabilisator		
27702 01	25 26 27	CITROËN	29417 01	14 16 18	CITROËN
Axialgelenk, Spurstange	51 52	FIAT	Lenker, Radaufhängung	20 22 23	
27710 01	212 213 214	PEUGEOT		37 39 42	FIAT
Trag-/Führungsgelenk	61 62 76	FORD		45 46 47	
27719 02	178 179	NISSAN		201 203 205	PEUGEOT
Trag-/Führungsgelenk	193 194 196	OPEL		207 209 210	
	197		29418 01	14 17 19	CITROËN
	244 245 247	RENAULT	Lenker, Radaufhängung	21 22 23	
	248 249			37 39 42	FIAT
27720 02	178 179	NISSAN		45 46 47	
Trag-/Führungsgelenk	193 195 196	OPEL		201 203 205	PEUGEOT
	197			207 209 210	
	244 246 247	RENAULT	29419 01	15 17 19	CITROËN
	248 249		Lenker, Radaufhängung	21 22 23	
27749 01	144 145	MERCEDES-BENZ		37 39 43	FIAT
Stabilisatorlager				45 46 47	
27756 01	97 98 100	MERCEDES-BENZ		201 203 205	PEUGEOT
Spurstange	101 103 105			207 209 210	
	107 108 109		29420 01	15 17 19	CITROËN
	289 290 291	VOLKSWAGEN	Lenker, Radaufhängung	21 22 24	
27869 01	59 61	FORD		37 39 43	FIAT
Achskörperlager				45 46 48	
27872 01	280	VOLKSWAGEN		201 203 205	PEUGEOT
Stange/Strebe, Stabilisator				207 209 210	
27911 01	50	FIAT	29514 01	234 239	RENAULT
Spurstangenkopf			Stange/Strebe, Stabilisator		
27924 01	2 5	CITROËN	29516 01	234 234 239	RENAULT
Lagerung, Lenker	224 227	PEUGEOT	Lagerung, Lenker	239	
27986 01	293 319 320	VOLKSWAGEN	29518 01	58 59	FORD
Spurstange	322		Achskörperlager		
27987 01	293 319 321	VOLKSWAGEN	29531 02	61 63	FORD
Spurstange	322		Stange/Strebe, Stabilisator		
28058 02	192	OPEL			
Lenker, Radaufhängung					

Arithmetische Liste

Artikelnummer	Seite	Hersteller	Artikelnummer	Seite	Hersteller
29532 01 Ⓢ	62 63	FORD	30134 01 Ⓢ	49 50	FIAT
Stange/Strebe, Stabilisator			Faltenbalgsatz, Lenkung	253 254 255 261	RENAULT SEAT
29611 01 Ⓢ	279	VOLKSWAGEN	30149 01	3 7	CITROËN
Axialgelenk, Spurstange			Faltenbalgsatz, Lenkung	224 228	PEUGEOT
29626 01 Ⓢ	78 79	FORD	30153 01	253 254 255	RENAULT
Trag-/Führungsgelenk			Faltenbalgsatz, Lenkung		
29636 01 Ⓢ	128 130	MERCEDES-BENZ	30154 01	254 255 256	RENAULT
Lenker, Radaufhängung			Faltenbalgsatz, Lenkung		
29637 01 Ⓢ	128 130	MERCEDES-BENZ	30161 01 Ⓢ	190	OPEL
Lenker, Radaufhängung			Faltenbalgsatz, Lenkung		
29709 01	265 267	SKODA	30168 01 Ⓢ	58	FORD
Lagerung, Lenker			Faltenbalgsatz, Lenkung		
29710 01 Ⓢ	265	SKODA	30172 01 Ⓢ	33 35 36	FIAT
Lagerung, Lenker			Faltenbalgsatz, Lenkung		
29909 01 Ⓢ	28 29	FIAT	30183 01	235	RENAULT
Trag-/Führungsgelenk			Faltenbalgsatz, Lenkung		
29916 01 Ⓢ	280 280	VOLKSWAGEN	30189 01 Ⓢ	66 68 70	FORD
Lagerung, Lenker			Faltenbalgsatz, Lenkung	71 72 73 74 75	
29924 01 Ⓢ	28 29	FIAT	30198 01	16 18 20	CITROËN
Spurstangenkopf			Faltenbalgsatz, Lenkung	21 23 24 202 204 206 208 209 211	PEUGEOT
29938 01 Ⓢ	190 191	OPEL	30203 01	16 18 20	CITROËN
Axialgelenk, Spurstange			Faltenbalgsatz, Lenkung	21 23 24 38 41 44 202 204 206 208 209 211	FIAT PEUGEOT
29943 01 Ⓢ	61 63	FORD	30206 01 Ⓢ	4 7	CITROËN
Lagerung, Lenker			Faltenbalgsatz, Lenkung	224 228	PEUGEOT
29945 01	62 63	FORD	30207 01 Ⓢ	4 7	CITROËN
Stabilisatorlager			Faltenbalgsatz, Lenkung	225 228	PEUGEOT
29946 01	62 63	FORD	30212 01 Ⓢ	194 195 196	OPEL
Stabilisatorlager			Faltenbalgsatz, Lenkung	198	
29947 01	62 63	FORD	30214 01	235	RENAULT
Stabilisatorlager			Faltenbalgsatz, Lenkung		
29973 01 Ⓢ	126	MERCEDES-BENZ	30235 01 Ⓢ	265	SKODA
Achsträgerlager			Faltenbalgsatz, Lenkung		
30111 01 ♂	260	SEAT	30243 01 Ⓢ	129 131	MERCEDES-BENZ
Faltenbalgsatz, Lenkung	278	VOLKSWAGEN	Faltenbalgsatz, Lenkung		
30112 01	276	VOLKSWAGEN	30248 01 ♂	225 228	PEUGEOT
Faltenbalgsatz, Lenkung			Faltenbalgsatz, Lenkung		
30114 01	3 6	CITROËN	30252 01 Ⓢ	191 192	OPEL
Faltenbalgsatz, Lenkung	224 227	PEUGEOT	Faltenbalgsatz, Lenkung		
30117 01 Ⓢ	277	VOLKSWAGEN	30257 01 Ⓢ	199 200	OPEL
Faltenbalgsatz, Lenkung			Faltenbalgsatz, Lenkung		
30121 01 Ⓢ	296 297 299	VOLKSWAGEN	30334 01 Ⓢ	259	SEAT
Faltenbalgsatz, Lenkung			Axialgelenk, Spurstange		
30122 01 ♂	224 227	PEUGEOT			
Faltenbalgsatz, Lenkung					
30127 01 Ⓢ	306 312 318	VOLKSWAGEN			
Faltenbalgsatz, Lenkung					
30130 01 Ⓢ	190	OPEL			
Faltenbalgsatz, Lenkung					
30132 01 Ⓢ	11 12 14	CITROËN			
Faltenbalgsatz, Lenkung	31 32 34 36 41 44 216 217 218 219 220 221	FIAT PEUGEOT			
30133 01 Ⓢ	49 50	FIAT			
Faltenbalgsatz, Lenkung	261	SEAT			

Artikelnummer	Seite	Hersteller	Artikelnummer	Seite	Hersteller
30335 01 	277	VOLKSWAGEN	31147 01 	110 111 112 281 282	MERCEDES-BENZ VOLKSWAGEN
Axialgelenk, Spurstange			Axialgelenk, Spurstange		
30336 01 	277	VOLKSWAGEN	31148 01	110 111 112 281	MERCEDES-BENZ VOLKSWAGEN
Spurstange			Spurstangenkopf		
30337 01 	277	VOLKSWAGEN	31196 01 	24 25	CITROËN
Spurstange			Trag-/Führungsgelenk	48 49 211 212	FIAT PEUGEOT
30372 01 	127 133 134	MERCEDES-BENZ	31250 01 	81	HYUNDAI
Stange/Strebe, Stabilisator			Trag-/Führungsgelenk		
30373 01 	127 133 134	MERCEDES-BENZ	31301 01	28 29	FIAT
Stange/Strebe, Stabilisator			Axialgelenk, Spurstange		
30606 01 	7 8 228	CITROËN PEUGEOT	31351 01 	24 25 48 49	CITROËN FIAT
Lenker, Radaufhängung			Stange/Strebe, Stabilisator	211 212	PEUGEOT
30607 01 	7 8 228	CITROËN PEUGEOT	31480 01 	260	SEAT
Lenker, Radaufhängung			Lagerung, Lenker	278	VOLKSWAGEN
30629 01 	280	VOLKSWAGEN	31898 01 	27	CITROËN
Lenker, Radaufhängung			Stange/Strebe, Stabilisator	215	PEUGEOT
30630 01 	280	VOLKSWAGEN	31899 01 	27	CITROËN
Lenker, Radaufhängung			Axialgelenk, Spurstange	215	PEUGEOT
30665 01 	281 282	VOLKSWAGEN	31900 01 	27	CITROËN
Stange/Strebe, Stabilisator			Spurstangenkopf	214 215	PEUGEOT
30666 01 	281 282	VOLKSWAGEN	31989 01 	239 240	RENAULT
Stange/Strebe, Stabilisator			Lagerung, Lenker		
30682 01 	180 181 198 199 256 257 258	NISSAN OPEL RENAULT	31990 01 	239 240	RENAULT
Axialgelenk, Spurstange			Lagerung, Lenker		
30721 01 	193 195 196	OPEL	31991 01 	240	RENAULT
Lagerung, Lenker	197 244 246 247 248 249	RENAULT	Achskörperlager		
30722 01 	193 195 196	OPEL	32011 01 	239 240	RENAULT
Lagerung, Lenker	197 244 246 247 248 249	RENAULT	Spurstangenkopf		
30773 01 	180 181	NISSAN	32012 01 	239 240	RENAULT
Trag-/Führungsgelenk	256 257 258	RENAULT	Spurstangenkopf		
30833 01 	264 266 267	SKODA			
Axialgelenk, Spurstange					
30908 01	114 116 119	MERCEDES-BENZ			
Lenkstange	121 123 125				
30919 01 	11 12 14	CITROËN PEUGEOT			
Faltenbalg, Lenkung	216 217 218 219 220 221				
30967 01 	294 320 321	VOLKSWAGEN			
Stange/Strebe, Stabilisator	323				
30991 01 	29	FIAT			
Axialgelenk, Spurstange					
31005 01 	82 85 89	IVECO			
Trag-/Führungsgelenk	90				
31006 01 	82 85 89	IVECO			
Trag-/Führungsgelenk	90				
31103 01 	82 86 88	IVECO			
Lagerung, Lenker	90				
31146 01	82 83 89	IVECO			
Spurstangenkopf	90				

Vergleichsliste

Vergleichs-Nr.	Artikelnummer	Vergleichs-Nr.	Artikelnummer	Vergleichs-Nr.	Artikelnummer
CITROËN		FIAT		FORD	
3520 N3	29417 01	13 31 640 080	26667 01	1 332 453	29531 02
3520 N4	29419 01	13 31 641 080	26668 01	1 332 463	29532 01
3520 P4	27065 02	13 33 754 080	27065 02	1 417 352	29626 01
3520 Q5	26714 02	13 33 755 080	27066 02	1 954 430	11860 02
3520 S2	30606 01	1331 937 080	29419 01	4 366 976	29943 01
3520 51	12064 01	1331 938 080	29417 01	4 381 840	28325 02
3520 76	22786 01	1331 939 080	29420 01	4 386 870	27710 01
3520.H5	17435 01	1331 940 080	29418 01	4 419 557	29946 01
3521 J3	29418 01	4 371 155	30133 01	4 419 558	29947 01
3521 J4	29420 01	4 371 156	30134 01	4 419 559	29945 01
3521 K4	27066 02	4 388 159	14773 02	4 577 976	27600 01
3521 L6	26715 02	4 402 649	11631 02	4 602 028	27599 01
3521 P3	30607 01	46 543 045	29909 01	4 616 978	27710 01
3521 34	12065 01	5 960 321	20030 01	5 021 410	11646 03
3521 52	22785 01	5 960 835	20031 02	5 021 430	26846 02
3521.E5	17436 01	5 983 406	11634 01	5 021 442	11659 01
3523 20	19247 01	5 995 503	20015 01	5 021 443	17842 01
3523 75	27924 01	5070 5629	31196 01	5 021 444	18483 01
3523 91	28898 01	51 717 000	29416 01	5 021 445	11654 01
3523 92	28899 01	7 082 812	26705 02	5 021 446	12831 01
3640 17	14773 02	7 567 284	11591 02	5 021 447	15468 02
3640 26	11591 02	7 601 261	20338 03	5 025 557	19130 01
3640 33	24539 01	7 690 960	27911 01	5 025 558	17861 02
3640 42	14767 04	7 695 190	22785 01	6 150 970	25538 01
3640 43	22339 04	7 695 191	22786 01	6 150 971	25539 01
3640 50	26047 02	78 20 249 212	20345 01	6 160 070	30189 01
3640 51	25534 02	9 943 623	30172 01	6 869 951	11651 01
3640 54	26668 01	9 945 836	25108 02	6 935 233	30168 01
3640 55	26667 01	9 946 982	30203 01	7 320 351	29518 01
3640 67	31196 01	93 800 662	11637 02	HYUNDAI	
3640 68	27299 02	95 66 950 880	27702 01	54530-4AA00	31250 01
3812 A4	27702 01	97 50 000 380	15342 01	56820-21100	15450 01
3812 C0	14792 01	97 50 000 380	30132 01	56820-36000	11841 01
3812 F0	31899 01	97 50 079 980	11603 02	56872-43000	22408 01
3812 27	15377 02	97 90 002 680	15377 02	IVECO	
3817 11	11603 02	98 845 025	30991 01	4253 4911	22817 01
3817 50	12070 04	98 845 026	31301 01	483 3825	11378 01
3817 73	31900 01	98 845 030	29924 01	500 310 933	22714 01
4006 22	30198 01	FORD		500 334 716	31006 01
4006 22	30203 01	1 000 445	24548 01	500 337 201	31146 01
4018 A3	24534 02	1 016 439	27869 01	500 379 801	31005 01
4018 A4	25108 02	1 020 174	17796 01	5003 06763	22818 01
4059 09	19251 03	1 020 175	17795 01	855 8524	11381 01
4066 16	30122 01	1 035 929	25176 01	855 8527	11380 01
4066 18	30919 01	1 044 014	28968 01	93 802 209	11638 02
4066 19	15342 01	1 047 145	19139 03	93 807 545	11639 01
4066 19	30132 01	1 047 797	17786 03	9380 0662	11637 02
4066 20	30114 01	1 055 191	27408 01	9380 7640	31103 01
4066 21	30248 01	1 055 194	25540 02	MERCEDES-BENZ	
4066 22	15622 01	1 063 372	27308 01	000 330 08 35	12825 01
4066 43	30207 01	1 070 337	17865 01	000 330 93 35	11378 01
4066 44	30206 01	1 070 338	17866 01	000 330 97 35	11380 01
5087 46	11589 02	1 085 520	25491 01	000 330 98 35	11381 01
5087 56	31898 01	1 111 410	22781 01	000 460 65 48	13606 01
5094 65	26577 01	1 111 411	24811 01	000 460 73 48	15468 02
5152 61	26578 01	1 111 412	22782 01	000 460 85 48	11391 01
5170 F5	31351 01	1 111 413	24810 01	000 460 86 48	11395 01
FIAT		1 130 273	18048 02	001 330 14 35	11407 01
1 479 759 080	26578 01	1 138 275	27593 03	001 330 48 35	12831 01
13 06 003 080	19251 03	1 330 238	22777 01	309 320 00 73	12834 01
13 06 716 080	24534 02	1 330 239	22778 01		

Vergleichs-Nr.	Artikelnummer	Vergleichs-Nr.	Artikelnummer	Vergleichs-Nr.	Artikelnummer
MERCEDES-BENZ		MERCEDES-BENZ		NISSAN	
318 320 00 73	26101 01	639 460 03 48	27665 02	48520-00QAM	30682 01
414 320 03 89	26015 02	667 320 00 44	26109 01	48520-27N25	16304 01
414 333 02 27	26016 02	667 320 00 73	12876 01	48520-73J25	25204 01
414 351 00 42	29973 01	667 323 04 85	18441 01	48521-G5125	16315 02
414 460 00 05	26520 02	667 323 06 85	27749 01	48521-00QAF	26706 01
414 460 01 05	26697 02	667 326 06 81	26928 01	48521-27N25	16296 01
414 460 02 05	26698 01	667 330 06 03	20898 01	48640-G5125	16316 01
601 321 03 50	12871 01	669 326 00 81	21790 01	48640-01N25	16307 02
601 322 00 85	26920 01	669 330 06 03	23962 01	48641-G5125	15595 01
601 330 04 35	11446 01	669 330 08 03	23965 01	48641-01N25	16308 02
601 330 05 35	11447 01	670 320 03 44	26110 01	54616- 00QAB	25814 02
601 460 15 05	11448 01	670 323 03 85	26940 01	54616-00QAC	25513 02
602 321 02 50	18852 01	670 326 01 81	26941 01	54618-00QAA	25815 02
602 326 04 82	21107 01	670 330 02 03	12877 01	54618-9C002	27303 02
602 330 04 03	11449 02	901 320 00 89	25802 01	54668-9C000	20246 02
602 330 09 03	11450 01	901 320 02 89	25800 01	OPEL	
602 330 57 35	11451 01	901 320 03 89	25801 01	16 03 008	29938 01
602 330 58 35	11452 01	901 326 00 81	27439 01	16 03 187	12148 02
608 330 03 03	23939 01	901 326 01 81	27440 01	16 03 202	17739 02
608 330 04 03	13566 01	901 333 02 14	24636 02	16 09 087	30161 01
631 320 00 28	11462 01	901 333 12 27	18875 03	16 09 121	30252 01
631 330 00 75	26573 01	901 460 01 48	19719 02	3 22 155	12170 01
631 330 03 03	13569 01	901 460 02 05	27756 01	3 22 158	12171 01
631 330 04 03	12842 01	901 460 04 55	18876 02	3 24 050	12178 01
631 330 04 35	12838 01	901 462 00 96	30243 01	3 24 066	25147 01
631 330 05 35	12844 01	904 326 08 81	20965 01	3 50 127	23711 01
631 330 06 03	12843 01	906 320 17 89	30665 01	3 52 002	28082 02
631 330 07 03	12841 01	906 320 18 89	30666 01	3 52 003	28081 02
631 338 03 10	12839 01	906 460 00 48	31148 01	3 52 041	28058 02
631 338 04 10	12840 01	906 460 00 55	31147 01	3 52 042	28059 02
631 460 07 05	12845 01	MITSUBISHI		3 52 309	26581 02
638 317 02 12	22934 01	MB 175544	11847 01	3 52 320	26580 01
638 317 04 12	23067 01	MB 176309	11849 03	3 52 803	26501 01
638 317 09 12	24597 01	MB 288119	15562 02	3 52 803	26501 02
638 323 02 68	22088 02	MB 315629	15450 01	3 53 562	26604 01
638 323 02 85	22214 01	MB 315775	11839 01	352 301	16056 02
638 323 03 68	22089 02	MB 315776	11840 03	4 02 644	26582 01
638 323 04 68	25344 02	MB 378704	11826 02	44 01 909	27720 02
638 323 05 68	25345 02	MB 527350	11852 01	44 08 474	30682 01
638 326 01 16	24724 01	MB 527352	15283 02	44 08 510	25510 01
638 326 02 81	24725 01	MB 527383-01	11853 03	44 08 511	25511 01
638 330 00 10	29636 01	MB 532971	15566 02	44 08 904	25513 02
638 330 00 27	22394 01	MB 864164	11842 02	4408476	30257 01
638 330 00 27	22394 02	MB 912519	11841 01	45 00 094	30721 01
638 330 01 10	29637 01	NISSAN		45 00 095	30722 01
638 333 00 14	26614 01	40110-G5110	15577 01	45 00 198	25814 02
638 333 08 14	26574 01	40110-01G26	11860 02	45 00 199	25815 02
638 352 04 50	26593 01	40160-G5400	11868 03	45 00 254	27719 02
638 352 06 50	26593 01	40160-00QAB	27719 02	45 01 260	30212 01
638 460 00 48	18874 01	40160-00QAD	27720 02	45 01 261	26706 01
638 460 00 48	18874 03	40160-00Q0A	30773 01	45 01 262	26712 02
638 460 02 05	19722 01	40160-01N25	11863 02	45 01 263	26713 02
638 460 02 05	25459 01	40160-9C500	20227 02	53 52 011	22773 01
639 320 02 89	30372 01	40161-48W25	11873 03	53 52 012	22774 01
639 320 03 89	30373 01	40161-9C500	20228 02	9 02 827	30130 01
639 330 04 10	27666 02	48510-01N25	16284 01	9 199 576	26581 02
639 330 05 10	27666 02	48520-G5125	16317 03	90 445 097	16056 02
639 333 02 27	27666 02	48520-00QAH	26712 02	PEUGEOT	
639 353 00 50	26593 01	48520-00QAJ	26713 02	3520 H5	17435 01
639 460 00 48	27664 02	48520-00QAK	25510 01	3520 N3	29417 01
639 460 00 55	27663 01	48520-00QAL	25511 01	3520 N4	29419 01

Vergleichsliste

Vergleichs-Nr.	Artikelnummer	Vergleichs-Nr.	Artikelnummer	Vergleichs-Nr.	Artikelnummer
PEUGEOT		RENAULT		SEAT	
3520 P4	27065 02	77 00 783 455	19373 01	1K0 407 365 C	26772 02
3520 Q5	26714 02	77 00 783 456	18142 01	1K0 407 366 C	26773 02
3520 S2	30606 01	77 00 799 404	29514 01	1K0 411 315 J	26774 01
3520 51	12064 01	77 01 049 282	25510 01	1K0 423 810 A	25329 02
3520 76	22786 01	77 01 049 283	25511 01	191 407 151 B	10172 01
3521 E5	17436 01	77 01 056 969	27720 02	191 407 181 E	10205 02
3521 J3	29418 01	77 01 349 064	22491 01	191 407 181 E	25352 01
3521 J4	29420 01	77 01 461 770	12236 01	191 407 181 SP	31480 01
3521 K4	27066 02	77 01 461 770	12236 02	191 411 327	17400 02
3521 L6	26715 02	77 01 462 427	18178 01	191 419 831	30112 01
3521 P3	30607 01	77 01 462 692	18179 01	3A0 422 811	18373 04
3521 52	22785 01	77 01 462 693	18180 01	3A0 422 812	17642 04
3523 20	19247 01	77 01 463 025	16503 03	357 407 365	10161 07
3523 75	27924 01	77 01 463 035	12125 01	357 408 182	10203 02
3523 91	28898 01	77 01 463 346	12128 01	4 402 649	11631 02
3523 92	28899 01	77 01 465 915	12129 01	5 960 321	20030 01
3608 28	11639 01	77 01 465 915	12129 02	5 960 835	20031 02
3640 17	14773 02	77 01 468 883	12119 03	5 983 406	11634 01
3640 26	11591 02	77 01 469 231	12117 02	5 995 503	20015 01
3640 33	24539 01	77 01 469 496	30183 01	6E0 419 831	30235 01
3640 42	14767 04	77 01 469 617	30154 01	6K0 422 803 D	28450 02
3640 43	22339 04	77 01 470 362	26706 01	6K0 422 803 F	30335 01
3640 50	26047 02	77 01 470 363	26712 02	6K0 422 804 D	28451 02
3640 51	25534 02	77 01 470 364	26713 02	6K0 422 804 E	30337 01
3640 54	26668 01	77 01 470 753	30214 01	6K0 422 804 F	30335 01
3640 55	26667 01	77 01 470 763	25476 01	6K0 422 807 D	30334 01
3640 67	31196 01	77 01 470 764	25475 01	6K0 422 807 F	30335 01
3640 68	27299 02	77 01 470 765	21191 01	6K0 422 811	27078 02
3812 A4	27702 01	77 01 470 766	21190 01	6K0 422 812	27079 02
3812 C0	14792 01	77 01 472 038	26768 01	6Q0 407 151 E	28644 01
3812 27	15377 02	77 01 472 113	26721 01	6Q0 407 182 A	29709 01
3817 11	11603 02	77 01 472 120	26711 01	6Q0 407 183 A	29710 01
3817 50	12070 04	77 01 473 333	30682 01	6Q0 407 365 M	25524 02
4006 22	30198 01	77 01 474 492	25446 02	6Q0 407 366 A	25525 02
4006 22	30203 01	77 01 474 493	25484 02	6Q0 411 315 J	25463 02
4018 A3	24534 02	77 01 477 385	30773 01	6Q0 423 803 E	27643 01
4018 A4	25108 02	77 01 478 029	27219 02	6Q0 423 803 G	27645 01
4059 09	19251 03	77 01 478 407	32011 01	6Q0 423 804 E	27644 01
4066 16	30122 01	77 01 478 408	32012 01	6Q0 423 804 G	27646 01
4066 18	30919 01	82 00 002 869	26938 01	6Q0 423 810 B	27321 01
4066 19	15342 01	82 00 049 624	26939 01	6Q0 423 810 E	30833 01
4066 19	30132 01	82 00 197 179	27056 01	6Q0 423 810 G	26671 01
4066 21	30248 01	82 00 197 187	27057 01	6Q0 423 811 C	26669 01
4066 22	15622 01	82 00 380 965	31991 01	6Q0 423 811 C	26669 02
4066 22	30149 01	82 00 586 564	31989 01	6Q0 423 812 C	26670 01
4066 43	30207 01	82 00 586 570	31990 01	6Q0 423 812 C	26670 02
4066 44	30206 01	82 00 651 161	29516 01	6Q0 501 541 E	26814 01
5087 46	11589 02	82 00 661 217	25513 02	7 601 261	20338 03
5087 56	31898 01	82 00 669 065	28334 02		
5094 65	26577 01	82 00 713 522	25814 02	SKODA	
5152 61	26578 01	82 00 713 523	25815 02	1J0 501 541 C	21236 01
5170 F5	31351 01			1J0 501 541 C	27627 01
RENAULT		SEAT		1K0 407 151 P	30629 01
60 25 370 231	30212 01	SE 138 162 131 A	30133 01	1K0 407 152 P	30630 01
77 00 302 122	30721 01	SE 138 162 132 A	30134 01	1K0 407 182	29916 01
77 00 302 123	30722 01	SE 141162410 A	20031 02	1K0 407 365 C	26772 02
77 00 312 851	27719 02	1H0 422 831 B	30111 01	1K0 407 366 C	26773 02
77 00 680 852	30153 01	1J0 501 541 C	21236 01	1K0 411 315 J	26774 01
77 00 734 714	24503 01	1J0 501 541 C	27627 01	1K0 423 810 A	25329 02
77 00 762 843	29518 01	1K0 407 151 P	30629 01	1K0 423 811 G	25327 01
77 00 774 566	30134 01	1K0 407 152 P	30630 01	1K0 423 812 G	25328 01
		1K0 407 182	29916 01	114 509 822	30133 01

Vergleichs-Nr.	Artikelnummer	Vergleichs-Nr.	Artikelnummer	Vergleichs-Nr.	Artikelnummer
SKODA		VOLKSWAGEN		VOLKSWAGEN	
114 509 823	30134 01	1K0 407 365 C	26772 02	357 407 182	10203 02
191 407 181 SP	31480 01	1K0 407 366 C	26773 02	357 407 365	10161 07
357 408 182	10203 02	1K0 411 315 J	26774 01	6E0 419 831	30235 01
6E0 419 831	30235 01	1K0 423 810 A	25329 02	6K0 422 803 D	28450 02
6Q0 407 151 E	28644 01	1K0 423 811 G	25327 01	6K0 422 803 E	30336 01
6Q0 407 182 A	29709 01	1K0 423 812 G	25328 01	6K0 422 804 D	28451 02
6Q0 407 183 A	29710 01	171 407 153 D	10165 01	6K0 422 804 E	30337 01
6Q0 407 365 M	25524 02	171 407 182 D	10202 01	6K0 422 804 F	30335 01
6Q0 407 366 A	25525 02	171 407 365 F	10160 04	6K0 422 807 D	30334 01
6Q0 411 315 J	25463 02	171 419 807 A	10282 01	6K0 422 807 F	30335 01
6Q0 419 803 D	27639 01	171 419 812	10251 02	6K0 422 811	27078 02
6Q0 419 804 D	27640 01	171 419 832 C/S	30117 01	6K0 422 812	27079 02
6Q0 419 807 D	27320 01	191 407 151 B	10172 01	6Q0 407 151 E	28644 01
6Q0 423 803 E	27643 01	191 407 181 E	10205 02	6Q0 407 182 A	29709 01
6Q0 423 803 G	27645 01	191 407 181 E	25352 01	6Q0 407 183 A	29710 01
6Q0 423 804 E	27644 01	191 407 181 SP	31480 01	6Q0 407 365 M	25524 02
6Q0 423 804 G	27646 01	191 411 327	17400 02	6Q0 407 366 A	25525 02
6Q0 423 810 B	27321 01	191 419 831	30112 01	6Q0 411 315 J	25463 02
6Q0 423 810 E	30833 01	2D0 407 361 A	18875 03	6Q0 419 803 D	27639 01
6Q0 423 811 C	26669 01	2D0 411 051	25800 01	6Q0 419 804 D	27640 01
6Q0 423 811 C	26669 02	2D0 411 052	25801 01	6Q0 419 807 D	27320 01
6Q0 423 812 C	26670 01	2D0 422 803	18876 02	6Q0 423 803 E	27643 01
6Q0 423 812 C	26670 02	2D0 422 803	27756 01	6Q0 423 803 G	27645 01
6Q0 501 541 E	26814 01	2D0 422 811	19719 02	6Q0 423 804 E	27644 01
6U0 407 365	15669 02	2D0 511 329	25802 01	6Q0 423 804 G	27646 01
6U0 422 807	29611 01	2D0 511 413 B	20965 01	6Q0 423 810 B	27321 01
6U0 422 811	15670 02	2E0 411 317 C	30665 01	6Q0 423 810 E	30833 01
SUZUKI		2E0 411 318 C	30666 01	6Q0 423 810 G	26671 01
45200-77500	15690 01	2E0 713 491	31147 01	6Q0 423 811 C	26669 01
TOYOTA		2E0 713 501	31148 01	6Q0 423 811 C	26669 02
43330-29245	11898 02	2K0 505 465 B	27872 01	6Q0 423 812 C	26670 01
43330-39265	16431 01	251 407 077	10174 01	6Q0 423 812 C	26670 02
43330-39295	11902 02	251 407 175	14378 01	6U0 422 807	29611 01
43350-29036	11904 01	251 407 187	10159 03	6U0 422 811	15670 02
43350-29056	11905 02	251 407 187 C	13784 02	7D0 407 140 A	14555 03
43350-29065	11903 02	251 407 361	10162 02	7D0 407 183	17681 01
43350-39115	16426 03	251 419 803	10270 01	7D0 407 361	14571 02
43360-39085	15717 02	251 419 807 A	10272 01	7D0 411 045	17682 02
45046-29155	15719 03	251 419 831 A	30121 01	7D0 419 831	30127 01
45046-29186	16374 02	251 501 131 A	10197 01	7H0 407 182	26935 01
45046-39235	11907 02	281 407 077	10175 01	7H0 407 182 A	26936 01
45406-29145	16361 02	281 407 179	10208 01	7H0 407 183	26937 01
45406-39155	11908 02	281 407 180	10207 01	7H0 407 361	27597 02
45503-29125	15195 02	281 407 183 C	14383 01	7H0 419 803 D	27987 01
45503-29135	15740 02	281 407 187 B	10157 01	7H0 419 804 D	27986 01
45503-29215	16397 02	281 407 361	10163 03	7H0 422 817 C	27594 01
45503-29255	11917 01	281 415 303 B	10247 01	7H0 422 817 C	27594 02
VOLKSWAGEN		281 415 701 E	10281 02	7H0 422 817 C	27596 01
J43 330 392 95	11902 02	281 415 711 A	13785 01	7H0 422 818 C	27595 01
J43 340 392 45	16431 01	281 415 801 D	10276 02	7H0 422 818 C	27595 02
J43 350 390 75	15717 02	281 415 801 D	10279 02	7H0 422 818 C	27596 01
J43 350 390 75	16426 03	281 415 801 D	10280 02	7H5 411 317 A	30967 01
J45 406 391 15	11908 02	281 415 802 A	10273 02	7H8 407 361 A	27598 02
1H0 411 314	27461 01	281 415 811	13786 02	701 407 077 A	25931 01
1H0 422 831 B	30111 01	281 415 812	13787 02	701 407 187 B	10155 03
1J0 501 541 C	21236 01	291 411 045	16612 01	701 407 361 B	10164 03
1J0 501 541 C	27627 01	291 415 701 E	10259 01	701 411 041	19129 01
1K0 407 151 P	30629 01	291 415 711 D	14496 01	701 411 049 B	21044 02
1K0 407 152 P	30630 01	291 415 711 F	22313 01	701 419 803 C	10291 02
1K0 407 182	29916 01	3A0 422 811	18373 04	701 419 803 D	10289 02
		3A0 422 812	17642 04	701 419 803 E	14547 02

Vergleichsliste

Vergleichs-Nr.	Artikelnummer	Vergleichs-Nr.	Artikelnummer	Vergleichs-Nr.	Artikelnummer
VOLKSWAGEN					
	701 419 804 C		10290 02		
	701 419 804 D		10278 02		
	701 419 804 E		14548 02		
	701 419 804 F		17673 02		
	701 419 804 F		22307 01		
	701 419 810		13770 02		
	701 419 810 A		10285 02		
	701 419 810 B		22307 01		
	701 419 811 A		10286 01		
	701 419 811 B		10274 02		
	701 419 811 C		14549 02		
	701 419 811 E		17674 02		
	701 419 812		10284 01		
	701 419 812 A		13794 02		
	701 419 812 B		10275 02		
	701 419 812 D		17675 02		
	701 599 381		26572 01		
	702 419 803 A		13795 02		
	702 419 803 B		10287 02		
	702 419 803 C		14570 02		
	702 419 803 D		17679 02		
	702 419 803 D		22307 01		
	702 419 804 B		13796 02		
	702 419 804 C		16630 02		

Neuaufnahmen

Artikelnummer	Seite	Hersteller	Artikelnummer	Seite	Hersteller		
10157 01	▼⊕♂	283 285 288	VOLKSWAGEN	14792 01	⊕♂	1 5	CITROËN
10160 04	▼⊕	276	VOLKSWAGEN	14792 01	⊕♂	222 225	PEUGEOT
10164 03	▼⊕	304 311 317	VOLKSWAGEN	15283 02	▼⊕	174	MITSUBISHI
11378 01		136	MERCEDES-BENZ	15468 02	♂♂	65 67 69	FORD
11447 01		113 116 118	MERCEDES-BENZ	15468 02	♂♂	92 94 96	MERCEDES-BENZ
		120 122 124		15577 01	▲⊕♂	184 185 186	NISSAN
		134		15690 01	▼⊕	268	SUZUKI
11451 01		114 116 118	MERCEDES-BENZ	15719 03	♂♂	273	TOYOTA
		120 120 122		15740 02	⊕♂	274	TOYOTA
		122 124 124		16296 01	⊕♂	183	NISSAN
11452 01		114 116 118	MERCEDES-BENZ	16304 01	♂♂	182 183	NISSAN
		120 120 122		16307 02	♂♂	182 183	NISSAN
		122 124 124		16308 02	♂♂	183	NISSAN
11860 02	▲⊕♂	182 183 184	NISSAN	16361 02	♂♂	269	TOYOTA
11863 02	▼⊕♂	183 184	NISSAN	16374 02	♂♂	273 274	TOYOTA
11873 03	▼♂♂	182	NISSAN	16397 02	⊕	274 275	TOYOTA
11907 02	♂♂	269 272	TOYOTA	16426 03	▲⊕♂	272	TOYOTA
11907 02	♂♂	294	VOLKSWAGEN	16426 03	▲⊕♂	295	VOLKSWAGEN
11917 01	♂♂	270 271	TOYOTA	16431 01	▼⊕	273	TOYOTA
12117 02		250 250	RENAULT	16431 01	▼⊕	295	VOLKSWAGEN
12119 03	▼⊕	251	RENAULT	17435 01	▼♂	1 5	CITROËN
12125 01	⊕	251 252 253	RENAULT	17435 01	▼♂	222 226	PEUGEOT
		254 255		17436 01	▼⊕	2 5	CITROËN
12236 02	♂♂	188	OPEL	17436 01	▼⊕	223 226	PEUGEOT
12236 02	♂♂	251 252 253	RENAULT	17642 04	♂♂	259	SEAT
		254 255		17642 04	♂♂	277	VOLKSWAGEN
12834 01		148 149 150	MERCEDES-BENZ	17786 03	▼⊕	56 57 59	FORD
		151 152 153		18048 02	♂	58 59 61	FORD
12838 01	♂	92 94 96	MERCEDES-BENZ	18373 04	♂	259	SEAT
12842 01	⊕	91 93 95	MERCEDES-BENZ	18373 04	♂	277	VOLKSWAGEN
12876 01		138 139 140	MERCEDES-BENZ	19139 03	⊕	70 71 72	FORD
13569 01	♂♂	91 93 95	MERCEDES-BENZ			73 74 75	
14767 04	▼⊕	2 6	CITROËN	20031 02	♂♂	261	SEAT
14767 04	▼⊕	223 226	PEUGEOT	20227 02	▼⊕	186 187	NISSAN

Artikelnummer	Seite	Hersteller
20228 02	186 187	NISSAN
20246 02	186 187	NISSAN
20338 03	261	SEAT
21107 01	117 119	MERCEDES-BENZ
21190 01	230 236	RENAULT
21191 01	230 236	RENAULT
22088 02	128 131	MERCEDES-BENZ
22089 02	129 131	MERCEDES-BENZ
22339 04	2 6	CITROËN
22339 04	223 227	PEUGEOT
22491 01	252 253 254 255	RENAULT
22714 01	83	IVECO
22773 01	189	OPEL
22774 01	189	OPEL
22777 01	59 60	FORD
22781 01	56 57	FORD
22782 01	56 57	FORD
22785 01	10 12 13	CITROËN
22785 01	33 34 35 53 54 55	FIAT
22785 01	216 217 218 219 220	PEUGEOT
22786 01	10 12 13	CITROËN
22786 01	33 34 35 53 54 55	FIAT
22786 01	216 217 218 219 220 221	PEUGEOT
22818 01	82 84 89	IVECO
23711 01	190	OPEL
24534 02	14 16 18 20 22 23	CITROËN
24534 02	36 38 42 44 46 47	FIAT
24534 02	201 203 205 207 208 210	PEUGEOT
24538 02	15 17 19	CITROËN
24538 02	37 39 43 45 48	FIAT
24538 02	202 204 206	PEUGEOT
24539 01	15 17 19	CITROËN
24539 01	37 40 43 45 48	FIAT
24539 01	202 204 206	PEUGEOT
24724 01	129 132	MERCEDES-BENZ
25204 01	186 187	NISSAN
25344 02	129 131	MERCEDES-BENZ
25345 02	129 131	MERCEDES-BENZ
25352 01	260	SEAT
25352 01	278	VOLKSWAGEN
25446 02	231 236	RENAULT
25459 01	128 130	MERCEDES-BENZ
25463 02	265 267	SKODA
25475 01	232 237	RENAULT
25476 01	232 237	RENAULT
25484 02	232 237	RENAULT
25510 01	180 181	NISSAN
25510 01	198 199	OPEL
25510 01	256 257	RENAULT
25511 01	180 181	NISSAN
25511 01	198 199	OPEL
25511 01	256 257	RENAULT
25513 02	181 182	NISSAN
25513 02	199 200	OPEL

Artikelnummer	Seite	Hersteller
25513 02	257 258	RENAULT
25524 02	264 267	SKODA
25525 02	264 267	SKODA
25534 02	3 6	CITROËN
25534 02	223 227	PEUGEOT
25538 01	66 68 69 71 72 73 74 75	FORD
25539 01	66 68 69 71 72 73 74 75	FORD
25540 02	70 71 72 73 74 75	FORD
25800 01	97 99 100 102 103 105 107 109 110	MERCEDES-BENZ
25800 01	289 290 291	VOLKSWAGEN
25802 01	98 99 101 102 104 106 108 109 110	MERCEDES-BENZ
25802 01	289 290 292	VOLKSWAGEN
25814 02	178 179	NISSAN
25814 02	194 196 198	OPEL
25814 02	241 242 243 245 246 247 248 249	RENAULT
25815 02	178 179	NISSAN
25815 02	194 196 198	OPEL
25815 02	241 242 243 245 246 247 248 249	RENAULT
25931 01	305 311 318	VOLKSWAGEN
26015 02	126	MERCEDES-BENZ
26016 02	126	MERCEDES-BENZ
26047 02	2 6	CITROËN
26047 02	223 227	PEUGEOT
26101 01	142	MERCEDES-BENZ
26109 01	155 156 157 158 159 160 161 162 163	MERCEDES-BENZ
26501 02	191 192	OPEL
26520 02	126	MERCEDES-BENZ
26572 01	306 312 319	VOLKSWAGEN
26573 01	92 94 96	MERCEDES-BENZ
26574 01	127 128 128 130 130 132 134	MERCEDES-BENZ
26577 01	224 227	PEUGEOT
26578 01	26	CITROËN
26578 01	51 52	FIAT
26578 01	213 214	PEUGEOT
26580 01	191 192 192	OPEL
26581 02	191 192 192	OPEL
26582 01	191 192	OPEL
26593 01	129 131	MERCEDES-BENZ
26604 01	190	OPEL
26614 01	127 128 128 130 130 133 134	MERCEDES-BENZ
26667 01	15 18 19 21 22 24	CITROËN
26667 01	37 40 43 45 47 48	FIAT

Neuaufnahmen

Artikelnummer	Seite	Hersteller
26667 01	202 204 206 208 209 211	PEUGEOT
26668 01	15 18 19 21 23 24	CITROËN
26668 01	38 40 43 45 47 48	FIAT
26668 01	202 204 206 208 209 211	PEUGEOT
26669 02	264 265 266	SKODA
26670 02	264 265 266	SKODA
26671 01	264 266 266	SKODA
26697 02	126	MERCEDES-BENZ
26698 01	126	MERCEDES-BENZ
26705 02	28 29	FIAT
26706 01	178 179	NISSAN
26706 01	193 194 196 197	OPEL
26706 01	244 245 247	RENAULT
26711 01	233 238	RENAULT
26712 02	178 179	NISSAN
26712 02	193 194 195 197	OPEL
26712 02	244 245 246	RENAULT
26713 02	178 179	NISSAN
26713 02	193 194 195 197	OPEL
26713 02	244 245 247	RENAULT
26714 02	2 5	CITROËN
26714 02	223 226	PEUGEOT
26715 02	2 6	CITROËN
26715 02	223 226	PEUGEOT
26721 01	233 238	RENAULT
26768 01	234 239	RENAULT
26772 02	280	VOLKSWAGEN
26773 02	280	VOLKSWAGEN
26774 01	280	VOLKSWAGEN
26814 01	265	SKODA
26846 02	66 67 69	FORD
26920 01	146 147	MERCEDES-BENZ
26935 01	320 321 322	VOLKSWAGEN
26936 01	294 320 321 322	VOLKSWAGEN
26937 01	294 320 321 323	VOLKSWAGEN
27056 01	234 238	RENAULT
27057 01	234 239	RENAULT
27065 02	25 26 27	CITROËN
27065 02	51 52	FIAT
27065 02	212 213 214	PEUGEOT
27066 02	25 26 27	CITROËN
27066 02	51 52	FIAT
27066 02	212 213 214	PEUGEOT
27078 02	259	SEAT
27078 02	277	VOLKSWAGEN
27079 02	259	SEAT
27079 02	277	VOLKSWAGEN
27219 02	180 181	NISSAN
27219 02	198 200	OPEL
27219 02	256 257 258	RENAULT
27299 02	7 8	CITROËN
27299 02	228	PEUGEOT
27303 02	187	NISSAN
27308 01	59 60	FORD
27320 01	264	SKODA

Artikelnummer	Seite	Hersteller
27321 01	264	SKODA
27408 01	59 60	FORD
27439 01	99 101 104 106	MERCEDES-BENZ
27440 01	98 99 101 102 104 106	MERCEDES-BENZ
27461 01	278	VOLKSWAGEN
27593 03	76 77 78	FORD
27594 02	293 319 321 322	VOLKSWAGEN
27595 02	293 319 321 322	VOLKSWAGEN
27596 01	293 293 319 319 321 321 322 322	VOLKSWAGEN
27597 02	294 320 321 323	VOLKSWAGEN
27598 02	320 321 323	VOLKSWAGEN
27599 01	76 77 78	FORD
27600 01	76 77 78	FORD
27627 01	265 267	SKODA
27639 01	263	SKODA
27640 01	263	SKODA
27643 01	263 266	SKODA
27644 01	263 266	SKODA
27645 01	263 266	SKODA
27646 01	263 266	SKODA
27663 01	127 132 133	MERCEDES-BENZ
27664 02	127 132 133	MERCEDES-BENZ
27665 02	127 132 133	MERCEDES-BENZ
27666 02	127 132 133	MERCEDES-BENZ
27702 01	25 26 27	CITROËN
27702 01	51 52	FIAT
27702 01	212 213 214	PEUGEOT
27710 01	61 62 76 77 78	FORD
27719 02	178 179	NISSAN
27719 02	193 194 196 197	OPEL
27719 02	244 245 247 248 249	RENAULT
27720 02	178 179	NISSAN
27720 02	193 195 196 197	OPEL
27720 02	244 246 247 248 249	RENAULT
27749 01	144 145	MERCEDES-BENZ
27756 01	97 98 100 101 103 105 107 108 109	MERCEDES-BENZ
27756 01	289 290 291	VOLKSWAGEN
27869 01	59 61	FORD
27872 01	280	VOLKSWAGEN
27911 01	50	FIAT
27924 01	2 5	CITROËN
27924 01	224 227	PEUGEOT
27986 01	293 319 320 322	VOLKSWAGEN
27987 01	293 319 321 322	VOLKSWAGEN
28058 02	192	OPEL
28059 02	192	OPEL
28081 02	189	OPEL
28082 02	190	OPEL

Artikelnummer	Seite	Hersteller
28325 02	61 62	FORD
28334 02	240	RENAULT
28450 02	259	SEAT
28451 02	259	SEAT
28644 01	264 267	SKODA
28898 01	7 7 8 8	CITROËN
28898 01	228 228	PEUGEOT
28899 01	8 8	CITROËN
28899 01	229	PEUGEOT
28968 01	59	FORD
29416 01	28	FIAT
29417 01	14 16 18 20 22 23	CITROËN
29417 01	37 39 42 45 46 47	FIAT
29417 01	201 203 205 207 209 210	PEUGEOT
29418 01	14 17 19 21 22 23	CITROËN
29418 01	37 39 42 45 46 47	FIAT
29418 01	201 203 205 207 209 210	PEUGEOT
29419 01	15 17 19 21 22 23	CITROËN
29419 01	37 39 43 45 46 47	FIAT
29419 01	201 203 205 207 209 210	PEUGEOT
29420 01	15 17 19 21 22 24	CITROËN
29420 01	37 39 43 45 46 48	FIAT
29420 01	201 203 205 207 209 210	PEUGEOT
29514 01	234 239	RENAULT
29516 01	234 234 239 239	RENAULT
29518 01	58 59	FORD
29531 02	61 63	FORD
29532 01	62 63	FORD
29611 01	279	VOLKSWAGEN
29626 01	78 79	FORD
29636 01	128 130	MERCEDES-BENZ
29637 01	128 130	MERCEDES-BENZ
29709 01	265 267	SKODA
29710 01	265	SKODA
29909 01	28 29	FIAT
29916 01	280 280	VOLKSWAGEN
29924 01	28 29	FIAT
29938 01	190 191	OPEL
29943 01	61 63	FORD
29945 01	62 63	FORD
29946 01	62 63	FORD
29947 01	62 63	FORD
29973 01	126	MERCEDES-BENZ
30111 01	260	SEAT
30111 01	278	VOLKSWAGEN
30112 01	276	VOLKSWAGEN
30114 01	3 6	CITROËN
30114 01	224 227	PEUGEOT
30117 01	277	VOLKSWAGEN
30121 01	296 297 299	VOLKSWAGEN

Artikelnummer	Seite	Hersteller
30122 01	224 227	PEUGEOT
30127 01	306 312 318	VOLKSWAGEN
30130 01	190	OPEL
30132 01	11 12 14	CITROËN
30132 01	31 32 34 36 41 44	FIAT
30132 01	216 217 218 219 220 221	PEUGEOT
30133 01	49 50	FIAT
30133 01	261	SEAT
30134 01	49 50	FIAT
30134 01	253 254 255	RENAULT
30134 01	261	SEAT
30149 01	3 7	CITROËN
30149 01	224 228	PEUGEOT
30153 01	253 254 255	RENAULT
30154 01	254 255 256	RENAULT
30161 01	190	OPEL
30168 01	58	FORD
30172 01	33 35 36	FIAT
30183 01	235	RENAULT
30189 01	66 68 70 71 72 73 74 75	FORD
30198 01	16 18 20 21 23 24	CITROËN
30198 01	202 204 206 208 209 211	PEUGEOT
30203 01	16 18 20 21 23 24	CITROËN
30203 01	38 41 44	FIAT
30203 01	202 204 206 208 209 211	PEUGEOT
30206 01	4 7	CITROËN
30206 01	224 228	PEUGEOT
30207 01	4 7	CITROËN
30207 01	225 228	PEUGEOT
30212 01	194 195 196 198	OPEL
30214 01	235	RENAULT
30235 01	265	SKODA
30243 01	129 131	MERCEDES-BENZ
30248 01	225 228	PEUGEOT
30252 01	191 192	OPEL
30257 01	199 200	OPEL
30334 01	259	SEAT
30335 01	277	VOLKSWAGEN
30336 01	277	VOLKSWAGEN
30337 01	277	VOLKSWAGEN
30372 01	127 133 134	MERCEDES-BENZ
30373 01	127 133 134	MERCEDES-BENZ
30606 01	7 8	CITROËN
30606 01	228	PEUGEOT
30607 01	7 8	CITROËN
30607 01	228	PEUGEOT
30629 01	280	VOLKSWAGEN
30630 01	280	VOLKSWAGEN
30665 01	281 282	VOLKSWAGEN
30666 01	281 282	VOLKSWAGEN
30682 01	180 181	NISSAN
30682 01	198 199	OPEL
30682 01	256 257 258	RENAULT
30721 01	193 195 196 197	OPEL

Neuaufnahmen

Artikelnummer	Seite	Hersteller
30721 01 ⊕Ⓜ	244 246 247 248 249	RENAULT
30722 01 ⊕Ⓜ	193 195 196 197	OPEL
30722 01 ⊕Ⓜ	244 246 247 248 249	RENAULT
30773 01 ⊕	180 181	NISSAN
30773 01 ⊕	256 257 258	RENAULT
30833 01 ⊕Ⓜ△	264 266 267	SKODA
30908 01	114 116 119 121 123 125	MERCEDES-BENZ
30919 01 ⊕	11 12 14	CITROËN
30919 01 ⊕	216 217 218 219 220 221	PEUGEOT
30967 01 ⊕	294 320 321 323	VOLKSWAGEN
30991 01 ⊕Ⓜ	29	FIAT
31005 01 ▲⊕	82 85 89 90	IVECO
31006 01 ▼⊕	82 85 89 90	IVECO
31103 01 ▼	82 86 88 90	IVECO
31146 01	82 83 89 90	IVECO
31147 01 △	110 111 112	MERCEDES-BENZ
31147 01 △	281 282	VOLKSWAGEN
31148 01	110 111 112	MERCEDES-BENZ
31148 01	281	VOLKSWAGEN
31196 01 ⊕	24 25	CITROËN
31196 01 ⊕	48 49	FIAT
31196 01 ⊕	211 212	PEUGEOT
31250 01 ⊕	81	HYUNDAI
31301 01	28 29	FIAT
31351 01 ⊕	24 25	CITROËN
31351 01 ⊕	48 49	FIAT
31351 01 ⊕	211 212	PEUGEOT
31480 01 ⊕Ⓜ(x2)	260	SEAT
31480 01 ⊕Ⓜ(x2)	278	VOLKSWAGEN
31898 01 ⊕	27	CITROËN
31898 01 ⊕	215	PEUGEOT
31899 01 ⊕△	27	CITROËN
31899 01 ⊕△	215	PEUGEOT
31900 01 ⊕	27	CITROËN
31900 01 ⊕	214 215	PEUGEOT
31989 01 ⊕Ⓜ	239 240	RENAULT
31990 01 ⊕Ⓜ	239 240	RENAULT
31991 01 ⊕Ⓜ	240	RENAULT
32011 01 ⊕	239 240	RENAULT
32012 01 ⊕	239 240	RENAULT

Artikelnummer	Seite	Hersteller
---------------	-------	------------

Geänderte Bestellnummer

Artikelnummer alt	Artikelnummer neu	Artikelnummer alt	Artikelnummer neu	Artikelnummer alt	Artikelnummer neu
01.02566.0	25147 01	04.99756.0	14773 02	12117 01	12117 02
01.03043.0	12064 01	10176 01	25931 01	14342 01	30112 01
01.03357.0	15669 02	10233 03	30111 01	14558 02	30127 01
01.49205.0	17795 01	10235 01	30121 01	14764 02	22339 04
01.99984.0	10266 01	10236 02	30112 01	14854 01	30130 01
02.05138.0	28082 02	11416 01	30908 01	15342 01	30132 01
02.05146.0	17865 01	11676 02	30114 01	15355 01	30133 01
02.05147.0	17866 01	11838 01	15450 01	15356 01	30134 01
02.05227.0	24810 01	11840 02	11840 03	15622 01	30149 01
04.03802.1	10285 02	11863 01	11863 02	15632 01	30153 01
04.03804.0	10164 03	11868 02	11868 03	15634 01	30154 01
04.46006.0	10163 03	12059 01	11639 01	15719 01	15719 03
04.99717.0	26846 02	12117 01	12117 02	17328 01	30117 01

Geänderte Bestellnummer

Artikelnummer alt	Artikelnummer neu	Artikelnummer alt	Artikelnummer neu	Artikelnummer alt	Artikelnummer neu
17416 01	15622 01				
17437 02	17436 01				
17438 02	17435 01				
17642 02	17642 04				
17745 01	30161 01				
18048 01	18048 02				
18373 02	18373 04				
19127 01	17842 01				
19128 01	18483 01				
19332 01	30168 01				
19333 01	11378 01				
19674 01	11380 01				
19750 01	11378 01				
19886 01	11381 01				
20051 01	30172 01				
22339 02	22339 04				
22751 01	30183 01				
24534 01	24534 02				
26699 01	26015 02				
26700 01	26016 02				
26739 01	22786 01				
26740 01	22785 01				
27078 01	27078 02				
27079 01	27079 02				
27544 01	11381 01				
27593 02	27593 03				
27637 01	27639 01				
27638 01	27640 01				
27976 01	27710 01				
28032 01	26711 01				
28038 01	28968 01				
28079 01	10172 01				
28080 01	10172 01				
28125 01	17435 01				
28126 01	17436 01				
28152 01	29418 01				
28153 01	29417 01				
28154 01	29420 01				
28155 01	29419 01				
28645 01	28644 01				
29531 01	29531 02				

Geänderte Bestellnummer

Artikelnummer neu	Artikelnummer alt	Artikelnummer neu	Artikelnummer alt	Artikelnummer neu	Artikelnummer alt
10163 03	04.46006.0	17866 01	02.05147.0	30112 01	10236 02
10164 03	04.03804.0	18048 02	18048 01	30112 01	14342 01
10172 01	28079 01	18373 04	18373 02	30114 01	11676 02
10172 01	28080 01	18483 01	19128 01	30117 01	17328 01
10266 01	01.99984.0	22339 04	14764 02	30121 01	10235 01
10285 02	04.03802.1	22339 04	22339 02	30127 01	14558 02
11378 01	19333 01	22785 01	26740 01	30130 01	14854 01
11378 01	19750 01	22786 01	26739 01	30132 01	15342 01
11380 01	19674 01	24534 02	24534 01	30133 01	15355 01
11381 01	19886 01	24810 01	02.05227.0	30134 01	15356 01
11381 01	27544 01	25147 01	01.02566.0	30149 01	15622 01
11639 01	12059 01	25931 01	10176 01	30153 01	15632 01
11840 03	11840 02	26015 02	26699 01	30154 01	15634 01
11863 02	11863 01	26016 02	26700 01	30161 01	17745 01
11868 03	11868 02	26711 01	28032 01	30168 01	19332 01
12064 01	01.03043.0	26846 02	04.99717.0	30172 01	20051 01
12117 02	12117 01	27078 02	27078 01	30183 01	22751 01
12117 02	12117 01	27079 02	27079 01	30908 01	11416 01
14773 02	04.99756.0	27593 03	27593 02		
15450 01	11838 01	27639 01	27637 01		
15622 01	17416 01	27640 01	27638 01		
15669 02	01.03357.0	27710 01	27976 01		
15719 03	15719 01	28082 02	02.05138.0		
17435 01	17438 02	28644 01	28645 01		
17435 01	28125 01	28968 01	28038 01		
17436 01	17437 02	29417 01	28153 01		
17436 01	28126 01	29418 01	28152 01		
17642 04	17642 02	29419 01	28155 01		
17795 01	01.49205.0	29420 01	28154 01		
17842 01	19127 01	29531 02	29531 01		
17865 01	02.05146.0	30111 01	10233 03		

ZF Trading GmbH
Obere Weiden 12 · 97424 Schweinfurt · Germany
Borgwardstraße 16 · 28279 Bremen · Germany
info.zf-trading@zf.com · www.zf.com/de/trading



