

2008

# Engine catalogue

Motorkatalog

Catalogue Moteur

Catalogo Componenti Motore

Catálogo de Componentes para Motor

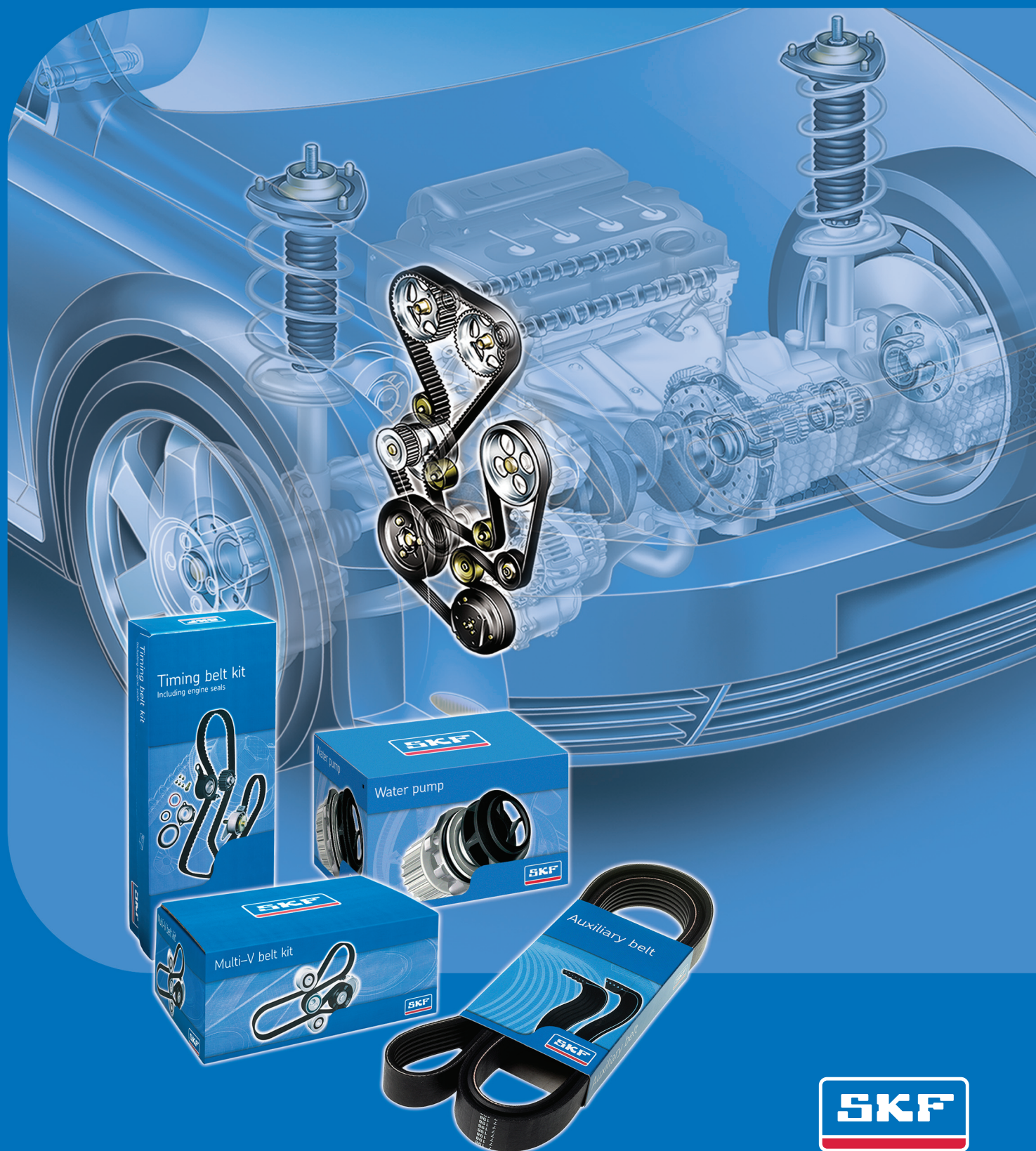





# Maintaining a 350 km/h R&D lab



In addition to SKF's renewed research and development facilities in Europe and the United States, Formula One car racing provides a unique environment for SKF to push the limits of the complex and fully diversified bearing related technology. A Ferrari single-seat car utilizes more than 150 SKF components. Lessons learned here are applied to the product we provide to automakers and the aftermarket worldwide.



|     | English                                       | Deutsch  | Français   | Italiano  | Español  |
|-----|---|--|--|---|--|
| 1)  | Camshaft + balancer kit                       | Satz für Nocken- und Ausgleichswelle                   | Kit d'arbre à cames + Kit d'arbre d'équilibrage                        | Albero a camme e kit di equilibrio                        | Kit de árbol de equilibrio                                     |
| 2)  | Water pump with accessories                   | Wasserpumpe mit Gehäuse                                | Pompe à eau avec accessoires   | Pompa acqua con accessori                                 | La bomba de agua y sus accesorios                              |
| 3)  | Timing belt kit with engine oil seals.        | SpannrollensatzPlus (mit Wellendichtringen)            | Kit de distribution avec joints SPI                                    | Kit tendicinghia con paraoli                              | Kit de correas de distribución con retenes del motor           |
| 4)  | Camshaft + Injection pump kit                 | Satz für Nockenwelle + Satz für Einspritzpumpe         | Kit d'arbre à cames + Kit de pompe à injection                         | Kit albero a camme + Kit pompa iniezione                  | Kit árbol de levas + Kit bomba de inyección                    |
| 5)  | Complete kit must be used                     | Kompletsatz ist einzubauen                             | Le kit complet doit être monté   | E' consigliabile l'utilizzo del kit completo              | Debe utilizarse un kit completo                                |
| 6)  | Except tropical climate                       | Ausser tropische Klimazone                             | Sauf climat tropical   | Ad eccezione del clima tropicale                          | Excepto clima tropical   |
| 7)  | With Dynamic Drive                            | Mit "Dynamic Drive"                                    | Avec Suspension Pilotée  | Con guida dinamica  | Con transmisión dinámica                                       |
| 8)  | Without Dynamic Drive                         | Ohne "Dynamic Drive"                                   | Sans Suspension Pilotée  | Senza guida dinamica                                      | Sin transmisión dinámica                                       |
| 9)  | For engine with multi-V belt                  | Für Motor mit Keilrippenriemen                         | Pour véhicules avec courroie multi-V                                   | Per motore con cinghia multi-V                            | Para motores con correa multi-V                                |
| 10) | For engine with V belt                        | Für Motor mit Keilriemen                               | Pour véhicules avec courroie V   | Per motore con cinghia V                                  | Para motores con correa en V                                   |
| 11) | Model generation 1                            | Modell Generation 1                                    | Modèles phase 1  | Modello prima generazione                                 | Modelo 1ª generación   |
| 12) | Model generation 2                            | Modell Generation 2                                    | Modèles phase 2  | Modello seconda generazione                               | Modelo 2ª generación   |
| 13) | With high pressure hyd pump 6+2               | Mit Hochdruckpumpe 6+2                                 | Avec pompe hydraulique 6+2   | Con alta pressione – pompa idraulica 6+2                  | Con bomba hidráulica de alta presión 6+2                       |
| 14) | With stop and start system                    | Mit Start/Stop-System                                  | Avec Système "Stop & Start"  | Con sistema Stop e Start                                  | Con sistema "Stop & Start"                                     |
| 15) | Without stop and start system                 | Ohne Start/Stop-System                                 | Sans Système "Stop & Start"  | Senza sistema Stop e Start                                | Sin sistema "Stop & Start"                                     |
| 16) | Only for aluminium backhouse                  | Nur für Aluminium                                      | Uniquement pour corps en aluminium                                     | Solo per ingresso acqua in alluminio                      | Solo para tapa posterior de aluminio                           |
| 17) | Alternator, 3 fixation points                 | Lichtmaschine, 3-Punkt-Fixierung                       | Alternateur 3 points de fixation                                       | Alternatore, 3 punti fissaggio                            | Alternador, 3 puntos de fijación                               |
| 18) | Alternator, 4 fixation points                 | Lichtmaschine, 4-Punkt-Fixierung                       | Alternateur 4 points de fixation                                       | Alternatore, 4 punti di fissaggio                         | Alternador, 4 puntos de fijación                               |
| 19) | Includes injection pump belt and tensioner    | Beinhaltet Riemen und Spannrolle für Einspritzpumpe    | Contient galet et courroie de pompe à injection                        | Comprende pompa iniezione, cinghia e tensionatore         | Incluye tensor y correa de bomba de inyección                  |
| 20) | Camshaft pulley must be OE ref: XS4Q 6A256 AC | Rolle (für Nockenwelle) muss OE Nr XS4Q 6A256 AC haben | Le numéro OE de la poulie d'arbre à cames doit être le "XS4Q 6A256 AC" | Puleggia albero a camme con riferimento OE: XS4Q 6A256 AC | La polea del árbol de levas debe ser la ref. OE: XS4Q 6A256 AC |
| 21) | Water pump idler                              | Umlenkrolle für Wasserpumpe                            | Galet monté sur la pompe à eau   | Puleggia Pompa Acqua                                      | Polea bomba de agua  |
| 22) | Turbocharger Intercooler                      | Turbolader   | Avec échangeur   | Sistema raffreddamento turbocompressore                   | Intercooler para turbocompresor                                |
| 23) | Except Turbocharger Intercooler               | Ausser Turbolader                                      | Sans échangeur   | Eccetto sistema raffreddamento turbocompressore           | Excepto intercooler para turbocompresor                        |
| 24) | With AC filter                                | Mit Filter (Klimaanlage)                               | Avec filtre de climatisation   | Con filtro AC   | Con filtro para el AC  |
| 25) | With standard radiator                        | Mit Kühler (Standard)                                  | Avec radiateur standard  | Con radiatore standard                                    | Con radiador estandar  |
| 26) | With heavy duty radiator                      | Mit Kühler   | Avec radiateur poids lourd   | Con radiatore rinforzato                                  | Con radiador de alto rendimiento                               |
| 27) | Camshaft kit                                  | Satz für Nockenwelle                                   | Kit d'arbre à cames  | Kit albero a camme  | Kit de árbol de levas  |
| 28) | Without power take off                        | Ohne Zapfwelle   | Sans prise de force  | Senza motore spento                                       | Sin potencia conectada   |
| 29) | With power take off                           | Mit Zapfwelle  | Avec prise de force  | Con motore spento   | Con potencia conectada   |
| 30) | With Anti-pollution                           | Schadstoffemission                                     | Avec système anti-pollution  | Con Anti-inquinamento                                     | Con anti-polución  |
| 31) | Without Anti-pollution                        | Ohne Schadstoffemission                                | Sans système anti-pollution  | Senza Anti-inquinamento                                   | Sin anti-polución  |
| 32) | Except equipment code COMPREX                 | Ausser Ausstattungs-Code COMPREX                       | Sauf équipement COMPREX  | Senza codice di equipaggiamento COMPREX                   | Excepto código de equipamiento COMPREX                         |
| 33) | For cold climate                              | Für kalte Temperaturen                                 | Pour pays à climat froid   | Per clima freddo  | Para clima frío  |
| 34) | Not for cold climate                          | Nicht für kalte Temperaturen                           | Sauf pays à climat froid   | Non per clima freddo                                      | No para clima frío   |
| 35) | Tempered climate                              | Gemäßigte Temperaturzone                               | Pour pays à climat tempéré   | Clima temperato   | Para clima templado  |
| 36) | Extreme cold climate                          | Extremtemperatur                                       | Pour pays à climat très froid  | Clima estremamente freddo                                 | Para clima extremadamente frío                                 |
| 37) | With heated windscreen                        | Mit beheizbarer Windschutzscheibe                      | Avec pare-brise chauffant  | Con parabrezza riscaldato                                 | Con parabrisas calefactable                                    |
| 38) | Without heated windscreen                     | Ohne beheizbare Windschutzscheibe                      | Sans pare-brise chauffant  | Senza parabrezza riscaldato                               | Sin parabrisas calefactable                                    |
| 39) | Equipment code L20                            | Ausstattungs-Code L20                                  | Code équipement L20  | Codice di equipaggiamento L20                             | Código de equipamiento L20                                     |
| 40) | Manufactured in France                        | Hergestellt in Frankreich                              | Modèles fabriqués en France  | Prodotto in Francia                                       | Fabricado en Francia   |

|     | Nederlands                                      | Polski  | Svenska                                     | Norsk   | Dansk  | Suomi  |
|-----|---|---|---|---|--|--|
| 1)  | Nokkenas & vliegwiël set                        | Zestaw do wałka rozrządu i układu wyważającego            | Kamaxel och balansaxelsats                  | Kamaxel + Vibrasjonsdemper                                | Knast- og balanceaxelsæt                             | Nokka-akseli + tasapainoakseli -sarja                      |
| 2)  | Waterpomp met accessoires                       | Pompa wody z akcesoriami                                  | Vattenpump med tillbehör                    | Vannpumpe med tillbehør                                   | Vandpumpe med tilbehør                               | Vesipumppu tarvikkeineen                                   |
| 3)  | Distributieset met motorafdichtingen            | Zestaw rozrządu z uszczelniającymi                        | Kamaxelsats med oljetätningar               | Registerreim sett med oljetetning                         | Tandremssæt med pakdåser                             | Jakohihnasarja öljytivisteineen                            |
| 4)  | Nokkenasset + de injectiepompsæt                | Zestaw do wałka rozrządu i pompy wtrysku                  | Kamaxelsats + Insprutningspumpsats          | Kamaxelsett + Innsprøytningspumpssett                     | Knastakselsæt + Indsprøjtningpumpsæt                 | Nokka-akseli -sarja + Ruiskutuspumppu -sarja               |
| 5)  | De volledige set moet worden gebruik            | Cały zestaw musi zostać użyty                             | Komplett sats skall användas                | Komplett sett må benyttes                                 | Der skal bruges et komplet sæt                       | Käytettävä täydellistä sarjaa                              |
| 6)  | Uitgezonderd tropisch klimaat                   | Z wyjątkiem klimatu tropikalnego                          | Ej tropiskt klimat                          | Unntat tropisk klima                                      | Tropisk klima undtaget                               | Paitsi trooppinen ilmasto                                  |
| 7)  | Met dynamische aandrijving                      | Z napędem dynamicznym                                     | Med Dynamic Drive                           | Med Dynamic Drive   | Med Dynamic Drive                                    | Aktiivisella kallistuksenvakaimella                        |
| 8)  | Zonder dynamische aandrijving                   | Bez napędu dynamicznego                                   | Ej Dynamic Drive                            | Uten Dynamic Drive  | Uden Dynamic Drive                                   | Ilman aktiivista kallistuksenvakainta                      |
| 9)  | Voor motor met multi-V riem                     | Do silnika z paskiem wielorokowym                         | För motor med multi-V rem                   | For motor med hjelperem (multi-V)                         | Motor med Multi-V-rem                                | Moniurahinnalliseen moottoriin                             |
| 10) | Voor motor met V riem                           | Do silnika z paskiem klinowym                             | För motor med V rem                         | For motor med V reim                                      | Motor med V-rem                                      | V -hinnalliseen moottoriin                                 |
| 11) | Model generatie 1                               | Model generacji 1   | Modell generation 1                         | Modell generation 1                                       | Model generation 1                                   | 1. sukupolven malli  |
| 12) | Model generatie 2                               | Model generacji 2   | Modell generation 2                         | Modell generation 2                                       | Model generation 2                                   | 2. sukupolven malli  |
| 13) | Met hoge druk hyd pomp 6+2                      | Z pompą wysokiego ciśnienia 6+2                           | Med högtrycks hyd pump 6+2                  | For høytrykks hydraulispumpe 6+2                          | Med hydraulisk højtrykspumpe 6+2                     | Suuripaineisella hydraulipumpulla 6+2 varustettuun malliin |
| 14) | Met Stop en Start systeem                       | Bez systemu Stop-Start                                    | Med stopp och start system                  | Med stopp og start system                                 | Med stop start system                                | Varustettu Stop and Start -järjestelmällä                  |
| 15) | Zonder Stop en Start systeem                    | Z systemem Stop-Start                                     | Ej stopp och start system                   | Uten stopp og start system                                | Uden stop start system                               | Ilman Stop and Start -järjestelmää                         |
| 16) | Alleen voor aluminium behuizing achterkant      | Tylko z aluminiową pokrywą                                | Bara för aluminium pumphus                  | Kun for hus i aluminium                                   | Kun til aluminium pumpehus                           | Vain alumiinirunkoon                                       |
| 17) | Alternator, 3 bevestigingspunten                | Punkty ustawienia alternatora 3                           | Generator med 3 fixeringspunkter            | Dynamo med 3 fikseringspunkter                            | Generator med 3 monteringspunkter                    | 3 kiinnityskohtaa laturissa                                |
| 18) | Alternator, 4 bevestigingspunten                | Punkty ustawienia alternatora 4                           | Generator med 4 fixeringspunkter            | Dynamo med 4 fikseringspunkter                            | Generator med 4 monteringspunkter                    | 4 kiinnityskohtaa laturissa                                |
| 19) | Bevat de injectiepompriem en spanrol            | Zestaw zawiera pompę wtryskową, pasek i napinacz          | Insprutningspump och spännulle              | Inkluderer injeksjonspumpereim og strammer                | Incl. Rem og strammer for indsprøjtning-pumpe        | Sisältää ruiskutuspumppun hinnan ja kiiristinrullan        |
| 20) | Nokkenas poelie moet OE ref: XS4Q 6A256 AC zijn | Stosować koło pasowe wałka rozrządu OE ref: XS4Q 6A256 AC | Kamaxelrulle måste vara OE ref: XS4Q6A256AC | Strammehjul til kamaxelreim må være OE ref: XS4Q 6A256 AC | Knastaksel løberulle skal være OE ref: XS4Q 6A256 AC | Nokkahihnapyörä pitää olla OE no: XS4Q 6A256 AC            |
| 21) | Waterpomplooprol                                | Koło pasowe pompy wody                                    | Löphjul för vattenpump                      | Løperulle for vannpumpen                                  | Medløberhjul til vandpumpe                           | Vesipumppu ohjainrulla                                     |
| 22) | Turbocharger Intercooler                        | Z intercoolere  | Turbo med laddluftskylare                   | Turbolader Intercooler                                    | Med turbolader Intercooler                           | Turboaitimen väljäähdyttimellä                             |
| 23) | Niet voor Turbocharger Intercooler              | Bez intercoolera  | Utom Turbo med laddluftskylare              | Uten Turbolader Intercooler                               | Uden turbolader Intercooler                          | Ilman turboaitimen väljäähdytintä                          |
| 24) | Met AC filter                                   | Z filtrem przeciwpyłkowym                                 | Med luftkonditioneringsfilter               | Med AC filter   | Med luftkonditioneringsfilter                        | Ilmastoinnin suodattimella                                 |
| 25) | Met standaard radiator                          | Ze standardową chłodnicą                                  | Med standardkylare                          | Med standard radiator                                     | Med standard køler                                   | Vakiojäähdyttimellä  |
| 26) | Met heavy duty radiator                         | Z wydajniejszą chłodnicą                                  | Med förstärkt kylare                        | Med høgkapasitets radiator                                | Til ekstra stor køler                                | Normaalla suuremmalla jäähdyttimellä                       |
| 27) | Nokkenasset                                     | Zestaw do wałka rozrządu                                  | Kamaxelsats                                 | Kamaxelsett   | Knastakselsæt  | Nokka-akseli -sarja  |
| 28) | Uitgezonderd aggregatenas                       | Bez wyłącznika mocy                                       | Ej kraftuttag                               | Unntat kraftuttak   | Uden kraftudtag                                      | Ei voiman ulosottoa  |
| 29) | Met aggregatenas                                | Z wyłącznikiem mocy                                       | Med kraftuttag                              | Med kraftuttak  | Med kraftudtag                                       | Voiman ulosotolla  |
| 30) | Met anti-pollutie                               | Z układem oczyszczania spalin                             | Med anti-förorening                         | Med anti-forurensning                                     | Med Anti forurening                                  | Saastumisen estolla  |
| 31) | Zonder anti-pollutie                            | Bez układu oczyszczania spalin                            | Utan anti-förorening                        | Uten anti-forurensning                                    | Uden Anti forurening                                 | Ilman saastumisen estoa                                    |
| 32) | Niet voor uitrustingscode code COMPREX          | Bez wyposażenia COMPREX                                   | Ej för utrustningskod COMPREX               | Uten utstyrskode COMPREX                                  | Uden udstyrskode COMPREX                             | Ilman varustekoodi COMPREX:a                               |
| 33) | Voor koud klimaat                               | Na zimną strefę klimatyczną                               | För kallt klimat                            | For kaldt klima   | Kold kold klima                                      | Kylmään ilmanalaan   |
| 34) | Niet voor koud klimaat                          | Nie na zimną strefę klimatyczną                           | Ej för kallt klimat                         | Ikke for kaldt klima                                      | Ikke kold klima                                      | Ei kylmään ilmanalaan                                      |
| 35) | Gematigd klimaat                                | Na umiarkowaną strefę klimatyczną                         | Tempererat klimat                           | Tempereret klima  | Tempereret klima                                     | Normaali ilmanalaan  |
| 36) | Extreem koud klimaat                            | Na skrajnie zimną strefę klimatyczną                      | Extremt kallt klimat                        | Ekstremt kaldt klima                                      | Ekstremt kaldt klima                                 | Erittäin kylmään ilmastoon                                 |
| 37) | Met verwarmd windscherm                         | Z ogrzewaniem przedniej szyby                             | Med oppvärmd vindruta                       | Med oppvarmet frontrute                                   | Med opvarmet forrude                                 | Lämmitettävällä tuulilasilla                               |
| 38) | Zonder verwarmd windscherm                      | Bez ogrzewania przedniej szyby                            | Ej oppvärmd vindruta                        | Uten oppvarmet frontrute                                  | Uden opvarmet forrude                                | Ilman lämmitettävää tuulilasia                             |
| 39) | Uitrustingscode L20                             | Kod wyposażenia L20                                       | Utrustningskod L20                          | Utstyrskode L20   | Udstyrskode L20                                      | Varustekoodi L20   |
| 40) | Geproduceerd in Frankrijk                       | Wyprodukowane we Francji                                  | Tillverkad in Frankrike                     | Produsert i Frankrike                                     | Produceret i Frankrig                                | Valmistettu Ranskassa                                      |



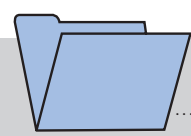
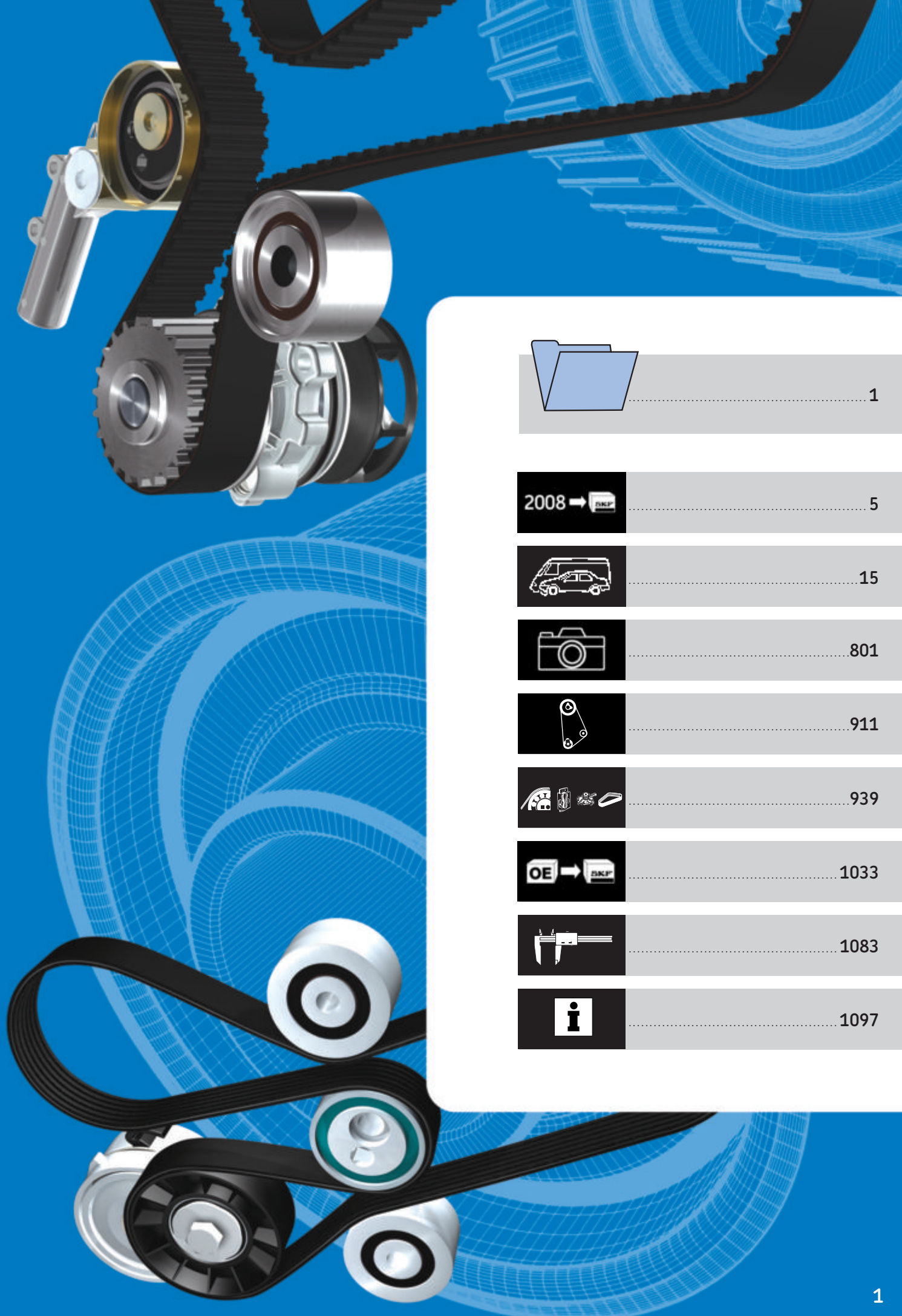

1

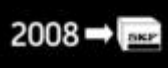

5



15



801



911



939



1033



1083



1097



# Install confidence

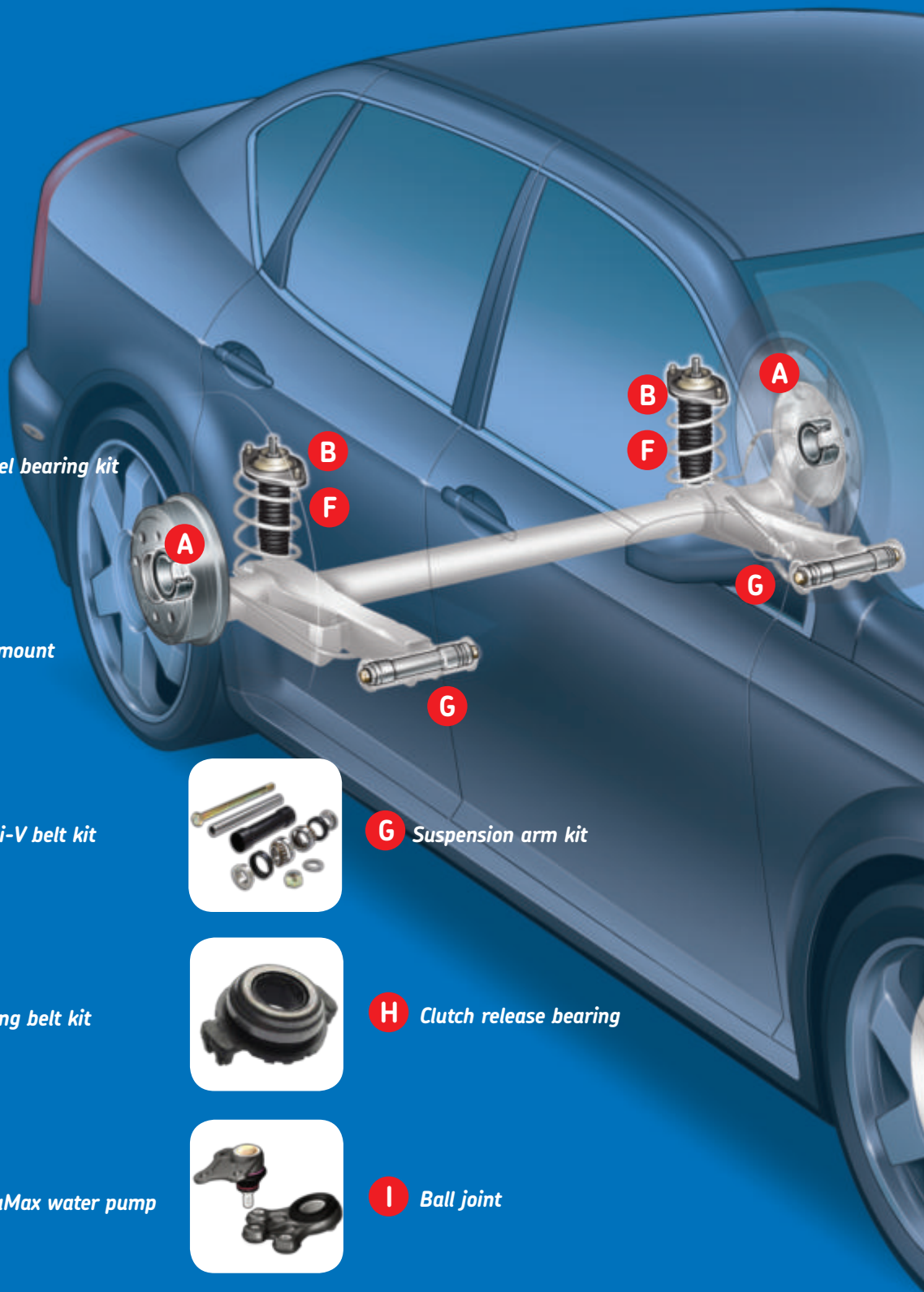

**A** *Wheel bearing kit*



**B** *Top mount*



**C** *Multi-V belt kit*



**D** *Timing belt kit*



**E** *AquaMax water pump*



**F** *Strut protection kit*



**G** *Suspension arm kit*



**H** *Clutch release bearing*



**I** *Ball joint*



**J** *Drive shaft kits*



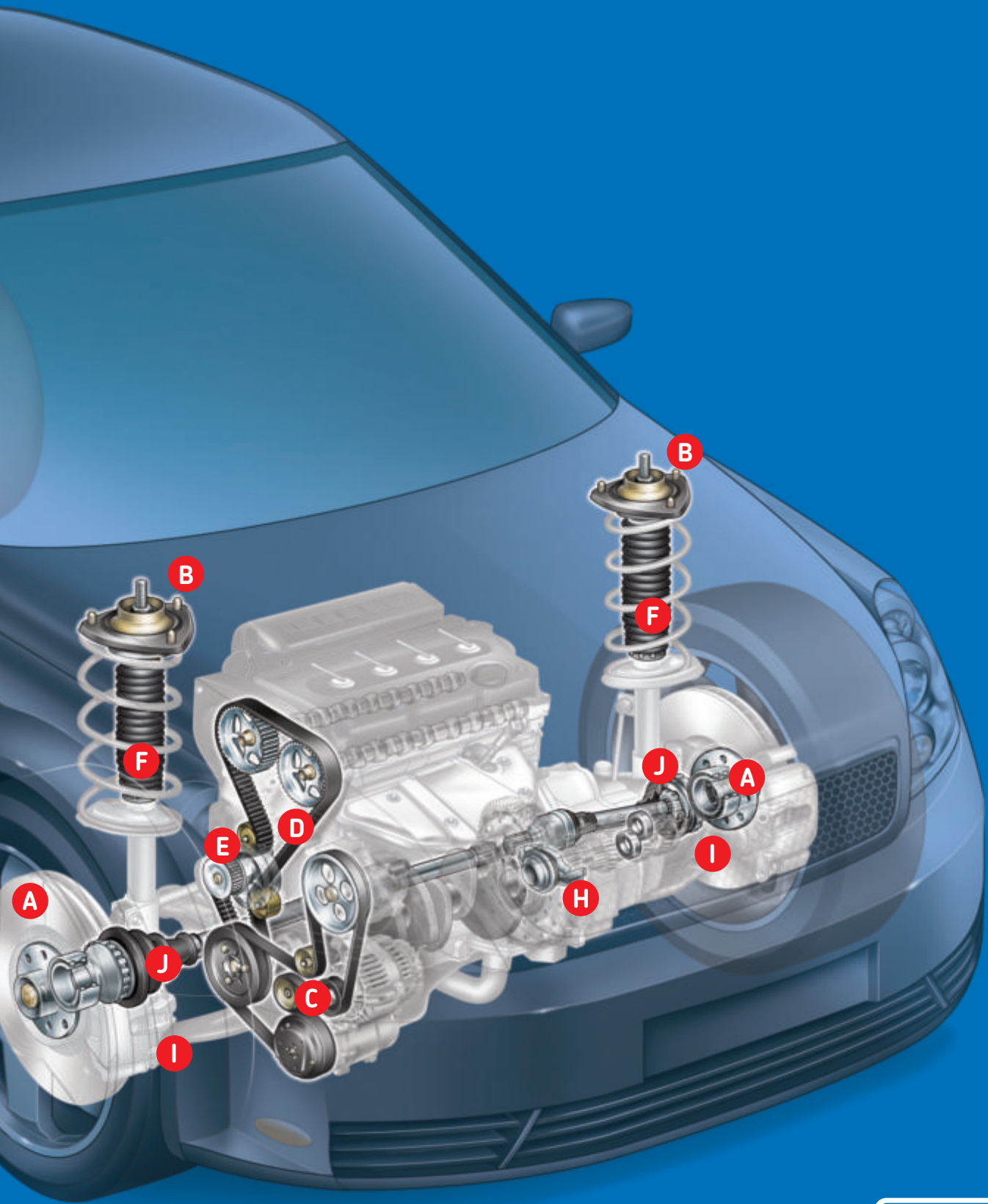





**Timing belt kit  
VKMA XXXXX**



**Timing belt kit  
VKMA XX9XX**



**Timing belt kit  
VKMC XXXXX**



**Timing belt kit  
VKMS XXXXX**



**Multi-V belt kit  
VKMA XXXXX**



**Auxiliary belt  
VKMV XXXXX**



**Belt tensioner pulley  
VKM XXXXX**



**Water pump kit  
VKPA XXXXX**



**Water pump kit  
VKPC XXXXX**



**Crankshaft pulley  
VKM 9XXXX**



2008 →



|           |       |   |
|-----------|-------|---|
| VKM 11007 | AUDI  | A4 (8D2, B5) / A4 Avant (8D5, B5)   |
| VKM 11009 | AUDI  | A4 (8D2, B5) / A4 Avant (8D5, B5) / A6 (4A, C4) / A6 Avant (4A, C4) / A6 (4B, C5) / A6 Avant (4B, C5) / CABRIOLET (8G7, B4)   |
|           | VW    | PASSAT (3B2) / Variant (3B5)  |
| VKM 11060 | AUDI  | 100 (4A, C4) / 100 Avant (4A, C4) / 80 (8C, B4) / 80 Avant (8C, B4) / A6 (4A, C4) / A6 Avant (4A, C4) / CABRIOLET (8G7, B4) / COUPE (89, 8B)  |
| VKM 11117 | AUDI  | A4 (8D2, B5) / A4 Avant (8D5, B5) / A4 (8E2, B6) / A4 Avant (8E5, B6) / A4 (8EC) / A4 Avant (8ED) / A4 Convertible (8H7) / A6 (4B, C5) / A6 Avant (4B, C5)  |
|           | SKODA | SUPERB  |
|           | VW    | PASSAT (3B3) / Variant (3B6)  |
| VKM 11144 | AUDI  | A6 (4B, C5) / A6 Avant (4B, C5)   |
|           | FORD  | GALAXY I  |
|           | SEAT  | AROSA   |
|           | VW    | BORA (1J2) / BORA Estate (1J6) / GOLF IV (1J1) / GOLF IV Variant (1J5) / LUPO (6X1, 6E1) / PASSAT (3B2) / Variant (3B5) / POLO (6N2) / SHARAN (7M8, 7M9, 7M6)   |
| VKM 11145 | AUDI  | A2 (8Z0) / A3 (8L1) / A4 (8D2, B5) / A4 Avant (8D5, B5) / A4 (8E2, B6) / A4 Avant (8E5, B6) / A6 (4B, C5) / A6 Avant (4B, C5)   |
|           | FORD  | GALAXY I  |
|           | SEAT  | ALHAMBRA / AROSA / LEON I (1M1) / TOLEDO II (1M2)   |
|           | SKODA | FABIA / OCTAVIA I (1U2) / OCTAVIA Combi (1U5) / SUPERB  |
|           | VW    | BORA (1J2) / BORA Estate (1J6) / GOLF IV (1J1) / GOLF IV Variant (1J5) / LUPO (6X1, 6E1) / NEW BEETLE (9C1, 1C1) / Convertible (1Y7) / PASSAT (3B2) / Variant (3B5) / PASSAT (3B3) / Variant (3B6) / POLO (6N2) / POLO (9N_) / SHARAN (7M8, 7M9, 7M6) |
| VKM 11154 | AUDI  | A4 (8D2, B5) / A4 Avant (8D5, B5) / A4 (8E2, B6) / A4 Avant (8E5, B6) / A4 (8EC) / A4 Avant (8ED) / A4 Convertible (8H7) / A6 (4B, C5) / A6 Avant (4B, C5) / A8 (4D2, 4D8) / ALLROAD (4BH)  |
|           | SKODA | SUPERB  |
|           | VW    | PASSAT (3B2) / Variant (3B5) / PASSAT (3B3) / Variant (3B6)   |
| VKM 11207 | AUDI  | A6 (4B, C5) / A6 Avant (4B, C5) / A8 (4D2, 4D8)   |
| VKM 11208 | AUDI  | A4 (8D2, B5) / A4 Avant (8D5, B5) / A6 (4A, C4) / A6 Avant (4A, C4) / A8 (4D2, 4D8)   |

2008 →



|           |            |  |
|-----------|------------|--|
| VKM 11209 | AUDI       | A4 (8D2, B5) / A4 Avant (8D5, B5) / A4 (8E2, B6) / A4 Avant (8E5, B6) / A4 Convertible (8H7) / A6 (4B, C5) / A6 Avant (4B, C5) / A6 (4F2) / A6 Avant (4F5) / A8 (4D2, 4D8) / ALLROAD (4BH) |
|           | SKODA      | SUPERB   |
|           | VW         | PASSAT (3B2) / Variant (3B5) / PASSAT (3B3) / Variant (3B6)  |
| VKM 11220 | AUDI       | A3 (8P1) / A3 Sportback (8PA) / A4 (8E2, B6) / A4 Avant (8E5, B6)  |
|           | VW         | GOLF V (1K1) / GOLF V VARIANT (1K1) / TOURAN   |
| VKM 11300 | AUDI       | A4 (8E2, B6) / A4 Avant (8E5, B6) / A4 (8EC) / A4 Avant (8ED) / A4 Convertible (8H7) / A6 (4B, C5) / A6 Avant (4B, C5) / A6 (4F2) / A6 Avant (4F5) / A8 (4E_)                              |
| VKM 11330 | AUDI       | A8 (4D2, 4D8)  |
| VKM 11331 | AUDI       | A8 (4D2, 4D8)  |
| VKM 12206 | FIAT       | 500 / DOBLO / GRANDE PUNTO / PANDA (169) / PUNTO (188) / STRADA  |
|           | LANCIA     | MUSA / YPSILON   |
| VKM 13262 | CITROËN    | C6   |
|           | LAND ROVER | DISCOVERY III / RANGE ROVER SPORT  |
|           | PEUGEOT    | 407 / 607  |
| VKM 13263 | CITROËN    | C4 / C4 Picasso / C5 II / C8   |
|           | PEUGEOT    | 307 / 407 / 807  |
| VKM 13264 | CITROËN    | C5 I / C5 II / C8 / JUMPER (244)   |
|           | FIAT       | SCUDO (220)  |
|           | PEUGEOT    | 406 / 607 / 807 / BOXER II / EXPERT I  |
|           | SUZUKI     | GRAND VITARA   |
| VKM 14224 | FORD       | FIESTA V / FOCUS C-MAX I / FOCUS C-MAX II / FOCUS II / FUSION / MONDEO IV  |
| VKM 15260 | OPEL       | ASTRA G / ASTRA H / CORSA D / MERIVA / VECTRA C / ZAFIRA B   |
|           | VAUXHALL   | ASTRA Mk V / ASTRA TwinTop / CORSA Mk III / MERIVA / VECTRA Mk II / ZAFIRA Mk II   |
| VKM 16003 | DACIA      | LOGAN  |
|           | RENAULT    | CLIO II / KANGOO / MEGANE I / SCENIC I / THALIA  |
| VKM 16040 | FORD       | FOCUS II / MONDEO IV / S-MAX   |
|           | VOLVO      | S40 II - V50 / S60 / S80 / V70 II / XC70 I / XC90  |
| VKM 21204 | AUDI       | A6 (4B, C5) / A6 Avant (4B, C5) / A8 (4D2, 4D8) / A8 (4E_)   |
|           | VW         | PHAETON (3D2) / TOUAREG (7LA)  |
| VKM 21302 | AUDI       | A4 (8E2, B6) / A4 Avant (8E5, B6) / A4 (8EC) / A4 Avant (8ED) / A4 Convertible (8H7) / A6 (4B, C5) / A6 Avant (4B, C5) / A6 (4F2) / A6 Avant (4F5) / A8 (4E_)                              |
| VKM 23218 | CITROËN    | XSARA  |
|           | PEUGEOT    | 306  |





2008 →



|           |            |   |
|-----------|------------|---|
| VKM 23261 | CITROËN    | C6  |
|           | LAND ROVER | DISCOVERY III / RANGE ROVER SPORT   |
|           | PEUGEOT    | 407 / 607   |
| VKM 23264 | CITROËN    | C5 I / C5 II / C8 / JUMPER (244)  |
|           | FIAT       | SCUDO (220)   |
|           | PEUGEOT    | 406 / 607 / 807 / BOXER II / EXPERT I   |
|           | SUZUKI     | GRAND VITARA  |
| VKM 25209 | OPEL       | ASTRA G / ASTRA H   |
|           | VAUXHALL   | ASTRA Mk IV / ASTRA Mk V  |
| VKM 27307 | LAND ROVER | FREELANDER I  |
|           | MG         | MG ZS / MG ZT   |
|           | ROVER      | 45 / 75 / 800   |
| VKM 71706 | TOYOTA     | LAND CRUISER 90   |
| VKM 72501 | NISSAN     | VANETTE CARGO   |
| VKM 73607 | HONDA      | CIVIC   |
| VKM 74601 | MAZDA      | 323 (BA) / 323 (BJ)   |
| VKM 74602 | MAZDA      | 323 (BJ) / 626 (GF) / 626 (GW) / PREMACY  |
| VKM 74607 | MAZDA      | 6 (GG) / 6 (GY)   |
| VKM 74608 | KIA        | CARNIVAL / SEDONA   |
| VKM 74609 | KIA        | CARNIVAL / SEDONA   |
| VKM 75628 | HYUNDAI    | ELANTRA / GETZ / LANTRA / MATRIX / SANTA FE / TRAJET  |
| VKM 75629 | HYUNDAI    | COUPE / ELANTRA / LANTRA / MATRIX   |
| VKM 75630 | HYUNDAI    | COUPE / SANTA FE / SONATA / TRAJET  |
| VKM 75633 | HYUNDAI    | SANTA FE / SONATA / TRAJET  |
|           | KIA        | SORENTO   |
| VKM 75634 | MITSUBISHI | COLT  |
| VKM 82503 | NISSAN     | VANETTE CARGO   |
| VKM 84503 | KIA        | CARNIVAL / SEDONA   |
| VKM 84504 | KIA        | CARNIVAL / SEDONA   |
| VKM 84506 | KIA        | CARNIVAL / SEDONA   |
| VKM 84602 | MAZDA      | 323 (BA) / 323 (BJ)   |
| VKM 84603 | MAZDA      | 323 (BJ) / 626 (GF) / 626 (GW) / PREMACY  |
| VKM 84608 | MAZDA      | 6 (GG) / 6 (GY)   |
| VKM 85146 | HYUNDAI    | ELANTRA / GETZ / LANTRA / MATRIX / SANTA FE / TRAJET  |
| VKM 85147 | HYUNDAI    | COUPE / ELANTRA / LANTRA / MATRIX   |
| VKM 85148 | HYUNDAI    | COUPE / SANTA FE / SONATA / TRAJET  |
| VKM 85150 | MITSUBISHI | COLT  |
| VKM 93301 | CITROËN    | BERLINGO / C5 I / C5 II / C8 / EVASION / JUMPER (230) / JUMPER (244) / JUMPY I / JUMPY II / XANTIA II / XSARA / XSARA PICASSO |
|           | PEUGEOT    | 206 / 306 / 307 / 406 / 806 / BOXER I / BOXER II / EXPERT I / PARTNER   |
| VKM 93302 | CITROËN    | BERLINGO / BX / EVASION / JUMPER (230) / JUMPY I / JUMPY II / XANTIA I / XANTIA II / XSARA / ZX                               |

2008 →



|            |   |  |
|------------|---|--|
| VKM 93305  | PEUGEOT   | 306 / 405 I / 405 II / 406 / 806 / BOXER I / EXPERT I / PARTNER  |
|            | CITROËN   | AX / SAXO / XSARA  |
| VKM 93306  | PEUGEOT   | 106 I / 106 II   |
|            | CITROËN   | EVASION / XANTIA I / XANTIA II / XM II   |
| VKMA 01007 | PEUGEOT   | 406 / 605 / 806  |
|            |   |  |
| VKMA 01007 | AUDI  | A4 (8D2, B5) / A4 Avant (8D5, B5)  |
| VKMA 01025 | AUDI  | 100 (4A, C4) / 100 Avant (4A, C4)  |
| VKMA 01060 | AUDI  | 100 (4A, C4) / 100 Avant (4A, C4) / 80 (8C, B4) / 80 Avant (8C, B4) / A6 (4A, C4) / A6 Avant (4A, C4) / CABRIOLET (8G7, B4) / COUPE (89, 8B)   |
|            | VKMA 01140  | AUDI   |
| VKMA 01220 | VW  | LUP0 (6X1, 6E1)  |
|            | AUDI  | A3 (8P1) / A3 Sportback (8PA) / A4 (8E2, B6) / A4 Avant (8E5, B6)  |
| VKMA 01222 | VW  | GOLF V (1K1) / GOLF V VARIANT (1K1) / TOURAN   |
|            | AUDI  | A3 (8P1) / A3 Sportback (8PA) / A4 (8EC) / A4 Avant (8ED) / A4 Convertible (8H7) / A6 (4F2) / A6 Avant (4F5) / TT (8J3) / TT Roadster (8J9)  |
| VKMA 01224 | SEAT  | ALTEA / ALTEA XL / LEON II (1P1) / TOLEDO III (5P2)  |
|            | SKODA   | OCTAVIA II (1Z3) / OCTAVIA II Combi (1Z5)  |
| VKMA 01226 | VW  | EOS / GOLF V (1K1) / GOLF V VARIANT (1K1) / GOLF V PLUS (5M1) / JETTA III (1KM) / PASSAT (3C2) / Variant (3C5)   |
|            | AUDI  | A4 (8E2, B6) / A4 Avant (8E5, B6)  |
| VKMA 01262 | VW  | TRANSPORTER IV   |
| VKMA 01266 | VW  | TRANSPORTER IV   |
| VKMA 01275 | SEAT  | CORDOBA (6L2) / IBIZA IV (6L1)   |
| VKMA 01301 | SKODA   | FABIA  |
|            | VW  | POLO (9N_) / POLO Saloon   |
| VKMA 01332 | AUDI  | A4 (8E2, B6) / A4 Avant (8E5, B6) / A4 (8EC) / A4 Avant (8ED) / A4 Convertible (8H7) / A6 (4B, C5) / A6 Avant (4B, C5) / A6 (4F2) / A6 Avant (4F5) / A8 (4E_)                              |
|            | AUDI  | A4 (8EC) / A4 Avant (8ED) / A4 Convertible (8H7) / A6 (4F2) / A6 Avant (4F5) / A6 Allroad (4FH) / A8 (4E_) / Q7  |
| VKMA 01902 | VW  | PHAETON (3D2) / TOUAREG (7LA)  |
|            | AUDI  | A4 (8D2, B5) / A4 Avant (8D5, B5) / A6 (4A, C4) / A6 Avant (4A, C4) / A8 (4D2, 4D8)  |
| VKMA 01903 | AUDI  | A4 (8D2, B5) / A4 Avant (8D5, B5) / A4 (8E2, B6) / A4 Avant (8E5, B6) / A4 Convertible (8H7) / A6 (4B, C5) / A6 Avant (4B, C5) / A6 (4F2) / A6 Avant (4F5) / A8 (4D2, 4D8) / ALLROAD (4BH) |

2008 →



|            |              |   |
|------------|--------------|---|
|            | <b>SKODA</b> | SUPERB  |
|            | <b>VW</b>    | PASSAT (3B2) / Variant (3B5) / PASSAT (3B3) / Variant (3B6)   |
| VKMA 01904 | <b>AUDI</b>  | A6 (4B, C5) / A6 Avant (4B, C5) / A8 (4D2, 4D8)   |
| VKMA 01905 | <b>AUDI</b>  | A6 (4B, C5) / A6 Avant (4B, C5) / A8 (4D2, 4D8)   |
| VKMA 01907 | <b>AUDI</b>  | A4 (8D2, B5) / A4 Avant (8D5, B5)   |
| VKMA 01908 | <b>AUDI</b>  | A4 (8D2, B5) / A4 Avant (8D5, B5) / A6 (4A, C4) / A6 Avant (4A, C4) / A6 (4B, C5) / A6 Avant (4B, C5) / CABRIOLET (8G7, B4)   |
|            | <b>VW</b>    | PASSAT (3B2) / Variant (3B5)  |
| VKMA 01918 | <b>AUDI</b>  | A4 (8D2, B5) / A4 Avant (8D5, B5) / A4 (8E2, B6) / A4 Avant (8E5, B6) / A4 (8EC) / A4 Avant (8ED) / A4 Convertible (8H7) / A6 (4B, C5) / A6 Avant (4B, C5)  |
|            | <b>SKODA</b> | SUPERB  |
|            | <b>VW</b>    | PASSAT (3B3) / Variant (3B6)  |
| VKMA 01927 | <b>AUDI</b>  | A6 (4B, C5) / A6 Avant (4B, C5) / A8 (4D2, 4D8) / A8 (4E_)  |
|            | <b>VW</b>    | PHAETON (3D2) / TOUAREG (7LA)   |
| VKMA 01940 | <b>AUDI</b>  | A2 (8Z0)  |
|            | <b>VW</b>    | LUPO (6X1, 6E1)   |
| VKMA 01941 | <b>AUDI</b>  | A6 (4B, C5) / A6 Avant (4B, C5)   |
|            | <b>SEAT</b>  | AROSA   |
|            | <b>VW</b>    | BORA (1J2) / BORA Estate (1J6) / GOLF IV (1J1) / GOLF IV Variant (1J5) / LUPO (6X1, 6E1) / PASSAT (3B2) / Variant (3B5) / POLO (6N2)  |
| VKMA 01942 | <b>AUDI</b>  | A2 (8Z0) / A3 (8L1) / A4 (8D2, B5) / A4 Avant (8D5, B5) / A4 (8E2, B6) / A4 Avant (8E5, B6) / A6 (4B, C5) / A6 Avant (4B, C5)   |
|            | <b>FORD</b>  | GALAXY I  |
|            | <b>SEAT</b>  | ALHAMBRA / AROSA / LEON I (1M1) / TOLEDO II (1M2)   |
|            | <b>SKODA</b> | FABIA / OCTAVIA I (1U2) / OCTAVIA Combi (1U5) / SUPERB  |
|            | <b>VW</b>    | BORA (1J2) / BORA Estate (1J6) / GOLF IV (1J1) / GOLF IV Variant (1J5) / LUPO (6X1, 6E1) / NEW BEETLE (9C1, 1C1) / Convertible (1Y7) / PASSAT (3B2) / Variant (3B5) / PASSAT (3B3) / Variant (3B6) / POLO (6N2) / POLO (9N_) / SHARAN (7M8, 7M9, 7M6) |
| VKMA 01943 | <b>FORD</b>  | GALAXY I  |
|            | <b>VW</b>    | SHARAN (7M8, 7M9, 7M6)  |
| VKMA 01951 | <b>AUDI</b>  | A4 (8D2, B5) / A4 Avant (8D5, B5) / A6 (4B, C5) / A6 Avant (4B, C5) / A8 (4D2, 4D8)   |
|            | <b>VW</b>    | PASSAT (3B2) / Variant (3B5) / PASSAT (3B3) / Variant (3B6)   |
| VKMA 01952 | <b>AUDI</b>  | A4 (8E2, B6) / A4 Avant (8E5, B6) / A4 (8EC) / A4 Avant (8ED) / A4 Convertible (8H7) / A6 (4B, C5) / A6 Avant (4B, C5) / A8 (4D2, 4D8) / ALLROAD (4BH)  |

2008 →



|            |                   |  |
|------------|-------------------|--|
|            | <b>SKODA</b>      | SUPERB   |
|            | <b>VW</b>         | PASSAT (3B3) / Variant (3B6)                   |
| VKMA 02193 | <b>ALFA ROMEO</b> | 147 / 159 / BRERA / GT                         |
|            | <b>FIAT</b>       | CROMA (194) / STILO                            |
|            | <b>OPEL</b>       | ASTRA H / SIGNUM / VECTRA C / ZAFIRA B         |
|            | <b>SAAB</b>       | 9-3 II   |
|            | <b>VAUXHALL</b>   | ASTRA Mk V / SIGNUM / VECTRA Mk II             |
| VKMA 02195 | <b>ALFA ROMEO</b> | 159  |
|            | <b>FIAT</b>       | CROMA (194)                                    |
|            | <b>LANCIA</b>     | THESIS   |
| VKMA 02197 | <b>ALFA ROMEO</b> | 147 / 156                                      |
|            | <b>FIAT</b>       | STILO  |
| VKMA 02198 | <b>FIAT</b>       | DOBLO  |
| VKMA 02277 | <b>ALFA ROMEO</b> | 145/146 / 147 / 155 / 156 / 166 / GTV / SPIDER |
|            | <b>LANCIA</b>     | DEDRA / DELTA II                               |
| VKMA 02283 | <b>ALFA ROMEO</b> | 156 / GT / GTV / SPIDER                        |
|            | <b>LANCIA</b>     | DELTA II / LYBRA                               |
| VKMA 02983 | <b>CITROËN</b>    | JUMPER (230) / JUMPER (244)                    |
|            | <b>FIAT</b>       | DUCATO (230) / DUCATO (244) / DUCATO (280/290) |
|            | <b>OPEL</b>       | ARENA / MOVANO                                 |
|            | <b>PEUGEOT</b>    | BOXER I / BOXER II                             |
|            | <b>RENAULT</b>    | MASTER I / MASTER II / TRAFIC I                |
|            | <b>VAUXHALL</b>   | ARENA / MOVANO                                 |
| VKMA 02984 | <b>FIAT</b>       | DUCATO (230) / DUCATO (280/290)                |
|            | <b>RENAULT</b>    | MASTER I                                       |
| VKMA 02986 | <b>FIAT</b>       | DUCATO (230)                                   |
|            | <b>OPEL</b>       | MOVANO   |
|            | <b>RENAULT</b>    | MASTER II                                      |
|            | <b>VAUXHALL</b>   | MOVANO   |
| VKMA 03218 | <b>CITROËN</b>    | XSARA  |
|            | <b>PEUGEOT</b>    | 306  |
| VKMA 03261 | <b>CITROËN</b>    | C6   |
|            | <b>LAND ROVER</b> | DISCOVERY III / RANGE ROVER SPORT              |
|            | <b>PEUGEOT</b>    | 407 / 607                                      |
| VKMA 03263 | <b>CITROËN</b>    | C4 / C4 Picasso / C5 II / C8                   |
|            | <b>PEUGEOT</b>    | 307 / 407 / 807                                |
| VKMA 03264 | <b>CITROËN</b>    | C5 I / C5 II / C8                              |
|            | <b>PEUGEOT</b>    | 406 / 607 / 807                                |
| VKMA 03265 | <b>FIAT</b>       | SCUDO (220)                                    |
|            | <b>PEUGEOT</b>    | EXPERT I                                       |
|            | <b>SUZUKI</b>     | GRAND VITARA                                   |
| VKMA 03266 | <b>CITROËN</b>    | JUMPER (244)                                   |
|            | <b>PEUGEOT</b>    | BOXER II                                       |
| VKMA 03301 | <b>CITROËN</b>    | XM II  |





2008 →



|            |            |  |
|------------|------------|--|
| VKMA 04224 | PEUGEOT    | 605  |
|            | FORD       | FIESTA V / FOCUS C-MAX I / FOCUS C-MAX II / FOCUS II / FUSION / MONDEO IV                      |
| VKMA 05156 | OPEL       | ASTRA G / ASTRA H / COMBO B / CORSA C / MERIVA / SIGNUM / TIGRA Twin Top / VECTRA C / ZAFIRA A |
|            | VAUXHALL   | ASTRA Mk IV / ASTRA Mk V / CORSA Mk II / MERIVA / TIGRA Mk II / VECTRA Mk II / ZAFIRA Mk I     |
| VKMA 06003 | DACIA      | LOGAN  |
|            | RENAULT    | CLIO II / KANGOO / MEGANE I / SCENIC I / THALIA  |
| VKMA 06040 | FORD       | FOCUS II / MONDEO IV / S-MAX   |
|            | VOLVO      | S40 II - V50 / S60 / S80 / V70 II / XC70 I / XC90  |
| VKMA 06605 | VOLVO      | C70 - S70 / V70 I  |
| VKMA 90008 | CHEVROLET  | MATIZ / SPARK  |
|            | DAEWOO     | MATIZ  |
| VKMA 91713 | TOYOTA     | LAND CRUISER 90  |
| VKMA 92517 | NISSAN     | VANETTE CARGO  |
| VKMA 92518 | NISSAN     | PATROL GR  |
| VKMA 93615 | HONDA      | CIVIC  |
| VKMA 93616 | HONDA      | CIVIC  |
| VKMA 94508 | KIA        | CARNIVAL / SEDONA  |
| VKMA 94509 | KIA        | CARNIVAL / SEDONA  |
| VKMA 94611 | MAZDA      | 323 (BA) / 323 (BJ)  |
| VKMA 94612 | MAZDA      | 323 (BJ) / 626 (GF) / 626 (GW) / PREMACY   |
| VKMA 94619 | MAZDA      | 6 (GG) / 6 (GY)  |
| VKMA 95655 | HYUNDAI    | COUPE / ELANTRA / LANTRA / MATRIX  |
| VKMA 95656 | HYUNDAI    | COUPE / ELANTRA / LANTRA   |
| VKMA 95657 | HYUNDAI    | COUPE / SANTA FE / SONATA / TRAJET   |
| VKMA 95658 | HYUNDAI    | SANTA FE / SONATA / TRAJET   |
| VKMA 95659 | HYUNDAI    | SANTA FE / SONATA  |
|            | KIA        | SORENTO  |
| VKMA 95660 | HYUNDAI    | ELANTRA / GETZ / LANTRA / MATRIX / SANTA FE / TRAJET   |
| VKMA 95663 | MITSUBISHI | COLT   |
| VKMA 95666 | MITSUBISHI | OUTLANDER  |
| VKMA 96218 | SUZUKI     | ALTO / SWIFT   |
| VKMA 98110 | SUBARU     | FORESTER / IMPREZA   |
| VKMA 98112 | SUBARU     | IMPREZA  |
| VKMC 04212 | FORD       | ESCORT V / ESCORT VI / ESCORT VII / FIESTA III / ORION III                                     |
| VKMC 05150 | OPEL       | VECTRA B   |
|            | VAUXHALL   | VECTRA Mk I  |
| VKMC 06003 | RENAULT    | CLIO II / KANGOO / MEGANE I / SCENIC I / THALIA  |
| VKMC 06005 | RENAULT    | CLIO II / KANGOO / MEGANE I  |

2008 →



|              |            |   |
|--------------|------------|---|
| VKMS 02215   | FIAT       | BRAVA/BRAVO (182) / MAREA   |
|              | LANCIA     | Y   |
| VKMS 02242-1 | FIAT       | BRAVA/BRAVO (182) / MAREA / MULTIPLA / PALIO/SIENA                          |
|              | LANCIA     | DEDRA / DELTA II  |
| VKMS 02242-2 | FIAT       | BRAVA/BRAVO (182) / DOBLO / MAREA / MULTIPLA / PALIO/SIENA / STILO          |
|              | LANCIA     | LYBRA   |
| VKMS 91001   | TOYOTA     | CAMRY   |
| VKMS 91303   | TOYOTA     | AVENSIS / AVENSIS VERSO / COROLLA / COROLLA VERSO / PICNIC / PREVIA / RAV 4 |
| VKMS 91304   | TOYOTA     | CAMRY   |
| VKMS 92517   | NISSAN     | VANETTE CARGO   |
| VKMS 92518   | NISSAN     | PATROL GR   |
| VKMS 93210   | HONDA      | CR-V  |
| VKMS 93601   | HONDA      | HR-V  |
| VKMS 93615   | HONDA      | CIVIC   |
| VKMS 93616   | HONDA      | CIVIC   |
| VKMS 94611   | MAZDA      | 323 (BA) / 323 (BJ)   |
| VKMS 94612   | MAZDA      | 626 (GF) / 626 (GW) / PREMACY   |
| VKMS 94619   | MAZDA      | 6 (GG) / 6 (GY)   |
| VKMS 95623   | MITSUBISHI | LANCER  |
| VKMS 95650   | MITSUBISHI | LANCER  |
| VKMS 95651-1 | MITSUBISHI | SPACE STAR  |
| VKMS 95651-2 | MITSUBISHI | SPACE STAR  |
| VKMS 95655   | HYUNDAI    | COUPE / ELANTRA / LANTRA / MATRIX   |
| VKMS 95656   | HYUNDAI    | COUPE / ELANTRA / LANTRA  |
| VKMS 95663   | MITSUBISHI | COLT  |
| VKMS 95666   | MITSUBISHI | OUTLANDER   |
| VKMS 97505   | DAIHATSU   | CUORE / MOVE  |
| VKMS 97507   | DAIHATSU   | CUORE   |
| VKMS 98110   | SUBARU     | FORESTER / IMPREZA  |



|           |       |  |
|-----------|-------|--|
| VKM 31006 | AUDI  | A4 (8E2, B6) / A4 Avant (8E5, B6) / A4 (8EC) / A4 Avant (8ED) / A4 Convertible (8H7) / A6 (4B, C5) / A6 Avant (4B, C5) / A6 (4F2) / A6 Avant (4F5)           |
| VKM 31022 | AUDI  | A3 (8P1) / A3 Sportback (8PA)  |
|           | SEAT  | ALTEA / ALTEA XL / LEON II (1P1) / TOLEDO III (5P2)  |
|           | SKODA | OCTAVIA II (1Z3)/OCTAVIA II Combi (1Z5)  |
|           | VW    | CADDY III (2KA) / CADDY III Estate (2KB) / GOLF V (1K1) / GOLF V VARIANT (1K1) / GOLF V PLUS (5M1) / JETTA III (1KM) / PASSAT (3C2) / Variant (3C5) / TOURAN |
| VKM 31035 | AUDI  | A2 (8Z0)   |

2008 →



|           |            |   |
|-----------|------------|---|
| VKM 31044 | SEAT       | CORDOBA (6L2) / IBIZA IV (6L1)  |
|           | SKODA      | FABIA / ROOMSTER  |
|           | VW         | FOX (5Z1) / LUPO (6X1, 6E1) / POLO (9N_) / POLO Saloon  |
| VKM 31047 | AUDI       | A3 (8P1) / A3 Sportback (8PA)   |
|           | SKODA      | OCTAVIA II (1Z3)/OCTAVIA II Combi (1Z5) / ROOMSTER  |
|           | VW         | EOS / GOLF V (1K1) / GOLF V VARIANT (1K1) / GOLF V PLUS (5M1) / JETTA III (1KM) / PASSAT (3C2) / Variant (3C5) / POLO (9N_) / TOURAN                                |
| VKM 31054 | AUDI       | A3 (8P1) / A3 Sportback (8PA)   |
|           | SEAT       | ALHAMBRA / ALTEA / ALTEA XL / LEON II (1P1) / TOLEDO III (5P2)  |
|           | SKODA      | OCTAVIA II (1Z3)/OCTAVIA II Combi (1Z5)   |
| VKM 31057 | VW         | CADDY III (2KA) / CADDY III Estate (2KB) / EOS / GOLF V (1K1) / GOLF V VARIANT (1K1) / GOLF V PLUS (5M1) / JETTA III (1KM) / SHARAN (7M8, 7M9, 7M6) / TRANSPORTER V |
|           | SEAT       | CORDOBA (6L2) / IBIZA IV (6L1)  |
|           | SKODA      | FABIA / ROOMSTER  |
| VKM 31058 | VW         | POLO (9N_) / POLO Saloon  |
|           | AUDI       | A4 (8E2, B6) / A4 Avant (8E5, B6) / A4 (8EC) / A4 Avant (8ED) / A4 (8K) / A4 Convertible (8H7) / A6 (4F2) / A6 Avant (4F5)  |
|           | SEAT       | CORDOBA (6L2) / IBIZA IV (6L1)  |
| VKM 31063 | SKODA      | FABIA / ROOMSTER  |
|           | VW         | POLO (9N_) / POLO Saloon / TIGUAN (5N)  |
|           | VW         | LT II / TRANSPORTER IV  |
| VKM 32035 | LANCIA     | Y   |
| VKM 32036 | FIAT       | BRAVA/BRAVO (182) / COUPE / MAREA   |
|           | LANCIA     | LYBRA   |
| VKM 32046 | ALFA ROMEO | 159   |
|           | FIAT       | CROMA (194) / GRANDE PUNTO / STILO  |
|           | OPEL       | ASTRA H / SIGNUM / VECTRA C / ZAFIRA B  |
|           | VAUXHALL   | ASTRA Mk V / SIGNUM / VECTRA Mk II / ZAFIRA Mk II   |
|           | FIAT       | 500 / DOBLO / IDEA / PALIO/SIENA / PANDA (169) / PUNTO (188)  |
| VKM 32080 | LANCIA     | MUSA / YPSILON  |
|           | ALFA ROMEO | 147 / 156 / 166 / GT / GTV / SPIDER   |
| VKM 32082 | LANCIA     | KAPPA / THESIS  |

2008 →



|           |            |  |
|-----------|------------|--|
| VKM 32083 | ALFA ROMEO | 147 / 156 / 166 / GT / GTV / SPIDER  |
|           | LANCIA     | KAPPA / THESIS   |
| VKM 32184 | FIAT       | STILO  |
| VKM 32243 | FIAT       | BRAVA/BRAVO (182) / DOBLO / MAREA / MULTIPLA / PALIO/SIENA / STILO                           |
|           | LANCIA     | LYBRA  |
| VKM 33064 | CITROËN    | C4   |
| VKM 33074 | PEUGEOT    | 307 / 407  |
|           | CITROËN    | C2 / C3 / C3 Pluriel / C4  |
| VKM 33075 | PEUGEOT    | 1007 / 207 / 207 CC / 207 SW / 307   |
|           | CITROËN    | C5 I / C5 II / C8  |
|           | FIAT       | ULYSSE (179AX)   |
| VKM 33083 | LANCIA     | PHEDRA   |
|           | PEUGEOT    | 406 / 407 / 607 / 807  |
| VKM 33100 | RENAULT    | AVANTIME / CLIO II / LAGUNA I / LAGUNA II  |
|           | CITROËN    | XM II  |
| VKM 33125 | PEUGEOT    | 605  |
|           | CITROËN    | BERLINGO / XSARA / XSARA PICASSO   |
| VKM 34012 | PEUGEOT    | 206 / PARTNER  |
|           | CITROËN    | JUMPER (230)   |
| VKM 34014 | FORD       | GALAXY I   |
|           | FORD       | FOCUS C-MAX I / FOCUS C-MAX II / FOCUS II  |
| VKM 34018 | VOLVO      | S40 II - V50   |
|           | FORD       | FOCUS I  |
| VKM 34025 | FORD       | MONDEO III / TRANSIT   |
| VKM 34033 | FORD       | FIESTA IV / FIESTA V / KA  |
|           | MAZDA      | 121 (JASM, JBSM)   |
| VKM 34046 | FORD       | SCORPIO / TRANSIT  |
| VKM 34047 | FORD       | MONDEO I / MONDEO II   |
| VKM 34048 | FORD       | MONDEO I / MONDEO II   |
| VKM 34051 | FORD       | FIESTA V / MONDEO III / TRANSIT  |
| VKM 34052 | FORD       | GALAXY II / MONDEO III / MONDEO IV / S-MAX / TRANSIT   |
|           | FORD       | ESCORT V / ESCORT VI / ESCORT VII / ORION III  |
| VKM 34056 | FORD       | ESCORT V / ESCORT VI / ESCORT VII / FIESTA III / ORION III                                   |
| VKM 34071 | FORD       | TRANSIT  |
| VKM 34072 | FORD       | TRANSIT  |
| VKM 34102 | FORD       | TRANSIT CONNECT / TOURNEO CONNECT  |
| VKM 34110 | FORD       | FOCUS C-MAX I / FOCUS II   |
| VKM 34111 | FORD       | FIESTA BOX / COURRIER / FIESTA IV / FOCUS C-MAX I / FOCUS II / GALAXY II / MONDEO IV / S-MAX |
|           | FIAT       | GRANDE PUNTO   |





2008 →



|           |            |  |
|-----------|------------|--|
| VKM 35212 | OPEL       | AGILA B / ASTRA H / COMBO B / CORSA C / CORSA D / MERIVA / TIGRA Twin Top        |
|           | VAUXHALL   | ASTRA Mk V / CORSA Mk II / CORSA Mk III / TIGRA Mk II                            |
| VKM 35214 | OPEL       | SIGNUM / VECTRA C  |
|           | RENAULT    | ESPACE IV / VEL SATIS  |
|           | VAUXHALL   | SIGNUM / VECTRA Mk II  |
| VKM 35216 | OPEL       | SIGNUM / VECTRA C  |
|           | RENAULT    | ESPACE IV / VEL SATIS  |
|           | SAAB       | 9-5  |
| VKM 35260 | OPEL       | ASTRA G / ASTRA H / CORSA D / MERIVA / SIGNUM / VECTRA C / ZAFIRA B              |
|           | VAUXHALL   | ASTRA Mk V / ASTRA TwinTop / CORSA Mk III / MERIVA / VECTRA Mk II / ZAFIRA Mk II |
|           | OPEL       | VIVARO   |
| VKM 36038 | RENAULT    | ESPACE IV / LAGUNA II / MASTER II / TRAFIC II / VEL SATIS                        |
|           | VAUXHALL   | VIVARO   |
|           | RENAULT    | MASTER II  |
| VKM 36064 | RENAULT    | MEGANE I   |
| VKM 36075 | RENAULT    | CLIO II / KANGOO   |
| VKM 36081 | RENAULT    | CLIO II / KANGOO   |
| VKM 36082 | RENAULT    | CLIO II / KANGOO   |
| VKM 36091 | DACIA      | LOGAN  |
| VKM 36220 | RENAULT    | CLIO II / KANGOO / LAGUNA I / LAGUNA II / MEGANE I / SCENIC I / THALIA           |
|           | VOLVO      | S60 / S80 / V70 II / XC70 I / XC90   |
| VKM 36236 | FORD       | FOCUS II   |
| VKM 36238 | VOLVO      | C30 / C70 - S70 / S40 II - V50   |
|           | FORD       | FOCUS II   |
| VKM 36240 | VOLVO      | C30 / C70 - S70 / S40 II - V50   |
|           | VOLVO      | C70 - S70 / S40 I - V40 / S60 / S80 / V70 I / V70 II / XC70 I                    |
| VKM 37005 | HONDA      | ACCORD   |
|           | LAND ROVER | FREELANDER I   |
|           | MG         | MG ZR / MG ZS  |
| VKM 37010 | ROVER      | 200 (RF) / 25 / 400 (RT) / 45 / 600 / STREETWISE                                 |
|           | LAND ROVER | FREELANDER I   |
| VKM 37011 | MG         | MG ZR / MG ZS / MG ZT  |
|           | ROVER      | 200 (RF) / 200 coupe (RF) / 25 / 400 (RT) / 45 / 75 / STREETWISE                 |
|           | LAND ROVER | FREELANDER I   |
| VKM 37011 | MG         | MG ZT  |
|           | ROVER      | 75   |

2008 →



|            |   |  |
|------------|---|--|
| VKM 37014  | MG  | MG ZR  |
|            | ROVER   | 200 (RF) / 200 (XW) / 200 coupe (RF) / 25 / 400 (XW) / 45 / STREETWISE   |
| VKM 37015  | MG  | MG ZR / MGF / MGTF   |
|            | ROVER   | 200 (RF) / 200 coupe (RF) / 25 / STREETWISE  |
| VKM 38221  | BMW   | 3 (E36) / 3 (E46) / 3 Compact (E36) / 3 Convertible (E36) / 3 Coupe (E36) / 3 Coupe (E46) / 3 Touring (E36) / 3 Touring (E46) / Z3 |
|            | BMW   | 3 (E46) / 3 Touring (E46) / 5 (E39) / 5 Touring (E39) / X5   |
| VKM 38240  | LAND ROVER  | FREELANDER I / RANGE ROVER III   |
|            | MG  | MG ZT  |
|            | ROVER   | 75   |
| VKM 38700  | MINI  | MINI   |
| VKM 61000  | TOYOTA  | CARINA / COROLLA / STARLET   |
| VKM 61002  | TOYOTA  | COROLLA  |
| VKM 61003  | TOYOTA  | COROLLA  |
| VKM 61009  | TOYOTA  | COROLLA  |
| VKM 61011  | TOYOTA  | STARLET  |
| VKM 61016  | TOYOTA  | AVENSIS / COROLLA VERSO  |
| VKM 63004  | HONDA   | ACCORD / CR-V / FR-V   |
| VKM 64000  | MAZDA   | 323 (BA) / 323 (BG)  |
| VKM 65004  | MITSUBISHI  | LANCER   |
| VKM 65005  | MITSUBISHI  | LANCER   |
| VKM 67000  | DAIHATSU  | SIRION / TERIOS  |
|            |  |    |
| VKMA 32023 | FIAT  | PUNTO (188)  |
| VKMA 32024 | ALFA ROMEO  | 156  |
|            | FIAT  | MAREA  |
|            | LANCIA  | LYBRA  |
| VKMA 32034 | FIAT  | BRAVA/BRAVO (182)  |
|            | LANCIA  | Y  |
| VKMA 32040 | FIAT  | 500 / BRAVO / DOBLO / IDEA / PANDA (169) / PUNTO (188) / STILO   |
|            | LANCIA  | MUSA / YPSILON   |
| VKMA 33067 | PEUGEOT   | 307  |
| VKMA 33093 | CITROËN   | BERLINGO / JUMPY I / XSARA   |
|            | PEUGEOT   | 306 / 406 / EXPERT I / PARTNER   |
| VKMA 33320 | CITROËN   | C4 / C5 II / C8  |
|            | FORD  | FOCUS C-MAX I / FOCUS C-MAX II / FOCUS II / MONDEO IV  |
|            | LANCIA  | PHEDRA   |
|            | PEUGEOT   | 307 / 407 / 607 / 807 / EXPERT II / EXPERT Tepee   |

2008 →



|   |                   |  |
|---|-------------------|--|
|   | <b>VOLVO</b>      | S40 II - V50   |
| VKMA 34103  | <b>FORD</b>       | FOCUS I  |
| VKMA 34104  | <b>FORD</b>       | FOCUS I  |
| VKMA 34107  | <b>FORD</b>       | FOCUS I / TRANSIT CONNECT / TOURNEO CONNECT  |
| VKMA 35125  | <b>OPEL</b>       | ASTRA F / COMBO A / CORSA B / TIGRA / VECTRA B   |
|   | <b>VAUXHALL</b>   | ASTRA Mk III / COMBO I / CORSA Mk I / TIGRA Mk I / VECTRA Mk I   |
| VKMA 36038  | <b>OPEL</b>       | VIVARO   |
|   | <b>RENAULT</b>    | LAGUNA II / MASTER II / TRAFIC II / VEL SATIS  |
|   | <b>VAUXHALL</b>   | VIVARO   |
| VKMA 36091  | <b>DACIA</b>      | LOGAN  |
|   | <b>RENAULT</b>    | CLIO II / KANGOO / LAGUNA I / LAGUNA II / MEGANE I / SCENIC I / THALIA   |
| VKMA 36220  | <b>VOLVO</b>      | S60 / S80 / V70 II / XC70 I  |
| VKMA 36230  | <b>VOLVO</b>      | C70 - S70 / S40 I - V40 / S60 / S80 / V70 I / V70 II / XC70 I  |
| VKMA 36520  | <b>VOLVO</b>      | 850 / C70 - S70 / S80 / V70 I / V70 II   |
| VKMA 38202  | <b>BMW</b>        | 3 (E36) / 3 Convertible (E36) / 3 Coupe (E36) / 5 (E34) / 5 Touring (E34)  |
|  |                   |  |
| VKPC 81220  | <b>AUDI</b>       | A3 (8P1) / A3 Sportback (8PA) / A4 (8E2, B6) / A4 Avant (8E5, B6)  |
|   | <b>SEAT</b>       | ALTEA / ALTEA XL / LEON II (1P1) / TOLEDO III (5P2)  |
|   | <b>SKODA</b>      | OCTAVIA II (1Z3) / OCTAVIA II Combi (1Z5)  |
|   | <b>VW</b>         | EOS / GOLF V (1K1) / GOLF V VARIANT (1K1) / GOLF V PLUS (5M1) / JETTA III (1KM) / PASSAT (3C2) / Variant (3C5) / TOURAN              |
| VKPC 81501  | <b>AUDI</b>       | A3 (8P1) / A3 Sportback (8PA)  |
|   | <b>SKODA</b>      | OCTAVIA II (1Z3) / OCTAVIA II Combi (1Z5)  |
|   | <b>VW</b>         | EOS / GOLF V (1K1) / GOLF V VARIANT (1K1) / GOLF V PLUS (5M1) / JETTA III (1KM) / PASSAT (3C2) / Variant (3C5) / POLO (9N_) / TOURAN |
| VKPC 82667  | <b>ALFA ROMEO</b> | 147 / 156 / 159 / 166 / BRERA / GT   |
|   | <b>FIAT</b>       | CROMA (194) / STILO  |
|   | <b>LANCIA</b>     | THESIS   |
|   | <b>OPEL</b>       | ASTRA H / SIGNUM / VECTRA C / ZAFIRA B   |
|   | <b>SAAB</b>       | 9-3 II   |
|   | <b>VAUXHALL</b>   | ASTRA Mk V / SIGNUM / VECTRA Mk II   |
| VKPC 83140  | <b>CITROËN</b>    | C1 / C2 / C3 / C3 Pluriel / XSARA  |
|   | <b>FORD</b>       | FIESTA V / FUSION  |
|   | <b>PEUGEOT</b>    | 1007 / 107 / 206 / 207 / 207 CC / 207 SW / 307   |
|   | <b>TOYOTA</b>     | AYGO   |

2008 →



|            |                      |  |
|------------|----------------------|--|
| VKPC 83258 | <b>CITROËN</b>       | C2 / C3 / C4   |
|            | <b>PEUGEOT</b>       | 1007 / 206 / 207 / 207 CC / 207 SW / 307   |
| VKPC 83259 | <b>CITROËN</b>       | BERLINGO / C3 / C4 / C4 Picasso / C5 II / JUMPY III / XSARA PICASSO  |
|            | <b>FORD</b>          | FIESTA V / FOCUS C-MAX I / FOCUS C-MAX II / FOCUS II / FUSION  |
|            | <b>MAZDA</b>         | 3  |
|            | <b>PEUGEOT</b>       | 1007 / 206 / 207 / 207 CC / 207 SW / 307 / 308 / 407 / EXPERT II / EXPERT Tepee / PARTNER                    |
|            | <b>VOLVO</b>         | S40 II - V50   |
| VKPC 84622 | <b>FORD</b>          | FIESTA V / FOCUS C-MAX I / FOCUS C-MAX II / FOCUS II / GALAXY II / MAVERICK / MONDEO III / MONDEO IV / S-MAX |
| VKPC 84629 | <b>FORD</b>          | FIESTA V / KA / STREET KA  |
| VKPC 85308 | <b>ALFA ROMEO</b>    | 159 / BRERA / SPIDER   |
|            | <b>FIAT</b>          | CROMA (194)  |
|            | <b>OPEL</b>          | ASTRA G / SIGNUM / SPEEDSTER / VECTRA B / VECTRA C / ZAFIRA A  |
|            | <b>SAAB</b>          | 9-3 II   |
|            | <b>VAUXHALL</b>      | ASTRA Mk IV / SIGNUM / VECTRA Mk I / VECTRA Mk II / VX 220 / ZAFIRA Mk I                                     |
| VKPC 85310 | <b>OPEL</b>          | AGILA B / ASTRA H / COMBO B / CORSA C / CORSA D / MERIVA / TIGRA Twin Top                                    |
|            | <b>VAUXHALL</b>      | ASTRA Mk V / COMBO II / CORSA Mk III / MERIVA / TIGRA Mk II  |
| VKPC 86129 | <b>NISSAN</b>        | PRIMERA  |
|            | <b>RENAULT</b>       | LAGUNA II / MEGANE II / SCENIC II / GRAND SCENIC   |
| VKPC 87420 | <b>LAND ROVER</b>    | FREELANDER I   |
|            | <b>MG</b>            | MG ZT  |
|            | <b>ROVER</b>         | 75   |
| VKPC 88850 | <b>MERCEDES-BENZ</b> | G-class (W463) / SPRINTER 2-t (W901 / W902) / SPRINTER 3-t (W903) / SPRINTER 4-t (W904)                      |
| VKPC 88853 | <b>MERCEDES-BENZ</b> | C-class (W203) / C-class (W204) / CLK (W209) / E-class (W211)  |
| VKPC 88855 | <b>MERCEDES-BENZ</b> | C-class (W203) / C-class (W204) / CLK (W209) / E-class (W211)  |
| VKPC 91813 | <b>TOYOTA</b>        | AVENSIS / AVENSIS VERSO / CAMRY / PICNIC / PREVIA / PREVIA/TARAGO / RAV 4                                    |
| VKPC 91814 | <b>TOYOTA</b>        | AVENSIS VERSO / COROLLA / COROLLA VERSO / PICNIC / PREVIA / RAV 4  |
| VKPC 92928 | <b>NISSAN</b>        | SUNNY / VANETTE CARGO  |
| VKPC 92929 | <b>NISSAN</b>        | TERRANO  |
| VKPC 93603 | <b>HONDA</b>         | JAZZ   |
| VKPC 93604 | <b>HONDA</b>         | CR-V / FR-V / STREAM   |
| VKPC 94613 | <b>MAZDA</b>         | B-SERIE (UN)   |
| VKPC 94614 | <b>MAZDA</b>         | B-SERIE (UN)   |

2008 →





2008 →



2008 →



|            |            |                          |
|------------|------------|--------------------------|
| VKPC 94617 | MAZDA      | 323 (BJ)                 |
| VKPC 95007 | HYUNDAI    | ATOS / ATOS PRIME / GETZ |
| VKPC 95859 | HYUNDAI    | COUPE                    |
| VKPC 95863 | MITSUBISHI | LANCER                   |
| VKPC 95864 | MITSUBISHI | LANCER / OUTLANDER       |
| VKPC 96403 | SUZUKI     | GRAND VITARA             |









































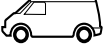























|            |  |            |            |            |
|------------|--|------------|------------|------------|
| VKM 16001  | RENAULT  | VKM 16003  | VKM 74005  | VKPA 82218 |
| VKM 21150  | AUDI, VW   | VKM 21151  |            | VKPA 82230 |
| VKMA 01150 | AUDI, VW   | VKMA 01151 | VKMA 02216 | VKPA 82428 |
| VKMA 01252 | VW   | VKMA 01262 | VKMA 06207 | VKPA 82429 |
| VKMA 01260 | VOLVO, VW  | VKMA 01258 | VKMA 07200 | VKPA 82441 |
| VKMA 06001 | RENAULT  | VKMA 06003 | VKMA 31060 | VKPA 82648 |
| VKMA 06118 | RENAULT  | VKMA 06115 | VKMA 31200 | VKPA 83431 |
| VKMA 06138 | RENAULT  | VKMA 06125 | VKMA 31201 | VKPA 83432 |
| VKMA 06211 | RENAULT  | VKMA 06213 | VKMA 31203 | VKPC 81603 |
| VKMA 31004 | AUDI, SEAT, SKODA, VW                              | VKMA 31014 | VKMA 31206 | VKPC 81806 |
| VKMA 33036 | PEUGEOT, CITROËN                                   | VKMA 33093 | VKMA 32012 | VKPC 82246 |
| VKMA 36030 | RENAULT  | VKMA 36038 | VKMA 32028 | VKPC 82426 |
| VKMC 01007 | AUDI   | VKMA 01907 | VKMA 32029 | VKPC 82432 |
| VKMC 01008 | AUDI, VW   | VKMA 01908 | VKMA 32212 | VKPC 82436 |
| VKMC 01018 | AUDI, SKODA, VW                                    | VKMA 01918 | VKMA 33023 | VKPC 82450 |
| VKMC 01141 | AUDI, SEAT, VW                                     | VKMA 01941 | VKMA 33027 | VKPC 82614 |
| VKMC 01142 | AUDI, FORD, SEAT, SKODA, VW                        | VKMA 01942 | VKMA 33031 | VKPC 82800 |
| VKMC 01143 | FORD, VW   | VKMA 01943 | VKMA 33033 | VKPC 83203 |
| VKMC 01150 | AUDI, VW   | VKMA 01951 | VKMA 33034 | VKPC 83403 |
| VKMC 01151 | AUDI   | VKMA 01951 | VKMA 33047 | VKPC 83603 |
| VKMC 01152 | AUDI, SKODA, VW                                    | VKMA 01952 | VKMA 33049 | VKPC 83605 |
| VKMC 01202 | AUDI   | VKMA 01902 | VKMA 33051 | VKPC 83607 |
| VKMC 01203 | AUDI, SKODA, VW                                    | VKMA 01903 | VKMA 33056 | VKPC 83616 |
| VKMC 01204 | AUDI   | VKMA 01904 | VKMA 33065 | VKPC 83618 |
| VKMC 01205 | AUDI   | VKMA 01905 | VKMA 33066 | VKPC 83624 |
| VKMC 01207 | AUDI, VW   | VKMA 01927 | VKMA 33106 | VKPC 83625 |
| VKMC 02383 | CITROËN, FIAT, OPEL, PEUGEOT,<br>RENAULT, VAUXHALL | VKMA 02983 | VKMA 33112 | VKPC 83628 |
| VKMC 02384 | FIAT, RENAULT                                      | VKMA 02984 | VKMA 33312 | VKPC 84400 |
| VKMC 02386 | FIAT, OPEL, RENAULT, VAUXHALL                      | VKMA 02986 | VKMA 34031 | VKPC 84603 |
| VKMC 06001 | RENAULT  | VKMC 06003 | VKMA 36002 | VKPC 84607 |
| VKMC 06216 | RENAULT  | VKMC 06005 | VKMA 36010 | VKPC 84609 |
| VKPC 83640 | CITROËN, FIAT, LANCIA, PEUGEOT                     | VKPC 83650 | VKMA 36012 | VKPC 84616 |
| VKPC 83645 | CITROËN, PEUGEOT                                   | VKPC 83140 | VKMA 36013 | VKPC 85203 |
|            |  |            | VKMA 36016 | VKPC 87203 |
|            |  |            | VKMA 36024 | VKPC 87609 |
|            |  |            | VKMC 01105 | VKPC 88803 |
|            |  |            | VKMS 97005 | VKPC 91414 |
|            |  |            |            | VKPC 92823 |















































































|   |     |   |     |
|---|-----|---|-----|
| ALFA ROMEO .....  | 17  | MINI .....  | 355 |
| AUDI .....  | 34  | MITSUBISHI  ..... | 356 |
| AUSTIN .....  | 84  | MITSUBISHI  ..... | 370 |
| AUTOBIANCHI.....  | 84  | NISSAN  .....     | 372 |
| BMW .....   | 85  | NISSAN  .....     | 384 |
| CHEVROLET .....   | 120 | OPEL  .....        | 388 |
| CITROËN  .....   | 121 | OPEL  .....       | 439 |
| CITROËN  .....   | 161 | PEUGEOT  .....    | 441 |
| DACIA .....   | 169 | PEUGEOT  .....    | 482 |
| DAEWOO.....   | 170 | PORSCHE.....  | 493 |
| DAIHATSU  .....  | 173 | PROTON.....   | 493 |
| DAIHATSU  .....  | 178 | RENAULT  .....    | 494 |
| FIAT  .....      | 179 | RENAULT  .....    | 551 |
| FIAT  .....      | 218 | ROVER .....   | 556 |
| FORD  .....     | 221 | SAAB.....   | 566 |
| FORD  .....    | 249 | SEAT.....   | 571 |
| HONDA .....   | 255 | SKODA .....   | 608 |
| HYUNDAI  ..... | 265 | SMART .....   | 619 |
| HYUNDAI  ..... | 271 | SSANGYONG .....   | 620 |
| ISUZU  .....   | 272 | SUBARU.....   | 621 |
| ISUZU  .....   | 272 | SUZUKI  .....   | 627 |
| IVECO.....  | 274 | SUZUKI  .....   | 631 |
| JEEP .....  | 275 | TALBOT .....  | 631 |
| KIA .....   | 275 | TOYOTA  .....   | 632 |
| LADA .....  | 278 | TOYOTA  .....   | 649 |
| LANCIA .....  | 279 | VAUXHALL  ..... | 654 |
| LAND ROVER .....  | 295 | VAUXHALL  ..... | 693 |
| MAZDA  .....   | 299 | VOLVO .....   | 695 |
| MAZDA  .....   | 310 | VW  .....        | 719 |
| MERCEDES-BENZ .....   | 311 | VW  .....        | 791 |
| MG.....   | 353 |   |     |

|  |                           |  |  |  |  |  |  |  |  |  |  |
|--|---------------------------|---|---|---|--|---|---|---|---|---|---|
| <b>ALFA ROMEO</b>  <b>145/146 1.4</b>       |                           |   |   |   |  |   |   |   |   |   |   |
|   | AR 33501                  | 07/94 → 12/96   |   |   | VKMA 02501<br>VKM 12500<br>VKM 12501   | 2<br>1<br>1   | 2   |   |   |   | T0058   |
|   | AR 33501                  | 07/94 → 12/96   |   |   | VKPC 82201   |   |   | 1   |   |   |   |
|   | B(Alt) AR 33501           | 07/94 → 12/96   |   |   | VKMV 5PK864  |   | 1   |   |   |   |   |
|  | B(PS) AR 33501            | 07/94 → 12/96   |   |   | VKMV 10AVx825  |   | 1   |   |   |   |   |
|  | B(AC) AR 33501            | 07/94 → 12/96   |   |   | VKMV 13AVx950  |   | 1   |   |   |   |   |
| <b>ALFA ROMEO</b>  <b>145/146 1.4 16V</b>   |                           |   |   |   |  |   |   |   |   |   |   |
|   | AR 33503                  | 11/96 → 01/01   |  |   | VKMC 02181<br>VKMA 02181<br>VKM 12182<br>VKM 22177                                 | 1<br>1<br>1<br>1  | 1<br>1<br>1   | 1   |   |   | T0144   |
|   | AR 33503                  | 11/96 → 01/01   |   |   | VKPC 82645   |   |   | 1   |   |   |   |
|   | B(Alt) AR 33503           | 11/96 → 01/01   | <i>AC</i>   |   | VKMA 32022<br>VKMV 6PK1045<br>VKM 32022  | 1<br>1  | 1<br>1  |   |   |   |   |
|  | B(Alt) AR 33503           | 11/96 → 02/99   | <b>AC, →IVETTno 3174687</b>   |   | VKMA 32020<br>VKMV 6PK1842<br>VKM 32001<br>VKM 32022                               | 1<br>1<br>1   | 1<br>1  |   |   |   |   |
|  | B(Alt) AR 33503           | 11/96 → 02/99   | <b>AC, →IMot. 1391187, VETTno 3174688 I→</b>                                      |   | VKMV 6PK1830<br>VKM 32001<br>VKM 32022   | 1   | 1   | 1   |   |   |   |
|  | B(Alt) AR 33503           | 03/99 → 01/01   | <b>AC, Mot. 1391188 I→</b>  |   | VKMV 6PK1855<br>VKM 32001<br>VKM 32022   | 1   | 1   | 1   |   |   |   |
| <b>ALFA ROMEO</b>  <b>145/146 1.6</b>     |                           |   |   |   |  |   |   |   |   |   |   |
|   | AR 33201                  | 10/94 → 12/96   |   |   | VKMA 02501<br>VKM 12500<br>VKM 12501   | 2<br>1<br>1   | 2   |   |   |   | T0058   |
|   | AR 33201                  | 10/94 → 12/96   |   |   | VKPC 82201   |   |   | 1   |   |   |   |
|   | B(Alt) AR 33201           | 10/94 → 12/96   |   |   | VKMV 5PK864  |   | 1   |   |   |   |   |
|  | B(PS) AR 33201            | 10/94 → 12/96   |   |   | VKMV 10AVx825  |   | 1   |   |   |   |   |
|  | B(AC) AR 33201            | 10/94 → 12/96   |   |   | VKMV 13AVx950  |   | 1   |   |   |   |   |
| <b>ALFA ROMEO</b>  <b>145/146 1.6 16V</b> |                           |   |   |   |  |   |   |   |   |   |   |
|   | AR 67601                  | 11/96 → 01/01   |   |   | VKMA 02184<br>VKM 12182<br>VKM 22177   | 1<br>1<br>1   | 1<br>1  |   |   |   | T0143   |
|   | AR 67601                  | 11/96 → 01/01   |   |   | VKPC 82451   |   |   | 1   |   |   |   |
|   | B(Alt) AR 32102, AR 67601 | 11/96 → 01/01   | <i>AC</i>   |   | VKMA 32022<br>VKMV 6PK1045<br>VKM 32022  | 1<br>1  | 1<br>1  |   |   |   |   |
|  | B(Alt) AR 32102           | 11/96 → 01/01   | <b>AC</b>   |   | VKMV 6PK1855<br>VKM 32001<br>VKM 32022   | 1   | 1   |   |   |   |   |
|  | B(Alt) AR 67601           | 11/96 → 01/01   | <b>AC, →IVETTno 3174687</b>   |   | VKMA 32020<br>VKMV 6PK1842<br>VKM 32001<br>VKM 32022                               | 1<br>1<br>1   | 1<br>1  |   |   |   |   |
|  | B(Alt) AR 67601           | 11/96 → 01/01   | <b>AC, VETTno 3174688 I→</b>  |   | VKMV 6PK1855<br>VKM 32001<br>VKM 32022   | 1   | 1   | 1   |   |   |   |
| <b>ALFA ROMEO</b>  <b>145/146 1.7 16V</b> |                           |   |   |   |  |   |   |   |   |   |   |
|   | AR 33401                  | 10/94 → 12/96   |   |   | VKMA 02510<br>VKM 22510<br>VKM 22510<br>VKM 22510<br>VKM 22510                     | 4<br>1<br>1<br>1<br>1   | 2   |   |   |   | T0093   |
|   | AR 33401                  | 10/94 → 12/96   |   |   | VKPC 82201   |   |   | 1   |   |   |   |
|   | B(Alt) AR 33401           | 10/94 → 12/96   |   |   | VKMV 5PK864  |   | 1   |   |   |   |   |
|  | B(PS) AR 33401            | 10/94 → 12/96   |   |   | VKMV 10AVx825  |   | 1   |   |   |   |   |









































|   |  |  |  |   |  |  |  |  |  |  |  |  |
|---|---|---|---|---|---|---|---|---|---|---|---|---|
|   | B(AC)   | AR 33401  | 10/94 → 12/96   | VKMC 13AVx950   |   |   | 1   |   |   |   |   |   |
| <b>ALFA ROMEO  145/146 1.8 16V</b>   |   |   |   |   |   |   |   |   |   |   |   |   |
|                                       |   | AR 32201, AR 67106, AR 67199  | 11/96 → 01/01   |  VKMC 02177<br>VKMA 02177<br>VKM 12173<br>VKM 22177  | 1   | 1   | 1   |   | 1   |   |   | T0128   |
|                                       |   | AR 32201, AR 67106, AR 67199  | 11/96 → 01/01   | VKPC 82645  |   |   |   |   | 1   |   |   |   |
|                                       | B(Alt)  | AR 32201, AR 67106, AR 67199  | 11/96 → 01/01   |  VKMA 32022<br>VKMV 6PK1045<br>VKM 32022   | 1   |   | 1   |   |   |   |   |   |
|   | B(Alt)  | AR 32201  | 03/98 → 01/01   |  VKMV 6PK1855<br>VKM 32001<br>VKM 32022  |   | 1   |   |   |   |   |   |   |
|   | B(Alt)  | AR 67106, AR 67199  | 11/96 → 01/01   |  VKMA 32020<br>VKMV 6PK1842<br>VKM 32001<br>VKM 32022  | 1   | 1   | 1   |   |   |   |   |   |
| <b>ALFA ROMEO  145/146 2.0 16V</b>   |   |   |   |   |   |   |   |   |   |   |   |   |
|                                       |   | AR 32301, AR 67204, AR 67299  | 01/97 → 01/01   |  VKMC 02177<br>VKMA 02177<br>VKM 12173<br>VKM 22177  | 1   | 1   | 1   |   | 1   |   |   | T0128   |
|   |   | AR 32301, AR 67204, AR 67299  | 01/97 → 01/01   | 1) VKMA 02277<br>VKM 12173<br>VKM 12277<br>VKM 22177  | 2   | 1   | 2   |   |   |   |   | T0235   |
|                                     |   | AR 32301, AR 67204, AR 67299  | 10/95 → 01/01   | VKPC 82645  |   |   |   |   | 1   |   |   |   |
|                                     | B(Alt)  | AR 32301  | 03/98 → 01/01   |  VKMV 7PK1080<br>VKM 32022   | 1   |   | 1   |   |   |   |   |   |
|   | B(Alt)  | AR 32301  | 03/98 → 01/01   |  VKMV 6PK1080<br>VKM 32022   | 1   |   | 1   |   |   |   |   |   |
|   | B(Alt)  | AR 32301  | 03/98 → 01/01   |  VKMV 7PK1975<br>VKM 32007<br>VKM 32022  | 1   | 1   |   |   |   |   |   |   |
|   | B(Alt)  | AR 32301  | 03/98 → 01/01   |  VKMV 6PK1975<br>VKM 32007<br>VKM 32022  | 1   | 1   |   |   |   |   |   |   |
|   | B(Alt)  | AR 67204, AR 67299  | 10/95 → 01/01   |  VKMV 7PK1080<br>VKM 32022   | 1   |   | 1   |   |   |   |   |   |
|   | B(Alt)  | AR 67204, AR 67299  | 10/95 → 01/01   |  VKM 32007<br>VKM 32022  | 1   | 1   |   |   |   |   |   |   |
| <b>ALFA ROMEO  145/146 1.9 TD</b>  |   |   |   |   |   |   |   |   |   |   |   |   |
|                                     |   | AR 33601, AR 67501  | 10/94 → 02/99   | VKMA 02154<br>VKM 12153<br>VKM 22153  | 1   | 1   | 1   |   |   |   |   | T0055   |
|                                     |   | AR 33601, AR 67501  | 10/94 → 02/99   | 2),  VKPA 82618<br>VKPC 82618  |   |   |   |   | 1   |   |   |   |
|   |   | AR 33601, AR 67501  | 10/94 → 02/99   | 2),  Mot. 1723044  VKPA 82666 |   |   |   |   | 1   |   |   |   |
|                                     | B(Alt)  | AR 33601, AR 67501  | 10/94 → 02/99   |  VKMV 5PK907   |   |   | 1   |   |   |   |   |   |
|   | B(Alt)  | AR 33601, AR 67501  | 10/94 → 02/99   |  VKMV 5PK915   |   |   | 1   |   |   |   |   |   |
|   | B(Alt)  | AR 33601, AR 67501  | 10/94 → 02/99   |  VKMV 5PK970<br>VKM 32242  |   | 1   |   |   |   |   |   |   |
|   | B(Alt)  | AR 33601, AR 67501  | 10/94 → 02/99   |  VKMV 5PK986<br>VKM 32242  |   | 1   |   |   |   |   |   |   |
| <b>ALFA ROMEO  145/146 1.9 JTD</b> |   |   |   |   |   |   |   |   |   |   |   |   |
|                                     |   | AR 32302  | 02/99 → 01/01   |  VKMC 02179<br>VKMA 02179  | 1   | 1   | 1   |   | 1   |   |   | 2<br>2 T0158  |



































|   |  |  |    |  |  |  |  |  |  |  |  |
|---|---|---|---|--|---|---|---|---|---|---|---|
|   |   |   |   | VKM 12174<br>VKM 22179   | 1   | 1   |   |   |   |   | 2   |
|                                  | AR 32302  | 02/99 → 01/01   |   | VKPC 82665   |   |   |   | 1   |   |   |   |
|                                  | <b>B(Alt)</b> AR 32302  | 02/99 → 01/01   | <b>AC</b>   | VKMA 32027<br>VKMV 6PK1036<br>VKM 32027  | 1   |   | 1   | 1   |   |   |   |
|   | <b>B(Alt)</b> AR 32302  | 02/99 → 02/99   | <b>AC, →IMot. 1370829</b>   | VKMA 32028<br>VKMV 6PK1775<br>VKM 32006<br>VKM 32027                               | 1   | 1   | 1   | 1   |   |   |   |
|   | <b>B(Alt)</b> AR 32302  | 03/99 → 01/01   | <b>AC, Mot. 1370830 I→</b>  | VKMA 32029<br>VKMV 6PK1795<br>VKM 32006<br>VKM 32027                               | 1   | 1   | 1   | 1   |   |   |   |
|                                  | AR 32302  | 02/99 → 01/01   |   | VKM _____  |   |   |   |   | 1   |   |   |
| <b>ALFA ROMEO  147 1.6 16V</b>   |   |   |   |  |   |   |   |   |   |   |   |
|                                  | AR 32104, AR 37203  | 01/01 → 10/07   |    | VKMC 02181<br>VKMA 02181<br>VKM 12182<br>VKM 22177                                 | 1   | 1   | 1   | 1   |   |   | T0144   |
|                                  | AR 32104, AR 37203  | 01/01 → 10/07   |   | VKPC 82645   |   |   |   | 1   |   |   |   |
|                                  | <b>B(Alt)</b> AR 32104, AR 37203  | 01/01 → 09/03   | <b>AC, →IMot. 2835764</b>   | VKMA 32022<br>VKMV 6PK1045<br>VKM 32022  | 1   |   | 1   | 1   |   |   |   |
|   | <b>B(Alt)</b> AR 32104, AR 37203  | 01/01 → 09/03   | <b>AC, Mot. 2835765 I→</b>  | VKM 32022  | 1   |   |   |   |   |   |   |
|   | <b>B(Alt)</b> AR 32104, AR 37203  | 01/01 → 09/03   | <b>AC, →IMot. 2835764</b>   | VKMV 6PK1855<br>VKM 32001<br>VKM 32022   | 1   | 1   |   | 1   |   |   |   |
|   | <b>B(Alt)</b> AR 32104, AR 37203  | 01/01 → 09/03   | <b>AC, Mot. 2835765 I→</b>  | VKMA 32020<br>VKMV 6PK1842<br>VKM 32001<br>VKM 32022                               | 1   | 1   | 1   | 1   |   |   |   |
|   | <b>B(Alt)</b> AR 32104, AR 37203  | 10/03 → 10/07   | <b>AC, Mot. 2835765 I→</b>  | VKM 32026  | 1   |   |   |   |   |   |   |
|   | <b>B(Alt)</b> AR 32104, AR 37203  | 10/03 → 10/07   | <b>AC, Mot. 2835765 I→</b>  | VKMV 6PK1842<br>VKM 32001<br>VKM 32026   | 1   | 1   |   | 1   |   |   |   |
| <b>ALFA ROMEO  147 2.0 16V</b> |   |   |   |  |   |   |   |   |   |   |   |
|                                | AR 32310  | 01/01 → 12/05   |  | VKMC 02177<br>VKMA 02177<br>VKM 12173<br>VKM 22177                                 | 1   | 1   | 1   | 1   |   |   | T0128   |
|   | AR 32310  | 01/01 → 12/05   | 1)  | VKMA 02277<br>VKM 12173<br>VKM 12277<br>VKM 22177                                  | 2   | 1   | 2   |   |   |   | T0235   |
|                                | AR 32310  | 01/01 → 03/07   |   | VKPC 82645   |   |   |   | 1   |   |   |   |
|                                | <b>B(Alt)</b> AR 32310  | 01/01 → 03/07   | <b>AC, →IMot. 2835764</b>   | VKMV 6PK1080<br>VKM 32026  | 1   |   | 1   |   |   |   |   |
|   | <b>B(Alt)</b> AR 32310  | 01/01 → 03/07   | <b>AC, Mot. 2835765 I→</b>  | VKMV 6PK1062<br>VKM 32026  | 1   |   | 1   |   |   |   |   |
|   | <b>B(Alt)</b> AR 32310  | 01/01 → 03/07   | <b>AC, →IMot. 2835764</b>   | VKMV 6PK1975<br>VKM 32007<br>VKM 32026   | 1   | 1   |   | 1   |   |   |   |
|   | <b>B(Alt)</b> AR 32310  | 01/01 → 03/07   | <b>AC, Mot. 2835765 I→</b>  | VKMV 6PK1962<br>VKM 32007<br>VKM 32026   | 1   | 1   |   | 1   |   |   |   |
| <b>ALFA ROMEO  147 3.2 GTA</b> |   |   |   |  |   |   |   |   |   |   |   |
|                                | 932 A.000   | 02/03 → 03/07   |   | VKMA _____<br>VKM _____<br>VKM 22540<br>VKM 22540                                  | 1   | 2   | 1   |   |   |   | T0238   |
|                                | 932 A.000   | 02/03 → 03/07   |   | —  |   |   |   | 1   |   |   |   |
|                                | <b>B(Alt)</b> 932 A.000   | 02/03 → 03/07   |   | VKMV 6PK1983<br>VKM 32030  |   | 1   | 1   |   |   |   |   |



ALFA ROMEO



















































|  |                                      |               |   |  |  |  |  |  |  |  |  |  |  |  |       |
|--|--------------------------------------|---------------|---|--|---|---|---|---|---|---|---|---|---|---|-------|
|  |                                      |               |   | VKM 32082  | 1   |   |   |   |   |   |   |   |   |   |       |
|  |                                      |               |   | VKM 32083  |   | 1   |   |   |   |   |   |   |   |   |       |
| <b>ALFA ROMEO  147 1.9 JTD</b>        |                                      |               |   |  |   |   |   |   |   |   |   |   |   |   |       |
|                                        | 182 B9.000, 937 A2.000               | 04/01 → 03/07 |  → IMot. 4109227             | VKMC 02179   | 1   | 1   | 1   |   | 1   |   |   |   |   | 2   | T0158 |
|  |                                      |               |   | VKMA 02179   | 1   | 1   | 1   |   |   |   |   |   |   | 2   |       |
|  |                                      |               |   | VKM 12174  | 1   |   |   |   |   |   |   |   |   |   |       |
|  |                                      |               |   | VKM 22179  |   | 1   |   |   |   |   |   |   |   | 2   |       |
|  | 182 B9.000, 937 A2.000               | 04/01 → 03/07 | Mot. 4109228  →   | VKMA 02192   | 1   | 1   | 1   |   |   |   |   |   |   |   | T0158 |
|  |                                      |               |   | VKM 12174  | 1   |   |   |   |   |   |   |   |   |   |       |
|  |                                      |               |   | VKM 22180  |   | 1   |   |   |   |   |   |   |   |   |       |
|                                        | 182 B9.000, 937 A2.000               | 04/01 → 03/07 |   | VKPC 82665   |   |   |   |   | 1   |   |   |   |   |   |       |
|                                        | <b>B(Alt)</b> 182 B9.000, 937 A2.000 | 04/01 → 03/07 | <b>AC</b>   | VKMA 32027   | 1   |   | 1   |   |   |   |   |   |   |   |       |
|  |                                      |               |   | VKMV 6PK1036   |   |   | 1   |   |   |   |   |   |   |   |       |
|  |                                      |               |   | VKM 32027  | 1   |   |   |   |   |   |   |   |   |   |       |
|  | <b>B(Alt)</b> 182 B9.000, 937 A2.000 | 04/01 → 12/05 | <b>AC</b>   | VKMA 32039   | 1   | 1   | 1   |   |   |   |   |   |   |   |       |
|  |                                      |               |   | VKMV 6PK1836   |   |   | 1   |   |   |   |   |   |   |   |       |
|  |                                      |               |   | VKM 32006  |   | 1   |   |   |   |   |   |   |   |   |       |
|  |                                      |               |   | VKM 32027  | 1   |   |   |   |   |   |   |   |   |   |       |
|                                        | 182 B9.000, 937 A2.000               | 04/01 → 12/05 |   | VKM_____   |   |   |   |   |   | 1   |   |   |   |   |       |
| <b>ALFA ROMEO  147 1.9 JTD 16V</b>    |                                      |               |   |  |   |   |   |   |   |   |   |   |   |   |       |
|                                        | 192 A5.000, 937 A4.000               | 11/02 → 03/07 | → IMot. 4109227   | VKMA 02190   | 1   | 1   | 1   |   |   |   |   |   |   | 2   | T0203 |
|  |                                      |               |   | VKM 12174  | 1   |   |   |   |   |   |   |   |   |   |       |
|  |                                      |               |   | VKM 22179  |   | 1   |   |   |   |   |   |   |   | 2   |       |
|  | 192 A5.000, 937 A4.000               | 11/02 → 03/07 | Mot. 4109228  →   | VKMA 02197   | 1   | 1   | 1   |   |   |   |   |   |   |   | T0203 |
|  |                                      |               |   | VKM 12174  | 1   |   |   |   |   |   |   |   |   |   |       |
|  |                                      |               |   | VKM 22180  |   | 1   |   |   |   |   |   |   |   |   |       |
|                                       | 192 A5.000, 937 A4.000               | 11/02 → 03/07 |   | VKPC 82667   |   |   |   |   | 1   |   |   |   |   |   |       |
|                                      | <b>B(Alt)</b> 192 A5.000, 937 A4.000 | 11/02 → 12/05 |   | VKMA 32039   | 1   | 1   | 1   |   |   |   |   |   |   |   |       |
|  |                                      |               |   | VKMV 6PK1836   |   |   | 1   |   |   |   |   |   |   |   |       |
|  |                                      |               |   | VKM 32006  |   | 1   |   |   |   |   |   |   |   |   |       |
|  |                                      |               |   | VKM 32027  | 1   |   |   |   |   |   |   |   |   |   |       |
|                                      | 192 A5.000                           | 11/02 → 12/05 |   | VKM_____   |   |   |   |   |   | 1   |   |   |   |   |       |
| <b>ALFA ROMEO  147 1.9 JTDM</b>     |                                      |               |   |  |   |   |   |   |   |   |   |   |   |   |       |
|                                      | 937 A3.000                           | 07/05 → 03/07 |                            | VKMC 02179   | 1   | 1   | 1   |   | 1   |   |   |   |   | 2   | T0158 |
|  |                                      |               |   | VKMA 02179   | 1   | 1   | 1   |   |   |   |   |   |   | 2   |       |
|  |                                      |               |   | VKM 12174  | 1   |   |   |   |   |   |   |   |   |   |       |
|  |                                      |               |   | VKM 22179  |   | 1   |   |   |   |   |   |   |   | 2   |       |
|                                      | 937 A3.000                           | 07/05 → 03/07 |   | VKPC 82665   |   |   |   |   | 1   |   |   |   |   |   |       |
|                                      | <b>B(Alt)</b> 937 A3.000             | 07/05 → 12/05 | <b>AC</b>   | VKMA 32027   | 1   |   | 1   |   |   |   |   |   |   |   |       |
|  |                                      |               |   | VKMV 6PK1036   |   |   | 1   |   |   |   |   |   |   |   |       |
|  |                                      |               |   | VKM 32027  | 1   |   |   |   |   |   |   |   |   |   |       |
|  | <b>B(Alt)</b> 937 A3.000             | 07/05 → 12/05 | <b>AC</b>   | VKMA 32039   | 1   | 1   | 1   |   |   |   |   |   |   |   |       |
|  |                                      |               |   | VKMV 6PK1836   |   |   | 1   |   |   |   |   |   |   |   |       |
|  |                                      |               |   | VKM 32006  |   | 1   |   |   |   |   |   |   |   |   |       |
|  |                                      |               |   | VKM 32027  | 1   |   |   |   |   |   |   |   |   |   |       |
|                                      | 937 A3.000                           | 07/05 → 12/05 |   | VKM_____   |   |   |   |   |   | 1   |   |   |   |   |       |
| <b>ALFA ROMEO  147 1.9 JTDM 16V</b> |                                      |               |   |  |   |   |   |   |   |   |   |   |   |   |       |
|                                      | 937 A5.000                           | 07/05 → 03/07 | <b>B(198x24 HSN),  198</b> | VKMA 02190   | 1   | 1   | 1   |   |   |   |   |   |   | 2   | T0203 |
|  |                                      |               |   | VKM 12174  | 1   |   |   |   |   |   |   |   |   |   |       |
|  |                                      |               |   | VKM 22179  |   | 1   |   |   |   |   |   |   |   | 2   |       |
|  | 937 A5.000                           | 07/05 → 12/06 | <b>B(199x24 HSN),  199</b> | VKMA 02193   | 1   | 1   | 1   |   |   |   |   |   |   |   | T0248 |
|  |                                      |               |   | VKM 12174  | 1   |   |   |   |   |   |   |   |   |   |       |
|  |                                      |               |   | VKM 22180  |   | 1   |   |   |   |   |   |   |   |   |       |
|                                      | 937 A5.000                           | 07/05 → 03/07 |   | VKPC 82667   |   |   |   |   | 1   |   |   |   |   |   |       |
|                                      | <b>B(Alt)</b> 937 A5.000             | 07/05 → 12/05 |   | VKMA 32039   | 1   | 1   | 1   |   |   |   |   |   |   |   |       |
|  |                                      |               |   | VKMV 6PK1836   |   |   | 1   |   |   |   |   |   |   |   |       |
|  |                                      |               |   | VKM 32006  |   | 1   |   |   |   |   |   |   |   |   |       |
|  |                                      |               |   | VKM 32027  | 1   |   |   |   |   |   |   |   |   |   |       |
|                                      | 937 A5.000                           | 07/05 → 12/05 |   | VKM_____   |   |   |   |   |   | 1   |   |   |   |   |       |
| <b>ALFA ROMEO  155 1.6 16V</b>      |                                      |               |   |  |   |   |   |   |   |   |   |   |   |   |       |
|                                      | AR 67601                             | 05/96 → 12/97 |   | VKMA 02184   | 1   | 1   | 1   |   |   |   |   |   |   |   | T0143 |
|  |                                      |               |   | VKM 12182  | 1   |   |   |   |   |   |   |   |   |   |       |
|  |                                      |               |   | VKM 22177  |   | 1   |   |   |   |   |   |   |   |   |       |
|                                      | AR 67601                             | 05/96 → 12/97 |   | VKPC 82451   |   |   |   |   | 1   |   |   |   |   |   |       |

|   |  |  |  |  |  |  |  |  |  |  |  |  |
|---|---|---|---|--|---|---|---|---|---|---|---|---|
|                                        | B(Alt)  | AR 67601  | 05/96 → 12/97   | AC   | VKMA 32022<br>VKMV 6PK1045<br>VKM 32022   | 1<br>1  | 1<br>1  |   |   |   |   |   |
|   | B(Alt)  | AR 67601  | 05/96 → 12/97   | AC   | VKMA 32020<br>VKMV 6PK1842<br>VKM 32001<br>VKM 32022                                | 1<br>1<br>1   | 1<br>1  |   |   |   |   |   |
| <b>ALFA ROMEO  155 1.7 16V</b>         |   |   |   |  |   |   |   |   |   |   |   |   |
|                                        |   | AR 67103, AR 67105<br>AR 67106  | 04/93 → 04/96<br>05/96 → 12/97  |  | <b>ΟΛΟΚΛΗΡΟ</b><br>VKMC 02177<br>VKMA 02177<br>VKM 12173<br>VKM 22177               | 1<br>1<br>1   | 1<br>1  | 1<br>1  | 1   |   |   | T0128   |
|                                        |   | AR 67103, AR 67105<br>AR 67106  | 04/93 → 04/96<br>05/96 → 12/97  |  | VKPC 82436<br>VKPC 82645  |   |   |   | 1<br>1  |   |   |   |
|                                        | B(Alt)  | AR 67103, AR 67105  | 04/93 → 04/96   | AC   | VKM 32242   |   | 1   |   |   |   |   |   |
|   | B(Alt)  | AR 67106  | 05/96 → 12/97   | AC   | VKMA 32022<br>VKMV 6PK1045<br>VKM 32022   | 1<br>1  | 1<br>1  |   |   |   |   |   |
|   | B(Alt)  | AR 67106  | 05/96 → 12/97   | AC   | VKMA 32020<br>VKMV 6PK1842<br>VKM 32001<br>VKM 32022                                | 1<br>1<br>1   | 1<br>1  |   |   |   |   |   |
|                                        | B(PS)   | AR 67103, AR 67105  | 04/93 → 04/96   |  | VKMV 4PK962   |   |   | 1   |   |   |   |   |
| <b>ALFA ROMEO  155 1.8 16V</b>         |   |   |   |  |   |   |   |   |   |   |   |   |
|                                       |   | AR 67101, AR 67102  | 01/92 → 12/96   |  | <b>ΟΛΟΚΛΗΡΟ</b>   |   |   |   |   |   |   |   |
|                                      |   | AR 67101, AR 67102  | 01/92 → 12/96   |  | VKPC 82436  |   |   |   | 1   |   |   |   |
|                                      | B(Alt)  | AR 67101, AR 67102  | 01/92 → 12/96   | AC   | VKM 32242   |   | 1   |   |   |   |   |   |
|   | B(PS)   | AR 67101, AR 67102  | 01/92 → 12/96   |  | VKMV 4PK962   |   |   | 1   |   |   |   |   |
| <b>ALFA ROMEO  155 2.0 16V</b>       |   |   |   |  |   |   |   |   |   |   |   |   |
|                                      |   | AR 67201, AR 67202<br>AR 67204, AR 67299  | 02/92 → 02/95<br>01/96 → 12/97  |  | <b>ΟΛΟΚΛΗΡΟ</b><br>VKMC 02177<br>VKMA 02177<br>VKM 12173<br>VKM 22177               | 1<br>1<br>1   | 1<br>1  | 1<br>1  | 1   |   |   | T0128   |
|   |   | AR 67204, AR 67299  | 01/96 → 12/97   | 1)   | VKMA 02277<br>VKM 12173<br>VKM 12277<br>VKM 22177                                   | 2<br>1<br>1   | 1<br>1  | 2   |   |   |   | T0235   |
|                                      |   | AR 67201, AR 67202<br>AR 67204  | 02/92 → 02/95<br>03/95 → 12/97  |  | VKPC 82436<br>VKPC 82645  |   |   |   | 1<br>1  |   |   |   |
|                                      | B(Alt)  | AR 67201, AR 67202  | 02/92 → 02/95   | AC   | VKM 32242   |   | 1   |   |   |   |   |   |
|   | B(Alt)  | AR 67204  | 03/95 → 12/97   | AC   | VKMV 7PK1080<br>VKM 32022   | 1   |   | 1   |   |   |   |   |
|   | B(Alt)  | AR 67204  | 03/95 → 12/97   | AC   | VKM 32007<br>VKM 32022  | 1   | 1   |   |   |   |   |   |
|                                      | B(PS)   | AR 67201, AR 67202  | 02/92 → 02/95   |  | VKMV 4PK962   |   |   | 1   |   |   |   |   |
| <b>ALFA ROMEO  155 2.0 16V Turbo</b> |   |   |   |  |   |   |   |   |   |   |   |   |
|                                      |   | AR 67203  | 01/92 → 12/96   |  | VKMA 02224<br>VKM 12101   | 1<br>1  |   | 1   |   |   |   | T0083   |
|                                      |   | AR 67203  | 01/92 → 12/97   |  | VKPC 82660  |   |   |   | 1   |   |   |   |
|                                      | B(Alt)  | AR 67203  | 01/92 → 12/97   |  | VKMV 5PK1050  |   |   | 1   |   |   |   |   |
|   | B(AC)   | AR 67203  | 01/92 → 12/97   |  | VKMV 13AVx850   |   |   | 1   |   |   |   |   |
|   | B(WP)   | AR 67203  | 01/92 → 12/97   | AC   | VKMV 13AVx875   |   |   | 1   |   |   |   |   |
|   | B(WP)   | AR 67203  | 01/92 → 12/97   | AC   | VKMV 13AVx750   |   |   | 1   |   |   |   |   |
| <b>ALFA ROMEO  155 2.5 V6</b>        |   |   |   |  |   |   |   |   |   |   |   |   |
|                                      |   | AR 67301, AR 67302,<br>AR 67303   | 02/92 → 12/97   |  | VKMA_____<br>VKM_____   | 1<br>1  |   | 1   |   |   |   |   |
|                                      |   | AR 67301, AR 67302,<br>AR 67303   | 02/92 → 12/97   |  | —   |   |   |   | 1   |   |   |   |

































| ALFA ROMEO  155 1.9 TD    |   |               |   |   |             |             |   |   |  |  |   |   |  |  |  |  |  |       |       |
|--|---|---------------|---|---|-------------|-------------|---|---|--|--|---|---|--|--|--|--|--|-------|-------|
|                            | AR 67501  | 04/93 → 12/97 |   | VKMA 02154<br>VKM 12153<br>VKM 22153  | 1<br>1      | 1<br>1      | 1 |   |  |  |   |   |  |  |  |  |  | T0055 |       |
|                            | AR 67501  | 04/93 → 12/97 | 2), →IMot. 1723043  | —   |             |             |   |   |  |  |   | 1 |  |  |  |  |  |       |       |
|  | AR 67501  | 04/93 → 12/97 | 2), Mot. 1723044  →   | VKPA 82666  |             |             |   |   |  |  |   | 1 |  |  |  |  |  |       |       |
|                            | <b>B(Alt)</b> AR 67501                                  | 04/93 → 12/97 | <b>AC</b> , →IMot. 1723042  | VKMOV 5PK970<br>VKM 32242   |             |             |   | 1 |  |  |   |   |  |  |  |  |  |       |       |
|  | <b>B(Alt)</b> AR 67501                                  | 04/93 → 12/97 | <b>AC</b> , Mot. 1723043  →   | VKMOV 5PK986<br>VKM 32242   |             |             |   | 1 |  |  | 1 |   |  |  |  |  |  |       |       |
| ALFA ROMEO  155 2.5 TD    |   |               |   |   |             |             |   |   |  |  |   |   |  |  |  |  |  |       |       |
|                            | VM 07 B, VM 31 B  | 04/93 → 12/97 |   |  |             |             |   |   |  |  |   |   |  |  |  |  |  |       |       |
|                            | VM 07 B, VM 31 B  | 04/93 → 03/95 |   | VKPC 82642  |             |             |   |   |  |  |   | 1 |  |  |  |  |  |       |       |
|                            | <b>B(Alt)</b> VM 07 B, VM 31 B                          | 04/93 → 12/97 |   | VKM 32017   |             |             |   | 1 |  |  |   |   |  |  |  |  |  |       |       |
| ALFA ROMEO  156 1.6 16V   |   |               |   |   |             |             |   |   |  |  |   |   |  |  |  |  |  |       |       |
|                            | AR 32103, AR 32104                                      | 09/97 → 05/06 |    | VKMC 02181<br>VKMA 02181<br>VKM 12182<br>VKM 22177                                | 1<br>1<br>1 | 1<br>1<br>1 | 1 |   |  |  | 1 |   |  |  |  |  |  | T0144 |       |
|  | AR 32102, AR 67601                                      | 09/97 → 05/06 |   | VKMA 02184<br>VKM 12182<br>VKM 22177  | 1<br>1      | 1<br>1      | 1 |   |  |  |   |   |  |  |  |  |  |       | T0143 |
|                            | AR 32102, AR 67601                                      | 09/97 → 05/06 |   | VKPC 82451  |             |             |   |   |  |  |   | 1 |  |  |  |  |  |       |       |
|  | AR 32103, AR 32104                                      | 09/97 → 05/06 |   | VKPC 82645  |             |             |   |   |  |  |   | 1 |  |  |  |  |  |       |       |
|                            | <b>B(Alt)</b> AR 32102, AR 32103,<br>AR 32104, AR 67601 | 09/97 → 05/06 | <b>AC</b> , →IMot. 2835764  | VKMA 32022<br>VKMOV 6PK1045<br>VKM 32022  | 1<br>1      |             |   | 1 |  |  |   |   |  |  |  |  |  |       |       |
|  | <b>B(Alt)</b> AR 32102, AR 32103,<br>AR 32104, AR 67601 | 09/97 → 05/06 | <b>AC</b> , Mot. 2835765  →   | VKM 32022   | 1           |             |   |   |  |  |   |   |  |  |  |  |  |       |       |
|  | <b>B(Alt)</b> AR 32102, AR 67601                        | 09/97 → 05/06 | <b>AC</b>   | VKMOV 6PK1855<br>VKM 32001<br>VKM 32022   |             |             |   | 1 |  |  |   |   |  |  |  |  |  |       |       |
|  | <b>B(Alt)</b> AR 32103, AR 32104                        | 09/97 → 09/03 | <b>AC</b> , →IMot. 2835764  | VKMOV 6PK1855<br>VKM 32001<br>VKM 32022   |             |             |   | 1 |  |  |   |   |  |  |  |  |  |       |       |
|  | <b>B(Alt)</b> AR 32103, AR 32104                        | 09/97 → 09/03 | <b>AC</b> , Mot. 2835765  →   | VKMA 32020<br>VKMOV 6PK1842<br>VKM 32001<br>VKM 32022                             | 1<br>1      | 1<br>1      | 1 |   |  |  |   |   |  |  |  |  |  |       |       |
|  | <b>B(Alt)</b> AR 32103, AR 32104                        | 10/03 → 05/06 | <b>AC</b> , Mot. 2835765  →   | VKMOV 6PK1842<br>VKM 32001<br>VKM 32026   |             |             |   | 1 |  |  |   |   |  |  |  |  |  |       |       |
| ALFA ROMEO  156 1.8 16V |   |               |   |   |             |             |   |   |  |  |   |   |  |  |  |  |  |       |       |
|                          | AR 32201  | 09/97 → 10/00 |  | VKMC 02177<br>VKMA 02177<br>VKM 12173<br>VKM 22177                                | 1<br>1<br>1 | 1<br>1<br>1 | 1 |   |  |  | 1 |   |  |  |  |  |  | T0128 |       |
|  | AR 32205  | 10/00 → 05/06 |   | VKMA 02186<br>VKM 12173<br>VKM 22177  | 1<br>1      | 1<br>1      | 1 |   |  |  |   |   |  |  |  |  |  |       | T0143 |
|                          | AR 32201  | 09/97 → 10/00 |   | VKPC 82645  |             |             |   |   |  |  |   | 1 |  |  |  |  |  |       |       |
|  | AR 32205  | 10/00 → 05/06 |   | VKPC 82451  |             |             |   |   |  |  |   | 1 |  |  |  |  |  |       |       |
|                          | <b>B(Alt)</b> AR 32201, AR 32205                        | 09/97 → 05/06 | <b>AC</b> , →IMot. 2835764  | VKMA 32022<br>VKMOV 6PK1045<br>VKM 32022  | 1<br>1      |             |   | 1 |  |  |   |   |  |  |  |  |  |       |       |
|  | <b>B(Alt)</b> AR 32201, AR 32205                        | 09/97 → 05/06 | <b>AC</b> , Mot. 2835765  →   | VKM 32022   | 1           |             |   |   |  |  |   |   |  |  |  |  |  |       |       |
|  | <b>B(Alt)</b> AR 32201, AR 32205                        | 09/97 → 09/03 | <b>AC</b> , →IMot. 2835764  | VKMOV 6PK1855<br>VKM 32001<br>VKM 32022   |             |             |   | 1 |  |  |   |   |  |  |  |  |  |       |       |
|  | <b>B(Alt)</b> AR 32201, AR 32205                        | 09/97 → 09/03 | <b>AC</b> , Mot. 2835765  →   | VKMA 32020<br>VKMOV 6PK1842<br>VKM 32001<br>VKM 32022                             | 1<br>1      | 1<br>1      | 1 |   |  |  |   |   |  |  |  |  |  |       |       |



































|  |  |  |    |  |  |  |  |  |  |  |  |  |  |
|--|---|---|---|--|---|---|---|---|---|---|---|---|---|
| B(Alt)   | AR 32205  | 10/03 → 05/06   | AC, Mot. 2835765 I→   | VKMOV 6PK1842<br>VKM 32001<br>VKM 32026  | 1   | 1   | 1   |   |   |   |   |   |   |
| <b>ALFA ROMEO  156 2.0 16V</b>      |   |   |   |  |   |   |   |   |   |   |   |   |   |
|                                     | AR 32301, AR 32303,<br>AR 32310   | 09/97 → 03/02   |    | VKMC 02177<br>VKMA 02177<br>VKM 12173<br>VKM 22177                                 | 1<br>1<br>1   | 1<br>1<br>1   | 1<br>1  | 1   |   |   |   |   | T0128   |
|  | AR 32301, AR 32303,<br>AR 32310   | 09/97 → 03/02   | 1)  | VKMA 02277<br>VKM 12173<br>VKM 12277<br>VKM 22177                                  | 2<br>1<br>1   | 1<br>1  | 2   |   |   |   |   |   | T0235   |
|                                     | AR 32301, AR 32303,<br>AR 32310   | 09/97 → 03/02   |   | VKPC 82645   |   |   |   | 1   |   |   |   |   |   |
|                                     | B(Alt) AR 32301   | 09/97 → 10/00   | AC, →IMot. 1385143  | VKMOV 7PK1080<br>VKM 32022   | 1   |   | 1   |   |   |   |   |   |   |
|  | B(Alt) AR 32301   | 09/97 → 10/00   | AC, Mot. 1385144 I→   | VKMOV 6PK1080<br>VKM 32022   | 1   |   | 1   |   |   |   |   |   |   |
|  | B(Alt) AR 32301   | 09/97 → 10/00   | AC, →IMot. 1385143  | VKMOV 7PK1975<br>VKM 32007<br>VKM 32022  | 1   | 1   | 1   |   |   |   |   |   |   |
|  | B(Alt) AR 32301   | 09/97 → 10/00   | AC, Mot. 1385144 I→   | VKMOV 6PK1975<br>VKM 32007<br>VKM 32022  | 1   | 1   | 1   |   |   |   |   |   |   |
|  | B(Alt) AR 32310   | 10/00 → 03/02   | AC, →IMot. 2835764  | VKMOV 6PK1080<br>VKM 32022   | 1   |   | 1   |   |   |   |   |   |   |
|  | B(Alt) AR 32310   | 10/00 → 03/02   | AC, Mot. 2835765 I→   | VKMOV 6PK1062<br>VKM 32022   | 1   |   | 1   |   |   |   |   |   |   |
|  | B(Alt) AR 32310   | 10/00 → 03/02   | AC, →IMot. 2835764  | VKMOV 6PK1975<br>VKM 32007<br>VKM 32022  | 1   | 1   | 1   |   |   |   |   |   |   |
|  | B(Alt) AR 32310   | 10/00 → 03/02   | AC, Mot. 2835765 I→   | VKMOV 6PK1962<br>VKM 32007<br>VKM 32022  | 1   | 1   | 1   |   |   |   |   |   |   |
| <b>ALFA ROMEO  156 2.0 JTS</b>    |   |   |   |  |   |   |   |   |   |   |   |   |   |
|                                   | 937 A1.000  | 03/02 → 05/06   |  | VKMC 02183<br>VKMA 02183<br>VKM 12182<br>VKM 22177                                 | 1<br>1<br>1   | 1<br>1<br>1   | 1<br>1  | 1   |   |   |   |   | T0128   |
|  | 937 A1.000  | 03/02 → 05/06   | 1)  | VKMA 02283<br>VKM 12182<br>VKM 12277<br>VKM 22177                                  | 2<br>1<br>1   | 1<br>1  | 2   |   |   |   |   |   | T0235   |
|                                   | 937 A1.000, 937 A2.000  | 03/02 → 05/06   |   | VKPC 82645   |   |   |   | 1   |   |   |   |   |   |
|                                   | B(Alt) 932 A2.000, 937 A1.000   | 03/02 → 05/06   |   | VKMOV 6PK1962<br>VKM 32007<br>VKM 32026  | 1   | 1   | 1   |   |   |   |   |   |   |
| <b>ALFA ROMEO  156 2.5 V6 24V</b> |   |   |   |  |   |   |   |   |   |   |   |   |   |
|                                   | AR 32401, AR 32405  | 09/97 → 05/06   |   | VKMA____<br>VKM____<br>VKM 22540<br>VKM 22540                                      | 1<br>1  | 2<br>1  | 1<br>1  |   |   |   |   |   | T0238   |
|                                   | AR 32401, AR 32405  | 09/97 → 05/06   |   | —  |   |   |   | 1   |   |   |   |   |   |
|                                   | B(Alt) AR 32401, AR 32405   | 09/97 → 05/06   |   | VKMOV 6PK1983<br>VKM 32030<br>VKM 32082<br>VKM 32083                               | 1   | 1   | 1   |   |   |   |   |   |   |
| <b>ALFA ROMEO  156 3.2 GTA</b>    |   |   |   |  |   |   |   |   |   |   |   |   |   |
|                                   | 932 A.000   | 03/02 → 05/06   |   | VKMA____<br>VKM____<br>VKM 22540<br>VKM 22540                                      | 1<br>1  | 2<br>1  | 1<br>1  |   |   |   |   |   | T0238   |
|                                   | 932 A.000   | 03/02 → 05/06   |   | —  |   |   |   | 1   |   |   |   |   |   |



|  |  |  |                  |  |  |  |  |  |  |  |  |
|--|---|---|---|--|---|---|---|---|---|---|---|
|  <b>B(Alt)</b> 932 A.000                               |   |   | 03/02 → 05/06   | VKMOV 6PK1983<br>VKM 32030<br>VKM 32082<br>VKM 32083                               | 1   | 1   |   |   |   |   |   |
| <b>ALFA ROMEO  156 1.9 JTD</b>                        |   |   |   |  |   |   |   |   |   |   |   |
|  937 A2.000, AR 32302,<br>AR 37101                     |   |   | 09/97 → 05/06    | VKMC 02179<br>VKMA 02179<br>VKM 12174<br>VKM 22179                                 | 1<br>1<br>1   | 1<br>1<br>1   | 1   | 1   |   |   | 2<br>2<br>2   |
|  937 A2.000, AR 32302,<br>AR 37101                     |   |   | 09/97 → 05/06   | VKPC 82665   |   |   |   | 1   |   |   |   |
|  <b>B(Alt)</b> 937 A2.000, AR 32302,<br>AR 37101       |   |   | 09/97 → 12/05 <b>AC</b>   | VKMA 32027<br>VKMOV 6PK1036<br>VKM 32027   | 1<br>1  | 1<br>1  |   |   |   |   |   |
| <b>B(Alt)</b> AR 32302   |   |   | 05/98 → 10/00 <b>AC, Mot. 1064562 I→</b>  | VKMA 32039<br>VKMOV 6PK1836<br>VKM 32006<br>VKM 32027                              | 1<br>1  | 1<br>1  | 1   |   |   |   |   |
| <b>B(Alt)</b> 937 A2.000, AR 32302,<br>AR 37101  |   |   | 05/00 → 12/05 <b>AC</b>   | VKMA 32039<br>VKMOV 6PK1836<br>VKM 32006<br>VKM 32027                              | 1<br>1<br>1   | 1<br>1<br>1   |   |   |   |   |   |
|  937 A2.000, AR 32302,<br>AR 37101                     |   |   | 09/97 → 12/05   | VKM_____   |   |   |   | 1   |   |   |   |
| <b>ALFA ROMEO  156 1.9 JTD 16V</b>                  |   |   |   |  |   |   |   |   |   |   |   |
|  192 A5.000, 937 A4.000                              |   |   | 11/02 → 05/06 <b>→IMot. 4109227</b>   | VKMA 02190<br>VKM 12174<br>VKM 22179   | 1<br>1  | 1<br>1  | 1   |   |   |   | 2<br>2  |
| 192 A5.000, 937 A4.000   |   |   | 11/02 → 05/06 <b>Mot. 4109228 I→</b>  | VKMA 02197<br>VKM 12174<br>VKM 22180   | 1<br>1  | 1<br>1  | 1   |   |   |   | T0203   |
| 937 A5.000   |   |   | 07/04 → 05/06   | VKMA 02190<br>VKM 12174<br>VKM 22179   | 1<br>1  | 1<br>1  | 1   |   |   |   | 2<br>2  |
|  192 A5.000, 937 A4.000                              |   |   | 11/02 → 05/06   | VKPC 82667   |   |   |   | 1   |   |   |   |
|  <b>B(Alt)</b> 195 A5.000, 937 A4.000,<br>937 A5.000 |   |   | 11/02 → 05/06   | VKMA 32039<br>VKMOV 6PK1836<br>VKM 32006<br>VKM 32027                              | 1<br>1  | 1<br>1  | 1   |   |   |   |   |
|  192 A5.000  |   |   | 11/02 → 12/05   | VKM_____   |   |   |   | 1   |   |   |   |
| <b>ALFA ROMEO  156 2.4 JTD</b>                      |   |   |   |  |   |   |   |   |   |   |   |
|  839 A6.000, 841 C000,<br>AR 32501                   |   |   | 09/97 → 05/06  | VKMC 02176<br>VKMA 02176<br>VKM 12174<br>VKM 22174                                 | 1<br>1<br>1   | 1<br>1<br>1   | 1   |   |   |   | T0158   |
|  839 A6.000, 841 C000,<br>AR 32501                   |   |   | 09/97 → 05/06   | VKPC 82665   |   |   |   | 1   |   |   |   |
|  <b>B(Alt)</b> 839 A6.000, AR 32501                  |   |   | 09/97 → 12/05 <b>AC</b>   | VKMA 32025<br>VKMOV 6PK1105<br>VKM 32025   | 1<br>1  | 1<br>1  |   |   |   |   |   |
| <b>B(Alt)</b> 839 A6.000, AR 32501   |   |   | 09/97 → 12/05 <b>AC, →IMot. 1904012</b>   | VKM 32018<br>VKM 32024<br>VKM 32025  | 1   | 1<br>1  |   |   |   |   |   |
| <b>B(Alt)</b> 839 A6.000, AR 32501   |   |   | 09/97 → 12/05 <b>AC, Mot. 1904013 I→</b>  | VKMA 32024<br>VKMOV 6PK1760<br>VKM 32018<br>VKM 32024<br>VKM 32025                 | 1<br>1  | 2<br>1<br>1   | 1   |   |   |   |   |
| <b>B(Alt)</b> 841 C000   |   |   | 03/02 → 05/06   | VKMA 32024<br>VKMOV 6PK1760<br>VKM 32018   | 1<br>1  | 2<br>1  | 1   |   |   |   |   |

|                                     |                                   |                                |    | VKM 32024<br>VKM 32025  | 1               | 1 |   |  |  |  |        |   |  |  |  |  |       |
|-------------------------------------|-----------------------------------|--------------------------------|----|---|-----------------|---|---|--|--|--|--------|---|--|--|--|--|-------|
| ⊙                                   | 839 A6.000, 841 C000,<br>AR 32501 | 09/97 → 12/05                  |    | VKM_____  |                 |   |   |  |  |  |        | 1 |  |  |  |  |       |
| <b>ALFA ROMEO  156 2.4 JTD 20V</b>  |                                   |                                |    |   |                 |   |   |  |  |  |        |   |  |  |  |  |       |
|                                     | 841 G.000, 841 M.000              | 10/03 → 05/06                  |    | VKMA 02191<br>VKM 12174<br>VKM 22174                              | 1<br>1          | 1 | 1 |  |  |  |        |   |  |  |  |  | T0203 |
|                                     | 841 G.000                         | 10/03 → 05/06                  |    | VKPC 82667  |                 |   |   |  |  |  | 1      |   |  |  |  |  |       |
| B(Alt)                              | 841 G.000, 841 M.000              | 10/03 → 05/06                  |    | VKMA 32024<br>VKMV 6PK1760<br>VKM 32018<br>VKM 32024<br>VKM 32025 | 1<br><br>1<br>1 | 2 | 1 |  |  |  |        |   |  |  |  |  |       |
| ⊙                                   | 841 G.000                         | 10/03 → 12/05                  |    | VKM_____  |                 |   |   |  |  |  |        | 1 |  |  |  |  |       |
| <b>ALFA ROMEO  159 1.9 JTS</b>      |                                   |                                |    |   |                 |   |   |  |  |  |        |   |  |  |  |  |       |
|                                     | 939A6.000                         | 09/05 → 10/07                  |    | ΟΛΟΚΛΟΝΟ  |                 |   |   |  |  |  |        |   |  |  |  |  |       |
|                                     | 939A6.000                         | 09/05 → 10/07                  |    | VKPC 85308  |                 |   |   |  |  |  | 1      |   |  |  |  |  |       |
| B(Alt)                              | 939A6.000                         | 09/05 → 10/07                  |    | VKMV_____<br>VKM 34027  | 1               |   | 1 |  |  |  |        |   |  |  |  |  |       |
| <b>ALFA ROMEO  159 2.2 JTS</b>      |                                   |                                |    |   |                 |   |   |  |  |  |        |   |  |  |  |  |       |
|                                     | 939A5.000                         | 09/05 → 09/06                  |    | ΟΛΟΚΛΟΝΟ  |                 |   |   |  |  |  |        |   |  |  |  |  |       |
|                                     | 939A5.000                         | 09/05 → 10/07                  |    | VKPC 85308  |                 |   |   |  |  |  | 1      |   |  |  |  |  |       |
| B(Alt)                              | 939A5.000                         | 09/05 → 10/07                  |    | VKMV_____<br>VKM 34027  | 1               |   | 1 |  |  |  |        |   |  |  |  |  |       |
| <b>ALFA ROMEO  159 3.2 JTS</b>      |                                   |                                |    |   |                 |   |   |  |  |  |        |   |  |  |  |  |       |
|                                     | 939 A.000                         | 12/05 → 10/07                  |    | ΟΛΟΚΛΟΝΟ  |                 |   |   |  |  |  |        |   |  |  |  |  |       |
| <b>ALFA ROMEO  159 1.9 JTDM</b>     |                                   |                                |    |   |                 |   |   |  |  |  |        |   |  |  |  |  |       |
|                                     | 937 A7.000, 939 A1.000            | 09/05 → 03/07                  |    | —<br>VKM 12174<br>VKM 22180                                       | 1<br>1          | 1 | 1 |  |  |  |        |   |  |  |  |  |       |
|                                     | 937 A7.000, 939 A1.000            | 09/05 → 03/07                  |    | VKPC 82665  |                 |   |   |  |  |  | 1      |   |  |  |  |  |       |
| B(Alt)                              | 937 A7.000, 939 A1.000            | 09/05 → 03/07                  |    | VKMV 6PK1735<br>VKM 32046   | 1               |   | 1 |  |  |  |        |   |  |  |  |  |       |
| <b>ALFA ROMEO  159 1.9 JTDM 16V</b> |                                   |                                |    |   |                 |   |   |  |  |  |        |   |  |  |  |  |       |
|                                     | 937 A8.000, 939A2.000             | 09/05 → 03/07                  |    | VKMA 02193<br>VKM 12174<br>VKM 22180                              | 1<br>1          | 1 | 1 |  |  |  |        |   |  |  |  |  | T0248 |
|                                     | 937 A8.000, 939A2.000             | 09/05 → 03/07                  |    | VKPC 82667  |                 |   |   |  |  |  | 1      |   |  |  |  |  |       |
| B(Alt)                              | 937 A8.000, 939A2.000             | 09/05 → 03/07                  |    | VKMV 6PK1735<br>VKM 32046   | 1               |   | 1 |  |  |  |        |   |  |  |  |  |       |
| <b>ALFA ROMEO  159 2.4 JTDM</b>     |                                   |                                |    |   |                 |   |   |  |  |  |        |   |  |  |  |  |       |
|                                     | 939A3.000                         | 09/05 → 10/07                  |    | VKMA 02195<br>VKM 12174<br>VKM 22174                              | 1<br>1          | 1 | 1 |  |  |  |        |   |  |  |  |  | T0248 |
|                                     | 939A3.000                         | 09/05 → 10/07                  |    | VKPC 82667  |                 |   |   |  |  |  | 1      |   |  |  |  |  |       |
| B(AC)                               | 939A3.000                         | 09/05 → 10/07                  |    | VKMV 6PK1580  |                 |   | 1 |  |  |  |        |   |  |  |  |  |       |
| <b>ALFA ROMEO  164 2.0 16V</b>      |                                   |                                |    |   |                 |   |   |  |  |  |        |   |  |  |  |  |       |
|                                     | AR 06416, AR 06420,<br>AR 64103   | 06/87 → 09/98                  |    | ΟΛΟΚΛΟΝΟ  |                 |   |   |  |  |  |        |   |  |  |  |  |       |
|                                     | AR 06416, AR 06420<br>AR 64103    | 06/87 → 09/92<br>09/92 → 09/98 |    | —<br>VKPC 82436   |                 |   |   |  |  |  | 1<br>1 |   |  |  |  |  |       |
| B(Alt)                              | AR 64103                          | 09/92 → 09/98                  | AC | VKM 32009   |                 | 1 |   |  |  |  |        |   |  |  |  |  |       |
| <b>ALFA ROMEO  164 2.0 Turbo</b>    |                                   |                                |    |   |                 |   |   |  |  |  |        |   |  |  |  |  |       |
|                                     | AR 06476                          | 10/87 → 12/92                  |    | VKMA 02450<br>VKM 12005   | 1<br>1          |   | 1 |  |  |  |        |   |  |  |  |  | T0035 |
|                                     | AR 06476                          | 10/87 → 09/98                  |    | VKPC 82614  |                 |   |   |  |  |  | 1      |   |  |  |  |  |       |
| <b>ALFA ROMEO  164 2.0 V6 Turbo</b> |                                   |                                |    |   |                 |   |   |  |  |  |        |   |  |  |  |  |       |
|                                     | AR 64102                          | 09/92 → 09/98                  |    | VKMA_____<br>VKM_____   | 1<br>1          |   | 1 |  |  |  |        |   |  |  |  |  |       |
|                                     | AR 64101, AR 64102                | 03/91 → 09/98                  |    | VKPC 82800  |                 |   |   |  |  |  | 1      |   |  |  |  |  |       |







































|  |  |  |    |  |  |  |  |  |  |  |  |  |
|--|--|---|---|---|--|---|---|---|---|---|---|---|
| <b>ALFA ROMEO  164 3.0 24V</b>      |  |   |   |   |  |   |   |   |   |   |   |   |
|                                      | AR 64304, AR 64307,<br>AR 64308, AR 66301,<br>AR 66302               | 09/92 → 09/98   |   |   | —<br>—<br>VKM 22541<br>VKM 22541   | 1<br>1  | 2<br>1  | 1<br>1  |   |   |   | T0237   |
|                                      | AR 64304, AR 64307,<br>AR 64308, AR 66301,<br>AR 66302               | 09/92 → 09/98   |   |   | —  |   |   |   | 1   |   |   |   |
|                                      | <b>B(Alt)</b> AR 64304, AR 64307,<br>AR 64308, AR 66301,<br>AR 66302 | 09/92 → 09/98   |   |   | VKM 32010  | 1   |   |   |   |   |   |   |
| <b>ALFA ROMEO  164 3.0 V6</b>       |  |   |   |   |  |   |   |   |   |   |   |   |
|                                      | AR 06410, AR 06412,<br>AR 64301, AR 64305,<br>AR 66303               | 06/87 → 09/98   |   |   | VKPC 82800   |   |   |   |   | 1   |   |   |
| <b>ALFA ROMEO  164 2.5 TD</b>       |  |   |   |   |  |   |   |   |   |   |   |   |
|                                      | VM 08 B, VM 32 B,<br>VM 84 A   | 06/87 → 09/98   |   |   |   |   |   |   |   |   |   |   |
|                                      | VM 08 B, VM 32 B   | 09/92 → 09/93   |   |   | VKPC 82642   |   |   |   |   | 1   |   |   |
|  | VM 08 B, VM 32 B   | 10/93 → 09/98   |   |   | VKPC 82810   |   |   |   |   | 1   |   |   |
|  | VM 84 A  | 06/87 → 09/92   |   | → Mot. 0023450  | —  |   |   |   |   | 1   |   |   |
|  | VM 84 A  | 06/87 → 09/92   |   | Mot. 0023451  →   | VKPC 82642   |   |   |   |   | 1   |   |   |
|                                      | <b>B(Alt)</b> VM 08 B, VM 32 B                                       | 09/92 → 09/98   |   | AC  | VKM 32017  |   | 1   |   |   |   |   |   |
| <b>ALFA ROMEO  166 2.0 16V</b>     |  |   |   |   |  |   |   |   |   |   |   |   |
|                                    | AR 34103, AR 36301   | 09/98 → 12/05   |  |   | VKMC 02177<br>VKMA 02177<br>VKM 12173<br>VKM 22177                                 | 1<br>1<br>1   | 1<br>1  | 1<br>1  | 1   |   |   | T0128   |
|  | AR 34103, AR 36301   | 09/98 → 12/05   | 1)  |   | VKMA 02277<br>VKM 12173<br>VKM 12277<br>VKM 22177                                  | 2<br>1<br>1   | 1   | 2   |   |   |   | T0235   |
|                                    | AR 34103, AR 36301   | 09/98 → 03/07   |   |   | VKPC 82645   |   |   |   | 1   |   |   |   |
|                                    | <b>B(Alt)</b> AR 34103   | 09/98 → 10/00   |   | → Mot. 1385143  | VKMOV 7PK1975<br>VKM 32007<br>VKM 32026  |   | 1   | 1   |   |   |   |   |
|  | <b>B(Alt)</b> AR 34103   | 09/98 → 10/00   |   | Mot. 1385144  →   | VKMOV 6PK1975<br>VKM 32007<br>VKM 32026  |   | 1   | 1   |   |   |   |   |
|  | <b>B(Alt)</b> AR 36301   | 10/00 → 03/07   |   | → Mot. 2835764  | VKMOV 6PK1975<br>VKM 32007<br>VKM 32026  |   | 1   | 1   |   |   |   |   |
|  | <b>B(Alt)</b> AR 36301   | 10/00 → 03/07   |   | Mot. 2835765  →   | VKMOV 6PK1962<br>VKM 32007<br>VKM 32026  |   | 1   | 1   |   |   |   |   |
| <b>ALFA ROMEO  166 2.0 V6</b>     |  |   |   |   |  |   |   |   |   |   |   |   |
|                                    | AR 34102   | 09/98 → 03/07   |   |   | —<br>—   | 1<br>1  |   | 1   |   |   |   |   |
|                                    | AR 34102   | 09/98 → 03/07   |   |   | —  |   |   |   | 1   |   |   |   |
|                                    | <b>B(Alt)</b> AR 34102   | 09/98 → 03/07   |   |   | VKMOV 6PK1983<br>VKM 32030<br>VKM 32082<br>VKM 32083                               |   | 1   | 1   |   |   |   |   |
| <b>ALFA ROMEO  166 2.5 V6 24V</b> |  |   |   |   |  |   |   |   |   |   |   |   |
|                                    | AR 34201, AR 36201   | 09/98 → 03/07   |   |   | VKMA _____<br>VKM _____<br>VKM 22540<br>VKM 22540                                  | 1<br>1  | 2<br>1  | 1<br>1  |   |   |   | T0238   |
|                                    | AR 34201, AR 36201   | 09/98 → 03/07   |   |   | —  |   |   |   | 1   |   |   |   |
|                                    | <b>B(Alt)</b> AR 34201, AR 36201                                     | 09/98 → 03/07   |   |   | VKMOV 6PK1983<br>VKM 32030<br>VKM 32082<br>VKM 32083                               |   | 1   | 1   |   | 1   |   |   |









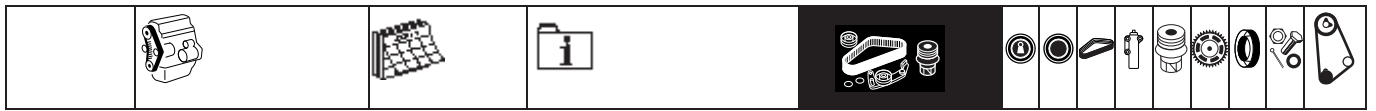





















| <b>ALFA ROMEO  166 3.0 V6 24V</b>  |   |               |               |   |   |   |   |  |  |   |  |   |  |  |  |  |  |       |
|------------------------------------|---|---------------|---------------|---|---|---|---|--|--|---|--|---|--|--|--|--|--|-------|
|                                    | AR 34301, AR 36101  | 09/98 → 03/07 | VKMA _____    | 1 | 2 | 1 |   |  |  |   |  |   |  |  |  |  |  | T0238 |
|                                    |   |               | VKM _____     | 1 |   |   |   |  |  |   |  |   |  |  |  |  |  |       |
|                                    |   |               | VKM 22540     |   |   | 1 |   |  |  |   |  |   |  |  |  |  |  |       |
|                                    |   |               | VKM 22540     |   |   | 1 |   |  |  |   |  |   |  |  |  |  |  |       |
|                                    | AR 34301, AR 36101  | 09/98 → 03/07 | —             |   |   |   |   |  |  |   |  | 1 |  |  |  |  |  |       |
|                                    | <b>B(Alt)</b> AR 34301, AR 36101                            | 09/98 → 03/07 | VKMOV 6PK1983 |   |   |   | 1 |  |  |   |  |   |  |  |  |  |  |       |
|                                    |   |               | VKM 32030     |   |   | 1 |   |  |  |   |  |   |  |  |  |  |  |       |
|                                    |   |               | VKM 32082     |   |   |   |   |  |  |   |  |   |  |  |  |  |  |       |
|                                    |   |               | VKM 32083     | 1 |   |   |   |  |  |   |  |   |  |  |  |  |  |       |
| <b>ALFA ROMEO  166 3.2 V6 24V</b>  |   |               |               |   |   |   |   |  |  |   |  |   |  |  |  |  |  |       |
|                                    | 936 A.000   | 10/03 → 03/07 | VKMA _____    | 1 | 2 | 1 |   |  |  |   |  |   |  |  |  |  |  | T0238 |
|                                    |   |               | VKM _____     | 1 |   |   |   |  |  |   |  |   |  |  |  |  |  |       |
|                                    |   |               | VKM 22540     |   |   | 1 |   |  |  |   |  |   |  |  |  |  |  |       |
|                                    |   |               | VKM 22540     |   |   | 1 |   |  |  |   |  |   |  |  |  |  |  |       |
|                                    | 936 A.000   | 10/03 → 03/07 | —             |   |   |   |   |  |  |   |  | 1 |  |  |  |  |  |       |
|                                    | <b>B(Alt)</b> 936 A.000                                     | 10/03 → 03/07 | VKMOV 6PK1983 |   |   |   | 1 |  |  |   |  |   |  |  |  |  |  |       |
|                                    |   |               | VKM 32030     |   |   | 1 |   |  |  |   |  |   |  |  |  |  |  |       |
|                                    |   |               | VKM 32082     |   |   |   |   |  |  |   |  |   |  |  |  |  |  |       |
|                                    |   |               | VKM 32083     | 1 |   |   |   |  |  |   |  |   |  |  |  |  |  |       |
| <b>ALFA ROMEO  166 2.4 JTD</b>     |   |               |               |   |   |   |   |  |  |   |  |   |  |  |  |  |  |       |
|                                    | 839 A6.000, 841 C000,<br>AR 34202                           | 09/98 → 03/07 | VKMC 02176    | 1 | 1 | 1 |   |  |  | 1 |  |   |  |  |  |  |  | T0158 |
|                                    |   |               | VKMA 02176    | 1 | 1 | 1 |   |  |  |   |  |   |  |  |  |  |  |       |
|                                    |   |               | VKM 12174     | 1 |   |   |   |  |  |   |  |   |  |  |  |  |  |       |
|                                    |   |               | VKM 22174     |   |   | 1 |   |  |  |   |  |   |  |  |  |  |  |       |
|                                    | 839 A6.000, 841 C000,<br>AR 34202                           | 09/98 → 03/07 | VKPC 82665    |   |   |   |   |  |  |   |  | 1 |  |  |  |  |  |       |
|                                    | <b>B(Alt)</b> 839 A6.000, 841 C000,<br>AR 34202             | 09/98 → 12/05 | VKMA 32004    | 1 | 2 | 1 |   |  |  |   |  |   |  |  |  |  |  |       |
|                                    |   |               | VKMOV 6PK1740 |   |   | 1 |   |  |  |   |  |   |  |  |  |  |  |       |
|                                    |   |               | VKM 32004     |   |   | 1 |   |  |  |   |  |   |  |  |  |  |  |       |
|                                    |   |               | VKM 32024     |   |   | 1 |   |  |  |   |  |   |  |  |  |  |  |       |
|                                    |   |               | VKM 32025     | 1 |   |   |   |  |  |   |  |   |  |  |  |  |  |       |
|                                    | 839 A6.000, 841 C000,<br>AR 34202                           | 09/98 → 12/05 | VKM _____     |   |   |   |   |  |  |   |  | 1 |  |  |  |  |  |       |
| <b>ALFA ROMEO  166 2.4 JTD 20V</b> |   |               |               |   |   |   |   |  |  |   |  |   |  |  |  |  |  |       |
|                                    | 841 G.000, 841 H.000,<br>841 M.000, 841 N.000               | 10/03 → 10/07 | VKMA 02191    | 1 | 1 | 1 |   |  |  |   |  |   |  |  |  |  |  | T0203 |
|                                    |   |               | VKM 12174     | 1 |   |   |   |  |  |   |  |   |  |  |  |  |  |       |
|                                    |   |               | VKM 22174     |   |   | 1 |   |  |  |   |  |   |  |  |  |  |  |       |
|                                    | 841 G.000, 841 H.000  | 10/03 → 10/07 | VKPC 82667    |   |   |   |   |  |  |   |  | 1 |  |  |  |  |  |       |
|                                    | <b>B(Alt)</b> 841 G.000, 841 H.000,<br>841 M.000, 841 N.000 | 10/03 → 10/07 | VKMA 32004    | 1 | 2 | 1 |   |  |  |   |  |   |  |  |  |  |  |       |
|                                    |   |               | VKMOV 6PK1740 |   |   | 1 |   |  |  |   |  |   |  |  |  |  |  |       |
|                                    |   |               | VKM 32004     |   |   | 1 |   |  |  |   |  |   |  |  |  |  |  |       |
|                                    |   |               | VKM 32024     |   |   | 1 |   |  |  |   |  |   |  |  |  |  |  |       |
|                                    |   |               | VKM 32025     | 1 |   |   |   |  |  |   |  |   |  |  |  |  |  |       |
|                                    | 841 G.000, 841 H.000  | 10/03 → 12/05 | VKM _____     |   |   |   |   |  |  |   |  | 1 |  |  |  |  |  |       |
| <b>ALFA ROMEO  33 1.2</b>          |   |               |               |   |   |   |   |  |  |   |  |   |  |  |  |  |  |       |
|                                    | AR 30585  | 06/83 → 12/89 | VKMA 02500    | 2 |   | 2 |   |  |  |   |  |   |  |  |  |  |  | T0004 |
|                                    |   |               | VKM 12500     | 1 |   |   |   |  |  |   |  |   |  |  |  |  |  |       |
|                                    |   |               | VKM 12501     | 1 |   |   |   |  |  |   |  |   |  |  |  |  |  |       |
|                                    | AR 30585  | 06/83 → 12/89 | VKPC 82201    |   |   |   |   |  |  |   |  | 1 |  |  |  |  |  |       |
| <b>ALFA ROMEO  33 1.3</b>          |   |               |               |   |   |   |   |  |  |   |  |   |  |  |  |  |  |       |
|                                    | AR 30168, AR 30502,<br>AR 30586, AR 30587                   | 05/83 → 12/89 | VKMA 02500    | 2 |   | 2 |   |  |  |   |  |   |  |  |  |  |  | T0004 |
|                                    |   |               | VKM 12500     | 1 |   |   |   |  |  |   |  |   |  |  |  |  |  |       |
|                                    |   |               | VKM 12501     | 1 |   |   |   |  |  |   |  |   |  |  |  |  |  |       |
|                                    | AR 30168, AR 30502,<br>AR 30586, AR 30587,<br>AS 30168      | 06/83 → 12/89 | VKPC 82201    |   |   |   |   |  |  |   |  | 1 |  |  |  |  |  |       |

































|  |   |                  |  |   |  |   |  |  |  |   |  |  |  |  |  |  |  |  |       |
|--|---|------------------|--|---|---|---|---|--|---|---|---|--|---|--|---|--|---|--|-------|
| <b>ALFA ROMEO  33 1.4</b>         |   |                  |  |   |   |   |   |  |   |   |   |  |   |  |   |  |   |  |       |
|                                    | AR 30587  | 06/91 → 09/94    | VKMA 02500   | 2 | 2   |   |   |  |   |   |   |  |   |  |   |  |   |  | T0004 |
|  |   |                  | VKM 12500  | 1 |   |   |   |  |   |   |   |  |   |  |   |  |   |  |       |
|  |   |                  | VKM 12501  | 1 |   |   |   |  |   |   |   |  |   |  |   |  |   |  |       |
|  | AR 30753, AR 30755  | 06/91 → 09/94    | VKMA 02501   | 2 | 2   |   |   |  |   |   |   |  |   |  |   |  |   |  | T0058 |
|  |   |                  | VKM 12500  | 1 |   |   |   |  |   |   |   |  |   |  |   |  |   |  |       |
|  |   |                  | VKM 12501  | 1 |   |   |   |  |   |   |   |  |   |  |   |  |   |  |       |
|                                    | AR 30753, AR 30755  | 06/91 → 09/94    | VKPC 82201   |   |   |   |   |  | 1   |   |   |  |   |  |   |  |   |  |       |
|                                    | <b>B(Alt)</b> AR 30753, AR 30755  | 06/91 → 09/94    | VKMV 10AVx850  |   |   |   |   |  | 1   |   |   |  |   |  |   |  |   |  |       |
|  | <b>B(PS)</b> AR 30753, AR 30755   | 06/91 → 09/94    | VKMV 10AVx825  |   |   |   |   |  | 1   |   |   |  |   |  |   |  |   |  |       |
| <b>ALFA ROMEO  33 1.5</b>         |   |                  |  |   |   |   |   |  |   |   |   |  |   |  |   |  |   |  |       |
|                                    | AR 30508, AR 30588  | 06/84 → 12/89    | VKMA 02500   | 2 | 2   |   |   |  |   |   |   |  |   |  |   |  |   |  | T0004 |
|  |   |                  | VKM 12500  | 1 |   |   |   |  |   |   |   |  |   |  |   |  |   |  |       |
|  |   |                  | VKM 12501  | 1 |   |   |   |  |   |   |   |  |   |  |   |  |   |  |       |
|  | AR 30750, AR 30751  | 01/90 → 09/94    | VKMA 02501   | 2 | 2   |   |   |  |   |   |   |  |   |  |   |  |   |  | T0058 |
|  |   |                  | VKM 12500  | 1 |   |   |   |  |   |   |   |  |   |  |   |  |   |  |       |
|  |   |                  | VKM 12501  | 1 |   |   |   |  |   |   |   |  |   |  |   |  |   |  |       |
|                                    | AR 30504, AR 30508,<br>AR 30514, AR 30520,<br>AR 30588, AR 30738,<br>AR 30750, AR 30751 | 06/83 → 09/94    | VKPC 82201   |   |   |   |   |  |   | 1 |   |  |   |  |   |  |   |  |       |
|                                    | <b>B(Alt)</b> AR 30738, AR 30750,<br>AR 30751   | 01/90 → 09/94    | VKMV 10AVx850  |   |   |   |   |  | 1   |   |   |  |   |  |   |  |   |  |       |
|  | <b>B(PS)</b> AR 30738, AR 30750,<br>AR 30751  | 01/90 → 09/94    | VKMV 10AVx825  |   |   |   |   |  | 1   |   |   |  |   |  |   |  |   |  |       |
| <b>ALFA ROMEO  33 1.7</b>        |   |                  |  |   |   |   |   |  |   |   |   |  |   |  |   |  |   |  |       |
|                                  | AR 30550, AR 30558,<br>AR 30736, AR 30737   | 01/86 → 09/94    | VKMA 02501   | 2 | 2   |   |   |  |   |   |   |  |   |  |   |  |   |  | T0058 |
|  |   |                  | VKM 12500  | 1 |   |   |   |  |   |   |   |  |   |  |   |  |   |  |       |
|  |   |                  | VKM 12501  | 1 |   |   |   |  |   |   |   |  |   |  |   |  |   |  |       |
|                                  | AR 30550, AR 30550/58,<br>AR 30558, AR 30736,<br>AR 30737, AR 30740                     | 01/86 → 09/94    | VKPC 82201   |   |   |   |   |  |   | 1 |   |  |   |  |   |  |   |  |       |
|                                  | <b>B(Alt)</b> AR 30736, AR 30737  | 01/90 → 09/94    | VKMV 10AVx850  |   |   |   |   |  | 1   |   |   |  |   |  |   |  |   |  |       |
|  | <b>B(PS)</b> AR 30736, AR 30737   | 01/90 → 09/94    | VKMV 10AVx825  |   |   |   |   |  | 1   |   |   |  |   |  |   |  |   |  |       |
| <b>ALFA ROMEO  33 1.7 16V</b>   |   |                  |  |   |   |   |   |  |   |   |   |  |   |  |   |  |   |  |       |
|                                  | AR 30746, AR 30747  | 01/90 → 09/94    | VKMA 02510   |   | 4   | 2 |   |  |   |   |   |  |   |  |   |  |   |  | T0093 |
|  |   |                  | VKM 22510  | 1 |   |   |   |  |   |   |   |  |   |  |   |  |   |  |       |
|  |   |                  | VKM 22510  | 1 |   |   |   |  |   |   |   |  |   |  |   |  |   |  |       |
|  |   |                  | VKM 22510  | 1 |   |   |   |  |   |   |   |  |   |  |   |  |   |  |       |
|  |   |                  | VKM 22510  | 1 |   |   |   |  |   |   |   |  |   |  |   |  |   |  |       |
|                                  | AR 30746, AR 30747  | 01/90 → 09/94    | VKPC 82201   |   |   |   |   |  |   | 1 |   |  |   |  |   |  |   |  |       |
|                                  | <b>B(Alt)</b> AR 30746, AR 30747  | 01/90 → 09/94    | VKMV 10AVx850  |   |   |   |   |  | 1   |   |   |  |   |  |   |  |   |  |       |
|  | <b>B(PS)</b> AR 30746, AR 30747   | 01/90 → 09/94    | VKMV 10AVx825  |   |   |   |   |  | 1   |   |   |  |   |  |   |  |   |  |       |
| <b>ALFA ROMEO  33 1.8 TD</b>    |   |                  |  |   |   |   |   |  |   |   |   |  |   |  |   |  |   |  |       |
|                                  | VM 82 A   | 01/88 → 06/90    | —  |   |   |   |   |  |   | 1 |   |  |   |  |   |  |   |  |       |
|  | VM 96 A   | 07/90 → 09/94    | VKPC 82642   |   |   |   |   |  |   | 1 |   |  |   |  |   |  |   |  |       |
| <b>ALFA ROMEO  75 1.6</b>       |   |                  |  |   |   |   |   |  |   |   |   |  |   |  |   |  |   |  |       |
|                                  | AR 06100, AR 61101  | 05/85 → 06/91    | <del>OKOKOK</del>  |   |   |   |   |  |   |   |   |  |   |  |   |  |   |  |       |
|                                  | AR 61101, AR 61102  | 05/85 → 09/89    | VKPC 82621   |   |   |   |   |  |   | 1 |   |  |   |  |   |  |   |  |       |
| <b>ALFA ROMEO  75 1.8</b>       |   |                  |  |   |   |   |   |  |   |   |   |  |   |  |   |  |   |  |       |
|                                  | AR 06168, AR 06202,<br>AR 61102, AR 61201   | 09/85 → 06/91    | <del>OKOKOK</del>  |   |   |   |   |  |   |   |   |  |   |  |   |  |   |  |       |
|                                  | AR 06168  | 09/88 → 02/92 2) | —  |   |   |   |   |  |   | 1 |   |  |   |  |   |  |   |  |       |
|  |   |                  | VKPC 82621   |   |   |   |   |  |   | 1 |   |  |   |  |   |  |   |  |       |
| <b>ALFA ROMEO  75 1.8 Turbo</b> |   |                  |  |   |   |   |   |  |   |   |   |  |   |  |   |  |   |  |       |
|                                  | AR 06134, AR 06158  | 02/86 → 06/91    | <del>OKOKOK</del>  |   |   |   |   |  |   |   |   |  |   |  |   |  |   |  |       |
|                                  | AR 06134  | 02/86 → 02/92 2) | —  |   |   |   |   |  |   | 1 |   |  |   |  |   |  |   |  |       |
|  |   |                  | VKPC 82621   |   |   |   |   |  |   | 1 |   |  |   |  |   |  |   |  |       |
| <b>ALFA ROMEO  75 2.0</b>       |   |                  |  |   |   |   |   |  |   |   |   |  |   |  |   |  |   |  |       |
|                                  | AR 06212  | 05/85 → 10/88    | <del>OKOKOK</del>  |   |   |   |   |  |   |   |   |  |   |  |   |  |   |  |       |









































| ALFA ROMEO  75 2.0 16V    |  |               |                 |  |  |  |  |  |  |  |  |  |  |  |  |  |  |  |  |       |
|--|--|---------------|-----------------|--|--|--|--|--|--|--|--|--|--|--|--|--|--|--|--|-------|
|                           | AR 06166, AR 06224   | 05/85 → 06/91 |                 |  |  |  |  |  |  |  |  |  |  |  |  |  |  |  |  |       |
|                           | AR 06224   | 05/85 → 02/92 |                 |  |  |  |  |  |  |  |  |  |  |  |  |  |  |  |  | 1     |
| ALFA ROMEO  75 2.5 V6     |  |               |                 |  |  |  |  |  |  |  |  |  |  |  |  |  |  |  |  |       |
|                           | AR 01646, AR 01911   | 05/85 → 08/86 |                 |  |  |  |  |  |  |  |  |  |  |  |  |  |  |  |  | 1     |
| ALFA ROMEO  75 3.0 V6     |  |               |                 |  |  |  |  |  |  |  |  |  |  |  |  |  |  |  |  |       |
|                           | AR 06120, AR 06124   | 01/87 → 12/89 |                 |  |  |  |  |  |  |  |  |  |  |  |  |  |  |  |  | 1     |
|  | AR 61503   | 02/90 → 02/92 |                 |  |  |  |  |  |  |  |  |  |  |  |  |  |  |  |  | 1     |
| ALFA ROMEO  75 2.0 TD     |  |               |                 |  |  |  |  |  |  |  |  |  |  |  |  |  |  |  |  |       |
|                           | VM 80 A  | 05/85 → 09/92 |                 |  |  |  |  |  |  |  |  |  |  |  |  |  |  |  |  |       |
|                           | VM 80 A  | 01/88 → 09/92 |                 |  |  |  |  |  |  |  |  |  |  |  |  |  |  |  |  | 1     |
| ALFA ROMEO  75 2.4 TD     |  |               |                 |  |  |  |  |  |  |  |  |  |  |  |  |  |  |  |  |       |
|                           | VM 81 A  | 01/89 → 02/92 |                 |  |  |  |  |  |  |  |  |  |  |  |  |  |  |  |  |       |
|                           | VM 81 A  | 01/89 → 02/92 |                 |  |  |  |  |  |  |  |  |  |  |  |  |  |  |  |  | 1     |
| ALFA ROMEO  ALFASUD 1.2   |  |               |                 |  |  |  |  |  |  |  |  |  |  |  |  |  |  |  |  |       |
|                           | AR 30102, AR 30102 S,<br>AR 30104  | 06/72 → 09/84 |                 |  |  |  |  |  |  |  |  |  |  |  |  |  |  |  |  | T0004 |
|  |  |               |                 |  |  |  |  |  |  |  |  |  |  |  |  |  |  |  |  |       |
|                           | AR 30102   | 01/78 → 12/81 | CH 505 1904 I → |  |  |  |  |  |  |  |  |  |  |  |  |  |  |  |  | 1     |
|  | AS 30100, AS 30102,<br>AS 30104  | 06/72 → 12/75 |                 |  |  |  |  |  |  |  |  |  |  |  |  |  |  |  |  | 1     |
|  | AS 30100, AS 30102,<br>AS 30104  | 01/76 → 09/84 |                 |  |  |  |  |  |  |  |  |  |  |  |  |  |  |  |  | 1     |
| ALFA ROMEO  ALFASUD 1.3  |  |               |                 |  |  |  |  |  |  |  |  |  |  |  |  |  |  |  |  |       |
|                         | AR 30160, AR 30164,<br>AR 30168, AR 30180,<br>AR 30184   | 09/76 → 12/84 |                 |  |  |  |  |  |  |  |  |  |  |  |  |  |  |  |  | T0004 |
|  |  |               |                 |  |  |  |  |  |  |  |  |  |  |  |  |  |  |  |  |       |
|                         | AS 30156, AS 30164,<br>AS 30168  | 09/76 → 12/84 |                 |  |  |  |  |  |  |  |  |  |  |  |  |  |  |  |  | 1     |
| ALFA ROMEO  ALFASUD 1.4 |  |               |                 |  |  |  |  |  |  |  |  |  |  |  |  |  |  |  |  |       |
|                         | AR 30164, AR 30168   | 05/78 → 12/89 |                 |  |  |  |  |  |  |  |  |  |  |  |  |  |  |  |  | T0004 |
|  |  |               |                 |  |  |  |  |  |  |  |  |  |  |  |  |  |  |  |  |       |
|                         | AR 30164, AR 30168   | 05/78 → 12/89 |                 |  |  |  |  |  |  |  |  |  |  |  |  |  |  |  |  | 1     |
| ALFA ROMEO  ALFASUD 1.5 |  |               |                 |  |  |  |  |  |  |  |  |  |  |  |  |  |  |  |  |       |
|                         | AR 30124, AR 30128,<br>AR 30146  | 05/78 → 12/85 |                 |  |  |  |  |  |  |  |  |  |  |  |  |  |  |  |  | T0004 |
|  |  |               |                 |  |  |  |  |  |  |  |  |  |  |  |  |  |  |  |  |       |
|                         | AR 30124, AR 30128,<br>AR 30146, AR 30182,<br>AR 30198, AS 30124,<br>AS 30126, AS 30128,<br>AS 30133, AS 30198 | 05/78 → 12/87 |                 |  |  |  |  |  |  |  |  |  |  |  |  |  |  |  |  | 1     |
| ALFA ROMEO  ALFASUD 1.7 |  |               |                 |  |  |  |  |  |  |  |  |  |  |  |  |  |  |  |  |       |
|                         | AR 30550, AR 30558   | 03/87 → 12/89 | e               |  |  |  |  |  |  |  |  |  |  |  |  |  |  |  |  | T0004 |
|  |  |               |                 |  |  |  |  |  |  |  |  |  |  |  |  |  |  |  |  |       |
|  | AR 30550, AR 30558   | 03/87 → 12/89 | f               |  |  |  |  |  |  |  |  |  |  |  |  |  |  |  |  | T0058 |
|  |  |               |                 |  |  |  |  |  |  |  |  |  |  |  |  |  |  |  |  |       |
|                         | AR 30550, AR 30558   | 03/87 → 12/89 |                 |  |  |  |  |  |  |  |  |  |  |  |  |  |  |  |  | 1     |
| ALFA ROMEO  ARNA 1.2    |  |               |                 |  |  |  |  |  |  |  |  |  |  |  |  |  |  |  |  |       |
|                         | AR 30102, AR 30500,<br>AR 31000  | 03/83 → 12/86 |                 |  |  |  |  |  |  |  |  |  |  |  |  |  |  |  |  | T0004 |
|  |  |               |                 |  |  |  |  |  |  |  |  |  |  |  |  |  |  |  |  |       |
|                         | AR 20500, AR31000  | 01/85 → 12/86 |                 |  |  |  |  |  |  |  |  |  |  |  |  |  |  |  |  | 1     |















































































|   |  |  |  |   |  |  |  |  |  |  |  |  |
|---|---|---|---|---|---|---|---|---|---|---|---|---|
|                                  | B(Alt)  | 937 A5.000  | 11/03 → 10/07   | AC  | VKMA 32039<br>VKMV 6PK1836<br>VKM 32006<br>VKM 32027                                | 1   | 1   | 1   |   |   |   |   |
|                                  |   | 937 A5.000  | 11/03 → 12/05   |   | VKM_____  | 1   |   |   |   | 1   |   |   |
| <b>ALFA ROMEO  GTV 1.8 16V</b>   |   |   |   |   |   |   |   |   |   |   |   |   |
|                                  |   | AR 32201  | 05/98 → 12/05   |    | VKMC 02177<br>VKMA 02177<br>VKM 12173<br>VKM 22177                                  | 1   | 1   | 1   | 1   |   |   | T0128   |
|                                  |   | AR 32201  | 05/98 → 03/07   |    | VKPC 82645  |   |   |   | 1   |   |   |   |
|                                  | B(Alt)  | AR 32201  | 05/98 → 09/03   | AC  | VKMA 32022<br>VKMV 6PK1045<br>VKM 32022   | 1   |   | 1   |   |   |   |   |
|   | B(Alt)  | AR 32201  | 05/98 → 09/03   | AC  | VKMV 6PK1855<br>VKM 32001<br>VKM 32022  |   | 1   | 1   |   |   |   |   |
|   | B(Alt)  | AR 32201  | 10/03 → 03/07   | AC  | VKMV 6PK1045<br>VKM 32026   | 1   |   | 1   |   |   |   |   |
|   | B(Alt)  | AR 32201  | 10/03 → 03/07   | AC  | VKM 32001<br>VKM 32026  | 1   | 1   |   |   |   |   |   |
| <b>ALFA ROMEO  GTV 2.0 16V</b>   |   |   |   |   |   |   |   |   |   |   |   |   |
|                                  |   | AR 16201, AR 32301,<br>AR 32310   | 06/95 → 12/05   |    | VKMC 02177<br>VKMA 02177<br>VKM 12173<br>VKM 22177                                  | 1   | 1   | 1   | 1   |   |   | T0128   |
|   |   | AR 16201, AR 32310  | 06/95 → 10/07   | 1)  | VKMA 02277<br>VKM 12173<br>VKM 12277<br>VKM 22177                                   | 2   | 1   | 2   |   |   |   | T0235   |
|                                |   | AR 16201, AR 32301,<br>AR 32310   | 06/95 → 10/07   |   | VKPC 82645  |   |   |   | 1   |   |   |   |
|                                | B(Alt)  | AR 16201  | 06/95 → 03/07   | AC  | VKMV 7PK1080<br>VKM 32022   | 1   |   | 1   |   |   |   |   |
|   | B(Alt)  | AR 16201  | 06/95 → 03/07   | AC  | VKM 32007<br>VKM 32022  | 1   | 1   |   |   |   |   |   |
|   | B(Alt)  | AR 32301  | 05/98 → 08/00   | AC, →IMot. 1385143  | VKMV 7PK1080<br>VKM 32026   | 1   |   | 1   |   |   |   |   |
|   | B(Alt)  | AR 32301  | 05/98 → 08/00   | AC, Mot. 1385144 I→   | VKMV 6PK1080<br>VKM 32026   | 1   |   | 1   |   |   |   |   |
|   | B(Alt)  | AR 32301, AR 32310  | 06/95 → 10/07   | AC, →IMot. 1385143  | VKMV 7PK1975<br>VKM 32007<br>VKM 32026  | 1   | 1   | 1   |   |   |   |   |
|   | B(Alt)  | AR 32301  | 05/98 → 08/00   | AC, Mot. 1385144 I→   | VKMV 6PK1975<br>VKM 32007<br>VKM 32026  | 1   | 1   | 1   |   |   |   |   |
|   | B(Alt)  | AR 32310  | 06/95 → 03/07   | AC, →IMot. 2835764  | VKMV 6PK1080<br>VKM 32026   | 1   |   | 1   |   |   |   |   |
|   | B(Alt)  | AR 32310  | 06/95 → 03/07   | AC, Mot. 2835765 I→   | VKMV 6PK1062<br>VKM 32026   | 1   |   | 1   |   |   |   |   |
|   | B(Alt)  | AR 32310  | 06/95 → 10/07   | AC, Mot. 1385144 I→,<br>→IMot. 2835764  | VKMV 6PK1975<br>VKM 32007<br>VKM 32026  | 1   | 1   | 1   |   |   |   |   |
|   | B(Alt)  | AR 32310  | 06/95 → 10/07   | AC, Mot. 2835765 I→   | VKMV 6PK1962<br>VKM 32007<br>VKM 32026  | 1   | 1   | 1   |   |   |   |   |
| <b>ALFA ROMEO  GTV 2.0 JTS</b> |   |   |   |   |   |   |   |   |   |   |   |   |
|                                |   | 937 A1.000  | 04/03 → 12/05   |  | VKMC 02183<br>VKMA 02183<br>VKM 12182<br>VKM 22177                                  | 1   | 1   | 1   | 1   |   |   | T0128   |



|  |  |  |    |  |  |  |  |  |  |  |  |  |  |  |  |
|--|---|---|---|--|---|---|---|---|---|---|---|---|---|---|---|
|  | 937 A1.000  | 04/03 → 12/05   | 1)  | VKMA 02283<br>VKM 12182<br>VKM 12277<br>VKM 22177                                  | 2<br>1<br>1<br>1  | 1<br>1  | 2   |   |   |   |   |   |   |   | T0235   |
|                                      | 937 A1.000  | 04/03 → 03/07   |   | VKPC 82645   |   |   |   |   | 1   |   |   |   |   |   |   |
|                                      | <b>B(Alt)</b> 937 A1.000  | 04/03 → 12/05   |   | VKMOV 6PK1962<br>VKM 32007<br>VKM 32026  | 1   | 1   | 1   |   |   |   |   |   |   |   |   |
| <b>ALFA ROMEO  GTV 2.0 V6 Turbo</b> |   |   |   |  |   |   |   |   |   |   |   |   |   |   |   |
|                                      | AR 16202  | 06/95 → 03/07   |   | VKMA____<br>VKM____  | 1<br>1  | 1   | 1   |   |   |   |   |   |   |   |   |
|                                      | AR 16202  | 06/95 → 06/05   |   | —  |   |   |   |   | 1   |   |   |   |   |   |   |
| <b>ALFA ROMEO  GTV 3.0 V6</b>       |   |   |   |  |   |   |   |   |   |   |   |   |   |   |   |
|                                      | AR 16102, AR 16105  | 10/96 → 03/07   |   | VKMA____<br>VKM____<br>VKM 22540<br>VKM 22540                                      | 1<br>1<br>1<br>1  | 2<br>1  | 1   |   |   |   |   |   |   |   | T0238   |
|                                      | AR 16102, AR 16105  | 10/96 → 06/05   |   | —  |   |   |   |   | 1   |   |   |   |   |   |   |
|                                      | <b>B(Alt)</b> AR 16102, AR 16105  | 10/96 → 03/07   |   | VKMOV 6PK1983<br>VKM 32030<br>VKM 32082<br>VKM 32083                               | 1<br>1<br>1<br>1  | 1   | 1   |   |   |   |   |   |   |   |   |
| <b>ALFA ROMEO  GTV 3.2 V6</b>       |   |   |   |  |   |   |   |   |   |   |   |   |   |   |   |
|                                      | 936 A6.000  | 04/03 → 03/07   |   | VKMA____<br>VKM____<br>VKM 22540<br>VKM 22540                                      | 1<br>1<br>1<br>1  | 2<br>1  | 1   |   |   |   |   |   |   |   | T0238   |
|                                    | 936 A6.000  | 04/03 → 06/05   |   | —  |   |   |   |   | 1   |   |   |   |   |   |   |
|                                    | <b>B(Alt)</b> 936 A6.000  | 04/03 → 03/07   |   | VKMOV 6PK1983<br>VKM 32030<br>VKM 32082<br>VKM 32083                               | 1<br>1<br>1<br>1  | 1   | 1   |   |   |   |   |   |   |   |   |
| <b>ALFA ROMEO  SPIDER 1.8 16V</b> |   |   |   |  |   |   |   |   |   |   |   |   |   |   |   |
|                                    | AR 32201  | 05/98 → 04/05   |  | VKMC 02177<br>VKMA 02177<br>VKM 12173<br>VKM 22177                                 | 1<br>1<br>1<br>1  | 1<br>1<br>1   | 1   |   | 1   |   |   |   |   |   | T0128   |
|                                    | AR 32201  | 05/98 → 04/05   |   | VKPC 82645   |   |   |   |   | 1   |   |   |   |   |   |   |
|                                    | <b>B(Alt)</b> AR 32201  | 05/98 → 09/03   | <b>AC</b>   | VKMA 32022<br>VKMOV 6PK1045<br>VKM 32022   | 1<br>1<br>1   |   | 1   |   | 1   |   |   |   |   |   |   |
|  | <b>B(Alt)</b> AR 32201  | 05/98 → 09/03   | <b>AC</b>   | VKMOV 6PK1855<br>VKM 32001<br>VKM 32022  | 1<br>1<br>1   | 1   | 1   |   |   |   |   |   |   |   |   |
|  | <b>B(Alt)</b> AR 32201  | 10/03 → 04/05   | <b>AC</b>   | VKMOV 6PK1045<br>VKM 32026   | 1<br>1  |   | 1   |   |   |   |   |   |   |   |   |
|  | <b>B(Alt)</b> AR 32201  | 10/03 → 04/05   | <b>AC</b>   | VKM 32001<br>VKM 32026   | 1<br>1  | 1   |   |   |   |   |   |   |   |   |   |
| <b>ALFA ROMEO  SPIDER 2.0 16V</b> |   |   |   |  |   |   |   |   |   |   |   |   |   |   |   |
|                                    | AR 16201, AR 32301,<br>AR 32310   | 06/95 → 04/05   |  | VKMC 02177<br>VKMA 02177<br>VKM 12173<br>VKM 22177                                 | 1<br>1<br>1<br>1  | 1<br>1<br>1   | 1   |   | 1   |   |   |   |   |   | T0128   |
|  | AR 16201, AR 32301,<br>AR 32310   | 06/95 → 04/05   | 1)  | VKMA 02277<br>VKM 12173<br>VKM 12277<br>VKM 22177                                  | 2<br>1<br>1<br>1  | 1   | 2   |   |   |   |   |   |   |   | T0235   |
|                                    | AR 16201, AR 32301,<br>AR 32310   | 06/95 → 04/05   |   | VKPC 82645   |   |   |   |   | 1   |   |   |   |   |   |   |
|                                    | <b>B(Alt)</b> AR 16201  | 06/95 → 04/05   | <b>AC</b>   | VKMOV 7PK1080<br>VKM 32022   | 1<br>1  |   | 1   |   |   |   |   |   |   |   |   |
|  | <b>B(Alt)</b> AR 16201  | 06/95 → 04/05   | <b>AC</b>   | VKM 32007<br>VKM 32022   | 1<br>1  | 1   |   |   |   |   |   |   |   |   |   |







































|   |  |  |  |  |  |  |  |  |  |  |  |  |
|---|---|---|---|--|---|---|---|---|---|---|---|---|
| B(Alt)  | AR 32301, AR 32310  | 06/95 → 04/05   | AC, →IMot. 1385143  | VKMV 7PK1080<br>VKM 32026  | 1   |   | 1   |   |   |   |   |   |
| B(Alt)  | AR 32301  | 05/98 → 08/00   | AC, Mot. 1385144 I→   | VKMV 6PK1080<br>VKM 32026  | 1   |   | 1   |   |   |   |   |   |
| B(Alt)  | AR 32301, AR 32310  | 06/95 → 04/05   | AC, →IMot. 1385143  | VKMV 7PK1975<br>VKM 32007<br>VKM 32026   | 1   | 1   |   |   |   |   |   |   |
| B(Alt)  | AR 32301  | 05/98 → 08/00   | AC, Mot. 1385144 I→   | VKMV 6PK1975<br>VKM 32007<br>VKM 32026   | 1   | 1   |   |   |   |   |   |   |
| B(Alt)  | AR 32310  | 06/95 → 04/05   | AC, Mot. 1385144 I→,<br>→IMot. 2835764  | VKMV 6PK1080<br>VKM 32026  | 1   |   | 1   |   |   |   |   |   |
| B(Alt)  | AR 32310  | 06/95 → 04/05   | AC, Mot. 2835765 I→   | VKMV 6PK1062<br>VKM 32026  | 1   |   | 1   |   |   |   |   |   |
| B(Alt)  | AR 32310  | 06/95 → 04/05   | AC, Mot. 1385144 I→,<br>→IMot. 2835764  | VKMV 6PK1975<br>VKM 32007<br>VKM 32026   | 1   | 1   |   |   |   |   |   |   |
| B(Alt)  | AR 32310  | 06/95 → 04/05   | AC, Mot. 2835765 I→   | VKMV 6PK1962<br>VKM 32007<br>VKM 32026   | 1   | 1   |   |   |   |   |   |   |
| <b>ALFA ROMEO  SPIDER 2.0 JTS</b>        |   |   |   |  |   |   |   |   |   |   |   |   |
|    | 937 A1.000  | 04/03 → 04/05   |  | VKMC 02183<br>VKMA 02183<br>VKM 12182<br>VKM 22177                                 | 1<br>1<br>1<br>1  | 1<br>1<br>1   | 1<br>1<br>1   |   | 1   |   |   | T0128   |
|   | 937 A1.000  | 04/03 → 04/05   | 1)  | VKMA 02283<br>VKM 12182<br>VKM 12277<br>VKM 22177                                  | 2<br>1<br>1<br>1  | 1<br>1<br>1   | 2   |   |   |   |   | T0235   |
|                                        | 937 A1.000  | 04/03 → 04/05   |   | VKPC 82645   |   |   |   |   | 1   |   |   |   |
|                                        | B(Alt) 937 A1.000   | 04/03 → 04/05   |   | VKMV 6PK1962<br>VKM 32007<br>VKM 32026   | 1   | 1   | 1   |   |   |   |   |   |
| <b>ALFA ROMEO  SPIDER 2.0 V6 Turbo</b> |   |   |   |  |   |   |   |   |   |   |   |   |
|                                        | AR 16202  | 05/98 → 04/05   |   | VKMA _____<br>VKM _____  | 1<br>1  |   | 1   |   |   |   |   |   |
|                                        | AR 16202  | 05/98 → 04/05   |   | —  |   |   |   |   | 1   |   |   |   |
| <b>ALFA ROMEO  SPIDER 2.2 JTS</b>      |   |   |   |  |   |   |   |   |   |   |   |   |
|                                        | 939 A5.000  | 09/06 → 09/06   |   | <b>XXXXXXXX</b>  |   |   |   |   |   |   |   |   |
|                                        | 939 A5.000  | 09/06 → 10/07   |   | VKPC 85308   |   |   |   |   | 1   |   |   |   |
|                                        | B(Alt) 939 A5.000   | 09/06 → 10/07   |   | VKMV _____<br>VKM 34027  | 1   |   | 1   |   |   |   |   |   |
| <b>ALFA ROMEO  SPIDER 3.0 V6</b>       |   |   |   |  |   |   |   |   |   |   |   |   |
|                                        | AR 16101  | 06/95 → 04/05   |   | VKMA _____<br>VKM _____  | 1<br>1  |   | 1   |   |   |   |   |   |
|   | AR 16105  | 01/99 → 04/05   |   | VKMA _____<br>VKM _____<br>VKM 22540<br>VKM 22540                                  | 1<br>1<br>1<br>1  | 2<br>1<br>1   | 1   |   |   |   |   | T0238   |
|                                        | AR 16101  | 06/95 → 04/05   |   | —  |   |   |   |   | 1   |   |   |   |
|   | AR 16105  | 01/99 → 04/05   |   | —  |   |   |   |   | 1   |   |   |   |
|                                        | B(Alt) AR 16105   | 10/00 → 04/05   |   | VKMV 6PK1983<br>VKM 32030<br>VKM 32082<br>VKM 32083                                | 1   | 1<br>1  | 1   |   |   |   |   |   |
| <b>ALFA ROMEO  SPIDER 3.2 JTS</b>      |   |   |   |  |   |   |   |   |   |   |   |   |
|                                        | 939 A.000   | 09/06 → 10/07   |   | <b>XXXXXXXX</b>  |   |   |   |   |   |   |   |   |
| <b>ALFA ROMEO  SPIDER 3.2 V6</b>       |   |   |   |  |   |   |   |   |   |   |   |   |
|                                        | 936 A6.000  | 04/03 → 04/05   |   | VKMA _____<br>VKM _____  | 1<br>1  | 2   | 1   |   |   |   |   | T0238   |

|   |  |  |                           |  |  |  |  |  |  |  |  |
|---|---|---|--|--|---|---|---|---|---|---|---|
|   |   |   |  | VKM 22540  | 1   |   |   |   |   |   |   |
|   |   |   |  | VKM 22540  | 1   |   |   |   |   |   |   |
|                                     | 936 A6.000  | 04/03 → 04/05   |  | —  |   |   | 1   |   |   |   |   |
|                                     | <b>B(Alt)</b> 936 A6.000  | 04/03 → 04/05   |  | VKMV 6PK1983<br>VKM 32030<br>VKM 32082<br>VKM 32083                                | 1   | 1   |   |   |   |   |   |
| <b>ALFA ROMEO  AR 6 2.4 D</b>      |   |   |  |  |   |   |   |   |   |   |   |
|                                     | 8144.61.200   | 04/85 → 02/86   |  | VKMA 02381<br>VKM 22380<br>VKM 22385   | 2<br>1<br>1   | 1   |   |   |   |   | T0014   |
| <b>ALFA ROMEO  AR 6 2.4 TD</b>     |   |   |  |  |   |   |   |   |   |   |   |
|                                     | 8144.21.220   | 01/87 → 12/89   |  | VKPC 82600   |   |   | 1   |   |   |   |   |
| <b>ALFA ROMEO  AR 6 2.5 D</b>      |   |   |  |  |   |   |   |   |   |   |   |
|                                     | 8144.67.220   | 03/86 → 12/89   |  | VKMA 02381<br>VKM 22380<br>VKM 22385   | 2<br>1<br>1   | 1   |   |   |   |   | T0014   |
| <b>ALFA ROMEO  AR 8 2.4 TD</b>     |   |   |  |  |   |   |   |   |   |   |   |
|                                     | 8140.21.200 D.I.  | 04/85 → 12/86   |  152, <b>B</b> (97152x30) | VKMA 02381<br>VKM 22380<br>VKM 22385   | 2<br>1<br>1   | 1   |   |   |   |   | T0014   |
|   | 8140.21.200 D.I.  | 04/85 → 12/86   |  153, <b>B</b> (97153x30) | VKMA 02382<br>VKM 22385<br>VKM 22385   | 2<br>1<br>1   | 1   |   |   |   |   | T0043   |
| <b>ALFA ROMEO  AR 8 2.5 D</b>      |   |   |  |  |   |   |   |   |   |   |   |
|                                    | 8144.67.220   | 09/86 → 12/89   |  | VKMA 02381<br>VKM 22380<br>VKM 22385   | 2<br>1<br>1   | 1   |   |   |   |   | T0014   |
| <b>AUDI  50 (86) 0.8</b>         |   |   |  |  |   |   |   |   |   |   |   |
|                                   | HE  | 01/76 → 07/78   |                         | VKMC 01100   |   | 1   | 1   |   |   |   | T0222   |
|                                   | HE  | 01/76 → 07/78   |  | VKPC 81200   |   |   | 1   |   |   |   |   |
|                                   | <b>B(Alt)</b> HE  | 01/76 → 07/78   | → <b>ICH</b> 86A 0087 520  | VKMV 10AVx695  |   | 1   |   |   |   |   |   |
|                                   | <b>B(Alt)</b> HE  | 01/76 → 07/78   | <b>CH</b> 86A 0087 521  →  | VKMV 10AVx675  |   | 1   |   |   |   |   |   |
| <b>AUDI  50 (86) 1.1</b>         |   |   |  |  |   |   |   |   |   |   |   |
|                                   | HB, HC  | 08/74 → 07/78   |                         | VKMC 01100   |   | 1   | 1   |   |   |   | T0222   |
|                                   | HB, HC  | 08/74 → 07/78   |  | VKPC 81200   |   |   | 1   |   |   |   |   |
|                                   | <b>B(Alt)</b> HB, HC  | 08/74 → 07/78   | → <b>ICH</b> 86A 0087 520  | VKMV 10AVx695  |   | 1   |   |   |   |   |   |
|                                   | <b>B(Alt)</b> HB, HC  | 08/74 → 07/78   | <b>CH</b> 86A 0087 521  →  | VKMV 10AVx675  |   | 1   |   |   |   |   |   |
| <b>AUDI  50 (86) 1.3</b>         |   |   |  |  |   |   |   |   |   |   |   |
|                                   | HH, HJ  | 01/77 → 07/78   |                         | VKMC 01100   |   | 1   | 1   |   |   |   | T0222   |
|                                   | HH, HJ  | 01/77 → 07/78   |  | VKPC 81200   |   |   | 1   |   |   |   |   |
|                                   | <b>B(Alt)</b> HH, HJ  | 01/77 → 07/78   | → <b>ICH</b> 86A 0087 520  | VKMV 10AVx695  |   | 1   |   |   |   |   |   |
|                                   | <b>B(Alt)</b> HH, HJ  | 01/77 → 07/78   | <b>CH</b> 86A 0087 521  →  | VKMV 10AVx675  |   | 1   |   |   |   |   |   |
| <b>AUDI  80 (80, 82, B1) 1.3</b> |   |   |  |  |   |   |   |   |   |   |   |
|                                   | ZA, ZF  | 05/72 → 07/78   | 3)   | VKMS 01000<br>VKMA 01000<br>VKM 11000  | 1<br>1<br>1   | 1   |   |   | 3   | 4   | T0005   |
|                                   | ZA, ZF  | 05/72 → 07/78   | 2)   | VKPA 81400<br>VKPC 81400   |   |   | 1   |   |   |   |   |
|                                   | <b>B(Alt)</b> ZA, ZF  | 05/72 → 07/78   |  | VKMV 10AVx950  |   | 1   |   |   |   |   |   |
| <b>AUDI  80 (80, 82, B1) 1.5</b> |   |   |  |  |   |   |   |   |   |   |   |
|                                   | YJ, ZB, ZC  | 05/72 → 07/76   | 3)   | VKMS 01000<br>VKMA 01000<br>VKM 11000  | 1<br>1<br>1   | 1   |   |   | 3   | 4   | T0005   |
|                                   | YJ, ZB, ZC  | 05/72 → 07/76   | 2)   | VKPA 81400<br>VKPC 81400   |   |   | 1   |   |   |   |   |
|                                   | <b>B(Alt)</b> YJ, ZB, ZC  | 05/72 → 07/76   |  | VKMV 10AVx950  |   | 1   |   |   |   |   |   |
| <b>AUDI  80 (80, 82, B1) 1.6</b> |   |   |  |  |   |   |   |   |   |   |   |
|                                   | XX, YN, YP, YS  | 09/73 → 07/78   | 3)   | VKMS 01000<br>VKMA 01000<br>VKM 11000  | 1<br>1<br>1   | 1   |   |   | 3   | 4   | T0005   |

|                                    | XX, YN, YP, YS                           | 09/73 → 07/78 | 2)                  | VKPA 81400<br>VKPC 81400              |             |   |   |        | 1<br>1 |   |   |       |
|------------------------------------|--|---------------|---------------------|---------------------------------------|-------------|---|---|--------|--------|---|---|-------|
|                                    | B(Alt) XX, YN, YP, YS                    | 09/73 → 07/78 |                     | VKPV 10AVx950                         |             | 1 |   |        |        |   |   |       |
| <b>AUDI  80 (81, 85, B2) 1.3</b>   |  |               |                     |                                       |             |   |   |        |        |   |   |       |
|                                    | FY, FZ                                   | 09/78 → 07/81 |                     | VKMC 01100                            |             |   | 1 | 1      |        |   |   | T0222 |
|                                    | EP                                       | 09/78 → 07/86 | 3)                  | VKMS 01000<br>VKMA 01000<br>VKM 11000 | 1<br>1<br>1 | 1 |   |        |        | 3 | 4 | T0005 |
|                                    | EP                                       | 09/78 → 07/86 | 2)                  | VKPA 81401<br>VKPC 81401              |             |   |   | 1<br>1 |        |   |   |       |
|                                    | FY, FZ                                   | 09/78 → 07/81 |                     | VKPC 81200                            |             |   |   | 1      |        |   |   |       |
|                                    | B(Alt) EP                                | 09/78 → 07/86 |                     | VKPV 10AVx950                         |             | 1 |   |        |        |   |   |       |
|                                    | B(Alt) FY, FZ                            | 09/78 → 07/81 | → ICH 81A 0113 357  | VKPV 10AVx695                         |             | 1 |   |        |        |   |   |       |
|                                    | B(Alt) FY, FZ                            | 09/78 → 07/81 | CH 81A 0113 358 I → | VKPV 10AVx675                         |             | 1 |   |        |        |   |   |       |
|                                    | B(PS) EP, FY, FZ                         | 09/78 → 07/86 |                     | VKPV 11.5x790                         |             | 1 |   |        |        |   |   |       |
| <b>AUDI  80 (81, 85, B2) 1.6</b>   |  |               |                     |                                       |             |   |   |        |        |   |   |       |
|                                    | DT, SA, WV, YN, YP, YT,<br>YY, YZ        | 08/78 → 12/86 | 3)                  | VKMS 01000<br>VKMA 01000<br>VKM 11000 | 1<br>1<br>1 | 1 |   |        |        | 3 | 4 | T0005 |
|                                    | DT, SA, WV, YN, YP, YT,<br>YY, YZ        | 08/78 → 12/86 | 2)                  | VKPA 81401<br>VKPC 81401              |             |   |   | 1<br>1 |        |   |   |       |
|                                    | B(Alt) DT, SA, WV, YN, YP, YT,<br>YY, YZ | 08/78 → 12/86 |                     | VKPV 10AVx950                         |             | 1 |   |        |        |   |   |       |
|                                    | B(PS) DT, SA                             | 08/78 → 07/86 |                     | VKPV 10AVx763                         |             | 1 |   |        |        |   |   |       |
|                                    | B(PS) WV, YN, YP, YT, YY, YZ             | 08/78 → 12/86 |                     | VKPV 11.5x790                         |             | 1 |   |        |        |   |   |       |
| <b>AUDI  80 (81, 85, B2) 1.8</b>   |  |               |                     |                                       |             |   |   |        |        |   |   |       |
|                                    | DS, DZ, JN, NE, PV, SF                   | 01/83 → 08/86 | 3)                  | VKMS 01000<br>VKMA 01000<br>VKM 11000 | 1<br>1<br>1 | 1 |   |        |        | 3 | 4 | T0005 |
|                                    | DS, DZ, JN, NE, PV, SF                   | 01/83 → 08/86 | 2)                  | VKPA 81401<br>VKPC 81401              |             |   |   | 1<br>1 |        |   |   |       |
|                                    | B(Alt) DS, DZ, JN, NE, PV, SF            | 01/83 → 08/86 |                     | VKPV 10AVx950                         |             | 1 |   |        |        |   |   |       |
|                                    | B(PS) DS, DZ, JN, NE, PV, SF             | 01/83 → 08/86 |                     | VKPV 10AVx763                         |             | 1 |   |        |        |   |   |       |
| <b>AUDI  80 (81, 85, B2) 1.9</b>   |  |               |                     |                                       |             |   |   |        |        |   |   |       |
|                                    | WN                                       | 09/81 → 07/83 |                     | VKMC 01031<br>VKMA 01031<br>VKM 21031 | 1<br>1<br>1 | 1 | 1 | 1      |        |   |   | T0020 |
|                                    | WN                                       | 09/81 → 07/83 |                     | VKPC 81605                            |             |   |   | 1      |        |   |   |       |
|                                    | B(Alt) WN                                | 09/81 → 07/83 |                     | VKPV 11.5x790                         |             | 1 |   |        |        |   |   |       |
|                                    | B(PS) WN                                 | 09/81 → 07/83 |                     | VKPV 13AVx990                         |             | 1 |   |        |        |   |   |       |
| <b>AUDI  80 (81, 85, B2) 2.0</b>   |  |               |                     |                                       |             |   |   |        |        |   |   |       |
|                                    | JS                                       | 10/83 → 09/84 |                     | VKMC 01031<br>VKMA 01031<br>VKM 21031 | 1<br>1<br>1 | 1 | 1 | 1      |        |   |   | T0020 |
|                                    | JS                                       | 10/83 → 09/84 |                     | VKPC 81605                            |             |   |   | 1      |        |   |   |       |
|                                    | B(Alt) JS                                | 10/83 → 09/84 |                     | VKPV 11.5x790                         |             | 1 |   |        |        |   |   |       |
|                                    | B(PS) JS                                 | 10/83 → 09/84 |                     | VKPV 13AVx990                         |             | 1 |   |        |        |   |   |       |
| <b>AUDI  80 (81, 85, B2) 2.2</b>   |  |               |                     |                                       |             |   |   |        |        |   |   |       |
|                                    | KK, KL, WE                               | 10/80 → 07/84 |                     | VKMC 01031<br>VKMA 01031<br>VKM 21031 | 1<br>1<br>1 | 1 | 1 | 1      |        |   |   | T0020 |
|                                    | KK, KL, WE                               | 10/80 → 07/84 |                     | VKPC 81605                            |             |   |   | 1      |        |   |   |       |
|                                    | B(Alt) KK, KL, WE                        | 10/80 → 07/84 |                     | VKPV 11.5x790                         |             | 1 |   |        |        |   |   |       |
|                                    | B(PS) KK, KL, WE                         | 10/80 → 07/84 |                     | VKPV 13AVx990                         |             | 1 |   |        |        |   |   |       |
|                                    | B(AC) KK, KL                             | 08/82 → 07/84 |                     | VKPV 13AVx990                         |             | 1 |   |        |        |   |   |       |
| <b>AUDI  80 (81, 85, B2) 1.6 D</b> |  |               |                     |                                       |             |   |   |        |        |   |   |       |
|                                    | CR, JK                                   | 08/80 → 08/86 | 3)                  | VKMS 01010<br>VKMA 01010<br>VKM 11010 | 1<br>1<br>1 | 1 | 1 |        |        | 3 | 2 | T0051 |































AUDI

|  |  |  |  |  |  |  |  |  |  |  |  |  |  |  |
|--|---|---|---|--|---|---|---|---|---|---|---|---|---|---|
|    | CR, JK  | 08/80 → 08/86   | 2)  | VKPA 81401<br>VKPC 81401   |   |   |   |   | 1<br>1  |   |   |   |   |   |
|    | <b>B(Alt)</b> CR, JK  | 08/80 → 06/84   | <b>AC</b>   | VKMOV 10AVx735   |   | 1   |   |   |   |   |   |   |   |   |
|  | <b>B(Alt)</b> CR, JK  | 08/80 → 06/84   | <b>AC</b>   | VKMOV 10AVx763   |   | 1   |   |   |   |   |   |   |   |   |
|  | <b>B(Alt)</b> CR, JK  | 06/84 → 08/86   |   | VKMOV 10AVx735   |   | 1   |   |   |   |   |   |   |   |   |
|  | <b>B(PS)</b> CR, JK   | 08/80 → 08/86   |   | VKMOV 11.5x790   |   | 1   |   |   |   |   |   |   |   |   |
|  | <b>B(AC)</b> CR, JK   | 08/80 → 06/84   |   | VKMOV 13AVx825   |   | 1   |   |   |   |   |   |   |   |   |
|  | <b>B(AC)</b> CR, JK   | 06/84 → 08/86   |   | VKMOV 10AVx763   |   | 1   |   |   |   |   |   |   |   |   |
| <b>AUDI  80 (81, 85, B2) 1.6 TD</b>         |   |   |   |  |   |   |   |   |   |   |   |   |   |   |
|    | CY  | 08/81 → 05/86   | 3)  | VKMS 01010<br>VKMA 01010<br>VKM 11010  | 1<br>1<br>1   | 1<br>1  |   |   |   |   | 3<br>1  | 2<br>1  |   | T0051   |
|    | CY  | 08/81 → 05/86   | 2)  | VKPA 81401<br>VKPC 81401   |   |   |   |   | 1<br>1  |   |   |   |   |   |
|    | <b>B(Alt)</b> CY  | 08/81 → 06/84   | <b>AC</b>   | VKMOV 10AVx735   |   | 1   |   |   |   |   |   |   |   |   |
|  | <b>B(Alt)</b> CY  | 08/81 → 06/84   | <b>AC</b>   | VKMOV 10AVx600   |   | 1   |   |   |   |   |   |   |   |   |
|  | <b>B(Alt)</b> CY  | 06/84 → 05/86   |   | VKMOV 10AVx735   |   | 1   |   |   |   |   |   |   |   |   |
|  | <b>B(PS)</b> CY   | 08/81 → 05/86   |   | VKMOV 11.5x790   |   | 1   |   |   |   |   |   |   |   |   |
|  | <b>B(AC)</b> CY   | 08/81 → 06/84   |   | VKMOV 13AVx825   |   | 1   |   |   |   |   |   |   |   |   |
|  | <b>B(AC)</b> CY   | 06/84 → 05/86   |   | VKMOV 10AVx775   |   | 1   |   |   |   |   |   |   |   |   |
| <b>AUDI  80 (89, 89Q, 8A, B3) 1.6</b>       |   |   |   |  |   |   |   |   |   |   |   |   |   |   |
|    | ABB, PP, RN   | 09/86 → 10/91   | 3)  | VKMS 01000<br>VKMA 01000<br>VKM 11000  | 1<br>1<br>1   | 1<br>1  |   |   |   |   | 3<br>3  | 4<br>3  |   | T0005   |
|    | ABB, PP, RN   | 09/86 → 10/91   | 2)  | VKPA 81401<br>VKPC 81401   |   |   |   |   | 1<br>1  |   |   |   |   |   |
|    | <b>B(Alt)</b> ABB, PP, RN   | 09/86 → 10/91   |   | VKMOV 10AVx950   |   | 1   |   |   |   |   |   |   |   |   |
|  | <b>B(PS)</b> ABB, PP, RN  | 09/86 → 10/91   |   | VKMOV 10AVx850   |   | 1   |   |   |   |   |   |   |   |   |
|  | <b>B(AC)</b> ABB, PP, RN  | 09/86 → 10/91   |   | VKMOV 13AVx800   |   | 1   |   |   |   |   |   |   |   |   |
| <b>AUDI  80 (89, 89Q, 8A, B3) 1.8</b>     |   |   |   |  |   |   |   |   |   |   |   |   |   |   |
|    | DZ, JN, NE, PM, RU,<br>SD, SF   | 06/86 → 10/91   | 3)  | VKMS 01000<br>VKMA 01000<br>VKM 11000  | 1<br>1<br>1   | 1<br>1  |   |   |   |   | 3<br>3  | 4<br>3  |   | T0005   |
|    | DZ, JN, NE, PM, RU,<br>SD, SF   | 06/86 → 10/91   | 2)  | VKPA 81401<br>VKPC 81401   |   |   |   |   | 1<br>1  |   |   |   |   |   |
|    | <b>B(Alt)</b> DZ, JN, NE, PM, RU,<br>SD, SF                                       | 06/86 → 10/91   |   | VKMOV 10AVx950   |   | 1   |   |   |   |   |   |   |   |   |
|  | <b>B(PS)</b> DZ, JN, NE, PM, RU,<br>SD, SF  | 06/86 → 10/91   |   | VKMOV 10AVx850   |   | 1   |   |   |   |   |   |   |   |   |
|  | <b>B(AC)</b> DZ, JN, NE, PM, RU,<br>SD, SF  | 06/86 → 10/91   |   | VKMOV 13AVx800   |   | 1   |   |   |   |   |   |   |   |   |
| <b>AUDI  80 (89, 89Q, 8A, B3) 2.0</b>     |   |   |   |  |   |   |   |   |   |   |   |   |   |   |
|    | 3A  | 08/88 → 08/91   | 3)  | VKMS 01000<br>VKMA 01000<br>VKM 11000  | 1<br>1<br>1   | 1<br>1  |   |   |   |   | 3<br>3  | 4<br>3  |   | T0005   |
|  | AAD   | 10/90 → 08/91   |   | VKMA 01001<br>VKM 11001  | 1<br>1  | 1   |   |   |   |   |   |   |   | T0091   |
|    | 3A, AAD   | 08/88 → 08/91   | 2)  | VKPA 81401<br>VKPC 81401   |   |   |   |   | 1<br>1  |   |   |   |   |   |
|    | <b>B(Alt)</b> 3A, AAD   | 08/88 → 08/91   |   | VKMOV 10AVx950   |   | 1   |   |   |   |   |   |   |   |   |
|  | <b>B(PS)</b> 3A, AAD  | 08/88 → 08/91   |   | VKMOV 10AVx850   |   | 1   |   |   |   |   |   |   |   |   |
|  | <b>B(AC)</b> 3A, AAD  | 08/88 → 08/91   |   | VKMOV 13AVx800   |   | 1   |   |   |   |   |   |   |   |   |
| <b>AUDI  80 (89, 89Q, 8A, B3) 2.0 16V</b> |   |   |   |  |   |   |   |   |   |   |   |   |   |   |
|    | 6A  | 03/90 → 09/91   |   | VKMA 01020<br>VKM 11020  | 1<br>1  | 1   |   |   |   |   |   |   |   | T0057   |
|    | 6A  | 03/90 → 09/91   | 2)  | VKPA 81401<br>VKPC 81401   |   |   |   |   | 1<br>1  |   |   |   |   |   |
|    | <b>B(Alt)</b> 6A  | 03/90 → 09/91   |   | VKMOV 10AVx910   |   | 1   |   |   |   |   |   |   |   |   |
|  | <b>B(PS)</b> 6A   | 03/90 → 09/91   |   | VKMOV 10AVx875   |   | 1   |   |   |   |   |   |   |   |   |























































































|  | B(AC)  | ACE      | 04/92 → 01/96 | VKMV 13AVx800  |   |   | 1 |  |   |  |  |  |         |
|--|--------|----------|---------------|----------------|---|---|---|--|---|--|--|--|---------|
| <b>AUDI  80 (8C, B4) / 80 Avant (8C, B4) 2.2</b>     |        |          |               |                |   |   |   |  |   |  |  |  |         |
|  |        | ABY, ADU | 02/93 → 07/95 | —              | 1 | 1 | 1 |  |   |  |  |  | T0230   |
|  |        |          |               | VKM 21052      | 1 |   | 1 |  |   |  |  |  |         |
|  |        | ABY, ADU | 02/93 → 07/95 | VKPC 81612     |   |   |   |  | 1 |  |  |  |         |
|  | B(Alt) | ABY, ADU | 02/93 → 07/95 | VKMV 4PK882    |   |   | 1 |  |   |  |  |  |         |
|  | B(AC)  | ABY, ADU | 02/93 → 07/95 | VKMV 13AVx915  |   |   | 1 |  |   |  |  |  |         |
| <b>AUDI  80 (8C, B4) / 80 Avant (8C, B4) 2.3</b>     |        |          |               |                |   |   |   |  |   |  |  |  |         |
|  |        | NG       | 09/91 → 01/96 | VKMA 01050     | 1 |   | 1 |  |   |  |  |  | T0698   |
|  |        |          |               | VKM 11050      | 1 |   |   |  |   |  |  |  |         |
|  |        | NG       | 09/91 → 01/96 | VKMA 01060     | 1 |   | 1 |  |   |  |  |  | T0698   |
|  |        |          |               | VKM 11060      | 1 |   |   |  |   |  |  |  |         |
|  |        | NG       | 09/91 → 01/96 | VKPC 81606     |   |   |   |  | 1 |  |  |  |         |
|  | B(Alt) | NG       | 09/91 → 01/96 | VKMV 10AVx865  |   |   | 1 |  |   |  |  |  |         |
|  | B(Alt) | NG       | 09/91 → 01/96 | VKMV 10AVx875  |   |   | 1 |  |   |  |  |  |         |
|  | B(PS)  | NG       | 09/91 → 01/96 | VKMV 13AVx1000 |   |   | 1 |  |   |  |  |  |         |
|  | B(AC)  | NG       | 09/91 → 01/96 | VKMV 13AVx915  |   |   | 1 |  |   |  |  |  |         |
| <b>AUDI  80 (8C, B4) / 80 Avant (8C, B4) 2.6</b>     |        |          |               |                |   |   |   |  |   |  |  |  |         |
|  |        | ABC      | 06/92 → 01/96 | VKMA 01200     | 1 | 1 | 1 |  |   |  |  |  | T0100   |
|  |        |          |               | VKM 11200      | 1 |   |   |  |   |  |  |  |         |
|  |        |          |               | VKM 21052      |   |   | 1 |  |   |  |  |  |         |
|  |        | ABC      | 06/92 → 01/96 | VKMA 01201     | 1 | 1 | 1 |  |   |  |  |  | 2 T0100 |
|  |        |          |               | VKM 11201      | 1 |   |   |  |   |  |  |  |         |
|  |        |          |               | VKM 21201      |   |   | 1 |  |   |  |  |  |         |
|  |        | ABC      | 06/92 → 01/96 | VKPC 81800     |   |   |   |  | 1 |  |  |  |         |
|  |        | ABC      | 06/92 → 01/96 | VKPC 81802     |   |   |   |  | 1 |  |  |  |         |
|  | B(Alt) | ABC      | 06/92 → 01/96 | VKMV 6PK1675   |   |   | 1 |  |   |  |  |  |         |
|  |        |          |               | VKM 31010      |   |   | 1 |  |   |  |  |  |         |
|  | B(Alt) | ABC      | 06/92 → 01/96 | VKMV 6PK2260   |   |   | 1 |  |   |  |  |  |         |
|  |        |          |               | VKM 31010      |   |   | 1 |  |   |  |  |  |         |
| <b>AUDI  80 (8C, B4) / 80 Avant (8C, B4) 2.8</b>     |        |          |               |                |   |   |   |  |   |  |  |  |         |
|  |        | AAH      | 09/91 → 01/96 | VKMA 01200     | 1 | 1 | 1 |  |   |  |  |  | T0100   |
|  |        |          |               | VKM 11200      | 1 |   |   |  |   |  |  |  |         |
|  |        |          |               | VKM 21052      |   |   | 1 |  |   |  |  |  |         |
|  |        | AAH      | 09/91 → 01/96 | VKMA 01201     | 1 | 1 | 1 |  |   |  |  |  | 2 T0100 |
|  |        |          |               | VKM 11201      | 1 |   |   |  |   |  |  |  |         |
|  |        |          |               | VKM 21201      |   |   | 1 |  |   |  |  |  |         |
|  |        | AAH      | 09/91 → 01/96 | VKPC 81800     |   |   |   |  | 1 |  |  |  |         |
|  |        | AAH      | 09/91 → 01/96 | VKPC 81802     |   |   |   |  | 1 |  |  |  |         |
|  | B(Alt) | AAH      | 09/91 → 01/96 | VKMV 6PK1675   |   |   | 1 |  |   |  |  |  |         |
|  |        |          |               | VKM 31010      |   |   | 1 |  |   |  |  |  |         |
|  | B(Alt) | AAH      | 09/91 → 01/96 | VKMV 6PK2260   |   |   | 1 |  |   |  |  |  |         |
|  |        |          |               | VKM 31010      |   |   | 1 |  |   |  |  |  |         |
| <b>AUDI  80 (8C, B4) / 80 Avant (8C, B4) 1.9 TD</b>  |        |          |               |                |   |   |   |  |   |  |  |  |         |
|  |        | AAZ      | 09/91 → 05/94 | VKMA 01011     | 1 |   | 1 |  |   |  |  |  | 4 T0069 |
|  |        |          |               | VKM 11010      | 1 |   |   |  |   |  |  |  |         |
|  |        | AAZ      | 06/94 → 12/94 | VKMA 01013     | 1 |   | 1 |  |   |  |  |  | 4 T0069 |
|  |        |          |               | VKM 11014      | 1 |   |   |  |   |  |  |  |         |
|  |        | AAZ      | 09/91 → 12/94 | VKPA 81401     |   |   |   |  | 1 |  |  |  |         |
|  |        |          |               | VKPC 81401     |   |   |   |  | 1 |  |  |  |         |
|  | B(Alt) | AAZ      | 09/91 → 12/94 | VKMV 6PK890    |   |   | 1 |  |   |  |  |  |         |
|  |        |          |               | VKM 31004      | 1 |   |   |  |   |  |  |  |         |
|  |        |          |               | VKM 31030      | 1 |   |   |  |   |  |  |  |         |
|  | B(Alt) | AAZ      | 09/91 → 12/94 | VKMV 6PK1175   |   |   | 1 |  |   |  |  |  |         |
|  |        |          |               | VKM 31004      | 1 |   |   |  |   |  |  |  |         |
|  |        |          |               | VKM 31030      | 1 |   |   |  |   |  |  |  |         |
|  | B(PS)  | AAZ      | 09/91 → 12/94 | VKMV 11.9x903  |   |   | 1 |  |   |  |  |  |         |
|  |        | AAZ      | 09/91 → 12/94 | VKM _____      |   |   |   |  | 1 |  |  |  |         |
| <b>AUDI  80 (8C, B4) / 80 Avant (8C, B4) 1.9 TDI</b> |        |          |               |                |   |   |   |  |   |  |  |  |         |
|  |        | 1Z       | 09/91 → 01/96 | VKMA 01012     | 1 | 1 | 1 |  |   |  |  |  | 5 T0650 |
|  |        |          |               | VKM 11012      | 1 |   |   |  |   |  |  |  |         |
|  |        |          |               | VKM 21012      |   |   | 1 |  |   |  |  |  |         |

|  |  |  |                                    |  |  |  |  |  |  |  |  |
|--|---|---|---|--|---|---|---|---|---|---|---|
|  | 1Z  | 09/91 → 01/96   | Mot. 289576 I→  | VKMA 01014<br>VKM 11014<br>VKM 21012   | 1<br>1  | 1   |   |   |   |   | 5 T0650   |
|                                   | 1Z  | 09/91 → 01/96   | 2)  | VKPA 81401<br>VKPC 81401   |   |   |   |   | 1<br>1  |   |   |
|                                   | B(Alt) 1Z   | 09/91 → 01/96   | A ⊙, AC   | VKMM 6PK890<br>VKM 31004<br>VKM 31030  | 1<br>1  |   | 1   |   |   |   |   |
|  | B(Alt) 1Z   | 09/91 → 01/96   | A ⊙, AC   | VKMM 6PK1175<br>VKM 31004<br>VKM 31030   | 1<br>1  |   | 1   |   |   |   |   |
|  | B(PS) 1Z  | 09/91 → 01/96   |   | VKMM 11.9x903  |   |   | 1   |   |   |   |   |
|                                   | 1Z  | 09/91 → 01/96   |   | VKM_____   |   |   |   |   | 1   |   |   |
| <b>AUDI  90 (81, 85, B2) 2.0</b>  |   |   |   |  |   |   |   |   |   |   |   |
|                                   | HP, JS, SK  | 10/84 → 03/87   |                                    | VKMC 01031<br>VKMA 01031<br>VKM 21031  | 1<br>1<br>1   | 1   | 1   | 1   |   |   | T0020   |
|                                   | HP, JS, SK  | 10/84 → 03/87   |   | VKPC 81605   |   |   |   | 1   |   |   |   |
|                                   | B(Alt) HP, JS, SK   | 10/84 → 03/87   | AC,<br>→ ICH 81-F-090 000   | VKMM 11.5x790  |   |   | 1   |   |   |   |   |
|  | B(Alt) HP, JS, SK   | 10/84 → 03/87   | AC,<br>CH 81-F-090 001 I→   | VKMM 11.2x820  |   |   | 1   |   |   |   |   |
|  | B(Alt) HP, JS, SK   | 10/84 → 03/87   | AC  | VKMM 10AVx850  |   |   | 1   |   |   |   |   |
|  | B(PS) HP, JS, SK  | 10/84 → 03/87   |   | VKMM 13AVx990  |   |   | 1   |   |   |   |   |
|  | B(AC) HP, JS, SK  | 10/84 → 03/87   |   | VKMM 13AVx990  |   |   | 1   |   |   |   |   |
| <b>AUDI  90 (81, 85, B2) 2.2</b> |   |   |   |  |   |   |   |   |   |   |   |
|                                 | JT, KX  | 01/85 → 03/87   |                                  | VKMC 01031<br>VKMA 01031<br>VKM 21031  | 1<br>1<br>1   | 1   | 1   | 1   |   |   | T0020   |
|  | KV  | 10/84 → 03/87   |  120, 2WD,<br>→ ICH 89-J-394 746 | VKMC 01031<br>VKMA 01031<br>VKM 21031  | 1<br>1<br>1   | 1   | 1   | 1   |   |   | T0020   |
|  | KV  | 10/84 → 03/87   |  142, 2WD,<br>CH 89-J-394 747 I→ | VKMC 01032<br>VKMA 01032<br>VKM 21032  | 1<br>1<br>1   | 1   | 1   | 1   |   |   | T0077   |
|  | KV  | 11/84 → 03/87   |  120, 4WD,<br>→ ICH 89-J-394 742 | VKMC 01031<br>VKMA 01031<br>VKM 21031  | 1<br>1<br>1   | 1   | 1   | 1   |   |   | T0020   |
|  | KV  | 11/84 → 03/87   |  142, 4WD,<br>CH 89-J-394 743 I→ | VKMC 01032<br>VKMA 01032<br>VKM 21032  | 1<br>1<br>1   | 1   | 1   | 1   |   |   | T0077   |
|                                 | JT, KX  | 01/85 → 03/87   |   | VKPC 81605   |   |   |   | 1   |   |   |   |
|  | KV  | 10/84 → 03/87   | 2WD,<br>→ ICH 89-J-394 746  | VKPC 81605   |   |   |   | 1   |   |   |   |
|  | KV  | 10/84 → 03/87   | 2WD,<br>CH 89-J-394 747 I→  | VKPC 81606   |   |   |   | 1   |   |   |   |
|  | KV  | 11/84 → 03/87   | 4WD,<br>→ ICH 89-J-394 742  | VKPC 81605   |   |   |   | 1   |   |   |   |
|  | KV  | 11/84 → 03/87   | 4WD,<br>CH 89-J-394 743 I→  | VKPC 81606   |   |   |   | 1   |   |   |   |
|                                 | B(Alt) JT, KV, KX   | 10/84 → 03/87   | AC,<br>→ ICH 81-F-090 000   | VKMM 11.5x790  |   |   | 1   |   |   |   |   |
|  | B(Alt) JT, KV, KX   | 10/84 → 03/87   | AC,<br>CH 81-F-090 001 I→   | VKMM 11.2x820  |   |   | 1   |   |   |   |   |
|  | B(Alt) JT, KV, KX   | 10/84 → 03/87   | AC  | VKMM 10AVx850  |   |   | 1   |   |   |   |   |
|  | B(PS) JT, KV, KX  | 10/84 → 03/87   |   | VKMM 13AVx990  |   |   | 1   |   |   |   |   |
|  | B(AC) JT, KV, KX  | 10/84 → 03/87   |   | VKMM 13AVx990  |   |   | 1   |   |   |   |   |



AUDI

































|  |           |               |  |  |   |  |  |  |   |  |   |  |  |  |       |
|--|-----------|---------------|--|--|---|---|--|---|---|---|---|---|--|---|-------|
| <b>AUDI  90 (81, 85, B2) 1.6 TD</b>             |           |               |  |  |   |   |  |   |   |   |   |   |  |   |       |
|    | CY        | 10/85 → 01/87 | 3)   | VKMS 01010   | 1 | 1   |  |   |   | 3   | 2 |   |  |   |       |
|  |           |               |  | VKMA 01010   | 1 | 1   |  |   |   |   | 1 |   |  |   | T0051 |
|  |           |               |  | VKM 11010  | 1 |   |  |   |   |   |   |   |  |   |       |
|    | CY        | 10/85 → 01/87 | 2)   | VKPA 81401   |   |   |  |   | 1 |   |   |   |  |   |       |
|  |           |               |  | VKPC 81401   |   |   |  |   | 1 |   |   |   |  |   |       |
|    | B(Alt) CY | 10/85 → 01/87 |  | VKMOV 10AVx735   |   | 1   |  |   |   |   |   |   |  |   |       |
|  | B(PS) CY  | 10/85 → 01/87 |  | VKMOV 11.5x790   |   | 1   |  |   |   |   |   |   |  |   |       |
|  | B(AC) CY  | 10/85 → 01/87 |  | VKMOV 13AVx825   |   | 1   |  |   |   |   |   |   |  |   |       |
| <b>AUDI  90 (89, 89Q, 8A, B3) 2.0</b>           |           |               |  |  |   |   |  |   |   |   |   |   |  |   |       |
|    | PS        | 07/88 → 09/91 |  → ICH 89-J-394 742   | VKMC 01031   | 1 | 1   |  | 1   |   |   |   |   |  |   | T0020 |
|  |           |               |  | VKMA 01031   | 1 | 1   |  |   |   |   |   |   |  |   |       |
|  |           |               |  | VKM 21031  | 1 |   |  |   |   |   |   |   |  |   |       |
|  | PS        | 07/88 → 09/91 |  CH 89-J-394 743 I→   | VKMC 01032   | 1 | 1   |  | 1   |   |   |   |   |  |   | T0077 |
|  |           |               |  | VKMA 01032   | 1 | 1   |  |   |   |   |   |   |  |   |       |
|  |           |               |  | VKM 21032  | 1 |   |  |   |   |   |   |   |  |   |       |
|    | PS        | 07/88 → 09/91 | → ICH 89-J-394 742   | VKPC 81605   |   |   |  | 1   |   |   |   |   |  |   |       |
|  | PS        | 07/88 → 09/91 | CH 89-J-394 743 I→   | VKPC 81606   |   |   |  | 1   |   |   |   |   |  |   |       |
|    | B(Alt) PS | 07/88 → 09/91 |  | VKMOV 10AVx865   |   | 1   |  |   |   |   |   |   |  |   |       |
|  | B(PS) PS  | 07/88 → 09/91 |  | VKMOV 13AVx990   |   | 1   |  |   |   |   |   |   |  |   |       |
| <b>AUDI  90 (89, 89Q, 8A, B3) 2.0 20V</b>       |           |               |  |  |   |   |  |   |   |   |   |   |  |   |       |
|    | NM        | 08/88 → 09/91 |  | —  | 1 | 1   |  |   |   |   |   |   |  |   | T0649 |
|  |           |               |  | VKM 21031  | 1 |   |  |   |   |   |   |   |  |   |       |
|  | NM        | 08/89 → 07/91 |  | VKMA 01034   | 1 | 1   |  |   |   |   |   |   |  |   | T0649 |
|  |           |               |  | VKM 21032  | 1 |   |  |   |   |   |   |   |  |   |       |
|   | NM        | 08/88 → 09/91 |  | VKPC 81606   |   |   |  | 1   |   |   |   |   |  |   |       |
|    | B(Alt) NM | 08/88 → 09/91 |  | VKMOV 10AVx865   |   | 1   |  |   |   |   |   |   |  |   |       |
|  | B(PS) NM  | 08/88 → 09/91 |  | VKMOV 13AVx990   |   | 1   |  |   |   |   |   |   |  |   |       |
|  | B(AC) NM  | 08/88 → 09/91 |  | VKMOV 13AVx915   |   | 1   |  |   |   |   |   |   |  |   |       |
| <b>AUDI  90 (89, 89Q, 8A, B3) 2.2</b>         |           |               |  |  |   |   |  |   |   |   |   |   |  |   |       |
|    | KV        | 04/87 → 07/91 |   120,<br>→ ICH 89-J-394 746 | VKMC 01031   | 1 | 1   |  | 1   |   |   |   |   |  |   | T0020 |
|  |           |               |  | VKMA 01031   | 1 | 1   |  |   |   |   |   |   |  |   |       |
|  |           |               |  | VKM 21031  | 1 |   |  |   |   |   |   |   |  |   |       |
|  | KV        | 04/87 → 07/91 |   142,<br>CH 89-J-394 747 I→ | VKMC 01032   | 1 | 1   |  | 1   |   |   |   |   |  |   | T0077 |
|  |           |               |  | VKMA 01032   | 1 | 1   |  |   |   |   |   |   |  |   |       |
|  |           |               |  | VKM 21032  | 1 |   |  |   |   |   |   |   |  |   |       |
|    | KV        | 04/87 → 07/91 | → ICH 89-J-394 746   | VKPC 81605   |   |   |  | 1   |   |   |   |   |  |   |       |
|  | KV        | 04/87 → 07/91 | CH 89-J-394 747 I→   | VKPC 81606   |   |   |  | 1   |   |   |   |   |  |   |       |
|    | B(Alt) KV | 04/87 → 07/91 |  | VKMOV 10AVx865   |   | 1   |  |   |   |   |   |   |  |   |       |
|  | B(PS) KV  | 04/87 → 07/91 |  | VKMOV 13AVx990   |   | 1   |  |   |   |   |   |   |  |   |       |
|  | B(AC) KV  | 04/87 → 07/91 |  | VKMOV 13AVx915   |   | 1   |  |   |   |   |   |   |  |   |       |
| <b>AUDI  90 (89, 89Q, 8A, B3) 2.2 quattro</b> |           |               |  |  |   |   |  |   |   |   |   |   |  |   |       |
|    | KV        | 04/87 → 09/91 |   120,<br>→ ICH 89-J-394 742 | VKMC 01031   | 1 | 1   |  | 1   |   |   |   |   |  |   | T0020 |
|  |           |               |  | VKMA 01031   | 1 | 1   |  |   |   |   |   |   |  |   |       |
|  |           |               |  | VKM 21031  | 1 |   |  |   |   |   |   |   |  |   |       |
|  | KV        | 04/87 → 09/91 |   142,<br>CH 89-J-394 743 I→ | VKMC 01032   | 1 | 1   |  | 1   |   |   |   |   |  |   | T0077 |
|  |           |               |  | VKMA 01032   | 1 | 1   |  |   |   |   |   |   |  |   |       |
|  |           |               |  | VKM 21032  | 1 |   |  |   |   |   |   |   |  |   |       |
|    | KV        | 04/87 → 09/91 | → ICH 89-J-394 742   | VKPC 81605   |   |   |  | 1   |   |   |   |   |  |   |       |
|  | KV        | 04/87 → 09/91 | CH 89-J-394 743 I→   | VKPC 81606   |   |   |  | 1   |   |   |   |   |  |   |       |
|    | B(Alt) KV | 04/87 → 09/91 |  | VKMOV 10AVx865   |   | 1   |  |   |   |   |   |   |  |   |       |
|  | B(PS) KV  | 04/87 → 09/91 |  | VKMOV 13AVx990   |   | 1   |  |   |   |   |   |   |  |   |       |
|  | B(AC) KV  | 04/87 → 09/91 |  | VKMOV 13AVx915   |   | 1   |  |   |   |   |   |   |  |   |       |
| <b>AUDI  90 (89, 89Q, 8A, B3) 2.3</b>         |           |               |  |  |   |   |  |   |   |   |   |   |  |   |       |
|    | NG        | 04/87 → 09/91 |   120,<br>→ ICH 89-J-396 702 | VKMC 01031   | 1 | 1   |  | 1   |   |   |   |   |  |   | T0020 |
|  |           |               |  | VKMA 01031   | 1 | 1   |  |   |   |   |   |   |  |   |       |
|  |           |               |  | VKM 21031  | 1 |   |  |   |   |   |   |   |  |   |       |

|   |  |  |                             |  |  |  |  |  |  |  |  |  |
|---|---|---|--|--|---|---|---|---|---|---|---|---|
|   | NG  | 04/87 → 09/91   |  142,<br>CH 89-J-396 703 I→ | VKMC 01032<br>VKMA 01032<br>VKM 21032  | 1<br>1<br>1   | 1<br>1  | 1   |   |   |   |   | T0077   |
|    | NG  | 04/87 → 07/91   | → ICH 89-J-396 702   | VKPC 81605   |   |   | 1   |   |   |   |   |   |
|   | NG  | 04/87 → 09/91   | CH 89-J-396 703 I→   | VKPC 81606   |   |   | 1   |   |   |   |   |   |
|    | B(Alt) NG   | 04/87 → 09/91   |  | VKMW 10AVx865  |   | 1   |   |   |   |   |   |   |
|   | B(PS) NG  | 04/87 → 09/91   |  | VKMW 13AVx990  |   | 1   |   |   |   |   |   |   |
|   | B(AC) NG  | 04/87 → 09/91   |  | VKMW 13AVx915  |   | 1   |   |   |   |   |   |   |
| <b>AUDI  90 (89, 89Q, 8A, B3) 2.3 20V</b>            |   |   |  |  |   |   |   |   |   |   |   |   |
|    | 7A  | 06/88 → 09/91   |  | —<br>VKM 21031   | 1<br>1  | 1   |   |   |   |   |   | T0649   |
|   | 7A  | 08/88 → 07/91   |  | VKMA 01034<br>VKM 21032  | 1<br>1  | 1   |   |   |   |   |   | T0649   |
|    | 7A  | 06/88 → 09/91   |  | VKPC 81606   |   |   | 1   |   |   |   |   |   |
|    | B(Alt) 7A   | 06/88 → 09/91   |  | VKMW 10AVx865  |   | 1   |   |   |   |   |   |   |
|   | B(PS) 7A  | 06/88 → 09/91   |  | VKMW 13AVx990  |   | 1   |   |   |   |   |   |   |
|   | B(AC) 7A  | 06/88 → 09/91   |  | VKMW 13AVx915  |   | 1   |   |   |   |   |   |   |
| <b>AUDI  90 (89, 89Q, 8A, B3) 2.3 quattro</b>        |   |   |  |  |   |   |   |   |   |   |   |   |
|    | NG  | 04/87 → 07/91   |  120,<br>→ ICH 89-J-394 742 | VKMC 01031<br>VKMA 01031<br>VKM 21031  | 1<br>1<br>1   | 1<br>1  | 1   |   |   |   |   | T0020   |
|   | NG  | 04/87 → 09/91   |  142,<br>CH 89-J-394 743 I→ | VKMC 01032<br>VKMA 01032<br>VKM 21032  | 1<br>1<br>1   | 1<br>1  | 1   |   |   |   |   | T0077   |
|   | NG  | 04/87 → 09/91   |  147                      | VKMA 01034<br>VKM 21032  | 1<br>1  | 1   |   |   |   |   |   | T0649   |
|    | NG  | 04/87 → 07/91   | → ICH 89-J-394 742   | VKPC 81605   |   |   | 1   |   |   |   |   |   |
|   | NG  | 04/87 → 09/91   | CH 89-J-394 743 I→   | VKPC 81606   |   |   | 1   |   |   |   |   |   |
|    | B(Alt) NG   | 04/87 → 09/91   |  | VKMW 10AVx865  |   | 1   |   |   |   |   |   |   |
|   | B(PS) NG  | 04/87 → 09/91   |  | VKMW 13AVx990  |   | 1   |   |   |   |   |   |   |
|   | B(AC) NG  | 04/87 → 09/91   |  | VKMW 13AVx915  |   | 1   |   |   |   |   |   |   |
| <b>AUDI  90 (89, 89Q, 8A, B3) 1.6 TD</b>           |   |   |  |  |   |   |   |   |   |   |   |   |
|    | RA, SB  | 04/87 → 09/91   | 3)   | VKMS 01010<br>VKMA 01010<br>VKM 11010  | 1<br>1<br>1   | 1   |   |   |   | 3   | 2   | T0051   |
|    | RA, SB  | 04/87 → 09/91   | 2)   | VKPA 81401<br>VKPC 81401   |   |   | 1<br>1  |   |   |   |   |   |
|    | B(Alt) RA, SB   | 04/87 → 09/91   | AC   | VKMW 10AVx735  |   | 1   |   |   |   |   |   |   |
|   | B(Alt) RA, SB   | 04/87 → 09/91   | AC   | VKMW 10AVx710<br>VKM 31009   |   | 1   |   |   |   |   |   |   |
|   | B(PS) RA, SB  | 04/87 → 09/91   |  | VKMW 10AVx785  |   | 1   |   |   |   |   |   |   |
| <b>AUDI  100 (43, C2) / 100 Avant (43, C2) 1.6</b> |   |   |  |  |   |   |   |   |   |   |   |   |
|    | VV  | 08/76 → 02/83   | 3)   | VKMS 01000<br>VKMA 01000<br>VKM 11000  | 1<br>1<br>1   | 1   |   |   |   | 3   | 4   | T0005   |
|    | VV  | 08/76 → 02/83   | 2)   | VKPA 81401<br>VKPC 81401   |   |   | 1<br>1  |   |   |   |   |   |
|    | B(Alt) VV   | 08/76 → 02/83   |  | VKMW 10AVx950  |   | 1   |   |   |   |   |   |   |
|   | B(PS) VV  | 08/76 → 02/83   |  | VKMW 11.5x790  |   | 1   |   |   |   |   |   |   |
| <b>AUDI  100 (43, C2) / 100 Avant (43, C2) 1.9</b> |   |   |  |  |   |   |   |   |   |   |   |   |
|    | WH  | 08/80 → 07/82   |                           | —  |   | 1   | 1   |   |   |   |   |   |
|    | WH  | 08/80 → 07/82   |  | VKPC 81605   |   |   | 1   |   |   |   |   |   |
|    | B(Alt) WH   | 08/80 → 07/82   |  | VKMW 11.5x790  |   | 1   |   |   |   |   |   |   |
|   | B(PS) WH  | 08/80 → 07/82   |  | VKMW 13AVx990  |   | 1   |   |   |   |   |   |   |
| <b>AUDI  100 (43, C2) / 100 Avant (43, C2) 2.0</b> |   |   |  |  |   |   |   |   |   |   |   |   |
|    | WA  | 06/76 → 07/80   | 3)   | VKMS 01000<br>VKMA 01000<br>VKM 11000  | 1<br>1<br>1   | 1   |   |   |   | 3   | 4   | T0005   |
|    | WA  | 06/76 → 12/78   |  | VKPC 81601   |   |   | 1   |   |   |   |   |   |













































































|   |  |  |  |                            |  |  |  |  |  |  |  |  |  |  |  |  |  |  |  |       |       |
|---|---|---|---|--|---|---|---|---|---|---|--|--|--|--|--|--|--|--|--|-------|-------|
|   | B(PS)   | KP, RT, SL  | 08/84 → 11/90   | AC   | VKMV 13AVx990   |   |   | 1   |   |   |  |  |  |  |  |  |  |  |  |       |       |
|   | B(AC)   | KP, RT, SL  | 08/84 → 11/90   |  | VKMV 13AVx915   |   |   | 1   |   |   |  |  |  |  |  |  |  |  |  |       |       |
| <b>AUDI  100 (44,44Q,C3)/100 Avant (44,44Q,C3) 2,2</b>         |   |   |   |  |   |   |   |   |   |   |  |  |  |  |  |  |  |  |  |       |       |
|    |   | KF  | 08/82 → 07/84   |  120,<br>CH 44-E-000 001 I→ | VKMC 01031<br>VKMA 01031<br>VKM 21031   | 1<br>1<br>1   | 1<br>1<br>1   | 1   |   |   |  |  |  |  |  |  |  |  |  | T0020 |       |
|   |   | KF  | 08/82 → 07/84   |  142,<br>→ ICH 44-D-200 000 | VKMC 01032<br>VKMA 01032<br>VKM 21032   | 1<br>1<br>1   | 1<br>1<br>1   | 1   |   |   |  |  |  |  |  |  |  |  |  |       | T0077 |
|   |   | WC  | 08/82 → 07/84   |  120                        | VKMC 01031<br>VKMA 01031<br>VKM 21031   | 1<br>1<br>1   | 1<br>1<br>1   | 1   |   |   |  |  |  |  |  |  |  |  |  |       | T0020 |
|    |   | KF, WC  | 08/82 → 07/84   |  | VKPC 81605  |   |   | 1   |   |   |  |  |  |  |  |  |  |  |  |       |       |
|    | B(Alt)  | KF, WC  | 08/82 → 07/84   |  | VKMV 11.5x790   |   |   | 1   |   |   |  |  |  |  |  |  |  |  |  |       |       |
|   | B(PS)   | KF, WC  | 08/82 → 07/84   | AC   | VKMV 13AVx950   |   |   | 1   |   |   |  |  |  |  |  |  |  |  |  |       |       |
|   | B(PS)   | KF, WC  | 08/82 → 07/84   | AC   | VKMV 13AVx990   |   |   | 1   |   |   |  |  |  |  |  |  |  |  |  |       |       |
|   | B(AC)   | KF, WC  | 08/82 → 07/84   |  | VKMV 13AVx915   |   |   | 1   |   |   |  |  |  |  |  |  |  |  |  |       |       |
| <b>AUDI  100 (44,44Q,C3)/100 Avant (44,44Q,C3) 2.2</b>         |   |   |   |  |   |   |   |   |   |   |  |  |  |  |  |  |  |  |  |       |       |
|    |   | KF, WU  | 08/82 → 07/84   |  120,<br>CH 44-E-000 001 I→ | VKMC 01031<br>VKMA 01031<br>VKM 21031   | 1<br>1<br>1   | 1<br>1<br>1   | 1   |   |   |  |  |  |  |  |  |  |  |  |       | T0020 |
|   |   | KF, WU  | 08/82 → 07/84   |  142,<br>→ ICH 44-D-200 000 | VKMC 01032<br>VKMA 01032<br>VKM 21032   | 1<br>1<br>1   | 1<br>1<br>1   | 1   |   |   |  |  |  |  |  |  |  |  |  |       | T0077 |
|   |   | KU  | 08/84 → 11/90   |  120,<br>→ IMot. 077 116  | VKMC 01031<br>VKMA 01031<br>VKM 21031   | 1<br>1<br>1   | 1<br>1<br>1   | 1   |   |   |  |  |  |  |  |  |  |  |  |       | T0020 |
|   |   | KU  | 08/84 → 11/90   |  142,<br>Mot. 077 116 I→  | VKMC 01032<br>VKMA 01032<br>VKM 21032   | 1<br>1<br>1   | 1<br>1<br>1   | 1   |   |   |  |  |  |  |  |  |  |  |  |       | T0077 |
|   |   | KZ, PX  | 10/84 → 09/86   |  120                      | VKMC 01031<br>VKMA 01031<br>VKM 21031   | 1<br>1<br>1   | 1<br>1<br>1   | 1   |   |   |  |  |  |  |  |  |  |  |  |       | T0020 |
|    |   | KF, KZ, PX, WU  | 08/82 → 09/86   |  | VKPC 81605  |   |   | 1   |   |   |  |  |  |  |  |  |  |  |  |       |       |
|   |   | KU  | 08/84 → 11/90   | → IMot. 077 115,<br>→ ICH 44-J-200 099   | VKPC 81605  |   |   | 1   |   |   |  |  |  |  |  |  |  |  |  |       |       |
|   |   | KU  | 08/84 → 11/90   | Mot. 077 116 I→,<br>CH 44-J-200 100 I→   | VKPC 81606  |   |   | 1   |   |   |  |  |  |  |  |  |  |  |  |       |       |
|    | B(Alt)  | KF, KU, KZ, PX, WU  | 08/82 → 11/90   |  | VKMV 11.5x790   |   |   | 1   |   |   |  |  |  |  |  |  |  |  |  |       |       |
|   | B(PS)   | KF, KU, KZ, PX, WU  | 08/82 → 11/90   | AC   | VKMV 13AVx950   |   |   | 1   |   |   |  |  |  |  |  |  |  |  |  |       |       |
|   | B(PS)   | KF, KU, KZ, PX, WU  | 08/82 → 11/90   | AC   | VKMV 13AVx990   |   |   | 1   |   |   |  |  |  |  |  |  |  |  |  |       |       |
|   | B(AC)   | KF, KU, KZ, PX, WU  | 08/82 → 11/90   |  | VKMV 13AVx915   |   |   | 1   |   |   |  |  |  |  |  |  |  |  |  |       |       |
| <b>AUDI  100 (44,44Q,C3)/100 Avant (44,44Q,C3) 2.2 Turbo</b> |   |   |   |  |   |   |   |   |   |   |  |  |  |  |  |  |  |  |  |       |       |
|    |   | MC  | 08/86 → 11/90   |  120,<br>→ IMot. 039 951  | VKMC 01031<br>VKMA 01031<br>VKM 21031   | 1<br>1<br>1   | 1<br>1<br>1   | 1   |   |   |  |  |  |  |  |  |  |  |  |       | T0020 |
|   |   | MC  | 08/86 → 11/90   |  142,<br>Mot. 039 952 I→  | VKMC 01032<br>VKMA 01032<br>VKM 21032   | 1<br>1<br>1   | 1<br>1<br>1   | 1   |   |   |  |  |  |  |  |  |  |  |  |       | T0077 |
|    |   | MC  | 08/86 → 11/90   | → IMot. 039 950,<br>→ ICH 44-J-200 099   | VKPC 81605  |   |   | 1   |   |   |  |  |  |  |  |  |  |  |  |       |       |
|   |   | MC  | 08/86 → 11/90   | Mot. 039 951 I→,<br>CH 44-J-200 100 I→   | VKPC 81606  |   |   | 1   |   |   |  |  |  |  |  |  |  |  |  |       |       |
|    | B(Alt)  | MC  | 08/86 → 11/90   |  | VKMV 11.5x790   |   |   | 1   |   |   |  |  |  |  |  |  |  |  |  |       |       |
|   | B(PS)   | MC  | 08/86 → 11/90   | AC   | VKMV 13AVx950   |   |   | 1   |   |   |  |  |  |  |  |  |  |  |  |       |       |
|   | B(PS)   | MC  | 08/86 → 11/90   | AC   | VKMV 13AVx990   |   |   | 1   |   |   |  |  |  |  |  |  |  |  |  |       |       |



AUDI

|   |  |  |                               |  |  |  |  |  |  |       |
|---|---|---|--|--|---|---|---|---|---|-------|
| B(AC)   | MC  | 08/86 → 11/90   |  | VKMV 13AVx915  |   |   | 1   |   |   |       |
| <b>AUDI  100 (44,44Q,C3)/100 Avant (44,44Q,C3) 2.3</b>       |   |   |  |  |   |   |   |   |   |       |
|   | NF  | 08/86 → 11/90   |  120,<br>→ I Mot. 063 969     | VKMC 01031<br>VKMA 01031<br>VKM 21031  | 1<br>1<br>1   | 1   | 1   |   |   | T0020 |
|   | NF  | 08/86 → 11/90   |  142,<br>Mot. 063 970 I →     | VKMC 01032<br>VKMA 01032<br>VKM 21032  | 1<br>1<br>1   | 1   | 1   |   |   | T0077 |
|   | NF  | 01/90 → 11/90   |  → I CH 44-J-246 281          | VKMC 01031<br>VKMA 01031<br>VKM 21031  | 1<br>1<br>1   | 1   | 1   |   |   | T0020 |
|   | NF  | 01/90 → 11/90   |  CH 44-J-246 282 I →          | VKMC 01032<br>VKMA 01032<br>VKM 21032  | 1<br>1<br>1   | 1   | 1   |   |   | T0077 |
|   | NF  | 08/86 → 11/90   | → I Mot. 063 968,<br>→ I CH 44-J-200 099   | VKPC 81605   |   |   |   | 1   |   |       |
|   | NF  | 08/86 → 11/90   | Mot. 063 969 I →,<br>CH 44-J-200 100 I →   | VKPC 81606   |   |   |   |   | 1   |       |
|   | NF  | 01/90 → 11/90   |  | VKPC 81612   |   |   |   |   | 1   |       |
|   | NF  | 01/90 → 11/90   | → I CH 44-J-246 281  | VKPC 81605   |   |   |   |   | 1   |       |
|   | NF  | 01/90 → 11/90   | CH 44-J-246 282 I →  | VKPC 81606   |   |   |   |   | 1   |       |
|   | B(Alt) NF   | 08/86 → 11/90   |  | VKMV 11.5x790  |   |   | 1   |   |   |       |
|   | B(PS) NF  | 08/86 → 11/90   | AC   | VKMV 13AVx950  |   |   | 1   |   |   |       |
|   | B(PS) NF  | 08/86 → 11/90   | AC   | VKMV 13AVx990  |   |   | 1   |   |   |       |
|   | B(AC) NF  | 08/86 → 11/90   |  | VKMV 13AVx915  |   |   | 1   |   |   |       |
| <b>AUDI  100 (44,44Q,C3)/100 Avant (44,44Q,C3) 2.0 D</b>   |   |   |  |  |   |   |   |   |   |       |
|   | CN  | 08/82 → 07/89   |  4)                         | VKMC 01040<br>VKMA 01040<br>VKM 21031  | 1<br>1<br>1   | 2   | 2   | 1   |   | T0012 |
|   | CN  | 08/82 → 11/90   | → I CH 44-L-100 000  | VKPC 81602   |   |   |   | 1   |   |       |
|   | CN  | 03/83 → 11/90   | CH 44-L-100 001 I →  | VKPC 81603   |   |   |   | 1   |   |       |
|   | B(Alt) CN   | 08/82 → 11/90   |  | VKMV 10AVx813  |   |   | 1   |   |   |       |
|   | B(PS) CN  | 08/82 → 11/90   |  | VKMV 13AVx990  |   |   | 1   |   |   |       |
| <b>AUDI  100 (44,44Q,C3)/100 Avant (44,44Q,C3) 2.0 TD</b>  |   |   |  |  |   |   |   |   |   |       |
|   | DE  | 08/82 → 02/88   |  4)                         | VKMC 01040<br>VKMA 01040<br>VKM 21031  | 1<br>1<br>1   | 2   | 2   | 1   |   | T0012 |
|   | NC  | 03/88 → 11/90   |  4),<br>→ I CH 44-L-100 000 | VKMC 01040<br>VKMA 01040<br>VKM 21031  | 1<br>1<br>1   | 2   | 2   | 1   |   | T0012 |
|   | NC  | 03/88 → 11/90   | 4), CH 44-L-100 001 I →  | VKMA 01040<br>VKM 21031  | 1<br>1  | 2   |   |   |   | T0012 |
|   | DE  | 08/82 → 02/88   |  | VKPC 81602   |   |   |   | 1   |   |       |
|   | NC  | 03/88 → 11/90   | → I CH 44-L-100 000  | VKPC 81602   |   |   |   | 1   |   |       |
|   | NC  | 03/88 → 11/90   | CH 44-L-100 001 I →  | VKPC 81603   |   |   |   | 1   |   |       |
|   | B(Alt) DE, NC   | 08/82 → 11/90   |  | VKMV 11.5x790  |   |   | 1   |   |   |       |
|   | B(PS) DE, NC  | 08/82 → 11/90   |  | VKMV 13AVx990  |   |   | 1   |   |   |       |
| <b>AUDI  100 (44,44Q,C3)/100 Avant (44,44Q,C3) 2.4 D</b>   |   |   |  |  |   |   |   |   |   |       |
|   | 3D  | 08/89 → 07/91   |  | —<br>VKM 21041   | 1<br>1  | 2   |   |   |   | T0078 |
|   | 3D  | 08/89 → 07/91   | → I CH 44-L-100 000  | VKPC 81602   |   |   |   | 1   |   |       |
|   | 3D  | 08/89 → 07/91   | CH 44-L-100 001 I →  | VKPC 81603   |   |   |   | 1   |   |       |
|   | B(Alt) 3D   | 08/89 → 07/91   |  | VKMV 10AVx838  |   |   | 1   |   |   |       |
| <b>AUDI  100 (44,44Q,C3)/100 Avant (44,44Q,C3) 2.5 TDI</b> |   |   |  |  |   |   |   |   |   |       |
|   | 1T  | 01/90 → 11/90   |  | —<br>VKM 11265<br>VKM 11266<br>VKM 21041   | 2<br>1<br>1   | 1   | 2   |   |   | T0095 |
|   | 1T  | 01/90 → 11/90   |  | VKPC 81805   |   |   |   | 1   |   |       |
|   | B(Alt) 1T   | 01/90 → 11/90   |  | VKMV 10AVx838  |   |   | 1   |   |   |       |

|  |                    |               |    |  |        |   |   |   |   |   |       |
|--|--------------------|---------------|---|--|--|---|---|---|---|---|-------|
| <b>AUDI  100 (4A, C4) / 100 Avant (4A, C4) 1.6</b>            |                    |               |   |  |  |   |   |   |   |   |       |
|   | ABB                | 03/92 → 07/93 | 3)  | VKMS 01000                             | 1  | 1 |   |   | 3 | 4 |       |
|  |                    |               |   | VKMA 01000                             | 1  | 1 |   |   |   | 3 | T0005 |
|  |                    |               |   | VKM 11000                              | 1  |   |   |   |   |   |       |
|   | ABB                | 03/92 → 07/93 | 2)  | VKPA 81401                             |  |   |   | 1 |   |   |       |
|  |                    |               |   | VKPC 81401                             |  |   |   | 1 |   |   |       |
|   | B(Alt)             | ABB           | 03/92 → 07/93   | VKMV 4PK855                            |  | 1 |   |   |   |   |       |
|  | B(PS)              | ABB           | 03/92 → 07/93   | VKMV 10AVx910                          |  | 1 |   |   |   |   |       |
|  | B(AC)              | ABB           | 03/92 → 07/93   | VKMV 13AVx800                          |  | 1 |   |   |   |   |       |
| <b>AUDI  100 (4A, C4) / 100 Avant (4A, C4) 2.0</b>            |                    |               |   |  |  |   |   |   |   |   |       |
|   | AAD, AAE, ABK      | 12/90 → 06/94 |   | VKMA 01001                             | 1  | 1 |   |   |   |   | T0091 |
|  |                    |               |   | VKM 11001                              | 1  |   |   |   |   |   |       |
|  | ACE                | 08/92 → 07/93 |   | VKMA 01020                             | 1  | 1 |   |   |   |   | T0057 |
|  |                    |               |   | VKM 11020                              | 1  |   |   |   |   |   |       |
|   | AAD, AAE, ABK, ACE | 12/90 → 06/94 | 2)  | VKPA 81401                             |  |   |   | 1 |   |   |       |
|  |                    |               |   | VKPC 81401                             |  |   |   | 1 |   |   |       |
|   | B(Alt)             | AAD, AAE, ABK | 12/90 → 06/94   | → ICH 4A-N-027 173                     | VKMV 10AVx950  |   | 1 |   |   |   |       |
|  | B(Alt)             | AAE           | 12/90 → 06/94   | CH 4A-N-027 174 I→                     | VKMV 4PK855  |   | 1 |   |   |   |       |
|  | B(PS)              | AAE           | 12/90 → 06/94   | → ICH 4A-M-077 361                     | VKMV 10AVx850  |   | 1 |   |   |   |       |
|  | B(PS)              | AAE           | 12/90 → 06/94   | CH 4A-M-077 362 I→, → ICH 4A-N-027 173 | VKMV 11.2x820  |   | 1 |   |   |   |       |
|  | B(PS)              | AAE           | 12/90 → 06/94   | CH 4A-N-027 174 I→                     | VKMV 10AVx910  |   | 1 |   |   |   |       |
|  | B(AC)              | AAE           | 12/90 → 06/94   |  | VKMV 13AVx800  |   | 1 |   |   |   |       |
| <b>AUDI  100 (4A, C4) / 100 Avant (4A, C4) 2.0 16V</b>        |                    |               |   |  |  |   |   |   |   |   |       |
|   | ACE                | 07/92 → 06/94 | → IMot. 016 500   | VKMA 01020                             | 1  | 1 |   |   |   |   | T0057 |
|  |                    |               |   | VKM 11020                              | 1  |   |   |   |   |   |       |
|  | ACE                | 07/92 → 06/94 | Mot. 016 501 I→   | VKMA 01023                             | 1  | 1 |   |   |   |   | T0057 |
|  |                    |               |   | VKM 11021                              | 1  |   |   |   |   |   |       |
|  | ACE                | 01/92 → 06/94 | → IMot. 017 139   | VKMA 01020                             | 1  | 1 |   |   |   |   | T0057 |
|  |                    |               |   | VKM 11020                              | 1  |   |   |   |   |   |       |
|  | ACE                | 01/92 → 06/94 | Mot. 017 140 I→   | VKMA 01023                             | 1  | 1 |   |   |   |   | T0057 |
|  |                    |               |   | VKM 11021                              | 1  |   |   |   |   |   |       |
|   | ACE                | 01/92 → 06/94 | 2)  | VKPA 81401                             |  |   |   | 1 |   |   |       |
|  |                    |               |   | VKPC 81401                             |  |   |   | 1 |   |   |       |
|   | B(Alt)             | ACE           | 01/92 → 06/94   | VKMV 4PK882                            |  | 1 |   |   |   |   |       |
|  | B(PS)              | ACE           | 01/92 → 06/94   | VKMV 10AVx910                          |  | 1 |   |   |   |   |       |
|  | B(AC)              | ACE           | 01/92 → 06/94   | VKMV 13AVx800                          |  | 1 |   |   |   |   |       |
| <b>AUDI  100 (4A, C4) / 100 Avant (4A, C4) 2.2 Turbo S4</b> |                    |               |   |  |  |   |   |   |   |   |       |
|   | AAN                | 08/91 → 06/94 |   | —                                      | 1  | 1 | 1 |   |   |   | T0230 |
|  |                    |               |   | —                                      | 1  |   | 1 |   |   |   |       |
|  |                    |               |   | VKM 21052                              |  | 1 |   |   |   |   |       |
|   | AAN                | 08/91 → 06/94 |   | VKPC 81612                             |  |   |   | 1 |   |   |       |
| <b>AUDI  100 (4A, C4) / 100 Avant (4A, C4) 2.3</b>          |                    |               |   |  |  |   |   |   |   |   |       |
|   | AAR                | 12/90 → 06/94 |   | VKMA 01050                             | 1  | 1 |   |   |   |   | T0698 |
|  |                    |               |   | VKM 11050                              | 1  |   |   |   |   |   |       |
|  | AAR                | 12/90 → 06/94 |    | VKMA 01060                             | 1  | 1 |   |   |   |   | T0698 |
|  |                    |               |   | VKM 11060                              | 1  |   |   |   |   |   |       |
|   | AAR                | 12/90 → 06/94 |   | VKPC 81612                             |  |   |   | 1 |   |   |       |
| <b>AUDI  100 (4A, C4) / 100 Avant (4A, C4) 2.6</b>          |                    |               |   |  |  |   |   |   |   |   |       |
|   | ABC, ACZ           | 03/92 → 06/94 |   | VKMA 01200                             | 1  | 1 | 1 |   |   |   | T0100 |
|  |                    |               |   | VKM 11200                              | 1  |   |   |   |   |   |       |
|  |                    |               |   | VKM 21052                              |  | 1 |   |   |   |   |       |
|   | ABC, ACZ           | 03/92 → 06/94 |   | VKPC 81800                             |  |   |   | 1 |   |   |       |
|   | B(Alt)             | ABC, ACZ      | 03/92 → 06/94   | AC, CH 4A-N-023 927 I→                 | VKMV 6PK1675   |   | 1 |   |   |   |       |
|  |                    |               |   |  | VKM 31010  | 1 |   |   |   |   |       |
|  | B(Alt)             | ABC, ACZ      | 03/92 → 06/94   | AC, CH 4A-N-023 927 I→                 | VKMV 6PK2260   |   | 1 |   |   |   |       |
|  |                    |               |   |  | VKM 31010  | 1 |   |   |   |   |       |
| <b>AUDI  100 (4A, C4) / 100 Avant (4A, C4) 2.8</b>          |                    |               |   |  |  |   |   |   |   |   |       |
|   | AAH                | 12/90 → 06/94 |   | VKMA 01200                             | 1  | 1 | 1 |   |   |   | T0100 |
|  |                    |               |   | VKM 11200                              | 1  |   |   |   |   |   |       |
|  |                    |               |   | VKM 21052                              |  | 1 |   |   |   |   |       |



AUDI

|  | AAH             | 12/90 → 06/94 |                           | VKPC 81800  |                                       |             |        |        |  |  |  |  |  |  |  |  |  |  |  |  |  |       |
|--|-----------------|---------------|---------------------------|---|---------------------------------------|-------------|--------|--------|--|--|--|--|--|--|--|--|--|--|--|--|--|-------|
|  | B(Alt) AAH      | 12/90 → 06/94 | AC,<br>CH 4A-N-023 927 I→ | VKMC 6PK1675<br>VKM 31010                         |                                       |             |        |        |  |  |  |  |  |  |  |  |  |  |  |  |  |       |
|  | B(Alt) AAH      | 12/90 → 06/94 | AC, CH 4A-N-023 927 I→    | VKMC 6PK2260<br>VKM 31010                         |                                       |             |        |        |  |  |  |  |  |  |  |  |  |  |  |  |  |       |
| <b>AUDI  100 (4A, C4) / 100 Avant (4A, C4) 4.2 V8 S4</b>   |                 |               |                           |   |                                       |             |        |        |  |  |  |  |  |  |  |  |  |  |  |  |  |       |
|  | ABH             | 10/92 → 06/94 |                           | VKMC _____<br>VKM _____<br>VKM _____<br>VKM _____ | 1<br>1<br>1                           | 2<br>2      | 1<br>1 | 1<br>1 |  |  |  |  |  |  |  |  |  |  |  |  |  |       |
|  | ABH             | 10/92 → 06/94 |                           | VKPC 81806  |                                       |             |        |        |  |  |  |  |  |  |  |  |  |  |  |  |  |       |
| <b>AUDI  100 (4A, C4) / 100 Avant (4A, C4) 2.4 D</b>       |                 |               |                           |   |                                       |             |        |        |  |  |  |  |  |  |  |  |  |  |  |  |  |       |
|  | AAS             | 12/90 → 06/94 |                           | —<br>VKM 11043<br>VKM 21031                       | 1<br>1                                | 1           | 2      |        |  |  |  |  |  |  |  |  |  |  |  |  |  | T0101 |
|  | AAS             | 12/90 → 06/94 |                           | VKPC 86619  |                                       |             |        |        |  |  |  |  |  |  |  |  |  |  |  |  |  |       |
|  | B(Alt) AAS      | 12/90 → 06/94 | AC                        | VKMC 6PK1705                                      |                                       |             |        |        |  |  |  |  |  |  |  |  |  |  |  |  |  |       |
| <b>AUDI  100 (4A, C4) / 100 Avant (4A, C4) 2.5 TDI</b>     |                 |               |                           |   |                                       |             |        |        |  |  |  |  |  |  |  |  |  |  |  |  |  |       |
|  | AAT             | 12/90 → 06/94 | → Mot. 038 460            | VKMA 01044<br>VKM 11043<br>VKM 21041              | 1<br>1                                | 1           | 1      |        |  |  |  |  |  |  |  |  |  |  |  |  |  | T0101 |
|  | AAT             | 12/90 → 06/94 | Mot. 038 461 I→           | VKMA 01025<br>VKM 11043<br>VKM 11072              | 2<br>1<br>1                           |             | 1      |        |  |  |  |  |  |  |  |  |  |  |  |  |  | T0101 |
|  | ABP             | 12/90 → 06/94 |                           | VKMA 01044<br>VKM 11043<br>VKM 21041              | 1<br>1                                | 1           | 1      |        |  |  |  |  |  |  |  |  |  |  |  |  |  | T0101 |
|  | AAT, ABP        | 12/90 → 06/94 |                           | VKPC 81805  |                                       |             |        |        |  |  |  |  |  |  |  |  |  |  |  |  |  |       |
|  | B(Alt) AAT, ABP | 12/90 → 06/94 | AC                        | VKMC 6PK1705                                      |                                       |             |        |        |  |  |  |  |  |  |  |  |  |  |  |  |  |       |
| <b>AUDI  200 (43) 2.1</b>                                  |                 |               |                           |   |                                       |             |        |        |  |  |  |  |  |  |  |  |  |  |  |  |  |       |
|  | WC              | 10/79 → 09/82 |                           | —   |                                       |             |        |        |  |  |  |  |  |  |  |  |  |  |  |  |  |       |
|  | WC              | 10/79 → 09/82 |                           | VKPC 81605  |                                       |             |        |        |  |  |  |  |  |  |  |  |  |  |  |  |  |       |
|  | B(Alt) WC       | 10/79 → 09/82 |                           | VKMC 11.5x790                                     |                                       |             |        |        |  |  |  |  |  |  |  |  |  |  |  |  |  |       |
|  | B(PS) WC        | 10/79 → 09/82 | → ICH 43-B-025 665        | VKMC 13AVx1000                                    |                                       |             |        |        |  |  |  |  |  |  |  |  |  |  |  |  |  |       |
|  | B(PS) WC        | 10/79 → 09/82 | CH 43-B-025 666 I→        | VKMC 13AVx990                                     |                                       |             |        |        |  |  |  |  |  |  |  |  |  |  |  |  |  |       |
|  | B(AC) WC        | 10/79 → 09/82 |                           | VKMC 13AVx915                                     |                                       |             |        |        |  |  |  |  |  |  |  |  |  |  |  |  |  |       |
| <b>AUDI  200 (43) 2.1 Turbo</b>                            |                 |               |                           |   |                                       |             |        |        |  |  |  |  |  |  |  |  |  |  |  |  |  |       |
|  | WJ              | 10/79 → 08/82 |                           | —   |                                       |             |        |        |  |  |  |  |  |  |  |  |  |  |  |  |  |       |
|  | WJ              | 10/79 → 08/82 |                           | VKPC 81605  |                                       |             |        |        |  |  |  |  |  |  |  |  |  |  |  |  |  |       |
|  | B(Alt) WJ       | 10/79 → 08/82 |                           | VKMC 11.5x790                                     |                                       |             |        |        |  |  |  |  |  |  |  |  |  |  |  |  |  |       |
|  | B(PS) WJ        | 10/79 → 08/82 | → ICH 43-B-025 665        | VKMC 13AVx1000                                    |                                       |             |        |        |  |  |  |  |  |  |  |  |  |  |  |  |  |       |
|  | B(PS) WJ        | 10/79 → 08/82 | CH 43-B-025 666 I→        | VKMC 13AVx990                                     |                                       |             |        |        |  |  |  |  |  |  |  |  |  |  |  |  |  |       |
|  | B(AC) WJ        | 10/79 → 08/82 |                           | VKMC 13AVx915                                     |                                       |             |        |        |  |  |  |  |  |  |  |  |  |  |  |  |  |       |
| <b>AUDI  200 (44, 44Q) / 200 Avant (44, 44Q) 2.1</b>       |                 |               |                           |   |                                       |             |        |        |  |  |  |  |  |  |  |  |  |  |  |  |  |       |
|  | WC              | 08/83 → 07/84 |                           | → ICH 44-E-012 000                                | —                                     |             |        |        |  |  |  |  |  |  |  |  |  |  |  |  |  |       |
|  | WC              | 08/83 → 07/84 |                           | CH 44-E-012 001 I→                                | VKMC 01031<br>VKMA 01031<br>VKM 21031 | 1<br>1<br>1 | 1<br>1 | 1<br>1 |  |  |  |  |  |  |  |  |  |  |  |  |  | T0020 |
|  | WC              | 08/83 → 07/84 |                           | VKPC 81605  |                                       |             |        |        |  |  |  |  |  |  |  |  |  |  |  |  |  |       |
| <b>AUDI  200 (44, 44Q) / 200 Avant (44, 44Q) 2.1 Turbo</b> |                 |               |                           |   |                                       |             |        |        |  |  |  |  |  |  |  |  |  |  |  |  |  |       |
|  | KG              | 08/83 → 01/88 |                           | VKMC 01031<br>VKMA 01031<br>VKM 21031             | 1<br>1<br>1                           | 1<br>1      | 1<br>1 |        |  |  |  |  |  |  |  |  |  |  |  |  |  | T0020 |
|  | KG              | 08/83 → 01/88 |                           | VKPC 81605  |                                       |             |        |        |  |  |  |  |  |  |  |  |  |  |  |  |  |       |
|  | B(Alt) KG       | 08/83 → 01/88 | → ICH 44-E-250 000        | VKMC 10AVx785                                     |                                       |             |        |        |  |  |  |  |  |  |  |  |  |  |  |  |  |       |
|  | B(Alt) KG       | 08/83 → 01/88 | CH 44-F-000 001 I→        | VKMC 11.2x820                                     |                                       |             |        |        |  |  |  |  |  |  |  |  |  |  |  |  |  |       |
| <b>AUDI  200 (44, 44Q) / 200 Avant (44, 44Q) 2.2</b>       |                 |               |                           |   |                                       |             |        |        |  |  |  |  |  |  |  |  |  |  |  |  |  |       |
|  | KU              | 08/84 → 07/85 |                           | VKMC 01031<br>VKMA 01031<br>VKM 21031             | 1<br>1<br>1                           | 1<br>1      | 1<br>1 |        |  |  |  |  |  |  |  |  |  |  |  |  |  | T0020 |

|  | KU              | 08/84 → 07/85 |  | VKPC 81605   |                       |        |   |  |   | 1      |  |       |
|--|-----------------|---------------|--|--|-----------------------|--------|---|--|---|--------|--|-------|
| <b>AUDI  200 (44, 44Q) / 200 Avant (44, 44Q) 2.2 20V</b>   |                 |               |  |  |                       |        |   |  |   |        |  |       |
|  | 3B              | 03/89 → 12/90 |  | VKM 21031  | 1                     | 1      |   |  |   |        |  | T0649 |
|  | 3B              | 03/89 → 12/90 | → ICH 44-J-246 281                     | VKPC 81605   |                       |        |   |  |   | 1      |  |       |
|  | 3B              | 03/89 → 12/90 | CH 44-J-246 282  →                     | VKPC 81606   |                       |        |   |  |   | 1      |  |       |
| <b>AUDI  200 (44, 44Q) / 200 Avant (44, 44Q) 2.2 Turbo</b> |                 |               |  |  |                       |        |   |  |   |        |  |       |
|  | 1B              | 02/88 → 12/91 | 120,<br>→ IMot. 001 570                | VKMC 01031<br>VKMA 01031<br>VKM 21031                          | 1<br>1<br>1           | 1<br>1 |   |  | 1 |        |  | T0020 |
|  | 1B              | 02/88 → 12/91 | 142,<br>Mot. 001 571  →                | VKMC 01032<br>VKMA 01032<br>VKM 21032                          | 1<br>1<br>1           | 1<br>1 |   |  | 1 |        |  | T0077 |
|  | 2B              | 02/88 → 12/90 | 120,<br>→ IMot. 001 068                | VKMC 01031<br>VKMA 01031<br>VKM 21031                          | 1<br>1<br>1           | 1<br>1 |   |  | 1 |        |  | T0020 |
|  | 2B              | 02/88 → 12/90 | 142,<br>Mot. 001 069  →                | VKMC 01032<br>VKMA 01032<br>VKM 21032                          | 1<br>1<br>1           | 1<br>1 |   |  | 1 |        |  | T0077 |
|  | MC              | 09/83 → 12/91 | 120,<br>→ IMot. 039 950                | VKMC 01031<br>VKMA 01031<br>VKM 21031                          | 1<br>1<br>1           | 1<br>1 |   |  | 1 |        |  | T0020 |
|  | MC              | 09/83 → 12/91 | 142,<br>Mot. 039 951  →                | VKMC 01032<br>VKMA 01032<br>VKM 21032                          | 1<br>1<br>1           | 1<br>1 |   |  | 1 |        |  | T0077 |
|  | 1B              | 02/88 → 12/91 | → IMot. 001 570,<br>→ ICH 44-J-200 099 | VKPC 81605   |                       |        |   |  |   | 1      |  |       |
|  | 1B              | 02/88 → 12/91 | Mot. 001 571  →,<br>CH 44-J-200 100  → | VKPC 81606   |                       |        |   |  |   | 1      |  |       |
|  | 2B              | 02/88 → 12/90 | → IMot. 001 068,<br>→ ICH 44-J-200 099 | VKPC 81605   |                       |        |   |  |   | 1      |  |       |
|  | 2B              | 02/88 → 12/90 | Mot. 001 069  →,<br>CH 44-J-200 100  → | VKPC 81606   |                       |        |   |  |   | 1      |  |       |
|  | MC              | 09/83 → 12/91 | → IMot. 039 950,<br>→ ICH 44-J-200 099 | VKPC 81605   |                       |        |   |  |   | 1      |  |       |
|  | MC              | 09/83 → 12/91 | Mot. 039 951  →,<br>CH 44-J-200 100  → | VKPC 81606   |                       |        |   |  |   | 1      |  |       |
| <b>AUDI  A2 (8ZO) 1.4</b>                                  |                 |               |  |  |                       |        |   |  |   |        |  |       |
|  | AUA, BBY        | 02/00 → 08/05 |  | VKMA 01121<br>VKM 11120<br>VKM 11124<br>VKM 21120<br>VKM 21121 | 2<br>1<br>1<br>1<br>1 | 2      | 2 |  |   |        |  | T0165 |
|  | AUA, BBY        | 02/00 → 08/05 |  | VKPC 81407   |                       |        |   |  |   | 1      |  |       |
|  | B(Alt) AUA, BBY | 02/00 → 08/05 | <b>AC</b>                              | VKMV 6PK745  |                       |        |   |  |   | 1      |  |       |
|  | B(Alt) AUA, BBY | 02/00 → 08/05 | <b>AC</b>                              | VKMA 31215<br>VKMV 6PK1084<br>VKM 31015                        | 1<br>1<br>1           |        |   |  |   | 1<br>1 |  |       |
| <b>AUDI  A2 (8ZO) 1.6 FSI</b>                              |                 |               |  |  |                       |        |   |  |   |        |  |       |
|  | BAD             | 05/02 → 08/05 |  | VKMA 01121<br>VKM 11120<br>VKM 11124<br>VKM 21120<br>VKM 21121 | 2<br>1<br>1<br>1<br>1 | 2      | 2 |  |   |        |  | T0165 |
|  | BAD             | 05/02 → 08/05 |  | VKPC 81419   |                       |        |   |  |   | 1      |  |       |
|  | B(Alt) BAD      | 05/02 → 08/05 | <b>AC</b>                              | VKMV 6PK736  |                       |        |   |  |   | 1      |  |       |
|  | B(Alt) BAD      | 05/02 → 08/05 | <b>AC</b>                              | VKMA 31216<br>VKMV 6PK1076<br>VKM 31015                        | 1<br>1<br>1           |        |   |  |   | 1<br>1 |  |       |



























| <b>B(Alt)</b>                    | AGN, APG  | 09/96 → 11/07 | AC | VKMA 31204<br>VKMV 6DK1195<br>VKM 31011                        | 1      |   | 1 |   |  |  |  |   |  |  |  |  |   |       |       |
|----------------------------------|---|---------------|----|--|--------|---|---|---|--|--|--|---|--|--|--|--|---|-------|-------|
| <b>AUDI  A3 (8L1) 1.8 Turbo</b>  |   |               |    |  |        |   |   |   |  |  |  |   |  |  |  |  |   |       |       |
|                                  | AGU, AJQ, APP, AQA,<br>ARX, ARY, ARZ, AUM,<br>AUQ | 12/96 → 11/07 |    | VKMA 01115<br>VKM 11115<br>VKM 21115                           | 1<br>1 | 1 | 1 |   |  |  |  |   |  |  |  |  |   | T0151 |       |
|                                  | AGU, AJQ, APP, AQA,<br>ARX, ARY, ARZ, AUM,<br>AUQ | 12/96 → 11/07 |    | VKMA 01116<br>VKM 11116<br>VKM 21115                           | 1<br>1 | 1 | 1 |   |  |  |  |   |  |  |  |  |   | T0151 |       |
|                                  | AGU, AJQ, APP, AQA,<br>ARX, ARY, ARZ, AUM,<br>AUQ | 12/96 → 11/07 |    | VKPC 81620   |        |   |   |   |  |  |  | 1 |  |  |  |  |   |       |       |
|                                  | AGU, AJQ, APP, AQA,<br>ARX, ARY, ARZ, AUM,<br>AUQ | 12/96 → 11/07 | AC | VKMA 31203<br>VKMV 6PK1120<br>VKM 31011                        | 1<br>1 |   | 1 |   |  |  |  |   |  |  |  |  |   |       |       |
| <b>B(Alt)</b>                    | AGU, AJQ, APP, AQA,<br>ARX, ARY, ARZ, AUM,<br>AUQ | 12/96 → 11/07 | AC | VKMA 31204<br>VKMV 6DK1195<br>VKM 31011                        | 1<br>1 |   | 1 |   |  |  |  |   |  |  |  |  |   |       |       |
| <b>AUDI  A3 (8L1) S3</b>         |   |               |    |  |        |   |   |   |  |  |  |   |  |  |  |  |   |       |       |
|                                  | AMK, APY, AUL                                     | 03/99 → 11/07 |    | VKMA 01115<br>VKM 11115<br>VKM 21115                           | 1<br>1 | 1 | 1 |   |  |  |  |   |  |  |  |  |   | T0151 |       |
|                                  | AMK, APY, AUL                                     | 03/99 → 11/07 |    | VKMA 01116<br>VKM 11116<br>VKM 21115                           | 1<br>1 | 1 | 1 | 1 |  |  |  |   |  |  |  |  |   | T0151 |       |
|                                  | BAM   | 10/01 → 11/07 |    | VKMA 01116<br>VKM 11116<br>VKM 21115                           | 1<br>1 | 1 | 1 | 1 |  |  |  |   |  |  |  |  |   | T0151 |       |
|                                  | AMK, APY, AUL, BAM                                | 03/99 → 11/07 |    | VKPC 81620   |        |   |   |   |  |  |  | 1 |  |  |  |  |   |       |       |
|                                  | AMK, APY, AUL, BAM                                | 03/99 → 11/07 | AC | VKMA 31203<br>VKMV 6PK1120<br>VKM 31011                        | 1<br>1 |   | 1 |   |  |  |  |   |  |  |  |  |   |       |       |
| <b>B(Alt)</b>                    | AMK, APY, AUL, BAM                                | 03/99 → 11/07 | AC | VKMA 31204<br>VKMV 6DK1195<br>VKM 31011                        | 1<br>1 |   | 1 |   |  |  |  |   |  |  |  |  |   |       |       |
| <b>AUDI  A3 (8L1) 1.9 TDI 90</b> |   |               |    |  |        |   |   |   |  |  |  |   |  |  |  |  |   |       |       |
|                                  | AGR   | 09/96 → 07/01 |    | VKMA 01130<br>VKM 11130<br>VKM 21004<br>VKM 21130              | 1<br>1 | 2 | 1 |   |  |  |  |   |  |  |  |  | 5 | T0173 |       |
|                                  | AGR   | 09/96 → 07/01 |    | VKMA 01131<br>VKM 11130<br>VKM 21004<br>VKM 21130<br>VKM 21131 | 1<br>1 | 3 | 1 |   |  |  |  |   |  |  |  |  |   | 8     | T0173 |
|                                  | ALH   | 09/96 → 07/01 |    | VKMA 01131<br>VKM 11130<br>VKM 21004<br>VKM 21130<br>VKM 21131 | 1<br>1 | 3 | 1 |   |  |  |  |   |  |  |  |  |   | 8     | T0173 |
|                                  | ALH   | 09/96 → 07/01 |    | VKMA 01251<br>VKM 11130<br>VKM 21004                           | 1<br>1 | 3 | 1 |   |  |  |  |   |  |  |  |  |   | 8     | T0173 |

































|  |  |  |                   |  |  |  |  |  |  |  |
|--|---|---|--|--|---|---|---|---|---|---|
|  |   |   |  | VKM 21130<br>VKM 21131   | 1<br>1  |   |   |   |   |   |
|                                      | AGR, ALH  | 09/96 → 07/01   |  | VKPC 81623   |   |   | 1   |   |   |   |
|                                      | <b>B(Alt)</b> AGR, ALH  | 09/96 → 12/97   | AC,<br>→ ICH 8L-V-200 000  | VKMA 31005<br>VKMV 6PK1660<br>VKM 31002<br>VKM 31018                               | 1<br>1<br>1   | 1   |   |   |   | 1<br>1  |
|  | <b>B(Alt)</b> AGR, ALH  | 01/98 → 07/01   | AC,<br>CH 8L-W-000 001 I→  | VKMA 31005<br>VKMV 6PK1660<br>VKM 31002<br>VKM 31018                               | 1<br>1<br>1   | 1   |   |   |   | 1<br>1  |
|  | <b>B(Alt)</b> AGR, ALH  | 09/96 → 12/97   | AC, → ICH 8L-V-200 000   | VKMA 31014<br>VKMV 6PK1660<br>VKM 31002<br>VKM 31012                               | 1<br>1<br>1   | 1   | 1   |   |   | 2<br>1<br>1   |
|  | <b>B(Alt)</b> AGR, ALH  | 01/98 → 07/01   | AC,<br>CH 8L-W-000 001 I→  | VKMA 31014<br>VKMV 6PK1660<br>VKM 31002<br>VKM 31012                               | 1<br>1<br>1   | 1   | 1   |   |   | 1<br>1  |
|                                      | AGR   | 09/96 → 07/01   |  | VKM_____   |   |   |   |   | 1   |   |
|  | ALH   | 09/96 → 07/01   | → ICH 8L-3-070 000,<br>8L-31222 000  | VKM_____   |   |   |   |   | 1   |   |
|  | ALH   | 09/96 → 07/01   | CH 8L-3-070 001,<br>8L-31222 001 I→  | VKM_____   |   |   |   |   | 1   |   |
| <b>AUDI  A3 (8L1) 1.9 TDI 100</b>   |   |   |  |  |   |   |   |   |   |   |
|                                    | ATD   | 10/00 → 11/07   |  → Mot. 165 000 | VKMA 01942<br>VKM 11142<br>VKM 11145<br>VKM 21142                                  | 1<br>1<br>1   | 1   | 1   | 1   |   | 3<br>T0184  |
|  | ATD   | 10/00 → 11/07   | → Mot. 165 000   | VKMA 01142<br>VKM 11142<br>VKM 21142   | 1<br>1  | 1   | 1   |   |   | 3<br>T0184  |
|  | ATD   | 10/00 → 11/07   | Mot. 165 001 I→  | VKMA 01250<br>VKM 11250<br>VKM 21147   | 1<br>1  | 1   | 1   |   |   | T0184   |
|  | AXR   | 10/00 → 11/07   |  | VKMA 01250<br>VKM 11250<br>VKM 21147   | 1<br>1  | 1   | 1   |   |   | T0184   |
|                                    | ATD, AXR  | 10/00 → 11/07   | → ICH 8L-2-150 000   | VKPC 81626   |   |   |   |   | 1   |   |
|  | ATD, AXR  | 10/00 → 11/07   | CH 8L-3-000 001 I→   | VKPC 81303   |   |   |   |   | 1   |   |
|                                    | <b>B(Alt)</b> ATD, AXR  | 10/00 → 11/07   | AC   | VKMA 31001<br>VKMV 6DK1195<br>VKM 31019  | 1<br>1  | 1   | 1   |   |   |   |
|  | <b>B(Alt)</b> ATD, AXR  | 10/00 → 11/07   | AC   | VKMA 31001<br>VKMV 6DK1195<br>VKM 31019  | 1<br>1  | 1   | 1   |   |   |   |
|                                    | ATD, AXR  | 10/00 → 11/07   |  | VKM_____   |   |   |   |   | 1   |   |
| <b>AUDI  A3 (8L1) 1.9 TDI 110</b> |   |   |  |  |   |   |   |   |   |   |
|                                    | AHF   | 08/97 → 07/01   | → Mot. 006 065   | VKMA 01130<br>VKM 11130<br>VKM 21004<br>VKM 21130                                  | 1<br>1<br>1   | 2   | 1   |   |   | 5<br>T0173  |
|  | AHF   | 08/97 → 07/01   | Mot. 006 066 I→,<br>→ Mot. 595 000   | VKMA 01131<br>VKM 11130<br>VKM 21004<br>VKM 21130<br>VKM 21131                     | 1<br>1  | 3   | 1   |   |   | 8<br>T0173  |
|  | AHF   | 08/97 → 07/01   | Mot. 595 001 I→  | VKMA 01251<br>VKM 11130<br>VKM 21004<br>VKM 21130<br>VKM 21131                     | 1<br>1  | 3   | 1   |   |   | 8<br>T0173  |
|  | ASV   | 08/97 → 07/01   | → Mot. 150 000   | VKMA 01131<br>VKM 11130<br>VKM 21004   | 1<br>1  | 3   | 1   |   |   | 8<br>T0173  |

|                                   |                             |               |                                     | VKM 21130     |   | 1 |   |   |   |   |  |   |   |   |  |   |       |       |
|-----------------------------------|-----------------------------|---------------|-------------------------------------|---------------|---|---|---|---|---|---|--|---|---|---|--|---|-------|-------|
|                                   |                             |               |                                     | VKM 21131     |   | 1 |   |   |   |   |  |   |   |   |  |   |       |       |
|                                   | ASV                         | 08/97 → 07/01 | Mot. 150 001 I→                     | VKMA 01251    | 1 | 3 | 1 |   |   |   |  |   |   |   |  | 8 | T0173 |       |
|                                   |                             |               |                                     | VKM 11130     | 1 |   |   |   |   |   |  |   |   |   |  |   |       |       |
|                                   |                             |               |                                     | VKM 21004     |   |   | 1 |   |   |   |  |   |   |   |  |   |       |       |
|                                   |                             |               |                                     | VKM 21130     |   |   | 1 |   |   |   |  |   |   |   |  |   |       |       |
|                                   |                             |               |                                     | VKM 21131     |   |   | 1 |   |   |   |  |   |   |   |  |   |       |       |
|                                   | AHF, ASV                    | 08/97 → 07/01 |                                     | VKPC 81623    |   |   |   |   |   | 1 |  |   |   |   |  |   |       |       |
|                                   | <b>B(Alt)</b> AHF, ASV      | 08/97 → 12/97 | AC,<br>→ ICH 8L-V-200 000           | VKMOV 6PK906  |   |   | 1 |   |   |   |  |   |   |   |  |   |       |       |
|                                   |                             |               |                                     | VKM 31002     |   | 1 |   |   |   |   |  |   |   |   |  | 1 |       |       |
|                                   |                             |               |                                     | VKM 31018     | 1 |   |   |   |   |   |  |   |   |   |  | 1 |       |       |
| <b>B(Alt)</b>                     | AHF, ASV                    | 08/97 → 12/97 | AC, → ICH 8L-V-200 000              | VKMA 31005    | 1 | 1 | 1 |   |   |   |  |   |   |   |  | 2 |       |       |
|                                   |                             |               |                                     | VKMOV 6PK1660 |   |   | 1 |   |   |   |  |   |   |   |  |   |       |       |
|                                   |                             |               |                                     | VKM 31002     |   | 1 |   |   |   |   |  |   |   |   |  | 1 |       |       |
|                                   |                             |               |                                     | VKM 31018     | 1 |   |   |   |   |   |  |   |   |   |  | 1 |       |       |
| <b>B(Alt)</b>                     | AHF, ASV                    | 01/98 → 07/01 | AC,<br>CH 8L-W-000 001 I→           | VKMOV 6PK906  |   |   | 1 |   |   |   |  |   |   |   |  |   |       | 1     |
|                                   |                             |               |                                     | VKM 31002     |   |   | 1 |   |   |   |  |   |   |   |  |   |       |       |
|                                   |                             |               |                                     | VKM 31012     | 1 |   |   |   |   |   |  |   |   |   |  |   |       |       |
| <b>B(Alt)</b>                     | AHF, ASV                    | 01/98 → 07/01 | AC,<br>CH 8L-W-000 001 I→           | VKMA 31014    | 1 | 1 | 1 |   |   |   |  |   |   |   |  | 1 |       |       |
|                                   |                             |               |                                     | VKMOV 6PK1660 |   |   | 1 |   |   |   |  |   |   |   |  |   |       |       |
|                                   |                             |               |                                     | VKM 31002     |   | 1 |   |   |   |   |  |   |   |   |  |   |       | 1     |
|                                   |                             |               |                                     | VKM 31012     | 1 |   |   |   |   |   |  |   |   |   |  |   |       |       |
|                                   | AHF, ASV                    | 08/97 → 07/01 | → ICH 8L-3-070 000,<br>8L-31222 000 | VKM_____      |   |   |   |   |   |   |  |   | 1 |   |  |   |       |       |
|                                   | AHF, ASV                    | 08/97 → 07/01 | CH 8L-3-070 001,<br>8L-31222 001 I→ | VKM_____      |   |   |   |   |   |   |  |   |   | 1 |  |   |       |       |
| <b>AUDI  A3 (8L1) 1.9 TDI 130</b> |                             |               |                                     |               |   |   |   |   |   |   |  |   |   |   |  |   |       |       |
|                                   | ASZ                         | 08/00 → 11/07 | → I Mot. 115 000                    | VKMA 01942    | 1 | 1 | 1 | 1 |   |   |  |   |   |   |  |   | 3     | T0184 |
|                                   |                             |               |                                     | VKM 11142     | 1 |   |   |   |   |   |  |   |   |   |  |   |       |       |
|                                   |                             |               |                                     | VKM 11145     |   |   |   | 1 |   |   |  |   |   |   |  |   |       |       |
|                                   |                             |               |                                     | VKM 21142     |   |   | 1 |   |   |   |  |   |   |   |  |   |       |       |
|                                   | ASZ                         | 08/00 → 11/07 | → I Mot. 115 000                    | VKMA 01142    | 1 | 1 | 1 |   |   |   |  |   |   |   |  |   | 3     | T0184 |
|                                   |                             |               |                                     | VKM 11142     | 1 |   |   |   |   |   |  |   |   |   |  |   |       |       |
|                                   |                             |               |                                     | VKM 21142     |   |   | 1 |   |   |   |  |   |   |   |  |   |       |       |
|                                   | ASZ                         | 08/00 → 11/07 | Mot. 115 001 I→                     | VKMA 01250    | 1 | 1 | 1 |   |   |   |  |   |   |   |  |   |       | T0184 |
|                                   |                             |               |                                     | VKM 11250     | 1 |   |   |   |   |   |  |   |   |   |  |   |       |       |
|                                   |                             |               |                                     | VKM 21147     |   |   | 1 |   |   |   |  |   |   |   |  |   |       |       |
|                                   | ASZ                         | 08/00 → 11/07 | → ICH 8L-2-150 000                  | VKPC 81626    |   |   |   |   |   |   |  |   | 1 |   |  |   |       |       |
|                                   | ASZ                         | 08/00 → 11/07 | CH 8L-3-000 001 I→                  | VKPC 81303    |   |   |   |   |   |   |  |   | 1 |   |  |   |       |       |
|                                   | <b>B(Alt)</b> ASZ           | 08/00 → 11/07 | AC                                  | VKMOV 6PK1120 |   |   |   | 1 |   |   |  |   |   |   |  |   |       |       |
|                                   |                             |               |                                     | VKM 31019     | 1 |   |   |   |   |   |  |   |   |   |  |   |       |       |
| <b>B(Alt)</b>                     | ASZ                         | 08/00 → 11/07 | AC                                  | VKMA 31001    | 1 |   | 1 |   |   |   |  |   |   |   |  |   |       |       |
|                                   |                             |               |                                     | VKMOV 6DK1195 |   |   | 1 |   |   |   |  |   |   |   |  |   |       |       |
|                                   |                             |               |                                     | VKM 31019     | 1 |   |   |   |   |   |  |   |   |   |  |   |       |       |
|                                   | ASZ                         | 08/00 → 11/07 |                                     | VKM_____      |   |   |   |   |   |   |  |   | 1 |   |  |   |       |       |
| <b>AUDI  A3 (8P1) 1.6</b>         |                             |               |                                     |               |   |   |   |   |   |   |  |   |   |   |  |   |       |       |
|                                   | BGU, BSE, BSF               | 05/03 → 11/07 |                                     | VKMA 01113    | 1 |   | 1 |   |   |   |  |   |   |   |  |   |       | T0149 |
|                                   |                             |               |                                     | VKM 11113     | 1 |   |   |   |   |   |  |   |   |   |  |   |       |       |
|                                   | BGU, BSE, BSF               | 05/03 → 11/07 |                                     | VKPC 81408    |   |   |   |   |   |   |  | 1 |   |   |  |   |       |       |
|                                   | <b>B(Alt)</b> BGU, BSE, BSF | 05/03 → 11/07 | AC                                  | VKMOV 6PK900  |   |   |   | 1 |   |   |  |   |   |   |  |   |       |       |
|                                   |                             |               |                                     | VKM 31011     | 1 |   |   |   |   |   |  |   |   |   |  |   |       |       |
| <b>B(Alt)</b>                     | BGU, BSE, BSF               | 05/03 → 11/07 | AC                                  | VKMOV 6PK1042 |   |   |   | 1 |   |   |  |   |   |   |  |   |       |       |
|                                   |                             |               |                                     | VKM 31011     | 1 |   |   |   |   |   |  |   |   |   |  |   |       |       |
| <b>AUDI  A3 (8P1) 1.6 FSI</b>     |                             |               |                                     |               |   |   |   |   |   |   |  |   |   |   |  |   |       |       |
|                                   | BAG, BLF, BLP               | 08/03 → 11/07 |                                     | OXOXOXO       |   |   |   |   |   |   |  |   |   |   |  |   |       |       |
|                                   | BAG, BLF, BLP               | 08/03 → 11/07 |                                     | VKPC 81501    |   |   |   |   |   |   |  |   | 1 |   |  |   |       |       |
|                                   | <b>B(Alt)</b> BAG, BLF, BLP | 08/03 → 11/07 | AC                                  | VKMOV 6PK1087 |   |   |   | 1 |   |   |  |   |   |   |  |   |       |       |
| <b>B(Alt)</b>                     | BAG, BLF, BLP               | 08/03 → 11/07 | AC                                  | VKMOV 6PK1736 |   |   |   | 1 |   |   |  |   |   |   |  |   |       |       |
|                                   |                             |               |                                     | VKM 31044     |   |   |   |   | 1 |   |  |   |   |   |  |   |       |       |
|                                   |                             |               |                                     | VKM 31047     | 1 |   |   |   |   |   |  |   |   |   |  |   |       |       |
| <b>AUDI  A3 (8P1) 1.8 TFSI</b>    |                             |               |                                     |               |   |   |   |   |   |   |  |   |   |   |  |   |       |       |
|                                   | BYT, BZB                    | 11/06 → 11/07 |                                     | OXOXOXO       |   |   |   |   |   |   |  |   |   |   |  |   |       |       |





















































|  |  |  |  |  |  |  |  |  |  |  |  |
|--|---|---|---|--|---|---|---|---|---|---|---|
|  |   |   |   | VKM 21220<br>VKM_____  | 1<br>1  |   |   |   |   |   |   |
|  | BLR, BLX, BLY, BVY,<br>BVZ  | 09/04 → 11/07   |   | VKMA 01222<br>VKM 11222<br>VKM 21220<br>VKM_____                                   | 1<br>1  | 2<br>1<br>1   | 1   |   |   |   | 2 T0247   |
|    | AXW, BLR, BLX, BLY,<br>BMB, BVY, BVZ  | 09/04 → 11/07   |   | VKPC 81220   |   |   |   | 1   |   |   |   |
|    | <b>B(Alt)</b> AXW, BLR, BLX, BLY,<br>BMB, BVY, BVZ                                | 09/04 → 11/07   | <i>AC</i>   | VKMOV 6PK900<br>VKM 31011  | 1   |   | 1   |   |   |   |   |
|  | <b>B(Alt)</b> AXW, BLR, BLX, BLY,<br>BMB, BVY, BVZ                                | 09/04 → 11/07   | <b>AC</b>   | VKMOV 6PK1042<br>VKM 31011   | 1   |   | 1   |   |   |   |   |
| <b>AUDI  A3 Sportback (8PA) 2.0 TFSI</b>      |   |   |   |  |   |   |   |   |   |   |   |
|    | AXX, BPY, BWA   | 09/04 → 11/07   |   | VKMA 01222<br>VKM 11222<br>VKM 21220<br>VKM_____                                   | 1<br>1  | 2<br>1<br>1   | 1   |   |   |   | 2 T0247   |
|    | AXX, BPY, BWA   | 09/04 → 11/07   |   | —  |   |   |   | 1   |   |   |   |
|    | <b>B(Alt)</b> AXX, BPY, BWA   | 09/04 → 11/07   | <i>AC</i>   | VKMOV 6PK953   |   |   | 1   |   |   |   |   |
|  | <b>B(Alt)</b> AXX, BPY, BWA   | 09/04 → 11/07   | <b>AC</b>   | VKMOV 6PK1054  |   |   | 1   |   |   |   |   |
| <b>AUDI  A3 Sportback (8PA) 3.2 V6</b>        |   |   |   |  |   |   |   |   |   |   |   |
|    | BMJ   | 09/04 → 11/07   |   | <del>OXOXOXO</del>   |   |   |   |   |   |   |   |
|   | BMJ   | 09/04 → 11/07   |   | —  |   |   |   | 1   |   |   |   |
|    | <b>B(Alt)</b> BMJ   | 09/04 → 11/07   | <i>AC</i> ,<br>→ ICH 8P-7-103 000   | VKMOV 6PK1240  |   |   | 1   |   |   |   |   |
|  | <b>B(Alt)</b> BMJ   | 09/04 → 11/07   | <b>AC</b> , → ICH 8P-7-103 000  | VKMOV 6PK1620  |   |   | 1   |   |   |   |   |
| <b>AUDI  A3 Sportback (8PA) 1.9 TDI</b>     |   |   |   |  |   |   |   |   |   |   |   |
|    | BKC, BLS, BXE   | 09/04 → 11/07   |   | VKMA 01250<br>VKM 11250<br>VKM 21147   | 1<br>1  | 1<br>1  | 1   |   |   |   | T0184   |
|    | BKC, BLS, BXE   | 09/04 → 11/07   |   | VKPC 81418   |   |   |   | 1   |   |   |   |
|    | <b>B(Alt)</b> BKC   | 09/04 → 12/05   | <i>AC</i> ,<br>→ ICH 8P-5A200 000,<br>8P-5B050 000                                | VKMOV 6PK950<br>VKM 31022  | 1   |   | 1   |   |   |   |   |
|  | <b>B(Alt)</b> BKC   | 09/04 → 12/05   | <b>AC</b> ,<br>→ ICH 8P-5A200 000,<br>8P-5B050 000                                | VKMOV 6PK1050<br>VKM 31022   | 1   |   | 1   |   |   |   |   |
|  | <b>B(Alt)</b> BKC   | 01/06 → 11/07   | <i>AC</i> , CH 8P-6A000 001,<br>8P-6B000 001  →                                   | VKMOV 6PK950<br>VKM 31054  | 1   |   | 1   |   |   |   |   |
|  | <b>B(Alt)</b> BKC   | 01/06 → 11/07   | <b>AC</b> , CH 8P-6A000 001,<br>8P-6B000 001  →                                   | VKMOV 6PK1050<br>VKM 31054   | 1   |   | 1   |   |   |   |   |
|  | <b>B(Alt)</b> BLS, BXE  | 09/04 → 11/07   | <i>AC</i>   | VKMOV 6PK950<br>VKM 31054  | 1   |   | 1   |   |   |   |   |
|  | <b>B(Alt)</b> BLS, BXE  | 09/04 → 11/07   | <b>AC</b>   | VKMOV 6PK1050<br>VKM 31054   | 1   |   | 1   |   |   |   |   |
|    | BKC, BLS, BXE   | 09/04 → 11/07   |   | VKM_____   |   |   |   | 1   |   |   |   |
| <b>AUDI  A3 Sportback (8PA) 2.0 TDI 136</b> |   |   |   |  |   |   |   |   |   |   |   |
|    | AZV   | 09/04 → 11/07   |   | VKMA 01255<br>VKM 11255<br>VKM 21147<br>VKM 21256                                  | 1<br>1  | 2<br>1<br>1   | 1   |   |   |   | 5 T0184   |
|    | AZV   | 09/04 → 11/07   |   | VKPC 81627   |   |   |   | 1   |   |   |   |
|    | <b>B(Alt)</b> AZV   | 09/04 → 11/07   | <i>AC</i>   | VKMOV 6PK950<br>VKM 31022  | 1   |   | 1   |   |   |   |   |
|  | <b>B(Alt)</b> AZV   | 09/04 → 11/07   | <b>AC</b>   | VKMOV 6PK1050<br>VKM 31022   | 1   |   | 1   |   |   |   |   |



|  | AZV                                   | 09/04 → 11/07 |           | VKM _____          |            |   |   |   |   |   |  | 1 |         |
|--|---------------------------------------|---------------|-----------|--------------------|------------|---|---|---|---|---|--|---|---------|
| <b>AUDI  A3 Sportback (8PA) 2.0 TDI 140</b>        |                                       |               |           |                    |            |   |   |   |   |   |  |   |         |
|  | BKD                                   | 09/04 → 11/07 |           | VKMA 01255         | 1          | 2 | 1 |   |   |   |  |   | 5 T0184 |
|  |                                       |               |           | VKM 11255          | 1          |   |   |   |   |   |  |   |         |
|  |                                       |               |           | VKM 21147          |            | 1 |   |   |   |   |  |   |         |
|  |                                       |               |           | VKM 21256          |            | 1 |   |   |   |   |  |   |         |
|  | BMM                                   | 06/05 → 11/07 |           | VKMA 01250         | 1          | 1 | 1 |   |   |   |  |   | T0184   |
|  |                                       |               |           | VKM 11250          | 1          |   |   |   |   |   |  |   |         |
|  |                                       |               |           | VKM 21147          |            | 1 |   |   |   |   |  |   |         |
|  | BKD                                   | 09/04 → 11/07 |           | VKPC 81627         |            |   |   |   |   | 1 |  |   |         |
|  | BMM                                   | 06/05 → 11/07 |           | VKPC 81303         |            |   |   |   |   | 1 |  |   |         |
|  | <b>B(Alt)</b> BKD                     | 09/04 → 11/07 | <b>AC</b> | VKMOV 6PK1050      |            |   | 1 |   |   |   |  |   |         |
|  |                                       |               |           | VKM 31022          | 1          |   |   |   |   |   |  |   |         |
|  | <b>B(Alt)</b> BKD                     | 11/05 → 11/07 | <b>AC</b> | VKMOV 6PK950       |            |   | 1 |   |   |   |  |   |         |
|  |                                       |               |           | VKM 31022          | 1          |   |   |   |   |   |  |   |         |
|  | <b>B(Alt)</b> BMM                     | 06/05 → 11/07 | <b>AC</b> | VKMOV 6PK950       |            |   | 1 |   |   |   |  |   |         |
|  |                                       |               |           | VKM 31054          | 1          |   |   |   |   |   |  |   |         |
|  | <b>B(Alt)</b> BMM                     | 06/05 → 11/07 | <b>AC</b> | VKMOV 6PK1050      |            |   | 1 |   |   |   |  |   |         |
|  |                                       |               |           | VKM 31054          | 1          |   |   |   |   |   |  |   |         |
|  | BKD                                   | 09/04 → 11/07 |           | VKM _____          |            |   |   |   |   | 1 |  |   |         |
| <b>AUDI  A3 Sportback (8PA) 2.0 TDI 170</b>        |                                       |               |           |                    |            |   |   |   |   |   |  |   |         |
|  | BMN                                   | 03/06 → 11/07 |           | VKMA _____         | 1          | 2 | 1 |   |   |   |  |   | 5 T0184 |
|  |                                       |               |           | VKM 11255          | 1          |   |   |   |   |   |  |   |         |
|  |                                       |               |           | VKM 21147          |            | 1 |   |   |   |   |  |   |         |
|  |                                       |               |           | VKM _____          |            | 1 |   |   |   |   |  |   |         |
|  | BMN                                   | 03/06 → 11/07 |           | VKPC _____         |            |   |   |   |   | 1 |  |   |         |
|  | <b>B(Alt)</b> BMN                     | 03/06 → 11/07 | <b>AC</b> | VKMOV 6PK950       |            |   | 1 |   |   |   |  |   |         |
|  |                                       |               |           | VKM 31022          | 1          |   |   |   |   |   |  |   |         |
|  | <b>B(Alt)</b> BMN                     | 03/06 → 11/07 | <b>AC</b> | VKMOV 6PK1050      |            |   | 1 |   |   |   |  |   |         |
|  |                                       |               |           | VKM 31022          | 1          |   |   |   |   |   |  |   |         |
|  | BMN                                   | 03/06 → 11/07 |           | VKM _____          |            |   |   |   |   | 1 |  |   |         |
| <b>AUDI  A4 (8D2, B5) / A4 Avant (8D5, B5) 1.6</b> |                                       |               |           |                    |            |   |   |   |   |   |  |   |         |
|  | ADP                                   | 01/95 → 12/97 |           | VKMA 01006         | 1          |   | 1 |   |   |   |  |   | 2 T0124 |
|  |                                       |               |           | VKM 11003          | 1          |   |   |   |   |   |  |   |         |
|  | AHL, ALZ, ANA, ARM                    | 01/95 → 09/01 |           | VKMA 01113         | 1          |   | 1 |   |   |   |  |   | T0149   |
|  |                                       |               |           | VKM 11113          | 1          |   |   |   |   |   |  |   |         |
|  | ADP                                   | 01/95 → 07/00 | 2)        | VKPA 81402         |            |   |   |   |   | 1 |  |   |         |
|  |                                       |               |           | VKPC 81402         |            |   |   |   |   | 1 |  |   |         |
|  | AHL, ALZ, ANA, ARM                    | 01/95 → 09/01 |           | VKPC 81408         |            |   |   |   |   | 1 |  |   |         |
|  | <b>B(Alt)</b> ADP, AHL, ALZ, ANA, ARM | 01/95 → 09/01 | <b>AC</b> | VKMOV 5PK1300      |            |   | 1 |   |   |   |  |   |         |
|  |                                       |               |           | VKM 31033          | 1          |   |   |   |   |   |  |   |         |
|  | <b>B(Alt)</b> ADP, AHL, ALZ, ANA, ARM | 01/95 → 09/01 | <b>AC</b> | VKMOV 4PK855       |            |   | 1 |   |   |   |  |   |         |
|  |                                       |               |           | VKM 31033          | 1          |   |   |   |   |   |  |   |         |
| <b>AUDI  A4 (8D2, B5) / A4 Avant (8D5, B5) 1.8</b> |                                       |               |           |                    |            |   |   |   |   |   |  |   |         |
|  | ADR                                   | 01/95 → 09/01 |           | → ICH 8D-T-155 000 | VKMA 01907 | 1 | 1 | 1 | 1 |   |  |   | 1 T0152 |
|  |                                       |               |           |                    | VKM 11007  | 1 |   |   |   |   |  |   |         |
|  |                                       |               |           |                    | VKM 11009  |   |   |   |   | 1 |  |   |         |
|  |                                       |               |           |                    | VKM 21004  |   |   |   |   | 1 |  |   |         |
|  | ADR                                   | 01/95 → 09/01 |           | → ICH 8D-T-155 000 | VKMA 01007 | 1 | 1 | 1 |   |   |  |   | 1 T0152 |
|  |                                       |               |           |                    | VKM 11007  | 1 |   |   |   |   |  |   |         |
|  |                                       |               |           |                    | VKM 21004  |   |   | 1 |   |   |  |   |         |
|  | ADR                                   | 01/95 → 09/01 |           | CH 8D-T-155 001 I→ | VKMA 01908 | 1 | 1 | 1 | 1 |   |  |   | 1 T0152 |
|  |                                       |               |           |                    | VKM 11008  | 1 |   |   |   |   |  |   |         |
|  |                                       |               |           |                    | VKM 11009  |   |   |   |   | 1 |  |   |         |
|  |                                       |               |           |                    | VKM 21004  |   |   |   |   | 1 |  |   |         |
|  | ADR                                   | 01/95 → 09/01 |           | CH 8D-T-155 001 I→ | VKMA 01008 | 1 | 1 | 1 |   |   |  |   | 1 T0152 |
|  |                                       |               |           |                    | VKM 11008  | 1 |   |   |   |   |  |   |         |
|  |                                       |               |           |                    | VKM 21004  |   |   | 1 |   |   |  |   |         |
|  | AFY                                   | 04/95 → 09/01 |           | 5)                 | VKMA 01908 | 1 | 1 | 1 | 1 |   |  |   | 1 T0152 |
|  |                                       |               |           |                    | VKM 11008  | 1 |   |   |   |   |  |   |         |
|  |                                       |               |           |                    | VKM 11009  |   |   |   |   | 1 |  |   |         |
|  |                                       |               |           |                    | VKM 21004  |   |   |   |   | 1 |  |   |         |



|  |  |  |  |  |  |  |  |  |  |  |  |  |  |  |  |  |  |  |  |  |  |  |  |  |  |  |  |  |  |  |  |  |  |  |  |  |  |  |  |  |  |  |  |  |  |  |  |  |  |  |  |  |  |  |  |  |  |  |  |  |  |  |  |  |  |  |  |  |  |  |  |  |  |  |  |  |  |  |  |  |  |  |  |  |  |  |  |  |  |  |  |  |  |  |  |  |  |  |  |  |  |  |  |  |  |  |  |  |  |  |  |  |  |  |  |  |  |  |  |  |  |  |  |  |  |  |  |  |  |  |  |  |  |  |  |  |  |  |  |  |  |  |  |  |  |  |  |  |  |  |  |  |  |  |  |  |  |  |  |  |  |  |  |  |  |  |  |  |  |  |  |  |  |  |  |  |  |  |  |  |  |  |  |  |  |  |  |  |  |  |  |  |  |  |  |  |  |  |  |  |  |  |  |  |  |  |  |  |  |  |  |  |  |  |  |  |  |  |  |  |  |  |  |  |  |  |  |  |  |  |  |  |  |  |  |  |  |  |  |  |  |  |  |  |  |  |  |  |  |  |  |  |  |  |  |  |  |  |  |  |  |  |  |  |  |  |  |  |  |  |  |  |  |  |  |  |  |  |  |  |  |  |  |  |  |  |  |  |  |  |  |  |  |  |  |  |  |  |  |  |  |  |  |  |  |  |  |  |  |  |  |  |  |  |  |  |  |  |  |  |  |  |  |  |  |  |  |  |  |  |  |  |  |  |  |  |  |  |  |  |  |  |  |  |  |  |  |  |  |  |  |  |  |  |  |  |  |  |  |  |  |  |  |  |  |  |  |  |  |  |  |  |
|---|---|---|--|---|---|---|---|---|---|---|---|---|---|---|---|---|---|---|---|---|---|---|---|---|---|---|---|---|---|---|---|---|---|---|---|---|---|---|---|---|---|---|---|---|---|---|---|---|---|---|---|---|---|---|---|---|---|---|---|---|---|---|---|---|---|---|---|---|---|---|---|---|---|---|---|---|---|---|---|---|---|---|---|---|---|---|---|---|---|---|---|---|---|---|---|---|---|---|---|---|---|---|---|---|---|---|---|---|---|---|---|---|---|---|---|---|---|---|---|---|---|---|---|---|---|---|---|---|---|---|---|---|---|---|---|---|---|---|---|---|---|---|---|---|---|---|---|---|---|---|---|---|---|---|---|---|---|---|---|---|---|---|---|---|---|---|---|---|---|---|---|---|---|---|---|---|---|---|---|---|---|---|---|---|---|---|---|---|---|---|---|---|---|---|---|---|---|---|---|---|---|---|---|---|---|---|---|---|---|---|---|---|---|---|---|---|---|---|---|---|---|---|---|---|---|---|---|--|--|--|--|--|--|--|--|--|--|--|--|--|--|--|--|--|--|--|--|--|--|--|--|--|--|--|--|--|--|--|--|--|--|--|--|--|--|--|--|--|--|--|--|--|--|--|--|--|--|--|--|--|--|--|--|--|--|--|--|--|--|--|--|--|--|--|--|--|--|--|--|--|--|--|--|--|--|--|--|--|--|--|--|--|--|--|--|--|--|--|--|--|--|--|--|--|--|--|--|--|--|--|--|--|--|--|--|--|--|--|--|--|--|--|--|--|--|--|--|--|--|--|--|--|--|--|--|--|--|--|--|--|--|--|--|--|--|--|--|--|--|--|--|--|
| AFY   | 04/95 → 09/01   | 5)  | VKMA 01008<br>VKM 11008  |   |   |   |   |   |   |   |   |   |   |   |   |   |   |   |   |   |   |   |   |   |   |   |   |   |   |   |   |   |   |   |   |   |   |   |   |   |   |   |   |   |   |   |   |   |   |   |   |   |   |   |   |   |   |   |   |   |   |   |   |   |   |   |   |   |   |   |   |   |   |   |   |   |   |   |   |   |   |   |   |   |   |   |   |   |   |   |   |   |   |   |   |   |   |   |   |   |   |   |   |   |   |   |   |   |   |   |   |   |   |   |   |   |   |   |   |   |   |   |   |   |   |   |   |   |   |   |   |   |   |   |   |   |   |   |   |   |   |   |   |   |   |   |   |   |   |   |   |   |   |   |   |   |   |   |   |   |   |   |   |   |   |   |   |   |   |   |   |   |   |   |   |   |   |   |   |   |   |   |   |   |   |   |   |   |   |   |   |   |   |   |   |   |   |   |   |   |   |   |   |   |   |   |   |   |   |   |   |   |   |   |   |   |   |   |   |   |   |   |   |   |   |   |   |  |  |  |  |  |  |  |  |  |  |  |  |  |  |  |  |  |  |  |  |  |  |  |  |  |  |  |  |  |  |  |  |  |  |  |  |  |  |  |  |  |  |  |  |  |  |  |  |  |  |  |  |  |  |  |  |  |  |  |  |  |  |  |  |  |  |  |  |  |  |  |  |  |  |  |  |  |  |  |  |  |  |  |  |  |  |  |  |  |  |  |  |  |  |  |  |  |  |  |  |  |  |  |  |  |  |  |  |  |  |  |  |  |  |  |  |  |  |  |  |  |  |  |  |  |  |  |  |  |  |  |  |  |  |  |  |  |  |  |  |  |  |  |  |  |

|   |  |  |    |  |  |  |  |  |  |  |  |
|---|---|---|---|--|---|---|---|---|---|---|---|
| <b>B(Alt)</b>   | AEB, AJL, ANB, APU,<br>ARK, AWT   | 01/95 → 09/01   | AC  | VKMV 4PK855<br>VKM 31033   | 1   |   | 1   |   |   |   |   |
| <b>AUDI  A4 (8D2, B5) / A4 Avant (8D5, B5) 2.4</b>         |   |   |   |  |   |   |   |   |   |   |   |
|    | AGA, AJG, ALF, AML,<br>AMM, APS, APZ, ARJ   | 03/97 → 09/01   |    | VKMA 01903<br>VKM 11202<br>VKM 11209<br>VKM 21202                                  | 1<br>1  | 1   | 1   | 1   |   |   | 1 T0153   |
|   | AFM   | 07/95 → 07/97   |   | VKMA 01201<br>VKM 11201<br>VKM 21201   | 1<br>1  | 1   | 1   |   |   |   | 2 T0100   |
|   | AGA, AJG, ALF, AML,<br>AMM, APS, APZ, ARJ   | 03/97 → 09/01   |   | VKMA 01202<br>VKM 11202<br>VKM 21202   | 1<br>1  | 1   | 1   |   |   |   | 1 T0153   |
|    | AFM, AGA, AJG, ALF,<br>AML, AMM, APS, APZ,<br>ARJ                                 | 07/95 → 09/01   |   | VKPC 81802   |   |   |   |   | 1   |   |   |
|    | <b>B(Alt)</b> AFM, AGA, AJG, ALF,<br>AML, AMM, APS, APZ,<br>ARJ                   | 07/95 → 09/01   | AC  | VKMV 6PK1760<br>VKM 31061  | 1   |   | 1   |   |   |   |   |
|   | <b>B(Alt)</b> AFM   | 07/95 → 07/97   | AC, CH 8D-T-185 642 I→  | VKMV 6PK1882<br>VKM 31061  | 1   |   | 1   |   |   |   |   |
|   | <b>B(Alt)</b> AGA, AJG, ALF, AML,<br>AMM, APS, APZ, ARJ                           | 03/97 → 09/01   | AC  | VKMV 6PK1882<br>VKM 31061  | 1   |   | 1   |   |   |   |   |
| <b>AUDI  A4 (8D2, B5) / A4 Avant (8D5, B5) 2.6</b>       |   |   |   |  |   |   |   |   |   |   |   |
|    | ABC, ACZ  | 01/95 → 07/98   |   | VKMA 01201<br>VKM 11201<br>VKM 21201   | 1<br>1  | 1   | 1   |   |   |   | 2 T0100   |
|    | ABC, ACZ  | 01/95 → 09/01   |   | VKPC 81802   |   |   |   |   | 1   |   |   |
|    | <b>B(Alt)</b> ABC, ACZ  | 01/95 → 09/01   | AC  | VKMV 6PK1760<br>VKM 31061  | 1   |   | 1   |   |   |   |   |
|   | <b>B(Alt)</b> ABC, ACZ  | 01/95 → 09/01   | AC, → ICH 8D-T-185 641  | VKM 31061  | 1   |   |   |   |   |   |   |
|   | <b>B(Alt)</b> ABC, ACZ  | 01/95 → 11/00   | AC, CH 8D-T-185 642 I→  | VKMV 6PK1882<br>VKM 31061  | 1   |   | 1   |   |   |   |   |
| <b>AUDI  A4 (8D2, B5) / A4 Avant (8D5, B5) 2.7 RS4</b>   |   |   |   |  |   |   |   |   |   |   |   |
|    | ASJ, AZR  | 05/00 → 09/01   |  | VKMA 01903<br>VKM 11202<br>VKM 11209<br>VKM 21202                                  | 1<br>1  | 1   | 1   | 1   |   |   | 1 T0153   |
|   | ASJ, AZR  | 05/00 → 09/01   |   | VKMA 01202<br>VKM 11202<br>VKM 21202   | 1<br>1  | 1   | 1   |   |   |   | 1 T0153   |
| <b>AUDI  A4 (8D2, B5) / A4 Avant (8D5, B5) 2.7 S4</b>    |   |   |   |  |   |   |   |   |   |   |   |
|    | AGB   | 09/97 → 09/01   |  | VKMA 01903<br>VKM 11202<br>VKM 11209<br>VKM 21202                                  | 1<br>1  | 1   | 1   | 1   |   |   | 1 T0153   |
|   | AGB   | 09/97 → 09/01   |   | VKMA 01202<br>VKM 11202<br>VKM 21202   | 1<br>1  | 1   | 1   |   |   |   | 1 T0153   |
|    | <b>B(Alt)</b> AGB   | 09/97 → 09/01   | AC  | VKMV 6PK1735<br>VKM 31061  | 1   |   | 1   |   |   |   |   |
|   | <b>B(Alt)</b> AGB   | 09/97 → 09/01   | AC  | VKMV 6PK1856<br>VKM 31061  | 1   |   | 1   |   |   |   |   |
| <b>AUDI  A4 (8D2, B5) / A4 Avant (8D5, B5) 2.7 Turbo</b> |   |   |   |  |   |   |   |   |   |   |   |
|    | AGB, AZB  | 02/99 → 09/00   |  | VKMA 01903<br>VKM 11202<br>VKM 11209<br>VKM 21202                                  | 1<br>1  | 1   | 1   | 1   |   |   | 1 T0153   |



































AUDI

























| <b>AUDI  A4 (8D2, B5) / A4 Avant (8D5, B5) 1.9 TDI 110</b> |                               |               |                        |   |   |   |   |  |   |  |   |  |  |  |   |   |       |  |
|--|-------------------------------|---------------|------------------------|---|---|---|---|--|---|--|---|--|--|--|---|---|-------|--|
|  | AFN, AVG                      | 10/95 → 09/01 | VKMA 01014             | 1 | 1 | 1 |   |  |   |  |   |  |  |  |   | 5 | T0650 |  |
|  |                               |               | VKM 11014              | 1 |   |   |   |  |   |  |   |  |  |  |   |   |       |  |
|  |                               |               | VKM 21012              |   | 1 |   |   |  |   |  |   |  |  |  |   |   |       |  |
|  | AFN, AVG                      | 10/95 → 09/01 | VKPC 81615             |   |   |   |   |  | 1 |  |   |  |  |  |   |   |       |  |
|  | <b>B(Alt)</b> AFN, AVG        | 10/95 → 09/01 | VKMA 5PK1592           |   |   | 1 |   |  |   |  |   |  |  |  |   |   |       |  |
|  |                               |               | VKM 31034              | 1 |   |   |   |  |   |  |   |  |  |  |   |   |       |  |
|  | <b>B(AC)</b> AFN, AVG         | 10/95 → 09/01 | VKMA 4PK855            |   |   | 1 |   |  |   |  |   |  |  |  |   |   |       |  |
|  |                               |               | VKM 31059              | 1 |   |   |   |  |   |  |   |  |  |  |   |   |       |  |
|  | AFN, AVG                      | 10/95 → 09/01 | VKM_____               |   |   |   |   |  |   |  | 1 |  |  |  |   |   |       |  |
| <b>AUDI  A4 (8D2, B5) / A4 Avant (8D5, B5) 1.9 TDI 115</b> |                               |               |                        |   |   |   |   |  |   |  |   |  |  |  |   |   |       |  |
|  | AJM, ATJ                      | 03/00 → 09/01 | VKMA 01942             | 1 | 1 | 1 | 1 |  |   |  |   |  |  |  |   | 3 | T0184 |  |
|  |                               |               | VKM 11142              | 1 |   |   |   |  |   |  |   |  |  |  |   |   |       |  |
|  |                               |               | VKM 11145              |   |   |   | 1 |  |   |  |   |  |  |  |   |   |       |  |
|  |                               |               | VKM 21142              |   | 1 |   |   |  |   |  |   |  |  |  |   |   |       |  |
|  | AJM, ATJ                      | 03/00 → 09/01 | VKMA 01142             | 1 | 1 | 1 |   |  |   |  |   |  |  |  |   | 3 | T0184 |  |
|  |                               |               | VKM 11142              | 1 |   |   |   |  |   |  |   |  |  |  |   |   |       |  |
|  |                               |               | VKM 21142              |   | 1 |   |   |  |   |  |   |  |  |  |   |   |       |  |
|  | AJM, ATJ                      | 03/00 → 09/01 | → ICH 8E-2-295 000     |   |   |   |   |  |   |  | 1 |  |  |  |   |   |       |  |
|  | AJM, ATJ                      | 03/00 → 09/01 | CH 8E-2-295 001 I→     |   |   |   |   |  |   |  | 1 |  |  |  |   |   |       |  |
|  | <b>B(Alt)</b> AJM, ATJ        | 03/00 → 09/01 | VKMA 31000             | 1 |   | 1 |   |  |   |  |   |  |  |  |   |   |       |  |
|  |                               |               | VKMA 5PK1432           |   |   | 1 |   |  |   |  |   |  |  |  |   |   |       |  |
|  |                               |               | VKM 31013              | 1 |   |   |   |  |   |  |   |  |  |  |   |   |       |  |
|  | <b>B(Alt), B(AC)</b> AJM, ATJ | 03/00 → 09/01 | VKMA 31020             | 2 |   | 2 |   |  |   |  |   |  |  |  |   |   |       |  |
|  |                               |               | VKMA 4PK855            |   |   | 1 |   |  |   |  |   |  |  |  |   |   |       |  |
|  |                               |               | VKMA 5PK1432           |   |   | 1 |   |  |   |  |   |  |  |  |   |   |       |  |
|  |                               |               | VKM 31013              | 1 |   |   |   |  |   |  |   |  |  |  |   |   |       |  |
|  |                               |               | VKM 31059              | 1 |   |   |   |  |   |  |   |  |  |  |   |   |       |  |
|  | <b>B(AC)</b> AJM, ATJ         | 03/00 → 09/01 | VKMA 4PK855            |   |   | 1 |   |  |   |  |   |  |  |  |   |   |       |  |
|  |                               |               | VKM 31059              | 1 |   |   |   |  |   |  |   |  |  |  |   |   |       |  |
|  | AJM, ATJ                      | 03/00 → 09/01 | VKM_____               |   |   |   |   |  |   |  | 1 |  |  |  |   |   |       |  |
| <b>AUDI  A4 (8D2, B5) / A4 Avant (8D5, B5) 2.5 TDI</b>     |                               |               |                        |   |   |   |   |  |   |  |   |  |  |  |   |   |       |  |
|  | AFB, AKN                      | 09/97 → 09/01 | VKMA 01951             | 2 | 1 | 2 | 1 |  |   |  |   |  |  |  |   | 3 | T0166 |  |
|  |                               |               | VKM 11150              | 1 |   |   |   |  |   |  |   |  |  |  |   |   |       |  |
|  |                               |               | VKM 11151              | 1 |   |   |   |  |   |  |   |  |  |  |   |   |       |  |
|  |                               |               | VKM 11154              |   |   |   | 1 |  |   |  |   |  |  |  |   |   |       |  |
|  |                               |               | VKM 21151              |   | 1 |   |   |  |   |  |   |  |  |  |   | 1 |       |  |
|  | AFB, AKN                      | 09/97 → 09/01 | VKMA 01151             | 2 | 1 | 2 |   |  |   |  |   |  |  |  |   | 2 | T0166 |  |
|  |                               |               | VKM 11150              | 1 |   |   |   |  |   |  |   |  |  |  |   |   |       |  |
|  |                               |               | VKM 11151              | 1 |   |   |   |  |   |  |   |  |  |  |   |   |       |  |
|  |                               |               | VKM 21151              |   | 1 |   |   |  |   |  |   |  |  |  |   | 1 |       |  |
|  | AFB, AKN                      | 09/97 → 09/01 | VKPC 81625             |   |   |   |   |  |   |  | 1 |  |  |  |   |   |       |  |
|  | <b>B(Alt)</b> AFB, AKN        | 09/97 → 09/01 | VKMA 6PK2404           |   |   | 1 |   |  |   |  |   |  |  |  |   |   |       |  |
|  |                               |               | VKM 31038              |   | 1 |   |   |  |   |  |   |  |  |  |   |   |       |  |
|  |                               |               | VKM 31039              |   | 1 |   |   |  |   |  |   |  |  |  | 1 |   |       |  |
|  |                               |               | VKM 31041              |   | 1 |   |   |  |   |  |   |  |  |  |   |   |       |  |
|  | <b>B(AC)</b> AFB, AKN         | 09/97 → 09/01 | VKMA 4PK1237           |   |   | 1 |   |  |   |  |   |  |  |  |   |   |       |  |
|  |                               |               | VKM 31040              | 1 |   |   |   |  |   |  |   |  |  |  |   |   |       |  |
| <b>AUDI  A4 (8E2, B6) / A4 Avant (8E5, B6) 1.6</b>         |                               |               |                        |   |   |   |   |  |   |  |   |  |  |  |   |   |       |  |
|  | ALZ                           | 11/00 → 12/04 | VKMA 01113             | 1 |   | 1 |   |  |   |  |   |  |  |  |   |   | T0149 |  |
|  |                               |               | VKM 11113              | 1 |   |   |   |  |   |  |   |  |  |  |   |   |       |  |
|  | ALZ                           | 11/00 → 12/04 | VKPC 81408             |   |   |   |   |  |   |  | 1 |  |  |  |   |   |       |  |
|  | <b>B(Alt)</b> ALZ             | 11/00 → 12/04 | AC, → ICH 8E-4-191 000 |   |   | 1 |   |  |   |  |   |  |  |  |   |   |       |  |
|  |                               |               | VKMA 6PK1589           |   |   | 1 |   |  |   |  |   |  |  |  |   |   |       |  |
|  |                               |               | VKM_____               |   | 1 |   |   |  |   |  |   |  |  |  |   |   |       |  |
|  |                               |               | VKM 31006              | 1 |   |   |   |  |   |  |   |  |  |  |   |   |       |  |
|  | <b>B(Alt)</b> ALZ             | 11/00 → 12/04 | AC, CH 8E-4-191 001 I→ |   |   | 1 |   |  |   |  |   |  |  |  |   |   |       |  |
|  |                               |               | VKMA 6PK1572           |   |   | 1 |   |  |   |  |   |  |  |  |   |   |       |  |
|  |                               |               | VKM_____               |   | 1 |   |   |  |   |  |   |  |  |  |   |   |       |  |
|  |                               |               | VKM 31006              | 1 |   |   |   |  |   |  |   |  |  |  |   |   |       |  |
| <b>AUDI  A4 (8E2, B6) / A4 Avant (8E5, B6) 1.8 Turbo</b>   |                               |               |                        |   |   |   |   |  |   |  |   |  |  |  |   |   |       |  |
|  | AMB, AVJ, BEX, BFB,<br>BKB    | 11/00 → 12/04 | VKMA 01918             | 1 |   | 1 | 1 |  |   |  |   |  |  |  |   | 3 | T0151 |  |
|  |                               |               | VKM 11018              | 1 |   |   |   |  |   |  |   |  |  |  |   |   |       |  |
|  |                               |               | VKM 11117              |   |   |   | 1 |  |   |  |   |  |  |  |   |   |       |  |

























|   |  |  |    |  |  |  |  |  |  |  |  |  |  |
|---|---|---|---|--|---|---|---|---|---|---|---|---|---|
|   | AMB, AVJ, BEX, BFB, BKB   | 11/00 → 12/04   |   | VKMA 01018<br>VKM 11018<br>VKM 21220   | 1<br>1  | 1<br>1  |   |   |   |   |   | 3   | T0151   |
|   | AMB, AVJ, BEX, BFB, BKB   | 11/00 → 12/04   |   | VKPC 81620   |   |   |   | 1   |   |   |   |   |   |
|   | <b>B(Alt)</b> AMB, AVJ, BEX, BFB, BKB   | 11/00 → 12/04   | AC, → ICH 8E-4-191 000  | VKMA 6PK1589<br>VKM _____<br>VKM 31006   | 1   | 1   |   | 1   |   |   |   |   |   |
|   | <b>B(Alt)</b> AMB, AVJ, BEX, BFB, BKB   | 11/00 → 12/04   | AC, CH 8E-4-191 001 I→  | VKMA 6PK1572<br>VKM _____<br>VKM 31006   | 1   | 1   |   | 1   |   |   |   |   |   |
| <b>AUDI  A4 (8E2, B6) / A4 Avant (8E5, B6) 2.0</b>       |   |   |   |  |   |   |   |   |   |   |   |   |   |
|   | ALT   | 11/00 → 12/04   |    | VKMA 01918<br>VKM 11018<br>VKM 11117   | 1<br>1  |   | 1   | 1   |   |   |   | 3   | T0151   |
|   | ALT   | 11/00 → 12/04   |   | VKMA 01018<br>VKM 11018<br>VKM 21220   | 1<br>1  | 1   | 1   |   |   |   |   | 3   | T0151   |
|   | ALT   | 11/00 → 12/04   |   | VKPC 81408   |   |   |   | 1   |   |   |   |   |   |
|   | <b>B(Alt)</b> ALT   | 11/00 → 12/04   | AC, → ICH 8E-4-191 000  | VKMA 6PK1589<br>VKM _____<br>VKM 31006   | 1   | 1   |   | 1   |   |   |   |   |   |
|   | <b>B(Alt)</b> ALT   | 11/00 → 12/04   | AC, CH 8E-4-191 001 I→  | VKMA 6PK1572<br>VKM _____<br>VKM 31006   | 1   | 1   |   | 1   |   |   |   |   |   |
| <b>AUDI  A4 (8E2, B6) / A4 Avant (8E5, B6) 2.0 FSI</b> |   |   |   |  |   |   |   |   |   |   |   |   |   |
|   | AWA   | 07/02 → 12/04   | → ICH 8E-3-390 000  | VKMA _____<br>VKM _____<br>VKM 21220<br>VKM _____                                  | 1<br>1  | 2   | 1   |   |   |   |   | 1   | T0247   |
|   | AWA   | 07/02 → 12/04   | CH 8E-3-390 001 I→,<br>→ ICH 8E-4-400 000   | VKMA 01220<br>VKM 11220<br>VKM 21220<br>VKM _____                                  | 1<br>1  | 2   | 1   |   |   |   |   | 2   | T0247   |
|   | AWA   | 07/02 → 12/04   | CH 8E-5-000 001 I→  | VKMA 01224<br>VKM 11220<br>VKM 21220<br>VKM _____                                  | 1<br>1  | 2   | 1   |   |   |   |   |   | T0247   |
|   | AWA   | 07/02 → 12/04   |   | VKPC 81220   |   |   |   | 1   |   |   |   |   |   |
|   | <b>B(Alt)</b> AWA   | 07/02 → 12/04   | AC, → ICH 8E-4-191 000  | VKMA 6PK1589<br>VKM _____<br>VKM 31006   | 1   | 1   |   | 1   |   |   |   |   |   |
|   | <b>B(Alt)</b> AWA   | 07/02 → 12/04   | AC, CH 8E-4-191 001 I→  | VKMA 6PK1572<br>VKM _____<br>VKM 31006   | 1   | 1   |   | 1   |   |   |   |   |   |
| <b>AUDI  A4 (8E2, B6) / A4 Avant (8E5, B6) 2.4</b>     |   |   |   |  |   |   |   |   |   |   |   |   |   |
|   | AMM, BDV  | 09/01 → 12/04   |  | VKMA 01903<br>VKM 11202<br>VKM 11209<br>VKM 21202                                  | 1<br>1  | 1   | 1   | 1   |   |   |   | 1   | T0153   |
|   | AMM, BDV  | 09/01 → 12/04   |   | VKMA 01202<br>VKM 11202<br>VKM 21202   | 1<br>1  | 1   | 1   |   |   |   |   | 1   | T0153   |
|   | AMM, BDV  | 09/01 → 12/04   |   | VKPC 81802   |   |   |   | 1   |   |   |   |   |   |
|   | <b>B(Alt)</b> AMM, BDV  | 09/01 → 12/04   |   | VKMA 6PK1856<br>VKM 31061  | 1   |   |   | 1   |   |   |   |   |   |
| <b>AUDI  A4 (8E2, B6) / A4 Avant (8E5, B6) 3.0</b>     |   |   |   |  |   |   |   |   |   |   |   |   |   |
|   | ASN, BBJ  | 11/00 → 12/04   |  | VKMC _____<br>VKMA 01301<br>VKM 11300<br>VKM _____<br>VKM 21302                    | 2<br>2<br>1<br>1  | 1<br>1  | 1<br>1  | 1   |   |   |   |   |   |





































| AUDI  A4 (8E2, B6) / A4 Avant (8E5, B6) 4.2 S4        |                   |               |   |                                     |   |        |   |   |   |  |  |  |   |  |  |   |       |
|--|-------------------|---------------|---|-------------------------------------|---|--------|---|---|---|--|--|--|---|--|--|---|-------|
|   | BBK               | 03/03 → 12/04 |   |                                     |   |        |   |   |   |  |  |  |   |  |  |   |       |
| AUDI  A4 (8E2, B6) / A4 Avant (8E5, B6) 1.9 TDI 100   |                   |               |   |                                     |   |        |   |   |   |  |  |  |   |  |  |   |       |
|   | AVB               | 05/01 → 12/04 |    | → ICH 8E-2-297 100                  | VKMA 01942<br>VKM 11142<br>VKM 11145<br>VKM 21142     | 1<br>1 | 1 | 1 | 1 |  |  |  |   |  |  | 3 | T0184 |
|  | AVB               | 05/01 → 12/04 |   | → ICH 8E-2-297 100                  | VKMA 01142<br>VKM 11142<br>VKM 21142                  | 1<br>1 | 1 | 1 |   |  |  |  |   |  |  | 3 | T0184 |
|  | AVB               | 05/01 → 12/04 |   | CH 8E-2-297 101 I→                  | VKMA 01250<br>VKM 11250<br>VKM 21147                  | 1<br>1 | 1 | 1 |   |  |  |  |   |  |  |   | T0184 |
|   | AVB               | 05/01 → 12/04 |   | → ICH 8E-2-295 000                  | VKPC 81626  |        |   |   |   |  |  |  | 1 |  |  |   |       |
|  | AVB               | 05/01 → 12/04 |   | CH 8E-2-295 001 I→                  | VKPC 81303  |        |   |   |   |  |  |  | 1 |  |  |   |       |
|   | B(Alt) AVB        | 05/01 → 12/03 |    | AC,<br>→ ICH 8E-3-500 000           | VKMA 31000<br>VKMV 5PK1432<br>VKM 31013               | 1<br>1 |   | 1 |   |  |  |  |   |  |  |   |       |
|  | B(Alt) AVB        | 01/04 → 12/04 |    | AC,<br>CH 8E-4-000 001 I→           | VKMV 6PK1123<br>VKM____<br>VKM 31058                  | 1      |   | 1 |   |  |  |  |   |  |  |   |       |
|  | B(Alt) AVB        | 01/04 → 12/04 |   | AC, CH 8E-4-000 001 I→              | VKMV 6PK1613<br>VKM____<br>VKM 31058                  | 1      |   | 1 |   |  |  |  |   |  |  |   |       |
|  | B(Alt), B(AC) AVB | 05/01 → 12/03 |   | AC, → ICH 8E-3-500 000              | VKMV 4PK841<br>VKMV 5PK1432<br>VKM 31013<br>VKM 31059 | 1<br>1 |   | 1 |   |  |  |  |   |  |  |   |       |
|   | AVB               | 05/01 → 12/04 |   | → ICH 8E-3-410 000                  | VKM____   |        |   |   |   |  |  |  | 1 |  |  |   |       |
|  | AVB               | 05/01 → 12/04 |   | CH 8E-3-410 001 I→                  | VKM____   |        |   |   |   |  |  |  | 1 |  |  |   |       |
| AUDI  A4 (8E2, B6) / A4 Avant (8E5, B6) 1.9 TDI 115 |                   |               |   |                                     |   |        |   |   |   |  |  |  |   |  |  |   |       |
|   | BKE               | 06/04 → 12/04 |   |                                     | VKMA 01250<br>VKM 11250<br>VKM 21147                  | 1<br>1 | 1 | 1 |   |  |  |  |   |  |  |   | T0184 |
|   | BKE               | 06/04 → 12/04 |   | CH 8E-2-295 001 I→                  | VKPC 81303  |        |   |   |   |  |  |  | 1 |  |  |   |       |
|   | B(Alt) BKE        | 06/04 → 12/04 |  | AC                                  | VKMV 6PK1123<br>VKM____<br>VKM 31058                  | 1      |   | 1 |   |  |  |  |   |  |  |   |       |
|  | B(Alt) BKE        | 06/04 → 12/04 |   | AC                                  | VKMV 6PK1613<br>VKM____<br>VKM 31058                  | 1      |   | 1 |   |  |  |  |   |  |  |   |       |
|   | BKE               | 06/04 → 12/04 |   | → ICH 8E-3-410 000                  | VKM____   |        |   |   |   |  |  |  | 1 |  |  |   |       |
|  | BKE               | 06/04 → 12/04 |   | CH 8E-3-410 001 I→                  | VKM____   |        |   |   |   |  |  |  | 1 |  |  |   |       |
| AUDI  A4 (8E2, B6) / A4 Avant (8E5, B6) 1.9 TDI 130 |                   |               |   |                                     |   |        |   |   |   |  |  |  |   |  |  |   |       |
|   | AVF, AWX          | 11/00 → 12/04 |  | → ICH 8E-2-297 100                  | VKMA 01942<br>VKM 11142<br>VKM 11145<br>VKM 21142     | 1<br>1 | 1 | 1 | 1 |  |  |  |   |  |  | 3 | T0184 |
|  | AVF, AWX          | 11/00 → 12/04 |   | → ICH 8E-2-297 100                  | VKMA 01142<br>VKM 11142<br>VKM 21142                  | 1<br>1 | 1 | 1 |   |  |  |  |   |  |  | 3 | T0184 |
|  | AVF, AWX          | 11/00 → 12/04 |   | CH 8E-2-297 101 I→                  | VKMA 01250<br>VKM 11250<br>VKM 21147                  | 1<br>1 | 1 | 1 |   |  |  |  |   |  |  |   | T0184 |
|   | AVF, AWX          | 11/00 → 12/04 |   | → ICH 8E-2-295 000                  | VKPC 81626  |        |   |   |   |  |  |  | 1 |  |  |   |       |
|  | AVF, AWX          | 11/00 → 12/04 |   | CH 8E-2-295 001 I→                  | VKPC 81303  |        |   |   |   |  |  |  | 1 |  |  |   |       |
|   | B(Alt) AVF        | 11/00 → 12/04 |  | AC, Man. GBX,<br>→ ICH 8E-4-010 000 | VKMA 31000<br>VKMV 5PK1432<br>VKM 31013               | 1<br>1 |   | 1 |   |  |  |  |   |  |  |   |       |











































































|   |  |  |       |  |  |  |  |  |  |  |  |  |  |  |
|---|---|---|--|--|---|---|---|---|---|---|---|---|---|---|
| B(Alt)  | AVF   | 11/00 → 12/04   | AC, Auto. GBX,<br>→ ICH 8E-3-500 000   | VKMA 31000<br>VKMV 5PK1432<br>VKM 31013  | 1<br>1  | 1<br>1  |   |   |   |   |   |   |   |   |
| B(Alt)  | AVF   | 11/01 → 12/04   | AC, Man. GBX,<br>CH 8E-4-010 001 I→  | VKMV 6PK1123<br>VKM____<br>VKM 31058   | 1   | 1   |   |   |   |   |   |   |   |   |
| B(Alt)  | AVF   | 11/01 → 12/04   | AC, Auto. GBX,<br>CH 8E-4-000 001 I→   | VKMV 6PK1123<br>VKM____<br>VKM 31058   | 1   | 1   |   |   |   |   |   |   |   |   |
| B(Alt)  | AVF   | 11/01 → 12/04   | AC, Man. GBX,<br>CH 8E-4-010 001 I→  | VKMV 6PK1613<br>VKM____<br>VKM 31058   | 1   | 1   |   |   |   |   |   |   |   |   |
| B(Alt)  | AVF   | 11/01 → 12/04   | AC, Auto. GBX,<br>CH 8E-4-000 001 I→   | VKMV 6PK1613<br>VKM____<br>VKM 31058   | 1   | 1   |   |   |   |   |   |   |   |   |
| B(Alt)  | AWX   | 11/00 → 12/04   | AC   | VKMA 31000<br>VKMV 5PK1432<br>VKM 31013  | 1<br>1  | 1<br>1  |   |   |   |   |   |   |   |   |
| B(Alt), B(AC)   | AVF   | 11/00 → 12/04   | AC, Man. GBX,<br>→ ICH 8E-4-010 000  | VKMV 4PK841<br>VKMV 5PK1432<br>VKM 31013<br>VKM 31059                              | 1<br>1  | 1<br>1  |   |   |   |   |   |   |   |   |
| B(Alt), B(AC)   | AVF   | 11/00 → 12/04   | AC, Auto. GBX,<br>→ ICH 8E-3-500 000   | VKMV 4PK841<br>VKMV 5PK1432<br>VKM 31013<br>VKM 31059                              | 1<br>1  | 1<br>1  |   |   |   |   |   |   |   |   |
| B(Alt), B(AC)   | AWX   | 11/00 → 12/04   | AC   | VKMV 4PK841<br>VKMV 5PK1432<br>VKM 31013<br>VKM 31059                              | 1<br>1  | 1<br>1  |   |   |   |   |   |   |   |   |
| ⊙   | AVF, AWX  | 11/00 → 12/04   | → ICH 8E-3-410 000   | VKM____  |   |   |   |   |   |   | 1   |   |   |   |
|   | AVF, AWX  | 11/00 → 12/04   | CH 8E-3-410 001 I→   | VKM____  |   |   |   |   |   |   | 1   |   |   |   |
| <b>AUDI  A4 (8E2, B6) / A4 Avant (8E5, B6) 2.5 TDI</b> |   |   |  |  |   |   |   |   |   |   |   |   |   |   |
|   | AKE, AYM, BAU, BCZ,<br>BDG, BDH, BFC  | 11/00 → 12/04   |  4) | VKMA 01952<br>VKM 11150<br>VKM 11151<br>VKM 11154<br>VKM 21151                     | 2<br>1<br>1   | 1<br>1  | 2<br>1  | 1<br>1  |   |   |   |   |   | 3 T0170   |
|   | AKE, AYM, BAU, BCZ,<br>BDG, BDH, BFC  | 11/00 → 12/04   | 4)   | VKMA 01152<br>VKM 11150<br>VKM 11151<br>VKM 21151                                  | 2<br>1<br>1   | 1<br>1  | 2<br>1  |   |   |   |   |   |   | 2 T0170   |
|   | AKE, AYM, BAU, BCZ,<br>BDG, BDH, BFC  | 11/00 → 12/04   |  | VKPC 81625   |   |   |   |   | 1   |   |   |   |   |   |
|   | B(Alt) AKE, AYM, BAU, BCZ,<br>BDG, BDH, BFC                                       | 11/00 → 12/04   |  | VKMV 6PK2404<br>VKM 31038<br>VKM 31039<br>VKM 31041                                |   | 1<br>1<br>1   | 1   |   |   |   |   | 1   |   |   |
|   | B(AC) AKE, AYM, BAU, BCZ,<br>BDG, BDH, BFC  | 11/00 → 12/04   |  | VKMV 4PK1217<br>VKM 31040  | 1   |   | 1   |   |   |   |   |   |   |   |
| <b>AUDI  A4 (8EC) / A4 Avant (8ED) 1.6</b>             |   |   |  |  |   |   |   |   |   |   |   |   |   |   |
|   | ALZ   | 11/04 → 11/07   |  | VKMA 01113<br>VKM 11113  | 1<br>1  |   | 1   |   |   |   |   |   |   | T0149   |
|   | ALZ   | 11/04 → 11/07   |  | VKPC 81408   |   |   |   |   | 1   |   |   |   |   |   |

|  |  |  |    |  |  |  |  |  |  |  |   |       |
|--|---|---|---|--|---|---|---|---|---|---|---|-------|
|  B(Alt)   | ALZ   | 11/04 → 11/07   | AC  | VKMV 6PK1080<br>VKM____<br>VKM 31006   | 1   | 1   | 1   |   |   |   |   |       |
| B(Alt)   | ALZ   | 11/04 → 11/07   | AC, → ICH 8E-4-191 000  | VKMV 6PK1589<br>VKM____<br>VKM 31006   | 1   | 1   | 1   |   |   |   |   |       |
| B(Alt)   | ALZ   | 11/04 → 11/07   | AC, CH 8E-4-191 001 I →   | VKMV 6PK1572<br>VKM____<br>VKM 31006   | 1   | 1   | 1   |   |   |   |   |       |
| <b>AUDI  A4 (8EC) / A4 Avant (8ED) 1.8 Turbo</b>  |   |   |   |  |   |   |   |   |   |   |   |       |
|  BFB  | BFB   | 11/04 → 11/07   |    | VKMA 01918<br>VKM 11018<br>VKM 11117   | 1   | 1   | 1   |   |   |   | 3 | T0151 |
|  | BFB   | 11/04 → 11/07   |   | VKMA 01018<br>VKM 11018<br>VKM 21220   | 1   | 1   | 1   |   |   |   | 3 | T0151 |
|  BFB  | BFB   | 11/04 → 11/07   |   | VKPC 81620   |   |   |   | 1   |   |   |   |       |
|  B(Alt)   | BFB   | 11/04 → 11/07   | AC  | VKMV 6PK1080<br>VKM____<br>VKM 31006   | 1   | 1   | 1   |   |   |   |   |       |
| B(Alt)   | BFB   | 11/04 → 11/07   | AC, → ICH 8E-4-191 000  | VKMV 6PK1589<br>VKM____<br>VKM 31006   | 1   | 1   | 1   |   |   |   |   |       |
| B(Alt)   | BFB   | 11/04 → 11/07   | AC, CH 8E-4-191 001 I →   | VKMV 6PK1572<br>VKM____<br>VKM 31006   | 1   | 1   | 1   |   |   |   |   |       |
| <b>AUDI  A4 (8EC) / A4 Avant (8ED) 2.0</b>      |   |   |   |  |   |   |   |   |   |   |   |       |
|  ALT  | ALT   | 11/04 → 11/07   |  | VKMA 01918<br>VKM 11018<br>VKM 11117   | 1   | 1   | 1   |   |   |   | 3 | T0151 |
|  | ALT   | 11/04 → 11/07   |   | VKMA 01018<br>VKM 11018<br>VKM 21220   | 1   | 1   | 1   |   |   |   | 3 | T0151 |
|  ALT  | ALT   | 11/04 → 11/07   |   | VKPC 81408   |   |   |   | 1   |   |   |   |       |
|  B(Alt)   | ALT   | 11/04 → 11/07   | AC  | VKMV 6PK1080<br>VKM____<br>VKM 31006   | 1   | 1   | 1   |   |   |   |   |       |
| B(Alt)   | ALT   | 11/04 → 11/07   | AC, → ICH 8E-4-191 000  | VKMV 6PK1589<br>VKM____<br>VKM 31006   | 1   | 1   | 1   |   |   |   |   |       |
| B(Alt)   | ALT   | 11/04 → 11/07   | AC, CH 8E-4-191 001 I →   | VKMV 6PK1572<br>VKM____<br>VKM 31006   | 1   | 1   | 1   |   |   |   |   |       |
| <b>AUDI  A4 (8EC) / A4 Avant (8ED) 2.0 FSI</b>  |   |   |   |  |   |   |   |   |   |   |   |       |
|  BPJ, BYK                                       | BPJ, BYK  | 10/06 → 11/07   |   | VKMA 01222<br>VKM 11222<br>VKM 21220<br>VKM____                                    | 1   | 2   | 1   |   |   |   | 2 | T0247 |
|  BPJ, BYK                                       | BPJ, BYK  | 10/06 → 11/07   |   | —  |   |   |   | 1   |   |   |   |       |
|  B(Alt)   | BPJ, BYK  | 10/06 → 11/07   |   | VKMV 6PK1572<br>VKM____<br>VKM 31006   | 1   | 1   | 1   |   |   |   |   |       |
| <b>AUDI  A4 (8EC) / A4 Avant (8ED) 2.0 TFSI</b> |   |   |   |  |   |   |   |   |   |   |   |       |
|  BGB, BUL, BWE                                  | BGB, BUL, BWE   | 11/04 → 11/07   |   | VKMA 01222<br>VKM 11222<br>VKM 21220<br>VKM____                                    | 1   | 2   | 1   |   |   |   | 2 | T0247 |
|  BGB, BUL, BWE                                  | BGB, BUL, BWE   | 11/04 → 11/07   |   | —  |   |   |   | 1   |   |   |   |       |
|  B(Alt)   | BGB, BUL, BWE   | 11/04 → 11/07   |   | VKMV 6PK1572<br>VKM____<br>VKM 31006   | 1   | 1   | 1   |   |   |   |   |       |
| <b>AUDI  A4 (8EC) / A4 Avant (8ED) 3.0</b>      |   |   |   |  |   |   |   |   |   |   |   |       |
|  BBJ  | BBJ   | 03/05 → 11/07   |  | VKMC____<br>VKMA 01301   | 2   | 1   | 1   | 1   |   |   |   |       |

















































AUDI

|   |  |               |      |  |  |  |  |  |  |  |  |
|---|--|---------------|--|---|---|---|---|---|---|---|---|
|   |  |               | VKM 11300<br>VKM ____<br>VKM 21302   | 1<br>1<br>1   |   |   |   |   |   |   |   |
| <b>AUDI  A4 (8EC) / A4 Avant (8ED) 3.2 FSI</b>     |  |               |  |   |   |   |   |   |   |   |   |
|   | AUK, BKH                                 | 01/05 → 11/07 | <b>OXOXOXO</b>   |   |   |   |   |   |   |   |   |
| <b>AUDI  A4 (8EC) / A4 Avant (8ED) 4.2 RS4, S4</b> |  |               |  |   |   |   |   |   |   |   |   |
|   | BBK, BNS                                 | 11/04 → 11/07 | <b>OXOXOXO</b>   |   |   |   |   |   |   |   |   |
| <b>AUDI  A4 (8EC) / A4 Avant (8ED) S4</b>          |  |               |  |   |   |   |   |   |   |   |   |
|   | BBK                                      | 11/04 → 11/07 | <b>OXOXOXO</b>   |   |   |   |   |   |   |   |   |
| <b>AUDI  A4 (8EC) / A4 Avant (8ED) 1.9 TDI</b>     |  |               |  |   |   |   |   |   |   |   |   |
|   | BKE, BRB                                 | 11/04 → 11/07 | VKMA 01250<br>VKM 11250<br>VKM 21147   | 1<br>1<br>1   | 1   | 1   |   |   |   |   | T0184   |
|   | BKE, BRB                                 | 11/04 → 11/07 | VKPC 81303   |   |   |   |   | 1   |   |   |   |
|   | <b>B(Alt)</b> BKE, BRB                   | 11/04 → 11/07 | VKMA 6PK1613<br>VKM ____<br>VKM 31058  | 1<br>1<br>1   |   | 1   |   |   |   |   |   |
|   | BKE                                      | 11/04 → 11/07 | → ICH 8E-3-410 000   |   |   |   |   |   | 1   |   |   |
|   | BKE                                      | 11/04 → 11/07 | CH 8E-3-410 001 →  |   |   |   |   |   | 1   |   |   |
|   | BRB                                      | 11/04 → 11/07 | VKM ____   |   |   |   |   |   | 1   |   |   |
| <b>AUDI  A4 (8EC) / A4 Avant (8ED) 2.0 TDI</b>     |  |               |  |   |   |   |   |   |   |   |   |
|   | BLB, BNA, BRD, BRE                       | 11/04 → 11/07 | VKMA 01255<br>VKM 11255<br>VKM 21147<br>VKM 21256                                      | 1<br>1<br>1<br>1  | 2   | 1   |   |   |   |   | 5 T0184   |
|   | BPW                                      | 11/04 → 11/07 | VKMA 01250<br>VKM 11250<br>VKM 21147   | 1<br>1<br>1   | 1   | 1   |   |   |   |   | T0184   |
|   | BLB, BNA, BRE                            | 11/04 → 11/07 | VKPC 81627   |   |   |   |   |   | 1   |   |   |
|   | BPW                                      | 11/04 → 11/07 | VKPC 81303   |   |   |   |   |   | 1   |   |   |
|   | <b>B(Alt)</b> BLB, BNA, BPW, BRD,<br>BRE | 11/04 → 11/07 | VKMA 6PK1613<br>VKM ____<br>VKM 31058  | 1<br>1<br>1   |   | 1   |   |   |   |   |   |
| <b>AUDI  A4 (8EC) / A4 Avant (8ED) 2.5 TDI</b>   |  |               |  |   |   |   |   |   |   |   |   |
|   | BCZ, BDG                                 | 11/04 → 11/07 |  4) | VKMA 01952<br>VKM 11150<br>VKM 11151<br>VKM 11154<br>VKM 21151                      | 2<br>1<br>1<br>1<br>1   | 1   | 2   | 1   |   |   | 3 T0170   |
|   | BCZ, BDG                                 | 11/04 → 11/07 | 4)   | VKMA 01152<br>VKM 11150<br>VKM 11151<br>VKM 21151                                   | 2<br>1<br>1<br>1  | 1   | 2   |   |   |   | 2 T0170   |
|   | BCZ, BDG                                 | 11/04 → 11/07 |  | VKPC 81625  |   |   |   |   | 1   |   |   |
|   | <b>B(Alt)</b> BCZ, BDG                   | 11/04 → 11/07 |  | VKMA 6PK2404<br>VKM 31038<br>VKM 31039<br>VKM 31041                                 |   | 1<br>1<br>1   |   |   |   | 1   |   |
|   | <b>B(AC)</b> BCZ, BDG                    | 11/04 → 11/07 |  | VKMA 4PK1217<br>VKM 31040   | 1   |   | 1   |   |   |   |   |
| <b>AUDI  A4 (8EC) / A4 Avant (8ED) 2.7 TDI</b>   |  |               |  |   |   |   |   |   |   |   |   |
|   | BPP, BSG                                 | 01/06 → 11/07 | B(Cam)   | <b>OXOXOXO</b>  |   |   |   |   |   |   |   |
|   | BPP, BSG                                 | 01/06 → 11/07 | B(inj)   | VKMA 01332<br>VKM 11332   | 1<br>1  |   | 1   |   |   |   | 1 T0246   |
| <b>AUDI  A4 (8EC) / A4 Avant (8ED) 3.0 TDI</b>   |  |               |  |   |   |   |   |   |   |   |   |
|   | ASB, BKN                                 | 11/04 → 11/07 | B(Cam)   | <b>OXOXOXO</b>  |   |   |   |   |   |   |   |
|   | ASB, BKN                                 | 11/04 → 11/07 | B(inj)   | VKMA 01332<br>VKM 11332   | 1<br>1  |   | 1   |   |   |   | 1 T0246   |
| <b>AUDI  A4 Convertible (8H7) 1.8 Turbo</b>      |  |               |  |   |   |   |   |   |   |   |   |
|   | BFB                                      | 07/02 → 11/07 |     | VKMA 01918<br>VKM 11018<br>VKM 11117  | 1<br>1<br>1   |   | 1   | 1   |   |   | 3 T0151   |

|  |  |  |    |  |  |  |  |  |  |  |  |  |
|--|---|---|---|--|---|---|---|---|---|---|---|---|
|  | BFB   | 07/02 → 11/07   |   | VKMA 01018<br>VKM 11018<br>VKM 21220   | 1<br>1  | 1<br>1  | 1   |   |   |   |   | 3 T0151   |
|   | BFB   | 07/02 → 11/07   |   | VKPC 81620   |   |   |   | 1   |   |   |   |   |
|   | BFB   | 07/02 → 11/07   | AC  | VKMV 6PK1080<br>VKM____<br>VKM 31006   | 1   | 1   | 1   |   |   |   |   |   |
|  | B(Alt) BFB  | 07/02 → 11/07   | AC, →ICH 8E-4-191 000   | VKMV 6PK1589<br>VKM____<br>VKM 31006   | 1   | 1   | 1   |   |   |   |   |   |
|  | B(Alt) BFB  | 07/02 → 11/07   | AC, CH 8E-4-191 001 I→  | VKMV 6PK1572<br>VKM____<br>VKM 31006   | 1   | 1   | 1   |   |   |   |   |   |
| <b>AUDI  A4 Convertible (8H7) 2.0</b>               |   |   |   |  |   |   |   |   |   |   |   |   |
|   | ALT   | 09/04 → 11/07   |    | VKMA 01918<br>VKM 11018<br>VKM 11117   | 1<br>1  | 1   | 1   | 1   |   |   |   | 3 T0151   |
|  | ALT   | 09/04 → 11/07   |   | VKMA 01018<br>VKM 11018<br>VKM 21220   | 1<br>1  | 1<br>1  | 1   |   |   |   |   | 3 T0151   |
|   | ALT   | 09/04 → 11/07   |   | VKPC 81408   |   |   |   | 1   |   |   |   |   |
|   | ALT   | 09/04 → 11/07   | AC  | VKMV 6PK1080<br>VKM____<br>VKM 31006   | 1   | 1   | 1   |   |   |   |   |   |
|  | B(Alt) ALT  | 09/04 → 11/07   | AC, →ICH 8E-4-191 000   | VKMV 6PK1589<br>VKM____<br>VKM 31006   | 1   | 1   | 1   |   |   |   |   |   |
|  | B(Alt) ALT  | 09/04 → 11/07   | AC, CH 8E-4-191 001 I→  | VKMV 6PK1572<br>VKM____<br>VKM 31006   | 1   | 1   | 1   |   |   |   |   |   |
| <b>AUDI  A4 Convertible (8H7) 2.0 TFSI</b>        |   |   |   |  |   |   |   |   |   |   |   |   |
|   | BWE   | 10/05 → 11/07   |   | VKMA 01222<br>VKM 11222<br>VKM 21220<br>VKM____                                    | 1<br>1  | 2<br>1  | 1<br>1  |   |   |   |   | 2 T0247   |
|   | BWE   | 10/05 → 11/07   |   | —  |   |   |   | 1   |   |   |   |   |
|   | BWE   | 10/05 → 11/07   |   | VKMV 6PK1572<br>VKM____<br>VKM 31006   | 1   | 1   | 1   |   |   |   |   |   |
| <b>AUDI  A4 Convertible (8H7) 2.4</b>             |   |   |   |  |   |   |   |   |   |   |   |   |
|   | AMM, BDV  | 04/02 → 11/07   |  | VKMA 01903<br>VKM 11202<br>VKM 11209<br>VKM 21202                                  | 1<br>1  | 1   | 1   | 1   |   |   |   | 1 T0153   |
|  | AMM, BDV  | 04/02 → 11/07   |   | VKMA 01202<br>VKM 11202<br>VKM 21202   | 1<br>1  | 1<br>1  | 1   |   |   |   |   | 1 T0153   |
|   | AMM, BDV  | 04/02 → 11/07   |   | VKPC 81802   |   |   |   | 1   |   |   |   |   |
|   | AMM, BDV  | 04/02 → 11/07   |   | VKMV 6PK1856<br>VKM 31061  | 1   | 1   | 1   |   |   |   |   |   |
| <b>AUDI  A4 Convertible (8H7) 3.0</b>             |   |   |   |  |   |   |   |   |   |   |   |   |
|   | ASN   | 04/02 → 11/07   |  | VKMC____<br>VKMA 01301<br>VKM 11300<br>VKM____<br>VKM 21302                        | 2<br>2<br>1<br>1  | 1<br>1  | 1<br>1  | 1   |   |   |   |   |
| <b>AUDI  A4 Convertible (8H7) 3.2 FSI</b>         |   |   |   |  |   |   |   |   |   |   |   |   |
|   | AUK, BKH  | 10/05 → 11/07   |   | XXXXXXXXXX   |   |   |   |   |   |   |   |   |
| <b>AUDI  A4 Convertible (8H7) 4.2 RS4, 4.2 S4</b> |   |   |   |  |   |   |   |   |   |   |   |   |
|   | BBK, BNS  | 03/04 → 11/07   |   | XXXXXXXXXX   |   |   |   |   |   |   |   |   |
| <b>AUDI  A4 Convertible (8H7) 2.0 TDI</b>         |   |   |   |  |   |   |   |   |   |   |   |   |
|   | BPW   | 10/05 → 11/07   |   | VKMA 01250<br>VKM 11250<br>VKM 21147   | 1<br>1  | 1<br>1  | 1   |   |   |   |   | T0184   |









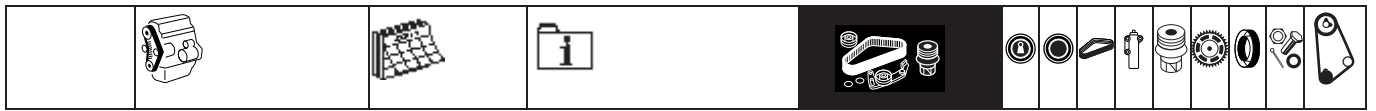



















AUDI

|  |  |  |     |  |  |  |  |  |  |  |  |  |  |  |
|--|---|---|--|--|---|---|---|---|---|---|---|---|---|---|
|    | BPW   | 10/05 → 11/07   |  | VKPC 81303   |   |   |   | 1   |   |   |   |   |   |   |
|    | <b>B(Alt)</b> BPW   | 10/05 → 11/07   |  | VKMV 6PK1613<br>VKM____<br>VKM 31058   | 1   | 1   |   |   |   |   |   |   |   |   |
| <b>AUDI  A4 Convertible (8H7) 2.5 TDI</b> |   |   |  |  |   |   |   |   |   |   |   |   |   |   |
|    | BCZ, BDG, BFC   | 08/02 → 11/07   |  4) | VKMA 01952<br>VKM 11150<br>VKM 11151<br>VKM 11154<br>VKM 21151                     | 2<br>1<br>1<br>1  | 1   | 2   | 1   |   |   |   |   | 3   | T0170   |
|  | BCZ, BDG, BFC   | 08/02 → 11/07   | 4)   | VKMA 01152<br>VKM 11150<br>VKM 11151<br>VKM 21151                                  | 2<br>1<br>1<br>1  | 1   | 2   |   |   |   |   |   | 2   | T0170   |
|    | BCZ, BDG, BFC   | 08/02 → 11/07   |  | VKPC 81625   |   |   |   | 1   |   |   |   |   |   |   |
|    | <b>B(Alt)</b> BCZ, BDG, BFC   | 08/02 → 11/07   |  | VKMV 6PK2404<br>VKM 31038<br>VKM 31039<br>VKM 31041                                |   | 1<br>1<br>1   | 1   |   |   |   | 1   |   |   |   |
|  | <b>B(AC)</b> BCZ, BDG, BFC  | 08/02 → 11/07   |  | VKMV 4PK1217<br>VKM 31040  | 1   |   | 1   |   |   |   |   |   |   |   |
| <b>AUDI  A4 Convertible (8H7) 2.7 TDI</b> |   |   |  |  |   |   |   |   |   |   |   |   |   |   |
|    | BPP, BSG  | 06/06 → 11/07   | <b>B(Cam)</b>  | <del>OKOKOK</del>  |   |   |   |   |   |   |   |   |   |   |
|  | BPP, BSG  | 06/06 → 11/07   | <b>B(inj)</b>  | VKMA 01332<br>VKM 11332  | 1<br>1  |   | 1   |   |   |   |   |   | 1   | T0246   |
| <b>AUDI  A4 Convertible (8H7) 3.0 TDI</b> |   |   |  |  |   |   |   |   |   |   |   |   |   |   |
|    | ASB, BKN  | 10/05 → 11/07   | <b>B(Cam)</b>  | <del>OKOKOK</del>  |   |   |   |   |   |   |   |   |   |   |
|  | ASB, BKN  | 10/05 → 11/07   | <b>B(inj)</b>  | VKMA 01332<br>VKM 11332  | 1<br>1  |   | 1   |   |   |   |   |   | 1   | T0246   |
| <b>AUDI  A4 (8K) 1.8 TFSI</b>           |   |   |  |  |   |   |   |   |   |   |   |   |   |   |
|    | CAB   | 11/07 → 11/07   |  | <del>OKOKOK</del>  |   |   |   |   |   |   |   |   |   |   |
| <b>AUDI  A4 (8K) 3.2 FSI</b>            |   |   |  |  |   |   |   |   |   |   |   |   |   |   |
|    | CAL   | 11/07 → 11/07   |  | <del>OKOKOK</del>  |   |   |   |   |   |   |   |   |   |   |
| <b>AUDI  A4 (8K) 2.0 TDI</b>            |   |   |  |  |   |   |   |   |   |   |   |   |   |   |
|    | CAG   | 11/07 → 11/07   |  | —<br>—<br>VKM 21142<br>VKM 21147<br>VKM 21256                                      | 1<br>1  | 3   | 1   |   |   |   |   |   |   |   |
|    | <b>B(Alt)</b> CAG   | 11/07 → 11/07   |  | VKM____<br>VKM 31058   | 1   |   | 1   |   |   |   |   |   |   |   |
| <b>AUDI  A4 (8K) 2.7 TDI</b>            |   |   |  |  |   |   |   |   |   |   |   |   |   |   |
|    | CAM   | 11/07 → 11/07   | <b>B(Cam)</b>  | <del>OKOKOK</del>  |   |   |   |   |   |   |   |   |   |   |
|  | CAM   | 11/07 → 11/07   | <b>B(inj)</b>  | —<br>VKM 11332   | 1<br>1  |   | 1   |   |   |   |   |   |   |   |
|    | CAM   | 11/07 → 11/07   |  | —  |   |   |   | 1   |   |   |   |   |   |   |
| <b>AUDI  A4 (8K) 3.0 TDI</b>            |   |   |  |  |   |   |   |   |   |   |   |   |   |   |
|    | CAP   | 11/07 → 11/07   | <b>B(Cam)</b>  | <del>OKOKOK</del>  |   |   |   |   |   |   |   |   |   |   |
|  | CAP   | 11/07 → 11/07   | <b>B(inj)</b>  | —<br>VKM 11332   | 1<br>1  |   | 1   |   |   |   |   |   |   |   |
|    | CAP   | 11/07 → 11/07   |  | —  |   |   |   | 1   |   |   |   |   |   |   |
| <b>AUDI  A5 1.8 TFSI</b>                |   |   |  |  |   |   |   |   |   |   |   |   |   |   |
|    | CAB   | 10/07 → 10/07   |  | <del>OKOKOK</del>  |   |   |   |   |   |   |   |   |   |   |
| <b>AUDI  A5 3.2 FSI</b>                 |   |   |  |  |   |   |   |   |   |   |   |   |   |   |
|    | CAL   | 06/07 → 10/07   |  | <del>OKOKOK</del>  |   |   |   |   |   |   |   |   |   |   |
| <b>AUDI  A5 S5</b>                      |   |   |  |  |   |   |   |   |   |   |   |   |   |   |
|    | CAV   | 06/07 → 10/07   |  | <del>OKOKOK</del>  |   |   |   |   |   |   |   |   |   |   |
| <b>AUDI  A5 2.7 TDI</b>                 |   |   |  |  |   |   |   |   |   |   |   |   |   |   |
|    | CAM   | 06/07 → 10/07   | <b>B(Cam)</b>  | <del>OKOKOK</del>  |   |   |   |   |   |   |   |   |   |   |
|  | CAM   | 06/07 → 10/07   | <b>B(inj)</b>  | —<br>VKM 11332   | 1<br>1  |   | 1   |   |   |   |   |   |   |   |
|    | CAM   | 06/07 → 10/07   |  | —  |   |   |   | 1   |   |   |   |   |   |   |

























































| AUDI  A5 3.0 TDI                                |               |               |   |                        |               |   |   |   |  |  |  |  |  |  |  |  |  |  |  |   |       |       |
|--|---------------|---------------|---|------------------------|---------------|---|---|---|--|--|--|--|--|--|--|--|--|--|--|---|-------|-------|
|   | CAP           | 06/07 → 10/07 |   | OXOXOXO                |               |   |   |   |  |  |  |  |  |  |  |  |  |  |  |   |       |       |
|  | CAP           | 06/07 → 10/07 | B(inj)  |                        |               |   |   |   |  |  |  |  |  |  |  |  |  |  |  |   |       |       |
|  |               |               |   | VKM 11332              | 1             |   |   |   |  |  |  |  |  |  |  |  |  |  |  |   |       |       |
|   | CAP           | 06/07 → 10/07 |   |                        |               |   |   |   |  |  |  |  |  |  |  |  |  |  |  |   |       |       |
|  |               |               |   |                        |               |   |   |   |  |  |  |  |  |  |  |  |  |  |  |   |       |       |
| AUDI  A6 (4A, C4) / A6 Avant (4A, C4) 1.8       |               |               |   |                        |               |   |   |   |  |  |  |  |  |  |  |  |  |  |  |   |       |       |
|   | ADR           | 12/95 → 12/97 |    | VKMA 01908             | 1             | 1 | 1 | 1 |  |  |  |  |  |  |  |  |  |  |  | 1 | T0152 |       |
|  |               |               |   | VKM 11008              | 1             |   |   |   |  |  |  |  |  |  |  |  |  |  |  |   |       |       |
|  |               |               |   | VKM 11009              |               |   |   |   |  |  |  |  |  |  |  |  |  |  |  |   |       |       |
|  |               |               |   | VKM 21004              |               |   | 1 |   |  |  |  |  |  |  |  |  |  |  |  |   |       |       |
|  | ADR           | 12/95 → 12/97 |   | VKMA 01008             | 1             | 1 | 1 |   |  |  |  |  |  |  |  |  |  |  |  |   | 1     | T0152 |
|  |               |               |   | VKM 11008              | 1             |   |   |   |  |  |  |  |  |  |  |  |  |  |  |   |       |       |
|  |               |               |   | VKM 21004              |               |   | 1 |   |  |  |  |  |  |  |  |  |  |  |  |   |       |       |
|   | ADR           | 12/95 → 12/97 | 2)  | VKPA 81402             |               |   |   |   |  |  |  |  |  |  |  |  |  |  |  |   |       |       |
|  |               |               |   | VKPC 81402             |               |   |   |   |  |  |  |  |  |  |  |  |  |  |  |   |       |       |
|   | B(Alt)        | ADR           | 12/95 → 12/97   | VKMMV 5PK1300          |               |   |   |   |  |  |  |  |  |  |  |  |  |  |  |   |       |       |
|  |               |               |   | VKM 31033              | 1             |   |   |   |  |  |  |  |  |  |  |  |  |  |  |   |       |       |
|  | B(AC)         | ADR           | 12/95 → 12/97   | VKMMV 4PK855           |               |   |   |   |  |  |  |  |  |  |  |  |  |  |  |   |       |       |
|  |               |               |   | VKM 31033              | 1             |   |   |   |  |  |  |  |  |  |  |  |  |  |  |   |       |       |
| AUDI  A6 (4A, C4) / A6 Avant (4A, C4) 2.0       |               |               |   |                        |               |   |   |   |  |  |  |  |  |  |  |  |  |  |  |   |       |       |
|   | AAE, ABK, ADW | 06/94 → 12/97 | → ICH 4A-S-060 808  | VKMA 01001             | 1             |   |   |   |  |  |  |  |  |  |  |  |  |  |  |   |       |       |
|  |               |               |   | VKM 11001              | 1             |   |   |   |  |  |  |  |  |  |  |  |  |  |  |   |       |       |
|  | AAE, ABK, ADW | 06/94 → 12/97 | CH 4A-S-060 809 I→  | VKMA 01003             | 1             |   |   |   |  |  |  |  |  |  |  |  |  |  |  |   |       |       |
|  |               |               |   | VKM 11003              | 1             |   |   |   |  |  |  |  |  |  |  |  |  |  |  |   |       |       |
|   | AAE, ABK, ADW | 06/94 → 12/97 | 2)  | VKPA 81401             |               |   |   |   |  |  |  |  |  |  |  |  |  |  |  |   |       |       |
|  |               |               |   | VKPC 81401             |               |   |   |   |  |  |  |  |  |  |  |  |  |  |  |   |       |       |
|   | B(Alt)        | AAE, ABK, ADW | 06/94 → 12/97   | VKMMV 4PK855           |               |   |   |   |  |  |  |  |  |  |  |  |  |  |  |   |       |       |
|  | B(PS)         | AAE, ABK, ADW | 06/94 → 12/97   | VKMMV 10AVx910         |               |   |   |   |  |  |  |  |  |  |  |  |  |  |  |   |       |       |
|  | B(AC)         | AAE, ABK, ADW | 06/94 → 12/97   | VKMMV 13AVx800         |               |   |   |   |  |  |  |  |  |  |  |  |  |  |  |   |       |       |
| AUDI  A6 (4A, C4) / A6 Avant (4A, C4) 2.0 16V |               |               |   |                        |               |   |   |   |  |  |  |  |  |  |  |  |  |  |  |   |       |       |
|   | ACE           | 06/94 → 06/95 |   | VKMA 01023             | 1             |   |   |   |  |  |  |  |  |  |  |  |  |  |  |   |       |       |
|  |               |               |   | VKM 11021              | 1             |   |   |   |  |  |  |  |  |  |  |  |  |  |  |   |       |       |
|  | ACE           | 07/95 → 12/97 |   | VKMA 01020             | 1             |   |   |   |  |  |  |  |  |  |  |  |  |  |  |   |       |       |
|  |               |               |   | VKM 11020              | 1             |   |   |   |  |  |  |  |  |  |  |  |  |  |  |   |       |       |
|   | ACE           | 06/94 → 12/97 | 2)  | VKPA 81401             |               |   |   |   |  |  |  |  |  |  |  |  |  |  |  |   |       |       |
|  |               |               |   | VKPC 81401             |               |   |   |   |  |  |  |  |  |  |  |  |  |  |  |   |       |       |
|   | B(Alt)        | ACE           | 06/94 → 12/97   | VKMMV 4PK882           |               |   |   |   |  |  |  |  |  |  |  |  |  |  |  |   |       |       |
|  | B(PS)         | ACE           | 06/94 → 12/97   | VKMMV 10AVx910         |               |   |   |   |  |  |  |  |  |  |  |  |  |  |  |   |       |       |
|  | B(AC)         | ACE           | 06/94 → 12/97   | VKMMV 13AVx800         |               |   |   |   |  |  |  |  |  |  |  |  |  |  |  |   |       |       |
| AUDI  A6 (4A, C4) / A6 Avant (4A, C4) 2.2 S6  |               |               |   |                        |               |   |   |   |  |  |  |  |  |  |  |  |  |  |  |   |       |       |
|   | AAN           | 06/94 → 12/97 |   | —                      | 1             | 1 | 1 |   |  |  |  |  |  |  |  |  |  |  |  |   |       |       |
|  |               |               |   | —                      | 1             |   |   |   |  |  |  |  |  |  |  |  |  |  |  |   |       |       |
|  |               |               |   | VKM 21052              |               |   | 1 |   |  |  |  |  |  |  |  |  |  |  |  |   |       |       |
|  | AAN           | 06/94 → 02/97 |   | —                      | 1             | 1 | 1 |   |  |  |  |  |  |  |  |  |  |  |  |   |       |       |
|  |               |               |   | —                      | 1             |   |   |   |  |  |  |  |  |  |  |  |  |  |  |   |       |       |
|  |               |               |   | VKM 21052              |               |   | 1 |   |  |  |  |  |  |  |  |  |  |  |  |   |       |       |
|   | AAN           | 06/94 → 12/97 |   | VKPC 81612             |               |   |   |   |  |  |  |  |  |  |  |  |  |  |  |   |       |       |
|  | AAN           | 06/94 → 02/97 |   | VKPC 81612             |               |   |   |   |  |  |  |  |  |  |  |  |  |  |  |   |       |       |
| AUDI  A6 (4A, C4) / A6 Avant (4A, C4) 2.3     |               |               |   |                        |               |   |   |   |  |  |  |  |  |  |  |  |  |  |  |   |       |       |
|   | AAR           | 06/94 → 12/95 |   | VKMA 01050             | 1             |   |   |   |  |  |  |  |  |  |  |  |  |  |  |   |       |       |
|  |               |               |   | VKM 11050              | 1             |   |   |   |  |  |  |  |  |  |  |  |  |  |  |   |       |       |
|  | AAR           | 06/94 → 12/95 |  | VKMA 01060             | 1             |   |   |   |  |  |  |  |  |  |  |  |  |  |  |   |       |       |
|  |               |               |   | VKM 11060              | 1             |   |   |   |  |  |  |  |  |  |  |  |  |  |  |   |       |       |
|   | AAR           | 06/94 → 12/95 |   | VKPC 81612             |               |   |   |   |  |  |  |  |  |  |  |  |  |  |  |   |       |       |
| AUDI  A6 (4A, C4) / A6 Avant (4A, C4) 2.4     |               |               |   |                        |               |   |   |   |  |  |  |  |  |  |  |  |  |  |  |   |       |       |
|   | AFM           | 07/95 → 12/97 |   | VKMA 01201             | 1             | 1 | 1 |   |  |  |  |  |  |  |  |  |  |  |  |   |       |       |
|  |               |               |   | VKM 11201              | 1             |   |   |   |  |  |  |  |  |  |  |  |  |  |  |   |       |       |
|  |               |               |   | VKM 21201              |               |   | 1 |   |  |  |  |  |  |  |  |  |  |  |  |   |       |       |
|   | AFM           | 07/95 → 12/97 |   | VKPC 81802             |               |   |   |   |  |  |  |  |  |  |  |  |  |  |  |   |       |       |
|   | B(Alt)        | AFM           | 07/95 → 12/97   | AC                     | VKM 31061     | 1 |   |   |  |  |  |  |  |  |  |  |  |  |  |   |       |       |
|  | B(Alt)        | AFM           | 07/95 → 12/97   | AC, → ICH 4A-T-046 054 | VKMMV 6PK1863 |   |   |   |  |  |  |  |  |  |  |  |  |  |  |   |       |       |
|  |               |               |   |                        | VKM 31061     | 1 |   |   |  |  |  |  |  |  |  |  |  |  |  |   |       |       |
|  | B(Alt)        | AFM           | 07/95 → 12/97   | AC, CH 4A-T-046 055 I→ | VKM 31061     | 1 |   |   |  |  |  |  |  |  |  |  |  |  |  |   |       |       |





| AUDI  A6 (4A, C4) / A6 Avant (4A, C4) 2.6       |                        |               |   |   |             |        |        |        |  |  |  |        |   |  |  |  |         |  |
|--|------------------------|---------------|---|---|-------------|--------|--------|--------|--|--|--|--------|---|--|--|--|---------|--|
|    | ABC, ACZ               | 06/94 → 12/97 | → ICH 4A-S-026 714  | VKMA 01200<br>VKM 11200<br>VKM 21052              | 1<br>1      | 1      | 1      |        |  |  |  |        |   |  |  |  | T0100   |  |
|  | ABC, ACZ               | 06/94 → 12/97 | CH 4A-S-026 715 I→  | VKMA 01201<br>VKM 11201<br>VKM 21201              | 1<br>1      | 1      | 1      |        |  |  |  |        |   |  |  |  | 2 T0100 |  |
|    | ABC, ACZ               | 06/94 → 12/97 | → ICH 4A-S-026 714  | VKPC 81800  |             |        |        |        |  |  |  | 1      |   |  |  |  |         |  |
|  | ABC, ACZ               | 06/94 → 12/97 | CH 4A-S-026 715 I→  | VKPC 81802  |             |        |        |        |  |  |  | 1      |   |  |  |  |         |  |
|    | <b>B(Alt)</b> ABC, ACZ | 06/94 → 12/97 | AC  | VKM 31061   | 1           |        |        |        |  |  |  |        |   |  |  |  |         |  |
|  | <b>B(Alt)</b> ABC, ACZ | 06/94 → 12/97 | AC, 2WD,<br>→ ICH 4A-T-046 054  | VKMA 01200<br>VKM 11200<br>VKM 21052              | 1           |        |        | 1      |  |  |  |        |   |  |  |  |         |  |
|  | <b>B(Alt)</b> ABC, ACZ | 06/94 → 12/97 | AC, 2WD,<br>CH 4A-T-046 055 I→  | VKM 31061   | 1           |        |        |        |  |  |  |        |   |  |  |  |         |  |
|  | <b>B(Alt)</b> ABC      | 06/94 → 12/97 | AC, 4WD,<br>→ ICH 4A-T-050 000  | VKMA 01200<br>VKM 11200<br>VKM 21052              | 1           |        |        | 1      |  |  |  |        |   |  |  |  |         |  |
|  | <b>B(Alt)</b> ABC      | 06/94 → 02/97 | AC, 4WD,<br>CH 4A-T-050 001 I→  | VKM 31061   | 1           |        |        |        |  |  |  |        |   |  |  |  |         |  |
| AUDI  A6 (4A, C4) / A6 Avant (4A, C4) 2.8       |                        |               |   |   |             |        |        |        |  |  |  |        |   |  |  |  |         |  |
|    | ACK                    | 12/95 → 12/97 |    | VKMA 01902<br>VKM 11202<br>VKM 11208<br>VKM 21202 | 1<br>1      | 1      | 1      | 1      |  |  |  |        | 1 |  |  |  | 2 T0153 |  |
|  | AAH                    | 06/94 → 12/97 | → ICH 4A-S-026 714  | VKMA 01200<br>VKM 11200<br>VKM 21052              | 1<br>1      | 1      | 1      |        |  |  |  |        |   |  |  |  | T0100   |  |
|  | AAH                    | 06/94 → 12/97 | CH 4A-S-026 715 I→  | VKMA 01201<br>VKM 11201<br>VKM 21201              | 1<br>1      | 1      | 1      |        |  |  |  |        |   |  |  |  | 2 T0100 |  |
|  | ACK                    | 12/95 → 12/97 |   | VKMA 01202<br>VKM 11202<br>VKM 21202              | 1<br>1      | 1      | 1      |        |  |  |  |        |   |  |  |  | 1 T0153 |  |
|  | AEJ                    | 08/95 → 07/96 |   | VKMA 01201<br>VKM 11201<br>VKM 21201              | 1<br>1      | 1      | 1      |        |  |  |  |        |   |  |  |  | 2 T0100 |  |
|    | AAH, ACK               | 06/94 → 12/97 | → ICH 4A-S-026 714  | VKPC 81800  |             |        |        |        |  |  |  | 1      |   |  |  |  |         |  |
|  | AAH, ACK               | 06/94 → 12/97 | CH 4A-S-026 715 I→  | VKPC 81802  |             |        |        |        |  |  |  | 1      |   |  |  |  |         |  |
|    | <b>B(Alt)</b> AAH, AEJ | 06/94 → 12/97 | AC  | VKM 31061   | 1           |        |        |        |  |  |  |        |   |  |  |  |         |  |
|  | <b>B(Alt)</b> AAH, AEJ | 06/94 → 12/97 | AC, → ICH 4A-T-046 054  | VKMA 01200<br>VKM 11200<br>VKM 21052              | 1           |        |        | 1      |  |  |  |        |   |  |  |  |         |  |
|  | <b>B(Alt)</b> AAH      | 06/94 → 12/97 | AC, → ICH 4A-T-050 000  | VKMA 01200<br>VKM 11200<br>VKM 21052              | 1           |        |        | 1      |  |  |  |        |   |  |  |  |         |  |
|  | <b>B(Alt)</b> AAH, AEJ | 06/94 → 12/97 | AC, CH 4A-T-046 055 I→  | VKM 31061   | 1           |        |        |        |  |  |  |        |   |  |  |  |         |  |
|  | <b>B(Alt)</b> ACK      | 12/95 → 12/97 | AC  | VKMA 01200<br>VKM 11200<br>VKM 21052              | 1           |        |        | 1      |  |  |  |        |   |  |  |  |         |  |
|  | <b>B(Alt)</b> ACK      | 12/95 → 12/97 | AC, → ICH 4A-T-049 217  | VKM 31061   | 1           |        |        |        |  |  |  |        |   |  |  |  |         |  |
|  | <b>B(Alt)</b> ACK      | 12/95 → 12/97 | AC, CH 4A-T-049 218 I→  | VKMA 01200<br>VKM 11200<br>VKM 21052              | 1           |        |        | 1      |  |  |  |        |   |  |  |  |         |  |
| AUDI  A6 (4A, C4) / A6 Avant (4A, C4) 4.2 S6  |                        |               |   |   |             |        |        |        |  |  |  |        |   |  |  |  |         |  |
|    | AEC, AHK               | 06/94 → 12/97 |  | VKMC____<br>____<br>VKM____<br>VKM____<br>VKM____ | 1<br>1<br>1 | 2<br>2 | 1<br>1 | 1<br>1 |  |  |  |        |   |  |  |  |         |  |
|    | AEC, AHK               | 06/94 → 12/97 |   | VKPC 81807  |             |        |        |        |  |  |  | 1      |   |  |  |  |         |  |
| AUDI  A6 (4A, C4) / A6 Avant (4A, C4) 1.9 TDI |                        |               |   |   |             |        |        |        |  |  |  |        |   |  |  |  |         |  |
|    | 1Z, AHU                | 06/94 → 12/97 |   | VKMA 01014<br>VKM 11014<br>VKM 21012              | 1<br>1      | 1      | 1      |        |  |  |  |        |   |  |  |  | 5 T0650 |  |
|    | 1Z, AHU                | 06/94 → 12/97 | 2)  | VKPA 81401<br>VKPC 81401                          |             |        |        |        |  |  |  | 1<br>1 |   |  |  |  |         |  |

|   |  |  |  |      |  |  |  |  |  |  |  |  |  |  |
|---|---|---|---|--|---|---|---|---|---|---|---|---|---|---|
|    | B(Alt)  | 1Z, AHU   | 06/94 → 12/97   | AC   | VKMV 6PK890<br>VKM 31004<br>VKM 31030   | 1<br>1  |   | 1   |   |   |   |   |   |   |
|   | B(Alt)  | 1Z, AHU   | 06/94 → 12/97   | AC   | VKMV 6PK1175<br>VKM 31004<br>VKM 31030  | 1<br>1  |   | 1   |   |   |   |   |   |   |
|   | B(PS)   | 1Z, AHU   | 06/94 → 12/97   |  | VKMV 11.9x903   |   |   | 1   |   |   |   |   |   |   |
|    |   | 1Z, AHU   | 06/94 → 12/97   |  | VKM_____  |   |   |   |   | 1   |   |   |   |   |
| <b>AUDI  A6 (4A, C4) / A6 Avant (4A, C4) 2.5 TDI</b>     |   |   |   |  |   |   |   |   |   |   |   |   |   |   |
|    |   | AAT, AEL  | 06/94 → 12/97   | 4)   | VKMA 01265<br>VKM 11072<br>VKM 11265<br>VKM 11266                                   | 3<br>1<br>1<br>1  |   | 2   |   |   |   |   |   | T0095   |
|    |   | AAT, AEL  | 06/94 → 12/97   |  | VKPC 86619  |   |   |   |   | 1   |   |   |   |   |
|    | B(Alt)  | AAT, AEL  | 06/94 → 12/97   | AC   | VKMV 6PK1341  |   |   | 1   |   |   |   |   |   |   |
|    |   | AAT, AEL  | 06/94 → 12/97   |  | VKM_____  |   |   |   |   | 1   |   |   |   |   |
| <b>AUDI  A6 (4B, C5) / A6 Avant (4B, C5) 1.8</b>         |   |   |   |  |   |   |   |   |   |   |   |   |   |   |
|    |   | AFY   | 05/97 → 01/05   |       | VKMA 01908<br>VKM 11008<br>VKM 11009<br>VKM 21004                                   | 1<br>1<br>1<br>1  | 1   | 1   | 1   | 1   |   |   |   | 1 T0152   |
|   |   | AFY   | 05/97 → 01/05   |  | VKMA 01008<br>VKM 11008<br>VKM 21004  | 1<br>1<br>1   | 1   | 1   | 1   |   |   |   |   | 1 T0152   |
|   |   | AJP, ANQ, AQE, ARH  | 07/97 → 01/05   |       | VKMA 01115<br>VKM 11115<br>VKM 21115  | 1<br>1<br>1   | 1   | 1   | 1   |   |   |   |   | 1 T0151   |
|    |   | AFY   | 05/97 → 04/04   | 2)   | VKPA 81402<br>VKPC 81402  |   |   |   |   | 1<br>1  |   |   |   |   |
|   |   | AJP, ANQ, AQE, ARH  | 07/97 → 04/04   |  | VKPC 81408  |   |   |   |   | 1   |   |   |   |   |
|    | B(Alt)  | AFY, AJP, ANQ, AQE, ARH   | 05/97 → 01/05   |  | VKMV 5PK1300<br>VKM 31033   | 1   |   | 1   |   |   |   |   |   |   |
| <b>AUDI  A6 (4B, C5) / A6 Avant (4B, C5) 1.8 Turbo</b> |   |   |   |  |   |   |   |   |   |   |   |   |   |   |
|    |   | AEB, AJL, ANB, APU, ARK   | 01/97 → 01/05   |  5) | VKMA 01908<br>VKM 11008<br>VKM 11009<br>VKM 21004                                   | 1<br>1<br>1<br>1  | 1   | 1   | 1   | 1   |   |   |   | 1 T0152   |
|   |   | AEB, AJL, ANB, APU, ARK   | 01/97 → 01/05   | 5)   | VKMA 01008<br>VKM 11008<br>VKM 21004  | 1<br>1<br>1   | 1   | 1   | 1   |   |   |   |   | 1 T0152   |
|   |   | AWT   | 01/97 → 01/05   |     | VKMA 01918<br>VKM 11018<br>VKM 11117  | 1<br>1<br>1   |   | 1   | 1   | 1   |   |   |   | 3 T0151   |
|   |   | AWT   | 01/97 → 01/05   |  | VKMA 01018<br>VKM 11018<br>VKM 21220  | 1<br>1<br>1   | 1   | 1   | 1   |   |   |   |   | 3 T0151   |
|    |   | AEB, AJL, ANB, APU, ARK, AWL  | 01/97 → 04/04   | 2)   | VKPA 81402<br>VKPC 81402  |   |   |   |   | 1<br>1  |   |   |   |   |
|   |   | AWT   | 01/97 → 04/04   |  | VKPC 81620  |   |   |   |   | 1   |   |   |   |   |
|    | B(Alt)  | AEB, AJL, ANB, APU, ARK, AWL, AWT   | 01/97 → 01/05   |  | VKMV 5PK1300<br>VKM 31033   | 1   |   | 1   |   |   |   |   |   |   |
| <b>AUDI  A6 (4B, C5) / A6 Avant (4B, C5) 2.0</b>       |   |   |   |  |   |   |   |   |   |   |   |   |   |   |
|    |   | ALT   | 08/01 → 01/05   |     | VKMA 01918<br>VKM 11018<br>VKM 11117  | 1<br>1<br>1   |   | 1   | 1   | 1   |   |   |   | 3 T0151   |
|   |   | ALT   | 08/01 → 01/05   |  | VKMA 01018<br>VKM 11018<br>VKM 21220  | 1<br>1<br>1   | 1   | 1   | 1   |   |   |   |   | 3 T0151   |
|    |   | ALT   | 08/01 → 04/04   |  | VKPC 81408  |   |   |   |   | 1   |   |   |   |   |



AUDI

|  | <b>B(Alt)</b> | ALT  | 08/01 → 01/05 |           | VKMOV 6PK1589<br>VKM____<br>VKM 31006                          | 1 | 1 | 1 |   |  |  |  |  |  |   |  |  |   |       |
|--|---------------|--|---------------|-----------|--|---|---|---|---|--|--|--|--|--|---|--|--|---|-------|
| <b>AUDI  A6 (4B, C5) / A6 Avant (4B, C5) 2.4</b>       |               |  |               |           |  |   |   |   |   |  |  |  |  |  |   |  |  |   |       |
|  |               | AGA, AJG, ALF, ALW,<br>AML, AMM, APC, APS,<br>APZ, ARJ, ARN, ASM,<br>BDV | 02/97 → 01/05 |           | VKMA 01903<br>VKM 11202<br>VKM 11209<br>VKM 21202              | 1 | 1 | 1 | 1 |  |  |  |  |  |   |  |  | 1 | T0153 |
|  |               | AGA, AJG, ALF, ALW,<br>AML, AMM, APC, APS,<br>APZ, ARJ, ARN, ASM,<br>BDV | 02/97 → 01/05 |           | VKMA 01202<br>VKM 11202<br>VKM 21202                           | 1 | 1 | 1 |   |  |  |  |  |  |   |  |  | 1 | T0153 |
|  |               | AGA, AJG, ALF, ALW,<br>AML, AMM, APC, APS,<br>APZ, ARJ, ARN, ASM,<br>BDV | 02/97 → 04/04 |           | VKPC 81802   |   |   |   |   |  |  |  |  |  | 1 |  |  |   |       |
|  | <b>B(Alt)</b> | AGA, AJG, ALF, ALW,<br>AML, AMM, APC, APS,<br>APZ, ARJ, ARN, ASM         | 02/97 → 12/01 | <b>AC</b> | VKMOV 6PK1882<br>VKM 31061                                     | 1 |   |   | 1 |  |  |  |  |  |   |  |  |   |       |
|  | <b>B(Alt)</b> | BDV  | 08/01 → 01/05 |           | VKMOV 6PK1882<br>VKM 31061                                     | 1 |   |   | 1 |  |  |  |  |  |   |  |  |   |       |
| <b>AUDI  A6 (4B, C5) / A6 Avant (4B, C5) 2.7 Turbo</b> |               |  |               |           |  |   |   |   |   |  |  |  |  |  |   |  |  |   |       |
|  |               | AJK, ARE, AZA, BES   | 12/97 → 01/05 |           | VKMA 01903<br>VKM 11202<br>VKM 11209<br>VKM 21202              | 1 | 1 | 1 | 1 |  |  |  |  |  |   |  |  | 1 | T0153 |
|  |               | AJK, ARE, AZA, BES   | 12/97 → 01/05 |           | VKMA 01202<br>VKM 11202<br>VKM 21202                           | 1 | 1 | 1 |   |  |  |  |  |  |   |  |  | 1 | T0153 |
|  |               | AJK, ARE, AZA, BES   | 12/97 → 04/04 |           | VKPC 81811   |   |   |   |   |  |  |  |  |  | 1 |  |  |   |       |
|  | <b>B(Alt)</b> | AJK, ARE, AZA, BES   | 12/97 → 12/01 | <b>AC</b> | VKMOV 6PK1856<br>VKM 31061                                     | 1 |   |   | 1 |  |  |  |  |  |   |  |  |   |       |
| <b>AUDI  A6 (4B, C5) / A6 Avant (4B, C5) 2.8</b>       |               |  |               |           |  |   |   |   |   |  |  |  |  |  |   |  |  |   |       |
|  |               | ACK, AGE, ALG, AMX,<br>APR, AQD, ATX                                     | 02/97 → 01/05 |           | VKMA 01903<br>VKM 11202<br>VKM 11209<br>VKM 21202              | 1 | 1 | 1 | 1 |  |  |  |  |  |   |  |  | 1 | T0153 |
|  |               | ACK, AGE, ALG, AMX,<br>APR, AQD, ATX                                     | 02/97 → 01/05 |           | VKMA 01202<br>VKM 11202<br>VKM 21202                           | 1 | 1 | 1 |   |  |  |  |  |  |   |  |  | 1 | T0153 |
|  |               | ACK, AGE, ALG, AMX,<br>APR, AQD, ATX                                     | 02/97 → 04/04 |           | VKPC 81802   |   |   |   |   |  |  |  |  |  | 1 |  |  |   |       |
|  | <b>B(Alt)</b> | ACK, AGE, ALG, AMX,<br>APR, AQD, ATX                                     | 02/97 → 01/05 | <b>AC</b> | VKMOV 6PK1882<br>VKM 31061                                     | 1 |   |   | 1 |  |  |  |  |  |   |  |  |   |       |
| <b>AUDI  A6 (4B, C5) / A6 Avant (4B, C5) 3.0</b>       |               |  |               |           |  |   |   |   |   |  |  |  |  |  |   |  |  |   |       |
|  |               | ASN, BBJ   | 08/01 → 01/05 |           | VKMC____<br>VKMA 01301<br>VKM 11300<br>VKM____<br>VKM 21302    | 2 | 1 | 1 | 1 |  |  |  |  |  |   |  |  |   |       |
|  |               |  |               |           |  | 2 | 1 | 1 |   |  |  |  |  |  |   |  |  |   |       |
|  |               |  |               |           |  | 1 |   |   |   |  |  |  |  |  |   |  |  |   |       |
|  |               |  |               |           |  | 1 |   |   |   |  |  |  |  |  |   |  |  |   |       |
|  |               |  |               |           |  |   | 1 |   |   |  |  |  |  |  |   |  |  |   |       |
| <b>AUDI  A6 (4B, C5) / A6 Avant (4B, C5) 4.2</b>       |               |  |               |           |  |   |   |   |   |  |  |  |  |  |   |  |  |   |       |
|  |               | ARS, ASG   | 11/98 → 01/05 |           | VKMA 01904<br>VKM 11154<br>VKM 11207<br>VKM 21203<br>VKM 21204 | 1 | 2 | 1 | 1 |  |  |  |  |  |   |  |  |   | T0153 |
|  |               |  |               |           |  | 1 |   |   |   |  |  |  |  |  |   |  |  |   |       |
|  |               |  |               |           |  |   | 1 |   |   |  |  |  |  |  |   |  |  |   |       |
|  |               |  |               |           |  |   |   | 1 |   |  |  |  |  |  |   |  |  |   |       |
|  |               |  |               |           |  |   |   |   | 1 |  |  |  |  |  |   |  |  |   |       |

|  | ARS, ASG                 | 11/98 → 01/05 | CH 4B-Y-130 001 I→,<br>→ ICH 4B-1-105 000 | VKMA 01905<br>VKM 11207<br>—<br>VKM 21203<br>VKM 21204         | 1<br>1 | 2 | 1 | 1 |  |  |  |  |  |  |  |  |  |  |  |  |  | T0153   |
|--|--------------------------|---------------|---|--|--------|---|---|---|--|--|--|--|--|--|--|--|--|--|--|--|--|---------|
|  | ARS, ASG                 | 11/98 → 01/05 | CH 4B-1-105 001 I→                        | VKMA 01927<br>VKM 11204<br>—<br>VKM 21203<br>VKM 21204         | 1<br>1 | 2 | 1 | 1 |  |  |  |  |  |  |  |  |  |  |  |  |  | T0153   |
| <b>AUDI  A6 (4B, C5) / A6 Avant (4B, C5) 4.2 RS6</b>     |                          |               |   |  |        |   |   |   |  |  |  |  |  |  |  |  |  |  |  |  |  |         |
|  | BCY, BRV                 | 07/02 → 01/05 |   | VKMA 01927<br>VKM 11204<br>—<br>VKM 21203<br>VKM 21204         | 1<br>1 | 2 | 1 | 1 |  |  |  |  |  |  |  |  |  |  |  |  |  | T0153   |
| <b>AUDI  A6 (4B, C5) / A6 Avant (4B, C5) 4.2 S6</b>      |                          |               |   |  |        |   |   |   |  |  |  |  |  |  |  |  |  |  |  |  |  |         |
|  | ANK, AQJ                 | 09/99 → 01/05 | → ICH 4B-Y-130 000                        | VKMA 01904<br>VKM 11154<br>VKM 11207<br>VKM 21203<br>VKM 21204 | 1<br>1 | 2 | 1 | 1 |  |  |  |  |  |  |  |  |  |  |  |  |  | T0153   |
|  | ANK, AQJ                 | 09/99 → 01/05 | CH 4B-1-105 001 I→                        | VKMA 01927<br>VKM 11204<br>—<br>VKM 21203<br>VKM 21204         | 1<br>1 | 2 | 1 | 1 |  |  |  |  |  |  |  |  |  |  |  |  |  | T0153   |
|  | ANK, AQJ                 | 09/99 → 01/05 | CH 4B-Y-130 001 I→,<br>→ ICH 4B-1-105 000 | VKMA 01905<br>VKM 11207<br>—<br>VKM 21203<br>VKM 21204         | 1<br>1 | 2 | 1 | 1 |  |  |  |  |  |  |  |  |  |  |  |  |  | T0153   |
|  | ANK, AQJ                 | 09/99 → 01/05 |   | —  |        |   |   |   |  |  |  |  |  |  |  |  |  |  |  |  |  | 1       |
| <b>AUDI  A6 (4B, C5) / A6 Avant (4B, C5) 1.9 TDI 110</b> |                          |               |   |  |        |   |   |   |  |  |  |  |  |  |  |  |  |  |  |  |  |         |
|  | AFN, AVG                 | 02/97 → 12/01 |   | VKMA 01014<br>VKM 11014<br>VKM 21012                           | 1<br>1 | 1 | 1 |   |  |  |  |  |  |  |  |  |  |  |  |  |  | 5 T0650 |
|  | AFN, AVG                 | 02/97 → 12/01 |   | VKPC 81615   |        |   |   |   |  |  |  |  |  |  |  |  |  |  |  |  |  | 1       |
|  | <b>B(Alt)</b> AFN, AVG   | 02/97 → 12/01 |   | VKMV 5PK1592<br>VKM 31034                                      | 1      |   |   | 1 |  |  |  |  |  |  |  |  |  |  |  |  |  |         |
|  | <b>B(AC)</b> AFN, AVG    | 02/97 → 12/01 |   | VKMV 4PK855<br>VKM 31059                                       | 1      |   |   | 1 |  |  |  |  |  |  |  |  |  |  |  |  |  |         |
|  | AFN, AVG                 | 02/97 → 12/01 |   | VKM_____   |        |   |   |   |  |  |  |  |  |  |  |  |  |  |  |  |  | 1       |
| <b>AUDI  A6 (4B, C5) / A6 Avant (4B, C5) 1.9 TDI 115</b> |                          |               |   |  |        |   |   |   |  |  |  |  |  |  |  |  |  |  |  |  |  |         |
|  | AJM                      | 07/00 → 01/05 |   | VKMA 01941<br>VKM 11141<br>VKM 11144<br>VKM 21142              | 1<br>1 | 1 | 1 | 1 |  |  |  |  |  |  |  |  |  |  |  |  |  | 2 T0184 |
|  | AJM                      | 07/00 → 01/05 |   | VKMA 01141<br>VKM 11141<br>VKM 21142                           | 1<br>1 | 1 | 1 |   |  |  |  |  |  |  |  |  |  |  |  |  |  | 1 T0184 |
|  | AJM                      | 07/00 → 04/04 |   | VKPC 81626   |        |   |   |   |  |  |  |  |  |  |  |  |  |  |  |  |  | 1       |
|  | <b>B(Alt)</b> AJM        | 07/00 → 01/05 |   | VKMA 31000<br>VKMV 5PK1432<br>VKM 31013                        | 1<br>1 |   |   | 1 |  |  |  |  |  |  |  |  |  |  |  |  |  |         |
|  | <b>B(Alt), B(AC)</b> AJM | 07/00 → 01/05 |   | VKMA 31020<br>VKMV 4PK855<br>VKMV 5PK1432                      | 2<br>1 |   |   | 2 |  |  |  |  |  |  |  |  |  |  |  |  |  |         |



|  |  |               |  |                        | VKM 31013    | 1 |   |   |   |   |  |  |         |
|--|--|---------------|--|------------------------|--------------|---|---|---|---|---|--|--|---------|
|  |  |               |  |                        | VKM 31059    | 1 |   |   |   |   |  |  |         |
| ⊙  | AJM  | 07/00 → 01/05 |  |                        | VKM_____     |   |   |   |   | 1 |  |  |         |
| <b>AUDI  A6 (4B, C5) / A6 Avant (4B, C5) 1.9 TDI 130</b> |  |               |  |                        |              |   |   |   |   |   |  |  |         |
|  | AVF, AWX   | 08/01 → 01/05 |  | → ICH 4B-2-120 000     | VKMA 01942   | 1 | 1 | 1 | 1 |   |  |  | 3 T0184 |
|  |  |               |  |                        | VKM 11142    | 1 |   |   |   |   |  |  |         |
|  |  |               |  |                        | VKM 11145    |   |   |   | 1 |   |  |  |         |
|  |  |               |  |                        | VKM 21142    |   | 1 |   |   |   |  |  |         |
|  | AVF, AWX   | 08/01 → 01/05 |  | → ICH 4B-2-120 000     | VKMA 01142   | 1 | 1 | 1 |   |   |  |  | 3 T0184 |
|  |  |               |  |                        | VKM 11142    | 1 |   |   |   |   |  |  |         |
|  |  |               |  |                        | VKM 21142    |   | 1 |   |   |   |  |  |         |
|  | AVF, AWX   | 08/01 → 01/05 |  | CH 4B-2-120 001 I→     | VKMA 01250   | 1 | 1 | 1 |   |   |  |  | T0184   |
|  |  |               |  |                        | VKM 11250    | 1 |   |   |   |   |  |  |         |
|  |  |               |  |                        | VKM 21147    |   | 1 |   |   |   |  |  |         |
| ⊙  | AVF, AWX   | 08/01 → 04/04 |  | → ICH 4B-2-125 000     | VKPC 81626   |   |   |   |   | 1 |  |  |         |
| ⊙  | AVF, AWX   | 08/01 → 04/04 |  | CH 4B-2-125 001 I→     | VKPC 81303   |   |   |   |   | 1 |  |  |         |
|  | <b>B(Alt)</b> AVF, AWX   | 08/01 → 01/05 |  |                        | VKMA 31000   | 1 |   | 1 |   |   |  |  |         |
|  |  |               |  |                        | VKMV 5PK1432 |   |   | 1 |   |   |  |  |         |
|  |  |               |  |                        | VKM 31013    | 1 |   |   |   |   |  |  |         |
|  | <b>B(AC)</b> AVF, AWX  | 08/01 → 01/05 |  |                        | VKMV 4PK841  |   |   | 1 |   |   |  |  |         |
|  |  |               |  |                        | VKM 31059    | 1 |   |   |   |   |  |  |         |
| ⊙  | AVF, AWX   | 08/01 → 01/05 |  |                        | VKM_____     |   |   |   |   | 1 |  |  |         |
| <b>AUDI  A6 (4B, C5) / A6 Avant (4B, C5) 2.5 TDI</b>     |  |               |  |                        |              |   |   |   |   |   |  |  |         |
|  | AFB, AKN   | 07/97 → 04/01 |  | 4)                     | VKMA 01951   | 2 | 1 | 2 | 1 |   |  |  | 3 T0166 |
|  |  |               |  |                        | VKM 11150    | 1 |   |   |   |   |  |  |         |
|  |  |               |  |                        | VKM 11151    | 1 |   |   |   |   |  |  |         |
|  |  |               |  |                        | VKM 11154    |   |   |   | 1 |   |  |  |         |
|  |  |               |  |                        | VKM 21151    |   | 1 |   |   |   |  |  | 1       |
|  | AFB, AKN   | 07/97 → 04/01 |  | 4)                     | VKMA 01151   | 2 | 1 | 2 |   |   |  |  | 2 T0166 |
|  |  |               |  |                        | VKM 11150    | 1 |   |   |   |   |  |  |         |
|  |  |               |  |                        | VKM 11151    | 1 |   |   |   |   |  |  |         |
|  |  |               |  |                        | VKM 21151    |   | 1 |   |   |   |  |  | 1       |
|  | AKE, BAU, BDH, BND   | 02/00 → 01/05 |  | 4),                    | VKMA 01951   | 2 | 1 | 2 | 1 |   |  |  | 3 T0166 |
|  |  |               |  |                        | VKM 11150    | 1 |   |   |   |   |  |  |         |
|  |  |               |  |                        | VKM 11151    | 1 |   |   |   |   |  |  |         |
|  |  |               |  |                        | VKM 11154    |   |   |   | 1 |   |  |  |         |
|  |  |               |  |                        | VKM 21151    |   | 1 |   |   |   |  |  | 1       |
|  | AKE, BAU, BDH, BND   | 02/00 → 01/05 |  | 4), → ICH 4B-Y-050 000 | VKMA 01151   | 2 | 1 | 2 |   |   |  |  | 2 T0166 |
|  |  |               |  |                        | VKM 11150    | 1 |   |   |   |   |  |  |         |
|  |  |               |  |                        | VKM 11151    | 1 |   |   |   |   |  |  |         |
|  |  |               |  |                        | VKM 21151    |   | 1 |   |   |   |  |  | 1       |
|  | AKE, BAU, BDH, BND   | 02/00 → 01/05 |  | 4),                    | VKMA 01952   | 2 | 1 | 2 | 1 |   |  |  | 3 T0170 |
|  |  |               |  |                        | VKM 11150    | 1 |   |   |   |   |  |  |         |
|  |  |               |  |                        | VKM 11151    | 1 |   |   |   |   |  |  |         |
|  |  |               |  |                        | VKM 11154    |   |   |   | 1 |   |  |  |         |
|  |  |               |  |                        | VKM 21151    |   | 1 |   |   |   |  |  | 1       |
|  | AKE, BAU, BDH, BND   | 02/00 → 01/05 |  | 4), CH 4B-Y-050 001 I→ | VKMA 01152   | 2 | 1 | 2 |   |   |  |  | 2 T0170 |
|  |  |               |  |                        | VKM 11150    | 1 |   |   |   |   |  |  |         |
|  |  |               |  |                        | VKM 11151    | 1 |   |   |   |   |  |  |         |
|  |  |               |  |                        | VKM 21151    |   | 1 |   |   |   |  |  | 1       |
|  | AYM, BCZ, BDG, BFC   | 08/01 → 01/05 |  | 4)                     | VKMA 01952   | 2 | 1 | 2 | 1 |   |  |  | 3 T0170 |
|  |  |               |  |                        | VKM 11150    | 1 |   |   |   |   |  |  |         |
|  |  |               |  |                        | VKM 11151    | 1 |   |   |   |   |  |  |         |
|  |  |               |  |                        | VKM 11154    |   |   |   | 1 |   |  |  |         |
|  |  |               |  |                        | VKM 21151    |   | 1 |   |   |   |  |  | 1       |
|  | AYM, BCZ, BDG, BFC   | 08/01 → 01/05 |  | 4)                     | VKMA 01152   | 2 | 1 | 2 |   |   |  |  | 2 T0170 |
|  |  |               |  |                        | VKM 11150    | 1 |   |   |   |   |  |  |         |
|  |  |               |  |                        | VKM 11151    | 1 |   |   |   |   |  |  |         |
|  |  |               |  |                        | VKM 21151    |   | 1 |   |   |   |  |  | 1       |
| ⊙  | AFB, AKE, AKN, AYM,<br>BAU, BCZ, BDG, BDH,<br>BFC, BND               | 07/97 → 04/04 |  |                        | VKPC 81625   |   |   |   |   | 1 |  |  |         |
|  | <b>B(Alt)</b> AFB, AKE, AKN, AYM,<br>BAU, BCZ, BDG, BDH,<br>BFC, BND | 07/97 → 01/05 |  |                        | VKMV 6PK2404 |   |   | 1 |   |   |  |  |         |
|  |  |               |  |                        | VKM 31038    | 1 |   |   |   |   |  |  |         |



| <b>B(AC)</b>                                    | AFB, AKE, AKN, AYM,<br>BAU, BDH, BND                   | 07/97 → 12/01 |               |  |  |  |  |  |  |  |  |  |
|---|--|---------------|---------------|--|--|--|--|--|--|--|--|--|
|   |  |               |               |  |  |  |  |  |  |  |  |  |
| <b>B(AC)</b>                                    | AFB, AKE, AKN, AYM,<br>BAU, BCZ, BDG, BDH,<br>BFC, BND | 01/02 → 01/05 |               |  |  |  |  |  |  |  |  |  |
| <b>AUDI  A6 (4F2) / A6 Avant (4F5) 2.0 TFSI</b> |  |               |               |  |  |  |  |  |  |  |  |  |
|   | BPJ  | 06/05 → 10/07 |               |  |  |  |  |  |  |  |  |  |
|   |  |               |               |  |  |  |  |  |  |  |  |  |
|   | BPJ  | 06/05 → 10/07 |               |  |  |  |  |  |  |  |  |  |
|   | <b>B(Alt)</b> BPJ                                      | 06/05 → 10/07 |               |  |  |  |  |  |  |  |  |  |
|   |  |               |               |  |  |  |  |  |  |  |  |  |
| <b>AUDI  A6 (4F2) / A6 Avant (4F5) 2.4</b>      |  |               |               |  |  |  |  |  |  |  |  |  |
|   | BDV  | 05/04 → 10/07 |               |  |  |  |  |  |  |  |  |  |
|   |  |               |               |  |  |  |  |  |  |  |  |  |
|   | BDV  | 05/04 → 10/07 |               |  |  |  |  |  |  |  |  |  |
|   | <b>B(Alt)</b> BDV                                      | 05/04 → 10/07 |               |  |  |  |  |  |  |  |  |  |
|   |  |               |               |  |  |  |  |  |  |  |  |  |
| <b>AUDI  A6 (4F2) / A6 Avant (4F5) 2.8 FSI</b>  |  |               |               |  |  |  |  |  |  |  |  |  |
|   | BDX  | 11/06 → 10/07 |               |  |  |  |  |  |  |  |  |  |
|   |  |               |               |  |  |  |  |  |  |  |  |  |
| <b>AUDI  A6 (4F2) / A6 Avant (4F5) 3.0</b>      |  |               |               |  |  |  |  |  |  |  |  |  |
|   | BBJ  | 05/04 → 05/06 |               |  |  |  |  |  |  |  |  |  |
|   |  |               |               |  |  |  |  |  |  |  |  |  |
|   |  |               |               |  |  |  |  |  |  |  |  |  |
| <b>AUDI  A6 (4F2) / A6 Avant (4F5) 3.2 FSI</b>  |  |               |               |  |  |  |  |  |  |  |  |  |
|   | BYU  | 09/06 → 10/07 |               |  |  |  |  |  |  |  |  |  |
|   | AUK  | 05/04 → 10/07 |               |  |  |  |  |  |  |  |  |  |
|   |  |               |               |  |  |  |  |  |  |  |  |  |
| <b>AUDI  A6 (4F2) / A6 Avant (4F5) 4.2</b>      |  |               |               |  |  |  |  |  |  |  |  |  |
|   | BAT  | 05/04 → 10/07 |               |  |  |  |  |  |  |  |  |  |
|   |  |               |               |  |  |  |  |  |  |  |  |  |
| <b>AUDI  A6 (4F2) / A6 Avant (4F5) 4.2 FSI</b>  |  |               |               |  |  |  |  |  |  |  |  |  |
|   | BJJ  | 06/06 → 10/07 |               |  |  |  |  |  |  |  |  |  |
|   |  |               |               |  |  |  |  |  |  |  |  |  |
| <b>AUDI  A6 (4F2) / A6 Avant (4F5) 4.2 S6</b>   |  |               |               |  |  |  |  |  |  |  |  |  |
|   | BXA  | 03/06 → 10/07 |               |  |  |  |  |  |  |  |  |  |
|   |  |               |               |  |  |  |  |  |  |  |  |  |
| <b>AUDI  A6 (4F2) / A6 Avant (4F5) 2.0 TDI</b>  |  |               |               |  |  |  |  |  |  |  |  |  |
|   | BLB, BNA, BRE, BRF,<br>BVG                             | 07/04 → 10/07 |               |  |  |  |  |  |  |  |  |  |
|   |  |               |               |  |  |  |  |  |  |  |  |  |
|   | BLB, BRE   | 07/04 → 06/07 |               |  |  |  |  |  |  |  |  |  |
|   | <b>B(Alt)</b> BLB, BNA, BRE, BRF,<br>BVG               | 07/04 → 10/07 |               |  |  |  |  |  |  |  |  |  |
|   |  |               |               |  |  |  |  |  |  |  |  |  |
| <b>AUDI  A6 (4F2) / A6 Avant (4F5) 2.7 TDI</b>  |  |               |               |  |  |  |  |  |  |  |  |  |
|   | BPP, BSG   | 11/04 → 10/07 | <b>B(Cam)</b> |  |  |  |  |  |  |  |  |  |
|   | BPP, BSG   | 11/04 → 10/07 | <b>B(inj)</b> |  |  |  |  |  |  |  |  |  |
|   |  |               |               |  |  |  |  |  |  |  |  |  |
| <b>AUDI  A6 (4F2) / A6 Avant (4F5) 3.0 TDI</b>  |  |               |               |  |  |  |  |  |  |  |  |  |
|   | ASB  | 06/06 → 10/07 | <b>B(Cam)</b> |  |  |  |  |  |  |  |  |  |
|   | ASB, BMK, BNG  | 05/04 → 10/07 | <b>B(inj)</b> |  |  |  |  |  |  |  |  |  |
|   |  |               |               |  |  |  |  |  |  |  |  |  |



| <b>AUDI</b> |                         | <b>A6 Allroad (4FH) 3.2 FSI</b> |                    |  |                        |   |   |  |  |  |  |  |         |
|-------------|-------------------------|---------------------------------|--------------------|--|------------------------|---|---|--|--|--|--|--|---------|
|             | AUK                     | 05/06 → 10/07                   |                    |  |                        |   |   |  |  |  |  |  |         |
| <b>AUDI</b> |                         | <b>A6 Allroad (4FH) 4.2 FSI</b> |                    |  |                        |   |   |  |  |  |  |  |         |
|             | BVJ                     | 05/06 → 10/07                   |                    |  |                        |   |   |  |  |  |  |  |         |
| <b>AUDI</b> |                         | <b>A6 Allroad (4FH) 2.7 TDI</b> |                    |  |                        |   |   |  |  |  |  |  |         |
|             | BPP, BSG                | 05/06 → 10/07                   |                    |  |                        |   |   |  |  |  |  |  |         |
|             |                         |                                 | VKMA 01332         | 1                                      |                        | 1 |   |  |  |  |  |  | 1 T0246 |
|             |                         |                                 | VKM 11332          | 1                                      |                        |   |   |  |  |  |  |  |         |
| <b>AUDI</b> |                         | <b>A6 Allroad (4FH) 3.0 TDI</b> |                    |  |                        |   |   |  |  |  |  |  |         |
|             | ASB, BNG                | 05/06 → 10/07                   |                    |  |                        |   |   |  |  |  |  |  |         |
|             |                         |                                 | VKMA 01332         | 1                                      |                        | 1 |   |  |  |  |  |  | 1 T0246 |
|             |                         |                                 | VKM 11332          | 1                                      |                        |   |   |  |  |  |  |  |         |
| <b>AUDI</b> |                         | <b>A8 (4D2, 4D8) 2.8</b>        |                    |  |                        |   |   |  |  |  |  |  |         |
|             | ACK                     | 04/96 → 09/02                   |                    | → ICH 4D-V-011 000                     |                        |   |   |  |  |  |  |  |         |
|             |                         |                                 | VKMA 01902         | 1                                      | 1                      | 1 | 1 |  |  |  |  |  | 2 T0153 |
|             |                         |                                 | VKM 11202          | 1                                      |                        |   |   |  |  |  |  |  |         |
|             |                         |                                 | VKM 11208          |  |                        |   | 1 |  |  |  |  |  |         |
|             |                         |                                 | VKM 21202          |  | 1                      |   |   |  |  |  |  |  |         |
|             | ACK                     | 04/96 → 09/02                   |                    | CH 4D-V-011 001 I→                     |                        |   |   |  |  |  |  |  |         |
|             |                         |                                 | VKMA 01903         | 1                                      | 1                      | 1 | 1 |  |  |  |  |  | 1 T0153 |
|             |                         |                                 | VKM 11202          | 1                                      |                        |   |   |  |  |  |  |  |         |
|             |                         |                                 | VKM 11209          |  |                        |   | 1 |  |  |  |  |  |         |
|             |                         |                                 | VKM 21202          |  | 1                      |   |   |  |  |  |  |  |         |
|             | ALG, AMX, APR, AQD      | 04/96 → 09/02                   |                    |  |                        |   |   |  |  |  |  |  |         |
|             |                         |                                 | VKMA 01903         | 1                                      | 1                      | 1 | 1 |  |  |  |  |  | 1 T0153 |
|             |                         |                                 | VKM 11202          | 1                                      |                        |   |   |  |  |  |  |  |         |
|             |                         |                                 | VKM 11209          |  |                        |   | 1 |  |  |  |  |  |         |
|             |                         |                                 | VKM 21202          |  | 1                      |   |   |  |  |  |  |  |         |
|             | AAH, AEJ                | 03/94 → 03/96                   | → ICH 4D-S-000 496 |  |                        |   |   |  |  |  |  |  | T0100   |
|             |                         |                                 | VKMA 01200         | 1                                      | 1                      | 1 |   |  |  |  |  |  |         |
|             |                         |                                 | VKM 11200          | 1                                      |                        |   |   |  |  |  |  |  |         |
|             |                         |                                 | VKM 21052          |  | 1                      |   |   |  |  |  |  |  |         |
|             | AAH, AEJ                | 03/94 → 03/96                   | CH 4D-S-000 497 I→ |  |                        |   |   |  |  |  |  |  |         |
|             |                         |                                 | VKMA 01201         | 1                                      | 1                      | 1 |   |  |  |  |  |  | 2 T0100 |
|             |                         |                                 | VKM 11201          | 1                                      |                        |   |   |  |  |  |  |  |         |
|             |                         |                                 | VKM 21201          |  | 1                      |   |   |  |  |  |  |  |         |
|             | ACK, ALG, AMX, APR, AQD | 04/96 → 09/02                   |                    |  |                        |   |   |  |  |  |  |  |         |
|             |                         |                                 | VKMA 01202         | 1                                      | 1                      | 1 |   |  |  |  |  |  | 1 T0153 |
|             |                         |                                 | VKM 11202          | 1                                      |                        |   |   |  |  |  |  |  |         |
|             |                         |                                 | VKM 21202          |  | 1                      |   |   |  |  |  |  |  |         |
|             | AAH, AEJ                | 03/94 → 03/96                   | → ICH 4D-S-000 496 |  |                        |   |   |  |  |  |  |  |         |
|             |                         |                                 | VKPC 81800         |  |                        |   |   |  |  |  |  |  | 1       |
|             | AAH, AEJ                | 03/94 → 03/96                   | CH 4D-S-000 497 I→ |  |                        |   |   |  |  |  |  |  |         |
|             |                         |                                 | VKPC 81802         |  |                        |   |   |  |  |  |  |  | 1       |
|             | ACK, ALG, AMX, APR, AQD | 04/96 → 09/02                   |                    |  |                        |   |   |  |  |  |  |  | 1       |
|             |                         |                                 | VKPC 81802         |  |                        |   |   |  |  |  |  |  | 1       |
|             | <b>B(Alt)</b>           | AAH, AEJ                        | 03/94 → 03/96      |  | AC, CH 4D-S-004 301 I→ |   |   |  |  |  |  |  |         |
|             |                         |                                 |                    |  |                        |   |   |  |  |  |  |  |         |
|             |                         |                                 | VKMA 6PK1760       |  |                        |   |   |  |  |  |  |  |         |
|             |                         |                                 | VKM 31061          | 1                                      |                        | 1 |   |  |  |  |  |  |         |
|             | <b>B(Alt)</b>           | ACK, ALG                        | 04/96 → 09/02      |  | AC                     |   |   |  |  |  |  |  |         |
|             |                         |                                 |                    |  |                        |   |   |  |  |  |  |  |         |
|             |                         |                                 | VKMA 6PK1760       |  |                        |   |   |  |  |  |  |  |         |
|             |                         |                                 | VKM 31061          | 1                                      |                        | 1 |   |  |  |  |  |  |         |
|             | <b>B(Alt)</b>           | ACK, ALG                        | 04/96 → 09/02      |  | AC                     |   |   |  |  |  |  |  |         |
|             |                         |                                 |                    |  |                        |   |   |  |  |  |  |  |         |
|             |                         |                                 | VKMA 6PK1882       |  |                        |   |   |  |  |  |  |  |         |
|             |                         |                                 | VKM 31061          | 1                                      |                        | 1 |   |  |  |  |  |  |         |
| <b>AUDI</b> |                         | <b>A8 (4D2, 4D8) 3.7</b>        |                    |  |                        |   |   |  |  |  |  |  |         |
|             | AEW, AKJ                | 07/95 → 12/98                   |                    |  |                        |   |   |  |  |  |  |  |         |
|             |                         |                                 | VKMC _____         | 1                                      | 2                      | 1 | 1 |  |  |  |  |  |         |
|             |                         |                                 | —                  | 1                                      | 2                      | 1 |   |  |  |  |  |  |         |
|             |                         |                                 | VKM _____          | 1                                      |                        |   |   |  |  |  |  |  |         |
|             |                         |                                 | VKM _____          |  | 1                      |   |   |  |  |  |  |  |         |
|             |                         |                                 | VKM _____          |  | 1                      |   |   |  |  |  |  |  |         |
|             | AKC, AQG                | 11/98 → 09/02                   |                    | → ICH 4D-Y-016 500                     |                        |   |   |  |  |  |  |  |         |
|             |                         |                                 |                    |  |                        |   |   |  |  |  |  |  |         |
|             |                         |                                 | VKMA 01904         | 1                                      | 2                      | 1 | 1 |  |  |  |  |  | 1 T0153 |
|             |                         |                                 | VKM 11154          |  |                        |   |   |  |  |  |  |  |         |
|             |                         |                                 | VKM 11207          | 1                                      |                        |   |   |  |  |  |  |  |         |
|             |                         |                                 | VKM 21203          |  | 1                      |   |   |  |  |  |  |  |         |
|             |                         |                                 | VKM 21204          |  | 1                      |   |   |  |  |  |  |  |         |
|             | AKC, AQG                | 11/98 → 09/02                   |                    | CH 4D-Y-016 501 I→, → ICH 4D-1-010 500 |                        |   |   |  |  |  |  |  |         |
|             |                         |                                 |                    |  |                        |   |   |  |  |  |  |  |         |
|             |                         |                                 | VKMA 01905         | 1                                      | 2                      | 1 | 1 |  |  |  |  |  | 1 T0153 |
|             |                         |                                 | VKM 11207          | 1                                      |                        |   |   |  |  |  |  |  |         |
|             |                         |                                 | —                  |  |                        |   | 1 |  |  |  |  |  |         |
|             |                         |                                 | VKM 21203          |  | 1                      |   |   |  |  |  |  |  |         |
|             |                         |                                 | VKM 21204          |  | 1                      |   |   |  |  |  |  |  |         |































|                                    | AKC, AQG                        | 11/98 → 09/02 |  | CH 4D-1-010 501 I→                        | VKMA 01927<br>VKM 11204<br>—<br>VKM 21203<br>VKM 21204         | 1<br>1      | 2 | 1 | 1 |  |   |  |  |  |  |  | T0153   |
|------------------------------------|---------------------------------|---------------|--|---|--|-------------|---|---|---|--|---|--|--|--|--|--|---------|
|                                    | AEW, AKJ                        | 07/95 → 12/98 |  |   | VKPC 81807   |             |   |   |   |  | 1 |  |  |  |  |  |         |
|                                    | AKC, AQG                        | 11/98 → 09/02 |  |   | —  |             |   |   |   |  | 1 |  |  |  |  |  |         |
| <b>AUDI  A8 (4D2, 4D8) 4.2</b>     |                                 |               |  |   |  |             |   |   |   |  |   |  |  |  |  |  |         |
|                                    | ABZ, AEM, AGH, AHC,<br>AKG, AKH | 03/94 → 06/99 |  |   | VKMC _____<br>—<br>VKM _____<br>VKM _____<br>VKM _____         | 1<br>1<br>1 | 2 | 1 | 1 |  |   |  |  |  |  |  |         |
|                                    | AQF, AQH, ARU, AUW,<br>AVP      | 11/98 → 09/02 |  | → ICH 4D-Y-016 500                        | VKMA 01904<br>VKM 11154<br>VKM 11207<br>VKM 21203<br>VKM 21204 | 1<br>1      | 2 | 1 | 1 |  |   |  |  |  |  |  | T0153   |
|                                    | AQF, AQH, ARU, AUW,<br>AVP      | 11/98 → 09/02 |  | CH 4D-Y-016 501 I→,<br>→ ICH 4D-1-010 500 | VKMA 01905<br>VKM 11207<br>—<br>VKM 21203<br>VKM 21204         | 1<br>1      | 2 | 1 | 1 |  |   |  |  |  |  |  | T0153   |
|                                    | AQF, AQH, ARU, AUW,<br>AVP      | 11/98 → 09/02 |  | CH 4D-1-010 501 I→                        | VKMA 01927<br>VKM 11204<br>—<br>VKM 21203<br>VKM 21204         | 1<br>1      | 2 | 1 | 1 |  |   |  |  |  |  |  | T0153   |
|                                    | ABZ, AEM, AHC, AKG,<br>AKH      | 03/94 → 06/99 |  |   | VKPC 81807   |             |   |   |   |  | 1 |  |  |  |  |  |         |
|                                    | AQF, AQH, ARU, AUW,<br>AVP      | 11/98 → 09/02 |  |   | —  |             |   |   |   |  | 1 |  |  |  |  |  |         |
| <b>AUDI  A8 (4D2, 4D8) 6.0 W12</b> |                                 |               |  |   |  |             |   |   |   |  |   |  |  |  |  |  |         |
|                                    | AZC                             | 01/01 → 09/02 |  |   | XXXXXXXXXX   |             |   |   |   |  |   |  |  |  |  |  |         |
| <b>AUDI  A8 (4D2, 4D8) 2.5 TDI</b> |                                 |               |  |   |  |             |   |   |   |  |   |  |  |  |  |  |         |
|                                    | AFB, AKN                        | 01/97 → 04/00 |  | 4)  | VKMA 01951<br>VKM 11150<br>VKM 11151<br>VKM 11154<br>VKM 21151 | 2<br>1<br>1 | 1 | 2 | 1 |  |   |  |  |  |  |  | 3 T0166 |
|                                    | AFB, AKN                        | 01/97 → 04/00 |  | 4)  | VKMA 01151<br>VKM 11150<br>VKM 11151<br>VKM 21151              | 2<br>1<br>1 | 1 | 2 |   |  |   |  |  |  |  |  | 2 T0166 |
|                                    | AKE                             | 09/00 → 09/02 |  | 4)  | VKMA 01952<br>VKM 11150<br>VKM 11151<br>VKM 11154<br>VKM 21151 | 2<br>1<br>1 | 1 | 2 | 1 |  |   |  |  |  |  |  | 3 T0170 |
|                                    | AKE                             | 09/00 → 09/02 |  | 4)  | VKMA 01152<br>VKM 11150<br>VKM 11151<br>VKM 21151              | 2<br>1<br>1 | 1 | 2 |   |  |   |  |  |  |  |  | 2 T0170 |
|                                    | AFB, AKE, AKN                   | 01/97 → 09/02 |  |   | VKPC 81625   |             |   |   |   |  | 1 |  |  |  |  |  |         |
|                                    | <b>B(Alt)</b> AFB, AKE, AKN     | 01/97 → 09/02 |  |   | VKMV 6PK2404<br>VKM 31038<br>VKM 31039<br>VKM 31041            |             |   | 1 |   |  |   |  |  |  |  |  | 1       |



| <b>B(AC)</b>                         | AFB, AKE, AKN          | 01/97 → 09/02 |               |  | VKMOV 4PK1237<br>VKM 31040                                  | 1                     | 1                     |                       |  |  |  |  |         |
|--------------------------------------|------------------------|---------------|---------------|--|---|-----------------------|-----------------------|-----------------------|--|--|--|--|---------|
| <b>AUDI  A8 (4D2, 4D8) 3.3 TDI</b>   |                        |               |               |  |   |                       |                       |                       |  |  |  |  |         |
|                                      | AKF                    | 06/00 → 09/02 |               |  | VKMC____<br>VKMA____<br>VKM 11330<br>VKM 11331<br>VKM 21330 | 2<br>2<br>1<br>1<br>1 | 1<br>1<br>1<br>1<br>1 | 1<br>1<br>1<br>1<br>1 |  |  |  |  |         |
|                                      | AKF                    | 06/00 → 09/02 |               |  | —   |                       |                       |                       |  |  |  |  |         |
| <b>AUDI  A8 (4E_) 3.0</b>            |                        |               |               |  |   |                       |                       |                       |  |  |  |  |         |
|                                      | ASN, BBJ               | 07/03 → 10/07 |               |  | VKMC____<br>VKMA 01301<br>VKM 11300<br>VKM____<br>VKM 21302 | 2<br>2<br>1<br>1<br>1 | 1<br>1<br>1<br>1<br>1 | 1<br>1<br>1<br>1<br>1 |  |  |  |  |         |
| <b>AUDI  A8 (4E_) 3.2 FSI</b>        |                        |               |               |  |   |                       |                       |                       |  |  |  |  |         |
|                                      | BPK                    | 06/05 → 10/07 |               |  | <del>XXXXXXXX</del>   |                       |                       |                       |  |  |  |  |         |
| <b>AUDI  A8 (4E_) 3.7</b>            |                        |               |               |  |   |                       |                       |                       |  |  |  |  |         |
|                                      | BFL                    | 10/02 → 10/07 |               |  | VKMA 01927<br>VKM 11204<br>—<br>VKM 21203<br>VKM 21204      | 1<br>1<br>1<br>1<br>1 | 2<br>1<br>1<br>1<br>1 | 1<br>1<br>1<br>1<br>1 |  |  |  |  | T0153   |
| <b>AUDI  A8 (4E_) 4.2</b>            |                        |               |               |  |   |                       |                       |                       |  |  |  |  |         |
|                                      | BFM                    | 10/02 → 10/07 |               |  | VKMA 01927<br>VKM 11204<br>—<br>VKM 21203<br>VKM 21204      | 1<br>1<br>1<br>1<br>1 | 2<br>1<br>1<br>1<br>1 | 1<br>1<br>1<br>1<br>1 |  |  |  |  | T0153   |
| <b>AUDI  A8 (4E_) 4.2 FSI</b>        |                        |               |               |  |   |                       |                       |                       |  |  |  |  |         |
|                                      | BVJ                    | 06/06 → 10/07 |               |  | <del>XXXXXXXX</del>   |                       |                       |                       |  |  |  |  |         |
| <b>AUDI  A8 (4E_) S8</b>             |                        |               |               |  |   |                       |                       |                       |  |  |  |  |         |
|                                      | BSM                    | 06/06 → 10/07 |               |  | <del>XXXXXXXX</del>   |                       |                       |                       |  |  |  |  |         |
| <b>AUDI  A8 (4E_) 6.0 W12</b>        |                        |               |               |  |   |                       |                       |                       |  |  |  |  |         |
|                                      | BHT, BTE               | 12/03 → 10/07 |               |  | <del>XXXXXXXX</del>   |                       |                       |                       |  |  |  |  |         |
| <b>AUDI  A8 (4E_) 3.0 TDI</b>        |                        |               |               |  |   |                       |                       |                       |  |  |  |  |         |
|                                      | ASB, BNG               | 08/03 → 10/07 | <b>B(Cam)</b> |  | <del>XXXXXXXX</del>   |                       |                       |                       |  |  |  |  |         |
|                                      | ASB, BNG               | 08/03 → 10/07 | <b>B(inj)</b> |  | VKMA 01332<br>VKM 11332                                     | 1<br>1                | 1<br>1                | 1<br>1                |  |  |  |  | 1 T0246 |
| <b>AUDI  A8 (4E_) 4.0 TDI</b>        |                        |               |               |  |   |                       |                       |                       |  |  |  |  |         |
|                                      | ASE                    | 03/03 → 10/07 | <b>B(Cam)</b> |  | <del>XXXXXXXX</del>   |                       |                       |                       |  |  |  |  |         |
|                                      | ASE                    | 03/03 → 10/07 | <b>B(inj)</b> |  | —<br>—<br>VKM 21142   | 1<br>1<br>1           | 1<br>1<br>1           | 1<br>1<br>1           |  |  |  |  | T0642   |
| <b>AUDI  A8 (4E_) 4.2 TDI</b>        |                        |               |               |  |   |                       |                       |                       |  |  |  |  |         |
|                                      | BMC, BVN               | 07/05 → 10/07 | <b>B(Cam)</b> |  | <del>XXXXXXXX</del>   |                       |                       |                       |  |  |  |  |         |
|                                      | BMC, BVN               | 07/05 → 10/07 | <b>B(inj)</b> |  | —<br>—  | 1<br>1                | 1<br>1                | 1<br>1                |  |  |  |  |         |
| <b>AUDI  ALLROAD (4BH) 2.7 Turbo</b> |                        |               |               |  |   |                       |                       |                       |  |  |  |  |         |
|                                      | ARE, BES               | 05/00 → 08/05 |               |  | VKMA 01903<br>VKM 11202<br>VKM 11209<br>VKM 21202           | 1<br>1<br>1<br>1      | 1<br>1<br>1<br>1      | 1<br>1<br>1<br>1      |  |  |  |  | 1 T0153 |
|                                      | ARE, BES               | 05/00 → 08/05 |               |  | VKMA 01202<br>VKM 11202<br>VKM 21202                        | 1<br>1<br>1           | 1<br>1<br>1           | 1<br>1<br>1           |  |  |  |  | 1 T0153 |
|                                      | ARE, BES               | 05/00 → 08/05 |               |  | VKPC 81811  |                       |                       | 1                     |  |  |  |  |         |
|                                      | <b>B(Alt)</b> ARE, BES | 05/00 → 08/05 | <b>AC</b>     |  | VKMOV 6PK1735<br>VKM 31061                                  | 1                     | 1                     | 1                     |  |  |  |  |         |
|                                      | <b>B(Alt)</b> ARE, BES | 05/00 → 08/05 | <b>AC</b>     |  | VKMOV 6PK1856<br>VKM 31061                                  | 1                     | 1                     | 1                     |  |  |  |  |         |
| <b>AUDI  ALLROAD (4BH) 4.2 V8</b>    |                        |               |               |  |   |                       |                       |                       |  |  |  |  |         |
|                                      | BAS                    | 07/02 → 08/05 |               |  | <del>XXXXXXXX</del>   |                       |                       |                       |  |  |  |  |         |

| <b>AUDI  ALLROAD (4B) 2.5 TDI</b>        |               |               |               |                    |                |   |   |   |   |  |   |  |  |  |   |       |       |
|--|---------------|---------------|---------------|--------------------|----------------|---|---|---|---|--|---|--|--|--|---|-------|-------|
|  |               | AKE, BAU, BCZ | 05/00 → 08/05 |                    | VKMA 01952     | 2 | 1 | 2 | 1 |  |   |  |  |  | 3 | T0170 |       |
|  |               |               |               |                    | VKM 11150      | 1 |   |   |   |  |   |  |  |  |   |       |       |
|  |               |               |               |                    | VKM 11151      | 1 |   |   |   |  |   |  |  |  |   |       |       |
|  |               |               |               |                    | VKM 11154      |   |   |   | 1 |  |   |  |  |  |   |       |       |
|  |               |               |               |                    | VKM 21151      |   | 1 |   |   |  |   |  |  |  | 1 |       |       |
|  |               | AKE, BAU, BCZ | 05/00 → 08/05 | 4)                 | VKMA 01152     | 2 | 1 | 2 |   |  |   |  |  |  | 2 | T0170 |       |
|  |               |               |               |                    | VKM 11150      | 1 |   |   |   |  |   |  |  |  |   |       |       |
|  |               |               |               |                    | VKM 11151      | 1 |   |   |   |  |   |  |  |  |   |       |       |
|  |               |               |               |                    | VKM 21151      |   | 1 |   |   |  |   |  |  |  | 1 |       |       |
|  |               | AKE, BAU, BCZ | 05/00 → 08/05 |                    | VKPC 81625     |   |   |   |   |  | 1 |  |  |  |   |       |       |
|  | <b>B(Alt)</b> | AKE, BAU, BCZ | 05/00 → 08/05 |                    | VKMV 6PK2404   |   |   | 1 |   |  |   |  |  |  |   |       |       |
|  |               |               |               |                    | VKM 31038      |   | 1 |   |   |  |   |  |  |  |   |       |       |
|  |               |               |               |                    | VKM 31039      |   | 1 |   |   |  |   |  |  |  | 1 |       |       |
|  |               |               |               |                    | VKM 31041      |   | 1 |   |   |  |   |  |  |  |   |       |       |
|  | <b>B(AC)</b>  | AKE, BAU, BCZ | 05/00 → 08/05 | → ICH 4B-3-090 000 | VKMV 4PK1237   |   |   | 1 |   |  |   |  |  |  |   |       |       |
|  |               |               |               |                    | VKM 31040      | 1 |   |   |   |  |   |  |  |  |   |       |       |
|  | <b>B(AC)</b>  | AKE, BAU, BCZ | 05/00 → 08/05 | CH 4B-3-090 001 I→ | VKMV 4PK1217   |   |   | 1 |   |  |   |  |  |  |   |       |       |
|  |               |               |               |                    | VKM 31040      | 1 |   |   |   |  |   |  |  |  |   |       |       |
| <b>AUDI  CABRIOLET (8G7, B4) 1.8</b>     |               |               |               |                    |                |   |   |   |   |  |   |  |  |  |   |       |       |
|  |               | ADR           | 01/97 → 08/00 |                    | VKMA 01908     | 1 | 1 | 1 | 1 |  |   |  |  |  | 1 | T0152 |       |
|  |               |               |               |                    | VKM 11008      | 1 |   |   |   |  |   |  |  |  |   |       |       |
|  |               |               |               |                    | VKM 11009      |   |   |   | 1 |  |   |  |  |  |   |       |       |
|  |               |               |               |                    | VKM 21004      |   | 1 |   |   |  |   |  |  |  |   |       |       |
|  |               | ADR           | 01/97 → 08/00 |                    | VKMA 01008     | 1 | 1 | 1 |   |  |   |  |  |  | 1 | T0152 |       |
|  |               |               |               |                    | VKM 11008      | 1 |   |   |   |  |   |  |  |  |   |       |       |
|  |               |               |               |                    | VKM 21004      |   | 1 |   |   |  |   |  |  |  |   |       |       |
|  |               | ADR           | 01/97 → 08/00 | 2)                 | VKPA 81402     |   |   |   |   |  | 1 |  |  |  |   |       |       |
|  |               |               |               |                    | VKPC 81402     |   |   |   |   |  | 1 |  |  |  |   |       |       |
|  | <b>B(Alt)</b> | ADR           | 01/97 → 08/00 | AC                 | VKMV 5PK1300   |   |   | 1 |   |  |   |  |  |  |   |       |       |
|  |               |               |               |                    | VKM 31033      | 1 |   |   |   |  |   |  |  |  |   |       |       |
|  | <b>B(Alt)</b> | ADR           | 01/97 → 08/00 | AC                 | VKMV 4PK855    |   |   | 1 |   |  |   |  |  |  |   |       |       |
|  |               |               |               |                    | VKM 31033      | 1 |   |   |   |  |   |  |  |  |   |       |       |
| <b>AUDI  CABRIOLET (8G7, B4) 2.0</b>     |               |               |               |                    |                |   |   |   |   |  |   |  |  |  |   |       |       |
|  |               | ABK           | 01/93 → 12/94 | → ICH 8G-S-002 743 | VKMA 01001     | 1 |   | 1 |   |  |   |  |  |  |   |       | T0091 |
|  |               |               |               |                    | VKM 11001      | 1 |   |   |   |  |   |  |  |  |   |       |       |
|  |               | ABK           | 10/94 → 07/98 | CH 8G-S-002 744 I→ | VKMA 01003     | 1 |   | 1 |   |  |   |  |  |  |   |       | T0091 |
|  |               |               |               |                    | VKM 11003      | 1 |   |   |   |  |   |  |  |  |   |       |       |
|  |               | ABK           | 01/93 → 07/98 | 2)                 | VKPA 81401     |   |   |   |   |  | 1 |  |  |  |   |       |       |
|  |               |               |               |                    | VKPC 81401     |   |   |   |   |  | 1 |  |  |  |   |       |       |
|  | <b>B(Alt)</b> | ABK           | 01/93 → 07/98 |                    | VKMV 4PK855    |   |   | 1 |   |  |   |  |  |  |   |       |       |
|  | <b>B(PS)</b>  | ABK           | 01/93 → 07/98 |                    | VKMV 10AVx910  |   |   | 1 |   |  |   |  |  |  |   |       |       |
|  | <b>B(AC)</b>  | ABK           | 01/93 → 07/98 |                    | VKMV 13AVx800  |   |   | 1 |   |  |   |  |  |  |   |       |       |
| <b>AUDI  CABRIOLET (8G7, B4) 2.0 16V</b> |               |               |               |                    |                |   |   |   |   |  |   |  |  |  |   |       |       |
|  |               | ACE           | 06/95 → 07/96 |                    | VKMA 01023     | 1 |   | 1 |   |  |   |  |  |  |   |       | T0057 |
|  |               |               |               |                    | VKM 11021      | 1 |   |   |   |  |   |  |  |  |   |       |       |
|  |               | ACE           | 06/95 → 07/96 | 2)                 | VKPA 81401     |   |   |   |   |  | 1 |  |  |  |   |       |       |
|  |               |               |               |                    | VKPC 81401     |   |   |   |   |  | 1 |  |  |  |   |       |       |
|  | <b>B(Alt)</b> | ACE           | 06/95 → 07/96 |                    | VKMV 4PK882    |   |   | 1 |   |  |   |  |  |  |   |       |       |
|  | <b>B(PS)</b>  | ACE           | 06/95 → 07/96 |                    | VKMV 10AVx875  |   |   | 1 |   |  |   |  |  |  |   |       |       |
|  | <b>B(AC)</b>  | ACE           | 06/95 → 07/96 |                    | VKMV 13AVx800  |   |   | 1 |   |  |   |  |  |  |   |       |       |
| <b>AUDI  CABRIOLET (8G7, B4) 2.3</b>     |               |               |               |                    |                |   |   |   |   |  |   |  |  |  |   |       |       |
|  |               | NG            | 05/91 → 07/94 |                    | VKMA 01050     | 1 |   | 1 |   |  |   |  |  |  |   |       | T0698 |
|  |               |               |               |                    | VKM 11050      | 1 |   |   |   |  |   |  |  |  |   |       |       |
|  |               | NG            | 05/91 → 07/94 |                    | VKMA 01060     | 1 |   | 1 |   |  |   |  |  |  |   |       | T0698 |
|  |               |               |               |                    | VKM 11060      | 1 |   |   |   |  |   |  |  |  |   |       |       |
|  |               | NG            | 05/91 → 07/94 |                    | VKPC 81612     |   |   |   |   |  | 1 |  |  |  |   |       |       |
|  | <b>B(Alt)</b> | NG            | 05/91 → 07/94 | → ICH 8G-N-004 830 | VKMV 10AVx865  |   |   | 1 |   |  |   |  |  |  |   |       |       |
|  | <b>B(Alt)</b> | NG            | 05/91 → 07/94 | CH 8G-N-004 831 I→ | VKMV 10AVx875  |   |   | 1 |   |  |   |  |  |  |   |       |       |
|  | <b>B(PS)</b>  | NG            | 05/91 → 07/94 |                    | VKMV 13AVx1000 |   |   | 1 |   |  |   |  |  |  |   |       |       |
|  | <b>B(AC)</b>  | NG            | 05/91 → 07/94 |                    | VKMV 13AVx915  |   |   | 1 |   |  |   |  |  |  |   |       |       |



































|   |  |  |  |  |  |  |  |  |  |  |  |
|---|---|---|---|--|---|---|---|---|---|---|---|
| <b>AUDI  CABRIOLET (8G7, B4) 2.6</b>       |   |   |   |  |   |   |   |   |   |   |   |
|   | ABC, ACZ  | 06/93 → 08/00   | → ICH 8G-S-001 302  | VKMA 01200<br>VKM 11200<br>VKM 21052   | 1<br>1  | 1   | 1   |   |   |   | T0100   |
|   | ABC, ACZ  | 06/93 → 08/00   | CH 8G-S-001 303 I→  | VKMA 01201<br>VKM 11201<br>VKM 21201   | 1<br>1  | 1   | 1   |   |   |   | 2 T0100   |
|   | ABC, ACZ  | 06/93 → 08/00   | → ICH 8G-S-001 302  | VKPC 81800   |   |   |   | 1   |   |   |   |
|   | ABC, ACZ  | 06/93 → 08/00   | CH 8G-S-001 303 I→  | VKPC 81802   |   |   |   | 1   |   |   |   |
|   | <b>B(Alt)</b> ABC, ACZ  | 06/93 → 08/00   | AC,<br>→ ICH 8G-R-003 280   | VKMA 6PK1675<br>VKM 31010  |   |   |   | 1   |   |   |   |
|   | <b>B(Alt)</b> ABC, ACZ  | 06/93 → 08/00   | AC, → ICH 8G-R-003 280  | VKMA 6PK2260<br>VKM 31010  |   |   |   | 1   |   |   |   |
| <b>AUDI  CABRIOLET (8G7, B4) 2.8</b>       |   |   |   |  |   |   |   |   |   |   |   |
|   | AAH   | 11/92 → 08/00   | → ICH 8G-S-001 302  | VKMA 01200<br>VKM 11200<br>VKM 21052   | 1<br>1  | 1   | 1   |   |   |   | T0100   |
|   | AAH   | 11/92 → 08/00   | CH 8G-S-001 303 I→  | VKMA 01201<br>VKM 11201<br>VKM 21201   | 1<br>1  | 1   | 1   |   |   |   | 2 T0100   |
|   | AAH   | 11/92 → 08/00   | → ICH 8G-S-001 302  | VKPC 81800   |   |   |   | 1   |   |   |   |
|   | AAH   | 11/92 → 08/00   | CH 8G-S-001 303 I→  | VKPC 81802   |   |   |   | 1   |   |   |   |
|   | <b>B(Alt)</b> AAH   | 11/92 → 08/00   | AC,<br>→ ICH 8G-R-003 280   | VKMA 6PK1675<br>VKM 31010  |   |   |   | 1   |   |   |   |
|   | <b>B(Alt)</b> AAH   | 11/92 → 08/00   | AC, → ICH 8G-R-003 280  | VKMA 6PK2260<br>VKM 31010  |   |   |   | 1   |   |   |   |
| <b>AUDI  CABRIOLET (8G7, B4) 1.9 TDI</b> |   |   |   |  |   |   |   |   |   |   |   |
|   | 1Z, AHU   | 06/95 → 08/00   |   | VKMA 01014<br>VKM 11014<br>VKM 21012   | 1<br>1  | 1   | 1   |   |   |   | 5 T0650   |
|   | 1Z, AHU   | 06/95 → 08/00   | 2)  | VKPA 81401<br>VKPC 81401   |   |   |   | 1   |   |   |   |
|   | <b>B(Alt)</b> 1Z, AHU   | 06/95 → 08/00   | A⊙, AC  | VKMA 6PK890<br>VKM 31004<br>VKM 31030  | 1<br>1  |   | 1   |   |   |   |   |
|   | <b>B(Alt)</b> 1Z, AHU   | 06/95 → 08/00   | A⊙, AC  | VKMA 6PK1175<br>VKM 31004<br>VKM 31030   | 1<br>1  |   | 1   |   |   |   |   |
|   | <b>B(PS)</b> 1Z, AHU  | 06/95 → 08/00   |   | VKMA 11.9x903  |   |   | 1   |   |   |   |   |
| <b>AUDI  COUPE (81, 85) 1.6</b>          |   |   |   |  |   |   |   |   |   |   |   |
|   | YN  | 07/80 → 08/81   | 3)  | VKMS 01000<br>VKMA 01000<br>VKM 11000  | 1<br>1<br>1   | 1   | 1   |   |   | 3   | 4<br>3 T0005  |
|   | YN  | 07/80 → 08/81   | 2)  | VKPA 81401<br>VKPC 81401   |   |   |   | 1   |   |   |   |
|   | <b>B(Alt)</b> YN  | 07/80 → 08/81   |   | VKMA 10AVx950  |   |   | 1   |   |   |   |   |
|   | <b>B(PS)</b> YN   | 07/80 → 08/81   | → ICH 85-E-156 773  | VKMA 11.5x790  |   |   | 1   |   |   |   |   |
|   | <b>B(PS)</b> YN   | 07/80 → 08/81   | CH 85-E-156 774 I→  | VKMA 10AVx763  |   |   | 1   |   |   |   |   |
|   | <b>B(AC)</b> YN   | 07/80 → 08/81   |   | VKMA 13AVx990  |   |   | 1   |   |   |   |   |
| <b>AUDI  COUPE (81, 85) 1.8</b>          |   |   |   |  |   |   |   |   |   |   |   |
|   | DD, DS, DZ, JN, NE, PV,<br>SF   | 08/81 → 10/88   | 3)  | VKMS 01000<br>VKMA 01000<br>VKM 11000  | 1<br>1<br>1   | 1   | 1   |   |   | 3   | 4<br>3 T0005  |
|   | DD, DS, DZ, JN, NE, PV,<br>SF   | 08/81 → 10/88   | 2)  | VKPA 81401<br>VKPC 81401   |   |   |   | 1   |   |   |   |
|   | <b>B(Alt)</b> DD, DS, DZ, JN, NE, PV,<br>SF                                       | 08/81 → 10/88   |   | VKMA 10AVx950  |   |   | 1   |   |   |   |   |
|   | <b>B(PS)</b> DD, DS, DZ, JN, NE, PV,<br>SF  | 08/81 → 10/88   | → ICH 85-E-156 773  | VKMA 11.5x790  |   |   | 1   |   |   |   |   |

| B(PS)                           | DD, DS, DZ, JN, NE, PV, SF | 08/81 → 10/88 | CH 85-E-156 774 I→                | VKMV 10AVx763                         |             |             |   |  | 1 |   |  |  |       |
|---------------------------------|----------------------------|---------------|-----------------------------------|---------------------------------------|-------------|-------------|---|--|---|---|--|--|-------|
| B(AC)                           | DD, DS, DZ, JN, NE, PV, SF | 08/81 → 10/88 |                                   | VKMV 13AVx990                         |             |             |   |  | 1 |   |  |  |       |
| <b>AUDI  COUPE (81, 85) 1.9</b> |                            |               |                                   |                                       |             |             |   |  |   |   |  |  |       |
|                                 | WN                         | 08/80 → 07/83 | → ICH 85-D-250 000                | —                                     |             |             |   |  | 1 | 1 |  |  |       |
|                                 | WN                         | 08/80 → 07/83 | CH 85-E-000 001 I→                | VKMC 01031<br>VKMA 01031<br>VKM 21031 | 1<br>1<br>1 | 1<br>1<br>1 | 1 |  |   |   |  |  | T0020 |
|                                 | WN                         | 08/80 → 07/83 |                                   | VKPC 81605                            |             |             |   |  |   | 1 |  |  |       |
|                                 | B(Alt) WN                  | 08/80 → 07/83 | <i>AC</i> ,<br>→ ICH 85-F-090 001 | VKMV 11.5x790                         |             |             |   |  | 1 |   |  |  |       |
|                                 | B(Alt) WN                  | 08/80 → 07/83 | <i>AC</i> ,<br>CH 85-F-090 001 I→ | VKMV 11.2x820                         |             |             |   |  | 1 |   |  |  |       |
|                                 | B(Alt) WN                  | 08/80 → 07/83 | AC                                | VKMV 10AVx850                         |             |             |   |  | 1 |   |  |  |       |
|                                 | B(PS) WN                   | 08/80 → 07/83 |                                   | VKMV 13AVx990                         |             |             |   |  | 1 |   |  |  |       |
|                                 | B(AC) WN                   | 08/80 → 07/83 |                                   | VKMV 13AVx990                         |             |             |   |  | 1 |   |  |  |       |
| <b>AUDI  COUPE (81, 85) 2.0</b> |                            |               |                                   |                                       |             |             |   |  |   |   |  |  |       |
|                                 | JS, SK                     | 09/83 → 04/88 | → ICH 85-D-250 000                | —                                     |             |             |   |  | 1 | 1 |  |  |       |
|                                 | JS, SK                     | 09/83 → 04/88 | CH 85-E-000 001 I→                | VKMC 01031<br>VKMA 01031<br>VKM 21031 | 1<br>1<br>1 | 1<br>1<br>1 | 1 |  |   |   |  |  | T0020 |
|                                 | JS, SK                     | 09/83 → 04/88 |                                   | VKPC 81605                            |             |             |   |  |   | 1 |  |  |       |
|                                 | B(Alt) JS, SK              | 09/83 → 04/88 | <i>AC</i> ,<br>→ ICH 85-F-090 001 | VKMV 11.5x790                         |             |             |   |  | 1 |   |  |  |       |
|                                 | B(Alt) JS, SK              | 09/83 → 04/88 | <i>AC</i> ,<br>CH 85-F-090 001 I→ | VKMV 11.2x820                         |             |             |   |  | 1 |   |  |  |       |
|                                 | B(Alt) JS, SK              | 09/83 → 04/88 | AC                                | VKMV 10AVx850                         |             |             |   |  | 1 |   |  |  |       |
|                                 | B(PS) JS, SK               | 09/83 → 04/88 |                                   | VKMV 13AVx990                         |             |             |   |  | 1 |   |  |  |       |
|                                 | B(AC) JS, SK               | 09/83 → 04/88 |                                   | VKMV 13AVx990                         |             |             |   |  | 1 |   |  |  |       |
| <b>AUDI  COUPE (81, 85) 2.1</b> |                            |               |                                   |                                       |             |             |   |  |   |   |  |  |       |
|                                 | KE, WE                     | 01/81 → 08/84 | → ICH 85-D-250 000                | —                                     |             |             |   |  | 1 | 1 |  |  |       |
|                                 | KE, WE                     | 01/81 → 08/84 | CH 85-E-000 001 I→                | VKMC 01031<br>VKMA 01031<br>VKM 21031 | 1<br>1<br>1 | 1<br>1<br>1 | 1 |  |   |   |  |  | T0020 |
|                                 | KE, WE                     | 01/81 → 08/84 |                                   | VKPC 81605                            |             |             |   |  |   | 1 |  |  |       |
|                                 | B(Alt) KE, WE              | 01/81 → 08/84 | <i>AC</i> ,<br>→ ICH 85-F-090 001 | VKMV 11.5x790                         |             |             |   |  | 1 |   |  |  |       |
|                                 | B(Alt) KE, WE              | 01/81 → 08/84 | <i>AC</i> ,<br>CH 85-F-090 001 I→ | VKMV 11.2x820                         |             |             |   |  | 1 |   |  |  |       |
|                                 | B(Alt) KE, WE              | 01/81 → 08/84 | AC                                | VKMV 10AVx850                         |             |             |   |  | 1 |   |  |  |       |
|                                 | B(PS) KE, WE               | 01/81 → 08/84 |                                   | VKMV 13AVx990                         |             |             |   |  | 1 |   |  |  |       |
|                                 | B(AC) KE, WE               | 01/81 → 08/84 |                                   | VKMV 13AVx990                         |             |             |   |  | 1 |   |  |  |       |
| <b>AUDI  COUPE (81, 85) 2.2</b> |                            |               |                                   |                                       |             |             |   |  |   |   |  |  |       |
|                                 | JT                         | 08/85 → 10/88 |                                   | VKMC 01031<br>VKMA 01031<br>VKM 21031 | 1<br>1<br>1 | 1<br>1<br>1 | 1 |  |   |   |  |  | T0020 |
|                                 | KV, KX                     | 07/81 → 10/88 | → ICH 85-D-250 000                | —                                     |             |             |   |  | 1 | 1 |  |  |       |
|                                 | KV, KX                     | 07/81 → 10/88 | CH 85-E-000 001 I→                | VKMC 01031<br>VKMA 01031<br>VKM 21031 | 1<br>1<br>1 | 1<br>1<br>1 | 1 |  |   |   |  |  | T0020 |
|                                 | JT, KV, KX                 | 07/81 → 10/88 |                                   | VKPC 81605                            |             |             |   |  |   | 1 |  |  |       |
|                                 | B(Alt) JT, KV, KX          | 07/81 → 10/88 | <i>AC</i> ,<br>→ ICH 85-F-090 001 | VKMV 11.5x790                         |             |             |   |  | 1 |   |  |  |       |
|                                 | B(Alt) JT, KV, KX          | 07/81 → 10/88 | <i>AC</i> ,<br>CH 85-F-090 001 I→ | VKMV 11.2x820                         |             |             |   |  | 1 |   |  |  |       |
|                                 | B(Alt) JT, KV, KX          | 07/81 → 10/88 | AC                                | VKMV 10AVx850                         |             |             |   |  | 1 |   |  |  |       |























AUDI











































































|  |  |  |                        |  |  |  |  |  |  |  |  |
|--|---|---|---|--|---|---|---|---|---|---|---|
| B(PS)  | JT, KV, KX  | 07/81 → 10/88   |   | VKMC 13AVx990  |   | 1   |   |   |   |   |   |
| B(AC)  | JT, KV, KX  | 07/81 → 10/88   |   | VKMC 13AVx990  |   | 1   |   |   |   |   |   |
| <b>AUDI  COUPE (81, 85) 2.3</b>       |   |   |   |  |   |   |   |   |   |   |   |
|                                        | NG  | 01/87 → 07/88   |                        | VKMC 01031<br>VKMA 01031<br>VKM 21031  | 1<br>1<br>1   | 1   | 1   |   |   |   | T0020   |
|  | NG  | 08/88 → 10/88   | <br>→ ICH 8B-M-033 000 | VKMC 01032<br>VKMA 01032<br>VKM 21032  | 1<br>1<br>1   | 1   | 1   | 1   |   |   | T0077   |
|  | NG  | 08/88 → 10/88   | CH 8B-M-033 001  →  | VKMA 01034<br>VKM 21032  | 1<br>1  | 1   |   |   |   |   | T0649   |
|                                        | NG  | 01/87 → 10/88   | → ICH 8B-M-033 000  | VKPC 81606   |   |   |   | 1   |   |   |   |
|  | NG  | 01/87 → 10/88   | CH 8B-M-033 001  →  | VKPC 81612   |   |   |   | 1   |   |   |   |
|                                        | B(Alt) NG   | 01/87 → 10/88   | AC,<br>→ ICH 85-F-090 001   | VKMC 11.5x790  |   |   | 1   |   |   |   |   |
|  | B(Alt) NG   | 01/87 → 10/88   | AC,<br>CH 85-F-090 001  →   | VKMC 11.2x820  |   |   | 1   |   |   |   |   |
|  | B(Alt) NG   | 01/87 → 10/88   | AC  | VKMC 10AVx850  |   | 1   |   |   |   |   |   |
|  | B(PS) NG  | 01/87 → 10/88   |   | VKMC 13AVx990  |   | 1   |   |   |   |   |   |
|  | B(AC) NG  | 01/87 → 10/88   |   | VKMC 13AVx990  |   | 1   |   |   |   |   |   |
| <b>AUDI  COUPE (89, 8B) 1.8</b>       |   |   |   |  |   |   |   |   |   |   |   |
|                                        | DZ  | 08/89 → 07/91   | 3)  | VKMS 01000<br>VKMA 01000<br>VKM 11000  | 1<br>1<br>1   | 1   |   |   | 3   | 4   | T0005   |
|                                      | DZ  | 08/89 → 07/91   | 2)  | VKPA 81401<br>VKPC 81401   |   |   |   | 1<br>1  |   |   |   |
|                                      | B(Alt) DZ   | 08/89 → 07/91   |   | VKMC 10AVx950  |   | 1   |   |   |   |   |   |
|  | B(PS) DZ  | 08/89 → 07/91   |   | VKMC 10AVx850  |   | 1   |   |   |   |   |   |
|  | B(AC) DZ  | 08/89 → 07/91   |   | VKMC 13AVx800  |   | 1   |   |   |   |   |   |
| <b>AUDI  COUPE (89, 8B) 2.0</b>     |   |   |   |  |   |   |   |   |   |   |   |
|                                      | 3A, AAD, ABK  | 05/89 → 12/96   | 3)  | VKMS 01000<br>VKMA 01000<br>VKM 11000  | 1<br>1<br>1   | 1   |   |   | 3   | 4   | T0005   |
|                                      | AAD, ABK  | 05/89 → 12/96   | 2)  | VKPA 81401<br>VKPC 81401   |   |   |   | 1<br>1  |   |   |   |
|                                      | B(Alt) 3A, AAD  | 05/89 → 12/96   |   | VKMC 10AVx950  |   | 1   |   |   |   |   |   |
|  | B(Alt) AAD  | 05/89 → 12/96   |   | VKMC 10AVx850  |   | 1   |   |   |   |   |   |
|  | B(Alt) ABK  | 05/89 → 12/96   |   | VKMC 4PK855  |   | 1   |   |   |   |   |   |
|  | B(PS) 3A  | 05/89 → 07/90   |   | VKMC 10AVx850  |   | 1   |   |   |   |   |   |
|  | B(PS) ABK   | 05/89 → 12/96   |   | VKMC 10AVx910  |   | 1   |   |   |   |   |   |
|  | B(AC) 3A, AAD, ABK  | 05/89 → 12/96   |   | VKMC 13AVx800  |   | 1   |   |   |   |   |   |
| <b>AUDI  COUPE (89, 8B) 2.0 16V</b> |   |   |   |  |   |   |   |   |   |   |   |
|                                      | 6A  | 01/92 → 07/92   |   | VKMA 01020<br>VKM 11020  | 1<br>1  | 1   |   |   |   |   | T0057   |
|  | ACE   | 08/92 → 12/96   | → Mot. 017 139  | VKMA 01020<br>VKM 11020  | 1<br>1  | 1   |   |   |   |   | T0057   |
|  | ACE   | 08/92 → 12/96   | Mot. 017 140  →   | VKMA 01023<br>VKM 11021  | 1<br>1  | 1   |   |   |   |   | T0057   |
|                                      | 6A, ACE   | 01/92 → 12/96   | 2)  | VKPA 81401<br>VKPC 81401   |   |   |   | 1<br>1  |   |   |   |
|                                      | B(Alt) 6A, ACE  | 01/92 → 12/96   |   | VKMC 4PK882  |   | 1   |   |   |   |   |   |
|  | B(PS) 6A, ACE   | 01/92 → 12/96   |   | VKMC 10AVx875  |   | 1   |   |   |   |   |   |
|  | B(AC) 6A, ACE   | 01/92 → 12/96   |   | VKMC 13AVx800  |   | 1   |   |   |   |   |   |
| <b>AUDI  COUPE (89, 8B) 2.0 20V</b> |   |   |   |  |   |   |   |   |   |   |   |
|                                      | NM  | 08/89 → 07/91   |   | —<br>VKM 21031   | 1<br>1  | 1   |   |   |   |   | T0649   |
|                                      | NM  | 08/89 → 07/91   |   | VKPC 81606   |   |   |   | 1   |   |   |   |
|                                      | B(Alt) NM   | 08/89 → 07/91   |   | VKMC 10AVx865  |   | 1   |   |   |   |   |   |
|  | B(PS) NM  | 08/89 → 07/91   |   | VKMC 13AVx990  |   | 1   |   |   |   |   |   |
|  | B(AC) NM  | 08/89 → 07/91   |   | VKMC 13AVx915  |   | 1   |   |   |   |   |   |



| AUDI  COUPE (89, 8B) 2.2       |               |               |   |                                       |             |        |   |  |   |       |
|---|---------------|---------------|---|---------------------------------------|-------------|--------|---|--|---|-------|
|                                | KV            | 11/88 → 07/91 |                          | VKMC 01032<br>VKMA 01032<br>VKM 21032 | 1<br>1<br>1 | 1<br>1 | 1 |  |   | T0077 |
|                                | KV            | 11/88 → 07/91 |   | VKPC 81606                            |             |        | 1 |  |   |       |
|                                | B(Alt) KV     | 11/88 → 07/91 |   | VKMV 10AVx865                         |             | 1      |   |  |   |       |
|   | B(PS) KV      | 11/88 → 07/91 |   | VKMV 13AVx990                         |             | 1      |   |  |   |       |
|   | B(AC) KV      | 11/88 → 07/91 |   | VKMV 13AVx915                         |             | 1      |   |  |   |       |
| AUDI  COUPE (89, 8B) 2.2 S2    |               |               |   |                                       |             |        |   |  |   |       |
|                                | 3B            | 09/90 → 09/92 |   | —<br>VKM 21031                        | 1<br>1      | 1      |   |  |   | T0649 |
|   | ABY           | 10/92 → 12/96 |   | —<br>VKM 21052                        | 1<br>1      | 1      |   |  |   | T0230 |
|                                | 3B            | 09/90 → 09/92 |   | VKPC 81606                            |             |        | 1 |  |   |       |
|   | ABY           | 10/92 → 12/96 |   | VKPC 81612                            |             |        | 1 |  |   |       |
|                                | B(Alt) 3B     | 09/90 → 09/92 |   | VKMV 10AVx865                         |             | 1      |   |  |   |       |
|   | B(Alt) ABY    | 10/92 → 12/96 |   | VKMV 4PK882                           |             | 1      |   |  |   |       |
|   | B(PS) 3B      | 09/90 → 09/92 |   | VKMV 13AVx990                         |             | 1      |   |  |   |       |
|   | B(PS) ABY     | 10/92 → 12/96 |   | VKMV 10AVx1025                        |             | 1      |   |  |   |       |
|   | B(AC) 3B, ABY | 09/90 → 12/96 |   | VKMV 13AVx915                         |             | 1      |   |  |   |       |
| AUDI  COUPE (89, 8B) 2.3       |               |               |   |                                       |             |        |   |  |   |       |
|                                | NG            | 10/88 → 12/96 | <br>→ ICH 8B-M-033 000   | VKMC 01032<br>VKMA 01032<br>VKM 21032 | 1<br>1<br>1 | 1      | 1 |  |   | T0077 |
|   | NG            | 10/88 → 12/96 | CH 8B-M-033 001 I→  | VKMA 01050<br>VKM 11050               | 1<br>1      | 1      |   |  |   | T0698 |
|   | NG            | 10/88 → 12/96 | <br>CH 8B-M-033 001 I→ | VKMA 01060<br>VKM 11060               | 1<br>1      | 1      |   |  |   | T0698 |
|                              | NG            | 10/88 → 12/96 | → ICH 8B-M-033 000  | VKPC 81606                            |             |        | 1 |  |   |       |
|   | NG            | 10/88 → 12/96 | CH 8B-M-033 001 I→  | VKPC 81612                            |             |        | 1 |  |   |       |
|                              | B(Alt) NG     | 10/88 → 12/96 | 2WD,<br>→ ICH 8B-N-003 457  | VKMV 10AVx865                         |             | 1      |   |  |   |       |
|   | B(Alt) NG     | 10/88 → 12/96 | 2WD,<br>CH 8B-N-003 458 I→  | VKMV 10AVx875                         |             | 1      |   |  |   |       |
|   | B(Alt) NG     | 11/88 → 12/96 | 4WD,<br>→ ICH 8B-N-003 901  | VKMV 10AVx865                         |             | 1      |   |  |   |       |
|   | B(Alt) NG     | 11/88 → 12/96 | 4WD,<br>CH 8B-N-003 902 I→  | VKMV 10AVx875                         |             | 1      |   |  |   |       |
|   | B(PS) NG      | 10/88 → 12/96 | 2WD   | VKMV 13AVx1000                        |             | 1      |   |  |   |       |
|   | B(PS) NG      | 11/88 → 12/96 | 4WD,<br>→ ICH 8B-N-003 901  | VKMV 13AVx990                         |             | 1      |   |  |   |       |
|   | B(PS) NG      | 11/88 → 12/96 | 4WD,<br>CH 8B-N-003 902 I→  | VKMV 13AVx1000                        |             | 1      |   |  |   |       |
|   | B(AC) NG      | 10/88 → 12/96 |   | VKMV 13AVx915                         |             | 1      |   |  |   |       |
| AUDI  COUPE (89, 8B) 2.3 20V |               |               |   |                                       |             |        |   |  |   |       |
|                              | 7A            | 11/88 → 07/91 |   | —<br>VKM 21031                        | 1<br>1      | 1      |   |  |   | T0649 |
|                              | 7A            | 11/88 → 07/91 |   | VKPC 81606                            |             |        | 1 |  |   |       |
|                              | B(Alt) 7A     | 11/88 → 07/91 |   | VKMV 10AVx865                         |             | 1      |   |  |   |       |
|   | B(PS) 7A      | 11/88 → 07/91 |   | VKMV 13AVx990                         |             | 1      |   |  |   |       |
|   | B(AC) 7A      | 11/88 → 07/91 |   | VKMV 13AVx915                         |             | 1      |   |  |   |       |
| AUDI  COUPE (89, 8B) 2.6     |               |               |   |                                       |             |        |   |  |   |       |
|                              | ABC           | 08/92 → 12/96 | → ICH 8B-S-000 544  | VKMA 01200<br>VKM 11200<br>VKM 21052  | 1<br>1<br>1 | 1      | 1 |  |   | T0100 |
|   | ABC           | 08/92 → 12/96 | CH 8B-S-000 545 I→  | VKMA 01201<br>VKM 11201<br>VKM 21201  | 1<br>1<br>1 | 1      | 1 |  | 2 | T0100 |

























































|  |  |  |   |  |  |  |  |  |  |  |  |  |
|--|---|---|--|--|---|---|---|---|---|---|---|---|
|    | ABC   | 08/92 → 12/96   | → ICH 8B-S-000 544   | VKPC 81800   |   |   |   |   |   | 1   |   |   |
|  | ABC   | 08/92 → 12/96   | CH 8B-S-000 545 I→   | VKPC 81802   |   |   |   |   |   | 1   |   |   |
|    | B(Alt) ABC  | 08/92 → 05/95   | AC,<br>→ ICH 8B-R-001 635  | VKMOV 6PK1675<br>VKM 31010   |   |   |   |   |   | 1   |   |   |
|  | B(Alt) ABC  | 08/92 → 05/95   | AC, → ICH 8B-R-001 635   | VKMOV 6PK2260<br>VKM 31010   |   |   |   |   |   | 1   |   |   |
| <b>AUDI  COUPE (89, 8B) 2.8</b>           |   |   |  |  |   |   |   |   |   |   |   |   |
|    | AAH   | 08/91 → 12/96   | → ICH 8B-S-000 544   | VKMA 01200<br>VKM 11200<br>VKM 21052   | 1   | 1   | 1   |   |   |   |   | T0100   |
|  | AAH   | 08/91 → 12/96   | CH 8B-S-000 545 I→   | VKMA 01201<br>VKM 11201<br>VKM 21201   | 1   | 1   | 1   |   |   |   |   | 2 T0100   |
|    | AAH   | 08/91 → 12/96   | → ICH 8B-S-000 544   | VKPC 81800   |   |   |   |   |   | 1   |   |   |
|  | AAH   | 08/91 → 12/96   | CH 8B-S-000 545 I→   | VKPC 81802   |   |   |   |   |   | 1   |   |   |
|    | B(Alt) AAH  | 08/91 → 05/95   | AC,<br>→ ICH 8B-R-001 635  | VKMOV 6PK1675<br>VKM 31010   |   |   |   |   |   | 1   |   |   |
|  | B(Alt) AAH  | 08/91 → 05/95   | AC, → ICH 8B-R-001 635   | VKMOV 6PK2260<br>VKM 31010   |   |   |   |   |   | 1   |   |   |
| <b>AUDI  Q7 3.6 FSI</b>                   |   |   |  |  |   |   |   |   |   |   |   |   |
|    | BHK   | 08/06 → 01/08   |  | <del>XXXXXXXX</del>  |   |   |   |   |   |   |   |   |
| <b>AUDI  Q7 4.2 FSI</b>                   |   |   |  |  |   |   |   |   |   |   |   |   |
|    | BAR   | 03/06 → 03/06   |  | <del>XXXXXXXX</del>  |   |   |   |   |   |   |   |   |
| <b>AUDI  Q7 3.0 TDI</b>                 |   |   |  |  |   |   |   |   |   |   |   |   |
|    | BUG, BUN  | 03/06 → 06/07   | B(Cam)   | <del>XXXXXXXX</del>  |   |   |   |   |   |   |   |   |
|  | BUG, BUN  | 03/06 → 06/07   | B(inj)   | VKMA 01332<br>VKM 11332  | 1   |   | 1   |   |   |   |   | 1 T0246   |
| <b>AUDI  Q7 4.2 TDI</b>                 |   |   |  |  |   |   |   |   |   |   |   |   |
|    | BTR   | 03/07 → 06/07   |  | <del>XXXXXXXX</del>  |   |   |   |   |   |   |   |   |
| <b>AUDI  QUATTRO (85) 2.1 20V Turbo</b> |   |   |  |  |   |   |   |   |   |   |   |   |
|    | KW  | 05/84 → 07/87   |  | —<br>VKM 21031   |   | 1   | 1   |   |   |   |   | T0649   |
|    | KW  | 05/84 → 07/87   | → ICH 85-J-900 643   | VKPC 81605   |   |   |   |   |   | 1   |   |   |
|  | KW  | 05/84 → 07/87   | CH 85-J-900 644 I→   | VKPC 81606   |   |   |   |   |   | 1   |   |   |
|    | B(Alt) KW   | 05/84 → 07/87   |  | VKMOV 13AVx990   |   |   |   |   |   | 1   |   |   |
|  | B(PS) KW  | 05/84 → 07/87   | → ICH 85-B-900 832   | VKMOV 13AVx1000  |   |   |   |   |   | 1   |   |   |
|  | B(PS) KW  | 05/84 → 07/87   | CH 85-B-900 833 I→   | VKMOV 13AVx990   |   |   |   |   |   | 1   |   |   |
|  | B(AC) KW  | 05/84 → 07/87   |  | VKMOV 13AVx950   |   |   |   |   |   | 1   |   |   |
| <b>AUDI  QUATTRO (85) 2.1 Turbo</b>     |   |   |  |  |   |   |   |   |   |   |   |   |
|    | GV, WR  | 07/80 → 07/87   | <br>CH 85-E-900 001 I→,<br>→ ICH 85-J-900 643 | VKMC 01031<br>VKMA 01031<br>VKM 21031  |   | 1   | 1   |   |   | 1   |   | T0020   |
|  | GV, WR  | 07/80 → 07/87   | <br>CH 85-J-900 644 I→                        | VKMC 01032<br>VKMA 01032<br>VKM 21032  |   | 1   | 1   |   |   | 1   |   | T0077   |
|    | GV, WR  | 07/80 → 07/87   | → ICH 85-J-900 643   | VKPC 81605   |   |   |   |   |   | 1   |   |   |
|  | GV, WR  | 07/80 → 07/87   | CH 85-J-900 644 I→   | VKPC 81606   |   |   |   |   |   | 1   |   |   |
|    | B(Alt) GV, WR   | 07/80 → 07/87   | → ICH 85-E-901 500   | VKMOV 10AVx785   |   |   |   |   |   | 1   |   |   |
|  | B(Alt) GV, WR   | 07/80 → 07/87   | CH 85-F-900 001 I→   | VKMOV 10AVx850   |   |   |   |   |   | 1   |   |   |
|  | B(PS) GV, WR  | 07/80 → 07/87   | → ICH 85-B-900 832   | VKMOV 13AVx1000  |   |   |   |   |   | 1   |   |   |
|  | B(PS) GV, WR  | 07/80 → 07/87   | CH 85-B-900 833 I→   | VKMOV 13AVx990   |   |   |   |   |   | 1   |   |   |
|  | B(AC) GV, WR  | 07/80 → 07/87   |  | VKMOV 13AVx950   |   |   |   |   |   | 1   |   |   |
| <b>AUDI  QUATTRO (85) 2.2 20V</b>       |   |   |  |  |   |   |   |   |   |   |   |   |
|    | RR  | 08/89 → 07/91   |  | —<br>VKM 21031   |   | 1   | 1   |   |   |   |   | T0649   |
|    | RR  | 08/89 → 07/91   | → ICH 85-J-900 643   | VKPC 81605   |   |   |   |   |   | 1   |   |   |
|  | RR  | 08/89 → 07/91   | CH 85-J-900 644 I→   | VKPC 81606   |   |   |   |   |   | 1   |   |   |
|    | B(Alt) RR   | 08/89 → 07/91   |  | VKMOV 11.2x820   |   |   |   |   |   | 1   |   |   |

|   |  |  |  |    |  |  |  |  |  |  |  |
|---|---|---|---|--|---|---|---|---|---|---|---|
|   | B(PS)   | RR  | 08/89 → 07/91   | → ICH 85-B-900 832   | VKMOV 13AVx1000   |   | 1   |   |   |   |   |
|   | B(PS)   | RR  | 08/89 → 07/91   | CH 85-B-900 833 I→   | VKMOV 13AVx990  |   | 1   |   |   |   |   |
|   | B(AC)   | RR  | 08/89 → 07/91   |  | VKMOV 13AVx950  |   | 1   |   |   |   |   |
| <b>AUDI  QUATTRO (85) 2.2 Turbo</b>                  |   |   |   |  |   |   |   |   |   |   |   |
|    | MB  |   | 08/87 → 07/89   | <br>CH 85-E-900 001 I→,<br>→ ICH 85-J-900 643 | VKMC 01031<br>VKMA 01031<br>VKM 21031   |   | 1<br>1<br>1   | 1<br>1  | 1   |   | T0020   |
|   | MB  |   | 08/87 → 07/89   | <br>CH 85-J-900 644 I→                        | VKMC 01032<br>VKMA 01032<br>VKM 21032   |   | 1<br>1<br>1   | 1<br>1  | 1   |   | T0077   |
|    | MB  |   | 08/87 → 07/89   | → ICH 85-J-900 643   | VKPC 81605  |   |   |   | 1   |   |   |
|   | MB  |   | 08/87 → 07/89   | CH 85-J-900 644 I→   | VKPC 81606  |   |   |   | 1   |   |   |
|    | B(Alt)  | MB  | 08/87 → 07/89   |  | VKMOV 11.2x820  |   |   | 1   |   |   |   |
|   | B(PS)   | MB  | 08/87 → 07/89   | → ICH 85-B-900 832   | VKMOV 13AVx1000   |   |   | 1   |   |   |   |
|   | B(PS)   | MB  | 08/87 → 07/89   | CH 85-B-900 833 I→   | VKMOV 13AVx990  |   |   | 1   |   |   |   |
|   | B(AC)   | MB  | 08/87 → 07/89   |  | VKMOV 13AVx950  |   |   | 1   |   |   |   |
| <b>AUDI  R8 4.2</b>                                  |   |   |   |  |   |   |   |   |   |   |   |
|    | BYH   |   | 04/07 → 10/07   |  | <b>OXOXOXO</b>  |   |   |   |   |   |   |
| <b>AUDI  TT (8N3) / TT Roadster (8N9) 1.8 Turbo</b>  |   |   |   |  |   |   |   |   |   |   |   |
|    | AJQ, AMU, APP, APX,<br>ARY, ATC, AUQ, AWP,<br>BAM                                 |   | 10/98 → 12/00   | <br>→ ICH 8N-Y-095 000                        | VKMA 01115<br>VKM 11115<br>VKM 21115  |   | 1<br>1<br>1   | 1<br>1  |   |   | T0151   |
|   | AJQ, AMU, APP, APX,<br>ARY, ATC, AUQ, AWP,<br>BAM                                 |   | 10/98 → 12/00   | <br>CH 8N-Y-095 001 I→                      | VKMA 01116<br>VKM 11116<br>VKM 21115  |   | 1<br>1<br>1   | 1<br>1  |   |   | T0151   |
|   | AJQ, AMU, APP, APX,<br>ARY, ATC, AUM, AUQ,<br>AWP, BAM, BFV, BVP,<br>BVR          |   | 01/01 → 11/07   |   | VKMA 01116<br>VKM 11116<br>VKM 21115  |   | 1<br>1<br>1   | 1<br>1  |   |   | T0151   |
|    | AJQ, AMU, APP, APX,<br>ARY, ATC, AUM, AUQ,<br>AWP, BAM, BFV, BVP,<br>BVR          |   | 10/98 → 11/07   |  | VKPC 81620  |   |   |   | 1   |   |   |
|    | B(Alt)  | AJQ, AMU, APP, APX,<br>ARY, ATC, AUM, AUQ,<br>AWP, BAM, BFV, BVP,<br>BVR          | 10/98 → 11/07   | <b>AC</b>  | VKMA 31203<br>VKMV 6PK1120<br>VKM 31011   |   | 1<br>1  | 1<br>1  |   |   |   |
|   | B(Alt)  | AJQ, AMU, APP, APX,<br>ARY, ATC, AUM, AUQ,<br>AWP, BAM, BFV, BVP,<br>BVR          | 10/98 → 11/07   | <b>AC</b>  | VKMA 31204<br>VKMV 6DK1195<br>VKM 31011   |   | 1<br>1  | 1<br>1  |   |   |   |
| <b>AUDI  TT (8N3) / TT Roadster (8N9) 3.2 V6</b>   |   |   |   |  |   |   |   |   |   |   |   |
|    | BHE, BPF  |   | 07/03 → 11/07   |  | <b>OXOXOXO</b>  |   |   |   |   |   |   |
|    | BHE, BPF  |   | 07/03 → 11/07   |  | —   |   |   |   | 1   |   |   |
| <b>AUDI  TT (8J3) / TT Roadster (8J9) 2.0 TFSI</b> |   |   |   |  |   |   |   |   |   |   |   |
|    | BPY, BWA  |   | 10/06 → 11/07   |  | VKMA 01222<br>VKM 11222<br>VKM 21220<br>VKM _____                                   |   | 1<br>1<br>1<br>1  | 2<br>1  | 1   |   | 2 T0247   |
|    | BPY, BWA  |   | 10/06 → 11/07   |  | —   |   |   |   | 1   |   |   |



AUDI

|   |  |  |  |   |  |  |  |  |  |  |  |  |  |  |       |
|---|---|---|---|---|---|---|---|---|---|---|---|---|---|---|-------|
|   | B(Alt)  | BPY, BWA  | 10/06 → 11/07   | AC  | VKMV 6PK953   |   |   | 1   |   |   |   |   |   |   |       |
|   | B(Alt)  | BPY, BWA  | 10/06 → 11/07   | AC  | VKMV 6PK1054  |   |   | 1   |   |   |   |   |   |   |       |
| <b>AUDI  TT (8J3) / TT Roadster (8J9) 3.2 V6</b> |   |   |   |   |   |   |   |   |   |   |   |   |   |   |       |
|   |   | BUB   | 10/06 → 11/07   |   | OXOXOX  |   |   |   |   |   |   |   |   |   |       |
|   |   | BUB   | 10/06 → 11/07   |   | —   |   |   |   |   | 1   |   |   |   |   |       |
|   | B(Alt)  | BUB   | 10/06 → 11/07   | → ICH 8J-7-013 500  | VKMV 6PK1620  |   |   | 1   |   |   |   |   |   |   |       |
| <b>AUDI  V8 (D1) 3.6</b>                         |   |   |   |   |   |   |   |   |   |   |   |   |   |   |       |
|   |   | PT  | 10/88 → 02/94   |    | VKMC _____  | 1   | 2   | 1   | 1   |   |   |   |   |   |       |
|   |   |   |   |   | —   | 1   | 2   | 1   |   |   |   |   |   |   |       |
|   |   |   |   |   | VKM _____   | 1   |   |   |   |   |   |   |   |   |       |
|   |   |   |   |   | VKM _____   |   | 1   |   |   |   |   |   |   |   |       |
|   |   |   |   |   | VKM _____   |   | 1   |   |   |   |   |   |   |   |       |
|   |   | PT  | 10/88 → 02/94   |   | VKPC 81806  |   |   |   |   | 1   |   |   |   |   |       |
| <b>AUDI  V8 (D1) 4.2</b>                         |   |   |   |   |   |   |   |   |   |   |   |   |   |   |       |
|   |   | ABH   | 10/91 → 02/94   |    | VKMC _____  | 1   | 2   | 1   | 1   |   |   |   |   |   |       |
|   |   |   |   |   | —   | 1   | 2   | 1   |   |   |   |   |   |   |       |
|   |   |   |   |   | VKM _____   | 1   |   |   |   |   |   |   |   |   |       |
|   |   |   |   |   | VKM _____   |   | 1   |   |   |   |   |   |   |   |       |
|   |   |   |   |   | VKM _____   |   | 1   |   |   |   |   |   |   |   |       |
|   |   | ABH   | 10/91 → 02/94   |   | VKPC 81806  |   |   |   |   | 1   |   |   |   |   |       |
| <b>AUSTIN MAESTRO 1.3</b>   |   |   |   |   |   |   |   |   |   |   |   |   |   |   |       |
|   |   | 12 H  | 03/83 → 08/90   |   | VKPC 87205  |   |   |   |   | 1   |   |   |   |   |       |
| <b>AUSTIN MAESTRO 1.6</b>   |   |   |   |   |   |   |   |   |   |   |   |   |   |   |       |
|    |   | 16 H  | 01/84 → 08/90   |   | VKMA 07200  | 1   |   | 1   |   |   |   |   |   |   | T0031 |
|   |   |   |   |   | VKM 17200   | 1   |   |   |   |   |   |   |   |   |       |
|   |   | 16 H  | 03/83 → 10/84   |   | —   |   |   |   |   | 1   |   |   |   |   |       |
|   |   | 16 H  | 10/84 → 08/90   |   | VKPC 87403  |   |   |   |   | 1   |   |   |   |   |       |
| <b>AUSTIN MAESTRO 2.0</b>   |   |   |   |   |   |   |   |   |   |   |   |   |   |   |       |
|   |   | 20H   | 10/84 → 08/90   | 5)  | VKMA 07100  | 1   |   | 1   |   |   |   |   |   |   | T0044 |
|   |   |   |   |   | VKM 17000   | 1   |   |   |   |   |   |   |   |   |       |
|   |   | 20 H  | 10/84 → 08/90   |   | VKPC 87609  |   |   |   |   | 1   |   |   |   |   |       |
| <b>AUSTIN METRO 1.0 /1.3/1.3 Turbo</b>  |   |   |   |   |   |   |   |   |   |   |   |   |   |   |       |
|   |   | 12H, 99H  | 10/80 → 04/90   |   | VKPC 87200  |   |   |   |   | 1   |   |   |   |   |       |
| <b>AUSTIN MINI 850</b>  |   |   |   |   |   |   |   |   |   |   |   |   |   |   |       |
|   |   | 85H   | 01/72 → 08/79   |   | VKPC 87200  |   |   |   |   | 1   |   |   |   |   |       |
| <b>AUSTIN MINI 1.0</b>  |   |   |   |   |   |   |   |   |   |   |   |   |   |   |       |
|   |   | 97H   | 10/67 → 01/72   |   | VKPC 87200  |   |   |   |   | 1   |   |   |   |   |       |
|   |   | 99H   | 01/72 → 12/78   |   | VKPC 87200  |   |   |   |   | 1   |   |   |   |   |       |
| <b>AUSTIN MINI 1.1</b>  |   |   |   |   |   |   |   |   |   |   |   |   |   |   |       |
|   |   | 10H   | 01/76 → 12/80   |   | VKPC 87200  |   |   |   |   | 1   |   |   |   |   |       |
| <b>AUSTIN MINI 1.3</b>  |   |   |   |   |   |   |   |   |   |   |   |   |   |   |       |
|   |   | 12A   | 10/69 → 08/80   |   | VKPC 87200  |   |   |   |   | 1   |   |   |   |   |       |
| <b>AUSTIN MONTEGO 1.3</b>   |   |   |   |   |   |   |   |   |   |   |   |   |   |   |       |
|   |   | 12 H  | 10/84 → 08/88   |   | VKPC 87205  |   |   |   |   | 1   |   |   |   |   |       |
| <b>AUSTIN MONTEGO 1.6</b>   |   |   |   |   |   |   |   |   |   |   |   |   |   |   |       |
|   |   | 16H   | 04/84 → 08/88   |   | VKMA 07200  | 1   |   | 1   |   |   |   |   |   |   | T0031 |
|   |   |   |   |   | VKM 17200   | 1   |   |   |   |   |   |   |   |   |       |
|   |   | 16 H  | 04/84 → 08/88   |   | VKPC 87403  |   |   |   |   | 1   |   |   |   |   |       |
| <b>AUSTIN MONTEGO 2.0</b>   |   |   |   |   |   |   |   |   |   |   |   |   |   |   |       |
|   |   | 20H   | 04/84 → 08/88   | 5)  | VKMA 07100  | 1   |   | 1   |   |   |   |   |   |   | T0044 |
|   |   |   |   |   | VKM 17000   | 1   |   |   |   |   |   |   |   |   |       |
|   |   | 20 H  | 04/84 → 08/91   |   | VKPC 87609  |   |   |   |   | 1   |   |   |   |   |       |
| <b>AUSTIN MONTEGO 2.0 Turbo</b>   |   |   |   |   |   |   |   |   |   |   |   |   |   |   |       |
|   |   | 20H   | 04/84 → 08/88   | 5)  | VKMA 07100  | 1   |   | 1   |   |   |   |   |   |   | T0044 |
|   |   |   |   |   | VKM 17000   | 1   |   |   |   |   |   |   |   |   |       |
|   |   | 20 H  | 04/84 → 08/88   |   | VKPC 87609  |   |   |   |   | 1   |   |   |   |   |       |
| <b>AUTOBIANCHI  Y10 1.0</b>                    |   |   |   |   |   |   |   |   |   |   |   |   |   |   |       |
|   |   | 156A2.000, 156A2.246  | 03/85 → 05/06   |  | VKMC 02200  | 1   |   | 1   |   | 1   |   |   |   |   |       |
|   |   |   |   |   | VKMA 02200  | 1   |   | 1   |   |   |   |   |   |   | T0009 |
|   |   |   |   |   | VKM 12200   | 1   |   |   |   |   |   |   |   |   |       |











































|   |  |  |  |  |  |  |  |  |  |  |  |
|---|---|---|---|--|---|---|---|---|---|---|---|
|   | 156A2.000, 156A2.246  | 03/85 → 07/03   | 3), → I Mot. 6315750  | VKMS 02200-1<br>VKMA 02200<br>VKM 12200  | 1<br>1<br>1   |   | 1   |   |   | 2   | T0009   |
|   | 156A2.000, 156A2.246  | 03/85 → 07/03   | 3), Mot. 6315751 I→   | VKMS 02200-2<br>VKMA 02200<br>VKM 12200  | 1<br>1<br>1   |   | 1   |   |   | 2   | T0009   |
|                                    | 156A2.000, 156A2.246  | 03/85 → 03/05   |   | VKPC 82214   |   |   |   | 1   |   |   |   |
|                                    | <b>B(Alt)</b> 156A2.000, 156A2.246  | 03/85 → 09/06   |   | VKMV 10AVx675  |   |   | 1   |   |   |   |   |
| <b>AUTOBIANCHI</b>  <b>Y10 1.1</b> |   |   |   |  |   |   |   |   |   |   |   |
|                                    | 156C.000, 156C.046  | 06/89 → 03/05   |  | VKMC 02200<br>VKMA 02200<br>VKM 12200  | 1<br>1<br>1   |   | 1   | 1   |   |   | T0009   |
|   | 156C.000, 156C.046  | 06/89 → 07/03   | 3), → I Mot. 6315750  | VKMS 02200-1<br>VKMA 02200<br>VKM 12200  | 1<br>1<br>1   |   | 1   |   |   | 2   | T0009   |
|   | 156C.000, 156C.046  | 06/89 → 07/03   | 3), Mot. 6315751 I→   | VKMS 02200-2<br>VKMA 02200<br>VKM 12200  | 1<br>1<br>1   |   | 1   |   |   | 2   | T0009   |
|                                    | 156C.000, 156C.046  | 06/89 → 03/05   |   | VKPC 82214   |   |   |   | 1   |   |   |   |
|                                    | <b>B(Alt)</b> 156C.000, 156C.046  | 06/89 → 05/06   |   | VKMV 10AVx675  |   |   | 1   |   |   |   |   |
| <b>AUTOBIANCHI</b>  <b>Y10 1.3</b> |   |   |   |  |   |   |   |   |   |   |   |
|                                    | 146A5.046, 156B.000   | 06/89 → 02/92   |   | —<br>VKM 12010   | 1<br>1  |   | 1   |   |   |   | T0039   |
|   | 146A5.046, 156B.000   | 03/92 → 07/03   |   | —<br>VKM 12200   | 1<br>1  |   | 1   |   |   |   | T0039   |
|                                    | 146A5.046, 156B.000   | 06/89 → 03/05   |   | VKPC 82208   |   |   |   | 1   |   |   |   |
| <b>BMW</b>  <b>1 (E87) 116</b>    |   |   |   |  |   |   |   |   |   |   |   |
|                                  | N45B16A   | 09/04 → 12/07   |   | <del>OKOKOKO</del>   |   |   |   |   |   |   |   |
|                                  | N45B16A   | 09/04 → 09/07   | 2)  | VKPA   |   |   |   | 1   |   |   |   |
|                                  | <b>B(Alt)</b> N45B16A   | 09/04 → 12/07   | <b>AC</b>   | VKMV 6PK1637<br>VKM  | 1   |   | 1   |   |   |   |   |
|   | <b>B(Alt)</b> N45B16A   | 09/04 → 12/07   | <b>AC</b>   | VKMV 6PK1870<br>VKM<br>VKM   | 1   |   | 1   |   | 1   |   |   |
| <b>BMW</b>  <b>1 (E87) 118</b>   |   |   |   |  |   |   |   |   |   |   |   |
|                                  | N42B20B   | 09/04 → 12/07   |   | <del>OKOKOKO</del>   |   |   |   |   |   |   |   |
|                                  | N42B20B   | 09/04 → 09/07   | 2)  | VKPA   |   |   |   | 1   |   |   |   |
|                                  | <b>B(Alt)</b> N42B20B   | 09/04 → 12/07   | <b>AC</b>   | VKMV 6PK1637<br>VKM  | 1   |   | 1   |   |   |   |   |
|   | <b>B(Alt)</b> N42B20B   | 09/04 → 12/07   | <b>AC</b>   | VKMV 6PK1870<br>VKM<br>VKM   | 1   |   | 1   |   | 1   |   |   |
| <b>BMW</b>  <b>1 (E87) 120</b>   |   |   |   |  |   |   |   |   |   |   |   |
|                                  | N42B20A   | 09/04 → 12/07   |   | <del>OKOKOKO</del>   |   |   |   |   |   |   |   |
|                                  | N42B20A   | 09/04 → 09/07   | 2)  | VKPA   |   |   |   | 1   |   |   |   |
|                                  | <b>B(Alt)</b> N42B20A   | 09/04 → 12/07   | <b>AC</b>   | VKMV 6PK1637<br>VKM  | 1   |   | 1   |   |   |   |   |
|   | <b>B(Alt)</b> N42B20A   | 09/04 → 12/07   | <b>AC</b>   | VKMV 6PK1870<br>VKM<br>VKM   | 1   |   | 1   |   | 1   |   |   |
| <b>BMW</b>  <b>1 (E87) 130</b>   |   |   |   |  |   |   |   |   |   |   |   |
|                                  | N52B30A   | 09/05 → 12/07   |   | <del>OKOKOKO</del>   |   |   |   |   |   |   |   |
|                                  | N52B30A   | 09/05 → 09/07   |   | —  |   |   |   | 1   |   |   |   |
|                                  | <b>B(Alt)</b> N52B30A   | 09/05 → 12/07   |   | VKMV 6PK1990   |   |   | 1   |   |   |   |   |
| <b>BMW</b>  <b>1 (E87) 118d</b>  |   |   |   |  |   |   |   |   |   |   |   |
|                                  | M47N204D4   | 09/04 → 03/06   |   | <del>OKOKOKO</del>   |   |   |   |   |   |   |   |
|                                  | M47N204D4   | 09/04 → 09/07   |   | VKPC 88635   |   |   |   | 1   |   |   |   |
|                                  | <b>B(Alt)</b> M47N204D4   | 09/04 → 12/07   | <b>AC</b>   | VKMV 6PK1683   |   |   | 1   |   |   |   |   |
|   | <b>B(Alt)</b> M47N204D4   | 09/04 → 12/07   | <b>AC</b>   | VKMV 6PK1836   |   |   | 1   |   |   |   |   |
| <b>BMW</b>  <b>1 (E87) 120d</b>  |   |   |   |  |   |   |   |   |   |   |   |
|                                  | M47N204D4, N47D20A  | 09/04 → 12/07   |   | <del>OKOKOKO</del>   |   |   |   |   |   |   |   |
|                                  | M47N204D4, N47D20A  | 09/04 → 09/07   | Man. GBX  | VKPC 88635   |   |   |   | 1   |   |   |   |



AUTOBIANCHI













































|  |  |  |    |  |  |  |  |  |  |  |  |  |
|--|---|---|---|--|---|---|---|---|---|---|---|---|
|  | M47N204D4, N47D20A  | 09/04 → 09/07   | Auto. GBX   | VKPC 88645   |   |   |   |   |   | 1   |   |   |
|                            | <b>B(Alt)</b> M47N204D4, N47D20A  | 09/04 → 12/07   | AC  | VKMOV 6PK1683  |   | 1   |   |   |   |   |   |   |
|  | <b>B(Alt)</b> M47N204D4, N47D20A  | 09/04 → 12/07   | AC  | VKMOV 6PK1836  |   | 1   |   |   |   |   |   |   |
| <b>BMW  3 (E21) 315</b>   |   |   |   |  |   |   |   |   |   |   |   |   |
|                            | M 10 B 16   | 03/81 → 03/84   |   | XXXXXXXX   |   |   |   |   |   |   |   |   |
|                            | M 10 B 16   | 03/81 → 03/84   |   | VKPC 88609   |   |   |   |   |   | 1   |   |   |
|                            | <b>B(Alt)</b> M 10 B 16   | 03/81 → 03/84   |   | VKMOV 10AVx875   |   | 1   |   |   |   |   |   |   |
|  | <b>B(AC)</b> M 10 B 16  | 03/81 → 03/84   |   | VKMOV 13AVx825   |   | 1   |   |   |   |   |   |   |
| <b>BMW  3 (E21) 316</b>   |   |   |   |  |   |   |   |   |   |   |   |   |
|                            | M 10 B 16   | 08/75 → 08/80   |   | XXXXXXXX   |   |   |   |   |   |   |   |   |
|                            | M 10 B 16   | 08/75 → 08/80   |   | VKPC 88609   |   |   |   |   |   | 1   |   |   |
|                            | <b>B(Alt)</b> M 10 B 16   | 08/75 → 08/80   | Man. GBX  | VKMOV 10AVx875   |   | 1   |   |   |   |   |   |   |
|  | <b>B(Alt)</b> M 10 B 16   | 08/75 → 08/80   | Auto. GBX   | VKMOV 10AVx850   |   | 1   |   |   |   |   |   |   |
|  | <b>B(PS)</b> M 10 B 16  | 08/75 → 08/80   |   | VKMOV 10AVx825   |   | 1   |   |   |   |   |   |   |
|  | <b>B(AC)</b> M 10 B 16  | 08/75 → 08/80   |   | VKMOV 13AVx825   |   | 1   |   |   |   |   |   |   |
| <b>BMW  3 (E21) 318</b>   |   |   |   |  |   |   |   |   |   |   |   |   |
|                            | M 10 B 18   | 08/75 → 08/82   |   | XXXXXXXX   |   |   |   |   |   |   |   |   |
|                            | M 10 B 18   | 08/75 → 08/82   |   | VKPC 88609   |   |   |   |   |   | 1   |   |   |
|                            | <b>B(Alt)</b> M 10 B 18   | 08/75 → 08/82   | Carbu., Man. GBX  | VKMOV 10AVx875   |   | 1   |   |   |   |   |   |   |
|  | <b>B(Alt)</b> M 10 B 18   | 08/75 → 08/82   | Carbu., Auto. GBX   | VKMOV 10AVx850   |   | 1   |   |   |   |   |   |   |
|  | <b>B(Alt)</b> M 10 B 18   | 11/79 → 08/82   | Injec., Man. GBX  | VKMOV 10AVx975   |   | 1   |   |   |   |   |   |   |
|  | <b>B(Alt)</b> M 10 B 18   | 11/79 → 08/82   | Injec., Auto. GBX   | VKMOV 10AVx950   |   | 1   |   |   |   |   |   |   |
|  | <b>B(PS)</b> M 10 B 18  | 08/75 → 08/82   | Carbu.  | VKMOV 10AVx825   |   | 1   |   |   |   |   |   |   |
|  | <b>B(PS)</b> M 10 B 18  | 11/79 → 08/82   | Injec.  | VKMOV 10AVx865   |   | 1   |   |   |   |   |   |   |
|  | <b>B(AC)</b> M 10 B 18  | 08/75 → 08/82   |   | VKMOV 13AVx825   |   | 1   |   |   |   |   |   |   |
| <b>BMW  3 (E21) 320</b> |   |   |   |  |   |   |   |   |   |   |   |   |
|                          | M 10 B 20   | 06/75 → 08/82   |   | XXXXXXXX   |   |   |   |   |   |   |   |   |
|  | M 20 B 20   | 09/77 → 08/82   |  | VKMA 08100   | 1   | 1   |   |   |   |   |   | T0049   |
|  |   |   |   | VKM 18100  | 1   |   |   |   |   |   |   |   |
|  | M 20 B 20   | 09/77 → 08/82   |  | VKMA 08110   | 1   | 1   |   |   |   |   |   | T0032   |
|  |   |   |   | VKM 18100  | 1   |   |   |   |   |   |   |   |
|                          | M 10 B 20   | 06/75 → 08/82   |   | VKPC 88609   |   |   |   |   |   | 1   |   |   |
|  | M 20 B 20   | 09/77 → 02/81   |   | —  |   |   |   |   |   | 1   |   |   |
|  | M 20 B 20   | 03/81 → 08/82   |   | VKPC 88605   |   |   |   |   |   | 1   |   |   |
|                          | <b>B(Alt)</b> M 10 B 20   | 06/75 → 08/82   | Injec.  | VKMOV 10AVx875   |   | 1   |   |   |   |   |   |   |
|  | <b>B(Alt)</b> M 10 B 20   | 08/75 → 08/77   | Carbu., Man. GBX  | VKMOV 10AVx875   |   | 1   |   |   |   |   |   |   |
|  | <b>B(Alt)</b> M 10 B 20   | 08/75 → 08/77   | Carbu., Auto. GBX   | VKMOV 10AVx850   |   | 1   |   |   |   |   |   |   |
|  | <b>B(Alt)</b> M 20 B 20   | 09/77 → 08/82   |   | VKMOV 10AVx950   |   | 1   |   |   |   |   |   |   |
|  | <b>B(PS)</b> M 10 B 20, M 20 B 20   | 06/75 → 08/82   |   | VKMOV 10AVx825   |   | 1   |   |   |   |   |   |   |
|  | <b>B(AC)</b> M 10 B 20  | 06/75 → 08/82   |   | VKMOV 13AVx825   |   | 1   |   |   |   |   |   |   |
| <b>BMW  3 (E21) 323</b> |   |   |   |  |   |   |   |   |   |   |   |   |
|                          | M 20 B 23   | 01/78 → 08/82   |  | VKMA 08100   | 1   | 1   |   |   |   |   |   | T0049   |
|  |   |   |   | VKM 18100  | 1   |   |   |   |   |   |   |   |
|  | M 20 B 23   | 01/78 → 08/82   |  | VKMA 08110   | 1   | 1   |   |   |   |   |   | T0032   |
|  |   |   |   | VKM 18100  | 1   |   |   |   |   |   |   |   |
|                          | M 20 B 23   | 01/78 → 02/81   |   | —  |   |   |   |   |   | 1   |   |   |
|  | M 20 B 23   | 03/81 → 08/82   |   | VKPC 88605   |   |   |   |   |   | 1   |   |   |
|                          | <b>B(Alt)</b> M 20 B 23   | 01/78 → 08/82   |   | VKMOV 10AVx950   |   | 1   |   |   |   |   |   |   |
|  | <b>B(PS)</b> M 20 B 23  | 01/78 → 08/82   |   | VKMOV 10AVx825   |   | 1   |   |   |   |   |   |   |
| <b>BMW  3 (E30) 316</b> |   |   |   |  |   |   |   |   |   |   |   |   |
|                          | M 40 B 16   | 12/90 → 06/91   |   | VKMA 08000   | 1   | 2   | 1   |   |   |   |   | T0087   |
|  |   |   |   | VKM 18000  | 1   |   |   |   |   |   |   |   |
|  |   |   |   | VKM 28000  |   | 1   |   |   |   |   |   |   |
|  |   |   |   | VKM 28001  |   | 1   |   |   |   |   |   |   |
|                          | M 40 B 16   | 09/87 → 06/91   |   | VKPC 88611   |   |   |   |   |   | 1   |   |   |
| <b>BMW  3 (E30) 318</b> |   |   |   |  |   |   |   |   |   |   |   |   |
|                          | M 10 B 18, M 42 B 18  | 09/82 → 08/91   |   | XXXXXXXX   |   |   |   |   |   |   |   |   |
|  | M 40 B 18   | 12/90 → 06/91   |   | VKMA 08000   | 1   | 2   | 1   |   |   |   |   | T0087   |
|  |   |   |   | VKM 18000  | 1   |   |   |   |   |   |   |   |



|  |  |  |                |  |  |  |  |  |  |  |  |
|--|---|---|---|--|---|---|---|---|---|---|---|
|  |   |   |   | VKM 28000  | 1   |   |   |   |   |   |   |
|  |   |   |   | VKM 28001  | 1   |   |   |   |   |   |   |
|                                       | M 10 B 18   | 09/82 → 12/90   |   | VKPC 88610   |   |   |   | 1   |   |   |   |
|  | M 40 B 18   | 09/87 → 06/91   |   | VKPC 88611   |   |   |   | 1   |   |   |   |
|  | M 42 B 18   | 09/89 → 08/91   |   | VKPC 88615   |   |   |   | 1   |   |   |   |
|                                       | <b>B(AC)</b> M 42 B 18  | 09/89 → 08/91   |   | VKMV 13AVx900  |   | 1   |   |   |   |   |   |
| <b>BMW  3 (E30) 320</b>               |   |   |   |  |   |   |   |   |   |   |   |
|                                       | S14204EA  | 05/88 → 12/90   |   | <b>OXOXOXO</b>   |   |   |   |   |   |   |   |
|  | M 20 B 20   | 09/82 → 06/91   |   | VKMA 08110   | 1   | 1   |   |   |   |   | T0032   |
|  |   |   |   | VKM 18100  | 1   |   |   |   |   |   |   |
|                                       | M 20 B 20   | 09/82 → 09/87   |   | VKPC 88605   |   |   |   | 1   |   |   |   |
|  | M 20 B 20   | 10/87 → 06/91   |   | VKPC 88607   |   |   |   | 1   |   |   |   |
|  | S14204EA  | 05/88 → 12/90   |   | —  |   |   |   | 1   |   |   |   |
| <b>BMW  3 (E30) 323</b>               |   |   |   |  |   |   |   |   |   |   |   |
|                                       | M 20 B 23   | 09/82 → 11/85   | <b>j,  127</b> | VKMA 08110   | 1   | 1   |   |   |   |   | T0032   |
|  |   |   |   | VKM 18100  | 1   |   |   |   |   |   |   |
|  | M 20 B 23   | 12/85 → 08/86   |   | VKMA 08110   | 1   | 1   |   |   |   |   | T0032   |
|  |   |   |   | VKM 18100  | 1   |   |   |   |   |   |   |
|                                       | M 20 B 23   | 09/82 → 08/86   |   | VKPC 88605   |   |   |   | 1   |   |   |   |
|                                       | <b>B(Alt)</b> M 20 B 23   | 09/82 → 06/83   |   | VKMV 10AVx950  |   | 1   |   |   |   |   |   |
|  | <b>B(Alt)</b> M 20 B 23   | 06/83 → 08/83   |   | VKMV 10AVx965  |   | 1   |   |   |   |   |   |
|  | <b>B(PS)</b> M 20 B 23  | 09/82 → 08/83   |   | VKMV 10AVx825  |   | 1   |   |   |   |   |   |
| <b>BMW  3 (E30) 325</b>               |   |   |   |  |   |   |   |   |   |   |   |
|                                       | M 20 B 25, M 20 B 27  | 09/83 → 11/85   | <b>j,  127</b> | VKMA 08110   | 1   | 1   |   |   |   |   | T0032   |
|  |   |   |   | VKM 18100  | 1   |   |   |   |   |   |   |
|  | M 20 B 25, M 20 B 27  | 12/85 → 08/91   |   | VKMA 08110   | 1   | 1   |   |   |   |   | T0032   |
|  |   |   |   | VKM 18100  | 1   |   |   |   |   |   |   |
|                                     | M 20 B 25, M 20 B 27  | 09/83 → 09/87   |   | VKPC 88605   |   |   |   | 1   |   |   |   |
|  | M 20 B 25, M 20 B 27  | 09/87 → 08/91   |   | VKPC 88607   |   |   |   | 1   |   |   |   |
|                                     | <b>B(Alt)</b> M 20 B 25, M 20 B 27  | 09/83 → 08/91   |   | VKMV 10AVx965  |   | 1   |   |   |   |   |   |
|  | <b>B(PS)</b> M 20 B 25, M 20 B 27   | 09/83 → 08/91   |   | VKMV 10AVx825  |   | 1   |   |   |   |   |   |
| <b>BMW  3 (E30) M3</b>              |   |   |   |  |   |   |   |   |   |   |   |
|                                     | S 14 B 23, S 14 B 25  | 07/86 → 01/92   |   | <b>OXOXOXO</b>   |   |   |   |   |   |   |   |
|                                     | S 14 B 23, S 14 B 25  | 07/86 → 01/92   |   | —  |   |   |   | 1   |   |   |   |
|                                     | <b>B(Alt)</b> S 14 B 23, S 14 B 25  | 07/86 → 01/92   |   | VKMV 10AVx865  |   | 1   |   |   |   |   |   |
|  | <b>B(PS)</b> S 14 B 23, S 14 B 25   | 07/86 → 01/92   |   | VKMV 10AVx813  |   | 1   |   |   |   |   |   |
|  | <b>B(AC)</b> S 14 B 23, S 14 B 25   | 07/86 → 01/92   |   | VKMV 13AVx800  |   | 1   |   |   |   |   |   |
| <b>BMW  3 (E30) 324 d</b>           |   |   |   |  |   |   |   |   |   |   |   |
|                                     | M 21 D 24 W   | 09/85 → 08/91   |   | VKMA 08120   | 1   | 1   |   |   |   |   | 1 T0033   |
|  |   |   |   | VKM 18120  | 1   |   |   |   |   |   | 1   |
|                                     | M 21 D 24 W   | 09/85 → 08/91   |   | VKPC 88614   |   |   |   | 1   |   |   |   |
|                                     | <b>B(Alt)</b> M 21 D 24 W   | 09/85 → 08/91   |   | VKMV 10AVx1000   |   | 1   |   |   |   |   |   |
|  | <b>B(PS)</b> M 21 D 24 W  | 09/85 → 08/91   |   | VKMV 10AVx865  |   | 1   |   |   |   |   |   |
|  | <b>B(AC)</b> M 21 D 24 W  | 09/85 → 05/88   |   | VKMV 13AVx800  |   | 1   |   |   |   |   |   |
| <b>BMW  3 (E30) 324 td</b>          |   |   |   |  |   |   |   |   |   |   |   |
|                                     | M 21 D 24,<br>M 21 D 24 WA  | 09/87 → 08/91   |   | VKMA 08120   | 1   | 1   |   |   |   |   | 1 T0033   |
|  |   |   |   | VKM 18120  | 1   |   |   |   |   |   | 1   |
|                                     | M 21 D 24,<br>M 21 D 24 WA  | 09/87 → 08/91   |   | VKPC 88614   |   |   |   | 1   |   |   |   |
|                                     | <b>B(Alt)</b> M 21 D 24,<br>M 21 D 24 WA  | 09/87 → 08/91   |   | VKMV 10AVx1000   |   | 1   |   |   |   |   |   |
|  | <b>B(PS)</b> M 21 D 24,<br>M 21 D 24 WA   | 09/87 → 08/91   |   | VKMV 10AVx865  |   | 1   |   |   |   |   |   |
| <b>BMW  3 Convertible (E30) 318</b> |   |   |   |  |   |   |   |   |   |   |   |
|                                     | M 40 B 18, M 40 B 18 C  | 12/90 → 10/93   |   | VKMA 08000   | 1   | 2   | 1   |   |   |   | T0087   |
|  |   |   |   | VKM 18000  | 1   |   |   |   |   |   |   |
|  |   |   |   | VKM 28000  |   | 1   |   |   |   |   |   |
|  |   |   |   | VKM 28001  |   | 1   |   |   |   |   |   |
|                                     | M 40 B 18, M 40 B 18 C  | 06/88 → 10/93   |   | VKPC 88611   |   |   |   | 1   |   |   |   |
|                                     | <b>B(Alt)</b> M 40 B 18, M 40 B 18 C  | 06/88 → 10/93   |   | VKMV 10AVx1013   |   | 1   |   |   |   |   |   |
|  | <b>B(PS)</b> M 40 B 18, M 40 B 18 C   | 06/88 → 10/93   |   | VKMV 10AVx800  |   | 1   |   |   |   |   |   |



BMW

|  |  |  |    |  |  |  |  |  |  |  |  |  |
|--|---|---|---|--|---|---|---|---|---|---|---|---|
| <b>B(AC)</b>   | M 40 B 18, M 40 B 18 C  | 06/88 → 10/93   |   | VKMV 13AVx850  |   | 1   |   |   |   |   |   |   |
| <b>BMW  3 Convertible (E30) 320</b> |   |   |   |  |   |   |   |   |   |   |   |   |
|                                      | M 20 B 20   | 04/86 → 12/91   |   | VKMA 08110<br>VKM 18100  | 1<br>1  | 1   |   |   |   |   |   | T0032   |
|                                      | M 20 B 20   | 04/86 → 09/87   |   | VKPC 88605   |   |   |   | 1   |   |   |   |   |
|  | M 20 B 20   | 10/87 → 10/93   |   | VKPC 88607   |   |   |   | 1   |   |   |   |   |
|                                      | <b>B(Alt)</b> M 20 B 20   | 04/86 → 10/93   |   | VKMV 10AVx965  |   | 1   |   |   |   |   |   |   |
|  | <b>B(PS)</b> M 20 B 20  | 04/86 → 10/93   |   | VKMV 10AVx825  |   | 1   |   |   |   |   |   |   |
| <b>BMW  3 Convertible (E30) 325</b> |   |   |   |  |   |   |   |   |   |   |   |   |
|                                      | M 20 B 25   | 12/85 → 10/93   |   | VKMA 08110<br>VKM 18100  | 1<br>1  | 1   |   |   |   |   |   | T0032   |
|                                      | M 20 B 25   | 12/85 → 09/87   |   | VKPC 88605   |   |   |   | 1   |   |   |   |   |
|  | M 20 B 25   | 09/87 → 10/93   |   | VKPC 88607   |   |   |   | 1   |   |   |   |   |
|                                      | <b>B(Alt)</b> M 20 B 25   | 12/85 → 10/93   |   | VKMV 10AVx965  |   | 1   |   |   |   |   |   |   |
|  | <b>B(PS)</b> M 20 B 25  | 12/85 → 10/93   |   | VKMV 10AVx825  |   | 1   |   |   |   |   |   |   |
| <b>BMW  3 Convertible (E30) M3</b>  |   |   |   |  |   |   |   |   |   |   |   |   |
|                                      | S 14 B 23   | 06/88 → 06/91   |   | <del>OXOXOXO</del>   |   |   |   |   |   |   |   |   |
|                                      | S 14 B 23   | 06/88 → 06/91   |   | —  |   |   |   | 1   |   |   |   |   |
|                                      | <b>B(Alt)</b> S 14 B 23   | 06/88 → 06/91   |   | VKMV 10AVx865  |   | 1   |   |   |   |   |   |   |
|  | <b>B(PS)</b> S 14 B 23  | 06/88 → 06/91   |   | VKMV 10AVx813  |   | 1   |   |   |   |   |   |   |
|  | <b>B(AC)</b> S 14 B 23  | 06/88 → 06/91   |   | VKMV 13AVx800  |   | 1   |   |   |   |   |   |   |
| <b>BMW  3 Touring (E30) 316</b>     |   |   |   |  |   |   |   |   |   |   |   |   |
|                                      | M 40 B 16   | 09/91 → 06/94   |   | VKMA 08000<br>VKM 18000<br>VKM 28000<br>VKM 28001                                  | 1<br>1<br>1<br>1  | 2   | 1   |   |   |   |   | T0087   |
|                                    | M 40 B 16   | 09/91 → 06/94   |   | VKPC 88611   |   |   |   | 1   |   |   |   |   |
|                                    | <b>B(Alt)</b> M 40 B 16   | 09/91 → 06/94   |   | VKMV 10AVx1013   |   |   | 1   |   |   |   |   |   |
|  | <b>B(PS)</b> M 40 B 16  | 09/91 → 06/94   |   | VKMV 10AVx800  |   |   | 1   |   |   |   |   |   |
|  | <b>B(AC)</b> M 40 B 16  | 09/91 → 06/94   |   | VKMV 13AVx850  |   |   | 1   |   |   |   |   |   |
| <b>BMW  3 Touring (E30) 318</b>   |   |   |   |  |   |   |   |   |   |   |   |   |
|                                    | M 40 B 18   | 12/90 → 06/94   |   | VKMA 08000<br>VKM 18000<br>VKM 28000<br>VKM 28001                                  | 1<br>1<br>1<br>1  | 2   | 1   |   |   |   |   | T0087   |
|                                    | M 40 B 18   | 09/87 → 06/94   |   | VKPC 88611   |   |   |   | 1   |   |   |   |   |
|                                    | <b>B(Alt)</b> M 40 B 18   | 09/87 → 06/94   |   | VKMV 10AVx1013   |   |   | 1   |   |   |   |   |   |
|  | <b>B(PS)</b> M 40 B 18  | 09/87 → 06/94   |   | VKMV 10AVx800  |   |   | 1   |   |   |   |   |   |
|  | <b>B(AC)</b> M 40 B 18  | 09/87 → 06/94   |   | VKMV 13AVx850  |   |   | 1   |   |   |   |   |   |
| <b>BMW  3 Touring (E30) 320</b>   |   |   |   |  |   |   |   |   |   |   |   |   |
|                                    | M 20 B 20   | 01/88 → 12/91   |   | VKMA 08110<br>VKM 18100  | 1<br>1  | 1   |   |   |   |   |   | T0032   |
|                                    | M 20 B 20   | 01/88 → 12/91   |   | VKPC 88607   |   |   |   | 1   |   |   |   |   |
|                                    | <b>B(Alt)</b> M 20 B 20   | 01/88 → 12/91   |   | VKMV 10AVx965  |   |   | 1   |   |   |   |   |   |
|  | <b>B(PS)</b> M 20 B 20  | 01/88 → 12/91   |  | VKMV 10AVx825  |   |   | 1   |   |   |   |   |   |
|  | <b>B(PS)</b> M 20 B 20  | 01/88 → 12/91   |  | VKMV 10AVx850  |   |   | 1   |   |   |   |   |   |
|  | <b>B(AC)</b> M 20 B 20  | 01/88 → 12/91   |   | VKMV 13AVx825  |   |   | 1   |   |   |   |   |   |
| <b>BMW  3 Touring (E30) 325</b>   |   |   |   |  |   |   |   |   |   |   |   |   |
|                                    | M 20 B 25   | 07/87 → 10/93   |   | VKMA 08110<br>VKM 18100  | 1<br>1  | 1   |   |   |   |   |   | T0032   |
|                                    | M 20 B 25   | 09/87 → 10/93   |   | VKPC 88607   |   |   |   | 1   |   |   |   |   |
|                                    | <b>B(Alt)</b> M 20 B 25   | 07/87 → 03/93   | <b>AC</b>   | VKMV 10AVx965  |   |   | 1   |   |   |   |   |   |
|  | <b>B(Alt)</b> M 20 B 25   | 07/87 → 03/93   | <b>AC, Man. GBX</b>   | VKMV 13AVx1050   |   |   | 1   |   |   |   |   |   |
|  | <b>B(Alt)</b> M 20 B 25   | 06/88 → 10/93   | <b>4WD</b>  | VKMV 10AVx965  |   |   | 1   |   |   |   |   |   |
|  | <b>B(PS)</b> M 20 B 25  | 07/87 → 03/93   |  | VKMV 10AVx825  |   |   | 1   |   |   |   |   |   |
|  | <b>B(PS)</b> M 20 B 25  | 07/87 → 03/93   |  | VKMV 10AVx850  |   |   | 1   |   |   |   |   |   |
|  | <b>B(PS)</b> M 20 B 25  | 06/88 → 10/93   | <b>4WD</b>  | VKMV 10AVx825  |   |   | 1   |   |   |   |   |   |
|  | <b>B(AC)</b> M 20 B 25  | 07/87 → 10/93   |   | VKMV 13AVx825  |   |   | 1   |   |   |   |   |   |

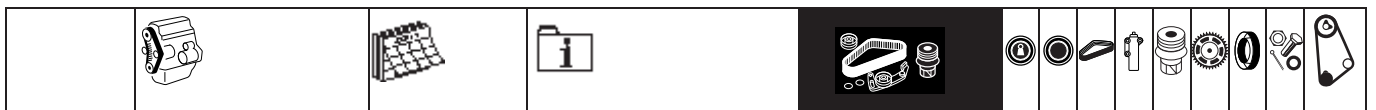



























































| BMW  3 Touring (E30) 324 td |  |               |  |                         |        |   |  |   |  |        |       |
|-----------------------------|--|---------------|--|-------------------------|--------|---|--|---|--|--------|-------|
|                             | M 21 D 24,<br>M 21 D 24 WA               | 01/88 → 06/93 |  | VKMA 08120<br>VKM 18120 | 1<br>1 | 1 |  |   |  | 1<br>1 | T0033 |
|                             | M 21 D 24,<br>M 21 D 24 WA               | 01/88 → 06/93 |  | VKPC 88614              |        |   |  | 1 |  |        |       |
|                             | <b>B(Alt)</b> M 21 D 24,<br>M 21 D 24 WA | 01/88 → 06/93 |  | VKMV 10AVx1000          |        | 1 |  |   |  |        |       |
|                             | <b>B(PS)</b> M 21 D 24,<br>M 21 D 24 WA  | 01/88 → 06/93 |  | VKMV 10AVx865           |        | 1 |  |   |  |        |       |
|                             | <b>B(AC)</b> M 21 D 24,<br>M 21 D 24 WA  | 01/88 → 06/93 |  | VKMV 13AVx800           |        | 1 |  |   |  |        |       |

| BMW  3 (E36) 316 |                         |                                |  |  |        |   |   |        |  |   |       |
|------------------|-------------------------|--------------------------------|--|--|--------|---|---|--------|--|---|-------|
|                  | M 43 B 16<br>M 40 B 16  | 07/93 → 02/98<br>09/90 → 09/93 |  | <del>OK</del><br>VKMA 08001<br>VKM 18001<br>VKM 28000<br>VKM 28001 | 1<br>1 | 2 | 1 |        |  |   | T0087 |
|                  | M 40 B 16<br>M 43 B 16  | 09/90 → 09/93<br>07/93 → 02/98 |  | VKPC 88616<br>VKPC 88615   |        |   |   | 1<br>1 |  |   |       |
|                  | <b>B(Alt)</b> M 43 B 16 | 07/93 → 09/95                  |  | VKMV 6PK1660<br>VKM 38003<br>VKM 38004<br>VKM 38008                | 1      |   | 1 |        |  | 1 |       |
|                  | <b>B(Alt)</b> M 43 B 16 | 07/93 → 09/95                  |  | VKMV 6PK1660<br>VKM 38004<br>VKM 38004<br>VKM 38008                |        |   | 1 |        |  | 1 |       |
|                  | <b>B(Alt)</b> M 43 B 16 | 09/95 → 02/98                  |  | VKMV 6PK1733<br>VKM 38221  | 1      |   | 1 |        |  |   |       |
|                  | <b>B(Alt)</b> M 43 B 16 | 09/95 → 02/98                  |  | VKMV 6PK1733<br>VKM 38004<br>VKM 38221                             |        | 1 | 1 |        |  |   |       |
|                  | <b>B(AC)</b> M 43 B 16  | 07/93 → 02/98                  |  | VKMV 4PK889<br>VKM 38230   | 1      |   | 1 |        |  |   |       |

| BMW  3 (E36) 318 |   |                                |    |  |        |   |   |        |  |   |       |
|------------------|---|--------------------------------|----|--|--------|---|---|--------|--|---|-------|
|                  | M 42 B 18, M 43 B 18,<br>M 44 B 19<br>M 40 B 18 | 03/93 → 02/98<br>12/90 → 10/93 |    | <del>OK</del><br>VKMA 08001<br>VKM 18001<br>VKM 28000<br>VKM 28001 | 1<br>1 | 2 | 1 |        |  |   | T0087 |
|                  | M 40 B 18<br>M 42 B 18, M 43 B 18,<br>M 44 B 19 | 12/90 → 10/93<br>03/93 → 02/98 |    | VKPC 88616<br>VKPC 88615   |        |   |   | 1<br>1 |  |   |       |
|                  | <b>B(Alt)</b> M 42 B 18                         | 03/93 → 09/97                  |    | VKMV 6PK1660<br>VKM 38003<br>VKM 38004<br>VKM 38008                | 1      |   | 1 |        |  | 1 |       |
|                  | <b>B(Alt)</b> M 42 B 18                         | 03/93 → 09/97                  | AC | VKMV 6PK1660<br>VKM 38004<br>VKM 38004<br>VKM 38008                |        |   | 1 |        |  | 1 |       |
|                  | <b>B(Alt)</b> M 43 B 18                         | 10/93 → 09/95                  |    | VKMV 6PK1660<br>VKM 38003<br>VKM 38004<br>VKM 38008                | 1      |   | 1 |        |  | 1 |       |
|                  | <b>B(Alt)</b> M 43 B 18, M 44 B 19              | 09/95 → 02/98                  |    | VKMV 6PK1733<br>VKM 38221  | 1      |   | 1 |        |  |   |       |
|                  | <b>B(Alt)</b> M 43 B 18                         | 10/93 → 09/95                  |    | VKMV 6PK1660<br>VKM 38004<br>VKM 38004<br>VKM 38008                |        |   | 1 |        |  | 1 |       |



|  |  |  |  |  |  |  |  |  |  |  |  |  |  |  |  |  |  |  |  |  |
|--|---|---|---|--|---|---|---|---|---|---|---|---|---|---|---|---|---|---|---|--|
| B(Alt)   | M 43 B 18, M 44 B 19  | 09/95 → 02/98   | 80A   | VKMV 6PK1733<br>VKM 38004<br>VKM 38221   | 1   | 1   | 1   |   |   |   |   |   |   |   |   |   |   |   |   |  |
| B(AC)  | M 42 B 18, M 43 B 18,<br>M 44 B 19  | 10/93 → 02/98   |   | VKMV 4PK889<br>VKM 38230   | 1   | 1   | 1   |   |   |   |   |   |   |   |   |   |   |   |   |  |
| <b>BMW  3 (E36) 320</b>       |   |   |   |  |   |   |   |   |   |   |   |   |   |   |   |   |   |   |   |  |
|                                | M 50 B, M 52 B  | 09/90 → 02/98   |   | <b>OKOKOKO</b>   |   |   |   |   |   |   |   |   |   |   |   |   |   |   |   |  |
|                                | M 50 B, M 52 B  | 09/90 → 02/98   |   | VKPC 88617   |   |   |   | 1   |   |   |   |   |   |   |   |   |   |   |   |  |
|                                | B(Alt), B(AC)M 50 B   | 09/91 → 09/94   | MT  | VKMA 38264   | 2   | 1   | 2   |   |   | 1   |   |   |   |   |   |   |   |   |   |  |
|  | B(Alt), B(AC)M 50 B   | 09/94 → 02/98   | MT  | VKMA 38266   | 1   | 1   | 2   |   |   | 1   |   |   |   |   |   |   |   |   |   |  |
|  | B(Alt), B(AC)M 50 B   | 09/91 → 02/98   | HT  | VKMA 38260   | 1   | 2   | 2   |   |   | 2   |   |   |   |   |   |   |   |   |   |  |
|  | B(Alt), B(AC)M 52 B   | 09/90 → 02/98   | MT  | VKMA 38265   | 1   | 1   | 2   |   |   | 1   |   |   |   |   |   |   |   |   |   |  |
|  | B(Alt), B(AC)M 52 B   | 09/90 → 02/98   | HT  | VKMA 38261   | 1   | 2   | 2   |   |   | 2   |   |   |   |   |   |   |   |   |   |  |
|  | B(Alt) M 50 B   | 09/91 → 09/94   | MT  | VKMA 38202<br>VKMV 6PK1555<br>VKM 38003<br>VKM 38202                               | 2<br>1<br>1   |   | 1<br>1  |   |   |   |   |   |   |   |   |   |   |   |   |  |
|  | B(Alt) M 50 B   | 09/94 → 02/98   | MT  | VKMA 38241<br>VKMV 6PK1555<br>VKM 38202  | 1<br>1  |   | 1<br>1  |   |   |   |   |   |   |   |   |   |   |   |   |  |
|  | B(Alt) M 50 B, M 52 B   | 09/90 → 02/98   | HT  | VKMA 38242<br>VKMV 6PK1555<br>VKM 38003<br>VKM 38004<br>VKM 38007                  | 1<br>1  | 1   | 1<br>1  |   |   | 1   |   |   |   |   |   |   |   |   |   |  |
|  | B(Alt) M 52 B   | 09/90 → 02/98   | MT  | VKMA 38241<br>VKMV 6PK1555<br>VKM 38202  | 1<br>1  |   | 1<br>1  |   |   |   |   |   |   |   |   |   |   |   |   |  |
|  | B(AC) M 50 B  | 09/90 → 02/98   |   | VKMV 5PK890<br>VKM 38004<br>VKM 38011  |   |   | 1   |   |   | 1   |   |   |   |   |   |   |   |   |   |  |
|  | B(AC) M 52 B  | 09/90 → 02/98   |   | VKMV 5PK906<br>VKM 38004<br>VKM 38011  |   |   | 1   |   |   | 1   |   |   |   |   |   |   |   |   |   |  |
| <b>BMW  3 (E36) 323 2.5</b> |   |   |   |  |   |   |   |   |   |   |   |   |   |   |   |   |   |   |   |  |
|                              | M 52 B 25   | 03/95 → 02/98   |   | <b>OKOKOKO</b>   |   |   |   |   |   |   |   |   |   |   |   |   |   |   |   |  |
|                              | M 52 B 25   | 03/95 → 02/98   |   | VKPC 88617   |   |   |   | 1   |   |   |   |   |   |   |   |   |   |   |   |  |
|                              | B(Alt), B(AC)M 52 B 25  | 03/95 → 02/98   | MT  | VKMA 38265   | 1   | 1   | 2   |   |   | 1   |   |   |   |   |   |   |   |   |   |  |
|  | B(Alt), B(AC)M 52 B 25  | 03/95 → 02/98   | HT  | VKMA 38261   | 1   | 2   | 2   |   |   | 2   |   |   |   |   |   |   |   |   |   |  |
|  | B(Alt) M 52 B 25  | 03/95 → 02/98   | MT  | VKMA 38241<br>VKMV 6PK1555<br>VKM 38202  | 1<br>1  |   | 1<br>1  |   |   |   |   |   |   |   |   |   |   |   |   |  |
|  | B(Alt) M 52 B 25  | 03/95 → 02/98   | HT  | VKMA 38242<br>VKMV 6PK1555<br>VKM 38003<br>VKM 38004<br>VKM 38007                  | 1<br>1  | 1   | 1<br>1  |   |   | 1   |   |   |   |   |   |   |   |   |   |  |
|  | B(AC) M 52 B  | 03/95 → 02/98   |   | VKMV 5PK906<br>VKM 38004<br>VKM 38011  |   |   | 1   |   |   | 1   |   |   |   |   |   |   |   |   |   |  |
| <b>BMW  3 (E36) 325</b>     |   |   |   |  |   |   |   |   |   |   |   |   |   |   |   |   |   |   |   |  |
|                              | M 50 B 25   | 09/90 → 09/95   |   | <b>OKOKOKO</b>   |   |   |   |   |   |   |   |   |   |   |   |   |   |   |   |  |
|                              | M 50 B 25   | 09/90 → 09/95   |   | VKPC 88617   |   |   |   | 1   |   |   |   |   |   |   |   |   |   |   |   |  |
|                              | B(Alt), B(AC)M 50 B 25  | 09/91 → 09/94   | MT  | VKMA 38264   | 2   | 1   | 2   |   |   | 1   |   |   |   |   |   |   |   |   |   |  |
|  | B(Alt), B(AC)M 50 B 25  | 09/91 → 09/95   | HT  | VKMA 38260   | 1   | 2   | 2   |   |   | 2   |   |   |   |   |   |   |   |   |   |  |
|  | B(Alt), B(AC)M 50 B 25  | 09/94 → 09/95   | MT  | VKMA 38266   | 1   | 1   | 2   |   |   | 1   |   |   |   |   |   |   |   |   |   |  |
|  | B(Alt) M 50 B 25  | 09/91 → 09/94   | MT  | VKMA 38202<br>VKMV 6PK1555<br>VKM 38003<br>VKM 38202                               | 2<br>1<br>1   |   | 1<br>1  |   |   |   |   |   |   |   |   |   |   |   |   |  |

|  |  |  |  |  |  |  |  |  |  |  |  |  |  |
|--|---|---|---|--|---|---|---|---|---|---|---|---|---|
|  | <b>B(Alt)</b> M 50 B 25   | 09/91 → 09/95   | HT  | VKMA 38242<br>VKMV 6PK1555<br>VKM 38003<br>VKM 38004<br>VKM 38007                  | 1   | 1   | 1   |   |   | 1   |   |   |   |
|  | <b>B(Alt)</b> M 50 B 25   | 09/94 → 09/95   | MT  | VKMA 38241<br>VKMV 6PK1555<br>VKM 38202  | 1   |   | 1   | 1   |   |   |   |   |   |
|  | <b>B(AC)</b> M 50 B   | 09/90 → 09/95   |   | VKMV 5PK890<br>VKM 38004<br>VKM 38011  |   | 1   | 1   |   |   |   | 1   |   |   |
| <b>BMW  3 (E36) 328</b>       |   |   |   |  |   |   |   |   |   |   |   |   |   |
|                               | M 52 B 28   | 01/95 → 02/98   |   | <b>ΟΛΟΚΛΗΡΟ</b>  |   |   |   |   |   |   |   |   |   |
|                               | M 52 B 28   | 01/95 → 02/98   |   | VKPC 88617   |   |   |   |   |   | 1   |   |   |   |
|                               | <b>B(Alt), B(AC)</b> M 52 B 28  | 01/95 → 02/98   | MT  | VKMA 38265   | 1   | 1   | 2   |   |   | 1   |   |   |   |
|  | <b>B(Alt), B(AC)</b> M 52 B 28  | 01/95 → 02/98   | HT  | VKMA 38261   | 1   | 2   | 2   |   |   | 2   |   |   |   |
|  | <b>B(Alt)</b> M 52 B 28   | 01/95 → 02/98   | MT  | VKMA 38241<br>VKMV 6PK1555<br>VKM 38202  | 1   |   | 1   | 1   |   |   |   |   |   |
|  | <b>B(Alt)</b> M 52 B 28   | 01/95 → 02/98   | HT  | VKMA 38242<br>VKMV 6PK1555<br>VKM 38003<br>VKM 38004<br>VKM 38007                  | 1   | 1   | 1   | 1   |   | 1   |   |   |   |
|  | <b>B(AC)</b> M 52 B   | 01/95 → 02/98   |   | VKMV 5PK906<br>VKM 38004<br>VKM 38011  |   | 1   | 1   |   |   |   | 1   |   |   |
| <b>BMW  3 (E36) M3</b>      |   |   |   |  |   |   |   |   |   |   |   |   |   |
|                             | S 50 B 30, S 50 B 32  | 08/94 → 02/98   |   | <b>ΟΛΟΚΛΗΡΟ</b>  |   |   |   |   |   |   |   |   |   |
|                             | S 50 B 30, S 50 B 32  | 08/94 → 02/98   |   | —  |   |   |   |   |   | 1   |   |   |   |
|                             | <b>B(Alt)</b> S 50 B 30, S 50 B 32  | 08/94 → 02/98   |   | VKMV 6PK1515<br>VKM 38003<br>VKM 38004<br>VKM 38007                                | 1   |   | 1   |   |   |   | 1   |   |   |
|  | <b>B(AC)</b> S 50 B 30, S 50 B 32   | 08/94 → 02/98   |   | VKMV 5PK1125<br>VKM 38230  | 1   |   | 1   |   |   |   |   |   |   |
|  | <b>B(AP)</b> S 50 B 30, S 50 B 32   | 08/94 → 02/98   |   | VKMV 5PK785  |   |   | 1   |   |   |   |   |   |   |
| <b>BMW  3 (E36) 318 tds</b> |   |   |   |  |   |   |   |   |   |   |   |   |   |
|                             | M 41 D 18   | 01/95 → 02/98   |   | <b>ΟΛΟΚΛΗΡΟ</b>  |   |   |   |   |   |   |   |   |   |
|                             | M 41 D 18   | 01/95 → 02/98   |   | VKPC 88826   |   |   |   |   |   | 1   |   |   |   |
|                             | <b>B(Alt)</b> M 41 D 18   | 01/95 → 02/98   |   | VKMV 5PK1885<br>VKM 38220<br>VKM 38225   | 1   |   | 1   |   |   |   |   |   |   |
|  | <b>B(AC)</b> M 41 D 18  | 01/95 → 02/98   |   | VKMV 4PK836  |   |   | 1   |   |   |   |   |   |   |
| <b>BMW  3 (E36) 325 td</b>  |   |   |   |  |   |   |   |   |   |   |   |   |   |
|                             | M 51 D 25   | 09/91 → 02/98   |   | <b>ΟΛΟΚΛΗΡΟ</b>  |   |   |   |   |   |   |   |   |   |
|                             | M 51 D 25   | 09/91 → 02/98   |   | VKPC 88826   |   |   |   |   |   | 1   |   |   |   |
|                             | <b>B(Alt)</b> M 51 D 25   | 09/91 → 02/98   |   | VKMV 5PK1815<br>VKM 38220<br>VKM 38225   | 1   |   | 1   |   |   |   |   |   |   |
|  | <b>B(AC)</b> M 51 D 25  | 10/94 → 02/98   |   | VKMV 4PK781<br>VKM 38230   | 1   |   | 1   |   |   |   |   |   |   |
|                             | M 51 D 25   | 09/91 → 02/98   |   | VKM_____   |   |   |   |   |   | 1   |   |   |   |
| <b>BMW  3 (E36) 325 tds</b> |   |   |   |  |   |   |   |   |   |   |   |   |   |
|                             | M 51 D 25   | 05/93 → 02/98   |   | <b>ΟΛΟΚΛΗΡΟ</b>  |   |   |   |   |   |   |   |   |   |
|                             | M 51 D 25   | 05/93 → 02/98   |   | VKPC 88826   |   |   |   |   |   | 1   |   |   |   |
|                             | <b>B(Alt)</b> M 51 D 25   | 05/93 → 02/98   |   | VKMV 5PK1815<br>VKM 38220<br>VKM 38225   | 1   |   | 1   |   |   |   |   |   |   |
|  | <b>B(AC)</b> M 51 D 25  | 10/94 → 02/98   |   | VKMV 4PK781<br>VKM 38230   | 1   |   | 1   |   |   |   |   |   |   |
|                             | M 51 D 25   | 05/93 → 02/98   |   | VKM_____   |   |   |   |   |   | 1   |   |   |   |



BMW



**BMW** **3 Compact (E36) 316**

|               |                         |               |  |   |   |  |   |   |  |  |  |  |   |   |   |  |  |  |
|---------------|-------------------------|---------------|--|---|---|--|---|---|--|--|--|--|---|---|---|--|--|--|
|               | M 43 B 16               | 03/94 → 08/00 |  | <b>OKOKOKO</b>                                      |   |  |   |   |  |  |  |  |   |   |   |  |  |  |
|               | M 43 B 16               | 03/94 → 08/00 |  | VKPC 88615  |   |  |   |   |  |  |  |  | 1 |   |   |  |  |  |
|               | <b>B(Alt)</b> M 43 B 16 | 03/94 → 09/95 |  | VKMV 6PK1660<br>VKM 38003<br>VKM 38004<br>VKM 38008 | 1 |  | 1 |   |  |  |  |  |   | 1 |   |  |  |  |
| <b>B(Alt)</b> | M 43 B 16               | 03/94 → 09/95 |  | VKMV 6PK1660<br>VKM 38004<br>VKM 38004<br>VKM 38008 |   |  | 1 | 1 |  |  |  |  |   |   | 1 |  |  |  |
| <b>B(Alt)</b> | M 43 B 16               | 09/95 → 08/00 |  | VKMV 6PK1733<br>VKM 38221                           | 1 |  |   | 1 |  |  |  |  |   |   |   |  |  |  |
| <b>B(Alt)</b> | M 43 B 16               | 09/95 → 08/00 |  | VKMV 6PK1733<br>VKM 38004<br>VKM 38221              | 1 |  | 1 |   |  |  |  |  |   |   |   |  |  |  |
| <b>B(AC)</b>  | M 43 B 16               | 03/94 → 08/00 |  | VKMV 4PK889<br>VKM 38230                            | 1 |  |   | 1 |  |  |  |  |   |   |   |  |  |  |

**BMW** **3 Compact (E36) 318**

|               |                         |               |  |   |   |  |   |   |  |  |  |  |   |   |   |  |  |  |
|---------------|-------------------------|---------------|--|---|---|--|---|---|--|--|--|--|---|---|---|--|--|--|
|               | M 42 B 18, M 44 B 19    | 11/94 → 08/00 |  | <b>OKOKOKO</b>                                      |   |  |   |   |  |  |  |  |   |   |   |  |  |  |
|               | M 42 B 18, M 44 B 19    | 11/94 → 08/00 |  | VKPC 88615  |   |  |   |   |  |  |  |  | 1 |   |   |  |  |  |
|               | <b>B(Alt)</b> M 42 B 18 | 11/94 → 08/95 |  | VKMV 6PK1660<br>VKM 38003<br>VKM 38004<br>VKM 38008 | 1 |  | 1 |   |  |  |  |  |   | 1 |   |  |  |  |
| <b>B(Alt)</b> | M 42 B 18               | 11/94 → 08/95 |  | VKMV 6PK1660<br>VKM 38004<br>VKM 38004<br>VKM 38008 |   |  | 1 | 1 |  |  |  |  |   |   | 1 |  |  |  |
| <b>B(Alt)</b> | M 44 B 19               | 07/95 → 08/00 |  | VKMV 6PK1733<br>VKM 38221                           | 1 |  |   | 1 |  |  |  |  |   |   |   |  |  |  |
| <b>B(Alt)</b> | M 44 B 19               | 07/95 → 08/00 |  | VKMV 6PK1733<br>VKM 38004<br>VKM 38221              | 1 |  | 1 |   |  |  |  |  |   |   |   |  |  |  |
| <b>B(AC)</b>  | M 42 B 18, M 44 B 19    | 11/94 → 08/00 |  | VKMV 4PK889<br>VKM 38230                            | 1 |  |   | 1 |  |  |  |  |   |   |   |  |  |  |

**BMW** **3 Compact (E36) 323**

















|                      |                                |               |           |   |   |   |   |  |  |  |  |  |   |   |   |  |  |  |
|----------------------|--------------------------------|---------------|-----------|---|---|---|---|--|--|--|--|--|---|---|---|--|--|--|
|                      | M 52 B 25                      | 08/97 → 08/00 |           | <b>OKOKOKO</b>  |   |   |   |  |  |  |  |  |   |   |   |  |  |  |
|                      | M 52 B 25                      | 08/97 → 08/00 |           | VKPC 88617  |   |   |   |  |  |  |  |  | 1 |   |   |  |  |  |
|                      | <b>B(Alt), B(AC)</b> M 52 B 25 | 08/97 → 08/00 | <b>MT</b> | VKMA 38265  | 1 | 1 | 2 |  |  |  |  |  |   | 1 |   |  |  |  |
| <b>B(Alt), B(AC)</b> | M 52 B 25                      | 08/97 → 08/00 | <b>HT</b> | VKMA 38261  | 1 | 2 | 2 |  |  |  |  |  |   |   | 2 |  |  |  |
| <b>B(Alt)</b>        | M 52 B 25                      | 08/97 → 08/00 | <b>MT</b> | VKMA 38241<br>VKMV 6PK1555<br>VKM 38202                           | 1 |   | 1 |  |  |  |  |  |   | 1 |   |  |  |  |
| <b>B(Alt)</b>        | M 52 B 25                      | 08/97 → 08/00 | <b>HT</b> | VKMA 38242<br>VKMV 6PK1555<br>VKM 38003<br>VKM 38004<br>VKM 38007 | 1 | 1 | 1 |  |  |  |  |  |   | 1 |   |  |  |  |
| <b>B(AC)</b>         | M 52 B                         | 08/97 → 08/00 |           | VKMV 5PK906<br>VKM 38004<br>VKM 38011                             |   |   | 1 |  |  |  |  |  |   |   | 1 |  |  |  |

**BMW** **3 Compact (E36) 318 tds**



|              |                         |               |  |  |   |  |   |   |  |  |  |  |  |   |  |  |  |  |
|--------------|-------------------------|---------------|--|--|---|--|---|---|--|--|--|--|--|---|--|--|--|--|
|              | M 41 D 18               | 01/95 → 08/00 |  | <b>OKOKOKO</b>                         |   |  |   |   |  |  |  |  |  |   |  |  |  |  |
|              | M 41 D 18               | 01/95 → 08/00 |  | VKPC 88826                             |   |  |   |   |  |  |  |  |  | 1 |  |  |  |  |
|              | <b>B(Alt)</b> M 41 D 18 | 01/95 → 08/00 |  | VKMV 5PK1885<br>VKM 38220<br>VKM 38225 | 1 |  | 1 |   |  |  |  |  |  |   |  |  |  |  |
| <b>B(AC)</b> | M 41 D 18               | 01/95 → 08/00 |  | VKMV 4PK836                            |   |  |   | 1 |  |  |  |  |  |   |  |  |  |  |

**BMW** **3 Convertible (E36) 318**



|  |           |               |  |                |  |  |  |  |  |  |  |  |  |   |  |  |  |  |
|--|-----------|---------------|--|----------------|--|--|--|--|--|--|--|--|--|---|--|--|--|--|
|  | M 43 B 18 | 01/94 → 04/99 |  | <b>OKOKOKO</b> |  |  |  |  |  |  |  |  |  |   |  |  |  |  |
|  | M 43 B 18 | 01/94 → 04/99 |  | VKPC 88615     |  |  |  |  |  |  |  |  |  | 1 |  |  |  |  |

|  |  |  |      |  |  |  |  |  |  |  |  |
|--|---|---|---|--|---|---|---|---|---|---|---|
|  B(Alt) M 43 B 18 | M 43 B 18   | 01/94 → 09/95   |  70A | VKMV 6PK1660<br>VKM 38003<br>VKM 38004<br>VKM 38008                                | 1   | 1   | 1   |   |   |   |   |
| B(Alt) M 43 B 18   | M 43 B 18   | 01/94 → 09/95   |  80A | VKMV 6PK1660<br>VKM 38004<br>VKM 38004<br>VKM 38008                                |   | 1   | 1   |   |   |   |   |
| B(Alt) M 43 B 18   | M 43 B 18   | 09/95 → 04/99   |  70A | VKMV 6PK1733<br>VKM 38221  | 1   |   | 1   |   |   |   |   |
| B(Alt) M 43 B 18   | M 43 B 18   | 09/95 → 04/99   |  80A | VKMV 6PK1733<br>VKM 38004<br>VKM 38221   |   | 1   | 1   |   |   |   |   |
| B(AC) M 43 B 18  | M 43 B 18   | 01/94 → 04/99   |   | VKMV 4PK889<br>VKM 38230   | 1   |   | 1   |   |   |   |   |

### BMW 3 Convertible (E36) 320

|  |                |               |    |   |             |        |        |   |        |   |  |
|--|----------------|---------------|----|---|-------------|--------|--------|---|--------|---|--|
|  M 50 B, M 52 B       | M 50 B, M 52 B | 12/93 → 04/99 |    | <b>OKOKOKO</b>  |             |        |        |   |        |   |  |
|  M 50 B, M 52 B       | M 50 B, M 52 B | 12/93 → 04/99 |    | VKPC 88617  |             |        |        | 1 |        |   |  |
|  B(Alt), B(AC) M 50 B | M 50 B         | 12/93 → 09/94 | MT | VKMA 38264  | 2           | 1      | 2      |   | 1      |   |  |
| B(Alt), B(AC) M 50 B   | M 50 B         | 09/94 → 04/99 | MT | VKMA 38266  | 1           | 1      | 2      |   | 1      |   |  |
| B(Alt), B(AC) M 50 B   | M 50 B         | 12/93 → 04/99 | HT | VKMA 38260  | 1           | 2      | 2      |   | 2      |   |  |
| B(Alt), B(AC) M 52 B   | M 52 B         | 12/93 → 04/99 | MT | VKMA 38265  | 1           | 1      | 2      |   | 1      |   |  |
| B(Alt), B(AC) M 52 B   | M 52 B         | 12/93 → 04/99 | HT | VKMA 38261  | 1           | 2      | 2      |   | 2      |   |  |
| B(Alt) M 50 B  | M 50 B         | 12/93 → 09/94 | MT | VKMA 38202<br>VKMV 6PK1555<br>VKM 38003<br>VKM 38202              | 2<br>1<br>1 |        | 1<br>1 |   |        |   |  |
| B(Alt) M 50 B  | M 50 B         | 09/94 → 04/99 | MT | VKMA 38241<br>VKMV 6PK1555<br>VKM 38202                           | 1<br>1      |        | 1<br>1 |   |        |   |  |
| B(Alt) M 52 B  | M 52 B         | 12/93 → 04/99 | MT | VKMA 38241<br>VKMV 6PK1555<br>VKM 38202                           | 1<br>1      |        | 1<br>1 |   |        |   |  |
| B(Alt) M 50 B, M 52 B  | M 50 B, M 52 B | 12/93 → 04/99 | HT | VKMA 38242<br>VKMV 6PK1555<br>VKM 38003<br>VKM 38004<br>VKM 38007 | 1<br>1      | 1<br>1 | 1<br>1 |   | 1<br>1 |   |  |
| B(AC) M 50 B   | M 50 B         | 12/93 → 04/99 |    | VKMV 5PK890<br>VKM 38004<br>VKM 38011                             |             | 1      | 1      |   |        | 1 |  |
| B(AC) M 52 B   | M 52 B         | 12/93 → 04/99 |    | VKMV 5PK906<br>VKM 38004<br>VKM 38011                             |             | 1      | 1      |   |        | 1 |  |

### BMW 3 Convertible (E36) 323 2.5

|   |           |               |    |   |        |        |        |   |        |   |  |
|---|-----------|---------------|----|---|--------|--------|--------|---|--------|---|--|
|  M 52 B 25               | M 52 B 25 | 06/95 → 04/99 |    | <b>OKOKOKO</b>  |        |        |        |   |        |   |  |
|  M 52 B 25               | M 52 B 25 | 06/95 → 04/99 |    | VKPC 88617  |        |        |        | 1 |        |   |  |
|  B(Alt), B(AC) M 52 B 25 | M 52 B 25 | 06/95 → 04/99 | MT | VKMA 38265  | 1      | 1      | 2      |   | 1      |   |  |
| B(Alt), B(AC) M 52 B 25   | M 52 B 25 | 06/95 → 04/99 | HT | VKMA 38261  | 1      | 2      | 2      |   | 2      |   |  |
| B(Alt) M 52 B 25  | M 52 B 25 | 06/95 → 04/99 | MT | VKMA 38241<br>VKMV 6PK1555<br>VKM 38202                           | 1<br>1 |        | 1<br>1 |   |        |   |  |
| B(Alt) M 52 B 25  | M 52 B 25 | 06/95 → 04/99 | HT | VKMA 38242<br>VKMV 6PK1555<br>VKM 38003<br>VKM 38004<br>VKM 38007 | 1<br>1 | 1<br>1 | 1<br>1 |   | 1<br>1 |   |  |
| B(AC) M 52 B  | M 52 B    | 06/95 → 04/99 |    | VKMV 5PK906<br>VKM 38004<br>VKM 38011                             |        | 1      | 1      |   |        | 1 |  |



























### BMW 3 Convertible (E36) 325

|   |           |               |  |                |  |  |  |  |  |  |  |
|---|-----------|---------------|--|----------------|--|--|--|--|--|--|--|
|  M 50 B 25 | M 50 B 25 | 03/93 → 03/95 |  | <b>OKOKOKO</b> |  |  |  |  |  |  |  |
|---|-----------|---------------|--|----------------|--|--|--|--|--|--|--|









BMW





|   |  |  |  |  |  |  |  |  |  |  |  |  |
|---|---|---|---|--|---|---|---|---|---|---|---|---|
|                                       | M 50 B 25   | 03/93 → 03/95   |   | VKPC 88617   |   |   |   | 1   |   |   |   |   |
|                                       | <b>B(Alt), B(AC)</b> M 50 B 25  | 03/93 → 09/94   | MT  | VKMA 38264   | 2   | 1   | 2   |   | 1   |   |   |   |
|   | <b>B(Alt), B(AC)</b> M 50 B 25  | 03/93 → 03/95   | HT  | VKMA 38260   | 1   | 2   | 2   |   | 2   |   |   |   |
|   | <b>B(Alt), B(AC)</b> M 50 B 25  | 09/94 → 03/95   | MT  | VKMA 38266   | 1   | 1   | 2   |   | 1   |   |   |   |
|   | <b>B(Alt)</b> M 50 B 25   | 03/93 → 09/94   | MT  | VKMA 38202<br>VKMV 6PK1555<br>VKM 38003<br>VKM 38202                               | 2<br>1<br>1   |   | 1<br>1  |   |   |   |   |   |
|   | <b>B(Alt)</b> M 50 B 25   | 09/94 → 03/95   | MT  | VKMA 38241<br>VKMV 6PK1555<br>VKM 38202  | 1<br>1  |   | 1<br>1  |   |   |   |   |   |
|   | <b>B(Alt)</b> M 50 B 25   | 03/93 → 03/95   | HT  | VKMA 38242<br>VKMV 6PK1555<br>VKM 38003<br>VKM 38004<br>VKM 38007                  | 1<br>1  | 1<br>1  | 1<br>1  |   | 1   |   |   |   |
|   | <b>B(AC)</b> M 50 B   | 03/93 → 03/95   |   | VKMV 5PK890<br>VKM 38004<br>VKM 38011  |   | 1   | 1   |   |   |   | 1   |   |
| <b>BMW  3 Convertible (E36) 328</b>  |   |   |   |  |   |   |   |   |   |   |   |   |
|                                       | M 52 B 28   | 03/95 → 04/99   |   | <b>OKOKOKO</b>   |   |   |   |   |   |   |   |   |
|                                       | M 52 B 28   | 03/95 → 04/99   |   | VKPC 88617   |   |   |   | 1   |   |   |   |   |
|                                       | <b>B(Alt), B(AC)</b> M 52 B 28  | 03/95 → 04/99   | MT  | VKMA 38265   | 1   | 1   | 2   |   | 1   |   |   |   |
|   | <b>B(Alt), B(AC)</b> M 52 B 28  | 03/95 → 04/99   | HT  | VKMA 38261   | 1   | 2   | 2   |   | 2   |   |   |   |
|   | <b>B(Alt)</b> M 52 B 28   | 03/95 → 04/99   | MT  | VKMA 38241<br>VKMV 6PK1555<br>VKM 38202  | 1<br>1  |   | 1<br>1  |   |   |   |   |   |
|   | <b>B(Alt)</b> M 52 B 28   | 03/95 → 04/99   | HT  | VKMA 38242<br>VKMV 6PK1555<br>VKM 38003<br>VKM 38004<br>VKM 38007                  | 1<br>1  | 1<br>1  | 1<br>1  |   | 1   |   |   |   |
|   | <b>B(AC)</b> M 52 B   | 03/95 → 04/99   |   | VKMV 5PK906<br>VKM 38004<br>VKM 38011  |   | 1   | 1   |   |   |   | 1   |   |
| <b>BMW  3 Convertible (E36) M3</b> |   |   |   |  |   |   |   |   |   |   |   |   |
|                                     | S 50 B 30, S 50 B 32  | 01/94 → 04/99   |   | <b>OKOKOKO</b>   |   |   |   |   |   |   |   |   |
|                                     | S 50 B 30, S 50 B 32  | 01/94 → 04/99   |   | —  |   |   |   | 1   |   |   |   |   |
|                                     | <b>B(Alt)</b> S 50 B 30, S 50 B 32  | 01/94 → 04/99   |   | VKMV 6PK1515<br>VKM 38003<br>VKM 38004<br>VKM 38007                                | 1   |   | 1   |   |   |   |   |   |
|   | <b>B(AC)</b> S 50 B 30, S 50 B 32   | 01/94 → 04/99   |   | VKMV 5PK1125<br>VKM 38230  | 1   |   | 1   |   |   |   | 1   |   |
|   | <b>B(AP)</b> S 50 B 30, S 50 B 32   | 01/94 → 04/99   |   | VKMV 5PK785  |   |   | 1   |   |   |   |   |   |
| <b>BMW  3 Coupe (E36) 316</b>      |   |   |   |  |   |   |   |   |   |   |   |   |
|                                     | M 43 B 16   | 09/93 → 04/99   |   | <b>OKOKOKO</b>   |   |   |   |   |   |   |   |   |
|                                     | M 43 B 16   | 09/93 → 04/99   |   | VKPC 88615   |   |   |   | 1   |   |   |   |   |
|                                     | <b>B(Alt)</b> M 43 B 16   | 09/93 → 09/95   | 🚫 70A   | VKMV 6PK1660<br>VKM 38003<br>VKM 38004<br>VKM 38008                                | 1   |   | 1   |   |   |   | 1   |   |
|   | <b>B(Alt)</b> M 43 B 16   | 09/93 → 09/95   | 🚫 80A   | VKMV 6PK1660<br>VKM 38004<br>VKM 38004<br>VKM 38008                                |   | 1<br>1  | 1   |   |   |   | 1   |   |
|   | <b>B(Alt)</b> M 43 B 16   | 09/95 → 04/99   | 🚫 70A   | VKMV 6PK1733<br>VKM 38221  | 1   |   | 1   |   |   |   |   |   |
|   | <b>B(Alt)</b> M 43 B 16   | 09/95 → 04/99   | 🚫 80A   | VKMV 6PK1733<br>VKM 38004<br>VKM 38221   | 1   | 1   | 1   |   |   |   |   |   |
|   | <b>B(AC)</b> M 43 B 16  | 09/93 → 04/99   |   | VKMV 4PK889<br>VKM 38230   | 1   |   | 1   |   |   |   |   |   |





**BMW  3 Coupe (E36) 318**

|   |                                   |               |   |   |   |  |  |   |  |  |  |  |   |  |  |  |  |  |  |
|---|-----------------------------------|---------------|---|---|---|--|--|---|--|--|--|--|---|--|--|--|--|--|--|
|  | M 42 B 18, M 44 B 19              | 03/92 → 04/99 |   | <b>Οι Όλοι</b>                                      |   |  |  |   |  |  |  |  |   |  |  |  |  |  |  |
|  | M 42 B 18, M 44 B 19              | 03/92 → 04/99 |   | VKPC 88615  |   |  |  |   |  |  |  |  | 1 |  |  |  |  |  |  |
|  | <b>B(Alt)</b> M 42 B 18           | 09/93 → 10/95 |  | VKMV 6PK1660<br>VKM 38003<br>VKM 38004<br>VKM 38008 | 1 |  |  | 1 |  |  |  |  |   |  |  |  |  |  |  |
|   | <b>B(Alt)</b> M 42 B 18           | 09/93 → 10/95 |  | VKMV 6PK1660<br>VKM 38004<br>VKM 38004<br>VKM 38008 |   |  |  | 1 |  |  |  |  |   |  |  |  |  |  |  |
|   | <b>B(Alt)</b> M 44 B 19           | 09/95 → 04/99 |  | VKMV 6PK1733<br>VKM 38221                           | 1 |  |  | 1 |  |  |  |  |   |  |  |  |  |  |  |
|   | <b>B(Alt)</b> M 44 B 19           | 09/95 → 04/99 |  | VKMV 6PK1733<br>VKM 38004<br>VKM 38221              | 1 |  |  | 1 |  |  |  |  |   |  |  |  |  |  |  |
|   | <b>B(AC)</b> M 42 B 18, M 44 B 19 | 03/94 → 04/99 |   | VKMV 4PK889<br>VKM 38230                            | 1 |  |  | 1 |  |  |  |  |   |  |  |  |  |  |  |





























**BMW  3 Coupe (E36) 320**

|   |                              |               |           |   |             |   |   |  |  |  |  |  |   |   |   |  |  |  |   |
|---|------------------------------|---------------|-----------|---|-------------|---|---|--|--|--|--|--|---|---|---|--|--|--|---|
|  | M 50 B, M 52 B               | 03/92 → 04/99 |           | <b>Οι Όλοι</b>  |             |   |   |  |  |  |  |  |   |   |   |  |  |  |   |
|  | M 50 B, M 52 B               | 03/92 → 04/99 |           | VKPC 88617  |             |   |   |  |  |  |  |  | 1 |   |   |  |  |  |   |
|  | <b>B(Alt), B(AC)</b> M 50 B  | 03/92 → 09/94 | <b>MT</b> | VKMA 38264  | 2           | 1 | 2 |  |  |  |  |  |   | 1 |   |  |  |  |   |
|   | <b>B(Alt), B(AC)</b> M 50 B  | 09/94 → 04/99 | <b>MT</b> | VKMA 38266  | 1           | 1 | 2 |  |  |  |  |  |   |   | 1 |  |  |  |   |
|   | <b>B(Alt), B(AC)</b> M 50 B  | 03/92 → 04/99 | <b>HT</b> | VKMA 38260  | 1           | 2 | 2 |  |  |  |  |  |   |   | 2 |  |  |  |   |
|   | <b>B(Alt), B(AC)</b> M 52 B  | 03/92 → 04/99 | <b>MT</b> | VKMA 38265  | 1           | 1 | 2 |  |  |  |  |  |   |   | 1 |  |  |  |   |
|   | <b>B(Alt), B(AC)</b> M 52 B  | 03/92 → 04/99 | <b>HT</b> | VKMA 38261  | 1           | 2 | 2 |  |  |  |  |  |   |   | 2 |  |  |  |   |
|   | <b>B(Alt)</b> M 50 B         | 03/92 → 09/94 | <b>MT</b> | VKMA 38202<br>VKMV 6PK1555<br>VKM 38003<br>VKM 38202              | 2<br>1<br>1 |   | 1 |  |  |  |  |  |   |   |   |  |  |  |   |
|   | <b>B(Alt)</b> M 50 B         | 09/94 → 04/99 | <b>MT</b> | VKMA 38241<br>VKMV 6PK1555<br>VKM 38202                           | 1<br>1      |   | 1 |  |  |  |  |  |   |   | 1 |  |  |  |   |
|   | <b>B(Alt)</b> M 52 B         | 03/92 → 04/99 | <b>MT</b> | VKMA 38241<br>VKMV 6PK1555<br>VKM 38202                           | 1<br>1      |   | 1 |  |  |  |  |  |   |   | 1 |  |  |  |   |
|   | <b>B(Alt)</b> M 50 B, M 52 B | 03/92 → 04/99 | <b>HT</b> | VKMA 38242<br>VKMV 6PK1555<br>VKM 38003<br>VKM 38004<br>VKM 38007 | 1<br>1      | 1 | 1 |  |  |  |  |  |   |   | 1 |  |  |  |   |
|   | <b>B(AC)</b> M 50 B          | 03/92 → 04/99 |           | VKMV 5PK890<br>VKM 38004<br>VKM 38011                             |             |   | 1 |  |  |  |  |  |   |   |   |  |  |  | 1 |
|   | <b>B(AC)</b> M 52 B          | 03/92 → 04/99 |           | VKMV 5PK906<br>VKM 38004<br>VKM 38011                             |             |   | 1 |  |  |  |  |  |   |   |   |  |  |  | 1 |





















**BMW  3 Coupe (E36) 323 2.5**

|   |                                |               |           |   |        |   |   |  |  |  |  |  |   |  |   |  |  |  |  |
|---|--------------------------------|---------------|-----------|---|--------|---|---|--|--|--|--|--|---|--|---|--|--|--|--|
|  | M 52 B 25                      | 03/95 → 04/99 |           | <b>Οι Όλοι</b>  |        |   |   |  |  |  |  |  |   |  |   |  |  |  |  |
|  | M 52 B 25                      | 03/95 → 04/99 |           | VKPC 88617  |        |   |   |  |  |  |  |  | 1 |  |   |  |  |  |  |
|  | <b>B(Alt), B(AC)</b> M 52 B 25 | 03/95 → 04/99 | <b>MT</b> | VKMA 38265  | 1      | 1 | 2 |  |  |  |  |  |   |  | 1 |  |  |  |  |
|   | <b>B(Alt), B(AC)</b> M 52 B 25 | 03/95 → 04/99 | <b>HT</b> | VKMA 38261  | 1      | 2 | 2 |  |  |  |  |  |   |  | 2 |  |  |  |  |
|   | <b>B(Alt)</b> M 52 B 25        | 03/95 → 04/99 | <b>MT</b> | VKMA 38241<br>VKMV 6PK1555<br>VKM 38202                           | 1<br>1 |   | 1 |  |  |  |  |  |   |  |   |  |  |  |  |
|   | <b>B(Alt)</b> M 52 B 25        | 03/95 → 04/99 | <b>HT</b> | VKMA 38242<br>VKMV 6PK1555<br>VKM 38003<br>VKM 38004<br>VKM 38007 | 1<br>1 | 1 | 1 |  |  |  |  |  |   |  | 1 |  |  |  |  |





































































|  |  |  |  |  |  |  |  |  |  |  |  |  |
|--|---|---|---|--|---|---|---|---|---|---|---|---|
| B(AC)  | M 52 B  | 03/95 → 04/99   |   | VKMV 5PK906<br>VKM 38004<br>VKM 38011  | 1   | 1   |   |   | 1   |   |   |   |
| <b>BMW  3 Coupe (E36) 325</b>     |   |   |   |  |   |   |   |   |   |   |   |   |
|                                    | M 50 B 25   | 03/92 → 04/99   |   | <b>ΟΧΛΟΧΟ</b>  |   |   |   |   |   |   |   |   |
|                                    | M 50 B 25   | 03/92 → 04/99   |   | VKPC 88617   |   |   |   |   | 1   |   |   |   |
|                                    | B(Alt), B(AC)   | M 50 B 25   | 03/92 → 09/94   | MT   | VKMA 38264  | 2   | 1   | 2   |   | 1   |   |   |
|  | B(Alt), B(AC)   | M 50 B 25   | 03/92 → 04/99   | HT   | VKMA 38260  | 1   | 2   | 2   |   | 2   |   |   |
|  | B(Alt), B(AC)   | M 50 B 25   | 09/94 → 04/99   | MT   | VKMA 38266  | 1   | 1   | 2   |   | 1   |   |   |
|  | B(Alt)  | M 50 B 25   | 03/92 → 09/94   | MT   | VKMA 38202<br>VKMV 6PK1555<br>VKM 38003<br>VKM 38202                                | 2<br>1<br>1   |   | 1   |   |   |   |   |
|  | B(Alt)  | M 50 B 25   | 03/92 → 04/99   | HT   | VKMA 38242<br>VKMV 6PK1555<br>VKM 38003<br>VKM 38004<br>VKM 38007                   | 1<br>1  | 1   | 1   |   | 1   |   |   |
|  | B(Alt)  | M 50 B 25   | 09/94 → 04/99   | MT   | VKMA 38241<br>VKMV 6PK1555<br>VKM 38202   | 1<br>1  |   | 1   | 1   |   |   |   |
|  | B(AC)   | M 50 B  | 03/92 → 04/99   |  | VKMV 5PK890<br>VKM 38004<br>VKM 38011   |   | 1   | 1   |   |   | 1   |   |
| <b>BMW  3 Coupe (E36) 328</b>    |   |   |   |  |   |   |   |   |   |   |   |   |
|                                  | M 52 B 28   | 01/95 → 04/99   |   | <b>ΟΧΛΟΧΟ</b>  |   |   |   |   |   |   |   |   |
|                                  | M 52 B 28   | 01/95 → 04/99   |   | VKPC 88617   |   |   |   |   | 1   |   |   |   |
|                                  | B(Alt), B(AC)   | M 52 B 28   | 01/95 → 04/99   | MT   | VKMA 38265  | 1   | 1   | 2   |   | 1   |   |   |
|  | B(Alt), B(AC)   | M 52 B 28   | 01/95 → 04/99   | HT   | VKMA 38261  | 1   | 2   | 2   |   | 2   |   |   |
|  | B(Alt)  | M 52 B 28   | 01/95 → 04/99   | MT   | VKMA 38241<br>VKMV 6PK1555<br>VKM 38202   | 1<br>1  |   | 1   | 1   |   |   |   |
|  | B(Alt)  | M 52 B 28   | 01/95 → 04/99   | HT   | VKMA 38242<br>VKMV 6PK1555<br>VKM 38003<br>VKM 38004<br>VKM 38007                   | 1<br>1  | 1   | 1   |   | 1   |   |   |
|  | B(AC)   | M 52 B  | 01/95 → 04/99   |  | VKMV 5PK906<br>VKM 38004<br>VKM 38011   |   | 1   | 1   |   |   | 1   |   |
| <b>BMW  3 Coupe (E36) M3</b>    |   |   |   |  |   |   |   |   |   |   |   |   |
|                                  | S 50 B 30, S 50 B 32  | 10/92 → 04/99   |   | <b>ΟΧΛΟΧΟ</b>  |   |   |   |   |   |   |   |   |
|                                  | S 50 B 30, S 50 B 32  | 10/92 → 04/99   |   | —  |   |   |   |   | 1   |   |   |   |
|                                  | B(Alt)  | S 50 B 30, S 50 B 32  | 10/92 → 04/99   |  | VKMV 6PK1515<br>VKM 38003<br>VKM 38004<br>VKM 38007                                 | 1   |   | 1   |   |   | 1   |   |
|  | B(AC)   | S 50 B 30, S 50 B 32  | 10/92 → 04/99   |  | VKMV 5PK1125<br>VKM 38230   | 1   |   | 1   |   |   |   |   |
|  | B(AP)   | S 50 B 30, S 50 B 32  | 10/92 → 04/99   |  | VKMV 5PK785   |   |   | 1   |   |   |   |   |
| <b>BMW  3 Touring (E36) 316</b> |   |   |   |  |   |   |   |   |   |   |   |   |
|                                  | M 43 B 16   | 01/96 → 10/99   |   | <b>ΟΧΛΟΧΟ</b>  |   |   |   |   |   |   |   |   |
|                                  | M 43 B 16   | 01/96 → 10/99   |   | VKPC 88615   |   |   |   |   | 1   |   |   |   |
|                                  | B(Alt)  | M 43 B 16   | 01/96 → 10/99   | 70A  | VKMV 6PK1733<br>VKM 38221   | 1   |   | 1   |   |   |   |   |
|  | B(Alt)  | M 43 B 16   | 01/96 → 10/99   | 80A  | VKMV 6PK1733<br>VKM 38004<br>VKM 38221  | 1   | 1   | 1   |   |   |   |   |
|  | B(AC)   | M 43 B 16   | 01/96 → 10/99   |  | VKMV 4PK889<br>VKM 38230  | 1   |   | 1   |   |   |   |   |











































| BMW  3 Touring (E36) 318       |                         |               |   |   |   |   |   |   |   |   |
|---|-------------------------|---------------|---|---|---|---|---|---|---|---|
|                                | M 43 B 18               | 07/95 → 10/99 |   | <b>ΟΛΟΚΛΗΡΟ</b>   |   |   |   |   |   |   |
|                                | M 43 B 18               | 07/95 → 10/99 |   | VKPC 88615  |   |   |   | 1 |   |   |
|                                | B(Alt) M 43 B 18        | 07/95 → 10/99 |  | VKMV 6PK1733<br>VKM 38221   | 1 |   | 1 |   |   |   |
|   | B(Alt) M 43 B 18        | 07/95 → 10/99 |  | VKMV 6PK1733<br>VKM 38004<br>VKM 38221                            | 1 | 1 | 1 |   |   |   |
|   | B(AC) M 43 B 18         | 07/95 → 10/99 |   | VKMV 4PK889<br>VKM 38230  | 1 |   | 1 |   |   |   |
| BMW  3 Touring (E36) 320       |                         |               |   |   |   |   |   |   |   |   |
|                                | M 52 B 20               | 01/95 → 10/99 |   | <b>ΟΛΟΚΛΗΡΟ</b>   |   |   |   |   |   |   |
|                                | M 52 B 20               | 01/95 → 10/99 |   | VKPC 88617  |   |   |   | 1 |   |   |
|                                | B(Alt), B(AC) M 52 B 20 | 01/95 → 10/99 | MT  | VKMA 38265  | 1 | 1 | 2 |   | 1 |   |
|   | B(Alt), B(AC) M 52 B 20 | 01/95 → 10/99 | HT  | VKMA 38261  | 1 | 2 | 2 |   | 2 |   |
|   | B(Alt) M 52 B 20        | 01/95 → 10/99 | MT  | VKMA 38241<br>VKMV 6PK1555<br>VKM 38202                           | 1 |   | 1 |   |   |   |
|   | B(Alt) M 52 B 20        | 01/95 → 10/99 | HT  | VKMA 38242<br>VKMV 6PK1555<br>VKM 38003<br>VKM 38004<br>VKM 38007 | 1 | 1 | 1 |   | 1 |   |
|   | B(AC) M 52 B            | 01/95 → 10/99 |   | VKMV 5PK906<br>VKM 38004<br>VKM 38011                             |   | 1 | 1 |   |   | 1 |
| BMW  3 Touring (E36) 323 2.5 |                         |               |   |   |   |   |   |   |   |   |
|                              | M 52 B 25               | 09/95 → 10/99 |   | <b>ΟΛΟΚΛΗΡΟ</b>   |   |   |   |   |   |   |
|                              | M 52 B 25               | 09/95 → 10/99 |   | VKPC 88617  |   |   |   | 1 |   |   |
|                              | B(Alt), B(AC) M 52 B 25 | 09/95 → 10/99 | MT  | VKMA 38265  | 1 | 1 | 2 |   | 1 |   |
|   | B(Alt), B(AC) M 52 B 25 | 09/95 → 10/99 | HT  | VKMA 38261  | 1 | 2 | 2 |   | 2 |   |
|   | B(Alt) M 52 B 25        | 09/95 → 10/99 | MT  | VKMA 38241<br>VKMV 6PK1555<br>VKM 38202                           | 1 |   | 1 |   |   |   |
|   | B(Alt) M 52 B 25        | 09/95 → 10/99 | HT  | VKMA 38242<br>VKMV 6PK1555<br>VKM 38003<br>VKM 38004<br>VKM 38007 | 1 | 1 | 1 |   | 1 |   |
|   | B(AC) M 52 B            | 09/95 → 10/99 |   | VKMV 5PK906<br>VKM 38004<br>VKM 38011                             |   | 1 | 1 |   |   | 1 |
| BMW  3 Touring (E36) 328     |                         |               |   |   |   |   |   |   |   |   |
|                              | M 52 B 28               | 01/95 → 10/99 |   | <b>ΟΛΟΚΛΗΡΟ</b>   |   |   |   |   |   |   |
|                              | M 52 B 28               | 01/95 → 10/99 |   | VKPC 88617  |   |   |   | 1 |   |   |
|                              | B(Alt), B(AC) M 52 B 28 | 01/95 → 10/99 | MT  | VKMA 38265  | 1 | 1 | 2 |   | 1 |   |
|   | B(Alt), B(AC) M 52 B 28 | 01/95 → 10/99 | HT  | VKMA 38261  | 1 | 2 | 2 |   | 2 |   |
|   | B(Alt) M 52 B 28        | 01/95 → 10/99 | MT  | VKMA 38241<br>VKMV 6PK1555<br>VKM 38202                           | 1 |   | 1 |   |   |   |
|   | B(Alt) M 52 B 28        | 01/95 → 10/99 | HT  | VKMA 38242<br>VKMV 6PK1555<br>VKM 38003<br>VKM 38004<br>VKM 38007 | 1 | 1 | 1 |   | 1 |   |
|   | B(AC) M 52 B            | 01/95 → 10/99 |   | VKMV 5PK906<br>VKM 38004<br>VKM 38011                             |   | 1 | 1 |   |   | 1 |
| BMW  3 Touring (E36) 318 tds |                         |               |   |   |   |   |   |   |   |   |
|                              | M 41 D 18               | 01/95 → 10/99 |   | <b>ΟΛΟΚΛΗΡΟ</b>   |   |   |   |   |   |   |
|                              | M 41 D 18               | 01/95 → 10/99 |   | VKPC 88826  |   |   |   | 1 |   |   |







































|  |  |  |  |  |  |  |  |  |  |  |  |  |
|--|---|---|---|--|---|---|---|---|---|---|---|---|
|                                      | B(Alt)  | M 41 D 18   | 01/95 → 10/99   | VKMV 5PK1885<br>VKM 38220<br>VKM 38225   | 1   |   | 1   |   |   |   |   |   |
|  | B(AC)   | M 41 D 18   | 01/95 → 10/99   | VKMV 4PK836  |   |   | 1   |   |   |   |   |   |
| <b>BMW  3 Touring (E36) 325 tds</b> |   |   |   |  |   |   |   |   |   |   |   |   |
|                                      |   | M 51 D 25   | 01/95 → 10/99   | <b>OXOXOXO</b>   |   |   |   |   |   |   |   |   |
|                                      |   | M 51 D 25   | 01/95 → 10/99   | VKPC 88826   |   |   |   | 1   |   |   |   |   |
|                                      | B(Alt)  | M 51 D 25   | 01/95 → 10/99   | VKMV 5PK1815<br>VKM 38220<br>VKM 38225   | 1   |   | 1   |   |   |   |   |   |
|  | B(AC)   | M 51 D 25   | 01/95 → 10/99   | VKMV 4PK781<br>VKM 38230   | 1   |   | 1   |   |   |   |   |   |
|                                      |   | M 51 D 25   | 01/95 → 10/99   | VKM_____   |   |   |   |   | 1   |   |   |   |
| <b>BMW  3 (E46) 316</b>             |   |   |   |  |   |   |   |   |   |   |   |   |
|                                      |   | M 43 B 16, N45B16A  | 04/00 → 02/05   | <b>OXOXOXO</b>   |   |   |   |   |   |   |   |   |
|                                      |   | M 43 B 16   | 04/00 → 12/02   | VKPC 88615   |   |   |   | 1   |   |   |   |   |
|  |   | N45B16A   | 06/02 → 02/05 2)  | VKPA_____  |   |   |   | 1   |   |   |   |   |
|                                      | B(Alt)  | M 43 B 16   | 04/00 → 02/05   | VKMV 6PK1733<br>VKM 38221<br>VKM 38226   | 1   |   | 1   |   |   |   |   |   |
|  | B(Alt)  | N45B16A   | 06/02 → 02/05 AC  | VKMV 6PK1637<br>VKM_____   | 1   |   | 1   |   |   |   |   |   |
|  | B(Alt)  | N45B16A   | 06/02 → 02/05 AC  | VKMV 6PK1870<br>VKM_____   | 1   |   | 1   |   |   |   |   |   |
|  | B(AC)   | M 43 B 16   | 04/00 → 02/05   | VKMV 5PK950<br>VKM 38231   | 1   |   | 1   |   |   |   |   |   |
| <b>BMW  3 (E46) 318</b>           |   |   |   |  |   |   |   |   |   |   |   |   |
|                                    |   | N 42 B 18, N 42 B 20,<br>M 43 B 19  | 02/98 → 02/05   | <b>OXOXOXO</b>   |   |   |   |   |   |   |   |   |
|                                    |   | N 42 B 18, N 42 B 20  | 09/01 → 02/05 2)  | VKPA_____  |   |   |   | 1   |   |   |   |   |
|  |   | M 43 B 19   | 02/98 → 02/05   | VKPC 88615   |   |   |   | 1   |   |   |   |   |
|                                    | B(Alt)  | N 42 B 18, N 42 B 20  | 09/01 → 02/05 AC  | VKMV 6PK1637<br>VKM_____   | 1   |   | 1   |   |   |   |   |   |
|  | B(Alt)  | N 42 B 18, N 42 B 20  | 09/01 → 02/05 AC  | VKMV 6PK1870<br>VKM_____   | 1   |   | 1   |   |   |   |   |   |
|  | B(Alt)  | M 43 B 19   | 02/98 → 09/01 6)  | VKMV 6PK1733<br>VKM 38221<br>VKM 38226   | 1   |   | 1   |   |   |   |   |   |
|  | B(AC)   | M 43 B 19   | 02/98 → 02/05   | VKMV 5PK950<br>VKM 38231   | 1   |   | 1   |   |   |   |   |   |
| <b>BMW  3 (E46) 320</b>           |   |   |   |  |   |   |   |   |   |   |   |   |
|                                    |   | M 52 B  | 03/98 → 09/00   | <b>OXOXOXO</b>   |   |   |   |   |   |   |   |   |
|                                    |   | M 52 B  | 03/98 → 09/00   | VKPC 88617   |   |   |   | 1   |   |   |   |   |
|                                    | B(Alt)  | M 52 B  | 03/98 → 09/00 MT  | VKMV 6PK1538<br>VKM 38003<br>VKM 38202   | 1   |   | 1   |   |   |   |   |   |
|  | B(Alt)  | M 52 B  | 03/98 → 09/00 HT  | VKMV 6PK1538<br>VKM 38003<br>VKM 38004<br>VKM 38007                                | 1   |   | 1   |   |   | 1   |   |   |
|  | B(AC)   | M 52 B  | 03/98 → 09/00   | VKMV 5PK863<br>VKM 38231   | 1   |   | 1   |   |   |   |   |   |
| <b>BMW  3 (E46) 323</b>           |   |   |   |  |   |   |   |   |   |   |   |   |
|                                    |   | M 52 B 25   | 03/98 → 09/00   | <b>OXOXOXO</b>   |   |   |   |   |   |   |   |   |
|                                    |   | M 52 B 25   | 03/98 → 09/00   | VKPC 88617   |   |   |   | 1   |   |   |   |   |
|                                    | B(Alt)  | M 52 B 25   | 03/98 → 09/00 MT  | VKMV 6PK1538<br>VKM 38003<br>VKM 38202   | 1   |   | 1   |   |   |   |   |   |
|  | B(Alt)  | M 52 B 25   | 03/98 → 09/00 HT  | VKMV 6PK1538<br>VKM 38003  | 1   |   | 1   |   |   |   |   |   |

|  |  |  |  |  |  |  |  |  |  |  |  |
|--|---|---|---|--|---|---|---|---|---|---|---|
|  |   |   |   | VKM 38004<br>VKM 38007   | 1   |   |   |   | 1   |   |   |
| <b>B(AC)</b>   | M 52 B 25   | 03/98 → 09/00   |   | VKMV 5PK863<br>VKM 38231   | 1   |   | 1   |   |   |   |   |
| <b>BMW  3 (E46) 325</b>     |   |   |   |  |   |   |   |   |   |   |   |
|                             | M54256S5  | 09/00 → 02/05   |   | <del>OKOKOKO</del>   |   |   |   |   |   |   |   |
|                             | M54256S5  | 09/00 → 02/05   |   | VKPC 88617   |   |   |   |   | 1   |   |   |
|                             | <b>B(Alt)</b> M54256S5  | 09/00 → 02/05   | <b>MT</b>   | VKMV 6PK1538<br>VKM 38003<br>VKM 38202   | 1<br>1  |   | 1   |   |   |   |   |
|  | <b>B(Alt)</b> M54256S5  | 09/00 → 02/05   | <b>HT</b>   | VKMV 6PK1538<br>VKM 38003<br>VKM 38004<br>VKM 38007                                | 1   |   | 1   |   |   | 1   |   |
|  | <b>B(AC)</b> M54256S5   | 09/00 → 09/02   |   | VKMV 5PK863<br>VKM 38231   | 1   |   | 1   |   |   |   |   |
|  | <b>B(AC)</b> M54256S5   | 09/02 → 02/05   |   | VKMV 4PK863  |   |   | 1   |   |   |   |   |
| <b>BMW  3 (E46) 328</b>     |   |   |   |  |   |   |   |   |   |   |   |
|                             | M 52 B 28   | 02/98 → 06/00   |   | <del>OKOKOKO</del>   |   |   |   |   |   |   |   |
|                             | M 52 B 28   | 02/98 → 06/00   |   | VKPC 88617   |   |   |   |   | 1   |   |   |
|                             | <b>B(Alt)</b> M 52 B 28   | 02/98 → 06/00   | <b>MT</b>   | VKMV 6PK1538<br>VKM 38003<br>VKM 38202   | 1<br>1  |   | 1   |   |   |   |   |
|  | <b>B(Alt)</b> M 52 B 28   | 02/98 → 06/00   | <b>HT</b>   | VKMV 6PK1538<br>VKM 38003<br>VKM 38004<br>VKM 38007                                | 1   |   | 1   |   |   | 1   |   |
|  | <b>B(AC)</b> M 52 B 28  | 02/98 → 06/00   |   | VKMV 5PK863<br>VKM 38231   | 1   |   | 1   |   |   |   |   |
| <b>BMW  3 (E46) 330</b>   |   |   |   |  |   |   |   |   |   |   |   |
|                           | M54306S3  | 06/00 → 02/05   |   | <del>OKOKOKO</del>   |   |   |   |   |   |   |   |
|                           | M54306S3  | 06/00 → 02/05   |   | VKPC 88617   |   |   |   |   | 1   |   |   |
|                           | <b>B(Alt)</b> M54306S3  | 06/00 → 02/05   | <b>MT</b>   | VKMV 6PK1538<br>VKM 38003<br>VKM 38202   | 1<br>1  |   | 1   |   |   |   |   |
|  | <b>B(Alt)</b> M54306S3  | 06/00 → 02/05   | <b>HT</b>   | VKMV 6PK1538<br>VKM 38003<br>VKM 38004<br>VKM 38007                                | 1   |   | 1   |   |   | 1   |   |
|  | <b>B(AC)</b> M54306S3   | 06/00 → 09/02   |   | VKMV 5PK863<br>VKM 38231   | 1   |   | 1   |   |   |   |   |
|  | <b>B(AC)</b> M54306S3   | 09/02 → 02/05   |   | VKMV 4PK863  |   |   | 1   |   |   |   |   |
| <b>BMW  3 (E46) 318 d</b> |   |   |   |  |   |   |   |   |   |   |   |
|                           | M47N204D4   | 03/03 → 02/05   |   | <del>OKOKOKO</del>   |   |   |   |   |   |   |   |
|                           | <b>B(Alt)</b> M47N204D4   | 03/03 → 02/05   |   | VKMV 6PK2080   |   |   | 1   |   |   |   |   |
|  | <b>B(AC)</b> M47N204D4  | 03/03 → 09/04   |   | VKMV 4PK968  |   |   | 1   |   |   |   |   |
| <b>BMW  3 (E46) 320 d</b> |   |   |   |  |   |   |   |   |   |   |   |
|                           | M 47 D 20, M47204D1,<br>M47N204D4   | 04/98 → 02/05   |   | <del>OKOKOKO</del>   |   |   |   |   |   |   |   |
|                           | M 47 D 20, M47204D1   | 04/98 → 09/01   | <b>Man. GBX</b>   | VKPC 88632   |   |   |   |   | 1   |   |   |
|  | M 47 D 20, M47204D1   | 04/98 → 09/01   | <b>Auto. GBX</b>  | VKPC 88637   |   |   |   |   | 1   |   |   |
|  | M47N204D4   | 09/01 → 01/05   | <b>Auto. GBX</b>  | VKPC 88636   |   |   |   |   | 1   |   |   |
|  | M47N204D4   | 09/01 → 01/05   | <b>Man. GBX</b>   | VKPC 88635   |   |   |   |   | 1   |   |   |
|                           | <b>B(Alt)</b> M 47 D 20, M47204D1   | 04/98 → 03/03   |   | VKMV 5PK2030<br>VKM 38220<br>VKM 38240   | 1   |   | 1   |   |   |   |   |
|  | <b>B(Alt)</b> M47N204D4   | 09/01 → 02/05   |   | VKMV 6PK2080   |   |   | 1   |   |   |   |   |
|  | <b>B(AC)</b> M 47 D 20, M47204D1  | 04/98 → 03/03   |   | VKMV 5PK836  |   |   | 1   |   |   |   |   |
|  | <b>B(AC)</b> M47N204D4  | 09/01 → 09/04   |   | VKMV 4PK968  |   |   | 1   |   |   |   |   |
| <b>BMW  3 (E46) 330 d</b> |   |   |   |  |   |   |   |   |   |   |   |
|                           | M 57 D 30, M57N306D2  | 10/99 → 02/05   |   | <del>OKOKOKO</del>   |   |   |   |   |   |   |   |
|                           | M 57 D 30   | 10/99 → 12/03   |   | VKPC 88430   |   |   |   |   | 1   |   |   |









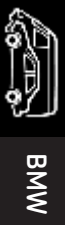





























































|  |  |  |  |  |  |  |  |  |  |  |  |  |
|--|---|---|---|--|---|---|---|---|---|---|---|---|
|  | M57N306D2   | 03/03 → 02/05   |   | VKPC 88636   |   |   |   | 1   |   |   |   |   |
|                                        | <b>B(Alt)</b> M 57 D 30   | 10/99 → 02/05   |   | VKMOV 5PK2063<br>VKM 38240<br>VKM 38240  | 1   |   | 1   |   |   |   |   |   |
|  | <b>B(AC)</b> M 57 D 30  | 10/00 → 02/05   |   | VKMOV 5PK810   |   |   | 1   |   |   |   |   |   |
| <b>BMW  3 Compact (E46) 316</b>       |   |   |   |  |   |   |   |   |   |   |   |   |
|                                        | N 42 B 18   | 06/01 → 02/05   |   | <b>ΟΧΛΟΧΟ</b>  |   |   |   |   |   |   |   |   |
|                                        | N 42 B 18   | 06/01 → 02/05 2)  |   | VKPA_____  |   |   |   | 1   |   |   |   |   |
|                                        | <b>B(Alt)</b> N 42 B 18   | 06/01 → 02/05   |   | VKMOV 6PK1637<br>VKM_____  | 1   |   | 1   |   |   |   |   |   |
|  | <b>B(AC)</b> N 42 B 18  | 06/01 → 02/05   |   | VKMOV 6PK1870<br>VKM_____<br>VKM_____  | 1   |   | 1   |   |   |   |   |   |
|  |   |   |   |  |   |   |   | 1   |   |   |   |   |
| <b>BMW  3 Compact (E46) 318</b>       |   |   |   |  |   |   |   |   |   |   |   |   |
|                                        | N 42 B 20   | 09/01 → 02/05   |   | <b>ΟΧΛΟΧΟ</b>  |   |   |   |   |   |   |   |   |
|                                        | N 42 B 20   | 09/01 → 02/05 2)  |   | VKPA_____  |   |   |   | 1   |   |   |   |   |
|                                        | <b>B(Alt)</b> N 42 B 20   | 09/01 → 02/05   |   | VKMOV 6PK1637<br>VKM_____  | 1   |   | 1   |   |   |   |   |   |
|  | <b>B(AC)</b> N 42 B 20  | 09/01 → 02/05   |   | VKMOV 6PK1870<br>VKM_____<br>VKM_____  | 1   |   | 1   |   |   |   |   |   |
|  |   |   |   |  |   |   |   | 1   |   |   |   |   |
| <b>BMW  3 Compact (E46) 325</b>       |   |   |   |  |   |   |   |   |   |   |   |   |
|                                        | M54256S5  | 06/01 → 02/05   |   | <b>ΟΧΛΟΧΟ</b>  |   |   |   |   |   |   |   |   |
|                                        | M54256S5  | 06/01 → 02/05   |   | VKPC 88617   |   |   |   | 1   |   |   |   |   |
|                                       | <b>B(Alt)</b> M54256S5  | 06/01 → 02/05   | MT  | VKMOV 6PK1538<br>VKM 38003<br>VKM 38202  | 1<br>1  |   | 1   |   |   |   |   |   |
|  | <b>B(Alt)</b> M54256S5  | 06/01 → 02/05   | HT  | VKMOV 6PK1538<br>VKM 38003<br>VKM 38004<br>VKM 38007                               | 1   |   | 1   |   |   |   | 1   |   |
|  | <b>B(AC)</b> M54256S5   | 06/01 → 09/02   |   | VKMOV 5PK863<br>VKM 38231  | 1   |   | 1   |   |   |   |   |   |
|  | <b>B(AC)</b> M54256S5   | 09/02 → 02/05   |   | VKMOV 4PK863   |   |   | 1   |   |   |   |   |   |
| <b>BMW  3 Compact (E46) 318 d</b>   |   |   |   |  |   |   |   |   |   |   |   |   |
|                                      | M47N204D4   | 03/03 → 02/05   |   | <b>ΟΧΛΟΧΟ</b>  |   |   |   |   |   |   |   |   |
|                                      | M47N204D4   | 03/03 → 02/05   |   | VKPC 88635   |   |   |   | 1   |   |   |   |   |
|                                      | <b>B(Alt)</b> M47N204D4   | 03/03 → 02/05   |   | VKMOV 6PK2080  |   |   | 1   |   |   |   |   |   |
|  | <b>B(AC)</b> M47N204D4  | 03/03 → 09/04   |   | VKMOV 4PK968   |   |   | 1   |   |   |   |   |   |
| <b>BMW  3 Compact (E46) 320 d</b>   |   |   |   |  |   |   |   |   |   |   |   |   |
|                                      | M47N204D4   | 09/01 → 02/05   |   | <b>ΟΧΛΟΧΟ</b>  |   |   |   |   |   |   |   |   |
|                                      | M47N204D4   | 09/01 → 02/05   | Man. GBX  | VKPC 88635   |   |   |   | 1   |   |   |   |   |
|  | M47N204D4   | 09/01 → 02/05   | Auto. GBX   | VKPC 88636   |   |   |   | 1   |   |   |   |   |
|                                      | <b>B(Alt)</b> M47N204D4   | 09/01 → 02/05   |   | VKMOV 6PK2080  |   |   | 1   |   |   |   |   |   |
|  | <b>B(AC)</b> M47N204D4  | 09/01 → 09/04   |   | VKMOV 4PK968   |   |   | 1   |   |   |   |   |   |
| <b>BMW  3 Convertible (E46) 318</b> |   |   |   |  |   |   |   |   |   |   |   |   |
|                                      | N 42 B 20   | 09/01 → 09/07   |   | <b>ΟΧΛΟΧΟ</b>  |   |   |   |   |   |   |   |   |
|                                      | N 42 B 20   | 09/01 → 09/07 2)  |   | VKPA_____  |   |   |   | 1   |   |   |   |   |
|                                      | <b>B(Alt)</b> N 42 B 20   | 09/01 → 09/07   |   | VKMOV 6PK1637<br>VKM_____  | 1   |   | 1   |   |   |   |   |   |
|  | <b>B(AC)</b> N 42 B 20  | 09/01 → 09/07   |   | VKMOV 6PK1870<br>VKM_____<br>VKM_____  | 1   |   | 1   |   |   |   |   |   |
|  |   |   |   |  |   |   |   | 1   |   |   |   |   |
| <b>BMW  3 Convertible (E46) 320</b> |   |   |   |  |   |   |   |   |   |   |   |   |
|                                      | M 54 B 22, M54226S1   | 09/00 → 09/07   |   | <b>ΟΧΛΟΧΟ</b>  |   |   |   |   |   |   |   |   |
|                                      | M 54 B 22, M54226S1   | 09/00 → 09/07   |   | VKPC 88617   |   |   |   | 1   |   |   |   |   |
|                                      | <b>B(Alt)</b> M 54 B 22, M54226S1   | 09/00 → 09/07   | MT  | VKMOV 6PK1538<br>VKM 38003<br>VKM 38202  | 1<br>1  |   | 1   |   |   |   |   |   |
|  | <b>B(Alt)</b> M 54 B 22, M54226S1   | 09/00 → 09/07   | HT  | VKMOV 6PK1538<br>VKM 38003   | 1   |   | 1   |   |   |   |   |   |



|  |  |  |  |  |  |  |  |  |  |  |
|--|---|---|---|--|---|---|---|---|---|---|
|  |   |   |   | VKM 38004<br>VKM 38007   | 1   |   |   |   | 1   |   |
| B(AC)  | M 54 B 22, M54226S1   | 09/00 → 09/02   |   | VKMV 5PK863<br>VKM 38231   | 1   | 1   |   |   |   |   |
| B(AC)  | M 54 B 22, M54226S1   | 09/02 → 09/07   |   | VKMV 4PK863  |   | 1   |   |   |   |   |
| <b>BMW  3 Convertible (E46) 323</b>     |   |   |   |  |   |   |   |   |   |   |
|   | M 52 B 25   | 04/00 → 09/00   |   | <del>OKOKOKO</del>   |   |   |   |   |   |   |
|   | M 52 B 25   | 04/00 → 09/00   |   | VKPC 88617   |   |   |   | 1   |   |   |
|   | B(Alt) M 52 B 25  | 04/00 → 09/00   | MT  | VKMV 6PK1538<br>VKM 38003<br>VKM 38202   | 1<br>1  | 1   |   |   |   |   |
| B(Alt)   | M 52 B 25   | 04/00 → 09/00   | HT  | VKMV 6PK1538<br>VKM 38003<br>VKM 38004<br>VKM 38007                                | 1<br>1  | 1   |   |   | 1   |   |
| B(AC)  | M 52 B 25   | 04/00 → 09/00   |   | VKMV 5PK863<br>VKM 38231   | 1   | 1   |   |   |   |   |
| <b>BMW  3 Convertible (E46) 325</b>     |   |   |   |  |   |   |   |   |   |   |
|   | M54256S5  | 09/00 → 09/07   |   | <del>OKOKOKO</del>   |   |   |   |   |   |   |
|   | M54256S5  | 09/00 → 09/07   |   | VKPC 88617   |   |   |   | 1   |   |   |
|   | B(Alt) M54256S5   | 09/00 → 09/07   | MT  | VKMV 6PK1538<br>VKM 38003<br>VKM 38202   | 1<br>1  | 1   |   |   |   |   |
| B(Alt)   | M54256S5  | 09/00 → 09/07   | HT  | VKMV 6PK1538<br>VKM 38003<br>VKM 38004<br>VKM 38007                                | 1<br>1  | 1   |   | 1   |   |   |
| B(AC)  | M54256S5  | 09/00 → 09/02   |   | VKMV 5PK863<br>VKM 38231   | 1   | 1   |   |   |   |   |
| B(AC)  | M54256S5  | 09/02 → 09/07   |   | VKMV 4PK863  |   | 1   |   |   |   |   |
| <b>BMW  3 Convertible (E46) 330</b>   |   |   |   |  |   |   |   |   |   |   |
|                                       | M54306S3  | 06/00 → 09/07   |   | <del>OKOKOKO</del>   |   |   |   |   |   |   |
|                                       | M54306S3  | 06/00 → 09/07   |   | VKPC 88617   |   |   |   | 1   |   |   |
|                                       | B(Alt) M54306S3   | 06/00 → 09/07   | MT  | VKMV 6PK1538<br>VKM 38003<br>VKM 38202   | 1<br>1  | 1   |   |   |   |   |
| B(Alt)   | M54306S3  | 06/00 → 09/07   | HT  | VKMV 6PK1538<br>VKM 38003<br>VKM 38004<br>VKM 38007                                | 1<br>1  | 1   |   | 1   |   |   |
| B(AC)  | M54306S3  | 06/00 → 09/02   |   | VKMV 5PK863<br>VKM 38231   | 1   | 1   |   |   |   |   |
| B(AC)  | M54306S3  | 09/02 → 09/07   |   | VKMV 4PK863  |   | 1   |   |   |   |   |
| <b>BMW  3 Convertible (E46) M3</b>    |   |   |   |  |   |   |   |   |   |   |
|                                       | S54326S4  | 04/01 → 09/07   |   | <del>OKOKOKO</del>   |   |   |   |   |   |   |
|                                       | S54326S4  | 04/01 → 09/07   |   | —  |   |   |   | 1   |   |   |
|                                       | B(AC) S54326S4  | 04/01 → 09/07   |   | VKMV 5PK829<br>VKM 38231   | 1   | 1   |   |   |   |   |
| <b>BMW  3 Convertible (E46) 320 d</b> |   |   |   |  |   |   |   |   |   |   |
|                                       | M47N204D4   | 02/05 → 09/07   |   | <del>OKOKOKO</del>   |   |   |   |   |   |   |
|                                       | M47N204D4   | 02/05 → 09/07   | Man. GBX  | VKPC 88635   |   |   |   | 1   |   |   |
|                                       | M47N204D4   | 02/05 → 09/07   | Auto. GBX   | VKPC 88636   |   |   |   | 1   |   |   |
| B(Alt)   | M47N204D4   | 02/05 → 09/07   |   | VKMV 6PK2080   |   | 1   |   |   |   |   |
| <b>BMW  3 Convertible (E46) 330 d</b> |   |   |   |  |   |   |   |   |   |   |
|                                       | M57N306D2   | 08/05 → 09/07   |   | VKPC 88636   |   |   |   | 1   |   |   |
| <b>BMW  3 Coupe (E46) 316</b>         |   |   |   |  |   |   |   |   |   |   |
|                                       | M 43 B 16, N45B16A  | 04/00 → 09/07   |   | <del>OKOKOKO</del>   |   |   |   |   |   |   |
|                                       | M 43 B 16   | 04/00 → 12/02   |   | VKPC 88615   |   |   |   | 1   |   |   |
|                                       | M 43 B 16   | 01/01 → 09/07   | 2)  | VKPA_____  |   |   |   | 1   |   |   |
| B(Alt)   | M 43 B 16   | 04/00 → 09/07   |   | VKMV 6PK1733<br>VKM 38221<br>VKM 38226   | 1<br>1  | 1   |   |   |   |   |





































































|  |  |  |  |  |  |  |  |  |  |  |  |
|--|---|---|---|--|---|---|---|---|---|---|---|
| B(Alt) N45B16A   |   | 06/02 → 09/07   | AC  | VKMV 6PK1870<br>VKM____<br>VKM____   | 1   |   | 1   |   |   |   |   |
| B(AC) M 43 B 16  |   | 04/00 → 09/07   |   | VKMV 5PK950<br>VKM 38231   | 1   |   | 1   |   |   |   |   |
| <b>BMW  3 Coupe (E46) 318</b>   |   |   |   |  |   |   |   |   |   |   |   |
|  N 42 B 20, M 43 B 19            |   | 11/99 → 09/01   |   | <b>OKOKOKO</b>   |   |   |   |   |   |   |   |
|  N 42 B 20                       |   | 09/01 → 09/07   | 2)  | VKPA____   |   |   |   | 1   |   |   |   |
| M 43 B 19  |   | 11/99 → 09/01   |   | VKPC 88615   |   |   |   | 1   |   |   |   |
|  B(Alt) N 42 B 20                |   | 09/01 → 09/07   | AC  | VKMV 6PK1637<br>VKM____  | 1   |   | 1   |   |   |   |   |
| B(Alt) N 42 B 20   |   | 09/01 → 09/07   | AC  | VKMV 6PK1870<br>VKM____<br>VKM____   | 1   |   | 1   |   |   |   |   |
| B(Alt) M 43 B 19   |   | 11/99 → 09/01   | 6)  | VKMV 6PK1733<br>VKM 38221<br>VKM 38226   | 1   |   | 1   |   |   |   |   |
| B(AC) M 43 B 19  |   | 11/99 → 09/01   |   | VKMV 5PK950<br>VKM 38231   | 1   |   | 1   |   |   |   |   |
| <b>BMW  3 Coupe (E46) 320</b>   |   |   |   |  |   |   |   |   |   |   |   |
|  M 52 B 20, M54226S1             |   | 08/99 → 09/07   |   | <b>OKOKOKO</b>   |   |   |   |   |   |   |   |
|  M 52 B 20, M54226S1             |   | 08/99 → 09/07   |   | VKPC 88617   |   |   |   | 1   |   |   |   |
|  B(Alt) M 52 B 20, M54226S1      |   | 08/99 → 09/07   | MT  | VKMV 6PK1538<br>VKM 38003<br>VKM 38202   | 1<br>1  |   | 1   |   |   |   |   |
| B(Alt) M 52 B 20, M54226S1   |   | 08/99 → 09/07   | HT  | VKMV 6PK1538<br>VKM 38003<br>VKM 38004<br>VKM 38007                                | 1   |   | 1   |   |   | 1   |   |
| B(AC) M 52 B 20, M54226S1  |   | 08/99 → 09/02   |   | VKMV 5PK863<br>VKM 38231   | 1   |   | 1   |   |   |   |   |
| B(AC) M54226S1   |   | 09/02 → 09/07   |   | VKMV 4PK863  |   |   | 1   |   |   |   |   |
| <b>BMW  3 Coupe (E46) 323</b> |   |   |   |  |   |   |   |   |   |   |   |
|  M 52 B 25                     |   | 04/99 → 09/00   |   | <b>OKOKOKO</b>   |   |   |   |   |   |   |   |
|  M 52 B 25                     |   | 04/99 → 09/00   |   | VKPC 88617   |   |   |   | 1   |   |   |   |
|  B(Alt) M 52 B 25              |   | 04/99 → 09/00   | MT  | VKMV 6PK1538<br>VKM 38003<br>VKM 38202   | 1<br>1  |   | 1   |   |   |   |   |
| B(Alt) M 52 B 25   |   | 04/99 → 09/00   | HT  | VKMV 6PK1538<br>VKM 38003<br>VKM 38004<br>VKM 38007                                | 1   |   | 1   |   |   | 1   |   |
| B(AC) M 52 B 25  |   | 04/99 → 09/00   |   | VKMV 5PK863<br>VKM 38231   | 1   |   | 1   |   |   |   |   |
| <b>BMW  3 Coupe (E46) 325</b> |   |   |   |  |   |   |   |   |   |   |   |
|  M54256S5                      |   | 09/00 → 09/07   |   | <b>OKOKOKO</b>   |   |   |   |   |   |   |   |
|  M54256S5                      |   | 09/00 → 09/07   |   | VKPC 88617   |   |   |   | 1   |   |   |   |
|  B(Alt) M54256S5               |   | 09/00 → 09/07   | MT  | VKMV 6PK1538<br>VKM 38003<br>VKM 38202   | 1<br>1  |   | 1   |   |   |   |   |
| B(Alt) M54256S5  |   | 09/00 → 09/07   | HT  | VKMV 6PK1538<br>VKM 38003<br>VKM 38004<br>VKM 38007                                | 1   |   | 1   |   |   | 1   |   |
| B(AC) M54256S5   |   | 09/00 → 09/02   |   | VKMV 5PK863<br>VKM 38231   | 1   |   | 1   |   |   |   |   |
| B(AC) M54256S5   |   | 09/02 → 09/07   |   | VKMV 4PK863  |   |   | 1   |   |   |   |   |
| <b>BMW  3 Coupe (E46) 328</b> |   |   |   |  |   |   |   |   |   |   |   |
|  M 52 B 28                     |   | 04/99 → 06/00   |   | <b>OKOKOKO</b>   |   |   |   |   |   |   |   |
|  M 52 B 28                     |   | 04/99 → 06/00   |   | VKPC 88617   |   |   |   | 1   |   |   |   |

|  |  |  |  |  |  |  |  |  |  |  |  |  |
|--|---|---|---|--|---|---|---|---|---|---|---|---|
|                                   | <b>B(Alt)</b> M 52 B 28   | 04/99 → 06/00   | MT  | VKMV 6PK1538<br>VKM 38003<br>VKM 38202   | 1<br>1  |   | 1   |   |   |   |   |   |
|  | <b>B(Alt)</b> M 52 B 28   | 04/99 → 06/00   | HT  | VKMV 6PK1538<br>VKM 38003<br>VKM 38004<br>VKM 38007                                | 1   |   | 1   |   |   | 1   |   |   |
|  | <b>B(AC)</b> M 52 B 28  | 04/99 → 06/00   |   | VKMV 5PK863<br>VKM 38231   | 1   |   | 1   |   |   |   |   |   |
| <b>BMW  3 Coupe (E46) 330</b>     |   |   |   |  |   |   |   |   |   |   |   |   |
|                                   | M54306S3  | 06/00 → 09/07   |   | <b>ΟΧΛΟΧΟ</b>  |   |   |   |   |   |   |   |   |
|                                   | M54306S3  | 06/00 → 09/07   |   | VKPC 88617   |   |   |   |   | 1   |   |   |   |
|                                   | <b>B(Alt)</b> M54306S3  | 06/00 → 09/07   | MT  | VKMV 6PK1538<br>VKM 38003<br>VKM 38202   | 1<br>1  |   | 1   |   |   |   |   |   |
|  | <b>B(Alt)</b> M54306S3  | 06/00 → 09/07   | HT  | VKMV 6PK1538<br>VKM 38003<br>VKM 38004<br>VKM 38007                                | 1   |   | 1   |   |   | 1   |   |   |
|  | <b>B(AC)</b> M54306S3   | 06/00 → 09/02   |   | VKMV 5PK863<br>VKM 38231   | 1   |   | 1   |   |   |   |   |   |
|  | <b>B(AC)</b> M54306S3   | 09/02 → 09/07   |   | VKMV 4PK863  |   |   | 1   |   |   |   |   |   |
| <b>BMW  3 Coupe (E46) M3</b>      |   |   |   |  |   |   |   |   |   |   |   |   |
|                                   | S54326S4, S54N326S4   | 06/00 → 09/07   |   | <b>ΟΧΛΟΧΟ</b>  |   |   |   |   |   |   |   |   |
|                                  | S54326S4, S54N326S4   | 06/00 → 09/07   |   | —  |   |   |   |   | 1   |   |   |   |
|                                 | <b>B(AC)</b> S54326S4, S54N326S4  | 06/00 → 09/07   |   | VKMV 5PK829<br>VKM 38231   | 1   |   | 1   |   |   |   |   |   |
| <b>BMW  3 Coupe (E46) 320 d</b> |   |   |   |  |   |   |   |   |   |   |   |   |
|                                 | M47N204D4   | 11/03 → 09/07   |   | <b>ΟΧΛΟΧΟ</b>  |   |   |   |   |   |   |   |   |
|                                 | M47N204D4   | 11/03 → 09/07   | Man. GBX  | VKPC 88635   |   |   |   |   | 1   |   |   |   |
|  | M47N204D4   | 11/03 → 09/07   | Auto. GBX   | VKPC 88636   |   |   |   |   | 1   |   |   |   |
|                                 | <b>B(Alt)</b> M47N204D4   | 11/03 → 09/07   |   | VKMV 6PK2080   |   |   | 1   |   |   |   |   |   |
|  | <b>B(AC)</b> M47N204D4  | 11/03 → 09/04   |   | VKMV 4PK968  |   |   | 1   |   |   |   |   |   |
| <b>BMW  3 Coupe (E46) 330 d</b> |   |   |   |  |   |   |   |   |   |   |   |   |
|                                 | M57N306D2   | 03/03 → 09/07   |   | <b>ΟΧΛΟΧΟ</b>  |   |   |   |   |   |   |   |   |
|                                 | M57N306D2   | 03/03 → 09/07   |   | VKPC 88636   |   |   |   |   | 1   |   |   |   |
| <b>BMW  3 Touring (E46) 316</b> |   |   |   |  |   |   |   |   |   |   |   |   |
|                                 | N 42 B 18, N 45 B16   | 03/02 → 02/05   |   | <b>ΟΧΛΟΧΟ</b>  |   |   |   |   |   |   |   |   |
|                                 | N 42 B 18, N 45 B16   | 03/02 → 02/05   | 2)  | VKPA _____   |   |   |   |   | 1   |   |   |   |
|                                 | <b>B(Alt)</b> N 42 B 18, N 45 B16   | 03/02 → 02/05   | <b>AC</b>   | VKMV 6PK1637<br>VKM _____  | 1   |   | 1   |   |   |   |   |   |
|  | <b>B(Alt)</b> N 42 B 18, N 45 B16   | 03/02 → 02/05   | <b>AC</b>   | VKMV 6PK1870<br>VKM _____<br>VKM _____   | 1   |   | 1   |   |   | 1   |   |   |
| <b>BMW  3 Touring (E46) 318</b> |   |   |   |  |   |   |   |   |   |   |   |   |
|                                 | N 42 B 20, M 43 B 19  | 10/99 → 02/05   |   | <b>ΟΧΛΟΧΟ</b>  |   |   |   |   |   |   |   |   |
|                                 | N 42 B 20   | 09/01 → 02/05   | 2)  | VKPA _____   |   |   |   |   | 1   |   |   |   |
|  | M 43 B 19   | 10/99 → 09/01   |   | VKPC 88615   |   |   |   |   | 1   |   |   |   |
|                                 | <b>B(Alt)</b> N 42 B 20   | 09/01 → 02/05   | <b>AC</b>   | VKMV 6PK1637<br>VKM _____  | 1   |   | 1   |   |   |   |   |   |
|  | <b>B(Alt)</b> N 42 B 20   | 09/01 → 02/05   | <b>AC</b>   | VKMV 6PK1870<br>VKM _____<br>VKM _____   | 1   |   | 1   |   |   | 1   |   |   |
|  | <b>B(Alt)</b> M 43 B 19   | 10/99 → 09/01   | 6)  | VKMV 6PK1733<br>VKM 38221<br>VKM 38226   | 1   |   | 1   |   |   | 1   |   |   |
|  | <b>B(AC)</b> M 43 B 19  | 10/99 → 09/01   |   | VKMV 5PK950<br>VKM 38231   | 1   |   | 1   |   |   |   |   |   |
| <b>BMW  3 Touring (E46) 320</b> |   |   |   |  |   |   |   |   |   |   |   |   |
|                                 | M 52 B, M54226S1  | 10/99 → 02/05   |   | <b>ΟΧΛΟΧΟ</b>  |   |   |   |   |   |   |   |   |
|                                 | M 52 B, M54226S1  | 10/99 → 02/05   |   | VKPC 88617   |   |   |   |   | 1   |   |   |   |











































BMW















































|  |  |  |  |  |  |  |  |  |  |  |  |  |
|--|---|---|---|--|---|---|---|---|---|---|---|---|
|                                      | <b>B(Alt)</b> M 52 B, M54226S1  | 10/99 → 02/05   | MT  | VKMV 6PK1538<br>VKM 38003<br>VKM 38202   | 1<br>1  | 1   |   |   |   |   |   |   |
|  | <b>B(Alt)</b> M 52 B, M54226S1  | 10/99 → 02/05   | HT  | VKMV 6PK1538<br>VKM 38003<br>VKM 38004<br>VKM 38007                                | 1   | 1   | 1   |   | 1   |   |   |   |
|  | <b>B(AC)</b> M 52 B, M54226S1   | 10/99 → 09/02   |   | VKMV 5PK863<br>VKM 38231   | 1   | 1   |   |   |   |   |   |   |
|  | <b>B(AC)</b> M54226S1   | 09/02 → 02/05   |   | VKMV 4PK863  |   | 1   |   |   |   |   |   |   |
| <b>BMW  3 Touring (E46) 325</b>     |   |   |   |  |   |   |   |   |   |   |   |   |
|                                      | M54256S5  | 09/00 → 02/05   |   | <del>OKOKOK</del>  |   |   |   |   |   |   |   |   |
|                                      | M54256S5  | 09/00 → 02/05   |   | VKPC 88617   |   |   |   | 1   |   |   |   |   |
|                                      | <b>B(Alt)</b> M54256S5  | 09/00 → 02/05   | MT  | VKMV 6PK1538<br>VKM 38003<br>VKM 38202   | 1<br>1  | 1   |   |   |   |   |   |   |
|  | <b>B(Alt)</b> M54256S5  | 09/00 → 02/05   | HT  | VKMV 6PK1538<br>VKM 38003<br>VKM 38004<br>VKM 38007                                | 1   | 1   | 1   |   |   | 1   |   |   |
|  | <b>B(AC)</b> M54256S5   | 09/00 → 09/02   |   | VKMV 5PK863<br>VKM 38231   | 1   | 1   |   |   |   |   |   |   |
|  | <b>B(AC)</b> M54256S5   | 09/02 → 02/05   |   | VKMV 4PK863  |   | 1   |   |   |   |   |   |   |
| <b>BMW  3 Touring (E46) 328</b>     |   |   |   |  |   |   |   |   |   |   |   |   |
|                                     | M 52 B 28   | 10/99 → 06/00   |   | <del>OKOKOK</del>  |   |   |   |   |   |   |   |   |
|                                    | M 52 B 28   | 10/99 → 06/00   |   | VKPC 88617   |   |   |   | 1   |   |   |   |   |
|                                    | <b>B(Alt)</b> M 52 B 28   | 10/99 → 06/00   | MT  | VKMV 6PK1538<br>VKM 38003<br>VKM 38202   | 1<br>1  | 1   |   |   |   |   |   |   |
|  | <b>B(Alt)</b> M 52 B 28   | 10/99 → 06/00   | HT  | VKMV 6PK1538<br>VKM 38003<br>VKM 38004<br>VKM 38007                                | 1   | 1   | 1   |   |   | 1   |   |   |
|  | <b>B(AC)</b> M 52 B 28  | 10/99 → 06/00   |   | VKMV 5PK863<br>VKM 38231   | 1   | 1   |   |   |   |   |   |   |
| <b>BMW  3 Touring (E46) 330</b>   |   |   |   |  |   |   |   |   |   |   |   |   |
|                                    | M54306S3  | 06/00 → 02/05   |   | <del>OKOKOK</del>  |   |   |   |   |   |   |   |   |
|                                    | M54306S3  | 06/00 → 02/05   |   | VKPC 88617   |   |   |   | 1   |   |   |   |   |
|                                    | <b>B(Alt)</b> M54306S3  | 06/00 → 02/05   | MT  | VKMV 6PK1538<br>VKM 38003<br>VKM 38202   | 1<br>1  | 1   |   |   |   |   |   |   |
|  | <b>B(Alt)</b> M54306S3  | 06/00 → 02/05   | HT  | VKMV 6PK1538<br>VKM 38003<br>VKM 38004<br>VKM 38007                                | 1   | 1   | 1   |   |   | 1   |   |   |
|  | <b>B(AC)</b> M54306S3   | 06/00 → 09/02   |   | VKMV 5PK863<br>VKM 38231   | 1   | 1   |   |   |   |   |   |   |
|  | <b>B(AC)</b> M54306S3   | 09/02 → 02/05   |   | VKMV 4PK863  |   | 1   |   |   |   |   |   |   |
| <b>BMW  3 Touring (E46) 318 d</b> |   |   |   |  |   |   |   |   |   |   |   |   |
|                                    | M47204D1, M47N204D4   | 03/02 → 02/05   |   | <del>OKOKOK</del>  |   |   |   |   |   |   |   |   |
|                                    | M47204D1  | 03/02 → 02/05   |   | VKPC 88632   |   |   |   | 1   |   |   |   |   |
|  | M47N204D4   | 03/02 → 02/05   | Man. GBX  | VKPC 88635   |   |   |   | 1   |   |   |   |   |
|  | M47N204D4   | 03/02 → 02/05   | Auto. GBX   | VKPC 88636   |   |   |   | 1   |   |   |   |   |
|                                    | <b>B(Alt)</b> M47204D1  | 03/02 → 02/05   |   | VKMV 5PK2030<br>VKM 38220<br>VKM 38240   | 1   | 1   |   |   |   |   |   |   |
|  | <b>B(Alt)</b> M47N204D4   | 03/03 → 02/05   |   | VKMV 6PK2080   |   | 1   |   |   |   |   |   |   |
|  | <b>B(AC)</b> M47204D1   | 03/02 → 02/05   |   | VKMV 5PK836  |   | 1   |   |   |   |   |   |   |
|  | <b>B(AC)</b> M47N204D4  | 03/03 → 09/04   |   | VKMV 4PK968  |   | 1   |   |   |   |   |   |   |
| <b>BMW  3 Touring (E46) 320 d</b> |   |   |   |  |   |   |   |   |   |   |   |   |
|                                    | M 47 D 20, M47204D1,<br>M47N204D4   | 03/00 → 02/05   |   | <del>OKOKOK</del>  |   |   |   |   |   |   |   |   |

|  |  |  |  |  |  |  |  |  |  |  |  |  |
|--|---|---|---|--|---|---|---|---|---|---|---|---|
|                                   | M47204D1  | 03/00 → 09/01   | Man. GBX  | VKPC 88632   |   |   |   |   |   | 1   |   |   |
|  | M47204D1  | 03/00 → 09/01   | Auto. GBX   | VKPC 88637   |   |   |   |   |   | 1   |   |   |
|  | M47N204D4   | 09/01 → 02/05   | Man. GBX  | VKPC 88635   |   |   |   |   |   | 1   |   |   |
|  | M47N204D4   | 09/01 → 02/05   | Auto. GBX   | VKPC 88636   |   |   |   |   |   | 1   |   |   |
|                                   | <b>B(Alt)</b> M 47 D 20, M47204D1   | 03/00 → 09/01   |   | VKMV 5PK2030<br>VKM 38220<br>VKM 38240   | 1   |   | 1   |   |   |   |   |   |
|  | <b>B(Alt)</b> M47N204D4   | 09/01 → 02/05   |   | VKMV 6PK2080   |   |   | 1   |   |   |   |   |   |
|  | <b>B(AC)</b> M 47 D 20, M47204D1  | 03/00 → 09/01   |   | VKMV 5PK836  |   |   | 1   |   |   |   |   |   |
|  | <b>B(AC)</b> M47N204D4  | 09/01 → 09/04   |   | VKMV 4PK968  |   |   | 1   |   |   |   |   |   |
| <b>BMW  3 Touring (E46) 330 d</b> |   |   |   |  |   |   |   |   |   |   |   |   |
|                                   | M 57 D 30, M57N306D2  | 10/99 → 02/05   |   | OKOKOKO  |   |   |   |   |   |   |   |   |
|                                   | M 57 D 30   | 10/99 → 12/03   |   | VKPC 88430   |   |   |   |   |   | 1   |   |   |
|  | M57N306D2   | 03/03 → 02/05   |   | VKPC 88636   |   |   |   |   |   | 1   |   |   |
|                                   | <b>B(Alt)</b> M 57 D 30   | 10/99 → 02/05   |   | VKMV 5PK2063<br>VKM 38240<br>VKM 38240   |   | 1   | 1   |   |   |   |   |   |
|  | <b>B(AC)</b> M 57 D 30  | 10/00 → 02/05   |   | VKMV 5PK810  |   |   | 1   |   |   |   |   |   |
| <b>BMW  3 (E90) 318</b>           |   |   |   |  |   |   |   |   |   |   |   |   |
|                                   | N46B20B   | 09/05 → 09/07   |   | OKOKOKO  |   |   |   |   |   |   |   |   |
|                                   | N43B20A   | 09/05 → 09/07   |   | —  |   |   |   |   |   | 1   |   |   |
|  | N46B20B   | 09/05 → 09/07 2)  |   | VKPA   |   |   |   |   |   | 1   |   |   |
|                                   | <b>B(Alt)</b> N46B20B   | 09/05 → 09/07   |   | VKMV 6PK1870<br>VKM<br>VKM   | 1   |   | 1   |   |   |   |   |   |
|  |   |   |   |  |   | 1   |   |   |   |   |   |   |
| <b>BMW  3 (E90) 320</b>         |   |   |   |  |   |   |   |   |   |   |   |   |
|                                 | N46B20A, N46B20C  | 01/05 → 09/07   |   | OKOKOKO  |   |   |   |   |   |   |   |   |
|                                 | N43B20A   | 01/05 → 09/07   |   | —  |   |   |   |   |   | 1   |   |   |
|  | N46B20C   | 01/05 → 09/07 2)  |   | VKPA   |   |   |   |   |   | 1   |   |   |
|                                 | <b>B(Alt)</b> N46B20A, N46B20C  | 01/05 → 09/07   | EUR   | VKMV 6PK1870<br>VKM<br>VKM   | 1   |   | 1   |   |   |   |   |   |
|  |   |   |   |  |   | 1   |   |   |   |   |   |   |
| <b>BMW  3 (E90) 320 si</b>      |   |   |   |  |   |   |   |   |   |   |   |   |
|                                 | N45B20A   | 05/06 → 09/07   |   | OKOKOKO  |   |   |   |   |   |   |   |   |
|                                 | N45B20A   | 05/06 → 09/07 2)  |   | VKPA   |   |   |   |   |   | 1   |   |   |
|                                 | <b>B(Alt)</b> N45B20A   | 05/06 → 09/07   |   | VKMV 6PK1870<br>VKM<br>VKM   | 1   |   | 1   |   |   |   |   |   |
|  |   |   |   |  |   | 1   |   |   |   |   |   |   |
| <b>BMW  3 (E90) 325</b>         |   |   |   |  |   |   |   |   |   |   |   |   |
|                                 | N52B25A   | 01/05 → 03/06   |   | OKOKOKO  |   |   |   |   |   |   |   |   |
|                                 | N52B25A, N53B30A  | 01/05 → 09/07   |   | —  |   |   |   |   |   | 1   |   |   |
|                                 | <b>B(Alt)</b> N52B25A   | 01/05 → 09/07   | EUR   | VKMV 6PK1990   |   |   | 1   |   |   |   |   |   |
| <b>BMW  3 (E90) 330</b>         |   |   |   |  |   |   |   |   |   |   |   |   |
|                                 | N52B30A   | 01/05 → 03/06   |   | OKOKOKO  |   |   |   |   |   |   |   |   |
|                                 | N52B30A, N53B30A  | 01/05 → 09/07   |   | —  |   |   |   |   |   | 1   |   |   |
|                                 | <b>B(Alt)</b> N52B30A   | 01/05 → 09/07   | EUR   | VKMV 6PK1990   |   |   | 1   |   |   |   |   |   |
| <b>BMW  3 (E90) 335i</b>        |   |   |   |  |   |   |   |   |   |   |   |   |
|                                 |   | 09/06 → 09/07   |   | —  |   |   |   |   |   | 1   |   |   |
| <b>BMW  3 (E90) 318 d</b>       |   |   |   |  |   |   |   |   |   |   |   |   |
|                                 | M47N204D4   | 09/05 → 03/06   |   | OKOKOKO  |   |   |   |   |   |   |   |   |
|                                 | M47N204D4   | 09/05 → 09/07   |   | VKPC 88635   |   |   |   |   |   | 1   |   |   |
|  | N47D20A   | 09/05 → 09/07   |   | —  |   |   |   |   |   | 1   |   |   |
|                                 | <b>B(Alt)</b> M47N204D4   | 09/05 → 09/07   |   | VKMV 6PK1836   |   |   | 1   |   |   |   |   |   |
| <b>BMW  3 (E90) 320 d</b>       |   |   |   |  |   |   |   |   |   |   |   |   |
|                                 | M47N204D4   | 01/05 → 03/06   |   | OKOKOKO  |   |   |   |   |   |   |   |   |
|                                 | M47N204D4   | 01/05 → 09/07   | Auto. GBX   | VKPC 88645   |   |   |   |   |   | 1   |   |   |
|  | N47D20A   | 01/05 → 09/07   | Man. GBX  | VKPC 88635   |   |   |   |   |   | 1   |   |   |
|                                 | <b>B(Alt)</b> M47N204D4   | 01/05 → 09/07   |   | VKMV 6PK1836   |   |   | 1   |   |   |   |   |   |
| <b>BMW  3 (E90) 325d</b>        |   |   |   |  |   |   |   |   |   |   |   |   |
|                                 |   | 09/06 → 09/07   |   | VKPC 88645   |   |   |   |   |   | 1   |   |   |



BMW

|  |                         |                            |          |   |
|--|-------------------------|----------------------------|--|---|
| <b>BMW</b>  <b>3 (E90) 330 d</b>              |                         |                            |  |   |
|    | M57306D3                | 09/05 → 03/06              | <b>OXOXOXO</b>   |   |
|    | M57306D3                | 09/05 → 09/07              | VKPC 88645   | 1 |
|    | <b>B(Alt)</b> M57306D3  | 09/05 → 09/07 <b>(EUR)</b> | VKMV 6PK1836   | 1 |
| <b>BMW</b>  <b>3 (E90) 335d</b>               |                         |                            |  |   |
|    |                         | 09/06 → 09/07              | VKPC 88645   | 1 |
| <b>BMW</b>  <b>3 Touring (E91) 318i</b>       |                         |                            |  |   |
|    | N43B20A                 | 01/06 → 09/07              | —  | 1 |
|  | N46B20B                 | 01/06 → 09/07 2)           | VKPA_____  | 1 |
| <b>BMW</b>  <b>3 Touring (E91) 320</b>        |                         |                            |  |   |
|    | N46B20A, N46B20C        | 09/05 → 03/06              | <b>OXOXOXO</b>   |   |
|    | N43B20A                 | 09/05 → 09/07              | —  | 1 |
|  | N46B20A, N46B20C        | 09/05 → 09/07              | VKPC 88645   | 1 |
|  | N46B20B                 | 09/05 → 09/07 2)           | VKPA_____  | 1 |
| <b>BMW</b>  <b>3 Touring (E91) 325</b>        |                         |                            |  |   |
|    | N52B25C                 | 09/05 → 03/06              | <b>OXOXOXO</b>   |   |
|    | N52B25C                 | 09/05 → 09/07              | —  | 1 |
|    | <b>B(Alt)</b> N52B25C   | 09/05 → 09/07 <b>(EUR)</b> | VKMV 6PK1990   | 1 |
| <b>BMW</b>  <b>3 Touring (E91) 330</b>        |                         |                            |  |   |
|    | N52B30A                 | 09/05 → 03/06              | <b>OXOXOXO</b>   |   |
|    | N52B30A                 | 09/05 → 09/07              | —  | 1 |
|    | <b>B(Alt)</b> N52B30A   | 09/05 → 09/07              | VKMV 6PK1990   | 1 |
| <b>BMW</b>  <b>3 Touring (E91) 318d</b>      |                         |                            |  |   |
|    | M47N204D4               | 09/05 → 09/07              | VKPC 88635   | 1 |
|  | N47D20A                 | 09/05 → 09/07              | —  | 1 |
| <b>BMW</b>  <b>3 Touring (E91) 320 d</b>    |                         |                            |  |   |
|    | M47N204D5               | 09/05 → 03/06              | <b>OXOXOXO</b>   |   |
|    | M47N204D5               | 09/05 → 09/07              | VKPC 88635   | 1 |
|    | <b>B(Alt)</b> M47N204D5 | 09/05 → 09/07              | VKMV 6PK1836   | 1 |
| <b>BMW</b>  <b>3 Touring (E91) 320d</b>     |                         |                            |  |   |
|    | N47D20A                 | 09/05 → 09/07              | —  | 1 |
| <b>BMW</b>  <b>3 Touring (E91) 325d</b>     |                         |                            |  |   |
|    | N52306D3                | 09/06 → 09/07              | VKPC 88645   | 1 |
| <b>BMW</b>  <b>3 Touring (E91) 330 d</b>    |                         |                            |  |   |
|    | M57306D3                | 09/05 → 03/06              | <b>OXOXOXO</b>   |   |
|    | M57306D3                | 09/05 → 09/07              | VKPC 88645   | 1 |
|    | <b>B(Alt)</b> M57306D3  | 09/05 → 09/07              | VKMV 6PK1836   | 1 |
| <b>BMW</b>  <b>3 Touring (E91) 335d</b>     |                         |                            |  |   |
|    | N52306D5                | 09/06 → 09/07              | VKPC 88645   | 1 |
| <b>BMW</b>  <b>3 Coupe (E92) 335i</b>       |                         |                            |  |   |
|    | N52B30A                 | 09/06 → 09/07              | —  | 1 |
|    | <b>B(Alt)</b> N52B30A   | 09/06 → 01/08              | VKMV 7PK1855   | 1 |
| <b>BMW</b>  <b>3 Coupe (E92) 325d</b>       |                         |                            |  |   |
|    | N47D20A                 | 03/07 → 09/07              | VKPC 88645   | 1 |
| <b>BMW</b>  <b>3 Coupe (E92) 330d</b>       |                         |                            |  |   |
|    | N47D20A                 | 09/06 → 09/07              | VKPC 88645   | 1 |
| <b>BMW</b>  <b>3 Coupe (E92) 335d</b>       |                         |                            |  |   |
|    | M57306D5                | 09/06 → 09/07              | VKPC 88645   | 1 |
| <b>BMW</b>  <b>3 Convertible (E93) 320i</b> |                         |                            |  |   |
|    | N46B20B                 | 03/07 → 09/07 2)           | VKPA_____  | 1 |
| <b>BMW</b>  <b>3 Convertible (E93) 330d</b> |                         |                            |  |   |
|    | M57306D3                | 03/07 → 09/07              | VKPC 88645   | 1 |
| <b>BMW</b>  <b>5 (E12) 518</b>              |                         |                            |  |   |
|    | M 10 B 18               | 07/74 → 08/81              | <b>OXOXOXO</b>   |   |
|    | M 10 B 18               | 07/74 → 08/81              | VKPC 88609   | 1 |
| <b>BMW</b>  <b>5 (E12) 520</b>              |                         |                            |  |   |
|    | M 10 B 20               | 08/72 → 08/77              | <b>OXOXOXO</b>   |   |

|  |  |  |    |  |  |  |  |  |  |  |  |  |
|--|---|---|---|--|---|---|---|---|---|---|---|---|
|  | M 20 B 20   | 09/77 → 05/81   |    | VKMA 08100<br>VKM 18100  | 1<br>1  | 1   |   |   |   |   |   | T0049   |
|  | M 20 B 20   | 09/77 → 05/81   |    | VKMA 08110<br>VKM 18100  | 1<br>1  | 1   |   |   |   |   |   | T0032   |
|                           | M 10 B 20   | 08/72 → 08/77   |   | VKPC 88609   |   |   |   | 1   |   |   |   |   |
|  | M 20 B 20   | 09/77 → 05/81   |   | —  |   |   |   | 1   |   |   |   |   |
|                           | B(Alt) M 20 B 20  | 09/77 → 05/81   | Carbu.  | VKMM 10AVx950  |   | 1   |   |   |   |   |   |   |
|  | B(Alt) M 20 B 20  | 09/77 → 05/81   | Injec.  | VKMM 10AVx875  |   | 1   |   |   |   |   |   |   |
| <b>BMW  5 (E12) 525</b>   |   |   |   |  |   |   |   |   |   |   |   |   |
|                           | M 30 B 25   | 08/73 → 05/81   |   | ΟΧΘΙΟΧΟ  |   |   |   |   |   |   |   |   |
|                           | M 30 B 25   | 08/73 → 03/78   |   | —  |   |   |   | 1   |   |   |   |   |
|  | M 30 B 25   | 03/78 → 05/81   | Man. GBX  | VKPC 88607   |   |   |   | 1   |   |   |   |   |
|  | M 30 B 25   | 03/78 → 05/81   | Auto. GBX   | VKPC 88802   |   |   |   | 1   |   |   |   |   |
|                           | B(Alt) M 30 B 25  | 08/73 → 05/81   |   | VKMM 13AVx1050   |   | 1   |   |   |   |   |   |   |
|  | B(PS) M 30 B 25   | 08/73 → 05/81   |   | VKMM 10AVx900  |   | 1   |   |   |   |   |   |   |
|  | B(AC) M 30 B 25   | 08/73 → 05/81   |   | VKMM 10AVx800  |   | 1   |   |   |   |   |   |   |
| <b>BMW  5 (E12) 528</b>   |   |   |   |  |   |   |   |   |   |   |   |   |
|                           | M 30 B 28   | 01/75 → 05/81   |   | ΟΧΘΙΟΧΟ  |   |   |   |   |   |   |   |   |
|                           | M 30 B 28   | 01/75 → 03/78   |   | —  |   |   |   | 1   |   |   |   |   |
|  | M 30 B 28   | 03/78 → 05/81   |   | VKPC 88802   |   |   |   | 1   |   |   |   |   |
|                           | B(Alt) M 30 B 28  | 01/75 → 05/81   |   | VKMM 13AVx1050   |   | 1   |   |   |   |   |   |   |
|  | B(PS) M 30 B 28   | 01/75 → 05/81   |   | VKMM 10AVx900  |   | 1   |   |   |   |   |   |   |
|  | B(AC) M 30 B 28   | 01/75 → 05/81   |   | VKMM 10AVx800  |   | 1   |   |   |   |   |   |   |
| <b>BMW  5 (E12) M 535</b> |   |   |   |  |   |   |   |   |   |   |   |   |
|                         | M 30 B 35   | 06/80 → 08/81   |   | ΟΧΘΙΟΧΟ  |   |   |   |   |   |   |   |   |
|                         | M 30 B 35   | 06/80 → 08/81   |   | VKPC 88802   |   |   |   | 1   |   |   |   |   |
|                         | B(Alt) M 30 B 35  | 06/80 → 08/81   |   | VKMM 13AVx1050   |   | 1   |   |   |   |   |   |   |
|  | B(PS) M 30 B 35   | 06/80 → 08/81   |   | VKMM 10AVx900  |   | 1   |   |   |   |   |   |   |
|  | B(AC) M 30 B 35   | 06/80 → 08/81   |   | VKMM 10AVx800  |   | 1   |   |   |   |   |   |   |
| <b>BMW  5 (E28) 518</b> |   |   |   |  |   |   |   |   |   |   |   |   |
|                         | M 10 B 18   | 06/81 → 12/87   |   | ΟΧΘΙΟΧΟ  |   |   |   |   |   |   |   |   |
|                         | M 10 B 18   | 06/81 → 04/82   |   | VKPC 88609   |   |   |   | 1   |   |   |   |   |
|  | M 10 B 18   | 05/82 → 12/87   |   | VKPC 88610   |   |   |   | 1   |   |   |   |   |
|                         | B(Alt) M 10 B 18  | 06/81 → 08/84   | Carbu.  | VKMM 10AVx875  |   | 1   |   |   |   |   |   |   |
|  | B(Alt) M 10 B 18  | 09/81 → 09/82   |  | VKMM 10AVx975  |   | 1   |   |   |   |   |   |   |
|  | B(Alt) M 10 B 18  | 09/82 → 05/83   |  | VKMM 10AVx940  |   | 1   |   |   |   |   |   |   |
|  | B(PS) M 10 B 18   | 06/81 → 10/83   | Carbu.  | VKMM 10AVx825  |   | 1   |   |   |   |   |   |   |
|  | B(PS) M 10 B 18   | 10/83 → 08/84   | Carbu.  | VKMM 10AVx813  |   | 1   |   |   |   |   |   |   |
| <b>BMW  5 (E28) 520</b> |   |   |   |  |   |   |   |   |   |   |   |   |
|                         | M 20 B 20   | 06/81 → 06/90   |  | VKMA 08100<br>VKM 18100  | 1<br>1  | 1   |   |   |   |   |   | T0049   |
|  | M 20 B 20   | 06/81 → 06/90   |  | VKMA 08110<br>VKM 18100  | 1<br>1  | 1   |   |   |   |   |   | T0032   |
|                         | M 20 B 20   | 06/81 → 09/87   |   | VKPC 88605   |   |   |   | 1   |   |   |   |   |
|  | M 20 B 20   | 10/87 → 06/90   |   | VKPC 88607   |   |   |   | 1   |   |   |   |   |
| <b>BMW  5 (E28) 525</b> |   |   |   |  |   |   |   |   |   |   |   |   |
|                         | M 30 B 25   | 06/81 → 12/87   |   | ΟΧΘΙΟΧΟ  |   |   |   |   |   |   |   |   |
|  | M 20 B 27   | 09/81 → 12/87   |   | VKMA 08110<br>VKM 18100  | 1<br>1  | 1   |   |   |   |   |   | T0032   |
|                         | M 30 B 25   | 06/81 → 12/87   |   | VKPC 88802   |   |   |   | 1   |   |   |   |   |
|  | M 20 B 27   | 09/81 → 09/87   |   | VKPC 88605   |   |   |   | 1   |   |   |   |   |
|  | M 20 B 27   | 09/87 → 12/87   |   | VKPC 88607   |   |   |   | 1   |   |   |   |   |
| <b>BMW  5 (E28) 528</b> |   |   |   |  |   |   |   |   |   |   |   |   |
|                         | M 30 B 28   | 06/81 → 12/87   |   | ΟΧΘΙΟΧΟ  |   |   |   |   |   |   |   |   |
|                         | M 30 B 28   | 06/81 → 12/87   |   | VKPC 88802   |   |   |   | 1   |   |   |   |   |
|                         | B(Alt) M 30 B 28  | 06/81 → 12/87   |   | VKMM 13AVx1050   |   | 1   |   |   |   |   |   |   |
|  | B(PS) M 30 B 28   | 06/81 → 04/84   |   | VKMM 10AVx900  |   | 1   |   |   |   |   |   |   |
|  | B(PS) M 30 B 28   | 04/84 → 12/87   |   | VKMM 10AVx888  |   | 1   |   |   |   |   |   |   |
|  | B(AC) M 30 B 28   | 06/81 → 09/84   |   | VKMM 13AVx800  |   | 1   |   |   |   |   |   |   |
|  | B(AC) M 30 B 28   | 09/84 → 12/87   |   | VKMM 10AVx800  |   | 1   |   |   |   |   |   |   |







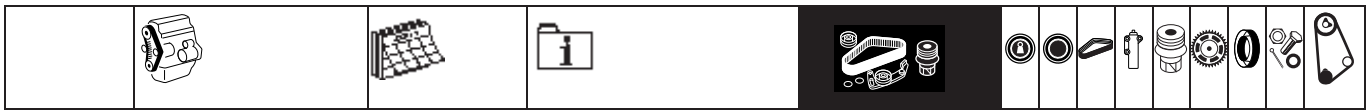































BMW



















































































| BMW | 5 (E28) 535             |               |    |                 |   |  |   |   |  |  |   |  |   |  |   |  |   |       |
|-----|-------------------------|---------------|----|-----------------|---|--|---|---|--|--|---|--|---|--|---|--|---|-------|
|     | M 30 B 35               | 01/85 → 12/87 |    | <b>OXOXOXO</b>  |   |  |   |   |  |  |   |  |   |  |   |  |   |       |
|     | M 30 B 35               | 01/85 → 12/87 |    | VKPC 88802      |   |  |   |   |  |  | 1 |  |   |  |   |  |   |       |
|     | B(PS) M 30 B 35         | 01/85 → 12/87 |    | VKMPV 10AVx888  |   |  |   |   |  |  | 1 |  |   |  |   |  |   |       |
|     | B(AC) M 30 B 35         | 01/85 → 12/87 |    | VKMPV 10AVx800  |   |  |   |   |  |  | 1 |  |   |  |   |  |   |       |
| BMW | 5 (E28) M5              |               |    |                 |   |  |   |   |  |  |   |  |   |  |   |  |   |       |
|     | S 38 B 35               | 08/85 → 12/87 |    | <b>OXOXOXO</b>  |   |  |   |   |  |  |   |  |   |  |   |  |   |       |
|     | B(Alt) S 38 B 35        | 08/85 → 12/87 |    | VKMPV 13AVx1050 |   |  |   |   |  |  | 1 |  |   |  |   |  |   |       |
|     | B(PS) S 38 B 35         | 08/85 → 12/87 |    | VKMPV 10AVx888  |   |  |   |   |  |  | 1 |  |   |  |   |  |   |       |
|     | B(AC) S 38 B 35         | 08/85 → 12/87 |    | VKMPV 10AVx800  |   |  |   |   |  |  | 1 |  |   |  |   |  |   |       |
| BMW | 5 (E28) 524 d           |               |    |                 |   |  |   |   |  |  |   |  |   |  |   |  |   |       |
|     | M 21 D 24 W             | 03/86 → 12/87 |    | VKMA 08120      | 1 |  |   | 1 |  |  |   |  |   |  |   |  | 1 | T0033 |
|     |                         |               |    | VKM 18120       | 1 |  |   |   |  |  |   |  |   |  |   |  | 1 |       |
|     | M 21 D 24 W             | 03/86 → 12/87 |    | VKPC 88614      |   |  |   |   |  |  |   |  | 1 |  |   |  |   |       |
|     | B(Alt) M 21 D 24 W      | 03/86 → 12/87 |    | VKMPV 10AVx1000 |   |  |   |   |  |  | 1 |  |   |  |   |  |   |       |
|     | B(PS) M 21 D 24 W       | 03/86 → 12/87 |    | VKMPV 10AVx865  |   |  |   |   |  |  | 1 |  |   |  |   |  |   |       |
| BMW | 5 (E28) 524 td          |               |    |                 |   |  |   |   |  |  |   |  |   |  |   |  |   |       |
|     | M 21 D 24 WA            | 09/83 → 12/87 |    | VKMA 08120      | 1 |  |   | 1 |  |  |   |  |   |  |   |  | 1 | T0033 |
|     |                         |               |    | VKM 18120       | 1 |  |   |   |  |  |   |  |   |  |   |  | 1 |       |
|     | M 21 D 24 WA            | 09/83 → 12/87 |    | VKPC 88614      |   |  |   |   |  |  |   |  | 1 |  |   |  |   |       |
|     | B(Alt) M 21 D 24 WA     | 09/83 → 12/87 |    | VKMPV 10AVx1000 |   |  |   |   |  |  | 1 |  |   |  |   |  |   |       |
|     | B(PS) M 21 D 24 WA      | 09/83 → 12/87 |    | VKMPV 10AVx865  |   |  |   |   |  |  | 1 |  |   |  |   |  |   |       |
| BMW | 5 (E34) 518             |               |    |                 |   |  |   |   |  |  |   |  |   |  |   |  |   |       |
|     | M 43 B 18               | 08/89 → 09/95 |    | <b>OXOXOXO</b>  |   |  |   |   |  |  |   |  |   |  |   |  |   |       |
|     | M 40 B 18               | 12/90 → 09/91 |    | VKMA 08000      | 1 |  | 2 | 1 |  |  |   |  |   |  |   |  |   | T0087 |
|     |                         |               |    | VKM 18000       | 1 |  |   |   |  |  |   |  |   |  |   |  |   |       |
|     |                         |               |    | VKM 28000       |   |  |   | 1 |  |  |   |  |   |  |   |  |   |       |
|     |                         |               |    | VKM 28001       |   |  |   | 1 |  |  |   |  |   |  |   |  |   |       |
|     | M 40 B 18               | 10/91 → 09/95 |    | VKMA 08001      | 1 |  | 2 | 1 |  |  |   |  |   |  |   |  |   | T0087 |
|     |                         |               |    | VKM 18001       | 1 |  |   |   |  |  |   |  |   |  |   |  |   |       |
|     |                         |               |    | VKM 28000       |   |  |   | 1 |  |  |   |  |   |  |   |  |   |       |
|     |                         |               |    | VKM 28001       |   |  |   | 1 |  |  |   |  |   |  |   |  |   |       |
|     | M 40 B 18               | 08/89 → 09/91 |    | VKPC 88611      |   |  |   |   |  |  |   |  | 1 |  |   |  |   |       |
|     | M 40 B 18               | 10/91 → 09/95 |    | VKPC 88616      |   |  |   |   |  |  |   |  | 1 |  |   |  |   |       |
|     | M 43 B 18               | 08/89 → 09/95 |    | VKPC 88615      |   |  |   |   |  |  |   |  | 1 |  |   |  |   |       |
|     | B(Alt) M 40 B 18        | 08/89 → 09/91 |    | VKMPV 10AVx1013 |   |  |   |   |  |  | 1 |  |   |  |   |  |   |       |
|     | B(Alt) M 40 B 18        | 09/91 → 09/95 |    | VKMPV 10AVx1025 |   |  |   |   |  |  | 1 |  |   |  |   |  |   |       |
|     | B(Alt) M 43 B 18        | 08/89 → 09/95 |    | VKMPV 6PK1660   |   |  |   |   |  |  | 1 |  |   |  |   |  |   |       |
|     |                         |               |    | VKM 38004       |   |  |   | 1 |  |  |   |  |   |  |   |  |   |       |
|     |                         |               |    | VKM 38004       |   |  |   | 1 |  |  |   |  |   |  |   |  |   |       |
|     |                         |               |    | VKM 38008       |   |  |   |   |  |  |   |  |   |  | 1 |  |   |       |
|     | B(PS) M 40 B 18         | 08/89 → 09/95 |    | VKMPV 10AVx800  |   |  |   |   |  |  | 1 |  |   |  |   |  |   |       |
|     | B(AC) M 40 B 18         | 08/89 → 09/91 |    | VKMPV 13AVx850  |   |  |   |   |  |  | 1 |  |   |  |   |  |   |       |
|     | B(AC) M 43 B 18         | 08/89 → 09/95 |    | VKMPV 4PK889    |   |  |   |   |  |  | 1 |  |   |  |   |  |   |       |
|     |                         |               |    | VKM 38230       | 1 |  |   |   |  |  |   |  |   |  |   |  |   |       |
| BMW | 5 (E34) 520             |               |    |                 |   |  |   |   |  |  |   |  |   |  |   |  |   |       |
|     | M 50 B 20               | 09/89 → 09/95 |    | <b>OXOXOXO</b>  |   |  |   |   |  |  |   |  |   |  |   |  |   |       |
|     | M 20 B 20               | 01/88 → 12/90 |    | VKMA 08110      | 1 |  |   | 1 |  |  |   |  |   |  |   |  |   | T0032 |
|     |                         |               |    | VKM 18100       | 1 |  |   |   |  |  |   |  |   |  |   |  |   |       |
|     | M 20 B 20               | 01/88 → 08/91 |    | VKPC 88607      |   |  |   |   |  |  |   |  | 1 |  |   |  |   |       |
|     | M 50 B 20               | 09/89 → 09/95 |    | VKPC 88617      |   |  |   |   |  |  |   |  | 1 |  |   |  |   |       |
|     | B(Alt), B(AC) M 50 B 20 | 01/92 → 09/95 | HT | VKMA 38261      | 1 |  | 2 | 2 |  |  |   |  |   |  | 2 |  |   |       |
|     | B(Alt), B(AC) M 50 B 20 | 09/94 → 09/95 | MT | VKMA 38265      | 1 |  | 1 | 2 |  |  |   |  |   |  | 1 |  |   |       |
|     | B(Alt) M 50 B 20        | 09/91 → 09/94 | MT | VKMA 38202      | 2 |  |   | 1 |  |  |   |  |   |  |   |  |   |       |
|     |                         |               |    | VKMPV 6PK1555   |   |  |   | 1 |  |  |   |  |   |  |   |  |   |       |
|     |                         |               |    | VKM 38003       | 1 |  |   |   |  |  |   |  |   |  |   |  |   |       |
|     |                         |               |    | VKM 38202       | 1 |  |   |   |  |  |   |  |   |  |   |  |   |       |
|     | B(Alt) M 50 B 20        | 09/94 → 09/95 | MT | VKMA 38241      | 1 |  |   | 1 |  |  |   |  |   |  |   |  |   |       |
|     |                         |               |    | VKMPV 6PK1555   |   |  |   | 1 |  |  |   |  |   |  |   |  |   |       |
|     |                         |               |    | VKM 38202       | 1 |  |   |   |  |  |   |  |   |  |   |  |   |       |

|   |  |  |           |  |  |  |  |  |  |  |  |  |
|---|---|---|--|--|---|---|---|---|---|---|---|---|
| <b>B(Alt)</b>   | M 50 B 20   | 09/91 → 09/95   | HT   | VKMA 38242<br>VKMV 6PK1555<br>VKM 38003<br>VKM 38004<br>VKM 38007                  | 1   | 1   | 1   |   | 1   |   |   |   |
| <b>B(AC)</b>  | M 50 B  | 01/92 → 09/95   |  | VKMA 38242<br>VKMV 6PK1555<br>VKM 38003<br>VKM 38004<br>VKM 38007                  |   | 1   | 1   |   | 1   |   |   |   |
| <b>BMW  5 (E34) 525</b>      |   |   |  |  |   |   |   |   |   |   |   |   |
|                              | M 50 B 25, M 52 B 25  | 09/89 → 09/95   |  | <b>OXOXOXO</b>   |   |   |   |   |   |   |   |   |
|   | M 20 B 25   | 01/88 → 08/91   |  | VKMA 08110<br>VKM 18100  | 1   |   | 1   |   |   |   |   | T0032   |
|                              | M 20 B 25   | 01/88 → 08/91   |  | VKPC 88607   |   |   |   |   | 1   |   |   |   |
|   | M 50 B 25, M 52 B 25  | 09/89 → 01/90   |  | VKPC 88802   |   |   |   |   | 1   |   |   |   |
|   | M 50 B 25, M 52 B 25  | 01/90 → 09/95   |  | VKPC 88617   |   |   |   |   | 1   |   |   |   |
|                              | <b>B(Alt), B(AC)</b> M 50 B 25,<br>M 52 B 25                                      | 01/92 → 09/95   | HT   | VKMA 38261   | 1   | 2   | 2   |   |   | 2   |   |   |
|   | <b>B(Alt), B(AC)</b> M 50 B 25,<br>M 52 B 25                                      | 09/94 → 09/95   | MT   | VKMA 38265   | 1   | 1   | 2   |   |   | 1   |   |   |
|   | <b>B(Alt)</b> M 50 B 25, M 52 B 25  | 09/91 → 09/94   | MT   | VKMA 38202<br>VKMV 6PK1555<br>VKM 38003<br>VKM 38202                               | 2   |   | 1   |   |   |   |   |   |
|   | <b>B(Alt)</b> M 50 B 25, M 52 B 25  | 09/94 → 09/95   | MT   | VKMA 38241<br>VKMV 6PK1555<br>VKM 38202  | 1   |   | 1   |   |   |   |   |   |
|   | <b>B(Alt)</b> M 50 B 25, M 52 B 25  | 09/91 → 09/95   | HT   | VKMA 38242<br>VKMV 6PK1555<br>VKM 38003<br>VKM 38004<br>VKM 38007                  | 1   | 1   | 1   |   |   | 1   |   |   |
|   | <b>B(AC)</b> M 50 B 25, M 52 B 25   | 01/92 → 09/95   |  | VKMA 38242<br>VKMV 6PK1555<br>VKM 38003<br>VKM 38004<br>VKM 38007                  |   | 1   | 1   |   |   | 1   |   |   |
| <b>BMW  5 (E34) 530</b>    |   |   |  |  |   |   |   |   |   |   |   |   |
|                            | M 30 B 30, M 60 B 30  | 01/88 → 09/95   |  | <b>OXOXOXO</b>   |   |   |   |   |   |   |   |   |
|                            | M 30 B 30   | 01/88 → 08/91   |  | VKPC 88802   |   |   |   |   | 1   |   |   |   |
|   | M 60 B 30   | 09/92 → 09/95   |  | VKPC 88831   |   |   |   |   | 1   |   |   |   |
|                            | <b>B(Alt)</b> M 60 B 30   | 09/92 → 09/95   |  104 mm | VKMV 7PK1580   |   |   | 1   |   |   |   |   |   |
|   | <b>B(Alt)</b> M 60 B 30   | 09/92 → 09/95   |  117 mm | VKMV 7PK1605   |   |   | 1   |   |   |   |   |   |
|   | <b>B(AC)</b> M 60 B 30  | 09/92 → 09/95   |  | VKMV 5PK980  |   |   | 1   |   |   |   |   |   |
| <b>BMW  5 (E34) 535</b>    |   |   |  |  |   |   |   |   |   |   |   |   |
|                            | M 30 B 35   | 01/88 → 09/95   |  | <b>OXOXOXO</b>   |   |   |   |   |   |   |   |   |
|                            | M 30 B 35   | 01/88 → 09/95   |  | VKPC 88802   |   |   |   |   | 1   |   |   |   |
| <b>BMW  5 (E34) 540</b>    |   |   |  |  |   |   |   |   |   |   |   |   |
|                            | M 60 B 40   | 09/92 → 09/95   |  | <b>OXOXOXO</b>   |   |   |   |   |   |   |   |   |
|                            | M 60 B 40   | 09/92 → 09/95   |  | VKPC 88831   |   |   |   |   | 1   |   |   |   |
|                            | <b>B(Alt)</b> M 60 B 40   | 09/92 → 09/95   |  104 mm | VKMV 7PK1580   |   |   | 1   |   |   |   |   |   |
|   | <b>B(Alt)</b> M 60 B 40   | 09/92 → 09/95   |  117 mm | VKMV 7PK1605   |   |   | 1   |   |   |   |   |   |
|   | <b>B(AC)</b> M 60 B 40  | 09/92 → 09/95   |  | VKMV 5PK980  |   |   | 1   |   |   |   |   |   |
| <b>BMW  5 (E34) M5</b>     |   |   |  |  |   |   |   |   |   |   |   |   |
|                            | S 38 B 36, S 38 B 38  | 10/88 → 09/95   |  | <b>OXOXOXO</b>   |   |   |   |   |   |   |   |   |
|                            | S 38 B 36   | 10/88 → 11/89   |  | —  |   |   |   |   | 1   |   |   |   |
|   | S 38 B 36, S 38 B 38  | 11/89 → 09/95   |  | —  |   |   |   |   | 1   |   |   |   |
| <b>BMW  5 (E34) 524 td</b> |   |   |  |  |   |   |   |   |   |   |   |   |
|                            | M 21 D 24,<br>M 21 D 24 WA  | 03/88 → 09/95   |  | VKMA 08120<br>VKM 18120  | 1   |   | 1   |   |   |   | 1   | T0033   |
|   | M 21 D 24,<br>M 21 D 24 WA  | 03/88 → 09/95   |  | VKMA 08120<br>VKM 18120  | 1   |   |   |   |   |   | 1   |   |
|                            | M 21 D 24,<br>M 21 D 24 WA  | 03/88 → 09/95   |  | VKPC 88612   |   |   |   |   | 1   |   |   |   |











































BMW









































|  |  |  |        |  |  |  |  |  |  |  |  |  |
|--|---|---|---|--|---|---|---|---|---|---|---|---|
|  <b>B(Alt)</b>                     | M 21 D 24,<br>M 21 D 24 WA  | 03/88 → 09/95   |   | VKMV 13AVx825<br>VKM 38009   | 1   | 1   |   |   |   |   |   |   |
| <b>BMW  5 (E34) 525 td</b>        |   |   |   |  |   |   |   |   |   |   |   |   |
|                                    | M 51 D 25   | 04/93 → 09/95   |   | <del>OKOKOKO</del>   |   |   |   |   |   |   |   |   |
|                                    | M 51 D 25   | 04/93 → 09/95   |   | VKPC 88826   |   |   |   | 1   |   |   |   |   |
|                                    | <b>B(Alt)</b> M 51 D 25   | 04/93 → 09/95   |   | VKMV 5PK1815<br>VKM 38220<br>VKM 38225   | 1   | 1   |   |   |   |   |   |   |
|  | <b>B(AC)</b> M 51 D 25  | 10/94 → 09/95   |   | VKMV 4PK781<br>VKM 38230   | 1   | 1   |   |   |   |   |   |   |
|                                    | M 51 D 25   | 04/93 → 09/95   |   | VKM_____   |   |   |   | 1   |   |   |   |   |
| <b>BMW  5 (E34) 525 tds</b>       |   |   |   |  |   |   |   |   |   |   |   |   |
|                                    | M 51 D 25   | 09/91 → 09/95   |   | <del>OKOKOKO</del>   |   |   |   |   |   |   |   |   |
|                                    | M 51 D 25   | 09/91 → 09/95   |   | VKPC 88826   |   |   |   | 1   |   |   |   |   |
|                                    | <b>B(Alt)</b> M 51 D 25   | 09/91 → 09/95   |   | VKMV 5PK1815<br>VKM 38220<br>VKM 38225   | 1   | 1   |   |   |   |   |   |   |
|  | <b>B(AC)</b> M 51 D 25  | 10/94 → 09/95   |   | VKMV 4PK781<br>VKM 38230   | 1   | 1   |   |   |   |   |   |   |
|                                    | M 51 D 25   | 09/91 → 09/95   |   | VKM_____   |   |   |   | 1   |   |   |   |   |
| <b>BMW  5 Touring (E34) 518</b>   |   |   |   |  |   |   |   |   |   |   |   |   |
|                                    | M 43 B 18   | 09/94 → 01/97   |   | <del>OKOKOKO</del>   |   |   |   |   |   |   |   |   |
|  | M 40 B 18   | 03/93 → 09/94   |   | VKMA 08001<br>VKM 18001<br>VKM 28000<br>VKM 28001                                  | 1<br>1  | 2<br>1<br>1   | 1   |   |   |   |   | T0087   |
|                                  | M 40 B 18   | 03/93 → 09/94   |   | VKPC 88616   |   |   |   | 1   |   |   |   |   |
|  | M 43 B 18   | 09/94 → 01/97   |   | VKPC 88615   |   |   |   | 1   |   |   |   |   |
|                                  | <b>B(Alt)</b> M 40 B 18   | 03/93 → 09/94   |   | VKMV 10AVx1025   |   |   |   | 1   |   |   |   |   |
|  | <b>B(Alt)</b> M 43 B 18   | 09/94 → 01/97   |  80A | VKMV 6PK1660<br>VKM 38004<br>VKM 38004<br>VKM 38008                                |   | 1<br>1  | 1   |   |   | 1   |   |   |
|  | <b>B(PS)</b> M 40 B 18  | 03/93 → 09/94   |   | VKMV 10AVx800  |   |   |   | 1   |   |   |   |   |
|  | <b>B(AC)</b> M 43 B 18  | 09/94 → 01/97   |   | VKMV 4PK889<br>VKM 38230   | 1   |   |   | 1   |   |   |   |   |
| <b>BMW  5 Touring (E34) 520</b> |   |   |   |  |   |   |   |   |   |   |   |   |
|                                  | M 50 B 20   | 11/91 → 01/97   |   | <del>OKOKOKO</del>   |   |   |   |   |   |   |   |   |
|                                  | M 50 B 20   | 11/91 → 01/97   |   | VKPC 88617   |   |   |   | 1   |   |   |   |   |
|                                  | <b>B(Alt), B(AC)</b> M 50 B 20  | 01/92 → 01/97   | HT  | VKMA 38261   | 1   | 2   | 2   |   |   | 2   |   |   |
|  | <b>B(Alt), B(AC)</b> M 50 B 20  | 09/94 → 01/97   | MT  | VKMA 38265   | 1   | 1   | 2   |   |   | 1   |   |   |
|  | <b>B(Alt)</b> M 50 B 20   | 11/91 → 09/94   | MT  | VKMA 38202<br>VKMV 6PK1555<br>VKM 38003<br>VKM 38202                               | 2<br>1<br>1   |   | 1<br>1  |   |   |   |   |   |
|  | <b>B(Alt)</b> M 50 B 20   | 09/94 → 01/97   | MT  | VKMA 38241<br>VKMV 6PK1555<br>VKM 38202  | 1<br>1  |   | 1<br>1  |   |   |   |   |   |
|  | <b>B(Alt)</b> M 50 B 20   | 11/91 → 01/97   | HT  | VKMA 38242<br>VKMV 6PK1555<br>VKM 38003<br>VKM 38004<br>VKM 38007                  | 1<br>1  | 1<br>1  | 1<br>1  |   |   | 1   |   |   |
|  | <b>B(AC)</b> M 50 B   | 01/92 → 01/97   |   | VKMV 5PK906<br>VKM 38004<br>VKM 38011  |   | 1   | 1   |   |   |   | 1   |   |
| <b>BMW  5 Touring (E34) 525</b> |   |   |   |  |   |   |   |   |   |   |   |   |
|                                  | M 50 B 25, M 52 B 25  | 11/91 → 01/97   |   | <del>OKOKOKO</del>   |   |   |   |   |   |   |   |   |
|                                  | M 50 B 25, M 52 B 25  | 11/91 → 01/97   |   | VKPC 88617   |   |   |   | 1   |   |   |   |   |
|                                  | <b>B(Alt), B(AC)</b> M 50 B 25,<br>M 52 B 25                                      | 01/92 → 01/97   | HT  | VKMA 38261   | 1   | 2   | 2   |   |   | 2   |   |   |

|  |  |  |    |  |  |  |  |  |  |  |  |
|--|---|---|---|--|---|---|---|---|---|---|---|
| <b>B(Alt), B(AC)</b> M 50 B 25,<br>M 52 B 25   |   |   |   |  |   |   |   |   |   |   |   |
|  |   | 09/94 → 01/97   | MT  | VKMA 38265   | 1   | 1   | 2   |   |   | 1   |   |
| <b>B(Alt)</b> M 50 B 25, M 52 B 25   |   | 11/91 → 09/94   | MT  | VKMA 38202<br>VKMV 6PK1555<br>VKM 38003<br>VKM 38202                               | 2<br>1<br>1   |   | 1<br>1  |   |   |   |   |
| <b>B(Alt)</b> M 50 B 25, M 52 B 25   |   | 09/94 → 01/97   | MT  | VKMA 38241<br>VKMV 6PK1555<br>VKM 38202  | 1<br>1  |   | 1<br>1  |   |   |   |   |
| <b>B(Alt)</b> M 50 B 25, M 52 B 25   |   | 11/91 → 01/97   | HT  | VKMA 38242<br>VKMV 6PK1555<br>VKM 38003<br>VKM 38004<br>VKM 38007                  | 1<br>1  | 1<br>1  |   |   | 1   |   |   |
| <b>B(AC)</b> M 50 B 25, M 52 B 25  |   | 01/92 → 01/97   |   | VKMV 5PK906<br>VKM 38004<br>VKM 38011  |   | 1   | 1   |   |   | 1   |   |
| <b>BMW  5 Touring (E34) 530</b>       |   |   |   |  |   |   |   |   |   |   |   |
|                                       | M 60 B 30   | 09/92 → 01/97   |   | OKOKOKO  |   |   |   |   |   |   |   |
|                                       | M 60 B 30   | 09/92 → 01/97   |   | VKPC 88831   |   |   |   |   | 1   |   |   |
|                                       | <b>B(Alt)</b> M 60 B 30   | 09/92 → 01/97   |    | VKMV 7PK1580   |   |   | 1   |   |   |   |   |
|                                       | <b>B(Alt)</b> M 60 B 30   | 09/92 → 01/97   |    | VKMV 7PK1605   |   |   | 1   |   |   |   |   |
| <b>BMW  5 Touring (E34) 540</b>       |   |   |   |  |   |   |   |   |   |   |   |
|                                       | M 60 B 40   | 09/93 → 01/97   |   | OKOKOKO  |   |   |   |   |   |   |   |
|                                      | M 60 B 40   | 09/93 → 01/97   |   | VKPC 88831   |   |   |   |   | 1   |   |   |
|                                     | <b>B(Alt)</b> M 60 B 40   | 09/93 → 01/97   |  | VKMV 7PK1580   |   |   | 1   |   |   |   |   |
|                                     | <b>B(Alt)</b> M 60 B 40   | 09/93 → 01/97   |  | VKMV 7PK1605   |   |   | 1   |   |   |   |   |
| <b>BMW  5 Touring (E34) M5</b>      |   |   |   |  |   |   |   |   |   |   |   |
|                                     | S 38 B 38   | 09/94 → 01/97   |   | OKOKOKO  |   |   |   |   |   |   |   |
|                                     | S 38 B 38   | 09/94 → 01/97   |   | —  |   |   |   |   | 1   |   |   |
| <b>BMW  5 Touring (E34) 525 td</b>  |   |   |   |  |   |   |   |   |   |   |   |
|                                     | M 51 D 25   | 03/93 → 01/97   |   | OKOKOKO  |   |   |   |   |   |   |   |
|                                     | M 51 D 25   | 03/93 → 01/97   |   | VKPC 88826   |   |   |   |   | 1   |   |   |
|                                     | <b>B(Alt)</b> M 51 D 25   | 03/93 → 01/97   |   | VKMV 5PK1815<br>VKM 38220<br>VKM 38225   | 1   |   | 1   |   |   |   |   |
|  | <b>B(AC)</b> M 51 D 25  | 10/94 → 01/97   |   | VKMV 4PK781<br>VKM 38230   | 1   |   | 1   |   |   |   |   |
|                                     | M 51 D 25   | 03/93 → 01/97   |   | VKM_____   |   |   |   |   | 1   |   |   |
| <b>BMW  5 Touring (E34) 525 tds</b> |   |   |   |  |   |   |   |   |   |   |   |
|                                     | M 51 D 25   | 12/91 → 01/97   |   | OKOKOKO  |   |   |   |   |   |   |   |
|                                     | M 51 D 25   | 12/91 → 01/97   |   | VKPC 88826   |   |   |   |   | 1   |   |   |
|                                     | <b>B(Alt)</b> M 51 D 25   | 12/91 → 01/97   |   | VKMV 5PK1815<br>VKM 38220<br>VKM 38225   | 1   |   | 1   |   |   |   |   |
|  | <b>B(AC)</b> M 51 D 25  | 10/94 → 01/97   |   | VKMV 4PK781<br>VKM 38230   | 1   |   | 1   |   |   |   |   |
|                                     | M 51 D 25   | 12/91 → 01/97   |   | VKM_____   |   |   |   |   | 1   |   |   |
| <b>BMW  5 (E39) 520</b>             |   |   |   |  |   |   |   |   |   |   |   |
|                                     | M 52 B, M 54 B 22   | 01/96 → 06/03   |   | OKOKOKO  |   |   |   |   |   |   |   |
|                                     | M 52 B, M 54 B 22   | 01/96 → 06/03   |   | VKPC 88617   |   |   |   |   | 1   |   |   |
|                                     | <b>B(Alt)</b> M 52 B  | 01/96 → 08/98   | MT  | VKMA 38241<br>VKMV 6PK1555<br>VKM 38202  | 1<br>1  |   | 1<br>1  |   |   |   |   |
|  | <b>B(Alt)</b> M 52 B  | 01/96 → 09/98   | HT  | VKMA 38242<br>VKMV 6PK1555<br>VKM 38003<br>VKM 38004<br>VKM 38007                  | 1<br>1  | 1<br>1  | 1<br>1  |   | 1   |   |   |
|  | <b>B(Alt)</b> M 52 B  | 09/98 → 09/00   | MT  | VKMV 6PK1538<br>VKM 38003<br>VKM 38202   | 1<br>1  |   | 1   |   |   |   |   |





















































BMW

|  |  |  |  |  |  |  |  |  |  |  |  |  |  |  |  |  |
|--|---|---|---|--|---|---|---|---|---|---|---|---|---|---|---|---|
| B(Alt)   | M 52 B  | 09/98 → 09/00   | HT  | VKMV 6PK1538<br>VKM 38003<br>VKM 38004<br>VKM 38007                                | 1   |   | 1   |   |   |   |   |   |   |   |   |   |
| B(AC)  | M 52 B  | 02/96 → 03/98   |   | VKMV 5PK906<br>VKM 38004<br>VKM 38011  |   | 1   | 1   |   |   | 1   |   |   |   |   |   |   |
| B(AC)  | M 52 B, M 54 B 22   | 03/98 → 09/02   |   | VKMV 5PK863<br>VKM 38231   | 1   |   | 1   |   |   |   |   |   |   |   |   |   |
| <b>BMW  5 (E39) 525</b>     |   |   |   |  |   |   |   |   |   |   |   |   |   |   |   |   |
|                              | M 52 B 25, M54256S5   | 11/95 → 06/03   |   | OXOXOXO  |   |   |   |   |   |   |   |   |   |   |   |   |
|                              | M 52 B 25, M54256S5   | 11/95 → 06/03   |   | VKPC 88617   |   |   |   |   |   | 1   |   |   |   |   |   |   |
|                              | B(Alt) M 52 B 25  | 11/95 → 09/98   | MT  | VKMA 38241<br>VKMV 6PK1555<br>VKM 38202  | 1   |   | 1   |   |   |   |   |   |   |   |   |   |
|  |   |   |   |  | 1   |   | 1   |   |   |   |   |   |   |   |   |   |
| B(Alt)   | M 52 B 25   | 11/95 → 09/98   | HT  | VKMA 38242<br>VKMV 6PK1555<br>VKM 38003<br>VKM 38004<br>VKM 38007                  | 1   | 1   | 1   |   |   | 1   |   |   |   |   |   |   |
|  |   |   |   |  | 1   |   | 1   |   |   |   |   |   |   |   |   |   |
| <b>BMW  5 (E39) 528</b>     |   |   |   |  |   |   |   |   |   |   |   |   |   |   |   |   |
|                              | M 52 B 28   | 11/95 → 09/00   |   | OXOXOXO  |   |   |   |   |   |   |   |   |   |   |   |   |
|                              | M 52 B 28   | 11/95 → 09/00   |   | VKPC 88617   |   |   |   |   |   | 1   |   |   |   |   |   |   |
|                              | B(Alt) M 52 B 28  | 11/95 → 09/98   | MT  | VKMA 38241<br>VKMV 6PK1555<br>VKM 38202  | 1   |   | 1   |   |   |   |   |   |   |   |   |   |
|  |   |   |   |  | 1   |   | 1   |   |   |   |   |   |   |   |   |   |
| <b>BMW  5 (E39) 530</b>   |   |   |   |  |   |   |   |   |   |   |   |   |   |   |   |   |
|                            | M54306S3  | 09/00 → 06/03   |   | OXOXOXO  |   |   |   |   |   |   |   |   |   |   |   |   |
|                            | M54306S3  | 09/00 → 06/03   |   | VKPC 88617   |   |   |   |   |   | 1   |   |   |   |   |   |   |
| <b>BMW  5 (E39) 535</b>   |   |   |   |  |   |   |   |   |   |   |   |   |   |   |   |   |
|                            | M 62 B  | 04/96 → 06/03   |   | OXOXOXO  |   |   |   |   |   |   |   |   |   |   |   |   |
|                            | M 62 B  | 04/96 → 09/98   |   | VKPC 88829   |   |   |   |   |   | 1   |   |   |   |   |   |   |
|  | M 62 B  | 09/98 → 06/03   |   | —  |   |   |   |   |   | 1   |   |   |   |   |   |   |
|                            | B(Alt) M 62 B   | 04/96 → 08/97   |   | VKMV 7PK1629   |   |   | 1   |   |   |   |   |   |   |   |   |   |
| B(Alt)   | M 62 B  | 09/97 → 09/98   |   | VKMV 7PK1629   |   |   | 1   |   |   |   |   |   |   |   |   |   |
| B(Alt)   | M 62 B  | 10/98 → 06/03   |   | VKMV 7PK1635   |   |   | 1   |   |   |   |   |   |   |   |   |   |
| B(AC)  | M 62 B  | 04/96 → 08/97   |   | VKMV 5PK1004   |   |   | 1   |   |   |   |   |   |   |   |   |   |
| B(AC)  | M 62 B  | 09/97 → 06/03   |   | VKMV 5PK1004   |   |   | 1   |   |   |   |   |   |   |   |   |   |
| <b>BMW  5 (E39) 540</b>   |   |   |   |  |   |   |   |   |   |   |   |   |   |   |   |   |
|                            | M 62 B 44   | 04/96 → 06/03   |   | OXOXOXO  |   |   |   |   |   |   |   |   |   |   |   |   |
|                            | M 62 B 44   | 04/96 → 09/98   |   | VKPC 88829   |   |   |   |   |   | 1   |   |   |   |   |   |   |
|  | M 62 B 44   | 09/98 → 06/03   |   | —  |   |   |   |   |   | 1   |   |   |   |   |   |   |
|                            | B(Alt) M 62 B 44  | 04/96 → 08/97   |   | VKMV 7PK1629   |   |   | 1   |   |   |   |   |   |   |   |   |   |
| B(Alt)   | M 62 B 44   | 09/97 → 09/98   |   | VKMV 7PK1629   |   |   | 1   |   |   |   |   |   |   |   |   |   |
| B(Alt)   | M 62 B 44   | 10/98 → 05/99   |   | VKMV 7PK1635   |   |   | 1   |   |   |   |   |   |   |   |   |   |
| B(AC)  | M 62 B 44   | 04/96 → 09/97   |   | VKMV 5PK1004   |   |   | 1   |   |   |   |   |   |   |   |   |   |
| B(AC)  | M 62 B 44   | 10/97 → 06/03   |   | VKMV 5PK1004   |   |   | 1   |   |   |   |   |   |   |   |   |   |
| <b>BMW  5 (E39) M5</b>    |   |   |   |  |   |   |   |   |   |   |   |   |   |   |   |   |
|                            | S 38 B 49, S 62 B 50  | 10/98 → 06/03   |   | OXOXOXO  |   |   |   |   |   |   |   |   |   |   |   |   |
|                            | S 38 B 49, S 62 B 50  | 10/98 → 06/03   |   | —  |   |   |   |   |   | 1   |   |   |   |   |   |   |
| <b>BMW  5 (E39) 520 d</b> |   |   |   |  |   |   |   |   |   |   |   |   |   |   |   |   |
|                            | M 47 D 20, M47204D1   | 02/00 → 06/03   |   | OXOXOXO  |   |   |   |   |   |   |   |   |   |   |   |   |
|                            | M 47 D 20, M47204D1   | 02/00 → 06/03   |   | VKPC 88637   |   |   |   |   |   | 1   |   |   |   |   |   |   |
|                            | B(Alt) M 47 D 20, M47204D1  | 02/00 → 06/03   |   | VKMV 5PK2030<br>VKM 38220<br>VKM 38240   | 1   |   | 1   |   |   |   |   |   |   |   |   |   |
|  |   |   |   |  |   |   | 1   |   |   |   |   |   |   |   |   |   |
| B(AC)  | M 47 D 20, M47204D1   | 02/00 → 06/03   |   | VKMV 5PK836  |   |   | 1   |   |   |   |   |   |   |   |   |   |
| <b>BMW  5 (E39) 525 d</b> |   |   |   |  |   |   |   |   |   |   |   |   |   |   |   |   |
|                            | M57256D1  | 02/00 → 06/03   |   | VKPC 88430   |   |   |   |   |   | 1   |   |   |   |   |   |   |

















































|  |  |  |  |  |  |  |  |  |  |  |  |  |
|--|---|---|---|--|---|---|---|---|---|---|---|---|
|                                   | B(Alt)  | M57256D1  | 02/00 → 06/03   | VKMV 5PK2063<br>VKM 38240<br>VKM 38240   |   | 1   | 1   |   |   |   |   |   |
|  | B(AC)   | M57256D1  | 10/00 → 06/03   | VKMV 5PK810  |   | 1   |   |   |   |   |   |   |
| <b>BMW  5 (E39) 525 td</b>        |   |   |   |  |   |   |   |   |   |   |   |   |
|                                   |   | M 51 D 25   | 01/97 → 06/03   | <b>OXOXOXO</b>   |   |   |   |   |   |   |   |   |
|                                   |   | M 51 D 25   | 01/97 → 06/03   | VKPC 88826   |   |   |   | 1   |   |   |   |   |
|                                   | B(Alt)  | M 51 D 25   | 01/97 → 06/03   | ⊗ 140A   | VKMV 5PK1815<br>VKM 38220<br>VKM 38225  | 1   |   | 1   |   |   |   |   |
|  | B(AC)   | M 51 D 25   | 01/97 → 06/03   |  | VKMV 4PK780   |   |   | 1   |   |   |   |   |
|                                   |   | M 51 D 25   | 01/97 → 06/03   |  | VKM_____  |   |   |   |   | 1   |   |   |
| <b>BMW  5 (E39) 525 tds</b>       |   |   |   |  |   |   |   |   |   |   |   |   |
|                                   |   | M 51 D 25   | 01/96 → 06/03   | <b>OXOXOXO</b>   |   |   |   |   |   |   |   |   |
|                                   |   | M 51 D 25   | 01/96 → 06/03   |  | VKPC 88826  |   |   |   | 1   |   |   |   |
|                                   | B(Alt)  | M 51 D 25   | 01/96 → 06/03   | ⊗ 140A   | VKMV 5PK1815<br>VKM 38220<br>VKM 38225  | 1   |   | 1   |   |   |   |   |
|  | B(AC)   | M 51 D 25   | 01/96 → 06/03   |  | VKMV 4PK780   |   |   | 1   |   |   |   |   |
|                                   |   | M 51 D 25   | 01/96 → 06/03   | Man. GBX   | VKM_____  |   |   |   |   | 1   |   |   |
| <b>BMW  5 (E39) 530 d</b>         |   |   |   |  |   |   |   |   |   |   |   |   |
|                                   |   | M 57 D 30   | 08/98 → 06/03   | <b>OXOXOXO</b>   |   |   |   |   |   |   |   |   |
|                                   |   | M 57 D 30   | 09/99 → 06/03   |  | VKPC 88430  |   |   |   | 1   |   |   |   |
|                                  | B(Alt)  | M 57 D 30   | 08/98 → 06/03   |  | VKMV 5PK2063<br>VKM 38240<br>VKM 38240  |   |   | 1   |   |   |   |   |
|  | B(AC)   | M 57 D 30   | 10/00 → 06/03   |  | VKMV 5PK810   |   |   | 1   |   |   |   |   |
| <b>BMW  5 Touring (E39) 520</b> |   |   |   |  |   |   |   |   |   |   |   |   |
|                                 |   | M 52 B 20   | 01/97 → 05/04   | <b>OXOXOXO</b>   |   |   |   |   |   |   |   |   |
|                                 |   | M 52 B 20   | 01/97 → 05/04   |  | VKPC 88617  |   |   |   | 1   |   |   |   |
|                                 | B(Alt)  | M 52 B 20   | 01/97 → 08/98   | MT   | VKMA 38241<br>VKMV 6PK1555<br>VKM 38202   | 1   |   | 1   |   |   |   |   |
|  | B(Alt)  | M 52 B 20   | 09/98 → 09/00   | MT   | VKMV 6PK1538<br>VKM 38003<br>VKM 38202  | 1   |   | 1   |   |   |   |   |
|  | B(Alt)  | M 52 B 20   | 01/97 → 08/98   | HT   | VKMA 38242<br>VKMV 6PK1555<br>VKM 38003<br>VKM 38004<br>VKM 38007                   | 1   | 1   | 1   |   | 1   |   |   |
|  | B(Alt)  | M 52 B 20   | 09/98 → 09/00   | HT   | VKMV 6PK1538<br>VKM 38003<br>VKM 38004<br>VKM 38007                                 | 1   |   | 1   |   |   | 1   |   |
|  | B(AC)   | M 52 B 20   | 01/97 → 03/98   |  | VKMV 5PK906<br>VKM 38004<br>VKM 38011   |   | 1   |   |   |   | 1   |   |
|  | B(AC)   | M 52 B 20   | 03/98 → 09/00   |  | VKMV 5PK863<br>VKM 38231  | 1   |   | 1   |   |   |   |   |
| <b>BMW  5 Touring (E39) 523</b> |   |   |   |  |   |   |   |   |   |   |   |   |
|                                 |   | M 52 B 25   | 01/97 → 09/00   | <b>OXOXOXO</b>   |   |   |   |   |   |   |   |   |
|                                 |   | M 52 B 25   | 01/97 → 09/00   |  | VKPC 88617  |   |   |   | 1   |   |   |   |
|                                 | B(Alt)  | M 52 B 25   | 01/97 → 09/98   | MT   | VKMA 38241<br>VKMV 6PK1555<br>VKM 38202   | 1   |   | 1   |   |   |   |   |
|  | B(Alt)  | M 52 B 25   | 01/97 → 09/98   | MT   | VKMA 38241<br>VKMV 6PK1555<br>VKM 38202   | 1   |   | 1   |   |   |   |   |
| <b>BMW  5 Touring (E39) 525</b> |   |   |   |  |   |   |   |   |   |   |   |   |
|                                 |   | M54256S5  | 09/00 → 05/04   | <b>OXOXOXO</b>   |   |   |   |   |   |   |   |   |
|                                 |   | M54256S5  | 09/00 → 05/04   |  | VKPC 88617  |   |   |   | 1   |   |   |   |
| <b>BMW  5 Touring (E39) 528</b> |   |   |   |  |   |   |   |   |   |   |   |   |
|                                 |   | M 52 B 28   | 01/97 → 09/00   | <b>OXOXOXO</b>   |   |   |   |   |   |   |   |   |



BMW

|  |  |  |  |  |  |  |  |  |  |  |  |  |
|--|---|---|---|--|---|---|---|---|---|---|---|---|
|                                        | M 52 B 28   | 01/97 → 09/00   |   | VKPC 88617   |   |   |   | 1   |   |   |   |   |
|                                        | <b>B(Alt)</b> M 52 B 28   | 01/97 → 09/98   | MT  | VKMA 38241<br>VKMV 6PK1555<br>VKM 38202  | 1   | 1   |   |   |   |   |   |   |
|  |   |   |   |  | 1   |   |   |   |   |   |   |   |
| <b>BMW  5 Touring (E39) 530</b>       |   |   |   |  |   |   |   |   |   |   |   |   |
|                                        | M54306S3  | 09/00 → 05/04   |   | ОхОхОхО  |   |   |   |   |   |   |   |   |
|                                        | M54306S3  | 09/00 → 05/04   |   | VKPC 88617   |   |   |   | 1   |   |   |   |   |
| <b>BMW  5 Touring (E39) 540</b>       |   |   |   |  |   |   |   |   |   |   |   |   |
|                                        | M 62 B 44   | 01/97 → 05/04   |   | ОхОхОхО  |   |   |   |   |   |   |   |   |
|                                        | M 62 B 44   | 01/97 → 09/98   |   | VKPC 88829   |   |   |   | 1   |   |   |   |   |
|                                        | <b>B(Alt)</b> M 62 B 44   | 01/97 → 08/97   |   | VKMOV 7PK1629  |   | 1   |   |   |   |   |   |   |
|  | <b>B(Alt)</b> M 62 B 44   | 09/97 → 09/98   |   | VKMOV 7PK1629  |   | 1   |   |   |   |   |   |   |
|  | <b>B(Alt)</b> M 62 B 44   | 10/98 → 05/99   |   | VKMOV 7PK1635  |   | 1   |   |   |   |   |   |   |
|  | <b>B(AC)</b> M 62 B 44  | 01/97 → 09/97   |   | VKMOV 5PK1004  |   | 1   |   |   |   |   |   |   |
|  | <b>B(AC)</b> M 62 B 44  | 10/97 → 05/04   |   | VKMOV 5PK1004  |   | 1   |   |   |   |   |   |   |
| <b>BMW  5 Touring (E39) 520 d</b>     |   |   |   |  |   |   |   |   |   |   |   |   |
|                                        | M 47 D 20, M47204D1   | 02/00 → 09/03   |   | ОхОхОхО  |   |   |   |   |   |   |   |   |
|                                        | M 47 D 20, M47204D1   | 02/00 → 09/03   |   | VKPC 88637   |   |   |   | 1   |   |   |   |   |
|                                        | <b>B(Alt)</b> M 47 D 20, M47204D1   | 02/00 → 09/03   |   | VKMOV 5PK2030<br>VKM 38220<br>VKM 38240  | 1   | 1   |   |   |   |   |   |   |
|  |   |   |   |  |   | 1   |   |   |   |   |   |   |
|  | <b>B(AC)</b> M 47 D 20, M47204D1  | 02/00 → 09/03   |   | VKMOV 5PK836   |   | 1   |   |   |   |   |   |   |
| <b>BMW  5 Touring (E39) 525 d</b>     |   |   |   |  |   |   |   |   |   |   |   |   |
|                                       | M57256D1  | 02/00 → 05/04   |   | ОхОхОхО  |   |   |   |   |   |   |   |   |
|                                      | M57256D1  | 02/00 → 05/04   |   | VKPC 88430   |   |   |   | 1   |   |   |   |   |
|                                      | <b>B(Alt)</b> M57256D1  | 02/00 → 05/04   |   | VKMOV 5PK2063<br>VKM 38240<br>VKM 38240  |   | 1   |   |   |   |   |   |   |
|  |   |   |   |  |   | 1   |   |   |   |   |   |   |
|  | <b>B(AC)</b> M57256D1   | 10/00 → 05/04   |   | VKMOV 5PK810   |   | 1   |   |   |   |   |   |   |
| <b>BMW  5 Touring (E39) 525 tds</b> |   |   |   |  |   |   |   |   |   |   |   |   |
|                                      | M 51 D 25   | 03/97 → 05/04   |   | ОхОхОхО  |   |   |   |   |   |   |   |   |
|                                      | M 51 D 25   | 03/97 → 05/04   |   | VKPC 88826   |   |   |   | 1   |   |   |   |   |
|                                      | <b>B(Alt)</b> M 51 D 25   | 03/97 → 05/04   | ⊗ 140A  | VKMOV 5PK1815<br>VKM 38220<br>VKM 38225  | 1   | 1   |   |   |   |   |   |   |
|  |   |   |   |  |   | 1   |   |   |   |   |   |   |
|  | <b>B(AC)</b> M 51 D 25  | 03/97 → 05/04   |   | VKMOV 4PK780   |   | 1   |   |   |   |   |   |   |
|                                      | M 51 D 25   | 03/97 → 05/04   | Man. GBX  | VKM_____   |   |   |   |   | 1   |   |   |   |
| <b>BMW  5 Touring (E39) 530 d</b>   |   |   |   |  |   |   |   |   |   |   |   |   |
|                                      | M 57 D 30   | 08/98 → 05/04   |   | ОхОхОхО  |   |   |   |   |   |   |   |   |
|                                      | M 57 D 30   | 09/99 → 05/04   |   | VKPC 88430   |   |   |   | 1   |   |   |   |   |
|                                      | <b>B(Alt)</b> M 57 D 30   | 08/98 → 05/04   |   | VKMOV 5PK2063<br>VKM 38240<br>VKM 38240  |   | 1   |   |   |   |   |   |   |
|  |   |   |   |  |   | 1   |   |   |   |   |   |   |
|  | <b>B(AC)</b> M 57 D 30  | 10/00 → 05/04   |   | VKMOV 5PK810   |   | 1   |   |   |   |   |   |   |
| <b>BMW  5 (E60) 520</b>             |   |   |   |  |   |   |   |   |   |   |   |   |
|                                      | M54226S1  | 07/03 → 03/06   |   | ОхОхОхО  |   |   |   |   |   |   |   |   |
|                                      | M54226S1  | 07/03 → 01/05   |   | VKPC 88617   |   |   |   | 1   |   |   |   |   |
|                                      | <b>B(Alt)</b> M54226S1  | 07/03 → 03/06   | MT  | VKMOV 6PK1538<br>VKM 38202   | 1   | 1   |   |   |   |   |   |   |
|  |   |   |   |  |   | 1   |   |   |   |   |   |   |
|  | <b>B(AC)</b> M54226S1   | 07/03 → 03/06   |   | VKMOV 4PK843   |   | 1   |   |   |   |   |   |   |
| <b>BMW  5 (E60) 523</b>             |   |   |   |  |   |   |   |   |   |   |   |   |
|                                      | N52B25A   | 07/05 → 03/06   |   | ОхОхОхО  |   |   |   |   |   |   |   |   |
|                                      | N52B25A   | 07/05 → 09/07   |   | —  |   |   |   | 1   |   |   |   |   |
|                                      | <b>B(Alt)</b> N52B25A   | 07/05 → 03/06   |   | VKMOV 6PK1990  |   | 1   |   |   |   |   |   |   |
| <b>BMW  5 (E60) 525</b>             |   |   |   |  |   |   |   |   |   |   |   |   |
|                                      | M54256S5, N52B25A   | 09/03 → 03/06   |   | ОхОхОхО  |   |   |   |   |   |   |   |   |
|                                      | M54256S5  | 09/03 → 01/05   |   | VKPC 88617   |   |   |   | 1   |   |   |   |   |
|                                      | <b>B(Alt)</b> M54256S5  | 09/03 → 03/06   |   | VKMOV 6PK1538<br>VKM 38202   | 1   | 1   |   |   |   |   |   |   |







































































































|  |  |  |  |  |  |  |  |  |  |  |
|--|---|---|---|--|---|---|---|---|---|---|
| <b>B(AC)</b>   | M54256S5  | 09/03 → 03/06   |   | VKMW 4PK843  |   |   |   | 1   |   |   |
| <b>BMW  5 (E60) 530</b>             |   |   |   |  |   |   |   |   |   |   |
|                                     | M54306S3, N52B30A   | 07/03 → 03/06   |   | ОЛОХОХО  |   |   |   |   |   |   |
|                                     | M54306S3  | 07/03 → 09/07   |   | VKPC 88617   |   |   |   | 1   |   |   |
|  | N52B30A   | 07/05 → 09/07   |   | —  |   |   |   | 1   |   |   |
| <b>BMW  5 (E60) 520 d</b>           |   |   |   |  |   |   |   |   |   |   |
|                                     | M47N204D5   | 07/05 → 03/06   |   | ОЛОХОХО  |   |   |   |   |   |   |
|                                     | M47N204D5   | 07/05 → 09/07   |   | VKPC 88645   |   |   |   | 1   |   |   |
|                                     | <b>B(Alt)</b> M47N204D5   | 07/05 → 03/06   |   | VKMW 6PK2080   |   |   |   | 1   |   |   |
| <b>BMW  5 (E60) 525 d</b>           |   |   |   |  |   |   |   |   |   |   |
|                                     | M57N256D4   | 06/04 → 03/06   |   | ОЛОХОХО  |   |   |   |   |   |   |
|                                     | M57N256D4   | 06/04 → 09/07   |   | VKPC 88645   |   |   |   | 1   |   |   |
|                                     | <b>B(Alt)</b> M57N256D4   | 06/04 → 03/06 7)  |   | VKMW 6PK2160   |   |   |   | 1   |   |   |
|  | <b>B(Alt)</b> M57N256D4   | 06/04 → 03/06 8)  |   | VKMW 6PK2080   |   |   |   | 1   |   |   |
|  | <b>B(AC)</b> M57N256D4  | 06/04 → 09/04   |   | VKMW 4PK863  |   |   |   | 1   |   |   |
| <b>BMW  5 (E60) 530 d</b>           |   |   |   |  |   |   |   |   |   |   |
|                                     | M57306D3, N57306D2  | 07/03 → 03/06   |   | ОЛОХОХО  |   |   |   |   |   |   |
|                                     | N57306D2  | 07/03 → 09/07   |   | VKPC 88645   |   |   |   | 1   |   |   |
|                                     | <b>B(Alt)</b> N57306D2  | 07/03 → 03/06 7)  |   | VKMW 6PK2160   |   |   |   | 1   |   |   |
|  | <b>B(Alt)</b> N57306D2  | 07/03 → 03/06 8)  |   | VKMW 6PK2080   |   |   |   | 1   |   |   |
|  | <b>B(AC)</b> N57306D2   | 07/03 → 09/04   |   | VKMW 4PK863  |   |   |   | 1   |   |   |
| <b>BMW  5 (E60) 535 d</b>           |   |   |   |  |   |   |   |   |   |   |
|                                    | M57306D4  | 09/04 → 03/06   |   | ОЛОХОХО  |   |   |   |   |   |   |
|                                   | M57306D4  | 09/04 → 09/07   |   | VKPC 88645   |   |   |   | 1   |   |   |
|                                   | <b>B(Alt)</b> M57306D4  | 09/04 → 03/06 7)  |   | VKMW 6PK2160   |   |   |   | 1   |   |   |
|  | <b>B(Alt)</b> M57306D4  | 09/04 → 03/06 8)  |   | VKMW 6PK2080   |   |   |   | 1   |   |   |
| <b>BMW  5 Touring (E61) 520</b>   |   |   |   |  |   |   |   |   |   |   |
|                                   | M54226S1  | 06/04 → 03/06   |   | ОЛОХОХО  |   |   |   |   |   |   |
|                                   | M54226S1  | 06/04 → 09/07   |   | VKPC 88617   |   |   |   | 1   |   |   |
| <b>BMW  5 Touring (E61) 523</b>   |   |   |   |  |   |   |   |   |   |   |
|                                   | N52B25A   | 07/05 → 03/06   |   | ОЛОХОХО  |   |   |   |   |   |   |
|                                   | N52B25A   | 07/05 → 09/07   |   | —  |   |   |   | 1   |   |   |
|                                   | <b>B(Alt)</b> N52B25A   | 07/05 → 03/06   |   | VKMW 6PK1990   |   |   |   | 1   |   |   |
| <b>BMW  5 Touring (E61) 525</b>   |   |   |   |  |   |   |   |   |   |   |
|                                   | M54256S5, N52B25A   | 06/04 → 03/06   |   | ОЛОХОХО  |   |   |   |   |   |   |
|                                   | M54256S5  | 06/04 → 01/05   |   | VKPC 88617   |   |   |   | 1   |   |   |
|  | N52B25A   | 07/05 → 09/07   |   | —  |   |   |   | 1   |   |   |
| <b>BMW  5 Touring (E61) 530</b>   |   |   |   |  |   |   |   |   |   |   |
|                                   | M54306S3, N52B30A   | 06/04 → 03/06   |   | ОЛОХОХО  |   |   |   |   |   |   |
|                                   | M54306S3  | 06/04 → 09/07   |   | VKPC 88617   |   |   |   | 1   |   |   |
|  | N52B30A   | 07/05 → 09/07   |   | —  |   |   |   | 1   |   |   |
| <b>BMW  5 Touring (E61) 520d</b>  |   |   |   |  |   |   |   |   |   |   |
|                                   | M47N204D5   | 07/05 → 09/07   |   | VKPC 88645   |   |   |   | 1   |   |   |
|                                   | <b>B(Alt)</b> M47N204D5   | 07/05 → 03/06   |   | VKMW 6PK2080   |   |   |   | 1   |   |   |
| <b>BMW  5 Touring (E61) 525 d</b> |   |   |   |  |   |   |   |   |   |   |
|                                   | M57N256D4   | 06/04 → 03/06   |   | ОЛОХОХО  |   |   |   |   |   |   |
|                                   | M57N256D4   | 06/04 → 09/07   |   | VKPC 88645   |   |   |   | 1   |   |   |
|                                   | <b>B(Alt)</b> M57N256D4   | 06/04 → 03/06 7)  |   | VKMW 6PK2160   |   |   |   | 1   |   |   |
|  | <b>B(Alt)</b> M57N256D4   | 06/04 → 03/06 8)  |   | VKMW 6PK2080   |   |   |   | 1   |   |   |
|  | <b>B(AC)</b> M57N256D4  | 06/04 → 09/04   |   | VKMW 4PK863  |   |   |   | 1   |   |   |
| <b>BMW  5 Touring (E61) 530 d</b> |   |   |   |  |   |   |   |   |   |   |
|                                   | M57306D3, N57306D2  | 06/04 → 03/06   |   | ОЛОХОХО  |   |   |   |   |   |   |
|                                   | M57306D3, N57306D2  | 06/04 → 09/07   |   | VKPC 88645   |   |   |   | 1   |   |   |
|                                   | <b>B(Alt)</b> N57306D2  | 06/04 → 03/06 7)  |   | VKMW 6PK2160   |   |   |   | 1   |   |   |
|  | <b>B(Alt)</b> N57306D2  | 06/04 → 03/06 8)  |   | VKMW 6PK2080   |   |   |   | 1   |   |   |
|  | <b>B(AC)</b> N57306D2   | 06/04 → 09/04   |   | VKMW 4PK863  |   |   |   | 1   |   |   |



BMW



| BMW  5 Touring (E61) 535 d |                             |                  |                      |  |  |  |  |  |  |   |  |   |  |  |  |  |  |  |  |
|---|-----------------------------|------------------|----------------------|--|--|--|--|--|--|---|--|---|--|--|--|--|--|--|--|
|                             | M57306D4                    | 09/04 → 03/06    | OKOKOKO              |  |  |  |  |  |  |   |  |   |  |  |  |  |  |  |  |
|                             | M57306D4                    | 09/04 → 09/07    | VKPC 88645           |  |  |  |  |  |  |   |  | 1 |  |  |  |  |  |  |  |
|                             | B(Alt) M57306D4             | 09/04 → 03/06 7) | VKMV 6PK2160         |  |  |  |  |  |  | 1 |  |   |  |  |  |  |  |  |  |
|                             | B(Alt) M57306D4             | 09/04 → 03/06 8) | VKMV 6PK2080         |  |  |  |  |  |  | 1 |  |   |  |  |  |  |  |  |  |
| BMW  6 (E24) 628           |                             |                  |                      |  |  |  |  |  |  |   |  |   |  |  |  |  |  |  |  |
|                             | M 30 B 28                   | 09/79 → 08/87    | OKOKOKO              |  |  |  |  |  |  |   |  |   |  |  |  |  |  |  |  |
|                             | M 30 B 28                   | 09/79 → 08/87    | VKPC 88802           |  |  |  |  |  |  |   |  | 1 |  |  |  |  |  |  |  |
|                             | B(Alt) M 30 B 28            | 09/79 → 08/87    | VKMV 13AVx1050       |  |  |  |  |  |  | 1 |  |   |  |  |  |  |  |  |  |
|                             | B(PS) M 30 B 28             | 09/79 → 09/84    | VKMV 10AVx900        |  |  |  |  |  |  | 1 |  |   |  |  |  |  |  |  |  |
|                             | B(PS) M 30 B 28             | 09/84 → 08/87    | VKMV 10AVx888        |  |  |  |  |  |  | 1 |  |   |  |  |  |  |  |  |  |
| BMW  6 (E24) 635           |                             |                  |                      |  |  |  |  |  |  |   |  |   |  |  |  |  |  |  |  |
|                             | M 30 B 35                   | 06/78 → 09/90    | OKOKOKO              |  |  |  |  |  |  |   |  |   |  |  |  |  |  |  |  |
|                             | M 30 B 35                   | 06/78 → 09/79    | —                    |  |  |  |  |  |  |   |  | 1 |  |  |  |  |  |  |  |
|                             | M 30 B 35                   | 09/79 → 05/89    | VKPC 88802           |  |  |  |  |  |  |   |  | 1 |  |  |  |  |  |  |  |
| BMW  7 (E23) 728           |                             |                  |                      |  |  |  |  |  |  |   |  |   |  |  |  |  |  |  |  |
|                             | M 30 B 28                   | 05/77 → 08/86    | OKOKOKO              |  |  |  |  |  |  |   |  |   |  |  |  |  |  |  |  |
|                             | M 30 B 28                   | 05/77 → 08/79    | —                    |  |  |  |  |  |  |   |  | 1 |  |  |  |  |  |  |  |
|                             | M 30 B 28                   | 09/79 → 08/86    | VKPC 88802           |  |  |  |  |  |  |   |  | 1 |  |  |  |  |  |  |  |
|                             | B(Alt) M 30 B 28            | 05/77 → 08/86    | VKMV 13AVx1050       |  |  |  |  |  |  | 1 |  |   |  |  |  |  |  |  |  |
|                             | B(PS) M 30 B 28             | 05/77 → 05/80    | VKMV 10AVx900        |  |  |  |  |  |  | 1 |  |   |  |  |  |  |  |  |  |
|                            | B(PS) M 30 B 28             | 05/81 → 08/86    | VKMV 10AVx913        |  |  |  |  |  |  | 1 |  |   |  |  |  |  |  |  |  |
|                           | B(AC) M 30 B 28             | 05/77 → 08/79    | Carbu. VKMV 10AVx800 |  |  |  |  |  |  | 1 |  |   |  |  |  |  |  |  |  |
|                           | B(AC) M 30 B 28             | 07/78 → 09/84    | Injec. VKMV 13AVx800 |  |  |  |  |  |  | 1 |  |   |  |  |  |  |  |  |  |
|                           | B(AC) M 30 B 28             | 09/84 → 08/86    | Injec. VKMV 10AVx800 |  |  |  |  |  |  | 1 |  |   |  |  |  |  |  |  |  |
| BMW  7 (E23) 730         |                             |                  |                      |  |  |  |  |  |  |   |  |   |  |  |  |  |  |  |  |
|                           | M 30 B 30                   | 05/77 → 08/79    | OKOKOKO              |  |  |  |  |  |  |   |  |   |  |  |  |  |  |  |  |
|                           | M 30 B 30                   | 05/77 → 08/79    | —                    |  |  |  |  |  |  |   |  | 1 |  |  |  |  |  |  |  |
|                           | B(Alt) M 30 B 30            | 05/77 → 08/79    | VKMV 13AVx1050       |  |  |  |  |  |  | 1 |  |   |  |  |  |  |  |  |  |
|                           | B(PS) M 30 B 30             | 05/77 → 08/79    | VKMV 10AVx900        |  |  |  |  |  |  | 1 |  |   |  |  |  |  |  |  |  |
|                           | B(AC) M 30 B 30             | 05/77 → 08/79    | VKMV 10AVx800        |  |  |  |  |  |  | 1 |  |   |  |  |  |  |  |  |  |
| BMW  7 (E23) 732         |                             |                  |                      |  |  |  |  |  |  |   |  |   |  |  |  |  |  |  |  |
|                           | M 30 B 32                   | 05/77 → 08/86    | OKOKOKO              |  |  |  |  |  |  |   |  |   |  |  |  |  |  |  |  |
|                           | M 30 B 32                   | 05/77 → 08/79    | —                    |  |  |  |  |  |  |   |  | 1 |  |  |  |  |  |  |  |
|                           | M 30 B 32                   | 09/79 → 08/86    | VKPC 88802           |  |  |  |  |  |  |   |  | 1 |  |  |  |  |  |  |  |
|                           | B(Alt) M 30 B 32            | 05/77 → 08/86    | VKMV 13AVx1050       |  |  |  |  |  |  | 1 |  |   |  |  |  |  |  |  |  |
| BMW  7 (E23) 735         |                             |                  |                      |  |  |  |  |  |  |   |  |   |  |  |  |  |  |  |  |
|                           | M 30 B 35                   | 09/79 → 08/86    | OKOKOKO              |  |  |  |  |  |  |   |  |   |  |  |  |  |  |  |  |
|                           | M 30 B 35                   | 09/79 → 08/86    | VKPC 88802           |  |  |  |  |  |  |   |  | 1 |  |  |  |  |  |  |  |
|                           | B(Alt) M 30 B 35            | 09/79 → 08/86    | VKMV 13AVx1050       |  |  |  |  |  |  | 1 |  |   |  |  |  |  |  |  |  |
|                           | B(PS) M 30 B 35             | 05/80 → 08/86    | VKMV 10AVx913        |  |  |  |  |  |  | 1 |  |   |  |  |  |  |  |  |  |
|                           | B(PS) M 30 B 35             | 05/80 → 08/86    | VKMV 10AVx900        |  |  |  |  |  |  | 1 |  |   |  |  |  |  |  |  |  |
|                           | B(AC) M 30 B 35             | 09/79 → 09/84    | VKMV 13AVx800        |  |  |  |  |  |  | 1 |  |   |  |  |  |  |  |  |  |
|                           | B(AC) M 30 B 35             | 09/84 → 08/86    | VKMV 10AVx800        |  |  |  |  |  |  | 1 |  |   |  |  |  |  |  |  |  |
| BMW  7 (E23) 745         |                             |                  |                      |  |  |  |  |  |  |   |  |   |  |  |  |  |  |  |  |
|                           | M 30 B 32, M 30 B 35        | 04/80 → 08/86    | OKOKOKO              |  |  |  |  |  |  |   |  |   |  |  |  |  |  |  |  |
|                           | M 30 B 32, M 30 B 35        | 04/80 → 08/86    | VKPC 88802           |  |  |  |  |  |  |   |  | 1 |  |  |  |  |  |  |  |
|                           | B(Alt) M 30 B 32, M 30 B 35 | 04/80 → 08/86    | VKMV 13AVx1050       |  |  |  |  |  |  | 1 |  |   |  |  |  |  |  |  |  |
|                           | B(PS) M 30 B 32, M 30 B 35  | 04/80 → 08/86    | VKMV 10AVx913        |  |  |  |  |  |  | 1 |  |   |  |  |  |  |  |  |  |
|                           | B(AC) M 30 B 32, M 30 B 35  | 04/80 → 08/86    | VKMV 10AVx800        |  |  |  |  |  |  | 1 |  |   |  |  |  |  |  |  |  |
| BMW  7 (E32) 730         |                             |                  |                      |  |  |  |  |  |  |   |  |   |  |  |  |  |  |  |  |
|                           | M 30 B 30, M 60 B 30        | 12/86 → 09/94    | OKOKOKO              |  |  |  |  |  |  |   |  |   |  |  |  |  |  |  |  |
|                           | M 30 B 30                   | 12/86 → 09/94    | VKPC 88802           |  |  |  |  |  |  |   |  | 1 |  |  |  |  |  |  |  |
|                           | M 60 B 30                   | 04/92 → 09/94    | VKPC 88831           |  |  |  |  |  |  |   |  | 1 |  |  |  |  |  |  |  |
|                           | B(Alt) M 30 B 30            | 12/86 → 09/94    | VKMV 13AVx1050       |  |  |  |  |  |  | 1 |  |   |  |  |  |  |  |  |  |
|                           | B(Alt) M 60 B 30            | 04/92 → 09/94    | 104 mm VKMV 7PK1580  |  |  |  |  |  |  | 1 |  |   |  |  |  |  |  |  |  |
|                           | B(Alt) M 60 B 30            | 04/92 → 09/94    | 117 mm VKMV 7PK1605  |  |  |  |  |  |  | 1 |  |   |  |  |  |  |  |  |  |

|  |  |  |    |  |  |  |  |  |  |  |
|--|---|---|---|--|---|---|---|---|---|---|
| B(PS)  | M 30 B 30   | 12/86 → 09/94   |   | VKMW 10AVx865  |   |   | 1   |   |   |   |
| B(AC)  | M 60 B 30   | 04/92 → 09/94   |   | VKMW 5PK980  |   |   | 1   |   |   |   |
| <b>BMW  7 (E32) 735</b>   |   |   |   |  |   |   |   |   |   |   |
|                           | M 30 B 35   | 09/86 → 09/92   |   | ΟΧΘΟΧΟ   |   |   |   |   |   |   |
|                           | M 30 B 35   | 09/86 → 09/92   |   | VKPC 88802   |   |   |   | 1   |   |   |
| <b>BMW  7 (E32) 740</b>   |   |   |   |  |   |   |   |   |   |   |
|                           | M 60 B 40   | 04/92 → 09/94   |   | ΟΧΘΟΧΟ   |   |   |   |   |   |   |
|                           | M 60 B 40   | 04/92 → 09/94   |   | VKPC 88831   |   |   |   |   | 1   |   |
|                           | B(Alt) M 60 B 40  | 04/92 → 09/94   |    | VKMW 7PK1580   |   |   | 1   |   |   |   |
|  | B(Alt) M 60 B 40  | 04/92 → 09/94   |    | VKMW 7PK1605   |   |   | 1   |   |   |   |
|  | B(AC) M 60 B 40   | 04/92 → 09/94   |   | VKMW 5PK980  |   |   | 1   |   |   |   |
| <b>BMW  7 (E32) 750</b>   |   |   |   |  |   |   |   |   |   |   |
|                           | M 70 B 50   | 09/87 → 09/94   |   | ΟΧΘΟΧΟ   |   |   |   |   |   |   |
| <b>BMW  7 (E38) 728</b>   |   |   |   |  |   |   |   |   |   |   |
|                           | M 52 B 28   | 08/95 → 11/01   |   | ΟΧΘΟΧΟ   |   |   |   |   |   |   |
|                           | M 52 B 28   | 08/95 → 11/01   |   | VKPC 88617   |   |   |   | 1   |   |   |
|                           | B(Alt) M 52 B 28  | 08/95 → 09/98   | MT  | VKMA 38241<br>VKMW 6PK1555<br>VKM 38202  | 1   |   | 1   | 1   |   |   |
|  |   |   |   |  | 1   |   |   |   |   |   |
|  | B(Alt) M 52 B 28  | 08/95 → 09/98   | HT  | VKMA 38242<br>VKMW 6PK1555<br>VKM 38003<br>VKM 38004<br>VKM 38007                  | 1   | 1   | 1   | 1   |   | 1   |
|  |   |   |   |  | 1   |   | 1   |   |   | 1   |
|  | B(Alt) M 52 B 28  | 10/98 → 11/01   | MT  | VKMW 6PK1538<br>VKM 38003<br>VKM 38202   | 1   |   | 1   |   |   |   |
|  |   |   |   |  | 1   |   |   |   |   |   |
|  | B(AC) M 52 B 28   | 08/95 → 03/98   |   | VKMW 5PK906<br>VKM 38004<br>VKM 38011  |   |   | 1   |   |   | 1   |
|  | B(AC) M 52 B 28   | 03/98 → 11/01   |   | VKMW 5PK863<br>VKM 38231   | 1   |   | 1   |   |   |   |
| <b>BMW  7 (E38) 730</b> |   |   |   |  |   |   |   |   |   |   |
|                         | M 60 B 30   | 10/94 → 11/01   |   | ΟΧΘΟΧΟ   |   |   |   |   |   |   |
|                         | M 60 B 30   | 10/94 → 11/01   |   | VKPC 88830   |   |   |   |   | 1   |   |
|                         | B(Alt) M 60 B 30  | 10/94 → 11/01   |  | VKMW 7PK1580   |   |   | 1   |   |   |   |
|  | B(Alt) M 60 B 30  | 10/94 → 11/01   |  | VKMW 7PK1605   |   |   | 1   |   |   |   |
|  | B(AC) M 60 B 30   | 10/94 → 11/01   |   | VKMW 5PK980  |   |   | 1   |   |   |   |
| <b>BMW  7 (E38) 735</b> |   |   |   |  |   |   |   |   |   |   |
|                         | M 62 B  | 01/96 → 11/01   |   | ΟΧΘΟΧΟ   |   |   |   |   |   |   |
|                         | M 62 B  | 01/96 → 09/98   |   | VKPC 88829   |   |   |   |   | 1   |   |
|  | M 62 B  | 09/98 → 11/01   |   | —  |   |   |   |   | 1   |   |
|                         | B(Alt) M 62 B   | 01/96 → 08/97   |   | VKMW 7PK1629   |   |   | 1   |   |   |   |
|  | B(Alt) M 62 B   | 09/97 → 09/98   |   | VKMW 7PK1629   |   |   | 1   |   |   |   |
|  | B(Alt) M 62 B   | 10/98 → 11/01   | Auto. GBX   | VKMW 7PK1635   |   |   | 1   |   |   |   |
| <b>BMW  7 (E38) 740</b> |   |   |   |  |   |   |   |   |   |   |
|                         | M 60 B 40, M 62 B 44  | 10/94 → 11/01   |   | ΟΧΘΟΧΟ   |   |   |   |   |   |   |
|                         | M 60 B 40   | 10/94 → 11/01   |   | VKPC 88830   |   |   |   |   | 1   |   |
|  | M 62 B 44   | 01/96 → 09/98   |   | VKPC 88829   |   |   |   |   | 1   |   |
|  | M 62 B 44   | 09/98 → 11/01   |   | —  |   |   |   |   | 1   |   |
|                         | B(Alt) M 60 B 40  | 10/94 → 11/01   |  | VKMW 7PK1580   |   |   | 1   |   |   |   |
|  | B(Alt) M 60 B 40  | 10/94 → 11/01   |  | VKMW 7PK1605   |   |   | 1   |   |   |   |
|  | B(AC) M 60 B 40   | 10/94 → 11/01   |   | VKMW 5PK980  |   |   | 1   |   |   |   |
|  | B(Alt) M 62 B 44  | 01/96 → 08/97   |   | VKMW 7PK1629   |   |   | 1   |   |   |   |
|  | B(Alt) M 62 B 44  | 09/97 → 09/98   |   | VKMW 7PK1629   |   |   | 1   |   |   |   |
|  | B(Alt) M 62 B 44  | 10/98 → 11/01   | Auto. GBX   | VKMW 7PK1635   |   |   | 1   |   |   |   |
| <b>BMW  7 (E38) 750</b> |   |   |   |  |   |   |   |   |   |   |
|                         | M 73 B 54   | 12/94 → 11/01   |   | ΟΧΘΟΧΟ   |   |   |   |   |   |   |



BMW

|                                 | <b>B(Alt)</b> | M 73 B 54            | 12/94 → 09/98 |          | VKMV 7PK1035                           |   |   |   |  | 1 |   |  |
|---------------------------------|---------------|----------------------|---------------|----------|--|---|---|---|--|---|---|--|
|                                 | <b>B(AC)</b>  | M 73 B 54            | 12/94 → 11/01 | 105 mm   | VKMV 6PK1195                           |   |   |   |  | 1 |   |  |
| <b>BMW  7 (E38) 725 tds</b>     |               |                      |               |          |  |   |   |   |  |   |   |  |
|                                 |               | M 51 D 25            | 04/96 → 11/01 |          | <del>OKOKOKO</del>                     |   |   |   |  |   |   |  |
|                                 |               | M 51 D 25            | 04/96 → 11/01 |          | VKPC 88826                             |   |   |   |  | 1 |   |  |
|                                 | <b>B(AC)</b>  | M 51 D 25            | 04/96 → 11/01 |          | VKMV 4PK780                            |   |   |   |  | 1 |   |  |
|                                 |               | M 51 D 25            | 04/96 → 11/01 | Man. GBX | VKM_____                               |   |   |   |  |   | 1 |  |
| <b>BMW  7 (E38) 730 d</b>       |               |                      |               |          |  |   |   |   |  |   |   |  |
|                                 |               | M 57 D 30, M57306D1  | 08/98 → 11/01 |          | <del>OKOKOKO</del>                     |   |   |   |  |   |   |  |
|                                 |               | M 57 D 30            | 08/98 → 09/99 |          | —                                      |   |   |   |  | 1 |   |  |
|                                 |               | M 57 D 30, M57306D1  | 09/99 → 11/01 |          | VKPC 88430                             |   |   |   |  | 1 |   |  |
| <b>BMW  7 (E38) 740 d</b>       |               |                      |               |          |  |   |   |   |  |   |   |  |
|                                 |               | M 67 D 39            | 05/99 → 11/01 |          | <del>OKOKOKO</del>                     |   |   |   |  |   |   |  |
|                                 |               | M 67 D 39            | 05/99 → 11/01 |          | —                                      |   |   |   |  | 1 |   |  |
| <b>BMW  7 (E65 / E66) 730</b>   |               |                      |               |          |  |   |   |   |  |   |   |  |
|                                 |               | M54306S3             | 03/03 → 03/06 |          | <del>OKOKOKO</del>                     |   |   |   |  |   |   |  |
|                                 |               | M54306S3             | 03/03 → 07/05 |          | VKPC 88617                             |   |   |   |  | 1 |   |  |
| <b>BMW  7 (E65 / E66) 730 d</b> |               |                      |               |          |  |   |   |   |  |   |   |  |
|                                 |               | N57306D2             | 10/02 → 03/06 |          | <del>OKOKOKO</del>                     |   |   |   |  |   |   |  |
|                                 |               | N57306D2             | 10/02 → 07/05 |          | VKPC 88636                             |   |   |   |  | 1 |   |  |
| <b>BMW  8 (E31) 840</b>         |               |                      |               |          |  |   |   |   |  |   |   |  |
|                                 |               | M 60 B 40, M 62 B 44 | 02/93 → 12/99 |          | <del>OKOKOKO</del>                     |   |   |   |  |   |   |  |
|                                 |               | M 60 B 40            | 02/93 → 02/96 |          | VKPC 88830                             |   |   |   |  | 1 |   |  |
|                                 |               | M 62 B 44            | 01/96 → 12/99 |          | VKPC 88829                             |   |   |   |  | 1 |   |  |
|                                 | <b>B(Alt)</b> | M 60 B 40            | 02/93 → 02/96 | 104 mm   | VKMV 7PK1580                           |   |   |   |  | 1 |   |  |
|                                 | <b>B(Alt)</b> | M 60 B 40            | 02/93 → 02/96 | 117 mm   | VKMV 7PK1605                           |   |   |   |  | 1 |   |  |
|                                 | <b>B(AC)</b>  | M 60 B 40            | 02/93 → 02/96 |          | VKMV 5PK980                            |   |   |   |  | 1 |   |  |
|                                 | <b>B(Alt)</b> | M 62 B 44            | 01/96 → 08/97 |          | VKMV 7PK1629                           |   |   |   |  | 1 |   |  |
|                                 | <b>B(Alt)</b> | M 62 B 44            | 10/97 → 12/99 |          | VKMV 7PK1629                           |   |   |   |  | 1 |   |  |
|                                 | <b>B(AC)</b>  | M 62 B 44            | 01/96 → 09/97 |          | VKMV 5PK1004                           |   |   |   |  | 1 |   |  |
|                                 | <b>B(AC)</b>  | M 62 B 44            | 09/97 → 12/99 |          | VKMV 5PK1004                           |   |   |   |  | 1 |   |  |
| <b>BMW  X3 2.0</b>              |               |                      |               |          |  |   |   |   |  |   |   |  |
|                                 |               | N46B20A              | 07/05 → 03/06 |          | <del>OKOKOKO</del>                     |   |   |   |  |   |   |  |
|                                 |               | N46B20A              | 07/05 → 09/07 | 2)       | VKPA_____                              |   |   |   |  | 1 |   |  |
|                                 | <b>B(Alt)</b> | N46B20A              | 07/05 → 03/06 |          | VKMV 6PK1870<br>VKM_____               | 1 |   | 1 |  |   |   |  |
|                                 |               |                      |               |          | VKM_____                               |   | 1 |   |  |   |   |  |
| <b>BMW  X3 2.5</b>              |               |                      |               |          |  |   |   |   |  |   |   |  |
|                                 |               | M54256S5             | 01/04 → 03/06 |          | <del>OKOKOKO</del>                     |   |   |   |  |   |   |  |
|                                 |               | M54256S5             | 01/04 → 09/07 |          | VKPC 88617                             |   |   |   |  | 1 |   |  |
|                                 | <b>B(Alt)</b> | M54256S5             | 01/04 → 03/06 | MT       | VKMV 6PK1538<br>VKM 38202              | 1 |   | 1 |  |   |   |  |
|                                 | <b>B(Alt)</b> | M54256S5             | 01/04 → 03/06 | HT       | VKMV 6PK1538<br>VKM 38004<br>VKM 38007 |   | 1 | 1 |  |   | 1 |  |
|                                 | <b>B(AC)</b>  | M54256S5             | 01/04 → 08/06 |          | VKMV 4PK863                            |   |   | 1 |  |   |   |  |
| <b>BMW  X3 3.0</b>              |               |                      |               |          |  |   |   |   |  |   |   |  |
|                                 |               | M54306S3             | 01/04 → 03/06 |          | <del>OKOKOKO</del>                     |   |   |   |  |   |   |  |
|                                 |               | M54306S3             | 01/04 → 09/07 |          | VKPC 88617                             |   |   |   |  | 1 |   |  |
|                                 | <b>B(Alt)</b> | M54306S3             | 01/04 → 03/06 | MT       | VKMV 6PK1538<br>VKM 38202              | 1 |   | 1 |  |   |   |  |
|                                 | <b>B(Alt)</b> | M54306S3             | 01/04 → 03/06 | HT       | VKMV 6PK1538<br>VKM 38004<br>VKM 38007 |   | 1 | 1 |  |   | 1 |  |
|                                 | <b>B(AC)</b>  | M54306S3             | 01/04 → 08/06 |          | VKMV 4PK863                            |   |   | 1 |  |   |   |  |
| <b>BMW  X3 2.0 d</b>            |               |                      |               |          |  |   |   |   |  |   |   |  |
|                                 |               | M47N204D4            | 10/04 → 03/06 |          | <del>OKOKOKO</del>                     |   |   |   |  |   |   |  |
|                                 |               | M47N204D4            | 10/04 → 09/07 |          | VKPC 88635                             |   |   |   |  | 1 |   |  |
|                                 | <b>B(Alt)</b> | M47N204D4            | 10/04 → 08/06 |          | VKMV 6PK2080                           |   |   | 1 |  |   |   |  |

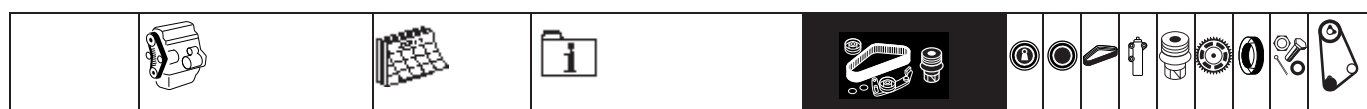



















| BMW  X3 3.0 d |   |               |                 |              |   |   |   |   |   |       |
|---------------|---|---------------|-----------------|--------------|---|---|---|---|---|-------|
|               | M54N306D2                               | 01/04 → 03/06 | <b>ΟΛΟΚΛΗΡΟ</b> |              |   |   |   |   |   |       |
|               | M54N306D2                               | 01/04 → 09/07 | VKPC 88645      |              |   | 1 |   |   |   |       |
|               | B(Alt) M54N306D2                        | 01/04 → 08/06 | VKMV 6PK2063    |              |   | 1 |   |   |   |       |
|               | B(AC) M54N306D2                         | 01/04 → 09/04 | VKMV 4PK882     |              |   | 1 |   |   |   |       |
| BMW  X5 3.0   |   |               |                 |              |   |   |   |   |   |       |
|               | M54306S3                                | 05/00 → 03/06 | <b>ΟΛΟΚΛΗΡΟ</b> |              |   |   |   |   |   |       |
|               | M54306S3                                | 05/00 → 09/07 | VKPC 88617      |              |   | 1 |   |   |   |       |
|               | B(Alt) M54306S3                         | 05/00 → 03/06 | MT              | VKMV 6PK1538 |   | 1 |   | 1 |   |       |
|               |   |               |                 | VKM 38003    |   | 1 |   |   |   |       |
|               |   |               |                 | VKM 38202    |   | 1 |   |   |   |       |
|               | B(Alt) M54306S3                         | 05/00 → 03/06 | HT              | VKMV 6PK1538 |   | 1 |   | 1 |   |       |
|               |   |               |                 | VKM 38003    |   | 1 |   |   |   |       |
|               |   |               |                 | VKM 38004    |   |   | 1 |   |   |       |
|               |   |               |                 | VKM 38007    |   |   |   |   | 1 |       |
|               | B(AC) M54306S3                          | 05/00 → 09/02 |                 | VKMV 5PK863  |   | 1 |   | 1 |   |       |
|               |   |               |                 | VKM 38231    |   | 1 |   |   |   |       |
|               | B(AC) M54306S3                          | 09/02 → 03/06 |                 | VKMV 4PK863  |   |   |   | 1 |   |       |
| BMW  X5 3.0 d |   |               |                 |              |   |   |   |   |   |       |
|               | M57N306D4                               | 12/03 → 03/06 | <b>ΟΛΟΚΛΗΡΟ</b> |              |   |   |   |   |   |       |
|               | M57306D1                                | 05/01 → 03/06 | <b>ΟΛΟΚΛΗΡΟ</b> |              |   |   |   |   |   |       |
|               | M57N306D4                               | 12/03 → 09/07 | VKPC 88636      |              |   |   | 1 |   |   |       |
|               | M57306D1                                | 05/01 → 09/07 | VKPC 88430      |              |   |   | 1 |   |   |       |
|               | B(Alt) M57306D1                         | 05/01 → 03/06 | Man. GBX        | VKMV 5PK2063 |   |   | 1 |   |   |       |
|               |   |               |                 | VKM 38240    |   | 1 |   |   |   |       |
|               |   |               |                 | VKM 38240    |   | 1 |   |   |   |       |
|               | B(Alt) M57306D1                         | 05/01 → 03/06 | Auto. GBX       | VKMV 5PK2020 |   |   | 1 |   |   |       |
|               |   |               |                 | VKM 38240    |   | 1 |   |   |   |       |
|               |   |               |                 | VKM 38240    |   | 1 |   |   |   |       |
|               | B(AC) M57306D1                          | 05/01 → 03/06 |                 | VKMV 5PK810  |   |   | 1 |   |   |       |
| BMW  Z1 2.5   |   |               |                 |              |   |   |   |   |   |       |
|               | M 20 B 25                               | 06/88 → 06/91 | VKMA 08110      |              | 1 |   | 1 |   |   | T0032 |
|               |   |               | VKM 18100       |              | 1 |   |   |   |   |       |
|               | M 20 B 25                               | 06/88 → 06/91 | VKPC 88607      |              |   |   | 1 |   |   |       |
|               | B(Alt) M 20 B 25                        | 06/88 → 06/91 | VKMV 10AVx965   |              |   |   | 1 |   |   |       |
|               | B(PS) M 20 B 25                         | 06/88 → 06/91 | VKMV 10AVx900   |              |   |   | 1 |   |   |       |
| BMW  Z3 1.8   |   |               |                 |              |   |   |   |   |   |       |
|               | M 43 B 18                               | 10/95 → 10/98 | <b>ΟΛΟΚΛΗΡΟ</b> |              |   |   |   |   |   |       |
|               | M 43 B 18                               | 10/95 → 10/98 | VKPC 88615      |              |   |   | 1 |   |   |       |
|               | B(Alt) M 43 B 18                        | 10/95 → 10/98 | 70A             | VKMV 6PK1733 |   |   | 1 |   |   |       |
|               |   |               |                 | VKM 38221    |   | 1 |   |   |   |       |
|               | B(Alt) M 43 B 18                        | 10/95 → 10/98 | 80A             | VKMV 6PK1733 |   |   | 1 |   |   |       |
|               |   |               |                 | VKM 38004    |   |   | 1 |   |   |       |
|               |   |               |                 | VKM 38221    |   | 1 |   |   |   |       |
|               | B(AC) M 43 B 18                         | 10/95 → 10/98 |                 | VKMV 4PK889  |   |   | 1 |   |   |       |
|               |   |               |                 | VKM 38230    |   | 1 |   |   |   |       |
| BMW  Z3 1.9   |   |               |                 |              |   |   |   |   |   |       |
|               | M 43 B 19, M 44 B 19,<br>M43194E1       | 10/95 → 01/03 | <b>ΟΛΟΚΛΗΡΟ</b> |              |   |   |   |   |   |       |
|               | M 43 B 19, M 44 B 19,<br>M43194E1       | 10/95 → 01/03 | VKPC 88615      |              |   |   | 1 |   |   |       |
|               | B(Alt) M 44 B 19                        | 10/95 → 03/99 | 70A             | VKMV 6PK1733 |   |   | 1 |   |   |       |
|               |   |               |                 | VKM 38221    |   | 1 |   |   |   |       |
|               | B(Alt) M 44 B 19                        | 10/95 → 03/99 | 80A             | VKMV 6PK1733 |   |   | 1 |   |   |       |
|               |   |               |                 | VKM 38004    |   |   | 1 |   |   |       |
|               |   |               |                 | VKM 38221    |   | 1 |   |   |   |       |
|               | B(AC) M 43 B 19, M 44 B 19,<br>M43194E1 | 10/95 → 01/03 |                 | VKMV 4PK889  |   |   | 1 |   |   |       |
|               |   |               |                 | VKM 38230    |   | 1 |   |   |   |       |
| BMW  Z3 2.0   |   |               |                 |              |   |   |   |   |   |       |
|               | M 52 B                                  | 04/99 → 01/03 | <b>ΟΛΟΚΛΗΡΟ</b> |              |   |   |   |   |   |       |



BMW

|                            | M 52 B                            | 04/99 → 01/03 |    |  | VKPC 88617   |   |   |   |  |  | 1 |  |   |       |
|----------------------------|-----------------------------------|---------------|----|--|--------------|---|---|---|--|--|---|--|---|-------|
| <b>BMW  Z3 2.2</b>         |                                   |               |    |  |              |   |   |   |  |  |   |  |   |       |
|                            | M 54 B 22, M54226S1               | 08/00 → 01/03 |    |  | ОХЛОХО       |   |   |   |  |  |   |  |   |       |
|                            | M 54 B 22, M54226S1               | 08/00 → 01/03 |    |  | VKPC 88617   |   |   |   |  |  | 1 |  |   |       |
| <b>BMW  Z3 2.8</b>         |                                   |               |    |  |              |   |   |   |  |  |   |  |   |       |
|                            | M 52 B 28                         | 04/97 → 06/00 |    |  | ОХЛОХО       |   |   |   |  |  |   |  |   |       |
|                            | M 52 B 28                         | 04/97 → 06/00 |    |  | VKPC 88617   |   |   |   |  |  | 1 |  |   |       |
|                            | <b>B(Alt)</b> M 52 B 28           | 07/97 → 09/98 | MT |  | VKMA 38241   | 1 |   | 1 |  |  |   |  |   |       |
|                            |                                   |               |    |  | VKMV 6PK1555 |   |   | 1 |  |  |   |  |   |       |
|                            |                                   |               |    |  | VKM 38202    | 1 |   |   |  |  |   |  |   |       |
|                            | <b>B(AP)</b> M 52 B 28            | 04/97 → 09/98 | MT |  | VKMA 38241   | 1 |   | 1 |  |  |   |  |   |       |
|                            |                                   |               |    |  | VKMV 6PK1555 |   |   | 1 |  |  |   |  |   |       |
|                            |                                   |               |    |  | VKM 38202    | 1 |   |   |  |  |   |  |   |       |
| <b>BMW  Z3 3.0</b>         |                                   |               |    |  |              |   |   |   |  |  |   |  |   |       |
|                            | M54306S3                          | 06/00 → 06/03 |    |  | ОХЛОХО       |   |   |   |  |  |   |  |   |       |
|                            | M54306S3                          | 06/00 → 06/03 |    |  | VKPC 88617   |   |   |   |  |  | 1 |  |   |       |
| <b>BMW  Z3 M 3.2</b>       |                                   |               |    |  |              |   |   |   |  |  |   |  |   |       |
|                            | S 50 B 32, S 54 B 32,<br>S54326S4 | 03/97 → 06/03 |    |  | ОХЛОХО       |   |   |   |  |  |   |  |   |       |
|                            | S 50 B 32                         | 03/97 → 06/01 |    |  | —            |   |   |   |  |  | 1 |  |   |       |
|                            | <b>B(Alt)</b> S 50 B 32           | 03/97 → 06/01 |    |  | VKMV 6PK1515 |   |   | 1 |  |  |   |  |   |       |
|                            |                                   |               |    |  | VKM 38003    | 1 |   |   |  |  |   |  |   |       |
|                            |                                   |               |    |  | VKM 38004    |   | 1 |   |  |  |   |  | 1 |       |
|                            |                                   |               |    |  | VKM 38007    |   |   |   |  |  |   |  |   |       |
|                            | <b>B(Alt)</b> S 54 B 32           | 06/01 → 01/03 |    |  | VKMV 6PK1460 |   |   | 1 |  |  |   |  |   |       |
|                            |                                   |               |    |  | VKM 38003    | 1 |   |   |  |  |   |  |   |       |
|                            |                                   |               |    |  | VKM 38004    |   | 1 |   |  |  |   |  | 1 |       |
|                            |                                   |               |    |  | VKM 38007    |   |   |   |  |  |   |  |   |       |
|                            | <b>B(AC)</b> S 54 B 32            | 06/01 → 01/03 |    |  | VKMV 5PK829  |   |   | 1 |  |  |   |  |   |       |
|                            |                                   |               |    |  | VKM 38231    | 1 |   |   |  |  |   |  |   |       |
|                            | <b>B(AP)</b> S 50 B 32            | 03/97 → 06/01 | AC |  | VKMV 5PK785  |   |   | 1 |  |  |   |  |   |       |
|                            | <b>B(AP)</b> S 50 B 32            | 03/97 → 06/01 | AC |  | VKMV 5PK1125 |   |   | 1 |  |  |   |  |   |       |
|                            |                                   |               |    |  | VKM 38230    | 1 |   |   |  |  |   |  |   |       |
| <b>BMW  Z4 2.0</b>         |                                   |               |    |  |              |   |   |   |  |  |   |  |   |       |
|                            | N46B20A                           | 04/05 → 03/06 |    |  | ОХЛОХО       |   |   |   |  |  |   |  |   |       |
|                            | N46B20A                           | 04/05 → 09/07 | 2) |  | VKPA _____   |   |   |   |  |  | 1 |  |   |       |
|                            | <b>B(Alt)</b> N46B20A             | 04/05 → 03/06 | AC |  | VKMV 6PK1637 |   |   | 1 |  |  |   |  |   |       |
|                            |                                   |               |    |  | VKM _____    | 1 |   |   |  |  |   |  |   |       |
|                            | <b>B(Alt)</b> N46B20A             | 04/05 → 03/06 | AC |  | VKMV 6PK1870 |   |   | 1 |  |  |   |  |   |       |
|                            |                                   |               |    |  | VKM _____    | 1 |   |   |  |  |   |  |   |       |
|                            |                                   |               |    |  | VKM _____    |   | 1 |   |  |  |   |  |   |       |
| <b>BMW  Z4 2.2</b>         |                                   |               |    |  |              |   |   |   |  |  |   |  |   |       |
|                            | M54226S1                          | 10/03 → 03/06 |    |  | ОХЛОХО       |   |   |   |  |  |   |  |   |       |
|                            | M54226S1                          | 10/03 → 09/07 |    |  | VKPC 88617   |   |   |   |  |  | 1 |  |   |       |
|                            | <b>B(AC)</b> M54226S1             | 10/03 → 03/06 |    |  | VKMV 4PK863  |   |   | 1 |  |  |   |  |   |       |
| <b>BMW  Z4 2.5</b>         |                                   |               |    |  |              |   |   |   |  |  |   |  |   |       |
|                            | M54256S5                          | 02/03 → 03/06 |    |  | ОХЛОХО       |   |   |   |  |  |   |  |   |       |
|                            | M54256S5                          | 02/03 → 09/07 |    |  | VKPC 88617   |   |   |   |  |  | 1 |  |   |       |
|                            | <b>B(AC)</b> M54256S5             | 02/03 → 03/06 |    |  | VKMV 4PK863  |   |   | 1 |  |  |   |  |   |       |
| <b>BMW  Z4 3.0</b>         |                                   |               |    |  |              |   |   |   |  |  |   |  |   |       |
|                            | M54306S3                          | 02/03 → 03/06 |    |  | ОХЛОХО       |   |   |   |  |  |   |  |   |       |
|                            | M54306S3, N52B30A                 | 02/03 → 09/07 |    |  | VKPC 88617   |   |   |   |  |  | 1 |  |   |       |
| <b>BMW  Z8 4.9</b>         |                                   |               |    |  |              |   |   |   |  |  |   |  |   |       |
|                            | S 38 B 49                         | 06/00 → 06/03 |    |  | ОХЛОХО       |   |   |   |  |  |   |  |   |       |
|                            | <b>B(Alt)</b> S 38 B 49           | 06/00 → 06/03 |    |  | VKMV 7PK1440 |   |   | 1 |  |  |   |  |   |       |
|                            | <b>B(AC)</b> S 38 B 49            | 06/00 → 06/03 |    |  | VKMV 5PK980  |   |   | 1 |  |  |   |  |   |       |
| <b>CHEVROLET  AVEO 1.2</b> |                                   |               |    |  |              |   |   |   |  |  |   |  |   |       |
|                            | F12S3                             | 08/02 → 01/05 |    |  | VKMA 05121   | 1 |   | 1 |  |  |   |  | 1 | T0092 |
|                            |                                   |               |    |  | VKM 15121    | 1 |   |   |  |  |   |  | 1 |       |

|   |  |  |  |   |  |  |  |  |  |  |  |  |  |       |
|---|---|---|---|---|---|---|---|---|---|---|---|---|---|-------|
| <b>CHEVROLET  AVEO 1.4</b>     |   |   |   |   |   |   |   |   |   |   |   |   |   |       |
|                                | F14D3   |   | 05/03 → 01/05   | VKMA 90000  | 1   | 1   | 1   |   |   |   |   |   |   | T0297 |
|   |   |   |   | VKM 70000   | 1   |   |   |   |   |   |   |   |   |       |
|   |   |   |   | VKM 80000   |   | 1   |   |   |   |   |   |   |   |       |
| <b>CHEVROLET  EPICA 2.0</b>    |   |   |   |   |   |   |   |   |   |   |   |   |   |       |
|                                | X20SED  |   | 07/02 → 01/08   | Mod. LA69, DOHC   | VKMA 05222  | 1   | 2   | 1   |   |   |   |   |   | T0116 |
|   |   |   |   |   | VKM 15202   | 1   |   |   |   |   |   |   |   |       |
|   |   |   |   |   | VKM 25212   |   | 1   |   |   |   |   |   |   |       |
|   |   |   |   |   | VKM 25212   |   | 1   |   |   |   |   |   |   |       |
| <b>CHEVROLET  MATIZ 0.8</b>    |   |   |   |   |   |   |   |   |   |   |   |   |   |       |
|                                |   |   | 05/05 → 01/07   |   | VKMA 90001  | 1   |   | 1   |   |   |   |   |   | T0697 |
|   |   |   |   |   | VKM 76102   | 1   |   |   |   |   |   |   |   |       |
|                                |   |   | 05/05 → 01/07   |   | VKPC 90450  |   |   |   |   | 1   |   |   |   |       |
| <b>CHEVROLET  MATIZ 1.0</b>    |   |   |   |   |   |   |   |   |   |   |   |   |   |       |
|                                |   |   | 05/05 → 01/07   |   | VKMA 90008  | 1   |   | 1   |   |   |   |   |   | T0302 |
|   |   |   |   |   | VKM 76102   | 1   |   |   |   |   |   |   |   |       |
|                                |   |   | 05/05 → 01/07   |   | VKPC 90450  |   |   |   |   | 1   |   |   |   |       |
| <b>CHEVROLET  SPARK 0.8</b>    |   |   |   |   |   |   |   |   |   |   |   |   |   |       |
|                                |   |   | 05/05 → 01/07   |   | VKMA 90001  | 1   |   | 1   |   |   |   |   |   | T0697 |
|   |   |   |   |   | VKM 76102   | 1   |   |   |   |   |   |   |   |       |
|                                |   |   | 05/05 → 01/07   |   | VKPC 90450  |   |   |   |   | 1   |   |   |   |       |
| <b>CHEVROLET  SPARK 1.0 SX</b> |   |   |   |   |   |   |   |   |   |   |   |   |   |       |
|                                |   |   | 05/05 → 01/07   |   | VKMA 90008  | 1   |   | 1   |   |   |   |   |   | T0302 |
|   |   |   |   |   | VKM 76102   | 1   |   |   |   |   |   |   |   |       |
|                               |   |   | 05/05 → 01/07   |   | VKPC 90450  |   |   |   |   | 1   |   |   |   |       |
| <b>CITROËN  AMI 1.0</b>      |   |   |   |   |   |   |   |   |   |   |   |   |   |       |
|                              | G10   |   | 03/73 → 12/77   |   | VKMA 03000  | 2   |   | 2   |   |   |   |   |   |       |
|   |   |   |   |   | VKM 12200   | 1   |   |   |   |   |   |   |   |       |
|   |   |   |   |   | VKM 12200   | 1   |   |   |   |   |   |   |   |       |
| <b>CITROËN  AX 1.0</b>       |   |   |   |   |   |   |   |   |   |   |   |   |   |       |
|                              | TU9M  |   | 07/86 → 12/98   |  | VKMC 03100  | 1   |   | 1   |   | 1   |   |   |   | T0044 |
|   |   |   |   |   | VKMA 03100  | 1   |   | 1   |   |   |   |   |   |       |
|   |   |   |   |   | VKM 13100   | 1   |   |   |   |   |   |   |   |       |
|   | TU9M  |   | 07/86 → 12/98   | 3)  | VKMS 03100-2  | 1   |   | 1   |   |   |   | 2   |   | T0044 |
|   |   |   |   |   | VKMA 03100  | 1   |   | 1   |   |   |   |   |   |       |
|   |   |   |   |   | VKM 13100   | 1   |   |   |   |   |   |   |   |       |
|                              | TU9M  |   | 07/86 → 12/98   |   | VKPC 83205  |   |   |   |   | 1   |   |   |   |       |
|                              | B(Alt) TU9M   |   | 07/86 → 12/98   | AC  | VKMV 10AVx710   |   |   | 1   |   |   |   |   |   |       |
|   | B(Alt) TU9M   |   | 07/86 → 05/91   | AC  | VKMV 4PK1020  |   |   | 1   |   |   |   |   |   |       |
|   |   |   |   |   | VKM 33012   | 1   |   |   |   |   |   |   |   |       |
|   | B(Alt) TU9M   |   | 05/91 → 12/98   | AC  | VKMA 33012  | 1   |   | 1   |   |   |   |   |   |       |
|   |   |   |   |   | VKMV 5PK1020  |   |   | 1   |   |   |   |   |   |       |
|   |   |   |   |   | VKM 33012   | 1   |   |   |   |   |   |   |   |       |
| <b>CITROËN  AX 1.1</b>       |   |   |   |   |   |   |   |   |   |   |   |   |   |       |
|                              | TU1, TU1CP, TU1M  |   | 09/86 → 12/97   |  | VKMC 03100  | 1   |   | 1   |   | 1   |   |   |   | T0044 |
|   |   |   |   |   | VKMA 03100  | 1   |   | 1   |   |   |   |   |   |       |
|   |   |   |   |   | VKM 13100   | 1   |   |   |   |   |   |   |   |       |
|   | TU1, TU1CP, TU1M  |   | 09/86 → 12/97   | 3)  | VKMS 03100-2  | 1   |   | 1   |   |   |   | 2   |   | T0044 |
|   |   |   |   |   | VKMA 03100  | 1   |   | 1   |   |   |   |   |   |       |
|   |   |   |   |   | VKM 13100   | 1   |   |   |   |   |   |   |   |       |
|                              | TU1, TU1CP, TU1M  |   | 09/86 → 12/97   |   | VKPC 83205  |   |   |   |   | 1   |   |   |   |       |
|                              | B(Alt) TU1, TU1CP, TU1M   |   | 09/86 → 12/97   | AC  | VKMV 10AVx710   |   |   | 1   |   |   |   |   |   |       |
|   | B(Alt) TU1, TU1CP, TU1M   |   | 09/86 → 05/91   | AC  | VKMV 4PK1020  |   |   | 1   |   |   |   |   |   |       |
|   |   |   |   |   | VKM 33012   | 1   |   |   |   |   |   |   |   |       |
|   | B(Alt) TU1, TU1CP, TU1M   |   | 05/91 → 12/97   | AC  | VKMA 33012  | 1   |   | 1   |   |   |   |   |   |       |
|   |   |   |   |   | VKMV 5PK1020  |   |   | 1   |   |   |   |   |   |       |
|   |   |   |   |   | VKM 33012   | 1   |   |   |   |   |   |   |   |       |
| <b>CITROËN  AX 1.3</b>       |   |   |   |   |   |   |   |   |   |   |   |   |   |       |
|                              | TU2   |   | 04/87 → 12/88   |  | VKMC 03100  | 1   |   | 1   |   | 1   |   |   |   | T0044 |
|   |   |   |   |   | VKMA 03100  | 1   |   | 1   |   |   |   |   |   |       |
|   |   |   |   |   | VKM 13100   | 1   |   |   |   |   |   |   |   |       |



CHEVROLET



|                              | TU2         | 04/87 → 12/88 | 3)                        | VKMS 03100-2<br>VKMA 03100<br>VKM 13100            | 1<br>1<br>1      |   | 1      |   |  |   |  |   | 2 |   |  | T0044 |
|------------------------------|-------------|---------------|---------------------------|--|------------------|---|--------|---|--|---|--|---|---|---|--|-------|
|                              | TU2         | 04/87 → 12/88 |                           | VKPC 83205   |                  |   |        |   |  | 1 |  |   |   |   |  |       |
|                              | B(Alt) TU2  | 04/87 → 12/88 | AC                        | VKMV 10AVx710                                      |                  |   | 1      |   |  |   |  |   |   |   |  |       |
|                              | B(Alt) TU2  | 04/87 → 12/88 | AC                        | VKMV 4PK1020<br>VKM 33012                          | 1                |   | 1      |   |  |   |  |   |   |   |  |       |
| <b>CITROËN  AX 1.4</b>       |             |               |                           |  |                  |   |        |   |  |   |  |   |   |   |  |       |
|                              | TU3         | 12/86 → 12/92 | 3),                       | VKMS 03110-2<br>VKMA 03110<br>VKM 13100            | 1<br>1<br>1      |   | 1      |   |  |   |  |   | 2 |   |  | T0044 |
|                              | TU3         | 01/93 → 04/97 |                           | VKMA 03111<br>VKM 13100                            | 1<br>1           |   | 1      |   |  |   |  |   |   |   |  | T0044 |
|                              | TU3         | 12/86 → 04/97 | Mot. Alu.                 | VKPC 83205   |                  |   |        |   |  | 1 |  |   |   |   |  |       |
|                              | TU3         | 04/87 → 04/97 | Mot. Cast.                | VKPC 83428   |                  |   |        |   |  | 1 |  |   |   |   |  |       |
|                              | B(Alt) TU3  | 12/86 → 04/97 | AC                        | VKMV 10AVx710                                      |                  |   | 1      |   |  |   |  |   |   |   |  |       |
|                              | B(Alt) TU3  | 12/86 → 05/91 | AC                        | VKMV 4PK1020<br>VKM 33012                          | 1                |   | 1      |   |  |   |  |   |   |   |  |       |
|                              | B(Alt) TU3  | 05/91 → 04/97 | AC                        | VKMA 33012<br>VKMV 5PK1020<br>VKM 33012            | 1<br>1<br>1      |   | 1<br>1 |   |  |   |  |   |   |   |  |       |
| <b>CITROËN  AX 1.4 D</b>     |             |               |                           |  |                  |   |        |   |  |   |  |   |   |   |  |       |
|                              | TUD3        | 09/88 → 12/97 |                           | VKMA 03120<br>VKM 13120<br>VKM 23120               | 1<br>1<br>1      | 1 | 1      |   |  |   |  |   |   |   |  | T0120 |
|                              | TUD3        | 09/88 → 12/97 |                           | VKPC 83205   |                  |   |        |   |  | 1 |  |   |   |   |  |       |
|                              | B(Alt) TUD3 | 09/88 → 12/97 | 9)                        | VKMV 5PK690  |                  |   | 1      |   |  |   |  |   |   |   |  |       |
|                              | B(Alt) TUD3 | 09/88 → 12/97 | 10)                       | VKMV 10AVx700                                      |                  |   | 1      |   |  |   |  |   |   |   |  |       |
| <b>CITROËN  AX 1.5 D</b>     |             |               |                           |  |                  |   |        |   |  |   |  |   |   |   |  |       |
|                              | TUD5        | 08/94 → 12/97 |                           | VKMC 03121<br>VKMA 03121<br>VKM 13120<br>VKM 23120 | 1<br>1<br>1<br>1 | 1 | 1      | 1 |  | 1 |  |   |   | 2 |  | T0120 |
|                              | TUD5        | 08/94 → 12/97 | 3)                        | VKMS 03121<br>VKMA 03121<br>VKM 13120<br>VKM 23120 | 1<br>1<br>1<br>1 | 1 | 1      | 1 |  |   |  |   | 2 | 2 |  | T0120 |
|                              | TUD5        | 08/94 → 12/97 |                           | VKPC 83428   |                  |   |        |   |  | 1 |  |   |   |   |  |       |
|                              | B(Alt) TUD5 | 08/94 → 12/97 |                           | VKMA 33045<br>VKMV 5PK775<br>VKM 33009             | 1<br>1<br>1      |   | 1      | 1 |  |   |  |   |   |   |  |       |
|                              | B(Alt) TUD5 | 08/94 → 12/97 |                           | VKMA 33046<br>VKMV 5PK960<br>VKM 33039             | 1<br>1<br>1      |   | 1      | 1 |  | 1 |  |   |   |   |  |       |
|                              | TUD5        | 11/97 → 12/97 |                           | VKM 93305  |                  |   |        |   |  |   |  | 1 |   |   |  |       |
| <b>CITROËN  AXEL 1.1</b>     |             |               |                           |  |                  |   |        |   |  |   |  |   |   |   |  |       |
|                              | G11/631     | 01/84 → 03/91 |                           | VKMA 03010<br>VKM 12200<br>VKM 12200               | 2<br>1<br>1      |   | 2      |   |  |   |  |   |   |   |  | T0221 |
| <b>CITROËN  AXEL 1.3</b>     |             |               |                           |  |                  |   |        |   |  |   |  |   |   |   |  |       |
|                              |             | 01/84 → 03/91 |                           | VKMA 03010<br>VKM 12200<br>VKM 12200               | 2<br>1<br>1      |   | 2      |   |  |   |  |   |   |   |  | T0221 |
| <b>CITROËN  BERLINGO 1.1</b> |             |               |                           |  |                  |   |        |   |  |   |  |   |   |   |  |       |
|                              | TU1JP       | 07/96 → 11/07 | M⊙,<br>→IMot. 3762433     | VKMC 03100<br>VKMA 03100<br>VKM 13100              | 1<br>1<br>1      |   | 1      | 1 |  | 1 |  |   |   |   |  | T0044 |
|                              | TU1JP       | 07/96 → 11/07 | 3), M⊙,<br>→IMot. 3762433 | VKMS 03100-2<br>VKMA 03100<br>VKM 13100            | 1<br>1<br>1      |   | 1      | 1 |  |   |  |   | 2 |   |  | T0044 |
|                              | TU1JP       | 07/96 → 11/07 | A⊙, Mot. 3762434  →       | VKMA 03253<br>VKM 13253                            | 1<br>1           |   | 1      |   |  |   |  |   |   |   |  | T0188 |

|  | TU1M+               | 07/96 → 11/07 | 3)   | VKMC 03100<br>VKMA 03100<br>VKM 13100   | 1<br>1<br>1 | 1      | 1 |   |   | T0044 |
|--|---------------------|---------------|--|---|-------------|--------|---|---|---|-------|
|  | TU1M+               | 07/96 → 11/07 | 3)   | VKMS 03100-2<br>VKMA 03100<br>VKM 13100 | 1<br>1<br>1 | 1      |   |   | 2 | T0044 |
|  | TU1JP               | 07/96 → 10/07 | → Mot. 3762433                                     | VKPC 83205                              |             |        |   | 1 |   |       |
|  | TU1JP               | 07/96 → 10/07 | Mot. 3762434  →                                    | VKPC 83644                              |             |        |   | 1 |   |       |
|  | TU1M+               | 07/96 → 10/07 |  | VKPC 83205                              |             |        |   | 1 |   |       |
|  | B(Alt) TU1M+        | 07/96 → 11/07 | 11), <del>70A</del> , <del>AC</del> , <del>Ø</del> | VKMV 10AVx710                           |             |        | 1 |   |   |       |
|  | B(Alt) TU1JP, TU1M+ | 07/96 → 11/07 | 11), <del>AC</del> , <del>Ø</del>                  | VKM 33012                               | 1           |        |   |   |   |       |
|  | B(Alt) TU1JP        | 07/01 → 11/07 | 11), <del>AC</del> , <del>Ø</del>                  | VKM 33012                               | 1           |        |   |   |   |       |
|  | B(Alt) TU1JP        | 07/96 → 11/07 | 12), <del>AC</del>                                 | VKMA 33024<br>VKMV 6PK1451<br>VKM 33018 |             | 1<br>1 | 1 |   |   |       |
|  | B(Alt) TU1JP        | 07/96 → 10/05 | 12), AC  | VKMV 6PK1560<br>VKM 33100<br>VKM 33101  | 1           | 1      | 1 |   |   |       |
|  | B(Alt) TU1JP        | 10/05 → 11/07 | 12), AC  | VKMV 6PK1564<br>VKM 33100<br>VKM _____  | 1           | 1      | 1 |   |   |       |
|  | B(PS) TU1JP         | 07/96 → 07/01 | 11), <del>AC</del>                                 | VKMA 33212<br>VKMV 5PK881<br>VKM 33012  | 1<br>1      | 1      | 1 |   |   |       |
|  | B(PS) TU1JP         | 07/96 → 09/01 | 11), AC  | VKMA 33312<br>VKM 33012                 | 1<br>1      | 1      | 1 |   |   |       |
|  | B(PS) TU1JP         | 09/01 → 11/07 | 11), AC  | VKMV 5PK1218<br>VKM 33012               | 1           | 1      | 1 |   |   |       |

**CITROËN BERLINGO 1.4**

























|  |              |               |  |   |             |        |   |   |   |       |
|--|--------------|---------------|--|---|-------------|--------|---|---|---|-------|
|  | TU3-2        | 07/96 → 11/07 | 3)   | VKMS 03110-2<br>VKMA 03110<br>VKM 13100 | 1<br>1<br>1 | 1      |   |   | 2 | T0044 |
|  | TU3JP        | 07/96 → 11/07 | 3), MØ,<br>→ Mot. 3666765                          | VKMS 03110-2<br>VKMA 03110<br>VKM 13100 | 1<br>1<br>1 | 1      |   |   | 2 | T0044 |
|  | TU3JP        | 07/96 → 11/07 | AØ, Mot. 3666766  →                                | VKMA 03254<br>VKM 13253                 | 1<br>1      | 1      |   |   |   | T0189 |
|  | TU3-2        | 07/96 → 10/07 |  | VKPC 83205                              |             |        |   | 1 |   |       |
|  | TU3A, TU3JP  | 07/96 → 10/07 | Mot. 3666766  →                                    | VKPC 83644                              |             |        |   | 1 |   |       |
|  | TU3JP        | 07/96 → 10/07 | → Mot. 3666765                                     | VKPC 83205                              |             |        |   | 1 |   |       |
|  | B(Alt) TU3JP | 07/96 → 11/07 | 11), <del>70A</del> , <del>AC</del> , <del>Ø</del> | VKMV 10AVx710                           |             |        | 1 |   |   |       |
|  | B(Alt) TU3JP | 07/96 → 11/07 | 11), <del>AC</del> , <del>Ø</del>                  | VKM 33012                               | 1           |        |   |   |   |       |
|  | B(Alt) TU3JP | 11/02 → 11/07 | 12), <del>AC</del>                                 | VKMA 33024<br>VKMV 6PK1451<br>VKM 33018 |             | 1<br>1 | 1 |   |   |       |
|  | B(Alt) TU3JP | 07/96 → 10/05 | 12), AC  | VKMV 6PK1560<br>VKM 33100<br>VKM 33101  | 1           | 1      | 1 |   |   |       |
|  | B(Alt) TU3JP | 10/05 → 11/07 | 12), AC  | VKMV 6PK1564<br>VKM 33100<br>VKM _____  | 1           | 1      | 1 |   |   |       |
|  | B(AC) TU3JP  | 07/96 → 11/07 | 11), AC, Ø   | VKMA 33312<br>VKM 33012                 | 1<br>1      | 1      | 1 |   |   |       |

**CITROËN BERLINGO 1.6 16V**

|  |               |               |                                   |                                      |        |   |   |   |  |   |       |
|--|---------------|---------------|-----------------------------------|--------------------------------------|--------|---|---|---|--|---|-------|
|  | TU5JP4        | 10/00 → 11/07 | → Mot. 1806404                    | VKMA 03132<br>VKM 13132<br>VKM 23130 | 1<br>1 | 1 | 1 |   |  | 1 | T0193 |
|  | TU5JP4        | 10/00 → 11/07 | Mot. 1806405  →                   | VKMA 03256<br>VKM 13256<br>VKM 23256 | 1<br>1 | 1 | 1 |   |  | 1 | T0193 |
|  | TU5JP4        | 10/00 → 10/07 |                                   | VKPC 83430                           |        |   |   | 1 |  |   |       |
|  | B(Alt) TU5JP4 | 10/00 → 11/07 | 11), <del>AC</del> , <del>Ø</del> | VKM 33012                            | 1      |   |   |   |  |   |       |
|  | B(Alt) TU5JP4 | 10/00 → 12/01 | 11), <del>AC</del>                | VKMV 4PK860                          |        |   | 1 |   |  |   |       |



CITROËN



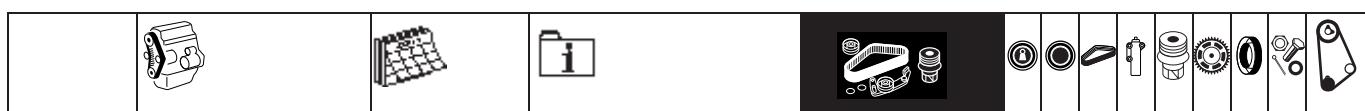





























|  |  |  |    |  |  |  |  |  |  |  |  |
|--|---|---|---|--|---|---|---|---|---|---|---|
| B(Alt)   | TU5JP4  | 10/00 → 10/05   | 12), AC   | VKMV 6PK1560<br>VKM 33100<br>VKM 33101   | 1   | 1   |   |   |   |   |   |
| B(PS)  | TU5JP4  | 10/00 → 12/01   | 11), AC   | VKM 33012  | 1   |   |   |   |   |   |   |
| B(PS)  | TU5JP4  | 10/00 → 09/01   | 11), AC   | VKMA 33312<br>VKM 33012  | 1   | 1   |   |   |   |   |   |
| B(PS)  | TU5JP4  | 09/01 → 11/07   | 11), AC   | VKMV 5PK1218<br>VKM 33012  | 1   | 1   |   |   |   |   |   |
| <b>CITROËN  BERLINGO 1.8</b>      |   |   |   |  |   |   |   |   |   |   |   |
|                                    | XU7JB   | 04/97 → 11/07   |   | VKMA 03201<br>VKM 13100  | 1   | 1   |   |   |   |   | T0018   |
|                                    | XU7JB   | 04/97 → 10/07   |   | VKPC 83615   |   |   | 1   |   |   |   |   |
|                                    | B(Alt)  | XU7JB   | 04/97 → 11/07   | i, 11), AC   | VKMA 33003<br>VKMV 6PK1076<br>VKM 33003   | 1   | 1   |   |   |   |   |
|  | B(Alt)  | XU7JB   | 04/97 → 11/07   | i, 11), AC   | VKMV 6PK1076<br>VKM 33025   |   | 1   |   |   |   |   |
|  | B(Alt)  | XU7JB   | 04/97 → 11/07   | 11), <del>Q</del> 120A, AC   | VKMA 33032<br>VKMV 6PK1660<br>VKM 33026<br>VKM 33028                                | 1   | 1   | 1   |   |   |   |
|  | B(Alt)  | XU7JB   | 04/97 → 11/07   | 11), <del>Q</del> 120A, AC   | VKMA 33033<br>VKMV 6PK1660<br>VKM 33027<br>VKM 33028                                | 1   | 1   | 1   |   |   |   |
| <b>CITROËN  BERLINGO 1.6 HDI</b> |   |   |   |  |   |   |   |   |   |   |   |
|                                  | DV6ATED4, DV6BTED4  | 07/05 → 11/07   |   | VKMA 03259<br>VKM 13140<br>VKM 23140   | 1   | 1   | 1   |   |   |   | T0195   |
|                                  | DV6ATED4, DV6BTED4  | 07/05 → 10/07   |   | VKPC 83259   |   |   | 1   |   |   |   |   |
|                                  | B(Alt)  | DV6ATED4, DV6BTED4  | 07/05 → 10/05   | 12), AC  | VKMA 33060<br>VKMV 6PK1341<br>VKM 33060<br>VKM 33060<br>VKM 33061                   | 1   | 2   | 1   |   |   | 1   |
|  | B(Alt)  | DV6ATED4, DV6BTED4  | 07/05 → 10/05   | 12), AC  | VKMA 33061<br>VKMV 6PK1705<br>VKM 33044<br>VKM 33061                                | 1   | 1   | 1   |   |   | 1   |
|  | B(Alt)  | DV6ATED4, DV6BTED4  | 10/05 → 11/07   | 12), AC  | VKM _____   | 1   |   |   |   |   |   |
|  | B(Alt)  | DV6ATED4, DV6BTED4  | 10/05 → 11/07   | 12), AC  | VKMV 6PK1710<br>VKM _____   | 1   | 1   |   |   |   |   |
| <b>CITROËN  BERLINGO 1.8 D</b>  |   |   |   |  |   |   |   |   |   |   |   |
|                                  | XUD7  | 07/96 → 11/07   |  | VKMC 03241<br>VKMA 03241<br>VKM 13241<br>VKM 23241                                 | 1   | 1   | 1   | 1   |   |   | T0017   |
|  | XUD7  | 07/96 → 11/07   | 3)  | VKMS 03241<br>VKMA 03241<br>VKM 13241<br>VKM 23241                                 | 1   | 1   | 1   |   |   | 2   | T0017   |
|                                  | XUD7  | 07/96 → 10/07   |   | VKPC 83420   |   |   |   | 1   |   |   |   |
|                                  | B(Alt)  | XUD7  | 07/96 → 11/07   | 11), AC, <del>Q</del>  | VKMV 6PK730   |   |   | 1   |   |   |   |
|  | B(Alt)  | XUD7  | 07/96 → 11/07   | 11), AC, <del>Q</del>  | VKMA 33040<br>VKMV 6PK1160<br>VKM 33002   | 1   | 1   | 1   |   |   |   |
|  | B(Alt)  | XUD7  | 07/96 → 11/07   | 11), AC, <del>Q</del>  | VKMA 33102<br>VKMV 6PK1110<br>VKM 33002   | 1   | 1   | 1   |   |   |   |
|  | B(Alt)  | XUD7  | 07/96 → 11/07   | 11), AC, <del>Q</del>  | VKMV 6PK1740<br>VKM 33013<br>VKM 33029<br>VKM 33311                                 | 1   | 1   |   |   |   | 1   |
|                                  | XUD7  | 07/96 → 11/07   |   | VKM 93302  |   |   |   |   | 1   |   |   |





































| CITROËN  BERLINGO 1.9 D   |                       |               |               |              |   |   |   |  |   |   |   |   |       |
|---------------------------|-----------------------|---------------|---------------|--------------|---|---|---|--|---|---|---|---|-------|
|                           | DW8, DW8B             | 07/98 → 11/07 |               | VKMC 03244   | 1 | 1 | 1 |  | 1 |   |   | 1 |       |
|                           |                       |               |               | VKMA 03244   | 1 | 1 | 1 |  |   |   |   | 1 | T0167 |
|                           |                       |               |               | VKM 13244    | 1 |   |   |  |   |   |   | 1 |       |
|                           |                       |               |               | VKM 23246    |   |   | 1 |  |   |   |   |   |       |
|                           | XUD9A, XUD9A/L        | 07/96 → 11/07 |               | VKMC 03241   | 1 | 1 | 1 |  | 1 |   |   |   | T0017 |
|                           |                       |               |               | VKMA 03241   | 1 | 1 | 1 |  |   |   |   |   |       |
|                           |                       |               |               | VKM 13241    | 1 |   |   |  |   |   |   |   |       |
|                           |                       |               |               | VKM 23241    |   |   | 1 |  |   |   |   |   |       |
|                           | XUD9A, XUD9A/L        | 07/96 → 11/07 | 3)            | VKMS 03241   | 1 | 1 | 1 |  |   |   |   | 2 | T0017 |
|                           |                       |               |               | VKMA 03241   | 1 | 1 | 1 |  |   |   |   |   |       |
|                           |                       |               |               | VKM 13241    | 1 |   |   |  |   |   |   |   |       |
|                           |                       |               |               | VKM 23241    |   |   | 1 |  |   |   |   |   |       |
|                           | DW8, DW8B             | 07/98 → 10/07 |               | VKPC 83639   |   |   |   |  | 1 |   |   |   |       |
|                           | XUD9A, XUD9A/L        | 07/96 → 10/07 |               | VKPC 83420   |   |   |   |  | 1 |   |   |   |       |
|                           | B(Alt) DW8, DW8B      | 07/98 → 07/02 | 15), 11), AC, | VKMA 33093   | 2 |   | 1 |  |   | 1 |   |   |       |
|                           |                       |               |               | VKMV 6PK1750 |   |   | 1 |  |   |   |   |   |       |
|                           |                       |               |               | VKM 33013    | 1 |   |   |  |   |   |   |   |       |
|                           |                       |               |               | VKM 33029    | 1 |   |   |  |   |   | 1 |   |       |
|                           |                       |               |               | VKM 33311    |   |   |   |  |   |   |   |   |       |
|                           | B(Alt) DW8, DW8B      | 07/98 → 11/07 | 11), AC,      | VKMV 6PK866  |   |   | 1 |  |   |   |   |   |       |
|                           |                       |               |               | VKM 33004    | 1 |   |   |  |   |   |   |   |       |
|                           | B(Alt) DW8, DW8B      | 07/98 → 11/07 | 11), AC,      | VKMV 6PK1042 |   |   | 1 |  |   |   |   |   |       |
|                           |                       |               |               | VKM 33004    | 1 |   |   |  |   |   |   |   |       |
|                           | B(Alt) DW8            | 07/98 → 11/99 | 11), AC,      | VKMA 33021   | 1 | 2 | 1 |  |   |   |   |   |       |
|                           |                       |               |               | VKMV 6PK1388 |   |   | 1 |  |   |   |   |   |       |
|                           |                       |               |               | VKM 33017    |   |   | 1 |  |   |   |   |   |       |
|                           |                       |               |               | VKM 33017    |   |   | 1 |  |   |   |   |   |       |
|                           |                       |               |               | VKM 33042    | 1 |   |   |  |   |   |   |   |       |
|                           | B(Alt) DW8            | 11/99 → 11/07 | 11), AC,      | VKMA 33027   | 1 | 2 | 1 |  |   |   |   |   |       |
|                           |                       |               |               | VKMV 6PK1437 |   |   | 1 |  |   |   |   |   |       |
|                           |                       |               |               | VKM 33017    |   |   | 1 |  |   |   |   |   |       |
|                           |                       |               |               | VKM 33031    |   |   | 1 |  |   |   |   |   |       |
|                           |                       |               |               | VKM 33032    | 1 |   |   |  |   |   |   |   |       |
|                           | B(Alt) DW8, DW8B      | 07/02 → 11/07 | 15), 11), AC, | VKMV 6PK1695 |   |   | 1 |  |   |   |   |   |       |
|                           |                       |               |               | VKM 33013    | 1 |   |   |  |   |   |   |   |       |
|                           | B(Alt) DW8B           | 07/98 → 11/07 | 11), AC,      | VKMA 33027   | 1 | 2 | 1 |  |   |   |   |   |       |
|                           |                       |               |               | VKMV 6PK1437 |   |   | 1 |  |   |   |   |   |       |
|                           |                       |               |               | VKM 33017    |   |   | 1 |  |   |   |   |   |       |
|                           |                       |               |               | VKM 33031    |   |   | 1 |  |   |   |   |   |       |
|                           |                       |               |               | VKM 33032    | 1 |   |   |  |   |   |   |   |       |
|                           | B(Alt) DW8B           | 07/98 → 11/07 | 12), AC       | VKMA 33027   | 1 | 2 | 1 |  |   |   |   |   |       |
|                           |                       |               |               | VKMV 6PK1437 |   |   | 1 |  |   |   |   |   |       |
|                           |                       |               |               | VKM 33017    |   |   | 1 |  |   |   |   |   |       |
|                           |                       |               |               | VKM 33031    |   |   | 1 |  |   |   |   |   |       |
|                           |                       |               |               | VKM 33032    | 1 |   |   |  |   |   |   |   |       |
|                           | B(Alt) DW8B           | 07/98 → 11/07 | 12), AC       | VKMV 6PK1680 |   |   | 1 |  |   |   |   |   |       |
|                           |                       |               |               | VKM 33013    | 1 |   |   |  |   |   |   |   |       |
|                           | B(Alt) XUD9A, XUD9A/L | 07/96 → 11/07 | 11), AC,      | VKMA 33040   | 1 |   | 1 |  |   |   |   |   |       |
|                           |                       |               |               | VKMV 6PK1160 |   |   | 1 |  |   |   |   |   |       |
|                           |                       |               |               | VKM 33002    | 1 |   |   |  |   |   |   |   |       |
|                           | B(Alt) XUD9A, XUD9A/L | 07/96 → 11/07 | 11), AC,      | VKMA 33102   | 1 |   | 1 |  |   |   |   |   |       |
|                           |                       |               |               | VKMV 6PK1110 |   |   | 1 |  |   |   |   |   |       |
|                           |                       |               |               | VKM 33002    | 1 |   |   |  |   |   |   |   |       |
|                           | B(Alt) XUD9A, XUD9A/L | 07/96 → 11/07 | 11), AC,      | VKMV 6PK1740 |   |   | 1 |  |   |   |   |   |       |
|                           |                       |               |               | VKM 33013    | 1 |   |   |  |   |   |   |   |       |
|                           |                       |               |               | VKM 33029    | 1 |   |   |  |   |   |   |   |       |
|                           |                       |               |               | VKM 33311    |   |   |   |  |   |   | 1 |   |       |
|                           | B(Alt) XUD9A, XUD9A/L | 07/96 → 11/07 | AC,           | VKMV 6PK730  |   |   | 1 |  |   |   |   |   |       |
|                           | DW8, DW8B             | 07/98 → 09/04 | AC            | VKM 93301    |   |   |   |  |   | 1 |   |   |       |
|                           | DW8, DW8B             | 09/04 → 11/07 | AC            | VKM_____     |   |   |   |  |   | 1 |   |   |       |
|                           | XUD9A, XUD9A/L        | 07/96 → 11/07 |               | VKM 93302    |   |   |   |  |   | 1 |   |   |       |
| CITROËN  BERLINGO 2.0 HDi |                       |               |               |              |   |   |   |  |   |   |   |   |       |
|                           | DW10TD                | 12/99 → 10/00 |               | VKMC 03246   | 1 | 1 | 1 |  | 1 |   |   | 1 |       |
|                           |                       |               |               | VKMA 03246   | 1 | 1 | 1 |  |   |   |   | 1 | T0168 |







































CITROËN

|   |  |  |            |  |  |  |  |  |  |  |  |  |  |  |
|---|---|---|---|--|---|---|---|---|---|---|---|---|---|---|
|   |   |   |   | VKM 13246<br>VKM 23246   | 1   |   |   |   |   |   |   |   | 1   |   |
|   | DW10TD  | 12/99 → 10/00   | 3)  | VKMS 03246<br>VKMA 03246<br>VKM 13246<br>VKM 23246                                 | 1<br>1<br>1   | 1   | 1   |   |   |   | 2   |   | 1<br>1  | T0168   |
|   | DW10TD  | 10/00 → 11/07   |            | VKMC 03247<br>VKMA 03247<br>VKM 13244<br>VKM 23246                                 | 1<br>1<br>1   | 1   | 1   |   | 1   |   |   |   | 1<br>1  | T0168   |
|                           | DW10TD  | 12/99 → 10/07   |   | VKPC 83639   |   |   |   |   | 1   |   |   |   |   |   |
|                           | <b>B(Alt)</b> DW10TD  | 12/99 → 11/07   | 11), <i>AC</i>  | VKMA 33044<br>VKMV 6PK1468<br>VKM 33024<br>VKM 33033<br>VKM 33069                  | 2<br>1<br>1   | 1   | 1   |   |   |   |   |   |   |   |
|   | <b>B(Alt)</b> DW10TD  | 12/99 → 11/07   | 11), <i>AC</i>  | VKMA 33037<br>VKMV 6PK1750<br>VKM 33013<br>VKM 33033                               | 2<br>1<br>1   |   | 1   |   |   |   |   |   |   |   |
|   | <b>B(Alt)</b> DW10TD  | 12/99 → 11/07   | 12), <i>AC</i>  | VKMA 33044<br>VKMV 6PK1468<br>VKM 33024<br>VKM 33033<br>VKM 33069                  | 2<br>1<br>1   | 1   | 1   |   |   |   |   |   |   |   |
|   | <b>B(Alt)</b> DW10TD  | 12/99 → 11/07   | 12), <i>AC</i>  | VKMV 6PK1740<br>VKM 33013<br>VKM 33033   | 1<br>1  |   | 1   |   |   |   |   |   |   |   |
|                         | DW10TD  | 12/99 → 09/04   |   | VKM 93301  |   |   |   |   |   | 1   |   |   |   |   |
|   | DW10TD  | 09/04 → 11/07   |   | VKM_____   |   |   |   |   |   | 1   |   |   |   |   |
| <b>CITROËN  BX 1.1</b> |   |   |   |  |   |   |   |   |   |   |   |   |   |   |
|                         | XW7   | 10/86 → 06/92   |   | <b>OXOXOXO</b>   |   |   |   |   |   |   |   |   |   |   |
|   | TU1M  | 05/88 → 06/92   |          | VKMC 03100<br>VKMA 03100<br>VKM 13100  | 1<br>1<br>1   |   | 1   |   | 1   |   |   |   |   | T0044   |
|   | TU1M  | 05/88 → 06/92   | 3)  | VKMS 03100-2<br>VKMA 03100<br>VKM 13100  | 1<br>1<br>1   |   | 1   |   |   |   | 2   |   |   | T0044   |
|                         | TU1M  | 05/88 → 06/92   |   | VKPC 83205   |   |   |   |   |   | 1   |   |   |   |   |
|   | XW7   | 10/86 → 05/88   | 2)  | VKPA 83200<br>VKPC 83200   |   |   |   |   |   | 1<br>1  |   |   |   |   |
|                         | <b>B(Alt)</b> TU1M  | 10/86 → 05/88   |   | VKMV 10AVx910  |   |   | 1   |   |   |   |   |   |   |   |
|   | <b>B(Alt)</b> TU1M  | 05/88 → 06/92   |   | VKMV 10AVx800  |   |   | 1   |   |   |   |   |   |   |   |
|   | <b>B(HP)</b> TU1M   | 05/88 → 06/92   |   | VKMV 10AVx710  |   |   | 1   |   |   |   |   |   |   |   |
| <b>CITROËN  BX 1.4</b> |   |   |   |  |   |   |   |   |   |   |   |   |   |   |
|                         | TU3   | 10/82 → 02/93   |  101     | VKMA 03111<br>VKM 13100  | 1<br>1  |   | 1   |   |   |   |   |   |   | T0044   |
|   | TU3   | 10/82 → 02/93   | 3),  108 | VKMS 03110-2<br>VKMA 03110<br>VKM 13100  | 1<br>1<br>1   |   | 1   |   |   |   | 2   |   |   | T0044   |
|                         | TU3   | 05/88 → 02/93   | <b>Mot. Cast.</b>   | VKPC 83428   |   |   |   |   |   | 1   |   |   |   |   |
|   | TU3   | 05/88 → 02/93   | <b>Mot. Alu.</b>  | VKPC 83205   |   |   |   |   |   | 1   |   |   |   |   |
|   | XY  | 10/82 → 05/88   | 2)  | VKPA 83200<br>VKPC 83200   |   |   |   |   |   | 1<br>1  |   |   |   |   |
|                         | <b>B(Alt)</b> XY  | 10/82 → 05/88   |   | VKMV 10AVx910  |   |   | 1   |   |   |   |   |   |   |   |
|   | <b>B(Alt)</b> TU3   | 05/88 → 02/93   |   | VKMV 10AVx800  |   |   | 1   |   |   |   |   |   |   |   |
| <b>CITROËN  BX 1.6</b> |   |   |   |  |   |   |   |   |   |   |   |   |   |   |
|                         | XU5   | 10/82 → 01/92   |   | VKMA 03200<br>VKM 13200  | 1<br>1  |   | 1   |   |   |   |   |   |   | T0018   |
|   | XU5   | 01/92 → 12/94   |   | VKMA 03201<br>VKM 13100  | 1<br>1  |   | 1   |   |   |   |   |   |   | T0018   |
|                         | XU5   | 10/82 → 08/91   |   | VKPC 83401   |   |   |   |   |   | 1   |   |   |   |   |
|   | XU5   | 09/91 → 12/94   |   | VKPC 83615   |   |   |   |   |   | 1   |   |   |   |   |
|                         | <b>B(Alt)</b> XU5   | 10/82 → 12/94   | <i>AC</i>   | VKMV 4PK954  |   |   | 1   |   |   |   |   |   |   |   |





































|   |  |  |    |  |  |  |  |  |  |  |  |
|---|---|---|---|--|---|---|---|---|---|---|---|
| <b>CITROËN  BX 1.9</b>         |   |   |   |  |   |   |   |   |   |   |   |
|                                | XU9   | 07/86 → 01/92   |   | VKMA 03200<br>VKM 13200  | 1<br>1  | 1   |   |   |   |   | T0018   |
|   | XU9   | 01/92 → 12/94   |   | VKMA 03201<br>VKM 13100  | 1<br>1  | 1   |   |   |   |   | T0018   |
|                                | XU9   | 07/86 → 08/91   |   | VKPC 83401   |   |   |   | 1   |   |   |   |
|   | XU9   | 09/91 → 12/94   |   | VKPC 83615   |   |   |   | 1   |   |   |   |
|                                | <b>B(Alt)</b> XU9   | 07/86 → 12/94   | <b>AC</b>   | VKMV 4PK954  |   | 1   |   |   |   |   |   |
|   | <b>B(HP)</b> XU9  | 07/86 → 12/94   |   | VKMV 10AVx800  |   | 1   |   |   |   |   |   |
| <b>CITROËN  BX 1.9 GTi 16V</b> |   |   |   |  |   |   |   |   |   |   |   |
|                                | XU9J4   | 09/87 → 02/93   |   | VKMA 03210<br>VKM 13210<br>VKM 13210   | 2<br>1<br>1   | 1   |   |   |   |   | T0064   |
|                                | XU9J4   | 09/87 → 02/93   |   | VKPC 83615   |   |   |   | 1   |   |   |   |
|                                | <b>B(Alt)</b> XU9J4   | 01/88 → 02/93   | <b>AC</b>   | VKMV 5PK1270<br>VKM 33001  | 1   | 1   |   |   |   |   |   |
|   | <b>B(HP)</b> XU9J4  | 09/87 → 01/88   |   | VKMV 10AVx625  |   | 1   |   |   |   |   |   |
|   | <b>B(HP)</b> XU9J4  | 01/88 → 02/93   |   | VKMV 10AVx650  |   | 1   |   |   |   |   |   |
| <b>CITROËN  BX 1.8 D</b>       |   |   |   |  |   |   |   |   |   |   |   |
|                                | XUD7  | 09/86 → 09/93   |    | VKMC 03240<br>VKMA 03240<br>VKM 13240<br>VKM 23240                                 | 1<br>1<br>1<br>1  | 1<br>1<br>1   | 1   |   |   | 2<br>2  | T0017   |
|   | XUD7  | 10/85 → 09/93   | 3)  | VKMS 03240<br>VKMA 03240<br>VKM 13240<br>VKM 23240                                 | 1<br>1<br>1<br>1  | 1<br>1<br>1   |   |   |   | 2<br>2  | T0017   |
|                              | XUD7  | 10/85 → 08/86   |   | VKPC 83401   |   |   |   | 1   |   |   |   |
|   | XUD7  | 09/86 → 09/93   |   | VKPC 83424   |   |   |   | 1   |   |   |   |
|                              | <b>B(Alt)</b> XUD7  | 10/85 → 09/93   | <b>AC</b> , Man. GBX  | VKMV 4PK698  |   | 1   |   |   |   |   |   |
|   | <b>B(Alt)</b> XUD7  | 10/85 → 09/93   | <b>AC</b> , Auto. GBX   | VKMV 5PK715  |   | 1   |   |   |   |   |   |
|   | <b>B(Alt)</b> XUD7  | 10/88 → 09/93   | <b>AC</b>   | VKMV 5PK1230<br>VKM 33006<br>VKM 33090   | 1<br>1<br>1   | 1   |   |   |   |   |   |
|                              | XUD7  | 10/85 → 09/93   | Man. GBX  | —  |   |   |   |   | 1   |   |   |
|   | XUD7  | 10/85 → 09/93   | Auto. GBX   | VKM 93302  |   |   |   |   | 1   |   |   |
| <b>CITROËN  BX 1.8 TD</b>    |   |   |   |  |   |   |   |   |   |   |   |
|                              | XUD7TE  | 03/88 → 12/94   |  | VKMC 03240<br>VKMA 03240<br>VKM 13240<br>VKM 23240                                 | 1<br>1<br>1<br>1  | 1<br>1<br>1   | 1   |   |   | 2<br>2  | T0017   |
|   | XUD7TE  | 03/88 → 12/94   | 3)  | VKMS 03240<br>VKMA 03240<br>VKM 13240<br>VKM 23240                                 | 1<br>1<br>1<br>1  | 1<br>1<br>1   |   |   |   | 2<br>2  | T0017   |
|                              | XUD7TE  | 03/88 → 12/94   |   | VKPC 83424   |   |   |   | 1   |   |   |   |
|                              | <b>B(Alt)</b> XUD7TE  | 03/88 → 02/93   | <b>AC</b>   | VKMV 5PK698  |   | 1   |   |   |   |   |   |
|   | <b>B(Alt)</b> XUD7TE  | 10/88 → 12/94   | <b>AC</b>   | VKMV 5PK1230<br>VKM 33006<br>VKM 33090   | 1<br>1<br>1   | 1   |   |   |   |   |   |
| <b>CITROËN  BX 1.9 D</b>     |   |   |   |  |   |   |   |   |   |   |   |
|                              | XUD9, XUD9A/U   | 09/86 → 12/94   |  | VKMC 03240<br>VKMA 03240<br>VKM 13240<br>VKM 23240                                 | 1<br>1<br>1<br>1  | 1<br>1<br>1   | 1   |   |   | 2<br>2  | T0017   |
|   | XUD9, XUD9A/U   | 09/83 → 12/94   | 3)  | VKMS 03240<br>VKMA 03240<br>VKM 13240<br>VKM 23240                                 | 1<br>1<br>1<br>1  | 1<br>1<br>1   |   |   |   | 2<br>2  | T0017   |
|                              | XUD9  | 09/83 → 08/86   |   | VKPC 83401   |   |   |   | 1   |   |   |   |
|   | XUD9, XUD9A/U   | 09/86 → 12/94   |   | VKPC 83424   |   |   |   | 1   |   |   |   |
|                              | <b>B(Alt)</b> XUD9, XUD9A/U   | 09/83 → 12/94   | 13)   | VKMA 33202<br>VKMV 6PK1130<br>VKM 33002  | 1<br>1<br>1   | 1<br>1  |   |   |   |   |   |



CITROËN































|   |  |  |  |  |  |  |  |  |  |  |  |  |
|---|---|---|---|--|---|---|---|---|---|---|---|---|
| B(Alt)  | XUD9, XUD9A/U   | 09/83 → 12/94   | AC, Man. GBX  | VKMV 4PK698  |   | 1   |   |   |   |   |   |   |
| B(Alt)  | XUD9, XUD9A/U   | 09/83 → 12/94   | AC, Auto. GBX   | VKMV 5PK715  |   | 1   |   |   |   |   |   |   |
| B(Alt)  | XUD9A/U   | 10/88 → 12/94   | AC  | VKMV 5PK1230<br>VKM 33006<br>VKM 33090   | 1   | 1   |   |   |   |   |   |   |
| ⊙   | XUD9, XUD9A/U   | 09/83 → 12/94   | Man. GBX  | —  |   |   |   |   | 1   |   |   |   |
|   | XUD9, XUD9A/U   | 09/83 → 12/94   | Auto. GBX   | VKM 93302  |   |   |   |   | 1   |   |   |   |
| <b>CITROËN  C1 1.0</b>       |   |   |   |  |   |   |   |   |   |   |   |   |
|                               | 1KR-FE  | 06/05 → 11/07   |   | OXOXOXO  |   |   |   |   |   |   |   |   |
|                               | 1KR-FE  | 06/05 → 10/07   |   | —  |   |   |   | 1   |   |   |   |   |
|                               | B(Alt) 1KR-FE   | 06/05 → 11/07   | AC  | VKMV 6PK850  |   | 1   |   |   |   |   |   |   |
|   | B(Alt) 1KR-FE   | 06/05 → 11/07   | AC  | VKMV 6PK1210   |   | 1   |   |   |   |   |   |   |
| <b>CITROËN  C1 1.4 HDi</b>   |   |   |   |  |   |   |   |   |   |   |   |   |
|                               | DV4TD   | 06/05 → 11/07   |   | VKMA 03140<br>VKM 13140<br>VKM 23140   | 1<br>1  | 1<br>1  | 1   |   |   |   |   | T0195   |
|                               | DV4TD   | 06/05 → 11/07   |   | VKPC 83140   |   |   |   | 1   |   |   |   |   |
|                               | B(Alt) DV4TD  | 06/05 → 11/07   | AC  | VKMA 33058<br>VKMV 6PK802<br>VKM 33043<br>VKM 33044                                | 1<br>1  | 1<br>1  | 1<br>1  |   |   |   |   | 1   |
|   | B(Alt) DV4TD  | 06/05 → 11/07   | AC  | VKMV 6PK966<br>VKM 33043   | 1   | 1   |   |   |   |   |   |   |
| <b>CITROËN  C2 1.1</b>       |   |   |   |  |   |   |   |   |   |   |   |   |
|                              | TU1A, TU1JP   | 09/03 → 11/07   |   | VKMA 03253<br>VKM 13253  | 1<br>1  | 1   |   |   |   |   |   | T0188   |
|                             | TU1A, TU1JP   | 09/03 → 10/07   |   | VKPC 83644   |   |   |   | 1   |   |   |   |   |
|                             | B(Alt) TU1A, TU1JP  | 09/03 → 11/07   | AC  | VKMV 6PK728  |   |   | 1   |   |   |   |   |   |
|   | B(Alt) TU1A   | 09/03 → 11/07   | AC  | VKMV 6PK1049<br>VKM 33074  | 1   |   | 1   |   |   |   |   |   |
|   | B(Alt) TU1JP  | 09/03 → 12/03   | AC  | VKMA 33059<br>VKMV 6PK1125<br>VKM 33042<br>VKM 33042                               | 2<br>1<br>1   | 1<br>1  |   |   |   |   |   |   |
|   | B(Alt) TU1JP  | 12/03 → 11/07   | AC  | VKMV 6PK1049<br>VKM 33074  | 1   | 1   |   |   |   |   |   |   |
| <b>CITROËN  C2 1.4</b>     |   |   |   |  |   |   |   |   |   |   |   |   |
|                             | TU3A, TU3JP   | 09/03 → 11/07   |   | VKMA 03254<br>VKM 13253  | 1<br>1  | 1   |   |   |   |   |   | T0189   |
|                             | TU3A, TU3JP   | 09/03 → 10/07   |   | VKPC 83644   |   |   |   | 1   |   |   |   |   |
|                             | B(Alt) TU3A, TU3JP  | 09/03 → 11/07   | AC  | VKMV 6PK728  |   |   | 1   |   |   |   |   |   |
|   | B(Alt) TU3A   | 09/03 → 11/07   | AC  | VKMV 6PK1049<br>VKM 33074  | 1   |   | 1   |   |   |   |   |   |
|   | B(Alt) TU3JP  | 09/03 → 12/03   | AC  | VKMA 33059<br>VKMV 6PK1125<br>VKM 33042<br>VKM 33042                               | 2<br>1<br>1   | 1<br>1  |   |   |   |   |   |   |
|   | B(Alt) TU3JP  | 12/03 → 11/07   | AC  | VKMV 6PK1049<br>VKM 33074  | 1   | 1   |   |   |   |   |   |   |
| <b>CITROËN  C2 1.4 16V</b> |   |   |   |  |   |   |   |   |   |   |   |   |
|                             | ET3J4   | 06/06 → 11/07   |   | VKMA 03258<br>VKM 13258<br>VKM 23258   | 1<br>1  | 1<br>1  | 1   |   |   |   |   | T0209   |
|                             | ET3J4   | 06/06 → 10/07   |   | VKPC 83258   |   |   |   | 1   |   |   |   |   |
|                             | B(Alt) ET3J4  | 06/06 → 11/07   | 14)   | VKMV 6PK1030<br>VKM_____   | 1   |   | 1   |   |   |   |   |   |
| <b>CITROËN  C2 1.6 16V</b> |   |   |   |  |   |   |   |   |   |   |   |   |
|                             | TU5JP4  | 09/03 → 11/07   |   | VKMA 03256<br>VKM 13256<br>VKM 23256   | 1<br>1  | 1<br>1  | 1   |   |   |   |   | T0193   |
|                             | TU5JP4  | 09/03 → 10/07   |   | VKPC 83430   |   |   |   | 1   |   |   |   |   |
|                             | B(Alt) TU5JP4   | 09/03 → 11/07   | AC  | VKMV 6PK728  |   |   | 1   |   |   |   |   |   |



































|   |  |  |  |  |  |  |  |  |  |  |  |  |  |  |
|---|---|---|---|--|---|---|---|---|---|---|---|---|---|---|
| B(Alt)  | TU5JP4  | 09/03 → 12/03   | AC  | VKMA 33059<br>VKMV 6PK1125<br>VKM 33042<br>VKM 33042                               | 2<br>1<br>1   | 1<br>1  |   |   |   |   |   |   |   |   |
| B(Alt)  | TU5JP4  | 12/03 → 11/07   | AC  | VKMV 6PK1049<br>VKM 33074  | 1   | 1   |   |   |   |   |   |   |   |   |
| <b>CITROËN  C2 1.6 16V VTS</b> |   |   |   |  |   |   |   |   |   |   |   |   |   |   |
|                                | TU5JP4S   | 01/05 → 11/07   |   | VKMA 03256<br>VKM 13256<br>VKM 23256   | 1<br>1  | 1<br>1  |   |   |   |   |   |   |   | T0193   |
|                                | TU5JP4S   | 01/05 → 10/07   |   | VKPC 83430   |   |   |   |   | 1   |   |   |   |   |   |
|                                | B(Alt) TU5JP4S  | 01/05 → 11/07   |   | VKMV 6PK1049<br>VKM 33074  | 1   | 1   |   |   |   |   |   |   |   |   |
| <b>CITROËN  C2 1.4 HDi</b>     |   |   |   |  |   |   |   |   |   |   |   |   |   |   |
|                                | DV4TD   | 09/03 → 11/07   |   | VKMA 03140<br>VKM 13140<br>VKM 23140   | 1<br>1  | 1<br>1  |   |   |   |   |   |   |   | T0195   |
|                                | DV4TD   | 09/03 → 10/07   |   | VKPC 83140   |   |   |   |   | 1   |   |   |   |   |   |
|                                | B(Alt) DV4TD  | 09/03 → 09/05   | AC  | VKMA 33058<br>VKMV 6PK802<br>VKM 33043<br>VKM 33044                                | 1<br>1  | 1<br>1  |   |   |   |   |   |   | 1   |   |
| B(Alt)  | DV4TD   | 09/03 → 09/05   | AC  | VKMA 33043<br>VKMV 6PK976<br>VKM 33043   | 1<br>1  | 1<br>1  |   |   |   |   |   |   |   |   |
| B(Alt)  | DV4TD   | 09/05 → 11/07   | AC  | VKM_____   |   | 1   |   |   |   |   |   |   |   |   |
| <b>CITROËN  C3 1.1</b>       |   |   |   |  |   |   |   |   |   |   |   |   |   |   |
|                              | TU1JP   | 02/02 → 11/07   |   | VKMA 03253<br>VKM 13253  | 1<br>1  | 1   |   |   |   |   |   |   |   | T0188   |
|                              | TU1JP   | 02/02 → 10/07   |   | VKPC 83644   |   |   |   |   | 1   |   |   |   |   |   |
|                              | B(Alt) TU1JP  | 02/02 → 11/03   | AC  | VKMA 33059<br>VKMV 6PK1125<br>VKM 33042<br>VKM 33042                               | 2<br>1<br>1   | 1<br>1  |   |   |   |   |   |   |   |   |
| B(Alt)  | TU1JP   | 12/03 → 11/07   | AC  | VKMV 6PK1049<br>VKM 33074  | 1   | 1   |   |   |   |   |   |   |   |   |
| <b>CITROËN  C3 1.4</b>       |   |   |   |  |   |   |   |   |   |   |   |   |   |   |
|                              | TU3JP   | 02/02 → 11/07   |   | VKMA 03254<br>VKM 13253  | 1<br>1  | 1   |   |   |   |   |   |   |   | T0189   |
|                              | TU3JP   | 02/02 → 10/07   |   | VKPC 83644   |   |   |   |   | 1   |   |   |   |   |   |
|                              | B(Alt) TU3JP  | 02/02 → 11/03   | AC  | VKMA 33059<br>VKMV 6PK1125<br>VKM 33042<br>VKM 33042                               | 2<br>1<br>1   | 1<br>1  |   |   |   |   |   |   |   |   |
| B(Alt)  | TU3JP   | 12/03 → 11/07   | AC  | VKMV 6PK1049<br>VKM 33074  | 1   | 1   |   |   |   |   |   |   |   |   |
| <b>CITROËN  C3 1.4 16V</b>   |   |   |   |  |   |   |   |   |   |   |   |   |   |   |
|                              | ET3J4   | 12/03 → 11/07   |   | VKMA 03258<br>VKM 13258<br>VKM 23258   | 1<br>1  | 1<br>1  |   |   |   |   |   |   |   | T0209   |
|                              | ET3J4   | 12/03 → 10/07   |   | VKPC 83258   |   |   |   |   | 1   |   |   |   |   |   |
|                              | B(Alt) ET3J4  | 12/03 → 11/07   | 14)   | VKMV 6PK1030<br>VKM_____   | 1   | 1   |   |   |   |   |   |   |   |   |
| B(Alt)  | ET3J4   | 12/03 → 11/07   | 15), AC   | VKMV 6PK815  |   | 1   |   |   |   |   |   |   |   |   |
| B(Alt)  | ET3J4   | 12/03 → 11/07   | 15), AC   | VKMV 6PK1049<br>VKM 33074  | 1   | 1   |   |   |   |   |   |   |   |   |
| <b>CITROËN  C3 1.6 16V</b>   |   |   |   |  |   |   |   |   |   |   |   |   |   |   |
|                              | TU5JP4  | 02/02 → 11/07   | →IMot. 1806404  | VKMA 03132<br>VKM 13132<br>VKM 23130   | 1<br>1  | 1<br>1  |   |   |   |   |   |   | 1   | T0193   |
|   |   |   |   |  |   | 1   |   |   |   |   |   |   | 1   |   |















































CITROËN

































|   |  |  |  |  |  |  |  |  |  |  |  |  |
|---|---|---|---|--|---|---|---|---|---|---|---|---|
|   | TU5JP4  | 02/02 → 11/07   | Mot. 1806405 I→   | VKMA 03256<br>VKM 13256<br>VKM 23256   | 1<br>1  | 1<br>1  |   |   |   |   |   | T0193   |
|                                   | TU5JP4  | 02/02 → 10/07   | <del>ARG</del> , <del>BR</del>  | VKPC 83430   |   |   |   |   | 1   |   |   |   |
|   | TU5JP4  | 02/02 → 10/07   | <del>ARG</del> , <del>BR</del>  | —  |   |   |   |   | 1   |   |   |   |
|                                   | <b>B(Alt)</b> TU5JP4  | 02/02 → 11/07   | <b>AC</b>   | VKMA 6PK728  |   |   | 1   |   |   |   |   |   |
|   | <b>B(Alt)</b> TU5JP4  | 02/02 → 11/03   | <b>AC</b>   | VKMA 33059<br>VKMV 6PK1125<br>VKM 33042<br>VKM 33042                               | 2<br>1<br>1   | 1<br>1  |   |   |   |   |   |   |
|   | <b>B(Alt)</b> TU5JP4  | 12/03 → 11/07   | <b>AC</b>   | VKMA 33074<br>VKMV 6PK1049   | 1   | 1   |   |   |   |   |   |   |
| <b>CITROËN  C3 1.4 HDi 70</b>    |   |   |   |  |   |   |   |   |   |   |   |   |
|                                   | DV4TD   | 02/02 → 11/07   |   | VKMA 03140<br>VKM 13140<br>VKM 23140   | 1<br>1  | 1<br>1  |   |   |   |   |   | T0195   |
|                                   | DV4TD   | 02/02 → 10/07   |   | VKPC 83140   |   |   |   |   | 1   |   |   |   |
|                                   | <b>B(Alt)</b> DV4TD   | 02/02 → 11/07   | 11), <b>AC</b>  | VKMA 33058<br>VKMV 6PK802<br>VKM 33043<br>VKM 33044                                | 1<br>1  | 1<br>1  |   |   |   |   |   | 1   |
|   | <b>B(Alt)</b> DV4TD   | 02/02 → 11/07   | 11), <b>AC</b>  | VKMA 33043<br>VKMV 6PK976<br>VKM 33043   | 1<br>1  | 1<br>1  |   |   |   |   |   |   |
|   | <b>B(Alt)</b> DV4TD   | 02/02 → 11/07   | 12), <b>AC</b>  | VKMA 33060<br>VKMV 6PK1341<br>VKM 33060<br>VKM 33060<br>VKM 33061                  | 1<br>1<br>1<br>1  | 2<br>1<br>1   | 1   |   |   |   |   | 1<br>1  |
|   | <b>B(Alt)</b> DV4TD   | 02/02 → 11/07   | 12), <b>AC</b>  | VKMA 33061<br>VKMV 6PK1705<br>VKM 33044<br>VKM 33061                               | 1<br>1<br>1   | 1<br>1  |   |   |   |   |   | 1   |
|                                 | DV4TD   | 02/02 → 11/07   |   | —  |   |   |   |   | 1   |   |   |   |
| <b>CITROËN  C3 1.4 HDi 90</b>  |   |   |   |  |   |   |   |   |   |   |   |   |
|                                 | DV4TED4   | 02/02 → 11/07   |   | VKMA 03141<br>VKM 13140<br>VKM 23140   | 1<br>1  | 1<br>1  |   |   |   |   |   | T0197   |
|                                 | DV4TED4   | 02/02 → 10/07   |   | VKPC 83140   |   |   |   |   | 1   |   |   |   |
|                                 | <b>B(Alt)</b> DV4TED4   | 02/02 → 11/07   | <b>AC</b>   | VKMA 33058<br>VKMV 6PK802<br>VKM 33043<br>VKM 33044                                | 1<br>1  | 1<br>1  |   |   |   |   |   | 1   |
|   | <b>B(Alt)</b> DV4TED4   | 02/02 → 11/07   | <b>AC</b>   | VKMA 33043<br>VKMV 6PK976<br>VKM 33043   | 1<br>1  | 1<br>1  |   |   |   |   |   |   |
|                                 | DV4TED4   | 02/02 → 12/04   |   | —  |   |   |   |   | 1   |   |   |   |
| <b>CITROËN  C3 1.6 HDi</b>     |   |   |   |  |   |   |   |   |   |   |   |   |
|                                 | DV6ATED4, DV6TED4   | 09/05 → 11/07   |   | VKMA 03259<br>VKM 13140<br>VKM 23140   | 1<br>1  | 1<br>1  |   |   |   |   |   | T0195   |
|                                 | DV6ATED4, DV6TED4   | 09/05 → 10/07   |   | VKPC 83259   |   |   |   |   | 1   |   |   |   |
|                                 | <b>B(Alt)</b> DV6ATED4, DV6TED4   | 09/05 → 11/07   | <b>AC</b>   | VKMA 33060<br>VKMV 6PK1341<br>VKM 33060<br>VKM 33060<br>VKM 33061                  | 1<br>1<br>1<br>1  | 2<br>1<br>1   | 1   |   |   |   |   | 1<br>1  |
|   | <b>B(Alt)</b> DV6ATED4, DV6TED4   | 09/05 → 11/07   | <b>AC</b>   | VKMA 33061<br>VKMV 6PK1705<br>VKM 33044<br>VKM 33061                               | 1<br>1<br>1   | 1<br>1  |   |   |   |   |   | 1   |
| <b>CITROËN  C3 Pluriel 1.4</b> |   |   |   |  |   |   |   |   |   |   |   |   |
|                                 | TU3A, TU3JP   | 05/03 → 11/07   |   | VKMA 03254<br>VKM 13253  | 1<br>1  | 1   |   |   |   |   |   | T0189   |
|                                 | TU3A, TU3JP   | 05/03 → 10/07   |   | VKPC 83644   |   |   |   |   | 1   |   |   |   |

|   |  |  |  |  |  |  |  |  |  |  |  |  |
|---|---|---|---|--|---|---|---|---|---|---|---|---|
|                                    | B(Alt) TU3A   | 05/03 → 11/07   | AC  | VKMV 6PK728  |   |   | 1   |   |   |   |   |   |
|   | B(Alt) TU3JP  | 05/03 → 11/07   | Dep. CEE 2000, AC   | VKMV 6PK1049<br>VKM 33074  | 1   |   | 1   |   |   |   |   |   |
|   | B(Alt) TU3JP  | 05/03 → 11/07   | Dep. IFL5, AC   | VKMA 33059<br>VKMV 6PK1125<br>VKM 33042<br>VKM 33042                               | 2<br>1<br>1   |   | 1<br>1  |   |   |   |   |   |
| <b>CITROËN  C3 Pluriel 1.6 16V</b> |   |   |   |  |   |   |   |   |   |   |   |   |
|                                    | TU5JP4  | 05/03 → 11/07   | → IMot. 1806404   | VKMA 03132<br>VKM 13132<br>VKM 23130   | 1<br>1  | 1   | 1   |   |   |   |   | 1 T0193   |
|   | TU5JP4  | 05/03 → 11/07   | Mot. 1806405 I→   | VKMA 03256<br>VKM 13256<br>VKM 23256   | 1<br>1  | 1   | 1   |   |   |   |   | 1 T0193   |
|                                    | TU5JP4  | 05/03 → 10/07   | <del>ARG</del> , <del>BR</del>  | VKPC 83430   |   |   |   |   | 1   |   |   |   |
|   | TU5JP4  | 05/03 → 10/07   | <del>ARG</del> , <del>BR</del>  | —  |   |   |   |   | 1   |   |   |   |
|                                    | B(Alt) TU5JP4   | 05/03 → 11/07   | AC  | VKMV 6PK728  |   |   | 1   |   |   |   |   |   |
|   | B(Alt) TU5JP4   | 05/03 → 11/07   | AC  | VKMA 33059<br>VKMV 6PK1125<br>VKM 33042<br>VKM 33042                               | 2<br>1<br>1   |   | 1<br>1  |   |   |   |   |   |
| <b>CITROËN  C3 Pluriel 1.4 HDi</b> |   |   |   |  |   |   |   |   |   |   |   |   |
|                                    | DV4TD   | 04/04 → 11/07   |   | VKMA 03140<br>VKM 13140<br>VKM 23140   | 1<br>1  | 1   | 1   |   |   |   |   | 1 T0195   |
|                                   | DV4TD   | 04/04 → 10/07   |   | VKPC 83140   |   |   |   |   | 1   |   |   |   |
|                                  | B(Alt) DV4TD  | 04/04 → 11/07   | AC  | VKMA 33058<br>VKMV 6PK802<br>VKM 33043<br>VKM 33044                                | 1<br>1  | 1   | 1<br>1  |   |   |   |   | 1   |
|   | B(Alt) DV4TD  | 04/04 → 11/07   | AC  | VKMA 33043<br>VKMV 6PK976<br>VKM 33043   | 1<br>1  |   | 1<br>1  |   |   |   |   |   |
|                                  | DV4TD   | 04/04 → 10/05   |   | —  |   |   |   |   | 1   |   |   |   |
| <b>CITROËN  C4 1.4 16V</b>       |   |   |   |  |   |   |   |   |   |   |   |   |
|                                  | ET3J4   | 11/04 → 11/07   |   | VKMA 03258<br>VKM 13258<br>VKM 23258   | 1<br>1  | 1   | 1   |   |   |   |   | 1 T0209   |
|                                  | ET3J4   | 11/04 → 10/07   |   | VKPC 83258   |   |   |   |   | 1   |   |   |   |
|                                  | B(Alt) ET3J4  | 11/04 → 11/07   | AC  | VKMV 6PK728  |   |   | 1   |   |   |   |   |   |
|   | B(Alt) ET3J4  | 11/04 → 11/07   | 80A, AC   | VKMV 6PK1049<br>VKM 33074  | 1   |   | 1   |   |   |   |   |   |
|   | B(Alt) ET3J4  | 11/04 → 11/07   | 120A, AC  | VKMV 6PK1069<br>VKM 33074  | 1   |   | 1   |   |   |   |   |   |
| <b>CITROËN  C4 1.6 16V</b>       |   |   |   |  |   |   |   |   |   |   |   |   |
|                                  | TU5JP4  | 11/04 → 11/07   |   | VKMA 03256<br>VKM 13256<br>VKM 23256   | 1<br>1  | 1   | 1   |   |   |   |   | 1 T0193   |
|                                  | TU5JP4  | 11/04 → 10/07   |   | VKPC 83430   |   |   |   |   | 1   |   |   |   |
|                                  | B(Alt) TU5JP4   | 11/04 → 11/07   | AC  | VKMV 6PK728  |   |   | 1   |   |   |   |   |   |
|   | B(Alt) TU5JP4   | 11/04 → 11/07   | 80A, AC   | VKMV 6PK1049<br>VKM 33074  | 1   |   | 1   |   |   |   |   |   |
|   | B(Alt) TU5JP4   | 11/04 → 11/07   | 120A, AC  | VKMV 6PK1069<br>VKM 33074  | 1   |   | 1   |   |   |   |   |   |
| <b>CITROËN  C4 2.0 16V</b>       |   |   |   |  |   |   |   |   |   |   |   |   |
|                                  | EW10A   | 11/04 → 11/07   |   | VKMA 03263<br>VKM 13263<br>VKM 23230   | 1<br>1  | 1   | 1   |   |   |   |   | 1 T0169   |
|   | EW10J4  | 11/04 → 11/07   |   | VKMA 03235<br>VKM 13234<br>VKM 23230   | 1<br>1  | 1   | 1   |   |   |   |   | 1 T0169   |
|   | EW10J4S   | 11/04 → 11/07   |   | VKMA 03260<br>VKM 13234<br>VKM 23230   | 1<br>1  | 1   | 1   |   |   |   |   | 1 T0169   |



CITROËN

|   |  |  |  |  |  |  |  |  |  |  |  |  |
|---|---|---|---|--|---|---|---|---|---|---|---|---|
|                                       | EW10A, EW10J4,<br>EW10J4S   | 11/04 → 10/07   | 16)   | VKPC 83650   |   |   |   | 1   |   |   |   |   |
|                                       | <b>B(Alt)</b> EW10A   | 11/04 → 11/07   |   | VKMV 6PK998<br>VKM_____  | 1   |   | 1   |   |   |   |   |   |
|                                       | <b>B(Alt)</b> EW10J4  | 11/04 → 11/07   |   | VKMA 33066<br>VKMV 6PK1710<br>VKM 33019<br>VKM 33020<br>VKM 33065                  | 1<br>1  | 2   | 1<br>1  |   |   |   |   |   |
|                                       | <b>B(Alt)</b> EW10J4S   | 11/04 → 11/07   |   | VKMV 6PK1710<br>VKM 33020<br>VKM 33063<br>VKM 33064                                | 1   |   | 1<br>1  |   |   |   |   |   |
| <b>CITROËN  C4 1.6 Hdi</b>           |   |   |   |  |   |   |   |   |   |   |   |   |
|                                       | DV6ATED4, DV6TED4   | 11/04 → 11/07   |   | VKMA 03259<br>VKM 13140<br>VKM 23140   | 1<br>1  | 1   | 1   |   |   |   |   | T0195   |
|                                       | DV6ATED4, DV6TED4   | 11/04 → 10/07   |   | VKPC 83259   |   |   |   | 1   |   |   |   |   |
|                                       | <b>B(Alt)</b> DV6ATED4, DV6TED4   | 11/04 → 10/05   | AC  | VKMA 33058<br>VKMV 6PK802<br>VKM 33043<br>VKM 33044                                | 1<br>1  | 1   | 1<br>1  |   |   |   |   | 1   |
|                                       | <b>B(Alt)</b> DV6ATED4, DV6TED4   | 11/04 → 10/05   | AC  | VKMA 33043<br>VKMV 6PK976<br>VKM 33043   | 1<br>1  |   | 1<br>1  |   |   |   |   |   |
|                                       | <b>B(Alt)</b> DV6ATED4, DV6TED4   | 10/05 → 11/07   | AC  | VKM_____   |   | 1   |   |   |   |   |   |   |
| <b>CITROËN  C4 2.0 Hdi</b>         |   |   |   |  |   |   |   |   |   |   |   |   |
|                                     | DW10BTED4   | 11/04 → 11/07   |   | VKMA 03257<br>VKM 13257<br>VKM 23257   | 1<br>1  | 1   | 1   |   |   |   |   | T0205   |
|                                     | DW10BTED4   | 11/04 → 10/07   |   | VKPC 83643   |   |   |   | 1   |   |   |   |   |
|                                     | <b>B(Alt)</b> DW10BTED4   | 11/04 → 11/07   |   | VKMA 33320<br>VKMV 6PK1217<br>VKM 33320  | 1<br>1  |   | 1<br>1  |   |   |   |   |   |
|                                     | DW10BTED4   | 11/04 → 11/07   |   | VKM_____   |   |   |   |   | 1   |   |   |   |
| <b>CITROËN  C4 Picasso 1.8 16V</b> |   |   |   |  |   |   |   |   |   |   |   |   |
|                                     | EW7A  | 10/06 → 11/07   |   | VKMA 03263<br>VKM 13263<br>VKM 23230   | 1<br>1  | 1   | 1   |   |   |   |   | T0169   |
|                                     | EW7A  | 10/06 → 10/07   | 16)   | VKPC 83650   |   |   |   | 1   |   |   |   |   |
|                                     | <b>B(Alt)</b> EW7A  | 10/06 → 11/07   |   | VKMV 6PK998<br>VKM_____  | 1   |   | 1   |   |   |   |   |   |
| <b>CITROËN  C4 Picasso 2.0 16V</b> |   |   |   |  |   |   |   |   |   |   |   |   |
|                                     | EW10A   | 10/06 → 11/07   |   | VKMA 03263<br>VKM 13263<br>VKM 23230   | 1<br>1  | 1   | 1   |   |   |   |   | T0169   |
|                                     | EW10A   | 10/06 → 10/07   | 16)   | VKPC 83650   |   |   |   | 1   |   |   |   |   |
|                                     | <b>B(Alt)</b> EW10A   | 10/06 → 11/07   |   | VKMV 6PK998<br>VKM_____  | 1   |   | 1   |   |   |   |   |   |
| <b>CITROËN  C4 Picasso 1.6 Hdi</b> |   |   |   |  |   |   |   |   |   |   |   |   |
|                                     | DV6TED4   | 10/06 → 11/07   |   | VKMA 03259<br>VKM 13140<br>VKM 23140   | 1<br>1  | 1   | 1   |   |   |   |   | T0195   |
|                                     | DV6TED4   | 10/06 → 10/07   |   | VKPC 83259   |   |   |   | 1   |   |   |   |   |
|                                     | <b>B(Alt)</b> DV6TED4   | 10/06 → 11/07   | AC  | VKM_____   |   | 1   |   |   |   |   |   |   |
| <b>CITROËN  C4 Picasso 2.0 Hdi</b> |   |   |   |  |   |   |   |   |   |   |   |   |
|                                     | DW10BTED4   | 10/06 → 11/07   |   | VKMA 03257<br>VKM 13257<br>VKM 23257   | 1<br>1  | 1   | 1   |   |   |   |   | T0205   |
|                                     | DW10BTED4   | 10/06 → 10/07   |   | VKPC 83643   |   |   |   | 1   |   |   |   |   |
|                                     | <b>B(Alt)</b> DW10BTED4   | 10/06 → 11/07   |   | VKMV 6PK1217   |   |   | 1   |   |   |   |   |   |
|                                     | DW10BTED4   | 10/06 → 11/07   | Man. GBX  | VKM_____   |   |   |   |   | 1   |   |   |   |







































|   |  |  |    |  |  |  |  |  |  |  |  |  |
|---|---|---|---|--|---|---|---|---|---|---|---|---|
| <b>CITROËN  C5 I 1.8 16V</b>       |   |   |   |  |   |   |   |   |   |   |   |   |
|                                    | EW7J4   | 03/01 → 08/04   |   | VKMA 03235<br>VKM 13234<br>VKM 23230   | 1<br>1  | 1   | 1   |   |   |   |   | T0169   |
|                                    | EW7J4   | 03/01 → 08/04   | 16)   | VKPC 83650   |   |   |   | 1   |   |   |   |   |
|                                    | <b>B(Alt)</b> EW7J4   | 03/01 → 08/04   | <b>AC</b>   | VKMA 33055<br>VKMV 6PK1188<br>VKM 33019<br>VKM 33020                               | 1<br>1  | 1   | 1   |   |   |   |   |   |
|   | <b>B(Alt)</b> EW7J4   | 03/01 → 06/03   | <b>AC</b>   | VKMA 33052<br>VKMV 6PK1706<br>VKM 33019<br>VKM 33020                               | 1<br>1  | 1   | 1   |   |   |   |   |   |
|   | <b>B(Alt)</b> EW7J4   | 06/03 → 08/04   | <b>AC</b>   | VKMV 6PK1710<br>VKM 33019<br>VKM 33020   | 1<br>1  |   | 1   |   |   |   |   |   |
| <b>CITROËN  C5 I 2.0 16V</b>       |   |   |   |  |   |   |   |   |   |   |   |   |
|                                    | EW10J4  | 03/01 → 08/04   |   | VKMA 03235<br>VKM 13234<br>VKM 23230   | 1<br>1  | 1   | 1   |   |   |   |   | T0169   |
|                                    | EW10J4  | 03/01 → 08/04   | 16)   | VKPC 83650   |   |   |   | 1   |   |   |   |   |
|                                    | <b>B(Alt)</b> EW10J4  | 03/01 → 08/04   | <b>AC</b>   | VKMA 33055<br>VKMV 6PK1188<br>VKM 33019<br>VKM 33020                               | 1<br>1  | 1   | 1   |   |   |   |   |   |
|   | <b>B(Alt)</b> EW10J4  | 03/01 → 06/03   | <b>AC</b>   | VKMA 33052<br>VKMV 6PK1706<br>VKM 33019<br>VKM 33020                               | 1<br>1  | 1   | 1   |   |   |   |   |   |
|   | <b>B(Alt)</b> EW10J4  | 06/03 → 08/04   | <b>AC</b>   | VKMV 6PK1710<br>VKM 33019<br>VKM 33020   | 1<br>1  |   | 1   |   |   |   |   |   |
| <b>CITROËN  C5 I 2.0 16V HPI</b> |   |   |   |  |   |   |   |   |   |   |   |   |
|                                  | EW10D   | 03/01 → 08/04   |   | VKMA 03231<br>VKM 13231<br>VKM 23230   | 1<br>1  | 1   | 1   |   |   |   |   | T0194   |
|                                  | EW10D   | 03/01 → 08/04   | 16)   | VKPC 83650   |   |   |   | 1   |   |   |   |   |
|                                  | <b>B(Alt)</b> EW10D   | 03/01 → 08/04   | <b>AC</b>   | VKMA 33055<br>VKMV 6PK1188<br>VKM 33019<br>VKM 33020                               | 1<br>1  | 1   | 1   |   |   |   |   |   |
|   | <b>B(Alt)</b> EW10D   | 03/01 → 06/03   | <b>AC</b>   | VKMA 33052<br>VKMV 6PK1706<br>VKM 33019<br>VKM 33020                               | 1<br>1  | 1   | 1   |   |   |   |   |   |
|   | <b>B(Alt)</b> EW10D   | 06/03 → 08/04   | <b>AC</b>   | VKMV 6PK1710<br>VKM 33019<br>VKM 33020   | 1<br>1  |   | 1   |   |   |   |   |   |
| <b>CITROËN  C5 I 3.0 V6</b>      |   |   |   |  |   |   |   |   |   |   |   |   |
|                                  | ES9J4S  | 03/01 → 08/04   |   | VKMA 03902<br>VKM 13902<br>VKM 23900<br>VKM 23900<br>VKM 23901                     | 1<br>1  | 3   | 1   |   |   |   |   | T0204   |
|                                  | ES9J4S  | 03/01 → 08/04   |   | —  |   |   |   | 1   |   |   |   |   |
|                                  | <b>B(Alt)</b> ES9J4S  | 03/01 → 08/04   |   | VKMV 6PK1585<br>VKM 33075  |   |   | 1   |   |   |   |   |   |
| <b>CITROËN  C5 I 2.0 HDi</b>     |   |   |   |  |   |   |   |   |   |   |   |   |
|                                  | DW10ATED, DW10TD  | 03/01 → 08/04   |  | VKMC 03247<br>VKMA 03247<br>VKM 13244<br>VKM 23246                                 | 1<br>1<br>1   | 1   | 1   | 1   |   | 1   |   | 1<br>1<br>1<br>1<br>T0168   |
|                                  | DW10ATED, DW10TD  | 03/01 → 08/04   |   | VKPC 83639   |   |   |   | 1   |   |   |   |   |













































|                               | <b>B(Alt)</b> | DW10ATED, DW10TD | 03/01 → 08/04 | <b>AC</b>            | VKMA 33051<br>VKMV 6PK1451<br>VKM 33024<br>VKM 33033<br>VKM 33069 | 2<br>1<br>1<br>1 | 1<br>1           | 1 |  |  |  |   |  |  |   |       |       |
|-------------------------------|---------------|------------------|---------------|----------------------|---|------------------|------------------|---|--|--|--|---|--|--|---|-------|-------|
|                               | <b>B(Alt)</b> | DW10ATED, DW10TD | 03/01 → 08/04 | <b>AC Delphi, AC</b> | VKMA 33037<br>VKMV 6PK1750<br>VKM 33013<br>VKM 33033              | 2<br>1<br>1      | 1<br>1           |   |  |  |  |   |  |  |   |       |       |
|                               | <b>B(Alt)</b> | DW10ATED, DW10TD | 03/01 → 06/02 | <b>AC Sanden, AC</b> | VKMA 33039<br>VKMV 6PK1736<br>VKM 33013<br>VKM 33033              | 2<br>1<br>1      | 1<br>1           |   |  |  |  |   |  |  |   |       |       |
|                               | <b>B(Alt)</b> | DW10ATED, DW10TD | 06/02 → 08/04 | <b>AC Sanden, AC</b> | VKMV 6PK1744<br>VKM 33013<br>VKM 33033                            | 1<br>1           | 1                |   |  |  |  |   |  |  |   |       |       |
|                               |               | DW10ATED         | 03/01 → 06/02 | <b>Man. GBX</b>      | VKM 93301   |                  |                  |   |  |  |  | 1 |  |  |   |       |       |
|                               |               | DW10ATED         | 03/01 → 06/02 | <b>Auto. GBX</b>     | VKM 93301   |                  |                  |   |  |  |  | 1 |  |  |   |       |       |
|                               |               | DW10ATED         | 06/02 → 08/04 | <b>Man. GBX</b>      | VKM_____  |                  |                  |   |  |  |  | 1 |  |  |   |       |       |
|                               |               | DW10ATED         | 07/02 → 08/04 | <b>Auto. GBX</b>     | VKM_____  |                  |                  |   |  |  |  | 1 |  |  |   |       |       |
|                               |               | DW10TD           | 03/01 → 06/02 |                      | VKM 93301   |                  |                  |   |  |  |  | 1 |  |  |   |       |       |
|                               |               | DW10TD           | 06/02 → 08/04 |                      | VKM_____  |                  |                  |   |  |  |  | 1 |  |  |   |       |       |
| <b>CITROËN  C5 I 2.2 HDi</b>  |               |                  |               |                      |   |                  |                  |   |  |  |  |   |  |  |   |       |       |
|                               |               | DW12TED4         | 03/01 → 04/04 |                      | VKMA 03252<br>VKM 13246<br>VKM 23246                              | 1<br>1           | 1<br>1           | 1 |  |  |  |   |  |  | 1 | T0179 |       |
|                               |               | DW12TED4         | 04/04 → 08/04 |                      | VKMA 03264<br>VKM 13264<br>VKM 23264                              | 1<br>1           | 1<br>1           | 1 |  |  |  |   |  |  |   |       | T0179 |
|                               |               | DW12TED4         | 03/01 → 08/04 |                      | VKPC 83643  |                  |                  |   |  |  |  | 1 |  |  |   |       |       |
|                               | <b>B(Alt)</b> | DW12TED4         | 03/01 → 08/04 |                      | VKMV 6PK1740<br>VKM 33033<br>VKM 33045                            | 1                | 1                |   |  |  |  |   |  |  |   |       |       |
|                               |               | DW12TED4         | 03/01 → 08/04 |                      | VKM 93301   |                  |                  |   |  |  |  | 1 |  |  |   |       |       |
| <b>CITROËN  C5 II 1.8 16V</b> |               |                  |               |                      |   |                  |                  |   |  |  |  |   |  |  |   |       |       |
|                               |               | EW7A             | 09/05 → 11/07 |                      | VKMA 03263<br>VKM 13263<br>VKM 23230                              | 1<br>1           | 1<br>1           | 1 |  |  |  |   |  |  |   |       | T0169 |
|                               |               | EW7J4            | 09/04 → 11/07 |                      | VKMA 03235<br>VKM 13234<br>VKM 23230                              | 1<br>1           | 1<br>1           | 1 |  |  |  |   |  |  |   |       | T0169 |
|                               |               | EW7A             | 09/05 → 10/07 |                      | —   |                  |                  |   |  |  |  | 1 |  |  |   |       |       |
|                               |               | EW7J4            | 09/04 → 10/07 | 16)                  | VKPC 83650  |                  |                  |   |  |  |  | 1 |  |  |   |       |       |
|                               | <b>B(Alt)</b> | EW7A             | 09/05 → 11/07 |                      | VKMV 6PK998<br>VKM_____   | 1                | 1                |   |  |  |  |   |  |  |   |       |       |
|                               | <b>B(Alt)</b> | EW7J4            | 09/04 → 11/07 |                      | VKMV 6PK1710<br>VKM 33019<br>VKM 33020                            | 1                | 1                |   |  |  |  |   |  |  |   |       |       |
| <b>CITROËN  C5 II 2.0 16V</b> |               |                  |               |                      |   |                  |                  |   |  |  |  |   |  |  |   |       |       |
|                               |               | EW10A            | 09/04 → 11/07 |                      | VKMA 03263<br>VKM 13263<br>VKM 23230                              | 1<br>1           | 1<br>1           | 1 |  |  |  |   |  |  |   |       | T0169 |
|                               |               | EW10A            | 09/04 → 10/07 | 16)                  | VKPC 83650  |                  |                  |   |  |  |  | 1 |  |  |   |       |       |
|                               | <b>B(Alt)</b> | EW10A            | 09/04 → 11/07 |                      | VKMV 6PK998<br>VKM_____   | 1                | 1                |   |  |  |  |   |  |  |   |       |       |
| <b>CITROËN  C5 II 3.0 V6</b>  |               |                  |               |                      |   |                  |                  |   |  |  |  |   |  |  |   |       |       |
|                               |               | ES9A             | 09/04 → 11/07 |                      | VKMA 03902<br>VKM 13902<br>VKM 23900<br>VKM 23900<br>VKM 23901    | 1<br>1           | 3<br>1<br>1<br>1 | 1 |  |  |  |   |  |  |   |       | T0204 |
|                               |               | ES9A             | 09/04 → 10/07 |                      | —   |                  |                  |   |  |  |  | 1 |  |  |   |       |       |
|                               | <b>B(Alt)</b> | ES9A             | 09/04 → 11/07 |                      | VKMV 6PK1585<br>VKM 33075   |                  | 1                |   |  |  |  | 1 |  |  |   |       |       |

| <b>CITROËN  C5 II 1.6 HDi</b>     |                  |               |              |   |   |   |  |   |  |   |  |   |       |
|-----------------------------------|------------------|---------------|--------------|---|---|---|--|---|--|---|--|---|-------|
|                                   | DV6TED4          | 09/04 → 11/07 | VKMA 03259   | 1 | 1 | 1 |  |   |  |   |  |   | T0195 |
|                                   |                  |               | VKM 13140    | 1 |   |   |  |   |  |   |  |   |       |
|                                   |                  |               | VKM 23140    |   | 1 |   |  |   |  |   |  |   |       |
|                                   | DV6TED4          | 09/04 → 10/07 | VKPC 83259   |   |   |   |  | 1 |  |   |  |   |       |
|                                   | B(Alt) DV6TED4   | 09/04 → 11/07 | VKMA 33061   | 1 | 1 | 1 |  |   |  |   |  |   |       |
|                                   |                  |               | VKMV 6PK1705 |   |   | 1 |  |   |  |   |  |   |       |
|                                   |                  |               | VKM 33044    |   | 1 |   |  |   |  |   |  | 1 |       |
|                                   |                  |               | VKM 33061    | 1 |   |   |  |   |  |   |  |   |       |
| <b>CITROËN  C5 II 2.0 HDi</b>     |                  |               |              |   |   |   |  |   |  |   |  |   |       |
|                                   | DW10BTED4        | 09/04 → 11/07 | VKMA 03257   | 1 | 1 | 1 |  |   |  |   |  |   | T0205 |
|                                   |                  |               | VKM 13257    | 1 |   |   |  |   |  |   |  |   |       |
|                                   |                  |               | VKM 23257    |   | 1 |   |  |   |  |   |  |   |       |
|                                   | DW10BTED4        | 09/04 → 10/07 | VKPC 83643   |   |   |   |  | 1 |  |   |  |   |       |
|                                   | B(Alt) DW10BTED4 | 09/04 → 11/07 | VKMA 33320   | 1 |   | 1 |  |   |  |   |  |   |       |
|                                   |                  |               | VKMV 6PK1217 |   |   | 1 |  |   |  |   |  |   |       |
|                                   |                  |               | VKM 33320    | 1 |   |   |  |   |  |   |  |   |       |
|                                   | DW10BTED4        | 09/04 → 11/07 | VKM_____     |   |   |   |  |   |  | 1 |  |   |       |
| <b>CITROËN  C5 II 2.2 HDi 133</b> |                  |               |              |   |   |   |  |   |  |   |  |   |       |
|                                   | DW12TED4         | 09/04 → 11/07 | VKMA 03264   | 1 | 1 | 1 |  |   |  |   |  |   | T0179 |
|                                   |                  |               | VKM 13264    | 1 |   |   |  |   |  |   |  |   |       |
|                                   |                  |               | VKM 23264    |   | 1 |   |  |   |  |   |  |   |       |
|                                   | DW12TED4         | 09/04 → 10/07 | VKPC 83643   |   |   |   |  | 1 |  |   |  |   |       |
|                                   | B(Alt) DW12TED4  | 09/04 → 11/07 | VKMV 6PK1740 |   |   | 1 |  |   |  |   |  |   |       |
|                                   |                  |               | VKM 33033    | 1 |   |   |  |   |  |   |  |   |       |
|                                   |                  |               | VKM 33045    |   | 1 |   |  |   |  |   |  |   |       |
|                                   | DW12TED4         | 09/04 → 11/07 | VKM 93301    |   |   |   |  |   |  | 1 |  |   |       |
| <b>CITROËN  C5 II 2.2 HDi 170</b> |                  |               |              |   |   |   |  |   |  |   |  |   |       |
|                                   | DW12BTED4        | 04/06 → 11/07 | —            | 1 | 1 | 1 |  |   |  |   |  |   | 1     |
|                                   |                  |               | VKM 13257    | 1 |   |   |  |   |  |   |  |   |       |
|                                   |                  |               | VKM 23257    |   | 1 |   |  |   |  |   |  |   |       |
|                                   | DW12BTED4        | 04/06 → 04/07 | —            |   |   |   |  | 1 |  |   |  |   |       |
|                                   | B(Alt) DW12BTED4 | 04/06 → 11/07 | VKMV 6PK1205 |   |   | 1 |  |   |  |   |  |   |       |
| <b>CITROËN  C6 3.0 V6</b>         |                  |               |              |   |   |   |  |   |  |   |  |   |       |
|                                   | ES9A             | 09/05 → 11/07 | VKMA 03902   | 1 | 3 | 1 |  |   |  |   |  |   | T0204 |
|                                   |                  |               | VKM 13902    | 1 |   |   |  |   |  |   |  |   |       |
|                                   |                  |               | VKM 23900    |   | 1 |   |  |   |  |   |  |   |       |
|                                   |                  |               | VKM 23900    |   | 1 |   |  |   |  |   |  |   |       |
|                                   |                  |               | VKM 23901    |   | 1 |   |  |   |  |   |  |   |       |
|                                   | ES9A             | 09/05 → 10/07 | —            |   |   |   |  | 1 |  |   |  |   |       |
|                                   | B(Alt) ES9A      | 09/05 → 11/07 | VKMV 6PK1590 |   |   | 1 |  |   |  |   |  |   |       |
| <b>CITROËN  C6 2.2 HdI</b>        |                  |               |              |   |   |   |  |   |  |   |  |   |       |
|                                   | DW12BTED4        | 06/06 → 11/07 | —            | 1 | 1 | 1 |  |   |  |   |  |   | 1     |
|                                   |                  |               | VKM 13257    | 1 |   |   |  |   |  |   |  |   |       |
|                                   |                  |               | VKM 23257    |   | 1 |   |  |   |  |   |  |   |       |
|                                   | DW12BTED4        | 06/06 → 10/07 | —            |   |   |   |  | 1 |  |   |  |   |       |
|                                   | B(Alt) DW12BTED4 | 06/06 → 11/07 | VKMV 6PK1205 |   |   | 1 |  |   |  |   |  |   |       |
| <b>CITROËN  C6 2.7 HdI</b>        |                  |               |              |   |   |   |  |   |  |   |  |   |       |
|                                   | DT17TED4         | 09/05 → 11/07 | VKMA 03261   | 2 | 2 | 2 |  |   |  |   |  |   | T0249 |
|                                   |                  |               | VKM_____     | 1 |   |   |  |   |  |   |  |   |       |
|                                   |                  |               | VKM 13262    | 1 |   |   |  |   |  |   |  |   |       |
|                                   |                  |               | VKM 23261    |   | 1 |   |  |   |  |   |  |   |       |
|                                   |                  |               | VKM 23261    |   | 1 |   |  |   |  |   |  |   |       |
|                                   | DT17TED4         | 09/05 → 10/07 | VKPC_____    |   |   |   |  | 1 |  |   |  |   |       |
|                                   | B(Alt) DT17TED4  | 09/05 → 11/07 | VKMV 6PK1887 |   |   | 1 |  |   |  |   |  |   |       |
|                                   |                  |               | VKM_____     | 1 |   |   |  |   |  |   |  |   |       |
|                                   |                  |               | VKM_____     |   | 1 |   |  |   |  |   |  |   |       |
| <b>CITROËN  C8 2.0 16V</b>        |                  |               |              |   |   |   |  |   |  |   |  |   |       |
|                                   | EW10A            | 09/05 → 11/07 | VKMA 03263   | 1 | 1 | 1 |  |   |  |   |  |   | T0169 |
|                                   |                  |               | VKM 13263    | 1 |   |   |  |   |  |   |  |   |       |
|                                   |                  |               | VKM 23230    |   | 1 |   |  |   |  |   |  |   |       |
|                                   |                  |               | VKMA 03235   | 1 | 1 | 1 |  |   |  |   |  |   | T0169 |
|                                   |                  |               | VKM 13234    | 1 |   |   |  |   |  |   |  |   |       |
|                                   |                  |               | VKM 23230    |   | 1 |   |  |   |  |   |  |   |       |



























































|   |  |  |    |  |  |  |  |  |  |  |  |  |
|---|---|---|---|--|---|---|---|---|---|---|---|---|
|                                   | EW10A   | 09/05 → 10/07   |   | —  |   |   |   |   |   | 1   |   |   |
|   | EW10J4  | 07/02 → 10/07   | 16)   | VKPC 83650   |   |   |   |   |   | 1   |   |   |
|                                   | <b>B(Alt)</b> EW10A   | 09/05 → 11/07   |   | VKMOV 6PK998<br>VKM_____   | 1   |   |   | 1   |   |   |   |   |
|   | <b>B(Alt)</b> EW10J4  | 07/02 → 11/04   |   | VKMOV 6PK1710<br>VKM 33019<br>VKM 33020  | 1   |   |   | 1   |   | 1   |   |   |
|   | <b>B(Alt)</b> EW10J4  | 11/04 → 11/07   |   | VKMOV 6PK1710<br>VKM 33019<br>VKM_____   | 1   |   |   | 1   |   | 1   |   |   |
| <b>CITROËN  C8 2.2 16V</b>       |   |   |   |  |   |   |   |   |   |   |   |   |
|                                   | EW12J4  | 07/02 → 11/07   |   | VKMA 03235<br>VKM 13234<br>VKM 23230   | 1<br>1  | 1   | 1   |   |   |   |   | T0169   |
|                                   | EW12J4  | 07/02 → 10/07   | 16)   | VKPC 83650   |   |   |   |   | 1   |   |   |   |
|                                   | <b>B(Alt)</b> EW12J4  | 07/02 → 11/04   |   | VKMOV 6PK1710<br>VKM 33019<br>VKM 33020  | 1   |   |   | 1   |   |   |   |   |
|   | <b>B(Alt)</b> EW12J4  | 11/04 → 11/07   |   | VKMOV 6PK1710<br>VKM 33019<br>VKM_____   | 1   |   |   | 1   |   | 1   |   |   |
| <b>CITROËN  C8 3.0 V6</b>        |   |   |   |  |   |   |   |   |   |   |   |   |
|                                   | ES9J4S  | 07/02 → 11/07   |   | VKMA 03902<br>VKM 13902<br>VKM 23900<br>VKM 23900<br>VKM 23901                     | 1<br>1  | 3   | 1   |   |   |   |   | T0204   |
|                                 | ES9J4S  | 07/02 → 10/07   |   | —  |   |   |   |   | 1   |   |   |   |
|                                 | <b>B(Alt)</b> ES9J4S  | 07/02 → 11/07   |   | VKMOV 6PK1585<br>VKM 33075   |   |   |   | 1   |   |   |   |   |
| <b>CITROËN  C8 2.0 HDi 110</b> |   |   |   |  |   |   |   |   |   |   |   |   |
|                                 | DW10ATED4   | 07/02 → 11/07   |  | VKMC 03248<br>VKMA 03248<br>VKM 13246<br>VKM 23246                                 | 1<br>1  | 1   | 1   |   | 1   |   |   | T0196   |
|                                 | DW10ATED4   | 07/02 → 10/07   |   | VKPC 83639   |   |   |   |   | 1   |   |   |   |
|                                 | <b>B(Alt)</b> DW10ATED4   | 07/02 → 11/07   |   | VKMOV 6PK1740<br>VKM 33013<br>VKM 33033  | 1<br>1  |   |   | 1   |   |   |   |   |
|                                 | DW10ATED4   | 07/02 → 11/02   |   | VKM 93301  |   |   |   |   |   | 1   |   |   |
|   | DW10ATED4   | 12/02 → 11/07   |   | VKM_____   |   |   |   |   |   | 1   |   |   |
| <b>CITROËN  C8 2.0 HDi 136</b> |   |   |   |  |   |   |   |   |   |   |   |   |
|                                 | DW10BTED4,<br>DW10UTED4   | 03/06 → 11/07   |   | VKMA 03257<br>VKM 13257<br>VKM 23257   | 1<br>1  | 1   | 1   |   |   |   |   | T0205   |
|                                 | DW10BTED4,<br>DW10UTED4   | 03/06 → 10/07   |   | VKPC 83643   |   |   |   |   | 1   |   |   |   |
|                                 | <b>B(Alt)</b> DW10BTED4,<br>DW10UTED4   | 03/06 → 11/07   |   | VKMA 33320<br>VKMOV 6PK1217<br>VKM 33320   | 1<br>1  |   |   | 1   |   | 1   |   |   |
|                                 | DW10BTED4   | 03/06 → 11/07   |   | VKM_____   |   |   |   |   |   | 1   |   |   |
| <b>CITROËN  C8 2.2 HDi</b>     |   |   |   |  |   |   |   |   |   |   |   |   |
|                                 | DW12TED4  | 07/02 → 04/04   |   | VKMA 03252<br>VKM 13246<br>VKM 23246   | 1<br>1  | 1   | 1   |   |   |   |   | T0179   |
|   | DW12TED4  | 04/04 → 11/07   |   | VKMA 03264<br>VKM 13264<br>VKM 23264   | 1<br>1  | 1   | 1   |   |   |   |   | T0179   |
|                                 | DW12TED4  | 07/02 → 10/07   |   | VKPC 83643   |   |   |   |   | 1   |   |   |   |
|                                 | <b>B(Alt)</b> DW12TED4  | 07/02 → 11/07   |   | VKMOV 6PK1740<br>VKM 33033<br>VKM 33045  | 1   |   |   | 1   |   |   |   |   |
|                                 | DW12ATED4   | 07/02 → 11/04   |   | VKM 93301  |   |   |   |   |   | 1   |   |   |

|  |  |  |  |  |  |  |  |  |  |  |  |  |
|--|---|---|---|--|---|---|---|---|---|---|---|---|
|  | DW12ATED4   | 11/04 → 11/07   |   | VKM _____  |   |   |   |   |   | 1   |   |   |
| <b>CITROËN  C-CROSSER 2.2 HDi</b> |   |   |   |  |   |   |   |   |   |   |   |   |
|                                   | DW12MTED4   | 02/07 → 11/07   |   | —  | 1   | 1   | 1   |   |   |   |   |   |
|  |   |   |   | —  | 1   |   |   |   |   |   |   |   |
|                                   | DW12MTED4   | 02/07 → 10/07   |   | —  |   |   |   |   | 1   |   |   |   |
| <b>CITROËN  CX 2.0</b>            |   |   |   |  |   |   |   |   |   |   |   |   |
|                                   | 829 A5, M20-616   | 09/74 → 10/83   |   | VKMA 06200<br>VKM 16200  | 1   |   | 1   |   |   |   |   | T0003   |
|  | 829 A5, X 2.0L  | 11/83 → 12/90   |   | VKMA 06201<br>VKM 16200  | 1   |   | 1   |   |   |   |   | T0024   |
|  |   |   |   |  | 1   |   |   |   |   |   |   |   |
|                                   | 829 A5  | 06/79 → 05/81   |   | —  |   |   |   |   | 1   |   |   |   |
|  | X 2L  | 06/79 → 06/81   |   | —  |   |   |   |   | 1   |   |   |   |
|  | X 2L  | 06/81 → 12/92   |   | VKPC 83626   |   |   |   |   | 1   |   |   |   |
| <b>CITROËN  CX 2.2</b>            |   |   |   |  |   |   |   |   |   |   |   |   |
|                                   | J6T A500, X 2.2L  | 07/85 → 12/90   |   | VKMA 06203<br>VKM 16200  | 1   |   | 1   |   |   |   |   | T0024   |
|  |   |   |   |  | 1   |   |   |   |   |   |   |   |
|                                   | J6T A500  | 07/85 → 12/92   |   | VKPC 83626   |   |   |   |   | 1   |   |   |   |
| <b>CITROËN  CX 2.5</b>            |   |   |   |  |   |   |   |   |   |   |   |   |
|                                   | M25-659, M25-668  | 07/83 → 12/92   |   | ΟΧΘΟΧΟ   |   |   |   |   |   |   |   |   |
|                                   | M25-659, M25-668  | 08/85 → 12/92   |   | VKPC 83617   |   |   |   |   | 1   |   |   |   |
| <b>CITROËN  CX 2.5 GTi Turbo</b>  |   |   |   |  |   |   |   |   |   |   |   |   |
|                                   | M25-662   | 06/84 → 08/85   |   | ΟΧΘΟΧΟ   |   |   |   |   |   |   |   |   |
|                                   | M25-662, M25-667  | 08/85 → 12/92   |   | VKPC 83617   |   |   |   |   | 1   |   |   |   |
| <b>CITROËN  CX 2.2 D</b>          |   |   |   |  |   |   |   |   |   |   |   |   |
|                                  | M22-621   | 10/75 → 02/79   |   | Ω  |   |   |   |   |   |   |   |   |
|                                 | X 2.2L  | 10/75 → 02/79   |   | VKPC 83617   |   |   |   |   | 1   |   |   |   |
| <b>CITROËN  CX 2.5 D</b>        |   |   |   |  |   |   |   |   |   |   |   |   |
|                                 | M25-629   | 02/78 → 12/83   |   | Ω  |   |   |   |   |   |   |   |   |
|  | M25-629, M25-660  | 01/84 → 12/90   |   | VKMA 03050<br>VKM 12200<br>VKM 13050   | 2<br>1<br>1   |   | 2   |   |   |   |   | T0021   |
|                                 | M25-629, M25-660  | 02/78 → 12/92   |   | VKPC 83617   |   |   |   |   | 1   |   |   |   |
| <b>CITROËN  CX 2.5 TD</b>       |   |   |   |  |   |   |   |   |   |   |   |   |
|                                 | M25-648   | 04/83 → 12/83   |   | Ω  |   |   |   |   |   |   |   |   |
|  | M25-648, M25-669  | 01/84 → 12/91   |   | VKMA 03050<br>VKM 12200<br>VKM 13050   | 2<br>1<br>1   |   | 2   |   |   |   |   | T0021   |
|                                 | M25-648, M25-669  | 04/83 → 12/92   |   | VKPC 83617   |   |   |   |   | 1   |   |   |   |
| <b>CITROËN  EVASION 1.8</b>     |   |   |   |  |   |   |   |   |   |   |   |   |
|                                 | XU7JP   | 05/97 → 07/02   |   | VKMA 03201<br>VKM 13100  | 1<br>1  |   | 1   |   |   |   |   | T0018   |
|                                 | XU7JP   | 05/97 → 07/02   |   | VKPC 83615   |   |   |   |   | 1   |   |   |   |
|                                 | B(Alt) XU7JP  | 05/97 → 06/98   | ⊗ 70, 80A, AC   | VKMA 6PK1067<br>VKM 33003  | 1   |   | 1   |   |   |   |   |   |
|  | B(Alt) XU7JP  | 05/97 → 06/98   | ⊗ 90A, AC   | VKMA 33003<br>VKMA 6PK1076<br>VKM 33003  | 1<br>1<br>1   |   | 1<br>1  |   |   |   |   |   |
|  | B(Alt) XU7JP  | 07/98 → 07/02   | ⊗ 70, 80A, AC   | VKMA 6PK1067<br>VKM 33021  | 1   |   | 1   |   |   |   |   |   |
|  | B(Alt) XU7JP  | 07/98 → 07/02   | ⊗ 90A, AC   | VKMA 33031<br>VKMA 6PK1076<br>VKM 33021  | 1<br>1<br>1   |   | 1<br>1  |   |   |   |   |   |
|  | B(Alt) XU7JP  | 05/97 → 07/02   | AC  | VKMA 33030<br>VKMA 6PK1660<br>VKM 33028<br>VKM 33034                               | 1<br>1<br>1<br>1  | 1   | 1<br>1  |   |   |   |   |   |
| <b>CITROËN  EVASION 2.0</b>     |   |   |   |  |   |   |   |   |   |   |   |   |
|                                 | XU10J2  | 06/94 → 07/02   |   | VKMA 03201<br>VKM 13100  | 1<br>1  |   | 1   |   |   |   |   | T0018   |
|                                 | XU10J2  | 06/94 → 07/02   |   | VKPC 83420   |   |   |   |   | 1   |   |   |   |
|                                 | B(Alt) XU10J2   | 06/94 → 06/98   | ⊗ 70A, AC   | VKMA 6PK1067<br>VKM 33003  | 1   |   | 1   |   |   |   |   |   |











































CITROËN













































|  |  |  |    |  |  |  |  |  |  |  |  |  |  |
|--|---|---|---|--|---|---|---|---|---|---|---|---|---|
| B(Alt)   | XU10J2  | 06/94 → 06/98   | 80, 90A, AC   | VKMA 33003<br>VKMV 6PK1076<br>VKM 33003  | 1<br>1  | 1<br>1  |   |   |   |   |   |   |   |
| B(Alt)   | XU10J2  | 07/98 → 07/02   | 70A, AC   | VKMA 33031<br>VKMV 6PK1076<br>VKM 33021  | 1<br>1  | 1<br>1  |   |   |   |   |   |   |   |
| B(Alt)   | XU10J2  | 06/94 → 07/02   | AC  | VKMA 33030<br>VKMV 6PK1660<br>VKM 33028<br>VKM 33034                               | 1<br>1  | 1<br>1  |   |   |   |   |   |   |   |
| <b>CITROËN  EVASION 2.0 16V</b>     |   |   |   |  |   |   |   |   |   |   |   |   |   |
|                                      | EW10J4  | 05/00 → 07/02   |   | VKMA 03235<br>VKM 13234<br>VKM 23230   | 1<br>1  | 1<br>1  |   |   |   |   |   |   | T0169   |
|  | XU10J4R   | 05/98 → 04/00   |   | VKMA 03213<br>VKM 13202<br>VKM 23213   | 1<br>1  | 1<br>1  |   |   |   |   |   | 1   | T0142   |
|                                      | EW10J4  | 05/00 → 07/02   | 16)   | VKPC 83650   |   |   |   | 1   |   |   |   |   |   |
|  | XU10J4R   | 05/98 → 04/00   |   | VKPC 83636   |   |   |   | 1   |   |   |   |   |   |
|                                      | B(Alt) EW10J4   | 05/00 → 07/02   | AC  | VKMA 33055<br>VKMV 6PK1188<br>VKM 33019<br>VKM 33020                               | 1<br>1  | 1<br>1  |   |   |   |   |   |   |   |
| B(Alt)   | EW10J4  | 05/00 → 07/02   | AC  | VKMA 33052<br>VKMV 6PK1706<br>VKM 33019<br>VKM 33020                               | 1<br>1  | 1<br>1  |   |   |   |   |   |   |   |
| B(Alt)   | XU10J4R   | 05/98 → 04/00   | AC  | VKMA 33034<br>VKMV 6PK1603<br>VKM 33028<br>VKM 33035                               | 1<br>1  | 1<br>1  |   |   |   |   |   |   |   |
| B(Alt)   | XU10J4R   | 05/98 → 04/00   | AC  | VKMA 33052<br>VKMV 6PK1706<br>VKM 33019<br>VKM 33020                               | 1<br>1  | 1<br>1  |   |   |   |   |   |   |   |
| B(Alt)   | XU10J4R   | 05/98 → 04/00   | AC  | VKMA 33034<br>VKMV 6PK1603<br>VKM 33028<br>VKM 33035                               | 1<br>1  | 1<br>1  |   |   |   |   |   |   |   |
| <b>CITROËN  EVASION 2.0 Turbo</b> |   |   |   |  |   |   |   |   |   |   |   |   |   |
|                                    | XU10J2TE  | 06/94 → 07/02   |   | VKMA 03201<br>VKM 13100  | 1<br>1  | 1   |   |   |   |   |   |   | T0018   |
|                                    | XU10J2TE  | 06/94 → 07/02   |   | VKPC 83420   |   |   |   | 1   |   |   |   |   |   |
|                                    | B(Alt) XU10J2TE   | 06/94 → 01/97   | 70A, AC   | VKMA 33003<br>VKMV 6PK1076<br>VKM 33003  | 1<br>1  | 1<br>1  |   |   |   |   |   |   |   |
| B(Alt)   | XU10J2TE  | 06/94 → 01/97   | 80, 90A, AC   | VKMA 33003<br>VKMV 6PK1076<br>VKM 33003  | 1<br>1  | 1<br>1  |   |   |   |   |   |   |   |
| B(Alt)   | XU10J2TE  | 02/97 → 07/02   | AC  | VKMA 33030<br>VKMV 6PK1660<br>VKM 33028<br>VKM 33034                               | 1<br>1  | 1<br>1  |   |   |   |   |   |   |   |
| B(Alt)   | XU10J2TE  | 02/97 → 07/02   | AC  | VKMA 33034<br>VKMV 6PK1603<br>VKM 33028<br>VKM 33035                               | 1<br>1  | 1<br>1  |   |   |   |   |   |   |   |
| <b>CITROËN  EVASION 1.9 TD</b>    |   |   |   |  |   |   |   |   |   |   |   |   |   |
|                                    | XUD9TE  | 11/94 → 07/02   |  | VKMC 03241<br>VKMA 03241<br>VKM 13241<br>VKM 23241                                 | 1<br>1<br>1   | 1<br>1<br>1   |   | 1   |   |   |   |   | T0017   |
|  | XUD9TE  | 11/94 → 07/02   | 3)  | VKMS 03241<br>VKMA 03241<br>VKM 13241<br>VKM 23241                                 | 1<br>1<br>1   | 1<br>1<br>1   |   |   |   |   | 2   |   | T0017   |

|   |  |  |    |  |  |  |  |  |  |  |  |  |
|---|---|---|---|--|---|---|---|---|---|---|---|---|
|                                  | XUD9TE  | 11/94 → 07/02   |   | VKPC 83420   |   |   |   | 1   |   |   |   |   |
|                                  | <b>B(Alt)</b> XUD9TE  | 11/94 → 05/95   | <b>AC</b>   | VKMA 33102<br>VKMV 6PK1110<br>VKM 33002  | 1   |   | 1   |   |   |   |   |   |
|   | <b>B(Alt)</b> XUD9TE  | 06/95 → 07/02   | <b>AC</b>   | VKMA 33035<br>VKMV 6PK1102<br>VKM 33002  | 1   |   | 1   |   |   |   |   |   |
|   | <b>B(Alt)</b> XUD9TE  | 11/94 → 07/02   | <b>AC</b>   | VKMV 6PK1739<br>VKM 33013<br>VKM 33029<br>VKM 33311                                | 1   |   | 1   |   |   |   |   |   |
|                                  | XUD9TE  | 11/94 → 07/02   |   | VKM 93302  |   |   |   |   | 1   |   |   |   |
| <b>CITROËN  EVASION 2.0 HDi</b>  |   |   |   |  |   |   |   |   |   |   |   |   |
|                                  | DW10ATED  | 08/99 → 04/00   |    | VKMC 03246<br>VKMA 03246<br>VKM 13246<br>VKM 23246                                 | 1   | 1   | 1   |   | 1   |   |   | 1   |
|   |   |   |   |  |   |   |   |   |   |   |   | 1   |
|   | DW10ATED  | 08/99 → 04/00   | 3)  | VKMS 03246<br>VKMA 03246<br>VKM 13246<br>VKM 23246                                 | 1   | 1   | 1   |   |   |   | 2   | 1   |
|   |   |   |   |  |   |   |   |   |   |   |   | 1   |
|   | DW10ATED  | 04/00 → 07/02   |    | VKMC 03247<br>VKMA 03247<br>VKM 13244<br>VKM 23246                                 | 1   | 1   | 1   |   | 1   |   |   | 1   |
|   |   |   |   |  |   |   |   |   |   |   |   | 1   |
|   | DW10ATED4   | 08/99 → 07/02   |    | VKMC 03248<br>VKMA 03248<br>VKM 13246<br>VKM 23246                                 | 1   | 1   | 1   |   | 1   |   |   | 1   |
|   |   |   |   |  |   |   |   |   |   |   |   | 1   |
|                                | DW10ATED,<br>DW10ATED4  | 08/99 → 07/02   |   | VKPC 83639   |   |   |   |   | 1   |   |   |   |
|                                | <b>B(Alt)</b> DW10ATED  | 08/99 → 07/02   | <b>AC</b>   | VKMA 33044<br>VKMV 6PK1468<br>VKM 33024<br>VKM 33033<br>VKM 33069                  | 2   | 1   | 1   |   |   |   |   |   |
|   | <b>B(Alt)</b> DW10ATED  | 08/99 → 07/02   | <b>AC Delphi, AC</b>  | VKMA 33037<br>VKMV 6PK1750<br>VKM 33013<br>VKM 33033                               | 2   |   | 1   |   |   |   |   |   |
|   | <b>B(Alt)</b> DW10ATED  | 08/99 → 07/02   | <b>AC Sanden, AC</b>  | VKMV 6PK1740<br>VKM 33013<br>VKM 33033   | 1   |   | 1   |   |   |   |   |   |
|                                | DW10ATED,<br>DW10ATED4  | 08/99 → 07/02   |   | VKM 93301  |   |   |   |   | 1   |   |   |   |
| <b>CITROËN  EVASION 2.1 TD</b> |   |   |   |  |   |   |   |   |   |   |   |   |
|                                | XUD11BTE  | 05/96 → 07/02   |  | VKMC 03251<br>VKMA 03251<br>VKM 13250<br>VKM 23213                                 | 1   | 1   | 1   |   | 1   |   |   | 1   |
|   |   |   |   |  |   |   |   |   |   |   |   | 1   |
|   | XUD11BTE  | 05/96 → 07/02   | 3)  | VKMS 03251<br>VKMA 03251<br>VKM 13250<br>VKM 23213                                 | 1   | 1   | 1   |   |   |   | 2   | 1   |
|   |   |   |   |  |   |   |   |   |   |   |   | 1   |
|                                | XUD11BTE  | 05/96 → 07/02   |   | VKPC 83425   |   |   |   |   | 1   |   |   |   |
|                                | <b>B(Alt)</b> XUD11BTE  | 05/96 → 07/02   | <b>AC</b>   | VKMA 33035<br>VKMV 6PK1102<br>VKM 33002  | 1   |   | 1   |   |   |   |   |   |
|   | <b>B(Alt)</b> XUD11BTE  | 05/96 → 07/02   | <b>AC</b>   | VKMV 6PK1740<br>VKM 33013<br>VKM 33029<br>VKM 33311                                | 1   |   | 1   |   |   |   |   |   |
|                                | XUD11BTE  | 05/96 → 07/02   |   | VKM 93306  |   |   |   |   | 1   |   |   |   |
| <b>CITROËN  GS 1.0</b>         |   |   |   |  |   |   |   |   |   |   |   |   |
|                                | G10, G10/612  | 09/70 → 09/77   |   | VKMA 03000<br>VKM 12200<br>VKM 12200   | 2   |   | 2   |   |   |   |   |   |











































CITROËN

|   |                                  |  |   |  |  |  |  |  |  |  |  |  |
|---|----------------------------------|---|--|---|--|---|---|---|---|---|---|---|
| <b>CITROËN  GS 1.1</b>         |                                  |   |  |   |  |   |   |   |   |   |   |   |
|                                 | G11/631                          | 09/77 → 05/82   |  |   | VKMA 03010   | 2   | 2   |   |   |   |   | T0221   |
|   |                                  |   |  |   | VKM 12200  | 1   |   |   |   |   |   |   |
|   |                                  |   |  |   | VKM 12200  | 1   |   |   |   |   |   |   |
| <b>CITROËN  GS 1.2</b>         |                                  |   |  |   |  |   |   |   |   |   |   |   |
|                                 | G12/611, G12/612, G12/619        | 04/73 → 07/79   |  |   | VKMA 03010   | 2   | 2   |   |   |   |   | T0221   |
|   |                                  |   |  |   | VKM 12200  | 1   |   |   |   |   |   |   |
|   |                                  |   |  |   | VKM 12200  | 1   |   |   |   |   |   |   |
| <b>CITROËN  GS 1.3</b>         |                                  |   |  |   |  |   |   |   |   |   |   |   |
|                                 | G13/625, G13/646                 | 09/79 → 07/86   |  |   | VKMA 03010   | 2   | 2   |   |   |   |   | T0221   |
|   |                                  |   |  |   | VKM 12200  | 1   |   |   |   |   |   |   |
|   |                                  |   |  |   | VKM 12200  | 1   |   |   |   |   |   |   |
| <b>CITROËN  LNA 1.0</b>        |                                  |   |  |   |  |   |   |   |   |   |   |   |
|                                 | XV8                              | 07/84 → 10/86   |  |   | <b>OKOKOKO</b>   |   |   |   |   |   |   |   |
|                                 | XV8                              | 07/84 → 10/86   | 2)   |   | VKPA 83200   |   |   |   | 1   |   |   |   |
|   |                                  |   |  |   | VKPC 83200   |   |   |   | 1   |   |   |   |
|                                 | <b>B(Alt)</b> XV8                | 07/84 → 10/86   |  |   | VKMOV 10AVx910   |   | 1   |   |   |   |   |   |
| <b>CITROËN  LNA 1.1</b>        |                                  |   |  |   |  |   |   |   |   |   |   |   |
|                                 | XW7                              | 07/82 → 04/85   |  |   | <b>OKOKOKO</b>   |   |   |   |   |   |   |   |
|                                 | XW7                              | 07/82 → 04/85   | 2)   |   | VKPA 83200   |   |   |   | 1   |   |   |   |
|   |                                  |   |  |   | VKPC 83200   |   |   |   | 1   |   |   |   |
|                                 | <b>B(Alt)</b> XW7                | 07/82 → 04/85   |  |   | VKMOV 10AVx910   |   | 1   |   |   |   |   |   |
| <b>CITROËN  SAXO 1.0</b>       |                                  |   |  |   |  |   |   |   |   |   |   |   |
|                                | TU9M                             | 05/96 → 11/07   |    |   | VKMC 03100   | 1   | 1   | 1   |   |   |   | T0044   |
|   |                                  |   |  |   | VKMA 03100   | 1   | 1   |   |   |   |   |   |
|   |                                  |   |  |   | VKM 13100  | 1   |   |   |   |   |   |   |
|   | TU9M                             | 05/96 → 11/07   | 3)   |   | VKMS 03100-2   | 1   | 1   |   |   | 2   |   | T0044   |
|   |                                  |   |  |   | VKMA 03100   | 1   | 1   |   |   |   |   |   |
|   |                                  |   |  |   | VKM 13100  | 1   |   |   |   |   |   |   |
|                               | TU9M                             | 05/96 → 10/07   |  |   | VKPC 83205   |   |   |   | 1   |   |   |   |
|                               | <b>B(Alt)</b> TU9M               | 05/96 → 11/07   | 10)  |   | VKMOV 10AVx710   |   | 1   |   |   |   |   |   |
| <b>CITROËN  SAXO 1.1</b>     |                                  |   |  |   |  |   |   |   |   |   |   |   |
|                               | TU1JP                            | 05/96 → 11/07   |  <b>M</b> , <b>⊙</b><br>→ <b>I</b> Mot. 3762433 |   | VKMC 03100   | 1   | 1   | 1   |   |   |   | T0044   |
|   |                                  |   |  |   | VKMA 03100   | 1   | 1   |   |   |   |   |   |
|   |                                  |   |  |   | VKM 13100  | 1   |   |   |   |   |   |   |
|   | TU1JP                            | 05/96 → 11/07   | 3), <b>M</b> , <b>⊙</b><br>→ <b>I</b> Mot. 3762433   |   | VKMS 03100-2   | 1   | 1   |   |   | 2   |   | T0044   |
|   |                                  |   |  |   | VKMA 03100   | 1   | 1   |   |   |   |   |   |
|   |                                  |   |  |   | VKM 13100  | 1   |   |   |   |   |   |   |
|   | TU1JP                            | 05/96 → 11/07   | <b>A</b> ⊙, <b>Mot.</b> 3762434   →  |   | VKMA 03253   | 1   | 1   |   |   |   |   | T0188   |
|   |                                  |   |  |   | VKM 13253  | 1   |   |   |   |   |   |   |
|   | TU1M+                            | 05/96 → 11/07   |   |   | VKMC 03100   | 1   | 1   | 1   |   |   |   | T0044   |
|   |                                  |   |  |   | VKMA 03100   | 1   | 1   |   |   |   |   |   |
|   |                                  |   |  |   | VKM 13100  | 1   |   |   |   |   |   |   |
|   | TU1M+                            | 05/96 → 11/07   | 3)   |   | VKMS 03100-2   | 1   | 1   |   |   | 2   |   | T0044   |
|   |                                  |   |  |   | VKMA 03100   | 1   | 1   |   |   |   |   |   |
|   |                                  |   |  |   | VKM 13100  | 1   |   |   |   |   |   |   |
|                               | TU1JP                            | 05/96 → 10/07   | → <b>I</b> Mot. 3762433  |   | VKPC 83205   |   |   |   | 1   |   |   |   |
|   | TU1JP                            | 05/96 → 10/07   | <b>Mot.</b> 3762434   →  |   | VKPC 83644   |   |   |   | 1   |   |   |   |
|   | TU1M+                            | 05/96 → 10/07   |  |   | VKPC 83205   |   |   |   | 1   |   |   |   |
|                               | <b>B(Alt)</b> TU1JP, TU1M, TU1M+ | 05/96 → 11/07   | 10), <b>AC</b>   |   | VKMOV 10AVx710   |   | 1   |   |   |   |   |   |
|                               | <b>B(Alt)</b> TU1JP, TU1M, TU1M+ | 05/96 → 11/07   | <b>AC</b>  |   | VKMA 33012   | 1   | 1   |   |   |   |   |   |
|   |                                  |   |  |   | VKMOV 5PK1020  |   | 1   |   |   |   |   |   |
|   |                                  |   |  |   | VKM 33012  | 1   |   |   |   |   |   |   |
| <b>CITROËN  SAXO 1.4 VTS</b> |                                  |   |  |   |  |   |   |   |   |   |   |   |
|                               | TU3JP                            | 05/96 → 11/07   | 3), <b>M</b> , <b>⊙</b><br>→ <b>I</b> Mot. 3666765   |   | VKMS 03110-2   | 1   | 1   |   |   | 2   |   | T0044   |
|   |                                  |   |  |   | VKMA 03110   | 1   | 1   |   |   |   |   |   |
|   |                                  |   |  |   | VKM 13100  | 1   |   |   |   |   |   |   |
|   | TU3JP                            | 05/96 → 11/07   | <b>A</b> ⊙, <b>Mot.</b> 3666766   →  |   | VKMA 03254   | 1   | 1   |   |   |   |   | T0189   |
|   |                                  |   |  |   | VKM 13253  | 1   |   |   |   |   |   |   |
|                               | TU3JP                            | 05/96 → 10/07   | → <b>I</b> Mot. 3666765  |   | VKPC 83205   |   |   |   | 1   |   |   |   |































|   |  |  |   |  |  |  |  |  |  |  |  |  |
|---|---|---|--|--|---|---|---|---|---|---|---|---|
|   | TU3JP   | 05/96 → 10/07   | Mot. 3666766 I→  | VKPC 83644   |   |   |   |   |   | 1   |   |   |
|                              | B(Alt) TU3JP  | 05/96 → 11/07   | 10), AC  | VKPV 10AVx710  |   |   | 1   |   |   |   |   |   |
|   | B(Alt) TU3JP  | 05/96 → 11/07   | AC   | VKMA 33012<br>VKMV 5PK1020<br>VKM 33012  | 1   |   | 1   |   |   | 1   |   |   |
| <b>CITROËN  SAXO 1.6</b>     |   |   |  |  |   |   |   |   |   |   |   |   |
|                              | TU5JP   | 05/96 → 11/07   |  | VKMA 03111<br>VKM 13100  | 1   |   | 1   |   |   |   |   | T0044   |
|                              | TU5JP   | 05/96 → 10/07   |  | VKPC 83428   | 1   |   |   |   | 1   |   |   |   |
|                              | B(Alt) TU5JP  | 05/96 → 11/07   | AC   | VKMA 33012<br>VKMV 5PK1020<br>VKM 33012  | 1   |   | 1   |   |   | 1   |   |   |
| <b>CITROËN  SAXO 1.6 VTS</b> |   |   |  |  |   |   |   |   |   |   |   |   |
|                              | TU5J4   | 06/96 → 11/07   |  | VKMA 03130<br>VKM 13130<br>VKM 23130   | 1   | 1   | 1   |   |   |   |   | 2 T0137   |
|                              | TU5J4   | 06/96 → 10/07   |  | VKPC 83430   |   |   |   |   | 1   |   |   |   |
|                              | B(Alt) TU5J4  | 06/96 → 11/07   | AC   | VKMA 33012<br>VKMV 5PK780<br>VKM 33012   | 1   |   | 1   |   |   |   |   |   |
|   | B(Alt) TU5J4  | 06/96 → 11/07   | AC   | VKMA 33012<br>VKMV 5PK1050<br>VKM 33012  | 1   |   | 1   |   |   |   |   |   |
| <b>CITROËN  SAXO 1.5 D</b>   |   |   |  |  |   |   |   |   |   |   |   |   |
|                              | TUD5  | 09/96 → 11/07   |   | VKMC 03121<br>VKMA 03121<br>VKM 13120<br>VKM 23120                                 | 1   | 1   | 1   |   | 1   |   |   | 2 T0120   |
|   | TUD5  | 09/96 → 11/07   | 3)   | VKMS 03121<br>VKMA 03121<br>VKM 13120<br>VKM 23120                                 | 1   | 1   | 1   |   |   |   | 2   | 2 T0120   |
|   | TUD5B   | 09/96 → 11/07   |  | VKMA 03122<br>VKM 13120<br>VKM 23122   | 1   | 1   | 1   |   |   |   |   | 2 T0120   |
|                            | TUD5, TUD5B   | 09/96 → 10/07   |  | VKPC 83428   |   |   |   |   | 1   |   |   |   |
|                            | B(Alt) TUD5, TUD5B  | 09/96 → 11/07   |  59.4 mm, AC,  | VKMA 33045<br>VKMV 5PK775<br>VKM 33009   | 1   |   | 1   |   |   | 1   |   |   |
|   | B(Alt) TUD5, TUD5B  | 09/96 → 11/07   |  66 mm, AC,    | VKMA 33046<br>VKMV 5PK960<br>VKM 33039   | 1   |   | 1   |   |   |   |   |   |
|   | B(Alt) TUD5, TUD5B  | 09/96 → 11/07   | AC,   | VKMA 33046<br>VKMV 5PK960<br>VKM 33039   | 1   |   | 1   |   |   |   |   |   |
|   | B(Alt) TUD5, TUD5B  | 09/96 → 11/07   | AC   | VKMA 33023<br>VKMV 5PK1030<br>VKM 33038  | 1   |   | 1   |   |   |   |   |   |
|                            | TUD5, TUD5B   | 09/96 → 11/07   |  | VKMA 33038<br>VKM 33035  | 1   |   |   |   |   | 1   |   |   |
| <b>CITROËN  VISA 1.0</b>   |   |   |  |  |   |   |   |   |   |   |   |   |
|                            | XV8   | 09/84 → 06/88   |  | <b>ΟΧΘΙΧΟ</b>  |   |   |   |   |   |   |   |   |
|                            | XV8   | 09/84 → 06/87   | 2)   | VKPA 83200<br>VKPC 83200   |   |   |   |   | 1   |   |   |   |
|                            | B(Alt) XV8  | 09/84 → 06/88   |  | VKMA 33045<br>VKMV 5PK775<br>VKM 33009   | 1   |   | 1   |   |   |   |   |   |
| <b>CITROËN  VISA 1.1</b>   |   |   |  |  |   |   |   |   |   |   |   |   |
|                            | XW  | 09/78 → 03/91   |  | <b>ΟΧΘΙΧΟ</b>  |   |   |   |   |   |   |   |   |
|                            | XW  | 09/78 → 06/87   | 2)   | VKPA 83200<br>VKPC 83200   |   |   |   |   | 1   |   |   |   |
|                            | B(Alt) XW   | 09/78 → 03/91   |  | VKMA 33045<br>VKMV 5PK775<br>VKM 33009   | 1   |   | 1   |   |   |   |   |   |
| <b>CITROËN  VISA 1.2</b>   |   |   |  |  |   |   |   |   |   |   |   |   |
|                            | XZ  | 07/80 → 06/82   |  | <b>ΟΧΘΙΧΟ</b>  |   |   |   |   |   |   |   |   |
|                            | XZ  | 07/80 → 06/82   | 2)   | VKPA 83200<br>VKPC 83200   |   |   |   |   | 1   |   |   |   |
|                            | B(Alt) XZ   | 07/80 → 06/82   |  | VKMA 33045<br>VKMV 5PK775<br>VKM 33009   | 1   |   | 1   |   |   |   |   |   |



CITROËN

















|   |  |  |                    |  |  |  |  |  |  |  |  |  |
|---|---|---|---|--|---|---|---|---|---|---|---|---|
| <b>CITROËN  VISA 1.4</b>           |   |   |   |  |   |   |   |   |   |   |   |   |
|                                     | XY  | 03/82 → 03/91   |   | <b>OXOXOXO</b>   |   |   |   |   |   |   |   |   |
|                                     | XY  | 03/82 → 06/87   | 2)  | VKPA 83200<br>VKPC 83200   |   |   |   | 1   |   |   |   |   |
|                                     | <b>B(Alt)</b> XY  | 03/82 → 03/91   |   | VKMOV 10AVx910   |   |   | 1   |   |   |   |   |   |
| <b>CITROËN  VISA 1.6 GTi</b>       |   |   |   |  |   |   |   |   |   |   |   |   |
|                                     | XU5   | 01/85 → 12/88   |   | VKMA 03200<br>VKM 13200  | 1   | 1   |   |   |   |   |   | T0018   |
|                                     | XU5   | 01/85 → 08/86   |   | VKPC 83401   |   |   |   | 1   |   |   |   |   |
|   | XU5   | 09/86 → 03/91   |   | VKPC 83424   |   |   |   | 1   |   |   |   |   |
|                                     | <b>B(Alt)</b> XU5   | 01/85 → 03/91   |   | VKMOV 4PK698   |   |   | 1   |   |   |   |   |   |
| <b>CITROËN  VISA 1.7 D</b>         |   |   |   |  |   |   |   |   |   |   |   |   |
|                                     | XUD7  | 09/86 → 03/91   |                    | VKMC 03240<br>VKMA 03240<br>VKM 13240<br>VKM 23240                                 | 1<br>1<br>1<br>1  | 1<br>1<br>1   |   | 1   |   |   |   | 2<br>2<br>T0017   |
|   | XUD7  | 01/85 → 08/86   |   | VKMA 03240<br>VKM 13240<br>VKM 23240   | 1<br>1<br>1   | 1<br>1  |   |   |   |   |   | 2<br>T0017  |
|                                     | XUD7  | 04/84 → 08/86   |   | VKPC 83401   |   |   |   | 1   |   |   |   |   |
|   | XUD7  | 09/86 → 03/91   |   | VKPC 83424   |   |   |   | 1   |   |   |   |   |
|                                     | <b>B(Alt)</b> XUD7  | 04/84 → 03/91   |   | VKMOV 4PK698   |   |   | 1   |   |   |   |   |   |
| <b>CITROËN  XANTIA I 1.6</b>       |   |   |   |  |   |   |   |   |   |   |   |   |
|                                     | XU5JP   | 03/93 → 01/98   |   | VKMA 03201<br>VKM 13100  | 1<br>1  | 1   |   |   |   |   |   | T0018   |
|                                   | XU5JP   | 03/93 → 01/98   |   | VKPC 83615   |   |   |   | 1   |   |   |   |   |
|                                   | <b>B(Alt)</b> XU5JP   | 03/93 → 01/98   | <b>AC</b>   | VKMA 33003<br>VKMV 6PK1076<br>VKM 33003  | 1<br>1  | 1<br>1  |   |   |   |   |   |   |
|   | <b>B(Alt)</b> XU5JP   | 03/93 → 01/98   | <b>AC</b>   | VKMA 33030<br>VKMV 6PK1660<br>VKM 33028<br>VKM 33034                               | 1<br>1<br>1<br>1  | 1<br>1<br>1   |   |   |   |   |   |   |
| <b>CITROËN  XANTIA I 1.8</b>     |   |   |   |  |   |   |   |   |   |   |   |   |
|                                   | XU7JB, XU7JP  | 03/93 → 01/98   |   | VKMA 03201<br>VKM 13100  | 1<br>1  | 1   |   |   |   |   |   | T0018   |
|                                   | XU7JB, XU7JP  | 03/93 → 01/98   |   | VKPC 83615   |   |   |   | 1   |   |   |   |   |
|                                   | <b>B(Alt)</b> XU7JP   | 03/93 → 01/98   | <b>AC</b>   | VKMA 33003<br>VKMV 6PK1076<br>VKM 33003  | 1<br>1  | 1<br>1  |   |   |   |   |   |   |
|   | <b>B(Alt)</b> XU7JP   | 03/93 → 01/98   | <b>AC</b>   | VKMA 33030<br>VKMV 6PK1660<br>VKM 33028<br>VKM 33034                               | 1<br>1<br>1<br>1  | 1<br>1<br>1   |   |   |   |   |   |   |
| <b>CITROËN  XANTIA I 1.8 16V</b> |   |   |   |  |   |   |   |   |   |   |   |   |
|                                   | XU7JP4  | 06/95 → 01/98   |   | VKMA 03214<br>VKM 13214<br>VKM 23214   | 1<br>1<br>1   | 1<br>1  | 1   |   |   |   |   | 2<br>1<br>1<br>T0142  |
|                                   | XU7JP4  | 06/95 → 01/98   |   | VKPC 83635   |   |   |   | 1   |   |   |   |   |
|                                   | <b>B(Alt)</b> XU7JP4  | 06/95 → 01/98   | <b>AC</b>   | VKMA 33003<br>VKMV 6PK1076<br>VKM 33003  | 1<br>1  | 1<br>1  |   |   |   |   |   |   |
|   | <b>B(Alt)</b> XU7JP4  | 06/95 → 01/98   |  120A, <b>AC</b> | VKMA 33033<br>VKMV 6PK1660<br>VKM 33027<br>VKM 33028                               | 1<br>1<br>1<br>1  | 1<br>1  | 1<br>1  |   |   |   |   |   |
|   | <b>B(Alt)</b> XU7JP4  | 06/95 → 01/98   |  90A, <b>AC</b>  | VKMA 33032<br>VKMV 6PK1660<br>VKM 33026<br>VKM 33028                               | 1<br>1<br>1<br>1  | 1<br>1  | 1<br>1  |   |   |   |   |   |
| <b>CITROËN  XANTIA I 2.0</b>     |   |   |   |  |   |   |   |   |   |   |   |   |
|                                   | XU10J2  | 03/93 → 01/98   |   | VKMA 03201<br>VKM 13100  | 1<br>1  | 1   |   |   |   |   |   | T0018   |



























|   |  |  |    |  |  |  |  |  |  |  |  |  |
|---|---|---|---|--|---|---|---|---|---|---|---|---|
|                                      | XU10J2  | 03/93 → 01/98   |   | VKPC 83420   |   |   |   | 1   |   |   |   |   |
|                                      | <b>B(Alt)</b> XU10J2  | 03/93 → 01/98   | <i>AC</i>   | VKMA 33003<br>VKMV 6PK1076<br>VKM 33003  | 1   |   | 1   | 1   |   |   |   |   |
|   | <b>B(Alt)</b> XU10J2  | 03/93 → 01/98   | <b>AC</b>   | VKMA 33030<br>VKMV 6PK1660<br>VKM 33028<br>VKM 33034                               | 1   | 1   | 1   | 1   |   |   |   |   |
| <b>CITROËN  XANTIA I 2.0 16V</b>     |   |   |   |  |   |   |   |   |   |   |   |   |
|                                      | XU10J4  | 03/93 → 01/98   |   | VKMA 03211<br>VKM 13210<br>VKM 13211   | 2   |   | 1   |   |   |   |   | T0118   |
|   | XU10J4R   | 06/95 → 01/98   |   | VKMA 03213<br>VKM 13202<br>VKM 23213   | 1   | 1   | 1   |   |   |   |   | T0142   |
|                                      | XU10J4  | 03/93 → 01/98   |   | VKPC 83420   |   |   |   | 1   |   |   |   |   |
|   | XU10J4R   | 06/95 → 01/98   |   | VKPC 83636   |   |   |   | 1   |   |   |   |   |
|                                      | <b>B(Alt)</b> XU10J4  | 03/93 → 01/98   | <i>AC</i>   | VKMA 33003<br>VKMV 6PK1076<br>VKM 33003  | 1   |   | 1   | 1   |   |   |   |   |
|   | <b>B(Alt)</b> XU10J4  | 03/93 → 01/98   | <b>AC</b>   | VKMA 33030<br>VKMV 6PK1660<br>VKM 33028<br>VKM 33034                               | 1   | 1   | 1   | 1   |   |   |   |   |
|   | <b>B(Alt)</b> XU10J4R   | 06/95 → 01/98   | <i>AC</i>   | VKMA 33030<br>VKMV 6PK1660<br>VKM 33028<br>VKM 33034                               | 1   |   | 1   | 1   |   |   |   |   |
|   | <b>B(Alt)</b> XU10J4R   | 06/95 → 01/98   | <b>AC</b>   | VKMA 33047<br>VKMV 6PK1658<br>VKM 33028<br>VKM 33035                               | 1   | 1   | 1   | 1   |   |   |   |   |
| <b>CITROËN  XANTIA I 2.0 Turbo</b> |   |   |   |  |   |   |   |   |   |   |   |   |
|                                    | XU10J2TE  | 06/95 → 01/98   |   | VKMA 03201<br>VKM 13100  | 1   |   | 1   |   |   |   |   | T0018   |
|                                    | XU10J2TE  | 06/95 → 01/98   |   | VKPC 83420   | 1   |   |   | 1   |   |   |   |   |
|                                    | <b>B(Alt)</b> XU10J2TE  | 06/95 → 01/98   | <i>AC</i>   | VKMA 33003<br>VKMV 6PK1076<br>VKM 33003  | 1   |   | 1   | 1   |   |   |   |   |
|   | <b>B(Alt)</b> XU10J2TE  | 06/95 → 01/98   | <b>AC</b>   | VKMA 33030<br>VKMV 6PK1660<br>VKM 33028<br>VKM 33034                               | 1   | 1   | 1   | 1   |   |   |   |   |
|   | <b>B(Alt)</b> XU10J4R   | 06/95 → 01/98   | <i>AC</i>   | VKMA 33047<br>VKMV 6PK1658<br>VKM 33028<br>VKM 33035                               | 1   |   | 1   | 1   |   |   |   |   |
| <b>CITROËN  XANTIA I 3.0 V6</b>    |   |   |   |  |   |   |   |   |   |   |   |   |
|                                    | ES9J4   | 01/97 → 01/98   |   | VKMA 23900<br>VKM 23900<br>VKM 23901   |   |   | 1   |   |   |   |   |   |
|                                    | ES9J4   | 01/97 → 01/98   |   | VKPC 83637   |   |   |   | 1   |   |   |   |   |
| <b>CITROËN  XANTIA I 1.9 D</b>     |   |   |   |  |   |   |   |   |   |   |   |   |
|                                    | XUD9  | 06/94 → 01/98   |  | VKMC 03241<br>VKMA 03241<br>VKM 13241<br>VKM 23241                                 | 1   | 1   | 1   | 1   |   |   |   | T0017   |
|   | XUD9  | 06/94 → 01/98   | 3)  | VKMS 03241<br>VKMA 03241<br>VKM 13241<br>VKM 23241                                 | 1   | 1   | 1   | 1   |   |   | 2   | T0017   |
|                                    | XUD9  | 06/94 → 01/98   |   | VKPC 83420   |   |   |   | 1   |   |   |   |   |
|                                    | <b>B(Alt)</b> XUD9  | 06/94 → 06/95   | <i>AC</i>   | VKMA 33202<br>VKMV 6PK1130<br>VKM 33002  | 1   |   | 1   | 1   |   |   |   |   |
|   | <b>B(Alt)</b> XUD9  | 07/95 → 01/98   | <i>AC</i>   | VKMA 33035<br>VKMV 6PK1102<br>VKM 33002  | 1   |   | 1   | 1   |   |   |   |   |































CITROËN





















|  |  |  |    |  |  |  |  |  |  |  |  |  |  |
|--|---|---|---|--|---|---|---|---|---|---|---|---|---|
| B(Alt)   | XUD9  | 06/94 → 12/96   | AC Harrissow, AC  | VKMV 6PK1710<br>VKM 33002<br>VKM 33040   | 1<br>1  |   | 1   |   |   |   |   |   |   |
| B(Alt)   | XUD9  | 12/96 → 01/98   | AC Harrissow, AC  | VKMV 6PK1736<br>VKM 33013<br>VKM 33029<br>VKM 33311                                | 1<br>1  |   | 1   |   |   | 1   |   |   |   |
| B(Alt)   | XUD9  | 06/94 → 06/95   | AC Sanden, AC   | VKMV 6PK1700<br>VKM 33002<br>VKM 33040   | 1<br>1  |   | 1   |   |   |   |   |   |   |
| B(Alt)   | XUD9  | 07/95 → 01/98   | AC Sanden, AC   | VKMV 6PK1726<br>VKM 33013<br>VKM 33029<br>VKM 33311                                | 1<br>1  |   | 1   |   |   |   | 1   |   |   |
|  | XUD9  | 06/94 → 01/98   |   | VKM 93302  |   |   |   |   |   | 1   |   |   |   |
| <b>CITROËN  XANTIA I 1.9 TD</b>   |   |   |   |  |   |   |   |   |   |   |   |   |   |
|  | XUD9SD, XUD9TE  | 10/94 → 01/98   |    | VKMC 03241<br>VKMA 03241<br>VKM 13241<br>VKM 23241                                 | 1<br>1<br>1   | 1<br>1  | 1<br>1  |   | 1   |   |   |   | T0017   |
|  | XUD9SD, XUD9TE  | 10/94 → 01/98   | 3)  | VKMS 03241<br>VKMA 03241<br>VKM 13241<br>VKM 23241                                 | 1<br>1<br>1   | 1<br>1  | 1<br>1  |   |   |   | 2   |   | T0017   |
|  | XUD9SD, XUD9TE  | 10/94 → 01/98   |   | VKPC 83420   |   |   |   |   | 1   |   |   |   |   |
| B(Alt)   | XUD9TE  | 10/94 → 06/95   | AC  | VKMA 33202<br>VKMV 6PK1130<br>VKM 33002  | 1<br>1  |   | 1<br>1  |   |   |   |   |   |   |
| B(Alt)   | XUD9SD, XUD9TE  | 07/95 → 01/98   | AC  | VKMA 33035<br>VKMV 6PK1102<br>VKM 33002  | 1<br>1  |   | 1<br>1  |   |   |   |   |   |   |
| B(Alt)   | XUD9SD, XUD9TE  | 10/94 → 12/96   | AC Harrissow, AC  | VKMV 6PK1710<br>VKM 33002<br>VKM 33040   | 1<br>1  |   | 1   |   |   |   |   |   |   |
| B(Alt)   | XUD9SD, XUD9TE  | 12/96 → 01/98   | AC Harrissow, AC  | VKMV 6PK1736<br>VKM 33013<br>VKM 33029<br>VKM 33311                                | 1<br>1  |   | 1   |   |   | 1   |   |   |   |
| B(Alt)   | XUD9TE  | 10/94 → 06/95   | AC Sanden, AC   | VKMV 6PK1700<br>VKM 33002<br>VKM 33040   | 1<br>1  |   | 1   |   |   |   |   |   |   |
| B(Alt)   | XUD9SD, XUD9TE  | 07/95 → 01/98   | AC Sanden, AC   | VKMV 6PK1726<br>VKM 33013<br>VKM 33029<br>VKM 33311                                | 1<br>1  |   | 1   |   |   |   | 1   |   |   |
|  | XUD9SD, XUD9TE  | 10/94 → 01/98   |   | VKM 93302  |   |   |   |   |   | 1   |   |   |   |
| <b>CITROËN  XANTIA I 2.1 TD</b> |   |   |   |  |   |   |   |   |   |   |   |   |   |
|  | XUD11BTE  | 06/95 → 01/98   |  | VKMC 03251<br>VKMA 03251<br>VKM 13250<br>VKM 23213                                 | 1<br>1<br>1   | 1<br>1  | 1<br>1  |   | 1   |   |   | 1<br>1  | T0080   |
|  | XUD11BTE  | 06/95 → 01/98   | 3)  | VKMS 03251<br>VKMA 03251<br>VKM 13250<br>VKM 23213                                 | 1<br>1<br>1   | 1<br>1  | 1<br>1  |   |   |   | 2<br>1  | 1<br>1  | T0080   |
|  | XUD11BTE  | 06/95 → 01/98   |   | VKPC 83425   |   |   |   |   | 1   |   |   |   |   |
| B(Alt)   | XUD11BTE  | 06/95 → 06/95   | AC  | VKMA 33202<br>VKMV 6PK1130<br>VKM 33002  | 1<br>1  |   | 1<br>1  |   |   |   |   |   |   |
| B(Alt)   | XUD11BTE  | 07/95 → 01/98   | AC  | VKMA 33035<br>VKMV 6PK1102<br>VKM 33002  | 1<br>1  |   | 1<br>1  |   |   |   |   |   |   |
| B(Alt)   | XUD11BTE  | 06/95 → 12/96   | AC Harrissow, AC  | VKMV 6PK1710<br>VKM 33002<br>VKM 33040   | 1<br>1  |   | 1   |   |   |   |   |   |   |

|  |  |  |  |  |  |  |  |  |  |  |  |  |
|--|---|---|---|--|---|---|---|---|---|---|---|---|
| B(Alt)   | XUD11BTE  | 12/96 → 01/98   | AC Harrissow, AC  | VKMOV 6PK1736<br>VKM 33013<br>VKM 33029<br>VKM 33311                               | 1<br>1  |   | 1   |   |   |   |   |   |
| B(Alt)   | XUD11BTE  | 06/95 → 06/95   | AC Sanden, AC   | VKMOV 6PK1700<br>VKM 33002<br>VKM 33040  | 1<br>1  |   | 1   |   |   |   |   |   |
| B(Alt)   | XUD11BTE  | 07/95 → 01/98   | AC Sanden, AC   | VKMOV 6PK1726<br>VKM 33013<br>VKM 33029<br>VKM 33311                               | 1<br>1  |   | 1   |   |   |   | 1   |   |
| ⊙  | XUD11BTE  | 06/95 → 01/98   |   | VKM 93306  |   |   |   |   |   | 1   |   |   |
| <b>CITROËN  XANTIA II 1.8</b>       |   |   |   |  |   |   |   |   |   |   |   |   |
|                                     | XU7JB   | 01/98 → 04/03   |   | VKMA 03201<br>VKM 13100  | 1<br>1  |   | 1   |   |   |   |   | T0018   |
|                                     | XU7JB   | 01/98 → 04/03   |   | VKPC 83615   |   |   |   |   | 1   |   |   |   |
|                                     | B(Alt) XU7JB  | 01/98 → 06/98   | AC  | VKMA 33003<br>VKMOV 6PK1076<br>VKM 33003   | 1<br>1  |   | 1<br>1  |   |   |   |   |   |
| B(Alt)   | XU7JB   | 07/98 → 04/03   | AC  | VKMA 33031<br>VKMOV 6PK1076<br>VKM 33021   | 1<br>1  |   | 1<br>1  |   |   |   |   |   |
| B(Alt)   | XU7JB   | 01/98 → 04/03   | 90A, AC   | VKMA 33032<br>VKMOV 6PK1660<br>VKM 33026<br>VKM 33028                              | 1<br>1  | 1<br>1  | 1<br>1  |   |   |   |   |   |
| B(Alt)   | XU7JB   | 01/98 → 04/03   | 120, 150A, AC   | VKMA 33033<br>VKMOV 6PK1660<br>VKM 33027<br>VKM 33028                              | 1<br>1  | 1<br>1  | 1<br>1  |   |   |   |   |   |
| B(Alt)   | XU7JB   | 01/98 → 04/03   | 13), 90A, AC  | VKMA 33032<br>VKMOV 6PK1660<br>VKM 33026<br>VKM 33028                              | 1<br>1  | 1<br>1  | 1<br>1  |   |   |   |   |   |
| <b>CITROËN  XANTIA II 1.8 16V</b> |   |   |   |  |   |   |   |   |   |   |   |   |
|                                   | XU7JP4  | 01/98 → 04/03   | Dep. CEE 95, A⊙   | VKMA 03214<br>VKM 13214<br>VKM 23214   | 1<br>1  | 1<br>1  | 1<br>1  |   |   |   |   | 2<br>1<br>1 T0142   |
|  | XU7JP4  | 01/98 → 04/03   | Dep. CEE 2000, A⊙   | VKMA 03216<br>VKM 13216<br>VKM 23214   | 1<br>1  | 1<br>1  | 1<br>1  |   |   |   |   | 2<br>1<br>1 T0142   |
|                                   | XU7JP4  | 01/98 → 04/03   |   | VKPC 83635   |   |   |   |   | 1   |   |   |   |
|                                   | B(Alt) XU7JP4   | 01/98 → 06/98   | AC  | VKMA 33003<br>VKMOV 6PK1076<br>VKM 33003   | 1<br>1  |   | 1<br>1  |   |   |   |   |   |
| B(Alt)   | XU7JP4  | 07/98 → 04/03   | AC  | VKMA 33031<br>VKMOV 6PK1076<br>VKM 33021   | 1<br>1  |   | 1<br>1  |   |   |   |   |   |
| B(Alt)   | XU7JP4  | 01/98 → 04/03   | 90A, AC   | VKMA 33032<br>VKMOV 6PK1660<br>VKM 33026<br>VKM 33028                              | 1<br>1  | 1<br>1  | 1<br>1  |   |   |   |   |   |
| B(Alt)   | XU7JP4  | 01/98 → 04/03   | 120, 150A, AC   | VKMA 33033<br>VKMOV 6PK1660<br>VKM 33027<br>VKM 33028                              | 1<br>1  | 1<br>1  | 1<br>1  |   |   |   |   |   |
| <b>CITROËN  XANTIA II 2.0</b>     |   |   |   |  |   |   |   |   |   |   |   |   |
|                                   | XU10J2  | 01/98 → 04/03   |   | VKMA 03201<br>VKM 13100  | 1<br>1  |   | 1   |   |   |   |   | T0018   |
|                                   | XU10J2  | 01/98 → 04/03   |   | VKPC 83420   |   |   |   |   | 1   |   |   |   |
|                                   | B(Alt) XU10J2   | 01/98 → 04/03   | AC  | VKMA 33003<br>VKMOV 6PK1076<br>VKM 33003   | 1<br>1  |   | 1<br>1  |   |   |   |   |   |
| B(Alt)   | XU10J2  | 01/98 → 04/03   | AC  | VKMA 33030<br>VKMOV 6PK1660  | 1<br>1  | 1<br>1  | 1<br>1  |   |   |   |   |   |





















CITROËN

|  |  |  |    |  |  |  |  |  |  |  |  |  |
|--|---|---|---|--|---|---|---|---|---|---|---|---|
|  |   |   |   | VKM 33028<br>VKM 33034   | 1   | 1   |   |   |   |   |   |   |
| <b>CITROËN  XANTIA II 2.0 16V</b>   |   |   |   |  |   |   |   |   |   |   |   |   |
|                                      | XU10J4R   | 01/98 → 04/03   |   | VKMA 03213<br>VKM 13202<br>VKM 23213   | 1<br>1  | 1   | 1   |   |   |   |   | T0142   |
|                                      | XU10J4R   | 01/98 → 04/03   |   | VKPC 83636   |   |   |   | 1   |   |   |   | 1   |
|                                      | <b>B(Alt)</b> XU10J4R   | 01/98 → 04/03   | <b>AC</b>   | VKMV 6PK1200<br>VKM 33022<br>VKM 33025   | 1   |   | 1   |   |   |   |   |   |
|  | <b>B(Alt)</b> XU10J4R   | 01/98 → 04/03   | <b>AC</b>   | VKMA 33047<br>VKMV 6PK1658<br>VKM 33028<br>VKM 33035                               | 1<br>1  | 1   | 1   |   | 1   |   |   |   |
| <b>CITROËN  XANTIA II 2.0 Turbo</b> |   |   |   |  |   |   |   |   |   |   |   |   |
|                                      | XU10J2TE  | 01/98 → 04/03   |   | VKMA 03201<br>VKM 13100  | 1<br>1  |   | 1   |   |   |   |   | T0018   |
|                                      | XU10J2TE  | 01/98 → 04/03   |   | VKPC 83420   |   |   |   | 1   |   |   |   |   |
|                                      | <b>B(Alt)</b> XU10J2TE  | 01/98 → 04/03   | <b>AC</b>   | VKMV 6PK1200<br>VKM 33022<br>VKM 33025   | 1   |   | 1   |   |   |   |   |   |
|  | <b>B(Alt)</b> XU10J2TE  | 01/98 → 04/03   | <b>AC</b>   | VKMA 33047<br>VKMV 6PK1658<br>VKM 33028<br>VKM 33035                               | 1<br>1  | 1   | 1   |   | 1   |   |   |   |
| <b>CITROËN  XANTIA II 3.0 V6</b>   |   |   |   |  |   |   |   |   |   |   |   |   |
|                                    | ES9J4   | 01/98 → 12/99   |   | —  |   |   |   |   |   |   |   |   |
|  | ES9J4   | 12/99 → 04/03   |   | VKM 23900<br>VKM 23900<br>VKM 23901  |   |   | 1<br>1<br>1   |   |   |   |   |   |
|  | ES9J4   | 12/99 → 04/03   |   | VKMA 03902<br>VKM 13902<br>VKM 23900<br>VKM 23900<br>VKM 23901                     | 1<br>1  | 3   | 1   |   |   |   |   | T0204   |
|                                    | ES9J4   | 01/98 → 12/99   |   | VKPC 83637   |   |   |   | 1   |   |   |   |   |
|  | ES9J4   | 12/99 → 04/03   |   | —  |   |   |   | 1   |   |   |   |   |
| <b>CITROËN  XANTIA II 1.9 TD</b>  |   |   |   |  |   |   |   |   |   |   |   |   |
|                                    | XUD9SD, XUD9TE  | 01/98 → 04/03   |  | VKMC 03241<br>VKMA 03241<br>VKM 13241<br>VKM 23241                                 | 1<br>1<br>1   | 1<br>1  | 1<br>1  |   | 1   |   |   | T0017   |
|  | XUD9SD, XUD9TE  | 01/98 → 04/03   | 3)  | VKMS 03241<br>VKMA 03241<br>VKM 13241<br>VKM 23241                                 | 1<br>1<br>1   | 1<br>1  | 1<br>1  |   |   |   | 2   | T0017   |
|                                    | XUD9SD, XUD9TE  | 01/98 → 04/03   |   | VKPC 83420   |   |   |   | 1   |   |   |   |   |
|                                    | <b>B(Alt)</b> XUD9SD, XUD9TE  | 01/98 → 04/03   | <b>AC</b>   | VKMA 33035<br>VKMV 6PK1102<br>VKM 33002  | 1<br>1  |   | 1<br>1  |   |   |   |   |   |
|  | <b>B(Alt)</b> XUD9SD, XUD9TE  | 01/98 → 04/03   | <b>AC</b> Harrissow, <b>AC</b> ,<br><b>Man. GBX</b>                                 | VKMV 6PK1736<br>VKM 33013<br>VKM 33029<br>VKM 33311                                | 1<br>1  |   | 1   |   |   |   | 1   |   |
|  | <b>B(Alt)</b> XUD9SD, XUD9TE  | 01/98 → 04/03   | <b>AC</b> Harrissow, <b>AC</b> ,<br><b>Auto. GBX</b>                                | VKMV 6PK1736<br>VKM 33008<br>VKM 33013<br>VKM 33029                                | 1<br>1  | 1   | 1   |   |   |   |   |   |
|  | <b>B(Alt)</b> XUD9SD, XUD9TE  | 01/98 → 04/03   | <b>AC</b> Sanden, <b>AC</b> , <b>Man. GBX</b>                                       | VKMV 6PK1726<br>VKM 33013<br>VKM 33029<br>VKM 33311                                | 1<br>1  |   | 1   |   |   |   | 1   |   |

|   |  |  |    |  |  |  |  |  |  |  |  |
|---|---|---|---|--|---|---|---|---|---|---|---|
| <b>B(Alt)</b>   | XUD9SD, XUD9TE  | 01/98 → 04/03   | AC Sanden, AC, Auto. GBX  | VKMA 33049<br>VKMV 6PK1726<br>VKM 33008<br>VKM 33013<br>VKM 33029                  | 2<br>1<br>1<br>1  | 1<br>1  | 1<br>1  |   |   |   |   |
| ⊙   | XUD9SD  | 01/98 → 04/03   |   | VKM 93302  |   |   |   |   | 1   |   |   |
|   | XUD9TE  | 01/98 → 04/03   | Man. GBX  | VKM 93302  |   |   |   |   | 1   |   |   |
|   | XUD9TE  | 01/98 → 05/99   | Auto. GBX   | VKM 93302  |   |   |   |   | 1   |   |   |
| <b>CITROËN  XANTIA II 2.0 HDi</b>  |   |   |   |  |   |   |   |   |   |   |   |
|                                    | DW10ATED, DW10TD  | 02/99 → 04/03   |    | VKMC 03246<br>VKMA 03246<br>VKM 13246<br>VKM 23246                                 | 1<br>1<br>1   | 1<br>1  | 1<br>1  | 1   |   | 1   | T0168   |
|   | DW10ATED, DW10TD  | 02/99 → 04/03   | 3)  | VKMS 03246<br>VKMA 03246<br>VKM 13246<br>VKM 23246                                 | 1<br>1<br>1   | 1<br>1  | 1<br>1  |   | 2   | 1   | T0168   |
|                                    | DW10ATED, DW10TD  | 02/99 → 04/03   |   | VKPC 83639   |   |   |   | 1   |   |   |   |
|                                    | <b>B(Alt)</b> DW10ATED, DW10TD  | 02/99 → 04/03   | <i>AC</i>   | VKMA 33051<br>VKMV 6PK1451<br>VKM 33024<br>VKM 33033<br>VKM 33069                  | 2<br>1<br>1   | 1<br>1  | 1<br>1  |   |   |   |   |
| <b>B(Alt)</b>   | DW10ATED, DW10TD  | 02/99 → 02/01   | AC Delphi, AC   | VKMA 33037<br>VKMV 6PK1750<br>VKM 33013<br>VKM 33033                               | 2<br>1<br>1   |   | 1<br>1  |   |   |   |   |
| <b>B(Alt)</b>   | DW10ATED, DW10TD  | 02/01 → 04/03   | AC Delphi, AC   | VKMV 6PK1747<br>VKM 33013<br>VKM 33033   | 1<br>1  |   | 1   |   |   |   |   |
| <b>B(Alt)</b>   | DW10ATED, DW10TD  | 02/99 → 04/03   | AC Sanden, AC   | VKMA 33039<br>VKMV 6PK1736<br>VKM 33013<br>VKM 33033                               | 2<br>1<br>1   |   | 1<br>1  |   |   |   |   |
| ⊙   | DW10ATED, DW10TD  | 02/99 → 04/03   |   | VKM 93301  |   |   |   |   | 1   |   |   |
| <b>CITROËN  XANTIA II 2.1 TD</b> |   |   |   |  |   |   |   |   |   |   |   |
|                                  | XUD11BTE  | 01/98 → 02/99   |  | VKMC 03251<br>VKMA 03251<br>VKM 13250<br>VKM 23213                                 | 1<br>1<br>1   | 1<br>1  | 1<br>1  | 1   |   | 1   | T0080   |
|   | XUD11BTE  | 01/98 → 02/99   | 3)  | VKMS 03251<br>VKMA 03251<br>VKM 13250<br>VKM 23213                                 | 1<br>1<br>1   | 1<br>1  | 1<br>1  |   | 2   | 1   | T0080   |
|                                  | XUD11BTE  | 01/98 → 02/99   |   | VKPC 83425   |   |   |   | 1   |   |   |   |
|                                  | <b>B(Alt)</b> XUD11BTE  | 01/98 → 02/99   | <i>AC</i>   | VKMA 33035<br>VKMV 6PK1102<br>VKM 33002  | 1<br>1  |   | 1<br>1  |   |   |   |   |
| <b>B(Alt)</b>   | XUD11BTE  | 01/98 → 02/99   | AC Harrissow, AC, Man. GBX  | VKMV 6PK1736<br>VKM 33013<br>VKM 33029<br>VKM 33311                                | 1<br>1  |   | 1   |   |   | 1   |   |
| <b>B(Alt)</b>   | XUD11BTE  | 01/98 → 02/99   | AC Harrissow, AC, Auto. GBX   | VKMV 6PK1736<br>VKM 33008<br>VKM 33013<br>VKM 33029                                | 1<br>1  |   | 1   |   |   |   |   |
| <b>B(Alt)</b>   | XUD11BTE  | 01/98 → 02/99   | AC Delphi, AC, Auto. GBX  | VKMV 6PK1736<br>VKM 33008<br>VKM 33013<br>VKM 33029                                | 1<br>1  |   | 1   |   |   |   |   |
| <b>B(Alt)</b>   | XUD11BTE  | 01/98 → 02/99   | AC Sanden, AC, Man. GBX   | VKMV 6PK1726<br>VKM 33013<br>VKM 33029<br>VKM 33311                                | 1<br>1  |   | 1   |   |   | 1   |   |



CITROËN

|   |  |  |  |  |  |  |  |  |  |  |  |  |  |  |
|---|---|---|---|--|---|---|---|---|---|---|---|---|---|---|
|   | B(Alt)  | XUD11BTE  | 01/98 → 02/99   | AC Sanden, AC, Auto. GBX   | VKMA 33049<br>VKMV 6PK1726<br>VKM 33008<br>VKM 33013<br>VKM 33029                   | 2<br>1<br>1<br>1  | 1<br>1  | 1   |   |   |   |   |   |   |
|   |   | XUD11BTE  | 01/98 → 02/99   |  | VKM 93306   |   |   |   |   | 1   |   |   |   |   |
| <b>CITROËN  XM I 2.0</b>         |   |   |   |  |   |   |   |   |   |   |   |   |   |   |
|   |   | XU102C, XU10J2,<br>XU10MZ   | 01/93 → 07/94   |  | VKMA 03201<br>VKM 13100   | 1<br>1  | 1   |   |   |   |   |   |   | T0018   |
|   |   | XU102C, XU10J2,<br>XU10MZ   | 05/89 → 12/92   |  | VKMA 03220<br>VKM 13220   | 1<br>1  | 1   |   |   |   |   |   |   | T0068   |
|   |   | XU102C, XU10J2,<br>XU10M  | 05/89 → 07/94   |  | VKPC 83420  |   |   |   | 1   |   |   |   |   |   |
|   | B(Alt)  | XU102C  | 05/89 → 07/94   | ⊗ 70A, AC  | VKMV 5PK690   |   | 1   |   |   |   |   |   |   |   |
|   | B(Alt)  | XU102C, XU10J2,<br>XU10MZ   | 05/89 → 07/94   | ⊗ 120, 80, 90A, AC   | VKMV 5PK710   |   | 1   |   |   |   |   |   |   |   |
|   | B(Alt)  | XU102C, XU10J2,<br>XU10MZ   | 05/89 → 07/94   | ⊗ 70A, AC  | VKMV 5PK1140<br>VKM 33007   |   | 1   | 1   |   |   |   |   |   |   |
|   | B(Alt)  | XU102C, XU10J2,<br>XU10MZ   | 05/89 → 07/94   | ⊗ 80, 90A, AC  | VKMV 5PK1125<br>VKM 33007   |   | 1   | 1   |   |   |   |   |   |   |
|   | B(HP)   | XU102C, XU10J2,<br>XU10MZ   | 05/89 → 07/94   |  | VKMV 10AVx1025  |   | 1   |   |   |   |   |   |   |   |
| <b>CITROËN  XM I 2.0 Turbo</b> |   |   |   |  |   |   |   |   |   |   |   |   |   |   |
|   |   | XU10J2TE/Z  | 09/92 → 06/94   |  | VKMA 03201<br>VKM 13100   | 1<br>1  | 1   |   |   |   |   |   |   | T0018   |
|   |   | XU10J2TE/Z  | 09/92 → 06/94   |  | VKPC 83420  |   |   |   | 1   |   |   |   |   |   |
|   | B(Alt)  | XU10J2TE/Z  | 09/92 → 06/94   | ⊗ 120, 80, 90A, AC   | VKMV 5PK710   |   | 1   |   |   |   |   |   |   |   |
|   | B(Alt)  | XU10J2TE/Z  | 09/92 → 06/94   | AC   | VKMV 5PK1151<br>VKM 33007   |   | 1   | 1   |   |   |   |   |   |   |
|   | B(HP)   | XU10J2TE/Z  | 09/92 → 06/94   |  | VKMV 10AVx1025  |   | 1   |   |   |   |   |   |   |   |
| <b>CITROËN  XM I 3.0 V6</b>    |   |   |   |  |   |   |   |   |   |   |   |   |   |   |
|   |   | ZPJ/Z, ZPJ4/Z   | 05/89 → 06/94   |  | ⊗⊗⊗⊗⊗   |   |   |   |   |   |   |   |   |   |
|   |   | ZPJ/Z, ZPJ4/Z   | 05/89 → 07/90   |  | —   |   |   |   | 1   |   |   |   |   |   |
|   |   | ZPJ/Z, ZPJ4/Z   | 07/90 → 06/94   |  | —   |   |   |   | 1   |   |   |   |   |   |
|   | B(Alt)  | ZPJ/Z, ZPJ4/Z   | 05/89 → 06/94   |  | VKMV 5PK850   |   | 1   |   |   |   |   |   |   |   |
|   | B(HP)   | ZPJ/Z, ZPJ4/Z   | 05/89 → 02/92   |  | VKMV 10AVx650   |   | 1   |   |   |   |   |   |   |   |
| <b>CITROËN  XM I 2.1 D</b>     |   |   |   |  |   |   |   |   |   |   |   |   |   |   |
|   |   | XUD11A  | 05/89 → 06/94   |  | VKMA 03250<br>VKM 13250<br>VKM 23120  | 1<br>1  | 1   | 1   |   |   |   |   | 1   | T0079   |
|   |   | XUD11A  | 05/89 → 06/94   |  | VKPC 83420  |   |   |   | 1   |   |   |   | 2   |   |
|   | B(Alt)  | XUD11A  | 05/89 → 06/94   | ⊗ 70A, AC  | VKMV 5PK715   |   | 1   |   |   |   |   |   |   |   |
|   | B(Alt)  | XUD11A  | 05/89 → 06/94   | ⊗ 90A, AC, Auto. GBX   | VKMV 5PK770   |   | 1   |   |   |   |   |   |   |   |
|   | B(Alt)  | XUD11A  | 11/91 → 04/94   | AC   | VKMA 33035<br>VKMV 6PK1102<br>VKM 33002   | 1<br>1  | 1   | 1   |   |   |   |   |   |   |
|   | B(Alt)  | XUD11A  | 11/91 → 04/94   | AC   | VKMV 6PK1726<br>VKM 33013<br>VKM 33029<br>VKM 33311                                 | 1<br>1  | 1   |   |   | 1   |   |   |   |   |
|   | B(Alt)  | XUD11A  | 01/93 → 06/94   | ⊗ 120, 80A, AC   | VKMV 5PK1160<br>VKM 33007   |   | 1   | 1   |   |   |   |   |   |   |
|   | B(Alt)  | XUD11A  | 01/93 → 06/94   | ⊗ 66 mm, AC  | VKMV 5PK1195<br>VKM 33007   |   | 1   | 1   |   |   |   |   |   |   |
|   | B(HP)   | XUD11A  | 05/89 → 07/90   |  | VKMV 10AVx1100  |   | 1   |   |   |   |   |   |   |   |
|   | B(HP)   | XUD11A  | 07/90 → 06/94   |  | VKMV 10AVx1090  |   | 1   |   |   |   |   |   |   |   |



**CITROËN** **XM I 2.1 TD**

|  |                                  |               |                            |  |                  |             |             |             |  |   |  |  |   |  |  |             |       |
|--|----------------------------------|---------------|----------------------------|--|------------------|-------------|-------------|-------------|--|---|--|--|---|--|--|-------------|-------|
|  | XUD11ATE, XUD11BTE               | 05/89 → 06/94 |                            | VKMC 03251<br>VKMA 03251<br>VKM 13250<br>VKM 23213 | 1<br>1<br>1<br>1 | 1<br>1<br>1 | 1<br>1<br>1 | 1<br>1<br>1 |  |   |  |  |   |  |  | 1<br>1<br>1 | T0080 |
|  | XUD11ATE, XUD11BTE               | 05/89 → 06/94 | 3)                         | VKMS 03251<br>VKMA 03251<br>VKM 13250<br>VKM 23213 | 1<br>1<br>1<br>1 | 1<br>1<br>1 | 1<br>1<br>1 |             |  |   |  |  | 2 |  |  | 1<br>1<br>1 | T0080 |
|  | XUD11ATE, XUD11BTE               | 05/89 → 06/94 |                            | VKPC 83425   |                  |             |             |             |  | 1 |  |  |   |  |  |             |       |
|  | <b>B(Alt)</b> XUD11ATE, XUD11BTE | 05/89 → 06/94 | 70A, <i>AC</i>             | VKMV 5PK715  |                  |             | 1           |             |  |   |  |  |   |  |  |             |       |
|  | <b>B(Alt)</b> XUD11ATE, XUD11BTE | 05/89 → 06/94 | 90A, <i>AC</i> , Auto. GBX | VKMV 5PK770  |                  |             | 1           |             |  |   |  |  |   |  |  |             |       |
|  | <b>B(Alt)</b> XUD11ATE, XUD11BTE | 01/93 → 06/94 | 120, 80A, <i>AC</i>        | VKMV 5PK1160<br>VKM 33007                          |                  |             | 1           |             |  |   |  |  |   |  |  |             |       |
|  | <b>B(Alt)</b> XUD11ATE, XUD11BTE | 01/93 → 06/94 | Ø 66 mm, <i>AC</i>         | VKMV 5PK1195<br>VKM 33007                          |                  |             | 1           |             |  |   |  |  |   |  |  |             |       |
|  | <b>B(HP)</b> XUD11ATE            | 05/89 → 07/90 |                            | VKMV 10AVx1100                                     |                  |             | 1           |             |  |   |  |  |   |  |  |             |       |
|  | <b>B(HP)</b> XUD11ATE, XUD11BTE  | 07/90 → 06/94 |                            | VKMV 10AVx1090                                     |                  |             | 1           |             |  |   |  |  |   |  |  |             |       |

**CITROËN** **XM II 2.0 16V**

|  |                       |               |           |  |             |        |        |  |  |   |  |  |  |  |  |  |   |       |
|--|-----------------------|---------------|-----------|--|-------------|--------|--------|--|--|---|--|--|--|--|--|--|---|-------|
|  | XU10J4R               | 05/94 → 10/00 |           | VKMA 03213<br>VKM 13202<br>VKM 23213                 | 1<br>1<br>1 | 1<br>1 | 1      |  |  |   |  |  |  |  |  |  | 1 | T0142 |
|  | XU10J4R               | 05/94 → 10/00 |           | VKPC 83636   |             |        |        |  |  | 1 |  |  |  |  |  |  |   |       |
|  | <b>B(Alt)</b> XU10J4R | 05/94 → 05/95 | <i>AC</i> | VKMA 33003<br>VKMV 6PK1076<br>VKM 33003              | 1<br>1      |        | 1<br>1 |  |  |   |  |  |  |  |  |  |   |       |
|  | <b>B(Alt)</b> XU10J4R | 06/95 → 10/00 | <i>AC</i> | VKMV 6PK1200<br>VKM 33022<br>VKM 33025               | 1           |        | 1      |  |  |   |  |  |  |  |  |  |   |       |
|  | <b>B(Alt)</b> XU10J4R | 05/94 → 05/95 | <i>AC</i> | VKMA 33030<br>VKMV 6PK1660<br>VKM 33028<br>VKM 33034 | 1<br>1      | 1<br>1 | 1<br>1 |  |  |   |  |  |  |  |  |  |   |       |
|  | <b>B(Alt)</b> XU10J4R | 06/95 → 10/00 | <i>AC</i> | VKMA 33047<br>VKMV 6PK1658<br>VKM 33028<br>VKM 33035 | 1<br>1      | 1<br>1 | 1<br>1 |  |  |   |  |  |  |  |  |  |   |       |
|  | <b>B(HP)</b> XU10J4R  | 05/94 → 10/00 |           | VKMV 10AVx1025                                       |             |        | 1      |  |  |   |  |  |  |  |  |  |   |       |

**CITROËN** **XM II 2.0 Turbo**































|  |                                    |               |           |  |        |        |        |  |  |   |  |  |  |  |  |  |  |       |
|--|------------------------------------|---------------|-----------|--|--------|--------|--------|--|--|---|--|--|--|--|--|--|--|-------|
|  | XU10J2TE, XU10J2TE/Z               | 05/94 → 10/00 |           | VKMA 03201<br>VKM 13100                              | 1<br>1 |        | 1      |  |  |   |  |  |  |  |  |  |  | T0018 |
|  | XU10J2TE, XU10J2TE/Z               | 05/94 → 10/00 |           | VKPC 83420   |        |        |        |  |  | 1 |  |  |  |  |  |  |  |       |
|  | <b>B(Alt)</b> XU10J2TE, XU10J2TE/Z | 05/94 → 05/95 | <i>AC</i> | VKMV 5PK710  |        |        | 1      |  |  |   |  |  |  |  |  |  |  |       |
|  | <b>B(Alt)</b> XU10J2TE, XU10J2TE/Z | 06/95 → 10/00 | <i>AC</i> | VKMV 6PK1200<br>VKM 33022<br>VKM 33025               | 1      |        | 1      |  |  |   |  |  |  |  |  |  |  |       |
|  | <b>B(Alt)</b> XU10J2TE, XU10J2TE/Z | 05/94 → 05/95 | <i>AC</i> | VKMV 5PK1151<br>VKM 33007                            |        |        | 1      |  |  |   |  |  |  |  |  |  |  |       |
|  | <b>B(Alt)</b> XU10J2TE, XU10J2TE/Z | 06/95 → 10/00 | <i>AC</i> | VKMA 33047<br>VKMV 6PK1658<br>VKM 33028<br>VKM 33035 | 1<br>1 | 1<br>1 | 1<br>1 |  |  |   |  |  |  |  |  |  |  |       |
|  | <b>B(HP)</b> XU10J2TE, XU10J2TE/Z  | 05/94 → 10/00 |           | VKMV 10AVx1025                                       |        |        | 1      |  |  |   |  |  |  |  |  |  |  |       |















**CITROËN** **XM II 3.0 V6**

|  |                        |                                |  |                                      |        |   |             |  |  |  |  |  |  |  |  |  |  |       |
|--|------------------------|--------------------------------|--|--------------------------------------|--------|---|-------------|--|--|--|--|--|--|--|--|--|--|-------|
|  | ZPJ/Z, ZPJ4/Z<br>ES9J4 | 05/94 → 10/00<br>04/97 → 12/99 |  | <b>OXOXOXO</b>                       |        |   |             |  |  |  |  |  |  |  |  |  |  |       |
|  | ES9J4                  | 12/99 → 10/00                  |  | VKM 23900<br>VKM 23900<br>VKM 23901  |        |   | 1<br>1<br>1 |  |  |  |  |  |  |  |  |  |  |       |
|  | ES9J4                  | 12/99 → 10/00                  |  | VKMA 03902<br>VKM 13902<br>VKM 23900 | 1<br>1 | 3 | 1           |  |  |  |  |  |  |  |  |  |  | T0204 |











|   |  |  |  |  |  |  |  |  |  |  |  |  |
|---|---|---|---|--|---|---|---|---|---|---|---|---|
|   |   |   |   | VKM 23900  | 1   |   |   |   |   |   |   |   |
|   |   |   |   | VKM 23901  | 1   |   |   |   |   |   |   |   |
|                                 | ES9J4   | 04/97 → 12/99   |   | VKPC 83637   |   |   |   | 1   |   |   |   |   |
|   | ES9J4   | 12/99 → 10/00   |   | —  |   |   |   | 1   |   |   |   |   |
|   | ZPJ/Z, ZPJ4/Z   | 05/94 → 10/00   |   | —  |   |   |   | 1   |   |   |   |   |
|                                 | <b>B(Alt)</b> ZPJ/Z, ZPJ4/Z   | 05/94 → 10/00   |   | VKMV 5PK850  |   | 1   |   |   |   |   |   |   |
| <b>CITROËN  XM II 2.1 D</b>    |   |   |   |  |   |   |   |   |   |   |   |   |
|                                 | XUD11A  | 07/94 → 08/96   |   | VKMA 03250   | 1   | 1   | 1   |   |   |   |   | 1 T0079   |
|   |   |   |   | VKM 13250  | 1   |   |   |   |   |   |   |   |
|   |   |   |   | VKM 23120  |   | 1   |   |   |   |   |   | 2   |
|                                 | XUD11A  | 07/94 → 08/96   |   | VKPC 83420   |   |   |   | 1   |   |   |   |   |
|                                 | <b>B(Alt)</b> XUD11A  | 06/95 → 08/96   | <b>AC</b>   | VKMA 33035   | 1   |   | 1   |   |   |   |   |   |
|   |   |   |   | VKMV 6PK1102   |   |   | 1   |   |   |   |   |   |
|   |   |   |   | VKM 33002  | 1   |   |   |   |   |   |   |   |
|   | <b>B(Alt)</b> XUD11A  | 06/95 → 08/96   | <b>AC</b>   | VKMV 6PK1726   | 1   |   | 1   |   |   |   |   |   |
|   |   |   |   | VKM 33013  | 1   |   |   |   |   |   |   |   |
|   |   |   |   | VKM 33029  |   |   |   |   | 1   |   |   |   |
|   |   |   |   | VKM 33311  |   |   |   |   |   |   |   |   |
| <b>CITROËN  XM II 2.1 TD</b>   |   |   |   |  |   |   |   |   |   |   |   |   |
|                                 | XUD11ATE, XUD11BTE  | 05/94 → 10/00   |  | VKMC 03251   | 1   | 1   | 1   |   | 1   |   |   | 1 T0080   |
|   |   |   |   | VKMA 03251   | 1   | 1   | 1   |   |   |   |   | 1 T0080   |
|   |   |   |   | VKM 13250  | 1   |   |   |   |   |   |   |   |
|   |   |   |   | VKM 23213  |   | 1   |   |   |   |   |   | 1   |
|   | XUD11ATE, XUD11BTE  | 05/94 → 10/00   | 3)  | VKMS 03251   | 1   | 1   | 1   |   |   |   | 2   | 1 T0080   |
|   |   |   |   | VKMA 03251   | 1   | 1   | 1   |   |   |   |   | 1 T0080   |
|   |   |   |   | VKM 13250  | 1   |   |   |   |   |   |   |   |
|   |   |   |   | VKM 23213  |   | 1   |   |   |   |   |   | 1   |
|                               | XUD11ATE, XUD11BTE  | 05/94 → 10/00   |   | VKPC 83425   |   |   |   | 1   |   |   |   |   |
|                               | <b>B(Alt)</b> XUD11ATE, XUD11BTE  | 05/94 → 05/95   | <b>AC</b>   | VKMV 5PK770  |   |   | 1   |   |   |   |   |   |
|   | <b>B(Alt)</b> XUD11ATE, XUD11BTE  | 06/95 → 10/00   | <b>AC</b>   | VKMA 33035   | 1   |   | 1   |   |   |   |   |   |
|   |   |   |   | VKMV 6PK1102   |   |   | 1   |   |   |   |   |   |
|   |   |   |   | VKM 33002  | 1   |   |   |   |   |   |   |   |
|   | <b>B(Alt)</b> XUD11ATE, XUD11BTE  | 05/94 → 05/95   | <b>AC</b>   | VKMV 5PK1195   |   |   | 1   |   |   |   |   |   |
|   |   |   |   | VKM 33007  |   | 1   |   |   |   |   |   |   |
|   | <b>B(Alt)</b> XUD11ATE, XUD11BTE  | 06/95 → 10/00   | <b>AC</b>   | VKMV 6PK1726   |   |   | 1   |   |   |   |   |   |
|   |   |   |   | VKM 33013  | 1   |   |   |   |   |   |   |   |
|   |   |   |   | VKM 33029  | 1   |   |   |   |   |   |   |   |
|   |   |   |   | VKM 33311  |   |   |   |   | 1   |   |   |   |
|                               | XUD11ATE, XUD11BTE  | 06/95 → 10/00   | <b>Man. GBX</b>   | VKM 93306  |   |   |   |   | 1   |   |   |   |
|   | XUD11ATE  | 06/95 → 08/96   | <b>Auto. GBX</b>  | VKM 93306  |   |   |   |   | 1   |   |   |   |
|   | XUD11BTE  | 05/94 → 10/00   | <b>Auto. GBX</b>  | VKM 93306  |   |   |   |   | 1   |   |   |   |
| <b>CITROËN  XM II 2.5 TD</b> |   |   |   |  |   |   |   |   |   |   |   |   |
|                               | DK5ATE  | 05/94 → 10/00   | 3)  | VKMS 03300   | 1   | 1   | 1   |   |   |   | 2   |   |
|   |   |   |   | VKMA 03300   | 1   | 1   | 1   |   |   |   |   | T0121   |
|   |   |   |   | VKM 13300  | 1   |   |   |   |   |   |   |   |
|   |   |   |   | VKM 23300  |   | 1   |   |   |   |   |   |   |
|   | DK5ATE  | 05/94 → 10/00   | 1)  | VKMA 03301   | 2   | 1   | 2   |   |   |   |   | T0646   |
|   |   |   |   | VKM 13300  | 1   |   |   |   |   |   |   |   |
|   |   |   |   | VKM 13301  | 1   |   |   |   |   |   |   |   |
|   |   |   |   | VKM 23300  |   | 1   |   |   |   |   |   |   |
|                               | DK5ATE  | 05/94 → 05/96   |   | VKPC 83810   |   |   |   | 1   |   |   |   |   |
|   | DK5ATE  | 05/96 → 10/00   |   | VKPC 83811   |   |   |   | 1   |   |   |   |   |
|                               | <b>B(Alt)</b> DK5ATE  | 05/94 → 10/00   | <b>AC</b>   | VKMV 6PK1188   |   |   | 1   |   |   |   |   |   |
|   |   |   |   | VKM 33014  |   | 1   |   |   |   |   |   |   |
|   | <b>B(Alt)</b> DK5ATE  | 05/94 → 10/00   | <b>AC</b>   | VKMV 6PK1862   |   |   | 1   |   |   |   |   |   |
|   |   |   |   | VKM 33083  | 1   |   |   |   |   |   |   |   |
|   | <b>B(WP)</b> DK5ATE   | 05/94 → 05/96   |   | VKMV 4PK946  |   |   | 1   |   |   |   |   |   |
|   |   |   |   | VKM 33086  | 1   |   |   |   |   |   |   |   |
|   | <b>B(WP)</b> DK5ATE   | 05/96 → 10/00   |   | VKMV 3PK946  |   |   | 1   |   |   |   |   |   |
|   |   |   |   | VKM 33086  | 1   |   |   |   |   |   |   |   |
| <b>CITROËN  XSARA 1.4</b>    |   |   |   |  |   |   |   |   |   |   |   |   |
|                               | TU3JP   | 04/97 → 08/05   | 3), <b>M⊙</b> ,<br>→ <b>IMot.</b> 3666765   | VKMS 03110-2   | 1   |   | 1   |   |   |   | 2   |   |
|   |   |   |   | VKMA 03110   | 1   |   | 1   |   |   |   |   | T0044   |
|   |   |   |   | VKM 13100  | 1   |   |   |   |   |   |   |   |

|   |  |  |  |  |  |  |  |  |  |  |  |  |  |  |  |       |
|---|---|---|---|--|---|---|---|---|---|---|---|---|---|---|---|-------|
|   | TU3JP   | 04/97 → 08/05   | A ⊙, Mot. 3666766 I →   | VKMA 03254<br>VKM 13253  | 1<br>1  |   | 1   |   |   |   |   |   |   |   |   | T0189 |
|  | TU3JP   | 04/97 → 08/05   | → I Mot. 3666765  | VKPC 83205   |   |   |   |   |   | 1   |   |   |   |   |   |       |
|   | TU3JP   | 04/97 → 08/05   | Mot. 3666766 I →  | VKPC 83644   |   |   |   |   |   | 1   |   |   |   |   |   |       |
|  | B(Alt) TU3JP  | 04/97 → 08/05   | 11), AC, ⊙  | VKMV 10AVx710  |   |   | 1   |   |   |   |   |   |   |   |   |       |
|   | B(Alt) TU3JP  | 04/97 → 08/05   | 11), AC, ⊙  | VKMV 4PK860  |   |   | 1   |   |   |   |   |   |   |   |   |       |
|   | B(Alt) TU3JP  | 04/97 → 08/05   | 12), AC   | VKMA 33024<br>VKMV 6PK1451<br>VKM 33018  |   | 1   | 1   |   |   |   |   |   |   |   |   |       |
|   | B(Alt) TU3JP  | 04/97 → 12/01   | 12), AC   | VKMA 33026<br>VKMV 6PK1564<br>VKM 33023<br>VKM 33037                               | 1   | 1   | 1   |   |   |   |   |   |   |   |   |       |
|   | B(Alt) TU3JP  | 12/01 → 08/05   | 12), AC   | VKMV 6PK1560<br>VKM 33100<br>VKM 33101   | 1   |   | 1   |   |   |   |   |   |   |   |   |       |
|   | B(PS) TU3JP   | 04/97 → 04/98   | 11), AC   | VKMA 33212<br>VKMV 5PK881<br>VKM 33012   | 1   |   | 1   |   |   |   |   |   |   |   |   |       |
|   | B(PS) TU3JP   | 04/98 → 08/05   | 11), AC   | VKMV 5PK829<br>VKM 33012   | 1   |   | 1   |   |   |   |   |   |   |   |   |       |
|   | B(PS) TU3JP   | 04/97 → 08/05   | 11), AC   | VKMA 33312<br>VKM 33012  | 1<br>1  |   | 1   |   |   |   |   |   |   |   |   |       |



### CITROËN XSARA 1.6

|   |              |               |            |  |        |   |   |  |  |   |  |  |  |  |  |       |
|---|--------------|---------------|------------|--|--------|---|---|--|--|---|--|--|--|--|--|-------|
|    | TU5JP        | 04/97 → 09/00 |            | VKMA 03111<br>VKM 13100                              | 1<br>1 |   | 1 |  |  |   |  |  |  |  |  | T0044 |
|  | TU5JP        | 04/97 → 09/00 |            | VKPC 83428   |        |   |   |  |  | 1 |  |  |  |  |  |       |
|  | B(Alt) TU5JP | 04/97 → 09/00 | 11), AC, ⊙ | VKMV 4PK860  |        |   | 1 |  |  |   |  |  |  |  |  |       |
|   | B(Alt) TU5JP | 04/97 → 09/00 | 12), AC    | VKMA 33024<br>VKMV 6PK1451<br>VKM 33018              |        | 1 | 1 |  |  |   |  |  |  |  |  |       |
|   | B(Alt) TU5JP | 04/97 → 09/00 | 12), AC    | VKMA 33026<br>VKMV 6PK1564<br>VKM 33023<br>VKM 33037 | 1      | 1 | 1 |  |  |   |  |  |  |  |  |       |
|   | B(PS) TU5JP  | 04/97 → 04/98 | 11), AC    | VKMA 33212<br>VKMV 5PK881<br>VKM 33012               | 1      |   | 1 |  |  |   |  |  |  |  |  |       |
|   | B(PS) TU5JP  | 04/98 → 09/00 | 11), AC    | VKMV 5PK829<br>VKM 33012                             | 1      |   | 1 |  |  |   |  |  |  |  |  |       |
|   | B(PS) TU5JP  | 04/97 → 09/00 | 11), AC    | VKMA 33312<br>VKM 33012                              | 1<br>1 |   | 1 |  |  |   |  |  |  |  |  |       |

### CITROËN XSARA 1.6 16V





















|   |               |               |                  |  |        |   |   |  |  |   |  |  |  |  |  |   |       |       |
|---|---------------|---------------|------------------|--|--------|---|---|--|--|---|--|--|--|--|--|---|-------|-------|
|  | TU5JP4        | 09/00 → 08/05 | → I Mot. 1806404 | VKMA 03132<br>VKM 13132<br>VKM 23130                 | 1<br>1 | 1 | 1 |  |  |   |  |  |  |  |  | 1 | T0193 |       |
|   | TU5JP4        | 09/00 → 08/05 | Mot. 1806405 I → | VKMA 03256<br>VKM 13256<br>VKM 23256                 | 1<br>1 | 1 | 1 |  |  |   |  |  |  |  |  |   | 1     | T0193 |
|  | TU5JP4        | 09/00 → 08/05 |                  | VKPC 83430   |        |   |   |  |  | 1 |  |  |  |  |  |   |       |       |
|  | B(Alt) TU5JP4 | 09/00 → 08/05 | 12), AC          | VKMA 33024<br>VKMV 6PK1451<br>VKM 33018              |        | 1 | 1 |  |  |   |  |  |  |  |  |   |       |       |
|   | B(Alt) TU5JP4 | 09/00 → 12/01 | 12), AC          | VKMA 33026<br>VKMV 6PK1564<br>VKM 33023<br>VKM 33037 | 1      | 1 | 1 |  |  |   |  |  |  |  |  |   |       |       |
|   | B(Alt) TU5JP4 | 12/01 → 08/05 | 12), AC          | VKMV 6PK1560<br>VKM 33100<br>VKM 33101               | 1      |   | 1 |  |  |   |  |  |  |  |  |   |       |       |





























### CITROËN XSARA 1.8

|   |              |               |  |                         |        |  |   |  |  |   |  |  |  |  |  |  |       |
|---|--------------|---------------|--|-------------------------|--------|--|---|--|--|---|--|--|--|--|--|--|-------|
|  | XU7JB, XU7JP | 04/97 → 09/00 |  | VKMA 03201<br>VKM 13100 | 1<br>1 |  | 1 |  |  |   |  |  |  |  |  |  | T0018 |
|  | XU7JB, XU7JP | 04/97 → 09/00 |  | VKPC 83615              |        |  |   |  |  | 1 |  |  |  |  |  |  |       |



CITROËN









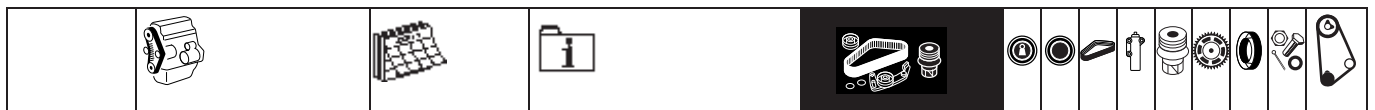



|  |  |  |  |  |  |  |  |  |  |  |  |  |
|--|---|---|---|--|---|---|---|---|---|---|---|---|
|  B(Alt)                          | XU7JB   | 04/97 → 06/98   | 11), AC   | VKMA 33003<br>VKMV 6PK1076<br>VKM 33003  | 1<br>1  | 1<br>1  |   |   |   |   |   |   |
| B(Alt)   | XU7JB   | 07/98 → 09/00   | 11), AC   | VKMA 33031<br>VKMV 6PK1076<br>VKM 33021  | 1<br>1  | 1<br>1  |   |   |   |   |   |   |
| B(Alt)   | XU7JB   | 04/97 → 09/00   | 11), AC   | VKMA 33032<br>VKMV 6PK1660<br>VKM 33026<br>VKM 33028                               | 1<br>1  | 1<br>1  |   |   |   |   |   |   |
| B(Alt)   | XU7JP   | 04/97 → 06/98   | 11), 70, 80A, AC  | VKMV 6PK1067<br>VKM 33003  | 1   | 1   |   |   |   |   |   |   |
| B(Alt)   | XU7JP   | 07/98 → 09/00   | 11), 70, 80A, AC  | VKMV 6PK1067<br>VKM 33021  | 1   | 1   |   |   |   |   |   |   |
| B(Alt)   | XU7JP   | 04/97 → 06/98   | 11), 90A, AC  | VKMA 33003<br>VKMV 6PK1076<br>VKM 33003  | 1<br>1  | 1<br>1  |   |   |   |   |   |   |
| B(Alt)   | XU7JP   | 07/98 → 09/00   | 11), 90A, AC  | VKMA 33031<br>VKMV 6PK1076<br>VKM 33021  | 1<br>1  | 1<br>1  |   |   |   |   |   |   |
| B(Alt)   | XU7JP   | 04/97 → 09/00   | 11), AC   | VKMA 33030<br>VKMV 6PK1660<br>VKM 33028<br>VKM 33034                               | 1<br>1  | 1<br>1  |   |   |   |   |   |   |
| <b>CITROËN  XSARA 1.8 16V</b>   |   |   |   |  |   |   |   |   |   |   |   |   |
|  B(Alt)                         | XU7JP4  | 04/97 → 09/00   |   | VKMA 03214<br>VKM 13214<br>VKM 23214   | 1<br>1  | 1<br>1  |   |   |   |   | 2<br>1<br>1   | T0142   |
|                                | XU7JP4  | 04/97 → 09/00   |   | VKPC 83635   |   |   | 1   |   |   |   |   |   |
|  B(Alt)                        | XU7JP4  | 04/97 → 06/98   | 11), AC   | VKMA 33003<br>VKMV 6PK1076<br>VKM 33003  | 1<br>1  | 1<br>1  |   |   |   |   |   |   |
| B(Alt)   | XU7JP4  | 07/98 → 09/00   | 11), AC   | VKMA 33031<br>VKMV 6PK1076<br>VKM 33021  | 1<br>1  | 1<br>1  |   |   |   |   |   |   |
| B(Alt)   | XU7JP4  | 04/97 → 09/00   | 11), AC   | VKMA 33032<br>VKMV 6PK1660<br>VKM 33026<br>VKM 33028                               | 1<br>1  | 1<br>1  |   |   |   |   |   |   |
| <b>CITROËN  XSARA 2.0 16V</b> |   |   |   |  |   |   |   |   |   |   |   |   |
|                                | EW10J4  | 09/00 → 08/05   |   | VKMA 03235<br>VKM 13234<br>VKM 23230   | 1<br>1  | 1<br>1  |   |   |   |   |   | T0169   |
|  | XU10J4R   | 07/98 → 09/00   |   | VKMA 03213<br>VKM 13202<br>VKM 23213   | 1<br>1  | 1<br>1  |   |   |   |   | 1   | T0142   |
|  | XU10J4RS  | 04/97 → 04/00   | M⊙  | VKMA 03213<br>VKM 13202<br>VKM 23213   | 1<br>1  | 1<br>1  |   |   |   |   | 1   | T0142   |
|  | XU10J4RS  | 04/00 → 03/05   | A⊙  | VKMA 03218<br>VKM 13218<br>VKM 23218   | 1<br>1  | 1<br>1  |   |   |   |   | 1   | T0242   |
|                                | EW10J4  | 09/00 → 08/05   | 16)   | VKPC 83650   |   |   | 1   |   |   |   |   |   |
|  | XU10J4R, XU10J4RS   | 04/97 → 03/05   |   | VKPC 83636   |   |   | 1   |   |   |   |   |   |
|  B(Alt)                        | EW10J4  | 09/00 → 08/05   | 12), AC   | VKMA 33019<br>VKMV 6PK1205<br>VKM 33019<br>VKM 33020                               | 1<br>1  | 1<br>1  |   |   |   |   |   |   |
| B(Alt)   | EW10J4  | 09/00 → 08/05   | 12), AC   | VKMA 33020<br>VKMV 6PK1726<br>VKM 33019<br>VKM 33020                               | 1<br>1  | 1<br>1  |   |   |   |   |   |   |
| B(Alt)   | XU10J4R, XU10J4RS   | 04/97 → 09/00   | 11), AC   | VKMV 6PK1160<br>VKM 33022<br>VKM 33025   | 1   | 1   |   |   |   |   |   |   |

























|  |  |  |    |  |  |  |  |  |  |  |  |  |
|--|---|---|---|--|---|---|---|---|---|---|---|---|
| B(Alt)   | XU10J4R, XU10J4RS   | 04/97 → 09/00   | 11), AC   | VKMA 33034<br>VKMV 6PK1603<br>VKM 33028<br>VKM 33035                               | 1<br>1  | 1<br>1  |   |   |   |   |   |   |
| B(Alt)   | XU10J4RS  | 02/98 → 08/04   | 11), AC, ⊕  | VKMA 33034<br>VKMV 6PK1603<br>VKM 33028<br>VKM 33035                               | 1<br>1  | 1<br>1  |   |   |   |   |   |   |
| B(Alt)   | XU10J4RS  | 02/98 → 03/05   | 11), AC, ⊕  | VKMA 33034<br>VKMV 6PK1603<br>VKM 33028<br>VKM 33035                               | 1<br>1  | 1<br>1  |   |   |   |   |   |   |
| B(Alt)   | XU10J4RS  | 02/98 → 03/05   | 12)   | VKMA 33034<br>VKMV 6PK1603<br>VKM 33028<br>VKM 33035                               | 1<br>1  | 1<br>1  |   |   |   |   |   |   |
| <b>CITROËN  XSARA 1.4 HDi</b> |   |   |   |  |   |   |   |   |   |   |   |   |
|                               | DV4TD   | 01/03 → 08/05   |   | VKMA 03140<br>VKM 13140<br>VKM 23140   | 1<br>1  | 1<br>1  |   |   |   |   |   | T0195   |
|                               | DV4TD   | 01/03 → 08/05   |   | VKPC 83140   |   |   |   | 1   |   |   |   |   |
|                               | B(Alt) DV4TD  | 01/03 → 08/05   | AC  | VKMA 33060<br>VKMV 6PK1341<br>VKM 33060<br>VKM 33060<br>VKM 33061                  | 1<br>1<br>1<br>1  | 2<br>1<br>1   | 1<br>1  |   |   |   |   | 1<br>1  |
| B(Alt)   | DV4TD   | 01/03 → 08/05   | AC  | VKMA 33061<br>VKMV 6PK1705<br>VKM 33044<br>VKM 33061                               | 1<br>1  | 1<br>1  | 1<br>1  |   |   |   |   | 1   |
|                             | DV4TD   | 01/03 → 08/05   |   | —  |   |   |   | 1   |   |   |   |   |
| <b>CITROËN  XSARA 1.5 D</b> |   |   |   |  |   |   |   |   |   |   |   |   |
|                             | TUD5  | 04/97 → 09/00   |  | VKMC 03121<br>VKMA 03121<br>VKM 13120<br>VKM 23120                                 | 1<br>1<br>1   | 1<br>1<br>1   | 1<br>1  | 1   |   |   |   | 2<br>2<br>2   |
|  | TUD5  | 04/97 → 09/00   | 3)  | VKMS 03121<br>VKMA 03121<br>VKM 13120<br>VKM 23120                                 | 1<br>1<br>1   | 1<br>1<br>1   | 1   |   |   | 2   |   | 2<br>2<br>2   |
|                             | TUD5  | 04/97 → 09/00   |   | VKPC 83428   |   |   |   | 1   |   |   |   |   |
|                             | B(Alt) TUD5   | 04/97 → 09/00   |   | VKMA 33046<br>VKMV 5PK960<br>VKM 33039   | 1<br>1  | 1<br>1  |   |   |   |   |   |   |
| B(AC)  | TUD5  | 04/97 → 09/00   |   | VKMA 33312<br>VKM 33012  | 1<br>1  | 1   |   |   |   |   |   |   |
|                             | TUD5  | 04/97 → 09/00   |   | VKM 93305  |   |   |   | 1   |   |   |   |   |
| <b>CITROËN  XSARA 1.8 D</b> |   |   |   |  |   |   |   |   |   |   |   |   |
|                             | XUD7  | 04/97 → 09/00   |  | VKMC 03241<br>VKMA 03241<br>VKM 13241<br>VKM 23241                                 | 1<br>1<br>1   | 1<br>1<br>1   | 1   | 1   |   |   |   | T0017   |
|  | XUD7  | 04/97 → 09/00   | 3)  | VKMS 03241<br>VKMA 03241<br>VKM 13241<br>VKM 23241                                 | 1<br>1<br>1   | 1<br>1<br>1   | 1   |   |   | 2   |   | T0017   |
|                             | XUD7  | 04/97 → 09/00   |   | VKPC 83420   |   |   |   | 1   |   |   |   |   |
|                             | B(Alt) XUD7   | 04/97 → 09/00   | AC, ⊕   | VKMA 33202<br>VKMV 6PK1130<br>VKM 33002  | 1<br>1  | 1<br>1  |   |   |   |   |   |   |
| B(Alt)   | XUD7  | 04/97 → 09/00   | AC, ⊕   | VKMA 33202<br>VKMV 6PK1130<br>VKM 33002  | 1<br>1  | 1<br>1  |   |   |   |   |   |   |
| B(Alt)   | XUD7  | 04/97 → 09/00   | AC  | VKMA 33202<br>VKMV 6PK1740<br>VKM 33013<br>VKM 33029<br>VKM 33311                  | 1<br>1  | 1   |   |   |   |   |   | 1   |
|                             | XUD7  | 04/97 → 09/00   |   | VKM 93302  |   |   |   | 1   |   |   |   |   |



CITROËN



































| CITROËN  XSARA 1.9 D    |                             |               |   |              |   |   |   |  |   |   |
|--|-----------------------------|---------------|---|--------------|---|---|---|--|---|---|
|                          | DW8, DW8B                   | 07/98 → 08/05 |    | VKMC 03244   | 1 | 1 | 1 |  | 1 |   |
|  |                             |               |   | VKMA 03244   | 1 | 1 | 1 |  |   | 1 |
|  |                             |               |   | VKM 13244    | 1 |   |   |  |   | 1 |
|  |                             |               |   | VKM 23246    |   | 1 |   |  |   | 1 |
|  | XUD9, XUD9BSD               | 04/97 → 09/00 |    | VKMC 03241   | 1 | 1 | 1 |  | 1 |   |
|  |                             |               |   | VKMA 03241   | 1 | 1 | 1 |  |   |   |
|  |                             |               |   | VKM 13241    | 1 |   |   |  |   |   |
|  |                             |               |   | VKM 23241    |   | 1 |   |  |   |   |
|  | XUD9, XUD9BSD               | 04/97 → 09/00 | 3)  | VKMS 03241   | 1 | 1 | 1 |  |   | 2 |
|  |                             |               |   | VKMA 03241   | 1 | 1 | 1 |  |   |   |
|  |                             |               |   | VKM 13241    | 1 |   |   |  |   |   |
|  |                             |               |   | VKM 23241    |   | 1 |   |  |   |   |
|                          | DW8, DW8B                   | 07/98 → 08/05 |   | VKPC 83639   |   |   |   |  | 1 |   |
|  | XUD9, XUD9BSD               | 04/97 → 09/00 |   | VKPC 83420   |   |   |   |  | 1 |   |
|                          | <b>B(Alt)</b> DW8           | 07/98 → 08/05 | 11), AC, Ø  | VKMV 6PK866  |   |   | 1 |  |   |   |
|  |                             |               |   | VKM 33004    | 1 |   |   |  |   |   |
|  | <b>B(Alt)</b> DW8           | 07/98 → 08/05 | 11), AC, Ø  | VKMV 6PK1042 |   |   | 1 |  |   |   |
|  |                             |               |   | VKM 33004    | 1 |   |   |  |   |   |
|  | <b>B(Alt)</b> DW8           | 07/98 → 10/99 | 11), AC, ⊕  | VKMA 33021   | 1 | 2 | 1 |  |   |   |
|  |                             |               |   | VKMV 6PK1388 |   |   | 1 |  |   |   |
|  |                             |               |   | VKM 33017    |   | 1 |   |  |   |   |
|  |                             |               |   | VKM 33017    |   | 1 |   |  |   |   |
|  |                             |               |   | VKM 33042    | 1 |   |   |  |   |   |
|  | <b>B(Alt)</b> DW8           | 10/99 → 08/05 | 11), AC, ⊕  | VKMA 33027   | 1 | 2 | 1 |  |   |   |
|  |                             |               |   | VKMV 6PK1437 |   |   | 1 |  |   |   |
|  |                             |               |   | VKM 33017    |   | 1 |   |  |   |   |
|  |                             |               |   | VKM 33031    |   | 1 |   |  |   |   |
|  |                             |               |   | VKM 33032    | 1 |   |   |  |   |   |
|  | <b>B(Alt)</b> DW8           | 07/98 → 08/05 | 11), AC, ⊕  | VKMA 33093   | 2 |   | 1 |  | 1 |   |
|  |                             |               |   | VKMV 6PK1750 |   |   | 1 |  |   |   |
|  |                             |               |   | VKM 33013    | 1 |   |   |  |   |   |
|  |                             |               |   | VKM 33029    | 1 |   |   |  |   |   |
|  |                             |               |   | VKM 33311    |   |   |   |  | 1 |   |
|  | <b>B(Alt)</b> DW8B          | 07/98 → 08/05 | 12), AC   | VKMA 33027   | 1 | 2 | 1 |  |   |   |
|  |                             |               |   | VKMV 6PK1437 |   |   | 1 |  |   |   |
|  |                             |               |   | VKM 33017    |   | 1 |   |  |   |   |
|  |                             |               |   | VKM 33031    |   | 1 |   |  |   |   |
|  |                             |               |   | VKM 33032    | 1 |   |   |  |   |   |
|  | <b>B(Alt)</b> DW8B          | 07/98 → 03/03 | AC  | VKMV 6PK1736 |   |   | 1 |  |   |   |
|  |                             |               |   | VKM 33013    | 1 |   |   |  |   |   |
|  |                             |               |   | VKM 33029    | 1 |   |   |  |   |   |
|  |                             |               |   | VKM 33311    |   |   |   |  | 1 |   |
|  | <b>B(Alt)</b> DW8B          | 03/03 → 08/05 | AC  | VKMV 6PK1680 |   |   | 1 |  |   |   |
|  |                             |               |   | VKM 33013    | 1 |   |   |  |   |   |
|  | <b>B(Alt)</b> XUD9, XUD9BSD | 04/97 → 09/00 | AC, Ø   | VKMV 6PK730  |   |   | 1 |  |   |   |
|  | <b>B(Alt)</b> XUD9, XUD9BSD | 04/97 → 09/00 | AC, ⊕   | VKMA 33202   | 1 |   | 1 |  |   |   |
|  |                             |               |   | VKMV 6PK1130 |   |   | 1 |  |   |   |
|  |                             |               |   | VKM 33002    | 1 |   |   |  |   |   |
|  | <b>B(Alt)</b> XUD9, XUD9BSD | 04/97 → 09/00 | AC  | VKMV 6PK1740 |   |   | 1 |  |   |   |
|  |                             |               |   | VKM 33013    | 1 |   |   |  |   |   |
|  |                             |               |   | VKM 33029    | 1 |   |   |  |   |   |
|  |                             |               |   | VKM 33311    |   |   |   |  | 1 |   |
|                        | DW8B                        | 12/02 → 08/05 | AC  | VKM 93301    |   |   |   |  | 1 |   |
|  | XUD9, XUD9BSD               | 04/97 → 09/00 |   | VKM 93302    |   |   |   |  | 1 |   |
| CITROËN  XSARA 1.9 TD |                             |               |   |              |   |   |   |  |   |   |
|                        | XUD9TE                      | 04/97 → 09/00 |  | VKMC 03241   | 1 | 1 | 1 |  | 1 |   |
|  |                             |               |   | VKMA 03241   | 1 | 1 | 1 |  |   |   |
|  |                             |               |   | VKM 13241    | 1 |   |   |  |   |   |
|  |                             |               |   | VKM 23241    |   | 1 |   |  |   |   |
|  | XUD9TE                      | 04/97 → 09/00 | 3)  | VKMS 03241   | 1 | 1 | 1 |  |   | 2 |
|  |                             |               |   | VKMA 03241   | 1 | 1 | 1 |  |   |   |
|  |                             |               |   | VKM 13241    | 1 |   |   |  |   |   |
|  |                             |               |   | VKM 23241    |   | 1 |   |  |   |   |
|                        | XUD9TE                      | 04/97 → 09/00 |   | VKPC 83420   |   |   |   |  | 1 |   |
|                        | <b>B(Alt)</b> XUD9TE        | 04/97 → 09/00 | AC, Ø   | VKMV 6PK730  |   |   | 1 |  |   |   |































|  |  |  |  |  |  |  |  |  |  |  |  |  |  |
|--|---|---|---|--|---|---|---|---|---|---|---|---|---|
| B(Alt)   | XUD9TE  | 04/97 → 09/00   | AC, ⊕   | VKMA 33202<br>VKMV 6PK1130<br>VKM 33002  | 1<br>1  | 1<br>1  |   |   |   |   |   |   |   |
| B(Alt)   | XUD9TE  | 04/97 → 09/00   | AC  | VKMV 6PK1739<br>VKM 33013<br>VKM 33029<br>VKM 33311                                | 1<br>1  | 1   |   |   |   | 1   |   |   |   |
| ⊕  | XUD9TE  | 04/97 → 09/00   |   | VKM 93302  |   |   |   |   |   | 1   |   |   |   |
| <b>CITROËN  XSARA 2.0 HDi 90</b>        |   |   |   |  |   |   |   |   |   |   |   |   |   |
|   | DW10TD  | 02/99 → 10/00   | ⊕   | VKMC 03246<br>VKMA 03246<br>VKM 13246<br>VKM 23246                                 | 1<br>1<br>1   | 1<br>1<br>1   | 1   | 1   |   |   |   | 1<br>1<br>1   | T0168   |
|  | DW10TD  | 02/99 → 10/00   | 3)  | VKMS 03246<br>VKMA 03246<br>VKM 13246<br>VKM 23246                                 | 1<br>1<br>1   | 1<br>1<br>1   |   |   |   | 2   |   | 1<br>1<br>1   | T0168   |
|  | DW10TD  | 10/00 → 08/05   | ⊕   | VKMC 03247<br>VKMA 03247<br>VKM 13244<br>VKM 23246                                 | 1<br>1<br>1   | 1<br>1<br>1   | 1   |   | 1   |   |   | 1<br>1<br>1   | T0168   |
| ⊕  | DW10TD  | 02/99 → 08/05   |   | VKPC 83639   |   |   |   |   | 1   |   |   |   |   |
|   | B(Alt) DW10TD   | 02/99 → 08/05   | 11), AC   | VKMA 33044<br>VKMV 6PK1468<br>VKM 33024<br>VKM 33033<br>VKM 33069                  | 2<br>1<br>1   | 1<br>1  | 1   |   |   |   |   |   |   |
|  | B(Alt) DW10TD   | 02/99 → 08/05   | 11), AC   | VKMA 33037<br>VKMV 6PK1750<br>VKM 33013<br>VKM 33033                               | 2<br>1<br>1   | 1<br>1  |   |   |   |   |   |   |   |
| ⊕  | DW10TD  | 02/99 → 08/05   |   | VKM 93301  |   |   |   |   |   | 1   |   |   |   |
| <b>CITROËN  XSARA 2.0 HDi 110</b>     |   |   |   |  |   |   |   |   |   |   |   |   |   |
|                                       | DW10ATED  | 05/01 → 08/05   | ⊕   | VKMC 03247<br>VKMA 03247<br>VKM 13244<br>VKM 23246                                 | 1<br>1<br>1   | 1<br>1<br>1   | 1   |   | 1   |   |   | 1<br>1<br>1   | T0168   |
| ⊕  | DW10ATED  | 05/01 → 08/05   |   | VKPC 83639   |   |   |   |   | 1   |   |   |   |   |
|                                       | B(Alt) DW10ATED   | 05/01 → 08/05   | 12), AC   | VKMA 33044<br>VKMV 6PK1468<br>VKM 33024<br>VKM 33033<br>VKM 33069                  | 2<br>1<br>1   | 1<br>1  | 1   |   |   |   |   |   |   |
|  | B(Alt) DW10ATED   | 05/01 → 08/05   | 12), AC   | VKMV 6PK1740<br>VKM 33013<br>VKM 33033   | 1<br>1  | 1   |   |   |   |   |   |   |   |
| ⊕  | DW10ATED  | 05/01 → 08/05   |   | VKM 93301  |   |   |   |   |   | 1   |   |   |   |
| <b>CITROËN  XSARA PICASSO 1.6 90</b>  |   |   |   |  |   |   |   |   |   |   |   |   |   |
|                                       | TU5JP   | 06/00 → 11/07   |   | VKMA 03111<br>VKM 13100  | 1<br>1  |   | 1   |   |   |   |   |   | T0044   |
| ⊕  | TU5JP   | 06/00 → 10/07   |   | VKPC 83428   |   |   |   |   | 1   |   |   |   |   |
|                                       | B(Alt) TU5JP  | 06/00 → 01/07   | AC  | VKMA 33024<br>VKMV 6PK1451<br>VKM 33018  |   | 1<br>1  | 1<br>1  |   |   |   |   |   |   |
|  | B(Alt) TU5JP  | 06/00 → 01/07   | AC  | VKMA 33026<br>VKMV 6PK1564<br>VKM 33023<br>VKM 33037                               | 1<br>1<br>1   | 1<br>1  | 1<br>1  |   |   |   |   |   |   |
| <b>CITROËN  XSARA PICASSO 1.6 100</b> |   |   |   |  |   |   |   |   |   |   |   |   |   |
|                                       | TU5JP   | 09/00 → 11/07   |   | VKMA 03111<br>VKM 13100  | 1<br>1  |   | 1   |   |   |   |   |   | T0044   |
| ⊕  | TU5JP   | 09/00 → 10/07   |   | VKPC 83428   |   |   |   |   | 1   |   |   |   |   |
|                                       | B(Alt) TU5JP  | 09/00 → 01/07   | AC  | VKMA 33024<br>VKMV 6PK1451<br>VKM 33018  |   | 1<br>1  | 1<br>1  |   |   |   |   |   |   |



CITROËN



























































|  |  |  |  |  |  |  |  |  |  |  |  |  |
|--|---|---|---|--|---|---|---|---|---|---|---|---|
| B(Alt)   | TU5JP   | 09/00 → 12/01   | AC  | VKMA 33026<br>VKMV 6PK1564<br>VKM 33023<br>VKM 33037                               | 1<br>1<br>1<br>1  | 1<br>1  | 1<br>1  |   |   |   |   |   |
| B(Alt)   | TU5JP   | 12/01 → 10/05   | AC  | VKMA 33026<br>VKMV 6PK1564<br>VKM 33100<br>VKM 33101                               | 1<br>1<br>1<br>1  | 1<br>1  | 1<br>1  |   |   |   |   |   |
| B(Alt)   | TU5JP   | 10/05 → 01/07   | AC  | VKMA 33026<br>VKMV 6PK1564<br>VKM 33100<br>VKM 33101                               | 1<br>1<br>1<br>1  | 1<br>1  | 1<br>1  |   |   |   |   |   |
| <b>CITROËN  XSARA PICASSO 1.6 16V</b>       |   |   |   |  |   |   |   |   |   |   |   |   |
|    | TU5JP4  | 09/05 → 11/07   |   | VKMA 03256<br>VKM 13256<br>VKM 23256   | 1<br>1<br>1   | 1<br>1  | 1<br>1  |   |   |   |   | T0193   |
|    | TU5JP4  | 09/05 → 10/07   |   | VKPC 83430   |   |   |   | 1   |   |   |   |   |
|    | B(Alt) TU5JP4   | 09/05 → 01/07   | AC  | VKMA 33024<br>VKMV 6PK1451<br>VKM 33018  | 1<br>1<br>1   | 1<br>1  | 1<br>1  |   |   |   |   |   |
| <b>CITROËN  XSARA PICASSO 1.8 16V</b>       |   |   |   |  |   |   |   |   |   |   |   |   |
|    | EW7J4   | 02/00 → 11/07   |   | VKMA 03235<br>VKM 13234<br>VKM 23230   | 1<br>1<br>1   | 1<br>1  | 1<br>1  |   |   |   |   | T0169   |
|    | EW7J4   | 02/00 → 10/07   | 16)   | VKPC 83650   |   |   |   | 1   |   |   |   |   |
|    | B(Alt) EW7J4  | 02/00 → 01/07   | AC  | VKMA 33019<br>VKMV 6PK1205<br>VKM 33019<br>VKM 33020                               | 1<br>1<br>1<br>1  | 1<br>1  | 1<br>1  |   |   |   |   |   |
| B(Alt)   | EW7J4   | 02/00 → 01/07   | AC  | VKMA 33020<br>VKMV 6PK1726<br>VKM 33019<br>VKM 33020                               | 1<br>1<br>1<br>1  | 1<br>1  | 1<br>1  |   |   |   |   |   |
| <b>CITROËN  XSARA PICASSO 2.0 16V</b>     |   |   |   |  |   |   |   |   |   |   |   |   |
|    | EW10J4  | 01/03 → 11/07   |   | VKMA 03235<br>VKM 13234<br>VKM 23230   | 1<br>1<br>1   | 1<br>1  | 1<br>1  |   |   |   |   | T0169   |
|    | EW10J4  | 01/03 → 10/07   | 16)   | VKPC 83650   |   |   |   | 1   |   |   |   |   |
|    | B(Alt) EW10J4   | 01/03 → 01/07   | AC  | VKMA 33019<br>VKMV 6PK1205<br>VKM 33019<br>VKM 33020                               | 1<br>1<br>1<br>1  | 1<br>1  | 1<br>1  |   |   |   |   |   |
| B(Alt)   | EW10J4  | 01/03 → 01/07   | AC  | VKMA 33020<br>VKMV 6PK1726<br>VKM 33019<br>VKM 33020                               | 1<br>1<br>1<br>1  | 1<br>1  | 1<br>1  |   |   |   |   |   |
| <b>CITROËN  XSARA PICASSO 1.6 HDi 90</b>  |   |   |   |  |   |   |   |   |   |   |   |   |
|    | DV6ATED4  | 09/05 → 11/07   |   | VKMA 03259<br>VKM 13140<br>VKM 23140   | 1<br>1<br>1   | 1<br>1  | 1<br>1  |   |   |   |   | T0195   |
|    | DV6ATED4  | 09/05 → 10/07   |   | VKPC 83259   |   |   |   | 1   |   |   |   |   |
|    | B(Alt) DV6ATED4   | 09/05 → 01/07   | AC  | VKMA 33060<br>VKMV 6PK1341<br>VKM 33060<br>VKM 33060<br>VKM 33061                  | 1<br>1<br>1<br>1<br>1   | 2<br>1<br>1   | 1<br>1  |   |   |   |   | 1<br>1  |
| B(Alt)   | DV6ATED4  | 09/05 → 01/07   | AC  | VKMA 33060<br>VKMV 6PK1710<br>VKM _____  | 1<br>1<br>1   |   | 1   |   |   |   |   |   |
| <b>CITROËN  XSARA PICASSO 1.6 HDi 110</b> |   |   |   |  |   |   |   |   |   |   |   |   |
|    | DV6TED4   | 05/04 → 11/07   |   | VKMA 03259<br>VKM 13140<br>VKM 23140   | 1<br>1<br>1   | 1<br>1  | 1<br>1  |   |   |   |   | T0195   |
|    | DV6TED4   | 05/04 → 10/07   |   | VKPC 83259   |   |   |   | 1   |   |   |   |   |
|    | B(Alt) DV6TED4  | 05/04 → 01/07   | AC  | VKMA 33060<br>VKMV 6PK1341<br>VKM 33060  | 1<br>1<br>1   | 2<br>1  | 1<br>1  |   |   |   |   | 1   |



































|  |  |  |            |  |  |  |  |  |  |  |
|--|---|---|---|--|---|---|---|---|---|---|
|  |   |   |   | VKM 33060<br>VKM 33061   | 1   | 1   |   |   |   | 1   |
| B(Alt)   | DV6TED4   | 05/04 → 01/07   | AC  | VKMA 33061<br>VKMV 6PK1705<br>VKM 33044<br>VKM 33061                               | 1   | 1   | 1   |   |   | 1   |
| <b>CITROËN  XSARA PICASSO 2.0 HDi</b> |   |   |   |  |   |   |   |   |   |   |
|                                       | DW10TD  | 12/99 → 10/00   |            | VKMC 03246<br>VKMA 03246<br>VKM 13246<br>VKM 23246                                 | 1   | 1   | 1   | 1   |   | 1   |
|  | DW10TD  | 12/99 → 10/00   | 3)  | VKMS 03246<br>VKMA 03246<br>VKM 13246<br>VKM 23246                                 | 1   | 1   | 1   |   | 2   | 1   |
|  | DW10TD  | 10/00 → 11/07   |            | VKMC 03247<br>VKMA 03247<br>VKM 13244<br>VKM 23246                                 | 1   | 1   | 1   | 1   |   | 1   |
|                                       | DW10TD  | 12/99 → 10/07   |   | VKPC 83639   |   |   |   | 1   |   |   |
|                                       | B(Alt) DW10TD   | 12/99 → 01/07   | AC  | VKMA 33044<br>VKMV 6PK1468<br>VKM 33024<br>VKM 33033<br>VKM 33069                  | 2   | 1   | 1   |   |   |   |
|  | B(Alt) DW10TD   | 12/99 → 01/07   | AC  | VKMV 6PK1740<br>VKM 33013<br>VKM 33033   | 1   |   | 1   |   |   |   |
|                                     | DW10TD  | 12/99 → 11/07   |   | VKM 93301  |   |   |   | 1   |   |   |
| <b>CITROËN  ZX 1.1</b>              |   |   |   |  |   |   |   |   |   |   |
|                                     | TU1M  | 03/91 → 06/97   |          | VKMC 03100<br>VKMA 03100<br>VKM 13100  | 1   |   | 1   | 1   |   |   |
|  | TU1M  | 03/91 → 06/97   | 3)  | VKMS 03100-2<br>VKMA 03100<br>VKM 13100  | 1   |   | 1   |   | 2   |   |
|                                     | TU1M  | 03/91 → 06/97   |   | VKPC 83205   |   |   |   | 1   |   |   |
|                                     | B(Alt) TU1M   | 03/91 → 06/97   | AC  | VKMV 10AVx710  |   |   | 1   |   |   |   |
|  | B(Alt) TU1M   | 03/91 → 06/97   | AC  | VKMV 4PK860  |   |   | 1   |   |   |   |
|  | B(PS) TU1M  | 12/94 → 06/97   | AC  | VKMA 33212<br>VKMV 5PK881<br>VKM 33012   | 1   |   | 1   |   |   |   |
|  | B(PS) TU1M  | 12/94 → 06/97   | AC  | VKMA 33312<br>VKM 33012  | 1   |   | 1   |   |   |   |
| <b>CITROËN  ZX 1.4</b>              |   |   |   |  |   |   |   |   |   |   |
|                                     | TU3-2   | 03/91 → 06/97   |  101     | VKMA 03111<br>VKM 13100  | 1   |   | 1   |   |   |   |
|  | TU3-2   | 03/91 → 06/97   | 3),  108 | VKMS 03110-2<br>VKMA 03110<br>VKM 13100  | 1   |   | 1   |   | 2   |   |
|  | TU3JP, TU3M   | 03/91 → 10/97   | 3)  | VKMS 03110-2<br>VKMA 03110<br>VKM 13100  | 1   |   | 1   |   | 2   |   |
|                                     | TU3-2, TU3JP, TU3M  | 03/91 → 10/97   |   | VKPC 83205   |   |   |   | 1   |   |   |
|                                     | B(Alt) TU3-2, TU3JP, TU3M   | 03/91 → 10/97   | AC,      | VKMV 4PK860  |   |   | 1   |   |   |   |
|  | B(Alt) TU3JP, TU3M  | 03/91 → 06/97   | AC  | VKMV 10AVx710  |   |   | 1   |   |   |   |
|  | B(Alt) TU3JP, TU3M  | 03/91 → 06/97   | AC  | VKMV 4PK860  |   |   | 1   |   |   |   |
|  | B(PS) TU3-2, TU3JP, TU3M  | 03/91 → 10/97   | AC  | VKMA 33212<br>VKMV 5PK881<br>VKM 33012   | 1   |   | 1   |   |   |   |
|  | B(PS) TU3-2, TU3JP, TU3M  | 03/91 → 10/97   | AC  | VKMA 33312<br>VKM 33012  | 1   |   | 1   |   |   |   |
|  | B(AC) TU3-2, TU3JP, TU3M  | 03/91 → 10/97   |          | VKM 33012  | 1   |   |   |   |   |   |



























CITROËN































|   |  |  |   |  |  |  |  |  |  |  |  |
|---|---|---|--|--|---|---|---|---|---|---|---|
| <b>CITROËN  ZX 1.6</b>       |   |   |  |  |   |   |   |   |   |   |   |
|                               | XU5JP, XU5M   | 03/91 → 10/97   |  114  | VKMA 03201<br>VKM 13100  | 1<br>1  | 1   |   |   |   |   | T0018   |
|   | XU5M  | 03/91 → 10/97   |  113  | VKMA 03200<br>VKM 13200  | 1<br>1  | 1   |   |   |   |   | T0018   |
|                               | XU5JP, XU5M   | 03/91 → 08/91   |  | VKPC 83401   |   |   |   | 1   |   |   |   |
|   | XU5JP, XU5M   | 09/91 → 10/97   |  | VKPC 83615   |   |   |   | 1   |   |   |   |
|                               | <b>B(Alt)</b> XU5JP   | 03/91 → 10/97   |    | VKMOV 6PK698   |   | 1   |   |   |   |   |   |
|   | <b>B(Alt)</b> XU5JP   | 03/91 → 10/97   |    | VKMOV 6PK1094<br>VKM 33003   | 1   | 1   |   |   |   |   |   |
|   | <b>B(Alt)</b> XU5JP   | 03/91 → 10/97   |  70, 80A,         | VKMOV 6PK1067<br>VKM 33003   | 1   | 1   |   |   |   |   |   |
|   | <b>B(Alt)</b> XU5JP   | 03/91 → 10/97   |  90A,             | VKMA 33003<br>VKMOV 6PK1076<br>VKM 33003   | 1<br>1<br>1   | 1<br>1  |   |   |   |   |   |
|   | <b>B(Alt)</b> XU5JP   | 03/91 → 10/97   |    | VKMA 33030<br>VKMOV 6PK1660<br>VKM 33028<br>VKM 33034                              | 1<br>1<br>1<br>1  | 1<br>1  | 1<br>1  |   |   |   |   |
|   | <b>B(Alt)</b> XU5M  | 03/91 → 10/97   |   | VKMOV 4PK698   |   | 1   |   |   |   |   |   |
|   | <b>B(Alt)</b> XU5M  | 03/91 → 10/97   |   | VKMOV 4PK954   |   | 1   |   |   |   |   |   |
|   | <b>B(AC)</b> XU5M   | 03/91 → 10/97   |  | VKMA 33010<br>VKMOV 4PK841<br>VKM 33010  | 1<br>1<br>1   | 1<br>1  |   |   |   |   |   |
| <b>CITROËN  ZX 1.8</b>      |   |   |  |  |   |   |   |   |   |   |   |
|                             | XU7JP   | 07/92 → 10/97   |  | VKMA 03201<br>VKM 13100  | 1<br>1  | 1   |   |   |   |   | T0018   |
|                             | XU7JP   | 07/92 → 10/97   |  | VKPC 83615   |   |   |   | 1   |   |   |   |
|                             | <b>B(Alt)</b> XU7JP   | 07/92 → 10/97   |    | VKMOV 6PK698   |   | 1   |   |   |   |   |   |
|   | <b>B(Alt)</b> XU7JP   | 07/92 → 10/97   |    | VKMOV 6PK1094<br>VKM 33003   | 1   | 1   |   |   |   |   |   |
|   | <b>B(Alt)</b> XU7JP   | 07/92 → 10/97   |  70, 80A,   | VKMOV 6PK1067<br>VKM 33003   | 1   | 1   |   |   |   |   |   |
|   | <b>B(Alt)</b> XU7JP   | 07/92 → 10/97   |  90A,       | VKMA 33003<br>VKMOV 6PK1076<br>VKM 33003   | 1<br>1<br>1   | 1<br>1  |   |   |   |   |   |
|   | <b>B(Alt)</b> XU7JP   | 07/92 → 10/97   |    | VKMA 33030<br>VKMOV 6PK1660<br>VKM 33028<br>VKM 33034                              | 1<br>1<br>1<br>1  | 1<br>1  | 1<br>1  |   |   |   |   |
| <b>CITROËN  ZX 1.8 16V</b> |   |   |  |  |   |   |   |   |   |   |   |
|                             | XU7JP4  | 01/96 → 02/98   |  | VKMA 03214<br>VKM 13214<br>VKM 23214   | 1<br>1<br>1   | 1<br>1  | 1<br>1  |   |   |   | 2<br>1<br>1 T0142   |
|                             | XU7JP4  | 01/96 → 02/98   |  | VKPC 83635   |   |   |   | 1   |   |   |   |
|                             | <b>B(Alt)</b> XU7JP4  | 01/96 → 02/98   |   | VKMA 33003<br>VKMOV 6PK1076<br>VKM 33003   | 1<br>1<br>1   | 1<br>1  |   |   |   |   |   |
|   | <b>B(Alt)</b> XU7JP4  | 01/96 → 02/98   |  90A,    | VKMA 33032<br>VKMOV 6PK1660<br>VKM 33026<br>VKM 33028                              | 1<br>1<br>1<br>1  | 1<br>1  | 1<br>1  |   |   |   |   |
|   | <b>B(Alt)</b> XU7JP4  | 01/96 → 02/98   |  120A,   | VKMA 33033<br>VKMOV 6PK1660<br>VKM 33027<br>VKM 33028                              | 1<br>1<br>1<br>1  | 1<br>1  | 1<br>1  |   |   |   |   |
| <b>CITROËN  ZX 1.9</b>     |   |   |  |  |   |   |   |   |   |   |   |
|                             | XU9JA   | 03/91 → 01/92   |  | VKMA 03200<br>VKM 13200  | 1<br>1  | 1   |   |   |   |   | T0018   |
|   | XU9JA   | 01/92 → 06/97   |  | VKMA 03201<br>VKM 13100  | 1<br>1  | 1   |   |   |   |   | T0018   |
|                             | XU9JA   | 03/91 → 08/91   |  | VKPC 83401   |   |   |   | 1   |   |   |   |
|   | XU9JA   | 09/91 → 06/97   |  | VKPC 83615   |   |   |   | 1   |   |   |   |

|  |  |  |                     |  |  |  |  |  |  |  |  |  |
|--|---|---|--|--|---|---|---|---|---|---|---|---|
|                             | B(Alt) XU9JA  | 03/91 → 06/97   |                     | VKMV 4PK698  |   |   | 1   |   |   |   |   |   |
|  | B(Alt) XU9JA  | 03/91 → 06/97   |                     | VKMV 4PK954  |   |   | 1   |   |   |   |   |   |
|  | B(AC) XU9JA   | 03/91 → 06/97   |  | VKMA 33010<br>VKMV 4PK841<br>VKM 33010   | 1   |   | 1   |   |   |   |   |   |
| <b>CITROËN  ZX 2.0</b>      |   |   |  |  |   |   |   |   |   |   |   |   |
|                             | XU10J2  | 07/92 → 06/97   |  | VKMA 03201<br>VKM 13100  | 1<br>1  |   | 1   |   |   |   |   | T0018   |
|                             | XU10J2  | 07/92 → 06/97   |  | VKPC 83420   |   |   |   | 1   |   |   |   |   |
|                             | B(Alt) XU10J2   | 07/92 → 06/97   | 17),  70, 80A, AC   | VKMV 6PK1067<br>VKM 33003  | 1   |   | 1   |   |   |   |   |   |
|  | B(Alt) XU10J2   | 07/92 → 06/97   | 17),  90A, AC       | VKMA 33003<br>VKMV 6PK1076<br>VKM 33003  | 1<br>1  |   | 1<br>1  |   |   |   |   |   |
|  | B(Alt) XU10J2   | 07/92 → 06/97   | 18), AC  | VKMV 6PK1160<br>VKM 33022<br>VKM 33025   | 1   |   | 1   |   |   | 1   |   |   |
|  | B(Alt) XU10J2   | 07/92 → 06/97   | 17), AC,            | VKMA 33030<br>VKMV 6PK1660<br>VKM 33028<br>VKM 33034                               | 1<br>1  | 1   | 1<br>1  |   |   |   |   |   |
|  | B(Alt) XU10J2   | 07/92 → 06/97   | 18), AC  | VKMA 33034<br>VKMV 6PK1603<br>VKM 33028<br>VKM 33035                               | 1<br>1  | 1   | 1<br>1  |   |   |   |   |   |
| <b>CITROËN  ZX 2.0 16V</b> |   |   |  |  |   |   |   |   |   |   |   |   |
|                           | XU10J4  | 07/92 → 06/97   |  | VKMA 03211<br>VKM 13210<br>VKM 13211   | 2<br>1<br>1   |   | 1   |   |   |   |   | T0118   |
|  | XU10J4RS  | 05/96 → 06/97   |  | VKMA 03213<br>VKM 13202<br>VKM 23213   | 1<br>1  | 1   | 1   |   |   |   |   | T0142   |
|                           | XU10J4  | 07/92 → 06/97   |  | VKPC 83420   |   |   |   | 1   |   |   |   |   |
|  | XU10J4RS  | 05/96 → 06/97   |  | VKPC 83636   |   |   |   | 1   |   |   |   |   |
|                           | B(Alt) XU10J4, XU10J4RS   | 07/92 → 06/97   | 17),  70, 80A, AC | VKMV 6PK1067<br>VKM 33003  | 1   |   | 1   |   |   |   |   |   |
|  | B(Alt) XU10J4, XU10J4RS   | 07/92 → 06/97   | 17),  90A, AC     | VKMA 33003<br>VKMV 6PK1076<br>VKM 33003  | 1<br>1  |   | 1<br>1  |   |   |   |   |   |
|  | B(Alt) XU10J4, XU10J4RS   | 07/92 → 06/97   | 18), AC  | VKMV 6PK1160<br>VKM 33022<br>VKM 33025   | 1   |   | 1   |   |   | 1   |   |   |
|  | B(Alt) XU10J4, XU10J4RS   | 07/92 → 06/97   | 17), AC  | VKMA 33030<br>VKMV 6PK1660<br>VKM 33028<br>VKM 33034                               | 1<br>1  | 1   | 1<br>1  |   |   |   |   |   |
|  | B(Alt) XU10J4, XU10J4RS   | 07/92 → 06/97   | 18), AC  | VKMA 33034<br>VKMV 6PK1603<br>VKM 33028<br>VKM 33035                               | 1<br>1  | 1   | 1<br>1  |   |   |   |   |   |
| <b>CITROËN  ZX 1.8 D</b>  |   |   |  |  |   |   |   |   |   |   |   |   |
|                           | XUD7  | 06/93 → 10/93   |                   | VKMC 03240<br>VKMA 03240<br>VKM 13240<br>VKM 23240                                 | 1<br>1<br>1   | 1   | 1   | 1   | 1   |   |   | 2<br>2<br>2<br>2<br>T0017   |
|  | XUD7  | 01/94 → 10/97   |                   | VKMC 03241<br>VKMA 03241<br>VKM 13241<br>VKM 23241                                 | 1<br>1<br>1   | 1   | 1   | 1   | 1   |   |   | T0017   |
|  | XUD7  | 06/93 → 01/94   | 3)   | VKMS 03240<br>VKMA 03240<br>VKM 13240<br>VKM 23240                                 | 1<br>1<br>1   | 1   | 1   | 1   |   |   | 2<br>2  | T0017   |
|  | XUD7  | 01/94 → 10/97   | 3)   | VKMS 03241<br>VKMA 03241   | 1<br>1  | 1   | 1   | 1   |   |   | 2   | T0017   |











































CITROËN











































|  |  |  |    |  |  |  |  |  |  |  |  |  |
|--|---|---|---|--|---|---|---|---|---|---|---|---|
|  |   |   |   | VKM 13241<br>VKM 23241   | 1   | 1   |   |   |   |   |   |   |
|                              | XUD7  | 06/93 → 09/93   |   | VKPC 83424   |   |   |   | 1   |   |   |   |   |
|  | XUD7  | 10/93 → 10/97   |   | VKPC 83420   |   |   |   | 1   |   |   |   |   |
|                              | B(Alt) XUD7   | 06/93 → 10/97   | AC, ⊕   | VKMOV 6PK730   |   | 1   |   |   |   |   |   |   |
|  | B(Alt) XUD7   | 06/93 → 10/97   | AC, ⊕   | VKMOV 6PK1170<br>VKM 33002   | 1   | 1   |   |   |   |   |   |   |
|  | B(Alt) XUD7   | 06/93 → 03/96   | AC, ⊕   | VKMOV 6PK1146<br>VKM 33002   | 1   | 1   |   |   |   |   |   |   |
|  | B(Alt) XUD7   | 03/96 → 10/97   | AC, ⊕   | VKMA 33202<br>VKMOV 6PK1130<br>VKM 33002   | 1<br>1<br>1   | 1<br>1  |   |   |   |   |   |   |
|  | B(Alt) XUD7   | 06/93 → 01/95   | AC, ⊕   | VKMA 33048<br>VKMOV 6PK1700<br>VKM 33002<br>VKM 33040                              | 2<br>1<br>1   | 1<br>1  |   |   |   |   |   |   |
|  | B(Alt) XUD7   | 01/95 → 10/97   | AC, ⊕   | VKMOV 6PK1740<br>VKM 33013<br>VKM 33029<br>VKM 33311                               | 1<br>1  | 1   |   |   |   | 1   |   |   |
|                              | XUD7  | 06/93 → 10/97   |   | VKM 93302  |   |   |   |   |   | 1   |   |   |
| <b>CITROËN  ZX 1.9 D</b>    |   |   |   |  |   |   |   |   |   |   |   |   |
|                              | XUD9  | 03/91 → 10/93   |    | VKMC 03240<br>VKMA 03240<br>VKM 13240<br>VKM 23240                                 | 1<br>1<br>1   | 1<br>1<br>1   | 1<br>1  | 1   |   |   | 2<br>2  | T0017   |
|  | XUD9  | 01/94 → 10/97   |  | VKMC 03241<br>VKMA 03241<br>VKM 13241<br>VKM 23241                                 | 1<br>1<br>1   | 1<br>1<br>1   | 1   | 1   |   |   |   | T0017   |
|  | XUD9  | 03/91 → 01/94   | 3)  | VKMS 03240<br>VKMA 03240<br>VKM 13240<br>VKM 23240                                 | 1<br>1<br>1   | 1<br>1<br>1   | 1   |   |   | 2<br>2  | 2   | T0017   |
|  | XUD9  | 01/94 → 10/97   | 3)  | VKMS 03241<br>VKMA 03241<br>VKM 13241<br>VKM 23241                                 | 1<br>1<br>1   | 1<br>1<br>1   | 1   |   |   | 2   |   | T0017   |
|                            | XUD9  | 03/91 → 09/93   |   | VKPC 83424   |   |   |   | 1   |   |   |   |   |
|  | XUD9  | 10/93 → 10/97   |   | VKPC 83420   |   |   |   | 1   |   |   |   |   |
|                            | B(Alt) XUD9   | 03/91 → 10/97   | AC, ⊕   | VKMOV 6PK730   |   | 1   |   |   |   |   |   |   |
|  | B(Alt) XUD9   | 03/91 → 10/97   | AC, ⊕   | VKMOV 6PK1170<br>VKM 33002   | 1   | 1   |   |   |   |   |   |   |
|  | B(Alt) XUD9   | 03/91 → 02/93   | AC, ⊕   | VKMA 33202<br>VKMOV 6PK1130<br>VKM 33002   | 1<br>1  | 1<br>1  |   |   |   |   |   |   |
|  | B(Alt) XUD9   | 03/93 → 03/96   | AC, ⊕   | VKMOV 6PK1146<br>VKM 33002   | 1   | 1   |   |   |   |   |   |   |
|  | B(Alt) XUD9   | 03/96 → 10/97   | AC, ⊕   | VKMA 33202<br>VKMOV 6PK1130<br>VKM 33002   | 1<br>1  | 1<br>1  |   |   |   |   |   |   |
|  | B(Alt) XUD9   | 03/91 → 01/95   | AC, ⊕   | VKMA 33048<br>VKMOV 6PK1700<br>VKM 33002<br>VKM 33040                              | 2<br>1<br>1   | 1<br>1  |   |   |   |   |   |   |
|  | B(Alt) XUD9   | 01/95 → 10/97   | AC, ⊕   | VKMOV 6PK1740<br>VKM 33013<br>VKM 33029<br>VKM 33311                               | 1<br>1  | 1   |   |   |   | 1   |   |   |
|                            | XUD9  | 03/91 → 10/97   |   | VKM 93302  |   |   |   |   |   | 1   |   |   |
| <b>CITROËN  ZX 1.9 TD</b> |   |   |   |  |   |   |   |   |   |   |   |   |
|                            | XUD9TE  | 07/92 → 10/93   |  | VKMC 03240<br>VKMA 03240<br>VKM 13240<br>VKM 23240                                 | 1<br>1<br>1   | 1<br>1<br>1   | 1   | 1   |   |   | 2<br>2  | T0017   |

|  |  |  |    |  |  |  |  |  |  |  |  |
|--|---|---|---|--|---|---|---|---|---|---|---|
|  | XUD9TE  | 01/94 → 10/97   |    | VKMC 03241<br>VKMA 03241<br>VKM 13241<br>VKM 23241                                 | 1<br>1<br>1   | 1<br>1<br>1   | 1<br>1<br>1   | 1   |   |   | T0017   |
|  | XUD9TE  | 07/92 → 01/94   | 3)  | VKMS 03240<br>VKMA 03240<br>VKM 13240<br>VKM 23240                                 | 1<br>1<br>1   | 1<br>1<br>1   |   |   |   | 2<br>2  | T0017   |
|  | XUD9TE  | 01/94 → 10/97   | 3)  | VKMS 03241<br>VKMA 03241<br>VKM 13241<br>VKM 23241                                 | 1<br>1<br>1   | 1<br>1<br>1   |   |   |   | 2   | T0017   |
|                           | XUD9TE  | 07/92 → 09/93   |   | VKPC 83424   |   |   |   | 1   |   |   |   |
|  | XUD9TE  | 10/93 → 10/97   |   | VKPC 83420   |   |   |   | 1   |   |   |   |
|                           | B(Alt) XUD9TE   | 07/92 → 10/97   | AC, ⊗   | VKMV 6PK730  |   |   | 1   |   |   |   |   |
|  | B(Alt) XUD9TE   | 07/92 → 10/97   | AC, ⊗   | VKMV 6PK1170<br>VKM 33002  | 1   |   | 1   |   |   |   |   |
|  | B(Alt) XUD9TE   | 07/92 → 02/93   | AC, ⊗   | VKMA 33202<br>VKMV 6PK1130<br>VKM 33002  | 1<br>1  |   | 1<br>1  |   |   |   |   |
|  | B(Alt) XUD9TE   | 03/93 → 03/96   | AC, ⊗   | VKMV 6PK1146<br>VKM 33002  | 1   |   | 1   |   |   |   |   |
|  | B(Alt) XUD9TE   | 03/96 → 10/97   | AC, ⊗   | VKMA 33202<br>VKMV 6PK1130<br>VKM 33002  | 1<br>1  |   | 1<br>1  |   |   |   |   |
|  | B(Alt) XUD9TE   | 07/92 → 01/95   | AC, ⊗   | VKMA 33048<br>VKMV 6PK1700<br>VKM 33002<br>VKM 33040                               | 2<br>1<br>1   |   | 1<br>1  |   |   |   |   |
|  | B(Alt) XUD9TE   | 01/95 → 10/97   | AC, ⊗   | VKMV 6PK1739<br>VKM 33013<br>VKM 33029<br>VKM 33311<br>VKM 93302                   | 1<br>1  |   | 1   |   |   | 1   |   |
|                         | XUD9TE  | 07/92 → 10/97   |   | VKMA 93302   |   |   |   | 1   |   |   |   |
| <b>CITROËN  C15 1.0</b> |   |   |   |  |   |   |   |   |   |   |   |
|                         | TU9   | 05/88 → 12/97   |  | VKMC 03100<br>VKMA 03100<br>VKM 13100  | 1<br>1<br>1   |   | 1<br>1  | 1   |   |   | T0044   |
|  | XV8   | 10/84 → 05/88   |   | <del>OKOKOKO</del>   |   |   |   |   |   |   |   |
|  | TU9   | 05/88 → 12/97   | 3)  | VKMS 03100-2<br>VKMA 03100<br>VKM 13100  | 1<br>1<br>1   |   | 1<br>1  |   |   | 2   | T0044   |
|                         | TU9   | 05/88 → 12/97   |   | VKPC 83205   |   |   |   | 1   |   |   |   |
|  | XV8   | 10/84 → 05/88   | 2)  | VKPA 83200<br>VKPC 83200   |   |   |   | 1<br>1  |   |   |   |
|                         | B(Alt) TU9, XV8   | 10/84 → 09/87   |   | VKMV 10AVx910  |   |   | 1   |   |   |   |   |
|  | B(Alt) TU9, XV8   | 10/87 → 12/97   |   | VKMV 10AVx710  |   |   | 1   |   |   |   |   |
| <b>CITROËN  C15 1.1</b> |   |   |   |  |   |   |   |   |   |   |   |
|                         | TU1   | 05/88 → 12/96   |  | VKMC 03100<br>VKMA 03100<br>VKM 13100  | 1<br>1<br>1   |   | 1<br>1  | 1   |   |   | T0044   |
|  | XW7   | 10/84 → 05/88   |   | <del>OKOKOKO</del>   |   |   |   |   |   |   |   |
|  | TU1   | 05/88 → 12/96   | 3)  | VKMS 03100-2<br>VKMA 03100<br>VKM 13100  | 1<br>1<br>1   |   | 1<br>1  |   |   | 2   | T0044   |
|                         | TU1   | 05/88 → 12/96   |   | VKPC 83205   |   |   |   | 1   |   |   |   |
|  | XW  | 10/84 → 05/88   | 2)  | VKPA 83200<br>VKPC 83200   |   |   |   | 1<br>1  |   |   |   |
|                         | B(Alt) XW7  | 10/84 → 09/87   |   | VKMV 10AVx910  |   |   | 1   |   |   |   |   |
|  | B(Alt) XW7  | 10/87 → 12/96   |   | VKMV 10AVx710  |   |   | 1   |   |   |   |   |
| <b>CITROËN  C15 1.3</b> |   |   |   |  |   |   |   |   |   |   |   |
|                         | G1A   | 07/87 → 05/88   |   | <del>OKOKOKO</del>   |   |   |   |   |   |   |   |
|                         | G1A   | 07/87 → 05/88   |   | VKPC 83206   |   |   |   | 1   |   |   |   |
| <b>CITROËN  C15 1.4</b> |   |   |   |  |   |   |   |   |   |   |   |
|                         | XY7   | 05/87 → 05/88   |   | <del>OKOKOKO</del>   |   |   |   |   |   |   |   |



CITROËN







































|  |  |  |                     |  |  |  |  |  |  |  |  |
|--|---|---|--|--|---|---|---|---|---|---|---|
|  | TU3   | 07/87 → 12/96   | Mot. Cast.,  101    | VKMA 03111<br>VKM 13100  | 1<br>1  | 1   |   |   |   |   | T0044   |
|  | TU3   | 05/88 → 12/96   | 3), Mot. Alu.,  108 | VKMS 03110-2<br>VKMA 03110<br>VKM 13100  | 1<br>1<br>1   | 1<br>1  |   |   | 2   |   | T0044   |
|                              | TU3   | 07/87 → 12/96   |  | VKPC 83205   |   |   |   | 1   |   |   |   |
|  | XY7   | 05/87 → 05/88   | 2)   | VKPA 83200<br>VKPC 83200   |   |   |   | 1<br>1  |   |   |   |
|                              | B(Alt) TU3, XY7   | 05/87 → 09/87   |  | VKMOV 10AVx910   |   | 1   |   |   |   |   |   |
|  | B(Alt) TU3, XY7   | 10/87 → 12/96   |  | VKMOV 10AVx710   |   | 1   |   |   |   |   |   |
| <b>CITROËN  C15 1.8 D</b>   |   |   |  |  |   |   |   |   |   |   |   |
|                              | XUD7  | 09/86 → 01/94   |                     | VKMC 03240<br>VKMA 03240<br>VKM 13240<br>VKM 23240                                 | 1<br>1<br>1<br>1  | 1<br>1  | 1<br>1  | 1   |   | 2<br>2  | T0017   |
|  | XUD7  | 01/94 → 12/00   |                     | VKMC 03241<br>VKMA 03241<br>VKM 13241<br>VKM 23241                                 | 1<br>1<br>1<br>1  | 1<br>1  | 1<br>1  | 1   |   |   | T0017   |
|  | XUD7  | 07/86 → 01/94   | 3)   | VKMS 03240<br>VKMA 03240<br>VKM 13240<br>VKM 23240                                 | 1<br>1<br>1<br>1  | 1<br>1  | 1<br>1  |   | 2<br>2  | 2<br>2  | T0017   |
|  | XUD7  | 01/94 → 12/00   | 3)   | VKMS 03241<br>VKMA 03241<br>VKM 13241<br>VKM 23241                                 | 1<br>1<br>1<br>1  | 1<br>1  | 1<br>1  |   | 2   |   | T0017   |
|                             | XUD7  | 07/86 → 09/86   |  | VKPC 83401   |   |   |   | 1   |   |   |   |
|  | XUD7  | 09/86 → 01/94   |  | VKPC 83424   |   |   |   | 1   |   |   |   |
|  | XUD7  | 01/94 → 12/00   |  | VKPC 83420   |   |   |   | 1   |   |   |   |
|                            | B(Alt) XUD7   | 07/86 → 12/00   |  | VKMOV 4PK698   |   | 1   |   |   |   |   |   |
|                            | XUD7  | 07/86 → 12/00   |  | —  |   |   |   | 1   |   |   |   |
| <b>CITROËN  C15 1.9 D</b> |   |   |  |  |   |   |   |   |   |   |   |
|                            | DW8B  | 12/00 → 08/05   |                   | VKMC 03244<br>VKMA 03244<br>VKM 13244<br>VKM 23246                                 | 1<br>1<br>1<br>1  | 1<br>1  | 1<br>1  | 1   |   | 1<br>1<br>1   | T0167   |
|                            | DW8B  | 12/00 → 10/07   |  | VKPC 83639   |   |   |   | 1   |   |   |   |
|                            | B(Alt) DW8B   | 12/00 → 05/04   |  | VKMOV 6PK747<br>VKM 33073  | 1   |   | 1   |   |   |   |   |
| <b>CITROËN  C25 1.8</b>   |   |   |  |  |   |   |   |   |   |   |   |
|                            | XM7T  | 07/87 → 02/94   |  | <del>VKMA 03111</del><br><del>VKM 13100</del>                                      |   |   |   |   |   |   |   |
|                            | XM7T  | 07/87 → 02/94   |  | VKPC 83630   |   |   |   | 1   |   |   |   |
|                            | B(Alt) XM7T   | 11/81 → 02/94   |  | VKMOV 10AVx925   |   | 1   |   |   |   |   |   |
|  | B(WP) XM7T  | 11/81 → 02/94   |  | VKMOV 10AVx888   |   | 1   |   |   |   |   |   |
| <b>CITROËN  C25 2.0</b>   |   |   |  |  |   |   |   |   |   |   |   |
|                            | XN1T  | 09/81 → 03/94   |  | <del>VKMA 03111</del><br><del>VKM 13100</del>                                      |   |   |   |   |   |   |   |
|                            | XN1T  | 09/81 → 03/94   |  | VKPC 83630   |   |   |   | 1   |   |   |   |
|                            | B(Alt) XN1T   | 09/81 → 03/94   |  | VKMOV 10AVx925   |   | 1   |   |   |   |   |   |
|  | B(WP) XN1T  | 09/81 → 03/94   |  | VKMOV 10AVx888   |   | 1   |   |   |   |   |   |
| <b>CITROËN  C25 1.9 D</b> |   |   |  |  |   |   |   |   |   |   |   |
|                            | XUD9A/U   | 07/87 → 02/94   |                   | VKMC 03240<br>VKMA 03240<br>VKM 13240<br>VKM 23240                                 | 1<br>1<br>1<br>1  | 1<br>1  | 1<br>1  | 1   |   | 2<br>2  | T0017   |
|  | XUD9A/U   | 07/87 → 02/94   | 3)   | VKMS 03240<br>VKMA 03240<br>VKM 13240<br>VKM 23240                                 | 1<br>1<br>1<br>1  | 1<br>1  | 1<br>1  |   | 2<br>2  | 2<br>2  | T0017   |
|                            | XUD9A/U   | 07/87 → 02/94   |  | VKPC 83424   |   |   |   | 1   |   |   |   |
|                            | B(Alt) XUD9A/U  | 07/87 → 02/94   |  | VKMOV 4PK795   |   | 1   |   |   |   |   |   |
|  | B(VP) XUD9A/U   | 07/87 → 02/94   |  | VKMOV 10AVx625   |   | 1   |   |   |   |   |   |
|                            | XUD9A/U   | 07/87 → 02/94   |  | —  |   |   |   | 1   |   |   |   |

|  |  |  |             |  |  |  |  |  |  |  |       |
|--|---|---|--|--|---|---|---|---|---|---|-------|
| <b>CITROËN  C25 1.9 TD</b>            |   |   |  |  |   |   |   |   |   |   |       |
|                                       | M705  | 04/92 → 02/94   |  | VKMA 02169<br>VKM 12153<br>VKM 22153   | 1<br>1  | 1   |   |   |   |   | T0086 |
|                                       | <b>B(Alt)</b> M705  | 04/92 → 02/94   |  | VKMV 4PK795  |   | 1   |   |   |   |   |       |
| <b>CITROËN  C25 2.5 D</b>             |   |   |  |  |   |   |   |   |   |   |       |
|                                       | U25-661   | 10/85 → 02/94   |  | VKMA 03050<br>VKM 12200<br>VKM 13050   | 2<br>1<br>1   |   | 2   |   |   |   | T0021 |
|                                       | U25-661   | 10/85 → 02/94   |  | VKPC 83617   |   |   |   | 1   |   |   |       |
|                                       | <b>B(Alt)</b> U25-661   | 10/85 → 02/94   |  | VKMV 10AVx700  |   | 1   |   |   |   |   |       |
|  | <b>B(PS)</b> U25-661  | 10/85 → 02/94   |  | VKMV 10AVx800  |   | 1   |   |   |   |   |       |
|  | <b>B(VP)</b> U25-661  | 10/85 → 02/94   |  | VKMV 10AVx600  |   | 1   |   |   |   |   |       |
| <b>CITROËN  C25 2.5 TD</b>            |   |   |  |  |   |   |   |   |   |   |       |
|                                       | U25-673   | 08/87 → 02/94   |  | VKMA 03050<br>VKM 12200<br>VKM 13050   | 2<br>1<br>1   |   | 2   |   |   |   | T0021 |
|                                       | U25-673   | 08/87 → 02/94   |  | VKPC 83617   |   |   |   | 1   |   |   |       |
|                                       | <b>B(Alt)</b> U25-673   | 08/87 → 02/94   |  | VKMV 10AVx700  |   | 1   |   |   |   |   |       |
|  | <b>B(PS)</b> U25-673  | 08/87 → 02/94   |  | VKMV 10AVx800  |   | 1   |   |   |   |   |       |
|  | <b>B(VP)</b> U25-673  | 08/87 → 02/94   |  | VKMV 10AVx600  |   | 1   |   |   |   |   |       |
| <b>CITROËN  JUMPER (230) 2.0</b>      |   |   |  |  |   |   |   |   |   |   |       |
|                                       | XU10J2, XU10J2U   | 02/94 → 04/02   |  | VKMA 03202<br>VKM 13202  | 1<br>1  | 1   |   |   |   |   | T0119 |
|                                     | XU10J2  | 02/94 → 04/02   |  | VKPC 83420   |   |   |   | 1   |   |   |       |
|                                     | <b>B(Alt)</b> XU10J2, XU10J2U   | 02/94 → 04/02   | <b>AC</b>  | VKMV 6PK698  |   | 1   |   |   |   |   |       |
|  | <b>B(Alt)</b> XU10J2, XU10J2U   | 02/94 → 04/02   | <b>AC</b>  | VKMV 6PK1094<br>VKM 33003  | 1   | 1   |   |   |   |   |       |
| <b>CITROËN  JUMPER (230) 1.9 D</b>  |   |   |  |  |   |   |   |   |   |   |       |
|                                     | XUD9  | 02/94 → 04/02   |           | VKMC 03241<br>VKMA 03241<br>VKM 13241<br>VKM 23241                                 | 1<br>1<br>1   | 1   |   | 1   |   |   | T0017 |
|  | XUD9  | 02/94 → 04/02   | 3)   | VKMS 03241<br>VKMA 03241<br>VKM 13241<br>VKM 23241                                 | 1<br>1<br>1   | 1   |   |   | 2   |   | T0017 |
|                                     | XUD9  | 02/94 → 04/02   |  | VKPC 83420   |   |   |   | 1   |   |   |       |
|                                     | <b>B(Alt)</b> XUD9  | 02/94 → 04/02   | <b>AC</b>  | VKMV 6PK730  |   | 1   |   |   |   |   |       |
|  | <b>B(Alt)</b> XUD9  | 02/94 → 04/02   |  120A, AC | VKMV 6PK1155<br>VKM 33002  | 1   | 1   |   |   |   |   |       |
|  | <b>B(Alt)</b> XUD9  | 02/94 → 04/02   |  80A, AC  | VKMA 33002<br>VKMV 6PK1151<br>VKM 33002  | 1<br>1  | 1   |   |   |   |   |       |
|                                     | XUD9  | 02/94 → 04/02   |           | VKM 93302  |   |   |   | 1   |   |   |       |
| <b>CITROËN  JUMPER (230) 1.9 TD</b> |   |   |  |  |   |   |   |   |   |   |       |
|                                     | XUD9TE  | 02/94 → 04/02   |           | VKMC 03241<br>VKMA 03241<br>VKM 13241<br>VKM 23241                                 | 1<br>1<br>1   | 1   |   | 1   |   |   | T0017 |
|  | XUD9TE  | 02/94 → 04/02   | 3)   | VKMS 03241<br>VKMA 03241<br>VKM 13241<br>VKM 23241                                 | 1<br>1<br>1   | 1   |   |   | 2   |   | T0017 |
|                                     | XUD9TE  | 02/94 → 04/02   |  | VKPC 83420   |   |   |   | 1   |   |   |       |
|                                     | <b>B(Alt)</b> XUD9TE  | 02/94 → 04/02   | <b>AC</b>  | VKMV 6PK730  |   | 1   |   |   |   |   |       |
|  | <b>B(Alt)</b> XUD9TE  | 02/94 → 04/02   |  120A, AC | VKMV 6PK1155<br>VKM 33002  | 1   | 1   |   |   |   |   |       |
|  | <b>B(Alt)</b> XUD9TE  | 02/94 → 04/02   |  80A, AC  | VKMA 33002<br>VKMV 6PK1151<br>VKM 33002  | 1<br>1  | 1   |   |   |   |   |       |
|                                     | XUD9TE  | 02/94 → 04/02   |           | VKM 93302  |   |   |   | 1   |   |   |       |





CITROËN



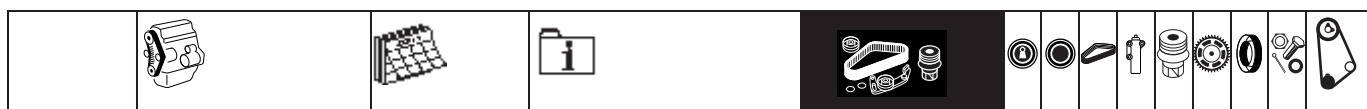

|   |  |  |    |  |  |  |  |  |  |  |  |  |
|---|---|---|---|--|---|---|---|---|---|---|---|---|
| <b>CITROËN  JUMPER (230) 2.0 HDi</b>   |   |   |   |  |   |   |   |   |   |   |   |   |
|   | DW10TD  | 11/01 → 04/02   |    | VKMC 03246   | 1   | 1   | 1   |   | 1   |   |   | 1   |
|   |   |   |   | VKMA 03246   | 1   | 1   | 1   |   |   |   |   | 1   |
|   |   |   |   | VKM 13246  | 1   |   |   |   |   |   |   | 1   |
|   |   |   |   | VKM 23246  |   | 1   |   |   |   |   |   | 1   |
|   | DW10TD  | 11/01 → 04/02   | 3)  | VKMS 03246   | 1   | 1   | 1   |   |   | 2   |   | 1   |
|   |   |   |   | VKMA 03246   | 1   | 1   | 1   |   |   |   |   | 1   |
|   |   |   |   | VKM 13246  | 1   |   |   |   |   |   |   | 1   |
|   |   |   |   | VKM 23246  |   | 1   |   |   |   |   |   | 1   |
|   | DW10TD  | 11/01 → 04/02   |   | VKPC 83639   |   |   |   |   | 1   |   |   |   |
|   | B(Alt) DW10TD   | 11/01 → 04/02   |    | VKMOV 6PK1468  |   |   | 1   |   |   |   |   |   |
|   |   |   |   | VKM 33024  | 1   |   |   |   |   |   |   |   |
|   |   |   |   | VKM 33033  | 1   |   |   |   |   |   |   |   |
|   |   |   |   | VKM 33314  |   | 1   |   |   |   |   |   |   |
|   | B(Alt) DW10TD   | 11/01 → 04/02   | AC  | VKMOV 6PK1182  | 1   |   | 1   |   |   |   |   |   |
|   |   |   |   | VKM 33032  |   | 1   |   |   |   |   |   |   |
|   |   |   |   | VKM 33314  |   |   |   |   |   |   |   |   |
|   | B(PS) DW10TD  | 11/01 → 04/02   |   | VKMOV 4PK755   |   |   | 1   |   |   |   |   |   |
|   | DW10TD  | 11/01 → 04/02   |    | VKM 93301  |   |   |   |   | 1   |   |   |   |
| <b>CITROËN  JUMPER (230) 2.5 D</b>     |   |   |   |  |   |   |   |   |   |   |   |   |
|   | DJ5   | 03/94 → 04/02   | 3)  | VKMS 03300   | 1   | 1   | 1   |   |   | 2   |   |   |
|   |   |   |   | VKMA 03300   | 1   | 1   | 1   |   |   |   |   |   |
|   |   |   |   | VKM 13300  | 1   |   |   |   |   |   |   |   |
|   |   |   |   | VKM 23300  |   | 1   |   |   |   |   |   |   |
|   | DJ5   | 03/94 → 05/96   |   | VKPC 83810   |   |   |   |   | 1   |   |   |   |
|   | DJ5   | 05/96 → 04/02   |   | VKPC 83811   |   |   |   |   | 1   |   |   |   |
|                                       | B(Alt) DJ5  | 03/94 → 04/02   |  | VKMOV 6PK802   |   |   | 1   |   |   |   |   |   |
|   | B(Alt) DJ5  | 03/94 → 04/02   |  | VKMOV 6PK1012  |   |   | 1   |   |   |   |   |   |
|   |   |   |   | VKM 33015  |   | 1   |   |   |   |   |   |   |
|   | B(AC) DJ5   | 03/94 → 04/02   |   | VKMOV 6PK915   |   |   | 1   |   |   |   |   |   |
|   |   |   |   | VKM 33014  |   | 1   |   |   |   |   |   |   |
|   | B(WP) DJ5   | 03/94 → 05/96   |   | VKMOV 4PK866   |   |   | 1   |   |   |   |   |   |
|   |   |   |   | VKM 33016  | 1   |   |   |   |   |   |   |   |
|   | B(WP) DJ5   | 05/96 → 04/02   |   | VKMOV 3PK866   |   |   | 1   |   |   |   |   |   |
|   |   |   |   | VKM 33016  | 1   |   |   |   |   |   |   |   |
| <b>CITROËN  JUMPER (230) 2.5 TD</b>  |   |   |   |  |   |   |   |   |   |   |   |   |
|                                       | DJ5T  | 03/94 → 04/02   | 3)  | VKMS 03300   | 1   | 1   | 1   |   |   | 2   |   |   |
|   |   |   |   | VKMA 03300   | 1   | 1   | 1   |   |   |   |   |   |
|   |   |   |   | VKM 13300  | 1   |   |   |   |   |   |   |   |
|   |   |   |   | VKM 23300  |   | 1   |   |   |   |   |   |   |
|                                       | DJ5T  | 03/94 → 05/96   |   | VKPC 83810   |   |   |   |   | 1   |   |   |   |
|   | DJ5T  | 05/96 → 04/02   |   | VKPC 83811   |   |   |   |   | 1   |   |   |   |
|                                       | B(Alt) DJ5T   | 03/94 → 04/02   |  | VKMOV 6PK802   |   |   | 1   |   |   |   |   |   |
|   | B(Alt) DJ5T   | 03/94 → 04/02   |  | VKMOV 6PK1012  |   |   | 1   |   |   |   |   |   |
|   |   |   |   | VKM 33015  |   | 1   |   |   |   |   |   |   |
|   | B(AC) DJ5T  | 03/94 → 04/02   |   | VKMOV 6PK915   |   |   | 1   |   |   |   |   |   |
|   |   |   |   | VKM 33014  |   | 1   |   |   |   |   |   |   |
|   | B(WP) DJ5T  | 03/94 → 05/96   |   | VKMOV 4PK946   |   |   | 1   |   |   |   |   |   |
|   |   |   |   | VKM 33016  | 1   |   |   |   |   |   |   |   |
|   | B(WP) DJ5T  | 05/96 → 04/02   |   | VKMOV 3PK946   |   |   | 1   |   |   |   |   |   |
|   |   |   |   | VKM 33016  | 1   |   |   |   |   |   |   |   |
| <b>CITROËN  JUMPER (230) 2.5 TDi</b> |   |   |   |  |   |   |   |   |   |   |   |   |
|                                       | DJ5TED  | 12/96 → 04/02   |   | VKMA 03304   | 1   | 1   | 1   |   |   |   |   |   |
|   |   |   |   | VKM 13304  | 1   |   |   |   |   |   |   |   |
|   |   |   |   | VKM 23304  |   | 1   |   |   |   |   |   |   |
|                                       | DJ5TED  | 12/96 → 04/02   |   | VKPC 83811   |   |   |   |   | 1   |   |   |   |
|                                       | B(Alt) DJ5TED   | 12/96 → 04/02   |  | VKMOV 6PK802   |   |   | 1   |   |   |   |   |   |
|   | B(Alt) DJ5TED   | 12/96 → 04/02   |  | VKMOV 6PK1012  |   |   | 1   |   |   |   |   |   |
|   |   |   |   | VKM 33015  |   | 1   |   |   |   |   |   |   |
|   | B(AC) DJ5TED  | 12/96 → 04/02   |   | VKMOV 6PK915   |   |   | 1   |   |   |   |   |   |
|   |   |   |   | VKM 33041  | 1   |   |   |   |   |   |   |   |
|   | B(WP) DJ5TED  | 12/96 → 04/02   |   | VKMOV 3PK946   |   |   | 1   |   |   |   |   |   |
|   |   |   |   | VKM 33125  | 1   |   |   |   |   |   |   |   |







**CITROËN  JUMPER (230) 2.8 HDi**

|   |                |               |   |            |  |   |   |   |  |   |  |  |  |  |  |  |       |
|---|----------------|---------------|---|------------|--|---|---|---|--|---|--|--|--|--|--|--|-------|
|  | Sofim 2800 HDi | 09/00 → 04/02 |  | VKMA 02983 |  | 2 | 1 | 1 |  |   |  |  |  |  |  |  | T0096 |
|   |                |               |   | VKM 22380  |  | 1 |   | 1 |  |   |  |  |  |  |  |  |       |
|   |                |               |   | VKM 22385  |  | 1 |   |   |  |   |  |  |  |  |  |  |       |
|   | Sofim 2800 HDi | 09/00 → 04/02 |   | VKMA 02383 |  | 2 | 1 |   |  |   |  |  |  |  |  |  | T0652 |
|   |                |               |   | VKM 22380  |  | 1 |   |   |  |   |  |  |  |  |  |  |       |
|   |                |               |   | VKM 22385  |  | 1 |   |   |  |   |  |  |  |  |  |  |       |
|  | Sofim 2800 HDi | 09/00 → 04/02 |   | VKPC 82652 |  |   |   |   |  | 1 |  |  |  |  |  |  |       |



**CITROËN  JUMPER (244) 2.0**

|   |               |               |           |              |   |  |   |  |  |   |  |  |  |  |  |  |       |
|---|---------------|---------------|-----------|--------------|---|--|---|--|--|---|--|--|--|--|--|--|-------|
|  | XU10J2        | 04/02 → 11/07 |           | VKMA 03202   | 1 |  | 1 |  |  |   |  |  |  |  |  |  | T0119 |
|   |               |               |           | VKM 13202    | 1 |  |   |  |  |   |  |  |  |  |  |  |       |
|  | XU10J2        | 04/02 → 10/07 |           | VKPC 83420   |   |  |   |  |  | 1 |  |  |  |  |  |  |       |
|  | B(Alt) XU10J2 | 04/02 → 11/07 | <i>AC</i> | VKMV 6PK698  |   |  | 1 |  |  |   |  |  |  |  |  |  |       |
|   | B(Alt) XU10J2 | 04/02 → 11/07 | <b>AC</b> | VKMV 6PK1094 |   |  | 1 |  |  |   |  |  |  |  |  |  |       |
|   |               |               |           | VKM 33003    | 1 |  |   |  |  |   |  |  |  |  |  |  |       |























**CITROËN  JUMPER (244) 2.0 HDi**

|   |               |               |   |              |   |   |   |  |   |   |  |   |   |  |  |   |       |
|---|---------------|---------------|---|--------------|---|---|---|--|---|---|--|---|---|--|--|---|-------|
|    | DW10TD        | 04/02 → 11/07 |  | VKMC 03246   | 1 | 1 | 1 |  | 1 |   |  |   |   |  |  |   | 1     |
|   |               |               |   | VKMA 03246   | 1 | 1 | 1 |  |   |   |  |   |   |  |  |   | 1     |
|   |               |               |   | VKM 13246    | 1 |   |   |  |   |   |  |   |   |  |  |   | 1     |
|   |               |               |   | VKM 23246    |   | 1 |   |  |   |   |  |   |   |  |  |   |       |
|   | DW10TD        | 04/02 → 11/07 | 3)  | VKMS 03246   | 1 | 1 | 1 |  |   |   |  |   | 2 |  |  | 1 |       |
|   |               |               |   | VKMA 03246   | 1 | 1 | 1 |  |   |   |  |   |   |  |  | 1 | T0168 |
|   |               |               |   | VKM 13246    | 1 |   |   |  |   |   |  |   |   |  |  | 1 |       |
|   |               |               |   | VKM 23246    |   | 1 |   |  |   |   |  |   |   |  |  |   |       |
|   | DW10TD        | 04/02 → 10/07 |   | VKPC 83639   |   |   |   |  |   | 1 |  |   |   |  |  |   |       |
|  | B(Alt) DW10TD | 04/02 → 05/04 | <i>AC</i>   | VKMV 6PK1468 |   |   | 1 |  |   |   |  |   |   |  |  |   |       |
|   |               |               |   | VKM 33024    | 1 |   |   |  |   |   |  |   |   |  |  |   |       |
|   |               |               |   | VKM 33033    | 1 |   |   |  |   |   |  |   |   |  |  |   |       |
|   |               |               |   | VKM 33314    |   | 1 |   |  |   |   |  |   |   |  |  |   |       |
|   | B(Alt) DW10TD | 05/04 → 11/07 | <i>AC</i>   | VKMA 33068   | 1 |   | 1 |  |   |   |  |   |   |  |  |   |       |
|   |               |               |   | VKMV 6PK872  |   |   | 1 |  |   |   |  |   |   |  |  |   |       |
|   |               |               |   | VKM 33032    | 1 |   |   |  |   |   |  |   |   |  |  |   |       |
|   | B(Alt) DW10TD | 04/02 → 05/04 | <b>AC</b>   | VKMV 6PK1182 |   |   | 1 |  |   |   |  |   |   |  |  |   |       |
|   |               |               |   | VKM 33024    | 1 |   |   |  |   |   |  |   |   |  |  |   |       |
|   |               |               |   | VKM 33032    | 1 |   |   |  |   |   |  |   |   |  |  |   |       |
|   |               |               |   | VKM 33314    |   | 1 |   |  |   |   |  |   |   |  |  |   |       |
|   | B(Alt) DW10TD | 05/04 → 11/07 | <b>AC</b>   | VKMV 6PK1182 |   |   | 1 |  |   |   |  |   |   |  |  |   |       |
|   |               |               |   | VKM 33032    | 1 |   |   |  |   |   |  |   |   |  |  |   |       |
|   |               |               |   | VKM 33314    |   | 1 |   |  |   |   |  |   |   |  |  |   |       |
|   | B(PS) DW10TD  | 04/02 → 11/07 |   | VKMV 4PK755  |   |   | 1 |  |   |   |  |   |   |  |  |   |       |
|  | DW10TD        | 04/02 → 04/04 | <i>AC</i>   | VKM 93301    |   |   |   |  |   |   |  | 1 |   |  |  |   |       |

**CITROËN  JUMPER (244) 2.2 HDi**

|   |                |               |           |              |   |   |   |  |  |   |  |  |  |  |  |  |       |
|---|----------------|---------------|-----------|--------------|---|---|---|--|--|---|--|--|--|--|--|--|-------|
|  | DW12TED        | 04/02 → 04/04 |           | VKMA 03255   | 1 | 1 | 1 |  |  |   |  |  |  |  |  |  | 1     |
|   |                |               |           | VKM 13246    | 1 |   |   |  |  |   |  |  |  |  |  |  | 1     |
|   |                |               |           | VKM 23246    |   | 1 |   |  |  |   |  |  |  |  |  |  |       |
|   | DW12TED        | 04/04 → 11/07 |           | VKMA 03266   | 1 | 1 | 1 |  |  |   |  |  |  |  |  |  | T0198 |
|   |                |               |           | VKM 13264    | 1 |   |   |  |  |   |  |  |  |  |  |  |       |
|   |                |               |           | VKM 23264    |   | 1 |   |  |  |   |  |  |  |  |  |  |       |
|  | DW12TED        | 04/02 → 10/07 |           | VKPC 83643   |   |   |   |  |  | 1 |  |  |  |  |  |  |       |
|  | B(Alt) DW12TED | 04/02 → 05/04 | <i>AC</i> | VKMV 6PK1468 |   |   | 1 |  |  |   |  |  |  |  |  |  |       |
|   |                |               |           | VKM 33024    | 1 |   |   |  |  |   |  |  |  |  |  |  |       |
|   |                |               |           | VKM 33033    | 1 |   |   |  |  |   |  |  |  |  |  |  |       |
|   |                |               |           | VKM 33314    |   | 1 |   |  |  |   |  |  |  |  |  |  |       |
|   | B(Alt) DW12TED | 05/04 → 11/07 | <i>AC</i> | VKMA 33068   | 1 |   | 1 |  |  |   |  |  |  |  |  |  |       |
|   |                |               |           | VKMV 6PK872  |   |   | 1 |  |  |   |  |  |  |  |  |  |       |
|   |                |               |           | VKM 33032    | 1 |   |   |  |  |   |  |  |  |  |  |  |       |
|   | B(Alt) DW12TED | 04/02 → 05/04 | <b>AC</b> | VKMV 6PK1182 |   |   | 1 |  |  |   |  |  |  |  |  |  |       |
|   |                |               |           | VKM 33024    | 1 |   |   |  |  |   |  |  |  |  |  |  |       |
|   |                |               |           | VKM 33032    | 1 |   |   |  |  |   |  |  |  |  |  |  |       |
|   |                |               |           | VKM 33314    |   | 1 |   |  |  |   |  |  |  |  |  |  |       |
|   | B(Alt) DW12TED | 05/04 → 11/07 | <b>AC</b> | VKMV 6PK1182 |   |   | 1 |  |  |   |  |  |  |  |  |  |       |
|   |                |               |           | VKM 33032    | 1 |   |   |  |  |   |  |  |  |  |  |  |       |
|   |                |               |           | VKM 33314    |   | 1 |   |  |  |   |  |  |  |  |  |  |       |







































|   |  |  |    |  |  |  |  |  |  |  |  |  |  |
|---|---|---|---|--|---|---|---|---|---|---|---|---|---|
| B(PS)   | DW12TED   | 04/02 → 11/07   |   | VKMOV 4PK755   |   | 1   |   |   |   |   |   |   |   |
|   | DW12TED   | 04/02 → 11/07   | AC  | VKM 93301  |   |   |   | 1   |   |   |   |   |   |
| <b>CITROËN  JUMPER (244) 2.8 HDi</b> |   |   |   |  |   |   |   |   |   |   |   |   |   |
|   | Sofim 2800 HDi  | 04/02 → 11/07   |    | VKMA 02983   |   | 2   | 1   | 1   |   |   |   |   | T0096   |
|   |   |   |   | VKM 22380  |   | 1   |   | 1   |   |   |   |   |   |
|   |   |   |   | VKM 22385  |   | 1   |   |   |   |   |   |   |   |
|   | Sofim 2800 HDi  | 04/02 → 11/07   |   | VKMA 02383   |   | 2   | 1   |   |   |   |   |   | T0652   |
|   |   |   |   | VKM 22380  |   | 1   |   |   |   |   |   |   |   |
|   |   |   |   | VKM 22385  |   | 1   |   |   |   |   |   |   |   |
|   | Sofim 2800 HDi  | 04/02 → 10/07   |   | VKPC 82652   |   |   |   |   | 1   |   |   |   |   |
| <b>CITROËN  JUMPER 2.2 HDi</b>       |   |   |   |  |   |   |   |   |   |   |   |   |   |
|   | 22DT  | 04/06 → 11/07   |   | <del>VKMA 02383</del>  |   |   |   |   |   |   |   |   |   |
|   | 22DT  | 04/06 → 10/07   | 2)  | VKPA _____   |   |   |   |   | 1   |   |   |   |   |
| B(Alt)  | 22DT  | 04/06 → 11/07   | AC  | VKMOV 6PK1670  |   |   |   | 1   |   |   |   |   |   |
|   |   |   |   | VKM 34030  |   | 1   |   |   |   |   |   |   |   |
|   |   |   |   | VKM _____  |   |   |   | 1   |   |   |   |   |   |
|   |   |   |   | VKM _____  |   |   |   | 1   |   |   |   |   |   |
| <b>CITROËN  JUMPER 3.0 HDi 160</b>   |   |   |   |  |   |   |   |   |   |   |   |   |   |
|   |   | 09/06 → 11/07   |   | <del>VKMA 02383</del>  |   |   |   |   |   |   |   |   |   |
| <b>CITROËN  JUMPY I 1.6</b>          |   |   |   |  |   |   |   |   |   |   |   |   |   |
|   | 1580SPI   | 10/95 → 11/07   |   | VKMA 02410   |   | 1   |   | 1   |   |   |   |   | T0052   |
|   |   |   |   | VKM 12200  |   | 1   |   |   |   |   |   |   |   |
|   | 1580SPI   | 10/95 → 10/07   | 2), <del>⊗</del>  | VKPA 83431   |   |   |   |   | 1   |   |   |   |   |
|   | 1580SPI   | 10/95 → 10/07   | 2), <del>⊗</del>  | VKPA 83432   |   |   |   |   | 1   |   |   |   |   |
| <b>CITROËN  JUMPY I 2.0 16V</b>     |   |   |   |  |   |   |   |   |   |   |   |   |   |
|   | EW10J4  | 03/00 → 11/07   |   | VKMA 03235   |   | 1   | 1   | 1   |   |   |   |   | T0169   |
|   |   |   |   | VKM 13234  |   | 1   |   |   |   |   |   |   |   |
|   |   |   |   | VKM 23230  |   |   |   | 1   |   |   |   |   |   |
|   | EW10J4  | 03/00 → 10/07   | 16)   | VKPC 83650   |   |   |   |   | 1   |   |   |   |   |
| B(Alt)  | EW10J4  | 03/00 → 11/05   | AC  | VKMA 33055   |   | 1   | 1   | 1   |   |   |   |   |   |
|   |   |   |   | VKMOV 6PK1188  |   |   |   | 1   |   |   |   |   |   |
|   |   |   |   | VKM 33019  |   | 1   |   |   |   |   |   |   |   |
|   |   |   |   | VKM 33020  |   |   |   | 1   |   |   |   |   |   |
| B(Alt)  | EW10J4  | 11/05 → 11/07   | AC  | VKMOV 6PK1188  |   |   |   | 1   |   |   |   |   |   |
|   |   |   |   | VKM 33019  |   | 1   |   |   |   |   |   |   |   |
|   |   |   |   | VKM _____  |   |   |   | 1   |   |   |   |   |   |
| B(Alt)  | EW10J4  | 03/00 → 11/05   | AC  | VKMOV 6PK1710  |   | 1   |   | 1   |   |   |   |   |   |
|   |   |   |   | VKM 33019  |   |   |   | 1   |   |   |   |   |   |
|   |   |   |   | VKM 33020  |   |   |   | 1   |   |   |   |   |   |
| B(Alt)  | EW10J4  | 11/05 → 11/07   | AC  | VKMOV 6PK1710  |   | 1   |   | 1   |   |   |   |   |   |
|   |   |   |   | VKM 33019  |   |   |   | 1   |   |   |   |   |   |
|   |   |   |   | VKM _____  |   |   |   | 1   |   |   |   |   |   |
| <b>CITROËN  JUMPY I 1.9 D</b>      |   |   |   |  |   |   |   |   |   |   |   |   |   |
|   | DW8, DW8B   | 04/98 → 11/07   |  | VKMC 03244   |   | 1   | 1   | 1   |   | 1   |   |   | T0167   |
|   |   |   |   | VKMA 03244   |   | 1   | 1   | 1   |   |   |   |   |   |
|   |   |   |   | VKM 13244  |   | 1   |   |   |   |   |   |   | 1   |
|   |   |   |   | VKM 23246  |   |   |   | 1   |   |   |   |   |   |
|   | XUD9  | 10/95 → 04/98   |  | VKMC 03241   |   | 1   | 1   | 1   |   | 1   |   |   | T0017   |
|   |   |   |   | VKMA 03241   |   | 1   | 1   | 1   |   |   |   |   |   |
|   |   |   |   | VKM 13241  |   | 1   |   |   |   |   |   |   |   |
|   |   |   |   | VKM 23241  |   |   |   | 1   |   |   |   |   |   |
|   | XUD9  | 10/95 → 04/98   | 3)  | VKMS 03241   |   | 1   | 1   | 1   |   |   | 2   |   | T0017   |
|   |   |   |   | VKMA 03241   |   | 1   | 1   | 1   |   |   |   |   |   |
|   |   |   |   | VKM 13241  |   | 1   |   |   |   |   |   |   |   |
|   |   |   |   | VKM 23241  |   |   |   | 1   |   |   |   |   |   |
|   | DW8, DW8B   | 04/98 → 10/07   |   | VKPC 83639   |   |   |   |   | 1   |   |   |   |   |
|   | XUD9  | 10/95 → 04/98   |   | VKPC 83420   |   |   |   |   | 1   |   |   |   |   |
| B(Alt)  | DW8   | 04/98 → 11/07   | AC, <del>⊗</del>  | VKMOV 6PK866   |   |   |   | 1   |   |   |   |   |   |
|   |   |   |   | VKM 33004  |   | 1   |   |   |   |   |   |   |   |
| B(Alt)  | DW8   | 04/98 → 11/07   | AC, <del>⊗</del>  | VKMOV 6PK1042  |   |   |   | 1   |   |   |   |   |   |
|   |   |   |   | VKM 33004  |   | 1   |   |   |   |   |   |   |   |
| B(Alt)  | DW8   | 04/98 → 10/99   | AC, <del>⊗</del>  | VKMA 33021   |   | 1   | 2   | 1   |   |   |   |   |   |
|   |   |   |   | VKMOV 6PK1388  |   |   |   | 1   |   |   |   |   |   |
|   |   |   |   | VKM 33017  |   |   |   | 1   |   |   |   |   |   |

|                                 |                    |               |               | VKM 33017    | 1            |   |   |   |  |   |   |   |   |  |   |       |
|---------------------------------|--------------------|---------------|---------------|--------------|--------------|---|---|---|--|---|---|---|---|--|---|-------|
|                                 |                    |               |               | VKM 33042    | 1            |   |   |   |  |   |   |   |   |  |   |       |
| B(Alt)                          | DW8                | 04/98 → 11/07 | AC, ⊕         | VKMA 33093   | 2            |   | 1 |   |  |   | 1 |   |   |  |   |       |
|                                 |                    |               |               | VKMV 6PK1750 | 1            |   | 1 |   |  |   |   |   |   |  |   |       |
|                                 |                    |               |               | VKM 33013    | 1            |   |   |   |  |   |   |   |   |  |   |       |
|                                 |                    |               |               | VKM 33029    | 1            |   |   |   |  |   |   |   |   |  |   |       |
|                                 |                    |               |               | VKM 33311    |              |   |   |   |  |   |   | 1 |   |  |   |       |
| B(Alt)                          | DW8                | 10/99 → 11/07 | AC, ⊕         | VKMA 33027   | 1            | 2 | 1 |   |  |   |   |   |   |  |   |       |
|                                 |                    |               |               | VKMV 6PK1437 |              |   | 1 |   |  |   |   |   |   |  |   |       |
|                                 |                    |               |               | VKM 33017    |              |   | 1 |   |  |   |   |   |   |  |   |       |
|                                 |                    |               |               | VKM 33031    |              |   | 1 |   |  |   |   |   |   |  |   |       |
|                                 |                    |               |               | VKM 33032    | 1            |   |   |   |  |   |   |   |   |  |   |       |
| B(Alt)                          | DW8B               | 04/98 → 11/07 | AC            | VKMA 33027   | 1            | 2 | 1 |   |  |   |   |   |   |  |   |       |
|                                 |                    |               |               | VKMV 6PK1437 |              |   | 1 |   |  |   |   |   |   |  |   |       |
|                                 |                    |               |               | VKM 33017    |              |   | 1 |   |  |   |   |   |   |  |   |       |
|                                 |                    |               |               | VKM 33031    |              |   | 1 |   |  |   |   |   |   |  |   |       |
|                                 |                    |               |               | VKM 33032    | 1            |   |   |   |  |   |   |   |   |  |   |       |
| B(Alt)                          | DW8B               | 04/98 → 12/02 | AC            | VKMV 6PK1736 | 1            |   | 1 |   |  |   |   |   |   |  |   |       |
|                                 |                    |               |               | VKM 33013    | 1            |   |   |   |  |   |   |   |   |  |   |       |
|                                 |                    |               |               | VKM 33029    | 1            |   |   |   |  |   |   |   |   |  |   |       |
|                                 |                    |               |               | VKM 33311    |              |   |   |   |  |   |   | 1 |   |  |   |       |
| B(Alt)                          | DW8B               | 12/02 → 11/07 | AC            | VKMV 6PK1680 | 1            |   | 1 |   |  |   |   |   |   |  |   |       |
|                                 |                    |               |               | VKM 33013    | 1            |   |   |   |  |   |   |   |   |  |   |       |
| B(Alt)                          | XUD9               | 10/95 → 04/98 | AC, ⊕         | VKMV 6PK730  |              |   | 1 |   |  |   |   |   |   |  |   |       |
| B(Alt)                          | XUD9               | 10/95 → 04/98 | AC, ⊕         | VKMA 33040   | 1            |   | 1 |   |  |   |   |   |   |  |   |       |
|                                 |                    |               |               | VKMV 6PK1160 |              |   | 1 |   |  |   |   |   |   |  |   |       |
|                                 |                    |               |               | VKM 33002    | 1            |   |   |   |  |   |   |   |   |  |   |       |
| B(Alt)                          | XUD9               | 10/95 → 04/98 | AC, ⊕         | VKMA 33102   | 1            |   | 1 |   |  |   |   |   |   |  |   |       |
|                                 |                    |               |               | VKMV 6PK1110 |              |   | 1 |   |  |   |   |   |   |  |   |       |
|                                 |                    |               |               | VKM 33002    | 1            |   |   |   |  |   |   |   |   |  |   |       |
| B(Alt)                          | XUD9               | 10/95 → 04/98 | AC, ⊕         | VKMV 6PK1736 |              |   | 1 |   |  |   |   |   |   |  |   |       |
|                                 |                    |               |               | VKM 33013    | 1            |   |   |   |  |   |   |   |   |  |   |       |
|                                 |                    |               |               | VKM 33029    | 1            |   |   |   |  |   |   |   |   |  |   |       |
|                                 |                    |               |               | VKM 33311    |              |   |   |   |  |   |   | 1 |   |  |   |       |
| ⊕                               | DW8B               | 04/98 → 09/04 | AC            | VKM 93301    |              |   |   |   |  |   |   | 1 |   |  |   |       |
|                                 | DW8B               | 09/04 → 11/07 | AC            | VKM _____    |              |   |   |   |  |   |   | 1 |   |  |   |       |
|                                 | XUD9A/U            | 10/95 → 04/98 |               | VKM 93302    |              |   |   |   |  |   |   | 1 |   |  |   |       |
| <b>CITROËN  JUMPY I 1.9 TD</b>  |                    |               |               |              |              |   |   |   |  |   |   |   |   |  |   |       |
|                                 | XUD9TE             | 10/95 → 11/07 |               | VKMC 03241   | 1            | 1 | 1 |   |  | 1 |   |   |   |  |   | T0017 |
|                                 |                    |               |               | VKMA 03241   | 1            | 1 | 1 |   |  |   |   |   |   |  |   |       |
|                                 |                    |               |               | VKM 13241    | 1            |   |   |   |  |   |   |   |   |  |   |       |
|                                 |                    |               |               | VKM 23241    |              |   | 1 |   |  |   |   |   |   |  |   |       |
|                                 | XUD9TE             | 10/95 → 11/07 | 3)            | VKMS 03241   | 1            | 1 | 1 |   |  |   |   |   | 2 |  |   | T0017 |
|                                 |                    |               |               | VKMA 03241   | 1            | 1 | 1 |   |  |   |   |   |   |  |   |       |
|                                 |                    |               |               | VKM 13241    | 1            |   |   |   |  |   |   |   |   |  |   |       |
|                                 |                    |               |               | VKM 23241    |              |   | 1 |   |  |   |   |   |   |  |   |       |
|                                 | XUD9TE             | 10/95 → 10/07 |               | VKPC 83420   |              |   |   |   |  |   |   | 1 |   |  |   |       |
|                                 | B(Alt)             | XUD9TE        | 10/95 → 11/07 | AC, ⊕        | VKMV 6PK730  |   |   | 1 |  |   |   |   |   |  |   |       |
|                                 | B(Alt)             | XUD9TE        | 10/95 → 11/07 | AC, ⊕        | VKMA 33040   | 1 |   | 1 |  |   |   |   |   |  |   |       |
|                                 |                    |               |               |              | VKMV 6PK1160 |   |   | 1 |  |   |   |   |   |  |   |       |
|                                 |                    |               |               |              | VKM 33002    | 1 |   |   |  |   |   |   |   |  |   |       |
|                                 | B(Alt)             | XUD9TE        | 10/95 → 11/07 | AC, ⊕        | VKMA 33102   | 1 |   | 1 |  |   |   |   |   |  |   |       |
|                                 |                    |               |               |              | VKMV 6PK1110 |   |   | 1 |  |   |   |   |   |  |   |       |
|                                 |                    |               |               |              | VKM 33002    | 1 |   |   |  |   |   |   |   |  |   |       |
|                                 | B(Alt)             | XUD9TE        | 10/95 → 11/07 | AC, ⊕        | VKMV 6PK1739 |   |   | 1 |  |   |   |   |   |  |   |       |
|                                 |                    |               |               |              | VKM 33013    | 1 |   |   |  |   |   |   |   |  |   |       |
|                                 |                    |               |               |              | VKM 33029    | 1 |   |   |  |   |   |   |   |  |   |       |
|                                 |                    |               |               |              | VKM 33311    |   |   |   |  |   |   |   | 1 |  |   |       |
|                                 |                    |               |               |              | VKM 93302    |   |   |   |  |   |   |   | 1 |  |   |       |
| <b>CITROËN  JUMPY I 2.0 HDi</b> |                    |               |               |              |              |   |   |   |  |   |   |   |   |  |   |       |
|                                 | DW10ATED, DW10BTED | 10/99 → 04/00 |               | VKMC 03246   | 1            | 1 | 1 |   |  | 1 |   |   |   |  | 1 | T0168 |
|                                 |                    |               |               | VKMA 03246   | 1            | 1 | 1 |   |  |   |   |   |   |  | 1 |       |
|                                 |                    |               |               | VKM 13246    | 1            |   |   |   |  |   |   |   |   |  | 1 |       |
|                                 |                    |               |               | VKM 23246    |              |   | 1 |   |  |   |   |   |   |  |   |       |
|                                 | DW10ATED, DW10BTED | 04/00 → 11/07 |               | VKMC 03247   | 1            | 1 | 1 |   |  | 1 |   |   |   |  | 1 | T0168 |
|                                 |                    |               |               | VKMA 03247   | 1            | 1 | 1 |   |  |   |   |   |   |  | 1 |       |









































CITROËN

|                                  |                                  |               |  |       | VKM 13244    | 1 |   |   |   |   |   | 1     |
|----------------------------------|----------------------------------|---------------|--|-------|--------------|---|---|---|---|---|---|-------|
|                                  |                                  |               |  |       | VKM 23246    |   | 1 |   |   |   |   |       |
|                                  | DW10ATED, DW10BTED               | 10/99 → 10/07 |  |       | VKPC 83639   |   |   |   | 1 |   |   |       |
|                                  | <b>B(Alt)</b> DW10ATED, DW10BTED | 10/99 → 11/07 |  | AC    | VKMA 33044   | 2 | 1 | 1 |   |   |   |       |
|                                  |                                  |               |  |       | VKMV 6PK1468 |   |   | 1 |   |   |   |       |
|                                  |                                  |               |  |       | VKM 33024    | 1 |   |   |   |   |   |       |
|                                  |                                  |               |  |       | VKM 33033    | 1 |   |   |   |   |   |       |
|                                  |                                  |               |  |       | VKM 33069    |   | 1 |   |   |   |   |       |
|                                  | <b>B(Alt)</b> DW10ATED, DW10BTED | 10/99 → 11/07 |  | AC    | VKMV 6PK1740 |   |   | 1 |   |   |   |       |
|                                  |                                  |               |  |       | VKM 33013    | 1 |   |   |   |   |   |       |
|                                  |                                  |               |  |       | VKM 33033    | 1 |   |   |   |   |   |       |
|                                  | DW10ATED, DW10BTED "W3"          | 10/99 → 11/07 |  |       | VKM 93301    |   |   |   |   | 1 |   |       |
|                                  | DW10ATED, DW10BTED "W3"          | 03/00 → 11/07 |  |       | VKM 93301    |   |   |   |   | 1 |   |       |
|                                  | DW10ATED, DW10BTED "W3"          | 01/02 → 11/07 |  |       | VKM 93301    |   |   |   |   | 1 |   |       |
|                                  | DW10BTED "W4", DW10BTED+         | 10/99 → 12/02 |  |       | VKM 93301    |   |   |   |   | 1 |   |       |
|                                  | DW10BTED "W4", DW10BTED+         | 03/00 → 12/02 |  |       | VKM 93301    |   |   |   |   | 1 |   |       |
|                                  | DW10BTED "W4", DW10BTED+         | 01/02 → 12/02 |  |       | VKM 93301    |   |   |   |   | 1 |   |       |
|                                  | DW10BTED "W4", DW10BTED+         | 12/02 → 11/07 |  |       | VKM_____     |   |   |   |   | 1 |   |       |
| <b>CITROËN  JUMPY II 1.9 TD</b>  |                                  |               |  |       |              |   |   |   |   |   |   |       |
|                                  | XUD9TE                           | 10/99 → 11/07 |  |       | VKMC 03241   | 1 | 1 | 1 |   | 1 |   |       |
|                                  |                                  |               |  |       | VKMA 03241   | 1 | 1 | 1 |   |   |   | T0017 |
|                                  |                                  |               |  |       | VKM 13241    | 1 |   |   |   |   |   |       |
|                                  |                                  |               |  |       | VKM 23241    |   | 1 |   |   |   |   |       |
|                                  | XUD9TE                           | 10/99 → 11/07 |  | 3)    | VKMS 03241   | 1 | 1 | 1 |   |   | 2 |       |
|                                  |                                  |               |  |       | VKMA 03241   | 1 | 1 | 1 |   |   |   | T0017 |
|                                  |                                  |               |  |       | VKM 13241    | 1 |   |   |   |   |   |       |
|                                  |                                  |               |  |       | VKM 23241    |   | 1 |   |   |   |   |       |
|                                  | XUD9TE                           | 10/99 → 10/07 |  |       | VKPC 83420   |   |   |   |   | 1 |   |       |
|                                  | <b>B(Alt)</b> XUD9TE             | 10/99 → 11/07 |  | AC, ⊕ | VKMV 6PK730  |   |   | 1 |   |   |   |       |
|                                  | <b>B(Alt)</b> XUD9TE             | 10/99 → 11/07 |  | AC, ⊕ | VKMA 33040   | 1 |   | 1 |   |   |   |       |
|                                  |                                  |               |  |       | VKMV 6PK1160 |   |   | 1 |   |   |   |       |
|                                  |                                  |               |  |       | VKM 33002    | 1 |   |   |   |   |   |       |
|                                  | <b>B(Alt)</b> XUD9TE             | 10/99 → 11/07 |  | AC, ⊕ | VKMA 33102   | 1 |   | 1 |   |   |   |       |
|                                  |                                  |               |  |       | VKMV 6PK1110 |   |   | 1 |   |   |   |       |
|                                  |                                  |               |  |       | VKM 33002    | 1 |   |   |   |   |   |       |
|                                  | <b>B(Alt)</b> XUD9TE             | 10/99 → 11/07 |  | AC, ⊕ | VKMV 6PK1739 |   |   | 1 |   |   |   |       |
|                                  |                                  |               |  |       | VKM 33013    | 1 |   |   |   |   |   |       |
|                                  |                                  |               |  |       | VKM 33029    | 1 |   |   |   |   |   |       |
|                                  |                                  |               |  |       | VKM 33311    |   |   |   |   | 1 |   |       |
|                                  | XUD9TE                           | 10/99 → 11/07 |  |       | VKM 93302    |   |   |   |   | 1 |   |       |
| <b>CITROËN  JUMPY II 2.0 HDi</b> |                                  |               |  |       |              |   |   |   |   |   |   |       |
|                                  | DW10ATED, DW10BTED               | 10/99 → 04/00 |  |       | VKMC 03246   | 1 | 1 | 1 |   | 1 |   | 1     |
|                                  |                                  |               |  |       | VKMA 03246   | 1 | 1 | 1 |   |   |   | 1     |
|                                  |                                  |               |  |       | VKM 13246    | 1 |   |   |   |   |   | 1     |
|                                  |                                  |               |  |       | VKM 23246    |   | 1 |   |   |   |   |       |
|                                  | DW10ATED, DW10BTED               | 04/00 → 11/07 |  |       | VKMC 03247   | 1 | 1 | 1 |   | 1 |   | 1     |
|                                  |                                  |               |  |       | VKMA 03247   | 1 | 1 | 1 |   |   |   | 1     |
|                                  |                                  |               |  |       | VKM 13244    | 1 |   |   |   |   |   | 1     |
|                                  |                                  |               |  |       | VKM 23246    |   | 1 |   |   |   |   |       |
|                                  | DW10ATED, DW10BTED               | 10/99 → 10/07 |  |       | VKPC 83639   |   |   |   |   | 1 |   |       |
|                                  | <b>B(Alt)</b> DW10ATED, DW10BTED | 10/99 → 11/07 |  | AC    | VKMA 33044   | 2 | 1 | 1 |   |   |   |       |
|                                  |                                  |               |  |       | VKMV 6PK1468 |   |   | 1 |   |   |   |       |
|                                  |                                  |               |  |       | VKM 33024    | 1 |   |   |   |   |   |       |
|                                  |                                  |               |  |       | VKM 33033    | 1 |   |   |   |   |   |       |
|                                  |                                  |               |  |       | VKM 33069    |   | 1 |   |   |   |   |       |
|                                  | <b>B(Alt)</b> DW10ATED, DW10BTED | 10/99 → 11/07 |  | AC    | VKMV 6PK1740 |   |   | 1 |   |   |   |       |
|                                  |                                  |               |  |       | VKM 33013    | 1 |   |   |   |   |   |       |
|                                  |                                  |               |  |       | VKM 33033    | 1 |   |   |   |   |   |       |
|                                  | DW10ATED, DW10BTED "W3"          | 10/99 → 11/07 |  |       | VKM 93301    |   |   |   |   | 1 |   |       |







































|   |  |  |  |  |  |  |  |  |  |  |  |  |       |
|---|---|---|---|--|---|---|---|---|---|---|---|---|-------|
|   | DW10BTED "W4",<br>DW10BTED+   | 10/99 → 12/02   |   | VKM 93301  |   |   |   |   |   |   | 1   |   |       |
|   | DW10BTED "W4",<br>DW10BTED+   | 12/02 → 11/07   |   | VKM____  |   |   |   |   |   |   | 1   |   |       |
| <b>CITROËN  JUMPY III 2.0 16V</b>    |   |   |   |  |   |   |   |   |   |   |   |   |       |
|                                      | EW10A   | 01/07 → 10/07   |   | —  |   |   |   |   |   |   | 1   |   |       |
|                                      | <b>B(Alt)</b> EW10A   | 01/07 → 11/07   |   | VKMV 6PK998<br>VKM____   | 1   |   | 1   |   |   |   |   |   |       |
| <b>CITROËN  JUMPY III 1.6 HDi 90</b> |   |   |   |  |   |   |   |   |   |   |   |   |       |
|                                      | DV6UTED4  | 01/07 → 10/07   |   | VKPC 83259   |   |   |   |   |   |   | 1   |   |       |
|                                      | <b>B(Alt)</b> DV6UTED4  | 01/07 → 11/07   | <i>AC</i>   | VKM____  | 1   |   |   |   |   |   |   |   |       |
| <b>CITROËN  JUMPY III 2.0 HDi</b>    |   |   |   |  |   |   |   |   |   |   |   |   |       |
|                                      | DW10BTED4,<br>DW10UTED4   | 01/07 → 11/07   |   | VKMA 03257<br>VKM 13257<br>VKM 23257   | 1<br>1  | 1   | 1   |   |   |   |   | T0205   |       |
|                                      | DW10BTED4,<br>DW10UTED4   | 01/07 → 10/07   |   | VKPC 83643   |   |   |   |   |   |   | 1   |   |       |
|                                      | <b>B(Alt)</b> DW10BTED4,<br>DW10UTED4   | 07/07 → 11/07   |   | VKMV 6PK1217   |   |   | 1   |   |   |   |   |   |       |
| <b>DACIA  LOGAN 1.4</b>              |   |   |   |  |   |   |   |   |   |   |   |   |       |
|                                      | K7J 710, K7J 714  | 09/04 → 12/07   |   | VKMA 06003<br>VKM 16003  | 1<br>1  | 1   |   |   |   |   |   | T0145   |       |
|                                      | K7J 710, K7J 714  | 09/04 → 12/07   |   | VKPC 86415   |   |   |   |   |   |   | 1   |   |       |
|                                      | <b>B(Alt)</b> K7J 710, K7J 714  | 09/04 → 12/07   | <i>AC, ⊕</i>  | VKMA 36091<br>VKMV 5PK1110<br>VKM 36091  | 1<br>1  | 1   | 1   |   |   |   |   |   |       |
|   | <b>B(Alt)</b> K7J 710, K7J 714  | 09/04 → 12/07   | <i>AC, ⊕</i>  | VKMA 36020<br>VKM 36031<br>VKM 36031   |   | 2<br>1<br>1   | 1   |   |   |   |   |   |       |
| <b>DACIA  LOGAN 1.6</b>            |   |   |   |  |   |   |   |   |   |   |   |   |       |
|                                    | K7M 710, K7M 714,<br>K7M 718  | 09/04 → 12/07   |   | VKMA 06003<br>VKM 16003  | 1<br>1  | 1   |   |   |   |   |   | T0145   |       |
|                                    | K7M 710, K7M 714,<br>K7M 718  | 09/04 → 12/07   |   | VKPC 86415   |   |   |   |   |   |   | 1   |   |       |
|                                    | <b>B(Alt)</b> K7M 710, K7M 714,<br>K7M 718  | 09/04 → 12/07   | <i>AC, ⊕</i>  | VKMA 36091<br>VKMV 5PK1110<br>VKM 36091  | 1<br>1  | 1   | 1   |   |   |   |   |   |       |
|   | <b>B(Alt)</b> K7M 710, K7M 714,<br>K7M 718  | 09/04 → 12/07   | <i>AC, ⊕</i>  | VKMA 36020<br>VKM 36031<br>VKM 36031   |   | 2<br>1<br>1   | 1   |   |   |   |   |   |       |
| <b>DACIA  LOGAN 1.6 16V</b>        |   |   |   |  |   |   |   |   |   |   |   |   |       |
|                                    | K4M 690, K4M 694,<br>K4M 698  | 02/06 → 12/07   |   | VKMA 06020<br>VKM 16020<br>VKM 26020   | 1<br>1  | 1   | 1   |   |   |   | 2   | 1   | T0159 |
|                                    | K4M 690, K4M 694,<br>K4M 698  | 02/06 → 12/07   |   | VKPC 86416   |   |   |   |   |   |   | 1   |   |       |
|                                    | <b>B(Alt)</b> K4M 690, K4M 694,<br>K4M 698  | 02/06 → 11/07   | <i>AC</i>   | VKMV 6PK1199   |   |   | 1   |   |   |   |   |   |       |
|   | <b>B(Alt)</b> K4M 690, K4M 694,<br>K4M 698  | 02/06 → 12/07   | <i>AC</i>   | VKMV 6PK1815<br>VKM 36031<br>VKM 36031   |   |   | 1   |   |   |   | 1<br>1  |   |       |
| <b>DACIA  LOGAN 1.5 dCi</b>        |   |   |   |  |   |   |   |   |   |   |   |   |       |
|                                    | K9K 790, K9K 792,<br>K9K 794, K9K 796   | 09/05 → 12/07   |   | VKMA 06132<br>VKM 16102  | 1<br>1  | 1   |   |   |   |   |   | 1   | T0191 |
|                                    | <b>B(Alt)</b> K9K 790, K9K 792,<br>K9K 794, K9K 796                               | 09/05 → 11/07   |   | VKMV 6PK1199   |   |   | 1   |   |   |   |   |   |       |



CITROËN



















|  |                      |  |       |  |  |  |  |  |  |  |  |  |
|--|----------------------|---|--|---|--|---|---|---|---|---|---|---|
| <b>DAEWOO  ARCADIA 3.2</b>  |                      |   |  |   |  |   |   |   |   |   |   |   |
|                              | V6                   | 01/94 → 12/95   |  |   | VKMA 93012<br>VKM 73004  | 1<br>1  | 1   |   |   |   |   | T0695   |
| <b>DAEWOO  AVEO 1.4</b>     |                      |   |  |   |  |   |   |   |   |   |   |   |
|                              | F14D3                | 05/03 → 09/04   | DOHC   |   | VKMA 90000<br>VKM 70000<br>VKM 80000   | 1<br>1  | 1   | 1   |   |   |   | T0297   |
| <b>DAEWOO  CIELO 1.5</b>    |                      |   |  |   |  |   |   |   |   |   |   |   |
|                              |                      | 01/94 → 12/97   | 3), DOHC   |   | VKMS 90000<br>VKMA 90000<br>VKM 70000<br>VKM 80000                                 | 1<br>1<br>1   | 1   | 1   |   |   | 2   | T0297   |
|  |                      | 01/94 → 01/96   | SOHC   |   | VKMA 05121<br>VKM 15121  | 1<br>1  | 1   |   |   |   |   | T0092   |
| <b>DAEWOO  CIELO 1.8</b>    |                      |   |  |   |  |   |   |   |   |   |   |   |
|                              |                      | 01/94 → 01/96   | SOHC   |   | VKMA 05121<br>VKM 15121  | 1<br>1  | 1   |   |   |   |   | T0092   |
| <b>DAEWOO  DAMAS 0.8</b>    |                      |   |  |   |  |   |   |   |   |   |   |   |
|                              | F8CL                 | 01/90 → 12/94   | Mod. Y7T11   |   | VKMA 90001<br>VKM 76102  | 1<br>1  | 1   |   |   |   |   | T0697   |
| <b>DAEWOO  ESPERO 1.5</b>   |                      |   |  |   |  |   |   |   |   |   |   |   |
|                              |                      | 10/93 → 12/93   |  SOHC |   | VKMC 05120   |   |   | 1   | 1   |   |   | T0228   |
|  |                      | 05/94 → 09/94   |  SOHC |   | VKMC 05121<br>VKMA 05121<br>VKM 15121  | 1<br>1<br>1   | 1   | 1   |   |   |   | T0092   |
|  |                      | 10/93 → 09/94   | 3), DOHC   |   | VKMS 90000<br>VKMA 90000<br>VKM 70000<br>VKM 80000                                 | 1<br>1<br>1   | 1   | 1   |   |   | 2   | T0297   |
|  | A15MF                | 02/95 → 01/96   | 3), DOHC   |   | VKMS 90002<br>VKMA 90002<br>VKM 70001  | 1<br>1<br>1   | 1   |   |   |   | 2   | T0299   |
|  |                      | 10/93 → 05/94   | SOHC   |   | VKMA 05121<br>VKM 15121  | 1<br>1  | 1   |   |   |   |   | 1   |
|  | A15MF                | 10/93 → 06/96   | SOHC   |   | VKMA 05121<br>VKM 15121  | 1<br>1  | 1   |   |   |   |   | T0092   |
|                            |                      | 10/93 → 06/94   | SOHC   |   | VKPC 85401   |   |   |   | 1   |   |   |   |
|  | V1.5L                | 02/95 → 06/99   | DOHC   |   | VKPC 90200   |   |   |   | 1   |   |   |   |
|  | Y1.5L                | 10/97 → 09/99   | SOHC   |   | VKPC 85206   |   |   |   | 1   |   |   |   |
| <b>DAEWOO  ESPERO 1.6</b> |                      |   |  |   |  |   |   |   |   |   |   |   |
|                            |                      | 01/94 → 06/96   | SOHC   |   | VKMA 05121<br>VKM 15121  | 1<br>1  | 1   |   |   |   |   | T0092   |
| <b>DAEWOO  ESPERO 1.8</b> |                      |   |  |   |  |   |   |   |   |   |   |   |
|                            | 1.8MPIFAMII          | 02/95 → 06/96   | 3), SOHC   |   | VKMS 90002<br>VKMA 90002<br>VKM 70001  | 1<br>1<br>1   | 1   |   |   |   | 2   | T0299   |
|                            | 81.8L                | 02/95 → 10/95   |  |   | VKPC 85407   |   |   |   | 1   |   |   |   |
|  | 81.8L                | 11/95 → 09/99   |  |   | VKPC 85400   |   |   |   | 1   |   |   |   |
| <b>DAEWOO  ESPERO 2.0</b> |                      |   |  |   |  |   |   |   |   |   |   |   |
|                            | 2.0MPFI, 2.0MPIFAMII | 10/91 → 06/96   | 3), SOHC   |   | VKMS 90002<br>VKMA 90002<br>VKM 70001  | 1<br>1<br>1   | 1   |   |   |   | 2   | T0299   |
|                            | Z2.0L                | 02/95 → 10/95   |  |   | VKPC 85407   |   |   |   | 1   |   |   |   |
|  | Z2.0L                | 11/95 → 06/99   |  |   | VKPC 85400   |   |   |   | 1   |   |   |   |
| <b>DAEWOO  EVANDA 2.0</b> |                      |   |  |   |  |   |   |   |   |   |   |   |
|                            |                      | 08/02 → 12/04   | DOHC   |   | VKMA 05222<br>VKM 15202<br>VKM 25212<br>VKM 25212                                  | 1<br>1  | 2   | 1   |   |   |   | T0116   |
|                            |                      | 08/02 → 12/04   |  |   | VKPC 85611   |   |   |   | 1   |   |   |   |
| <b>DAEWOO  FINO 0.8</b>   |                      |   |  |   |  |   |   |   |   |   |   |   |
|                            | F8C                  | 01/93 → 12/94   | Mod. Y3S11   |   | VKMA 90001<br>VKM 76102  | 1<br>1  | 1   |   |   |   |   | T0697   |













































|   |  |  |  |  |  |  |  |  |  |  |  |  |       |
|---|---|---|---|--|---|---|---|---|---|---|---|---|-------|
| <b>DAEWOO  KALOS 1.2</b>     |   |   |   |  |   |   |   |   |   |   |   |   |       |
|                              |   | 08/02 → 12/04   | SOHC  | VKMA 05121<br>VKM 15121  | 1<br>1  |   | 1   |   |   |   |   | 1<br>1  | T0092 |
| <b>DAEWOO  KALOS 1.4</b>     |   |   |   |  |   |   |   |   |   |   |   |   |       |
|                              |   | 09/02 → 12/04   | SOHC  | VKMA 05121<br>VKM 15121  | 1<br>1  |   | 1   |   |   |   |   | 1<br>1  | T0092 |
|   |   | 05/03 → 09/04   | DOHC  | VKMA 90000<br>VKM 70000<br>VKM 80000   | 1<br>1  | 1   | 1   |   |   |   |   |   | T0297 |
|                              |   | 09/02 → 03/04   | Mod. LA69, DOHC   | VKPC 90402   |   |   |   |   | 1   |   |   |   |       |
| <b>DAEWOO  LABO 0.8</b>      |   |   |   |  |   |   |   |   |   |   |   |   |       |
|                              | F8CL  | 01/90 → 12/94   | Mod. Y7T51  | VKMA 90001<br>VKM 76102  | 1<br>1  |   | 1   |   |   |   |   |   | T0697 |
| <b>DAEWOO  LACETTI 1.4</b>   |   |   |   |  |   |   |   |   |   |   |   |   |       |
|                              |   | 02/04 → 06/04   | 3)  | VKMS 90000<br>VKMA 90000<br>VKM 70000<br>VKM 80000                                 | 1<br>1<br>1   | 1<br>1  | 1<br>1  |   |   |   |   | 2   | T0297 |
|                              | F14D3   | 02/04 → 12/04   |   | VKPC 90402   |   |   |   |   | 1   |   |   |   |       |
| <b>DAEWOO  LACETTI 1.6</b>   |   |   |   |  |   |   |   |   |   |   |   |   |       |
|                              |   | 02/04 → 06/04   | 3)  | VKMS 90000<br>VKMA 90000<br>VKM 70000<br>VKM 80000                                 | 1<br>1<br>1   | 1<br>1  | 1<br>1  |   |   |   |   | 2   | T0297 |
|                              | F16D3   | 02/04 → 12/04   |   | VKPC 90402   |   |   |   |   | 1   |   |   |   |       |
| <b>DAEWOO  LACETTI 1.8</b>  |   |   |   |  |   |   |   |   |   |   |   |   |       |
|                            |   | 02/04 → 06/04   |   | VKMA 05222<br>VKM 15202<br>VKM 25212<br>VKM 25212                                  | 1<br>1  | 2<br>1  | 1<br>1  |   |   |   |   |   | T0116 |
|                            | T18SED  | 02/04 → 12/04   |   | VKPC 85611   |   |   |   |   | 1   |   |   |   |       |
| <b>DAEWOO  LANOS 1.4</b>   |   |   |   |  |   |   |   |   |   |   |   |   |       |
|                            | A14SMS  | 05/97 → 09/05   | 3), DOHC  | VKMS 90000<br>VKMA 90000<br>VKM 70000<br>VKM 80000                                 | 1<br>1<br>1   | 1<br>1  | 1<br>1  |   |   |   |   | 2   | T0297 |
|   | A14SMS  | 05/97 → 09/05   | SOHC  | VKMA 05121<br>VKM 15121  | 1<br>1  |   | 1   |   |   |   |   | 1<br>1  | T0092 |
|                            | A14SMS  | 05/97 → 09/05   | SOHC  | VKPC 90202   |   |   |   |   | 1   |   |   |   |       |
|   | A14SMS  | 05/97 → 09/05   | DOHC  | VKPC 90200   |   |   |   |   | 1   |   |   |   |       |
| <b>DAEWOO  LANOS 1.5</b>   |   |   |   |  |   |   |   |   |   |   |   |   |       |
|                            | A15SMS  | 05/97 → 09/05   | 3), DOHC  | VKMS 90000<br>VKMA 90000<br>VKM 70000<br>VKM 80000                                 | 1<br>1<br>1   | 1<br>1  | 1<br>1  |   |   |   |   | 2   | T0297 |
|   | A15SMS  | 05/97 → 09/05   | SOHC  | VKMA 05121<br>VKM 15121  | 1<br>1  |   | 1   |   |   |   |   | 1<br>1  | T0092 |
|                            | A15SMS  | 05/97 → 09/05   | SOHC  | VKPC 90202   |   |   |   |   | 1   |   |   |   |       |
|   | A15SMS  | 05/97 → 09/05   | DOHC  | VKPC 90202   |   |   |   |   | 1   |   |   |   |       |
| <b>DAEWOO  LANOS 1.6</b>   |   |   |   |  |   |   |   |   |   |   |   |   |       |
|                            | A16DMS  | 05/97 → 09/05   | 3), DOHC  | VKMS 90000<br>VKMA 90000<br>VKM 70000<br>VKM 80000                                 | 1<br>1<br>1   | 1<br>1  | 1<br>1  |   |   |   |   | 2   | T0297 |
|   | A16DMS  | 05/97 → 09/05   | SOHC  | VKMA 05121<br>VKM 15121  | 1<br>1  |   | 1   |   |   |   |   | 1<br>1  | T0092 |
|                            | A16DMS  | 05/97 → 09/05   | SOHC  | VKPC 90202   |   |   |   |   | 1   |   |   |   |       |
|   | A16DMS  | 05/97 → 09/05   | DOHC  | VKPC 90202   |   |   |   |   | 1   |   |   |   |       |
| <b>DAEWOO  LEGANZA 1.8</b> |   |   |   |  |   |   |   |   |   |   |   |   |       |
|                            |   | 01/97 → 12/98   | SOHC  | VKMA 05402<br>VKM 15402  | 1<br>1  |   | 1   |   |   |   |   |   | T0105 |
|   |   | 01/97 → 12/98   | DOHC  | VKMA 05222<br>VKM 15202<br>VKM 25212<br>VKM 25212                                  | 1<br>1  | 2<br>1  | 1<br>1  |   |   |   |   |   | T0116 |







































DAEWOO







































|  |  |  |  |  |  |  |  |  |  |  |  |  |
|--|---|---|---|--|---|---|---|---|---|---|---|---|
| <b>DAEWOO  LEGANZA 2.0</b>  |   |   |   |  |   |   |   |   |   |   |   |   |
|                              | X20SED  | 06/97 → 12/98   | SOHC  | VKMA 05402<br>VKM 15402  | 1<br>1  |   | 1   |   |   |   |   | T0105   |
|  | X20SED  | 06/97 → 12/02   | DOHC  | VKMA 05222<br>VKM 15202<br>VKM 25212<br>VKM 25212                                  | 1<br>1<br>1<br>1  | 2   | 1   |   |   |   |   | T0116   |
|                              | Z2.0L   | 06/97 → 12/02   | DOHC  | VKPC 85611   |   |   |   | 1   |   |   |   |   |
| <b>DAEWOO  LEGANZA 2.2</b>  |   |   |   |  |   |   |   |   |   |   |   |   |
|                              |   | 01/97 → 12/98   | DOHC  | VKMA 05223<br>VKM 15202<br>VKM 25212<br>VKM 25212                                  | 1<br>1<br>1<br>1  | 2   | 1   |   |   |   |   | T0139   |
| <b>DAEWOO  LEMANS 1.5</b>   |   |   |   |  |   |   |   |   |   |   |   |   |
|                              |   | 01/92 → 12/93   | 3), DOHC  | VKMS 90000<br>VKMA 90000<br>VKM 70000<br>VKM 80000                                 | 1<br>1<br>1<br>1  | 1   | 1   |   |   |   | 2   | T0297   |
| <b>DAEWOO  MAGNUS 2.0</b>   |   |   |   |  |   |   |   |   |   |   |   |   |
|                              | X20SED  | 07/99 → 09/06   | Mod. LF69, DOHC   | VKMA 05222<br>VKM 15202<br>VKM 25212<br>VKM 25212                                  | 1<br>1<br>1<br>1  | 2   | 1   |   |   |   |   | T0116   |
|                              | X20SED  | 07/99 → 09/06   |   | VKPC 85611   |   |   |   | 1   |   |   |   |   |
| <b>DAEWOO  MATIZ 0.8</b>    |   |   |   |  |   |   |   |   |   |   |   |   |
|                             | F8CV  | 09/98 → 03/04   | Mod. KLA4   | VKMA 90001<br>VKM 76102  | 1<br>1  |   | 1   |   |   |   |   | T0697   |
|                            | F8CV  | 09/98 → 04/04   | Mod. KLA4   | VKPC 90450   |   |   |   | 1   |   |   |   |   |
| <b>DAEWOO  MATIZ 1.0</b>  |   |   |   |  |   |   |   |   |   |   |   |   |
|                            | G10CV   | 01/03 → 04/04   | Mod. KLA0   | VKMA 90008<br>VKM 76102  | 1<br>1  |   | 1   |   |   |   |   | T0302   |
|                            | G10CV   | 01/03 → 04/04   | Mod. KLA0   | VKPC 90450   |   |   |   | 1   |   |   |   |   |
| <b>DAEWOO  MICA 0.8</b>   |   |   |   |  |   |   |   |   |   |   |   |   |
|                            | F8C   | 01/93 → 12/94   | Mod. Y3S11  | VKMA 90001<br>VKM 76102  | 1<br>1  |   | 1   |   |   |   |   | T0697   |
| <b>DAEWOO  NEXIA 1.5</b>  |   |   |   |  |   |   |   |   |   |   |   |   |
|                            | A15MF, G15MF  | 02/95 → 08/97   | 3), DOHC  | VKMS 90000<br>VKMA 90000<br>VKM 70000<br>VKM 80000                                 | 1<br>1<br>1<br>1  | 1   | 1   |   |   |   | 2   | T0297   |
|  | A15MF, G15MF  | 02/95 → 08/97   | SOHC  | VKMA 05121<br>VKM 15121  | 1<br>1  |   | 1   |   |   |   | 1   | T0092   |
|                            | A15MF, V1.5L<br>G15MF, Y1.5L  | 02/95 → 08/97   |   | VKPC 90200<br>VKPC 85206   |   |   |   | 1   |   |   |   |   |
| <b>DAEWOO  NEXIA 1.8</b>  |   |   |   |  |   |   |   |   |   |   |   |   |
|                            | C18LE   | 10/95 → 08/97   | SOHC  | VKMA 05121<br>VKM 15121  | 1<br>1  |   | 1   |   |   |   | 1   | T0092   |
|  | C18LE   | 10/95 → 08/97   | DOHC  | VKMA 90000<br>VKM 70000<br>VKM 80000   | 1<br>1<br>1   | 1   | 1   |   |   |   |   | T0297   |
| <b>DAEWOO  NUBIRA 1.5</b> |   |   |   |  |   |   |   |   |   |   |   |   |
|                            |   | 01/96 → 12/97   | 3), DOHC  | VKMS 90000<br>VKMA 90000<br>VKM 70000<br>VKM 80000                                 | 1<br>1<br>1<br>1  | 1   | 1   |   |   |   | 2   | T0297   |
|  |   | 01/96 → 12/97   | SOHC  | VKMA 05121<br>VKM 15121  | 1<br>1  |   | 1   |   |   |   | 1   | T0092   |
|                            | Y1.5L   | 01/97 → 07/03   |   | VKPC 90402   |   |   |   | 1   |   |   |   |   |
| <b>DAEWOO  NUBIRA 1.6</b> |   |   |   |  |   |   |   |   |   |   |   |   |
|                            | A16DMS  | 05/97 → 12/02   | 3), DOHC  | VKMS 90000<br>VKMA 90000<br>VKM 70000<br>VKM 80000                                 | 1<br>1<br>1<br>1  | 1   | 1   |   |   |   | 2   | T0297   |
|                            | 61.6L   | 05/97 → 06/04   |   | VKPC 90402   |   |   |   | 1   |   |   |   |   |

|  |  |  |  |  |  |  |  |  |  |  |  |  |
|--|---|---|---|--|---|---|---|---|---|---|---|---|
| <b>DAEWOO  NUBIRA 1.8</b>       |   |   |   |  |   |   |   |   |   |   |   |   |
|                                 |   | 01/96 → 12/97   | DOHC  | VKMA 05222   | 1   | 2   | 1   |   |   |   |   | T0116   |
|  |   |   |   | VKM 15202  | 1   |   |   |   |   |   |   |   |
|  |   |   |   | VKM 25212  |   | 1   |   |   |   |   |   |   |
|  |   |   |   | VKM 25212  |   | 1   |   |   |   |   |   |   |
|                                 | T18SED  | 08/03 → 06/04   | Mod. 81.8L  | VKPC 85611   |   |   |   | 1   |   |   |   |   |
| <b>DAEWOO  NUBIRA 2.0</b>       |   |   |   |  |   |   |   |   |   |   |   |   |
|                                 | X20SED  | 01/96 → 12/02   | SOHC  | VKMA 05402   | 1   |   | 1   |   |   |   |   | T0105   |
|  |   |   |   | VKM 15402  | 1   |   |   |   |   |   |   |   |
|  | X20SED  | 01/96 → 12/02   | DOHC  | VKMA 05222   | 1   | 2   | 1   |   |   |   |   | T0116   |
|  |   |   |   | VKM 15202  | 1   |   |   |   |   |   |   |   |
|  |   |   |   | VKM 25212  |   | 1   |   |   |   |   |   |   |
|  |   |   |   | VKM 25212  |   | 1   |   |   |   |   |   |   |
|                                 | C20SED, X20SED  | 06/99 → 03/02   |   | VKPC 85611   |   |   |   | 1   |   |   |   |   |
| <b>DAEWOO  REZZO 1.6</b>        |   |   |   |  |   |   |   |   |   |   |   |   |
|                                 | A16DMS  | 08/01 → 01/08   | 3), DOHC  | VKMS 90000   | 1   | 1   | 1   |   |   |   | 2   | T0297   |
|  |   |   |   | VKMA 90000   | 1   | 1   | 1   |   |   |   |   |   |
|  |   |   |   | VKM 70000  | 1   |   |   |   |   |   |   |   |
|  |   |   |   | VKM 80000  |   | 1   |   |   |   |   |   |   |
| <b>DAEWOO  REZZO 1.8</b>        |   |   |   |  |   |   |   |   |   |   |   |   |
|                                 | A18DMS  | 09/00 → 01/03   | SOHC  | VKMA 90007   | 1   | 1   | 1   |   |   |   |   | T0301   |
|  |   |   |   | VKM 70004  | 1   |   |   |   |   |   |   |   |
|  |   |   |   | VKM 80002  |   | 1   |   |   |   |   |   |   |
| <b>DAEWOO  REZZO 2.0</b>        |   |   |   |  |   |   |   |   |   |   |   |   |
|                                 | X20SED  | 09/00 → 01/03   | DOHC  | VKMA 05222   | 1   | 2   | 1   |   |   |   |   | T0116   |
|  |   |   |   | VKM 15202  | 1   |   |   |   |   |   |   |   |
|  |   |   |   | VKM 25212  |   | 1   |   |   |   |   |   |   |
|  |   |   |   | VKM 25212  |   | 1   |   |   |   |   |   |   |
| <b>DAEWOO  TACUMA 1.6</b>     |   |   |   |  |   |   |   |   |   |   |   |   |
|                               | A16DMS  | 08/01 → 09/04   | 3), DOHC  | VKMS 90000   | 1   | 1   | 1   |   |   |   | 2   | T0297   |
|  |   |   |   | VKMA 90000   | 1   | 1   | 1   |   |   |   |   |   |
|  |   |   |   | VKM 70000  | 1   |   |   |   |   |   |   |   |
|  |   |   |   | VKM 80000  |   | 1   |   |   |   |   |   |   |
| <b>DAEWOO  TACUMA 1.8</b>     |   |   |   |  |   |   |   |   |   |   |   |   |
|                               | F18D2   | 05/00 → 04/03   | Mod. UA75, SOHC   | VKMA 90007   | 1   | 1   | 1   |   |   |   |   | T0301   |
|  |   |   |   | VKM 70004  | 1   |   |   |   |   |   |   |   |
|  |   |   |   | VKM 80002  |   | 1   |   |   |   |   |   |   |
| <b>DAEWOO  TACUMA 2.0</b>     |   |   |   |  |   |   |   |   |   |   |   |   |
|                               | X20SED  | 05/00 → 09/04   | Mod. UF75, DOHC   | VKMA 05222   | 1   | 2   | 1   |   |   |   |   | T0116   |
|  |   |   |   | VKM 15202  | 1   |   |   |   |   |   |   |   |
|  |   |   |   | VKM 25212  |   | 1   |   |   |   |   |   |   |
|  |   |   |   | VKM 25212  |   | 1   |   |   |   |   |   |   |
| <b>DAEWOO  TICO 0.8</b>       |   |   |   |  |   |   |   |   |   |   |   |   |
|                               | F8C   | 11/93 → 03/97   |   | VKMA 90001   | 1   |   | 1   |   |   |   |   | T0697   |
|  |   |   |   | VKM 76102  | 1   |   |   |   |   |   |   |   |
|                               | F8C   | 02/95 → 03/97   |   | VKPC 90450   |   |   |   | 1   |   |   |   |   |
| <b>DAIHATSU  APPLAUSE 1.6</b> |   |   |   |  |   |   |   |   |   |   |   |   |
|                               | HD, HDE   | 06/89 → 05/00   | 3), Mod. A101, A111, SOHC   | VKMS 97501   | 1   |   | 1   |   |   |   | 2   | T0696   |
|  |   |   |   | VKMA 97501   | 1   |   | 1   |   |   |   |   |   |
|  |   |   |   | VKM 77500  | 1   |   |   |   |   |   |   |   |
|                               | HD, HDE   | 06/89 → 07/97   | Mod. A101, A111, SOHC   | VKPC 97200   |   |   |   | 1   |   |   |   |   |
| <b>DAIHATSU  CHARADE 0.85</b> |   |   |   |  |   |   |   |   |   |   |   |   |
|                               | CD  | 10/77 → 12/82   | Mod. G20  | —  | 1   |   | 1   |   |   |   |   |   |
|  |   |   |   | VKM 77100  | 1   |   |   |   |   |   |   |   |
| <b>DAIHATSU  CHARADE 0.9</b>  |   |   |   |  |   |   |   |   |   |   |   |   |
|                               | CD  | 01/83 → 12/86   | Mod. G21  | VKMA 97300   | 1   |   | 1   |   |   |   |   | T0696   |
|  |   |   |   | VKM 77300  | 1   |   |   |   |   |   |   |   |
| <b>DAIHATSU  CHARADE 1.0</b>  |   |   |   |  |   |   |   |   |   |   |   |   |
|                               | CB  | 11/90 → 03/96   | 3), Mod. G100, G202, SOHC   | VKMS 97009   | 1   |   | 1   |   |   |   | 2   | T0696   |
|  |   |   |   | VKMA 97009   | 1   |   | 1   |   |   |   |   |   |
|  |   |   |   | VKM 77300  | 1   |   |   |   |   |   |   |   |





















































DAEWOO





































|   |  |  |  |  |  |  |  |  |  |  |  |  |  |  |  |       |
|---|---|---|---|--|---|---|---|---|---|---|---|---|---|---|---|-------|
|   | CB  | 03/87 → 11/90   | Mod. G100, SOHC   | VKMA 97300<br>VKM 77300  | 1<br>1  | 1   |   |   |   |   |   |   |   |   |   | T0696 |
|   | CB 20, CB 22  | 10/77 → 02/83   | Mod. G10  | —<br>VKM 77100   | 1<br>1  | 1   |   |   |   |   |   |   |   |   |   |       |
|   | CB 20, CB 22  | 10/83 → 12/86   | Mod. G11  | VKMA 97300<br>VKM 77300  | 1<br>1  | 1   |   |   |   |   |   |   |   |   |   | T0696 |
|   | CB 23, CB 80 T  | 03/87 → 11/90   | Mod. G100, DOHC   | —<br>—<br>—<br>VKM 87000   | 2<br>1<br>1<br>1  | 1   | 1   |   |   |   |   |   |   |   |   |       |
|   | EJVE  | 03/03 → 08/05   | Mod. L251, DOHC   | VKMA 97505<br>VKM 77503  | 1<br>1  | 1   |   |   |   |   |   |   |   |   |   | T0613 |
|                                     | CB  | 03/87 → 10/95   | Mod. G100, G202, SOHC   | VKPC 97000   |   |   |   |   |   | 1   |   |   |   |   |   |       |
|   | CB 20, CB 22  | 10/83 → 12/84   | Mod. G11  | VKPC 87203   |   |   |   |   |   | 1   |   |   |   |   |   |       |
|   | CB 20, CB 22  | 01/85 → 12/86   | Mod. G11  | VKPC 97000   |   |   |   |   |   | 1   |   |   |   |   |   |       |
|   | CB 23, CB 80 T, CB 90   | 03/87 → 12/92   | Mod. G100   | VKPC 97001   |   |   |   |   |   | 1   |   |   |   |   |   |       |
|   | EJVE  | 03/03 → 10/04   | Mod. L251, DOHC   | VKPC _____   |   |   |   |   |   | 1   |   |   |   |   |   |       |
|   | EJVE  | 11/04 → 08/05   | Mod. L251, DOHC   | VKPC _____   |   |   |   |   |   | 1   |   |   |   |   |   |       |
|                                     | B(Alt) EJVE   | 03/03 → 08/05   | Mod. L251, DOHC   | VKMV _____   |   |   |   | 1   |   |   |   |   |   |   |   |       |
| <b>DAIHATSU  CHARADE 1.0 Turbo</b> |   |   |   |  |   |   |   |   |   |   |   |   |   |   |   |       |
|                                     | CB  | 03/87 → 10/90   | Mod. G100, SOHC   | VKPC 97000   |   |   |   |   |   | 1   |   |   |   |   |   |       |
|   | CB 60   | 10/83 → 12/84   | Mod. G11  | VKPC 87203   |   |   |   |   |   | 1   |   |   |   |   |   |       |
|   | CB 60   | 01/85 → 12/86   | Mod. G11  | VKPC 97000   |   |   |   |   |   | 1   |   |   |   |   |   |       |
|   | CB 61   | 03/87 → 10/90   | Mod. G100   | VKPC 97001   |   |   |   |   |   | 1   |   |   |   |   |   |       |
| <b>DAIHATSU  CHARADE 1.3</b>       |   |   |   |  |   |   |   |   |   |   |   |   |   |   |   |       |
|                                     | HCE, HCU  | 06/88 → 05/00   | 3), Mod. G102, G112, G200, G204, SOHC   | VKMS 97503<br>VKMA 97503<br>VKM 77500  | 1<br>1<br>1   | 1   | 1   |   |   |   |   | 2   |   |   |   | T0696 |
|                                   | HCE, HCU  | 06/88 → 11/97   | Mod. G102, G112, G200, G204, SOHC   | VKPC 97200   |   |   |   |   |   | 1   |   |   |   |   |   |       |
|   | HCE, HCU  | 12/97 → 11/99   | Mod. G200, G204, SOHC   | VKPC _____   |   |   |   |   |   | 1   |   |   |   |   |   |       |
|                                   | B(PS) HCE, HCU  | 01/93 → 11/99   | Mod. G200, G204, SOHC   | VKMV _____   |   |   |   | 1   |   |   |   |   |   |   |   |       |
|   | B(WP) HCE, HCU  | 01/93 → 11/99   | Mod. G200, G204, SOHC   | VKMV _____   |   |   |   | 1   |   |   |   |   |   |   |   |       |
| <b>DAIHATSU  CHARADE 1.5</b>     |   |   |   |  |   |   |   |   |   |   |   |   |   |   |   |       |
|                                   | HEE   | 08/94 → 05/00   | 3), Mod. G203, SOHC   | VKMS 97501<br>VKMA 97501<br>VKM 77500  | 1<br>1<br>1   | 1   | 1   |   |   |   |   | 2   |   |   |   | T0696 |
|                                   | HEE   | 08/94 → 11/97   | Mod. G203, SOHC   | VKPC 97200   |   |   |   |   |   | 1   |   |   |   |   |   |       |
|   | HEE   | 12/97 → 05/00   | Mod. G203, SOHC   | VKPC _____   |   |   |   |   |   | 1   |   |   |   |   |   |       |
|                                   | B(PS) HEE   | 08/94 → 05/00   | Mod. G203, SOHC   | VKMV _____   |   |   |   | 1   |   |   |   |   |   |   |   |       |
|   | B(AC) HEE   | 08/94 → 05/00   | Mod. G203, SOHC   | VKMV 4PK820  |   |   |   | 1   |   |   |   |   |   |   |   |       |
|   | B(WP) HEE   | 08/94 → 05/00   | Mod. G203, SOHC   | VKMV _____   |   |   |   | 1   |   |   |   |   |   |   |   |       |
| <b>DAIHATSU  CHARADE 1.6</b>     |   |   |   |  |   |   |   |   |   |   |   |   |   |   |   |       |
|                                   | HDE   | 03/93 → 05/00   | 3), Mod. G201, SOHC   | VKMS 97501<br>VKMA 97501<br>VKM 77500  | 1<br>1<br>1   | 1   | 1   |   |   |   |   | 2   |   |   |   | T0696 |
|                                   | HDE   | 03/93 → 11/97   | Mod. G201, SOHC   | VKPC 97200   |   |   |   |   |   | 1   |   |   |   |   |   |       |
|   | HDE   | 12/97 → 11/99   | Mod. G201, SOHC   | VKPC _____   |   |   |   |   |   | 1   |   |   |   |   |   |       |
|                                   | B(PS) HDE   | 03/93 → 11/99   | Mod. G201, SOHC   | VKMV _____   |   |   |   | 1   |   |   |   |   |   |   |   |       |
|   | B(AC) HDE   | 03/93 → 11/99   | Mod. G201, SOHC   | VKMV 4PK820  |   |   |   | 1   |   |   |   |   |   |   |   |       |
|   | B(WP) HDE   | 03/93 → 11/99   | Mod. G201, SOHC   | VKMV _____   |   |   |   | 1   |   |   |   |   |   |   |   |       |
| <b>DAIHATSU  CHARADE 1.0 D</b>   |   |   |   |  |   |   |   |   |   |   |   |   |   |   |   |       |
|                                   | CL 10   | 10/83 → 12/86   | Mod. G30  | —<br>VKM 77300   | 1<br>1  | 1   |   |   |   |   |   |   |   |   |   |       |
|   | CL 10   | 10/83 → 12/86   | Mod. G30, Injec.  | —<br>—   | 1<br>1  | 1   |   |   |   |   |   |   |   |   |   |       |
|                                   | CL  | 03/87 → 12/92   | Mod. G101, SOHC   | VKPC 87203   |   |   |   |   |   | 1   |   |   |   |   |   |       |
|   | CL 10   | 10/83 → 03/87   | Mod. G30  | VKPC 87203   |   |   |   |   |   | 1   |   |   |   |   |   |       |
| <b>DAIHATSU  CHARADE 1.0 TD</b>  |   |   |   |  |   |   |   |   |   |   |   |   |   |   |   |       |
|                                   | CL  | 11/90 → 12/92   | Mod. G101, SOHC   | VKMS 97005<br>VKMA 97005<br>VKM 77300  | 1<br>1<br>1   | 1   | 1   |   |   |   |   | 3   |   |   |   | T0696 |
|   | CL 60   | 02/85 → 12/86   | Mod. G30  | VKMA 97005<br>VKM 77300  | 1<br>1  | 1   |   |   |   |   |   |   |   |   |   | T0696 |

|   |  |  |  |  |  |  |  |  |  |  |
|---|---|---|---|--|---|---|---|---|---|---|
|                                  | CL  | 03/87 → 12/92   | Mod. G101, SOHC   | VKPC 87203   |   |   |   | 1   |   |   |
|   | CL 60   | 02/85 → 03/87   | Mod. G30  | VKPC 87203   |   |   |   | 1   |   |   |
| <b>DAIHATSU  CHARMANT 1.3</b>    |   |   |   |  |   |   |   |   |   |   |
|                                  | 3A-U  | 10/81 → 12/87   | Mod. A55  | VKMA 91202<br>VKM 71202  | 1<br>1  | 1   |   |   |   | T0696   |
|                                  | 4K  | 11/81 → 12/83   | Mod. A35  | VKPC 91402   |   |   |   | 1   |   |   |
| <b>DAIHATSU  CHARMANT 1.6</b>    |   |   |   |  |   |   |   |   |   |   |
|                                  | 4A  | 08/83 → 07/87   | 3), Mod. A60  | VKMS 91202<br>VKMA 91202<br>VKM 71202  | 1<br>1<br>1   | 1   |   |   | 2   | T0696   |
| <b>DAIHATSU  COPEN 0.7</b>       |   |   |   |  |   |   |   |   |   |   |
|                                  | JBDE  | 09/03 → 01/08   | Mod. L880   | <del>OKOKOKO</del>   |   |   |   |   |   |   |
|                                  | JBDE  | 09/03 → 01/08   | Mod. L880, DOHC   | VKPC _____   |   |   |   | 1   |   |   |
| <b>DAIHATSU  COPEN 1.3</b>       |   |   |   |  |   |   |   |   |   |   |
|                                  | K3VE  | 03/06 → 01/08   | Mod. L881   | <del>OKOKOKO</del>   |   |   |   |   |   |   |
|                                  | K3VE  | 03/06 → 01/08   | Mod. L881, DOHC   | VKPC _____   |   |   |   | 1   |   |   |
| <b>DAIHATSU  CUORE 0.55</b>      |   |   |   |  |   |   |   |   |   |   |
|                                  | EB  | 08/85 → 04/89   | Mod. L70S   | —<br>VKM 77501   | 1<br>1  | 1   |   |   |   |   |
|   | EB  | 04/89 → 02/90   | Mod. L70S   | —<br>VKM 77401   | 1<br>1  | 1   |   |   |   |   |
| <b>DAIHATSU  CUORE 0.8</b>       |   |   |   |  |   |   |   |   |   |   |
|                                  | ED  | 10/90 → 08/92   | Mod. L201, SOHC   | VKMA 97007<br>VKM 77401  | 1<br>1  | 1   |   |   |   | T0696   |
|   | ED  | 09/92 → 08/94   | Mod. L201, SOHC   | VKMA 97504<br>VKM 77401  | 1<br>1  | 1   |   |   |   | T0696   |
|   | ED10  | 09/85 → 04/89   | Mod. L80, L81   | —<br>VKM 77501   | 1<br>1  | 1   |   |   |   |   |
|   | ED10  | 11/89 → 12/90   | Mod. L80  | VKMA 97007<br>VKM 77401  | 1<br>1  | 1   |   |   |   | T0696   |
|   | ED20  | 01/95 → 10/98   | Mod. L501, SOHC   | VKMA 97504<br>VKM 77401  | 1<br>1  | 1   |   |   |   | T0696   |
|                                | ED, ED20  | 10/90 → 10/98   | Mod. L201, L501, SOHC   | VKPC 97002   |   |   |   | 1   |   |   |
| <b>DAIHATSU  CUORE 1.0</b>     |   |   |   |  |   |   |   |   |   |   |
|                                | EJDE, EJVE  | 10/98 → 09/02   | 3), Mod. L701, DOHC   | VKMS 97505<br>VKMA 97505<br>VKM 77503  | 1<br>1<br>1   | 1   |   |   | 2   | T0613   |
|   | EJDE, EJVE  | 10/02 → 08/05   | 3), Mod. L251, L701, DOHC   | VKMS 97507<br>VKMA 97505<br>VKM 77503  | 1<br>1<br>1   | 1   |   |   | 2   | T0613   |
|                                | EJDE, EJVE  | 10/98 → 12/02   | Mod. L701, DOHC   | VKPC _____   |   |   |   | 1   |   |   |
|   | EJVE  | 05/03 → 08/05   | Mod. L251, DOHC   | VKPC _____   |   |   |   | 1   |   |   |
|   | EJVE  | 09/05 → 03/07   | Mod. L251, DOHC   | VKPC _____   |   |   |   | 1   |   |   |
|                                | B(Alt) EJDE, EJVE   | 10/98 → 08/05   | Mod. L251, L701, DOHC   | VKMV _____   |   |   | 1   |   |   |   |
|   | B(WP) EJDE, EJVE  | 10/98 → 05/03   | Mod. L701, DOHC   | VKMV _____   |   |   | 1   |   |   |   |
| <b>DAIHATSU  DOMINO 0.85</b>   |   |   |   |  |   |   |   |   |   |   |
|                                | ED  | 08/85 → 04/89   | Mod. L80, L81   | —<br>VKM 77501   | 1<br>1  | 1   |   |   |   |   |
|   | ED  | 05/89 → 08/92   | Mod. L201, L80  | VKMA 97007<br>VKM 77401  | 1<br>1  | 1   |   |   |   | T0696   |
|   | ED  | 09/92 → 03/94   | Mod. L201   | VKMA 97504<br>VKM 77401  | 1<br>1  | 1   |   |   |   | T0696   |
| <b>DAIHATSU  FERENZA 1.6</b>   |   |   |   |  |   |   |   |   |   |   |
|                                | HDC, HDE  | 10/88 → 10/99   | 3), Mod. F300, SOHC   | VKMS 97501<br>VKMA 97501<br>VKM 77500  | 1<br>1<br>1   | 1   |   |   | 2   | T0696   |
|                                | HDC, HDE  | 10/88 → 07/01   | Mod. F300, SOHC   | VKPC 97201   |   |   |   | 1   |   |   |
| <b>DAIHATSU  GRAN MOVE 1.5</b> |   |   |   |  |   |   |   |   |   |   |
|                                | HEEG  | 10/96 → 07/98   | 3), Mod. G303, SOHC   | VKMS 97501<br>VKMA 97501<br>VKM 77500  | 1<br>1<br>1   | 1   |   |   | 2   | T0696   |
|                                | HEEG  | 10/96 → 11/97   | Mod. G303, SOHC   | VKPC 97200   |   |   |   | 1   |   |   |
|   | HEEG  | 12/97 → 07/98   | Mod. G303, SOHC   | VKPC _____   |   |   |   | 1   |   |   |









































DAIHATSU

|   |  |  |  |  |  |  |  |  |  |  |  |  |
|---|---|---|---|--|---|---|---|---|---|---|---|---|
|                                     | B(PS)   | HEEG  | 10/96 → 07/98   | Mod. G303, SOHC  | VKMOV_____  |   | 1   |   |   |   |   |   |
|   | B(AC)   | HEEG  | 10/96 → 07/98   | Mod. G303, SOHC  | VKMOV 4PK820  |   | 1   |   |   |   |   |   |
|   | B(WP)   | HEEG  | 10/96 → 07/98   | Mod. G303, SOHC  | VKMOV_____  |   | 1   |   |   |   |   |   |
| <b>DAIHATSU  GRAN MOVE 1.6</b>     |   |   |   |  |   |   |   |   |   |   |   |   |
|                                     | HDEP  |   | 05/98 → 07/02   | 3), Mod. G301, SOHC  | VKMS 97501<br>VKMA 97501<br>VKM 77500   | 1<br>1<br>1   | 1   |   |   | 2   |   | T0696   |
|                                     | HDEP  |   | 05/98 → 07/02   | Mod. G301, SOHC  | VKPC_____   |   |   | 1   |   |   |   |   |
|                                     | B(PS)   | HDEP  | 05/98 → 07/02   | Mod. G301, SOHC  | VKMOV_____  |   | 1   |   |   |   |   |   |
|   | B(AC)   | HDEP  | 05/98 → 07/02   | Mod. G301, SOHC  | VKMOV 4PK820  |   | 1   |   |   |   |   |   |
|   | B(WP)   | HDEP  | 05/98 → 07/02   | Mod. G301, SOHC  | VKMOV_____  |   | 1   |   |   |   |   |   |
| <b>DAIHATSU  HANDI 0.85</b>        |   |   |   |  |   |   |   |   |   |   |   |   |
|                                     | ED  |   | 08/85 → 04/89   | Mod. L80, L81  | —<br>VKM 77501  | 1<br>1  | 1   |   |   |   |   |   |
|   | ED  |   | 05/89 → 02/90   | Mod. L80   | VKMA 97007<br>VKM 77401   | 1<br>1  | 1   |   |   |   |   | T0696   |
| <b>DAIHATSU  L200 0.66</b>         |   |   |   |  |   |   |   |   |   |   |   |   |
|                                     | EF-CL   |   | 07/94 → 09/97   | Mod. L2#   | VKPC 97002  |   |   | 1   |   |   |   |   |
| <b>DAIHATSU  L201 0.85</b>         |   |   |   |  |   |   |   |   |   |   |   |   |
|                                     | ED-10   |   | 08/96 → 09/97   | Mod. L2#   | VKPC 97002  |   |   | 1   |   |   |   |   |
| <b>DAIHATSU  MATERIA 1.3</b>       |   |   |   |  |   |   |   |   |   |   |   |   |
|                                     | K3VE  |   | 10/06 → 01/08   | Mod. M401  | OXOXOXO   |   |   |   |   |   |   |   |
|                                     | K3VE  |   | 10/06 → 01/08   | Mod. M401, DOHC  | VKPC_____   |   |   | 1   |   |   |   |   |
| <b>DAIHATSU  MATERIA 1.5</b>      |   |   |   |  |   |   |   |   |   |   |   |   |
|                                   | 3SZV  |   | 10/06 → 01/08   | Mod. M402  | OXOXOXO   |   |   |   |   |   |   |   |
|                                   | 3SZV  |   | 10/06 → 01/08   | Mod. M402, DOHC  | VKPC_____   |   |   | 1   |   |   |   |   |
| <b>DAIHATSU  MATERIA 1.5 4WD</b> |   |   |   |  |   |   |   |   |   |   |   |   |
|                                   | 3SZV  |   | 10/06 → 01/08   | Mod. M412  | OXOXOXO   |   |   |   |   |   |   |   |
|                                   | 3SZV  |   | 10/06 → 01/08   | Mod. M412, DOHC  | VKPC_____   |   |   | 1   |   |   |   |   |
| <b>DAIHATSU  MIRA 0.55</b>       |   |   |   |  |   |   |   |   |   |   |   |   |
|                                   | EB  |   | 08/85 → 04/89   | Mod. L70V, L71V  | —<br>VKM 77501  | 1<br>1  | 1   |   |   |   |   |   |
|   | EB  |   | 04/89 → 02/90   | Mod. L70V, L71V  | —<br>VKM 77401  | 1<br>1  | 1   |   |   |   |   |   |
| <b>DAIHATSU  MIRA 0.85</b>       |   |   |   |  |   |   |   |   |   |   |   |   |
|                                   | ED  |   | 06/90 → 08/92   | Mod. L201  | VKMA 97007<br>VKM 77401   | 1<br>1  | 1   |   |   |   |   | T0696   |
|   | ED  |   | 09/92 → 03/94   | Mod. L201  | VKMA 97504<br>VKM 77401   | 1<br>1  | 1   |   |   |   |   | T0696   |
| <b>DAIHATSU  MOVE 0.8</b>        |   |   |   |  |   |   |   |   |   |   |   |   |
|                                   | ED20  |   | 01/97 → 09/98   | 3), Mod. L601, SOHC  | —<br>VKMA 97504<br>VKM 77401  | 1<br>1<br>1   | 1   |   |   | 2   |   | T0696   |
|                                   | ED20  |   | 01/97 → 09/98   | Mod. L601, SOHC  | VKPC 97002  |   |   | 1   |   |   |   |   |
| <b>DAIHATSU  MOVE 1.0</b>        |   |   |   |  |   |   |   |   |   |   |   |   |
|                                   | EJDE, EJVE  |   | 10/98 → 09/02   | 3), Mod. L901, DOHC  | VKMS 97505<br>VKMA 97505<br>VKM 77503   | 1<br>1<br>1   | 1   |   |   | 2   |   | T0613   |
|                                   | EJDE, EJVE  |   | 10/98 → 09/02   | Mod. L901, DOHC  | VKPC_____   |   |   | 1   |   |   |   |   |
|                                   | B(Alt)  | EJDE, EJVE  | 10/98 → 09/02   | Mod. L901, DOHC  | VKMOV_____  |   | 1   |   |   |   |   |   |
|   | B(WP)   | EJDE, EJVE  | 10/98 → 09/02   | Mod. L901, DOHC  | VKMOV_____  |   | 1   |   |   |   |   |   |
| <b>DAIHATSU  ROCKY 2.8 D/TD</b>  |   |   |   |  |   |   |   |   |   |   |   |   |
|                                   | DL  |   | 05/93 → 06/01   | Mod. F73, F78, SOHC  | VKMA_____   | 1   | 1   | 1   |   |   |   |   |
|                                   | DL  |   | 05/93 → 06/01   | Mod. F73, F78, SOHC  | VKPC_____   |   |   |   | 1   |   |   |   |
| <b>DAIHATSU  SIRION 1.0</b>      |   |   |   |  |   |   |   |   |   |   |   |   |
|                                   | 1KRF  |   | 01/05 → 12/06   | Mod. M300  | OXOXOXO   |   |   |   |   |   |   |   |
|   | EJDE, EJVE  |   | 04/98 → 01/05   | Mod. M100, DOHC  | VKMA 97505<br>VKM 77503   | 1<br>1  | 1   |   |   |   |   | T0613   |
|                                   | 1KRF  |   | 01/05 → 12/06   | Mod. M300, DOHC  | VKPC_____   |   |   | 1   |   |   |   |   |
|   | EJDE, EJVE  |   | 04/98 → 01/05   | Mod. M100, DOHC  | VKPC_____   |   |   | 1   |   |   |   |   |
|                                   | B(Alt)  | EJDE, EJVE  | 04/98 → 01/05   | Mod. M100, DOHC  | VKMOV_____  |   | 1   |   |   |   |   |   |































|  |  |  |  |  |  |  |  |  |  |  |  |
|--|---|---|---|--|---|---|---|---|---|---|---|
|  | B(WP) EJDE, EJVE  | 04/98 → 01/05   | Mod. M100, DOHC   | VKMV _____   |   |   | 1   |   |   |   |   |
| <b>DAIHATSU  SIRION 1.0 4WD</b>         |   |   |   |  |   |   |   |   |   |   |   |
|   | EJDE, EJVE  | 04/99 → 01/05   | Mod. M110, DOHC   | VKMA 97505<br>VKM 77503  | 1<br>1  |   | 1   |   |   |   | T0613   |
|   | EJDE, EJVE  | 04/99 → 01/05   | Mod. M110, DOHC   | VKPC _____   |   |   |   | 1   |   |   |   |
|   | B(Alt) EJDE, EJVE   | 04/99 → 01/05   | Mod. M110, DOHC   | VKMV _____   |   |   | 1   |   |   |   |   |
|  | B(WP) EJDE, EJVE  | 04/99 → 01/05   | Mod. M110, DOHC   | VKMV _____   |   |   | 1   |   |   |   |   |
| <b>DAIHATSU  SIRION 1.3</b>             |   |   |   |  |   |   |   |   |   |   |   |
|   | K3VE  | 01/05 → 03/07   | Mod. M301   | XXXXXXXXXX   |   |   |   |   |   |   |   |
|   | K3VE  | 01/05 → 03/07   | Mod. M301, DOHC   | VKPC _____   |   |   |   | 1   |   |   |   |
|   | B(Alt) K3VE   | 01/05 → 06/07   | Mod. M301, DOHC, AC   | VKMA _____<br>VKMV _____<br>VKM 67000<br>VKM _____                                 |   | 2   | 1   |   |   |   |   |
|  |   |   |   |  |   |   | 1   |   |   |   |   |
|  |   |   |   |  |   |   | 1   |   |   |   |   |
|  | B(AC) K3VE  | 01/05 → 06/07   | Mod. M301, DOHC   | VKMA _____<br>VKMV _____<br>VKM 67000<br>VKM _____                                 |   | 2   | 1   |   |   |   |   |
|  |   |   |   |  |   |   | 1   |   |   |   |   |
|  |   |   |   |  |   |   | 1   |   |   |   |   |
| <b>DAIHATSU  SIRION 1.3 Sport</b>       |   |   |   |  |   |   |   |   |   |   |   |
|   | K3VE  | 08/00 → 08/04   | Mod. M101   | XXXXXXXXXX   |   |   |   |   |   |   |   |
|   | K3VE  | 08/00 → 08/04   | Mod. M101, DOHC   | VKPC _____   |   |   |   | 1   |   |   |   |
|   | B(Alt) K3VE   | 08/00 → 08/04   | Mod. M101, DOHC, AC   | VKMA _____<br>VKMV _____<br>VKM _____  |   | 1   | 1   |   |   |   |   |
|  |   |   |   |  |   |   | 1   |   |   |   |   |
|  | B(AC) K3VE  | 08/00 → 08/04   | Mod. M101, DOHC   | VKMA _____<br>VKMV _____<br>VKM _____  |   | 1   | 1   |   |   |   |   |
|  |   |   |   |  |   |   | 1   |   |   |   |   |
| <b>DAIHATSU  SIRION 1.3 Sport 4WD</b> |   |   |   |  |   |   |   |   |   |   |   |
|                                       | K3VE  | 08/00 → 08/04   | Mod. M111   | XXXXXXXXXX   |   |   |   |   |   |   |   |
|                                       | K3VE  | 08/00 → 08/04   | Mod. M111, DOHC   | VKPC _____   |   |   |   | 1   |   |   |   |
|                                       | B(Alt) K3VE   | 08/00 → 08/04   | Mod. M111, DOHC, AC   | VKMA _____<br>VKMV _____<br>VKM _____  |   | 1   | 1   |   |   |   |   |
|  |   |   |   |  |   |   | 1   |   |   |   |   |
|  | B(AC) K3VE  | 08/00 → 08/04   | Mod. M111, DOHC   | VKMA _____<br>VKMV _____<br>VKM _____  |   | 1   | 1   |   |   |   |   |
|  |   |   |   |  |   |   | 1   |   |   |   |   |
| <b>DAIHATSU  SPORTRAK 1.6</b>         |   |   |   |  |   |   |   |   |   |   |   |
|                                       | HD  | 10/88 → 07/03   | Mod. F300, F310   | VKPC 97201   |   |   |   | 1   |   |   |   |
| <b>DAIHATSU  TERIOS 1.3</b>           |   |   |   |  |   |   |   |   |   |   |   |
|                                       | K3VE  | 09/01 → 10/05   | Mod. J122   | XXXXXXXXXX   |   |   |   |   |   |   |   |
|                                       | K3VE  | 09/01 → 12/05   | Mod. J122, DOHC   | VKPC _____   |   |   |   | 1   |   |   |   |
|                                       | B(PS) K3VE  | 09/01 → 10/05   | Mod. J122, DOHC   | VKMV _____   |   |   | 1   |   |   |   |   |
|  | B(AC) K3VE  | 09/01 → 05/04   | Mod. J122, DOHC   | VKMA _____<br>VKMV _____<br>VKM 67000<br>VKM _____                                 |   | 2   | 1   |   |   |   |   |
|  |   |   |   |  |   |   | 1   |   |   |   |   |
|  |   |   |   |  |   |   | 1   |   |   |   |   |
|  | B(AC) K3VE  | 06/04 → 10/05   | Mod. J122, DOHC   | VKMA _____<br>VKMV _____<br>VKM 67000<br>VKM _____                                 |   | 2   | 1   |   |   |   |   |
|  |   |   |   |  |   |   | 1   |   |   |   |   |
|  |   |   |   |  |   |   | 1   |   |   |   |   |
| <b>DAIHATSU  TERIOS 1.3 4WD</b>       |   |   |   |  |   |   |   |   |   |   |   |
|                                       | K3VE  | 10/00 → 10/05   | Mod. J102   | XXXXXXXXXX   |   |   |   |   |   |   |   |
|  | HCEJ  | 10/97 → 05/00   | 3), Mod. J100, SOHC   | VKMS 97503<br>VKMA 97503<br>VKM 77500  | 1<br>1<br>1   |   | 1   |   |   | 2   | T0696   |
|                                       | HCEJ  | 10/97 → 05/00   | Mod. J100, SOHC   | VKPC 97201   |   |   |   | 1   |   |   |   |
|  | K3VE  | 10/00 → 10/05   | Mod. J102, DOHC   | VKPC _____   |   |   |   | 1   |   |   |   |
|                                       | B(PS) HCEJ  | 10/97 → 10/00   | Mod. J100, SOHC, AC   | VKMV _____   |   |   | 1   |   |   |   |   |
|  | B(AC) HCEJ  | 10/97 → 10/00   | Mod. J100, SOHC   | VKMA _____<br>VKMV _____<br>VKM _____  |   | 1   | 1   |   |   |   |   |
|  |   |   |   |  |   |   | 1   |   |   |   |   |























|   |                   |               |                     |  |  |  |  |  |  |  |  |  |  |
|---|-------------------|---------------|---------------------|--|---|---|---|---|---|---|---|---|---|
| B(AC)   | K3VE              | 10/00 → 05/04 | Mod. J102, DOHC     | VKMA____<br>VKMV____<br>VKM 67000  | 2   | 1   |   |   |   |   |   |   |   |
|   |                   |               |                     | VKM____  | 1   | 1   |   |   |   |   |   |   |   |
| B(AC)   | K3VE              | 06/04 → 10/05 | Mod. J102, DOHC     | VKMA____<br>VKMV____<br>VKM 67000  | 2   | 1   |   |   |   |   |   |   |   |
|   |                   |               |                     | VKM____  | 1   | 1   |   |   |   |   |   |   |   |
| B(WP)   | HCEJ              | 10/97 → 10/00 | Mod. J100, SOHC     | VKMV 4PK780  |   | 1   |   |   |   |   |   |   |   |
| B(WP)   | K3VE              | 10/00 → 10/05 | Mod. J102, DOHC     | VKMV____   |   | 1   |   |   |   |   |   |   |   |
| <b>DAIHATSU</b>  <b>TERIOS 1.5</b>     |                   |               |                     |  |   |   |   |   |   |   |   |   |   |
|   | 3SZV              | 11/05 → 01/08 | Mod. J200           | <del>OKOKOKO</del>   |   |   |   |   |   |   |   |   |   |
|   | 3SZV              | 11/05 → 01/08 | Mod. J200, DOHC     | VKPC____   |   |   |   |   | 1   |   |   |   |   |
| <b>DAIHATSU</b>  <b>TERIOS 1.5 4WD</b> |                   |               |                     |  |   |   |   |   |   |   |   |   |   |
|   | 3SZV              | 05/06 → 01/08 | Mod. J210           | <del>OKOKOKO</del>   |   |   |   |   |   |   |   |   |   |
|   | 3SZV              | 05/06 → 01/08 | Mod. J210, DOHC     | VKPC____   |   |   |   |   | 1   |   |   |   |   |
| <b>DAIHATSU</b>  <b>TREVIS 1.0</b>     |                   |               |                     |  |   |   |   |   |   |   |   |   |   |
|   | EJVE              | 06/06 → 01/08 | Mod. L651, DOHC     | VKMA 97505<br>VKM 77503  | 1   | 1   |   |   |   |   |   |   | T0613   |
|   |                   |               |                     | VKM____  | 1   |   |   |   |   |   |   |   |   |
|   | EJVE              | 06/06 → 10/07 | Mod. L651, DOHC     | VKPC____   |   |   |   |   | 1   |   |   |   |   |
|   | B(Alt) EJVE       | 06/06 → 01/08 | Mod. L651, DOHC     | VKMV____   |   | 1   |   |   |   |   |   |   |   |
| <b>DAIHATSU</b>  <b>YRV 1.0</b>        |                   |               |                     |  |   |   |   |   |   |   |   |   |   |
|   | EJVE              | 02/01 → 08/05 | Mod. M200, DOHC     | VKMA 97505<br>VKM 77503  | 1   | 1   |   |   |   |   |   |   | T0613   |
|   |                   |               |                     | VKM____  | 1   |   |   |   |   |   |   |   |   |
|                                        | EJVE              | 02/01 → 08/05 | Mod. M200, DOHC     | VKPC____   |   |   |   |   | 1   |   |   |   |   |
|                                       | B(Alt) EJVE       | 02/01 → 08/05 | Mod. M200, DOHC     | VKMV____   |   | 1   |   |   |   |   |   |   |   |
|                                       | B(WP) EJVE        | 02/01 → 08/05 | Mod. M200, DOHC     | VKMV____   |   | 1   |   |   |   |   |   |   |   |
| <b>DAIHATSU</b>  <b>YRV 1.3</b>      |                   |               |                     |  |   |   |   |   |   |   |   |   |   |
|                                       | K3VE, K3VT        | 02/01 → 08/05 | Mod. M201           | <del>OKOKOKO</del>   |   |   |   |   |   |   |   |   |   |
|                                       | K3VE, K3VT        | 02/01 → 08/05 | Mod. M201, DOHC     | VKPC____   |   |   |   |   | 1   |   |   |   |   |
|                                       | B(Alt) K3VE, K3VT | 02/01 → 08/05 | Mod. M201, DOHC, AC | VKMA____<br>VKMV____<br>VKM____  | 1   | 1   |   |   |   |   |   |   |   |
|   |                   |               |                     | VKM____  | 1   | 1   |   |   |   |   |   |   |   |
| B(AC)   | K3VE, K3VT        | 02/01 → 08/05 | Mod. M201, DOHC     | VKMA____<br>VKMV____<br>VKM____  | 1   | 1   |   |   |   |   |   |   |   |
|   |                   |               |                     | VKM____  | 1   | 1   |   |   |   |   |   |   |   |
| <b>DAIHATSU</b>  <b>YRV 1.3 4WD</b>  |                   |               |                     |  |   |   |   |   |   |   |   |   |   |
|                                       | K3VE              | 02/01 → 08/05 | Mod. M211           | <del>OKOKOKO</del>   |   |   |   |   |   |   |   |   |   |
|                                       | K3VE              | 02/01 → 08/05 | Mod. M211, DOHC     | VKPC____   |   |   |   |   | 1   |   |   |   |   |
|                                       | B(Alt) K3VE       | 02/01 → 08/05 | Mod. M211, DOHC, AC | VKMA____<br>VKMV____<br>VKM____  | 1   | 1   |   |   |   |   |   |   |   |
|   |                   |               |                     | VKM____  | 1   | 1   |   |   |   |   |   |   |   |
| B(AC)   | K3VE              | 02/01 → 08/05 | Mod. M211, DOHC     | VKMA____<br>VKMV____<br>VKM____  | 1   | 1   |   |   |   |   |   |   |   |
|   |                   |               |                     | VKM____  | 1   | 1   |   |   |   |   |   |   |   |
| <b>DAIHATSU</b>  <b>HIJET 0.55</b>   |                   |               |                     |  |   |   |   |   |   |   |   |   |   |
|                                       | AB                | 04/81 → 05/82 | Mod. S65            | —<br>VKM 77100   | 1   | 1   |   |   |   |   |   |   |   |
|   |                   |               |                     | VKM____  | 1   | 1   |   |   |   |   |   |   |   |
|   | EB                | 05/86 → 04/89 | Mod. S80, S81       | —<br>VKM 77501   | 1   | 1   |   |   |   |   |   |   |   |
|   |                   |               |                     | VKM____  | 1   | 1   |   |   |   |   |   |   |   |
|   | EB                | 04/89 → 02/90 | Mod. S80, S81       | —<br>VKM 77401   | 1   | 1   |   |   |   |   |   |   |   |
|   |                   |               |                     | VKM____  | 1   | 1   |   |   |   |   |   |   |   |
| <b>DAIHATSU</b>  <b>HIJET 0.85</b>   |                   |               |                     |  |   |   |   |   |   |   |   |   |   |
|                                       | CD                | 05/82 → 05/86 | Mod. S70            | VKMA 97300<br>VKM 77300  | 1   | 1   |   |   |   |   |   |   | T0696   |
|   |                   |               |                     | VKM____  | 1   | 1   |   |   |   |   |   |   |   |
| <b>DAIHATSU</b>  <b>HIJET 1.0</b>    |                   |               |                     |  |   |   |   |   |   |   |   |   |   |
|                                       | CB                | 11/83 → 05/86 | Mod. S75, S76       | VKMA 97300<br>VKM 77300  | 1   | 1   |   |   |   |   |   |   | T0696   |
|   |                   |               |                     | VKM____  | 1   | 1   |   |   |   |   |   |   |   |
|   | CB                | 12/92 → 07/94 | Mod. S85            | VKMA 97009<br>VKM 77300  | 1   | 1   |   |   |   |   |   |   | T0696   |
|   |                   |               |                     | VKM____  | 1   | 1   |   |   |   |   |   |   |   |

| <b>DAIHATSU  ROCKY 1.6</b>      |                                       |               |                 |  |                  |             |   |   |  |  |  |       |
|---------------------------------|---------------------------------------|---------------|-----------------|--|------------------|-------------|---|---|--|--|--|-------|
|                                 | HDE                                   | 07/90 → 05/92 | Mod. F300S      | VKMA 97501<br>VKM 77500                            | 1<br>1           | 1           |   |   |  |  |  | T0696 |
| <b>DAIHATSU  ROCKY 2.3</b>      |                                       |               |                 |  |                  |             |   |   |  |  |  |       |
|                                 | 4Y                                    | 05/93 → 06/01 | Mod. F98        | <b>OXOXOXO</b>                                     |                  |             |   |   |  |  |  |       |
| <b>FIAT  500 1.2</b>            |                                       |               |                 |  |                  |             |   |   |  |  |  |       |
|                                 | 169 A4.000                            | 10/07 → 10/07 |                 | VKMA _____<br>VKM 12206                            | 1<br>1           | 1           |   |   |  |  |  | T0250 |
|                                 | 169 A4.000                            | 10/07 → 10/07 |                 | VKPC 82251   |                  |             |   | 1 |  |  |  |       |
|                                 | B(Alt) 169 A4.000                     | 10/07 → 10/07 | AC              | VKMV 4PK668  |                  | 1           |   |   |  |  |  |       |
|                                 | B(Alt) 169 A4.000                     | 10/07 → 10/07 | AC              | VKMA 32040<br>VKMV 5PK1145<br>VKM 32023            | 1<br><br>1       | 1<br>1      |   |   |  |  |  |       |
| <b>FIAT  500 1.4</b>            |                                       |               |                 |  |                  |             |   |   |  |  |  |       |
|                                 | 169 A3.000                            | 10/07 → 10/07 |                 | VKMA 02204<br>VKM 12201                            | 1<br>1           | 1           |   |   |  |  |  | T0160 |
|                                 | 169 A3.000                            | 10/07 → 10/07 |                 | VKPC 82251   |                  |             |   | 1 |  |  |  |       |
|                                 | B(Alt) 169 A3.000                     | 10/07 → 10/07 | AC              | VKMV 4PK668  |                  | 1           |   |   |  |  |  |       |
|                                 | B(Alt) 169 A3.000                     | 10/07 → 10/07 | AC              | VKMA 32040<br>VKMV 5PK1145<br>VKM 32023            | 1<br><br>1       | 1<br>1      |   |   |  |  |  |       |
| <b>FIAT  500 1.3 D Multijet</b> |                                       |               |                 |  |                  |             |   |   |  |  |  |       |
|                                 | 169 A1.000                            | 10/07 → 10/07 |                 | <b>OXOXOXO</b>                                     |                  |             |   |   |  |  |  |       |
|                                 | 169 A1.000                            | 10/07 → 10/07 |                 | VKPC 85700   |                  |             |   | 1 |  |  |  |       |
|                                 | B(Alt) 169 A1.000                     | 10/07 → 10/07 | AC              | VKMV 6PK1180<br>VKM 32080                          | 1                | 1           |   |   |  |  |  |       |
|                                 | B(Alt) 169 A1.000                     | 10/07 → 10/07 | AC              | VKMV 6PK1310<br>VKM 32080                          | 1                | 1           |   |   |  |  |  |       |
| <b>FIAT  ARGENTA 1.6</b>        |                                       |               |                 |  |                  |             |   |   |  |  |  |       |
|                                 | 132 D.000                             | 04/81 → 12/85 | →IMot. 1480467  | —<br>VKM 12001                                     | 1                |             |   |   |  |  |  |       |
|                                 | 132 D.000                             | 04/81 → 12/85 | Mot. 1480468 I→ | —<br>VKM 12003                                     | 1                |             |   |   |  |  |  |       |
| <b>FIAT  ARGENTA 2.0</b>        |                                       |               |                 |  |                  |             |   |   |  |  |  |       |
|                                 | 132 C2.000, 132 C3.000,<br>132 D1.000 | 01/81 → 12/83 |                 | —<br>VKM 12001                                     | 1                |             |   |   |  |  |  |       |
|                                 | 132 C2.000, 132 C3.000,<br>132 D1.000 | 01/84 → 07/86 |                 | —<br>VKM 12012                                     | 1                |             |   |   |  |  |  |       |
|                                 | 132 C3.000                            | 01/83 → 07/86 |                 | VKPC 82412   |                  |             |   | 1 |  |  |  |       |
| <b>FIAT  ARGENTA 2.5 D</b>      |                                       |               |                 |  |                  |             |   |   |  |  |  |       |
|                                 | 8144.61                               | 06/81 → 11/85 |                 | VKMA 02381<br>VKM 22380<br>VKM 22385               | 2<br>1<br>1      | 1           |   |   |  |  |  | T0014 |
|                                 | 8144.61                               | 06/81 → 11/85 |                 | VKPC 82606   |                  |             |   | 1 |  |  |  |       |
| <b>FIAT  ARGENTA 2.5 TD</b>     |                                       |               |                 |  |                  |             |   |   |  |  |  |       |
|                                 | 8144.61.500.81                        | 07/83 → 08/85 |                 | VKMA 02381<br>VKM 22380<br>VKM 22385               | 2<br>1<br>1      | 1           |   |   |  |  |  | T0014 |
| <b>FIAT  BARCHETTA 1.8 16V</b>  |                                       |               |                 |  |                  |             |   |   |  |  |  |       |
|                                 | 183 A1.000                            | 04/95 → 05/98 | →IVETTno 37640  | VKMC 02177<br>VKMA 02177<br>VKM 12173<br>VKM 22177 | 1<br>1<br>1<br>1 | 1<br>1<br>1 | 1 | 1 |  |  |  | T0128 |
|                                 | 183 A1.000                            | 06/98 → 12/05 | VETTno 37641 I→ | VKMC 02183<br>VKMA 02183<br>VKM 12182<br>VKM 22177 | 1<br>1<br>1<br>1 | 1<br>1<br>1 | 1 | 1 |  |  |  | T0128 |
|                                 | 188 A6.000                            | 04/95 → 05/98 | →IVETTno 37640  | VKMA 02186<br>VKM 12173<br>VKM 22177               | 1<br>1<br>1      | 1           | 1 |   |  |  |  | T0143 |



































|   |  |  |                   |  |  |  |  |  |  |  |  |  |
|---|---|---|--|--|---|---|---|---|---|---|---|---|
|   | 188 A6.000  | 06/98 → 12/05   | VETTno 37641  →  | VKMA 02184<br>VKM 12182<br>VKM 22177   | 1<br>1  | 1   | 1   |   |   |   |   | T0143   |
|   | 183 A1.000  | 04/95 → 12/06   |  | VKPC 82645   |   |   |   | 1   |   |   |   |   |
|   | 188 A6.000  | 04/95 → 12/06   |  | VKPC 82451   |   |   |   | 1   |   |   |   |   |
|   | <b>B(Alt)</b> 183 A1.000  | 04/95 → 12/06   | AC   | VKMA 32022<br>VKMV 6PK1045<br>VKM 32022  | 1   |   | 1   |   |   |   |   |   |
|   | <b>B(Alt)</b> 183 A1.000  | 04/95 → 12/06   | AC   | VKMA 32020<br>VKMV 6PK1842<br>VKM 32001<br>VKM 32022                               | 1   | 1   | 1   |   | 1   |   |   |   |
|   | <b>B(Alt)</b> 188 A6.000  | 04/95 → 12/06   | AC, →IMot. 2988825   | VKMA 32022<br>VKMV 6PK1045<br>VKM 32022  | 1   |   | 1   |   | 1   |   |   |   |
|   | <b>B(Alt)</b> 188 A6.000  | 04/95 → 12/06   | AC, Mot. 2988826  →  | VKM 32022  | 1   |   |   |   |   |   |   |   |
|   | <b>B(Alt)</b> 188 A6.000  | 04/95 → 12/05   | AC   | VKMV 6PK1795<br>VKM 32001<br>VKM 32022   |   | 1   | 1   |   |   |   |   |   |
| <b>FIAT  BRAVA/BRAVO (182) 1.2 16V</b>   |   |   |  |  |   |   |   |   |   |   |   |   |
|   | 182 B2.000  | 12/98 → 04/99   |                   | —<br>VKMA 02204<br>VKM 12201   | 1<br>1  | 1   | 1   | 1   |   |   |   | T0160   |
|   | 182 B2.000, 188 A5.000  | 05/99 → 10/01   |                   | —<br>VKMA 02204<br>VKM 12201   | 1<br>1  | 1   | 1   | 1   |   |   |   | T0160   |
|    | 182 B2.000  | 12/98 → 04/99   |  | VKPC 82249   |   |   |   | 1   |   |   |   |   |
|   | 182 B2.000, 188 A5.000  | 05/99 → 10/01   |  | VKPC 82251   |   |   |   | 1   |   |   |   |   |
|   | <b>B(Alt)</b> 182 B2.000, 188 A5.000  | 12/98 → 10/01   | AC   | VKMV 4PK675  |   |   | 1   |   |   |   |   |   |
|   | <b>B(Alt)</b> 182 B2.000  | 12/98 → 10/00   | AC   | VKMV 4PK698  |   |   | 1   |   |   |   |   |   |
|   | <b>B(Alt)</b> 188 A5.000  | 10/00 → 10/01   | AC   | VKMA 32034<br>VKMV 5PK1585<br>VKM 32033<br>VKM 32034                               | 1   | 1   | 1   |   |   |   |   |   |
|   | <b>B(PS)</b> 182 B2.000   | 12/98 → 10/00   |  | VKMV 3PK915  |   |   | 1   |   |   |   |   |   |
|   | <b>B(PS)</b> 188 A5.000   | 10/00 → 10/01   | AC   | VKMV 3PK915  |   |   | 1   |   |   |   |   |   |
|   | <b>B(AC)</b> 182 B2.000   | 12/98 → 10/00   |  | VKMV 4PK841  |   |   | 1   |   |   |   |   |   |
| <b>FIAT  BRAVA/BRAVO (182) 1.4 12V</b> |   |   |  |  |   |   |   |   |   |   |   |   |
|   | 182 A3.000, 182 A5.000  | 10/95 → 10/01   |  →IMot. 705144  | —<br>VKMA 02215<br>VKM 12215   | 1<br>1  | 1   | 1   | 1   |   |   |   | T0129   |
|   | 182 A3.000, 182 A5.000  | 10/95 → 10/01   |  Mot. 705145  → | —<br>VKMA 02215<br>VKM 12215   | 1<br>1  | 1   | 1   | 1   |   |   |   | T0129   |
|   | 182 A3.000, 182 A5.000  | 10/95 → 10/01   | 3)   | VKMS 02215<br>VKMA 02215<br>VKM 12215  | 1<br>1  | 1   | 1   |   |   | 2   |   | T0129   |
|   | 182 A3.000, 182 A5.000  | 10/95 → 10/01   | →IMot. 705144  | VKPC 82437   |   |   |   | 1   |   |   |   |   |
|   | 182 A3.000, 182 A5.000  | 10/95 → 10/01   | Mot. 705145  →   | VKPC 82247   |   |   |   | 1   |   |   |   |   |
|   | <b>B(Alt)</b> 182 A3.000, 182 A5.000  | 10/95 → 10/01   |                 | VKMV 4PK755  |   |   | 1   |   |   |   |   |   |
|   | <b>B(Alt)</b> 182 A3.000, 182 A5.000  | 10/95 → 10/01   | AC,             | VKMA 32022<br>VKMV 6PK1045<br>VKM 32022  | 1   |   | 1   |   |   |   |   |   |
|   | <b>B(Alt)</b> 182 A3.000, 182 A5.000  | 10/95 → 10/01   | AC,             | VKMA 32020<br>VKMV 6PK1842<br>VKM 32001<br>VKM 32022                               | 1   | 1   | 1   |   | 1   |   |   |   |
| <b>FIAT  BRAVA/BRAVO (182) 1.6 16V</b> |   |   |  |  |   |   |   |   |   |   |   |   |
|   | 178 A8.011, 182 A4.000,<br>182 A4.027,<br>182 A6.000, 182 B6.000                  | 10/95 → 07/99   | 3)   | VKMS 02242-1<br>VKMA 02242<br>VKM 12242<br>VKM 22242                               | 1<br>1  | 1<br>1  | 1<br>1  |   |   | 4   |   | T0130   |

|   |  |  |    |  |  |  |  |  |  |  |
|---|---|---|---|--|---|---|---|---|---|---|
|   | 178 A8.011, 182 A4.000,<br>182 A4.027,<br>182 A6.000, 182 B6.000                  | 08/99 → 10/01   | 3)  | VKMS 02242-2<br>VKMA 02242<br>VKM 12242<br>VKM 22242                               | 1<br>1<br>1   | 1<br>1  |   |   | 4   | T0130   |
|    | 178 A8.011, 182 A4.000,<br>182 A4.027,<br>182 A6.000, 182 B6.000                  | 10/95 → 10/01   | 2)  | VKPA 82441<br>VKPC 82441   |   |   |   |   | 1<br>1  |   |
|    | <b>B(Alt)</b> 178 A8.011, 182 A4.000,<br>182 A4.027,<br>182 A6.000, 182 B6.000    | 10/95 → 02/00   |   | VKMV 5PK938<br>VKM 32242   |   | 1   |   |   |   |   |
|   | <b>B(Alt)</b> 178 A8.011, 182 A4.000,<br>182 A4.027,<br>182 A6.000, 182 B6.000    | 03/00 → 10/01   |   | VKMV 5PK938<br>VKM 32243   | 1   |   | 1   |   |   |   |
|   | <b>B(PS)</b> 178 A8.011, 182 A4.000,<br>182 A4.027,<br>182 A6.000, 182 B6.000     | 10/95 → 10/01   |   | VKMV 3PK668  |   |   | 1   |   |   |   |
|   | <b>B(AC)</b> 178 A8.011, 182 A4.000,<br>182 A4.027,<br>182 A6.000, 182 B6.000     | 10/95 → 02/00   |   | VKMV 4PK962<br>VKM 32242   |   | 1   |   | 1   |   |   |
|   | <b>B(AC)</b> 178 A8.011, 182 A4.000,<br>182 A4.027,<br>182 A6.000, 182 B6.000     | 03/00 → 10/01   |   | VKMV 4PK962<br>VKM 32243   |   | 1   |   | 1   |   |   |
| <b>FIAT  BRAVA/BRAVO (182) 1.8 16V</b> |   |   |   |  |   |   |   |   |   |   |
|                                        | 182 A2.000  | 10/95 → 10/01   |  | VKMC 02183<br>VKMA 02183<br>VKM 12182<br>VKM 22177                                 | 1<br>1<br>1   | 1<br>1  | 1   | 1   |   | T0128   |
|                                        | 182 A2.000  | 10/95 → 10/01   |   | VKPC 82645   |   |   |   | 1   |   |   |
|                                        | <b>B(Alt)</b> 182 A2.000  | 10/95 → 10/01   | <b>AC</b>   | VKMA 32022<br>VKMV 6PK1045<br>VKM 32022  | 1   |   | 1   | 1   |   |   |
|   | <b>B(Alt)</b> 182 A2.000  | 10/95 → 07/99   | <b>AC, →IVETTno 4873621</b>   | VKMA 32020<br>VKMV 6PK1842<br>VKM 32001<br>VKM 32022                               | 1   | 1   | 1   | 1   |   |   |
|   | <b>B(Alt)</b> 182 A2.000  | 08/99 → 10/01   | <b>AC, VETTno 4873622 I→</b>  | VKMV 6PK1855<br>VKM 32001<br>VKM 32022   |   | 1   |   | 1   |   |   |
| <b>FIAT  BRAVA/BRAVO (182) 2.0 20V</b> |   |   |   |  |   |   |   |   |   |   |
|                                        | 182 A1.000, 182 B7.000  | 10/95 → 10/01   |   | VKMA 02172<br>VKM 12172<br>VKM 22174   | 1<br>1  | 1   | 1   |   |   | T0075   |
|                                        | 182 A1.000, 182 B7.000  | 10/95 → 10/01   |   | VKPC 82646   |   |   |   | 1   |   |   |
|                                        | <b>B(Alt)</b> 182 A1.000, 182 B7.000  | 10/95 → 10/01   | <b>AC</b>   | VKMV 6PK703  |   |   | 1   |   |   |   |
|   | <b>B(Alt)</b> 182 A1.000  | 10/95 → 07/98   | <b>AC, →IMot. 517623</b>  | VKM 32002  |   | 1   |   |   |   |   |
|   | <b>B(Alt)</b> 182 A1.000  | 10/95 → 07/98   | <b>AC, Mot. 517624 I→</b>   | VKM 32002<br>VKM 32005<br>VKM 32015  |   |   | 1<br>1  |   |   |   |
|   | <b>B(Alt)</b> 182 B7.000  | 07/98 → 10/01   | <b>AC</b>   | VKM 32002<br>VKM 32005<br>VKM 32015  |   |   | 1<br>1  |   |   |   |
|   | <b>B(PS)</b> 182 A1.000   | 10/95 → 07/98   | <b>→IMot. 1140488</b>   | VKMV 6PK1139<br>VKM 32005<br>VKM 32015   |   |   | 1   |   |   |   |
|   | <b>B(PS)</b> 182 A1.000   | 10/95 → 07/98   | <b>Mot. 1140489 I→</b>  | VKMV 6PK1139<br>VKM 32015<br>VKM 32036   |   |   | 1   |   | 1   |   |





































FIAT

|  |        |  |  |    |  |  |  |  |  |  |  |  |  |
|--|--------|---|---|---|--|---|---|---|---|---|---|---|---|
|  | B(PS)  | 182 B7.000  | 07/98 → 10/01   |   | VKMC 6PK1139<br>VKM 32015<br>VKM 32036   | 1   | 1   |   |   |   |   |   |   |
| <b>FIAT  BRAVA/BRAVO (182) 1.9 D</b>        |        |   |   |   |  |   |   |   |   |   |   |   |   |
|    |        | 160 A7.000  | 10/95 → 10/01   |   | VKMA 02154<br>VKM 12153<br>VKM 22153   | 1<br>1  | 1   | 1   |   |   |   |   | T0055   |
|    |        | 160 A7.000  | 10/95 → 10/01   | 2)  | VKPA 82240   |   |   |   | 1   |   |   |   |   |
|    | B(Alt) | 160 A7.000  | 10/95 → 10/01   | AC  | VKMC 6PK986<br>VKM 32154   |   | 1   |   |   |   |   |   |   |
|  | B(PS)  | 160 A7.000  | 10/95 → 10/01   |   | VKMC 10AVx650  |   |   | 1   |   |   |   |   |   |
|  | B(AC)  | 160 A7.000  | 10/95 → 10/01   |   | VKMC 5PK938  |   |   | 1   |   |   |   |   |   |
| <b>FIAT  BRAVA/BRAVO (182) 1.9 TD 75</b>    |        |   |   |   |  |   |   |   |   |   |   |   |   |
|    |        | 182 A8.000  | 03/96 → 10/01   |    | VKMC 02174<br>VKMA 02174<br>VKM 12174<br>VKM 22179                                 | 1<br>1<br>1   | 1<br>1  | 1<br>1  |   | 1   |   |   | 2<br>2<br>2<br>T0140  |
|    |        | 182 A8.000  | 03/96 → 10/01   |   | VKPC 82665   |   |   |   | 1   |   |   |   |   |
|    | B(Alt) | 182 A8.000  | 03/96 → 10/01   | AC, →IMot. 1865932  | VKMC 6PK1036<br>VKM 32022  | 1   |   | 1   |   |   |   |   |   |
|  | B(Alt) | 182 A8.000  | 03/96 → 10/01   | AC, Mot. 1865933 I→   | VKMC 6PK1036<br>VKM 32027  | 1   |   | 1   |   |   |   |   |   |
|  | B(Alt) | 182 A8.000  | 03/96 → 10/01   | AC, →IMot. 1865932  | VKMA 32050<br>VKMC 6PK1830<br>VKM 32006<br>VKM 32022                               | 1<br>1<br>1   | 1   | 1<br>1  |   |   |   |   |   |
|  | B(Alt) | 182 A8.000  | 03/96 → 10/01   | AC, Mot. 1865933 I→   | VKMA 32039<br>VKMC 6PK1836<br>VKM 32006<br>VKM 32027                               | 1<br>1<br>1   | 1   | 1<br>1  |   |   |   |   |   |
|    |        | 182 A8.000  | 03/96 → 10/01   |   | VKM _____  |   |   |   |   | 1   |   |   |   |
| <b>FIAT  BRAVA/BRAVO (182) 1.9 TD 100</b> |        |   |   |   |  |   |   |   |   |   |   |   |   |
|    |        | 182 A7.000  | 03/96 → 10/01   |  | VKMC 02174<br>VKMA 02174<br>VKM 12174<br>VKM 22179                                 | 1<br>1<br>1   | 1<br>1  | 1<br>1  |   | 1   |   |   | 2<br>2<br>2<br>T0140  |
|    |        | 182 A7.000  | 03/96 → 10/01   |   | VKPC 82665   |   |   |   | 1   |   |   |   |   |
|    | B(Alt) | 182 A7.000  | 03/96 → 10/01   | AC  | VKMC 6PK1036<br>VKM 32022  | 1   |   | 1   |   |   |   |   |   |
|  | B(Alt) | 182 A7.000  | 03/96 → 10/01   | AC  | VKMA 32050<br>VKMC 6PK1830<br>VKM 32006<br>VKM 32022                               | 1<br>1<br>1   | 1   | 1<br>1  |   |   |   |   |   |
|    |        | 182 A7.000  | 03/96 → 10/01   |   | VKM _____  |   |   |   |   | 1   |   |   |   |
| <b>FIAT  BRAVA/BRAVO (182) 1.9 JTD</b>    |        |   |   |   |  |   |   |   |   |   |   |   |   |
|    |        | 182 B4.000, 182 B9.000  | 12/98 → 10/01   |  | VKMC 02179<br>VKMA 02179<br>VKM 12174<br>VKM 22179                                 | 1<br>1<br>1   | 1<br>1  | 1<br>1  |   | 1   |   |   | 2<br>2<br>2<br>T0158  |
|    |        | 182 B4.000, 182 B9.000  | 12/98 → 10/01   |   | VKPC 82665   |   |   |   | 1   |   |   |   |   |
|    | B(Alt) | 182 B4.000, 182 B9.000  | 12/98 → 10/01   | AC  | VKMA 32027<br>VKMC 6PK1036<br>VKM 32027  | 1<br>1  |   | 1<br>1  |   |   |   |   |   |
|  | B(Alt) | 182 B4.000  | 12/98 → 02/99   | AC, →IMot. 1370829  | VKMA 32028<br>VKMC 6PK1775<br>VKM 32006<br>VKM 32027                               | 1<br>1<br>1   | 1   | 1<br>1  |   |   |   |   |   |
|  | B(Alt) | 182 B4.000  | 03/99 → 10/01   | AC, Mot. 1370830 I→   | VKMA 32029<br>VKMC 6PK1795<br>VKM 32006<br>VKM 32027                               | 1<br>1<br>1   | 1   | 1<br>1  |   |   |   |   |   |
|  | B(Alt) | 182 B9.000  | 09/00 → 10/01   | AC  | VKMA 32029<br>VKMC 6PK1795   | 1<br>1  | 1   | 1<br>1  |   |   |   |   |   |

| ⊙ | 182 B4.000, 182 B9.000                                 | 12/98 → 10/01 |  |  |  |  |  |  |  |  |  |  |       |
|---|--|---------------|--|--|--|--|--|--|--|--|--|--|-------|
|   | <b>FIAT  BRAVO 1.4 16V</b>                             |               |  |  |  |  |  |  |  |  |  |  |       |
|   | 192 B2.000   | 04/07 → 09/07 |  |  |  |  |  |  |  |  |  |  | T0160 |
|   | 192 B2.000   | 04/07 → 09/07 |  |  |  |  |  |  |  |  |  |  |       |
|   | B(Alt) 192 B2.000                                      | 04/07 → 09/07 |  |  |  |  |  |  |  |  |  |  |       |
|   | B(Alt) 192 B2.000                                      | 04/07 → 09/07 |  |  |  |  |  |  |  |  |  |  |       |
|   | <b>FIAT  BRAVO 1.4 T-Jet</b>                           |               |  |  |  |  |  |  |  |  |  |  |       |
|   | 198 A1.000   | 09/07 → 09/07 |  |  |  |  |  |  |  |  |  |  | T0160 |
|   | 198 A1.000   | 09/07 → 09/07 |  |  |  |  |  |  |  |  |  |  |       |
|   | B(Alt) 198 A1.000                                      | 09/07 → 09/07 |  |  |  |  |  |  |  |  |  |  |       |
|   | <b>FIAT  BRAVO 1.9 D Multijet</b>                      |               |  |  |  |  |  |  |  |  |  |  |       |
|   | 192 A1.000   | 04/07 → 09/07 |  |  |  |  |  |  |  |  |  |  | T0158 |
|   | 192 A8.000   | 04/07 → 09/07 |  |  |  |  |  |  |  |  |  |  | T0158 |
|   | 192 A1.000, 192 A8.000                                 | 04/07 → 09/07 |  |  |  |  |  |  |  |  |  |  |       |
|   | B(Alt) 192 A1.000                                      | 04/07 → 09/07 |  |  |  |  |  |  |  |  |  |  |       |
|   | <b>FIAT  CAMPAGNOLA 2.4 D</b>                          |               |  |  |  |  |  |  |  |  |  |  |       |
|   | 8144.61.200  | 06/74 → 10/89 |  |  |  |  |  |  |  |  |  |  | T0014 |
|   | <b>FIAT  CINQUECENTO 0.7</b>                           |               |  |  |  |  |  |  |  |  |  |  |       |
|   | 170 A.000, 170 A.046                                   | 12/91 → 01/98 |  |  |  |  |  |  |  |  |  |  |       |
|   | 170 A.000, 170 A.046                                   | 12/91 → 01/98 |  |  |  |  |  |  |  |  |  |  |       |
|   | B(Alt) 170 A.000, 170 A.046                            | 12/91 → 01/98 |  |  |  |  |  |  |  |  |  |  |       |
|   | <b>FIAT  CINQUECENTO 0.9</b>                           |               |  |  |  |  |  |  |  |  |  |  |       |
|   | 1170 A1.000,<br>1170 A1.046,<br>170 A1.000, 170 A1.046 | 07/91 → 01/98 |  |  |  |  |  |  |  |  |  |  |       |
|   | 1170 A1.000,<br>1170 A1.046,<br>170 A1.000, 170 A1.046 | 07/91 → 01/98 |  |  |  |  |  |  |  |  |  |  |       |
|   | 1170 A1.000,<br>1170 A1.046,<br>170 A1.000, 170 A1.046 | 07/91 → 01/98 |  |  |  |  |  |  |  |  |  |  |       |
|   | B(Alt) 1170 A1.000                                     | 07/91 → 01/98 |  |  |  |  |  |  |  |  |  |  |       |
|   | B(Alt) 1170 A1.046,<br>170 A1.046                      | 07/91 → 01/98 |  |  |  |  |  |  |  |  |  |  |       |
|   | B(Alt) 170 A1.000                                      | 07/91 → 12/93 |  |  |  |  |  |  |  |  |  |  |       |
|   | B(AC) 1170 A1.046,<br>170 A1.046                       | 07/91 → 01/98 |  |  |  |  |  |  |  |  |  |  |       |
|   | <b>FIAT  CINQUECENTO 1.1</b>                           |               |  |  |  |  |  |  |  |  |  |  |       |
|   | 176 B2.000   | 10/94 → 01/98 |  |  |  |  |  |  |  |  |  |  | T0009 |
|   | 176 B2.000   | 10/94 → 01/98 |  |  |  |  |  |  |  |  |  |  |       |
|   | B(Alt) 176 B2.000                                      | 10/94 → 01/98 |  |  |  |  |  |  |  |  |  |  |       |
|   | B(Alt) 176 B2.000                                      | 10/94 → 01/98 |  |  |  |  |  |  |  |  |  |  |       |
|   | B(Alt) 176 B2.000                                      | 10/94 → 01/98 |  |  |  |  |  |  |  |  |  |  |       |

| <b>FIAT  COUPE 1.8 16V</b>       |                               |               |  |                     |              |   |   |   |  |   |  |  |  |       |
|----------------------------------|-------------------------------|---------------|--|---------------------|--------------|---|---|---|--|---|--|--|--|-------|
|                                  | 183 A1.000                    | 03/96 → 05/98 |  | → Mot. 1070426      | VKMC 02177   | 1 | 1 | 1 |  | 1 |  |  |  | T0128 |
|                                  |                               |               |  |                     | VKMA 02177   | 1 | 1 | 1 |  |   |  |  |  |       |
|                                  |                               |               |  |                     | VKM 12173    | 1 |   |   |  |   |  |  |  |       |
|                                  |                               |               |  |                     | VKM 22177    |   | 1 |   |  |   |  |  |  |       |
|                                  | 183 A1.000                    | 06/98 → 08/00 |  | Mot. 1070427  →     | VKMC 02183   | 1 | 1 | 1 |  | 1 |  |  |  | T0128 |
|                                  |                               |               |  |                     | VKMA 02183   | 1 | 1 | 1 |  |   |  |  |  |       |
|                                  |                               |               |  |                     | VKM 12182    | 1 |   |   |  |   |  |  |  |       |
|                                  |                               |               |  |                     | VKM 22177    |   | 1 |   |  |   |  |  |  |       |
|                                  | 183 A1.000                    | 03/96 → 08/00 |  |                     | VKPC 82645   |   |   |   |  | 1 |  |  |  |       |
|                                  | B(Alt) 183 A1.000             | 03/96 → 08/00 |  | AC                  | VKMA 32022   | 1 |   | 1 |  |   |  |  |  |       |
|                                  |                               |               |  |                     | VKMV 6PK1045 |   |   | 1 |  |   |  |  |  |       |
|                                  |                               |               |  |                     | VKM 32022    | 1 |   |   |  |   |  |  |  |       |
|                                  | B(Alt) 183 A1.000             | 03/96 → 05/98 |  | AC, → Mot. 1070426  | VKMA 32020   | 1 | 1 | 1 |  |   |  |  |  |       |
|                                  |                               |               |  |                     | VKMV 6PK1842 |   |   | 1 |  |   |  |  |  |       |
|                                  |                               |               |  |                     | VKM 32001    |   | 1 |   |  |   |  |  |  |       |
|                                  |                               |               |  |                     | VKM 32022    | 1 |   |   |  |   |  |  |  |       |
|                                  | B(Alt) 183 A1.000             | 06/98 → 08/00 |  | AC, Mot. 1070427  → | VKMV 6PK1855 |   |   | 1 |  |   |  |  |  |       |
|                                  |                               |               |  |                     | VKM 32001    |   | 1 |   |  |   |  |  |  |       |
|                                  |                               |               |  |                     | VKM 32022    | 1 |   |   |  |   |  |  |  |       |
| <b>FIAT  COUPE 2.0 16V</b>       |                               |               |  |                     |              |   |   |   |  |   |  |  |  |       |
|                                  | 836 A3.000                    | 11/93 → 08/96 |  |                     | VKMA 02224   | 1 |   | 1 |  |   |  |  |  | T0083 |
|                                  |                               |               |  |                     | VKM 12101    | 1 |   |   |  |   |  |  |  |       |
|                                  | 836 A3.000                    | 11/93 → 08/96 |  |                     | VKPC 82660   |   |   |   |  | 1 |  |  |  |       |
| <b>FIAT  COUPE 2.0 16V Turbo</b> |                               |               |  |                     |              |   |   |   |  |   |  |  |  |       |
|                                  | 175 A1.000                    | 11/93 → 08/96 |  |                     | VKMA 02224   | 1 |   | 1 |  |   |  |  |  | T0083 |
|                                  |                               |               |  |                     | VKM 12101    | 1 |   |   |  |   |  |  |  |       |
|                                  | 175 A1.000                    | 11/93 → 08/96 |  |                     | VKPC 82660   |   |   |   |  | 1 |  |  |  |       |
| <b>FIAT  COUPE 2.0 20V</b>       |                               |               |  |                     |              |   |   |   |  |   |  |  |  |       |
|                                  | 182 A1.000, 182 B3.000        | 08/96 → 08/00 |  |                     | VKMA 02172   | 1 | 1 | 1 |  |   |  |  |  | T0075 |
|                                  |                               |               |  |                     | VKM 12172    | 1 |   |   |  |   |  |  |  |       |
|                                  |                               |               |  |                     | VKM 22174    |   | 1 |   |  |   |  |  |  |       |
|                                  | 182 A1.000, 182 B3.000        | 08/96 → 08/00 |  |                     | VKPC 82646   |   |   |   |  | 1 |  |  |  |       |
|                                  | B(Alt) 182 A1.000, 182 B3.000 | 08/96 → 08/00 |  | AC                  | VKMV 6PK703  |   |   | 1 |  |   |  |  |  |       |
|                                  | B(Alt) 182 A1.000, 182 B3.000 | 08/96 → 08/00 |  | AC                  | VKM 32002    |   | 1 |   |  |   |  |  |  |       |
|                                  |                               |               |  |                     | VKM 32005    |   | 1 |   |  |   |  |  |  |       |
|                                  |                               |               |  |                     | VKM 32015    | 1 |   |   |  |   |  |  |  |       |
|                                  | B(PS) 182 A1.000              | 08/96 → 04/98 |  |                     | VKMV 6PK1139 |   | 1 | 1 |  |   |  |  |  |       |
|                                  |                               |               |  |                     | VKM 32005    |   | 1 |   |  |   |  |  |  |       |
|                                  |                               |               |  |                     | VKM 32015    | 1 |   |   |  |   |  |  |  |       |
|                                  | B(PS) 182 B3.000              | 04/98 → 08/00 |  | → Mot. 1140488      | VKMV 6PK1139 |   |   | 1 |  |   |  |  |  |       |
|                                  |                               |               |  |                     | VKM 32005    |   | 1 |   |  |   |  |  |  |       |
|                                  |                               |               |  |                     | VKM 32015    | 1 |   |   |  |   |  |  |  |       |
|                                  | B(PS) 182 B3.000              | 04/98 → 08/00 |  | Mot. 1140489  →     | VKMV 6PK1139 |   |   | 1 |  |   |  |  |  |       |
|                                  |                               |               |  |                     | VKM 32015    | 1 |   |   |  |   |  |  |  |       |
|                                  |                               |               |  |                     | VKM 32036    |   | 1 |   |  |   |  |  |  |       |
| <b>FIAT  COUPE 2.0 20V Turbo</b> |                               |               |  |                     |              |   |   |   |  |   |  |  |  |       |
|                                  | 175 A3.000                    | 08/96 → 08/00 |  |                     | VKMA 02172   | 1 | 1 | 1 |  |   |  |  |  | T0075 |
|                                  |                               |               |  |                     | VKM 12172    | 1 |   |   |  |   |  |  |  |       |
|                                  |                               |               |  |                     | VKM 22174    |   | 1 |   |  |   |  |  |  |       |
|                                  | 175 A3.000                    | 08/96 → 08/00 |  |                     | VKPC 82646   |   |   |   |  | 1 |  |  |  |       |
|                                  | B(Alt) 175 A3.000             | 08/96 → 08/00 |  | AC                  | VKMV 6PK703  |   |   | 1 |  |   |  |  |  |       |
|                                  | B(Alt) 175 A3.000             | 08/96 → 08/00 |  | AC                  | VKM 32002    |   | 1 |   |  |   |  |  |  |       |
|                                  |                               |               |  |                     | VKM 32005    |   | 1 |   |  |   |  |  |  |       |
|                                  |                               |               |  |                     | VKM 32015    | 1 |   |   |  |   |  |  |  |       |
|                                  | B(PS) 175 A3.000              | 08/96 → 08/00 |  | → Mot. 1444576      | VKMV 6PK1139 |   |   | 1 |  |   |  |  |  |       |
|                                  |                               |               |  |                     | VKM 32005    |   | 1 |   |  |   |  |  |  |       |
|                                  |                               |               |  |                     | VKM 32015    | 1 |   |   |  |   |  |  |  |       |
|                                  | B(PS) 175 A3.000              | 08/96 → 08/00 |  | Mot. 1444577  →     | VKMV 6PK1139 |   |   | 1 |  |   |  |  |  |       |
|                                  |                               |               |  |                     | VKM 32015    | 1 |   |   |  |   |  |  |  |       |
|                                  |                               |               |  |                     | VKM 32036    |   | 1 |   |  |   |  |  |  |       |
| <b>FIAT  CROMA (154) 1.6</b>     |                               |               |  |                     |              |   |   |   |  |   |  |  |  |       |
|                                  | 154 A.048                     | 12/85 → 12/90 |  |                     | —            | 1 |   | 1 |  |   |  |  |  | T0038 |
|                                  |                               |               |  |                     | VKM 12101    | 1 |   |   |  |   |  |  |  |       |



|   |  |  |  |  |  |  |  |  |  |  |
|---|---|---|---|--|---|---|---|---|---|---|
|                                    | 154 A.048   | 12/85 → 12/90   |   |  |   |   |   | 1   |   |   |
| <b>FIAT  CROMA (154) 2.0</b>       |   |   |   |  |   |   |   |   |   |   |
|                                    | 154 A1.000, 154 C5.000  | 12/85 → 09/92   |   | VKMA 02450<br>VKM 12005  | 1<br>1  | 1   |   |   |   | T0035   |
|   | 154 C3.000, 154 C3.046,<br>834 B.000, 834 B.146                                   | 01/91 → 08/96   |   | VKMA 02227<br>VKM 12227  | 1<br>1  | 1   |   |   |   | T0035   |
|                                    | 154 A1.000, 154 C3.000,<br>834 B.000  | 12/85 → 09/92   |   | VKPC 82614   |   |   |   | 1   |   |   |
|   | 154 C3.046, 834 B.146   | 10/87 → 08/96   |   | VKPC 82622   |   |   |   | 1   |   |   |
|                                    | <b>B(PS)</b> 154 C3.000, 154 C3.046,<br>154 C5.000                                | 03/87 → 08/96   | <b>AC</b>   | VKMV 13AVx850  |   | 1   |   |   |   |   |
|   | <b>B(PS)</b> 154 C3.000, 154 C3.046,<br>154 C5.000                                | 03/87 → 08/96   | <b>AC</b>   | VKMV 13AVx750  |   | 1   |   |   |   |   |
|   | <b>B(AC)</b> 154 C3.000, 154 C3.046,<br>154 C5.000                                | 03/87 → 08/96   |   | VKMV 13AVx875  |   | 1   |   |   |   |   |
| <b>FIAT  CROMA (154) 2.0 16V</b>   |   |   |   |  |   |   |   |   |   |   |
|                                    | 154 E1.000  | 08/92 → 08/96   |   | VKMA 02224<br>VKM 12101  | 1<br>1  | 1   |   |   |   | T0083   |
|                                    | 154 E1.000  | 08/92 → 08/96   |   | VKPC 82629   |   |   |   | 1   |   |   |
|                                    | <b>B(Alt)</b> 154 E1.000  | 08/92 → 08/96   |   | VKMV 5PK1100   |   | 1   |   |   |   |   |
|   | <b>B(PS)</b> 154 E1.000   | 08/92 → 08/96   | <b>AC</b>   | VKMV 13AVx850  |   | 1   |   |   |   |   |
|   | <b>B(PS)</b> 154 E1.000   | 08/92 → 08/96   | <b>AC</b>   | VKMV 13AVx750  |   | 1   |   |   |   |   |
|   | <b>B(AC)</b> 154 E1.000   | 08/92 → 08/96   |   | VKMV 13AVx875  |   | 1   |   |   |   |   |
| <b>FIAT  CROMA (154) 2.0 Turbo</b> |   |   |   |  |   |   |   |   |   |   |
|                                   | 154 C4.046, 834 C.146   | 01/91 → 08/96   |   | VKMA 02227<br>VKM 12227  | 1<br>1  | 1   |   |   |   | T0035   |
|                                  | <b>B(Alt)</b> 154 C4.046  | 05/93 → 08/96   |   | VKMV 5PK1100   |   | 1   |   |   |   |   |
|   | <b>B(PS)</b> 154 C4.046   | 06/87 → 08/96   | <b>AC</b>   | VKMV 13AVx850  |   | 1   |   |   |   |   |
|   | <b>B(PS)</b> 154 C4.046   | 06/87 → 08/96   | <b>AC</b>   | VKMV 13AVx750  |   | 1   |   |   |   |   |
|   | <b>B(AC)</b> 154 C4.046   | 06/87 → 08/96   |   | VKMV 13AVx875  |   | 1   |   |   |   |   |
| <b>FIAT  CROMA (154) 2.5 V6</b>  |   |   |   |  |   |   |   |   |   |   |
|                                  | 834 G.000   | 06/93 → 08/96   |   | VKPC 82800   |   |   |   | 1   |   |   |
| <b>FIAT  CROMA (154) 1.9 TD</b>  |   |   |   |  |   |   |   |   |   |   |
|                                  | 154 C6.000, 154 D1.000  | 01/91 → 12/96   |   | VKMA 02155<br>VKM 12150<br>VKM 22155   | 1<br>1<br>1   | 1   | 1   |   |   | T0084   |
|                                  | 154 C6.000  | 05/89 → 10/92   | 2)  | —<br>VKPC 82620  |   |   |   | 1<br>1  |   |   |
|                                  | <b>B(Alt)</b> 154 C6.000  | 05/89 → 10/92   | <b>AC</b>   | VKMV 5PK907  |   | 1   |   |   |   |   |
|   | <b>B(Alt)</b> 154 D1.000  | 11/92 → 12/96   | <b>AC</b> , →IMot. 1731341  | VKMV 5PK970<br>VKM 32242   |   | 1   | 1   |   |   |   |
|   | <b>B(Alt)</b> 154 D1.000  | 11/92 → 12/96   | <b>AC</b> , Mot. 1731342 I→   | VKMV 5PK986<br>VKM 32242   |   | 1   | 1   |   |   |   |
|   | <b>B(Alt)</b> 154 C6.000, 154 D1.000  | 05/89 → 12/96   | <b>AC</b> , →IMot. 0953135  | VKM 32016  |   | 1   |   |   |   |   |
|   | <b>B(Alt)</b> 154 C6.000, 154 D1.000  | 05/89 → 12/96   | <b>AC</b> , Mot. 0953136 I→   | VKMV 5PK970<br>VKM 32242   |   | 1   | 1   |   |   |   |
|   | <b>B(PS)</b> 154 C6.000   | 05/89 → 10/92   |   | VKMV 10AVx710  |   | 1   |   |   |   |   |
|   | <b>B(PS)</b> 154 D1.000   | 11/92 → 12/96   |   | VKMV 10AVx735  |   | 1   |   |   |   |   |
|   | <b>B(AC)</b> 154 C6.000, 154 D1.000   | 05/89 → 12/96   | →IMot. 1896623  | VKMV 5PK1065   |   | 1   |   |   |   |   |
|   | <b>B(AC)</b> 154 C6.000, 154 D1.000   | 05/89 → 12/96   | Mot. 1896624 I→   | VKMV 5PK1020   |   | 1   |   |   |   |   |
| <b>FIAT  CROMA (154) 2.4 TD</b>  |   |   |   |  |   |   |   |   |   |   |
|                                  | 8144.91.2000  | 12/85 → 08/89   |   | VKPC 82616   |   |   |   | 1   |   |   |
| <b>FIAT  CROMA (154) 2.5 D</b>   |   |   |   |  |   |   |   |   |   |   |
|                                  | 8144.67   | 12/85 → 12/89   |   | VKPC 82616   |   |   |   | 1   |   |   |
| <b>FIAT  CROMA (154) 2.5 TD</b>  |   |   |   |  |   |   |   |   |   |   |
|                                  | 8144.97, 8144.97 S  | 05/89 → 08/96   |   | —<br>—   | 1<br>1  | 1   |   |   |   |   |
|   | 8144.97 Y   | 05/89 → 08/96   |   | VKMA 02422<br>VKM 12400  | 1<br>1  | 1   |   |   |   | T0115   |
|                                  | 8144.97, 8144.97 S  | 05/89 → 08/96   | →IMot. 1339978  | VKPC 82616   |   |   |   | 1   |   |   |

























































FIAT

|   |               | 8144.97, 8144.97 S   | 05/89 → 08/96 | 2), Mot. 1339979  →                               | VKPA 82648     |   |   |   |  |  |   | 1     |
|---|---------------|----------------------|---------------|---|----------------|---|---|---|--|--|---|-------|
|   |               | 8144.97Y             | 05/89 → 08/96 |   | VKPC 82638     |   |   |   |  |  |   | 1     |
| <b>FIAT  CROMA (194) 1.8 16V</b>        |               |                      |               |   |                |   |   |   |  |  |   |       |
|   |               | 939 A4.000           | 12/05 → 12/06 |   | —              | 1 | 1 | 1 |  |  |   |       |
|   |               |                      |               |   | VKM___         | 1 |   |   |  |  |   |       |
|   |               |                      |               |   | VKM___         |   | 1 |   |  |  |   |       |
| <b>FIAT  CROMA (194) 2.2 16V</b>        |               |                      |               |   |                |   |   |   |  |  |   |       |
|   |               | 194 A1.000           | 06/05 → 12/06 |   | <b>OXOXOXO</b> |   |   |   |  |  |   |       |
|   |               | 194 A1.000           | 06/05 → 03/07 |   | VKPC 85308     |   |   |   |  |  | 1 |       |
|   | <b>B(Alt)</b> | 194 A1.000           | 06/05 → 03/07 |   | VKMA 34027     | 1 |   | 1 |  |  |   |       |
|   |               |                      |               |   | VKMV 5PK1028   |   |   | 1 |  |  |   |       |
|   |               |                      |               |   | VKM 34027      | 1 |   |   |  |  |   |       |
| <b>FIAT  CROMA (194) 1.9 D Multijet</b> |               |                      |               |   |                |   |   |   |  |  |   |       |
|   |               | 939A1.000            | 06/05 → 03/07 |   | —              | 1 | 1 | 1 |  |  |   |       |
|   |               |                      |               |   | VKM 12174      | 1 |   |   |  |  |   |       |
|   |               |                      |               |   | VKM 22180      |   | 1 |   |  |  |   |       |
|   |               | 939A2.000            | 06/05 → 03/07 |   | VKMA 02193     | 1 | 1 | 1 |  |  |   | T0248 |
|   |               |                      |               |   | VKM 12174      | 1 |   |   |  |  |   |       |
|   |               |                      |               |   | VKM 22180      |   | 1 |   |  |  |   |       |
|   |               | 939A1.000            | 06/05 → 03/07 |   | VKPC 82665     |   |   |   |  |  | 1 |       |
|   |               | 939A2.000            | 06/05 → 03/07 |   | VKPC 82667     |   |   |   |  |  | 1 |       |
|   | <b>B(Alt)</b> | 939A1.000, 939A2.000 | 06/05 → 03/07 |   | VKMV 6PK1410   |   |   | 1 |  |  |   |       |
|   |               |                      |               |   | VKM 32046      | 1 |   |   |  |  |   |       |
|   |               |                      |               |   | VKM___         |   | 1 |   |  |  |   |       |
|   |               |                      |               |   | VKM___         |   | 1 |   |  |  |   |       |
|   |               | 939A1.000, 939A2.000 | 06/05 → 12/05 |   | VKM___         |   |   |   |  |  | 1 |       |
| <b>FIAT  CROMA (194) 2.4 D Multijet</b> |               |                      |               |   |                |   |   |   |  |  |   |       |
|   |               | 939A3.000            | 06/05 → 03/07 |   | VKMA 02195     | 1 | 1 | 1 |  |  |   | T0248 |
|   |               |                      |               |   | VKM 12174      | 1 |   |   |  |  |   |       |
|   |               |                      |               |   | VKM 22174      |   | 1 |   |  |  |   |       |
|   |               | 939A3.000            | 06/05 → 03/07 |   | VKPC 82667     |   |   |   |  |  | 1 |       |
|   |               | 939A3.000            | 06/05 → 12/05 |   | VKM___         |   |   |   |  |  | 1 |       |
| <b>FIAT  DOBLO 1.2</b>                  |               |                      |               |   |                |   |   |   |  |  |   |       |
|   |               | 223 A5.000           | 03/01 → 12/05 | <b>M</b> , <b>MO</b> ,<br>→ <b>I</b> Mot. 2533528 | VKMC 02203     | 1 |   | 1 |  |  | 1 |       |
|   |               |                      |               |   | VKMA 02203     | 1 |   | 1 |  |  |   | T0175 |
|   |               |                      |               |   | VKM 12200      | 1 |   |   |  |  |   |       |
|   |               | 223 A5.000           | 03/01 → 12/05 | <b>A</b> <b>M</b> , Mot. 2533529  →               | VKMA___        | 1 |   | 1 |  |  |   | T0250 |
|   |               |                      |               |   | VKM 12206      | 1 |   |   |  |  |   |       |
|   |               | 223 A5.000           | 03/01 → 03/07 | → <b>I</b> Mot. 2533528                           | VKPC 82250     |   |   |   |  |  | 1 |       |
|   |               | 223 A5.000           | 03/01 → 03/07 | <b>M</b> ot. 2533529  →                           | VKPC 82251     |   |   |   |  |  | 1 |       |
|   | <b>B(Alt)</b> | 223 A5.000           | 03/01 → 03/07 | <b>AC</b> , → <b>I</b> Mot. 0714685               | VKMV 4PK675    |   |   | 1 |  |  |   |       |
|   | <b>B(Alt)</b> | 223 A5.000           | 03/01 → 03/07 | <b>AC</b> , Mot. 0714685  →                       | VKMV 4PK668    |   |   | 1 |  |  |   |       |
|   | <b>B(Alt)</b> | 223 A5.000           | 03/01 → 02/05 | <b>AC</b>   | VKMV 4PK698    |   |   | 1 |  |  |   |       |
|   | <b>B(PS)</b>  | 223 A5.000           | 03/01 → 03/07 | <b>AC</b>   | VKMV 3PK915    |   |   | 1 |  |  |   |       |
|   | <b>B(AC)</b>  | 223 A5.000           | 03/01 → 03/07 |   | VKMV 4PK841    |   |   | 1 |  |  |   |       |
| <b>FIAT  DOBLO 1.4</b>                  |               |                      |               |   |                |   |   |   |  |  |   |       |
|   |               | 350 A1.000           | 10/05 → 03/07 |   | VKMA___        | 1 |   | 1 |  |  |   | T0250 |
|   |               |                      |               |   | VKM 12206      | 1 |   |   |  |  |   |       |
|   |               | 350 A1.000           | 10/05 → 03/07 |   | VKPC 82251     |   |   |   |  |  | 1 |       |
|   | <b>B(Alt)</b> | 350 A1.000           | 10/05 → 03/07 | <b>AC</b>   | VKMV 4PK668    |   |   | 1 |  |  |   |       |
|   | <b>B(Alt)</b> | 350 A1.000           | 10/05 → 03/07 | <b>AC</b>   | VKMA 32040     | 1 |   | 1 |  |  |   |       |
|   |               |                      |               |   | VKMV 5PK1145   |   |   | 1 |  |  |   |       |
|   |               |                      |               |   | VKM 32023      | 1 |   |   |  |  |   |       |
|   | <b>B(PS)</b>  | 350 A1.000           | 10/05 → 03/07 | <b>AC</b>   | VKMV 3PK915    |   |   | 1 |  |  |   |       |
| <b>FIAT  DOBLO 1.6 16V</b>              |               |                      |               |   |                |   |   |   |  |  |   |       |
|   |               | 182 B6.000           | 10/01 → 03/07 | 3)  | VKMS 02242-2   | 1 | 1 | 1 |  |  |   | 4     |
|   |               |                      |               |   | VKMA 02242     | 1 | 1 | 1 |  |  |   | T0130 |
|   |               |                      |               |   | VKM 12242      | 1 |   |   |  |  |   |       |
|   |               |                      |               |   | VKM 22242      |   | 1 |   |  |  |   |       |
|   |               | 182 B6.000           | 10/01 → 03/07 | 2)  | VKPA 82441     |   |   |   |  |  | 1 |       |
|   |               |                      |               |   | VKPC 82441     |   |   |   |  |  | 1 |       |

|                                   | B(Alt) | 182 B6.000   | 10/01 → 03/07 | AC                 | VKMV 5PK938<br>VKM 32243                           | 1           | 1           |             |  |   |  |  |  |  |  |  |  |             |             |             |       |       |
|-----------------------------------|--------|--|---------------|--------------------|--|-------------|-------------|-------------|--|---|--|--|--|--|--|--|--|-------------|-------------|-------------|-------|-------|
| <b>FIAT  DOBLO 1.3 D Multijet</b> |        |  |               |                    |  |             |             |             |  |   |  |  |  |  |  |  |  |             |             |             |       |       |
|                                   |        | 188 A9.000, 199 A2.000                               | 10/05 → 09/07 |                    | OXOXOXO  |             |             |             |  |   |  |  |  |  |  |  |  |             |             |             |       |       |
|                                   |        | 199 A2.000, 223 A9.000                               | 10/05 → 09/07 |                    | VKPC 85700   |             |             |             |  | 1 |  |  |  |  |  |  |  |             |             |             |       |       |
|                                   | B(Alt) | 199 A2.000, 223 A9.000                               | 10/05 → 09/07 | AC                 | VKMV 6PK1180<br>VKM 32080                          | 1           | 1           |             |  |   |  |  |  |  |  |  |  |             |             |             |       |       |
|                                   | B(Alt) | 199 A2.000, 223 A9.000                               | 10/05 → 09/07 | AC                 | VKMV 6PK1310<br>VKM 32080                          | 1           | 1           |             |  |   |  |  |  |  |  |  |  |             |             |             |       |       |
| <b>FIAT  DOBLO 1.3 JTD 16V</b>    |        |  |               |                    |  |             |             |             |  |   |  |  |  |  |  |  |  |             |             |             |       |       |
|                                   |        | 188 A9.000   | 05/04 → 09/07 |                    | OXOXOXO  |             |             |             |  |   |  |  |  |  |  |  |  |             |             |             |       |       |
|                                   |        | 188 A9.000   | 05/04 → 09/07 |                    | VKPC 85700   |             |             |             |  | 1 |  |  |  |  |  |  |  |             |             |             |       |       |
|                                   | B(Alt) | 188 A9.000   | 05/04 → 09/07 | AC                 | VKMV 6PK1180<br>VKM 32080                          | 1           | 1           |             |  |   |  |  |  |  |  |  |  |             |             |             |       |       |
|                                   | B(Alt) | 188 A9.000   | 05/04 → 09/07 | AC                 | VKMV 6PK1310<br>VKM 32080                          | 1           | 1           |             |  |   |  |  |  |  |  |  |  |             |             |             |       |       |
| <b>FIAT  DOBLO 1.9 D</b>          |        |  |               |                    |  |             |             |             |  |   |  |  |  |  |  |  |  |             |             |             |       |       |
|                                   |        | 223 A6.000   | 03/01 → 04/04 |                    | VKMC 02174<br>VKMA 02174<br>VKM 12174<br>VKM 22179 | 1<br>1<br>1 | 1<br>1<br>1 | 1<br>1<br>1 |  | 1 |  |  |  |  |  |  |  | 2<br>2<br>2 |             | T0140       |       |       |
|                                   |        | 223 A6.000   | 05/04 → 09/07 |                    | VKMA 02198<br>VKM 12174<br>VKM 22180               | 1<br>1      | 1<br>1      | 1<br>1      |  |   |  |  |  |  |  |  |  |             |             |             | T0140 |       |
|                                   |        | 223 A6.000   | 03/01 → 09/07 |                    | VKPC 82665   |             |             |             |  | 1 |  |  |  |  |  |  |  |             |             |             |       |       |
|                                   | B(Alt) | 223 A6.000   | 03/01 → 09/07 | AC                 | VKMV 6PK1050<br>VKM 32027                          | 1           |             | 1           |  |   |  |  |  |  |  |  |  |             |             |             |       |       |
|                                   | B(Alt) | 223 A6.000   | 03/01 → 09/07 | AC                 | VKMV 6PK1815<br>VKM 32006<br>VKM 32027             | 1           | 1           | 1           |  |   |  |  |  |  |  |  |  |             |             |             |       |       |
|                                   |        | 223 A6.000   | 03/01 → 12/05 | AC, →IMot, 2235206 | VKM _____  |             |             |             |  |   |  |  |  |  |  |  |  |             |             |             |       |       |
|                                   |        | 223 A6.000   | 03/01 → 12/05 | AC                 | VKM _____  |             |             |             |  |   |  |  |  |  |  |  |  |             |             |             |       |       |
| <b>FIAT  DOBLO 1.9 D Multijet</b> |        |  |               |                    |  |             |             |             |  |   |  |  |  |  |  |  |  |             |             |             |       |       |
|                                   |        | 186 A9.000   | 10/05 → 09/07 |                    | VKMA 02192<br>VKM 12174<br>VKM 22180               | 1<br>1      | 1<br>1      | 1<br>1      |  |   |  |  |  |  |  |  |  |             |             |             | T0158 |       |
|                                   |        | 186 A9.000   | 10/05 → 09/07 |                    | VKPC 82665   |             |             |             |  | 1 |  |  |  |  |  |  |  |             |             |             |       |       |
|                                   | B(Alt) | 186 A9.000   | 10/05 → 12/05 | AC                 | VKMV 6PK1050<br>VKM 32027                          | 1           |             | 1           |  |   |  |  |  |  |  |  |  |             |             |             |       |       |
| <b>FIAT  DOBLO 1.9 JTD</b>        |        |  |               |                    |  |             |             |             |  |   |  |  |  |  |  |  |  |             |             |             |       |       |
|                                   |        | 182 B9.000, 223 B2.000                               | 10/01 → 09/07 |                    | VKMC 02179<br>VKMA 02179<br>VKM 12174<br>VKM 22179 | 1<br>1<br>1 | 1<br>1<br>1 | 1<br>1<br>1 |  | 1 |  |  |  |  |  |  |  |             | 2<br>2<br>2 |             | T0158 |       |
|                                   |        | 223 A7.000, 223 B1.000                               | 07/03 → 04/04 |                    | VKMC 02179<br>VKMA 02179<br>VKM 12174<br>VKM 22179 | 1<br>1<br>1 | 1<br>1<br>1 | 1<br>1<br>1 |  | 1 |  |  |  |  |  |  |  |             |             | 2<br>2<br>2 |       | T0158 |
|                                   |        | 223 A7.000, 223 B1.000                               | 05/04 → 09/07 |                    | VKMA 02192<br>VKM 12174<br>VKM 22180               | 1<br>1      | 1<br>1      | 1<br>1      |  |   |  |  |  |  |  |  |  |             |             |             |       | T0158 |
|                                   |        | 182 B9.000, 223 A7.000,<br>223 B1.000,<br>223 B2.000 | 10/01 → 09/07 |                    | VKPC 82665   |             |             |             |  |   |  |  |  |  |  |  |  |             |             |             |       |       |
|                                   | B(Alt) | 182 B9.000, 223 A7.000,<br>223 B2.000                | 10/01 → 09/07 | AC                 | VKMV 6PK1050<br>VKM 32027                          | 1           |             | 1           |  |   |  |  |  |  |  |  |  |             |             |             |       |       |
|                                   | B(Alt) | 182 B9.000, 223 A7.000,<br>223 B1.000,<br>223 B2.000 | 10/01 → 09/07 | AC                 | VKMV 6PK1815<br>VKM 32006<br>VKM 32027             | 1           | 1           | 1           |  |   |  |  |  |  |  |  |  |             |             |             |       |       |

















































|   |  |  |  |  |  |  |  |  |  |  |  |  |  |
|---|---|---|---|--|---|---|---|---|---|---|---|---|---|
| ⑥   | 182 B9.000, 223 A7.000,<br>223 B1.000,<br>223 B2.000                              | 10/01 → 09/07   |   | VKM_____   |   |   |   |   |   |   |   |   | 1   |
| <b>FIAT  DUNA 1.1</b>      |   |   |   |  |   |   |   |   |   |   |   |   |   |
| ⑥   | 146 A6.000  | 01/87 → 12/91   |   | VKPC 82208   |   |   |   |   |   |   |   |   | 1   |
| <b>FIAT  DUNA 1.3</b>      |   |   |   |  |   |   |   |   |   |   |   |   |   |
| ⑥   | 146 A5.000  | 01/87 → 12/91   |   | VKPC 82208   |   |   |   |   |   |   |   |   | 1   |
| <b>FIAT  DUNA 1.7 D</b>    |   |   |   |  |   |   |   |   |   |   |   |   |   |
| ⑥   | 149 B3.000  | 01/87 → 12/91   |   | VKMA 02152<br>VKM 12151<br>VKM 22151   | 1<br>1<br>1   | 1<br>1  | 1   |   |   |   |   |   | T0053   |
| ⑥   | 149 B3.000  | 01/87 → 12/91 2)  |   | VKPA 82210<br>VKPC 82210   |   |   |   |   |   |   |   |   | 1<br>1  |
| <b>FIAT  ELBA 1.3</b>      |   |   |   |  |   |   |   |   |   |   |   |   |   |
| ⑥   | 146 A5.000  | 04/86 → 12/93   |   | VKPC 82208   |   |   |   |   |   |   |   |   | 1   |
| <b>FIAT  ELBA 1.5</b>      |   |   |   |  |   |   |   |   |   |   |   |   |   |
| ⑥   | 149 C1.000  | 01/92 → 12/96   |   | VKMA 02111<br>VKM 12101  | 1<br>1  | 1   |   |   |   |   |   |   | T0011   |
| ⑥   | 149 C1.000  | 04/86 → 10/92 2)  |   | VKPA 82218<br>VKPC 82218   |   |   |   |   |   |   |   |   | 1<br>1  |
| <b>FIAT  ELBA 1.6</b>      |   |   |   |  |   |   |   |   |   |   |   |   |   |
| ⑥   | 146 C6.000, 146 D6.000  | 04/89 → 12/96   |   | VKMA 02410<br>VKM 12200  | 1<br>1  | 1   |   |   |   |   |   |   | T0052   |
| <b>FIAT  ELBA 1.7 D</b>    |   |   |   |  |   |   |   |   |   |   |   |   |   |
| ⑥   | 146 B2.000  | 04/89 → 12/96   |   | VKMA 02152<br>VKM 12151<br>VKM 22151   | 1<br>1<br>1   | 1<br>1  | 1   |   |   |   |   |   | T0053   |
| ⑥   | 146 B2.000  | 04/89 → 12/96 2)  |   | VKPA 82210<br>VKPC 82210   |   |   |   |   |   |   |   |   | 1<br>1  |
| <b>FIAT  FIORINO 900</b> |   |   |   |  |   |   |   |   |   |   |   |   |   |
| ⑥   | 100 GL.000  | 10/77 → 12/84 2)  |   | VKPA 82202   |   |   |   |   |   |   |   |   | 1   |
| <b>FIAT  FIORINO 1.0</b> |   |   |   |  |   |   |   |   |   |   |   |   |   |
| ⑥   | 127 A.000   | 01/80 → 12/87   |   | VKPC 82208   |   |   |   |   |   |   |   |   | 1   |
| <b>FIAT  FIORINO 1.1</b> |   |   |   |  |   |   |   |   |   |   |   |   |   |
| ⑥   | 146 A9.000  | 09/87 → 12/93   |   | VKMA 02216<br>VKM 12200  | 1<br>1  | 1   |   |   |   |   |   |   | T0040   |
| ⑥   | 146 A9.000  | 11/86 → 12/93   |   | VKPC 82208   |   |   |   |   |   |   |   |   | 1   |
| <b>FIAT  FIORINO 1.3</b> |   |   |   |  |   |   |   |   |   |   |   |   |   |
| ⑥   | 146 A5.000  | 12/87 → 12/94   |   | —<br>VKM 12200   | 1<br>1  | 1   |   |   |   |   |   |   | T0039   |
| ⑥   | 146 A5.000  | 12/87 → 12/94   |   | VKPC 82208   |   |   |   |   |   |   |   |   | 1   |
| <b>FIAT  FIORINO 1.4</b> |   |   |   |  |   |   |   |   |   |   |   |   |   |
| ⑥   | 146 C5.000, 146 D5.000  | 05/94 → 05/01   |   | VKMA 02410<br>VKM 12200  | 1<br>1  | 1   |   |   |   |   |   |   | T0052   |
| ⑥   | 146 C5.000, 146 D5.000  | 05/94 → 03/95 2)  |   | VKPA 82431<br>VKPC 82431   |   |   |   |   |   |   |   |   | 1<br>1  |
|   | 146 C5.000, 146 D5.000  | 04/95 → 05/01 2)  |   | —<br>VKPC 82246  |   |   |   |   |   |   |   |   | 1<br>1  |
| ⑥   | <b>B(Alt)</b> 146 C5.000, 146 D5.000  | 05/94 → 03/95   |   | VKM 32009  |   | 1   |   |   |   |   |   |   |   |
| <b>FIAT  FIORINO 1.5</b> |   |   |   |  |   |   |   |   |   |   |   |   |   |
| ⑥   | 149 C1.000  | 01/88 → 12/93   |   | VKMA 02111<br>VKM 12101  | 1<br>1  | 1   |   |   |   |   |   |   | T0011   |
| ⑥   | 149 C1.000  | 01/88 → 12/93 2)  |   | VKPA 82218<br>VKPC 82218   |   |   |   |   |   |   |   |   | 1<br>1  |
| <b>FIAT  FIORINO 1.6</b> |   |   |   |  |   |   |   |   |   |   |   |   |   |
| ⑥   | 146 C6.000, 146 D6.000  | 10/93 → 12/01   |   | VKMA 02410<br>VKM 12200  | 1<br>1  | 1   |   |   |   |   |   |   | T0052   |
| ⑥   | 146 C6.000, 146 D6.000  | 10/93 → 03/95 2)  |   | VKPA 82431<br>VKPC 82431   |   |   |   |   |   |   |   |   | 1<br>1  |
|   | 146 C6.000, 146 D6.000  | 04/95 → 05/01 2)  |   | —<br>VKPC 82246  |   |   |   |   |   |   |   |   | 1<br>1  |
| ⑥   | <b>B(Alt)</b> 146 C6.000, 146 D6.000  | 10/93 → 03/95   |   | VKM 32009  |   | 1   |   |   |   |   |   |   |   |

|   |                                       |  |    |  |  |  |  |  |  |  |  |  |  |
|---|---------------------------------------|---|---|---|--|---|---|---|---|---|---|---|---|
| <b>FIAT  FIORINO 1.3 D</b>         |                                       |   |   |   |  |   |   |   |   |   |   |   |   |
|                                    | 127 A5.000                            | 03/82 → 12/88   | →   | Mot. 35571  | —  | 1   | 1   | 1   |   |   |   |   | T0227   |
|   |                                       |   |   |   | VKM 12630  | 1   |   |   |   |   |   |   |   |
|   |                                       |   |   |   | VKM 22630  |   | 1   |   |   |   |   |   |   |
|   | 127 A5.000                            | 03/82 → 12/88   | Mot. 35572  | →   | VKMA 02630   | 1   | 1   | 1   |   |   |   |   | T0028   |
|   |                                       |   |   |   | VKM 12630  | 1   |   |   |   |   |   |   |   |
|   |                                       |   |   |   | VKM 22630  |   | 1   |   |   |   |   |   |   |
|                                    | 127 A5.000                            | 03/82 → 12/88   |   |   | VKPC 82208   |   |   |   |   | 1   |   |   |   |
| <b>FIAT  FIORINO 1.7 D</b>         |                                       |   |   |   |  |   |   |   |   |   |   |   |   |
|                                    | 146 B2.000, 149 B2.000,<br>149 B3.000 | 12/87 → 07/01   |   |   | VKMA 02152   | 1   | 1   | 1   |   |   |   |   | T0053   |
|   |                                       |   |   |   | VKM 12151  | 1   |   |   |   |   |   |   |   |
|   |                                       |   |   |   | VKM 22151  |   | 1   |   |   |   |   |   |   |
|                                    | 146 B2.000, 149 B3.000                | 12/87 → 07/04   | 2)  |   | VKPA 82210   |   |   |   |   | 1   |   |   |   |
|   |                                       |   |   |   | VKPC 82210   |   |   |   |   | 1   |   |   |   |
| <b>FIAT  FIORINO 1.7 TD</b>        |                                       |   |   |   |  |   |   |   |   |   |   |   |   |
|                                    | 146 D7.000                            | 01/97 → 05/01   |   |   | VKMA 02152   | 1   | 1   | 1   |   |   |   |   | T0053   |
|   |                                       |   |   |   | VKM 12151  | 1   |   |   |   |   |   |   |   |
|   |                                       |   |   |   | VKM 22151  |   | 1   |   |   |   |   |   |   |
| <b>FIAT  IDEA 1.2 16V</b>          |                                       |   |   |   |  |   |   |   |   |   |   |   |   |
|                                    | 188 A5.000                            | 01/04 → 12/06   |    |   | —  | 1   |   | 1   |   | 1   |   |   | T0160   |
|   |                                       |   |   |   | VKMA 02204   | 1   |   | 1   |   |   |   |   |   |
|   |                                       |   |   |   | VKM 12201  | 1   |   |   |   |   |   |   |   |
|                                    | 188 A5.000                            | 01/04 → 12/06   |   |   | VKPC 82251   |   |   |   |   | 1   |   |   |   |
|                                    | B(Alt) 188 A5.000                     | 01/04 → 12/06   |   | AC  | VKMMV 4PK675   |   |   | 1   |   |   |   |   |   |
|   | B(Alt) 188 A5.000                     | 01/04 → 12/06   |   | AC  | VKMA 32040   | 1   |   | 1   |   |   |   |   |   |
|   |                                       |   |   |   | VKMMV 5PK1145  |   |   | 1   |   |   |   |   |   |
|   |                                       |   |   |   | VKM 32023  | 1   |   |   |   |   |   |   |   |
| <b>FIAT  IDEA 1.4</b>            |                                       |   |   |   |  |   |   |   |   |   |   |   |   |
|                                  | 188 A5.000                            | 10/05 → 03/07   |  |   | —  | 1   |   | 1   |   | 1   |   |   | T0160   |
|   |                                       |   |   |   | VKMA 02204   | 1   |   | 1   |   |   |   |   |   |
|   |                                       |   |   |   | VKM 12201  | 1   |   |   |   |   |   |   |   |
|                                  | 188 A5.000                            | 10/05 → 03/07   |   |   | VKPC 82251   |   |   |   |   | 1   |   |   |   |
|                                  | B(Alt) 188 A5.000                     | 10/05 → 03/07   |   | AC  | VKMMV 4PK675   |   |   | 1   |   |   |   |   |   |
|   | B(Alt) 188 A5.000                     | 10/05 → 03/07   |   | AC  | VKMA 32040   | 1   |   | 1   |   |   |   |   |   |
|   |                                       |   |   |   | VKMMV 5PK1145  |   |   | 1   |   |   |   |   |   |
|   |                                       |   |   |   | VKM 32023  | 1   |   |   |   |   |   |   |   |
| <b>FIAT  IDEA 1.4 16V</b>        |                                       |   |   |   |  |   |   |   |   |   |   |   |   |
|                                  | 192 B2.000, 843 A1.000                | 01/04 → 03/07   |  |   | —  | 1   |   | 1   |   | 1   |   |   | T0160   |
|   |                                       |   |   |   | VKMA 02204   | 1   |   | 1   |   |   |   |   |   |
|   |                                       |   |   |   | VKM 12201  | 1   |   |   |   |   |   |   |   |
|                                  | 192 B2.000, 843 A1.000                | 01/04 → 03/07   |   |   | VKPC 82251   |   |   |   |   | 1   |   |   |   |
|                                  | B(Alt) 192 B2.000, 843 A1.000         | 01/04 → 03/07   |   | AC  | VKMMV 4PK675   |   |   | 1   |   |   |   |   |   |
|   | B(Alt) 192 B2.000, 843 A1.000         | 01/04 → 03/07   |   | AC  | VKMA 32040   | 1   |   | 1   |   |   |   |   |   |
|   |                                       |   |   |   | VKMMV 5PK1145  |   |   | 1   |   |   |   |   |   |
|   |                                       |   |   |   | VKM 32023  | 1   |   |   |   |   |   |   |   |
| <b>FIAT  IDEA 1.3 D Multijet</b> |                                       |   |   |   |  |   |   |   |   |   |   |   |   |
|                                  | 199 A3.000                            | 10/05 → 09/07   |   |   | <b>ΟΛΟΚΛΗΡΟ</b>  |   |   |   |   |   |   |   |   |
|                                  | 199 A3.000                            | 10/05 → 09/07   |   |   | VKPC 85700   |   |   |   |   | 1   |   |   |   |
|                                  | B(Alt) 199 A3.000                     | 10/05 → 09/07   |   | AC  | VKMMV 6PK1180  |   |   | 1   |   |   |   |   |   |
|   |                                       |   |   |   | VKM 32080  | 1   |   |   |   |   |   |   |   |
|   | B(Alt) 199 A3.000                     | 10/05 → 09/07   |   | AC  | VKMMV 6PK1310  |   |   | 1   |   |   |   |   |   |
|   |                                       |   |   |   | VKM 32080  | 1   |   |   |   |   |   |   |   |
| <b>FIAT  IDEA 1.3 JTD</b>        |                                       |   |   |   |  |   |   |   |   |   |   |   |   |
|                                  | 188 A9.000                            | 01/04 → 09/07   |   |   | <b>ΟΛΟΚΛΗΡΟ</b>  |   |   |   |   |   |   |   |   |
|                                  | 188 A9.000                            | 01/04 → 09/07   |   |   | VKPC 85700   |   |   |   |   | 1   |   |   |   |
|                                  | B(Alt) 188 A9.000                     | 01/04 → 09/07   |   | AC  | VKMMV 6PK1180  |   |   | 1   |   |   |   |   |   |
|   |                                       |   |   |   | VKM 32080  | 1   |   |   |   |   |   |   |   |
|   | B(AC) 188 A9.000                      | 01/04 → 09/07   |   | AC  | VKMMV 6PK1310  |   |   | 1   |   |   |   |   |   |
|   |                                       |   |   |   | VKM 32080  | 1   |   |   |   |   |   |   |   |



FIAT

| <b>FIAT</b>  <b>IDEA 1.9 JTD</b>    |   |               |  |               |   |   |   |   |   |   |   |  |  |  |  |  |   |   |       |       |       |
|--|---|---------------|--|---------------|---|---|---|---|---|---|---|--|--|--|--|--|---|---|-------|-------|-------|
|                                      | 188 B2.000  | 01/04 → 09/07 |  | VKMA 02179    | 1 | 1 | 1 |   |   |   |   |  |  |  |  |  | 2 |   | T0158 |       |       |
|  |   |               |  | VKM 12174     | 1 |   |   |   |   |   |   |  |  |  |  |  |   |   |       |       |       |
|  |   |               |  | VKM 22179     |   |   | 1 |   |   |   |   |  |  |  |  |  |   | 2 |       |       |       |
|                                      | 188 B2.000  | 01/04 → 09/07 |  | VKPC 82665    |   |   |   |   |   | 1 |   |  |  |  |  |  |   |   |       |       |       |
|                                      | <b>B(Alt)</b> 188 B2.000  | 01/04 → 06/06 |  | VKMOV 6PK1195 |   |   |   | 1 |   |   |   |  |  |  |  |  |   |   |       |       |       |
|  |   |               |  | VKM 32006     |   |   | 1 |   |   |   |   |  |  |  |  |  |   |   |       |       |       |
|  |   |               |  | VKM 32027     | 1 |   |   |   |   |   |   |  |  |  |  |  |   |   |       |       |       |
|  |   |               |  | VKM 32030     |   |   | 1 |   |   |   |   |  |  |  |  |  |   |   |       |       |       |
|                                      | 188 B2.000  | 01/04 → 12/05 |  | VKM _____     |   |   |   |   |   |   | 1 |  |  |  |  |  |   |   |       |       |       |
| <b>FIAT</b>  <b>MAREA 1.2 16V</b>   |   |               |  |               |   |   |   |   |   |   |   |  |  |  |  |  |   |   |       |       |       |
|                                      | 182 B2.000  | 10/98 → 04/99 |                           | —             | 1 |   | 1 |   | 1 |   |   |  |  |  |  |  |   |   |       | T0160 |       |
|  |   |               |  | VKMA 02204    | 1 |   | 1 |   |   |   |   |  |  |  |  |  |   |   |       |       |       |
|  |   |               |  | VKM 12201     | 1 |   |   |   |   |   |   |  |  |  |  |  |   |   |       |       |       |
|  | 182 B2.000  | 05/99 → 09/07 |                           | —             | 1 |   | 1 |   | 1 |   |   |  |  |  |  |  |   |   |       |       | T0160 |
|  |   |               |  | VKMA 02204    | 1 |   | 1 |   |   |   |   |  |  |  |  |  |   |   |       |       |       |
|  |   |               |  | VKM 12201     | 1 |   |   |   |   |   |   |  |  |  |  |  |   |   |       |       |       |
|                                      | 182 B2.000  | 10/98 → 04/99 |  | VKPC 82249    |   |   |   |   |   | 1 |   |  |  |  |  |  |   |   |       |       |       |
|  | 182 B2.000  | 05/99 → 03/07 |  | VKPC 82251    |   |   |   |   |   | 1 |   |  |  |  |  |  |   |   |       |       |       |
|                                      | <b>B(Alt)</b> 182 B2.000  | 10/98 → 09/07 | <b>AC</b>  | VKMOV 4PK675  |   |   |   | 1 |   |   |   |  |  |  |  |  |   |   |       |       |       |
|  | <b>B(Alt)</b> 182 B2.000  | 10/98 → 09/07 | <b>AC</b>  | VKMOV 4PK698  |   |   |   | 1 |   |   |   |  |  |  |  |  |   |   |       |       |       |
|  | <b>B(PS)</b> 182 B2.000   | 10/98 → 09/07 |  | VKMOV 3PK915  |   |   |   | 1 |   |   |   |  |  |  |  |  |   |   |       |       |       |
|  | <b>B(AC)</b> 182 B2.000   | 10/98 → 09/07 |  | VKMOV 4PK841  |   |   |   | 1 |   |   |   |  |  |  |  |  |   |   |       |       |       |
| <b>FIAT</b>  <b>MAREA 1.4 12V</b>   |   |               |  |               |   |   |   |   |   |   |   |  |  |  |  |  |   |   |       |       |       |
|                                     | 182 A3.000  | 09/96 → 03/07 |  → <b>IMot. 705144</b>   | —             | 1 |   | 1 |   | 1 |   |   |  |  |  |  |  |   |   |       |       | T0129 |
|  |   |               |  | VKMA 02215    | 1 |   | 1 |   |   |   |   |  |  |  |  |  |   |   |       |       |       |
|  |   |               |  | VKM 12215     | 1 |   |   |   |   |   |   |  |  |  |  |  |   |   |       |       |       |
|  | 182 A3.000  | 09/96 → 03/07 |  <b>Mot. 705145</b>   → | —             | 1 |   | 1 |   | 1 |   |   |  |  |  |  |  |   |   |       |       | T0129 |
|  |   |               |  | VKMA 02215    | 1 |   | 1 |   |   |   |   |  |  |  |  |  |   |   |       |       |       |
|  |   |               |  | VKM 12215     | 1 |   |   |   |   |   |   |  |  |  |  |  |   |   |       |       |       |
|  | 182 A3.000  | 09/96 → 12/06 | 3)   | VKMS 02215    | 1 |   | 1 |   |   |   |   |  |  |  |  |  | 2 |   |       |       | T0129 |
|  |   |               |  | VKMA 02215    | 1 |   | 1 |   |   |   |   |  |  |  |  |  |   |   |       |       |       |
|  |   |               |  | VKM 12215     | 1 |   |   |   |   |   |   |  |  |  |  |  |   |   |       |       |       |
|                                    | 182 A3.000  | 09/96 → 03/07 | → <b>IMot. 705144</b>  | VKPC 82437    |   |   |   |   |   | 1 |   |  |  |  |  |  |   |   |       |       |       |
|  | 182 A3.000  | 09/96 → 03/07 | <b>Mot. 705145</b>   →   | VKPC 82247    |   |   |   |   |   | 1 |   |  |  |  |  |  |   |   |       |       |       |
|                                    | <b>B(Alt)</b> 182 A3.000  | 09/96 → 03/07 | <b>AC</b>  | VKMA 32022    | 1 |   | 1 |   |   |   |   |  |  |  |  |  |   |   |       |       |       |
|  |   |               |  | VKMOV 6PK1045 |   |   | 1 |   |   |   |   |  |  |  |  |  |   |   |       |       |       |
|  |   |               |  | VKM 32022     | 1 |   |   |   |   |   |   |  |  |  |  |  |   |   |       |       |       |
|  | <b>B(Alt)</b> 182 A3.000  | 09/96 → 03/07 | <b>AC</b>  | VKMA 32020    | 1 | 1 | 1 |   |   |   |   |  |  |  |  |  |   |   |       |       |       |
|  |   |               |  | VKMOV 6PK1842 |   |   | 1 |   |   |   |   |  |  |  |  |  |   |   |       |       |       |
|  |   |               |  | VKM 32001     |   |   | 1 |   |   |   |   |  |  |  |  |  |   |   |       |       |       |
|  |   |               |  | VKM 32022     | 1 |   |   |   |   |   |   |  |  |  |  |  |   |   |       |       |       |
| <b>FIAT</b>  <b>MAREA 1.6 16V</b> |   |               |  |               |   |   |   |   |   |   |   |  |  |  |  |  |   |   |       |       |       |
|                                    | 182 A4.000, 182 B6.000,<br>185 A3.000                           | 09/96 → 07/99 | 3)   | VKMS 02242-1  | 1 | 1 | 1 |   |   |   |   |  |  |  |  |  | 4 |   |       |       | T0130 |
|  |   |               |  | VKMA 02242    | 1 | 1 | 1 |   |   |   |   |  |  |  |  |  |   |   |       |       |       |
|  |   |               |  | VKM 12242     | 1 |   |   |   |   |   |   |  |  |  |  |  |   |   |       |       |       |
|  |   |               |  | VKM 22242     |   |   | 1 |   |   |   |   |  |  |  |  |  |   |   |       |       |       |
|  | 182 A4.000, 182 B6.000,<br>185 A3.000                           | 08/99 → 09/07 | 3)   | VKMS 02242-2  | 1 | 1 | 1 |   |   |   |   |  |  |  |  |  | 4 |   |       |       | T0130 |
|  |   |               |  | VKMA 02242    | 1 | 1 | 1 |   |   |   |   |  |  |  |  |  |   |   |       |       |       |
|  |   |               |  | VKM 12242     | 1 |   |   |   |   |   |   |  |  |  |  |  |   |   |       |       |       |
|  |   |               |  | VKM 22242     |   |   | 1 |   |   |   |   |  |  |  |  |  |   |   |       |       |       |
|                                    | 182 A4.000, 185 A3.000,<br>186 A4.000                           | 09/96 → 09/07 | 2)   | VKPA 82441    |   |   |   |   |   | 1 |   |  |  |  |  |  |   |   |       |       |       |
|  |   |               |  | VKPC 82441    |   |   |   |   |   | 1 |   |  |  |  |  |  |   |   |       |       |       |
|                                    | <b>B(Alt)</b> 182 A4.000, 182 B5.098,<br>182 B6.000, 185 A3.000 | 09/96 → 02/00 |  | VKMOV 5PK938  |   |   | 1 |   |   |   |   |  |  |  |  |  |   |   |       |       |       |
|  |   |               |  | VKM 32242     |   |   | 1 |   |   |   |   |  |  |  |  |  |   |   |       |       |       |
|  | <b>B(Alt)</b> 182 A4.000, 182 B5.098,<br>182 B6.000, 185 A3.000 | 03/00 → 09/07 |  | VKMOV 5PK938  |   |   | 1 |   |   |   |   |  |  |  |  |  |   |   |       |       |       |
|  |   |               |  | VKM 32243     |   |   | 1 |   |   |   |   |  |  |  |  |  |   |   |       |       |       |
|  | <b>B(PS)</b> 182 A4.000, 182 B5.098,<br>182 B6.000, 185 A3.000  | 09/96 → 09/07 |  | VKMOV 3PK668  |   |   | 1 |   |   |   |   |  |  |  |  |  |   |   |       |       |       |

|   |  |  |    |  |  |  |  |  |  |  |  |  |
|---|---|---|---|--|---|---|---|---|---|---|---|---|
| B(AC)   | 182 A4.000, 182 B5.098,<br>182 B6.000, 185 A3.000                                 | 09/96 → 02/00   |   | VKMCV 4PK962<br>VKM 32242  |   | 1   |   |   |   |   |   |   |
| B(AC)   | 182 A4.000, 182 B5.098,<br>185 A3.000   | 03/00 → 09/07   |   | VKMCV 4PK962<br>VKM 32243  |   | 1   |   |   |   |   |   |   |
| B(AC)   | 182 B6.000  | 03/00 → 06/01   |   | VKMCV 4PK962<br>VKM 32243  |   | 1   |   |   |   |   |   |   |
| <b>FIAT  MAREA 1.8 16V</b>     |   |   |   |  |   |   |   |   |   |   |   |   |
|                                | 182 A2.000  | 09/96 → 12/06   |    | VKMC 02183<br>VKMA 02183<br>VKM 12182<br>VKM 22177                                 | 1<br>1<br>1   | 1<br>1<br>1   | 1   | 1   |   |   |   | T0128   |
|                                | 182 A2.000  | 09/96 → 03/07   |   | VKPC 82645   |   |   |   | 1   |   |   |   |   |
|                                | B(Alt) 182 A2.000   | 09/96 → 03/07   | <i>AC</i>   | VKMA 32022<br>VKMV 6PK1045<br>VKM 32022  | 1<br>1  | 1<br>1  |   |   |   |   |   |   |
|   | B(Alt) 182 A2.000   | 09/96 → 03/07   | AC  | VKMA 32020<br>VKMV 6PK1842<br>VKM 32001<br>VKM 32022                               | 1<br>1<br>1   | 1<br>1<br>1   |   |   |   |   |   |   |
| <b>FIAT  MAREA 2.0 20V</b>     |   |   |   |  |   |   |   |   |   |   |   |   |
|                                | 182 A1.000, 182 A7.000,<br>182 B7.000   | 09/96 → 01/01   |   | VKMA 02172<br>VKM 12172<br>VKM 22174   | 1<br>1  | 1<br>1  | 1   |   |   |   |   | T0075   |
|   | 185 A8.000  | 01/01 → 09/07   |   | VKMA 02185<br>VKM 12172<br>VKM 22174   | 1<br>1  | 1<br>1  | 1   |   |   |   |   | T0143   |
|                              | 182 A1.000, 182 B7.000,<br>185 A8.000   | 09/96 → 09/07   |   | VKPC 82646   |   |   |   | 1   |   |   |   |   |
|                              | B(Alt) 182 A1.000, 182 B7.000,<br>185 A8.000                                      | 09/96 → 09/07   | <i>AC</i>   | VKMCV 6PK703   |   |   | 1   |   |   |   |   |   |
|   | B(Alt) 182 A1.000   | 09/96 → 04/99   | AC, →IMot. 517623   | VKM 32002  |   | 1   |   |   |   |   |   |   |
|   | B(Alt) 182 A1.000   | 09/96 → 04/99   | AC, Mot. 517624 I→  | VKM 32002<br>VKM 32005<br>VKM 32015  | 1   | 1<br>1  |   |   |   |   |   |   |
|   | B(Alt) 182 B7.000, 185 A8.000   | 04/99 → 09/07   | AC  | VKM 32002<br>VKM 32005<br>VKM 32015  | 1   | 1<br>1  |   |   |   |   |   |   |
|   | B(PS) 182 A1.000  | 09/96 → 04/99   | →IMot. 1140488  | VKMCV 6PK1139<br>VKM 32005<br>VKM 32015  | 1   | 1   | 1   |   |   |   |   |   |
|   | B(PS) 182 A1.000  | 09/96 → 04/99   | Mot. 1140489 I→   | VKMCV 6PK1139<br>VKM 32015<br>VKM 32036  | 1   | 1   | 1   |   |   |   |   |   |
|   | B(PS) 182 B7.000, 185 A8.000  | 04/99 → 09/07   |   | VKMCV 6PK1139<br>VKM 32015<br>VKM 32036  | 1   | 1   | 1   |   |   |   |   |   |
| <b>FIAT  MAREA 1.9 TD 75</b> |   |   |   |  |   |   |   |   |   |   |   |   |
|                              | 182 A8.000  | 09/96 → 09/07   |  | VKMC 02174<br>VKMA 02174<br>VKM 12174<br>VKM 22179                                 | 1<br>1<br>1   | 1<br>1<br>1   | 1   | 1   |   |   | 2<br>2  | T0140   |
|                              | 182 A8.000  | 09/96 → 09/07   |   | VKPC 82665   |   |   |   | 1   |   |   |   |   |
|                              | B(Alt) 182 A8.000   | 09/96 → 09/07   | <i>AC</i> , →IMot. 1865932  | VKMCV 6PK1036<br>VKM 32022   | 1   |   | 1   |   |   |   |   |   |
|   | B(Alt) 182 A8.000   | 09/96 → 09/07   | <i>AC</i> , Mot. 1865933 I→   | VKMCV 6PK1036<br>VKM 32027   | 1   |   | 1   |   |   |   |   |   |
|   | B(Alt) 182 A8.000   | 09/96 → 09/07   | AC, →IMot. 1865932  | VKMA 32050<br>VKMV 6PK1830<br>VKM 32006<br>VKM 32022                               | 1<br>1<br>1   | 1<br>1  | 1   |   |   |   |   |   |



FIAT































|                               | B(Alt) | 182 A8.000                            | 09/96 → 09/07 | AC, Mot. 1865933 I→ | VKMA 32039<br>VKMV 6PK1836<br>VKM 32006<br>VKM 32027              | 1<br>1<br>1<br>1      | 1<br>1      | 1<br>1 |  |   |  |  |             |
|-------------------------------|--------|---------------------------------------|---------------|---------------------|---|-----------------------|-------------|--------|--|---|--|--|-------------|
| ⊙                             |        | 182 A8.000                            | 09/96 → 12/05 |                     | VKM_____  |                       |             |        |  | 1 |  |  |             |
| <b>FIAT  MAREA 1.9 TD 100</b> |        |                                       |               |                     |   |                       |             |        |  |   |  |  |             |
|                               |        | 182 A7.000                            | 09/96 → 09/07 |                     | VKMC 02174<br>VKMA 02174<br>VKM 12174<br>VKM 22179                | 1<br>1<br>1<br>1      | 1<br>1<br>1 | 1<br>1 |  | 1 |  |  | 2<br>2<br>2 |
|                               |        | 182 A7.000                            | 09/96 → 09/07 |                     | VKPC 82665  |                       |             |        |  | 1 |  |  |             |
|                               | B(Alt) | 182 A7.000                            | 09/96 → 09/07 | AC                  | VKMV 6PK1036<br>VKM 32022   | 1                     |             | 1      |  |   |  |  |             |
|                               | B(Alt) | 182 A7.000                            | 09/96 → 09/07 | AC                  | VKMA 32050<br>VKMV 6PK1830<br>VKM 32006<br>VKM 32022              | 1<br>1<br>1<br>1      | 1<br>1      | 1<br>1 |  |   |  |  |             |
| ⊙                             |        | 182 A7.000                            | 09/96 → 12/05 |                     | VKM_____  |                       |             |        |  | 1 |  |  |             |
| <b>FIAT  MAREA 1.9 JTD</b>    |        |                                       |               |                     |   |                       |             |        |  |   |  |  |             |
|                               |        | 182 B4.000, 186 A6.000                | 04/99 → 09/07 |                     | VKMC 02179<br>VKMA 02179<br>VKM 12174<br>VKM 22179                | 1<br>1<br>1<br>1      | 1<br>1<br>1 | 1<br>1 |  | 1 |  |  | 2<br>2<br>2 |
|                               |        | 182 B4.000, 186 A6.000                | 04/99 → 09/07 |                     | VKPC 82665  |                       |             |        |  | 1 |  |  |             |
|                               | B(Alt) | 182 B4.000, 186 A6.000                | 04/99 → 09/07 | AC                  | VKMA 32027<br>VKMV 6PK1036<br>VKM 32027                           | 1<br>1<br>1           |             | 1<br>1 |  |   |  |  |             |
|                               | B(Alt) | 182 B4.000, 182 B9.000,<br>186 A6.000 | 04/99 → 09/07 | AC                  | VKMA 32039<br>VKMV 6PK1836<br>VKM 32006<br>VKM 32027              | 1<br>1<br>1<br>1      | 1<br>1      | 1<br>1 |  |   |  |  |             |
| ⊙                             |        | 182 B4.000, 186 A6.000                | 04/99 → 12/05 |                     | VKM_____  |                       |             |        |  | 1 |  |  |             |
| <b>FIAT  MAREA 2.4 TD</b>     |        |                                       |               |                     |   |                       |             |        |  |   |  |  |             |
|                               |        | 185 A2.000                            | 09/96 → 04/99 |                     | VKMA 02171<br>VKM 12174<br>VKM 22174                              | 1<br>1<br>1           | 1<br>1      | 1<br>1 |  |   |  |  | T0140       |
|                               |        | 185 A2.000                            | 09/96 → 04/99 |                     | VKPC 82665  |                       |             |        |  | 1 |  |  |             |
|                               | B(Alt) | 185 A2.000                            | 09/96 → 04/99 | AC                  | VKMA 32025<br>VKMV 6PK1105<br>VKM 32025                           | 1<br>1<br>1           |             | 1<br>1 |  |   |  |  |             |
|                               | B(Alt) | 185 A2.000                            | 09/96 → 04/99 | AC, →IMot. 543351   | VKMA 32004<br>VKMV 6PK1740<br>VKM 32004<br>VKM 32024<br>VKM 32025 | 1<br>1<br>1<br>1<br>1 | 2<br>1<br>1 | 1<br>1 |  |   |  |  |             |
|                               | B(Alt) | 185 A2.000                            | 09/96 → 04/99 | AC, Mot. 543352 I→  | VKMA 32024<br>VKMV 6PK1760<br>VKM 32018<br>VKM 32024<br>VKM 32025 | 1<br>1<br>1<br>1<br>1 | 2<br>1<br>1 | 1<br>1 |  |   |  |  |             |
| <b>FIAT  MAREA 2.4 JTD</b>    |        |                                       |               |                     |   |                       |             |        |  |   |  |  |             |
|                               |        | 185 A6.000                            | 04/99 → 09/07 |                     | VKMC 02176<br>VKMA 02176<br>VKM 12174<br>VKM 22174                | 1<br>1<br>1<br>1      | 1<br>1<br>1 | 1<br>1 |  | 1 |  |  | T0158       |
|                               |        | 185 A6.000                            | 04/99 → 09/07 |                     | VKPC 82665  |                       |             |        |  | 1 |  |  |             |
|                               | B(Alt) | 185 A6.000                            | 04/99 → 09/07 | AC                  | VKMA 32025<br>VKMV 6PK1105<br>VKM 32025                           | 1<br>1<br>1           |             | 1<br>1 |  |   |  |  |             |
|                               | B(Alt) | 185 A6.000                            | 04/99 → 09/07 | AC                  | VKMA 32024<br>VKMV 6PK1760<br>VKM 32018<br>VKM 32024<br>VKM 32025 | 1<br>1<br>1<br>1<br>1 | 2<br>1<br>1 | 1<br>1 |  |   |  |  |             |



| FIAT  MULTIPLA 1.6 16V |   |               |                         |  |             |             |             |   |        |                  |
|------------------------|---|---------------|-------------------------|--|-------------|-------------|-------------|---|--------|------------------|
|                        | 182 A4.000, 186 A3.000,<br>186 A4.000                           | 04/99 → 07/99 | 3)                      | VKMS 02242-1<br>VKMA 02242<br>VKM 12242<br>VKM 22242 | 1<br>1<br>1 | 1<br>1<br>1 | 1<br>1<br>1 |   | 4      | T0130            |
|                        | 182 A4.000, 182 B6.000,<br>186 A3.000, 186 A4.000               | 08/99 → 10/07 | 3)                      | VKMS 02242-2<br>VKMA 02242<br>VKM 12242<br>VKM 22242 | 1<br>1<br>1 | 1<br>1<br>1 | 1<br>1<br>1 |   | 4      | T0130            |
|                        | 182 A4.000, 182 B6.000,<br>186 A3.000, 186 A4.000               | 04/99 → 10/07 | 2)                      | VKPA 82441<br>VKPC 82441                             |             |             |             |   | 1<br>1 |                  |
|                        | <b>B(Alt)</b> 182 A4.000, 186 A3.000,<br>186 A4.000             | 04/99 → 02/00 |                         | VKMV 5PK938<br>VKM 32242                             |             |             | 1           |   |        |                  |
|                        | <b>B(Alt)</b> 182 A4.000, 182 B6.000,<br>186 A3.000, 186 A4.000 | 03/00 → 10/07 |                         | VKMV 5PK938<br>VKM 32243                             |             |             | 1           |   |        |                  |
|                        | <b>B(PS)</b> 182 A4.000, 182 B6.000,<br>186 A3.000, 186 A4.000  | 04/99 → 10/07 |                         | VKMV 3PK668  |             |             | 1           |   |        |                  |
|                        | <b>B(AC)</b> 182 A4.000, 182 B6.000,<br>186 A3.000, 186 A4.000  | 04/99 → 06/01 |                         | VKMV 4PK962<br>VKM 32242                             |             |             | 1           |   |        |                  |
| FIAT  MULTIPLA 1.9 JTD |   |               |                         |  |             |             |             |   |        |                  |
|                        | 182 B4.000, 186 A6.000  | 04/99 → 06/04 |                         | VKMC 02179<br>VKMA 02179<br>VKM 12174<br>VKM 22179   | 1<br>1<br>1 | 1<br>1<br>1 | 1<br>1<br>1 | 1 |        | 2<br>2<br>2<br>2 |
|                        | 186 A8.000  | 07/02 → 06/04 |                         | VKMC 02179<br>VKMA 02179<br>VKM 12174<br>VKM 22179   | 1<br>1<br>1 | 1<br>1<br>1 | 1<br>1<br>1 | 1 |        | 2<br>2<br>2<br>2 |
|                        | 186A9.000   | 04/02 → 10/07 |                         | VKMC 02179<br>VKMA 02179<br>VKM 12174<br>VKM 22179   | 1<br>1<br>1 | 1<br>1<br>1 | 1<br>1<br>1 | 1 |        | 2<br>2<br>2<br>2 |
|                        | 182 B4.000, 186 A8.000  | 07/04 → 12/06 |                         | VKMA 02192<br>VKM 12174<br>VKM 22180                 | 1<br>1      | 1<br>1      | 1<br>1      |   |        | T0158            |
|                        | 182 B4.000, 186 A6.000,<br>186 A8.000, 186A9.000                | 04/99 → 10/07 |                         | VKPC 82665   |             |             |             | 1 |        |                  |
|                        | <b>B(Alt)</b> 182 B4.000, 186 A6.000,<br>186 A8.000, 186A9.000  | 04/99 → 10/07 | <b>AC</b>               | VKMA 32027<br>VKMV 6PK1036<br>VKM 32027              | 1<br>1      |             | 1<br>1      |   |        |                  |
|                        | <b>B(Alt)</b> 182 B4.000, 186 A6.000,<br>186 A8.000, 186A9.000  | 04/99 → 12/06 | <b>AC</b>               | VKMA 32039<br>VKMV 6PK1836<br>VKM 32006<br>VKM 32027 | 1<br>1<br>1 | 1<br>1<br>1 | 1<br>1<br>1 |   |        |                  |
| FIAT  PALIO/SIENA 1.0  |   |               |                         |  |             |             |             |   |        |                  |
|                        | 178 A1.000  | 04/96 → 10/07 |                         | —<br>VKM 12200                                       | 1<br>1      |             | 1           |   |        | T0251            |
|                        | 178 A1.000  | 04/96 → 10/07 |                         | —  |             |             |             | 1 |        |                  |
|                        | <b>B(Alt)</b> 178 A1.000  | 04/96 → 10/07 | <b>AC, Ø</b>            | VKMV 6PK1105<br>VKM 32005                            |             |             | 1           |   |        |                  |
| FIAT  PALIO/SIENA 1.1  |   |               |                         |  |             |             |             |   |        |                  |
|                        | 178 B9.033  | 07/97 → 10/03 | → <b>Mot.</b> 9042883   | VKMC 02202<br>VKMA 02202<br>VKM 12200                | 1<br>1<br>1 | 1<br>1<br>1 | 1<br>1<br>1 |   |        | T0009            |
|                        | 178 B9.033  | 07/97 → 10/03 | <b>Mot.</b> 9042884   → | VKMC 02210<br>VKMA 02210<br>VKM 12200                | 1<br>1<br>1 | 1<br>1<br>1 | 1<br>1<br>1 |   |        | T0174            |
|                        | 178 B9.033  | 07/97 → 10/03 | → <b>Mot.</b> 9042883   | VKPC 82214   |             |             |             | 1 |        |                  |





































|                              |        | 178 B9.033   | 07/97 → 10/03 | Mot. 9042884 I→    | VKPC 82250   |             |             |             |   |  | 1 |  |       |
|------------------------------|--------|--|---------------|--------------------|--|-------------|-------------|-------------|---|--|---|--|-------|
|                              | B(Alt) | 178 B9.033   | 07/97 → 09/98 |                    | VKMV 4PK675  |             | 1           |             |   |  |   |  |       |
| <b>FIAT  PALIO/SIENA 1.2</b> |        |  |               |                    |  |             |             |             |   |  |   |  |       |
|                              |        | 178 B5.000, 178 B7.045,<br>178 C4.066,<br>178 E2.000, 188 A4.000 | 04/96 → 10/07 | → Mot. 9042883     | VKMC 02201<br>VKMA 02201<br>VKM 12200                | 1<br>1<br>1 | 1<br>1      | 1           |   |  |   |  | T0117 |
|                              |        | 178 B5.000, 178 B7.045,<br>178 C4.066,<br>178 E2.000, 188 A4.000 | 04/96 → 10/07 | Mot. 9042884 I→    | VKMC 02203<br>VKMA 02203<br>VKM 12200                | 1<br>1<br>1 | 1<br>1      | 1           |   |  |   |  | T0175 |
|                              |        | 188 A5.000   | 09/01 → 10/07 |                    | VKMA 02204<br>VKM 12201                              | 1<br>1      | 1           |             |   |  |   |  | T0160 |
|                              |        | 178 B5.000, 178 B7.045,<br>178 C4.066,<br>178 E2.000, 188 A4.000 | 04/96 → 10/07 | → Mot. 9042883     | VKPC 82214   |             |             | 1           |   |  |   |  |       |
|                              |        | 178 B5.000, 178 B7.045,<br>178 C4.066,<br>178 E2.000, 188 A4.000 | 04/96 → 10/07 | Mot. 9042884 I→    | VKPC 82250   |             |             | 1           |   |  |   |  |       |
|                              |        | 188 A5.000   | 09/01 → 10/07 |                    | VKPC 82251   |             |             | 1           |   |  |   |  |       |
|                              | B(Alt) | 178 B5.000, 178 B7.045,<br>178 C4.066,<br>178 E2.000, 188 A4.000 | 04/96 → 04/02 | AC, Ø              | VKMV 4PK675  |             | 1           |             |   |  |   |  |       |
|                              | B(Alt) | 178 B5.000, 178 B7.045,<br>178 C4.066,<br>178 E2.000, 188 A4.000 | 05/02 → 10/07 | AC, Ø              | VKMV 4PK668  |             | 1           |             |   |  |   |  |       |
|                              | B(Alt) | 178 B5.000, 178 B7.045,<br>178 C4.066,<br>178 E2.000, 188 A4.000 | 04/96 → 10/07 | AC                 | VKMV 4PK698  |             | 1           |             |   |  |   |  |       |
|                              | B(Alt) | 188 A5.000   | 09/01 → 10/07 | <del>TR</del> , AC | VKMV 4PK675  |             | 1           |             |   |  |   |  |       |
|                              | B(Alt) | 188 A5.000   | 09/01 → 10/07 | <del>TR</del> , AC | VKMV 4PK668  |             | 1           |             |   |  |   |  |       |
|                              | B(PS)  | 178 B5.000, 178 B7.045,<br>178 C4.066,<br>178 E2.000, 188 A4.000 | 04/96 → 10/07 |                    | VKMV 3PK915  |             | 1           |             |   |  |   |  |       |
|                              | B(AC)  | 178 B5.000, 178 B7.045,<br>178 C4.066,<br>178 E2.000, 188 A4.000 | 04/96 → 10/07 |                    | VKMV 4PK841  |             | 1           |             |   |  |   |  |       |
|                              | B(AC)  | 188 A5.000   | 09/01 → 10/07 |                    | VKM 32023<br>VKM 32031                               | 1           | 1           |             |   |  |   |  |       |
| <b>FIAT  PALIO/SIENA 1.4</b> |        |  |               |                    |  |             |             |             |   |  |   |  |       |
|                              |        | 178 B2.000, 178 B2.016   | 04/96 → 10/07 |                    | —<br>VKM 12200                                       | 1<br>1      | 1           |             |   |  |   |  |       |
|                              |        | 178 B2.000, 178 B2.016   | 04/96 → 10/07 | 2), Ø              | —  |             |             | 1           |   |  |   |  |       |
|                              |        | 178 B2.000, 178 B2.016   | 04/96 → 10/07 | 2), Ø              | VKPC 82246<br>VKPA 82230<br>VKPC 82230               |             |             | 1<br>1<br>1 |   |  |   |  |       |
| <b>FIAT  PALIO/SIENA 1.6</b> |        |  |               |                    |  |             |             |             |   |  |   |  |       |
|                              |        | 178 C7.098, 178 D2..011  | 07/97 → 07/99 | 3)                 | VKMS 02242-1<br>VKMA 02242<br>VKM 12242<br>VKM 22242 | 1<br>1<br>1 | 1<br>1<br>1 |             |   |  | 4 |  | T0130 |
|                              |        | 178 C7.098,<br>178 D2..011,<br>182 B6.000                        | 08/99 → 10/07 | 3)                 | VKMS 02242-2<br>VKMA 02242<br>VKM 12242<br>VKM 22242 | 1<br>1<br>1 | 1<br>1<br>1 |             |   |  | 4 |  | T0130 |
|                              |        | 178 C7.098,<br>178 D2..011,<br>182 B6.000                        | 07/97 → 10/07 | 2)                 | VKPA 82441<br>VKPC 82441                             |             |             | 1<br>1      |   |  |   |  |       |
|                              | B(Alt) | 178 C7.098, 178 D2..011  | 10/99 → 02/00 |                    | VKMV 5PK938<br>VKM 32242                             |             | 1           |             | 1 |  |   |  |       |

|  |  |  |  |  |  |  |  |  |  |  |
|--|---|---|---|--|---|---|---|---|---|---|
| B(Alt)   | 178 C7.098,<br>178 D2.011,<br>182 B6.000  |   | 03/00 → 10/07   | VKMOV 5PK938<br>VKM 32243  | 1   | 1   |   |   |   |   |
| B(PS)  | 178 D2.011,<br>178 D2.011,<br>182 B6.000  |   | 07/97 → 09/07   | VKMOV 3PK668   |   | 1   |   |   |   |   |
| B(AC)  | 178 C7.098,<br>178 D2.011,<br>182 B6.000  |   | 07/97 → 10/07   | VKMOV 4PK854   |   | 1   |   |   |   |   |
| <b>FIAT  PALIO/SIENA 1.6 16V</b>          |   |   |   |  |   |   |   |   |   |   |
|   | 178 B3.000,<br>178 D2.011,<br>182 B6.000  |   | 04/96 → 07/99 3)  | VKMS 02242-1<br>VKMA 02242<br>VKM 12242<br>VKM 22242                               | 1<br>1<br>1<br>1  | 1<br>1<br>1   |   |   | 4   | T0130   |
|  | 178 B3.000,<br>178 D2.011,<br>182 B6.000  |   | 08/99 → 10/07 3)  | VKMS 02242-2<br>VKMA 02242<br>VKM 12242<br>VKM 22242                               | 1<br>1<br>1<br>1  | 1<br>1<br>1   |   |   | 4   | T0130   |
|   | 178 B3.000,<br>178 D2.011,<br>182 B6.000  |   | 04/96 → 10/07 2)  | VKPA 82441<br>VKPC 82441   |   |   |   |   | 1<br>1  |   |
|    | B(Alt) 178 B3.000,<br>178 D2.011,<br>182 B6.000                                   |   | 10/99 → 02/00   | VKMOV 5PK938<br>VKM 32242  |   | 1   |   |   | 1   |   |
|  | B(Alt) 178 B3.000,<br>178 D2.011,<br>182 B6.000                                   |   | 03/00 → 10/07   | VKMOV 5PK938<br>VKM 32243  |   | 1   |   |   | 1   |   |
|  | B(PS) 178 B3.000,<br>178 D2.011,<br>182 B6.000                                    |   | 04/96 → 10/07   | VKMOV 3PK668   |   |   |   |   | 1   |   |
|  | B(AC) 178 B3.000,<br>178 D2.011,<br>182 B6.000                                    |   | 04/96 → 10/07   | VKMOV 4PK854   |   |   |   |   | 1   |   |
| <b>FIAT  PALIO/SIENA 1.3 D Multijet</b> |   |   |   |  |   |   |   |   |   |   |
|   | 188 A9.000  |   | 06/03 → 10/07   | <b>OXOXOXO</b>   |   |   |   |   |   |   |
|   | B(Alt) 188 A9.000   |   | 06/03 → 10/07 AC  | VKMOV 6PK1180<br>VKM 32080   | 1   |   |   |   | 1   |   |
|  | B(Alt) 188 A9.000   |   | 06/03 → 10/07 AC  | VKMOV 6PK1310<br>VKM 32080   | 1   |   |   |   | 1   |   |
| <b>FIAT  PALIO/SIENA 1.7 TD</b>         |   |   |   |  |   |   |   |   |   |   |
|   | 176 A3.000, 178 A3.000  |   | 04/96 → 10/07   | VKMA 02152<br>VKM 12151<br>VKM 22151   | 1<br>1<br>1   | 1<br>1  | 1   |   |   | T0053   |
|   | 176 A3.000, 178 A3.000  |   | 04/96 → 10/07 2)  | —  |   |   |   |   | 1   |   |
| <b>FIAT  PALIO/SIENA 1.9 D</b>          |   |   |   |  |   |   |   |   |   |   |
|   | 223 A6.000  |   | 03/01 → 10/07   | VKMA 02174<br>VKM 12174<br>VKM 22179   | 1<br>1<br>1   | 1<br>1  | 1   |   |   | 2 T0140   |
|   | 223 A6.000  |   | 03/01 → 10/07   | VKPC 82665   |   |   |   |   | 1   |   |
|   | 223 A6.000  |   | 03/01 → 12/05 AC, → IMot. 2346957   | VKM _____  |   |   |   |   | 1   |   |
|  | 223 A6.000  |   | 03/01 → 12/05 AC  | VKM _____  |   |   |   |   | 1   |   |
| <b>FIAT  PANDA (141A) 650</b>           |   |   |   |  |   |   |   |   |   |   |
|   | 141 A.000   |   | 01/82 → 03/86   | <b>OXOXOXO</b>   |   |   |   |   |   |   |
|   | 141 A.000   |   | 01/82 → 07/01 2)  | VKPA 82202   |   |   |   |   | 1   |   |
| <b>FIAT  PANDA (141A) 750</b>           |   |   |   |  |   |   |   |   |   |   |
|   | 141 B.000   |   | 01/86 → 01/95   | <b>OXOXOXO</b>   |   |   |   |   |   |   |







































FIAT

































|  |               |  |                    |   |  |  |  |  |  |  |  |  |
|--|--|---|---|---|---|---|---|---|---|---|---|---|
|  | 156 A4.000, 156 A4.048   | 01/86 → 12/97   |                    | VKMC 02200<br>VKMA 02200<br>VKM 12200   | 1<br>1<br>1   | 1<br>1  | 1   |   |   |   |   | T0009   |
|  | 156 A4.048   | 01/95 → 12/97   | 3), → Mot. 6315750  | VKMS 02200-1<br>VKMA 02200<br>VKM 12200   | 1<br>1<br>1   | 1<br>1  |   |   | 2   |   |   | T0009   |
|  | 156 A4.048   | 01/95 → 12/97   | 3), Mot. 6315751  →   | VKMS 02200-2<br>VKMA 02200<br>VKM 12200   | 1<br>1<br>1   | 1<br>1  |   |   | 2   |   |   | T0009   |
|                                  | 141 B.000  | 01/86 → 01/95   | 2)  | VKPA 82220  |   |   |   | 1   |   |   |   |   |
|  | 156 A4.000, 156 A4.048   | 01/86 → 12/97   |   | VKPC 82214  |   |   |   | 1   |   |   |   |   |
|                                  | <b>B(Alt)</b> 141 B.000  | 01/86 → 01/95   |   | VKMOV 10AVx800  |   | 1   |   |   |   |   |   |   |
|  | <b>B(Alt)</b> 156 A4.000, 156 A4.048   | 01/86 → 12/97   |   | VKMOV 10AVx675  |   | 1   |   |   |   |   |   |   |
| <b>FIAT  PANDA (141A) 900</b>   |  |   |   |   |   |   |   |   |   |   |   |   |
|                                  | 100 GL3.000,<br>1170 A1.046, 146 A.000   | 10/80 → 12/96   |   |    |   |   |   |   |   |   |   |   |
|                                  | 100 GL3.000, 146 A.000   | 10/80 → 06/94   | 2)  | VKPA 82220  |   |   |   | 1   |   |   |   |   |
|  | 1170 A1.046  | 04/92 → 12/96   | 2)  | VKPA 82203  |   |   |   | 1   |   |   |   |   |
| <b>FIAT  PANDA (141A) 950</b>   |  |   |   |   |   |   |   |   |   |   |   |   |
|                                  | A 112 B1.054   | 09/82 → 08/83   |   |    |   |   |   |   |   |   |   |   |
| <b>FIAT  PANDA (141A) 1.0</b>   |  |   |   |   |   |   |   |   |   |   |   |   |
|                                  | 141 C2.000, 156 A2.000,<br>156 A2.048,<br>156 A2.100,<br>156 A2.146,<br>156 A2.246, 156 A3.000 | 01/85 → 08/98   |                    | VKMC 02200<br>VKMA 02200<br>VKM 12200   | 1<br>1<br>1   | 1<br>1  | 1   |   |   |   |   | T0009   |
|  | 156 A2.246   | 09/98 → 04/99   |  → Mot. 9042883  | VKMC 02200<br>VKMA 02200<br>VKM 12200   | 1<br>1<br>1   | 1<br>1  | 1   |   |   |   |   | T0009   |
|  | 156 A2.246   | 05/99 → 02/04   |  Mot. 9042884  → | VKMC 02210<br>VKMA 02210<br>VKM 12200   | 1<br>1<br>1   | 1<br>1  | 1   |   |   |   |   | T0174   |
|  | A 112 B1.054   | 09/83 → 03/86   |   |  |   |   |   |   |   |   |   |   |
|  | 141 C2.000, 156 A2.000,<br>156 A2.048,<br>156 A2.100,<br>156 A2.146,<br>156 A2.246, 156 A3.000 | 01/85 → 04/99   | 3), → Mot. 6315750  | VKMS 02200-1<br>VKMA 02200<br>VKM 12200   | 1<br>1<br>1   | 1<br>1  |   |   | 2   |   |   | T0009   |
|  | 141 C2.000, 156 A2.000,<br>156 A2.048,<br>156 A2.100,<br>156 A2.146,<br>156 A2.246, 156 A3.000 | 01/85 → 04/99   | 3), Mot. 6315751  →   | VKMS 02200-2<br>VKMA 02200<br>VKM 12200   | 1<br>1<br>1   | 1<br>1  |   |   | 2   |   |   | T0009   |
|                                | 141 C2.000, 156 A2.000,<br>156 A2.048,<br>156 A2.100,<br>156 A2.146,<br>156 A2.246, 156 A3.000 | 01/85 → 08/98   |   | VKPC 82214  |   |   |   | 1   |   |   |   |   |
|  | 156 A2.246   | 09/98 → 04/99   | → Mot. 9042883  | VKPC 82214  |   |   |   | 1   |   |   |   |   |
|  | 156 A2.246   | 05/99 → 02/04   | Mot. 9042884  →   | VKPC 82250  |   |   |   | 1   |   |   |   |   |
|  | A 112 B1.054   | 09/83 → 12/86   | 2)  | VKPA 82202  |   |   |   | 1   |   |   |   |   |
|                                | <b>B(Alt)</b> 141 C2.000, 156 A2.000,<br>156 A2.048,<br>156 A2.100,<br>156 A2.146, 156 A3.000  | 01/85 → 08/98   |   | VKMOV 10AVx675  |   | 1   |   |   |   |   |   |   |
| <b>FIAT  PANDA (141A) 1.1</b> |  |   |   |   |   |   |   |   |   |   |   |   |
|                                | 156 C.046, 176 B2.000  | 05/91 → 07/04   |  → Mot. 9042883  | VKMC 02200<br>VKMA 02200<br>VKM 12200   | 1<br>1<br>1   | 1<br>1  | 1   |   |   |   |   | T0009   |
|  | 156 C.046, 176 B2.000  | 05/91 → 07/04   |  Mot. 9042884  → | VKMC 02210<br>VKMA 02210<br>VKM 12200   | 1<br>1<br>1   | 1<br>1  | 1   |   |   |   |   | T0174   |

|                                  | 187 A1.000                          | 02/95 → 09/03 |   | VKMC 02210<br>VKMA 02210<br>VKM 12200   | 1<br>1<br>1 | 1 | 1 |  |   |  |  |   | T0174 |
|----------------------------------|-------------------------------------|---------------|---|---|-------------|---|---|--|---|--|--|---|-------|
|                                  | 156 C.046, 176 B2.000               | 05/91 → 07/04 | 3), →   Mot. 6315750                      | VKMS 02200-1<br>VKMA 02200<br>VKM 12200 | 1<br>1<br>1 | 1 |   |  |   |  |  | 2 | T0009 |
|                                  | 156 C.046, 176 B2.000               | 05/91 → 07/04 | 3), Mot. 6315751   →,<br>→   Mot. 9042883 | VKMS 02200-2<br>VKMA 02200<br>VKM 12200 | 1<br>1<br>1 | 1 | 1 |  |   |  |  | 2 | T0009 |
|                                  | 156 C.046, 176 B2.000               | 05/91 → 07/04 | →   Mot. 9042883                          | VKPC 82214                              |             |   |   |  | 1 |  |  |   |       |
|                                  | 156 C.046, 176 B2.000               | 05/91 → 07/04 | Mot. 9042884   →                          | VKPC 82250                              |             |   |   |  | 1 |  |  |   |       |
|                                  | 187 A1.000                          | 02/95 → 09/03 |   | VKPC 82250                              |             |   |   |  | 1 |  |  |   |       |
|                                  | <b>B(Alt)</b> 156 C.046, 176 B2.000 | 01/93 → 07/04 |   | VKMV 4PK675                             |             |   | 1 |  |   |  |  |   |       |
| <b>FIAT  PANDA (141A_) 1.3 D</b> |                                     |               |   |   |             |   |   |  |   |  |  |   |       |
|                                  | 156 A5.000                          | 04/86 → 12/92 |   | VKMA 02630<br>VKM 12630<br>VKM 22630    | 1<br>1<br>1 | 1 | 1 |  |   |  |  |   | T0028 |
|                                  | 156 A5.000                          | 04/86 → 12/92 |   | VKPC 82208                              |             |   |   |  | 1 |  |  |   |       |
| <b>FIAT  PANDA (169) 1.1</b>     |                                     |               |   |   |             |   |   |  |   |  |  |   |       |
|                                  | 187 A1.000                          | 09/03 → 12/05 | →   Mot. 2533528                          | VKMC 02210<br>VKMA 02210<br>VKM 12200   | 1<br>1<br>1 | 1 | 1 |  | 1 |  |  |   | T0174 |
|                                  | 187 A1.000                          | 09/03 → 12/06 | Mot. 2533529   →                          | VKMA<br>VKM 12206                       | 1<br>1      | 1 |   |  |   |  |  |   | T0250 |
|                                  | 187 A1.000                          | 09/03 → 10/07 | →   Mot. 2533528                          | VKPC 82250                              |             |   |   |  | 1 |  |  |   |       |
|                                  | 187 A1.000                          | 09/03 → 10/07 | Mot. 2533529   →                          | VKPC 82251                              |             |   |   |  | 1 |  |  |   |       |
|                                  | <b>B(Alt)</b> 187 A1.000            | 09/03 → 10/07 | AC  | VKMV 4PK668                             |             |   | 1 |  |   |  |  |   |       |
|                                  | <b>B(Alt)</b> 187 A1.000            | 09/03 → 10/07 | AC  | VKMA 32040<br>VKMV 5PK1145<br>VKM 32023 | 1<br>1<br>1 | 1 | 1 |  |   |  |  |   |       |
| <b>FIAT  PANDA (169) 1.2</b>     |                                     |               |   |   |             |   |   |  |   |  |  |   |       |
|                                  | 188 A4.000                          | 09/03 → 10/07 | →   Mot. 2533528                          | VKMC 02203<br>VKMA 02203<br>VKM 12200   | 1<br>1<br>1 | 1 | 1 |  | 1 |  |  |   | T0175 |
|                                  | 188 A4.000                          | 09/03 → 10/07 | Mot. 2533529   →                          | VKMA<br>VKM 12206                       | 1<br>1      | 1 |   |  |   |  |  |   | T0250 |
|                                  | 188 A4.000                          | 09/03 → 10/07 | →   Mot. 2533528                          | VKPC 82250                              |             |   |   |  | 1 |  |  |   |       |
|                                  | 188 A4.000                          | 09/03 → 10/07 | Mot. 2533529   →                          | VKPC 82251                              |             |   |   |  | 1 |  |  |   |       |
|                                  | <b>B(Alt)</b> 188 A4.000            | 09/03 → 10/07 | AC  | VKMA 32040<br>VKMV 5PK1145<br>VKM 32023 | 1<br>1<br>1 | 1 | 1 |  |   |  |  |   |       |
| <b>FIAT  PANDA (169) 1.3 JTD</b> |                                     |               |   |   |             |   |   |  |   |  |  |   |       |
|                                  | 188 A9.000                          | 09/03 → 10/07 |   | <b>OXOXOXO</b>                          |             |   |   |  |   |  |  |   |       |
|                                  | 188 A9.000                          | 09/03 → 10/07 |   | VKPC 85700                              |             |   |   |  | 1 |  |  |   |       |
|                                  | <b>B(Alt)</b> 188 A9.000            | 09/03 → 10/07 | AC  | VKMV 6PK1180<br>VKM 32080               | 1           |   | 1 |  |   |  |  |   |       |
|                                  | <b>B(Alt)</b> 188 A9.000            | 09/03 → 10/07 | AC  | VKMV 6PK1310<br>VKM 32080               | 1           |   | 1 |  |   |  |  |   |       |
| <b>FIAT  PUNTO (176) 1.1</b>     |                                     |               |   |   |             |   |   |  |   |  |  |   |       |
|                                  | 176 A6.000, 176 B2.000              | 01/97 → 09/99 | →   Mot. 9042883                          | VKMC 02202<br>VKMA 02202<br>VKM 12200   | 1<br>1<br>1 | 1 | 1 |  | 1 |  |  |   | T0009 |
|                                  | 176 A6.000, 176 B2.000              | 01/97 → 09/99 | Mot. 9042844   →                          | VKMC 02210<br>VKMA 02210<br>VKM 12200   | 1<br>1<br>1 | 1 | 1 |  | 1 |  |  |   | T0174 |
|                                  | 176 A6.000, 176 B2.000              | 09/93 → 12/96 | 3), →   Mot. 6315750                      | VKMS 02200-1<br>VKMA 02200<br>VKM 12200 | 1<br>1<br>1 | 1 | 1 |  |   |  |  | 2 | T0009 |
|                                  | 176 A6.000, 176 B2.000              | 09/93 → 12/96 | 3), Mot. 6315751   →,<br>→   Mot. 9042883 | VKMS 02200-2<br>VKMA 02200<br>VKM 12200 | 1<br>1<br>1 | 1 | 1 |  |   |  |  | 2 | T0009 |
|                                  | 176 A6.000, 176 B2.000              | 09/93 → 02/00 | →   Mot. 9042883                          | VKPC 82214                              |             |   |   |  | 1 |  |  |   |       |
|                                  | 176 A6.000, 176 B2.000              | 09/93 → 02/00 | Mot. 9042884   →                          | VKPC 82250                              |             |   |   |  | 1 |  |  |   |       |



































|   |  |  |  |                         |  |  |  |  |  |  |  |       |
|---|---|---|---|---|---|---|---|---|---|---|---|-------|
|                                       | <b>B(Alt)</b>   | 176 A6.000, 176 B2.000  | 09/93 → 09/99   | <b>AC</b>   | VKMV 4PK675   |   |   | 1   |   |   |   |       |
|   | <b>B(PS)</b>  | 176 A6.000, 176 B2.000  | 09/93 → 12/96   |   | VKMV 4PK854   |   |   | 1   |   |   |   |       |
|   | <b>B(PS)</b>  | 176 A6.000, 176 B2.000  | 01/97 → 09/99   |   | VKMV 3PK915   |   |   | 1   |   |   |   |       |
| <b>FIAT  PUNTO (176) 1.2</b>         |   |   |   |   |   |   |   |   |   |   |   |       |
|                                       |   | 176 A7.000, 176 B1.000  | 01/94 → 06/00   |                          | VKMC 02201  | 1   |   | 1   | 1   |   |   |       |
|   |   |   |   |   | VKMA 02201  | 1   |   | 1   |   |   |   | T0117 |
|   |   |   |   |   | VKM 12200   | 1   |   |   |   |   |   |       |
|   |   | 176 A8.000, 176 B4.000  | 01/94 → 06/00   |  → <b>IMot.</b> 9042883  | VKMC 02201  | 1   |   | 1   | 1   |   |   |       |
|   |   |   |   |   | VKMA 02201  | 1   |   | 1   |   |   |   | T0117 |
|   |   |   |   |   | VKM 12200   | 1   |   |   |   |   |   |       |
|   |   | 176 A8.000, 176 B4.000  | 01/94 → 06/00   |  <b>Mot.</b> 9042884   → | VKMC 02203  | 1   |   | 1   | 1   |   |   |       |
|   |   |   |   |   | VKMA 02203  | 1   |   | 1   |   |   |   | T0175 |
|   |   |   |   |   | VKM 12200   | 1   |   |   |   |   |   |       |
|                                       |   | 176 A7.000, 176 B1.000  | 01/94 → 06/00   |   | VKPC 82214  |   |   |   | 1   |   |   |       |
|   |   | 176 A8.000, 176 B4.000  | 01/94 → 06/00   | → <b>IMot.</b> 9042883  | VKPC 82214  |   |   |   | 1   |   |   |       |
|   |   | 176 A8.000, 176 B4.000  | 01/94 → 06/00   | <b>Mot.</b> 9042884   →   | VKPC 82250  |   |   |   | 1   |   |   |       |
|                                       | <b>B(Alt)</b>   | 176 A7.000  | 01/94 → 12/96   | <b>AC</b>   | VKMV 4PK675   |   |   | 1   |   |   |   |       |
|   | <b>B(PS)</b>  | 176 A7.000  | 01/94 → 12/96   |   | VKMV 4PK854   |   |   | 1   |   |   |   |       |
| <b>FIAT  PUNTO (176) 1.2 16V</b>     |   |   |   |   |   |   |   |   |   |   |   |       |
|                                       |   | 176 B9.000  | 04/97 → 04/99   |                          | —   | 1   |   | 1   | 1   |   |   |       |
|   |   |   |   |   | VKMA 02204  | 1   |   | 1   |   |   |   | T0160 |
|   |   |   |   |   | VKM 12201   | 1   |   |   |   |   |   |       |
|   |   | 176 B9.000  | 05/99 → 06/00   |                          | —   | 1   |   | 1   | 1   |   |   |       |
|   |   |   |   |   | VKMA 02204  | 1   |   | 1   |   |   |   | T0160 |
|   |   |   |   |   | VKM 12201   | 1   |   |   |   |   |   |       |
|                                      |   | 176 B9.000  | 04/97 → 04/99   |   | VKPC 82249  |   |   |   | 1   |   |   |       |
|   |   | 176 B9.000  | 05/99 → 06/00   |   | VKPC 82251  |   |   |   | 1   |   |   |       |
|                                     | <b>B(Alt)</b>   | 176 B9.000  | 04/97 → 09/99   | <b>AC</b>   | VKMV 4PK675   |   |   | 1   |   |   |   |       |
|   | <b>B(PS)</b>  | 176 B9.000  | 04/97 → 09/99   |   | VKMV 3PK915   |   |   | 1   |   |   |   |       |
| <b>FIAT  PUNTO (176) 1.4 Turbo</b> |   |   |   |   |   |   |   |   |   |   |   |       |
|                                     |   | 176 A4.000, 176 B6.000  | 01/94 → 09/99   |   | VKMA 02410  | 1   |   | 1   |   |   |   |       |
|   |   |   |   |   | VKM 12200   | 1   |   |   |   |   |   | T0052 |
|                                     |   | 176 A4.000, 176 B6.000  | 01/94 → 09/99   | 2)  | VKPA 82230  |   |   |   | 1   |   |   |       |
|   |   |   |   |   | VKPC 82230  |   |   |   | 1   |   |   |       |
|                                     | <b>B(Alt)</b>   | 176 A4.000, 176 B6.000  | 01/94 → 09/99   | <b>AC</b>   | VKMV 5PK938   |   |   | 1   |   |   |   |       |
|   |   |   |   |   | VKM 32242   |   | 1   |   |   |   |   |       |
|   | <b>B(PS)</b>  | 176 A4.000, 176 B6.000  | 01/94 → 09/99   |   | VKMV 10AVx690   |   |   | 1   |   |   |   |       |
|   | <b>B(AC)</b>  | 176 A4.000  | 01/94 → 04/95   |   | VKMV 3PK1006  |   |   | 1   |   |   |   |       |
|   |   |   |   |   | VKM 32009   |   | 1   |   |   |   |   |       |
|   | <b>B(AC)</b>  | 176 A4.000  | 05/95 → 04/96   |   | VKMV 4PK980   |   |   | 1   |   |   |   |       |
|   |   |   |   |   | VKM 32009   |   | 1   |   |   |   |   |       |
|   | <b>B(AC)</b>  | 176 A4.000, 176 B6.000  | 05/96 → 09/99   |   | VKMV 4PK980   |   |   | 1   |   |   |   |       |
|   |   |   |   |   | VKM 32242   |   | 1   |   |   |   |   |       |
| <b>FIAT  PUNTO (176) 1.6</b>       |   |   |   |   |   |   |   |   |   |   |   |       |
|                                     |   | 176 A9.000  | 01/94 → 04/97   |   | VKMA 02410  | 1   |   | 1   |   |   |   |       |
|   |   |   |   |   | VKM 12200   | 1   |   |   |   |   |   | T0052 |
|                                     |   | 176 A9.000  | 01/94 → 04/97   | 2)  | VKPA 82230  |   |   |   | 1   |   |   |       |
|   |   |   |   |   | VKPC 82230  |   |   |   | 1   |   |   |       |
|                                     | <b>B(Alt)</b>   | 176 A9.000  | 01/94 → 04/97   |   | VKMV 5PK938   |   |   | 1   |   |   |   |       |
|   |   |   |   |   | VKM 32242   |   | 1   |   |   |   |   |       |
|   | <b>B(PS)</b>  | 176 A9.000  | 01/94 → 04/97   |   | VKMV 10AVx690   |   |   | 1   |   |   |   |       |
|   | <b>B(AC)</b>  | 176 A9.000  | 01/94 → 04/96   | → <b>IMot.</b> 9396121  | VKMV 4PK1006  |   |   | 1   |   |   |   |       |
|   |   |   |   |   | VKM 32009   |   | 1   |   |   |   |   |       |
|   | <b>B(AC)</b>  | 176 A9.000  | 01/94 → 04/96   | <b>Mot.</b> 9396122   →   | VKMV 4PK980   |   |   | 1   |   |   |   |       |
|   |   |   |   |   | VKM 32009   |   | 1   |   |   |   |   |       |
|   | <b>B(AC)</b>  | 176 A9.000  | 05/96 → 04/97   |   | VKMV 4PK980   |   |   | 1   |   |   |   |       |
|   |   |   |   |   | VKM 32242   |   | 1   |   |   |   |   |       |
| <b>FIAT  PUNTO (176) 1.7 D</b>     |   |   |   |   |   |   |   |   |   |   |   |       |
|                                     |   | 176 B3.000  | 04/94 → 02/00   |   | VKMA 02152  | 1   | 1   | 1   |   |   |   |       |
|   |   |   |   |   | VKM 12151   | 1   |   |   |   |   |   | T0053 |
|   |   |   |   |   | VKM 22151   |   | 1   |   |   |   |   |       |
|                                     |   | 176 B3.000  | 04/94 → 02/00   | 2), <b>L.H.D</b>  | VKPA 82653  |   |   |   | 1   |   |   |       |
|                                     | <b>B(Alt)</b>   | 176 B3.000  | 04/94 → 02/00   |   | VKMV 6PK935   |   |   | 1   |   |   |   |       |





































|   |  |  |  |                        |  |  |  |  |  |  |  |  |  |
|---|---|---|---|--|---|---|---|---|---|---|---|---|---|
|   | B(PS)   | 176 B3.000  | 04/94 → 02/00   | VKMW 3PK719  |   |   | 1   |   |   |   |   |   |   |
| <b>FIAT  PUNTO (176) 1.7 TD</b>    |   |   |   |  |   |   |   |   |   |   |   |   |   |
|                                    |   | 176 A3.000, 176 A5.000,<br>176 B7.000   | 01/94 → 02/00   | VKMA 02152<br>VKM 12151<br>VKM 22151   | 1<br>1  | 1   | 1   |   |   |   |   |   | T0053   |
|                                    |   | 176 A3.000, 176 A5.000  | 01/94 → 12/96   | 2). AC   |   |   |   |   |   |   |   |   | 1   |
|   |   | 176 A3.000, 176 B7.000  | 01/97 → 09/99   | 2). →IMot. 2427907   |   |   |   |   |   |   |   |   | 1   |
|   |   | 176 A3.000, 176 B7.000  | 01/97 → 09/99   | 2). Mot. 2427908 I→  |   |   |   |   |   |   |   |   | 1   |
|                                    | B(Alt)  | 176 A3.000  | 01/94 → 09/99   | AC, →IMot. 1815664   |   |   |   |   |   |   |   |   | 1   |
|   | B(Alt)  | 176 A3.000  | 01/94 → 09/99   | AC, Mot. 1815665 I→  |   |   |   |   |   |   |   |   | 1   |
|   | B(Alt)  | 176 A5.000  | 01/94 → 02/00   | AC, →IMot. 1815651   |   |   |   |   |   |   |   |   | 1   |
|   | B(Alt)  | 176 A5.000  | 01/94 → 02/00   | AC, Mot. 1815652 I→  |   |   |   |   |   |   |   |   | 1   |
|   | B(Alt)  | 176 B7.000  | 09/96 → 09/99   | AC   |   |   |   |   |   |   |   |   | 1   |
|   | B(Alt)  | 176 A3.000, 176 A5.000,<br>176 B7.000   | 01/94 → 02/00   | AC   |   |   |   |   |   |   |   |   | 1   |
|   | B(PS)   | 176 A3.000, 176 A5.000,<br>176 B7.000   | 01/94 → 02/00   | VKMW 3PK719  |   |   |   |   |   |   |   |   | 1   |
|   | B(AC)   | 176 A3.000, 176 A5.000  | 01/94 → 02/00   | →IMot. 1954265   |   |   |   |   |   |   |   |   | 1   |
|   | B(AC)   | 176 A3.000, 176 A5.000  | 01/94 → 02/00   | Mot. 1954266 I→  |   |   |   |   |   |   |   |   | 1   |
|   | B(AC)   | 176 B7.000  | 09/96 → 09/99   | VKMW 4PK946<br>VKM 32011   |   |   |   |   |   |   |   |   | 1   |
|   | B(AC)   | 176 A3.000, 176 A5.000  | 01/94 → 02/00   | VKMW 4PK946  |   |   |   |   |   |   |   |   | 1   |
|   | B(AC)   | 176 B7.000  | 09/96 → 09/99   | VKMW 4PK946  |   |   |   |   |   |   |   |   | 1   |
| <b>FIAT  PUNTO (188) 1.2</b>       |   |   |   |  |   |   |   |   |   |   |   |   |   |
|                                   |   | 188 A4.000  | 09/99 → 09/07   |  MØ,<br>→IMot. 2533528 | VKMC 02203<br>VKMA 02203<br>VKM 12200   | 1<br>1<br>1   |   |   |   |   |   |   | 1   |
|   |   | 188 A4.000  | 09/99 → 09/07   | AØ, Mot. 2533529 I→  | VKMA _____<br>VKM 12206   | 1<br>1  |   |   |   |   |   |   | 1   |
|                                  |   | 188 A4.000  | 09/99 → 09/07   | →IMot. 2533528   | VKPC 82250  |   |   |   |   |   |   |   | 1   |
|   |   | 188 A4.000  | 09/99 → 09/07   | Mot. 2533529 I→  | VKPC 82251  |   |   |   |   |   |   |   | 1   |
|                                  | B(Alt)  | 188 A4.000  | 09/03 → 09/07   | AC   | VKMW 4PK668   |   |   |   |   |   |   |   | 1   |
|   | B(Alt)  | 188 A4.000  | 09/99 → 01/02   | AC, L.H.D  | VKMA 32023<br>VKMW 5PK1175<br>VKM 32023   | 1<br>1<br>1   |   |   |   |   |   |   | 1   |
|   | B(Alt)  | 188 A4.000  | 02/02 → 12/02   | AC, L.H.D  | VKM 32023   | 1   |   |   |   |   |   |   | 1   |
|   | B(Alt)  | 188 A4.000  | 01/03 → 09/07   | AC   | VKMA 32040<br>VKMW 5PK1145<br>VKM 32023   | 1<br>1<br>1   |   |   |   |   |   |   | 1   |
| <b>FIAT  PUNTO (188) 1.2 16V</b> |   |   |   |  |   |   |   |   |   |   |   |   |   |
|                                  |   | 188 A5.000  | 09/99 → 09/07   |                       | —<br>VKMA 02204<br>VKM 12201  | 1<br>1<br>1   |   |   |   |   |   |   | 1   |
|                                  |   | 188 A5.000  | 09/99 → 09/07   |  | VKPC 82251  |   |   |   |   |   |   |   | 1   |
|                                  | B(Alt)  | 188 A5.000  | 09/99 → 09/07   | AC   | VKMW 4PK675   |   |   |   |   |   |   |   | 1   |
|   | B(Alt)  | 188 A5.000  | 09/99 → 12/02   | AC, L.H.D,<br>→IMot. 0616579   | VKMA 32023<br>VKMW 5PK1175<br>VKM 32023   | 1<br>1<br>1   |   |   |   |   |   |   | 1   |
|   | B(Alt)  | 188 A5.000  | 09/99 → 12/02   | AC, L.H.D  | VKM 32023   | 1   |   |   |   |   |   |   | 1   |
|   | B(Alt)  | 188 A5.000  | 01/03 → 09/07   | Mot. 0616580 I→<br>AC  | VKMA 32040<br>VKMW 5PK1145<br>VKM 32023   | 1<br>1<br>1   |   |   |   |   |   |   | 1   |
| <b>FIAT  PUNTO (188) 1.4 16V</b> |   |   |   |  |   |   |   |   |   |   |   |   |   |
|                                  |   | 843 A1.000  | 09/03 → 12/06   |                       | —<br>VKMA 02204<br>VKM 12201  | 1<br>1<br>1   |   |   |   |   |   |   | 1   |
|                                  |   | 843 A1.000  | 09/03 → 12/06   |  | VKPC 82251  |   |   |   |   |   |   |   | 1   |
|                                  | B(Alt)  | 843 A1.000  | 09/03 → 12/06   | AC   | VKMW 4PK675   |   |   |   |   |   |   |   | 1   |

































FIAT

























|   |  |  |  |   |  |  |  |  |  |  |  |  |
|---|---|---|---|---|---|---|---|---|---|---|---|---|
|   | B(Alt)  | 843 A1.000  | 09/03 → 12/06   | AC  | VKMA 32040<br>VKMV 5PK1145<br>VKM 32023   | 1<br>1<br>1   | 1<br>1  |   |   |   |   |   |
| <b>FIAT  PUNTO (188) 1.8 16V</b>     |   |   |   |   |   |   |   |   |   |   |   |   |
|                                       |   | 183 A1.000  | 09/99 → 12/06   |    | VKMC 02183<br>VKMA 02183<br>VKM 12182<br>VKM 22177                                  | 1<br>1<br>1<br>1  | 1<br>1  | 1<br>1  | 1   |   |   | T0128   |
|   |   | 188 A6.000  | 09/99 → 12/06   |   | VKMA 02184<br>VKM 12182<br>VKM 22177  | 1<br>1<br>1   | 1<br>1  | 1   |   |   |   | T0143   |
|                                       |   | 183 A1.000  | 09/99 → 12/06   |   | VKPC 82645  |   |   |   | 1   |   |   |   |
|   |   | 188 A6.000  | 09/99 → 12/06   |   | VKPC 82451  |   |   |   | 1   |   |   |   |
|                                       | B(Alt)  | 183 A1.000  | 09/99 → 09/03   |   | VKMV 6PK1842<br>VKM 32001<br>VKM 32002<br>VKM 32022                                 | 1   | 1<br>1  | 1   |   |   |   |   |
|   | B(Alt)  | 183 A1.000  | 10/03 → 12/06   |   | VKMV 6PK1842<br>VKM 32001<br>VKM 32002<br>VKM 32026                                 | 1   | 1<br>1  | 1   |   |   |   |   |
| <b>FIAT  PUNTO (188) 1.3 JTD 16V</b> |   |   |   |   |   |   |   |   |   |   |   |   |
|                                       |   | 188 A9.000  | 06/03 → 12/05   |   | <b>OXOXOXO</b>  |   |   |   |   |   |   |   |
|                                       |   | 188 A9.000  | 06/03 → 09/07   |   | VKPC 85700  |   |   |   | 1   |   |   |   |
|                                       | B(Alt)  | 188 A9.000  | 06/03 → 09/07   | AC  | VKMV 6PK1180<br>VKM 32080   | 1   |   | 1   |   |   |   |   |
|   | B(Alt)  | 188 A9.000  | 06/03 → 09/07   | AC  | VKMV 6PK1310<br>VKM 32080   | 1   |   | 1   |   |   |   |   |
| <b>FIAT  PUNTO (188) 1.9 D</b>     |   |   |   |   |   |   |   |   |   |   |   |   |
|                                     |   | 188 A3.000  | 09/99 → 12/06   |  | VKMC 02174<br>VKMA 02174<br>VKM 12174<br>VKM 22179                                  | 1<br>1<br>1<br>1  | 1<br>1  | 1<br>1  | 1   |   |   | 2<br>2<br>2   |
|                                     |   | 188 A3.000  | 09/99 → 09/07   |   | VKPC 82665  |   |   |   | 1   |   |   |   |
|                                     | B(Alt)  | 188 A3.000  | 09/99 → 09/07   | AC  | VKMV 6PK815   |   |   | 1   |   |   |   |   |
|   | B(Alt)  | 188 A3.000  | 09/99 → 04/02   | AC → IVETTno 2189544,<br>4516379  | VKMA 32030<br>VKMV 6PK1230<br>VKM 32006<br>VKM 32027<br>VKM 32030                   | 1<br>1<br>1<br>1  | 2<br>1  | 1<br>1  |   |   |   |   |
|   | B(Alt)  | 188 A3.000  | 05/02 → 09/07   | AC, VETTno 2189545,<br>4516380 I→   | VKMV 6PK1195<br>VKM 32006<br>VKM 32027<br>VKM 32030                                 | 1   | 1   | 1   |   |   |   |   |
| <b>FIAT  PUNTO (188) 1.9 JTD</b>   |   |   |   |   |   |   |   |   |   |   |   |   |
|                                     |   | 188 A2.000  | 09/99 → 09/07   |  | VKMC 02179<br>VKMA 02179<br>VKM 12174<br>VKM 22179                                  | 1<br>1<br>1<br>1  | 1<br>1  | 1<br>1  | 1   |   |   | 2<br>2<br>2   |
|   |   | 188 A7.000  | 02/00 → 06/04   |  | VKMC 02179<br>VKMA 02179<br>VKM 12174<br>VKM 22179                                  | 1<br>1<br>1<br>1  | 1<br>1  | 1<br>1  | 1   |   |   | 2<br>2  |
|   |   | 188 B2.000  | 06/03 → 09/07   |  | VKMC 02179<br>VKMA 02179<br>VKM 12174<br>VKM 22179                                  | 1<br>1<br>1<br>1  | 1<br>1  | 1<br>1  | 1   |   |   | 2<br>2  |
|   |   | 188 A7.000  | 07/04 → 10/07   |   | VKMA 02192<br>VKM 12174<br>VKM 22180  | 1<br>1<br>1   | 1   | 1   |   |   |   | T0158   |
|                                     |   | 188 A2.000, 188 A7.000,<br>188 B2.000   | 09/99 → 10/07   |   | VKPC 82665  |   |   |   | 1   |   |   |   |
|                                     | B(Alt)  | 188 A2.000, 188 A7.000  | 09/99 → 09/07   | AC  | VKMV 6PK815   |   |   | 1   |   |   |   |   |

|   |  |  |  |  |  |  |  |  |  |  |  |
|---|---|---|---|--|---|---|---|---|---|---|---|
| B(Alt)  | 188 A2.000, 188 A7.000  | 09/99 → 04/02   | AC. → I VETNo 2189544   | VKMA 32030<br>VKMV 6PK1230<br>VKM 32006<br>VKM 32027<br>VKM 32030                  | 1<br>1<br>1<br>1  | 2<br>1<br>1   | 1<br>1  |   |   |   |   |
| B(Alt)  | 188 A2.000, 188 A7.000  | 05/02 → 09/07   | AC, VETNo 2189545 I→  | VKMA 32030<br>VKMV 6PK1195<br>VKM 32006<br>VKM 32027<br>VKM 32030                  | 1<br>1<br>1   | 1<br>1  | 1<br>1  |   |   |   |   |
| B(Alt)  | 188 B2.000  | 06/03 → 09/07   |   | VKMA 32030<br>VKMV 6PK1195<br>VKM 32006<br>VKM 32027<br>VKM 32030                  | 1<br>1<br>1   | 1<br>1  | 1<br>1  |   |   |   |   |
| ⊙   | 188 A2.000, 188 A7.000,<br>188 B2.000   | 09/99 → 09/07   |   | VKM _____  |   |   |   | 1   |   |   |   |
| <b>FIAT  GRANDE PUNTO 1.2</b>              |   |   |   |  |   |   |   |   |   |   |   |
|    | 199 A4.000  | 10/05 → 03/07   |   | VKMA _____<br>VKM 12206  | 1<br>1  | 1   |   |   |   |   | T0250   |
|    | 199 A4.000  | 10/05 → 03/07   |   | VKPC 82251   |   |   | 1   |   |   |   |   |
|    | B(Alt) 199 A4.000   | 10/05 → 03/07   | AC  | VKMA 32023<br>VKMV 4PK668  | 1   |   | 1   |   |   |   |   |
|    | B(Alt) 199 A4.000   | 10/05 → 03/07   | AC  | VKM 32023  | 1   |   |   |   |   |   |   |
| <b>FIAT  GRANDE PUNTO 1.4</b>              |   |   |   |  |   |   |   |   |   |   |   |
|    | 350 A1.000  | 10/05 → 03/07   |   | VKMA _____<br>VKM 12206  | 1<br>1  | 1   |   |   |   |   | T0250   |
|    | 350 A1.000  | 10/05 → 03/07   |   | VKPC 82251   |   |   | 1   |   |   |   |   |
|   | B(Alt) 350 A1.000   | 10/05 → 03/07   | AC  | VKMA 32023<br>VKMV 4PK668  | 1   |   | 1   |   |   |   |   |
|    | B(Alt) 350 A1.000   | 10/05 → 03/07   | AC  | VKM 32023  | 1   |   |   |   |   |   |   |
| <b>FIAT  GRANDE PUNTO 1.4 16V</b>        |   |   |   |  |   |   |   |   |   |   |   |
|    | B(Alt) 199 A6.000   | 10/05 → 03/07   | AC  | VKMA 32023<br>VKMV 4PK668  | 1   |   | 1   |   |   |   |   |
|    | B(Alt) 199 A6.000   | 10/05 → 03/07   | AC  | VKM 32023  | 1   |   |   |   |   |   |   |
| <b>FIAT  GRANDE PUNTO 1.3 D Multijet</b> |   |   |   |  |   |   |   |   |   |   |   |
|    | 199 A2.000, 199 A3.000  | 10/05 → 09/07   |   | ΟΧΛΟΧΟ   |   |   |   |   |   |   |   |
|    | 199 A2.000, 199 A3.000  | 10/05 → 09/07   |   | VKPC 85700   |   |   | 1   |   |   |   |   |
|    | B(Alt) 199 A2.000, 199 A3.000   | 10/05 → 09/07   | AC  | VKMA 32023<br>VKMV 6PK1182<br>VKM 35023  | 1   |   | 1   |   |   |   |   |
| <b>FIAT  GRANDE PUNTO 1.9 D Multijet</b> |   |   |   |  |   |   |   |   |   |   |   |
|    | 199 A5.000, 939 A1.000  | 10/05 → 09/07   |   | —<br>VKM 12174<br>VKM 22180  | 1<br>1  | 1<br>1  | 1   |   |   |   |   |
|    | 199 A5.000, 939 A1.000  | 10/05 → 09/07   |   | VKPC 82665   |   |   | 1   |   |   |   |   |
|    | B(Alt) 199 A5.000, 939 A1.000   | 10/05 → 09/07   |   | VKMA 32023<br>VKMV 6PK1390<br>VKM 32046<br>VKM _____<br>VKM _____                  | 1<br>1<br>1<br>1  |   | 1   |   |   |   |   |
| ⊙   | 199 A5.000, 939 A1.000  | 10/05 → 12/05   |   | VKM _____  |   |   |   | 1   |   |   |   |
| <b>FIAT  REGATA 1.3</b>                  |   |   |   |  |   |   |   |   |   |   |   |
|    | 138 B2.000, 149 A3.000,<br>149 A7.000   | 09/83 → 12/85   | Man. GBX,<br>→ I Mot. 5771822   | VKMA 02140<br>VKM 12003  | 1<br>1  | 1   |   |   |   |   | T0003   |
|   | 138 B2.000, 149 A3.000,<br>149 A7.000   | 09/83 → 12/85   | Auto. GBX,<br>→ I Mot. 5771822  | VKMA 02110<br>VKM 12003  | 1<br>1  | 1   |   |   |   |   | T0011   |
|   | 138 B2.000, 149 A3.000,<br>149 A7.000   | 01/86 → 07/89   | Man. GBX,<br>Mot. 5771823 I→  | VKMA 02101<br>VKM 12101  | 1<br>1  | 1   |   |   |   |   | T0003   |
|   | 138 B2.000, 149 A3.000,<br>149 A7.000   | 01/86 → 07/89   | Auto. GBX,<br>Mot. 5771823 I→   | VKMA 02111<br>VKM 12101  | 1<br>1  | 1   |   |   |   |   | T0011   |
|    | 149 A3.000, 149 A7.000  | 09/83 → 07/89   | 2), AC  | VKPA 82222   |   |   | 1   |   |   |   |   |









































FIAT













|   |  |  |  |  |  |  |  |  |  |  |  |  |  |  |  |  |  |
|---|---|---|---|--|---|---|---|---|---|---|---|---|---|---|---|---|---|
|   | 149 A3.000, 149 A7.000  | 09/83 → 07/89   | AC  | VKPC 82216   |   |   |   | 1   |   |   |   |   |   |   |   |   |   |
| <b>FIAT  REGATA 1.5</b>      |   |   |   |  |   |   |   |   |   |   |   |   |   |   |   |   |   |
|                               | 138B3, 149C1.000  | 09/83 → 12/85   | AC, →IMot.5771822   | VKMA 02110<br>VKM 12003  | 1<br>1  | 1   |   |   |   |   |   |   |   |   |   |   | T0011   |
|   | 138B3   | 09/84 → 12/85   | AC, Mot.5771823  →  | VKMA 02110<br>VKM 12003  | 1<br>1  | 1   |   |   |   |   |   |   |   |   |   |   | T0011   |
|   | 138B3, 149 A5.000,<br>149C1.000   | 01/86 → 07/89   | AC, Mot.5771823  →  | VKMA 02111<br>VKM 12101  | 1<br>1  | 1   |   |   |   |   |   |   |   |   |   |   | T0011   |
|   | 138B3, 149 A5.000,<br>149C1.000   | 01/86 → 07/89   | AC  | —<br>VKM 12101   | 1   |   |   |   |   |   |   |   |   |   |   |   |   |
|                               | 138 B3.000  | 09/83 → 04/85   | 2)  | VKPA 82222   |   |   |   | 1   |   |   |   |   |   |   |   |   |   |
| <b>FIAT  REGATA 1.6</b>      |   |   |   |  |   |   |   |   |   |   |   |   |   |   |   |   |   |
|                               | 149 A.000   | 10/83 → 06/90   | →IMot.1484418   | —<br>VKM 12001   | 1<br>1  | 1   |   |   |   |   |   |   |   |   |   |   | T0007   |
|   | 149 A.000   | 10/83 → 06/90   | Mot.1484419  →,<br>→IMot.7409424  | —<br>VKM 12003   | 1<br>1  | 1   |   |   |   |   |   |   |   |   |   |   | T0007   |
|   | 149 A.000   | 10/83 → 06/90   | Mot.7409425  →  | —<br>VKM 12101   | 1<br>1  | 1   |   |   |   |   |   |   |   |   |   |   | T0038   |
|   | 149 A2.000, 149 A4.000  | 10/83 → 12/86   | →IMot.1484418   | —<br>VKM 12001   | 1   |   |   |   |   |   |   |   |   |   |   |   |   |
|   | 149 A2.000, 149 A4.000  | 10/83 → 12/86   | Mot.1484419  →  | —<br>VKM 12003   | 1   |   |   |   |   |   |   |   |   |   |   |   |   |
|   | 149 A2.000, 149 A4.000  | 01/87 → 12/90   |   | VKMA 02005<br>VKM 12005  | 1<br>1  | 1   |   |   |   |   |   |   |   |   |   |   | T0041   |
|                              | 149 A.000   | 10/83 → 06/90   |   | —  |   |   |   | 1   |   |   |   |   |   |   |   |   |   |
|   | 149 A2.000, 149 A4.000  | 10/83 → 12/90   |   | VKPC 82424   |   |   |   | 1   |   |   |   |   |   |   |   |   |   |
| <b>FIAT  REGATA 1.7 D</b>  |   |   |   |  |   |   |   |   |   |   |   |   |   |   |   |   |   |
|                             | 138 B6.000  | 09/83 → 12/86   |   | —<br>VKM 12160<br>VKM 22160  | 1<br>1  | 1<br>1  | 1   |   |   |   |   |   |   |   |   |   | T0010   |
|   | 149 B3.000  | 01/84 → 12/89   |   | —<br>VKM 12150<br>VKM 22150  | 1<br>1  | 1<br>1  | 1   |   |   |   |   |   |   |   |   |   | T0037   |
|                             | 138 B6.000  | 09/83 → 12/86   | 2)  | —  |   |   |   | 1   |   |   |   |   |   |   |   |   |   |
|   | 149 B3.000  | 01/84 → 12/89   |   | —  |   |   |   | 1   |   |   |   |   |   |   |   |   |   |
| <b>FIAT  REGATA 1.9 D</b>  |   |   |   |  |   |   |   |   |   |   |   |   |   |   |   |   |   |
|                             | 149 A1.000  | 04/84 → 12/85   |   | —<br>VKM 12150   | 1<br>1  | 1<br>1  | 1   |   |   |   |   |   |   |   |   |   | T0034   |
|   | 149 A1.000  | 01/86 → 07/89   | AC  | VKMA 02175<br>VKM 12150<br>VKM 22150   | 1<br>1<br>1   | 1<br>1<br>1   | 1   |   |   |   |   |   |   |   |   |   | T0042   |
|   | 149 A1.000  | 01/86 → 07/89   | AC  | —<br>VKM 12150   | 1<br>1  | 1<br>1  | 1   |   |   |   |   |   |   |   |   |   | T0034   |
|                             | B(Alt) 149 A1.000   | 04/84 → 07/89   | AC  | VKM 32016<br>VKM 32016<br>VKM 32016  |   | 1<br>1<br>1   |   |   |   |   |   |   |   |   |   |   |   |
| <b>FIAT  REGATA 1.9 TD</b> |   |   |   |  |   |   |   |   |   |   |   |   |   |   |   |   |   |
|                             | 831 D1.000  | 05/86 → 07/89   | AC  | VKMA 02175<br>VKM 12150<br>VKM 22150   | 1<br>1<br>1   | 1<br>1<br>1   | 1   |   |   |   |   |   |   |   |   |   | T0042   |
|   | 831 D1.000  | 05/86 → 07/89   | AC  | —<br>VKM 12150   | 1<br>1  | 1<br>1  | 1   |   |   |   |   |   |   |   |   |   | T0034   |
|                             | 831 D1.000  | 05/86 → 07/89   | 2)  | VKPA 82608<br>—  |   |   |   | 1<br>1  |   |   |   |   |   |   |   |   |   |
| <b>FIAT  RITMO 1.1</b>     |   |   |   |  |   |   |   |   |   |   |   |   |   |   |   |   |   |
|                             | 138 B.000, 138 B1.000,<br>138 C1.000  | 10/82 → 10/85   |   | VKMA 02140<br>VKM 12003  | 1<br>1  | 1   |   |   |   |   |   |   |   |   |   |   | T0003   |
|   | 146 A4.048  | 04/85 → 12/87   | →IMot.5771822   | VKMA 02140<br>VKM 12003  | 1<br>1  | 1   |   |   |   |   |   |   |   |   |   |   | T0003   |





|   |  |  |                                  |  |  |  |  |  |  |  |  |       |
|---|---|---|---|--|---|---|---|---|---|---|---|-------|
|   | 146 A4.048  | 04/85 → 12/87   | Mot. 5771823 I→   | VKMA 02101<br>VKM 12101  | 1<br>1  |   | 1   |   |   |   |   | T0003 |
|                          | 138 B.000, 138 B1.000,<br>138 C1.000, 146 A4.048                                  | 10/82 → 12/87   | 2), AC  | VKPA 82222   |   |   |   | 1   |   |   |   |       |
|   | 138 B.000, 138 B1.000,<br>138 C1.000, 146 A4.048                                  | 10/82 → 12/87   | AC  | VKPC 82216   |   |   |   | 1   |   |   |   |       |
| <b>FIAT  RITMO 1.3</b>   |   |   |   |  |   |   |   |   |   |   |   |       |
|                          | 138 A1.000  | 01/78 → 09/82   | → ICH 2750813   | —<br>VKM 12100   | 1   |   |   |   |   |   |   |       |
|   | 138 A1.000  | 01/78 → 09/82   | CH 2750814 I→   | VKMA 02140<br>VKM 12003  | 1<br>1  | 1   |   |   |   |   |   | T0003 |
|   | 138 A3.000  | 01/81 → 09/82   |   | —<br>VKM 12100   | 1   |   |   |   |   |   |   |       |
|   | 138 B2.000, 149 A3.000,<br>149 A7.000   | 01/83 → 08/85   | B(41116x19),  116,<br>Man. GBX   | VKMA 02140<br>VKM 12003  | 1<br>1  | 1   |   |   |   |   |   | T0003 |
|   | 138 B2.000, 149 A3.000,<br>149 A7.000   | 01/83 → 08/85   | B(41118x19),  118,<br>Auto. GBX  | VKMA 02110<br>VKM 12003  | 1<br>1  | 1   |   |   |   |   |   | T0011 |
|                          | 138 A1.000, 138 A3.000,<br>149A7.000  | 01/78 → 08/85   | 2), AC  | VKPA 82222   |   |   |   | 1   |   |   |   |       |
|   | 138 A1.000, 138 A3.000,<br>149A7.000  | 01/78 → 08/85   | AC  | VKPC 82216   |   |   |   | 1   |   |   |   |       |
| <b>FIAT  RITMO 1.5</b>   |   |   |   |  |   |   |   |   |   |   |   |       |
|                          | 138 A2.000, 138 C3.048  | 01/78 → 10/82   |   | VKMA 02110<br>VKM 12003  | 1<br>1  | 1   |   |   |   |   |   | T0011 |
|   | 138 A4.000, 138 B3.000,<br>138 C2.048,<br>149 A5.000, 149 C1.000                  | 01/80 → 07/89   | AC, Man. GBX,<br>→ IMot. 5771822  | —<br>VKM 12003   | 1   |   |   |   |   |   |   |       |
|   | 138 A4.000, 138 B3.000,<br>138 C2.048,<br>149 A5.000, 149 C1.000                  | 01/80 → 07/89   | AC, Man. GBX,<br>Mot. 5771823 I→  | —<br>VKM 12101   | 1   |   |   |   |   |   |   |       |
|   | 138 A4.000, 138 B3.000,<br>138 C2.048,<br>149 A5.000, 149 C1.000                  | 01/80 → 12/85   | B(41118x19),  118,<br>Man. GBX | VKMA 02110<br>VKM 12003  | 1<br>1  | 1   |   |   |   |   |   | T0011 |
|   | 138 A4.000, 138 B3.000,<br>138 C2.048,<br>149 A5.000, 149 C1.000                  | 01/86 → 07/89   | Auto. GBX,<br>→ IMot. 5771822   | VKMA 02110<br>VKM 12003  | 1<br>1  | 1   |   |   |   |   |   | T0011 |
|   | 138 A4.000, 138 B3.000,<br>138 C2.048,<br>149 A5.000, 149 C1.000                  | 01/86 → 07/89   | Auto. GBX,<br>Mot. 5771823 I→   | VKMA 02111<br>VKM 12101  | 1<br>1  | 1   |   |   |   |   |   | T0011 |
|                        | 138 A2.000, 138 C3.048  | 01/78 → 10/82   | AC  | VKPC 82216   |   |   |   | 1   |   |   |   |       |
|   | 138 A2.000, 138 A4.000,<br>138 B3.000, 138 C3.048                                 | 01/78 → 01/85   | 2), AC  | VKPA 82222   |   |   |   | 1   |   |   |   |       |
|   | 138 A4.000, 138 B3.000,<br>138 C2.048, 149 A5.000                                 | 01/85 → 07/89   | 2), AC  | VKPA 82218<br>VKPC 82218   |   |   |   | 1<br>1  |   |   |   |       |
|   | 138 A4.000, 138 B3.000,<br>138 C2.048, 149 A5.000                                 | 01/80 → 07/89   | AC  | VKPC 82216   |   |   |   | 1   |   |   |   |       |
| <b>FIAT  RITMO 1.6</b> |   |   |   |  |   |   |   |   |   |   |   |       |
|                        | 138 AR.000  | 05/81 → 12/82   |   | —<br>VKM 12001   | 1   |   |   |   |   |   |   |       |
|   | 138 AR.000  | 01/83 → 07/83   | B(41144x19),  144              | —<br>VKM 12001   | 1   |   |   |   |   |   |   |       |
|   | 138 AR.000, 138 AR.048,<br>149 C2.000   | 08/83 → 11/86   | B(41143x19),  143              | —<br>VKM 12003   | 1   |   |   |   |   |   |   |       |



FIAT

|   |  |                      |                   |  |  |  |  |  |  |  |  |  |
|---|---|---|--|--|---|---|---|---|---|---|---|---|
|   | 138 AR.000, 138 AR.048,<br>149 C2.000   | 12/86 → 12/87   | B(41138x18),  138 | VKMA 02005<br>VKM 12005  | 1<br>1  | 1   |   |   |   |   |   | T0041   |
|                                     | 138 AR.000, 138AR   | 05/81 → 05/85   |  | —  |   |   |   | 1   |   |   |   |   |
|   | 138 AR.000, 138 AR.048,<br>138AR, 138AR.000                                       | 06/85 → 12/87   |  | VKPC 82424   |   |   |   | 1   |   |   |   |   |
| <b>FIAT  RITMO 2.0</b>             |   |   |  |  |   |   |   |   |   |   |   |   |
|                                     | 138 AR1.000,<br>138 AR2.000   | 11/81 → 12/87   |  | —<br>VKM 12004   | 1   |   |   |   |   |   |   |   |
|                                     | 138 AR1.000   | 11/81 → 12/87   |  | —  |   |   |   | 1   |   |   |   |   |
| <b>FIAT  RITMO 1.7 D</b>           |   |   |  |  |   |   |   |   |   |   |   |   |
|                                     | 138 A5.000, 138 B6.000  | 10/79 → 12/82   |  | VKMA 02161<br>VKM 22160<br>VKM 22160   |   | 2<br>1<br>1   | 1   |   |   |   |   | T0648   |
|   | 138 B6.000  | 01/83 → 10/85   |  | —<br>VKM 12160<br>VKM 22160  | 1<br>1  | 1<br>1  | 1   |   |   |   |   | T0010   |
|   | 138 C.000, 149 B3.000   | 05/85 → 12/87   |  | —<br>VKM 12150<br>VKM 22150  | 1<br>1  | 1<br>1  | 1   |   |   |   |   | T0037   |
|                                     | 138 B6.000  | 10/79 → 12/81 2)  |  | —<br>VKPC 82410  |   |   |   | 1<br>1  |   |   |   |   |
|   | 138 B6.000  | 01/82 → 10/85 2)  |  | —  |   |   |   | 1<br>1  |   |   |   |   |
| <b>FIAT  RITMO 1.9 TD</b>          |   |   |  |  |   |   |   |   |   |   |   |   |
|                                    | 831 D1.000  | 12/85 → 12/87   |  | —<br>VKM 12150   | 1<br>1  | 1<br>1  | 1   |   |   |   |   | T0034   |
|                                   | 831 D1.000  | 12/85 → 12/87 2)  |  | VKPA 82608   |   |   |   | 1<br>1  |   |   |   |   |
| <b>FIAT  SCUDO (220) 1.6</b>     |   |   |  |  |   |   |   |   |   |   |   |   |
|                                   | 220 A 2.000   | 02/96 → 03/07   |  | VKMA 02410<br>VKM 12200  | 1<br>1  | 1   |   |   |   |   |   | T0052   |
|                                   | 220 A 2.000   | 02/96 → 03/07 2),  |  | VKPA 83431   |   |   |   | 1   |   |   |   |   |
|   | 220 A 2.000   | 02/96 → 03/07 2),  |  | VKPA 83432   |   |   |   | 1   |   |   |   |   |
|                                   | <b>B(Alt)</b> 220 A 2.000   | 02/96 → 03/07 <b>AC</b>   |  | VKMV 4PK903<br>VKM 32154   |   | 1   | 1   |   |   |   |   |   |
|   | <b>B(PS)</b> 220 A 2.000  | 02/96 → 03/07   |  | VKMV 10AVx690  |   |   | 1   |   |   |   |   |   |
| <b>FIAT  SCUDO (220) 2.0 16V</b> |   |   |  |  |   |   |   |   |   |   |   |   |
|                                   | RFN   | 06/00 → 12/05   |  | VKMA 03235<br>VKM 13234<br>VKM 23230   | 1<br>1  | 1<br>1  | 1   |   |   |   |   | T0169   |
|                                   | RFN   | 06/00 → 06/05 16)   |  | VKPC 83650   |   |   |   | 1   |   |   |   |   |
|                                   | <b>B(Alt)</b> RFN   | 06/00 → 11/04 <b>AC</b>   |  | VKMA 33055<br>VKMV 6PK1188<br>VKM 33019<br>VKM 33020                               | 1<br>1  | 1<br>1  | 1<br>1  |   |   |   |   |   |
|   | <b>B(Alt)</b> RFN   | 06/00 → 11/04 <b>AC</b>   |  | VKMA 33052<br>VKMV 6PK1706<br>VKM 33019<br>VKM 33020                               | 1<br>1  | 1<br>1  | 1<br>1  |   |   |   |   |   |
| <b>FIAT  SCUDO (220) 1.9 D</b>   |   |   |  |  |   |   |   |   |   |   |   |   |
|                                   | D9B   | 02/96 → 12/05      |  | VKMC 03241<br>VKMA 03241<br>VKM 13241<br>VKM 23241                                 | 1<br>1<br>1   | 1<br>1<br>1   | 1   | 1   |   |   |   | T0017   |
|   | WJY (DW8B), WJZ (DW8)   | 04/98 → 10/07      |  | VKMC 03244<br>VKMA 03244<br>VKM 13244<br>VKM 23246                                 | 1<br>1<br>1   | 1<br>1<br>1   | 1   | 1   |   |   | 1<br>1<br>1   | T0167   |
|   | D9B   | 02/96 → 10/07 3)  |  | VKMS 03241<br>VKMA 03241<br>VKM 13241<br>VKM 23241                                 | 1<br>1<br>1   | 1<br>1<br>1   | 1   |   |   | 2   |   | T0017   |
|                                   | D9B   | 02/96 → 10/07   |  | VKPC 83420   |   |   |   | 1   |   |   |   |   |

































|   |  |  |  |  |  |  |  |  |  |  |  |
|---|---|---|---|--|---|---|---|---|---|---|---|
|   | WJY (DW8B), WJZ (DW8)   | 04/98 → 10/07   |   | VKPC 83639   |   |   |   | 1   |   |   |   |
|  | B(Alt) D9B  | 02/96 → 10/07   | AC, ⊗   | VKMA 33040<br>VKMV 6PK1160<br>VKM 33002  | 1   |   | 1   |   |   |   |   |
|   | B(Alt) D9B  | 02/96 → 10/07   | AC, ⊗   | VKMA 33102<br>VKMV 6PK1110<br>VKM 33002  | 1   |   | 1   |   |   |   |   |
|   | B(Alt) D9B  | 02/96 → 06/05   | AC, ⊗   | VKMA 33027<br>VKMV 6PK1437<br>VKM 33017<br>VKM 33031<br>VKM 33032                  | 1   |   | 1   |   |   |   |   |
|   | B(Alt) WJY (DW8B)   | 10/99 → 03/07   | AC, ⊗<br>VETTno 0008375 I→  | VKMA 33027<br>VKMV 6PK1437<br>VKM 33017<br>VKM 33031<br>VKM 33032                  | 1   | 2   | 1   |   |   |   |   |
|   | B(Alt) WJY (DW8B)   | 12/02 → 03/07   | AC, ⊗<br>VETTno 0009520 I→  | VKMA 33027<br>VKMV 6PK1437<br>VKM 33017<br>VKM 33031<br>VKM 33032                  | 1   |   | 1   |   |   |   |   |
|   | B(Alt) WJY (DW8B)   | 04/98 → 11/02   | AC, ⊗<br>→IVETTno 0009519   | VKMA 33027<br>VKMV 6PK1437<br>VKM 33017<br>VKM 33031<br>VKM 33032                  | 1   |   | 1   |   |   |   |   |
|   | B(Alt) WJY (DW8B)   | 12/02 → 10/07   | AC, ⊗<br>VETTno 0009520 I→  | VKMA 33027<br>VKMV 6PK1437<br>VKM 33017<br>VKM 33031<br>VKM 33032                  | 1   |   | 1   |   |   |   |   |
|   | B(Alt) WJZ (DW8)  | 04/98 → 10/07   | AC, ⊗   | VKMA 33027<br>VKMV 6PK1437<br>VKM 33017<br>VKM 33031<br>VKM 33032                  | 1   |   | 1   |   |   |   |   |
|   | B(Alt) WJZ (DW8)  | 04/98 → 10/07   | AC, ⊗   | VKMA 33027<br>VKMV 6PK1437<br>VKM 33017<br>VKM 33031<br>VKM 33032                  | 1   |   | 1   |   |   |   |   |
|   | B(Alt) WJZ (DW8)  | 04/98 → 09/99   | AC, ⊗<br>→IVETTno 0008374   | VKMA 33027<br>VKMV 6PK1437<br>VKM 33017<br>VKM 33031<br>VKM 33032                  | 1   | 2   | 1   |   |   |   |   |
|   | B(Alt) WJZ (DW8)  | 10/99 → 10/07   | AC, ⊗<br>VETTno 0008375 I→  | VKMA 33027<br>VKMV 6PK1437<br>VKM 33017<br>VKM 33031<br>VKM 33032                  | 1   | 2   | 1   |   |   |   |   |
|   | B(Alt) WJZ (DW8)  | 04/98 → 10/07   | AC, ⊗   | VKMA 33027<br>VKMV 6PK1437<br>VKM 33017<br>VKM 33031<br>VKM 33032                  | 1   |   | 1   |   |   |   |   |









































| FIAT  SCUDO (220) 1.9 TD |                            |               |   |  |   |   |   |  |   |   |       |
|---|----------------------------|---------------|---|--|---|---|---|--|---|---|-------|
|                          | D8B, DHX (XUD9TF/L)        | 02/96 → 10/07 |  | VKMC 03241<br>VKMA 03241<br>VKM 13241<br>VKM 23241 | 1 | 1 | 1 |  | 1 |   | T0017 |
|   | D8B, DHX (XUD9TF/L)        | 02/96 → 10/07 | 3)  | VKMS 03241<br>VKMA 03241<br>VKM 13241<br>VKM 23241 | 1 | 1 | 1 |  |   | 2 | T0017 |
|                          | D8B, DHX (XUD9TF/L)        | 02/96 → 10/07 |   | VKPC 83420   |   |   |   |  | 1 |   |       |
|                          | B(Alt) D8B, DHX (XUD9TF/L) | 02/96 → 10/07 | AC, ⊗   | VKMA 33040<br>VKMV 6PK1160<br>VKM 33002            | 1 |   | 1 |  |   |   |       |
|   | B(Alt) D8B, DHX (XUD9TF/L) | 02/96 → 10/07 | AC, ⊗   | VKMA 33102<br>VKMV 6PK1110<br>VKM 33002            | 1 |   | 1 |  |   |   |       |































FIAT



|   |  |  |                    |   |  |  |  |  |  |  |  |  |
|---|---|---|---|---|---|---|---|---|---|---|---|---|
| <b>B(Alt)</b>   | D8B, DHX (XUD9TF/L)   | 02/96 → 10/07   | AC.                | VKMV 6PK1739<br>VKM 33013<br>VKM 33029  | 1   | 1   |   |   |   |   |   |   |
| <b>FIAT  SCUDO (220) 2.0 JTD</b>       |   |   |   |   |   |   |   |   |   |   |   |   |
|   | RHX, RHZ  | 12/99 → 04/00   |  → IVETNo 0008561  | VKMC 03246<br>VKMA 03246<br>VKM 13246<br>VKM 23246                                  | 1   | 1   | 1   | 1   |   |   | 1   | T0168   |
|   | RHX, RHZ  | 04/00 → 11/03   |  VETNo 0008562   → | VKMC 03247<br>VKMA 03247<br>VKM 13244<br>VKM 23246                                  | 1   | 1   | 1   | 1   | 1   |   | 1   | T0168   |
|   | RHX, RHZ  | 12/03 → 10/07   |                    | VKMC 03246<br>VKMA 03246<br>VKM 13246<br>VKM 23246                                  | 1   | 1   | 1   | 1   | 1   |   | 1   | T0168   |
|   | RHX, RHZ  | 12/99 → 10/07   |   | VKPC 83639  |   |   |   |   | 1   |   |   |   |
|   | <b>B(Alt)</b> RHX, RHZ  | 12/99 → 10/07   | AC  | VKMA 33044<br>VKMV 6PK1468<br>VKM 33024<br>VKM 33033<br>VKM 33069                   | 2   | 1   | 1   | 1   |   |   |   |   |
|   | <b>B(Alt)</b> RHX, RHZ  | 12/99 → 05/01   | AC Delphi, AC.<br>→ IVETNo 0008981  | VKMV 5PK967<br>VKM 33013<br>VKM 33033   | 1   |   | 1   |   |   |   |   |   |
|   | <b>B(Alt)</b> RHX, RHZ  | 12/99 → 05/01   | AC Sanden, AC.<br>→ IVETNo 0008981  | VKMV 6PK1740<br>VKM 33013<br>VKM 33033  | 1   |   | 1   |   |   |   |   |   |
|   | <b>B(Alt)</b> RHX, RHZ  | 06/01 → 12/03   | AC, VETNo 0008982   →   | VKMV 6PK1740<br>VKM 33013<br>VKM 33033  | 1   |   | 1   |   |   |   |   |   |
|   | <b>B(Alt)</b> RHX, RHZ  | 01/04 → 10/07   | AC  | VKMV 6PK1740<br>VKM 33013<br>VKM 33033  | 1   |   | 1   |   |   |   |   |   |
| <b>FIAT  SCUDO (220) 2.0 JTD 16V</b> |   |   |   |   |   |   |   |   |   |   |   |   |
|                                       | RHM   | 12/02 → 04/04   |  → IVETNo 10011  | VKMC 03248<br>VKMA 03248<br>VKM 13246<br>VKM 23246                                  | 1   | 1   | 1   | 1   | 1   |   | 1   | T0196   |
|   | RHW   | 12/02 → 10/07   |                  | VKMC 03248<br>VKMA 03248<br>VKM 13246<br>VKM 23246                                  | 1   | 1   | 1   | 1   | 1   |   | 1   | T0196   |
|   | RHM   | 05/04 → 10/07   | VETNo 10012   →   | VKMA 03265<br>VKM 13264<br>VKM 23264  | 1   | 1   | 1   |   |   |   |   | T0196   |
|                                       | RHM, RHW  | 12/02 → 10/07   |   | VKPC 83639  |   |   |   |   | 1   |   |   |   |
|                                       | <b>B(Alt)</b> RHM, RHW  | 12/02 → 10/07   | AC  | VKMA 33044<br>VKMV 6PK1468<br>VKM 33024<br>VKM 33033<br>VKM 33069                   | 2   | 1   | 1   | 1   |   |   |   |   |
|   | <b>B(Alt)</b> RHM, RHW  | 12/02 → 10/07   | AC  | VKMV 6PK1740<br>VKM 33013<br>VKM 33033  | 1   |   | 1   |   |   |   |   |   |
| <b>FIAT  SEDICI 1.6 16V</b>          |   |   |   |   |   |   |   |   |   |   |   |   |
|                                       | M16A  | 06/06 → 12/06   |   |  |   |   |   |   |   |   |   |   |
| <b>FIAT  SEDICI 1.9 D Multijet</b>   |   |   |   |   |   |   |   |   |   |   |   |   |
|                                       | D19AA   | 06/06 → 10/07   |   | —<br>VKM 12174<br>VKM 22180   | 1   | 1   | 1   |   |   |   |   |   |
|                                       | D19AA   | 06/06 → 10/07   |   | VKPC 82665  |   |   |   |   | 1   |   |   |   |



























|   |                               |                  |           |                 |              |   |   |   |  |   |   |   |   |  |   |  |  |       |
|---|-------------------------------|------------------|--|-----------------|--------------|---|---|---|--|---|---|---|---|--|---|--|--|-------|
| <b>FIAT  SEICENTO 0.9</b>    |                               |                  |  |                 |              |   |   |   |  |   |   |   |   |  |   |  |  |       |
|                              | 1170 A1.046                   | 01/98 → 12/05    |  | OKOKOKO         |              |   |   |   |  |   |   |   |   |  |   |  |  |       |
|                              | 1170 A1.046                   | 01/98 → 09/07 2) |  | VKPA 82203      |              |   |   |   |  |   |   |   | 1 |  |   |  |  |       |
|                              | B(Alt) 1170 A1.046            | 01/98 → 09/07    |  | VKMV 10AVx800   |              |   |   |   |  |   | 1 |   |   |  |   |  |  |       |
| <b>FIAT  SEICENTO 1.1</b>    |                               |                  |  |                 |              |   |   |   |  |   |   |   |   |  |   |  |  |       |
|                              | 176 B2.000                    | 01/98 → 09/07    |   | → Mot. 9042883  | VKMC 02202   | 1 |   | 1 |  | 1 |   |   |   |  |   |  |  | T0009 |
|   |                               |                  |  |                 | VKMA 02202   | 1 |   | 1 |  |   |   |   |   |  |   |  |  |       |
|   |                               |                  |  |                 | VKM 12200    | 1 |   |   |  |   |   |   |   |  |   |  |  |       |
|   | 176 B2.000                    | 01/98 → 09/07    |   | Mot. 9042884  → | VKMC 02210   | 1 |   | 1 |  | 1 |   |   |   |  |   |  |  | T0174 |
|   |                               |                  |  |                 | VKMA 02210   | 1 |   | 1 |  |   |   |   |   |  |   |  |  |       |
|   |                               |                  |  |                 | VKM 12200    | 1 |   |   |  |   |   |   |   |  |   |  |  |       |
|   | 187 A1.000                    | 01/98 → 09/07    |  | → Mot. 2934169  | VKMA 02210   | 1 |   | 1 |  |   |   |   |   |  |   |  |  | T0174 |
|   |                               |                  |  |                 | VKM 12200    | 1 |   |   |  |   |   |   |   |  |   |  |  |       |
|   | 187 A1.000                    | 01/98 → 09/07    |  | Mot. 2934170  → | —            | 1 |   | 1 |  |   |   |   |   |  |   |  |  |       |
|   |                               |                  |  |                 | VKM 12200    | 1 |   |   |  |   |   |   |   |  |   |  |  |       |
|                              | 176 B2.000                    | 01/98 → 09/07    |  | → Mot. 9042883  | VKPC 82214   |   |   |   |  |   |   |   | 1 |  |   |  |  |       |
|   | 176 B2.000                    | 01/98 → 09/07    |  | Mot. 9042884  → | VKPC 82250   |   |   |   |  |   |   |   | 1 |  |   |  |  |       |
|                              | B(Alt) 176 B2.000             | 01/98 → 09/07    |  | AC              | VKMV 4PK675  |   |   |   |  |   |   | 1 |   |  |   |  |  |       |
|   | B(Alt) 187 A1.000             | 01/98 → 09/07    |  | AC              | VKMV 4PK668  |   |   |   |  |   |   | 1 |   |  |   |  |  |       |
| <b>FIAT  STILO 1.2 16V</b>   |                               |                  |  |                 |              |   |   |   |  |   |   |   |   |  |   |  |  |       |
|                              | 188 A5.000                    | 02/02 → 12/06    |   |                 | —            | 1 |   | 1 |  | 1 |   |   |   |  |   |  |  | T0160 |
|   |                               |                  |  |                 | VKMA 02204   | 1 |   | 1 |  |   |   |   |   |  |   |  |  |       |
|   |                               |                  |  |                 | VKM 12201    | 1 |   |   |  |   |   |   |   |  |   |  |  |       |
|                              | 188 A5.000                    | 02/02 → 12/06    |  |                 | VKPC 82251   |   |   |   |  |   |   |   | 1 |  |   |  |  |       |
|                             | B(Alt) 188 A5.000             | 02/02 → 12/06    |  | AC              | VKMV 4PK675  |   |   |   |  |   |   | 1 |   |  |   |  |  |       |
|   | B(Alt) 188 A5.000             | 02/02 → 12/06    |  | AC              | VKM 32023    | 1 |   |   |  |   |   |   |   |  |   |  |  |       |
| <b>FIAT  STILO 1.4 16V</b> |                               |                  |  |                 |              |   |   |   |  |   |   |   |   |  |   |  |  |       |
|                            | 192 B2.000, 843 A1.000        | 01/04 → 10/07    |   |                 | —            | 1 |   | 1 |  | 1 |   |   |   |  |   |  |  | T0160 |
|   |                               |                  |  |                 | VKMA 02204   | 1 |   | 1 |  |   |   |   |   |  |   |  |  |       |
|   |                               |                  |  |                 | VKM 12201    | 1 |   |   |  |   |   |   |   |  |   |  |  |       |
|                            | 192 B2.000, 843 A1.000        | 01/04 → 10/07    |  |                 | VKPC 82251   |   |   |   |  |   |   |   | 1 |  |   |  |  |       |
|                            | B(Alt) 192 B2.000, 843 A1.000 | 01/04 → 10/07    |  | AC              | VKMV 4PK675  |   |   |   |  |   |   | 1 |   |  |   |  |  |       |
|   | B(Alt) 192 B2.000, 843 A1.000 | 01/04 → 10/07    |  | AC              | VKMA 32040   | 1 |   | 1 |  |   |   |   |   |  |   |  |  |       |
|   |                               |                  |  |                 | VKMV 5PK1145 |   |   | 1 |  |   |   |   |   |  |   |  |  |       |
|   |                               |                  |  |                 | VKM 32023    | 1 |   |   |  |   |   |   |   |  |   |  |  |       |
| <b>FIAT  STILO 1.6 16V</b> |                               |                  |  |                 |              |   |   |   |  |   |   |   |   |  |   |  |  |       |
|                            | 182 B6.000                    | 10/01 → 10/07 3) |  |                 | VKMS 02242-2 | 1 | 1 | 1 |  |   |   |   |   |  | 4 |  |  | T0130 |
|   |                               |                  |  |                 | VKMA 02242   | 1 | 1 | 1 |  |   |   |   |   |  |   |  |  |       |
|   |                               |                  |  |                 | VKM 12242    | 1 |   |   |  |   |   |   |   |  |   |  |  |       |
|   |                               |                  |  |                 | VKM 22242    |   |   | 1 |  |   |   |   |   |  |   |  |  |       |
|                            | 182 B6.000                    | 10/01 → 10/07 2) |  |                 | VKPA 82441   |   |   |   |  |   |   |   | 1 |  |   |  |  |       |
|   |                               |                  |  |                 | VKPC 82441   |   |   |   |  |   |   |   | 1 |  |   |  |  |       |
|                            | B(Alt) 182 B6.000             | 10/01 → 10/07    |  |                 | VKMV 5PK938  |   |   |   |  |   |   | 1 |   |  |   |  |  |       |
|   |                               |                  |  |                 | VKM 32243    |   |   | 1 |  |   |   |   |   |  |   |  |  |       |
| <b>FIAT  STILO 1.8 16V</b> |                               |                  |  |                 |              |   |   |   |  |   |   |   |   |  |   |  |  |       |
|                            | 192 A4.000                    | 10/01 → 12/06    |  |                 | VKMA 02184   | 1 | 1 | 1 |  |   |   |   |   |  |   |  |  | T0143 |
|   |                               |                  |  |                 | VKM 12182    | 1 |   |   |  |   |   |   |   |  |   |  |  |       |
|   |                               |                  |  |                 | VKM 22177    |   |   | 1 |  |   |   |   |   |  |   |  |  |       |
|                            | 192 A4.000                    | 10/01 → 12/06    |  |                 | VKPC 82451   |   |   |   |  |   |   |   | 1 |  |   |  |  |       |
|                            | B(Alt) 192 A4.000             | 10/01 → 02/03    |  |                 | VKMV 6PK1285 |   |   |   |  |   |   | 1 |   |  |   |  |  |       |
|   |                               |                  |  |                 | VKM 32026    | 1 |   |   |  |   |   |   |   |  |   |  |  |       |
|   |                               |                  |  |                 | VKM 32184    |   |   | 1 |  |   |   |   |   |  |   |  |  |       |
|   |                               |                  |  |                 | VKM 32184    |   |   | 1 |  |   |   |   |   |  |   |  |  |       |
|   | B(Alt) 192 A4.000             | 03/03 → 12/06    |  |                 | VKMV 6PK1265 |   |   |   |  |   |   | 1 |   |  |   |  |  |       |
|   |                               |                  |  |                 | VKM 32026    | 1 |   |   |  |   |   |   |   |  |   |  |  |       |
|   |                               |                  |  |                 | VKM 32184    |   |   | 1 |  |   |   |   |   |  |   |  |  |       |
|   |                               |                  |  |                 | VKM 32184    |   |   | 1 |  |   |   |   |   |  |   |  |  |       |
| <b>FIAT  STILO 2.4 20V</b> |                               |                  |  |                 |              |   |   |   |  |   |   |   |   |  |   |  |  |       |
|                            | 192 A2.000                    | 10/01 → 12/06    |  |                 | VKMA 02178   | 1 | 1 | 1 |  |   |   |   |   |  |   |  |  | T0128 |
|   |                               |                  |  |                 | VKM 12172    | 1 |   |   |  |   |   |   |   |  |   |  |  |       |
|   |                               |                  |  |                 | VKM 22174    |   |   | 1 |  |   |   |   |   |  |   |  |  |       |
|                            | 192 A2.000                    | 10/01 → 12/06    |  |                 | VKPC 82646   |   |   |   |  |   |   |   | 1 |  |   |  |  |       |



|  |  |  |                  |  |  |  |  |  |  |  |  |  |
|--|---|---|---|--|---|---|---|---|---|---|---|---|
|    | B(AC)   | 192 A2.000  | 10/01 → 12/06   | VKMOV 6PK1147<br>VKM 32002   | 1   | 1   |   |   |   |   |   |   |
| <b>FIAT  STILO 1.9 D Multijet</b>       |   |   |   |  |   |   |   |   |   |   |   |   |
|    |   | 192 A8.000  | 09/05 → 10/07    | VKMC 02179<br>VKMA 02179<br>VKM 12174<br>VKM 22179                                 | 1<br>1<br>1   | 1<br>1<br>1   | 1   | 1   |   |   | 2   | T0158   |
|  |   | 192 A9.000  | 09/05 → 12/06   | VKMA 02192<br>VKM 12174<br>VKM 22180   | 1<br>1  | 1<br>1  | 1   |   |   |   | 2   | T0158   |
|    |   | 192 A8.000, 192 A9.000  | 09/05 → 10/07   | VKPC 82665   |   |   |   | 1   |   |   |   |   |
|    | B(Alt)  | 192 A8.000  | 09/05 → 10/05   | VKMOV 6PK1270<br>VKM 32006<br>VKM 32027<br>VKM 32030                               | 1   | 1<br>1  | 1   |   |   |   |   |   |
|  | B(Alt)  | 192 A8.000  | 11/05 → 10/07   | VKMOV 6PK1255<br>VKM 32006<br>VKM 32027<br>VKM 32030                               | 1   | 1<br>1  | 1   |   |   |   |   |   |
|  | B(Alt)  | 192 A9.000  | 09/05 → 12/06 <i>AC</i>   | VKMOV 6PK815   |   |   | 1   |   |   |   |   |   |
|  | B(Alt)  | 192 A9.000  | 09/05 → 10/05 <b>AC</b>   | VKMOV 6PK1270<br>VKM 32006<br>VKM 32027<br>VKM 32030                               | 1   | 1<br>1  | 1   |   |   |   |   |   |
|  | B(Alt)  | 192 A9.000  | 11/05 → 12/06 <b>AC</b>   | VKMOV 6PK1255<br>VKM 32006<br>VKM 32027<br>VKM 32030                               | 1   | 1<br>1  | 1   |   |   |   |   |   |
|                                        |   | 192 A8.000, 192 A9.000  | 09/05 → 12/05   | VKM_____   |   |   |   |   | 1   |   |   |   |
| <b>FIAT  STILO 1.9 D Multijet 16V</b> |   |   |   |  |   |   |   |   |   |   |   |   |
|                                        |   | 937A5.000   | 09/05 → 10/07   | VKMA 02193<br>VKM 12174<br>VKM 22180   | 1<br>1  | 1<br>1  | 1   |   |   |   |   | T0248   |
|                                        |   | 937A5.000   | 09/05 → 10/07   | VKPC 82667   |   |   |   | 1   |   |   |   |   |
|                                        | B(Alt)  | 937A5.000   | 09/05 → 10/07   | VKMOV 6PK1360<br>VKM 32006<br>VKM 32046<br>VKM 32184                               | 1   | 1<br>1  | 1   |   |   |   |   |   |
|                                        |   | 937A5.000   | 09/05 → 12/05   | VKM_____   |   |   |   |   | 1   |   |   |   |
| <b>FIAT  STILO 1.9 JTD</b>            |   |   |   |  |   |   |   |   |   |   |   |   |
|                                        |   | 192 A1.000, 192 A3.000,<br>937A7.000  | 10/01 → 06/04  | VKMC 02179<br>VKMA 02179<br>VKM 12174<br>VKM 22179                                 | 1<br>1<br>1   | 1<br>1<br>1   | 1   | 1   |   |   | 2   | T0158   |
|  |   | 192 A1.000, 192 A3.000,<br>937A7.000  | 07/04 → 10/07   | VKMA 02192<br>VKM 12174<br>VKM 22180   | 1<br>1  | 1<br>1  | 1   |   |   |   | 2   | T0158   |
|  |   | 192 B1.000, 937A4.000   | 09/03 → 10/07   | VKMA 02197<br>VKM 12174<br>VKM 22180   | 1<br>1  | 1<br>1  | 1   |   |   |   |   | T0203   |
|                                        |   | 192 A1.000, 192 A3.000,<br>937A7.000  | 10/01 → 10/07   | VKPC 82665   |   |   |   |   | 1   |   |   |   |
|  |   | 192 B1.000, 937A4.000   | 09/03 → 10/07   | VKPC 82667   |   |   |   |   | 1   |   |   |   |
|                                        | B(Alt)  | 192 A1.000, 192 A3.000,<br>937A7.000  | 10/01 → 10/07 <i>AC</i>   | VKMOV 6PK815   |   |   | 1   |   |   |   |   |   |
|  | B(Alt)  | 192 A1.000, 192 A3.000,<br>937A7.000  | 10/01 → 10/05 <b>AC</b>   | VKMOV 6PK1270<br>VKM 32006<br>VKM 32027<br>VKM 32030                               | 1   | 1<br>1  | 1   |   |   |   |   |   |
|  | B(Alt)  | 192 A1.000, 192 A3.000,<br>937A7.000  | 11/05 → 10/07 <b>AC</b>   | VKMOV 6PK1255<br>VKM 32006   | 1   |   | 1   |   |   |   |   |   |

|                                |               |  |               | VKM 32027   | 1            |   |   |   |   |   |  |  |       |
|--------------------------------|---------------|--|---------------|---|--------------|---|---|---|---|---|--|--|-------|
|                                |               |  |               | VKM 32030   |              | 1 |   |   |   |   |  |  |       |
|                                | <b>B(Alt)</b> | 192 B1.000, 937A4.000                            | 09/03 → 10/07 | VKMV 6PK1360  |              |   | 1 |   |   |   |  |  |       |
|                                |               |  |               | VKM 32006   | 1            |   |   |   |   |   |  |  |       |
|                                |               |  |               | VKM_____  |              |   |   |   |   |   |  |  |       |
|                                |               |  |               | VKM 32184   |              | 1 |   |   |   |   |  |  |       |
|                                |               | 192 A1.000, 192 A3.000,<br>192 B1.000, 937A4.000 | 01/03 → 12/05 | VKM_____  |              |   |   |   |   | 1 |  |  |       |
| <b>FIAT  STILO 1.9 JTD 16V</b> |               |  |               |   |              |   |   |   |   |   |  |  |       |
|                                |               | 192 A5.000                                       | 01/04 → 10/07 | VKMA 02197  | 1            | 1 | 1 |   |   |   |  |  | T0203 |
|                                |               |  |               | VKM 12174   | 1            |   |   |   |   |   |  |  |       |
|                                |               |  |               | VKM 22180   |              | 1 |   |   |   |   |  |  |       |
|                                |               | 192 A5.000                                       | 01/04 → 10/07 | VKPC 82667  |              |   |   |   |   | 1 |  |  |       |
|                                | <b>B(Alt)</b> | 192 A5.000                                       | 01/04 → 10/07 | VKMV 6PK1360  |              |   | 1 |   |   |   |  |  |       |
|                                |               |  |               | VKM 32006   | 1            | 1 |   |   |   |   |  |  |       |
|                                |               |  |               | VKM_____  |              |   |   |   |   |   |  |  |       |
|                                |               |  |               | VKM 32184   |              | 1 |   |   |   |   |  |  |       |
|                                |               | 192 A5.000                                       | 01/04 → 12/05 | VKM_____  |              |   |   |   |   | 1 |  |  |       |
| <b>FIAT  STRADA 1.2</b>        |               |  |               |   |              |   |   |   |   |   |  |  |       |
|                                |               | 178 B5.000                                       | 06/99 → 12/03 | → <b>Mot.</b> 9042883   | VKMC 02201   | 1 |   | 1 | 1 |   |  |  | T0117 |
|                                |               |  |               |   | VKMA 02201   | 1 |   | 1 |   |   |  |  |       |
|                                |               |  |               |   | VKM 12200    | 1 |   |   |   |   |  |  |       |
|                                |               | 178 B5.000                                       | 06/99 → 12/03 | <b>Mot.</b> 9042884 <b>I→</b>                                   | VKMC 02203   | 1 |   | 1 | 1 |   |  |  |       |
|                                |               |  |               |   | VKMA 02203   | 1 |   | 1 |   |   |  |  | T0175 |
|                                |               |  |               |   | VKM 12200    | 1 |   |   |   |   |  |  |       |
|                                |               | 178 B5.000                                       | 01/04 → 09/07 | → <b>Mot.</b> 2546254   | VKMC 02203   | 1 |   | 1 | 1 |   |  |  | T0175 |
|                                |               |  |               |   | VKMA 02203   | 1 |   | 1 |   |   |  |  |       |
|                                |               |  |               |   | VKM 12200    | 1 |   |   |   |   |  |  |       |
|                                |               | 188 A4.000                                       | 04/03 → 09/07 |   | VKMC 02203   | 1 |   | 1 | 1 |   |  |  | T0175 |
|                                |               |  |               |   | VKMA 02203   | 1 |   | 1 |   |   |  |  |       |
|                                |               |  |               |   | VKM 12200    | 1 |   |   |   |   |  |  |       |
|                                |               | 178 B5.000                                       | 01/04 → 09/07 | <b>A</b> <b>Mot.</b> 2546254 <b>I→</b>                          | VKMA_____    | 1 |   | 1 |   |   |  |  | T0250 |
|                                |               |  |               |   | VKM 12206    | 1 |   |   |   |   |  |  |       |
|                                |               | 178 B5.000                                       | 06/99 → 12/03 | <b>→</b> <b>Mot.</b> 9042883                                    | VKPC 82214   |   |   |   |   | 1 |  |  |       |
|                                |               | 178 B5.000                                       | 06/99 → 12/03 | <b>Mot.</b> 9042884 <b>I→</b> ,<br><b>→</b> <b>Mot.</b> 2546254 | VKPC 82250   |   |   |   |   | 1 |  |  |       |
|                                |               | 178 B5.000                                       | 01/04 → 09/07 | <b>Mot.</b> 2546255 <b>I→</b>                                   | VKPC 82251   |   |   |   |   | 1 |  |  |       |
|                                |               | 188 A4.000                                       | 04/03 → 09/07 |   | VKPC 82250   |   |   |   |   | 1 |  |  |       |
|                                | <b>B(Alt)</b> | 178 B5.000                                       | 06/99 → 02/05 | <b>AC</b>   | VKMV 4PK698  |   |   | 1 |   |   |  |  |       |
|                                | <b>B(Alt)</b> | 178 B5.000                                       | 05/02 → 09/07 | <b>AC</b> ,   | VKMV 4PK668  |   |   | 1 |   |   |  |  |       |
|                                | <b>B(Alt)</b> | 188 A4.000                                       | 04/03 → 09/07 | <b>AC</b>   | VKMV 4PK675  |   |   | 1 |   |   |  |  |       |
|                                | <b>B(Alt)</b> | 188 A4.000                                       | 04/03 → 09/07 | <b>AC</b>   | VKM 32023    | 1 |   |   |   |   |  |  |       |
|                                |               |  |               |   | VKM 32031    |   | 1 |   |   |   |  |  |       |
|                                | <b>B(PS)</b>  | 178 B5.000                                       | 06/99 → 09/07 |   | VKMV 3PK915  |   |   | 1 |   |   |  |  |       |
|                                | <b>B(AC)</b>  | 178 B5.000                                       | 06/99 → 09/07 |   | VKMV 4PK841  |   |   | 1 |   |   |  |  |       |
| <b>FIAT  STRADA 1.7 TD</b>     |               |  |               |   |              |   |   |   |   |   |  |  |       |
|                                |               | 176 A3.000                                       | 06/99 → 09/07 |   | VKMA 02152   | 1 | 1 | 1 |   |   |  |  | T0053 |
|                                |               |  |               |   | VKM 12151    | 1 |   |   |   |   |  |  |       |
|                                |               |  |               |   | VKM 22151    |   | 1 |   |   |   |  |  |       |
|                                |               | 176 A3.000                                       | 06/99 → 09/07 | 2)  | —            |   |   |   |   | 1 |  |  |       |
| <b>FIAT  STRADA 1.9 D</b>      |               |  |               |   |              |   |   |   |   |   |  |  |       |
|                                |               | 223 A6.000                                       | 12/00 → 03/07 |   | VKMC 02174   | 1 | 1 | 1 |   | 1 |  |  | 2     |
|                                |               |  |               |   | VKMA 02174   | 1 | 1 | 1 |   |   |  |  | 2     |
|                                |               |  |               |   | VKM 12174    | 1 |   |   |   |   |  |  | 2     |
|                                |               |  |               |   | VKM 22179    |   | 1 |   |   |   |  |  |       |
|                                |               | 223 A6.000                                       | 12/00 → 03/07 |   | VKPC 82665   |   |   |   |   | 1 |  |  |       |
|                                | <b>B(Alt)</b> | 223 A6.000                                       | 12/00 → 06/05 | <b>AC</b>   | VKMV 6PK1050 |   |   | 1 |   |   |  |  |       |
|                                |               |  |               |   | VKM 32027    | 1 |   |   |   |   |  |  |       |
|                                | <b>B(Alt)</b> | 223 A6.000                                       | 12/00 → 06/05 | <b>AC</b>   | VKM 32005    |   | 1 |   |   |   |  |  |       |
|                                |               |  |               |   | VKM 32027    | 1 |   |   |   |   |  |  |       |
|                                |               | 223 A6.000                                       | 12/00 → 12/05 |   | VKM_____     |   |   |   |   | 1 |  |  |       |
| <b>FIAT  STRADA 1.9 JTD</b>    |               |  |               |   |              |   |   |   |   |   |  |  |       |
|                                |               | 188 A2.000                                       | 04/03 → 06/04 |   | VKMC 02179   | 1 | 1 | 1 |   | 1 |  |  | 2     |
|                                |               |  |               |   | VKMA 02179   | 1 | 1 | 1 |   |   |  |  | 2     |





































|  |  |  |                     |  |  |  |  |  |  |  |  |  |  |
|--|---|---|--|--|---|---|---|---|---|---|---|---|---|
|  |   |   |  | VKM 12174<br>VKM 22179   | 1   | 1   |   |   |   |   |   |   | 2   |
|  | 188 A2.000  | 07/04 → 03/07   |  | VKMA 02192<br>VKM 12174<br>VKM 22180   | 1<br>1  | 1<br>1  | 1   |   |   |   |   |   | T0158   |
|                            | 188 A2.000  | 04/03 → 03/07   |  | VKPC 82665   |   |   |   |   | 1   |   |   |   |   |
|                            | B(Alt) 188 A2.000   | 04/03 → 06/05   | AC   | VKMV 6PK1080<br>VKM 32027  | 1   |   | 1   |   |   |   |   |   |   |
|  | B(Alt) 188 A2.000   | 04/03 → 06/05   | AC   | VKMV 6PK1844<br>VKM 32005<br>VKM 32027   | 1   | 1   | 1   |   |   |   |   |   |   |
|                            | 188 A2.000  | 04/03 → 12/05   |  | VKM_____   | 1   |   |   |   |   | 1   |   |   |   |
| <b>FIAT  TEMpra 1.4</b>   |   |   |  |  |   |   |   |   |   |   |   |   |   |
|                            | 159 A2.000, 160 A1.046,<br>836 A4.000   | 03/91 → 08/96   |  | VKMA 02410<br>VKM 12200  | 1<br>1  | 1   |   |   |   |   |   |   | T0052   |
|                            | 159 A2.000  | 03/91 → 12/92   | 2), AC, ⊗  | —<br>VKPC 82224  |   |   |   |   | 1<br>1  |   |   |   |   |
|  | 159 A2.000, 160 A1.046  | 03/91 → 12/92   | ⊗, Auto. GBX   | VKPC 82450   |   |   |   |   | 1   |   |   |   |   |
|  | 159 A2.000, 160 A1.046  | 03/91 → 12/92   | 2), AC   | VKPA 82431<br>VKPC 82431   |   |   |   |   | 1<br>1  |   |   |   |   |
|  | 159 A2.000  | 01/93 → 08/96   | 2), →IMot. 9336692   | VKPA 82431<br>VKPC 82431   |   |   |   |   | 1<br>1  |   |   |   |   |
|  | 159 A2.000  | 01/93 → 08/96   | 2), Mot. 9336693  →  | —<br>VKPC 82246  |   |   |   |   | 1<br>1  |   |   |   |   |
|  | 160 A1.046, 836 A4.000  | 03/92 → 08/96   | AC, ⊗, →IMot. 9336692  | VKPC 82245   |   |   |   |   | 1   |   |   |   |   |
|  | 160 A1.046  | 01/93 → 08/96   | 2), ⊗, →IMot. 9336692  | VKPA 82431<br>VKPC 82431   |   |   |   |   | 1<br>1  |   |   |   |   |
|  | 836 A4.000  | 03/92 → 08/96   | 2), AC, ⊗,<br>→IMot. 9336692   | VKPA 82431<br>VKPC 82431   |   |   |   |   | 1<br>1  |   |   |   |   |
|  | 836 A4.000  | 03/92 → 08/96   | 2), AC, ⊗,<br>Mot. 9336693  →  | —<br>VKPC 82246  |   |   |   |   | 1<br>1  |   |   |   |   |
|  | 836 A4.000  | 03/92 → 08/96   | 2), AC, ⊗,<br>Mot. 9336693  →  | VKPA 82230<br>VKPC 82230   |   |   |   |   | 1<br>1  |   |   |   |   |
| <b>FIAT  TEMpra 1.6</b> |   |   |  |  |   |   |   |   |   |   |   |   |   |
|                          | 159 A3.000, 159 A3.046,<br>159 A3.048,<br>159 B9.000, 835 C1.000                  | 03/90 → 08/96   |  | VKMA 02410<br>VKM 12200  | 1<br>1  | 1   |   |   |   |   |   |   | T0052   |
|                          | 159 A3.000  | 03/90 → 04/93   | 2), AC, ⊗, Man. GBX  | —<br>VKPC 82224  |   |   |   |   | 1<br>1  |   |   |   |   |
|  | 159 A3.000  | 03/90 → 04/93   | AC, ⊗, Man. GBX,<br>→IMot. 8666674   | VKPC 82245   |   |   |   |   | 1   |   |   |   |   |
|  | 159 A3.000, 159 A3.046  | 03/90 → 08/96   | 2), AC, Man. GBX   | VKPA 82431<br>VKPC 82431   |   |   |   |   | 1<br>1  |   |   |   |   |
|  | 159 A3.046  | 06/90 → 08/96   | ⊗, Auto. GBX   | VKPC 82450   |   |   |   |   | 1   |   |   |   |   |
|  | 159 A3.046  | 06/90 → 08/96   | AC, Man. GBX   | VKPC 82245   |   |   |   |   | 1   |   |   |   |   |
|  | 159 A3.048  | 06/92 → 12/92   | ⊗, Mot. 8666674  →   | VKPC 82245   |   |   |   |   | 1   |   |   |   |   |
|  | 159 A3.048  | 06/92 → 12/92   | 2), AC, Man. GBX   | VKPA 82431<br>VKPC 82431   |   |   |   |   | 1<br>1  |   |   |   |   |
|  | 159 A3.048  | 01/93 → 08/96   |  | VKPC 82450   |   |   |   |   | 1   |   |   |   |   |
|  | 159 B9.000  | 06/94 → 08/96   | 2)   | VKPA 82230<br>VKPC 82230   |   |   |   |   | 1<br>1  |   |   |   |   |
|  | 835 C1.000  | 10/90 → 08/96   | →IMot. 9336692   | VKPC 82245   |   |   |   |   | 1   |   |   |   |   |
|  | 835 C1.000  | 10/90 → 08/96   | 2), Mot. 9336693  →  | VKPA 82230<br>VKPC 82230   |   |   |   |   | 1<br>1  |   |   |   |   |
| <b>FIAT  TEMpra 1.8</b> |   |   |  |  |   |   |   |   |   |   |   |   |   |
|                          | 159 A4.000  | 03/90 → 08/96   | B(41139x18),  139 | VKMA 02222<br>VKM 12005  | 1<br>1  | 1   |   |   |   |   |   |   | T0089   |
|  | 159 A4.046, 835 C2.000,<br>835 C4.000, 836 A5.000                                 | 03/90 → 08/96   | B(41142x18),  142 | VKMA 02227<br>VKM 12227  | 1<br>1  | 1   |   |   |   |   |   |   | T0035   |
|                          | 159 A4.000  | 03/90 → 12/92   |  | VKPC 82432   |   |   |   |   | 1   |   |   |   |   |
|  | 159 A4.046, 835 C2.000,<br>835 C4.000, 836 A5.000                                 | 03/90 → 08/96   |  | VKPC 82647   |   |   |   |   | 1   |   |   |   |   |

| <b>FIAT  TEMpra 2.0</b>    |   |               |                                |   |             |   |   |  |        |  |   |  |       |
|----------------------------|---|---------------|--------------------------------|---|-------------|---|---|--|--------|--|---|--|-------|
|                            | 159 A6.046  | 10/90 → 08/96 |                                | VKMA 02227<br>VKM 12227                 | 1<br>1      | 1 |   |  |        |  |   |  | T0035 |
|                            | 159 A6.046  | 10/90 → 07/91 |                                | VKPC 82622                              |             |   |   |  | 1      |  |   |  |       |
|                            | 159 A6.046  | 08/91 → 08/96 |                                | VKPC 82647                              |             |   |   |  | 1      |  |   |  |       |
| <b>FIAT  TEMpra 1.9 D</b>  |   |               |                                |   |             |   |   |  |        |  |   |  |       |
|                            | 160 A7.000  | 07/91 → 08/96 |                                | VKMA 02154<br>VKM 12153<br>VKM 22153    | 1<br>1      | 1 | 1 |  |        |  |   |  | T0055 |
|                            | 160 A7.000  | 07/91 → 08/96 | 2)                             | VKPA 82429<br>VKPC 82429                |             |   |   |  | 1<br>1 |  |   |  |       |
| <b>FIAT  TEMpra 1.9 TD</b> |   |               |                                |   |             |   |   |  |        |  |   |  |       |
|                            | 160 A6.000, 160 B6.046,<br>160 D1.000             | 05/90 → 08/96 |                                | VKMA 02154<br>VKM 12153<br>VKM 22153    | 1<br>1      | 1 | 1 |  |        |  |   |  | T0055 |
|                            | 160 A6.000, 160 B6.046,<br>160 D1.000             | 05/90 → 08/96 | 2), Mot. 1071902 I→            | VKPA 82618<br>VKPC 82618                |             |   |   |  | 1<br>1 |  |   |  |       |
| <b>FIAT  TIPO 1.1</b>      |   |               |                                |   |             |   |   |  |        |  |   |  |       |
|                            | 160 A3.000  | 01/88 → 10/91 | 3)                             | VKMS 02200-1<br>VKMA 02200<br>VKM 12200 | 1<br>1<br>1 | 1 | 1 |  |        |  | 2 |  | T0009 |
|                            | 160 A3.000  | 01/88 → 10/91 |                                | VKPC 82214                              |             |   |   |  | 1      |  |   |  |       |
|                            | B(Alt) 160 A3.000                                 | 01/88 → 10/91 |                                | VKMW 10AVx675                           |             |   | 1 |  |        |  |   |  |       |
| <b>FIAT  TIPO 1.4</b>      |   |               |                                |   |             |   |   |  |        |  |   |  |       |
|                            | 160 A1.000, 160 A1.046,<br>160 A1.048, 836 A4.000 | 07/87 → 04/95 |                                | VKMA 02410<br>VKM 12200                 | 1<br>1      | 1 |   |  |        |  |   |  | T0052 |
|                            | 160 A1.000, 160 A1.048                            | 07/87 → 12/89 | AC, Ø<br>→ IMot. 7131546       | VKPC 82224                              |             |   |   |  | 1      |  |   |  |       |
|                            | 160 A1.000, 160 A1.048                            | 07/87 → 12/89 | 2), AC, Ø<br>Mot. 7131547 I→   | —<br>VKPC 82224                         |             |   |   |  | 1<br>1 |  |   |  |       |
|                            | 160 A1.000, 160 A1.046,<br>160 A1.048             | 07/87 → 12/92 | 2), AC, Ø                      | VKPA 82431<br>VKPC 82431                |             |   |   |  | 1<br>1 |  |   |  |       |
|                            | 160 A1.000, 160 A1.046,<br>160 A1.048             | 07/87 → 12/92 | Ø, Man. GBX                    | VKPC 82245                              |             |   |   |  | 1      |  |   |  |       |
|                            | 160 A1.046  | 05/89 → 12/92 | AC, Ø<br>→ IVETTno 2125555     | —                                       |             |   |   |  | 1      |  |   |  |       |
|                            | 160 A1.046  | 05/89 → 12/92 | 2), AC, Ø<br>VETTno 2125556 I→ | VKPA 82431<br>VKPC 82431                |             |   |   |  | 1<br>1 |  |   |  |       |
|                            | 160 A1.046  | 01/93 → 04/95 | 2), → IMot. 9336691            | VKPA 82431<br>VKPC 82431                |             |   |   |  | 1<br>1 |  |   |  |       |
|                            | 160 A1.046  | 01/93 → 04/95 | Mot. 9336692 I→                | VKPC 82245                              |             |   |   |  | 1      |  |   |  |       |
|                            | 836 A4.000  | 05/89 → 04/95 | 2), AC, Ø<br>→ IMot. 9336691   | VKPA 82431<br>VKPC 82431                |             |   |   |  | 1<br>1 |  |   |  |       |
|                            | 836 A4.000  | 05/89 → 04/95 | AC, Ø<br>→ IMot. 9336691       | VKPC 82431                              |             |   |   |  | 1      |  |   |  |       |
|                            | 836 A4.000  | 05/89 → 04/95 | AC, Ø<br>Mot. 9336692 I→       | VKPC 82246                              |             |   |   |  | 1      |  |   |  |       |
|                            | 836 A4.000  | 05/89 → 04/95 | AC, Ø<br>→ IMot. 9336691       | VKPC 82245                              |             |   |   |  | 1      |  |   |  |       |
|                            | 836 A4.000  | 05/89 → 04/95 | 2), AC, Ø<br>Mot. 9336692 I→   | VKPA 82230<br>VKPC 82230                |             |   |   |  | 1<br>1 |  |   |  |       |
|                            | 836 A4.000  | 05/89 → 04/95 | AC, → IMot. 9336691            | VKPC 82245                              |             |   |   |  | 1      |  |   |  |       |
|                            | 836 A4.000  | 05/89 → 04/95 | 2), AC, Mot. 9336692 I→        | VKPA 82230<br>VKPC 82230                |             |   |   |  | 1<br>1 |  |   |  |       |
| <b>FIAT  TIPO 1.6</b>      |   |               |                                |   |             |   |   |  |        |  |   |  |       |
|                            | 159 A3.046, 159 A3.048,<br>160 A2.000, 835 C1.000 | 01/88 → 04/95 |                                | VKMA 02410<br>VKM 12200                 | 1<br>1      | 1 |   |  |        |  |   |  | T0052 |









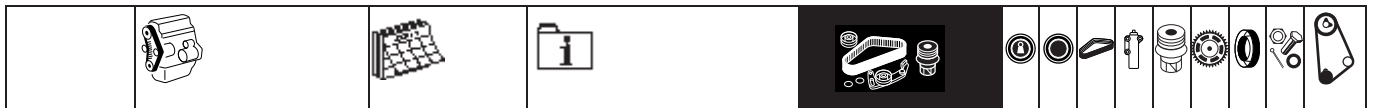





FIAT

|  |  |  |  |  |  |  |  |  |  |  |  |  |  |
|--|---|---|---|--|---|---|---|---|---|---|---|---|---|
|                              | 159 A3.046  | 07/90 → 01/93   | AC, Ø<br>→ I VETNo 2125554  | —  |   |   |   |   |   | 1   |   |   |   |
|  | 159 A3.046  | 07/90 → 01/93   | 2), AC, Ø<br>VETNo 2125555 I→   | VKPA 82431<br>VKPC 82431   |   |   |   |   |   | 1<br>1  |   |   |   |
|  | 159 A3.046, 160 A2.000  | 01/88 → 01/93   | 2), AC, Ø   | VKPA 82431<br>VKPC 82431   |   |   |   |   |   | 1<br>1  |   |   |   |
|  | 159 A3.046, 160 A2.000  | 01/88 → 01/93   | Man. GBX  | VKPC 82245   |   |   |   |   |   | 1   |   |   |   |
|  | 159 A3.048  | 01/93 → 04/95   |   | VKPC 82450   |   |   |   |   |   | 1   |   |   |   |
|  | 160 A2.000  | 01/88 → 10/91   | AC, Ø<br>→ I Mot. 7131546   | VKPC 82224   |   |   |   |   |   | 1   |   |   |   |
|  | 160 A2.000  | 01/88 → 10/91   | 2), AC, Ø<br>Mot. 7131547 I→  | —<br>VKPC 82224  |   |   |   |   |   | 1<br>1  |   |   |   |
|  | 835 C1.000  | 10/92 → 04/95   | AC, Ø<br>→ I Mot. 9336691   | VKPC 82245   |   |   |   |   |   | 1   |   |   |   |
|  | 835 C1.000  | 10/92 → 04/95   | 2), AC, Ø<br>Mot. 9336692 I→  | VKPA 82230<br>VKPC 82230   |   |   |   |   |   | 1<br>1  |   |   |   |
|  | 835 C1.000  | 10/92 → 04/95   | AC → I Mot. 9336691   | VKPC 82245   |   |   |   |   |   | 1   |   |   |   |
|  | 835 C1.000  | 10/92 → 04/95   | 2), AC, Mot. 9336692 I→   | VKPA 82230<br>VKPC 82230   |   |   |   |   |   | 1<br>1  |   |   |   |
| <b>FIAT  TIPO 1.8</b>       |   |   |   |  |   |   |   |   |   |   |   |   |   |
|                              | 159 A4.000  | 10/90 → 04/95   |   | VKMA 02222<br>VKM 12005  | 1<br>1  | 1   |   |   |   |   |   |   | T0089   |
|  | 159 A4.046, 835 A6.000,<br>835 C2.000,<br>835 C4.000, 836 A5.000                  | 10/90 → 04/95   |   | VKMA 02227<br>VKM 12227  | 1<br>1  | 1   |   |   |   |   |   |   | T0035   |
|                            | 159 A4.000  | 10/90 → 03/93   |   | VKPC 82432   |   |   |   |   |   | 1   |   |   |   |
|  | 159 A4.000  | 04/93 → 04/95   |   | —  |   |   |   |   |   | 1   |   |   |   |
|  | 159 A4.046, 835 C2.000,<br>835 C4.000, 836 A5.000                                 | 10/90 → 04/95   |   | VKPC 82647   |   |   |   |   |   | 1   |   |   |   |
|                            | <b>B(PS)</b> 160 A5.000   | 10/90 → 06/93   | <b>AC</b>   | VKMOV 13AVx715   |   | 1   |   |   |   |   |   |   |   |
| <b>FIAT  TIPO 1.8 16V</b> |   |   |   |  |   |   |   |   |   |   |   |   |   |
|                            | 160 A5.000  | 11/89 → 06/92   | → I Mot. 1066635  | —<br>VKM 12101   | 1<br>1  | 1   |   |   |   |   |   |   | T0035   |
|  | 160 A5.000  | 11/89 → 06/92   | Mot. 1066636 I→   | —<br>VKM 12101   | 1<br>1  | 1   |   |   |   |   |   |   | T0085   |
|                            | 160 A5.000  | 11/89 → 06/92   |   | VKPC 82647   |   |   |   |   |   | 1   |   |   |   |
|                            | <b>B(AC)</b> 160 A5.000   | 11/89 → 06/92   |   | VKMOV 13AVx850   |   | 1   |   |   |   |   |   |   |   |
| <b>FIAT  TIPO 2.0</b>     |   |   |   |  |   |   |   |   |   |   |   |   |   |
|                            | 159 A5.046, 159 A6.046  | 03/90 → 04/95   |   | VKMA 02227<br>VKM 12227  | 1<br>1  | 1   |   |   |   |   |   |   | T0035   |
|                            | 159 A5.046, 159 A6.046  | 03/90 → 04/95   | → I Mot. 1308142  | VKPC 82622   |   |   |   |   |   | 1   |   |   |   |
|  | 159 A5.046, 159 A6.046  | 03/90 → 04/95   | Mot. 1308143 I→   | VKPC 82647   |   |   |   |   |   | 1   |   |   |   |
| <b>FIAT  TIPO 2.0 16V</b> |   |   |   |  |   |   |   |   |   |   |   |   |   |
|                            | 160 A8.046, 836 A3.000  | 07/91 → 04/95   |   | VKMA 02224<br>VKM 12101  | 1<br>1  | 1   |   |   |   |   |   |   | T0083   |
|                            | 160 A8.046  | 07/91 → 04/95   |   | VKPC 82629   |   |   |   |   |   | 1   |   |   |   |
|  | 836 A3.000  | 03/93 → 04/95   |   | VKPC 82660   |   |   |   |   |   | 1   |   |   |   |
| <b>FIAT  TIPO 1.7 D</b>   |   |   |   |  |   |   |   |   |   |   |   |   |   |
|                            | 149 B4.000  | 01/88 → 10/95   |   | VKMA 02153<br>VKM 12153<br>VKM 22153   | 1<br>1<br>1   | 1<br>1  |   |   |   |   |   |   | T0054   |
|                            | 149 B4.000  | 01/88 → 10/95   | 2)  | —  |   |   |   |   |   | 1   |   |   |   |
| <b>FIAT  TIPO 1.9 D</b>   |   |   |   |  |   |   |   |   |   |   |   |   |   |
|                            | 160 A7.000  | 07/91 → 08/96   |   | VKMA 02154<br>VKM 12153<br>VKM 22153   | 1<br>1<br>1   | 1<br>1  |   |   |   |   |   |   | T0055   |
|                            | 160 A7.000  | 07/91 → 08/96   | 2)  | VKPA 82429<br>VKPC 82429   |   |   |   |   |   | 1<br>1  |   |   |   |
|                            | <b>B(Alt)</b> 160 A7.000  | 01/93 → 08/96   | <b>ESC</b>  | VKMOV 5PK986<br>VKM 32242  |   | 1   |   |   |   | 1   |   |   |   |













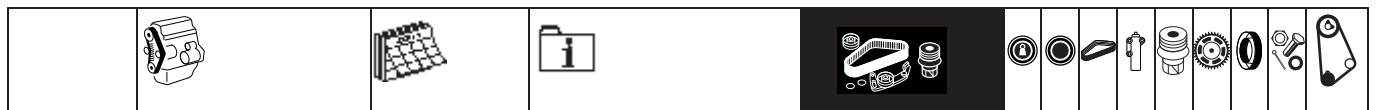











| FIAT  TIPO 1.9 TD        |  |               |                                   |  |        |        |        |        |  |       |
|---|--|---------------|-----------------------------------|--|--------|--------|--------|--------|--|-------|
|                          | 160 A6.000, 160 A6.046,<br>160 B6.046,<br>160 D1.000               | 09/90 → 04/95 |                                   | VKMA 02154<br>VKM 12153<br>VKM 22153                 | 1<br>1 | 1<br>1 | 1      |        |  | T0055 |
|                          | 160 A6.000, 160 A6.046,<br>160 D1.000                              | 09/90 → 04/95 | 2), AC,<br>→IMot. 1730139         | VKPA 82618<br>VKPC 82618                             |        |        |        | 1<br>1 |  |       |
|                          | <b>B(Alt)</b> 160 A6.000, 160 A6.046,<br>160 B6.046,<br>160 D1.000 | 09/90 → 04/95 | AC. →IMot. 0953304                | VKMW 5PK962<br>VKM 32016                             | 1      |        | 1      |        |  |       |
|   | <b>B(Alt)</b> 160 A6.000, 160 A6.046,<br>160 B6.046,<br>160 D1.000 | 09/90 → 04/95 | AC, Mot. 0953305 I→               | VKMW 5PK970<br>VKM 32009                             | 1      |        | 1      |        |  |       |
| FIAT  ULYSSE (220) 1.8   |  |               |                                   |  |        |        |        |        |  |       |
|                          | LFW  | 05/97 → 08/02 |                                   | VKMA 03201<br>VKM 13100                              | 1<br>1 |        | 1      |        |  | T0018 |
|                          | LFW  | 05/97 → 08/02 |                                   | VKPC 83615   |        |        |        | 1      |  |       |
|                          | <b>B(Alt)</b> LFW  | 05/97 → 06/98 | 70A, AC,<br>→IVETTno 0007905      | VKMW 6PK1067<br>VKM 33003                            | 1      |        | 1      |        |  |       |
|   | <b>B(Alt)</b> LFW  | 05/97 → 06/98 | 80, 90A, AC,<br>→IVETTno 0007905  | VKMA 33003<br>VKMW 6PK1076<br>VKM 33003              | 1<br>1 |        | 1<br>1 |        |  |       |
|   | <b>B(Alt)</b> LFW  | 07/98 → 08/02 | 70A, AC,<br>VETTno 0007906 I→     | VKMW 6PK1067<br>VKM 33021                            | 1      |        | 1      |        |  |       |
|   | <b>B(Alt)</b> LFW  | 07/98 → 08/02 | 80, 90A, AC,<br>VETTno 0007906 I→ | VKMA 33031<br>VKMW 6PK1076<br>VKM 33021              | 1<br>1 |        | 1<br>1 |        |  |       |
|   | <b>B(Alt)</b> LFW  | 05/97 → 08/02 | AC                                | VKMA 33030<br>VKMW 6PK1660<br>VKM 33028<br>VKM 33034 | 1<br>1 | 1      | 1<br>1 |        |  |       |
| FIAT  ULYSSE (220) 2.0 |  |               |                                   |  |        |        |        |        |  |       |
|                        | RFU (XU10J2C)  | 06/94 → 08/02 |                                   | VKMA 03201<br>VKM 13100                              | 1<br>1 |        | 1      |        |  | T0018 |
|                        | RFU (XU10J2C)  | 06/94 → 08/02 |                                   | VKPC 83420   |        |        |        | 1      |  |       |
|                        | <b>B(Alt)</b> RFU (XU10J2C)  | 06/94 → 06/98 | 70A, AC,<br>→IVETTno 0007905      | VKMW 6PK1067<br>VKM 33003                            | 1      |        | 1      |        |  |       |
|   | <b>B(Alt)</b> RFU (XU10J2C)  | 06/94 → 06/98 | 80, 90A, AC,<br>→IVETTno 0007905  | VKMA 33003<br>VKMW 6PK1076<br>VKM 33003              | 1<br>1 |        | 1<br>1 |        |  |       |
|   | <b>B(Alt)</b> RFU (XU10J2C)  | 07/98 → 08/02 | 70A, AC,<br>VETTno 0007906 I→     | VKMW 6PK1067<br>VKM 33021                            | 1      |        | 1      |        |  |       |
|   | <b>B(Alt)</b> RFU (XU10J2C)  | 07/98 → 08/02 | 80, 90A, AC,<br>VETTno 0007906 I→ | VKMA 33031<br>VKMW 6PK1076<br>VKM 33021              | 1<br>1 |        | 1<br>1 |        |  |       |
|   | <b>B(Alt)</b> RFU (XU10J2C)  | 06/94 → 08/02 | AC                                | VKMA 33030<br>VKMW 6PK1660<br>VKM 33028<br>VKM 33034 | 1<br>1 | 1      | 1<br>1 |        |  |       |



FIAT

| <b>FIAT  ULYSSE (220) 2.0 16V</b>   |                               |               |                                  |              |   |   |   |  |  |   |  |   |   |       |
|-------------------------------------|-------------------------------|---------------|----------------------------------|--------------|---|---|---|--|--|---|--|---|---|-------|
|                                     | RFN                           | 09/00 → 08/02 |                                  | VKMA 03235   | 1 | 1 | 1 |  |  |   |  |   |   | T0169 |
|                                     |                               |               |                                  | VKM 13234    | 1 |   |   |  |  |   |  |   |   |       |
|                                     |                               |               |                                  | VKM 23230    |   | 1 |   |  |  |   |  |   |   |       |
|                                     | RFV                           | 05/98 → 09/00 |                                  | VKMA 03213   | 1 | 1 | 1 |  |  |   |  |   |   | T0142 |
|                                     |                               |               |                                  | VKM 13202    | 1 |   |   |  |  |   |  |   |   |       |
|                                     |                               |               |                                  | VKM 23213    |   | 1 |   |  |  |   |  |   | 1 |       |
|                                     | RFN                           | 09/00 → 08/02 | 16)                              | VKPC 83650   |   |   |   |  |  | 1 |  |   |   |       |
|                                     | RFV                           | 05/98 → 09/00 |                                  | VKPC 83636   |   |   |   |  |  | 1 |  |   |   |       |
|                                     | <b>B(Alt)</b> RFN             | 09/00 → 08/02 | <b>AC</b>                        | VKMA 33055   | 1 | 1 | 1 |  |  |   |  |   |   |       |
|                                     |                               |               |                                  | VKMV 6PK1188 |   |   | 1 |  |  |   |  |   |   |       |
|                                     |                               |               |                                  | VKM 33019    | 1 |   |   |  |  |   |  |   |   |       |
|                                     |                               |               |                                  | VKM 33020    |   | 1 |   |  |  |   |  |   |   |       |
|                                     | <b>B(Alt)</b> RFN             | 09/00 → 08/02 | <b>AC</b>                        | VKMA 33052   | 1 | 1 | 1 |  |  |   |  |   |   |       |
|                                     |                               |               |                                  | VKMV 6PK1706 |   |   | 1 |  |  |   |  |   |   |       |
|                                     |                               |               |                                  | VKM 33019    | 1 |   |   |  |  |   |  |   |   |       |
|                                     |                               |               |                                  | VKM 33020    |   | 1 |   |  |  |   |  |   |   |       |
|                                     | <b>B(Alt)</b> RFV             | 05/98 → 09/00 | <b>AC</b>                        | VKMV 6PK1160 |   |   | 1 |  |  |   |  |   |   |       |
|                                     |                               |               |                                  | VKM 33022    | 1 |   |   |  |  |   |  |   |   |       |
|                                     |                               |               |                                  | VKM 33025    |   | 1 |   |  |  |   |  |   |   |       |
|                                     | <b>B(Alt)</b> RFV             | 05/98 → 09/00 | <b>AC</b>                        | VKMA 33034   | 1 | 1 | 1 |  |  |   |  |   |   |       |
|                                     |                               |               |                                  | VKMV 6PK1603 |   |   | 1 |  |  |   |  |   |   |       |
|                                     |                               |               |                                  | VKM 33028    | 1 |   |   |  |  |   |  |   |   |       |
|                                     |                               |               |                                  | VKM 33035    |   | 1 |   |  |  |   |  |   |   |       |
| <b>FIAT  ULYSSE (220) 2.0 Turbo</b> |                               |               |                                  |              |   |   |   |  |  |   |  |   |   |       |
|                                     | RGX (XU10J2CTE)               | 06/94 → 08/02 |                                  | VKMA 03201   | 1 |   | 1 |  |  |   |  |   |   | T0018 |
|                                     |                               |               |                                  | VKM 13100    | 1 |   |   |  |  |   |  |   |   |       |
|                                     | RGX (XU10J2CTE)               | 06/94 → 08/02 |                                  | VKPC 83420   |   |   |   |  |  | 1 |  |   |   |       |
|                                     | <b>B(Alt)</b> RGX (XU10J2CTE) | 06/94 → 01/97 | 70A, <b>AC</b>                   | VKMV 6PK1067 |   |   | 1 |  |  |   |  |   |   |       |
|                                     |                               |               |                                  | VKM 33003    | 1 |   |   |  |  |   |  |   |   |       |
|                                     | <b>B(Alt)</b> RGX (XU10J2CTE) | 06/94 → 01/97 | 80, 90A, <b>AC</b>               | VKMA 33003   | 1 |   | 1 |  |  |   |  |   |   |       |
|                                     |                               |               |                                  | VKMV 6PK1076 |   |   | 1 |  |  |   |  |   |   |       |
|                                     |                               |               |                                  | VKM 33003    | 1 |   |   |  |  |   |  |   |   |       |
|                                     | <b>B(Alt)</b> RGX (XU10J2CTE) | 02/97 → 08/02 | <b>AC</b>                        | VKMV 6PK1160 |   |   | 1 |  |  |   |  |   |   |       |
|                                     |                               |               |                                  | VKM 33022    | 1 |   |   |  |  |   |  |   |   |       |
|                                     |                               |               |                                  | VKM 33025    |   | 1 |   |  |  |   |  |   |   |       |
|                                     | <b>B(Alt)</b> RGX (XU10J2CTE) | 06/94 → 01/97 | <b>AC</b>                        | VKMA 33030   | 1 | 1 | 1 |  |  |   |  |   |   |       |
|                                     |                               |               |                                  | VKMV 6PK1660 |   |   | 1 |  |  |   |  |   |   |       |
|                                     |                               |               |                                  | VKM 33028    | 1 |   |   |  |  |   |  |   |   |       |
|                                     |                               |               |                                  | VKM 33034    |   | 1 |   |  |  |   |  |   |   |       |
|                                     | <b>B(Alt)</b> RGX (XU10J2CTE) | 02/97 → 08/02 | <b>AC</b>                        | VKMA 33034   | 1 | 1 | 1 |  |  |   |  |   |   |       |
|                                     |                               |               |                                  | VKMV 6PK1603 |   |   | 1 |  |  |   |  |   |   |       |
|                                     |                               |               |                                  | VKM 33028    | 1 |   |   |  |  |   |  |   |   |       |
|                                     |                               |               |                                  | VKM 33035    |   | 1 |   |  |  |   |  |   |   |       |
| <b>FIAT  ULYSSE (220) 1.9 TD</b>    |                               |               |                                  |              |   |   |   |  |  |   |  |   |   |       |
|                                     | D8B, DHX                      | 02/95 → 08/02 |                                  | VKMC 03241   | 1 | 1 | 1 |  |  | 1 |  |   |   | T0017 |
|                                     |                               |               |                                  | VKMA 03241   | 1 | 1 | 1 |  |  |   |  |   |   |       |
|                                     |                               |               |                                  | VKM 13241    | 1 |   |   |  |  |   |  |   |   |       |
|                                     |                               |               |                                  | VKM 23241    |   | 1 |   |  |  |   |  |   |   |       |
|                                     | D8B, DHX                      | 02/95 → 08/02 | 3)                               | VKMS 03241   | 1 | 1 | 1 |  |  |   |  | 2 |   | T0017 |
|                                     |                               |               |                                  | VKMA 03241   | 1 | 1 | 1 |  |  |   |  |   |   |       |
|                                     |                               |               |                                  | VKM 13241    | 1 |   |   |  |  |   |  |   |   |       |
|                                     |                               |               |                                  | VKM 23241    |   | 1 |   |  |  |   |  |   |   |       |
|                                     | D8B, DHX                      | 02/95 → 08/02 |                                  | VKPC 83420   |   |   |   |  |  | 1 |  |   |   |       |
|                                     | <b>B(Alt)</b> D8B, DHX        | 02/95 → 06/95 | <b>AC</b> ,<br>→IVETTno 0006179  | VKMA 33102   | 1 |   | 1 |  |  |   |  |   |   |       |
|                                     |                               |               |                                  | VKMV 6PK1110 |   |   | 1 |  |  |   |  |   |   |       |
|                                     |                               |               |                                  | VKM 33002    | 1 |   |   |  |  |   |  |   |   |       |
|                                     | <b>B(Alt)</b> D8B, DHX        | 06/95 → 08/02 | <b>AC</b> ,<br>VETTno 0006180 I→ | VKMA 33035   | 1 |   | 1 |  |  |   |  |   |   |       |
|                                     |                               |               |                                  | VKMV 6PK1102 |   |   | 1 |  |  |   |  |   |   |       |
|                                     |                               |               |                                  | VKM 33002    | 1 |   |   |  |  |   |  |   |   |       |
|                                     | <b>B(Alt)</b> D8B, DHX        | 02/95 → 08/02 | <b>AC</b>                        | VKMV 6PK1739 |   |   | 1 |  |  |   |  |   |   |       |
|                                     |                               |               |                                  | VKM 33013    | 1 |   |   |  |  |   |  |   |   |       |
|                                     |                               |               |                                  | VKM 33029    | 1 |   |   |  |  |   |  |   |   |       |

































| FIAT  ULYSSE (220) 2.0 JTD     |                           |               |   |               |   |   |   |  |   |  |  |   |  |   |  |  |  |  |  |  |       |
|---|---------------------------|---------------|---|---------------|---|---|---|--|---|--|--|---|--|---|--|--|--|--|--|--|-------|
|                                | RHW                       | 10/99 → 08/02 |                    | VKMC 03248    | 1 | 1 | 1 |  | 1 |  |  |   |  |   |  |  |  |  |  |  |       |
|   |                           |               |   | VKMA 03248    | 1 | 1 | 1 |  |   |  |  |   |  |   |  |  |  |  |  |  | T0196 |
|   |                           |               |   | VKM 13246     | 1 |   |   |  |   |  |  |   |  |   |  |  |  |  |  |  |       |
|   |                           |               |   | VKM 23246     |   |   | 1 |  |   |  |  |   |  |   |  |  |  |  |  |  |       |
|   | RHZ                       | 10/99 → 04/00 |  → I VETno 0008560 | VKMC 03246    | 1 | 1 | 1 |  | 1 |  |  |   |  |   |  |  |  |  |  |  | T0168 |
|   |                           |               |   | VKMA 03246    | 1 | 1 | 1 |  |   |  |  |   |  |   |  |  |  |  |  |  |       |
|   |                           |               |   | VKM 13246     | 1 |   |   |  |   |  |  |   |  |   |  |  |  |  |  |  |       |
|   |                           |               |   | VKM 23246     |   |   | 1 |  |   |  |  |   |  |   |  |  |  |  |  |  |       |
|   | RHZ                       | 04/00 → 08/02 |  VETno 0008561 I → | VKMC 03247    | 1 | 1 | 1 |  | 1 |  |  |   |  |   |  |  |  |  |  |  | T0168 |
|   |                           |               |   | VKMA 03247    | 1 | 1 | 1 |  |   |  |  |   |  |   |  |  |  |  |  |  |       |
|   |                           |               |   | VKM 13244     | 1 |   |   |  |   |  |  |   |  |   |  |  |  |  |  |  |       |
|   |                           |               |   | VKM 23246     |   |   | 1 |  |   |  |  |   |  |   |  |  |  |  |  |  |       |
|                                | RHW, RHZ                  | 10/99 → 08/02 |   | VKPC 83639    |   |   |   |  |   |  |  | 1 |  |   |  |  |  |  |  |  |       |
|                                | <b>B(Alt)</b> RHW, RHZ    | 10/99 → 08/02 | <b>AC</b> Harrissow, <b>AC</b>  | VKMOV 6PK1740 |   |   |   |  | 1 |  |  |   |  |   |  |  |  |  |  |  |       |
|   |                           |               |   | VKM 33013     | 1 |   |   |  |   |  |  |   |  |   |  |  |  |  |  |  |       |
|   |                           |               |   | VKM 33033     | 1 |   |   |  |   |  |  |   |  |   |  |  |  |  |  |  |       |
|   | <b>B(Alt)</b> RHW, RHZ    | 10/99 → 08/02 | <b>AC</b> Delphi, <b>AC</b>   | VKMA 33037    | 2 |   |   |  | 1 |  |  |   |  |   |  |  |  |  |  |  |       |
|   |                           |               |   | VKMOV 6PK1750 |   |   |   |  | 1 |  |  |   |  |   |  |  |  |  |  |  |       |
|   |                           |               |   | VKM 33013     | 1 |   |   |  |   |  |  |   |  |   |  |  |  |  |  |  |       |
|   |                           |               |   | VKM 33033     | 1 |   |   |  |   |  |  |   |  |   |  |  |  |  |  |  |       |
|   | <b>B(Alt)</b> RHW, RHZ    | 10/99 → 08/02 | <b>AC</b>   | VKMA 33044    | 2 | 1 |   |  | 1 |  |  |   |  |   |  |  |  |  |  |  |       |
|   |                           |               |   | VKMOV 6PK1468 |   |   |   |  | 1 |  |  |   |  |   |  |  |  |  |  |  |       |
|   |                           |               |   | VKM 33024     | 1 |   |   |  |   |  |  |   |  |   |  |  |  |  |  |  |       |
|   |                           |               |   | VKM 33033     | 1 |   |   |  |   |  |  |   |  |   |  |  |  |  |  |  |       |
|   |                           |               |   | VKM 33069     |   |   |   |  | 1 |  |  |   |  |   |  |  |  |  |  |  |       |
| FIAT  ULYSSE (220) 2.1 TD     |                           |               |   |               |   |   |   |  |   |  |  |   |  |   |  |  |  |  |  |  |       |
|                              | P8C                       | 03/96 → 10/99 |                  | VKMC 03251    | 1 | 1 | 1 |  | 1 |  |  |   |  |   |  |  |  |  |  |  |       |
|   |                           |               |   | VKMA 03251    | 1 | 1 | 1 |  |   |  |  |   |  |   |  |  |  |  |  |  |       |
|   |                           |               |   | VKM 13250     | 1 |   |   |  |   |  |  |   |  |   |  |  |  |  |  |  |       |
|   |                           |               |   | VKM 23213     |   |   | 1 |  |   |  |  |   |  |   |  |  |  |  |  |  |       |
|   | P8C                       | 03/96 → 10/99 | 3)  | VKMS 03251    | 1 | 1 | 1 |  |   |  |  |   |  | 2 |  |  |  |  |  |  | T0080 |
|   |                           |               |   | VKMA 03251    | 1 | 1 | 1 |  |   |  |  |   |  |   |  |  |  |  |  |  |       |
|   |                           |               |   | VKM 13250     | 1 |   |   |  |   |  |  |   |  |   |  |  |  |  |  |  |       |
|   |                           |               |   | VKM 23213     |   |   | 1 |  |   |  |  |   |  |   |  |  |  |  |  |  |       |
|                              | P8C                       | 03/96 → 10/99 |   | VKPC 83425    |   |   |   |  |   |  |  | 1 |  |   |  |  |  |  |  |  |       |
|                              | <b>B(Alt)</b> P8C         | 03/96 → 10/99 | <b>AC</b>   | VKMA 33035    | 1 |   |   |  | 1 |  |  |   |  |   |  |  |  |  |  |  |       |
|   |                           |               |   | VKMOV 6PK1102 |   |   |   |  | 1 |  |  |   |  |   |  |  |  |  |  |  |       |
|   |                           |               |   | VKM 33002     | 1 |   |   |  |   |  |  |   |  |   |  |  |  |  |  |  |       |
|   | <b>B(Alt)</b> P8C         | 03/96 → 10/99 | <b>AC</b>   | VKMOV 6PK1739 |   |   |   |  | 1 |  |  |   |  |   |  |  |  |  |  |  |       |
|   |                           |               |   | VKM 33013     | 1 |   |   |  |   |  |  |   |  |   |  |  |  |  |  |  |       |
|   |                           |               |   | VKM 33029     | 1 |   |   |  |   |  |  |   |  |   |  |  |  |  |  |  |       |
| FIAT  ULYSSE (179AX) 2.0 16V |                           |               |   |               |   |   |   |  |   |  |  |   |  |   |  |  |  |  |  |  |       |
|                              | RFN(EW10J4)               | 08/02 → 12/06 |   | VKMA 03235    | 1 | 1 | 1 |  |   |  |  |   |  |   |  |  |  |  |  |  |       |
|   |                           |               |   | VKM 13234     | 1 |   |   |  |   |  |  |   |  |   |  |  |  |  |  |  |       |
|   |                           |               |   | VKM 23230     |   |   | 1 |  |   |  |  |   |  |   |  |  |  |  |  |  |       |
|                              | RFN(EW10J4)               | 08/02 → 06/05 | 16)   | VKPC 83650    |   |   |   |  |   |  |  | 1 |  |   |  |  |  |  |  |  |       |
|                              | <b>B(Alt)</b> RFN(EW10J4) | 08/02 → 11/04 | <b>AC</b>   | VKMA 33055    | 1 | 1 |   |  | 1 |  |  |   |  |   |  |  |  |  |  |  |       |
|   |                           |               |   | VKMOV 6PK1188 |   |   |   |  | 1 |  |  |   |  |   |  |  |  |  |  |  |       |
|   |                           |               |   | VKM 33019     | 1 |   |   |  |   |  |  |   |  |   |  |  |  |  |  |  |       |
|   |                           |               |   | VKM 33020     |   |   | 1 |  |   |  |  |   |  |   |  |  |  |  |  |  |       |
|   | <b>B(Alt)</b> RFN(EW10J4) | 08/02 → 11/04 | <b>AC</b>   | VKMA 33052    | 1 | 1 |   |  | 1 |  |  |   |  |   |  |  |  |  |  |  |       |
|   |                           |               |   | VKMOV 6PK1706 |   |   |   |  | 1 |  |  |   |  |   |  |  |  |  |  |  |       |
|   |                           |               |   | VKM 33019     | 1 |   |   |  |   |  |  |   |  |   |  |  |  |  |  |  |       |
|   |                           |               |   | VKM 33020     |   |   | 1 |  |   |  |  |   |  |   |  |  |  |  |  |  |       |
| FIAT  ULYSSE (179AX) 3.0 V6  |                           |               |   |               |   |   |   |  |   |  |  |   |  |   |  |  |  |  |  |  |       |
|                              | XFW                       | 08/02 → 12/05 |   | VKMA 03902    | 1 | 3 | 1 |  |   |  |  |   |  |   |  |  |  |  |  |  |       |
|   |                           |               |   | VKM 13902     | 1 |   |   |  |   |  |  |   |  |   |  |  |  |  |  |  |       |
|   |                           |               |   | VKM 23900     |   |   | 1 |  |   |  |  |   |  |   |  |  |  |  |  |  |       |
|   |                           |               |   | VKM 23900     |   |   | 1 |  |   |  |  |   |  |   |  |  |  |  |  |  |       |
|   |                           |               |   | VKM 23901     |   |   | 1 |  |   |  |  |   |  |   |  |  |  |  |  |  |       |
|                              | XFW                       | 08/02 → 12/06 |   | —             |   |   |   |  |   |  |  | 1 |  |   |  |  |  |  |  |  |       |
|                              | <b>B(Alt)</b> XFW         | 08/02 → 06/05 |   | VKMOV 6PK1585 |   |   |   |  | 1 |  |  | 1 |  |   |  |  |  |  |  |  |       |
|   |                           |               |   | VKM 33075     |   |   |   |  |   |  |  |   |  |   |  |  |  |  |  |  |       |















































































FIAT

| <b>FIAT</b> <b>ULYSSE (179AX) 2.0 JTD 16V</b> |               |                                       |               |   |  |             |             |        |  |   |  |  |  |  |   |  |  |  |             |       |
|---|---------------|---------------------------------------|---------------|---|--|-------------|-------------|--------|--|---|--|--|--|--|---|--|--|--|-------------|-------|
|   |               | RHM(DW10ATED4),<br>RHW(DW10ATED4)     | 08/02 → 12/06 |   | VKMC 03248<br>VKMA 03248<br>VKM 13246<br>VKM 23246 | 1<br>1<br>1 | 1<br>1<br>1 | 1<br>1 |  | 1 |  |  |  |  |   |  |  |  | 1<br>1<br>1 | T0196 |
|   |               | RHM(DW10ATED4),<br>RHW(DW10ATED4)     | 08/02 → 12/06 |   | VKPC 83639   |             |             |        |  | 1 |  |  |  |  |   |  |  |  |             |       |
|   | <b>B(Alt)</b> | RHM(DW10ATED4),<br>RHW(DW10ATED4)     | 08/02 → 12/06 |   | VKMV 6PK1740<br>VKM 33013<br>VKM 33033             | 1<br>1      |             | 1      |  |   |  |  |  |  |   |  |  |  |             |       |
|   |               | RHK, RHR                              | 05/03 → 12/06 |   | VKM _____  |             |             |        |  | 1 |  |  |  |  |   |  |  |  |             |       |
| <b>FIAT</b> <b>ULYSSE (179AX) 2.2 JTD 16V</b> |               |                                       |               |   |  |             |             |        |  |   |  |  |  |  |   |  |  |  |             |       |
|   |               | 4HW(DW12ATED4)                        | 08/02 → 12/06 |   | VKMA 03252<br>VKM 13246<br>VKM 23246               | 1<br>1      | 1<br>1      | 1      |  |   |  |  |  |  |   |  |  |  | 1<br>1      | T0179 |
|   |               | 4HW(DW12ATED4)                        | 08/02 → 12/06 |   | VKPC 83643   |             |             |        |  | 1 |  |  |  |  |   |  |  |  |             |       |
|   | <b>B(Alt)</b> | 4HW(DW12ATED4)                        | 08/02 → 12/06 |   | VKMV 6PK1740<br>VKM 33033<br>VKM 33045             | 1           |             | 1      |  |   |  |  |  |  |   |  |  |  |             |       |
| <b>FIAT</b> <b>UNO 0.9</b>                    |               |                                       |               |   |  |             |             |        |  |   |  |  |  |  |   |  |  |  |             |       |
|   |               | 146 A.000, 146 A.1000                 | 03/83 → 09/92 |   | <b>OXOXOXO</b>                                     |             |             |        |  |   |  |  |  |  |   |  |  |  |             |       |
|   |               | 146 A.000, 146 A.1000                 | 03/83 → 09/92 | 2)  | VKPA 82202   |             |             |        |  | 1 |  |  |  |  |   |  |  |  |             |       |
| <b>FIAT</b> <b>UNO 1.0</b>                    |               |                                       |               |   |  |             |             |        |  |   |  |  |  |  |   |  |  |  |             |       |
|   |               | 156 A2.048, 156 A2.100,<br>156 A2.246 | 04/84 → 12/94 |   | VKMC 02200<br>VKMA 02200<br>VKM 12200              | 1<br>1<br>1 |             | 1<br>1 |  | 1 |  |  |  |  |   |  |  |  |             | T0009 |
|   |               | 146 A2.166, 146 D8.000,<br>156 A2.246 | 04/94 → 08/00 | → <b>IMot.</b> 9042882                                | VKMC 02200<br>VKMA 02200<br>VKM 12200              | 1<br>1<br>1 |             | 1<br>1 |  | 1 |  |  |  |  |   |  |  |  |             | T0009 |
|   |               | 146 A2.166, 146 D8.000,<br>156 A2.246 | 04/94 → 08/00 | , <b>Mot.</b> 9042883  →                              | VKMC 02210<br>VKMA 02210<br>VKM 12200              | 1<br>1<br>1 |             | 1<br>1 |  | 1 |  |  |  |  |   |  |  |  |             | T0174 |
|   |               | 156 A2.048, 156 A2.100,<br>156 A2.246 | 04/84 → 08/00 | 3), → <b>IMot.</b> 6315749                            | VKMS 02200-1<br>VKMA 02200<br>VKM 12200            | 1<br>1<br>1 |             | 1<br>1 |  |   |  |  |  |  | 2 |  |  |  |             | T0009 |
|   |               | 156 A2.048, 156 A2.100,<br>156 A2.246 | 04/84 → 12/94 | 3), <b>Mot.</b> 6315750  →                            | VKMS 02200-2<br>VKMA 02200<br>VKM 12200            | 1<br>1<br>1 |             | 1<br>1 |  |   |  |  |  |  | 2 |  |  |  |             | T0009 |
|   |               | 156 A2.246                            | 04/94 → 08/00 | 3), <b>Mot.</b> 6315750  →,<br>→ <b>IMot.</b> 9042882 | VKMS 02200-2<br>VKMA 02200<br>VKM 12200            | 1<br>1<br>1 |             | 1<br>1 |  |   |  |  |  |  | 2 |  |  |  |             | T0009 |
|   |               | 146 A2.166, 146 D8.000                | 04/94 → 08/00 | 3), → <b>IMot.</b> 9042882                            | VKMS 02200-2<br>VKMA 02200<br>VKM 12200            | 1<br>1<br>1 |             | 1<br>1 |  |   |  |  |  |  | 2 |  |  |  |             | T0009 |
|   |               | 146 C7.000                            | 01/89 → 12/93 |   | VKMA 02021<br>VKM 12200                            | 1<br>1      |             | 1      |  |   |  |  |  |  |   |  |  |  |             | T0006 |
|   |               | 146 C7.000                            | 01/89 → 12/93 |   | VKPC 82208   |             |             |        |  | 1 |  |  |  |  |   |  |  |  |             |       |
|   |               | 156 A2.048, 156 A2.100,<br>156 A2.246 | 04/84 → 12/94 |   | VKPC 82214   |             |             |        |  | 1 |  |  |  |  |   |  |  |  |             |       |
|   |               | 146 A2.166, 146 D8.000,<br>156 A2.246 | 04/94 → 08/00 | → <b>IMot.</b> 9042882                                | VKPC 82214   |             |             |        |  | 1 |  |  |  |  |   |  |  |  |             |       |
|   |               | 146 A2.166, 146 D8.000,<br>156 A2.246 | 04/94 → 08/00 | <b>Mot.</b> 9042883  →                                | VKPC 82250   |             |             |        |  | 1 |  |  |  |  |   |  |  |  |             |       |
|   | <b>B(Alt)</b> | 156 A2.246                            | 04/84 → 12/94 |   | VKMV 10AVx675                                      |             |             |        |  | 1 |  |  |  |  |   |  |  |  |             |       |
| <b>FIAT</b> <b>UNO 1.1</b>                    |               |                                       |               |   |  |             |             |        |  |   |  |  |  |  |   |  |  |  |             |       |
|   |               | 146 C3.000, 156 C.046,<br>160 A3.000  | 04/89 → 12/93 |   | VKMC 02200<br>VKMA 02200<br>VKM 12200              | 1<br>1<br>1 |             | 1<br>1 |  | 1 |  |  |  |  |   |  |  |  |             | T0009 |

|   |  |  |  |  |  |  |  |  |  |  |       |
|---|---|---|---|--|---|---|---|---|---|---|-------|
|   | 146 C3.000, 156 C.046,<br>160 A3.000  | 04/89 → 12/93   | 3), → Mot. 6315749  | VKMS 02200-1<br>VKMA 02200<br>VKM 12200  | 1<br>1<br>1   | 1<br>1  |   |   | 2   |   | T0009 |
|   | 146 C3.000, 156 C.046,<br>160 A3.000  | 04/89 → 12/93   | 3), Mot. 6315750  →   | VKMS 02200-2<br>VKMA 02200<br>VKM 12200  | 1<br>1<br>1   | 1<br>1  |   |   | 2   |   | T0009 |
|   | 138 B.000, 146 A4.048   | 01/83 → 12/88   | → Mot. 5782517  | VKMA 02140<br>VKM 12003  | 1<br>1  | 1   |   |   |   |   | T0003 |
|   | 138 B.000, 146 A4.048   | 01/83 → 12/88   | Mot. 5782518  →   | VKMA 02101<br>VKM 12101  | 1<br>1  | 1   |   |   |   |   | T0003 |
|   | 146 A4.044  | 01/86 → 12/89   | → Mot. 5782517  | VKMA 02140<br>VKM 12003  | 1<br>1  | 1   |   |   |   |   | T0003 |
|                              | 146 C3.000, 156 C.046,<br>160 A3.000  | 04/89 → 12/93   |   | VKPC 82214   |   |   |   | 1   |   |   |       |
| <b>FIAT  UNO 1.3</b>         |   |   |   |  |   |   |   |   |   |   |       |
|                              | 138 B2.000, 149 A7.000  | 01/83 → 12/88   | → Mot. 5783767  | VKMA 02140<br>VKM 12003  | 1<br>1  | 1   |   |   |   |   | T0003 |
|   | 138 B2.000, 149 A7.000  | 01/83 → 12/88   | Mot. 5783768  →   | VKMA 02101<br>VKM 12101  | 1<br>1  | 1   |   |   |   |   | T0003 |
|                              | 138 B2.000, 149 A7.000  | 01/83 → 08/89   | 2)  | VKPA 82222   |   |   |   | 1   |   |   |       |
| <b>FIAT  UNO 1.3 Turbo</b>   |   |   |   |  |   |   |   |   |   |   |       |
|                              | 146 A2.246  | 09/89 → 03/91   |   | VKMA 02111<br>VKM 12101  | 1<br>1  | 1   |   |   |   |   | T0011 |
|                              | 146 A2.000, 146 A2.146,<br>146 A2.246   | 04/85 → 03/91   | 2)  | VKPA 82218<br>VKPC 82218   |   |   |   | 1<br>1  |   |   |       |
| <b>FIAT  UNO 1.4</b>       |   |   |   |  |   |   |   |   |   |   |       |
|                            | 160 A1.046, 160 A1.048  | 09/89 → 12/93   |   | VKMA 02410<br>VKM 12200  | 1<br>1  | 1   |   |   |   |   | T0052 |
|                            | 160 A1.046  | 09/89 → 12/93   | 2)  | VKPA 82431<br>VKPC 82431   |   |   |   | 1<br>1  |   |   |       |
|   | 160 A1.048  | 09/89 → 10/92   | 2)  | —<br>VKPC 82224  |   |   |   | 1<br>1  |   |   |       |
|                            | B(Alt) 160 A1.046   | 09/89 → 12/93   | AC, → Mot. 8114396  | VKM 32242  |   | 1   |   |   |   |   |       |
|   | B(Alt) 160 A1.046   | 09/89 → 12/93   | AC, Mot. 8114396  →   | VKM 32009  |   | 1   |   |   |   |   |       |
|   | B(Alt) 160 A1.048   | 09/89 → 12/93   | AC, → Mot. 8114396  | VKM 32242  |   | 1   |   |   |   |   |       |
|   | B(Alt) 160 A1.048   | 09/89 → 12/93   | AC, Mot. 8114396  →   | VKM 32009  |   | 1   |   |   |   |   |       |
|   | B(Alt) 160 A1.046, 160 A1.048   | 09/89 → 12/93   | AC  | VKMOV 4PK962<br>VKM 32009  |   | 1   | 1   |   |   |   |       |
|   | B(AC) 160 A1.046, 160 A1.048  | 09/89 → 12/93   |   | VKMOV 5PK884<br>VKM 32009  |   | 1   | 1   |   |   |   |       |
| <b>FIAT  UNO 1.4 Turbo</b> |   |   |   |  |   |   |   |   |   |   |       |
|                            | 146 A8.000, 146 A8.046  | 09/89 → 12/96   |   | VKMA 02410<br>VKM 12200  | 1<br>1  | 1   |   |   |   |   | T0052 |
|                            | 146 A8.000  | 12/89 → 12/96   | 2)  | VKPA 82222   |   |   |   | 1   |   |   |       |
|   | 146 A8.046  | 09/89 → 09/93   | 2)  | VKPA 82431<br>VKPC 82431   |   |   |   | 1<br>1  |   |   |       |
|                            | B(Alt) 146 A8.046   | 09/89 → 09/93   |   | VKMOV 4PK903<br>VKM 32009  |   | 1   | 1   |   |   |   |       |
| <b>FIAT  UNO 1.5</b>       |   |   |   |  |   |   |   |   |   |   |       |
|                            | 138 C2.048, 149 C1.000  | 10/85 → 12/88   |   | VKMA 02110<br>VKM 12003  | 1<br>1  | 1   |   |   |   |   | T0011 |
|   | 149 C1.000  | 01/89 → 12/93   |   | VKMA 02111<br>VKM 12101  | 1<br>1  | 1   |   |   |   |   | T0011 |
|                            | 149 C1.000  | 10/85 → 12/93   | 2)  | VKPA 82218<br>VKPC 82218   |   |   |   | 1<br>1  |   |   |       |
| <b>FIAT  UNO 1.3 D</b>     |   |   |   |  |   |   |   |   |   |   |       |
|                            | 127 A5.000, 146 B1.000  | 06/83 → 03/92   |   | VKMA 02630<br>VKM 12630<br>VKM 22630   | 1<br>1<br>1   | 1<br>1  | 1   |   |   |   | T0028 |
|                            | 127 A5.000, 146 B1.000  | 06/83 → 03/92   |   | VKPC 82208   |   |   |   | 1   |   |   |       |











































|   |   |               |    |  |  |  |  |  |  |  |  |  |  |
|---|---|---------------|---|---|---|--|---|---|---|---|---|---|---|
| <b>FIAT  UNO 1.4 TD</b>                |   |               |   |   |   |  |   |   |   |   |   |   |   |
|   | 146 B.000, 146 B3.000                             | 10/86 → 10/90 |   | VKMA 02151  | 1   | 1  | 1   |   |   |   |   |   | T0094   |
|   |   |               |   | VKM 12151   | 1   |  |   |   |   |   |   |   |   |
|   |   |               |   | VKM 22151   |   | 1  |   |   |   |   |   |   |   |
|   | 146 B.000   | 10/86 → 06/90 | 2)  | VKPA 82426  |   |  |   |   | 1   |   |   |   |   |
|   | 146 B3.000  | 10/86 → 10/90 | 2)  | VKPC 82426  |   |  |   |   | 1   |   |   |   |   |
|   |   |               |   | VKPA 82440  |   |  |   |   | 1   |   |   |   |   |
| <b>FIAT  UNO 1.7 D</b>                 |   |               |   |   |   |  |   |   |   |   |   |   |   |
|   | 146 B2.000, 149 B3.000                            | 07/86 → 12/93 |   | VKMA 02152  | 1   | 1  | 1   |   |   |   |   |   | T0053   |
|   |   |               |   | VKM 12151   | 1   |  |   |   |   |   |   |   |   |
|   |   |               |   | VKM 22151   |   | 1  |   |   |   |   |   |   |   |
|   | 146 B2.000, 149 B3.000                            | 07/86 → 12/93 | 2)  | VKPA 82428  |   |  |   |   | 1   |   |   |   |   |
|   |   |               |   | VKPC 82428  |   |  |   |   | 1   |   |   |   |   |
| <b>FIAT  UNO 1.9 D</b>                 |   |               |   |   |   |  |   |   |   |   |   |   |   |
|   | 149 B5.046  | 09/89 → 03/94 |   | —   | 1   | 1  | 1   |   |   |   |   |   | T0054   |
|   |   |               |   | VKM 12151   | 1   |  |   |   |   |   |   |   |   |
|   |   |               |   | VKM 22151   |   | 1  |   |   |   |   |   |   |   |
|   | 149 B5.046  | 09/89 → 03/94 | 2)  | VKPA 82428  |   |  |   |   | 1   |   |   |   |   |
|   |   |               |   | VKPC 82428  |   |  |   |   | 1   |   |   |   |   |
| <b>FIAT  DUCATO (280/290) 1.8</b>      |   |               |   |   |   |  |   |   |   |   |   |   |   |
|   | 169 B, XM7T/169B                                  | 01/82 → 12/88 |   | VKPC 83630  |   |  |   |   | 1   |   |   |   |   |
| <b>FIAT  DUCATO (280/290) 2.0</b>      |   |               |   |   |   |  |   |   |   |   |   |   |   |
|   | 170 B, 170 D                                      | 07/85 → 03/94 |   | OXOXOXO   |   |  |   |   |   |   |   |   |   |
|   | 170 B, 170 D, XN 1T                               | 01/82 → 03/94 |   | VKPC 83630  |   |  |   |   | 1   |   |   |   |   |
| <b>FIAT  DUCATO (280/290) 1.9 D</b>   |   |               |   |   |   |  |   |   |   |   |   |   |   |
|                                       | 149 B1.000  | 01/90 → 03/94 |   | VKMA 02168  | 1   | 1  | 1   |   |   |   |   |   | T0084   |
|   |   |               |   | VKM 12153   | 1   |  |   |   |   |   |   |   |   |
|   |   |               |   | VKM 22153   |   | 1  |   |   |   |   |   |   |   |
|                                       | 149 B1.000  | 02/87 → 03/94 | 2)  | VKPA 82634  |   |  |   |   | 1   |   |   |   |   |
| <b>FIAT  DUCATO (280/290) 1.9 TD</b> |   |               |   |   |   |  |   |   |   |   |   |   |   |
|                                       | 280 A1.000  | 01/90 → 03/94 |   | VKMA 02169  | 1   | 1  | 1   |   |   |   |   |   | T0086   |
|   |   |               |   | VKM 12153   | 1   |  |   |   |   |   |   |   |   |
|   |   |               |   | VKM 22153   |   | 1  |   |   |   |   |   |   |   |
|                                       | 280 A1.000  | 03/89 → 03/94 | 2)  | VKPA 82634  |   |  |   |   | 1   |   |   |   |   |
| <b>FIAT  DUCATO (280/290) 2.4 D</b>  |   |               |   |   |   |  |   |   |   |   |   |   |   |
|                                       | 8144.61   | 01/82 → 10/86 |   | VKPC 82600  |   |  |   |   | 1   |   |   |   |   |
|   | 8144.61   | 11/86 → 08/90 |   | VKPC 82643  |   |  |   |   | 1   |   |   |   |   |
| <b>FIAT  DUCATO (280/290) 2.5 D</b>  |   |               |   |   |   |  |   |   |   |   |   |   |   |
|                                       | 8144.67   | 08/90 → 03/94 |  | VKMA 02983  |   | 2  | 1   | 1   |   |   |   |   | T0096   |
|   |   |               |   | —   |   |  |   | 1   |   |   |   |   |   |
|   |   |               |   | VKM 22380   |   | 1  |   |   |   |   |   |   |   |
|   |   |               |   | VKM 22385   |   | 1  |   |   |   |   |   |   |   |
|   | 8144.67   | 01/82 → 07/90 |   | VKMA 02381  |   | 2  | 1   |   |   |   |   |   | T0014   |
|   |   |               |   | VKM 22380   |   | 1  |   |   |   |   |   |   |   |
|   |   |               |   | VKM 22385   |   | 1  |   |   |   |   |   |   |   |
|   | 8144.67   | 08/90 → 03/94 |   | VKMA 02383  |   | 2  | 1   |   |   |   |   |   | T0652   |
|   |   |               |   | VKM 22380   |   | 1  |   |   |   |   |   |   |   |
|   |   |               |   | VKM 22385   |   | 1  |   |   |   |   |   |   |   |
|   | CDR93, CRD93                                      | 01/82 → 08/90 |   | VKMA 03050  |   | 2  | 2   |   |   |   |   |   | T0021   |
|   |   |               |   | VKM 12200   |   | 1  |   |   |   |   |   |   |   |
|   |   |               |   | VKM 13050   |   | 1  |   |   |   |   |   |   |   |
|                                       | 8144.67,<br>CRD93L (U25-661),<br>U25/661, U25-661 | 01/82 → 08/90 |   | VKPC 83617  |   |  |   |   | 1   |   |   |   |   |
|   | 8144.67   | 01/82 → 03/94 |   | VKPC 82643  |   |  |   |   | 1   |   |   |   |   |
| <b>FIAT  DUCATO (280/290) 2.5 TD</b> |   |               |   |   |   |  |   |   |   |   |   |   |   |
|                                       | 8140.27   | 08/90 → 03/94 |  | VKMA 02984  |   | 2  | 1   | 1   |   |   |   |   | T0097   |
|   |   |               |   | —   |   |  |   | 1   |   |   |   |   |   |
|   |   |               |   | VKM 22385   |   | 1  |   |   |   |   |   |   |   |
|   |   |               |   | VKM 22385   |   | 1  |   |   |   |   |   |   |   |
|   | 8140.27   | 08/90 → 03/94 |   | VKMA 02384  |   | 2  | 1   |   |   |   |   |   | T0653   |
|   |   |               |   | VKM 22385   |   | 1  |   |   |   |   |   |   |   |
|   |   |               |   | VKM 22385   |   | 1  |   |   |   |   |   |   |   |

|                                     |  |             |  |  |  |  |  |  |  |  |  |  |
|--|---|--|--|---|---|---|---|---|---|---|---|---|
| 8144.21  | 01/86 → 07/90   |  | VKMA 02382<br>VKM 22385<br>VKM 22385   | 2<br>1<br>1   | 1   |   |   |   |   |   |   | T0043   |
|  8140.27, 8144.21                   | 01/86 → 03/94   |  | VKPC 82643   |   |   |   | 1   |   |   |   |   |   |
| <b>FIAT  DUCATO (230) 2.0</b>       |   |  |  |   |   |   |   |   |   |   |   |   |
|  R5B, RFW                           | 03/94 → 04/02   |  | VKMA 03202<br>VKM 13202  | 1<br>1  | 1   |   |   |   |   |   |   | T0119   |
|  R5B, RFW, RHW                      | 03/94 → 04/02   |  | VKPC 83420   |   |   |   | 1   |   |   |   |   |   |
|  B(Alt) R5B, RFW                    | 03/94 → 04/02   | AC   | VKMMV 6PK1094<br>VKM 33003   | 1   | 1   |   |   |   |   |   |   |   |
| <b>FIAT  DUCATO (230) 1.9 D</b>     |   |  |  |   |   |   |   |   |   |   |   |   |
|  D9B, DJY                           | 04/98 → 04/02   |             | VKMC 03241<br>VKMA 03241<br>VKM 13241<br>VKM 23241                                 | 1<br>1<br>1<br>1  | 1<br>1<br>1   | 1   | 1   |   |   |   |   | T0017   |
| D9B, DJY   | 04/98 → 04/02   | 3)   | VKMS 03241<br>VKMA 03241<br>VKM 13241<br>VKM 23241                                 | 1<br>1<br>1<br>1  | 1<br>1<br>1   |   |   |   | 2   |   |   | T0017   |
| 230 A2.000   | 03/94 → 04/02   |  | VKMA 02169<br>VKM 12153<br>VKM 22153   | 1<br>1<br>1   | 1<br>1  | 1   |   |   |   |   |   | T0086   |
|  230 A2.000                         | 03/94 → 04/02   | 2)   | VKPA 82670   |   |   |   | 1   |   |   |   |   |   |
| DJY  | 04/98 → 04/02   |  | VKPC 83420   |   |   |   | 1   |   |   |   |   |   |
|  B(Alt) DJY                         | 04/98 → 04/02   | AC   | VKMMV 6PK730   |   |   | 1   |   |   |   |   |   |   |
| B(Alt) DJY   | 04/98 → 04/02   |  120A, AC   | VKMMV 6PK1155<br>VKM 33002   | 1   |   | 1   |   |   |   |   |   |   |
| B(Alt) DJY   | 04/98 → 04/02   |  80A, AC  | VKMA 33040<br>VKMMV 6PK1160<br>VKM 33002   | 1<br>1  | 1   | 1   |   |   |   |   |   |   |
| B(PS) DJY  | 04/98 → 04/02   |  | VKMMV 4PK755   |   |   | 1   |   |   |   |   |   |   |
| B(AC) 230 A2.000   | 03/94 → 04/02   |  | VKMMV 5PK1050  |   |   | 1   |   |   |   |   |   |   |
| <b>FIAT  DUCATO (230) 1.9 TD</b>  |   |  |  |   |   |   |   |   |   |   |   |   |
|  DHX (XUD9TF/L)                   | 04/98 → 04/02   |           | VKMC 03241<br>VKMA 03241<br>VKM 13241<br>VKM 23241                                 | 1<br>1<br>1<br>1  | 1<br>1<br>1   | 1   | 1   |   |   |   |   | T0017   |
| DHX (XUD9TF/L)   | 04/98 → 04/02   | 3)   | VKMS 03241<br>VKMA 03241<br>VKM 13241<br>VKM 23241                                 | 1<br>1<br>1<br>1  | 1<br>1<br>1   |   |   |   | 2   |   |   | T0017   |
| 230 A3.000, 230 A4.000   | 03/94 → 04/02   |  | VKMA 02169<br>VKM 12153<br>VKM 22153   | 1<br>1<br>1   | 1<br>1  | 1   |   |   |   |   |   | T0086   |
|  230 A3.000, 230 A4.000           | 03/94 → 04/02   | 2), AC,   | VKPA 82671   |   |   |   | 1   |   |   |   |   |   |
| 230 A3.000, 230 A4.000   | 03/94 → 04/02   | 2), AC   | —  |   |   |   | 1   |   |   |   |   |   |
| DHX (XUD9TF/L)   | 04/98 → 04/02   |  | VKPC 83420   |   |   |   | 1   |   |   |   |   |   |
|  B(Alt) DHX (XUD9TF/L)            | 04/98 → 04/02   | AC   | VKMMV 6PK730   |   |   | 1   |   |   |   |   |   |   |
| B(Alt) DHX (XUD9TF/L)  | 04/98 → 04/02   |  120A, AC | VKMMV 6PK1155<br>VKM 33002   | 1   |   | 1   |   |   |   |   |   |   |
| B(Alt) DHX (XUD9TF/L)  | 04/98 → 04/02   |  80A, AC  | VKMA 33040<br>VKMMV 6PK1160<br>VKM 33002   | 1<br>1  | 1   | 1   |   |   |   |   |   |   |
| B(PS) DHX (XUD9TF/L)   | 04/98 → 04/02   |  | VKMMV 4PK755   |   |   | 1   |   |   |   |   |   |   |
| <b>FIAT  DUCATO (230) 2.0 JTD</b> |   |  |  |   |   |   |   |   |   |   |   |   |
|  RHV (DW10)                       | 10/01 → 04/02   |           | VKMC 03246<br>VKMA 03246<br>VKM 13246<br>VKM 23246                                 | 1<br>1<br>1<br>1  | 1<br>1<br>1   | 1   | 1   |   |   |   | 1   | T0168   |
| RHV (DW10)   | 10/01 → 04/02   |  | VKPC 83639   |   |   |   | 1   |   |   |   |   |   |
|  B(Alt) RHV (DW10)                | 10/01 → 04/02   | AC   | VKMMV 6PK1468<br>VKM 33024<br>VKM 33033<br>VKM 33314                               | 1<br>1<br>1   | 1   | 1   |   |   |   |   |   |   |





























































































|  |  |  |    |  |  |  |  |  |  |  |  |  |  |
|--|---|---|---|--|---|---|---|---|---|---|---|---|---|
| <b>B(Alt)</b>  | RHV (DW10)  | 10/01 → 04/02   | <b>AC</b>   | VKMV 6PK1182<br>VKM 33032<br>VKM 33314   | 1   |   | 1   |   |   |   |   |   |   |
| <b>B(PS)</b>   | RHV (DW10)  | 10/01 → 04/02   |   | VKMV 4PK755  |   |   | 1   |   |   |   |   |   |   |
| <b>FIAT  DUCATO (230) 2.5 D</b>     |   |   |   |  |   |   |   |   |   |   |   |   |   |
|                                      | 8140.67   | 03/94 → 04/02   |    | VKMA 02983<br>—<br>VKM 22380<br>VKM 22385  |   | 2   | 1   | 1   |   |   |   |   | T0096   |
|  | 8140.67   | 03/94 → 04/02   |   | VKMA 02383<br>VKM 22380<br>VKM 22385   |   | 2   | 1   |   |   |   |   |   | T0652   |
|                                      | 8140.67   | 03/94 → 04/02   |   | VKPC 82652   |   |   |   |   | 1   |   |   |   |   |
| <b>FIAT  DUCATO (230) 2.5 TDI</b>   |   |   |   |  |   |   |   |   |   |   |   |   |   |
|                                      | 8140.47, 8140.47R   | 03/94 → 04/02   |    | VKMA 02984<br>—<br>VKM 22385<br>VKM 22385  |   | 2   | 1   | 1   |   |   |   |   | T0097   |
|  | 8140.47, 8140.47R   | 03/94 → 04/02   |   | VKMA 02384<br>VKM 22385<br>VKM 22385   |   | 2   | 1   |   |   |   |   |   | T0653   |
|                                      | 8140.47, 8140.47R   | 03/94 → 04/02   |   | VKPC 82652   |   |   |   |   | 1   |   |   |   |   |
| <b>FIAT  DUCATO (230) 2.8 D</b>     |   |   |   |  |   |   |   |   |   |   |   |   |   |
|                                      | 8140.63   | 02/98 → 04/02   |    | VKMA 02984<br>—<br>VKM 22385<br>VKM 22385  |   | 2   | 1   | 1   |   |   |   |   | T0097   |
|  | 8140.63   | 02/98 → 04/02   |   | VKMA 02384<br>VKM 22385<br>VKM 22385   |   | 2   | 1   |   |   |   |   |   | T0653   |
|                                    | 8140.63   | 02/98 → 04/02   |   | VKPC 82652   |   |   |   |   | 1   |   |   |   |   |
| <b>FIAT  DUCATO (230) 2.8 JTD</b> |   |   |   |  |   |   |   |   |   |   |   |   |   |
|                                    | 8140.43S  | 11/00 → 04/02   |  | VKMA 02983<br>—<br>VKM 22380<br>VKM 22385  |   | 2   | 1   | 1   |   |   |   |   | T0096   |
|  | 8140.43S  | 11/00 → 04/02   |   | VKMA 02383<br>VKM 22380<br>VKM 22385   |   | 2   | 1   |   |   |   |   |   | T0652   |
|                                    | 8140.43S  | 11/00 → 04/02   |   | VKPC 82652   |   |   |   |   | 1   |   |   |   |   |
| <b>FIAT  DUCATO (230) 2.8 TDI</b> |   |   |   |  |   |   |   |   |   |   |   |   |   |
|                                    | 8140.43   | 10/97 → 04/02   |  | VKMA 02986<br>—<br>VKM 22385<br>VKM 22385  |   | 2   | 1   | 1   |   |   |   |   | T0155   |
|  | 8140.43   | 10/97 → 04/02   |   | VKMA 02386<br>VKM 22385<br>VKM 22385   |   | 2   | 1   |   |   |   |   |   | T0155   |
|                                    | 8140.43   | 10/97 → 04/02   |   | VKPC 82652   |   |   |   |   | 1   |   |   |   |   |
| <b>FIAT  DUCATO (244) 2.0</b>     |   |   |   |  |   |   |   |   |   |   |   |   |   |
|                                    | RFL   | 04/02 → 03/07   |   | VKMA 03202<br>VKM 13202  | 1   |   | 1   |   |   |   |   |   | T0119   |
|                                    | RFL   | 04/02 → 03/07   |   | VKPC 83420   |   |   |   |   | 1   |   |   |   |   |
|                                    | <b>B(Alt)</b> RFL   | 04/02 → 03/07   | <b>AC</b>   | VKMV 6PK698  |   |   | 1   |   |   |   |   |   |   |
|  | <b>B(Alt)</b> RFL   | 04/02 → 03/07   | <b>AC</b>   | VKMV 6PK1094<br>VKM 33003  | 1   |   | 1   |   |   |   |   |   |   |
| <b>FIAT  DUCATO (244) 2.0 JTD</b> |   |   |   |  |   |   |   |   |   |   |   |   |   |
|                                    | RHV (DW10)  | 04/02 → 03/07   |  | VKMC 03246<br>VKMA 03246<br>VKM 13246<br>VKM 23246                                 | 1   | 1   | 1   |   | 1   |   |   | 1   | T0168   |
|                                    | RHV (DW10)  | 04/02 → 03/07   |   | VKPC 83639   |   |   |   |   | 1   |   |   |   |   |

| <b>FIAT  DUCATO (244) 2.3 JTD</b>  |                        |               |          |              |   |   |   |   |  |   |  |  |  |  |  |  |  |  |       |
|------------------------------------|------------------------|---------------|----------|--------------|---|---|---|---|--|---|--|--|--|--|--|--|--|--|-------|
|                                    | F1AE0481C              | 04/02 → 09/07 |          | VKMA 02390   | 1 | 1 | 1 |   |  |   |  |  |  |  |  |  |  |  | T0199 |
|                                    |                        |               |          | VKM 12390    | 1 |   |   |   |  |   |  |  |  |  |  |  |  |  |       |
|                                    |                        |               |          | VKM 22390    |   | 1 |   |   |  |   |  |  |  |  |  |  |  |  |       |
|                                    | F1AE0481C              | 04/02 → 09/07 |          | —            |   |   |   |   |  | 1 |  |  |  |  |  |  |  |  |       |
| <b>FIAT  DUCATO (244) 2.8 JTD</b>  |                        |               |          |              |   |   |   |   |  |   |  |  |  |  |  |  |  |  |       |
|                                    | 8140.43S               | 04/02 → 09/07 |          | VKMA 02983   |   | 2 | 1 | 1 |  |   |  |  |  |  |  |  |  |  | T0096 |
|                                    |                        |               |          | —            |   | 1 |   | 1 |  |   |  |  |  |  |  |  |  |  |       |
|                                    |                        |               |          | VKM 22380    |   | 1 |   |   |  |   |  |  |  |  |  |  |  |  |       |
|                                    |                        |               |          | VKM 22385    |   | 1 |   |   |  |   |  |  |  |  |  |  |  |  |       |
|                                    | 8140.43S               | 04/02 → 09/07 |          | VKMA 02383   |   | 2 | 1 |   |  |   |  |  |  |  |  |  |  |  | T0652 |
|                                    |                        |               |          | VKM 22380    |   | 1 |   |   |  |   |  |  |  |  |  |  |  |  |       |
|                                    |                        |               |          | VKM 22385    |   | 1 |   |   |  |   |  |  |  |  |  |  |  |  |       |
|                                    | 8140.43S               | 04/02 → 09/07 |          | VKPC 82652   |   |   |   |   |  | 1 |  |  |  |  |  |  |  |  |       |
| <b>FIAT  DUCATO 2.2 D Multijet</b> |                        |               |          |              |   |   |   |   |  |   |  |  |  |  |  |  |  |  |       |
|                                    | 4HV                    | 07/06 → 03/07 |          | ΟΧΛΟΧΟ       |   |   |   |   |  |   |  |  |  |  |  |  |  |  |       |
|                                    | B(Alt) 4HV             | 07/06 → 03/07 | AC       | VKMW 6PK1670 |   |   |   | 1 |  |   |  |  |  |  |  |  |  |  |       |
|                                    |                        |               |          | VKM 34030    |   | 1 |   |   |  |   |  |  |  |  |  |  |  |  |       |
|                                    |                        |               |          | VKM_____     |   |   |   |   |  |   |  |  |  |  |  |  |  |  |       |
|                                    |                        |               |          | VKM_____     |   |   |   | 1 |  |   |  |  |  |  |  |  |  |  |       |
| <b>FIAT  TALENTO (290) 2.0</b>     |                        |               |          |              |   |   |   |   |  |   |  |  |  |  |  |  |  |  |       |
|                                    | 170 B                  | 03/89 → 03/94 |          | ΟΧΛΟΧΟ       |   |   |   |   |  |   |  |  |  |  |  |  |  |  |       |
|                                    | 170 B                  | 03/89 → 03/94 |          | VKPC 83630   |   |   |   |   |  | 1 |  |  |  |  |  |  |  |  |       |
| <b>FIAT  TALENTO (290) 1.9 D</b>   |                        |               |          |              |   |   |   |   |  |   |  |  |  |  |  |  |  |  |       |
|                                    | 149 B1.000             | 03/89 → 03/94 |          | VKMA 02168   | 1 | 1 | 1 |   |  |   |  |  |  |  |  |  |  |  | T0084 |
|                                    |                        |               |          | VKM 12153    | 1 |   |   |   |  |   |  |  |  |  |  |  |  |  |       |
|                                    |                        |               |          | VKM 22153    |   |   | 1 |   |  |   |  |  |  |  |  |  |  |  |       |
|                                    | 149 B1.000             | 03/89 → 03/94 | 2)       | VKPA 82634   |   |   |   |   |  | 1 |  |  |  |  |  |  |  |  |       |
| <b>FORD  CAPRI 1.3</b>             |                        |               |          |              |   |   |   |   |  |   |  |  |  |  |  |  |  |  |       |
|                                    | J1E                    | 01/71 → 06/85 |          | VKMA 04000   | 1 |   | 1 |   |  |   |  |  |  |  |  |  |  |  | T0029 |
|                                    |                        |               |          | VKM 14000    | 1 |   |   |   |  |   |  |  |  |  |  |  |  |  |       |
| <b>FORD  CAPRI 1.6</b>             |                        |               |          |              |   |   |   |   |  |   |  |  |  |  |  |  |  |  |       |
|                                    | LAC, LCE, LCN, LE, LEC | 01/69 → 04/87 |          | VKMA 04000   | 1 |   | 1 |   |  |   |  |  |  |  |  |  |  |  | T0029 |
|                                    |                        |               |          | VKM 14000    | 1 |   |   |   |  |   |  |  |  |  |  |  |  |  |       |
|                                    | LAC, LCE, LEC          | 02/74 → 12/77 |          | VKPC 84600   |   |   |   |   |  | 1 |  |  |  |  |  |  |  |  |       |
|                                    | LCN                    | 01/78 → 04/87 | Fix.FAN  | VKPC 84600   |   |   |   |   |  | 1 |  |  |  |  |  |  |  |  |       |
|                                    | LCN                    | 01/78 → 04/87 | Fix.FAN  | VKPC 84600   |   |   |   |   |  | 1 |  |  |  |  |  |  |  |  |       |
|                                    | LCN                    | 01/78 → 04/87 | Auto.FAN | VKPC 84601   |   |   |   |   |  | 1 |  |  |  |  |  |  |  |  |       |
|                                    | LCN                    | 01/78 → 04/87 | Auto.FAN | VKPC 84601   |   |   |   |   |  | 1 |  |  |  |  |  |  |  |  |       |
| <b>FORD  CAPRI 1.7</b>             |                        |               |          |              |   |   |   |   |  |   |  |  |  |  |  |  |  |  |       |
|                                    | TV 17 H                | 12/68 → 08/72 |          | VKPC 84400   |   |   |   |   |  | 1 |  |  |  |  |  |  |  |  |       |
| <b>FORD  CAPRI 2.0</b>             |                        |               |          |              |   |   |   |   |  |   |  |  |  |  |  |  |  |  |       |
|                                    | NEN, OHC TL 20 H       | 01/78 → 12/85 |          | VKMA 04001   | 1 |   | 1 |   |  |   |  |  |  |  |  |  |  |  | T0030 |
|                                    |                        |               |          | VKM 14000    | 1 |   |   |   |  |   |  |  |  |  |  |  |  |  |       |
|                                    | NEN, OHC TL 20 H       | 01/78 → 12/85 | Fix.FAN  | VKPC 84600   |   |   |   |   |  | 1 |  |  |  |  |  |  |  |  |       |
|                                    | NEN, OHC TL 20 H       | 01/78 → 12/85 | Fix.FAN  | VKPC 84600   |   |   |   |   |  | 1 |  |  |  |  |  |  |  |  |       |
|                                    | NEN, OHC TL 20 H       | 01/78 → 12/85 | Auto.FAN | VKPC 84601   |   |   |   |   |  | 1 |  |  |  |  |  |  |  |  |       |
|                                    | NEN, OHC TL 20 H       | 01/78 → 12/85 | Auto.FAN | VKPC 84601   |   |   |   |   |  | 1 |  |  |  |  |  |  |  |  |       |
| <b>FORD  CAPRI 2.3</b>             |                        |               |          |              |   |   |   |   |  |   |  |  |  |  |  |  |  |  |       |
|                                    | YYN                    | 06/79 → 09/84 |          | VKPC 84608   |   |   |   |   |  | 1 |  |  |  |  |  |  |  |  |       |
|                                    | YYN                    | 10/84 → 12/85 |          | VKPC 84609   |   |   |   |   |  | 1 |  |  |  |  |  |  |  |  |       |
| <b>FORD  CAPRI 2.8</b>             |                        |               |          |              |   |   |   |   |  |   |  |  |  |  |  |  |  |  |       |
|                                    | PRN                    | 01/81 → 09/84 |          | VKPC 84608   |   |   |   |   |  | 1 |  |  |  |  |  |  |  |  |       |
|                                    | PRN                    | 10/84 → 04/87 |          | VKPC 84609   |   |   |   |   |  | 1 |  |  |  |  |  |  |  |  |       |
| <b>FORD  CONSUL 1.7</b>            |                        |               |          |              |   |   |   |   |  |   |  |  |  |  |  |  |  |  |       |
|                                    |                        | 01/72 → 12/75 |          | VKPC 84400   |   |   |   |   |  | 1 |  |  |  |  |  |  |  |  |       |
| <b>FORD  CORSAIR 1.7</b>           |                        |               |          |              |   |   |   |   |  |   |  |  |  |  |  |  |  |  |       |
|                                    |                        | 10/65 → 03/71 |          | VKPC 84400   |   |   |   |   |  | 1 |  |  |  |  |  |  |  |  |       |
| <b>FORD  COUGAR 2.0 16V</b>        |                        |               |          |              |   |   |   |   |  |   |  |  |  |  |  |  |  |  |       |
|                                    | ZH20 Zetec             | 08/98 → 01/99 |          | VKMA 04213   | 1 | 2 | 1 |   |  |   |  |  |  |  |  |  |  |  | T0162 |
|                                    |                        |               |          | VKM 14211    | 1 |   |   |   |  |   |  |  |  |  |  |  |  |  |       |
|                                    |                        |               |          | VKM 24212    |   |   | 1 |   |  |   |  |  |  |  |  |  |  |  |       |
|                                    |                        |               |          | VKM 24214    |   |   | 1 |   |  |   |  |  |  |  |  |  |  |  |       |









































|  |  |  |  |  |  |  |  |  |  |  |  |  |  |  |
|--|---|---|---|--|---|---|---|---|---|---|---|---|---|---|
|  | ZH20 Zetec  | 02/99 → 12/01   |   | VKMA 04214<br>VKM 14211<br>VKM 24213   | 1<br>1  | 1   |   |   |   |   |   |   |   | T0162   |
|                                      | ZH20 Zetec  | 08/98 → 12/01   |   | VKPC 84415   |   |   |   |   | 1   |   |   |   |   |   |
|                                      | <b>B(Alt)</b> ZH20 Zetec  | 08/98 → 12/01   | <b>AC</b>   | VKMV 6PK1973<br>VKM 34010<br>VKM_____  | 1   |   | 1   |   |   |   |   |   |   |   |
|  | <b>B(Alt)</b> ZH20 Zetec  | 08/98 → 12/01   | <b>AC, Man. GBX</b>   | VKMV 6PK2120<br>VKM 34010<br>VKM_____  | 1   |   | 1   |   |   |   |   |   |   |   |
|  | <b>B(Alt)</b> ZH20 Zetec  | 08/98 → 12/01   | <b>AC, Auto. GBX</b>  | VKMV 6PK2103<br>VKM 34010<br>VKM_____  | 1   |   | 1   |   |   |   |   |   |   |   |
| <b>FORD  COUGAR 2.5 V6</b>          |   |   |   |  |   |   |   |   |   |   |   |   |   |   |
|                                      | Duratec   | 08/98 → 12/01   |   | <del>OKOKOKO</del>   |   |   |   |   |   |   |   |   |   |   |
|                                      | Duratec   | 08/98 → 12/01   | 2)  | VKPA_____  |   |   |   |   | 1   |   |   |   |   |   |
| <b>FORD  ESCORT I 1.1</b>           |   |   |   |  |   |   |   |   |   |   |   |   |   |   |
|                                      | G1  | 01/68 → 08/70   |   | —  |   |   |   |   | 1   |   |   |   |   |   |
|  | G1, G1/G2/KL11  | 08/70 → 02/76   |   | VKPC 84201   |   |   |   |   | 1   |   |   |   |   |   |
| <b>FORD  ESCORT I 1.3</b>           |   |   |   |  |   |   |   |   |   |   |   |   |   |   |
|                                      | J1/J2/J3/KL13   | 06/68 → 08/70   |   | —  |   |   |   |   | 1   |   |   |   |   |   |
|  | J1/J2/J3/KL13, J1F  | 08/70 → 02/76   |   | VKPC 84201   |   |   |   |   | 1   |   |   |   |   |   |
|  | J2  | 06/70 → 02/76   |   | VKPC 84201   |   |   |   |   | 1   |   |   |   |   |   |
| <b>FORD  ESCORT II 1.1</b>          |   |   |   |  |   |   |   |   |   |   |   |   |   |   |
|                                     | HL11 CVH  | 01/76 → 08/80   |   | VKMA 04200<br>VKM 14200  | 1<br>1  |   | 1   |   |   |   |   |   |   | T0070   |
|                                    | HL11 CVH  | 12/74 → 05/79   |   | VKPC 84201   |   |   |   |   | 1   |   |   |   |   |   |
|  | HL11 CVH  | 05/79 → 08/80   |   | —  |   |   |   |   | 1   |   |   |   |   |   |
| <b>FORD  ESCORT II 1.3</b>        |   |   |   |  |   |   |   |   |   |   |   |   |   |   |
|                                    | HL13 CVH  | 01/76 → 07/81   |   | VKMA 04200<br>VKM 14200  | 1<br>1  |   | 1   |   |   |   |   |   |   | T0070   |
|                                    | HL13 CVH  | 12/74 → 05/79   |   | VKPC 84201   |   |   |   |   | 1   |   |   |   |   |   |
|  | HL13 CVH  | 05/79 → 08/80   |   | —  |   |   |   |   | 1   |   |   |   |   |   |
| <b>FORD  ESCORT II 2.0</b>        |   |   |   |  |   |   |   |   |   |   |   |   |   |   |
|                                    | NE  | 03/73 → 08/80   |   | VKMA 04001<br>VKM 14000  | 1<br>1  |   | 1   |   |   |   |   |   |   | T0030   |
|                                    | NE  | 08/75 → 08/80   |   | VKPC 84600   |   |   |   |   | 1   |   |   |   |   |   |
| <b>FORD  ESCORT III 1.1</b>       |   |   |   |  |   |   |   |   |   |   |   |   |   |   |
|                                    | BL 11 (OHV/HCS)   | 08/83 → 12/85   |   | <del>OKOKOKO</del>   |   |   |   |   |   |   |   |   |   |   |
|  | HL11 CVH  | 09/80 → 08/83   |   | VKMA 04200<br>VKM 14200  | 1<br>1  |   | 1   |   |   |   |   |   |   | T0070   |
|                                    | BL 11 (OHV/HCS)   | 08/83 → 12/85   |   | VKPC 84205   |   |   |   |   | 1   |   |   |   |   |   |
|  | HL11 CVH  | 09/80 → 08/83   |   | VKPC 84207   |   |   |   |   | 1   |   |   |   |   |   |
|                                    | <b>B(Alt)</b> BL 11 (OHV/HCS)   | 08/83 → 12/85   |   | VKMV 10AVx825  |   |   | 1   |   |   |   |   |   |   |   |
| <b>FORD  ESCORT III 1.3</b>       |   |   |   |  |   |   |   |   |   |   |   |   |   |   |
|                                    | HL13 CVH  | 09/80 → 12/85   |   | VKMA 04200<br>VKM 14200  | 1<br>1  |   | 1   |   |   |   |   |   |   | T0070   |
|                                    | HL13 CVH  | 09/80 → 12/85   |   | VKPC 84207   |   |   |   |   | 1   |   |   |   |   |   |
|                                    | <b>B(Alt)</b> HL13 CVH  | 09/80 → 09/83   |   | VKMV 10AVx800  |   |   | 1   |   |   |   |   |   |   |   |
| <b>FORD  ESCORT III 1.6</b>       |   |   |   |  |   |   |   |   |   |   |   |   |   |   |
|                                    | HL16 CVH  | 09/80 → 06/83   |   | VKMA_____<br>VKM 14200   | 1<br>1  |   | 1   |   |   |   |   |   |   | T0070   |
|  | HL16 CVH  | 07/83 → 12/85   |   | VKMA 04201<br>VKM 14201  | 1<br>1  |   | 1   |   |   |   |   |   |   | T0070   |
|                                    | HL16 CVH  | 09/80 → 12/85   |   | VKPC 84207   |   |   |   |   | 1   |   |   |   |   |   |
|                                    | <b>B(Alt)</b> HL16 CVH  | 09/80 → 09/83   | <b>Carbu.</b>   | VKMV 10AVx800  |   |   | 1   |   |   |   |   |   |   |   |
| <b>FORD  ESCORT III 1.6 Turbo</b> |   |   |   |  |   |   |   |   |   |   |   |   |   |   |
|                                    | HL16T CVH   | 11/84 → 12/85   |   | VKMA 04201<br>VKM 14201  | 1<br>1  |   | 1   |   |   |   |   |   |   | T0070   |
|                                    | HL16T CVH   | 11/84 → 12/85   |   | VKPC 84207   |   |   |   |   | 1   |   |   |   |   |   |

|   |                              |               |  |  |   |   |  |  |  |   |  |   |  |  |  |   |  |       |  |
|---|------------------------------|---------------|--|--|---|---|---|--|---|---|---|---|---|--|---|---|---|-------|--|
| <b>FORD  ESCORT III 1.6 D</b>      |                              |               |  |  |   |   |   |  |   |   |   |   |   |  |   |   |   |       |  |
|                                    | D16                          | 02/84 → 12/85 |  | VKMA 04101   | 1 |   | 1   |  |   |   |   |   |   |  |   | 1 |   | T0022 |  |
|   |                              |               |  | VKM 14101  | 1 |   |   |  |   |   |   |   |   |  |   | 1 |   |       |  |
|                                    | D16                          | 02/84 → 12/85 |  | VKPC 84403   |   |   |   |  |   | 1 |   |   |   |  |   |   |   |       |  |
| <b>FORD  ESCORT IV 1.1</b>         |                              |               |  |  |   |   |   |  |   |   |   |   |   |  |   |   |   |       |  |
|                                    | HL11 CVH                     | 10/85 → 12/87 |  | VKMA 04200   | 1 |   | 1   |  |   |   |   |   |   |  |   |   |   | T0070 |  |
|   |                              |               |  | VKM 14200  | 1 |   |   |  |   |   |   |   |   |  |   |   |   |       |  |
|                                    | HL11 CVH                     | 10/85 → 07/88 |  | VKPC 84205   |   |   |   |  |   | 1 |   |   |   |  |   |   |   |       |  |
|   | HL11 CVH                     | 08/88 → 09/90 |  | VKPC 84209   |   |   |   |  |   | 1 |   |   |   |  |   |   |   |       |  |
|                                    | <b>B(Alt)</b> HL11 CVH       | 10/85 → 08/88 |  | VKMV 10AVx825  |   |   | 1   |  |   |   |   |   |   |  |   |   |   |       |  |
|   | <b>B(Alt)</b> HL11 CVH       | 08/88 → 09/90 |  | VKMV 10AVx813  |   |   | 1   |  |   |   |   |   |   |  |   |   |   |       |  |
| <b>FORD  ESCORT IV 1.3</b>         |                              |               |  |  |   |   |   |  |   |   |   |   |   |  |   |   |   |       |  |
|                                    | HL13 CVH                     | 01/86 → 12/87 |  | VKMA 04200   | 1 |   | 1   |  |   |   |   |   |   |  |   |   |   | T0070 |  |
|   |                              |               |  | VKM 14200  | 1 |   |   |  |   |   |   |   |   |  |   |   |   |       |  |
|                                    | HL13 CVH                     | 01/86 → 10/86 |  | VKPC 84205   |   |   |   |  |   | 1 |   |   |   |  |   |   |   |       |  |
|   | HL13 CVH                     | 11/86 → 07/88 |  | VKPC 84208   |   |   |   |  |   | 1 |   |   |   |  |   |   |   |       |  |
|   | HL13 CVH                     | 08/88 → 10/90 |  | VKPC 84209   |   |   |   |  |   | 1 |   |   |   |  |   |   |   |       |  |
|                                    | <b>B(Alt)</b> HL13 CVH       | 01/86 → 08/88 |  | VKMV 10AVx825  |   |   | 1   |  |   |   |   |   |   |  |   |   |   |       |  |
|   | <b>B(Alt)</b> HL13 CVH       | 08/88 → 10/90 |  | VKMV 10AVx813  |   |   | 1   |  |   |   |   |   |   |  |   |   |   |       |  |
| <b>FORD  ESCORT IV 1.4</b>         |                              |               |  |  |   |   |   |  |   |   |   |   |   |  |   |   |   |       |  |
|                                    | HL14 CVH                     | 10/85 → 10/90 |  | VKMA 04201   | 1 |   | 1   |  |   |   |   |   |   |  |   |   |   | T0070 |  |
|   |                              |               |  | VKM 14201  | 1 |   |   |  |   |   |   |   |   |  |   |   |   |       |  |
|                                    | HL14 CVH                     | 10/85 → 12/85 |  | VKPC 84207   |   |   |   |  |   | 1 |   |   |   |  |   |   |   |       |  |
|   | HL14 CVH                     | 01/86 → 10/90 |  | VKPC 84208   |   |   |   |  |   | 1 |   |   |   |  |   |   |   |       |  |
|                                   | <b>B(Alt)</b> HL14 CVH       | 10/85 → 12/88 | Carbu. AC  | VKMV 11.9x758  |   |   | 1   |  |   |   |   |   |   |  |   |   |   |       |  |
| <b>FORD  ESCORT IV 1.6</b>       |                              |               |  |  |   |   |   |  |   |   |   |   |   |  |   |   |   |       |  |
|                                  | HL16 CVH                     | 01/86 → 07/90 |  | VKMA 04201   | 1 |   | 1   |  |   |   |   |   |   |  |   |   |   | T0070 |  |
|   |                              |               |  | VKM 14201  | 1 |   |   |  |   |   |   |   |   |  |   |   |   |       |  |
|                                  | HL16 CVH                     | 01/86 → 07/90 |  | VKPC 84208   |   |   |   |  |   | 1 |   |   |   |  |   |   |   |       |  |
|                                  | <b>B(Alt)</b> HL16 CVH       | 01/86 → 12/88 | Carbu. AC  | VKMV 11.9x758  |   |   | 1   |  |   |   |   |   |   |  |   |   |   |       |  |
|   | <b>B(Alt)</b> HL16 CVH       | 12/88 → 07/90 | Carbu. AC  | VKMV 11.9x758  |   |   | 1   |  |   |   |   |   |   |  |   |   |   |       |  |
| <b>FORD  ESCORT IV 1.6 Turbo</b> |                              |               |  |  |   |   |   |  |   |   |   |   |   |  |   |   |   |       |  |
|                                  | HL16T CVH                    | 01/86 → 07/90 |  | VKMA 04201   | 1 |   | 1   |  |   |   |   |   |   |  |   |   |   | T0070 |  |
|   |                              |               |  | VKM 14201  | 1 |   |   |  |   |   |   |   |   |  |   |   |   |       |  |
|                                  | HL16T CVH                    | 01/86 → 07/90 |  | VKPC 84208   |   |   |   |  |   | 1 |   |   |   |  |   |   |   |       |  |
| <b>FORD  ESCORT IV 1.6 D</b>     |                              |               |  |  |   |   |   |  |   |   |   |   |   |  |   |   |   |       |  |
|                                  | D16                          | 01/86 → 01/89 |  | VKMA 04101   | 1 |   | 1   |  |   |   |   |   |   |  |   | 1 |   | T0022 |  |
|   |                              |               |  | VKM 14101  | 1 |   |   |  |   |   |   |   |   |  |   | 1 |   |       |  |
|                                  | D16                          | 01/86 → 01/89 |  | VKPC 84403   |   |   |   |  |   | 1 |   |   |   |  |   |   |   |       |  |
|                                  | <b>B(Alt)</b> D16            | 01/86 → 01/89 | AC   | VKMV 10AVx838  |   |   | 1   |  |   |   |   |   |   |  |   |   |   |       |  |
| <b>FORD  ESCORT IV 1.8 D</b>     |                              |               |  |  |   |   |   |  |   |   |   |   |   |  |   |   |   |       |  |
|                                  | D18                          | 01/89 → 07/90 |  4) | —  | 2 | 1 | 2   |  |   | 1 |   |   |   |  |   | 4 |   | T0081 |  |
|   |                              |               |  | VKMA 04103   | 2 | 1 | 2   |  |   |   |   |   |   |  |   | 4 |   |       |  |
|   |                              |               |  | VKM 14100  | 1 |   |   |  |   |   |   |   |   |  |   | 1 |   |       |  |
|   |                              |               |  | VKM 14103  | 1 |   |   |  |   |   |   |   |   |  |   | 1 |   |       |  |
|   |                              |               |  | VKM 24100  |   | 1 |   |  |   |   |   |   |   |  |   | 1 |   |       |  |
|   | D18                          | 01/89 → 07/90 | 3), 4)   | VKMS 04103   | 2 | 1 | 2   |  |   |   |   | 3 |   |  |   | 9 |   | T0081 |  |
|   |                              |               |  | VKMA 04103   | 2 | 1 | 2   |  |   |   |   |   |   |  |   | 4 |   |       |  |
|   |                              |               |  | VKM 14100  | 1 |   |   |  |   |   |   |   |   |  |   | 1 |   |       |  |
|   |                              |               |  | VKM 14103  | 1 |   |   |  |   |   |   |   |   |  |   | 1 |   |       |  |
|   |                              |               |  | VKM 24100  |   | 1 |   |  |   |   |   |   |   |  |   | 1 |   |       |  |
|                                  | D18                          | 01/89 → 07/90 |  | VKPC 84620   |   |   |   |  |   | 1 |   |   |   |  |   |   |   |       |  |
|                                  | <b>B(Alt)</b> D18            | 01/89 → 07/90 | AC   | VKMV 3PK648  |   |   | 1   |  |   |   |   |   |   |  |   |   |   |       |  |
| <b>FORD  ESCORT V 1.3</b>        |                              |               |  |  |   |   |   |  |   |   |   |   |   |  |   |   |   |       |  |
|                                  | BL13 (OHV/HCS)               | 07/90 → 09/92 |  | <b>XXXXXX</b>  |   |   |   |  |   |   |   |   |   |  |   |   |   |       |  |
|                                  | BL13 (OHV/HCS)               | 07/90 → 04/91 |  | VKPC 84209   |   |   |   |  |   | 1 |   |   |   |  |   |   |   |       |  |
|   | BL13 (OHV/HCS)               | 05/91 → 09/92 |  | VKPC 84210   |   |   |   |  |   | 1 |   |   |   |  |   |   |   |       |  |
|                                  | <b>B(Alt)</b> BL13 (OHV/HCS) | 06/92 → 09/92 |  | VKMV 10AVx800  |   |   | 1   |  |   |   |   |   |   |  |   |   |   |       |  |



| <b>FORD  ESCORT V 1.4</b>      |                       |               |                           |   |                       |                  |   |   |   |                                |
|--------------------------------|-----------------------|---------------|---------------------------|---|-----------------------|------------------|---|---|---|--------------------------------|
|                                | HL14 CVH              | 07/90 → 04/92 | B(58097x19.75 HSN),<br>97 | VKMA 04201<br>VKM 14201   | 1<br>1                | 1                |   |   |   | T0070                          |
|                                | HL14 CVH              | 05/92 → 12/92 | B(58097x21.6 HSN),<br>97  | VKMA 04202<br>VKM 14201   | 1<br>1                | 1                |   |   |   | T0070                          |
|                                | HL14 CVH              | 07/90 → 12/92 |                           | VKPC 84208  |                       |                  |   | 1 |   |                                |
|                                | B(Alt) HL14 CVH       | 07/90 → 12/92 | AC,                       | VKM 34013   |                       | 1                |   |   |   |                                |
| <b>FORD  ESCORT V 1.6</b>      |                       |               |                           |   |                       |                  |   |   |   |                                |
|                                | HL16 CVH              | 07/90 → 04/92 | B(58097x19.75 HSN),<br>97 | VKMA 04201<br>VKM 14201   | 1<br>1                | 1                |   |   |   | T0070                          |
|                                | HL16 CVH              | 05/92 → 12/92 | B(58097x21.6 HSN),<br>97  | VKMA 04202<br>VKM 14201   | 1<br>1                | 1                |   |   |   | T0070                          |
|                                | HL16 CVH              | 07/90 → 12/92 |                           | VKPC 84208  |                       |                  |   | 1 |   |                                |
|                                | B(Alt) HL16 CVH       | 07/90 → 12/92 | AC,                       | VKM 34013   |                       | 1                |   |   |   |                                |
| <b>FORD  ESCORT V 1.8 16V</b>  |                       |               |                           |   |                       |                  |   |   |   |                                |
|                                | ZH18 Zetec            | 02/92 → 12/92 |                           | VKMC 04212<br>VKMA 04212<br>VKM 14210<br>VKM 24210<br>VKM 24211 | 1<br>1<br>1<br>1<br>1 | 2<br>2<br>1<br>1 | 1 | 1 |   | 5<br>5<br>T0104                |
|                                | ZH18 Zetec            | 02/92 → 12/92 |                           | VKPC 84406  |                       |                  |   | 1 |   |                                |
|                                | B(Alt) ZH18 Zetec     | 02/92 → 12/92 | AC,                       | VKMC 04212<br>VKM 14210<br>VKM 24210<br>VKM 24211               |                       |                  | 1 |   |   |                                |
|                                | B(Alt) ZH18 Zetec     | 02/92 → 12/92 | AC,                       | VKMC 04212<br>VKM 14210<br>VKM 24210<br>VKM 24211               | 1                     |                  | 1 |   |   |                                |
| <b>FORD  ESCORT V 2.0</b>      |                       |               |                           |   |                       |                  |   |   |   |                                |
|                                | DH20                  | 05/91 → 12/92 |                           |   |                       |                  |   |   |   |                                |
|                                | DH20                  | 05/91 → 12/92 |                           | VKPC 84412  |                       |                  |   | 1 |   |                                |
| <b>FORD  ESCORT V 1.8 D</b>    |                       |               |                           |   |                       |                  |   |   |   |                                |
|                                | D18                   | 07/90 → 12/92 | 4)                        | —<br>VKMA 04103<br>VKM 14100<br>VKM 14103<br>VKM 24100          | 2<br>2<br>1<br>1      | 1<br>1<br>2      | 2 | 1 |   | 4<br>4<br>1<br>1<br>1<br>T0081 |
|                                | D18                   | 07/90 → 12/92 | 3), 4)                    | VKMS 04103<br>VKMA 04103<br>VKM 14100<br>VKM 14103<br>VKM 24100 | 2<br>2<br>1<br>1      | 1<br>1<br>2      |   |   | 3 | 9<br>4<br>1<br>1<br>1<br>T0081 |
|                                | D18                   | 07/90 → 12/92 |                           | VKPC 84620  |                       |                  |   | 1 |   |                                |
|                                | B(Alt) D18            | 07/90 → 08/91 | AC,                       | VKMC 04103<br>VKM 14100<br>VKM 14103<br>VKM 24100               |                       |                  | 1 |   |   |                                |
|                                | B(Alt) D18            | 08/91 → 12/92 | AC,                       | VKMC 04103<br>VKM 14100<br>VKM 14103<br>VKM 24100               |                       |                  | 1 |   |   |                                |
|                                | B(PS) D18             | 07/90 → 12/92 | AC                        | VKMC 04103<br>VKM 14100<br>VKM 14103<br>VKM 24100               | 1                     |                  | 1 |   |   |                                |
| <b>FORD  ESCORT VI 1.3</b>     |                       |               |                           |   |                       |                  |   |   |   |                                |
|                                | BL13 (OHV/HCS)        | 09/92 → 01/95 |                           |   |                       |                  |   |   |   |                                |
|                                | BL13 (OHV/HCS)        | 09/92 → 01/95 |                           | VKPC 84210  |                       |                  |   | 1 |   |                                |
|                                | B(Alt) BL13 (OHV/HCS) | 09/92 → 01/95 |                           | VKMC 04103<br>VKM 14100<br>VKM 14103<br>VKM 24100               |                       |                  | 1 |   |   |                                |
| <b>FORD  ESCORT VI 1.4</b>     |                       |               |                           |   |                       |                  |   |   |   |                                |
|                                | HL14 CVH              | 09/92 → 01/95 |                           | VKMA 04202<br>VKM 14201   | 1<br>1                |                  | 1 |   |   | T0070                          |
|                                | HL14 CVH              | 09/92 → 01/95 |                           | VKPC 84208  |                       |                  |   | 1 |   |                                |
|                                | B(Alt) HL14 CVH       | 09/92 → 01/95 | AC,                       | VKM 34013   |                       |                  | 1 |   |   |                                |
| <b>FORD  ESCORT VI 1.6 16V</b> |                       |               |                           |   |                       |                  |   |   |   |                                |
|                                | ZH16 Zetec            | 09/92 → 01/95 |                           | VKMC 04212<br>VKMA 04212<br>VKM 14210<br>VKM 24210<br>VKM 24211 | 1<br>1<br>1<br>1<br>1 | 2<br>2<br>1<br>1 | 1 | 1 |   | 5<br>5<br>T0104                |

|  |  |  |       |    |  |  |  |  |  |  |  |  |
|--|---|---|--|--|---|---|---|---|---|---|---|---|
|                                 | ZH16 Zetec  | 09/92 → 01/95   |  | VKPC 84406   |   |   |   |   | 1   |   |   |   |
|                                 | B(Alt) ZH16 Zetec   | 09/92 → 01/95   | AC, ⊗  | VKMW 6PK915  |   |   | 1   |   |   |   |   |   |
|  | B(Alt) ZH16 Zetec   | 09/92 → 06/93   | AC, ⊗  | VKMW 6PK1810<br>VKM 34056<br>VKM 34061   | 1   |   | 1   |   |   |   |   |   |
|  | B(Alt) ZH16 Zetec   | 08/93 → 01/95   | AC, ⊗  | VKMW 6PK1920<br>VKM 34056<br>VKM 34061   | 1   |   | 1   |   |   |   |   |   |
|  |   |   |  |  |   | 1   |   |   |   |   |   |   |
| <b>FORD  ESCORT VI 1.8 16V</b>  |   |   |  |  |   |   |   |   |   |   |   |   |
|                                 | ZH18 Zetec  | 09/92 → 01/95   |       | VKMC 04212<br>VKMA 04212<br>VKM 14210<br>VKM 24210<br>VKM 24211                      | 1<br>1<br>1<br>1  | 2<br>2<br>1   | 1<br>1  | 1   |   |   | 5<br>5  | T0104   |
|                                 | ZH18 Zetec  | 09/92 → 01/95   |  | VKPC 84406   |   |   |   | 1   |   |   |   |   |
|                                 | B(Alt) ZH18 Zetec   | 09/92 → 01/95   | AC, ⊗  | VKMW 6PK915  |   |   | 1   |   |   |   |   |   |
|  | B(Alt) ZH18 Zetec   | 09/92 → 06/93   | AC, ⊗  | VKMW 6PK1810<br>VKM 34056<br>VKM 34061   | 1   |   | 1   |   |   |   |   |   |
|  | B(Alt) ZH18 Zetec   | 08/93 → 01/95   | AC, ⊗  | VKMW 6PK1920<br>VKM 34056<br>VKM 34061   | 1   |   | 1   |   |   |   |   |   |
|  |   |   |  |  |   | 1   |   |   |   |   |   |   |
| <b>FORD  ESCORT VI 2.0</b>      |   |   |  |  |   |   |   |   |   |   |   |   |
|                                 | DH20  | 09/92 → 01/95   |  |    |   |   |   |   |   |   |   |   |
|                                | DH20  | 09/92 → 01/95   |  | VKPC 84412   |   |   |   | 1   |   |   |   |   |
|                               | B(Alt) DH20   | 05/93 → 01/95   | AC   | VKMW 6PK1650<br>VKM 34061  |   |   | 1   |   |   |   |   |   |
|  |   |   |  |  |   |   | 1   |   |   |   |   |   |
| <b>FORD  ESCORT VI 1.8 D</b>  |   |   |  |  |   |   |   |   |   |   |   |   |
|                               | D18   | 09/92 → 01/95   |  4) | —<br>VKMA 04103<br>VKM 14100<br>VKM 14103<br>VKM 24100                               | 2<br>2<br>1<br>1  | 1<br>1  | 2<br>2  | 1   |   |   | 4<br>4<br>1<br>1  | T0081   |
|  | D18   | 09/92 → 01/95   | 3), 4)   | VKMS 04103<br>VKMA 04103<br>VKM 14100<br>VKM 14103<br>VKM 24100                      | 2<br>2<br>1<br>1  | 1<br>1  | 2<br>2  |   |   | 3   | 9<br>4<br>1<br>1  | T0081   |
|                               | D18   | 09/92 → 01/95   |  | VKPC 84620   |   |   |   | 1   |   |   |   |   |
|                               | B(Alt) D18  | 09/92 → 07/93   | AC, ⊗  | VKMW 3PK675  |   |   | 1   |   |   |   |   |   |
|  | B(Alt) D18  | 07/93 → 01/95   | AC, ⊗  | VKMW 5PK705  |   |   | 1   |   |   |   |   |   |
|  | B(Alt) D18  | 06/93 → 01/95   | AC, ⊗  | VKMW 5PK1025   |   |   | 1   |   |   |   |   |   |
|  | B(PS) D18   | 09/92 → 01/95   | AC   | VKMW 4PK654<br>VKM 34004   | 1   |   | 1   |   |   |   |   |   |
|  |   |   |  |  |   |   | 1   |   |   |   |   |   |
| <b>FORD  ESCORT VI 1.8 TD</b> |   |   |  |  |   |   |   |   |   |   |   |   |
|                               | D18T, D18TI   | 02/93 → 01/95   | 3), 4)   | VKMS 04103<br>VKMA 04103<br>VKM 14100<br>VKM 14103<br>VKM 24100                      | 2<br>2<br>1<br>1  | 1<br>1  | 2<br>2  |   |   | 3   | 9<br>4<br>1<br>1  | T0081   |
|                               | D18T  | 02/93 → 01/95   |  | VKPC 84410   |   |   |   | 1   |   |   |   |   |
|  | D18TI   | 02/93 → 01/95   |  | VKPC 84409   |   |   |   | 1   |   |   |   |   |
|                               | B(Alt) D18TI  | 02/93 → 01/95   | AC, ⊗  | VKMW 5PK705  |   |   | 1   |   |   |   |   |   |
|  | B(Alt) D18TI  | 06/93 → 01/95   | AC, ⊗  | VKMW 5PK1025   |   |   | 1   |   |   |   |   |   |
|  | B(PS) D18TI   | 02/93 → 01/95   | AC   | VKMW 4PK654<br>VKM 34004   | 1   |   | 1   |   |   |   |   |   |
|  |   |   |  |  |   |   | 1   |   |   |   |   |   |
| <b>FORD  ESCORT VII 1.3</b>   |   |   |  |  |   |   |   |   |   |   |   |   |
|                               | BL13 (OHV/HCS)  | 01/95 → 02/99   |  |  |   |   |   |   |   |   |   |   |
|                               | BL13 (OHV/HCS)  | 01/95 → 02/99   |  | VKPC 84210   |   |   |   | 1   |   |   |   |   |
|                               | B(Alt) BL13 (OHV/HCS)   | 01/95 → 02/99   |  | VKMW 10AVx800  |   |   | 1   |   |   |   |   |   |



FORD

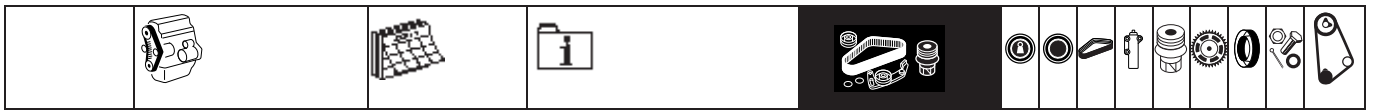

**FORD** **ESCORT VII 1.4**

|  |                        |               |             |            |   |  |   |  |  |  |   |  |  |  |  |  |  |  |       |
|--|------------------------|---------------|-------------|------------|---|--|---|--|--|--|---|--|--|--|--|--|--|--|-------|
|  | HL14 CVH               | 01/95 → 02/99 |             | VKMA 04202 | 1 |  | 1 |  |  |  |   |  |  |  |  |  |  |  | T0070 |
|  |                        |               |             | VKM 14201  | 1 |  |   |  |  |  |   |  |  |  |  |  |  |  |       |
|  | HL14 CVH               | 01/95 → 02/99 |             | VKPC 84208 |   |  |   |  |  |  | 1 |  |  |  |  |  |  |  |       |
|  | <b>B(Alt)</b> HL14 CVH | 01/95 → 02/99 | <b>AC</b> , | VKM 34013  |   |  | 1 |  |  |  |   |  |  |  |  |  |  |  |       |

**FORD** **ESCORT VII 1.6 16V**

|  |                          |               |                         |              |   |   |   |  |   |  |   |  |  |   |  |  |  |  |       |
|--|--------------------------|---------------|-------------------------|--------------|---|---|---|--|---|--|---|--|--|---|--|--|--|--|-------|
|  | ZH16 Zetec               | 01/95 → 09/99 |                         | VKMC 04212   | 1 | 2 | 1 |  | 1 |  |   |  |  | 5 |  |  |  |  |       |
|  |                          |               |                         | VKMA 04212   | 1 | 2 | 1 |  |   |  |   |  |  | 5 |  |  |  |  | T0104 |
|  |                          |               |                         | VKM 14210    | 1 |   |   |  |   |  |   |  |  |   |  |  |  |  |       |
|  |                          |               |                         | VKM 24210    |   |   | 1 |  |   |  |   |  |  |   |  |  |  |  |       |
|  |                          |               |                         | VKM 24211    |   |   | 1 |  |   |  |   |  |  |   |  |  |  |  |       |
|  | ZH16 Zetec               | 10/98 → 07/00 |                         | VKMA 04212   | 1 | 2 | 1 |  |   |  |   |  |  | 5 |  |  |  |  | T0104 |
|  |                          |               |                         | VKM 14210    | 1 |   |   |  |   |  |   |  |  |   |  |  |  |  |       |
|  |                          |               |                         | VKM 24210    |   |   | 1 |  |   |  |   |  |  |   |  |  |  |  |       |
|  |                          |               |                         | VKM 24211    |   |   | 1 |  |   |  |   |  |  |   |  |  |  |  |       |
|  | ZH16 Zetec               | 01/95 → 04/98 |                         | VKPC 84406   |   |   |   |  |   |  | 1 |  |  |   |  |  |  |  |       |
|  | ZH16 Zetec               | 05/98 → 07/00 |                         | VKPC 84415   |   |   |   |  |   |  | 1 |  |  |   |  |  |  |  |       |
|  | <b>B(Alt)</b> ZH16 Zetec | 01/95 → 09/99 | <b>AC</b> ,             | VKMV 6PK915  |   |   |   |  | 1 |  |   |  |  |   |  |  |  |  |       |
|  | <b>B(Alt)</b> ZH16 Zetec | 01/95 → 07/00 | <b>AC</b> , , Man. GBX  | VKMV 6PK1674 |   |   |   |  | 1 |  |   |  |  |   |  |  |  |  |       |
|  |                          |               |                         | VKM 34034    |   |   |   |  | 1 |  |   |  |  |   |  |  |  |  |       |
|  |                          |               |                         | VKM 34056    | 1 |   |   |  |   |  |   |  |  |   |  |  |  |  |       |
|  | <b>B(Alt)</b> ZH16 Zetec | 01/95 → 07/00 | <b>AC</b> , , Auto. GBX | VKMV 6PK1650 |   |   |   |  | 1 |  |   |  |  |   |  |  |  |  |       |
|  |                          |               |                         | VKM 34034    |   |   |   |  | 1 |  |   |  |  |   |  |  |  |  |       |
|  |                          |               |                         | VKM 34056    | 1 |   |   |  |   |  |   |  |  |   |  |  |  |  |       |
|  | <b>B(Alt)</b> ZH16 Zetec | 01/95 → 07/00 | <b>AC</b> ,             | VKMV 6PK1920 |   |   |   |  | 1 |  |   |  |  |   |  |  |  |  |       |
|  |                          |               |                         | VKM 34034    |   |   |   |  | 1 |  |   |  |  |   |  |  |  |  |       |
|  |                          |               |                         | VKM 34056    | 1 |   |   |  |   |  |   |  |  |   |  |  |  |  |       |

**FORD** **ESCORT VII 1.8 16V**

|  |                          |               |                         |              |   |   |   |  |   |  |   |  |  |   |  |  |  |  |       |
|--|--------------------------|---------------|-------------------------|--------------|---|---|---|--|---|--|---|--|--|---|--|--|--|--|-------|
|  | ZH18 Zetec               | 01/95 → 08/00 |                         | VKMC 04212   | 1 | 2 | 1 |  | 1 |  |   |  |  | 5 |  |  |  |  |       |
|  |                          |               |                         | VKMA 04212   | 1 | 2 | 1 |  |   |  |   |  |  | 5 |  |  |  |  | T0104 |
|  |                          |               |                         | VKM 14210    | 1 |   |   |  |   |  |   |  |  |   |  |  |  |  |       |
|  |                          |               |                         | VKM 24210    |   |   | 1 |  |   |  |   |  |  |   |  |  |  |  |       |
|  |                          |               |                         | VKM 24211    |   |   | 1 |  |   |  |   |  |  |   |  |  |  |  |       |
|  | ZH18 Zetec               | 01/95 → 04/98 |                         | VKPC 84406   |   |   |   |  |   |  | 1 |  |  |   |  |  |  |  |       |
|  | ZH18 Zetec               | 05/98 → 08/00 |                         | VKPC 84415   |   |   |   |  |   |  | 1 |  |  |   |  |  |  |  |       |
|  | <b>B(Alt)</b> ZH18 Zetec | 01/95 → 08/00 | <b>AC</b> ,             | VKMV 6PK915  |   |   |   |  | 1 |  |   |  |  |   |  |  |  |  |       |
|  | <b>B(Alt)</b> ZH18 Zetec | 01/95 → 08/00 | <b>AC</b> , , Man. GBX  | VKMV 6PK1674 |   |   |   |  | 1 |  |   |  |  |   |  |  |  |  |       |
|  |                          |               |                         | VKM 34034    |   |   |   |  | 1 |  |   |  |  |   |  |  |  |  |       |
|  |                          |               |                         | VKM 34056    | 1 |   |   |  |   |  |   |  |  |   |  |  |  |  |       |
|  | <b>B(Alt)</b> ZH18 Zetec | 01/95 → 08/00 | <b>AC</b> , , Auto. GBX | VKMV 6PK1650 |   |   |   |  | 1 |  |   |  |  |   |  |  |  |  |       |
|  |                          |               |                         | VKM 34034    |   |   |   |  | 1 |  |   |  |  |   |  |  |  |  |       |
|  |                          |               |                         | VKM 34056    | 1 |   |   |  |   |  |   |  |  |   |  |  |  |  |       |
|  | <b>B(Alt)</b> ZH18 Zetec | 01/95 → 08/00 | <b>AC</b> ,             | VKMV 6PK1920 |   |   |   |  | 1 |  |   |  |  |   |  |  |  |  |       |
|  |                          |               |                         | VKM 34034    |   |   |   |  | 1 |  |   |  |  |   |  |  |  |  |       |
|  |                          |               |                         | VKM 34056    | 1 |   |   |  |   |  |   |  |  |   |  |  |  |  |       |

**FORD** **ESCORT VII 2.0**

|  |                    |               |           |                       |  |  |  |  |   |  |   |  |  |  |  |  |  |  |  |
|--|--------------------|---------------|-----------|-----------------------|--|--|--|--|---|--|---|--|--|--|--|--|--|--|--|
|  | DH20               | 02/95 → 10/98 |           | <del>VKMA 04103</del> |  |  |  |  |   |  |   |  |  |  |  |  |  |  |  |
|  | DH20               | 02/95 → 10/98 |           | VKPC 84412            |  |  |  |  |   |  | 1 |  |  |  |  |  |  |  |  |
|  | <b>B(Alt)</b> DH20 | 02/95 → 10/98 | <b>AC</b> | VKMV 6PK1650          |  |  |  |  | 1 |  |   |  |  |  |  |  |  |  |  |
|  |                    |               |           | VKM 34061             |  |  |  |  | 1 |  |   |  |  |  |  |  |  |  |  |

















































**FORD** **ESCORT VII 1.8 D**

|  |     |               |      |            |   |   |   |  |   |  |  |  |  |   |  |  |  |  |       |
|--|-----|---------------|------|------------|---|---|---|--|---|--|--|--|--|---|--|--|--|--|-------|
|  | D18 | 01/95 → 10/95 | , 4) | —          | 2 | 1 | 2 |  | 1 |  |  |  |  | 4 |  |  |  |  |       |
|  |     |               |      | VKMA 04103 | 2 | 1 | 2 |  |   |  |  |  |  | 4 |  |  |  |  | T0081 |
|  |     |               |      | VKM 14100  | 1 |   |   |  |   |  |  |  |  | 1 |  |  |  |  |       |
|  |     |               |      | VKM 14103  | 1 |   |   |  |   |  |  |  |  | 1 |  |  |  |  |       |
|  |     |               |      | VKM 24100  |   |   | 1 |  |   |  |  |  |  | 1 |  |  |  |  |       |
|  | D18 | 11/95 → 01/97 | , 4) | —          | 2 | 1 | 2 |  | 1 |  |  |  |  | 4 |  |  |  |  |       |
|  |     |               |      | VKMA 04106 | 2 | 1 | 2 |  |   |  |  |  |  | 4 |  |  |  |  | T0081 |
|  |     |               |      | VKM 14103  | 1 |   |   |  |   |  |  |  |  | 1 |  |  |  |  |       |
|  |     |               |      | VKM 14105  | 1 |   |   |  |   |  |  |  |  | 1 |  |  |  |  |       |
|  |     |               |      | VKM 24100  |   |   | 1 |  |   |  |  |  |  | 1 |  |  |  |  |       |
|  | D18 | 02/97 → 02/99 | , 4) | —          | 2 | 1 | 2 |  | 1 |  |  |  |  | 4 |  |  |  |  |       |
|  |     |               |      | VKMA 04107 | 2 | 1 | 2 |  |   |  |  |  |  | 4 |  |  |  |  | T0081 |
|  |     |               |      | VKM 14103  | 1 |   |   |  |   |  |  |  |  | 1 |  |  |  |  |       |



|                                |                |               |        | VKM 14107    | 1 |   |   |  |  |   |  |   |   |  | 1     |
|--------------------------------|----------------|---------------|--------|--------------|---|---|---|--|--|---|--|---|---|--|-------|
|                                |                |               |        | VKM 24107    |   | 1 |   |  |  |   |  |   |   |  |       |
|                                | D18            | 01/95 → 10/95 | 3), 4) | VKMS 04103   | 2 | 1 | 2 |  |  |   |  | 3 | 9 |  | T0081 |
|                                |                |               |        | VKMA 04103   | 2 | 1 | 2 |  |  |   |  |   | 4 |  |       |
|                                |                |               |        | VKM 14100    | 1 |   |   |  |  |   |  |   | 1 |  |       |
|                                |                |               |        | VKM 14103    | 1 |   |   |  |  |   |  |   | 1 |  |       |
|                                |                |               |        | VKM 24100    |   | 1 |   |  |  |   |  |   | 1 |  |       |
|                                | D18            | 11/95 → 01/97 | 3), 4) | VKMS 04106   | 2 | 1 | 2 |  |  |   |  | 3 | 9 |  | T0081 |
|                                |                |               |        | VKMA 04106   | 2 | 1 | 2 |  |  |   |  |   | 4 |  |       |
|                                |                |               |        | VKM 14103    | 1 |   |   |  |  |   |  |   | 1 |  |       |
|                                |                |               |        | VKM 14105    | 1 |   |   |  |  |   |  |   | 1 |  |       |
|                                |                |               |        | VKM 24100    |   | 1 |   |  |  |   |  |   | 1 |  |       |
|                                | D18            | 01/95 → 02/99 |        | VKPC 84620   |   |   |   |  |  | 1 |  |   |   |  |       |
|                                | B(Alt) D18     | 01/95 → 02/99 | AC, ⊕  | VKMV 5PK705  |   |   | 1 |  |  |   |  |   |   |  |       |
| <b>FORD  ESCORT VII 1.8 TD</b> |                |               |        |              |   |   |   |  |  |   |  |   |   |  |       |
|                                | D18TI          | 10/98 → 07/00 | 19)    | —            | 2 | 1 | 2 |  |  | 1 |  |   | 4 |  | T0081 |
|                                |                |               |        | VKMA 04107   | 2 | 1 | 2 |  |  |   |  |   | 4 |  |       |
|                                |                |               |        | VKM 14103    | 1 |   |   |  |  |   |  |   | 1 |  |       |
|                                |                |               |        | VKM 14107    | 1 |   |   |  |  |   |  |   | 1 |  |       |
|                                |                |               |        | VKM 24107    |   | 1 |   |  |  |   |  |   | 1 |  |       |
|                                | D18TI          | 01/95 → 10/95 | 3), 4) | VKMS 04103   | 2 | 1 | 2 |  |  |   |  | 3 | 9 |  | T0081 |
|                                |                |               |        | VKMA 04103   | 2 | 1 | 2 |  |  |   |  |   | 4 |  |       |
|                                |                |               |        | VKM 14100    | 1 |   |   |  |  |   |  |   | 1 |  |       |
|                                |                |               |        | VKM 14103    | 1 |   |   |  |  |   |  |   | 1 |  |       |
|                                |                |               |        | VKM 24100    |   | 1 |   |  |  |   |  |   | 1 |  |       |
|                                | D18TI          | 11/95 → 01/97 | 3), 4) | VKMS 04106   | 2 | 1 | 2 |  |  |   |  | 3 | 9 |  | T0081 |
|                                |                |               |        | VKMA 04106   | 2 | 1 | 2 |  |  |   |  |   | 4 |  |       |
|                                |                |               |        | VKM 14103    | 1 |   |   |  |  |   |  |   | 1 |  |       |
|                                |                |               |        | VKM 14105    | 1 |   |   |  |  |   |  |   | 1 |  |       |
|                                |                |               |        | VKM 24100    |   | 1 |   |  |  |   |  |   | 1 |  |       |
|                                | D18TI          | 02/97 → 07/00 | 4)     | VKMA 04107   | 2 | 1 | 2 |  |  |   |  |   | 4 |  | T0081 |
|                                |                |               |        | VKM 14103    | 1 |   |   |  |  |   |  |   | 1 |  |       |
|                                |                |               |        | VKM 14107    | 1 |   |   |  |  |   |  |   | 1 |  |       |
|                                |                |               |        | VKM 24107    |   | 1 |   |  |  |   |  |   | 1 |  |       |
|                                | D18TI          | 01/95 → 07/00 |        | VKPC 84409   |   |   |   |  |  | 1 |  |   |   |  |       |
|                                | B(Alt) D18TI   | 01/95 → 07/00 | AC, ⊕  | VKMV 5PK705  |   |   | 1 |  |  |   |  |   |   |  |       |
|                                | B(Alt) D18TI   | 01/95 → 07/00 | AC, ⊕  | VKMV 5PK1144 |   |   | 1 |  |  |   |  |   |   |  |       |
|                                |                |               |        | VKM 34005    | 1 |   |   |  |  |   |  |   |   |  |       |
|                                | B(PS) D18TI    | 01/95 → 07/00 |        | VKMV 4PK654  |   |   | 1 |  |  |   |  |   |   |  |       |
|                                |                |               |        | VKM 34004    | 1 |   |   |  |  |   |  |   |   |  |       |
| <b>FORD  FIESTA I 0.9</b>      |                |               |        |              |   |   |   |  |  |   |  |   |   |  |       |
|                                | BL10 (OHV/HCS) | 05/76 → 08/83 |        |              |   |   |   |  |  |   |  |   |   |  |       |
|                                | BL10 (OHV/HCS) | 05/76 → 08/83 |        | VKPC 84205   |   |   |   |  |  | 1 |  |   |   |  |       |
| <b>FORD  FIESTA I 1.1</b>      |                |               |        |              |   |   |   |  |  |   |  |   |   |  |       |
|                                | HL11 CVH       | 05/76 → 08/83 |        | VKMA 04200   | 1 |   | 1 |  |  |   |  |   |   |  | T0070 |
|                                |                |               |        | VKM 14200    | 1 |   |   |  |  |   |  |   |   |  |       |
|                                | HL11 CVH       | 05/76 → 08/83 |        | VKPC 84205   |   |   |   |  |  | 1 |  |   |   |  |       |
| <b>FORD  FIESTA I 1.3</b>      |                |               |        |              |   |   |   |  |  |   |  |   |   |  |       |
|                                | HL13 CVH       | 08/77 → 08/83 |        | VKMA 04200   | 1 |   | 1 |  |  |   |  |   |   |  | T0070 |
|                                |                |               |        | VKM 14200    | 1 |   |   |  |  |   |  |   |   |  |       |
|                                | HL13 CVH       | 08/77 → 08/83 |        | VKPC 84205   |   |   |   |  |  | 1 |  |   |   |  |       |
| <b>FORD  FIESTA I 1.6</b>      |                |               |        |              |   |   |   |  |  |   |  |   |   |  |       |
|                                | HL16 CVH       | 08/81 → 05/83 |        | VKMA _____   | 1 |   | 1 |  |  |   |  |   |   |  | T0070 |
|                                |                |               |        | VKM 14200    | 1 |   |   |  |  |   |  |   |   |  |       |
|                                | HL16 CVH       | 06/83 → 08/83 |        | VKMA 04201   | 1 |   | 1 |  |  |   |  |   |   |  | T0070 |
|                                |                |               |        | VKM 14201    | 1 |   |   |  |  |   |  |   |   |  |       |
|                                | HL16 CVH       | 08/81 → 08/83 |        | VKPC 84205   |   |   |   |  |  | 1 |  |   |   |  |       |
| <b>FORD  FIESTA II 1.0</b>     |                |               |        |              |   |   |   |  |  |   |  |   |   |  |       |
|                                | BL10 (OHV/HCS) | 09/83 → 11/89 |        |              |   |   |   |  |  |   |  |   |   |  |       |
|                                | BL10 (OHV/HCS) | 09/83 → 11/89 |        | VKPC 84205   |   |   |   |  |  | 1 |  |   |   |  |       |
| <b>FORD  FIESTA II 1.1</b>     |                |               |        |              |   |   |   |  |  |   |  |   |   |  |       |
|                                | HL11 CVH       | 09/83 → 12/87 |        | VKMA 04200   | 1 |   | 1 |  |  |   |  |   |   |  | T0070 |
|                                |                |               |        | VKM 14200    | 1 |   |   |  |  |   |  |   |   |  |       |
|                                | HL11 CVH       | 09/83 → 02/89 |        | VKPC 84205   |   |   |   |  |  | 1 |  |   |   |  |       |







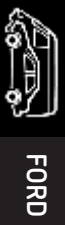



























































|  |  |  |                                     |  |  |  |  |  |  |  |  |  |
|--|---|---|--|--|---|---|---|---|---|---|---|---|
| <b>FORD  FIESTA II 1.3</b>        |   |   |  |  |   |   |   |   |   |   |   |   |
|                                    | HL13 CVH  | 09/83 → 01/86   |  | VKMA 04200<br>VKM 14200  | 1<br>1  | 1   |   |   |   |   |   | T0070   |
|                                    | HL13 CVH<br>HL13 CVH  | 09/83 → 01/86<br>02/86 → 01/87  |  | VKPC 84207<br>VKPC 84208   |   |   | 1<br>1  |   |   |   |   |   |
| <b>FORD  FIESTA II 1.4</b>        |   |   |  |  |   |   |   |   |   |   |   |   |
|                                    | HL14 CVH  | 09/83 → 12/85   |  | VKMA<br>VKM 14200  | 1<br>1  | 1   |   |   |   |   |   | T0070   |
|  | HL14 CVH  | 01/86 → 11/89   |  | VKMA 04201<br>VKM 14201  | 1<br>1  | 1   |   |   |   |   |   | T0070   |
|                                    | HL14 CVH<br>HL14 CVH  | 10/85 → 01/86<br>02/86 → 11/89  |  | VKPC 84207<br>VKPC 84208   |   |   | 1<br>1  |   |   |   |   |   |
| <b>FORD  FIESTA II 1.6</b>        |   |   |  |  |   |   |   |   |   |   |   |   |
|                                    | HL16 CVH  | 03/84 → 02/89   |  | VKMA 04201<br>VKM 14201  | 1<br>1  | 1   |   |   |   |   |   | T0070   |
|                                    | HL16 CVH<br>HL16 CVH  | 03/84 → 01/86<br>02/86 → 02/89  |  | VKPC 84207<br>VKPC 84208   |   |   | 1<br>1  |   |   |   |   |   |
| <b>FORD  FIESTA II 1.6 D</b>      |   |   |  |  |   |   |   |   |   |   |   |   |
|                                    | D16   | 04/84 → 02/89   |  | VKMA 04101<br>VKM 14101  | 1<br>1  | 1   |   |   |   |   | 1<br>1  | T0022   |
|                                    | D16   | 04/84 → 02/89   |  | VKPC 84403   |   |   | 1   |   |   |   |   |   |
| <b>FORD  FIESTA III 1.0</b>       |   |   |  |  |   |   |   |   |   |   |   |   |
|                                    | BL10 (OHV/HCS)  | 03/89 → 12/95   |  | OKOKOKO  |   |   |   |   |   |   |   |   |
|                                    | BL10 (OHV/HCS)<br>BL10 (OHV/HCS)  | 03/89 → 05/91<br>06/91 → 12/95  |  | VKPC 84209<br>VKPC 84210   |   |   | 1<br>1  |   |   |   |   |   |
|                                   | <b>B(Alt)</b> BL10 (OHV/HCS)  | 06/92 → 12/95   |  | VKVMV 10AVx800   |   | 1   |   |   |   |   |   |   |
| <b>FORD  FIESTA III 1.1</b>     |   |   |  |  |   |   |   |   |   |   |   |   |
|                                  | BL11 (OHV/HCS)  | 03/89 → 12/95   |  | OKOKOKO  |   |   |   |   |   |   |   |   |
|                                  | BL11 (OHV/HCS)<br>BL11 (OHV/HCS)  | 03/89 → 05/91<br>06/91 → 12/95  |  | VKPC 84209<br>VKPC 84210   |   |   | 1<br>1  |   |   |   |   |   |
|                                  | <b>B(Alt)</b> BL11 (OHV/HCS)  | 06/92 → 12/95   |  | VKVMV 10AVx800   |   | 1   |   |   |   |   |   |   |
| <b>FORD  FIESTA III 1.3</b>     |   |   |  |  |   |   |   |   |   |   |   |   |
|                                  | BL13 (OHV/HCS)  | 03/89 → 12/95   |  | OKOKOKO  |   |   |   |   |   |   |   |   |
|                                  | BL13 (OHV/HCS)<br>BL13 (OHV/HCS)  | 03/89 → 01/91<br>02/91 → 12/95  |  | VKPC 84209<br>VKPC 84210   |   |   | 1<br>1  |   |   |   |   |   |
|                                  | <b>B(Alt)</b> BL13 (OHV/HCS)  | 06/92 → 12/95   |  | VKVMV 10AVx800   |   | 1   |   |   |   |   |   |   |
|  | <b>B(PS)</b> BL13 (OHV/HCS)   | 01/94 → 12/95   |                                   | VKVMV 4PK860<br>VKM 34061  |   | 1   | 1   |   |   |   |   |   |
|  | <b>B(AC)</b> BL13 (OHV/HCS)   | 01/94 → 12/95   |  | VKVMV 4PK825<br>VKM 34061  |   | 1   | 1   |   |   |   |   |   |
| <b>FORD  FIESTA III 1.4</b>     |   |   |  |  |   |   |   |   |   |   |   |   |
|                                  | HL14 CVH  | 03/89 → 04/92   | <b>B(58097x19.75 HSN),</b><br> 97 | VKMA 04201<br>VKM 14201  | 1<br>1  | 1   |   |   |   |   |   | T0070   |
|  | HL14 CVH  | 05/92 → 12/95   | <b>B(58097x21.6 HSN),</b><br> 97  | VKMA 04202<br>VKM 14201  | 1<br>1  | 1   |   |   |   |   |   | T0070   |
|                                  | HL14 CVH  | 03/89 → 12/95   |  | VKPC 84208   |   |   | 1   |   |   |   |   |   |
| <b>FORD  FIESTA III 1.6</b>     |   |   |  |  |   |   |   |   |   |   |   |   |
|                                  | HL16 CVH  | 01/89 → 04/92   | <b>B(58097x19.75 HSN),</b><br> 97 | VKMA 04201<br>VKM 14201  | 1<br>1  | 1   |   |   |   |   |   | T0070   |
|  | HL16 CVH  | 05/92 → 01/94   | <b>B(58097x21.6 HSN),</b><br> 97  | VKMA 04202<br>VKM 14201  | 1<br>1  | 1   |   |   |   |   |   | T0070   |
|                                  | HL16 CVH  | 01/89 → 01/94   |  | VKPC 84208   |   |   | 1   |   |   |   |   |   |
| <b>FORD  FIESTA III 1.6 16V</b> |   |   |  |  |   |   |   |   |   |   |   |   |
|                                  | ZH16 Zetec  | 01/94 → 12/95   |                                   | VKMC 04212<br>VKMA 04212<br>VKM 14210<br>VKM 24210<br>VKM 24211                    | 1<br>1<br>1<br>1<br>1   | 2<br>2<br>1<br>1  | 1<br>1  | 1   |   |   | 5<br>5  | T0104   |
|                                  | ZH16 Zetec  | 01/94 → 12/95   |  | VKPC 84406   |   |   | 1   |   |   |   |   |   |

|                                   | B(Alt) | ZH16 Zetec | 01/94 → 12/95 | AC, Ø                     | VKMV 6PK915   |                       |        | 1      |   |   |   |                                |
|-----------------------------------|--------|------------|---------------|---------------------------|---|-----------------------|--------|--------|---|---|---|--------------------------------|
| <b>FORD  FIESTA III 1.6 Turbo</b> |        |            |               |                           |   |                       |        |        |   |   |   |                                |
|                                   |        | HL16T CVH  | 03/90 → 04/92 | B(58097x19.75 HSN),<br>97 | VKMA 04201<br>VKM 14201   | 1<br>1                |        | 1      |   |   |   | T0070                          |
|                                   |        | HL16T CVH  | 05/92 → 10/92 | B(58097x21.6 HSN),<br>97  | VKMA 04202<br>VKM 14201   | 1<br>1                |        | 1      |   |   |   | T0070                          |
|                                   |        | HL16T CVH  | 03/90 → 10/92 |                           | VKPC 84208  |                       |        |        | 1 |   |   |                                |
| <b>FORD  FIESTA III 1.8 16V</b>   |        |            |               |                           |   |                       |        |        |   |   |   |                                |
|                                   |        | ZH18 Zetec | 02/92 → 12/95 |                           | VKMC 04212<br>VKMA 04212<br>VKM 14210<br>VKM 24210<br>VKM 24211 | 1<br>1<br>1<br>1<br>1 | 2<br>2 | 1<br>1 |   | 1 |   | 5<br>5<br>T0104                |
|                                   |        | ZH18 Zetec | 02/92 → 12/95 |                           | VKPC 84406  |                       |        |        | 1 |   |   |                                |
|                                   | B(Alt) | ZH18 Zetec | 02/92 → 12/95 | AC, Ø                     | VKMV 6PK915   |                       |        | 1      |   |   |   |                                |
| <b>FORD  FIESTA III 1.8 D</b>     |        |            |               |                           |   |                       |        |        |   |   |   |                                |
|                                   |        | D18        | 03/89 → 10/95 | 4)                        | —<br>VKMA 04103<br>VKM 14100<br>VKM 14103<br>VKM 24100          | 2<br>2<br>1<br>1      | 1<br>1 | 2<br>2 |   | 1 |   | 4<br>4<br>1<br>1<br>1<br>T0081 |
|                                   |        | D18        | 11/95 → 12/95 | 4)                        | —<br>VKMA 04106<br>VKM 14103<br>VKM 14105<br>VKM 24100          | 2<br>2<br>1<br>1      | 1<br>1 | 2<br>2 |   | 1 |   | 4<br>4<br>1<br>1<br>1<br>T0081 |
|                                   |        | D18        | 03/89 → 10/95 | 3), 4)                    | VKMS 04103<br>VKMA 04103<br>VKM 14100<br>VKM 14103<br>VKM 24100 | 2<br>2<br>1<br>1      | 1<br>1 | 2<br>2 |   |   | 3 | 9<br>4<br>1<br>1<br>1<br>T0081 |
|                                   |        | D18        | 11/95 → 12/95 | 3), 4)                    | VKMS 04106<br>VKMA 04106<br>VKM 14103<br>VKM 14105<br>VKM 24100 | 2<br>2<br>1<br>1      | 1<br>1 | 2<br>2 |   |   | 3 | 9<br>4<br>1<br>1<br>1<br>T0081 |
|                                   |        | D18        | 03/89 → 12/95 |                           | VKPC 84620  |                       |        |        | 1 |   |   |                                |
|                                   | B(Alt) | D18        | 08/91 → 12/95 | Ø                         | VKMV 3PK675   |                       |        | 1      |   |   |   |                                |
|                                   | B(PS)  | D18        | 01/94 → 12/95 | Ø                         | VKMV 4PK654<br>VKM 34004  | 1                     |        | 1      |   |   |   |                                |
| <b>FORD  FIESTA III 1.8 TD</b>    |        |            |               |                           |   |                       |        |        |   |   |   |                                |
|                                   |        | D18T       | 03/93 → 10/95 | 3), 4)                    | VKMS 04103<br>VKMA 04103<br>VKM 14100<br>VKM 14103<br>VKM 24100 | 2<br>2<br>1<br>1      | 1<br>1 | 2<br>2 |   |   | 3 | 9<br>4<br>1<br>1<br>1<br>T0081 |
|                                   |        | D18T       | 11/95 → 12/95 | 3), 4)                    | VKMS 04106<br>VKMA 04106<br>VKM 14103<br>VKM 14105<br>VKM 24100 | 2<br>2<br>1<br>1      | 1<br>1 | 2<br>2 |   |   | 3 | 9<br>4<br>1<br>1<br>1<br>T0081 |
|                                   |        | D18T       | 03/93 → 12/95 |                           | VKPC 84410  |                       |        |        | 1 |   |   |                                |
|                                   | B(Alt) | D18T       | 03/93 → 12/95 | Ø                         | VKMV 3PK828<br>VKM 34002  | 1                     |        | 1      |   |   |   |                                |
|                                   | B(Alt) | D18T       | 03/93 → 12/95 | Ø                         | VKMV 3PK1023<br>VKM 34003                                       | 1                     |        | 1      |   |   |   |                                |
| <b>FORD  FIESTA IV 1.25 16V</b>   |        |            |               |                           |   |                       |        |        |   |   |   |                                |
|                                   |        | ZH12 Zetec | 08/95 → 02/97 |                           | VKMA 04220<br>VKM 14220   | 1<br>1                |        | 1      |   |   |   | T0131                          |
|                                   |        | ZH12 Zetec | 03/97 → 01/02 |                           | VKMA 04222<br>VKM 14222   | 1<br>1                |        | 1      |   |   |   | T0131                          |
|                                   |        | ZH12 Zetec | 08/95 → 01/02 |                           | VKPC 84215  |                       |        |        | 1 |   |   |                                |



FORD



























|   |  |  |       |  |  |  |  |  |  |  |  |  |
|---|---|---|--|--|---|---|---|---|---|---|---|---|
|  B(Alt)                           | ZH12 Zetec  | 08/95 → 01/02   | AC, ⊗  | VKMOV 6PK1181<br>VKM 34007<br>VKM 34034  | 1   | 1   |   |   |   |   |   |   |
| B(Alt)  | ZH12 Zetec  | 08/95 → 01/02   | AC, ⊗  | VKMOV 6PK1780<br>VKM 34007<br>VKM 34034  | 1   | 1   |   |   |   |   |   |   |
| B(Alt)  | ZH12 Zetec  | 08/95 → 12/98   | AC, ⊗  | VKMOV 6PK1750<br>VKM 34007<br>VKM 34034  | 1   | 1   |   |   |   |   |   |   |
| B(Alt)  | ZH12 Zetec  | 01/99 → 01/02   | AC, ⊗  | VKMOV 6PK1767<br>VKM 34007<br>VKM 34034  | 1   | 1   |   |   |   |   |   |   |
| B(Alt)  | ZH12 Zetec  | 08/95 → 01/02   | AC, ⊗  | VKMOV 6PK1930<br>VKM 34008<br>VKM 34034  | 1   | 1   |   |   |   |   |   |   |
| <b>FORD  FIESTA IV 1.3</b>       |   |   |  |  |   |   |   |   |   |   |   |   |
|                                   | BL13 (OHV/HCS)  | 08/95 → 01/02   |  | <del>VKMOV 6PK1181</del>   |   |   |   |   |   |   |   |   |
|                                   | BL13 (OHV/HCS)  | 08/95 → 01/02   |  | VKPC 84216   |   |   |   | 1   |   |   |   |   |
|                                   | B(Alt) BL13 (OHV/HCS)   | 08/95 → 01/02   | AC, ⊗  | VKMOV 10AVx800   |   |   | 1   |   |   |   |   |   |
| B(Alt)  | BL13 (OHV/HCS)  | 01/98 → 09/98   | AC, ⊗  | VKMOV 6PK1760<br>VKM 34033<br>VKM 34034  | 1   | 1   |   |   |   |   |   |   |
| B(Alt)  | BL13 (OHV/HCS)  | 01/98 → 01/02   | AC, ⊗  | VKMOV 6PK1936<br>VKM 34033<br>VKM 34034  | 1   | 1   |   |   |   |   |   |   |
| <b>FORD  FIESTA IV 1.4 16V</b> |   |   |  |  |   |   |   |   |   |   |   |   |
|                                 | ZH14 Zetec  | 04/96 → 02/97   |  | VKMA 04220<br>VKM 14220  | 1<br>1  | 1   |   |   |   |   |   | T0131   |
|   | ZH14 Zetec  | 03/97 → 01/02   |  | VKMA 04222<br>VKM 14222  | 1<br>1  | 1   |   |   |   |   |   | T0131   |
|                                 | ZH14 Zetec  | 04/96 → 01/02   |  | VKPC 84215   |   |   |   | 1   |   |   |   |   |
|                                 | B(Alt) ZH14 Zetec   | 04/96 → 01/02   | AC, ⊗  | VKMOV 6PK1181<br>VKM 34007<br>VKM 34034  | 1   | 1   |   |   |   |   |   |   |
| B(Alt)  | ZH14 Zetec  | 04/96 → 01/02   | AC, ⊗  | VKMOV 6PK1780<br>VKM 34007<br>VKM 34034  | 1   | 1   |   |   |   |   |   |   |
| B(Alt)  | ZH14 Zetec  | 04/96 → 12/98   | AC, ⊗  | VKMOV 6PK1750<br>VKM 34007<br>VKM 34034  | 1   | 1   |   |   |   |   |   |   |
| B(Alt)  | ZH14 Zetec  | 01/99 → 01/02   | AC, ⊗  | VKMOV 6PK1767<br>VKM 34007<br>VKM 34034  | 1   | 1   |   |   |   |   |   |   |
| B(Alt)  | ZH14 Zetec  | 04/96 → 01/02   | AC, ⊗  | VKMOV 6PK1930<br>VKM 34008<br>VKM 34034  | 1   | 1   |   |   |   |   |   |   |
| <b>FORD  FIESTA IV 1.6 16V</b> |   |   |  |  |   |   |   |   |   |   |   |   |
|                                 | ZH16 Zetec  | 02/00 → 01/02   |  | VKMA 04222<br>VKM 14222  | 1<br>1  | 1   |   |   |   |   |   | T0131   |
|                                 | ZH16 Zetec  | 02/00 → 01/02   |  | VKPC 84215   |   |   |   | 1   |   |   |   |   |
|                                 | B(Alt) ZH16 Zetec   | 02/00 → 12/00   | AC   | VKMOV 6PK1767<br>VKM 34007<br>VKM 34034  | 1   | 1   |   |   |   |   |   |   |
| B(Alt)  | ZH16 Zetec  | 02/00 → 01/02   | AC   | VKMOV 6PK1930<br>VKM 34008<br>VKM 34034  | 1   | 1   |   |   |   |   |   |   |
| <b>FORD  FIESTA IV 1.8 D</b>   |   |   |  |  |   |   |   |   |   |   |   |   |
|                                 | D18   | 08/95 → 10/95   |  4) | —<br>VKMA 04103<br>VKM 14100<br>VKM 14103<br>VKM 24100                             | 2<br>2<br>1<br>1  | 1<br>1  | 2<br>2  | 1   |   |   | 4<br>4<br>1<br>1  | T0081   |
|   | D18   | 11/95 → 01/97   |  4) | —<br>VKMA 04106  | 2<br>2  | 1<br>1  | 2<br>2  | 1   |   |   | 4<br>4  | T0081   |

|   |  |  |  |  |  |  |  |  |  |  |  |
|---|---|---|---|--|---|---|---|---|---|---|---|
|   |   |   |   | VKM 14103  | 1   |   |   |   |   |   | 1   |
|   |   |   |   | VKM 14105  | 1   |   |   |   |   |   | 1   |
|   |   |   |   | VKM 24100  |   | 1   |   |   |   |   | 1   |
|   | D18   | 02/97 → 04/00   | Ⓚ, 4)   | —  | 2   | 1   | 2   |   | 1   |   |   |
|   |   |   |   | VKMA 04107   | 2   | 1   | 2   |   |   |   | 4   |
|   |   |   |   | VKM 14103  | 1   |   |   |   |   |   | 1   |
|   |   |   |   | VKM 14107  | 1   |   |   |   |   |   | 1   |
|   |   |   |   | VKM 24107  |   | 1   |   |   |   |   |   |
|   | D18   | 08/95 → 10/95   | 3), 4)  | VKMS 04103   | 2   | 1   | 2   |   |   | 3   | 9   |
|   |   |   |   | VKMA 04103   | 2   | 1   | 2   |   |   |   | 4   |
|   |   |   |   | VKM 14100  | 1   |   |   |   |   |   | 1   |
|   |   |   |   | VKM 14103  | 1   |   |   |   |   |   | 1   |
|   |   |   |   | VKM 24100  |   | 1   |   |   |   |   | 1   |
|   | D18   | 11/95 → 01/97   | 3), 4)  | VKMS 04106   | 2   | 1   | 2   |   |   | 3   | 9   |
|   |   |   |   | VKMA 04106   | 2   | 1   | 2   |   |   |   | 4   |
|   |   |   |   | VKM 14103  | 1   |   |   |   |   |   | 1   |
|   |   |   |   | VKM 14105  | 1   |   |   |   |   |   | 1   |
|   |   |   |   | VKM 24100  |   | 1   |   |   |   |   | 1   |
|                                  | D18   | 08/95 → 04/00   |   | VKPC 84620   |   |   |   |   | 1   |   |   |
|                                  | B(Alt) D18  | 08/95 → 08/96   | ⊘   | VKMW 3PK675  |   |   | 1   |   |   |   |   |
|                                  | B(Alt) D18  | 08/96 → 04/00   | ⊘   | VKMW 5PK886  |   |   | 1   |   |   |   |   |
|                                  | B(Alt) D18  | 08/95 → 04/00   | ⊘   | VKMW 5PK1144   |   |   | 1   |   |   |   |   |
|   |   |   |   | VKM 34005  | 1   |   |   |   |   |   |   |
|                                  | B(PS) D18   | 08/95 → 04/00   | AC  | VKMW 4PK654  |   |   | 1   |   |   |   |   |
|   |   |   |   | VKM 34004  | 1   |   |   |   |   |   |   |
|                                  | B(PS) D18   | 08/95 → 04/00   | AC  | VKMW 5PK672  |   |   | 1   |   |   |   |   |
| <b>FORD  FIESTA IV 1.8 DI</b>    |   |   |   |  |   |   |   |   |   |   |   |
|                                | LD18 Lynx   | 04/00 → 01/02   | 20)   | VKMA 04108   | 1   |   | 1   |   |   |   | T0171   |
|   |   |   |   | VKM 14108  | 1   |   |   |   |   |   |   |
|                                | LD18 Lynx   | 04/00 → 01/02   |   | VKPC 84416   |   |   |   |   | 1   |   |   |
|                                | B(Alt) LD18 Lynx  | 04/00 → 01/02   | AC  | VKMW 6PK1687   |   |   | 1   |   |   |   |   |
|   |   |   |   | VKM 34034  |   | 1   |   |   |   |   |   |
|   |   |   |   | VKM 34111  |   | 1   |   |   |   |   |   |
|                                | B(Alt) LD18 Lynx  | 04/00 → 01/02   | AC  | VKMW 6PK1610   |   |   | 1   |   |   |   |   |
|   |   |   |   | VKM 34034  |   | 1   |   |   |   |   |   |
|   |   |   |   | VKM 34107  |   | 1   |   |   |   |   |   |
| <b>FORD  FIESTA V 1.25 16V</b> |   |   |   |  |   |   |   |   |   |   |   |
|                                | ZH12 Zetec  | 05/02 → 04/05   |   | VKMA 04222   | 1   |   | 1   |   |   |   | T0131   |
|   |   |   |   | VKM 14222  | 1   |   |   |   |   |   |   |
|   | ZH12 Zetec  | 04/05 → 05/07   |   | VKMA 04224   | 1   |   | 1   |   |   |   | T0131   |
|   |   |   |   | VKM 14224  | 1   |   |   |   |   |   |   |
|                                | ZH12 Zetec  | 05/02 → 04/05   |   | VKPC 84215   |   |   |   |   | 1   |   |   |
|   | ZH12 Zetec  | 04/05 → 05/07   |   | VKPC _____   |   |   |   |   | 1   |   |   |
| <b>FORD  FIESTA V 1.3</b>      |   |   |   |  |   |   |   |   |   |   |   |
|                                | Duratec   | 11/01 → 05/07   |   | ⊘  |   |   |   |   |   |   |   |
|                                | Duratec   | 11/01 → 05/07   |   | VKPC 84629   |   |   |   |   | 1   |   |   |
|                                | B(Alt) Duratec  | 11/01 → 05/07   | AC, ⊘   | VKMW 6PK1688   |   |   | 1   |   |   |   |   |
|   |   |   |   | VKM 34033  | 1   |   |   |   |   |   |   |
|   |   |   |   | VKM 34034  |   | 1   |   |   |   |   |   |
|                                | B(Alt) Duratec  | 05/02 → 10/04   | AC, ⊘   | VKMW _____   |   |   | 1   |   |   |   |   |
|   |   |   |   | VKM 34033  | 1   |   |   |   |   |   |   |
|   |   |   |   | VKM 34034  |   | 1   |   |   |   |   |   |
| <b>FORD  FIESTA V 1.4 16V</b>  |   |   |   |  |   |   |   |   |   |   |   |
|                                | ZH14 Zetec  | 11/01 → 04/05   |   | VKMA 04222   | 1   |   | 1   |   |   |   | T0131   |
|   |   |   |   | VKM 14222  | 1   |   |   |   |   |   |   |
|   | ZH14 Zetec  | 04/05 → 05/07   |   | VKMA 04224   | 1   |   | 1   |   |   |   | T0131   |
|   |   |   |   | VKM 14224  | 1   |   |   |   |   |   |   |
|                                | ZH14 Zetec  | 11/01 → 04/05   |   | VKPC 84215   |   |   |   |   | 1   |   |   |
|   | ZH14 Zetec  | 04/05 → 05/07   |   | VKPC _____   |   |   |   |   | 1   |   |   |
| <b>FORD  FIESTA V 1.6 16V</b>  |   |   |   |  |   |   |   |   |   |   |   |
|                                | ZH16 Zetec  | 11/01 → 04/05   |   | VKMA 04222   | 1   |   | 1   |   |   |   | T0131   |
|   |   |   |   | VKM 14222  | 1   |   |   |   |   |   |   |
|   | ZH16 Zetec  | 04/05 → 05/07   |   | VKMA 04224   | 1   |   | 1   |   |   |   | T0131   |
|   |   |   |   | VKM 14224  | 1   |   |   |   |   |   |   |
|                                | ZH16 Zetec  | 11/01 → 04/05   |   | VKPC 84215   |   |   |   |   | 1   |   |   |



FORD









































|                                | ZH16 Zetec               | 04/05 → 05/07 |           | VKPC_____   |                  |             |        |  | 1 |  |  |  |  |        |       |  |
|--------------------------------|--------------------------|---------------|-----------|---|------------------|-------------|--------|--|---|--|--|--|--|--------|-------|--|
| <b>FORD  FIESTA V 2.0 16V</b>  |                          |               |           |   |                  |             |        |  |   |  |  |  |  |        |       |  |
|                                | Duratec                  | 03/05 → 05/07 |           | OXOXOXO   |                  |             |        |  |   |  |  |  |  |        |       |  |
|                                | Duratec                  | 03/05 → 09/07 |           | VKPC 84622  |                  |             |        |  | 1 |  |  |  |  |        |       |  |
|                                | <b>B(Alt)</b> Duratec    | 03/05 → 11/05 | <b>AC</b> | VKM 34051   |                  | 1           |        |  |   |  |  |  |  |        |       |  |
|                                | <b>B(Alt)</b> Duratec    | 11/05 → 05/07 | <b>AC</b> | VKM_____  |                  | 1           |        |  |   |  |  |  |  |        |       |  |
| <b>FORD  FIESTA V 1.4 TDCi</b> |                          |               |           |   |                  |             |        |  |   |  |  |  |  |        |       |  |
|                                | Duratorq                 | 11/01 → 05/07 |           | VKMA 03140<br>VKM 13140<br>VKM 23140                              | 1<br>1           | 1<br>1      | 1      |  |   |  |  |  |  |        | T0195 |  |
|                                | Duratorq                 | 11/01 → 05/07 |           | VKPC 83140  |                  |             |        |  | 1 |  |  |  |  |        |       |  |
|                                | <b>B(Alt)</b> Duratorq   | 11/01 → 05/07 | <b>AC</b> | VKMA 33060<br>VKMV 6PK1341<br>VKM 33060<br>VKM 33060<br>VKM 33061 | 1<br>1<br>1<br>1 | 2<br>1<br>1 | 1<br>1 |  |   |  |  |  |  | 1<br>1 |       |  |
|                                | <b>B(Alt)</b> Duratorq   | 11/01 → 05/07 | <b>AC</b> | VKMA 33061<br>VKMV 6PK1705<br>VKM 33044<br>VKM 33061              | 1<br>1<br>1      | 1<br>1      | 1<br>1 |  |   |  |  |  |  |        | 1     |  |
| <b>FORD  FIESTA V 1.6 TDCi</b> |                          |               |           |   |                  |             |        |  |   |  |  |  |  |        |       |  |
|                                | Duratorq                 | 11/04 → 05/07 |           | VKMA 03259<br>VKM 13140<br>VKM 23140                              | 1<br>1           | 1<br>1      | 1      |  |   |  |  |  |  |        | T0195 |  |
|                                | Duratorq                 | 11/04 → 09/07 |           | VKPC 83259  |                  |             |        |  | 1 |  |  |  |  |        |       |  |
|                                | <b>B(Alt)</b> Duratorq   | 11/04 → 05/07 | <b>AC</b> | VKMA 33058<br>VKMV 6PK802<br>VKM 33043<br>VKM 33044               | 1<br>1           | 1<br>1      | 1<br>1 |  |   |  |  |  |  |        | 1     |  |
|                                | <b>B(Alt)</b> Duratorq   | 11/04 → 05/07 | <b>AC</b> | VKMA 33043<br>VKMV 6PK976<br>VKM 33043                            | 1<br>1           |             | 1<br>1 |  |   |  |  |  |  |        |       |  |
| <b>FORD  FOCUS I 1.4 16V</b>   |                          |               |           |   |                  |             |        |  |   |  |  |  |  |        |       |  |
|                                | ZH14 Zetec               | 10/98 → 11/04 |           | VKMA 04222<br>VKM 14222   | 1<br>1           |             | 1      |  |   |  |  |  |  |        | T0131 |  |
|                                | ZH14 Zetec               | 10/98 → 11/04 |           | VKPC 84215  |                  |             |        |  | 1 |  |  |  |  |        |       |  |
|                                | <b>B(Alt)</b> ZH14 Zetec | 10/98 → 08/01 | <b>AC</b> | VKM 34034   |                  | 1           |        |  |   |  |  |  |  |        |       |  |
|                                | <b>B(Alt)</b> ZH14 Zetec | 08/01 → 11/04 | <b>AC</b> | VKMV 6PK1042<br>VKM 34034   |                  | 1           | 1      |  |   |  |  |  |  |        |       |  |
|                                | <b>B(Alt)</b> ZH14 Zetec | 10/98 → 02/02 | <b>AC</b> | VKMV 6PK1893<br>VKM 34018<br>VKM 34034                            | 1                |             | 1      |  |   |  |  |  |  |        |       |  |
|                                | <b>B(Alt)</b> ZH14 Zetec | 02/02 → 11/04 | <b>AC</b> | VKMV 6PK1915<br>VKM 34018<br>VKM 34034                            | 1                | 1           | 1      |  |   |  |  |  |  |        |       |  |
| <b>FORD  FOCUS I 1.6 16V</b>   |                          |               |           |   |                  |             |        |  |   |  |  |  |  |        |       |  |
|                                | ZH16 Zetec               | 10/98 → 11/04 |           | VKMA 04222<br>VKM 14222   | 1<br>1           |             | 1      |  |   |  |  |  |  |        | T0131 |  |
|                                | ZH16 Zetec               | 10/98 → 11/04 |           | VKPC 84215  |                  |             |        |  | 1 |  |  |  |  |        |       |  |
|                                | <b>B(Alt)</b> ZH16 Zetec | 10/98 → 08/01 | <b>AC</b> | VKM 34034   |                  | 1           |        |  |   |  |  |  |  |        |       |  |
|                                | <b>B(Alt)</b> ZH16 Zetec | 08/01 → 11/04 | <b>AC</b> | VKMV 6PK1042<br>VKM 34034   |                  | 1           | 1      |  |   |  |  |  |  |        |       |  |
|                                | <b>B(Alt)</b> ZH16 Zetec | 10/98 → 02/02 | <b>AC</b> | VKMV 6PK1893<br>VKM 34018<br>VKM 34034                            | 1                |             | 1      |  |   |  |  |  |  |        |       |  |
|                                | <b>B(Alt)</b> ZH16 Zetec | 02/02 → 11/04 | <b>AC</b> | VKMV 6PK1915<br>VKM 34018<br>VKM 34034                            | 1                | 1           | 1      |  |   |  |  |  |  |        |       |  |
| <b>FORD  FOCUS I 1.8 16V</b>   |                          |               |           |   |                  |             |        |  |   |  |  |  |  |        |       |  |
|                                | ZH18 Zetec               | 10/98 → 01/99 |           | VKMA 04213<br>VKM 14211<br>VKM 24212<br>VKM 24214                 | 1<br>1           | 2<br>1<br>1 | 1      |  |   |  |  |  |  |        | T0162 |  |

|   |  |  |  |  |  |  |  |  |  |  |  |  |
|---|---|---|---|--|---|---|---|---|---|---|---|---|
|   | ZH18 Zetec  | 01/99 → 11/04   |   | VKMA 04214<br>VKM 14211<br>VKM 24213   | 1<br>1  | 1<br>1  | 1   |   |   |   |   | T0162   |
|                                        | ZH18 Zetec  | 10/98 → 11/04   |   | VKPC 84415   |   |   |   | 1   |   |   |   |   |
|                                        | B(Alt) ZH18 Zetec   | 10/98 → 06/01   | AC  | VKMV 6PK1973<br>VKM 34010<br>VKM _____   | 1   | 1   |   |   |   |   |   |   |
|   | B(Alt) ZH18 Zetec   | 06/01 → 11/04   | AC  | VKMV 6PK1973<br>VKM 34010<br>VKM _____   | 1   | 1   |   |   |   |   |   |   |
|   | B(Alt) ZH18 Zetec   | 10/98 → 06/01   | AC  | VKMV 6PK2103<br>VKM 34010<br>VKM _____   | 1   | 1   |   |   |   |   |   |   |
|   | B(Alt) ZH18 Zetec   | 06/01 → 11/04   | AC  | VKMV 6PK2103<br>VKM 34010<br>VKM _____<br>VKM _____                                | 1   | 1<br>1<br>1   |   |   |   |   |   |   |
| <b>FORD  FOCUS I 2.0 16V</b>           |   |   |   |  |   |   |   |   |   |   |   |   |
|                                        | ZH20 Zetec  | 10/98 → 01/99   |   | VKMA 04213<br>VKM 14211<br>VKM 24212<br>VKM 24214                                  | 1<br>1  | 2<br>1<br>1   | 1   |   |   |   |   | T0162   |
|   | ZH20 Zetec  | 01/99 → 11/04   |   | VKMA 04214<br>VKM 14211<br>VKM 24213   | 1<br>1  | 1<br>1  | 1   |   |   |   |   | T0162   |
|                                        | ZH20 Zetec  | 10/98 → 11/04   |   | VKPC 84415   |   |   |   | 1   |   |   |   |   |
|                                       | B(Alt) ZH20 Zetec   | 10/98 → 06/01   | AC  | VKMV 6PK1973<br>VKM 34010<br>VKM _____   | 1   | 1   |   |   |   |   |   |   |
|   | B(Alt) ZH20 Zetec   | 06/01 → 11/04   | AC  | VKMV 6PK1973<br>VKM 34010<br>VKM _____   | 1   | 1   |   |   |   |   |   |   |
|   | B(Alt) ZH20 Zetec   | 10/98 → 06/01   | AC  | VKMV 6PK2103<br>VKM 34010<br>VKM _____   | 1   | 1   |   |   |   |   |   |   |
|   | B(Alt) ZH20 Zetec   | 06/01 → 11/04   | AC  | VKMV 6PK2103<br>VKM 34010<br>VKM _____<br>VKM _____                                | 1   | 1<br>1<br>1   |   |   |   |   |   |   |
| <b>FORD  FOCUS I RS</b>              |   |   |   |  |   |   |   |   |   |   |   |   |
|                                      | ZH20 Zetec  | 10/02 → 11/04   |   | —  |   |   |   | 1   |   |   |   |   |
| <b>FORD  FOCUS I ST170</b>           |   |   |   |  |   |   |   |   |   |   |   |   |
|                                      | ZH20 Zetec  | 03/02 → 11/04   |   | —<br>VKM 24213   | 1<br>1  | 1<br>1  | 1   |   |   |   |   | 1<br>1 T0162  |
|                                      | ZH20 Zetec  | 03/02 → 11/04   |   | VKPC 84415   |   |   |   | 1   |   |   |   |   |
| <b>FORD  FOCUS I 1.8 TDCi / TDDi</b> |   |   |   |  |   |   |   |   |   |   |   |   |
|                                      | LD18 Lynx   | 10/98 → 11/04   | 20)   | VKMA 04108<br>VKM 14108  | 1<br>1  |   | 1   |   |   |   |   | T0171   |
|                                      | LD18 Lynx   | 10/98 → 11/04   |   | VKPC 84416   |   |   |   | 1   |   |   |   |   |
|                                      | B(Alt) LD18 Lynx  | 10/98 → 05/01   | AC  | VKMA 34103<br>VKMV 6PK1414<br>VKM 34107<br>VKM 34108                               | 1   | 1<br>1  | 1   |   |   |   |   |   |
|   | B(Alt) LD18 Lynx  | 05/01 → 11/04   | AC  | VKMA 34104<br>VKMV 6PK1418<br>VKM 34107<br>VKM 34108                               | 1   | 1<br>1  | 1   |   |   |   |   |   |
|   | B(Alt) LD18 Lynx  | 10/98 → 11/04   | AC  | VKMA 34107<br>VKMV 6PK1715<br>VKM 34107<br>VKM 34108                               | 1   | 1<br>1  | 1   |   |   |   |   |   |











































FORD



|  |  |  |  |  |  |  |  |  |  |  |  |  |
|--|---|---|---|--|---|---|---|---|---|---|---|---|
| <b>FORD  FOCUS II 1.4 16V</b>           |   |   |   |  |   |   |   |   |   |   |   |   |
|    | ZH14 Zetec  | 11/04 → 04/05   |   | VKMA 04222<br>VKM 14222  | 1<br>1  | 1   |   |   |   |   |   | T0131   |
|  | ZH14 Zetec  | 04/05 → 11/07   |   | VKMA 04224<br>VKM 14224  | 1<br>1  | 1   |   |   |   |   |   | T0131   |
|    | ZH14 Zetec  | 11/04 → 04/05   |   | VKPC 84215   |   |   |   | 1   |   |   |   |   |
|  | ZH14 Zetec  | 04/05 → 11/07   |   | VKPC _____   |   |   |   | 1   |   |   |   |   |
| <b>FORD  FOCUS II 1.6 16V</b>           |   |   |   |  |   |   |   |   |   |   |   |   |
|    | ZH16 Zetec  | 11/04 → 04/05   |   | VKMA 04222<br>VKM 14222  | 1<br>1  | 1   |   |   |   |   |   | T0131   |
|  | ZH16 Zetec  | 04/05 → 11/07   |   | VKMA 04224<br>VKM 14224  | 1<br>1  | 1   |   |   |   |   |   | T0131   |
|    | ZH16 Zetec  | 04/05 → 11/07   |   | VKPC _____   |   |   |   | 1   |   |   |   |   |
|  | ZH16 Zetec  | 11/04 → 04/05   |   | VKPC 84215   |   |   |   | 1   |   |   |   |   |
|  | ZH16 Zetec  | 10/06 → 11/07   |   | —  |   |   |   | 1   |   |   |   |   |
| <b>FORD  FOCUS II 1.8 16V Flexifuel</b> |   |   |   |  |   |   |   |   |   |   |   |   |
|    | Duratec   | 12/05 → 11/07   |   | <del>OKOKOK</del>  |   |   |   |   |   |   |   |   |
|    | Duratec   | 12/05 → 11/07   |   | VKPC 84622   |   |   |   | 1   |   |   |   |   |
|    | B(Alt) Duratec  | 12/05 → 11/07   |   | VKMV 6PK1306<br>VKM 34014  | 1   | 1   |   |   |   |   |   |   |
| <b>FORD  FOCUS II 2.0 16V</b>           |   |   |   |  |   |   |   |   |   |   |   |   |
|    | Duratec   | 11/04 → 11/07   |   | <del>OKOKOK</del>  |   |   |   |   |   |   |   |   |
|    | Duratec   | 11/04 → 11/07   |   | VKPC 84622   |   |   |   | 1   |   |   |   |   |
|    | B(Alt) Duratec  | 11/04 → 11/07   |   | VKMV 6PK1306<br>VKM 34014  | 1   | 1   |   |   |   |   |   |   |
| <b>FORD  FOCUS II 2.5 20V</b>         |   |   |   |  |   |   |   |   |   |   |   |   |
|                                        | Duratec   | 10/05 → 11/07   |   | VKMA 06040<br>VKM 16040<br>VKM 26602   | 1<br>1  | 1<br>1  |   |   |   |   |   | T0163   |
|                                        | Duratec   | 10/05 → 11/07   |   | —  |   |   |   | 1   |   |   |   |   |
|                                        | B(Alt) Duratec  | 10/05 → 11/07   |   | VKMV 5PK891<br>VKM 36236   | 1   | 1   |   |   |   |   |   |   |
|  | B(AC) Duratec   | 10/05 → 11/07   |   | VKMA _____<br>VKMV 5PK847<br>VKM 36238   | 1<br>1  | 1<br>1  |   |   |   |   |   |   |
| <b>FORD  FOCUS II 1.6 TDCi</b>        |   |   |   |  |   |   |   |   |   |   |   |   |
|                                        | Duratorq  | 11/04 → 11/07   |   | VKMA 03259<br>VKM 13140<br>VKM 23140   | 1<br>1  | 1<br>1  |   |   |   |   |   | T0195   |
|                                        | Duratorq  | 11/04 → 11/07   |   | VKPC 83259   |   |   |   | 1   |   |   |   |   |
|                                        | B(Alt) Duratorq   | 11/04 → 11/07   | <i>AC</i>   | VKMA 33058<br>VKMV 6PK802<br>VKM 33043<br>VKM 33044                                | 1<br>1  | 1<br>1  | 1<br>1  |   |   |   |   | 1   |
|  | B(Alt) Duratorq   | 11/04 → 11/07   | <i>AC</i>   | VKMA 33043<br>VKMV 6PK976<br>VKM 33043   | 1<br>1  | 1<br>1  |   |   |   |   |   |   |
| <b>FORD  FOCUS II 1.8 TDCi</b>        |   |   |   |  |   |   |   |   |   |   |   |   |
|                                        | LD18 Lynx   | 11/04 → 11/07   | 20)   | VKMA 04108<br>VKM 14108  | 1<br>1  | 1   |   |   |   |   |   | T0171   |
|                                        | LD18 Lynx   | 11/04 → 11/07   |   | VKPC 84416   |   |   |   | 1   |   |   |   |   |
|                                        | B(Alt) LD18 Lynx  | 11/04 → 11/07   | <i>AC</i>   | VKM 34110<br>VKM 34111   | 1   |   | 1   |   |   |   |   |   |
|  | B(Alt) LD18 Lynx  | 11/04 → 11/07   | <i>AC</i>   | VKMV 6PK1520<br>VKM 34110<br>VKM 34111   | 1   |   | 1   |   |   |   |   |   |
| <b>FORD  FOCUS II 2.0 TDCi</b>        |   |   |   |  |   |   |   |   |   |   |   |   |
|                                        | Duratorq  | 11/04 → 11/07   |   | VKMA 03257<br>VKM 13257<br>VKM 23257   | 1<br>1  | 1<br>1  |   |   |   |   |   | T0205   |
|                                        | Duratorq  | 11/04 → 11/07   |   | VKPC 83643   |   |   |   | 1   |   |   |   |   |

|  | <b>B(Alt)</b> | Duratorq   | 11/04 → 11/07 | VKMA 33320    | 1            |   | 1 |  |  |  |  |  |  |  |  |  |  |  |  |  |  |  |  |  |  |       |       |
|--|---------------|------------|---------------|---------------|--------------|---|---|--|--|--|--|--|--|--|--|--|--|--|--|--|--|--|--|--|--|-------|-------|
|  |               |            |               | VKMA 6PK1217  |              |   | 1 |  |  |  |  |  |  |  |  |  |  |  |  |  |  |  |  |  |  |       |       |
|  |               |            |               | VKM 33320     | 1            |   |   |  |  |  |  |  |  |  |  |  |  |  |  |  |  |  |  |  |  |       |       |
| <b>FORD  FOCUS C-MAX I 1.6 16V</b>           |               |            |               |               |              |   |   |  |  |  |  |  |  |  |  |  |  |  |  |  |  |  |  |  |  |       |       |
|  |               | ZH16 Zetec | 10/03 → 04/05 | VKMA 04222    | 1            |   | 1 |  |  |  |  |  |  |  |  |  |  |  |  |  |  |  |  |  |  | T0131 |       |
|  |               |            |               | VKM 14222     | 1            |   |   |  |  |  |  |  |  |  |  |  |  |  |  |  |  |  |  |  |  |       |       |
|  |               | ZH16 Zetec | 04/05 → 03/07 | VKMA 04224    | 1            |   | 1 |  |  |  |  |  |  |  |  |  |  |  |  |  |  |  |  |  |  | T0131 |       |
|  |               |            |               | VKM 14224     | 1            |   |   |  |  |  |  |  |  |  |  |  |  |  |  |  |  |  |  |  |  |       |       |
|  |               | ZH16 Zetec | 10/03 → 04/05 | VKPC 84215    |              |   |   |  |  |  |  |  |  |  |  |  |  |  |  |  |  |  |  |  |  |       |       |
|  |               | ZH16 Zetec | 04/05 → 03/07 | VKPC _____    |              |   |   |  |  |  |  |  |  |  |  |  |  |  |  |  |  |  |  |  |  |       |       |
| <b>FORD  FOCUS C-MAX I 1.8 16V</b>           |               |            |               |               |              |   |   |  |  |  |  |  |  |  |  |  |  |  |  |  |  |  |  |  |  |       |       |
|  |               | Duratec    | 10/03 → 03/07 | <b>ΟΧΛΟΧΟ</b> |              |   |   |  |  |  |  |  |  |  |  |  |  |  |  |  |  |  |  |  |  |       |       |
|  |               | Duratec    | 10/03 → 03/07 | VKPC 84622    |              |   |   |  |  |  |  |  |  |  |  |  |  |  |  |  |  |  |  |  |  |       |       |
|  | <b>B(Alt)</b> | Duratec    | 10/03 → 03/07 | VKMA 6PK1306  |              |   |   |  |  |  |  |  |  |  |  |  |  |  |  |  |  |  |  |  |  |       |       |
|  |               |            |               | VKM 34014     | 1            |   |   |  |  |  |  |  |  |  |  |  |  |  |  |  |  |  |  |  |  |       |       |
| <b>FORD  FOCUS C-MAX I 1.8 16V Flexifuel</b> |               |            |               |               |              |   |   |  |  |  |  |  |  |  |  |  |  |  |  |  |  |  |  |  |  |       |       |
|  |               | Duratec    | 01/06 → 03/07 | <b>ΟΧΛΟΧΟ</b> |              |   |   |  |  |  |  |  |  |  |  |  |  |  |  |  |  |  |  |  |  |       |       |
|  |               | Duratec    | 01/06 → 03/07 | VKPC 84622    |              |   |   |  |  |  |  |  |  |  |  |  |  |  |  |  |  |  |  |  |  |       |       |
|  | <b>B(Alt)</b> | Duratec    | 01/06 → 03/07 | VKMA 6PK1306  |              |   |   |  |  |  |  |  |  |  |  |  |  |  |  |  |  |  |  |  |  |       |       |
|  |               |            |               | VKM 34014     | 1            |   |   |  |  |  |  |  |  |  |  |  |  |  |  |  |  |  |  |  |  |       |       |
| <b>FORD  FOCUS C-MAX I 2.0 16V</b>           |               |            |               |               |              |   |   |  |  |  |  |  |  |  |  |  |  |  |  |  |  |  |  |  |  |       |       |
|  |               | Duratec    | 04/04 → 03/07 | <b>ΟΧΛΟΧΟ</b> |              |   |   |  |  |  |  |  |  |  |  |  |  |  |  |  |  |  |  |  |  |       |       |
|  |               | Duratec    | 04/04 → 03/07 | VKPC 84622    |              |   |   |  |  |  |  |  |  |  |  |  |  |  |  |  |  |  |  |  |  |       |       |
|  | <b>B(Alt)</b> | Duratec    | 04/04 → 03/07 | VKMA 6PK1306  |              |   |   |  |  |  |  |  |  |  |  |  |  |  |  |  |  |  |  |  |  |       |       |
|  |               |            |               | VKM 34014     | 1            |   |   |  |  |  |  |  |  |  |  |  |  |  |  |  |  |  |  |  |  |       |       |
| <b>FORD  FOCUS C-MAX I 1.6 TDCi</b>          |               |            |               |               |              |   |   |  |  |  |  |  |  |  |  |  |  |  |  |  |  |  |  |  |  |       |       |
|  |               | Duratorq   | 10/03 → 03/07 | VKMA 03259    | 1            | 1 | 1 |  |  |  |  |  |  |  |  |  |  |  |  |  |  |  |  |  |  |       | T0195 |
|  |               |            |               | VKM 13140     | 1            |   |   |  |  |  |  |  |  |  |  |  |  |  |  |  |  |  |  |  |  |       |       |
|  |               |            |               | VKM 23140     |              |   | 1 |  |  |  |  |  |  |  |  |  |  |  |  |  |  |  |  |  |  |       |       |
|  |               | Duratorq   | 10/03 → 03/07 | VKPC 83259    |              |   |   |  |  |  |  |  |  |  |  |  |  |  |  |  |  |  |  |  |  |       |       |
|  | <b>B(Alt)</b> | Duratorq   | 10/03 → 03/07 | VKMA 33058    | 1            | 1 | 1 |  |  |  |  |  |  |  |  |  |  |  |  |  |  |  |  |  |  |       |       |
|  |               |            |               | VKMA 6PK802   |              |   |   |  |  |  |  |  |  |  |  |  |  |  |  |  |  |  |  |  |  |       |       |
|  |               |            |               | VKM 33043     | 1            |   |   |  |  |  |  |  |  |  |  |  |  |  |  |  |  |  |  |  |  |       |       |
|  |               |            |               | VKM 33044     |              |   | 1 |  |  |  |  |  |  |  |  |  |  |  |  |  |  |  |  |  |  | 1     |       |
|  | <b>B(Alt)</b> | Duratorq   | 10/03 → 03/07 | VKMA 33043    | 1            |   |   |  |  |  |  |  |  |  |  |  |  |  |  |  |  |  |  |  |  |       |       |
|  |               |            |               | VKMA 6PK976   |              |   |   |  |  |  |  |  |  |  |  |  |  |  |  |  |  |  |  |  |  |       |       |
|  |               |            |               | VKM 33043     | 1            |   |   |  |  |  |  |  |  |  |  |  |  |  |  |  |  |  |  |  |  |       |       |
| <b>FORD  FOCUS C-MAX I 1.8 TDCi</b>          |               |            |               |               |              |   |   |  |  |  |  |  |  |  |  |  |  |  |  |  |  |  |  |  |  |       |       |
|  |               | LD18 Lynx  | 01/05 → 03/07 | 20)           | VKMA 04108   | 1 |   |  |  |  |  |  |  |  |  |  |  |  |  |  |  |  |  |  |  |       | T0171 |
|  |               |            |               |               | VKM 14108    | 1 |   |  |  |  |  |  |  |  |  |  |  |  |  |  |  |  |  |  |  |       |       |
|  |               | LD18 Lynx  | 01/05 → 03/07 |               | VKPC 84416   |   |   |  |  |  |  |  |  |  |  |  |  |  |  |  |  |  |  |  |  |       |       |
|  | <b>B(Alt)</b> | LD18 Lynx  | 01/05 → 03/07 | <b>AC</b>     | VKM 34110    | 1 |   |  |  |  |  |  |  |  |  |  |  |  |  |  |  |  |  |  |  |       |       |
|  |               |            |               |               | VKM 34111    |   |   |  |  |  |  |  |  |  |  |  |  |  |  |  |  |  |  |  |  |       |       |
|  | <b>B(Alt)</b> | LD18 Lynx  | 01/05 → 03/07 | <b>AC</b>     | VKMA 6PK1520 |   |   |  |  |  |  |  |  |  |  |  |  |  |  |  |  |  |  |  |  |       |       |
|  |               |            |               |               | VKM 34110    | 1 |   |  |  |  |  |  |  |  |  |  |  |  |  |  |  |  |  |  |  |       |       |
|  |               |            |               |               | VKM 34111    |   |   |  |  |  |  |  |  |  |  |  |  |  |  |  |  |  |  |  |  |       |       |
| <b>FORD  FOCUS C-MAX I 2.0 TDCi</b>          |               |            |               |               |              |   |   |  |  |  |  |  |  |  |  |  |  |  |  |  |  |  |  |  |  |       |       |
|  |               | Duratorq   | 10/03 → 03/07 | VKMA 03257    | 1            | 1 | 1 |  |  |  |  |  |  |  |  |  |  |  |  |  |  |  |  |  |  |       | T0205 |
|  |               |            |               | VKM 13257     | 1            |   |   |  |  |  |  |  |  |  |  |  |  |  |  |  |  |  |  |  |  |       |       |
|  |               |            |               | VKM 23257     |              |   | 1 |  |  |  |  |  |  |  |  |  |  |  |  |  |  |  |  |  |  |       |       |
|  |               | Duratorq   | 10/03 → 03/07 |               | VKPC 83643   |   |   |  |  |  |  |  |  |  |  |  |  |  |  |  |  |  |  |  |  |       |       |
|  | <b>B(Alt)</b> | Duratorq   | 11/03 → 03/07 | VKMA 33320    | 1            |   |   |  |  |  |  |  |  |  |  |  |  |  |  |  |  |  |  |  |  |       |       |
|  |               |            |               | VKMA 6PK1217  |              |   |   |  |  |  |  |  |  |  |  |  |  |  |  |  |  |  |  |  |  |       |       |
|  |               |            |               | VKM 33320     | 1            |   |   |  |  |  |  |  |  |  |  |  |  |  |  |  |  |  |  |  |  |       |       |
| <b>FORD  FOCUS C-MAX II 1.6 16V</b>          |               |            |               |               |              |   |   |  |  |  |  |  |  |  |  |  |  |  |  |  |  |  |  |  |  |       |       |
|  |               | ZH16 Zetec | 02/07 → 09/07 | VKMA 04224    | 1            |   |   |  |  |  |  |  |  |  |  |  |  |  |  |  |  |  |  |  |  |       | T0131 |
|  |               |            |               | VKM 14224     | 1            |   |   |  |  |  |  |  |  |  |  |  |  |  |  |  |  |  |  |  |  |       |       |
|  |               | ZH16 Zetec | 02/07 → 11/07 | —             |              |   |   |  |  |  |  |  |  |  |  |  |  |  |  |  |  |  |  |  |  |       |       |
| <b>FORD  FOCUS C-MAX II 1.8 16V</b>          |               |            |               |               |              |   |   |  |  |  |  |  |  |  |  |  |  |  |  |  |  |  |  |  |  |       |       |
|  |               | Duratec    | 02/07 → 09/07 | <b>ΟΧΛΟΧΟ</b> |              |   |   |  |  |  |  |  |  |  |  |  |  |  |  |  |  |  |  |  |  |       |       |
|  |               | Duratec    | 02/07 → 05/07 | VKPC 84622    |              |   |   |  |  |  |  |  |  |  |  |  |  |  |  |  |  |  |  |  |  |       |       |



|  |               |  |  |  |  |  |  |  |  |  |  |  |
|--|---------------|---|---|---|--|---|---|---|---|---|---|---|
|    | <b>B(Alt)</b> | Duratec   | 02/07 → 09/07   |   | VKMV 6PK1306<br>VKM 34014  | 1   | 1   |   |   |   |   |   |
| <b>FORD  FOCUS C-MAX II 1.8 16V Flexifuel</b> |               |   |   |   |  |   |   |   |   |   |   |   |
|    |               | Duratec   | 02/07 → 09/07   |   | <del>OKOKOKO</del>   |   |   |   |   |   |   |   |
|    |               | Duratec   | 02/07 → 05/07   |   | VKPC 84622   |   |   |   | 1   |   |   |   |
|    | <b>B(Alt)</b> | Duratec   | 02/07 → 09/07   |   | VKMV 6PK1306<br>VKM 34014  | 1   | 1   |   |   |   |   |   |
| <b>FORD  FOCUS C-MAX II 2.0 16V</b>           |               |   |   |   |  |   |   |   |   |   |   |   |
|    |               | Duratec   | 02/07 → 09/07   |   | <del>OKOKOKO</del>   |   |   |   |   |   |   |   |
|    |               | Duratec   | 02/07 → 05/07   |   | VKPC 84622   |   |   |   | 1   |   |   |   |
|    | <b>B(Alt)</b> | Duratec   | 02/07 → 09/07   |   | VKMV 6PK1306<br>VKM 34014  | 1   | 1   |   |   |   |   |   |
| <b>FORD  FOCUS C-MAX II 1.6 TDCi</b>          |               |   |   |   |  |   |   |   |   |   |   |   |
|    |               | Duratorq  | 02/07 → 11/07   |   | VKMA 03259<br>VKM 13140<br>VKM 23140   | 1<br>1  | 1<br>1  |   |   |   |   | T0195   |
|    |               | Duratorq  | 02/07 → 11/07   |   | VKPC 83259   |   |   |   | 1   |   |   |   |
|    | <b>B(Alt)</b> | Duratorq  | 02/07 → 11/07   | <b>AC</b>   | VKMA 33058<br>VKMV 6PK802<br>VKM 33043<br>VKM 33044                                | 1<br>1  | 1<br>1  |   |   |   |   |   |
|  | <b>B(Alt)</b> | Duratorq  | 02/07 → 11/07   | <b>AC</b>   | VKMA 33043<br>VKMV 6PK976<br>VKM 33043   | 1<br>1  | 1<br>1  |   |   |   |   |   |
| <b>FORD  FOCUS C-MAX II 2.0 TDCi</b>         |               |   |   |   |  |   |   |   |   |   |   |   |
|    |               | Duratorq  | 02/07 → 09/07   |   | VKMA 03257<br>VKM 13257<br>VKM 23257   | 1<br>1  | 1<br>1  |   |   |   |   | T0205   |
|    |               | Duratorq  | 02/07 → 11/07   |   | VKPC 83643   |   |   |   | 1   |   |   |   |
|    | <b>B(Alt)</b> | Duratorq  | 02/07 → 11/07   |   | VKMA 33320<br>VKMV 6PK1217<br>VKM 33320  | 1<br>1  | 1<br>1  |   |   |   |   |   |
| <b>FORD  FUSION 1.25 16V</b>                |               |   |   |   |  |   |   |   |   |   |   |   |
|    |               | ZH12 Zetec  | 08/04 → 04/05   |   | VKMA 04222<br>VKM 14222  | 1<br>1  | 1   |   |   |   |   | T0131   |
|  |               | ZH12 Zetec  | 04/05 → 11/07   |   | VKMA 04224<br>VKM 14224  | 1<br>1  | 1   |   |   |   |   | T0131   |
|    |               | ZH12 Zetec  | 08/04 → 04/05   |   | VKPC 84215   |   |   |   | 1   |   |   |   |
|  |               | ZH12 Zetec  | 04/05 → 11/07   |   | VKPC_____  |   |   |   | 1   |   |   |   |
| <b>FORD  FUSION 1.4 16V</b>                 |               |   |   |   |  |   |   |   |   |   |   |   |
|    |               | ZH14 Zetec  | 08/02 → 04/05   |   | VKMA 04222<br>VKM 14222  | 1<br>1  | 1   |   |   |   |   | T0131   |
|  |               | ZH14 Zetec  | 04/05 → 11/07   |   | VKMA 04224<br>VKM 14224  | 1<br>1  | 1   |   |   |   |   | T0131   |
|    |               | ZH14 Zetec  | 08/02 → 04/05   |   | VKPC 84215   |   |   |   | 1   |   |   |   |
|  |               | ZH14 Zetec  | 04/05 → 11/07   |   | VKPC_____  |   |   |   | 1   |   |   |   |
| <b>FORD  FUSION 1.6 16V</b>                 |               |   |   |   |  |   |   |   |   |   |   |   |
|    |               | ZH16 Zetec  | 08/02 → 04/05   |   | VKMA 04222<br>VKM 14222  | 1<br>1  | 1   |   |   |   |   | T0131   |
|  |               | ZH16 Zetec  | 04/05 → 11/07   |   | VKMA 04224<br>VKM 14224  | 1<br>1  | 1   |   |   |   |   | T0131   |
|    |               | ZH16 Zetec  | 08/02 → 04/05   |   | VKPC 84215   |   |   |   | 1   |   |   |   |
|  |               | ZH16 Zetec  | 04/05 → 11/07   |   | VKPC_____  |   |   |   | 1   |   |   |   |
| <b>FORD  FUSION 1.4 TDCi</b>                |               |   |   |   |  |   |   |   |   |   |   |   |
|    |               | Duratorq  | 08/02 → 11/07   |   | VKMA 03140<br>VKM 13140<br>VKM 23140   | 1<br>1  | 1<br>1  |   |   |   |   | T0195   |
|    |               | Duratorq  | 08/02 → 11/07   |   | VKPC 83140   |   |   |   | 1   |   |   |   |
|    | <b>B(Alt)</b> | Duratorq  | 08/02 → 11/07   | <b>AC</b>   | VKMA 33060<br>VKMV 6PK1341<br>VKM 33060<br>VKM 33060<br>VKM 33061                  | 1<br>1<br>1<br>1  | 2<br>1<br>1   | 1<br>1  |   |   |   | 1<br>1  |

|                               | <b>B(Alt)</b> Duratorq        | 08/02 → 11/07 | <b>AC</b> | VKMA 33061<br>VKMV 6PK1705<br>VKM 33044<br>VKM 33061 | 1 | 1 | 1 |   |  |   |  |  |   | 1     |
|-------------------------------|-------------------------------|---------------|-----------|--|---|---|---|---|--|---|--|--|---|-------|
| <b>FORD  FUSION 1.6 TDCi</b>  |                               |               |           |  |   |   |   |   |  |   |  |  |   |       |
|                               | Duratorq                      | 11/04 → 11/07 |           | VKMA 03259<br>VKM 13140<br>VKM 23140                 | 1 | 1 | 1 |   |  |   |  |  |   | T0195 |
|                               | Duratorq                      | 11/04 → 11/07 |           | VKPC 83259   |   |   |   |   |  | 1 |  |  |   |       |
|                               | <b>B(Alt)</b> Duratorq        | 11/04 → 11/07 | <b>AC</b> | VKMA 33058<br>VKMV 6PK802<br>VKM 33043<br>VKM 33044  | 1 | 1 | 1 |   |  |   |  |  |   | 1     |
|                               | <b>B(Alt)</b> Duratorq        | 11/04 → 11/07 | <b>AC</b> | VKMA 33043<br>VKMV 6PK976<br>VKM 33043               | 1 |   | 1 |   |  |   |  |  |   |       |
| <b>FORD  GALAXY I 2.0</b>     |                               |               |           |  |   |   |   |   |  |   |  |  |   |       |
|                               | DL20                          | 11/95 → 11/07 |           | <b>ΟΧΘΙΧΟ</b>  |   |   |   |   |  |   |  |  |   |       |
|                               | DL20                          | 11/95 → 11/07 |           | VKPC 84412   |   |   |   |   |  | 1 |  |  |   |       |
|                               | <b>B(Alt)</b> DL20            | 11/95 → 12/99 | <b>AC</b> | VKMV 6PK1430<br>VKM 34012<br>VKM 34034               | 1 |   | 1 |   |  |   |  |  |   |       |
|                               | <b>B(Alt)</b> DL20            | 11/95 → 11/07 | <b>AC</b> | VKMV 6PK1575<br>VKM 34012<br>VKM 34034               | 1 |   | 1 |   |  |   |  |  |   |       |
| <b>FORD  GALAXY I 2.3 16V</b> |                               |               |           |  |   |   |   |   |  |   |  |  |   |       |
|                               | DH23                          | 01/97 → 11/07 |           | <b>ΟΧΘΙΧΟ</b>  |   |   |   |   |  |   |  |  |   |       |
|                               | DH23                          | 01/97 → 11/07 |           | VKPC 84412   |   |   |   |   |  | 1 |  |  |   |       |
|                               | <b>B(Alt)</b> DH23            | 01/97 → 03/00 | <b>AC</b> | VKMV 6PK1430<br>VKM 34012<br>VKM 34034               | 1 |   | 1 |   |  |   |  |  |   |       |
|                               | <b>B(Alt)</b> DH23            | 01/97 → 03/00 | <b>AC</b> | VKMV 6PK1575<br>VKM 34012<br>VKM 34034               | 1 |   | 1 |   |  |   |  |  |   |       |
|                               | <b>B(Alt)</b> DH23            | 09/01 → 02/07 |           | VKMV 6PK1575<br>VKM 34012<br>VKM 34034               | 1 |   | 1 |   |  |   |  |  |   |       |
| <b>FORD  GALAXY I 2.8 V6</b>  |                               |               |           |  |   |   |   |   |  |   |  |  |   |       |
|                               | AAA, AMY, AYL                 | 11/95 → 05/07 |           | <b>ΟΧΘΙΧΟ</b>  |   |   |   |   |  |   |  |  |   |       |
|                               | AAA, AMY, AYL                 | 11/95 → 10/01 |           | VKPC 81611   |   |   |   |   |  | 1 |  |  |   |       |
|                               | AYL                           | 11/01 → 11/07 |           | —  |   |   |   |   |  | 1 |  |  |   |       |
|                               | <b>B(Alt)</b> AAA, AMY        | 11/95 → 04/00 | <b>AC</b> | VKMA 31060<br>VKMV 7DK1360<br>VKM 31060              | 1 |   | 1 |   |  |   |  |  |   |       |
| <b>FORD  GALAXY I 1.9 TDI</b> |                               |               |           |  |   |   |   |   |  |   |  |  |   |       |
|                               | ANU, VW19NPD                  | 03/95 → 03/00 |           | VKMA 01943<br>VKM 11143<br>VKM 11144<br>VKM 21142    | 1 | 1 | 1 | 1 |  |   |  |  | 2 | T0184 |
|                               | ANU, AUY, VW19NPD,<br>VW19PPD | 04/00 → 04/02 |           | VKMA 01942<br>VKM 11142<br>VKM 11145<br>VKM 21142    | 1 | 1 | 1 | 1 |  |   |  |  | 3 | T0184 |
|                               | 1Z, AHU, VW19N                | 03/95 → 03/00 |           | VKMA 01019<br>VKM 11014<br>VKM 21012                 | 1 | 1 | 1 |   |  |   |  |  | 5 | T0650 |
|                               | AFN, AVG, VW19P               | 08/97 → 04/00 |           | VKMA 01019<br>VKM 11014<br>VKM 21012                 | 1 | 1 | 1 |   |  |   |  |  | 5 | T0650 |
|                               | ANU, VW19NPD                  | 03/95 → 03/00 |           | VKMA 01143<br>VKM 11143<br>VKM 21142                 | 1 | 1 | 1 |   |  |   |  |  |   | T0184 |





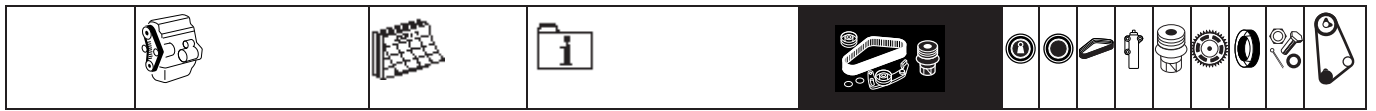





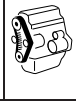



















|                                       | ANU, AUY, VW19NPD, VW19PPD                           | 04/00 → 04/02 |                 | VKMA 01142<br>VKM 11142<br>VKM 21142                                  | 1<br>1      | 1<br>1 | 1<br>1      |  |  |  |  |        |  |  |  |  |  | 3 | T0184 |
|---------------------------------------|--|---------------|-----------------|---|-------------|--------|-------------|--|--|--|--|--------|--|--|--|--|--|---|-------|
|                                       | ANU, ASZ, AUY, BTB, VW19NPD, VW19PPD                 | 05/02 → 11/07 |                 | VKMA 01250<br>VKM 11250<br>VKM 21147                                  | 1<br>1      | 1<br>1 | 1           |  |  |  |  |        |  |  |  |  |  |   | T0184 |
|                                       | 1Z, AFN, AHU, AVG, VW19N, VW19P                      | 03/95 → 11/07 | 2)              | VKPA 81401<br>VKPC 81401  |             |        |             |  |  |  |  | 1<br>1 |  |  |  |  |  |   |       |
|                                       | ANU, AUY, VW19NPD, VW19PPD                           | 03/95 → 04/02 |                 | VKPC 81626  |             |        |             |  |  |  |  | 1      |  |  |  |  |  |   |       |
|                                       | ANU, AUY, VW19NPD, VW19PPD                           | 05/02 → 11/07 |                 | VKPC 81303  |             |        |             |  |  |  |  | 1      |  |  |  |  |  |   |       |
|                                       | ASZ  | 02/03 → 11/07 |                 | VKPC 81418  |             |        |             |  |  |  |  | 1      |  |  |  |  |  |   |       |
|                                       | <b>B(Alt)</b> ASZ, AUY, BTB, VW19PPD                 | 04/00 → 11/07 |                 | VKMA 31001<br>VKMV 6DK1195<br>VKM 31019                               | 1<br>1      |        | 1<br>1      |  |  |  |  |        |  |  |  |  |  |   |       |
|                                       | <b>B(Alt), B(PS)</b> 1Z, AFN, AHU, AVG, VW19N, VW19P | 03/95 → 09/99 | 120A, <b>Ac</b> | VKMA 31028<br>VKMV 10AVx730<br>VKMV 6PK1045<br>VKM 31004<br>VKM 31030 | 2<br>1<br>1 |        | 2<br>1<br>1 |  |  |  |  |        |  |  |  |  |  |   |       |
|                                       | <b>B(Alt), B(PS)</b> 1Z, AFN, AHU, AVG, VW19N, VW19P | 03/95 → 09/99 | <b>AC</b>       | VKMA 31030<br>VKMV 11.5x790<br>VKMV 6PK1145<br>VKM 31004<br>VKM 31030 | 2<br>1<br>1 |        | 2<br>1<br>1 |  |  |  |  |        |  |  |  |  |  |   |       |
|                                       | 1Z, AHU, ANU, ASZ, AUY                               | 04/00 → 08/03 |                 | VKM_____  |             |        |             |  |  |  |  | 1      |  |  |  |  |  |   |       |
| <b>FORD</b> <b>GALAXY II 2.0</b>      |  |               |                 |   |             |        |             |  |  |  |  |        |  |  |  |  |  |   |       |
|                                       | Duratec  | 05/06 → 11/07 |                 | <del>OKOKOK</del>   |             |        |             |  |  |  |  |        |  |  |  |  |  |   |       |
|                                       | Duratec  | 05/06 → 11/07 |                 | VKPC 84622  |             |        |             |  |  |  |  | 1      |  |  |  |  |  |   |       |
|                                       | <b>B(Alt)</b> Duratec                                | 05/06 → 11/07 |                 | VKMV 6PK2198<br>VKM_____  | 1           |        | 1           |  |  |  |  |        |  |  |  |  |  |   |       |
| <b>FORD</b> <b>GALAXY II 1.8 TDCi</b> |  |               |                 |   |             |        |             |  |  |  |  |        |  |  |  |  |  |   |       |
|                                       | LD18 Lynx  | 05/06 → 11/07 |                 | VKMA 04108<br>VKM 14108   | 1<br>1      |        | 1           |  |  |  |  |        |  |  |  |  |  |   | T0171 |
|                                       | LD18 Lynx  | 05/06 → 11/07 |                 | VKPC 84416  |             |        |             |  |  |  |  | 1      |  |  |  |  |  |   |       |
|                                       | <b>B(Alt)</b> LD18 Lynx                              | 05/06 → 11/07 |                 | VKMV 6PK1688<br>VKM 34111<br>VKM_____                                 | 1           |        | 1           |  |  |  |  |        |  |  |  |  |  |   |       |
| <b>FORD</b> <b>GALAXY II 2.0 TDCi</b> |  |               |                 |   |             |        |             |  |  |  |  |        |  |  |  |  |  |   |       |
|                                       | Duratorq   | 05/06 → 11/07 |                 | VKMA 03257<br>VKM 13257<br>VKM 23257                                  | 1<br>1      | 1      | 1           |  |  |  |  |        |  |  |  |  |  |   | T0205 |
|                                       | Duratorq   | 05/06 → 11/07 |                 | VKPC 83643  |             |        |             |  |  |  |  | 1      |  |  |  |  |  |   |       |
|                                       | <b>B(Alt)</b> Duratorq                               | 05/06 → 11/07 |                 | VKM 33320   | 1           |        |             |  |  |  |  |        |  |  |  |  |  |   |       |
| <b>FORD</b> <b>GRANADA 1.6</b>        |  |               |                 |   |             |        |             |  |  |  |  |        |  |  |  |  |  |   |       |
|                                       | LCK  | 07/81 → 08/85 |                 | VKMA 04000<br>VKM 14000   | 1<br>1      |        | 1           |  |  |  |  |        |  |  |  |  |  |   | T0029 |
|                                       | LCK  | 07/81 → 08/85 | <b>Fix.FAN</b>  | VKPC 84600  |             |        |             |  |  |  |  | 1      |  |  |  |  |  |   |       |
|                                       | LCK  | 07/81 → 08/85 | <b>Auto.FAN</b> | VKPC 84601  |             |        |             |  |  |  |  | 1      |  |  |  |  |  |   |       |
|                                       | LCK  | 07/81 → 08/85 | <b>Auto.FAN</b> | VKPC 84601  |             |        |             |  |  |  |  | 1      |  |  |  |  |  |   |       |
| <b>FORD</b> <b>GRANADA 1.7</b>        |  |               |                 |   |             |        |             |  |  |  |  |        |  |  |  |  |  |   |       |
|                                       | MWB, MY, MYE, TV 17 H                                | 03/72 → 05/82 |                 | VKPC 84400  |             |        |             |  |  |  |  | 1      |  |  |  |  |  |   |       |
| <b>FORD</b> <b>GRANADA 2.0</b>        |  |               |                 |   |             |        |             |  |  |  |  |        |  |  |  |  |  |   |       |
|                                       | NEK, NEP, NY, NYP, TL20 OHC                          | 01/75 → 08/85 |                 | VKMA 04001<br>VKM 14000   | 1<br>1      |        | 1           |  |  |  |  |        |  |  |  |  |  |   | T0030 |

















| FORD  GRANADA 2.3      |   |            |   |  |  |   |   |   |  |   |   |   |  |  |  |  |  |   |       |
|------------------------|---|------------|---|--|--|---|---|---|--|---|---|---|--|--|--|--|--|---|-------|
|                        | YYH, YYP, YYU 08/77 → 09/84                     | VKPC 84608 |   |  |  |   |   | 1 |  |   |   |   |  |  |  |  |  |   |       |
|                        | YYP, YYU 10/84 → 08/85                          | VKPC 84609 |   |  |  |   |   | 1 |  |   |   |   |  |  |  |  |  |   |       |
| FORD  GRANADA 2.8      |   |            |   |  |  |   |   |   |  |   |   |   |  |  |  |  |  |   |       |
|                        | PRB, PRC, PRD, PYA, PYU 08/77 → 09/84           | VKPC 84608 |   |  |  |   |   | 1 |  |   |   |   |  |  |  |  |  |   |       |
|                        | PRC, PRD, PYA, PYU 10/84 → 08/85                | VKPC 84609 |   |  |  |   |   | 1 |  |   |   |   |  |  |  |  |  |   |       |
| FORD  GRANADA 1.9 D    |   |            |   |  |  |   |   |   |  |   |   |   |  |  |  |  |  |   |       |
|                        | 08/77 → 08/82                                   | VKPC 83616 |   |  |  |   |   | 1 |  |   |   |   |  |  |  |  |  |   |       |
| FORD  GRANADA 2.1 D    |   |            |   |  |  |   |   |   |  |   |   |   |  |  |  |  |  |   |       |
|                        | WTA 08/77 → 08/82                               | VKPC 83616 |   |  |  |   |   | 1 |  |   |   |   |  |  |  |  |  |   |       |
| FORD  GRANADA 2.5 D    |   |            |   |  |  |   |   |   |  |   |   |   |  |  |  |  |  |   |       |
|                        | PD25 08/82 → 08/85                              | OXOXOXO    |   |  |  |   |   |   |  |   |   |   |  |  |  |  |  |   |       |
|                        | PD25 08/82 → 08/85                              | VKPC 83423 |   |  |  |   |   |   |  |   |   |   |  |  |  |  |  | 1 |       |
| FORD  KA 1.3           |   |            |   |  |  |   |   |   |  |   |   |   |  |  |  |  |  |   |       |
|                        | BL13 (OHV/HCS), ZL13 Zetec 09/96 → 05/07        | OXOXOXO    |   |  |  |   |   |   |  |   |   |   |  |  |  |  |  |   |       |
|                        | BL13 (OHV/HCS), ZL13 Zetec 09/96 → 10/02        | VKPC 84216 |   |  |  |   |   |   |  |   |   |   |  |  |  |  |  | 1 |       |
|                        | BL13 (OHV/HCS), ZL13 Zetec 10/02 → 08/06        | SOHC       | VKPC 84629                              |  |  |   |   |   |  |   |   |   |  |  |  |  |  | 1 |       |
|                        | B(Alt) BL13 (OHV/HCS), ZL13 Zetec 09/96 → 12/05 | AC, ⊕      | VKMV 6PK1760<br>VKM 34033<br>VKM 34034  |  |  | 1 |   |   |  | 1 |   |   |  |  |  |  |  |   |       |
|                        | B(Alt) BL13 (OHV/HCS), ZL13 Zetec 09/96 → 12/05 | AC, ⊕      | VKMV 6PK1936<br>VKM 34033<br>VKM 34034  |  |  | 1 |   |   |  |   | 1 |   |  |  |  |  |  |   |       |
|                        | B(Alt) ZL13 Zetec 08/02 → 12/05                 | AC, ⊕      | VKMV                                    |  |  |   |   |   |  | 1 |   |   |  |  |  |  |  |   |       |
|                        | B(Alt) ZL13 Zetec 08/02 → 12/05                 | AC, ⊕      | VKMV 6PK2196                            |  |  |   |   |   |  |   | 1 |   |  |  |  |  |  |   |       |
| FORD  KA 1.6           |   |            |   |  |  |   |   |   |  |   |   |   |  |  |  |  |  |   |       |
|                        | ZL16 Zetec 07/03 → 05/07                        | OXOXOXO    |   |  |  |   |   |   |  |   |   |   |  |  |  |  |  |   |       |
|                        | ZL16 Zetec 07/03 → 08/06                        | VKPC 84629 |   |  |  |   |   |   |  |   |   |   |  |  |  |  |  | 1 |       |
|                        | B(Alt) ZL16 Zetec 07/03 → 12/05                 | AC         | VKMV                                    |  |  |   |   |   |  |   | 1 |   |  |  |  |  |  |   |       |
|                        | B(Alt) ZL16 Zetec 07/03 → 12/05                 | AC         | VKMV 6PK2196                            |  |  |   |   |   |  |   |   | 1 |  |  |  |  |  |   |       |
| FORD  MAVERICK 2.0 16V |   |            |   |  |  |   |   |   |  |   |   |   |  |  |  |  |  |   |       |
|                        | ZH20 Zetec 02/01 → 11/07                        | —          | VKM 14216<br>VKM 24213                  |  |  | 1 | 1 | 1 |  |   |   |   |  |  |  |  |  |   | T0162 |
|                        | ZH20 Zetec 02/01 → 11/07                        | —          |   |  |  | 1 |   | 1 |  |   |   |   |  |  |  |  |  |   |       |
|                        | B(Alt) ZH20 Zetec 02/01 → 05/03                 | AC         | VKMV 6PK2103<br>VKM 34010<br>VKM        |  |  | 1 |   |   |  |   | 1 |   |  |  |  |  |  |   |       |
|                        | B(Alt) ZH20 Zetec 05/03 → 11/07                 | AC         | VKMV 6PK2103<br>VKM 34010<br>VKM<br>VKM |  |  | 1 |   |   |  |   | 1 |   |  |  |  |  |  |   |       |
| FORD  MAVERICK 2.3 16V |   |            |   |  |  |   |   |   |  |   |   |   |  |  |  |  |  |   |       |
|                        | Duratec 03/04 → 11/07                           | OXOXOXO    |   |  |  |   |   |   |  |   |   |   |  |  |  |  |  |   |       |
|                        | Duratec 03/04 → 08/04                           | VKPC 84622 |   |  |  |   |   |   |  |   |   |   |  |  |  |  |  | 1 |       |
|                        | Duratec 08/04 → 11/07                           | —          |   |  |  |   |   |   |  |   |   |   |  |  |  |  |  | 1 |       |
| FORD  MAVERICK 2.4     |   |            |   |  |  |   |   |   |  |   |   |   |  |  |  |  |  |   |       |
|                        | KA24 02/93 → 04/98                              | OXOXOXO    |   |  |  |   |   |   |  |   |   |   |  |  |  |  |  |   |       |
| FORD  MAVERICK 3.0 24V |   |            |   |  |  |   |   |   |  |   |   |   |  |  |  |  |  |   |       |
|                        | Duratec 03/04 → 11/07                           | OXOXOXO    |   |  |  |   |   |   |  |   |   |   |  |  |  |  |  |   |       |
| FORD  MAVERICK 3.0 V6  |   |            |   |  |  |   |   |   |  |   |   |   |  |  |  |  |  |   |       |
|                        | Duratec 02/01 → 11/07                           | OXOXOXO    |   |  |  |   |   |   |  |   |   |   |  |  |  |  |  |   |       |
| FORD  MAVERICK 2.7 TD  |   |            |   |  |  |   |   |   |  |   |   |   |  |  |  |  |  |   |       |
|                        | TD27 02/93 → 04/98                              | OXOXOXO    |   |  |  |   |   |   |  |   |   |   |  |  |  |  |  |   |       |





|  |                          |  |  |  |  |  |  |  |  |  |  |  |  |
|--|--------------------------|---|---|---|--|---|---|---|---|---|---|---|---|
| <b>FORD  MONDEO I 1.6 16V</b>   |                          |   |   |   |  |   |   |   |   |   |   |   |   |
|                                  | ZH16 Zetec               | 02/93 → 08/96   |   |   | VKMA 04212   | 1   | 2   | 1   |   |   |   |   | 5 T0104   |
|  |                          |   |   |   | VKM 14210  | 1   |   |   |   |   |   |   |   |
|  |                          |   |   |   | VKM 24210  |   |   | 1   |   |   |   |   |   |
|  |                          |   |   |   | VKM 24211  |   |   | 1   |   |   |   |   |   |
|                                  | ZH16 Zetec               | 02/93 → 08/96   |   |   | VKPC 84407   |   |   |   | 1   |   |   |   |   |
|                                  | <b>B(Alt)</b> ZH16 Zetec | 02/93 → 08/96   | <i>AC</i>   |   | VKMMV 6PK1719  | 1   |   | 1   |   |   |   |   |   |
|  |                          |   |   |   | VKM 34047  |   |   |   |   |   |   |   |   |
|  |                          |   |   |   | VKM 34048  |   | 1   |   |   |   |   |   |   |
|  | <b>B(Alt)</b> ZH16 Zetec | 02/93 → 08/95   | <b>AC</b>   |   | VKMMV 6PK2080  | 1   |   | 1   |   |   |   |   |   |
|  |                          |   |   |   | VKM 34047  |   |   |   |   |   |   |   |   |
|  |                          |   |   |   | VKM 34048  |   | 1   |   |   |   |   |   |   |
|  | <b>B(Alt)</b> ZH16 Zetec | 08/95 → 08/96   | <b>AC, Man. GBX</b>   |   | VKMMV 6PK2120  | 1   |   | 1   |   |   |   |   |   |
|  |                          |   |   |   | VKM 34047  |   |   |   |   |   |   |   |   |
|  |                          |   |   |   | VKM 34048  |   | 1   |   |   |   |   |   |   |
|  | <b>B(Alt)</b> ZH16 Zetec | 08/95 → 08/96   | <b>AC, Auto. GBX</b>  |   | VKMMV 6PK2080  | 1   |   | 1   |   |   |   |   |   |
|  |                          |   |   |   | VKM 34047  |   |   |   |   |   |   |   |   |
|  |                          |   |   |   | VKM 34048  |   | 1   |   |   |   |   |   |   |
| <b>FORD  MONDEO I 1.8 16V</b>   |                          |   |   |   |  |   |   |   |   |   |   |   |   |
|                                  | ZH18 Zetec               | 02/93 → 08/96   |   |   | VKMA 04212   | 1   | 2   | 1   |   |   |   |   | 5 T0104   |
|  |                          |   |   |   | VKM 14210  | 1   |   |   |   |   |   |   |   |
|  |                          |   |   |   | VKM 24210  |   |   | 1   |   |   |   |   |   |
|  |                          |   |   |   | VKM 24211  |   |   | 1   |   |   |   |   |   |
|                                  | ZH18 Zetec               | 02/93 → 08/96   |   |   | VKPC 84407   |   |   |   | 1   |   |   |   |   |
|                                 | <b>B(Alt)</b> ZH18 Zetec | 02/93 → 08/96   | <i>AC</i>   |   | VKMMV 6PK1719  | 1   |   | 1   |   |   |   |   |   |
|  |                          |   |   |   | VKM 34047  |   |   |   |   |   |   |   |   |
|  |                          |   |   |   | VKM 34048  |   | 1   |   |   |   |   |   |   |
|  | <b>B(Alt)</b> ZH18 Zetec | 02/93 → 08/95   | <b>AC</b>   |   | VKMMV 6PK2080  | 1   |   | 1   |   |   |   |   |   |
|  |                          |   |   |   | VKM 34047  |   |   |   |   |   |   |   |   |
|  |                          |   |   |   | VKM 34048  |   | 1   |   |   |   |   |   |   |
|  | <b>B(Alt)</b> ZH18 Zetec | 08/95 → 08/96   | <b>AC, Man. GBX</b>   |   | VKMMV 6PK2120  | 1   |   | 1   |   |   |   |   |   |
|  |                          |   |   |   | VKM 34047  |   |   |   |   |   |   |   |   |
|  |                          |   |   |   | VKM 34048  |   | 1   |   |   |   |   |   |   |
|  | <b>B(Alt)</b> ZH18 Zetec | 08/95 → 08/96   | <b>AC, Auto. GBX</b>  |   | VKMMV 6PK2080  | 1   |   | 1   |   |   |   |   |   |
|  |                          |   |   |   | VKM 34047  |   |   |   |   |   |   |   |   |
|  |                          |   |   |   | VKM 34048  |   | 1   |   |   |   |   |   |   |
| <b>FORD  MONDEO I 2.0 16V</b> |                          |   |   |   |  |   |   |   |   |   |   |   |   |
|                                | ZH20 Zetec               | 01/93 → 08/96   |   |   | VKMA 04212   | 1   | 2   | 1   |   |   |   |   | 5 T0104   |
|  |                          |   |   |   | VKM 14210  | 1   |   |   |   |   |   |   |   |
|  |                          |   |   |   | VKM 24210  |   |   | 1   |   |   |   |   |   |
|  |                          |   |   |   | VKM 24211  |   |   | 1   |   |   |   |   |   |
|                                | ZH20 Zetec               | 01/93 → 08/96   |   |   | VKPC 84407   |   |   |   | 1   |   |   |   |   |
|                                | <b>B(Alt)</b> ZH20 Zetec | 01/93 → 08/96   | <i>AC</i>   |   | VKMMV 6PK1719  | 1   |   | 1   |   |   |   |   |   |
|  |                          |   |   |   | VKM 34047  |   |   |   |   |   |   |   |   |
|  |                          |   |   |   | VKM 34048  |   | 1   |   |   |   |   |   |   |
|  | <b>B(Alt)</b> ZH20 Zetec | 01/93 → 08/95   | <b>AC</b>   |   | VKMMV 6PK2080  | 1   |   | 1   |   |   |   |   |   |
|  |                          |   |   |   | VKM 34047  |   |   |   |   |   |   |   |   |
|  |                          |   |   |   | VKM 34048  |   | 1   |   |   |   |   |   |   |
|  | <b>B(Alt)</b> ZH20 Zetec | 08/95 → 08/96   | <b>AC, Man. GBX</b>   |   | VKMMV 6PK2120  | 1   |   | 1   |   |   |   |   |   |
|  |                          |   |   |   | VKM 34047  |   |   |   |   |   |   |   |   |
|  |                          |   |   |   | VKM 34048  |   | 1   |   |   |   |   |   |   |
|  | <b>B(Alt)</b> ZH20 Zetec | 08/95 → 08/96   | <b>AC, Auto. GBX</b>  |   | VKMMV 6PK2080  | 1   |   | 1   |   |   |   |   |   |
|  |                          |   |   |   | VKM 34047  |   |   |   |   |   |   |   |   |
|  |                          |   |   |   | VKM 34048  |   | 1   |   |   |   |   |   |   |
| <b>FORD  MONDEO I 2.5 V6</b>  |                          |   |   |   |  |   |   |   |   |   |   |   |   |
|                                | Duratec                  | 07/94 → 08/96   |   |   | <b>OXOXOXO</b>   |   |   |   |   |   |   |   |   |
|                                | Duratec                  | 07/94 → 08/96   | 2)  |   | VKPA_____  |   |   |   | 1   |   |   |   |   |
| <b>FORD  MONDEO I 1.8 TD</b>  |                          |   |   |   |  |   |   |   |   |   |   |   |   |
|                                | D18TI                    | 06/93 → 10/95   | 3), 4)  |   | VKMS 04103   | 2   | 1   | 2   |   |   |   | 3   | 9   |
|  |                          |   |   |   | VKMA 04103   | 2   | 1   | 2   |   |   |   |   | 4   |
|  |                          |   |   |   | VKM 14100  | 1   |   |   |   |   |   |   | 1   |
|  |                          |   |   |   | VKM 14103  | 1   |   |   |   |   |   |   | 1   |
|  |                          |   |   |   | VKM 24100  |   | 1   |   |   |   |   |   | 1   |
|  |                          |   |   |   |  |   |   |   |   |   |   |   |   |





|               |  |  |  |  |  |  |  |  |  |  |  |       |
|--|---|---|--|---|---|---|---|---|---|---|---|-------|
| D18TI  | 11/95 → 08/96   | 3), 4)  | VKMS 04106<br>VKMA 04106<br>VKM 14103<br>VKM 14105<br>VKM 24100                    | 2<br>2<br>1<br>1  | 1<br>1  | 2   |   |   |   | 3   | 9   | T0081 |
|  D18TI        | 06/93 → 08/96   |   | VKPC 84408   |   |   |   |   | 1   |   |   |   |       |
|  B(Alt) D18TI | 09/93 → 08/96   |   | VKMV 5PK870<br>VKM 34042   | 1   |   | 1   |   |   |   |   |   |       |
| B(AC) D18TI  | 09/93 → 08/96   |   | VKMV 5PK882<br>VKM 34043   | 1   |   | 1   |   |   |   |   |   |       |

### FORD MONDEO II 1.6 16V































|   |               |               |   |        |        |   |  |   |  |  |   |       |
|---|---------------|---------------|---|--------|--------|---|--|---|--|--|---|-------|
|  ZH16 Zetec        | 09/96 → 05/98 |               | VKMA 04212<br>VKM 14210<br>VKM 24210<br>VKM 24211 | 1<br>1 | 2<br>1 | 1 |  |   |  |  | 5 | T0104 |
| ZH16 Zetec  | 06/98 → 01/99 |               | VKMA 04213<br>VKM 14211<br>VKM 24212<br>VKM 24214 | 1<br>1 | 2<br>1 | 1 |  |   |  |  |   | T0162 |
| ZH16 Zetec  | 02/99 → 11/00 |               | VKMA 04214<br>VKM 14211<br>VKM 24213              | 1<br>1 | 1      | 1 |  |   |  |  |   | T0162 |
|  ZH16 Zetec        | 09/96 → 05/98 |               | VKPC 84407  |        |        |   |  | 1 |  |  |   |       |
| ZH16 Zetec  | 05/98 → 11/00 |               | VKPC 84415  |        |        |   |  | 1 |  |  |   |       |
|  B(Alt) ZH16 Zetec | 09/96 → 05/98 | AC            | VKMV 6PK1719<br>VKM 34047<br>VKM 34048            | 1      |        | 1 |  |   |  |  |   |       |
| B(Alt) ZH16 Zetec   | 05/98 → 11/00 | AC            | VKMV 6PK1973<br>VKM 34010<br>VKM_____             | 1      |        | 1 |  |   |  |  |   |       |
| B(Alt) ZH16 Zetec   | 09/96 → 05/98 | AC, Man. GBX  | VKMV 6PK2120<br>VKM 34047<br>VKM 34048            | 1      |        | 1 |  |   |  |  |   |       |
| B(Alt) ZH16 Zetec   | 05/98 → 11/00 | AC, Man. GBX  | VKMV 6PK2120<br>VKM 34010<br>VKM_____             | 1      |        | 1 |  |   |  |  |   |       |
| B(Alt) ZH16 Zetec   | 09/96 → 05/98 | AC, Auto. GBX | VKMV 6PK2080<br>VKM 34047<br>VKM 34048            | 1      |        | 1 |  |   |  |  |   |       |
| B(Alt) ZH16 Zetec   | 05/98 → 11/00 | AC, Auto. GBX | VKMV 6PK2103<br>VKM 34010<br>VKM_____             | 1      |        | 1 |  |   |  |  |   |       |

### FORD MONDEO II 1.8 16V

|   |               |              |   |        |        |   |  |   |  |  |   |       |
|---|---------------|--------------|---|--------|--------|---|--|---|--|--|---|-------|
|  ZH18 Zetec        | 09/96 → 05/98 |              | VKMA 04212<br>VKM 14210<br>VKM 24210<br>VKM 24211 | 1<br>1 | 2<br>1 | 1 |  |   |  |  | 5 | T0104 |
| ZH18 Zetec  | 06/98 → 01/99 |              | VKMA 04213<br>VKM 14211<br>VKM 24212<br>VKM 24214 | 1<br>1 | 2<br>1 | 1 |  |   |  |  |   | T0162 |
| ZH18 Zetec  | 02/99 → 11/00 |              | VKMA 04214<br>VKM 14211<br>VKM 24213              | 1<br>1 | 1      | 1 |  |   |  |  |   | T0162 |
|  ZH18 Zetec        | 09/96 → 05/98 |              | VKPC 84407  |        |        |   |  | 1 |  |  |   |       |
| ZH18 Zetec  | 05/98 → 11/00 |              | VKPC 84415  |        |        |   |  | 1 |  |  |   |       |
|  B(Alt) ZH18 Zetec | 09/96 → 05/98 | AC           | VKMV 6PK1719<br>VKM 34047<br>VKM 34048            | 1      |        | 1 |  |   |  |  |   |       |
| B(Alt) ZH18 Zetec   | 05/98 → 11/00 | AC           | VKMV 6PK1973<br>VKM 34010<br>VKM_____             | 1      |        | 1 |  |   |  |  |   |       |
| B(Alt) ZH18 Zetec   | 09/96 → 05/98 | AC, Man. GBX | VKMV 6PK2120<br>VKM 34047<br>VKM 34048            | 1      |        | 1 |  |   |  |  |   |       |



















































FORD

|  |  |  |       |   |  |  |  |  |  |  |  |  |
|--|---|---|--|---|---|---|---|---|---|---|---|---|
| B(Alt)   | ZH18 Zetec  | 05/98 → 11/00   | AC, Man. GBX   | VKMOV 6PK2120<br>VKM 34010<br>VKM_____  | 1   | 1   |   |   |   |   |   |   |
| B(Alt)   | ZH18 Zetec  | 09/96 → 05/98   | AC, Auto. GBX  | VKMOV 6PK2080<br>VKM 34047<br>VKM 34048   | 1   | 1   |   |   |   |   |   |   |
| B(Alt)   | ZH18 Zetec  | 05/98 → 11/00   | AC, Auto. GBX  | VKMOV 6PK2103<br>VKM 34010<br>VKM_____  | 1   | 1   |   |   |   |   |   |   |
| <b>FORD  MONDEO II 2.0 16V</b>    |   |   |  |   |   |   |   |   |   |   |   |   |
|                                    | ZH20 Zetec  | 09/96 → 05/98   |  | VKMA 04212<br>VKM 14210<br>VKM 24210<br>VKM 24211                                   | 1<br>1  | 2<br>1<br>1   | 1   |   |   |   |   | 5 T0104   |
|  | ZH20 Zetec  | 06/98 → 01/99   |  | VKMA 04213<br>VKM 14211<br>VKM 24212<br>VKM 24214                                   | 1<br>1  | 2<br>1<br>1   | 1   |   |   |   |   | T0162   |
|  | ZH20 Zetec  | 02/99 → 11/00   |  | VKMA 04214<br>VKM 14211<br>VKM 24213  | 1<br>1  | 1<br>1  | 1   |   |   |   |   | T0162   |
|                                    | ZH20 Zetec  | 09/96 → 05/98   |  | VKPC 84407  |   |   |   |   | 1   |   |   |   |
|                                    | ZH20 Zetec  | 05/98 → 11/00   |  | VKPC 84415  |   |   |   |   | 1   |   |   |   |
|                                    | B(Alt) ZH20 Zetec   | 09/96 → 05/98   | AC   | VKMOV 6PK1719<br>VKM 34047<br>VKM 34048   | 1   | 1   | 1   |   |   |   |   |   |
| B(Alt)   | ZH20 Zetec  | 05/98 → 11/00   | AC   | VKMOV 6PK1973<br>VKM 34010<br>VKM_____  | 1   | 1   | 1   |   |   |   |   |   |
| B(Alt)   | ZH20 Zetec  | 09/96 → 05/98   | AC, Man. GBX   | VKMOV 6PK2120<br>VKM 34047<br>VKM 34048   | 1   | 1   | 1   |   |   |   |   |   |
| B(Alt)   | ZH20 Zetec  | 05/98 → 11/00   | AC, Man. GBX   | VKMOV 6PK2120<br>VKM 34010<br>VKM_____  | 1   | 1   | 1   |   |   |   |   |   |
| B(Alt)   | ZH20 Zetec  | 09/96 → 05/98   | AC, Auto. GBX  | VKMOV 6PK2080<br>VKM 34047<br>VKM 34048   | 1   | 1   | 1   |   |   |   |   |   |
| B(Alt)   | ZH20 Zetec  | 05/98 → 11/00   | AC, Auto. GBX  | VKMOV 6PK2103<br>VKM 34010<br>VKM_____  | 1   | 1   | 1   |   |   |   |   |   |
| <b>FORD  MONDEO II 2.5 V6</b>   |   |   |  |   |   |   |   |   |   |   |   |   |
|                                  | Duratec   | 09/96 → 11/00   |  |  |   |   |   |   |   |   |   |   |
|                                  | Duratec   | 09/96 → 11/00   | 2)   | VKPA_____   |   |   |   |   | 1   |   |   |   |
| <b>FORD  MONDEO II 1.8 TD</b>   |   |   |  |   |   |   |   |   |   |   |   |   |
|                                  | D18TI   | 10/96 → 11/00   |  4) | —<br>VKMA 04107<br>VKM 14103<br>VKM 14107<br>VKM 24107                              | 2<br>2<br>1<br>1  | 1<br>1<br>1<br>1  | 2<br>2  | 1   |   |   |   | 4<br>4<br>1<br>1 T0081  |
|  | D18TI   | 09/96 → 09/96   | 3), 4)   | VKMS 04106<br>VKMA 04106<br>VKM 14103<br>VKM 14105<br>VKM 24100                     | 2<br>2<br>1<br>1  | 1<br>1<br>1<br>1  | 2<br>2  |   |   | 3   |   | 9<br>4<br>1<br>1<br>1 T0081   |
|                                  | D18TI   | 09/96 → 11/00   |  | VKPC 84408  |   |   |   |   | 1   |   |   |   |
|                                  | B(Alt) D18TI  | 09/96 → 11/00   |  | VKMOV 5PK870<br>VKM 34042   | 1   | 1   | 1   |   |   |   |   |   |
| B(AC)  | D18TI   | 09/96 → 11/00   |  | VKMOV 5PK882<br>VKM 34043   | 1   | 1   | 1   |   |   |   |   |   |
| <b>FORD  MONDEO III 1.8 16V</b> |   |   |  |   |   |   |   |   |   |   |   |   |
|                                  | Duratec   | 11/00 → 11/07   |  |  |   |   |   |   |   |   |   |   |
|                                  | Duratec   | 11/00 → 11/07   |  | VKPC 84622  |   |   |   |   | 1   |   |   |   |

|  | B(Alt) Duratec  | 11/00 → 11/05 |    | VKMV 6PK2227<br>VKM 34051<br>VKM 34052                            | 1 | 1 | 1 |  |  |  |  |   |  |  |  |  |  |  |  |       |       |
|--|-----------------|---------------|----|---|---|---|---|--|--|--|--|---|--|--|--|--|--|--|--|-------|-------|
|  | B(Alt) Duratec  | 11/05 → 11/07 |    | VKMV 6PK2222<br>VKM____<br>VKM 34052                              | 1 | 1 | 1 |  |  |  |  |   |  |  |  |  |  |  |  |       |       |
| <b>FORD  MONDEO III 2.0 16V</b>              |                 |               |    |   |   |   |   |  |  |  |  |   |  |  |  |  |  |  |  |       |       |
|  | Duratec         | 11/00 → 11/07 |    | <b>OXOXOXO</b>  |   |   |   |  |  |  |  |   |  |  |  |  |  |  |  |       |       |
|  | Duratec         | 11/00 → 11/07 |    | VKPC 84622  |   |   |   |  |  |  |  | 1 |  |  |  |  |  |  |  |       |       |
|  | B(Alt) Duratec  | 11/00 → 11/05 |    | VKMV 6PK2227<br>VKM 34051<br>VKM 34052                            | 1 | 1 | 1 |  |  |  |  |   |  |  |  |  |  |  |  |       |       |
|  | B(Alt) Duratec  | 11/05 → 11/07 |    | VKMV 6PK2222<br>VKM____<br>VKM 34052                              | 1 | 1 | 1 |  |  |  |  |   |  |  |  |  |  |  |  |       |       |
| <b>FORD  MONDEO III 2.5 V6</b>               |                 |               |    |   |   |   |   |  |  |  |  |   |  |  |  |  |  |  |  |       |       |
|  | Duratec         | 11/00 → 11/07 |    | <b>OXOXOXO</b>  |   |   |   |  |  |  |  |   |  |  |  |  |  |  |  |       |       |
|  | Duratec         | 11/00 → 11/07 | 2) | VKPA_____   |   |   |   |  |  |  |  | 1 |  |  |  |  |  |  |  |       |       |
|  | B(Alt) Duratec  | 11/00 → 11/07 |    | VKMV 6PK2080  |   |   | 1 |  |  |  |  |   |  |  |  |  |  |  |  |       |       |
|  | B(WP) Duratec   | 10/03 → 11/07 |    | VKMV 3PK649   |   |   | 1 |  |  |  |  |   |  |  |  |  |  |  |  |       |       |
| <b>FORD  MONDEO III 3.0 V6</b>               |                 |               |    |   |   |   |   |  |  |  |  |   |  |  |  |  |  |  |  |       |       |
|  | Duratec         | 04/02 → 11/07 |    | <b>OXOXOXO</b>  |   |   |   |  |  |  |  |   |  |  |  |  |  |  |  |       |       |
|  | Duratec         | 04/02 → 11/07 |    | —   |   |   |   |  |  |  |  | 1 |  |  |  |  |  |  |  |       |       |
|  | B(Alt) Duratec  | 04/02 → 11/07 |    | VKMV 6PK2080  |   |   | 1 |  |  |  |  |   |  |  |  |  |  |  |  |       |       |
|  | B(WP) Duratec   | 10/03 → 11/07 |    | VKMV 3PK649   |   |   | 1 |  |  |  |  |   |  |  |  |  |  |  |  |       |       |
| <b>FORD  MONDEO III 2.0 DI / TDDi / TDCi</b> |                 |               |    |   |   |   |   |  |  |  |  |   |  |  |  |  |  |  |  |       |       |
|  | Duratorq        | 11/00 → 11/07 |    | <b>OXOXOXO</b>  |   |   |   |  |  |  |  |   |  |  |  |  |  |  |  |       |       |
|  | Duratorq        | 11/00 → 11/07 | 2) | VKPA 84621  |   |   |   |  |  |  |  | 1 |  |  |  |  |  |  |  |       |       |
|  | B(Alt) Duratorq | 11/00 → 11/07 | AC | VKMA 34030<br>VKMV 6PK1642<br>VKM 34030<br>VKM 34031<br>VKM 34032 | 1 | 2 | 1 |  |  |  |  |   |  |  |  |  |  |  |  |       |       |
|  | B(PS) Duratorq  | 11/00 → 09/04 |    | VKMV 4PK735<br>VKM 34025  | 1 |   | 1 |  |  |  |  |   |  |  |  |  |  |  |  |       |       |
| <b>FORD  MONDEO III 2.2 TDCi</b>             |                 |               |    |   |   |   |   |  |  |  |  |   |  |  |  |  |  |  |  |       |       |
|  | Duratorq        | 09/04 → 11/07 |    | <b>OXOXOXO</b>  |   |   |   |  |  |  |  |   |  |  |  |  |  |  |  |       |       |
|  | Duratorq        | 09/04 → 11/07 | 2) | VKPA 84621  |   |   |   |  |  |  |  | 1 |  |  |  |  |  |  |  |       |       |
|  | B(Alt) Duratorq | 09/04 → 11/07 |    | VKMA 34030<br>VKMV 6PK1642<br>VKM 34030<br>VKM 34031<br>VKM 34032 | 1 | 2 | 1 |  |  |  |  |   |  |  |  |  |  |  |  |       |       |
|  |                 |               |    |   |   |   | 1 |  |  |  |  |   |  |  |  |  |  |  |  |       |       |
| <b>FORD  MONDEO IV 1.6 16V</b>               |                 |               |    |   |   |   |   |  |  |  |  |   |  |  |  |  |  |  |  |       |       |
|  | Duratec         | 03/07 → 11/07 |    | VKMA 04224<br>VKM 14224   | 1 |   | 1 |  |  |  |  |   |  |  |  |  |  |  |  | T0131 |       |
|  | Duratec         | 03/07 → 11/07 |    | —   | 1 |   |   |  |  |  |  | 1 |  |  |  |  |  |  |  |       |       |
| <b>FORD  MONDEO IV 2.0 16V</b>               |                 |               |    |   |   |   |   |  |  |  |  |   |  |  |  |  |  |  |  |       |       |
|  | Duratec         | 03/07 → 09/07 |    | <b>OXOXOXO</b>  |   |   |   |  |  |  |  |   |  |  |  |  |  |  |  |       |       |
|  | Duratec         | 03/07 → 09/07 |    | VKPC 84622  |   |   |   |  |  |  |  | 1 |  |  |  |  |  |  |  |       |       |
|  | B(Alt) Duratec  | 03/07 → 11/07 |    | VKMV 6PK2198<br>VKM____<br>VKM 34052                              | 1 | 1 | 1 |  |  |  |  |   |  |  |  |  |  |  |  |       |       |
| <b>FORD  MONDEO IV 2.5 20V</b>               |                 |               |    |   |   |   |   |  |  |  |  |   |  |  |  |  |  |  |  |       |       |
|  | Duratec         | 03/07 → 11/07 |    | VKMA 06040<br>VKM 16040<br>VKM 26602                              | 1 | 1 | 1 |  |  |  |  |   |  |  |  |  |  |  |  |       | T0163 |
|  | Duratec         | 03/07 → 09/07 |    | —   |   |   |   |  |  |  |  | 1 |  |  |  |  |  |  |  |       |       |
|  | B(Alt) Duratec  | 03/07 → 04/07 |    | VKMV 5PK1094  |   |   | 1 |  |  |  |  |   |  |  |  |  |  |  |  |       |       |
|  | B(AC) Duratec   | 03/07 → 04/07 |    | VKMV 5PK628   |   |   | 1 |  |  |  |  |   |  |  |  |  |  |  |  |       |       |

















































| <b>FORD  MONDEO IV 1.8 TDCi</b> |                              |               |  |                  |             |   |   |   |  |                  |       |
|---------------------------------|------------------------------|---------------|--|------------------|-------------|---|---|---|--|------------------|-------|
|                                 | LD18 Lynx                    | 03/07 → 11/07 | VKMA 04108<br>VKM 14108                                | 1<br>1           | 1           |   |   |   |  |                  | T0171 |
|                                 | LD18 Lynx                    | 03/07 → 11/07 | VKPC 84416   |                  |             |   | 1 |   |  |                  |       |
|                                 | <b>B(Alt)</b> LD18 Lynx      | 03/07 → 11/07 | VKMOV 6PK1688<br>VKM 34111<br>VKM_____                 | 1                | 1           |   |   |   |  |                  |       |
| <b>FORD  MONDEO IV 2.0 TDCi</b> |                              |               |  |                  |             |   |   |   |  |                  |       |
|                                 | Duratorq                     | 03/07 → 11/07 | VKMA 03257<br>VKM 13257<br>VKM 23257                   | 1<br>1           | 1<br>1      |   |   |   |  |                  | T0205 |
|                                 | Duratorq                     | 03/07 → 09/07 | VKPC 83643   |                  |             |   | 1 |   |  |                  |       |
|                                 | <b>B(Alt)</b> Duratorq       | 03/07 → 11/07 | VKMA 33320<br>VKMOV 6PK1217<br>VKM 33320               | 1<br>1           | 1<br>1      |   |   |   |  |                  |       |
| <b>FORD  ORION I 1.3</b>        |                              |               |  |                  |             |   |   |   |  |                  |       |
|                                 | HL13 CVH                     | 07/83 → 01/86 | VKMA 04200<br>VKM 14200                                | 1<br>1           | 1           |   |   |   |  |                  | T0070 |
|                                 | HL13 CVH                     | 07/83 → 12/85 | VKPC 84207   |                  |             |   | 1 |   |  |                  |       |
|                                 | HL13 CVH                     | 01/86 → 03/86 | VKPC 84208   |                  |             |   | 1 |   |  |                  |       |
|                                 | <b>B(Alt)</b> HL13 CVH       | 07/83 → 09/83 | VKMOV 10AVx800   |                  | 1           |   |   |   |  |                  |       |
| <b>FORD  ORION I 1.6</b>        |                              |               |  |                  |             |   |   |   |  |                  |       |
|                                 | HL16 CVH                     | 07/83 → 03/86 | VKMA 04201<br>VKM 14201                                | 1<br>1           | 1           |   |   |   |  |                  | T0070 |
|                                 | HL16 CVH                     | 07/83 → 12/85 | VKPC 84207   |                  |             |   | 1 |   |  |                  |       |
|                                 | HL16 CVH                     | 01/86 → 03/86 | VKPC 84208   |                  |             |   | 1 |   |  |                  |       |
|                                 | <b>B(Alt)</b> HL16 CVH       | 07/83 → 09/83 | Carbu. VKMOV 10AVx800                                  |                  | 1           |   |   |   |  |                  |       |
| <b>FORD  ORION I 1.6 D</b>      |                              |               |  |                  |             |   |   |   |  |                  |       |
|                                 | D16                          | 02/84 → 03/86 | VKMA 04101<br>VKM 14101                                | 1<br>1           | 1           |   |   |   |  | 1<br>1           | T0022 |
|                                 | D16                          | 02/84 → 03/86 | VKPC 84403   |                  |             |   | 1 |   |  |                  |       |
| <b>FORD  ORION II 1.3</b>       |                              |               |  |                  |             |   |   |   |  |                  |       |
|                                 | BL13 (OHV/HCS)               | 12/85 → 07/90 | <del>OXOXOXO</del>                                     |                  |             |   |   |   |  |                  |       |
|                                 | BL13 (OHV/HCS)               | 12/85 → 07/88 | VKPC 84205   |                  |             |   | 1 |   |  |                  |       |
|                                 | BL13 (OHV/HCS)               | 08/88 → 07/90 | VKPC 84209   |                  |             |   | 1 |   |  |                  |       |
|                                 | <b>B(Alt)</b> BL13 (OHV/HCS) | 12/85 → 07/88 | VKMOV 10AVx825   |                  | 1           |   |   |   |  |                  |       |
|                                 | <b>B(Alt)</b> BL13 (OHV/HCS) | 08/88 → 07/90 | VKMOV 10AVx813   |                  | 1           |   |   |   |  |                  |       |
| <b>FORD  ORION II 1.4</b>       |                              |               |  |                  |             |   |   |   |  |                  |       |
|                                 | HL14 CVH                     | 12/85 → 07/90 | VKMA 04201<br>VKM 14201                                | 1<br>1           | 1           |   |   |   |  |                  | T0070 |
|                                 | HL14 CVH                     | 12/85 → 07/90 | VKPC 84208   |                  |             |   | 1 |   |  |                  |       |
|                                 | <b>B(Alt)</b> HL14 CVH       | 12/85 → 12/88 | Carbu. AC VKMOV 11.9x758                               |                  | 1           |   |   |   |  |                  |       |
| <b>FORD  ORION II 1.6</b>       |                              |               |  |                  |             |   |   |   |  |                  |       |
|                                 | HL16 CVH                     | 12/85 → 07/90 | VKMA 04201<br>VKM 14201                                | 1<br>1           | 1           |   |   |   |  |                  | T0070 |
|                                 | HL16 CVH                     | 12/85 → 07/90 | VKPC 84208   |                  |             |   | 1 |   |  |                  |       |
|                                 | <b>B(Alt)</b> HL16 CVH       | 12/85 → 12/88 | Carbu. AC VKMOV 11.9x758                               |                  | 1           |   |   |   |  |                  |       |
| <b>FORD  ORION II 1.6 D</b>     |                              |               |  |                  |             |   |   |   |  |                  |       |
|                                 | D16                          | 12/85 → 01/89 | VKMA 04101<br>VKM 14101                                | 1<br>1           | 1           |   |   |   |  | 1<br>1           | T0022 |
|                                 | D16                          | 12/85 → 01/89 | VKPC 84403   |                  |             |   | 1 |   |  |                  |       |
|                                 | <b>B(Alt)</b> D16            | 12/85 → 01/89 | AC VKMOV 10AVx838                                      |                  | 1           |   |   |   |  |                  |       |
| <b>FORD  ORION II 1.8 D</b>     |                              |               |  |                  |             |   |   |   |  |                  |       |
|                                 | D18                          | 01/89 → 07/90 | —<br>VKMA 04103<br>VKM 14100<br>VKM 14103<br>VKM 24100 | 2<br>2<br>1<br>1 | 1<br>1<br>2 | 2 | 1 |   |  | 4<br>4<br>1<br>1 | T0081 |
|                                 | D18                          | 01/89 → 07/90 | 3), 4) VKMS 04103<br>VKMA 04103<br>VKM 14100           | 2<br>2<br>1      | 1<br>1<br>2 | 2 |   | 3 |  | 9<br>4<br>1      | T0081 |

|   |  |  |                                    |  |  |  |  |  |  |  |  |
|---|---|---|---|--|---|---|---|---|---|---|---|
|   |   |   |   | VKM 14103<br>VKM 24100   | 1   | 1   |   |   |   |   | 1<br>1  |
|                                  | D18   | 01/89 → 07/90   |   | VKPC 84620   |   |   | 1   |   |   |   |   |
|                                  | <b>B(Alt)</b> D18   | 01/89 → 07/90   | <b>AC</b>   | VKMV 3PK648  |   | 1   |   |   |   |   |   |
| <b>FORD  ORION III 1.3</b>       |   |   |   |  |   |   |   |   |   |   |   |
|                                  | BL13 (OHV/HCS)  | 07/90 → 12/93   |   | <b>OXOXOXO</b>   |   |   |   |   |   |   |   |
|                                  | BL13 (OHV/HCS)  | 07/90 → 04/91   |   | VKPC 84209   |   |   | 1   |   |   |   |   |
|   | BL13 (OHV/HCS)  | 05/91 → 12/93   |   | VKPC 84210   |   |   | 1   |   |   |   |   |
|                                  | <b>B(Alt)</b> BL13 (OHV/HCS)  | 06/92 → 12/93   |   | VKMV 10AVx800  |   | 1   |   |   |   |   |   |
| <b>FORD  ORION III 1.4</b>       |   |   |   |  |   |   |   |   |   |   |   |
|                                  | HL14 CVH  | 07/90 → 04/92   | <b>B</b> (58097x19.75 HSN),<br> 97 | VKMA 04201<br>VKM 14201  | 1<br>1  |   | 1   |   |   |   | T0070   |
|   | HL14 CVH  | 05/92 → 12/93   | <b>B</b> (58097x21.6 HSN),<br> 97  | VKMA 04202<br>VKM 14201  | 1<br>1  |   | 1   |   |   |   | T0070   |
|                                  | HL14 CVH  | 07/90 → 12/93   |   | VKPC 84208   |   |   |   | 1   |   |   |   |
|                                  | <b>B(Alt)</b> HL14 CVH  | 07/90 → 12/93   | <b>AC</b> ,                        | VKM 34013  |   | 1   |   |   |   |   |   |
| <b>FORD  ORION III 1.6</b>       |   |   |   |  |   |   |   |   |   |   |   |
|                                  | HL16 CVH  | 07/90 → 04/92   | <b>B</b> (58097x19.75 HSN),<br> 97 | VKMA 04201<br>VKM 14201  | 1<br>1  |   | 1   |   |   |   | T0070   |
|   | HL16 CVH  | 05/92 → 12/92   | <b>B</b> (58097x21.6 HSN),<br> 97  | VKMA 04202<br>VKM 14201  | 1<br>1  |   | 1   |   |   |   | T0070   |
|                                 | HL16 CVH  | 07/90 → 12/92   |   | VKPC 84208   |   |   |   | 1   |   |   |   |
|                                | <b>B(Alt)</b> HL16 CVH  | 07/90 → 12/92   | <b>AC</b> ,                      | VKM 34013  |   | 1   |   |   |   |   |   |
| <b>FORD  ORION III 1.6 16V</b> |   |   |   |  |   |   |   |   |   |   |   |
|                                | ZH16 Zetec  | 07/92 → 12/93   |                                  | VKMC 04212<br>VKMA 04212<br>VKM 14210<br>VKM 24210<br>VKM 24211                    | 1<br>1<br>1<br>1<br>1   | 2<br>2  | 1<br>1  |   | 1   |   | 5<br>5<br>T0104   |
|                                | ZH16 Zetec  | 07/92 → 12/93   |   | VKPC 84406   |   |   |   | 1   |   |   |   |
|                                | <b>B(Alt)</b> ZH16 Zetec  | 07/92 → 06/93   | <b>AC</b> ,                      | VKMV 6PK1810<br>VKM 34056<br>VKM 34061   | 1   |   | 1   |   |   |   |   |
| <b>FORD  ORION III 1.8 16V</b> |   |   |   |  |   |   |   |   |   |   |   |
|                                | ZH18 Zetec  | 01/92 → 12/93   |                                  | VKMC 04212<br>VKMA 04212<br>VKM 14210<br>VKM 24210<br>VKM 24211                    | 1<br>1<br>1<br>1<br>1   | 2<br>2  | 1<br>1  |   | 1   |   | 5<br>5<br>T0104   |
|                                | ZH18 Zetec  | 01/92 → 12/93   |   | VKPC 84406   |   |   |   | 1   |   |   |   |
|                                | <b>B(Alt)</b> ZH18 Zetec  | 01/92 → 06/93   | <b>AC</b> ,                      | VKMV 6PK1810<br>VKM 34056<br>VKM 34061   | 1   |   | 1   |   |   |   |   |
| <b>FORD  ORION III 1.8 D</b>   |   |   |   |  |   |   |   |   |   |   |   |
|                                | D18   | 11/90 → 12/93   |  4)                              | —<br>VKMA 04103<br>VKM 14100<br>VKM 14103<br>VKM 24100                             | 2<br>2<br>1<br>1  | 1<br>1  | 2<br>2  |   | 1   |   | 4<br>4<br>1<br>1<br>1<br>T0081  |
|   | D18   | 11/90 → 12/93   | 3), 4)  | VKMS 04103<br>VKMA 04103<br>VKM 14100<br>VKM 14103<br>VKM 24100                    | 2<br>2<br>1<br>1  | 1<br>1  | 2<br>2  |   |   | 3   | 9<br>4<br>1<br>1<br>1<br>T0081  |
|                                | D18   | 11/90 → 12/93   |   | VKPC 84620   |   |   |   | 1   |   |   |   |
| <b>FORD  ORION III 1.8 TD</b>  |   |   |   |  |   |   |   |   |   |   |   |
|                                | D18T, D18Ti   | 03/92 → 12/93   | 3), 4)  | VKMS 04103<br>VKMA 04103<br>VKM 14100<br>VKM 14103<br>VKM 24100                    | 2<br>2<br>1<br>1  | 1<br>1  | 2<br>2  |   |   | 3   | 9<br>4<br>1<br>1<br>1<br>T0081  |















































FORD

|   |  |  |  |  |  |  |  |  |  |  |  |  |
|---|---|---|---|--|---|---|---|---|---|---|---|---|
|                                 | D18T  | 03/92 → 12/93   |   | VKPC 84410   |   |   |   |   | 1   |   |   |   |
|   | D18TI   | 03/92 → 12/93   |   | VKPC 84409   |   |   |   |   | 1   |   |   |   |
| <b>FORD  PUMA 1.4 16V</b>      |   |   |   |  |   |   |   |   |   |   |   |   |
|                                 | ZH14 Zetec  | 11/97 → 10/00   |   | VKMA 04222<br>VKM 14222  | 1<br>1  | 1   |   |   |   |   |   | T0131   |
|                                 | ZH14 Zetec  | 11/97 → 10/00   |   | VKPC 84215   |   |   |   |   | 1   |   |   |   |
|                                 | <b>B(Alt)</b> ZH14 Zetec  | 11/97 → 10/00   | AC, ⊗   | VKMOV 6PK1181<br>VKM 34007<br>VKM 34034  | 1   |   | 1   |   |   |   |   |   |
|   | <b>B(Alt)</b> ZH14 Zetec  | 11/97 → 10/00   | AC, ⊗   | VKMOV 6PK1767<br>VKM 34007<br>VKM 34034  | 1   |   | 1   |   |   |   |   |   |
|   | <b>B(Alt)</b> ZH14 Zetec  | 11/97 → 10/00   | AC, ⊗   | VKMOV 6PK1930<br>VKM 34008<br>VKM 34034  | 1   |   | 1   |   |   |   |   |   |
| <b>FORD  PUMA 1.6 16V</b>      |   |   |   |  |   |   |   |   |   |   |   |   |
|                                 | ZH16 Zetec  | 08/00 → 10/07   |   | VKMA 04222<br>VKM 14222  | 1<br>1  | 1   |   |   |   |   |   | T0131   |
|                                 | ZH16 Zetec  | 08/00 → 10/07   |   | VKPC 84215   |   |   |   |   | 1   |   |   |   |
|                                 | <b>B(Alt)</b> ZH16 Zetec  | 08/00 → 10/07   | AC  | VKMOV 6PK1767<br>VKM 34007<br>VKM 34034  | 1   |   | 1   |   |   |   |   |   |
|   | <b>B(Alt)</b> ZH16 Zetec  | 08/00 → 10/07   | AC  | VKMOV 6PK1930<br>VKM 34008<br>VKM 34034  | 1   |   | 1   |   |   |   |   |   |
| <b>FORD  PUMA 1.7 16V</b>     |   |   |   |  |   |   |   |   |   |   |   |   |
|                               | ZH17 Zetec  | 03/97 → 10/07   | 5)  | VKMA 04223   | 1   | 1   |   |   |   |   |   | 2 T0131   |
|                               | ZH17 Zetec  | 03/97 → 10/07   |   | VKPC 84215   |   |   |   |   | 1   |   |   |   |
|                               | <b>B(Alt)</b> ZH17 Zetec  | 03/97 → 10/07   | AC  | VKMOV 6PK1930<br>VKM 34009<br>VKM 34034  | 1   |   | 1   |   |   |   |   |   |
| <b>FORD  RANGER 2.5 D</b>    |   |   |   |  |   |   |   |   |   |   |   |   |
|                               | WL  | 10/99 → 04/02   |   | VKMA 94616<br>VKM 74604  | 1<br>1  | 1   |   |   |   |   |   | T0661   |
|                               | WL  | 10/99 → 04/02   |   | —  |   |   |   |   | 1   |   |   |   |
|                               | <b>B(AC)</b> WL   | 10/99 → 04/02   |   | VKMOV 13AVx1000  |   |   | 1   |   |   |   |   |   |
| <b>FORD  RANGER 2.5 TD</b>   |   |   |   |  |   |   |   |   |   |   |   |   |
|                               | WL-T  | 10/99 → 06/07   |   | VKMA 94616<br>VKM 74604  | 1<br>1  | 1   |   |   |   |   |   | T0661   |
|                               | WL-T  | 10/99 → 09/07   |   | —  |   |   |   |   | 1   |   |   |   |
|                               | <b>B(AC)</b> WL-T   | 10/99 → 06/07   |   | VKMOV 13AVx1000  |   |   | 1   |   |   |   |   |   |
| <b>FORD  SCORPIO 1.8</b>     |   |   |   |  |   |   |   |   |   |   |   |   |
|                               | TL18H OHC   | 04/85 → 12/89   |   | VKMA 04001<br>VKM 14000  | 1<br>1  | 1   |   |   |   |   |   | T0030   |
|                               | TL18H OHC   | 04/85 → 02/92   |   | VKPC 84601   |   |   |   |   | 1   |   |   |   |
| <b>FORD  SCORPIO 2.0</b>     |   |   |   |  |   |   |   |   |   |   |   |   |
|                               | DL20  | 05/89 → 08/98   |   | OXOXOXO  |   |   |   |   |   |   |   |   |
|   | TL20 OHC  | 04/85 → 12/89   |   | VKMA 04001<br>VKM 14000  | 1<br>1  | 1   |   |   |   |   |   | T0030   |
|                               | DL20, TH20 OHC  | 05/89 → 08/98   |   | VKPC 84411   |   |   |   |   | 1   |   |   |   |
|   | TL20 OHC  | 04/85 → 09/94   |   | VKPC 84601   |   |   |   |   | 1   |   |   |   |
|                               | <b>B(Alt)</b> DL20  | 10/94 → 08/98   | AC  | VKMOV 6PK1755<br>VKM 34046   | 1   |   | 1   |   |   |   |   |   |
| <b>FORD  SCORPIO 2.0 16V</b> |   |   |   |  |   |   |   |   |   |   |   |   |
|                               | DH20  | 10/94 → 08/98   |   | OXOXOXO  |   |   |   |   |   |   |   |   |
|                               | DH20  | 10/94 → 08/98   |   | VKPC 84411   |   |   |   |   | 1   |   |   |   |
|                               | <b>B(Alt)</b> DH20  | 10/94 → 08/98   | AC  | VKMOV 6PK1755<br>VKM 34046   | 1   |   | 1   |   |   |   |   |   |
| <b>FORD  SCORPIO 2.3 16V</b> |   |   |   |  |   |   |   |   |   |   |   |   |
|                               | DH23  | 06/96 → 08/98   |   | OXOXOXO  |   |   |   |   |   |   |   |   |
|                               | DH23  | 06/96 → 08/98   |   | VKPC 84411   |   |   |   |   | 1   |   |   |   |









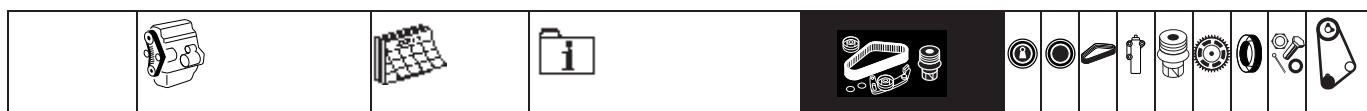



































|                              | B(Alt) | DH23               | 06/96 → 08/98 | AC, Man. GBX              | VKMV 6PK2040<br>VKM____<br>VKM 34046 | 1 | 1 | 1 |   |  |  |  |  |       |
|------------------------------|--------|--------------------|---------------|---------------------------|--------------------------------------|---|---|---|---|--|--|--|--|-------|
| <b>FORD  SCORPIO 2.4</b>     |        |                    |               |                           |                                      |   |   |   |   |  |  |  |  |       |
|                              |        | TV24               | 09/86 → 10/94 |                           | <b>Οι φίλοι</b>                      |   |   |   |   |  |  |  |  |       |
|                              |        | TV24               | 09/86 → 10/94 |                           | VKPC 84405                           |   |   |   | 1 |  |  |  |  |       |
| <b>FORD  SCORPIO 2.8</b>     |        |                    |               |                           |                                      |   |   |   |   |  |  |  |  |       |
|                              |        | TV28               | 04/85 → 11/86 |                           | <b>Οι φίλοι</b>                      |   |   |   |   |  |  |  |  |       |
|                              |        | TV28               | 04/85 → 11/86 |                           | VKPC 84609                           |   |   |   | 1 |  |  |  |  |       |
| <b>FORD  SCORPIO 2.9</b>     |        |                    |               |                           |                                      |   |   |   |   |  |  |  |  |       |
|                              |        | TV29               | 09/86 → 08/98 |                           | <b>Οι φίλοι</b>                      |   |   |   |   |  |  |  |  |       |
|                              |        | TV29               | 09/86 → 08/98 |                           | VKPC 84405                           |   |   |   | 1 |  |  |  |  |       |
| <b>FORD  SCORPIO 2.9 24V</b> |        |                    |               |                           |                                      |   |   |   |   |  |  |  |  |       |
|                              |        | CP29 Cosworth      | 04/91 → 08/98 |                           | <b>Οι φίλοι</b>                      |   |   |   |   |  |  |  |  |       |
|                              |        | CP29 Cosworth      | 04/91 → 08/98 |                           | VKPC 84405                           |   |   |   | 1 |  |  |  |  |       |
| <b>FORD  SCORPIO 2.5 D</b>   |        |                    |               |                           |                                      |   |   |   |   |  |  |  |  |       |
|                              |        | PD25               | 12/85 → 12/94 |                           | <b>Οι φίλοι</b>                      |   |   |   |   |  |  |  |  |       |
|                              |        | PD25               | 12/85 → 12/94 |                           | VKPC 83423                           |   |   |   | 1 |  |  |  |  |       |
| <b>FORD  SCORPIO 2.5 TD</b>  |        |                    |               |                           |                                      |   |   |   |   |  |  |  |  |       |
|                              |        | PD25T              | 06/88 → 07/93 |                           | <b>Οι φίλοι</b>                      |   |   |   |   |  |  |  |  |       |
|                              |        | VM25T              | 08/93 → 08/98 |                           | <b>Οι φίλοι</b>                      |   |   |   |   |  |  |  |  |       |
|                              |        | PD25T              | 06/88 → 07/93 |                           | VKPC 83604                           |   |   |   | 1 |  |  |  |  |       |
|                              |        | VM25T              | 08/93 → 09/96 |                           | VKPC 82642                           |   |   |   | 1 |  |  |  |  |       |
|                              |        | VM25T              | 10/96 → 08/98 |                           | VKPC 82810                           |   |   |   | 1 |  |  |  |  |       |
|                              | B(Alt) | VM25T              | 08/93 → 09/94 |                           | VKM 32017<br>VKM 32017<br>VKM 32017  |   |   | 1 | 1 |  |  |  |  |       |
|                              | B(Alt) | VM25T              | 10/94 → 09/96 | AC                        | VKM 32017<br>VKM 32017<br>VKM 32017  |   |   | 1 | 1 |  |  |  |  |       |
| <b>FORD  SIERRA 1.3</b>      |        |                    |               |                           |                                      |   |   |   |   |  |  |  |  |       |
|                              |        | JCT                | 08/82 → 12/86 |                           | VKMA 04000<br>VKM 14000              | 1 | 1 |   |   |  |  |  |  | T0029 |
|                              |        | JCT                | 08/82 → 12/86 |                           | VKPC 84600                           |   |   |   | 1 |  |  |  |  |       |
|                              |        | JCT                | 08/82 → 12/86 |                           | VKPC 84601                           |   |   |   | 1 |  |  |  |  |       |
| <b>FORD  SIERRA 1.6</b>      |        |                    |               |                           |                                      |   |   |   |   |  |  |  |  |       |
|                              |        | HL16 CVH           | 01/90 → 04/92 | B(58097x19.75 HSN),<br>97 | VKMA 04201<br>VKM 14201              | 1 | 1 |   |   |  |  |  |  | T0070 |
|                              |        | HL16 CVH           | 05/92 → 02/93 | B(58097x21.6 HSN),<br>97  | VKMA 04202<br>VKM 14201              | 1 | 1 |   |   |  |  |  |  | T0070 |
|                              |        | TL16 OHC           | 08/82 → 01/84 | 119, B(84119x19)          | VKMA 04000<br>VKM 14000              | 1 | 1 |   |   |  |  |  |  | T0029 |
|                              |        | TL16 OHC           | 02/84 → 12/86 | 122, B(84122x19)          | VKMA 04001<br>VKM 14000              | 1 | 1 |   |   |  |  |  |  | T0030 |
|                              |        | HL16 CVH, TL16 OHC | 08/82 → 02/93 |                           | VKPC 84600                           |   |   |   | 1 |  |  |  |  |       |
|                              |        | HL16 CVH, TL16 OHC | 08/82 → 02/93 |                           | VKPC 84601                           |   |   |   | 1 |  |  |  |  |       |
| <b>FORD  SIERRA 1.8</b>      |        |                    |               |                           |                                      |   |   |   |   |  |  |  |  |       |
|                              |        | HL18 CVH           | 10/84 → 02/93 |                           | VKMA 04204<br>VKM 14204              | 1 | 1 |   |   |  |  |  |  | T0048 |
|                              |        | TL18 OHC           | 10/84 → 05/88 |                           | VKMA 04001<br>VKM 14000              | 1 | 1 |   |   |  |  |  |  | T0030 |
|                              |        | HL18 CVH, TL18 OHC | 10/84 → 09/89 |                           | VKPC 84600                           |   |   |   | 1 |  |  |  |  |       |
|                              |        | HL18 CVH, TL18 OHC | 10/84 → 09/89 |                           | VKPC 84601                           |   |   |   | 1 |  |  |  |  |       |
|                              |        | HL18 CVH           | 05/88 → 02/93 |                           | VKPC 84610                           |   |   |   | 1 |  |  |  |  |       |
| <b>FORD  SIERRA 2.0</b>      |        |                    |               |                           |                                      |   |   |   |   |  |  |  |  |       |
|                              |        | DH20, DL20         | 01/90 → 02/93 |                           | <b>Οι φίλοι</b>                      |   |   |   |   |  |  |  |  |       |
|                              |        | TL20 OHC           | 01/92 → 02/93 |                           | VKMA 04001<br>VKM 14000              | 1 | 1 |   |   |  |  |  |  | T0030 |
|                              |        | DH20               | 11/87 → 01/90 |                           | VKPC 84601                           |   |   |   | 1 |  |  |  |  |       |
|                              |        | DL20, TL20 OHC     | 08/82 → 02/93 |                           | VKPC 84600                           |   |   |   | 1 |  |  |  |  |       |
|                              |        | DL20, TL20 OHC     | 08/82 → 02/93 |                           | VKPC 84601                           |   |   |   | 1 |  |  |  |  |       |
|                              |        | NYT                | 08/82 → 10/84 | Mot. 1  →                 | VKPC 84608                           |   |   |   | 1 |  |  |  |  |       |





|  |  |  |  |  |  |  |  |  |  |  |  |  |  |  |
|--|---|---|---|--|---|---|---|---|---|---|---|---|---|---|
|  | NYT   | 08/82 → 10/84   | Mot. 1   →  | VKPC 84607   |   |   |   |   | 1   |   |   |   |   |   |
|  | TH20 OHC  | 07/89 → 12/92   |   | VKPC 84411   |   |   |   |   | 1   |   |   |   |   |   |
|  | TL20 OHC  | 01/87 → 01/91   |   | VKPC 84411   |   |   |   |   | 1   |   |   |   |   |   |
|  | TL20 OHC  | 01/91 → 02/93   |   | VKPC 84412   |   |   |   |   | 1   |   |   |   |   |   |
| <b>FORD  SIERRA 2.0 16V</b>   |   |   |   |  |   |   |   |   |   |   |   |   |   |   |
|                                | N5C, N5D  | 01/90 → 02/93   |   | —  | 1   | 1   |   |   |   |   |   |   |   |   |
|  |   |   |   | —  | 1   |   |   |   |   |   |   |   |   |   |
| <b>FORD  SIERRA 2.3</b>       |   |   |   |  |   |   |   |   |   |   |   |   |   |   |
|                                | YYT   | 08/82 → 09/84   |   | VKPC 84608   |   |   |   |   | 1   |   |   |   |   |   |
|  | YYT   | 10/84 → 12/86   |   | VKPC 84609   |   |   |   |   | 1   |   |   |   |   |   |
| <b>FORD  SIERRA 2.8</b>       |   |   |   |  |   |   |   |   |   |   |   |   |   |   |
|                                | PR5, PR6, PRT   | 08/82 → 09/84   |   | VKPC 84608   |   |   |   |   | 1   |   |   |   |   |   |
|  | PR5, PR6, PR7, PR8, PRG, PRT  | 10/84 → 02/93   |   | VKPC 84609   |   |   |   |   | 1   |   |   |   |   |   |
| <b>FORD  SIERRA 2.9</b>       |   |   |   |  |   |   |   |   |   |   |   |   |   |   |
|                                | B4A, B4B, B4C   | 08/88 → 02/93   |   | VKPC 84405   |   |   |   |   | 1   |   |   |   |   |   |
| <b>FORD  SIERRA 1.8 TD</b>    |   |   |   |  |   |   |   |   |   |   |   |   |   |   |
|                                | D18T  | 08/88 → 02/93   | 3), 4)  | VKMS 04103   | 2   | 1   | 2   |   |   |   |   | 3   | 9   | T0081   |
|  |   |   |   | VKMA 04103   | 2   | 1   | 2   |   |   |   |   |   | 4   | T0081   |
|  |   |   |   | VKM 14100  | 1   |   |   |   |   |   |   |   | 1   |   |
|  |   |   |   | VKM 14103  | 1   |   |   |   |   |   |   |   | 1   |   |
|  |   |   |   | VKM 24100  |   | 1   |   |   |   |   |   |   | 1   |   |
|  | D18T  | 08/88 → 02/93   | 21)   | —  | 2   | 2   | 2   |   |   |   |   |   | 4   | T0081   |
|  |   |   |   | VKM 14100  | 1   |   |   |   |   |   |   |   | 1   |   |
|  |   |   |   | VKM 14103  | 1   |   |   |   |   |   |   |   | 1   |   |
|  |   |   |   | VKM 24100  |   | 1   |   |   |   |   |   |   | 1   |   |
|  |   |   |   | VKM 24104  |   | 1   |   |   |   |   |   |   | 1   |   |
|                              | D18T  | 08/88 → 02/93   |   | VKPC 84410   |   |   |   |   | 1   |   |   |   |   |   |
|                              | B(Alt) D18T   | 08/88 → 02/93   |   | VKMOV 3PK814   |   |   | 1   |   |   |   |   |   |   |   |
|  | B(PS) D18T  | 08/88 → 02/93   |   | VKMOV 3PK1023  |   |   | 1   |   |   |   |   |   |   |   |
|  |   |   |   | VKM 34003  | 1   |   |   |   |   |   |   |   |   |   |
|  | B(WP) D18T  | 08/88 → 02/93   |   | VKMOV 3PK828   |   |   | 1   |   |   |   |   |   |   |   |
|  |   |   |   | VKM 34002  | 1   |   |   |   |   |   |   |   |   |   |
| <b>FORD  SIERRA 2.3 D</b>   |   |   |   |  |   |   |   |   |   |   |   |   |   |   |
|                              | PD23  | 08/82 → 02/93   |   | <del>OKOKOK</del>  |   |   |   |   |   |   |   |   |   |   |
|                              | PD23  | 08/82 → 02/93   |   | VKPC 83423   |   |   |   |   | 1   |   |   |   |   |   |
| <b>FORD  S-MAX 2.0 16V</b>  |   |   |   |  |   |   |   |   |   |   |   |   |   |   |
|                              | Duratec   | 05/06 → 04/07   |   | <del>OKOKOK</del>  |   |   |   |   |   |   |   |   |   |   |
|                              | Duratec   | 05/06 → 09/07   |   | VKPC 84622   |   |   |   |   | 1   |   |   |   |   |   |
|                              | B(Alt) Duratec  | 05/06 → 04/07   |   | VKMOV 6PK2198  |   |   | 1   |   |   |   |   |   |   |   |
|  |   |   |   | VKM_____   | 1   | 1   |   |   |   |   |   |   |   |   |
|  |   |   |   | VKM 34052  |   |   |   |   |   |   |   |   |   |   |
| <b>FORD  S-MAX 2.5 20V</b>  |   |   |   |  |   |   |   |   |   |   |   |   |   |   |
|                              | Duratec   | 05/06 → 04/07   |   | VKMA 06040   | 1   | 1   | 1   |   |   |   |   |   |   | T0163   |
|  |   |   |   | VKM 16040  | 1   |   |   |   |   |   |   |   |   |   |
|  |   |   |   | VKM 26602  |   | 1   |   |   |   |   |   |   |   |   |
|                              | Duratec   | 05/06 → 09/07   |   | —  |   |   |   |   | 1   |   |   |   |   |   |
|                              | B(Alt) Duratec  | 05/06 → 04/07   |   | VKMOV 5PK1094  |   |   | 1   |   |   |   |   |   |   |   |
|  | B(AC) Duratec   | 05/06 → 04/07   |   | VKMOV 5PK628   |   |   | 1   |   |   |   |   |   |   |   |
| <b>FORD  S-MAX 1.8 TDCi</b> |   |   |   |  |   |   |   |   |   |   |   |   |   |   |
|                              | LD18 Lynx   | 05/06 → 04/07   |   | VKMA 04108   | 1   |   | 1   |   |   |   |   |   |   | T0171   |
|  |   |   |   | VKM 14108  | 1   |   |   |   |   |   |   |   |   |   |
|                              | LD18 Lynx   | 05/06 → 09/07   |   | VKPC 84416   |   |   |   |   | 1   |   |   |   |   |   |
|                              | B(Alt) LD18 Lynx  | 05/06 → 04/07   |   | VKMOV 6PK1688  |   |   | 1   |   |   |   |   |   |   |   |
|  |   |   |   | VKM 34111  | 1   | 1   |   |   |   |   |   |   |   |   |
|  |   |   |   | VKM_____   |   |   |   |   |   |   |   |   |   |   |
| <b>FORD  S-MAX 2.0 TDCi</b> |   |   |   |  |   |   |   |   |   |   |   |   |   |   |
|                              | Duratorq  | 05/06 → 04/07   |   | VKMA 03257   | 1   | 1   | 1   |   |   |   |   |   |   | T0205   |
|  |   |   |   | VKM 13257  | 1   |   |   |   |   |   |   |   |   |   |
|  |   |   |   | VKM 23257  |   | 1   |   |   |   |   |   |   |   |   |
|                              | Duratorq  | 05/06 → 09/07   |   | VKPC 83643   |   |   |   |   | 1   |   |   |   |   |   |
|                              | B(Alt) Duratorq   | 05/06 → 04/07   |   | VKM 33320  | 1   |   |   |   |   |   |   |   |   |   |







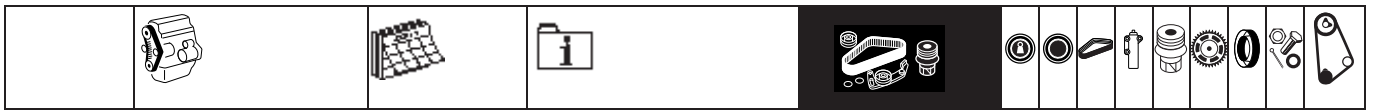































| FORD  STREET KA 1.6         |                   |               |                  |               |   |   |  |  |   |  |   |       |
|--|-------------------|---------------|------------------|---------------|---|---|--|--|---|--|---|-------|
|                             | ZL16 Zetec        | 05/03 → 07/05 | <b>OXOXOXO</b>   |               |   |   |  |  |   |  |   |       |
|                             | ZL16 Zetec        | 05/03 → 07/05 | VKPC 84629       |               |   |   |  |  | 1 |  |   |       |
|                             | B(Alt) ZL16 Zetec | 05/03 → 07/05 | <b>AC</b>        | VKMV          |   |   |  |  | 1 |  |   |       |
|                             | B(Alt) ZL16 Zetec | 05/03 → 07/05 | <b>AC</b>        | VKMV 6PK2196  |   |   |  |  | 1 |  |   |       |
| FORD  TAUNUS 1.3            |                   |               |                  |               |   |   |  |  |   |  |   |       |
|                             | JAC               | 01/70 → 02/76 |                  | VKPC 84600    |   |   |  |  | 1 |  |   |       |
| FORD  TAUNUS 1.6            |                   |               |                  |               |   |   |  |  |   |  |   |       |
|                             | LAD, LCJ          | 01/70 → 02/76 |                  | VKPC 84600    |   |   |  |  | 1 |  |   |       |
| FORD  ESCORT BOX 81 1.1     |                   |               |                  |               |   |   |  |  |   |  |   |       |
|                             | HL11 CVH          | 03/81 → 02/86 |                  | VKMA 04200    | 1 | 1 |  |  |   |  |   | T0070 |
|  |                   |               |                  | VKM 14200     | 1 |   |  |  |   |  |   |       |
|                             | HL11 CVH          | 03/81 → 02/86 |                  | VKPC 84205    |   |   |  |  | 1 |  |   |       |
|                             | B(Alt) HL11 CVH   | 08/83 → 02/86 |                  | VKMV 10AVx825 |   |   |  |  | 1 |  |   |       |
| FORD  ESCORT BOX 81 1.3     |                   |               |                  |               |   |   |  |  |   |  |   |       |
|                             | HL13 CVH          | 03/81 → 02/86 |                  | VKMA 04200    | 1 | 1 |  |  |   |  |   | T0070 |
|  |                   |               |                  | VKM 14200     | 1 |   |  |  |   |  |   |       |
|                             | HL13 CVH          | 03/81 → 12/85 |                  | VKPC 84207    |   |   |  |  | 1 |  |   |       |
|  | HL13 CVH          | 01/86 → 02/86 |                  | VKPC 84208    |   |   |  |  | 1 |  |   |       |
|                             | B(Alt) HL13 CVH   | 03/81 → 09/83 |                  | VKMV 10AVx800 |   |   |  |  | 1 |  |   |       |
| FORD  ESCORT BOX 81 1.6     |                   |               |                  |               |   |   |  |  |   |  |   |       |
|                             | HL16 CVH          | 03/81 → 06/83 |                  | VKMA          | 1 | 1 |  |  |   |  |   | T0070 |
|  |                   |               |                  | VKM 14200     | 1 |   |  |  |   |  |   |       |
|  | HL16 CVH          | 07/83 → 02/86 |                  | VKMA 04201    | 1 | 1 |  |  |   |  |   | T0070 |
|  |                   |               |                  | VKM 14201     | 1 |   |  |  |   |  |   |       |
|                           | HL16 CVH          | 03/81 → 12/85 |                  | VKPC 84207    |   |   |  |  | 1 |  |   |       |
|  | HL16 CVH          | 01/86 → 02/86 |                  | VKPC 84208    |   |   |  |  | 1 |  |   |       |
|                           | B(Alt) HL16 CVH   | 03/81 → 09/83 | <b>Carbu.</b>    | VKMV 10AVx800 |   |   |  |  | 1 |  |   |       |
| FORD  ESCORT BOX 81 1.6 D |                   |               |                  |               |   |   |  |  |   |  |   |       |
|                           | D16               | 02/84 → 02/86 |                  | VKMA 04101    | 1 | 1 |  |  |   |  | 1 | T0022 |
|  |                   |               |                  | VKM 14101     | 1 |   |  |  |   |  | 1 |       |
|                           | D16               | 02/84 → 02/86 |                  | VKPC 84403    |   |   |  |  | 1 |  |   |       |
| FORD  ESCORT BOX 86 1.1   |                   |               |                  |               |   |   |  |  |   |  |   |       |
|                           | HL11 CVH          | 05/86 → 12/87 |                  | VKMA 04200    | 1 | 1 |  |  |   |  |   | T0070 |
|  |                   |               |                  | VKM 14200     | 1 |   |  |  |   |  |   |       |
|                           | HL11 CVH          | 05/86 → 07/88 |                  | VKPC 84205    |   |   |  |  | 1 |  |   |       |
|  | HL11 CVH          | 08/88 → 07/90 |                  | VKPC 84209    |   |   |  |  | 1 |  |   |       |
|                           | B(Alt) HL11 CVH   | 05/86 → 08/88 |                  | VKMV 10AVx825 |   |   |  |  | 1 |  |   |       |
|                           | B(Alt) HL11 CVH   | 08/88 → 07/90 |                  | VKMV 10AVx813 |   |   |  |  | 1 |  |   |       |
| FORD  ESCORT BOX 86 1.3   |                   |               |                  |               |   |   |  |  |   |  |   |       |
|                           | HL13 CVH          | 02/86 → 07/88 |                  | VKPC 84205    |   |   |  |  | 1 |  |   |       |
|  | HL13 CVH          | 07/88 → 07/90 |                  | VKPC 84209    |   |   |  |  | 1 |  |   |       |
|  | HL13 CVH          | 08/88 → 07/90 |                  | VKPC 84209    |   |   |  |  | 1 |  |   |       |
|                           | B(Alt) HL13 CVH   | 02/86 → 08/88 |                  | VKMV 10AVx825 |   |   |  |  | 1 |  |   |       |
|                           | B(Alt) HL13 CVH   | 08/88 → 07/90 |                  | VKMV 10AVx813 |   |   |  |  | 1 |  |   |       |
| FORD  ESCORT BOX 86 1.4   |                   |               |                  |               |   |   |  |  |   |  |   |       |
|                           | HL14 CVH          | 02/86 → 07/90 |                  | VKMA 04201    | 1 | 1 |  |  |   |  |   | T0070 |
|  |                   |               |                  | VKM 14201     | 1 |   |  |  |   |  |   |       |
|                           | HL14 CVH          | 02/86 → 07/90 |                  | VKPC 84208    |   |   |  |  | 1 |  |   |       |
|                           | B(Alt) HL14 CVH   | 02/86 → 12/88 | <b>Carbu. AC</b> | VKMV 11.9x758 |   |   |  |  | 1 |  |   |       |
| FORD  ESCORT BOX 86 1.6   |                   |               |                  |               |   |   |  |  |   |  |   |       |
|                           | HL16 CVH          | 02/86 → 07/90 |                  | VKMA 04201    | 1 | 1 |  |  |   |  |   | T0070 |
|  |                   |               |                  | VKM 14201     | 1 |   |  |  |   |  |   |       |
|                           | HL16 CVH          | 02/86 → 07/90 |                  | VKPC 84208    |   |   |  |  | 1 |  |   |       |
| FORD  ESCORT BOX 86 1.6 D |                   |               |                  |               |   |   |  |  |   |  |   |       |
|                           | D16               | 02/86 → 07/90 |                  | VKMA 04101    | 1 | 1 |  |  |   |  | 1 | T0022 |
|  |                   |               |                  | VKM 14101     | 1 |   |  |  |   |  | 1 |       |
|                           | D16               | 02/86 → 07/90 |                  | VKPC 84403    |   |   |  |  | 1 |  |   |       |
|                           | B(Alt) D16        | 02/86 → 07/90 | <b>AC</b>        | VKMV 10AVx838 |   |   |  |  | 1 |  |   |       |









































| FORD  ESCORT BOX 86 1.8 D |                 |               |                           |             |   |   |   |  |   |  |   |  |   |       |
|---------------------------|-----------------|---------------|---------------------------|-------------|---|---|---|--|---|--|---|--|---|-------|
|                           | D18             | 07/88 → 07/90 | 4)                        | —           | 2 | 1 | 2 |  | 1 |  |   |  | 4 | T0081 |
|                           |                 |               |                           | VKMA 04103  | 2 | 1 | 2 |  |   |  |   |  | 4 |       |
|                           |                 |               |                           | VKM 14100   | 1 |   |   |  |   |  |   |  | 1 |       |
|                           |                 |               |                           | VKM 14103   | 1 |   |   |  |   |  |   |  | 1 |       |
|                           | D18             | 07/88 → 07/90 | 3), 4)                    | VKM 24100   |   | 1 |   |  |   |  |   |  | 1 |       |
|                           | D18             | 07/88 → 07/90 | 3), 4)                    | VKMS 04103  | 2 | 1 | 2 |  |   |  | 3 |  | 9 | T0081 |
|                           |                 |               |                           | VKMA 04103  | 2 | 1 | 2 |  |   |  |   |  | 4 |       |
|                           |                 |               |                           | VKM 14100   | 1 |   |   |  |   |  |   |  | 1 |       |
|                           |                 |               |                           | VKM 14103   | 1 |   |   |  |   |  |   |  | 1 |       |
|                           | D18             | 07/88 → 07/90 |                           | VKM 24100   |   | 1 |   |  |   |  |   |  | 1 |       |
|                           | D18             | 07/88 → 07/90 | AC                        | VKPC 84620  |   |   |   |  | 1 |  |   |  |   |       |
|                           | D18             | 07/88 → 07/90 | AC                        | VKMV 3PK648 |   |   | 1 |  |   |  |   |  |   |       |
| FORD  ESCORT BOX 91 1.3   |                 |               |                           |             |   |   |   |  |   |  |   |  |   |       |
|                           | HL13 CVH        | 07/90 → 04/91 |                           | VKPC 84209  |   |   |   |  | 1 |  |   |  |   |       |
|                           | HL13 CVH        | 05/91 → 12/94 |                           | VKPC 84210  |   |   |   |  | 1 |  |   |  |   |       |
| FORD  ESCORT BOX 91 1.4   |                 |               |                           |             |   |   |   |  |   |  |   |  |   |       |
|                           | HL14 CVH        | 07/90 → 04/92 | B(58097x19.75 HSN),<br>97 | VKMA 04201  | 1 |   | 1 |  |   |  |   |  |   | T0070 |
|                           |                 |               |                           | VKM 14201   | 1 |   |   |  |   |  |   |  |   |       |
|                           | HL14 CVH        | 05/92 → 12/94 | B(58097x21.6 HSN),<br>97  | VKMA 04202  | 1 |   | 1 |  |   |  |   |  |   | T0070 |
|                           |                 |               |                           | VKM 14201   | 1 |   |   |  |   |  |   |  |   |       |
|                           | HL14 CVH        | 07/90 → 12/94 |                           | VKPC 84208  |   |   |   |  | 1 |  |   |  |   |       |
|                           | B(Alt) HL14 CVH | 07/90 → 12/94 | AC,                       | VKM 34013   |   | 1 |   |  |   |  |   |  |   |       |
| FORD  ESCORT BOX 91 1.8 D |                 |               |                           |             |   |   |   |  |   |  |   |  |   |       |
|                           | D18             | 07/90 → 12/94 | 4)                        | —           | 2 | 1 | 2 |  | 1 |  |   |  | 4 | T0081 |
|                           |                 |               |                           | VKMA 04103  | 2 | 1 | 2 |  |   |  |   |  | 4 |       |
|                           |                 |               |                           | VKM 14100   | 1 |   |   |  |   |  |   |  | 1 |       |
|                           |                 |               |                           | VKM 14103   | 1 |   |   |  |   |  |   |  | 1 |       |
|                           | D18             | 07/90 → 12/94 | 3), 4)                    | VKM 24100   |   | 1 |   |  |   |  |   |  | 1 |       |
|                           | D18             | 07/90 → 12/94 | 3), 4)                    | VKMS 04103  | 2 | 1 | 2 |  |   |  | 3 |  | 9 | T0081 |
|                           |                 |               |                           | VKMA 04103  | 2 | 1 | 2 |  |   |  |   |  | 4 |       |
|                           |                 |               |                           | VKM 14100   | 1 |   |   |  |   |  |   |  | 1 |       |
|                           |                 |               |                           | VKM 14103   | 1 |   |   |  |   |  |   |  | 1 |       |
|                           | D18             | 07/90 → 12/94 |                           | VKM 24100   |   | 1 |   |  |   |  |   |  | 1 |       |
|                           | D18             | 07/90 → 12/94 |                           | VKPC 84620  |   |   |   |  | 1 |  |   |  |   |       |
| FORD  ESCORT BOX 95 1.4   |                 |               |                           |             |   |   |   |  |   |  |   |  |   |       |
|                           | HL14 CVH        | 01/95 → 10/07 | B(58097x21.6 HSN),<br>97  | VKMA 04202  | 1 |   | 1 |  |   |  |   |  |   | T0070 |
|                           |                 |               |                           | VKM 14201   | 1 |   |   |  |   |  |   |  |   |       |
|                           | HL14 CVH        | 01/95 → 09/07 |                           | VKPC 84208  |   |   |   |  | 1 |  |   |  |   |       |
|                           | B(Alt) HL14 CVH | 01/95 → 10/07 | AC,                       | VKM 34013   |   | 1 |   |  |   |  |   |  |   |       |
| FORD  ESCORT BOX 95 1.8 D |                 |               |                           |             |   |   |   |  |   |  |   |  |   |       |
|                           | D18             | 01/95 → 10/95 | 4)                        | —           | 2 | 1 | 2 |  | 1 |  |   |  | 4 | T0081 |
|                           |                 |               |                           | VKMA 04103  | 2 | 1 | 2 |  |   |  |   |  | 4 |       |
|                           |                 |               |                           | VKM 14100   | 1 |   |   |  |   |  |   |  | 1 |       |
|                           |                 |               |                           | VKM 14103   | 1 |   |   |  |   |  |   |  | 1 |       |
|                           | D18             | 11/95 → 01/97 | 4)                        | VKM 24100   |   | 1 |   |  |   |  |   |  | 1 |       |
|                           | D18             | 11/95 → 01/97 | 4)                        | VKMA 04106  | 2 | 1 | 2 |  | 1 |  |   |  | 4 | T0081 |
|                           |                 |               |                           | VKM 14103   | 2 | 1 | 2 |  |   |  |   |  | 4 |       |
|                           |                 |               |                           | VKM 14105   | 1 |   |   |  |   |  |   |  | 1 |       |
|                           |                 |               |                           | VKM 24100   | 1 |   |   |  |   |  |   |  | 1 |       |
|                           | D18             | 02/97 → 10/07 | 4)                        | VKM 24100   |   | 1 |   |  |   |  |   |  | 1 |       |
|                           | D18             | 02/97 → 10/07 | 4)                        | VKMA 04107  | 2 | 1 | 2 |  | 1 |  |   |  | 4 | T0081 |
|                           |                 |               |                           | VKM 14103   | 2 | 1 | 2 |  |   |  |   |  | 4 |       |
|                           |                 |               |                           | VKM 14107   | 1 |   |   |  |   |  |   |  | 1 |       |
|                           |                 |               |                           | VKM 24107   | 1 |   |   |  |   |  |   |  | 1 |       |
|                           | D18             | 01/95 → 10/95 | 3), 4)                    | VKM 24107   |   | 1 |   |  |   |  |   |  | 1 |       |
|                           | D18             | 01/95 → 10/95 | 3), 4)                    | VKMS 04103  | 2 | 1 | 2 |  |   |  | 3 |  | 9 | T0081 |
|                           |                 |               |                           | VKMA 04103  | 2 | 1 | 2 |  |   |  |   |  | 4 |       |
|                           |                 |               |                           | VKM 14100   | 1 |   |   |  |   |  |   |  | 1 |       |
|                           |                 |               |                           | VKM 14103   | 1 |   |   |  |   |  |   |  | 1 |       |
|                           | D18             | 11/95 → 01/97 | 3), 4)                    | VKM 24100   |   | 1 |   |  |   |  |   |  | 1 |       |
|                           | D18             | 11/95 → 01/97 | 3), 4)                    | VKMS 04106  | 2 | 1 | 2 |  |   |  | 3 |  | 9 | T0081 |
|                           |                 |               |                           | VKMA 04106  | 2 | 1 | 2 |  |   |  |   |  | 4 |       |

|   |  |  |       |  |  |  |  |  |  |  |  |  |
|---|---|---|--|--|---|---|---|---|---|---|---|---|
|   |   |   |  | VKM 14103  | 1   |   |   |   |   |   |   | 1   |
|   |   |   |  | VKM 14105  | 1   |   |   |   |   |   |   | 1   |
|   |   |   |  | VKM 24100  |   | 1   |   |   |   |   |   | 1   |
|    | D18   | 01/95 → 09/07   |  | VKPC 84620   |   |   |   | 1   |   |   |   |   |
|    | B(Alt) D18  | 01/95 → 10/07   | AC, ⊕  | VKMV 5PK705  |   |   | 1   |   |   |   |   |   |
| <b>FORD  ESCORT BOX 95 1.8 TD</b>          |   |   |  |  |   |   |   |   |   |   |   |   |
|    | D18T  | 02/97 → 06/01   |  4)   | —  | 2   | 1   | 2   |   | 1   |   |   | 4   |
|   |   |   |  | VKMA 04107   | 2   | 1   | 2   |   |   |   |   | 4   |
|   |   |   |  | VKM 14103  | 1   |   |   |   |   |   |   | 1   |
|   |   |   |  | VKM 14107  | 1   |   |   |   |   |   |   | 1   |
|   |   |   |  | VKM 24107  |   | 1   |   |   |   |   |   |   |
|   | D18T  | 12/95 → 01/97   | 3), 4)   | VKMS 04106   | 2   | 1   | 2   |   |   |   | 3   | 9   |
|   |   |   |  | VKMA 04106   | 2   | 1   | 2   |   |   |   |   | 4   |
|   |   |   |  | VKM 14103  | 1   |   |   |   |   |   |   | 1   |
|   |   |   |  | VKM 14105  | 1   |   |   |   |   |   |   | 1   |
|   |   |   |  | VKM 24100  |   | 1   |   |   |   |   |   | 1   |
|    | D18T  | 12/95 → 06/01   |  | VKPC 84409   |   |   |   |   | 1   |   |   |   |
|    | B(Alt) D18T   | 12/95 → 06/01   | AC, ⊕  | VKMV 5PK705  |   |   | 1   |   |   |   |   |   |
|   | B(Alt) D18T   | 12/95 → 06/01   | AC, ⊕  | VKMV 5PK1144   |   |   | 1   |   |   |   |   |   |
|   |   |   |  | VKM 34005  | 1   |   |   |   |   |   |   |   |
|   | B(PS) D18T  | 12/95 → 06/01   |  | VKMV 4PK654  |   |   | 1   |   |   |   |   |   |
|   |   |   |  | VKM 34004  | 1   |   |   |   |   |   |   |   |
| <b>FORD  FIESTA BOX / COURRIER 1.0</b>     |   |   |  |  |   |   |   |   |   |   |   |   |
|    | BL10 (OHV/HCS)  | 10/77 → 11/89   |  | OXOXOXO  |   |   |   |   |   |   |   |   |
|    | BL10 (OHV/HCS)  | 10/77 → 01/89   |  | VKPC 84205   |   |   |   |   | 1   |   |   |   |
| <b>FORD  FIESTA BOX / COURRIER 1.1</b>    |   |   |  |  |   |   |   |   |   |   |   |   |
|    | HL11 CVH  | 10/77 → 11/86   |  | VKMA 04200   | 1   |   | 1   |   |   |   |   | T0070   |
|   |   |   |  | VKM 14200  | 1   |   |   |   |   |   |   |   |
|    | HL11 CVH  | 10/77 → 11/86   |  | VKPC 84205   |   |   |   |   | 1   |   |   |   |
| <b>FORD  FIESTA BOX / COURRIER 1.3</b>   |   |   |  |  |   |   |   |   |   |   |   |   |
|    | BL13 (OHV/HCS)  | 09/91 → 05/07   |  | OXOXOXO  |   |   |   |   |   |   |   |   |
|    | BL13 (OHV/HCS)  | 09/91 → 02/96   |  | VKPC 84210   |   |   |   |   | 1   |   |   |   |
|   | BL13 (OHV/HCS)  | 02/96 → 09/07   |  | VKPC 84216   |   |   |   |   | 1   |   |   |   |
| <b>FORD  FIESTA BOX / COURRIER 1.4</b>   |   |   |  |  |   |   |   |   |   |   |   |   |
|    | HL14 CVH  | 04/96 → 10/99   |  | VKMA 04202   | 1   |   | 1   |   |   |   |   | T0070   |
|   |   |   |  | VKM 14201  | 1   |   |   |   |   |   |   |   |
|    | HL14 CVH  | 04/96 → 10/99   |  | VKPC 84215   |   |   |   |   | 1   |   |   |   |
|    | B(Alt) HL14 CVH   | 04/96 → 10/99   | AC, ⊕  | VKMV 6PK1181   |   |   | 1   |   |   |   |   |   |
|   |   |   |  | VKM 34007  | 1   |   |   |   |   |   |   |   |
|   |   |   |  | VKM 34034  |   | 1   |   |   |   |   |   |   |
|   | B(Alt) HL14 CVH   | 04/96 → 10/99   | AC, ⊕  | VKMV 6PK1780   |   |   | 1   |   |   |   |   |   |
|   |   |   |  | VKM 34007  | 1   |   |   |   |   |   |   |   |
|   |   |   |  | VKM 34034  |   | 1   |   |   |   |   |   |   |
|   | B(Alt) HL14 CVH   | 04/96 → 12/98   | AC, ⊕  | VKMV 6PK1750   |   |   | 1   |   |   |   |   |   |
|   |   |   |  | VKM 34007  | 1   |   |   |   |   |   |   |   |
|   |   |   |  | VKM 34034  |   | 1   |   |   |   |   |   |   |
|   | B(Alt) HL14 CVH   | 01/99 → 10/99   | AC, ⊕  | VKMV 6PK1767   |   |   | 1   |   |   |   |   |   |
|   |   |   |  | VKM 34007  | 1   |   |   |   |   |   |   |   |
|   |   |   |  | VKM 34034  |   | 1   |   |   |   |   |   |   |
|   | B(Alt) HL14 CVH   | 04/96 → 10/99   | AC, ⊕  | VKMV 6PK1930   |   |   | 1   |   |   |   |   |   |
|   |   |   |  | VKM 34008  | 1   |   |   |   |   |   |   |   |
|   |   |   |  | VKM 34034  |   | 1   |   |   |   |   |   |   |
| <b>FORD  FIESTA BOX / COURRIER 1.8 D</b> |   |   |  |  |   |   |   |   |   |   |   |   |
|    | D18   | 03/89 → 10/95   |  4) | —  | 2   | 1   | 2   |   | 1   |   |   | 4   |
|   |   |   |  | VKMA 04103   | 2   | 1   | 2   |   |   |   |   | 4   |
|   |   |   |  | VKM 14100  | 1   |   |   |   |   |   |   | 1   |
|   |   |   |  | VKM 14103  | 1   |   |   |   |   |   |   | 1   |
|   |   |   |  | VKM 24100  |   | 1   |   |   |   |   |   | 1   |
|   | D18   | 11/95 → 01/97   |  4) | —  | 2   | 1   | 2   |   | 1   |   |   | 4   |
|   |   |   |  | VKMA 04106   | 2   | 1   | 2   |   |   |   |   | 4   |
|   |   |   |  | VKM 14103  | 1   |   |   |   |   |   |   | 1   |
|   |   |   |  | VKM 14105  | 1   |   |   |   |   |   |   | 1   |
|   |   |   |  | VKM 24100  |   | 1   |   |   |   |   |   | 1   |



FORD

|  |  |  |             |  |  |  |  |  |  |  |  |       |
|--|---|---|--|--|---|---|---|---|---|---|---|-------|
|  | D18   | 02/97 → 11/07   |  4)         | —  | 2   | 1   | 2   |   | 1   |   | 4   |       |
|  |   |   |  | VKMA 04107   | 2   | 1   | 2   |   |   |   | 4   | T0081 |
|  |   |   |  | VKM 14103  | 1   |   |   |   |   |   | 1   |       |
|  |   |   |  | VKM 14107  | 1   |   |   |   |   |   | 1   |       |
|  |   |   |  | VKM 24107  |   | 1   |   |   |   |   |   |       |
|  | D18   | 03/89 → 10/95   | 3), 4)   | VKMS 04103   | 2   | 1   | 2   |   |   |   | 3   | 9     |
|  |   |   |  | VKMA 04103   | 2   | 1   | 2   |   |   |   | 4   | T0081 |
|  |   |   |  | VKM 14100  | 1   |   |   |   |   |   | 1   |       |
|  |   |   |  | VKM 14103  | 1   |   |   |   |   |   | 1   |       |
|  |   |   |  | VKM 24100  |   | 1   |   |   |   |   | 1   |       |
|  | D18   | 11/95 → 01/97   | 3), 4)   | VKMS 04106   | 2   | 1   | 2   |   |   |   | 3   | 9     |
|  |   |   |  | VKMA 04106   | 2   | 1   | 2   |   |   |   | 4   | T0081 |
|  |   |   |  | VKM 14103  | 1   |   |   |   |   |   | 1   |       |
|  |   |   |  | VKM 14105  | 1   |   |   |   |   |   | 1   |       |
|  |   |   |  | VKM 24100  |   | 1   |   |   |   |   | 1   |       |
|    | D18   | 03/89 → 09/07   |  | VKPC 84620   |   |   |   |   | 1   |   |   |       |
|    | B(Alt) D18  | 03/89 → 08/91   |  | VKMOV 3PK675   |   |   | 1   |   |   |   |   |       |
|  | B(Alt) D18  | 08/91 → 12/95   |  | VKMOV 3PK648   |   |   | 1   |   |   |   |   |       |
|  | B(Alt) D18  | 08/96 → 10/07   |  | VKMOV 5PK886   |   |   | 1   |   |   |   |   |       |
|  | B(PS) D18   | 03/89 → 02/96   |  | VKMOV 4PK654<br>VKM 34004  | 1   |   | 1   |   |   |   |   |       |
|  | B(PS) D18   | 02/96 → 10/07   | AC   | VKMOV 4PK654<br>VKM 34004  | 1   |   | 1   |   |   |   |   |       |
|  | B(PS) D18   | 02/96 → 10/07   | AC   | VKMOV 5PK672   |   |   | 1   |   |   |   |   |       |
| <b>FORD  FIESTA BOX / COURRIER 1.8 DI</b> |   |   |  |  |   |   |   |   |   |   |   |       |
|   | LD18 Lynx   | 03/00 → 11/07   | 20)  | VKMA 04108<br>VKM 14108  | 1   |   | 1   |   |   |   |   | T0171 |
|    | LD18 Lynx   | 09/00 → 09/07   |  | VKPC 84416   |   |   |   |   | 1   |   |   |       |
|    | B(Alt) LD18 Lynx  | 03/00 → 10/07   | AC   | VKMOV 6PK1687<br>VKM 34034<br>VKM 34111  |   |   | 1   |   |   |   |   |       |
|  | B(Alt) LD18 Lynx  | 03/00 → 10/07   | AC   | VKMOV 6PK1610<br>VKM 34034<br>VKM 34107  |   |   | 1   |   |   |   |   |       |
| <b>FORD  P 100 I 1.6</b>                |   |   |  |  |   |   |   |   |   |   |   |       |
|    | LCR   | 04/82 → 09/87   |  | VKMA 04000<br>VKM 14000  | 1   |   | 1   |   |   |   |   | T0029 |
|    | LCR   | 04/82 → 09/87   |  | VKPC 84600   |   |   |   |   | 1   |   |   |       |
| <b>FORD  P 100 II 2.0</b>               |   |   |  |  |   |   |   |   |   |   |   |       |
|    | NAE   | 10/87 → 10/07   |  | VKMA 04001<br>VKM 14000  | 1   |   | 1   |   |   |   |   | T0030 |
| <b>FORD  P 100 II 1.8 TD</b>            |   |   |  |  |   |   |   |   |   |   |   |       |
|    | D18T  | 10/87 → 12/92   | 3), 4)   | VKMS 04103<br>VKMA 04103<br>VKM 14100<br>VKM 14103<br>VKM 24100                    | 2   | 1   | 2   |   |   |   | 3   | 9     |
|  |   |   |  |  | 2   | 1   | 2   |   |   |   | 4   | T0081 |
|  |   |   |  |  | 1   |   |   |   |   |   | 1   |       |
|  |   |   |  |  | 1   |   |   |   |   |   | 1   |       |
|  |   |   |  |  |   | 1   |   |   |   |   | 1   |       |
|    | D18T  | 10/87 → 12/92   |  | VKPC 84410   |   |   |   |   | 1   |   |   |       |
|    | B(Alt) D18T   | 10/87 → 12/92   |  | VKMOV 3PK814   |   |   | 1   |   |   |   |   |       |
|  | B(PS) D18T  | 10/87 → 12/92   |  | VKMOV 3PK1023<br>VKM 34003   | 1   |   | 1   |   |   |   |   |       |
|  | B(WP) D18T  | 10/87 → 12/92   |  | VKMOV 3PK828<br>VKM 34002  | 1   |   | 1   |   |   |   |   |       |
| <b>FORD  TRANSIT 1.5</b>                |   |   |  |  |   |   |   |   |   |   |   |       |
|    | EX  | 01/71 → 05/73   |  | VKPC 84400   |   |   |   |   | 1   |   |   |       |
| <b>FORD  TRANSIT 1.6</b>                |   |   |  |  |   |   |   |   |   |   |   |       |
|    | TL16  | 01/78 → 09/92   |  | VKMA 04000<br>VKM 14000  | 1   |   | 1   |   |   |   |   | T0029 |
|    | TL16  | 01/78 → 07/87   |  Auto.FAN | VKPC 84601   |   |   |   |   | 1   |   |   |       |
|  | TL16  | 01/78 → 07/87   |  Auto.FAN | VKPC 84601   |   |   |   |   | 1   |   |   |       |
| <b>FORD  TRANSIT 1.7</b>                |   |   |  |  |   |   |   |   |   |   |   |       |
|    | EY  | 04/71 → 03/78   |  | VKPC 84400   |   |   |   |   | 1   |   |   |       |

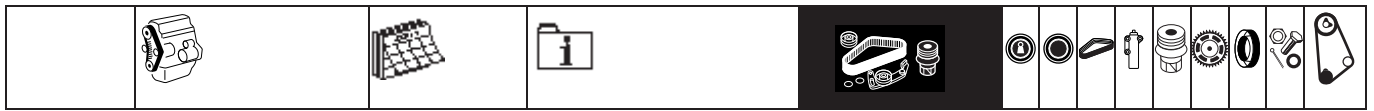

































| FORD  TRANSIT 2.0      |                            |                  |                 |               |   |   |   |   |  |       |
|------------------------|----------------------------|------------------|-----------------|---------------|---|---|---|---|--|-------|
|                        | DL20                       | 06/94 → 03/00    |                 | <b>ΟΧΘΟΧΟ</b> |   |   |   |   |  |       |
|                        | TL20                       | 01/78 → 09/94    |                 | VKMA 04001    | 1 |   | 1 |   |  | T0030 |
|                        |                            |                  |                 | VKM 14000     | 1 |   |   |   |  |       |
|                        | DL20                       | 06/94 → 03/00    |                 | VKPC 84411    |   |   |   | 1 |  |       |
|                        | TL20                       | 10/85 → 09/94    |                 | VKPC 84601    |   |   |   | 1 |  |       |
|                        | <b>B(Alt)</b> DL20         | 06/94 → 03/00    | <b>AC, ⊕</b>    | VKMV 6PK1800  |   |   | 1 |   |  |       |
|                        |                            |                  |                 | VKM 34040     | 1 |   |   |   |  |       |
| FORD  TRANSIT 2.3 16V  |                            |                  |                 |               |   |   |   |   |  |       |
|                        | Duratec                    | 07/06 → 11/07    |                 | <b>ΟΧΘΟΧΟ</b> |   |   |   |   |  |       |
|                        | DH23                       | 04/01 → 05/07    |                 | <b>ΟΧΘΟΧΟ</b> |   |   |   |   |  |       |
|                        | DH23                       | 04/01 → 04/05    |                 | VKPC 84411    |   |   |   | 1 |  |       |
|                        | <b>B(Alt)</b> Duratec      | 07/06 → 11/07    | <b>AC</b>       | VKM 34051     |   | 1 |   |   |  |       |
|                        |                            |                  |                 | VKM 34052     | 1 |   |   |   |  |       |
|                        | <b>B(Alt)</b> Duratec      | 07/06 → 11/07    | <b>AC</b>       | VKM 34051     |   | 1 |   |   |  |       |
|                        |                            |                  |                 | VKM 34052     | 1 |   |   |   |  |       |
|                        | <b>B(Alt)</b> DH23         | 04/01 → 12/05    | <b>AC</b>       | VKMV 6PK1780  |   |   | 1 |   |  |       |
|                        |                            |                  |                 | VKM 34046     | 1 |   |   |   |  |       |
|                        | <b>B(Alt)</b> DH23         | 04/01 → 12/05    | <b>AC</b>       | VKMV 6PK1954  |   | 1 |   |   |  |       |
|                        |                            |                  |                 | VKM _____     |   | 1 |   |   |  |       |
|                        |                            |                  |                 | VKM 34046     | 1 |   |   |   |  |       |
| FORD  TRANSIT 2.9      |                            |                  |                 |               |   |   |   |   |  |       |
|                        | TV29                       | 01/91 → 05/07    |                 | <b>ΟΧΘΟΧΟ</b> |   |   |   |   |  |       |
|                        | TV29                       | 01/91 → 07/05    |                 | VKPC 84405    |   |   |   | 1 |  |       |
| FORD  TRANSIT 2.0 D    |                            |                  |                 |               |   |   |   |   |  |       |
|                        | Duratorq                   | 08/00 → 05/07    |                 | <b>ΟΧΘΟΧΟ</b> |   |   |   |   |  |       |
|                        | Duratorq                   | 08/00 → 12/04 2) |                 | VKPA 84621    |   |   |   | 1 |  |       |
|                        | <b>B(Alt)</b> Duratorq     | 08/00 → 12/05    | <b>AC</b>       | VKMA 34031    | 1 | 2 | 1 |   |  |       |
|                        |                            |                  |                 | VKMV 6PK1636  |   |   | 1 |   |  |       |
|                        |                            |                  |                 | VKM 34030     |   | 1 |   |   |  |       |
|                        |                            |                  |                 | VKM 34031     |   | 1 |   |   |  |       |
|                        |                            |                  |                 | VKM 34032     | 1 |   |   |   |  |       |
|                        | <b>B(PS)</b> Duratorq      | 08/00 → 12/05    |                 | VKMV 4PK735   |   |   | 1 |   |  |       |
|                        |                            |                  |                 | VKM 34025     | 1 |   |   |   |  |       |
| FORD  TRANSIT 2.0 TDCi |                            |                  |                 |               |   |   |   |   |  |       |
|                        | Duratorq                   | 08/02 → 05/07    |                 | <b>ΟΧΘΟΧΟ</b> |   |   |   |   |  |       |
|                        | Duratorq                   | 08/02 → 12/04 2) |                 | VKPA 84621    |   |   |   | 1 |  |       |
|                        | <b>B(Alt)</b> Duratorq     | 08/02 → 12/05    | <b>AC</b>       | VKMA 34031    | 1 | 2 | 1 |   |  |       |
|                        |                            |                  |                 | VKMV 6PK1636  |   |   | 1 |   |  |       |
|                        |                            |                  |                 | VKM 34030     |   | 1 |   |   |  |       |
|                        |                            |                  |                 | VKM 34031     |   | 1 |   |   |  |       |
|                        |                            |                  |                 | VKM 34032     | 1 |   |   |   |  |       |
|                        | <b>B(PS)</b> Duratorq      | 08/02 → 12/05    |                 | VKMV 4PK735   |   |   | 1 |   |  |       |
|                        |                            |                  |                 | VKM 34025     | 1 |   |   |   |  |       |
| FORD  TRANSIT 2.2 TDCi |                            |                  |                 |               |   |   |   |   |  |       |
|                        | Duratorq                   | 07/06 → 11/07    |                 | <b>ΟΧΘΟΧΟ</b> |   |   |   |   |  |       |
|                        | Duratorq                   | 07/06 → 08/06 2) |                 | VKPA _____    |   |   |   | 1 |  |       |
|                        | <b>B(Alt)</b> Duratorq     | 07/06 → 11/07    | <b>AC</b>       | VKMV 6PK1670  |   |   | 1 |   |  |       |
|                        |                            |                  |                 | VKM 34030     |   | 1 |   |   |  |       |
|                        |                            |                  |                 | VKM _____     | 1 |   |   |   |  |       |
|                        |                            |                  |                 | VKM _____     |   | 1 |   |   |  |       |
| FORD  TRANSIT 2.4 D    |                            |                  |                 |               |   |   |   |   |  |       |
|                        | PD24N, PD24P               | 01/00 → 05/07    |                 | <b>ΟΧΘΟΧΟ</b> |   |   |   |   |  |       |
|                        | 4AA                        | 11/77 → 12/85    |                 | VKMA 04300    | 1 |   | 1 |   |  | T0008 |
|                        |                            |                  |                 | VKM 14300     | 1 |   |   |   |  |       |
|                        | 4AA                        | 11/77 → 03/84    | <b>Fix.FAN</b>  | VKPC 84603    |   |   |   | 1 |  |       |
|                        | 4AA                        | 01/80 → 10/86    | <b>Auto.FAN</b> | VKPC 84616    |   |   |   | 1 |  |       |
|                        | PD24N, PD24P               | 01/00 → 12/04 2) |                 | VKPA 84623    |   |   |   | 1 |  |       |
|                        | <b>B(Alt)</b> PD24N, PD24P | 01/00 → 12/05    | <b>AC</b>       | VKMV _____    |   |   | 1 |   |  |       |
|                        |                            |                  |                 | VKM 34071     | 1 |   |   |   |  |       |
|                        |                            |                  |                 | VKM 34072     |   | 1 |   |   |  |       |
|                        |                            |                  |                 | VKM _____     |   | 1 |   |   |  |       |



|  | <b>B(Alt)</b> | PD24N, PD24P   | 01/00 → 12/05 | <b>AC</b>     | VKM 34071<br>VKM 34072<br>VKM_____               | 1 |   |   | 1 |   |   |  |  |         |
|--|---------------|--|---------------|---------------|--|---|---|---|---|---|---|--|--|---------|
| <b>FORD  TRANSIT 2.4 TD, 2.4 TDi</b>                   |               |  |               |               |  |   |   |   |   |   |   |  |  |         |
|  |               | PD24PP   | 07/01 → 05/07 |               | <b>OXOXOXO</b>                                   |   |   |   |   |   |   |  |  |         |
|  |               | PD24PP   | 07/01 → 12/04 | 2)            | VKPA 84623                                       |   |   |   |   | 1 |   |  |  |         |
|  | <b>B(Alt)</b> | PD24PP   | 07/01 → 12/05 | <b>AC</b>     | VKMV_____<br>VKM 34071<br>VKM 34072<br>VKM_____  | 1 |   | 1 |   |   |   |  |  |         |
|  | <b>B(Alt)</b> | PD24PP   | 07/01 → 12/05 | <b>AC</b>     | VKM 34071<br>VKM 34072<br>VKM_____               | 1 |   |   | 1 |   |   |  |  |         |
| <b>FORD  TRANSIT 2.4 TDCi</b>                          |               |  |               |               |  |   |   |   |   |   |   |  |  |         |
|  |               | Duratorq   | 03/04 → 11/07 |               | <b>OXOXOXO</b>                                   |   |   |   |   |   |   |  |  |         |
|  |               | Duratorq   | 07/06 → 11/06 | 2)            | VKPA_____  |   |   |   |   | 1 |   |  |  |         |
|  | <b>B(Alt)</b> | Duratorq   | 07/06 → 11/07 | <b>AC</b>     | VKM_____<br>VKM_____<br>VKM_____                 | 1 |   | 1 |   |   |   |  |  |         |
|  | <b>B(Alt)</b> | Duratorq   | 07/06 → 11/07 | <b>AC</b>     | VKMV 7PK2842<br>VKM_____<br>VKM_____<br>VKM_____ | 1 |   |   | 1 |   |   |  |  |         |
| <b>FORD  TRANSIT 2.5 D</b>                             |               |  |               |               |  |   |   |   |   |   |   |  |  |         |
|  |               | 4AB, 4BA, 4BC, 4CA,<br>4CC, 4DA, 4FA   | 12/85 → 07/91 | <b>M⊙</b>     | VKMA 04301<br>VKM 14301                          | 1 |   | 1 |   |   |   |  |  | T0027   |
|  |               | 4AB, 4BA, 4BC, 4CA,<br>4CC, 4DA, 4FA, 4FB,<br>4FC, 4FD, 4GA, 4HB,<br>4HC, D25N, D25P | 08/91 → 06/97 | <b>A⊙, 5)</b> | VKMA 04304                                       | 1 |   | 1 |   |   |   |  |  | 1 T0185 |
|  |               | 4ED, 4FA, 4FB, 4FC,<br>4FD, 4HB, 4HC, D25N,<br>D25P                                  | 07/97 → 03/00 | <b>A⊙, 5)</b> | VKMA 04305                                       | 1 |   | 1 |   |   |   |  |  | 1 T0186 |
|  |               | 4AB  | 10/83 → 12/85 |               | VKPC 84617                                       |   |   |   |   | 1 |   |  |  |         |
|  |               | 4AB, 4BA, 4BC, 4CA,<br>4CC, 4DA, 4ED, 4FA,<br>4FB, 4FC, 4FD, 4GA,<br>4HB, 4HC        | 01/86 → 03/00 |               | VKPC 84618                                       |   |   |   |   |   | 1 |  |  |         |
|  | <b>B(PS)</b>  | 4ED, 4FA, 4FB, 4FC,<br>4FD, 4HB, 4HC   | 06/94 → 03/00 | <b>AC</b>     | VKMV 6PK1430                                     |   |   |   | 1 |   |   |  |  |         |
| <b>FORD  TRANSIT 2.5 TD</b>                            |               |  |               |               |  |   |   |   |   |   |   |  |  |         |
|  |               | 4EA  | 05/91 → 07/91 | <b>M⊙</b>     | VKMA 04301<br>VKM 14301                          | 1 |   | 1 |   |   |   |  |  | T0027   |
|  |               | 4EA, 4EB, 4EC, 4GA,<br>4GB, 4GC, 4GD, 4GE,<br>4GF, 4HA, 4HD                          | 08/91 → 06/97 | <b>A⊙, 5)</b> | VKMA 04304                                       | 1 |   | 1 |   |   |   |  |  | 1 T0185 |
|  |               | 4EB, 4EC, 4GA, 4GB,<br>4GC, 4GD, 4GE, 4GF,<br>4HA, 4HD                               | 07/97 → 05/07 | <b>A⊙, 5)</b> | VKMA 04305                                       | 1 |   | 1 |   |   |   |  |  | 1 T0186 |
|  |               | 4EA, 4EB, 4EC, 4GA,<br>4GB, 4GC, 4GD, 4GE,<br>4GF, 4HA, 4HD                          | 05/91 → 07/05 |               | VKPC 84618                                       |   |   |   |   |   | 1 |  |  |         |
|  | <b>B(PS)</b>  | 4EB, 4EC, 4GA, 4GB,<br>4GC, 4GD, 4GE, 4GF  | 06/94 → 03/00 | <b>AC</b>     | VKMV 6PK1430                                     |   |   |   | 1 |   |   |  |  |         |
| <b>FORD  TRANSIT 2.5 TDI</b>                           |               |  |               |               |  |   |   |   |   |   |   |  |  |         |
|  |               | 4EB, 4EC   | 06/94 → 06/97 | <b>A⊙, 5)</b> | VKMA 04304                                       | 1 |   | 1 |   |   |   |  |  | 1 T0185 |
|  |               | 4EB, 4EC   | 07/97 → 03/00 | <b>A⊙, 5)</b> | VKMA 04305                                       | 1 |   | 1 |   |   |   |  |  | 1 T0186 |
|  |               | 4EB, 4EC   | 06/94 → 03/00 |               | VKPC 84618                                       |   |   |   |   |   | 1 |  |  |         |
|  | <b>B(PS)</b>  | 4EB, 4EC   | 06/94 → 03/00 | <b>AC</b>     | VKMV 6PK1430                                     |   |   |   | 1 |   |   |  |  |         |
| <b>FORD  TRANSIT CONNECT / TOURNEO CONNECT 1.8 16V</b> |               |  |               |               |  |   |   |   |   |   |   |  |  |         |
|  |               | ZH18 Zetec   | 06/02 → 02/06 |               | VKMA 04214<br>VKM 14211<br>VKM 24213             | 1 | 1 | 1 |   |   |   |  |  | T0162   |
|  |               | ZH18 Zetec   | 06/02 → 04/05 |               | VKPC 84415                                       |   |   |   |   |   | 1 |  |  |         |

































































|  |  |  |  |  |  |  |  |  |  |  |  |  |
|--|---|---|---|--|---|---|---|---|---|---|---|---|
|   | <b>B(Alt)</b> ZH18 Zetec  | 06/02 → 12/05   | <i>AC</i>   | VKMV 6PK1973<br>VKM 34010<br>VKM_____  | 1   |   | 1   |   |   |   |   |   |
|  | <b>B(Alt)</b> ZH18 Zetec  | 06/02 → 12/05   | <b>AC</b>   | VKMV 6PK2103<br>VKM 34010<br>VKM_____  | 1   |   | 1   |   |   |   |   |   |
|  |   |   |   |  |   |   | 1   |   |   |   |   |   |
|  |   |   |   |  |   |   | 1   |   |   |   |   |   |
| <b>FORD  TRANSIT CONNECT / TOURNEO CONNECT 1.8 Di</b>   |   |   |   |  |   |   |   |   |   |   |   |   |
|   | LD18 Lynx   | 06/02 → 02/06   | 20)   | VKMA 04108<br>VKM 14108  | 1   |   | 1   |   |   |   |   | T0171   |
|   | LD18 Lynx   | 06/02 → 04/05   |   | VKPC 84416   |   |   |   |   | 1   |   |   |   |
|   | <b>B(Alt)</b> LD18 Lynx   | 06/02 → 05/03   | <i>AC</i>   | VKMV 6PK1418<br>VKM 34102<br>VKM 34108   |   |   | 1   |   |   |   |   |   |
|  |   |   |   |  | 1   |   | 1   |   |   |   |   |   |
|  | <b>B(Alt)</b> LD18 Lynx   | 06/02 → 12/05   | <b>AC</b>   | VKMA 34107<br>VKMV 6PK1715<br>VKM 34107<br>VKM 34108                               | 1   | 1   | 1   |   |   |   |   |   |
|  |   |   |   |  |   |   | 1   |   |   |   |   |   |
| <b>FORD  TRANSIT CONNECT / TOURNEO CONNECT 1.8 TDCi</b> |   |   |   |  |   |   |   |   |   |   |   |   |
|   | LD18 Lynx   | 06/02 → 02/06   | 20)   | VKMA 04108<br>VKM 14108  | 1   |   | 1   |   |   |   |   | T0171   |
|   | LD18 Lynx   | 06/02 → 04/05   |   | VKPC 84416   |   |   |   |   | 1   |   |   |   |
|   | <b>B(Alt)</b> LD18 Lynx   | 06/02 → 05/03   | <i>AC</i>   | VKMV 6PK1418<br>VKM 34102<br>VKM 34108   |   |   | 1   |   |   |   |   |   |
|  |   |   |   |  | 1   |   | 1   |   |   |   |   |   |
|  | <b>B(Alt)</b> LD18 Lynx   | 06/02 → 12/05   | <b>AC</b>   | VKMA 34107<br>VKMV 6PK1715<br>VKM 34107<br>VKM 34108                               | 1   | 1   | 1   |   |   |   |   |   |
|  |   |   |   |  |   |   | 1   |   |   |   |   |   |
| <b>FORD  TRANSIT TOURNEO 2.2 TDCi</b>                 |   |   |   |  |   |   |   |   |   |   |   |   |
|   | Duratorq  | 07/06 → 11/07   |   | <del>XXXXXXXX</del>  |   |   |   |   |   |   |   |   |
|   | Duratorq  | 07/06 → 08/06   | 2)  | VKPA_____  |   |   |   |   | 1   |   |   |   |
|   | <b>B(Alt)</b> Duratorq  | 07/06 → 11/07   | <b>AC</b>   | VKMV 6PK1670<br>VKM 34030<br>VKM_____  |   |   | 1   |   |   |   |   |   |
|  |   |   |   |  | 1   |   | 1   |   |   |   |   |   |
|  |   |   |   |  |   |   | 1   |   |   |   |   |   |
| <b>HONDA  ACCORD 1.6</b>                              |   |   |   |  |   |   |   |   |   |   |   |   |
|   | A16A1   | 01/86 → 12/89   | 3)  | VKMS 93200<br>VKMA 93200<br>VKM 73200  | 1   |   | 1   |   |   |   | 2   | T0413   |
|  |   |   |   |  | 1   |   | 1   |   |   |   |   |   |
|  | D16B6   | 10/98 → 12/02   |   | VKMA 93006<br>VKM 73005  | 1   |   | 1   |   |   |   |   | T0682   |
|  |   |   |   |  | 1   |   |   |   |   |   |   |   |
|  | EG, EL  | 01/78 → 04/83   |   | VKMA 93007<br>—  | 1   |   | 1   |   |   |   |   | T0662   |
|  |   |   |   |  | 1   |   |   |   |   |   |   |   |
|  | EZ  | 01/84 → 10/85   |   | VKMA 93200<br>VKM 73200  | 1   |   | 1   |   |   |   |   | T0413   |
|  |   |   |   |  | 1   |   |   |   |   |   |   |   |
|   | A16A1   | 11/85 → 12/89   |   | VKPC 93410   |   |   |   |   | 1   |   |   |   |
|  | EG, EL  | 09/81 → 09/83   |   | VKPC 93405   |   |   |   |   | 1   |   |   |   |
| <b>HONDA  ACCORD 1.8</b>                              |   |   |   |  |   |   |   |   |   |   |   |   |
|   | F18A  | 01/90 → 12/97   | 3)  | VKMS 93600<br>VKMA 93600<br>VKM 73011<br>VKM 73600                                 | 2   |   | 2   |   |   |   | 3   | T0669   |
|  |   |   |   |  | 2   |   | 2   |   |   |   |   |   |
|  |   |   |   |  | 1   |   |   |   |   |   |   |   |
|  |   |   |   |  | 1   |   |   |   |   |   |   |   |
|  | F18B2   | 12/99 → 12/02   | 3)  | VKMS 93011<br>VKMA 93011<br>VKM 73011<br>VKM 73600                                 | 2   |   | 2   |   |   |   | 3   | T0397   |
|  |   |   |   |  | 2   |   | 2   |   |   |   |   |   |
|  |   |   |   |  | 1   |   |   |   |   |   |   |   |
|  |   |   |   |  | 1   |   |   |   |   |   |   |   |
|  | ET1   | 01/84 → 10/85   |   | VKMA 93200<br>VKM 73200  | 1   |   | 1   |   |   |   |   | T0413   |
|  |   |   |   |  | 1   |   |   |   |   |   |   |   |
|  | F18B2   | 10/98 → 06/02   |   | VKMA 93011<br>VKM 73011<br>VKM 73600   | 2   |   | 2   |   |   |   |   | T0397   |
|  |   |   |   |  | 1   |   |   |   |   |   |   |   |
|  |   |   |   |  | 1   |   |   |   |   |   |   |   |
|   | ET1   | 09/83 → 10/85   |   | —  |   |   |   |   | 1   |   |   |   |
|  | F18A  | 01/90 → 12/97   |   | VKPC 93601   |   |   |   |   | 1   |   |   |   |
|   | <b>B(Alt)</b> F18B2   | 10/98 → 12/02   | <b>AC</b>   | VKMV 6PK1105   |   |   | 1   |   |   |   |   |   |



FORD













































| HONDA  ACCORD 2.0          |   |               |          |  |                  |        |   |   |   |  |       |
|---|---|---------------|----------|--|------------------|--------|---|---|---|--|-------|
|                             | K20A  | 02/03 → 03/06 |          | <b>OXOXOXO</b>                                     |                  |        |   |   |   |  |       |
|   | A20A1, A20A2, A20A3, A20A4                      | 11/85 → 12/89 | 3), SOHC | VKMS 93200<br>VKMA 93200<br>VKM 73200              | 1<br>1<br>1      | 1<br>1 |   |   | 2 |  | T0413 |
|   | F20A2, F20A4, F20A6, F20A7, F20A8, F20Z2, F20Z3 | 01/90 → 12/94 | 3)       | VKMS 93600<br>VKMA 93600<br>VKM 73011<br>VKM 73600 | 2<br>2<br>1<br>1 | 2<br>2 |   |   | 3 |  | T0669 |
|   | F20B3, F20Z1                                    | 01/94 → 12/97 | 3)       | VKMS 93600<br>VKMA 93600<br>VKM 73011<br>VKM 73600 | 2<br>2<br>1<br>1 | 2<br>2 |   |   | 3 |  | T0669 |
|   | F20B5, F20B6, F20B7                             | 01/99 → 12/02 | 3)       | VKMS 93011<br>VKMA 93011<br>VKM 73011<br>VKM 73600 | 2<br>2<br>1<br>1 | 2<br>2 |   |   | 3 |  | T0397 |
|   | B20A2, B20A8                                    | 01/87 → 12/89 | DOHC     | VKMA 93100<br>VKM 73002                            | 1<br>1           | 1      |   |   |   |  | T0677 |
|                             | A20A1, A20A2, A20A3, A20A4                      | 11/85 → 12/89 | SOHC     | VKPC 93410   |                  |        |   | 1 |   |  |       |
|   | B20A2, B20A8                                    | 01/87 → 12/89 | DOHC     | VKPC 93600   |                  |        |   | 1 |   |  |       |
|   | F20A2, F20A4, F20A6, F20A7, F20A8               | 01/90 → 09/93 |          | VKPC 93601   |                  |        |   | 1 |   |  |       |
|   | F20B3, F20Z1, F20Z2                             | 01/94 → 12/97 |          | VKPC 93601   |                  |        |   | 1 |   |  |       |
|   | F20B5, F20B6, F20B7                             | 02/98 → 12/02 |          | VKPC 93601   |                  |        |   | 1 |   |  |       |
|                           | <b>B(Alt)</b> F20B6                             | 10/98 → 12/02 |          | VKMV 6PK1105                                       |                  |        | 1 |   |   |  |       |
|   | <b>B(Alt)</b> K20A                              | 01/06 → 03/06 |          | VKM 63004  | 1                |        |   |   |   |  |       |
| HONDA  ACCORD 2.2        |   |               |          |  |                  |        |   |   |   |  |       |
|                           | F22A3, F22A7, F22A8                             | 01/90 → 12/93 | 3)       | VKMS 93600<br>VKMA 93600<br>VKM 73011<br>VKM 73600 | 2<br>2<br>1<br>1 | 2<br>2 |   |   | 3 |  | T0669 |
|   | F22B5   | 01/94 → 12/97 | 3)       | VKMS 93600<br>VKMA 93600<br>VKM 73011<br>VKM 73600 | 2<br>2<br>1<br>1 | 2<br>2 |   |   | 3 |  | T0669 |
|   | H22A  | 01/93 → 12/97 | DOHC     | VKMA 93014<br>VKM 73006<br>VKM 73007               | 2<br>1<br>1      | 2      |   |   |   |  | T0400 |
|                           | F22A3, F22A7, F22A8                             | 01/90 → 12/93 |          | VKPC 93601   |                  |        |   | 1 |   |  |       |
|   | F22B5   | 01/94 → 12/97 |          | VKPC 93601   |                  |        |   | 1 |   |  |       |
| HONDA  ACCORD 2.2 Type-R |   |               |          |  |                  |        |   |   |   |  |       |
|                           | H22A7   | 02/99 → 06/02 |          | VKMA 93014<br>VKM 73006<br>VKM 73007               | 2<br>1<br>1      | 2      |   |   |   |  | T0400 |
| HONDA  ACCORD 2.2 Vtec   |   |               |          |  |                  |        |   |   |   |  |       |
|                           | F22B  | 01/94 → 12/97 |          | VKMA 93011<br>VKM 73011<br>VKM 73600               | 2<br>1<br>1      | 2      |   |   |   |  | T0397 |
|   | F22Z2   | 02/96 → 12/96 |          | VKMA 93011<br>VKM 73011<br>VKM 73600               | 2<br>1<br>1      | 2      |   |   |   |  | T0397 |
|                           | F22Z2   | 02/96 → 11/97 |          | VKPC 93601   |                  |        |   | 1 |   |  |       |
| HONDA  ACCORD 2.3        |   |               |          |  |                  |        |   |   |   |  |       |
|                           | F23A7, F23Z5                                    | 02/98 → 12/02 | 3)       | VKMS 93011<br>VKMA 93011<br>VKM 73011<br>VKM 73600 | 2<br>2<br>1<br>1 | 2<br>2 |   |   | 3 |  | T0397 |
|   | H23A3   | 03/93 → 12/94 |          | VKMA 93013<br>VKM 73011<br>VKM 73600               | 2<br>1<br>1      | 2      |   |   |   |  | T0669 |
|                           | F23A3, F23A7                                    | 02/98 → 12/02 |          | VKPC 93601   |                  |        |   | 1 |   |  |       |
|   | H23A3   | 03/93 → 12/94 |          | —  |                  |        |   | 1 |   |  |       |

|   |  |  |  |  |  |  |  |  |  |  |  |
|---|---|---|---|--|---|---|---|---|---|---|---|
|  B(Alt) F23Z5                      |   | 11/00 → 12/02   |   | VKMV 6PK1105   |   |   | 1   |   |   |   |   |
| <b>HONDA  ACCORD 2.4</b>           |   |   |   |  |   |   |   |   |   |   |   |
|  K24A, K24A8                       |   | 02/03 → 01/08   |   |  |   |   |   |   |   |   |   |
|  B(Alt) K24A, K24A8                |   | 01/06 → 01/08   |   | VKM 63004  |   | 1   |   |   |   |   |   |
| <b>HONDA  ACCORD 2.4 Vtec</b>      |   |   |   |  |   |   |   |   |   |   |   |
|  B(Alt) K24A2                      |   | 01/06 → 03/06   |   | VKM 63004  |   | 1   |   |   |   |   |   |
| <b>HONDA  ACCORD 3.0 V6</b>        |   |   |   |  |   |   |   |   |   |   |   |
|  J30A1                             |   | 02/98 → 12/02   |   | VKMA 93612<br>VKM 73605<br>VKM 83003   |   | 1<br>1  | 1   |   |   |   | T0690   |
| <b>HONDA  ACCORD 2.0 TDi</b>       |   |   |   |  |   |   |   |   |   |   |   |
|  20T2N                             |   | 04/96 → 06/02   |   | VKMA 07302<br>VKM 17302<br>VKM 17304<br>VKM 27302                                  |   | 2<br>1<br>1   | 1   | 2   |   |   | 2 T0141   |
|  20T2N                             |   | 04/96 → 12/00   |   | VKPC 87813   |   |   |   |   | 1   |   |   |
|  B(Alt) 20T2N                      |   | 02/99 → 12/02   | AC  | VKMV 6PK1462<br>VKM 37005  |   | 1   |   | 1   |   |   |   |
| <b>HONDA  ACCORD 2.2 CTDi</b>      |   |   |   |  |   |   |   |   |   |   |   |
|  N22A1                             |   | 01/04 → 03/06   |   |  |   |   |   |   |   |   |   |
|  B(Alt) N22A1                      |   | 01/04 → 03/06   |   | VKMV_____  |   |   | 1   |   |   |   |   |
| <b>HONDA  ACURA 1.6</b>            |   |   |   |  |   |   |   |   |   |   |   |
|  D16A                              |   | 01/86 → 12/87   |   | —<br>VKM 73003   |   | 1<br>1  |   | 1   |   |   |   |
| <b>HONDA  BALLADE 1.3</b>        |   |   |   |  |   |   |   |   |   |   |   |
|  EV                              |   | 09/84 → 12/87   |   | VKMA 93101<br>VKM 73101  |   | 1<br>1  |   | 1   |   |   | T0682   |
| <b>HONDA  BALLADE 1.5</b>        |   |   |   |  |   |   |   |   |   |   |   |
|  EW                              |   | 09/84 → 12/87   |   | VKMA 93101<br>VKM 73101  |   | 1<br>1  |   | 1   |   |   | T0682   |
| <b>HONDA  BALLADE SPORTS 1.3</b> |   |   |   |  |   |   |   |   |   |   |   |
|  EV                              |   | 09/84 → 12/87   |   | VKMA 93101<br>VKM 73101  |   | 1<br>1  |   | 1   |   |   | T0682   |
| <b>HONDA  BALLADE SPORTS 1.5</b> |   |   |   |  |   |   |   |   |   |   |   |
|  EW                              |   | 09/84 → 12/87   |   | VKMA 93101<br>VKM 73101  |   | 1<br>1  |   | 1   |   |   | T0682   |
| <b>HONDA  CITY 1.3</b>           |   |   |   |  |   |   |   |   |   |   |   |
|  B(Alt)                          |   | 12/99 → 09/03   |   | VKMV_____  |   |   | 1   |   |   |   |   |
|  B(PS)                           |   | 12/99 → 09/03   |   | VKMV_____  |   |   | 1   |   |   |   |   |
| <b>HONDA  CIVIC 1.2</b>          |   |   |   |  |   |   |   |   |   |   |   |
|  D12B                            |   | 01/88 → 12/91 3)  |   | VKMS 93500<br>VKMA 93500<br>VKM 73000  |   | 1<br>1<br>1   |   | 1   |   |   | 2 T0682   |
|   |   | ZA1, ZA2  | 01/84 → 10/87 3)  | VKMS 93101<br>VKMA 93101<br>VKM 73101  |   | 1<br>1<br>1   |   | 1   |   |   | 2 T0682   |
|  D12B                            |   | 01/86 → 12/92   |   | VKPC 87404   |   |   |   |   | 1   |   |   |
|   |   | ZA1, ZA2  | 01/84 → 10/87   | VKPC 93205   |   |   |   |   | 1   |   |   |
| <b>HONDA  CIVIC 1.3</b>          |   |   |   |  |   |   |   |   |   |   |   |
|  D13B1, D13B2                    |   | 01/88 → 11/95 3)  |   | VKMS 93500<br>VKMA 93500<br>VKM 73000  |   | 1<br>1<br>1   |   | 1   |   |   | 2 T0682   |
|   |   | EV2   | 01/84 → 10/87 3)  | VKMS 93101<br>VKMA 93101<br>VKM 73101  |   | 1<br>1<br>1   |   | 1   |   |   | 2 T0682   |
|  D13B1, D13B2                    |   | 01/88 → 11/95   |   | VKPC 87404   |   |   |   |   | 1   |   |   |
|   |   | EN1, EN2, EN4   | 09/79 → 12/84   | —  |   |   |   |   | 1   |   |   |
|   |   | EV2   | 10/83 → 10/87   | VKPC 93205   |   |   |   |   | 1   |   |   |
|  B(AC) D13B2                     |   | 01/94 → 12/94   |   | VKMA 63000<br>VKMV 4PK795<br>VKM 63000   |   |   | 1<br>1  | 1   |   |   |   |

















































HONDA

|   |  |  |  |  |  |  |  |  |  |  |  |  |
|---|---|---|---|--|---|---|---|---|---|---|---|---|
| <b>B(AC)</b>  | D13B2   | 01/95 → 11/95   |   | VKMA 63001<br>VKMV 4PK795<br>VKM 63001   | 1<br>1<br>1   | 1<br>1  |   |   |   |   |   |   |
| <b>HONDA  CIVIC 1.4</b>          |   |   |   |  |   |   |   |   |   |   |   |   |
|                                   | L13A7   | 01/06 → 06/06   |   | <b>OXOXOXO</b>   |   |   |   |   |   |   |   |   |
|   | D14A1   | 01/88 → 12/91   | 3)  | VKMS 93500<br>VKMA 93500<br>VKM 73000  | 1<br>1<br>1   | 1<br>1  |   |   | 2   |   |   | T0682   |
|   | D14A2, D14A5  | 09/94 → 12/96   | 3)  | VKMS 93500<br>VKMA 93500<br>VKM 73000  | 1<br>1<br>1   | 1<br>1  |   |   | 2   |   |   | T0682   |
|   | D14A3, D14A4, D14Z1   | 01/96 → 12/00   | 3)  | VKMS 93005<br>VKMA 93005<br>VKM 73005  | 1<br>1<br>1   | 1<br>1  |   |   | 2   |   |   | T0682   |
|   | D14A7, D14A8  | 01/97 → 12/99   | 3)  | VKMS 93005<br>VKMA 93005<br>VKM 73005  | 1<br>1<br>1   | 1<br>1  |   |   | 2   |   |   | T0682   |
|   | D14Z, D14Z5, D14Z6  | 02/01 → 12/05   | 3)  | VKMS 93615<br>VKMA 93615<br>VKM 73607  | 1<br>1<br>1   | 1<br>1  |   |   | 2<br>2<br>1   | 2<br>2  |   | T0682   |
|                                   | D14A1   | 01/88 → 12/89   |   | VKPC 87404   |   |   |   |   | 1   |   |   |   |
|   | D14A2, D14A5  | 01/95 → 12/95   |   | VKPC 87404   |   |   |   |   | 1   |   |   |   |
|   | D14A3, D14A4, D14Z1   | 01/96 → 12/00   |   | VKPC 93000   |   |   |   |   | 1   |   |   |   |
|   | D14A7, D14A8  | 01/97 → 12/99   |   | VKPC 93000   |   |   |   |   | 1   |   |   |   |
|   | D14Z, D14Z5, D14Z6  | 02/01 → 12/05   |   | VKPC _____   |   |   |   |   | 1   |   |   |   |
|                                   | <b>B(AC)</b> D14A2, D14A5   | 01/95 → 12/96   |   | VKMA 63001<br>VKMV 4PK795<br>VKM 63001   |   | 1<br>1<br>1   | 1<br>1  |   |   |   |   |   |
| <b>HONDA  CIVIC 1.5</b>        |   |   |   |  |   |   |   |   |   |   |   |   |
|                                 | D15A, EW2, EW3, EW4   | 01/84 → 10/87   | 3)  | VKMS 93101<br>VKMA 93101<br>VKM 73101  | 1<br>1<br>1   | 1<br>1  |   |   | 2   |   |   | T0682   |
|   | D15B2, D15B7  | 01/88 → 11/95   | 3)  | VKMS 93500<br>VKMA 93500<br>VKM 73000  | 1<br>1<br>1   | 1<br>1  |   |   | 2   |   |   | T0682   |
|   | D15Z1   | 01/92 → 11/95   | 3), Vtec  | VKMS 93005<br>VKMA 93005<br>VKM 73005  | 1<br>1<br>1   | 1<br>1  |   |   | 2   |   |   | T0682   |
|   | D15Z6   | 01/96 → 12/00   | 3), Vtec  | VKMS 93005<br>VKMA 93005<br>VKM 73005  | 1<br>1<br>1   | 1<br>1  |   |   | 2   |   |   | T0682   |
|   | D15Z8   | 01/97 → 12/99   | 3), Vtec  | VKMS 93005<br>VKMA 93005<br>VKM 73005  | 1<br>1<br>1   | 1<br>1  |   |   | 2   |   |   | T0682   |
|                                 | D15B1, D15B2  | 01/88 → 11/95   |   | VKPC 87404   |   |   |   |   | 1   |   |   |   |
|   | D15Z1   | 01/92 → 11/95   | Vtec  | VKPC 93411   |   |   |   |   | 1   |   |   |   |
|   | D15Z6   | 01/96 → 12/00   | Vtec  | VKPC 93000   |   |   |   |   | 1   |   |   |   |
|   | D15Z8   | 01/97 → 12/99   | Vtec  | VKPC 93000   |   |   |   |   | 1   |   |   |   |
|   | EW2, EW3, EW4   | 10/83 → 10/87   |   | VKPC 93205   |   |   |   |   | 1   |   |   |   |
|                                 | <b>B(AC)</b> D15B2, D15Z1   | 10/91 → 07/94   |   | VKMA 63000<br>VKMV 4PK795<br>VKM 63000   |   | 1<br>1<br>1   | 1<br>1  |   |   |   |   |   |
|   | <b>B(AC)</b> D15B2, D15Z1   | 01/95 → 11/95   |   | VKMA 63001<br>VKMV 4PK795<br>VKM 63001   |   | 1<br>1<br>1   | 1<br>1  |   |   |   |   |   |
| <b>HONDA  CIVIC 1.5 Vtec-E</b> |   |   |   |  |   |   |   |   |   |   |   |   |
|                                 | D15Z3   | 09/94 → 12/96   | 3)  | VKMS 93005<br>VKMA 93005<br>VKM 73005  | 1<br>1<br>1   | 1<br>1  |   |   | 2   |   |   | T0682   |
|                                 | D15Z3   | 01/95 → 12/95   |   | VKPC 93411   |   |   |   |   | 1   |   |   |   |
|   | D15Z3   | 01/96 → 12/96   |   | VKPC 93213   |   |   |   |   | 1   |   |   |   |
| <b>HONDA  CIVIC 1.6</b>        |   |   |   |  |   |   |   |   |   |   |   |   |
|                                 | R16A  | 01/06 → 09/07   |   | <b>OXOXOXO</b>   |   |   |   |   |   |   |   |   |
|   | B16A2   | 01/92 → 12/00   | 3), Vtec, DOHC  | VKMS 93201<br>VKMA 93201<br>VKM 73201  | 1<br>1<br>1   | 1<br>1  |   |   | 3   |   |   | T0677   |

|   |  |  |  |  |  |  |  |  |  |  |  |  |  |
|---|---|---|---|--|---|---|---|---|---|---|---|---|---|
|   | D16A6, D16Y3, D16Y7, D16Z2  | 01/88 → 12/96   | 3), SOHC  | VKMS 93001<br>VKMA 93001<br>VKM 73000  | 1<br>1<br>1   | 1<br>1  |   |   |   |   | 2   |   | T0682   |
|   | D16A7, D16A9  | 01/88 → 09/91   | 3), DOHC  | VKMS 93002<br>VKMA 93002<br>VKM 73000  | 1<br>1<br>1   | 1<br>1  |   |   |   |   | 3   |   | T0677   |
|   | D16A7   | 08/93 → 10/95   | 3)  | VKMS 93500<br>VKMA 93500<br>VKM 73000  | 1<br>1<br>1   | 1<br>1  |   |   |   |   | 2   |   | T0682   |
|   | D16B2   | 01/97 → 02/98   | 3)  | VKMS 93005<br>VKMA 93005<br>VKM 73005  | 1<br>1<br>1   | 1<br>1  |   |   |   |   | 2   |   | T0682   |
|   | D16B2, D16W3, D16W4   | 04/98 → 12/99   | 3)  | VKMS 93006<br>VKMA 93006<br>VKM 73005  | 1<br>1<br>1   | 1<br>1  |   |   |   |   | 2   |   | T0682   |
|   | D16V1   | 02/01 → 12/05   | 3), Mod. EP2, EU8   | VKMS 93616<br>VKMA 93616<br>VKM 73607  | 1<br>1<br>1   | 1<br>1  |   |   |   |   | 2<br>2<br>1   |   | T0682   |
|   | D16W7   | 02/01 → 12/05   | 3), Mod. ES5, Vtec  | VKMS 93616<br>VKMA 93616<br>VKM 73607  | 1<br>1<br>1   | 1<br>1  |   |   |   |   | 2<br>2<br>1   |   | T0682   |
|   | D16Y5   | 01/96 → 12/00   | 3)  | VKMS 93006<br>VKMA 93006<br>VKM 73005  | 1<br>1<br>1   | 1<br>1  |   |   |   |   | 2   |   | T0682   |
|   | D16Z2   | 01/88 → 09/91   | 3)  | VKMS 93001<br>VKMA 93001<br>VKM 73000  | 1<br>1<br>1   | 1<br>1  |   |   |   |   | 2   |   | T0682   |
|   | D16Z7   | 01/92 → 10/95   | 3), Vtec  | VKMS 93005<br>VKMA 93005<br>VKM 73005  | 1<br>1<br>1   | 1<br>1  |   |   |   |   | 2   |   | T0682   |
|   | ZC  | 04/87 → 12/92   | DOHC  | VKMA 93002<br>VKM 73000  | 1<br>1  | 1   |   |   |   |   |   |   | T0677   |
|   | ZC  | 06/87 → 09/91   | SOHC  | VKMA 93001<br>VKM 73000  | 1<br>1  | 1   |   |   |   |   |   |   | T0682   |
|                              | B16A2   | 01/92 → 11/95   | Vtec, DOHC  | VKPC 93601   |   |   |   |   |   |   | 1   |   |   |
|   | B16A2   | 01/96 → 12/00   | Vtec, DOHC  | VKPC 93415   |   |   |   |   |   |   | 1   |   |   |
|   | D16A6, D16A7, D16A9, D16Z2  | 01/88 → 10/95   |   | VKPC 87404   |   |   |   |   |   |   | 1   |   |   |
|   | D16B2   | 01/97 → 12/99   |   | VKPC 93000   |   |   |   |   |   |   | 1   |   |   |
|   | D16V1   | 02/01 → 12/05   | Mod. EP2, EU8   | VKPC _____   |   |   |   |   |   |   | 1   |   |   |
|   | D16W7   | 02/01 → 12/05   | Mod. ES5, Vtec  | VKPC _____   |   |   |   |   |   |   | 1   |   |   |
|   | D16Y3   | 01/95 → 12/96   |   | VKPC 87404   |   |   |   |   |   |   | 1   |   |   |
|   | D16Y5   | 01/96 → 12/00   | Vtec  | VKPC 93000   |   |   |   |   |   |   | 1   |   |   |
|   | D16Z7   | 01/92 → 10/95   | Vtec  | VKPC 93411   |   |   |   |   |   |   | 1   |   |   |
|   | R16A  | 01/06 → 09/07   |   | —  |   |   |   |   |   |   | 1   |   |   |
| <b>HONDA  CIVIC 1.6 Vtec</b> |   |   |   |  |   |   |   |   |   |   |   |   |   |
|                              | B16A1   | 10/89 → 12/90   | 3)  | VKMS 93201<br>VKMA 93201<br>VKM 73201  | 1<br>1<br>1   | 1<br>1  |   |   |   |   | 3   |   | T0677   |
|   | B16A2   | 01/94 → 11/95   | 3)  | VKMS 93201<br>VKMA 93201<br>VKM 73201  | 1<br>1<br>1   | 1<br>1  |   |   |   |   | 3   |   | T0677   |
|   | D16Y2   | 01/95 → 12/96   | 3)  | VKMS 93006<br>VKMA 93006<br>VKM 73005  | 1<br>1<br>1   | 1<br>1  |   |   |   |   | 2   |   | T0682   |
|   | D16Y6, D16Y8, D16Z6, D16Z7, D16Z9   | 01/92 → 12/00   | 3)  | VKMS 93006<br>VKMA 93006<br>VKM 73005  | 1<br>1<br>1   | 1<br>1  |   |   |   |   | 2   |   | T0682   |
|                              | B16A1   | 10/89 → 12/90   |   | VKPC 93601   |   |   |   |   |   |   | 1   |   |   |
|   | B16A2   | 01/94 → 11/95   |   | VKPC 93601   |   |   |   |   |   |   | 1   |   |   |
|   | D16Y2   | 01/95 → 12/95   |   | VKPC 93411   |   |   |   |   |   |   | 1   |   |   |
|   | D16Y2   | 01/96 → 12/96   |   | VKPC 93213   |   |   |   |   |   |   | 1   |   |   |
|   | D16Y6, D16Y8  | 01/96 → 12/00   |   | VKPC 93000   |   |   |   |   |   |   | 1   |   |   |
|   | D16Z6, D16Z7, D16Z9   | 01/92 → 12/95   |   | VKPC 93411   |   |   |   |   |   |   | 1   |   |   |
|                              | <b>B(AC)</b> D16Z6  | 01/94 → 12/94   |   | VKMA 63000<br>VKMV 4PK795<br>VKM 63000   |   | 1<br>1<br>1   | 1<br>1  |   |   |   |   |   |   |



HONDA





































|  |              |  |  |  |  |  |  |  |  |  |  |  |  |  |
|--|--------------|---|---|---|--|---|---|---|---|---|---|---|---|---|
|  | <b>B(AC)</b> | D16Z6   | 01/95 → 11/95   |   | VKMA 63001<br>VKMV 4PK795<br>VKM 63001   | 1<br>1<br>1   | 1<br>1  |   |   |   |   |   |   |   |
| <b>HONDA  CIVIC 1.7</b>           |              |   |   |   |  |   |   |   |   |   |   |   |   |   |
|                                    |              | D17A5   | 02/01 → 12/05   | 3), Mod. ES1, Vtec  | VKMS 93616<br>VKMA 93616<br>VKM 73607  | 1<br>1<br>1   | 1<br>1  |   |   |   | 2<br>2<br>1   | 2<br>2<br>1   |   | T0682   |
|                                    |              | D17A5   | 02/01 → 12/05   | Mod. ES1, Vtec  | VKPC_____  |   |   |   | 1   |   |   |   |   |   |
| <b>HONDA  CIVIC 1.8</b>           |              |   |   |   |  |   |   |   |   |   |   |   |   |   |
|                                    |              | R18A1, R18A2<br>B18C4   | 01/06 → 09/07<br>01/97 → 12/99  |   | OXOXOXO<br>—<br>VKM 73201  |   |   |   |   |   |   |   |   |   |
|                                    |              | B18C4   | 01/97 → 12/99   |   | VKPC 93415   | 1<br>1  | 1   |   |   | 1   |   |   |   |   |
| <b>HONDA  CIVIC 2.0 Sport</b>     |              |   |   |   |  |   |   |   |   |   |   |   |   |   |
|                                    |              | K20A3   | 01/04 → 09/05   | Mod. EV1, Vtec  | OXOXOXO  |   |   |   |   |   |   |   |   |   |
|                                    |              | K20A3   | 01/04 → 09/05   | Mod. EV1, Vtec  | —  |   |   |   |   |   |   |   |   |   |
| <b>HONDA  CIVIC 1.3 Hybrid</b>    |              |   |   |   |  |   |   |   |   |   |   |   |   |   |
|                                    |              | LDA2  | 01/06 → 06/06   | Mod. FD3  | OXOXOXO  |   |   |   |   |   |   |   |   |   |
| <b>HONDA  CIVIC 1.7 CTDi</b>      |              |   |   |   |  |   |   |   |   |   |   |   |   |   |
|                                    |              | 4EE-2   | 01/02 → 12/05   |   | —  | 1   | 1   |   |   |   |   |   |   |   |
|                                    |              | 4EE-2   | 01/02 → 08/05   |   | —  |   |   |   | 1   |   |   |   | 1   |   |
| <b>HONDA  CIVIC 2.0 D</b>         |              |   |   |   |  |   |   |   |   |   |   |   |   |   |
|                                    |              | 20T2N   | 04/98 → 12/00   |   | VKPC 87813   |   |   |   | 1   |   |   |   |   |   |
| <b>HONDA  CIVIC 2.0 TD</b>        |              |   |   |   |  |   |   |   |   |   |   |   |   |   |
|                                   |              | 20T2N   | 01/97 → 02/98   |   | VKMA 07302<br>VKM 17302<br>VKM 17304<br>VKM 27302                                  | 2<br>1<br>1<br>1  | 1<br>1  | 2   |   |   |   |   | 2   | T0141   |
|                                  |              | 20T2N   | 01/97 → 02/98   |   | VKPC 87813   |   |   |   | 1   |   |   |   |   |   |
| <b>HONDA  CIVIC 2.2 CTDi</b>    |              |   |   |   |  |   |   |   |   |   |   |   |   |   |
|                                  |              | N22A2   | 01/06 → 06/06   |   | OXOXOXO  |   |   |   |   |   |   |   |   |   |
| <b>HONDA  CIVIC CRX 1.6</b>     |              |   |   |   |  |   |   |   |   |   |   |   |   |   |
|                                  |              | B16A  | 01/92 → 12/96   | 3)  | VKMS 93201<br>VKMA 93201<br>VKM 73201  | 1<br>1<br>1   | 1<br>1  |   |   |   | 3   |   |   | T0677   |
|  |              | D16Z  | 01/92 → 12/96   | 3)  | VKMS 93006<br>VKMA 93006<br>VKM 73005  | 1<br>1<br>1   | 1<br>1  |   |   |   | 2   |   |   | T0682   |
| <b>HONDA  CIVIC DEL SOL 1.5</b> |              |   |   |   |  |   |   |   |   |   |   |   |   |   |
|                                  |              | D15B  | 01/93 → 12/95   | 3)  | VKMS 93500<br>VKMA 93500<br>VKM 73000  | 1<br>1<br>1   | 1<br>1  |   |   |   | 2   |   |   | T0682   |
| <b>HONDA  CIVIC DEL SOL 1.6</b> |              |   |   |   |  |   |   |   |   |   |   |   |   |   |
|                                  |              | B16A  | 01/92 → 12/96   | 3)  | VKMS 93201<br>VKMA 93201<br>VKM 73201  | 1<br>1<br>1   | 1<br>1  |   |   |   | 3   |   |   | T0677   |
|  |              | D16Z  | 01/92 → 12/96   | 3)  | VKMS 93006<br>VKMA 93006<br>VKM 73005  | 1<br>1<br>1   | 1<br>1  |   |   |   | 2   |   |   | T0682   |
| <b>HONDA  CIVIC PRO 1.3</b>     |              |   |   |   |  |   |   |   |   |   |   |   |   |   |
|                                  |              | EV  | 10/83 → 09/87   |   | VKMA 93101<br>VKM 73101  | 1<br>1  | 1   |   |   |   |   |   |   | T0682   |
| <b>HONDA  CIVIC PRO 1.5</b>     |              |   |   |   |  |   |   |   |   |   |   |   |   |   |
|                                  |              | D15B  | 07/78 → 08/89   |   | VKMA 93500<br>VKM 73000  | 1<br>1  | 1   |   |   |   |   |   |   | T0682   |
| <b>HONDA  CIVIC SHUTTLE 1.3</b> |              |   |   |   |  |   |   |   |   |   |   |   |   |   |
|                                  |              | EV  | 09/84 → 08/87   |   | VKMA 93101<br>VKM 73101  | 1<br>1  | 1   |   |   |   |   |   |   | T0682   |
| <b>HONDA  CIVIC SHUTTLE 1.4</b> |              |   |   |   |  |   |   |   |   |   |   |   |   |   |
|                                  |              | D14A  | 01/88 → 12/91   | 3)  | VKMS 93500<br>VKMA 93500<br>VKM 73000  | 1<br>1<br>1   | 1<br>1  |   |   |   | 2   |   |   | T0682   |

















































|  |  |  |  |  |  |  |  |  |  |  |  |
|--|---|---|---|--|---|---|---|---|---|---|---|
|                                 | D14A  | 01/88 → 12/91   |   | VKPC 87404   |   |   |   | 1   |   |   |   |
| <b>HONDA  CIVIC SHUTTLE 1.5</b> |   |   |   |  |   |   |   |   |   |   |   |
|                                 | D15B  | 01/88 → 12/91 3)  |   | VKMS 93500<br>VKMA 93500<br>VKM 73000  | 1<br>1<br>1   | 1   |   |   | 2   |   | T0682   |
|                                 | D15B  | 01/88 → 12/91   |   | VKPC 87404   |   |   |   | 1   |   |   |   |
| <b>HONDA  CIVIC SHUTTLE 1.6</b> |   |   |   |  |   |   |   |   |   |   |   |
|                                 | D16A, D16Z  | 01/88 → 12/91 3)  |   | VKMS 93001<br>VKMA 93001<br>VKM 73000  | 1<br>1<br>1   | 1   |   |   | 2   |   | T0682   |
|                                 | D16A/Z  | 01/88 → 12/91   |   | VKPC 87404   |   |   |   | 1   |   |   |   |
| <b>HONDA  CONCERTO 1.4</b>      |   |   |   |  |   |   |   |   |   |   |   |
|                                 | D14A1, D14A8  | 08/89 → 12/91 3)  |   | VKMS 93500<br>VKMA 93500<br>VKM 73000  | 1<br>1<br>1   | 1   |   |   | 2   |   | T0682   |
|                                 | D14A1, D14A8  | 08/89 → 10/91   |   | VKPC 87404   |   |   |   | 1   |   |   |   |
| <b>HONDA  CONCERTO 1.5</b>      |   |   |   |  |   |   |   |   |   |   |   |
|                                 | D15B2   | 08/89 → 12/93 3)  |   | VKMS 93500<br>VKMA 93500<br>VKM 73000  | 1<br>1<br>1   | 1   |   |   | 2   |   | T0682   |
|  | ZC  | 06/88 → 02/91   |   | VKMA 93001<br>VKM 73000  | 1<br>1  | 1   |   |   |   |   | T0682   |
|                                 | D15B2   | 08/89 → 03/95   |   | VKPC 87404   |   |   |   | 1   |   |   |   |
| <b>HONDA  CONCERTO 1.6</b>      |   |   |   |  |   |   |   |   |   |   |   |
|                                 | D16A, D16Z  | 01/90 → 12/93 3), DOHC  |   | VKMS 93002<br>VKMA 93002<br>VKM 73000  | 1<br>1<br>1   | 1   |   |   | 3   |   | T0677   |
|  | D16A8, D16Z2  | 01/90 → 12/93 3), SOHC  |   | VKMS 93001<br>VKMA 93001<br>VKM 73000  | 1<br>1<br>1   | 1   |   |   | 2   |   | T0682   |
|                               | D16A8, D16Z2  | 08/89 → 03/95   |   | VKPC 87404   |   |   |   | 1   |   |   |   |
| <b>HONDA  CONCERTO 1.8 TD</b> |   |   |   |  |   |   |   |   |   |   |   |
|                               |   | 01/94 → 12/96   |   | VKPC 83420   |   |   |   | 1   |   |   |   |
| <b>HONDA  CR-V 1.8</b>        |   |   |   |  |   |   |   |   |   |   |   |
|                               | B18B  | 01/95 → 12/98   |   | VKPC 93001   |   |   |   | 1   |   |   |   |
| <b>HONDA  CR-V 2.0</b>        |   |   |   |  |   |   |   |   |   |   |   |
|                               | B20Z1, K20A   | 01/02 → 02/06   |   | <del>OKOKOKO</del>   |   |   |   |   |   |   |   |
|  | B20B, B20Z1   | 01/97 → 12/01 3)  |   | VKMS 93210<br>VKMA 93210<br>VKM 73201  | 1<br>1<br>1   | 1   |   |   | 3   |   | T0677   |
|                               | B20B, B20Z1   | 01/97 → 12/01   |   | VKPC_____  |   |   |   | 1   |   |   |   |
|  | K20A  | 07/02 → 09/06 Mod. RD5, (J)   |   | VKPC 93604   |   |   |   | 1   |   |   |   |
|  | K20A  | 07/02 → 09/06 Mod. RD8, (GB)  |   | —  |   |   |   |   |   |   |   |
|                               | B(Alt) B20B, B20Z1  | 10/95 → 02/02   |   | VKMOV 4PK820   |   | 1   |   |   |   |   |   |
|  | B(Alt) K20A   | 07/02 → 02/06 Mod. RD5  |   | VKM 63004  | 1   |   |   |   |   |   |   |
|  | B(PS) B20B, B20Z1   | 10/95 → 02/02   |   | VKMOV_____   |   | 1   |   |   |   |   |   |
|  | B(AC) B20B, B20Z1   | 10/95 → 02/02   |   | VKMOV_____   |   | 1   |   |   |   |   |   |
| <b>HONDA  CR-V 2.4 Vtec</b>   |   |   |   |  |   |   |   |   |   |   |   |
|                               | K24A  | 03/02 → 02/06   |   | <del>OKOKOKO</del>   |   |   |   |   |   |   |   |
|                               | K24A  | 01/05 → 09/06 (J)   |   | VKPC 93604   |   |   |   | 1   |   |   |   |
|                               | B(Alt) K24A   | 03/02 → 02/06   |   | VKM 63004  | 1   |   |   |   |   |   |   |
| <b>HONDA  CR-V 2.2 CTDi</b>   |   |   |   |  |   |   |   |   |   |   |   |
|                               | N22A  | 02/05 → 09/06   |   | <del>OKOKOKO</del>   |   |   |   |   |   |   |   |
|                               | N22A  | 02/05 → 09/06   |   | —  |   |   |   | 1   |   |   |   |
|                               | B(Alt) N22A   | 02/05 → 09/06   |   | VKMOV_____   |   | 1   |   |   |   |   |   |
| <b>HONDA  CRX 1.3</b>         |   |   |   |  |   |   |   |   |   |   |   |
|                               | EV2   | 01/84 → 10/87 3)  |   | VKMS 93101<br>VKMA 93101<br>VKM 73101  | 1<br>1<br>1   | 1   |   |   | 2   |   | T0682   |
| <b>HONDA  CRX 1.4</b>         |   |   |   |  |   |   |   |   |   |   |   |
|                               | D14A  | 01/88 → 12/91   |   | VKPC 87404   |   |   |   | 1   |   |   |   |
|  | D14A  | 01/92 → 07/03   |   | VKPC 93601   |   |   |   | 1   |   |   |   |



HONDA















































|   |                     |               |                    |  |   |  |  |  |   |  |   |  |  |  |  |  |       |
|---|---------------------|---------------|--------------------|--|---|---|--|---|---|---|---|---|--|---|--|---|-------|
| <b>HONDA  CRX 1.5</b>              |                     |               |                    |  |   |   |  |   |   |   |   |   |  |   |  |   |       |
|                                     | EW3                 | 01/84 → 11/86 | 3)                 | VKMS 93101   | 1 | 1   |  |   |   |   | 2 |   |  |   |  |   | T0682 |
|   | D15B                | 07/87 → 08/90 |                    | VKMA 93101   | 1 | 1   |  |   |   |   |   |   |  |   |  |   | T0682 |
|   |                     |               |                    | VKM 73101  | 1 |   |  |   |   |   |   |   |  |   |  |   |       |
|   |                     |               |                    | VKMA 93500   | 1 | 1   |  |   |   |   |   |   |  |   |  |   | T0682 |
|   |                     |               |                    | VKM 73000  | 1 |   |  |   |   |   |   |   |  |   |  |   |       |
|                                     | EW3                 | 10/83 → 12/85 |                    | VKPC 93205   |   |   |  |   |   | 1   |   |   |  |   |  |   |       |
| <b>HONDA  CRX 1.6</b>              |                     |               |                    |  |   |   |  |   |   |   |   |   |  |   |  |   |       |
|                                     | B16A2               | 03/92 → 12/96 | 3)                 | VKMS 93201   | 1 | 1   |  |   |   |   | 3 |   |  |   |  |   | T0677 |
|   |                     |               |                    | VKMA 93201   | 1 | 1   |  |   |   |   |   |   |  |   |  |   |       |
|   |                     |               |                    | VKM 73201  | 1 |   |  |   |   |   |   |   |  |   |  |   |       |
|   | D16A9, D16Z5        | 10/87 → 12/90 | 3)                 | VKMS 93001   | 1 | 1   |  |   |   |   | 2 |   |  |   |  |   | T0682 |
|   |                     |               |                    | VKMA 93001   | 1 | 1   |  |   |   |   |   |   |  |   |  |   |       |
|   |                     |               |                    | VKM 73000  | 1 |   |  |   |   |   |   |   |  |   |  |   |       |
|   | D16Z6               | 03/92 → 12/96 | 3)                 | VKMS 93006   | 1 | 1   |  |   |   |   | 2 |   |  |   |  |   | T0682 |
|   |                     |               |                    | VKMA 93006   | 1 | 1   |  |   |   |   |   |   |  |   |  |   |       |
|   |                     |               |                    | VKM 73005  | 1 |   |  |   |   |   |   |   |  |   |  |   |       |
|   | ZC                  | 07/87 → 08/89 |                    | VKMA 93002   | 1 | 1   |  |   |   |   |   |   |  |   |  |   | T0677 |
|   |                     |               |                    | VKM 73000  | 1 |   |  |   |   |   |   |   |  |   |  |   |       |
|                                     | B16A2, D16Z6        | 03/92 → 12/97 |                    | VKPC 93411   |   |   |  |   |   | 1   |   |   |  |   |  |   |       |
|   | D16A9, D16Z5        | 10/87 → 12/91 |                    | VKPC 87404   |   |   |  |   |   | 1   |   |   |  |   |  |   |       |
| <b>HONDA  CRX 1.6 Vtec</b>         |                     |               |                    |  |   |   |  |   |   |   |   |   |  |   |  |   |       |
|                                     | B16A1               | 10/89 → 12/91 |                    | VKPC 87404   |   |   |  |   |   | 1   |   |   |  |   |  |   |       |
| <b>HONDA  FR-V 1.7</b>             |                     |               |                    |  |   |   |  |   |   |   |   |   |  |   |  |   |       |
|                                     | D17A2               | 02/05 → 12/06 |                    | VKPC_____  |   |   |  |   |   | 1   |   |   |  |   |  |   |       |
|                                    | B(PS) D17A2         | 02/05 → 12/06 |                    | VKMV_____  |   |   |  |   | 1 |   |   |   |  |   |  |   |       |
| <b>HONDA  FR-V 2.0</b>           |                     |               |                    |  |   |   |  |   |   |   |   |   |  |   |  |   |       |
|                                   | K20A9               | 02/05 → 12/06 |                    | VKPC 93604   |   |   |  |   |   | 1   |   |   |  |   |  |   |       |
|                                   | B(Alt) K20A9        | 02/05 → 12/06 |                    | VKMV_____  | 1 |   |  |   | 1 |   |   |   |  |   |  |   |       |
|   |                     |               |                    | VKM 63004  |   |   |  |   |   |   |   |   |  |   |  |   |       |
| <b>HONDA  FR-V 2.2 CTDi</b>      |                     |               |                    |  |   |   |  |   |   |   |   |   |  |   |  |   |       |
|                                   | N22A                | 01/06 → 09/07 |                    | —  |   |   |  |   |   | 1   |   |   |  |   |  |   |       |
|                                   | B(Alt) N22A         | 01/06 → 09/07 |                    | VKMV_____  |   |   |  |   | 1 |   |   |   |  |   |  |   |       |
| <b>HONDA  HR-V 1.6</b>           |                     |               |                    |  |   |   |  |   |   |   |   |   |  |   |  |   |       |
|                                   | D16W1, D16W5        | 03/99 → 12/00 | 3), → Mot. 1120502 | VKMS 93006   | 1 | 1   |  |   |   |   | 2 |   |  |   |  |   | T0682 |
|   |                     |               |                    | VKMA 93006   | 1 | 1   |  |   |   |   |   |   |  |   |  |   |       |
|   |                     |               |                    | VKM 73005  | 1 |   |  |   |   |   |   |   |  |   |  |   |       |
|   | D16W1, D16W5        | 03/99 → 12/00 | 3), Mot. 1120503 → | VKMS 93601   | 1 | 1   |  |   |   |   | 2 |   |  |   |  |   | T0682 |
|   |                     |               |                    | VKMA 93006   | 1 | 1   |  |   |   |   |   |   |  |   |  |   |       |
|   |                     |               |                    | VKM 73005  | 1 |   |  |   |   |   |   |   |  |   |  |   |       |
|   | D16W1, D16W5        | 01/01 → 12/05 | 3)                 | VKMS 93601   | 1 | 1   |  |   |   |   | 2 |   |  |   |  |   | T0682 |
|   |                     |               |                    | VKMA 93006   | 1 | 1   |  |   |   |   |   |   |  |   |  |   |       |
|   |                     |               |                    | VKM 73005  | 1 |   |  |   |   |   |   |   |  |   |  |   |       |
|                                   | D16W1, D16W5        | 03/99 → 12/05 |                    | VKPC 93000   |   |   |  |   |   | 1   |   |   |  |   |  |   |       |
|                                   | B(Alt) D16W1, D16W5 | 03/99 → 04/03 |                    | VKMV_____  |   |   |  |   | 1 |   |   |   |  |   |  |   |       |
|   | B(PS) D16W1, D16W5  | 03/99 → 04/03 |                    | VKMV_____  |   |   |  |   | 1 |   |   |   |  |   |  |   |       |
|   | B(AC) D16W1, D16W5  | 03/99 → 04/03 |                    | VKMV_____  |   |   |  |   | 1 |   |   |   |  |   |  |   |       |
|   |                     |               |                    | VKM 63001  |   |   |  |   | 1 |   |   |   |  |   |  |   |       |
| <b>HONDA  INTEGRA 1.5</b>        |                     |               |                    |  |   |   |  |   |   |   |   |   |  |   |  |   |       |
|                                   | EW                  | 02/86 → 05/87 |                    | VKMA 93101   | 1 | 1   |  |   |   |   |   |   |  |   |  |   | T0682 |
|   |                     |               |                    | VKM 73101  | 1 |   |  |   |   |   |   |   |  |   |  |   |       |
|                                   | EW                  | 10/86 → 04/87 |                    | VKPC 93205   |   |   |  |   |   | 1   |   |   |  |   |  |   |       |
| <b>HONDA  INTEGRA 1.6</b>        |                     |               |                    |  |   |   |  |   |   |   |   |   |  |   |  |   |       |
|                                   | D16A3               | 03/86 → 12/87 |                    | —  | 1 | 1   |  |   |   |   |   |   |  |   |  |   |       |
|   |                     |               |                    | VKM 73003  | 1 |   |  |   |   |   |   |   |  |   |  |   |       |
|   | ZC                  | 04/89 → 10/91 |                    | VKMA 93001   | 1 | 1   |  |   |   |   |   |   |  |   |  |   | T0682 |
|   |                     |               |                    | VKM 73000  | 1 |   |  |   |   |   |   |   |  |   |  |   |       |
|                                   | EP                  | 04/82 → 01/85 |                    | VKPC 93405   |   |   |  |   |   | 1   |   |   |  |   |  |   |       |
|   | EW                  | 01/86 → 12/90 |                    | VKPC 93205   |   |   |  |   |   | 1   |   |   |  |   |  |   |       |
|   | ZC                  | 01/87 → 12/90 |                    | VKPC 87404   |   |   |  |   |   | 1   |   |   |  |   |  |   |       |
| <b>HONDA  INTEGRA 1.8 Type-R</b> |                     |               |                    |  |   |   |  |   |   |   |   |   |  |   |  |   |       |
|                                   | B18C6               | 01/98 → 10/01 |                    | VKPC 93415   |   |   |  |   |   | 1   |   |   |  |   |  |   |       |

|   |              |  |  |  |  |  |  |  |  |  |  |  |
|---|--------------|---|---|---|--|---|---|---|---|---|---|---|
| <b>HONDA  INTEGRA 2.0</b>    |              |   |   |   |  |   |   |   |   |   |   |   |
|                              | K20A, K20Z   | 02/02 → 01/08   |   | <b>ΟΛΟΚΛΗΡΟ</b>   |  |   |   |   |   |   |   |   |
| <b>HONDA  JAZZ 1.2</b>       |              |   |   |   |  |   |   |   |   |   |   |   |
|                              | L12A1        | 03/02 → 09/07   |   | <b>ΟΛΟΚΛΗΡΟ</b>   |  |   |   |   |   |   |   |   |
|                              | L12A1        | 03/02 → 09/07   |   | VKPC 93603  |  |   |   |   | 1   |   |   |   |
|                              | B(Alt) L12A1 | 03/02 → 06/03   | AC  | VKMMV 5PK850  |  |   | 1   |   |   |   |   |   |
|                              | B(Alt) L12A1 | 03/02 → 12/02   | AC  | VKMA _____<br>VKMMV _____<br>VKM _____  |  | 1   | 1   |   |   |   |   |   |
|                              | B(Alt) L12A1 | 01/03 → 12/05   | AC  | VKMA _____<br>VKMMV _____<br>VKM _____  |  | 1   | 1   |   |   |   |   |   |
| <b>HONDA  JAZZ 1.4</b>       |              |   |   |   |  |   |   |   |   |   |   |   |
|                              | L13A1        | 03/02 → 09/07   |   | <b>ΟΛΟΚΛΗΡΟ</b>   |  |   |   |   |   |   |   |   |
|                              | L13A1        | 03/02 → 09/07   |   | VKPC 93603  |  |   |   |   | 1   |   |   |   |
|                              | B(Alt) L13A1 | 03/02 → 12/02   | AC  | VKMA _____<br>VKMMV _____<br>VKM _____  |  | 1   | 1   |   |   |   |   |   |
|                              | B(Alt) L13A1 | 01/03 → 09/07   | AC  | VKMA _____<br>VKMMV _____<br>VKM _____  |  | 1   | 1   |   |   |   |   |   |
| <b>HONDA  JAZZ 1.5</b>       |              |   |   |   |  |   |   |   |   |   |   |   |
|                              | L15A1        | 04/02 → 09/07   |   | <b>ΟΛΟΚΛΗΡΟ</b>   |  |   |   |   |   |   |   |   |
|                             | L15A1        | 04/02 → 09/07   |   | VKPC 93603  |  |   |   |   | 1   |   |   |   |
|                            | B(Alt) L15A1 | 04/02 → 12/02   | AC  | VKMA _____<br>VKMMV _____<br>VKM _____  |  | 1   | 1   |   |   |   |   |   |
|                            | B(Alt) L15A1 | 01/03 → 09/07   | AC  | VKMA _____<br>VKMMV _____<br>VKM _____  |  | 1   | 1   |   |   |   |   |   |
| <b>HONDA  LEGEND 2.5</b>   |              |   |   |   |  |   |   |   |   |   |   |   |
|                            | C25A1, C25A2 | 01/86 → 06/88   | 3)  | VKMS 93302<br>VKMA 93302<br>VKM 73001   | 1<br>1<br>1  |   | 1   |   |   |   | 2   | T0416   |
|                            | C25A1, C25A2 | 01/86 → 06/88   |   | VKPC 87610  |  |   |   |   | 1   |   |   |   |
| <b>HONDA  LEGEND 2.7</b>   |              |   |   |   |  |   |   |   |   |   |   |   |
|                            | C27A1        | 10/87 → 12/90   | 3)  | VKMS 93302<br>VKMA 93302<br>VKM 73001   | 1<br>1<br>1  |   | 1   |   |   |   | 2   | T0416   |
|                            | C27A1        | 10/87 → 12/90   |   | VKPC 87610  |  |   |   |   | 1   |   |   |   |
| <b>HONDA  LEGEND 3.2</b>   |              |   |   |   |  |   |   |   |   |   |   |   |
|                            | C32A2        | 01/91 → 10/94   |   | VKMA 93012<br>VKM 73004   | 1<br>1   |   | 1   |   |   |   |   | T0695   |
| <b>HONDA  LOGO 1.3</b>     |              |   |   |   |  |   |   |   |   |   |   |   |
|                            | D13B7        | 01/96 → 01/03   | 3)  | VKMS 93019<br>VKMA 93019<br>VKM 73005   | 1<br>1<br>1  |   | 1   |   |   |   | 2   | T0682   |
|                            | B(Alt) D13B7 | 03/99 → 03/02   |   | VKMMV _____   |  |   | 1   |   |   |   |   |   |
|                            | B(AC) D13B7  | 03/99 → 03/02   |   | VKM 63001   |  |   | 1   |   |   |   |   |   |
| <b>HONDA  NSX 3.0 Vtec</b> |              |   |   |   |  |   |   |   |   |   |   |   |
|                            | C30A3, C30A4 | 06/90 → 09/05   |   | <b>ΟΛΟΚΛΗΡΟ</b>   |  |   |   |   |   |   |   |   |
| <b>HONDA  NSX 3.2 Vtec</b> |              |   |   |   |  |   |   |   |   |   |   |   |
|                            | C32B2        | 01/97 → 09/05   |   | <b>ΟΛΟΚΛΗΡΟ</b>   |  |   |   |   |   |   |   |   |
| <b>HONDA  ODYSSEY 2.2</b>  |              |   |   |   |  |   |   |   |   |   |   |   |
|                            | F22B         | 01/95 → 12/99   |   | VKMA 93600<br>VKM 73011<br>VKM 73600  | 2<br>1<br>1  |   | 2   |   |   |   |   | T0669   |
| <b>HONDA  ODYSSEY 2.3</b>  |              |   |   |   |  |   |   |   |   |   |   |   |
|                            | F23A         | 01/98 → 07/03   |   | VKPC 93601  |  |   |   |   | 1   |   |   |   |











































































HONDA

|   |  |  |  |  |  |  |  |  |  |  |  |  |  |
|---|---|---|---|--|---|---|---|---|---|---|---|---|---|
| <b>HONDA  PASSPORT 2.6</b>       |   |   |   |  |   |   |   |   |   |   |   |   |   |
|                                   | 4ZE1  | 11/93 → 12/94   |   | VKMA 99003<br>VKM 79000  | 1<br>1  | 1   |   |   |   |   |   |   | T0627   |
| <b>HONDA  PRELUDE 1.6</b>        |   |   |   |  |   |   |   |   |   |   |   |   |   |
|                                   | EL, EL14  | 01/79 → 10/82   |   | VKMA 93007<br>—  | 1<br>1  | 1   |   |   |   |   |   |   | T0662   |
|                                   | EL, EL14  | 01/82 → 10/82   | Mot. N1600001 I→  | VKPC 93405   |   |   |   |   | 1   |   |   |   |   |
| <b>HONDA  PRELUDE 1.8</b>        |   |   |   |  |   |   |   |   |   |   |   |   |   |
|                                   | ET2, ET3, ET4   | 11/83 → 04/87   | 3)  | VKMS 93200<br>VKMA 93200<br>VKM 73200  | 1<br>1<br>1   | 1   |   |   |   | 2   |   |   | T0413   |
|                                   | EK  | 10/81 → 11/82   |   | VKPC 93405   |   |   |   |   | 1   |   |   |   |   |
| <b>HONDA  PRELUDE 2.0</b>        |   |   |   |  |   |   |   |   |   |   |   |   |   |
|                                   | A20A, B20A, B20A4   | 04/86 → 12/87   | 3), Mod. BA, BA4, SOHC  | VKMS 93200<br>VKMA 93200<br>VKM 73200  | 1<br>1<br>1   | 1   |   |   |   | 2   |   |   | T0413   |
|   | F20A4   | 02/92 → 10/00   | 3), Mod. BB3, BB9   | VKMS 93600<br>VKMA 93600<br>VKM 73011<br>VKM 73600                                 | 2<br>2<br>1<br>1  | 2   |   |   |   | 3   |   |   | T0669   |
|   | B20A1   | 04/86 → 12/87   | Mod. BA2, DOHC  | VKMA 93100<br>VKM 73002  | 1<br>1  | 1   |   |   |   |   |   |   | T0677   |
|   | B20A3, B20A5, B20A9   | 01/88 → 12/91   | Mod. BA4, SOHC  | —<br>VKM 73002   | 1<br>1  | 1   |   |   |   |   |   |   |   |
|   | B20A3, B20A5, B20A9   | 01/88 → 12/91   | Mod. BA4, DOHC  | VKMA 93009<br>VKM 73002  | 1<br>1  | 1   |   |   |   |   |   |   | T0677   |
|                                  | B20A1   | 04/86 → 12/87   | Mod. BA, BA2, SOHC  | VKPC 93410   |   |   |   |   | 1   |   |   |   |   |
|   | B20A1   | 04/86 → 12/87   | Mod. BA, BA2, DOHC  | VKPC 93600   |   |   |   |   | 1   |   |   |   |   |
|   | B20A3, B20A4, B20A5,<br>B20A7   | 04/87 → 01/92   | Mod. BA, BA4, Carbu.  | VKPC 93600   |   |   |   |   | 1   |   |   |   |   |
|   | F20A4   | 02/92 → 10/00   | Mod. BB3, BB9   | VKPC 93601   |   |   |   |   | 1   |   |   |   |   |
|                                 | B(Alt) F20A4  | 10/96 → 10/00   | AC  | VKMV 6PK950  |   |   |   |   | 1   |   |   |   |   |
| <b>HONDA  PRELUDE 2.2</b>      |   |   |   |  |   |   |   |   |   |   |   |   |   |
|                                 | F22A  | 10/96 → 10/00   | 3), Mod. BB5, SOHC  | VKMS 93600<br>VKMA 93600<br>VKM 73011<br>VKM 73600                                 | 2<br>2<br>1<br>1  | 2   |   |   |   | 3   |   |   | T0669   |
|                                 | F22A  | 10/96 → 10/00   | Mod. BB5, SOHC  | VKPC 93601   |   |   |   |   | 1   |   |   |   |   |
| <b>HONDA  PRELUDE 2.2 Vtec</b> |   |   |   |  |   |   |   |   |   |   |   |   |   |
|                                 | H22A2, H22A5  | 02/93 → 10/00   | Mod. BB1, BB6, BB8,<br>DOHC   | VKMA 93014<br>VKM 73006<br>VKM 73007   | 2<br>1<br>1   | 2   |   |   |   |   |   |   | T0400   |
|                                 | H22A2, H22A5  | 02/93 → 10/00   | Mod. BB1, BB6, BB8  | —  |   |   |   |   | 1   |   |   |   |   |
| <b>HONDA  PRELUDE 2.3</b>      |   |   |   |  |   |   |   |   |   |   |   |   |   |
|                                 | H23A2   | 02/92 → 12/95   | Mod. BB2, DOHC  | VKMA 93013<br>VKM 73011<br>VKM 73600   | 2<br>1<br>1   | 2   |   |   |   |   |   |   | T0669   |
| <b>HONDA  QUINTET 1.6</b>      |   |   |   |  |   |   |   |   |   |   |   |   |   |
|                                 | EL  | 01/81 → 03/83   |   | VKMA 93007<br>—  | 1<br>1  | 1   |   |   |   |   |   |   | T0662   |
|                                 | EL  | 01/82 → 12/84   |   | VKPC 93405   |   |   |   |   | 1   |   |   |   |   |
| <b>HONDA  S2000 2.0 Vtec</b>   |   |   |   |  |   |   |   |   |   |   |   |   |   |
|                                 | F20C  | 06/99 → 12/05   |   | XXXXXXXXXX   |   |   |   |   |   |   |   |   |   |
| <b>HONDA  SHUTTLE 2.2</b>      |   |   |   |  |   |   |   |   |   |   |   |   |   |
|                                 | F22B8   | 10/94 → 12/97   | 3)  | VKMS 93600<br>VKMA 93600<br>VKM 73011<br>VKM 73600                                 | 2<br>2<br>1<br>1  | 2   |   |   |   | 3   |   |   | T0669   |
|                                 | F22B8   | 10/94 → 12/97   |   | VKPC 93601   |   |   |   |   | 1   |   |   |   |   |
|                                 | B(Alt) F22B8  | 10/94 → 02/98   | AC  | VKMV_____  |   |   |   |   | 1   |   |   |   |   |
| <b>HONDA  SHUTTLE 2.3</b>      |   |   |   |  |   |   |   |   |   |   |   |   |   |
|                                 | F23A7   | 10/97 → 12/99   | 3)  | VKMS 93011<br>VKMA 93011   | 2<br>2  | 2   |   |   |   | 3   |   |   | T0397   |

|                                 |                     |               |           | VKM 73011      | 1 |   |   |   |  |  |  |   |       |
|---------------------------------|---------------------|---------------|-----------|----------------|---|---|---|---|--|--|--|---|-------|
|                                 |                     |               |           | VKM 73600      | 1 |   |   |   |  |  |  |   |       |
|                                 | F23A7               | 10/97 → 12/99 |           | VKPC 93601     |   |   |   | 1 |  |  |  |   |       |
|                                 | <b>B(Alt)</b> F23A7 | 10/97 → 06/02 | <b>AC</b> | VKMV ____      |   |   | 1 |   |  |  |  |   |       |
| <b>HONDA  S-MX 2.0</b>          |                     |               |           |                |   |   |   |   |  |  |  |   |       |
|                                 | B20B                | 01/96 → 07/03 |           | VKPC 93001     |   |   |   | 1 |  |  |  |   |       |
| <b>HONDA  STEP WAGON 2.0</b>    |                     |               |           |                |   |   |   |   |  |  |  |   |       |
|                                 | B20B                | 04/96 → 12/01 |           | VKMA 93210     | 1 |   | 1 |   |  |  |  |   | T0677 |
|                                 |                     |               |           | VKM 73201      | 1 |   |   |   |  |  |  |   |       |
| <b>HONDA  STREAM 1.7</b>        |                     |               |           |                |   |   |   |   |  |  |  |   |       |
|                                 | D17A2               | 05/01 → 12/05 |           | VKPC ____      |   |   |   | 1 |  |  |  |   |       |
|                                 | <b>B(PS)</b> D17A2  | 05/01 → 01/03 |           | VKMV ____      |   |   | 1 |   |  |  |  |   |       |
| <b>HONDA  STREAM 2.0</b>        |                     |               |           |                |   |   |   |   |  |  |  |   |       |
|                                 | K20A                | 05/01 → 12/05 |           | <b>OKOKOKO</b> |   |   |   |   |  |  |  |   |       |
|                                 | K20A                | 05/01 → 12/05 |           | VKPC 93604     |   |   |   | 1 |  |  |  |   |       |
| <b>HYUNDAI  ACCENT 1.3</b>      |                     |               |           |                |   |   |   |   |  |  |  |   |       |
|                                 | G4EH                | 10/94 → 01/00 | 3), SOHC  | VKMS 95030     | 1 |   | 1 |   |  |  |  | 2 | T0691 |
|                                 |                     |               |           | VKMA 95030     | 1 |   | 1 |   |  |  |  |   |       |
|                                 |                     |               |           | VKM 75006      | 1 |   |   |   |  |  |  |   |       |
|                                 | G4E-A               | 01/00 → 12/04 |           | VKMA 95648     | 1 |   | 1 |   |  |  |  |   | T0697 |
|                                 |                     |               |           | VKM 75006      | 1 |   |   |   |  |  |  |   |       |
|                                 | G4E-A, G4EH         | 09/99 → 03/06 | SOHC      | VKPC 95856     |   |   |   | 1 |  |  |  | 1 |       |
|                                 | G4E-A               | 11/01 → 03/06 | 22)       | VKPC 95853     |   |   |   | 1 |  |  |  |   |       |
|                                 | G4EH                | 01/95 → 01/00 |           | VKPC 95008     |   |   |   | 1 |  |  |  |   |       |
| <b>HYUNDAI  ACCENT 1.5</b>      |                     |               |           |                |   |   |   |   |  |  |  |   |       |
|                                 | G4EB, G4EC-G, G4EK  | 10/94 → 11/02 | 3), DOHC  | VKMS 95632     | 1 | 1 | 1 |   |  |  |  | 2 | T0557 |
|                                 |                     |               |           | VKMA 95632     | 1 | 1 | 1 |   |  |  |  |   |       |
|                                 |                     |               |           | VKM 75006      | 1 |   |   |   |  |  |  |   |       |
|                                 |                     |               |           | VKM 85145      |   |   | 1 |   |  |  |  |   |       |
|                                 | G4EK                | 10/94 → 01/00 | 3), SOHC  | VKMS 95030     | 1 |   | 1 |   |  |  |  | 2 | T0691 |
|                                 |                     |               |           | VKMA 95030     | 1 |   | 1 |   |  |  |  |   |       |
|                                 |                     |               |           | VKM 75006      | 1 |   |   |   |  |  |  |   |       |
|                                 | G4EB, G4EC-G        | 01/00 → 01/03 | SOHC      | VKMA 95648     | 1 |   | 1 |   |  |  |  |   | T0697 |
|                                 |                     |               |           | VKM 75006      | 1 |   |   |   |  |  |  |   |       |
|                                 | D-Eng VGT           | 11/01 → 08/02 |           | VKPC 95858     |   |   |   | 1 |  |  |  |   |       |
|                                 | G4EB, G4EC-G, G4EK  | 10/95 → 09/07 | DOHC      | VKPC 95857     |   |   |   | 1 |  |  |  | 1 |       |
|                                 | G4EB, G4EC-G, G4EK  | 09/99 → 03/06 | SOHC      | VKPC 95856     |   |   |   | 1 |  |  |  | 1 |       |
|                                 | G4EB, G4EC-G        | 11/01 → 03/06 | 22)       | VKPC 95853     |   |   |   | 1 |  |  |  |   |       |
|                                 | G4EK                | 01/95 → 01/00 |           | VKPC 95008     |   |   |   | 1 |  |  |  |   |       |
| <b>HYUNDAI  ACCENT 1.6</b>      |                     |               |           |                |   |   |   |   |  |  |  |   |       |
|                                 | G4ED                | 12/02 → 01/03 | 3), DOHC  | VKMS 95632     | 1 | 1 | 1 |   |  |  |  | 2 | T0557 |
|                                 |                     |               |           | VKMA 95632     | 1 | 1 | 1 |   |  |  |  |   |       |
|                                 |                     |               |           | VKM 75006      | 1 |   |   |   |  |  |  |   |       |
|                                 |                     |               |           | VKM 85145      |   |   | 1 |   |  |  |  |   |       |
|                                 | G4ED-G              | 12/02 → 03/06 | 22)       | VKPC 95853     |   |   |   | 1 |  |  |  |   |       |
|                                 | G4ED-G              | 12/02 → 03/06 | SOHC      | VKPC 95856     |   |   |   | 1 |  |  |  | 1 |       |
|                                 | G4ED-G              | 12/02 → 03/06 | DOHC      | VKPC 95857     |   |   |   | 1 |  |  |  | 1 |       |
| <b>HYUNDAI  ACCENT 1.5 CRDi</b> |                     |               |           |                |   |   |   |   |  |  |  |   |       |
|                                 |                     | 11/05 → 03/06 | 22)       | VKPC 95853     |   |   |   | 1 |  |  |  |   |       |
|                                 |                     | 11/05 → 03/06 | SOHC      | VKPC 95856     |   |   |   | 1 |  |  |  | 1 |       |
|                                 |                     | 11/05 → 03/06 | DOHC      | VKPC 95857     |   |   |   | 1 |  |  |  | 1 |       |
| <b>HYUNDAI  AMICA 1.0</b>       |                     |               |           |                |   |   |   |   |  |  |  |   |       |
|                                 | G4HC                | 01/99 → 12/03 |           | VKMA 95641     | 1 |   | 1 |   |  |  |  |   | T0691 |
|                                 |                     |               |           | VKM 75621      | 1 |   |   |   |  |  |  |   |       |
| <b>HYUNDAI  ATOS 0.8</b>        |                     |               |           |                |   |   |   |   |  |  |  |   |       |
|                                 |                     | 09/97 → 12/00 |           | VKMA 95638     | 1 |   | 1 |   |  |  |  |   | T0697 |
|                                 |                     |               |           | VKM 75621      | 1 |   |   |   |  |  |  |   |       |
| <b>HYUNDAI  ATOS 1.0</b>        |                     |               |           |                |   |   |   |   |  |  |  |   |       |
|                                 | G4HC, G4HC-E        | 01/97 → 12/03 |           | VKMA 95641     | 1 |   | 1 |   |  |  |  |   | T0691 |
|                                 |                     |               |           | VKM 75621      | 1 |   |   |   |  |  |  |   |       |
|                                 | G4HC, G4HC-E        | 07/01 → 12/03 |           | VKPC 95007     |   |   |   | 1 |  |  |  |   |       |
| <b>HYUNDAI  ATOS PRIME 1.0</b>  |                     |               |           |                |   |   |   |   |  |  |  |   |       |
|                                 | G4HC, G4HC-E        | 01/99 → 12/03 |           | VKMA 95641     | 1 |   | 1 |   |  |  |  |   | T0691 |
|                                 |                     |               |           | VKM 75621      | 1 |   |   |   |  |  |  |   |       |







































|   |  |  |  |  |  |  |  |  |  |  |  |  |  |  |  |  |  |  |  |  |       |
|---|---|---|---|--|---|---|---|---|---|---|---|---|---|---|---|---|---|---|---|---|-------|
|                                     | G4HC, G4HC-E  | 07/01 → 12/03   |   | VKPC 95007   |   |   |   |   |   |   |   |   |   | 1   |   |   |   |   |   |   |       |
| <b>HYUNDAI  COUPE 1.6</b>          |   |   |   |  |   |   |   |   |   |   |   |   |   |   |   |   |   |   |   |   |       |
|                                     | 4G61, G4GR  | 12/96 → 04/00   | 3), DOHC  | VKMS 95655   | 1   | 1   | 1   |   |   |   |   |   |   |   |   |   | 2   |   |   | T0658   |       |
|   |   |   |   | VKMA 95655   | 1   | 1   | 1   |   |   |   |   |   |   |   |   |   |   |   |   |   |       |
|   |   |   |   | VKM 75629  | 1   |   |   |   |   |   |   |   |   |   |   |   |   |   |   |   |       |
|   |   |   |   | VKM 85147  |   | 1   |   |   |   |   |   |   |   |   |   |   |   |   |   |   |       |
|   | 4G61, G4ED-G, G4GR  | 05/00 → 01/07   | 3), SOHC  | VKMS 95632   | 1   | 1   | 1   |   |   |   |   |   |   |   |   |   | 2   |   |   | T0557   |       |
|   |   |   |   | VKMA 95632   | 1   | 1   | 1   |   |   |   |   |   |   |   |   |   |   |   |   |   |       |
|   |   |   |   | VKM 75006  | 1   |   |   |   |   |   |   |   |   |   |   |   |   |   |   |   |       |
|   |   |   |   | VKM 85145  |   | 1   |   |   |   |   |   |   |   |   |   |   |   |   |   |   |       |
|                                     | 4G61, G4GR  | 12/96 → 05/99   |   | VKPC 95859   |   |   |   |   |   |   |   |   |   | 1   |   |   |   |   |   |   |       |
|   | 4G61, G4GR  | 06/99 → 05/00   |   | VKPC 95852   |   |   |   |   |   |   |   |   |   | 1   |   |   |   |   |   |   |       |
|   | G4ED-G  | 04/02 → 10/06   |   | VKPC 95857   |   |   |   |   |   |   |   |   |   | 1   |   |   |   |   |   | 1   |       |
| <b>HYUNDAI  COUPE 2.0</b>          |   |   |   |  |   |   |   |   |   |   |   |   |   |   |   |   |   |   |   |   |       |
|                                     | G4GC-G, G4GF  | 08/96 → 05/06   | 3), DOHC  | VKMS 95656   | 1   | 1   | 1   |   |   |   |   |   |   |   |   |   | 2   |   |   | T0658   |       |
|   |   |   |   | VKMA 95656   | 1   | 1   | 1   |   |   |   |   |   |   |   |   |   |   |   |   |   |       |
|   |   |   |   | VKM 75629  | 1   |   |   |   |   |   |   |   |   |   |   |   |   |   |   |   |       |
|   |   |   |   | VKM 85147  |   | 1   |   |   |   |   |   |   |   |   |   |   |   |   |   |   |       |
|                                     | G4GF  | 08/96 → 05/99   |   | VKPC 95859   |   |   |   |   |   |   |   |   |   | 1   |   |   |   |   |   |   |       |
|   | G4GF  | 06/99 → 04/02   |   | VKPC 95852   |   |   |   |   |   |   |   |   |   | 1   |   |   |   |   |   |   |       |
| <b>HYUNDAI  COUPE 2.7</b>          |   |   |   |  |   |   |   |   |   |   |   |   |   |   |   |   |   |   |   |   |       |
|                                     |   | 09/01 → 12/05   |   | VKMA 95657   | 1   | 1   | 1   |   |   |   |   |   |   |   |   |   |   |   |   |   | T0690 |
|   |   |   |   | VKM 75630  | 1   |   |   |   |   |   |   |   |   |   |   |   |   |   |   |   |       |
|   |   |   |   | VKM 85148  |   | 1   |   |   |   |   |   |   |   |   |   |   |   |   |   |   |       |
| <b>HYUNDAI  ELANTRA 1.5</b>        |   |   |   |  |   |   |   |   |   |   |   |   |   |   |   |   |   |   |   |   |       |
|                                     | G4DJ  | 12/90 → 09/94   | 3), SOHC  | VKMS 95619   | 1   |   | 1   |   |   |   |   |   |   |   |   |   | 2   |   |   | T0697   |       |
|   |   |   |   | VKMA 95619   | 1   |   | 1   |   |   |   |   |   |   |   |   |   |   |   |   |   |       |
|   |   |   |   | VKM 75100  | 1   |   |   |   |   |   |   |   |   |   |   |   |   |   |   |   |       |
| <b>HYUNDAI  ELANTRA 1.6</b>      |   |   |   |  |   |   |   |   |   |   |   |   |   |   |   |   |   |   |   |   |       |
|                                   | G4ED-G, G4GA  | 08/06 → 10/07   |   | <del>VKMS 95632</del>  |   |   |   |   |   |   |   |   |   |   |   |   |   |   |   |   |       |
|   | G4ED-G, G4GA  | 06/00 → 07/06   | 3), 23), DOHC   | VKMS 95632   | 1   | 1   | 1   |   |   |   |   |   |   |   |   |   | 2   |   |   | T0557   |       |
|   |   |   |   | VKMA 95632   | 1   | 1   | 1   |   |   |   |   |   |   |   |   |   |   |   |   |   |       |
|   |   |   |   | VKM 75006  | 1   |   |   |   |   |   |   |   |   |   |   |   |   |   |   |   |       |
|   |   |   |   | VKM 85145  |   | 1   |   |   |   |   |   |   |   |   |   |   |   |   |   |   |       |
|   | G4CR  | 07/92 → 09/94   | DOHC  | VKMA 95013   | 2   | 1   | 2   |   |   |   |   |   |   |   |   |   |   |   |   | T0666   |       |
|   |   |   |   | VKM 75044  | 1   |   |   |   |   |   |   |   |   |   |   |   |   |   |   |   |       |
|   |   |   |   | VKM 75144  | 1   |   |   |   |   |   |   |   |   |   |   |   |   |   |   |   |       |
|   |   |   |   | VKM 85000  |   | 1   |   |   |   |   |   |   |   |   |   |   |   |   |   |   |       |
|   | G4ED-G, G4GA  | 01/01 → 07/06   | 22)   | VKMA 95660   | 1   | 1   | 1   |   |   |   |   |   |   |   |   |   |   |   |   | T0575   |       |
|   |   |   |   | VKM 75628  | 1   |   |   |   |   |   |   |   |   |   |   |   |   |   |   |   |       |
|   |   |   |   | VKM 85146  |   | 1   |   |   |   |   |   |   |   |   |   |   |   |   |   |   |       |
|                                   | G4ED-G  | 04/02 → 07/03   | DOHC  | VKPC 95857   |   |   |   |   |   |   |   |   |   | 1   |   |   |   |   |   | 1   |       |
| <b>HYUNDAI  ELANTRA 1.8</b>      |   |   |   |  |   |   |   |   |   |   |   |   |   |   |   |   |   |   |   |   |       |
|                                   | G4BB, G4GB  | 06/00 → 05/06   | 3), 23), DOHC   | VKMS 95655   | 1   | 1   | 1   |   |   |   |   |   |   |   |   |   | 2   |   |   | T0658   |       |
|   |   |   |   | VKMA 95655   | 1   | 1   | 1   |   |   |   |   |   |   |   |   |   |   |   |   |   |       |
|   |   |   |   | VKM 75629  | 1   |   |   |   |   |   |   |   |   |   |   |   |   |   |   |   |       |
|   |   |   |   | VKM 85147  |   | 1   |   |   |   |   |   |   |   |   |   |   |   |   |   |   |       |
|   | G4CN  | 06/92 → 09/94   | 3), DOHC  | VKMS 95005   | 2   | 1   | 2   |   |   |   |   |   |   |   |   |   | 5   |   |   | T0479   |       |
|   |   |   |   | VKMA 95005   | 2   | 1   | 2   |   |   |   |   |   |   |   |   |   |   |   |   |   |       |
|   |   |   |   | VKM 75044  | 1   |   |   |   |   |   |   |   |   |   |   |   |   |   |   |   |       |
|   |   |   |   | VKM 75144  | 1   |   |   |   |   |   |   |   |   |   |   |   |   |   |   |   |       |
|   |   |   |   | VKM 85000  |   | 1   |   |   |   |   |   |   |   |   |   |   |   |   |   |   |       |
|   | G4BB, G4GB  | 01/01 → 08/06   | 22)   | VKMA 95660   | 1   | 1   | 1   |   |   |   |   |   |   |   |   |   |   |   |   | T0575   |       |
|   |   |   |   | VKM 75628  | 1   |   |   |   |   |   |   |   |   |   |   |   |   |   |   |   |       |
|   |   |   |   | VKM 85146  |   | 1   |   |   |   |   |   |   |   |   |   |   |   |   |   |   |       |
| <b>HYUNDAI  ELANTRA 2.0</b>      |   |   |   |  |   |   |   |   |   |   |   |   |   |   |   |   |   |   |   |   |       |
|                                   | G4GC-G  | 06/00 → 05/06   | 3), 23), DOHC   | VKMS 95656   | 1   | 1   | 1   |   |   |   |   |   |   |   |   |   | 2   |   |   | T0658   |       |
|   |   |   |   | VKMA 95656   | 1   | 1   | 1   |   |   |   |   |   |   |   |   |   |   |   |   |   |       |
|   |   |   |   | VKM 75629  | 1   |   |   |   |   |   |   |   |   |   |   |   |   |   |   |   |       |
|   |   |   |   | VKM 85147  |   | 1   |   |   |   |   |   |   |   |   |   |   |   |   |   |   |       |
|   | G4GC-G  | 01/01 → 08/06   | 22)   | VKMA 95660   | 1   | 1   | 1   |   |   |   |   |   |   |   |   |   |   |   |   | T0575   |       |
|   |   |   |   | VKM 75628  | 1   |   |   |   |   |   |   |   |   |   |   |   |   |   |   |   |       |
|   |   |   |   | VKM 85146  |   | 1   |   |   |   |   |   |   |   |   |   |   |   |   |   |   |       |
| <b>HYUNDAI  ELANTRA 2.0 CRDi</b> |   |   |   |  |   |   |   |   |   |   |   |   |   |   |   |   |   |   |   |   |       |
|                                   | D4EA  | 04/01 → 05/06   | 3), 23), DOHC   | VKMS 95656   | 1   | 1   | 1   |   |   |   |   |   |   |   |   |   | 2   |   |   | T0658   |       |
|   |   |   |   | VKMA 95656   | 1   | 1   | 1   |   |   |   |   |   |   |   |   |   |   |   |   |   |       |





































|   |  |  |  |  |  |  |  |  |  |  |  |  |
|---|---|---|---|--|---|---|---|---|---|---|---|---|
|   |   |   |   | VKM 75629  | 1   |   |   |   |   |   |   |   |
|   |   |   |   | VKM 85147  |   | 1   |   |   |   |   |   |   |
|   | D4EA  | 04/01 → 08/06   | 22)   | VKMA 95660   | 1   | 1   | 1   |   |   |   |   | T0575   |
|   |   |   |   | VKM 75628  | 1   |   |   |   |   |   |   |   |
|   |   |   |   | VKM 85146  |   | 1   |   |   |   |   |   |   |
|                                  | D4EA  | 04/01 → 01/06   |   | VKPC 95853   |   |   |   |   | 1   |   |   |   |
| <b>HYUNDAI  EXCEL 1.3</b>        |   |   |   |  |   |   |   |   |   |   |   |   |
|                                  | G4DG  | 01/90 → 07/94   | 3)  | VKMS 95619   | 1   |   | 1   |   |   |   | 2   |   |
|   |   |   |   | VKMA 95619   | 1   |   | 1   |   |   |   |   | T0697   |
|   |   |   |   | VKM 75100  | 1   |   |   |   |   |   |   |   |
|                                  | G4DG  | 01/90 → 01/95   |   | VKPC 95008   |   |   |   |   | 1   |   |   |   |
| <b>HYUNDAI  EXCEL 1.5</b>        |   |   |   |  |   |   |   |   |   |   |   |   |
|                                  | 16V   | 01/96 → 01/03   | 3), DOHC  | VKMS 95632   | 1   | 1   | 1   |   |   |   | 2   |   |
|   |   |   |   | VKMA 95632   | 1   | 1   | 1   |   |   |   |   | T0557   |
|   |   |   |   | VKM 75006  | 1   |   |   |   |   |   |   |   |
|   |   |   |   | VKM 85145  |   | 1   |   |   |   |   |   |   |
|   | G15B, G4DJ  | 01/90 → 07/94   | 3)  | VKMS 95619   | 1   |   | 1   |   |   |   | 2   |   |
|   |   |   |   | VKMA 95619   | 1   |   | 1   |   |   |   |   | T0697   |
|   |   |   |   | VKM 75100  | 1   |   |   |   |   |   |   |   |
|                                  | G4DJ  | 01/90 → 01/95   |   | VKPC 95008   |   |   |   |   | 1   |   |   |   |
| <b>HYUNDAI  GALLOPER 2.5</b>     |   |   |   |  |   |   |   |   |   |   |   |   |
|                                  |   | 07/98 → 01/08   | Mod. Innovation   | —  | 1   |   | 1   |   |   |   |   |   |
|   |   |   |   | VKM 75612  | 1   |   |   |   |   |   |   |   |
| <b>HYUNDAI  GALLOPER 3.0</b>     |   |   |   |  |   |   |   |   |   |   |   |   |
|                                  | G6AT  | 05/96 → 11/02   |   | —  | 1   |   | 1   |   |   |   |   |   |
|   |   |   |   | —  | 1   |   |   |   |   |   |   |   |
| <b>HYUNDAI  GALLOPER 2.5 TD</b> |   |   |   |  |   |   |   |   |   |   |   |   |
|                                | 4D56  | 01/98 → 11/02   |   | VKMA 95014   | 2   |   | 2   |   |   |   |   | T0668   |
|   |   |   |   | VKM 75601  | 1   |   |   |   |   |   |   |   |
|   |   |   |   | VKM 75612  | 1   |   |   |   |   |   |   |   |
| <b>HYUNDAI  GETZ 1.1</b>       |   |   |   |  |   |   |   |   |   |   |   |   |
|                                | G4HD  | 09/02 → 08/05   |   | VKMA 95641   | 1   |   | 1   |   |   |   |   | T0691   |
|   |   |   |   | VKM 75621  | 1   |   |   |   |   |   |   |   |
|                                | G4HD  | 09/02 → 05/04   |   | VKPC 95007   |   |   |   |   | 1   |   |   |   |
| <b>HYUNDAI  GETZ 1.3</b>       |   |   |   |  |   |   |   |   |   |   |   |   |
|                                | G4E-A   | 09/02 → 08/05   |   | VKMA 95648   | 1   |   | 1   |   |   |   |   | T0697   |
|   |   |   |   | VKM 75006  | 1   |   |   |   |   |   |   |   |
|                                | G4E-A   | 09/02 → 07/05   |   | VKPC 95856   |   |   |   |   | 1   |   | 1   |   |
| <b>HYUNDAI  GETZ 1.4</b>       |   |   |   |  |   |   |   |   |   |   |   |   |
|                                |   | 08/05 → 01/07   | 3)  | VKMS 95632   | 1   | 1   | 1   |   |   |   | 2   |   |
|   |   |   |   | VKMA 95632   | 1   | 1   | 1   |   |   |   |   | T0557   |
|   |   |   |   | VKM 75006  | 1   |   |   |   |   |   |   |   |
|   |   |   |   | VKM 85145  |   | 1   |   |   |   |   |   |   |
| <b>HYUNDAI  GETZ 1.6</b>       |   |   |   |  |   |   |   |   |   |   |   |   |
|                                | G4ED-G  | 08/05 → 01/07   | 3)  | VKMS 95632   | 1   | 1   | 1   |   |   |   | 2   |   |
|   |   |   |   | VKMA 95632   | 1   | 1   | 1   |   |   |   |   | T0557   |
|   |   |   |   | VKM 75006  | 1   |   |   |   |   |   |   |   |
|   |   |   |   | VKM 85145  |   | 1   |   |   |   |   |   |   |
|                                | G4ED-G  | 09/02 → 05/04   |   | VKPC 95857   |   |   |   |   | 1   |   | 1   |   |
| <b>HYUNDAI  GETZ 1.5 CRDi</b>  |   |   |   |  |   |   |   |   |   |   |   |   |
|                                | D3-EA, D4FA   | 07/03 → 08/05   | 22)   | VKMA 95660   | 1   | 1   | 1   |   |   |   |   | T0575   |
|   |   |   |   | VKM 75628  | 1   |   |   |   |   |   |   |   |
|   |   |   |   | VKM 85146  |   | 1   |   |   |   |   |   |   |
|                                | D3-EA   | 07/03 → 02/05   |   | VKPC 95853   |   |   |   |   | 1   |   |   |   |
|   | D-Eng VGT   | 07/03 → 01/08   |   | VKPC 95858   |   |   |   |   | 1   |   |   |   |
| <b>HYUNDAI  GRACE 2.4</b>      |   |   |   |  |   |   |   |   |   |   |   |   |
|                                | D4BX  | 01/92 → 12/94   |   | —  | 2   |   | 2   |   |   |   |   |   |
|   |   |   |   | VKM 75033  | 1   |   |   |   |   |   |   |   |
|   |   |   |   | VKM 75113  | 1   |   |   |   |   |   |   |   |
| <b>HYUNDAI  GRACE 2.4 D</b>    |   |   |   |  |   |   |   |   |   |   |   |   |
|                                | D4BX  | 01/92 → 12/94   |   | VKMA 95010   | 2   |   | 2   |   |   |   |   | T0668   |
|   |   |   |   | VKM 75601  | 1   |   |   |   |   |   |   |   |
|   |   |   |   | VKM 75612  | 1   |   |   |   |   |   |   |   |



HYUNDAI





























|  |  |  |  |  |  |  |  |  |  |  |  |  |
|--|---|---|---|--|---|---|---|---|---|---|---|---|
| <b>HYUNDAI  LANTRA 1.5</b>        |   |   |   |  |   |   |   |   |   |   |   |   |
|                                    | G15B, G4DJ  | 10/90 → 09/94   | 3)  | VKMS 95619   | 1   | 1   |   |   | 2   |   |   |   |
|  |   |   |   | VKMA 95619   | 1   | 1   |   |   |   |   |   | T0697   |
|  |   |   |   | VKM 75100  | 1   |   |   |   |   |   |   |   |
|  | G4EK  | 12/96 → 12/01   | 3), SOHC  | VKMS 95030   | 1   | 1   |   |   | 2   |   |   |   |
|  |   |   |   | VKMA 95030   | 1   | 1   |   |   |   |   |   | T0691   |
|  |   |   |   | VKM 75006  | 1   |   |   |   |   |   |   |   |
|                                    | G4DJ  | 12/90 → 11/95   |   | VKPC 95008   |   |   |   | 1   |   |   |   |   |
| <b>HYUNDAI  LANTRA 1.6</b>        |   |   |   |  |   |   |   |   |   |   |   |   |
|                                    | 4G61, G4GR  | 01/00 → 08/06   | 3), DOHC  | VKMS 95632   | 1   | 1   | 1   |   |   | 2   |   |   |
|  |   |   |   | VKMA 95632   | 1   | 1   | 1   |   |   |   |   | T0557   |
|  |   |   |   | VKM 75006  | 1   |   |   |   |   |   |   |   |
|  |   |   |   | VKM 85145  |   | 1   |   |   |   |   |   |   |
|  | G4CR  | 07/92 → 09/94   | DOHC  | VKMA 95013   | 2   | 1   | 2   |   |   |   |   | T0666   |
|  |   |   |   | VKM 75044  | 1   |   |   |   |   |   |   |   |
|  |   |   |   | VKM 75144  | 1   |   |   |   |   |   |   |   |
|  |   |   |   | VKM 85000  |   | 1   |   |   |   |   |   |   |
|                                    | G4CR  | 12/90 → 11/95   |   | VKPC 95427   |   |   |   | 1   |   |   |   |   |
| <b>HYUNDAI  LANTRA 1.8</b>        |   |   |   |  |   |   |   |   |   |   |   |   |
|                                    | G4CN  | 06/92 → 09/94   | 3), DOHC  | VKMS 95005   | 2   | 1   | 2   |   |   | 5   |   |   |
|  |   |   |   | VKMA 95005   | 2   | 1   | 2   |   |   |   |   | T0479   |
|  |   |   |   | VKM 75044  | 1   |   |   |   |   |   |   |   |
|  |   |   |   | VKM 75144  | 1   |   |   |   |   |   |   |   |
|  |   |   |   | VKM 85000  |   | 1   |   |   |   |   |   |   |
|  | G4GM  | 01/96 → 08/06   | 3), DOHC  | VKMS 95655   | 1   | 1   | 1   |   |   | 2   |   |   |
|  |   |   |   | VKMA 95655   | 1   | 1   | 1   |   |   |   |   | T0658   |
|  |   |   |   | VKM 75629  | 1   |   |   |   |   |   |   |   |
|  |   |   |   | VKM 85147  |   | 1   |   |   |   |   |   |   |
|                                  | G4CN  | 09/91 → 11/95   |   | VKPC 95424   |   |   |   | 1   |   |   |   |   |
| <b>HYUNDAI  LANTRA 2.0</b>      |   |   |   |  |   |   |   |   |   |   |   |   |
|                                  | G4GF  | 08/96 → 05/06   | 3), DOHC  | VKMS 95656   | 1   | 1   | 1   |   |   | 2   |   |   |
|  |   |   |   | VKMA 95656   | 1   | 1   | 1   |   |   |   |   | T0658   |
|  |   |   |   | VKM 75629  | 1   |   |   |   |   |   |   |   |
|  |   |   |   | VKM 85147  |   | 1   |   |   |   |   |   |   |
|  | G4GF  | 01/01 → 08/06   | 2)  | VKMA 95660   | 1   | 1   | 1   |   |   |   |   | T0575   |
|  |   |   |   | VKM 75628  | 1   |   |   |   |   |   |   |   |
|  |   |   |   | VKM 85146  |   | 1   |   |   |   |   |   |   |
| <b>HYUNDAI  LANTRA 1.9 D</b>    |   |   |   |  |   |   |   |   |   |   |   |   |
|                                  |   | 03/98 → 11/02   |   | VKMA 03241   | 1   | 1   | 1   |   |   |   |   | T0017   |
|  |   |   |   | VKM 13241  | 1   |   |   |   |   |   |   |   |
|  |   |   |   | VKM 23241  |   | 1   |   |   |   |   |   |   |
|                                  | XUD   | 01/95 → 09/00   |   | VKPC 83420   |   |   |   | 1   |   |   |   |   |
| <b>HYUNDAI  MATRIX 1.6</b>      |   |   |   |  |   |   |   |   |   |   |   |   |
|                                  | G4ED-G  | 06/01 → 02/07   | 3)  | VKMS 95632   | 1   | 1   | 1   |   |   | 2   |   |   |
|  |   |   |   | VKMA 95632   | 1   | 1   | 1   |   |   |   |   | T0557   |
|  |   |   |   | VKM 75006  | 1   |   |   |   |   |   |   |   |
|  |   |   |   | VKM 85145  |   | 1   |   |   |   |   |   |   |
|                                  | G4ED-G  | 04/02 → 02/03   |   | VKPC 95857   |   |   |   | 1   |   |   | 1   |   |
| <b>HYUNDAI  MATRIX 1.8</b>      |   |   |   |  |   |   |   |   |   |   |   |   |
|                                  | G4GB-G  | 06/01 → 10/06   | 3)  | VKMS 95655   | 1   | 1   | 1   |   |   | 2   |   |   |
|  |   |   |   | VKMA 95655   | 1   | 1   | 1   |   |   |   |   | T0658   |
|  |   |   |   | VKM 75629  | 1   |   |   |   |   |   |   |   |
|  |   |   |   | VKM 85147  |   | 1   |   |   |   |   |   |   |
|                                  | G4GB-G  | 06/01 → 05/04   |   | VKPC 95852   |   |   |   | 1   |   |   |   |   |
| <b>HYUNDAI  MATRIX 1.5 CRDi</b> |   |   |   |  |   |   |   |   |   |   |   |   |
|                                  | D3-EA, D4FA   | 10/01 → 04/05   | 3), 22)   | VKMS _____   | 1   | 1   | 1   |   |   | 3   |   |   |
|  |   |   |   | VKMA 95660   | 1   | 1   | 1   |   |   |   |   | T0575   |
|  |   |   |   | VKM 75628  | 1   |   |   |   |   |   |   |   |
|  |   |   |   | VKM 85146  |   | 1   |   |   |   |   |   |   |
|                                  | D3-EA, D4FA   | 10/01 → 05/05   |   | VKPC 95853   |   |   |   | 1   |   |   |   |   |
| <b>HYUNDAI  PONY 1.3</b>        |   |   |   |  |   |   |   |   |   |   |   |   |
|                                  | G4DG  | 10/89 → 07/94   | 3)  | VKMS 95619   | 1   | 1   |   |   | 2   |   |   |   |
|  |   |   |   | VKMA 95619   | 1   | 1   |   |   |   |   |   | T0697   |
|  |   |   |   | VKM 75100  | 1   |   |   |   |   |   |   |   |
|  | G4EH  | 08/94 → 12/95   |   | VKMA 95030   | 1   | 1   |   |   |   |   |   | T0691   |
|  |   |   |   | VKM 75006  | 1   |   |   |   |   |   |   |   |



|  |  |  |  |  |  |  |  |  |  |  |
|--|---|---|---|--|---|---|---|---|---|---|
|                                     | G4DG  | 10/85 → 01/95   |   | VKPC 95008   |   |   |   |   | 1   |   |
| <b>HYUNDAI  PONY 1.4</b>            |   |   |   |  |   |   |   |   |   |   |
|                                     |   | 02/78 → 07/03   |   | —  |   |   |   |   | 1   |   |
| <b>HYUNDAI  PONY 1.5</b>            |   |   |   |  |   |   |   |   |   |   |
|                                     | G15B, G4DJ  | 10/89 → 07/94   | 3)  | VKMS 95619<br>VKMA 95619<br>VKM 75100  | 1<br>1<br>1   | 1   |   |   | 2   | T0697   |
|  | G4AJ  | 05/86 → 01/88   |   | VKMA 95206<br>VKM 75100  | 1<br>1  | 1   |   |   |   | T0697   |
|  | G4EK  | 07/94 → 12/95   |   | VKMA 95030<br>VKM 75006  | 1<br>1  | 1   |   |   |   | T0691   |
|                                     | G4DJ  | 10/85 → 01/95   |   | VKPC 95008   |   |   |   |   | 1   |   |
| <b>HYUNDAI  S COUPE 1.5</b>         |   |   |   |  |   |   |   |   |   |   |
|                                     | G15B, G4DJ  | 02/90 → 06/92   | 3)  | VKMS 95619<br>VKMA 95619<br>VKM 75100  | 1<br>1<br>1   | 1   |   |   | 2   | T0697   |
|  | G4EK  | 07/93 → 09/94   | 3)  | VKMS 95030<br>VKMA 95030<br>VKM 75006  | 1<br>1<br>1   | 1   |   |   | 2   | T0691   |
|  | G4EK  | 06/92 → 07/93   |   | —<br>VKM 75006   | 1<br>1  | 1   |   |   |   |   |
|                                     | G4DJ, G4EK  | 03/90 → 05/96   |   | VKPC 95008   |   |   |   |   | 1   |   |
| <b>HYUNDAI  S COUPE 1.5 Turbo</b>   |   |   |   |  |   |   |   |   |   |   |
|                                     | G4EK-TC   | 07/93 → 09/94   | 3)  | VKMS 95030<br>VKMA 95030<br>VKM 75006  | 1<br>1<br>1   | 1   |   |   | 2   | T0691   |
|  | G4EK-TC   | 06/92 → 07/93   |   | —<br>VKM 75006   | 1<br>1  | 1   |   |   |   |   |
| <b>HYUNDAI  SANTA FE 2.0</b>      |   |   |   |  |   |   |   |   |   |   |
|                                   | G4BP  | 08/01 → 12/05   | DOHC  | VKMA 95658<br>VKM 75613<br>VKM 75633<br>VKM 85000                                  | 2<br>1<br>1<br>1  | 1   | 2   |   |   | T0666   |
|                                   | G4BP  | 08/01 → 12/05   | DOHC  | VKPC 95850   |   |   |   |   | 1   |   |
| <b>HYUNDAI  SANTA FE 2.4</b>      |   |   |   |  |   |   |   |   |   |   |
|                                   | G4JS-G  | 02/01 → 12/05   | DOHC  | VKMA 95659<br>VKM 75613<br>VKM 75633<br>VKM 85000                                  | 2<br>1<br>1<br>1  | 1   | 2   |   |   | T0666   |
|                                   | G4JS-G  | 02/01 → 12/05   | DOHC  | VKPC 95850   |   |   |   |   | 1   |   |
|  | Sirius-II D   | 01/99 → 12/01   |   | VKPC 95850   |   |   |   |   | 1   |   |
| <b>HYUNDAI  SANTA FE 2.4 4X4</b>  |   |   |   |  |   |   |   |   |   |   |
|                                   | G4JS-G  | 02/01 → 12/05   | DOHC  | VKMA 95659<br>VKM 75613<br>VKM 75633<br>VKM 85000                                  | 2<br>1<br>1<br>1  | 1   | 2   |   |   | T0666   |
|                                   | G4JS-G  | 02/01 → 12/05   | DOHC  | VKPC 95850   |   |   |   |   | 1   |   |
| <b>HYUNDAI  SANTA FE 2.7</b>      |   |   |   |  |   |   |   |   |   |   |
|                                   | G6BA-G  | 02/01 → 12/05   | DOHC  | VKMA 95657<br>VKM 75630<br>VKM 85148   | 1<br>1<br>1   | 1   | 1   |   |   | T0690   |
| <b>HYUNDAI  SANTA FE 2.0 CRDi</b> |   |   |   |  |   |   |   |   |   |   |
|                                   | D4EA  | 04/01 → 12/05   | 22)   | VKMA 95660<br>VKM 75628<br>VKM 85146   | 1<br>1<br>1   | 1   | 1   |   |   | T0575   |
|                                   | D4EA  | 04/01 → 01/06   | SOHC  | VKPC 95853   |   |   |   |   | 1   |   |
| <b>HYUNDAI  SANTAMO 2.0</b>       |   |   |   |  |   |   |   |   |   |   |
|                                   |   | 02/95 → 12/00   | 3), DOHC  | VKMS 95005<br>VKMA 95005<br>VKM 75044<br>VKM 75144<br>VKM 85000                    | 2<br>2<br>1<br>1<br>1   | 1   | 2   |   | 5   | T0479   |
|  |   | 01/95 → 04/97   |   | VKMA 95639<br>VKM 75008<br>VKM 75130   | 2<br>1<br>1   |   | 2   |   |   | T0673   |

































































































HYUNDAI

|   |  |  |  |  |  |  |  |  |  |  |  |  |
|---|---|---|---|--|---|---|---|---|---|---|---|---|
|   |   | 04/97 → 12/00   | SOHC  | VKMA 95642<br>VKM 75008<br>VKM 75130   | 2<br>1<br>1   | 2   |   |   |   |   |   | T0665   |
|   | LPG   | 02/95 → 12/99   |   | —<br>VKM 75130   | 1<br>1  | 1   |   |   |   |   |   |   |
| <b>HYUNDAI  SONATA 1.8</b>   |   |   |   |  |   |   |   |   |   |   |   |   |
|                               |   | 07/93 → 10/95   | SOHC  | VKMA 95639<br>VKM 75008<br>VKM 75130   | 2<br>1<br>1   | 2   |   |   |   |   |   | T0673   |
|   |   | 11/95 → 06/98   | SOHC  | VKMA 95642<br>VKM 75008<br>VKM 75130   | 2<br>1<br>1   | 2   |   |   |   |   |   | T0665   |
|                               | G4CM  | 04/89 → 08/91   | SOHC  | VKPC 95611   |   |   |   | 1   |   |   |   |   |
| <b>HYUNDAI  SONATA 2.0</b>   |   |   |   |  |   |   |   |   |   |   |   |   |
|                               | G4CP, G4CP-D, G4CP-U  | 05/91 → 10/94   | 3), DOHC  | VKMS 95005<br>VKMA 95005<br>VKM 75044<br>VKM 75144<br>VKM 85000                    | 2<br>2<br>1<br>1<br>1   | 1<br>1<br>1   | 2   |   |   | 5   |   | T0479   |
|   | G4CP, G4CP-D  | 07/93 → 10/95   | SOHC  | VKMA 95639<br>VKM 75008<br>VKM 75130   | 2<br>1<br>1   | 2   |   |   |   |   |   | T0673   |
|   | G4CP, G4CP-D,<br>G4CP-DM  | 11/95 → 06/98   | SOHC  | VKMA 95642<br>VKM 75008<br>VKM 75130   | 2<br>1<br>1   | 2   |   |   |   |   |   | T0665   |
|   | G4CP, G4CP-D,<br>G4CP-DM  | 02/96 → 06/98   | DOHC  | VKMA 95652<br>VKM 75144<br>VKM 75613<br>VKM 85000                                  | 2<br>1<br>1<br>1  | 1<br>1  | 2   |   |   |   |   | T0666   |
|   | G4JP-EG   | 10/01 → 11/04   |   | VKMA 95658<br>VKM 75613<br>VKM 75633<br>VKM 85000                                  | 2<br>1<br>1<br>1  | 1<br>1  | 2   |   |   |   |   | T0666   |
|                             | G4CP  | 04/89 → 08/91   | SOHC  | VKPC 95611   |   |   |   | 1   |   |   |   |   |
|   | G4CP, G4CP-D,<br>G4CP-DM, G4CP-U  | 04/89 → 12/96   | DOHC  | VKPC 95424   |   |   |   | 1   |   |   |   |   |
|   | G4JP-G  | 04/01 → 10/01   |   | VKPC 95850   |   |   |   | 1   |   |   |   |   |
| <b>HYUNDAI  SONATA 2.4</b> |   |   |   |  |   |   |   |   |   |   |   |   |
|                             |   | 07/89 → 05/91   | SOHC  | VKMA 95015<br>VKM 75008<br>VKM 75033   | 2<br>1<br>1   | 2   |   |   |   |   |   | T0673   |
|   |   | 11/99 → 10/01   |   | VKMA 95659<br>VKM 75613<br>VKM 75633<br>VKM 85000                                  | 2<br>1<br>1<br>1  | 1<br>1  | 2   |   |   |   |   | T0666   |
|                             |   | 01/99 → 10/01   |   | VKPC 95850   |   |   |   | 1   |   |   |   |   |
|   | G4CS  | 04/89 → 08/91   |   | VKPC 95611   |   |   |   | 1   |   |   |   |   |
| <b>HYUNDAI  SONATA 2.5</b> |   |   |   |  |   |   |   |   |   |   |   |   |
|                             | G6BV-G  | 11/99 → 10/01   |   | VKMA 95657<br>VKM 75630<br>VKM 85148   | 1<br>1<br>1   | 1<br>1  | 1   |   |   |   |   | T0690   |
| <b>HYUNDAI  SONATA 2.7</b> |   |   |   |  |   |   |   |   |   |   |   |   |
|                             | G6BA, G6BA-G  | 10/01 → 11/04   |   | VKMA 95657<br>VKM 75630<br>VKM 85148   | 1<br>1<br>1   | 1<br>1  | 1   |   |   |   |   | T0690   |
| <b>HYUNDAI  SONATA 3.0</b> |   |   |   |  |   |   |   |   |   |   |   |   |
|                             | G6AT  | 01/91 → 10/94   | 3), SOHC  | VKMS 95003<br>VKMA 95003<br>VKM 75004  | 1<br>1<br>1   | 1<br>1  |   |   |   | 3   |   | T0695   |
|   | G6AT  | 01/95 → 06/98   |   | —<br>—   | 1<br>1  | 1   |   |   |   |   |   |   |
|                             | G4AT  | 01/91 → 06/98   |   | —  |   |   |   | 1   |   |   |   |   |
|   | G4AT  | 01/91 → 08/91   | SOHC  | VKPC 95611   |   |   |   | 1   |   |   |   |   |
|   | G6AT  | 05/94 → 05/98   | DOHC  | VKPC 95424   |   |   |   | 1   |   |   |   |   |

| <b>HYUNDAI</b> |                  |  | <b>STAREX 2.5 TD</b>   |          |            |   |   |   |  |  |  |   |  |   |  |   |  |       |
|----------------|------------------|--|------------------------|----------|------------|---|---|---|--|--|--|---|--|---|--|---|--|-------|
|                | 4D56             |  | 01/98 → 11/02          |          | VKMA 95014 | 2 |   | 2 |  |  |  |   |  |   |  |   |  | T0668 |
|                |                  |  |                        |          | VKM 75601  | 1 |   |   |  |  |  |   |  |   |  |   |  |       |
|                |                  |  |                        |          | VKM 75612  | 1 |   |   |  |  |  |   |  |   |  |   |  |       |
| <b>HYUNDAI</b> |                  |  | <b>STELLAR 1.4</b>     |          |            |   |   |   |  |  |  |   |  |   |  |   |  |       |
|                | 4G33             |  | 10/83 → 08/86          |          | —          |   |   |   |  |  |  | 1 |  |   |  |   |  |       |
| <b>HYUNDAI</b> |                  |  | <b>STELLAR 1.6</b>     |          |            |   |   |   |  |  |  |   |  |   |  |   |  |       |
|                | 4G32B            |  | 10/83 → 12/91          |          | —          |   |   |   |  |  |  | 1 |  |   |  |   |  |       |
| <b>HYUNDAI</b> |                  |  | <b>TERRACAN 3.5</b>    |          |            |   |   |   |  |  |  |   |  |   |  |   |  |       |
|                |                  |  | 12/01 → 11/02          | 2)       | VKPA 95003 |   |   |   |  |  |  | 1 |  |   |  |   |  |       |
| <b>HYUNDAI</b> |                  |  | <b>TRAJET 2.0</b>      |          |            |   |   |   |  |  |  |   |  |   |  |   |  |       |
|                | G4JP-G           |  | 03/00 → 01/04          | DOHC     | VKMA 95658 | 2 | 1 | 2 |  |  |  |   |  |   |  |   |  | T0666 |
|                |                  |  |                        |          | VKM 75613  | 1 |   |   |  |  |  |   |  |   |  |   |  |       |
|                |                  |  |                        |          | VKM 75633  | 1 |   |   |  |  |  |   |  |   |  |   |  |       |
|                |                  |  |                        |          | VKM 85000  |   | 1 |   |  |  |  |   |  |   |  |   |  |       |
|                | G4JP-G           |  | 03/00 → 05/03          | DOHC     | VKPC 95850 |   |   |   |  |  |  | 1 |  |   |  |   |  |       |
| <b>HYUNDAI</b> |                  |  | <b>TRAJET 2.7</b>      |          |            |   |   |   |  |  |  |   |  |   |  |   |  |       |
|                |                  |  | 09/00 → 01/04          | DOHC     | VKMA 95657 | 1 | 1 | 1 |  |  |  |   |  |   |  |   |  | T0690 |
|                |                  |  |                        |          | VKM 75630  | 1 |   |   |  |  |  |   |  |   |  |   |  |       |
|                |                  |  |                        |          | VKM 85148  |   | 1 |   |  |  |  |   |  |   |  |   |  |       |
| <b>HYUNDAI</b> |                  |  | <b>TRAJET 2.0 CRDi</b> |          |            |   |   |   |  |  |  |   |  |   |  |   |  |       |
|                | D4EA             |  | 04/01 → 07/06          | 22)      | VKMA 95660 | 1 | 1 | 1 |  |  |  |   |  |   |  |   |  | T0575 |
|                |                  |  |                        |          | VKM 75628  | 1 |   |   |  |  |  |   |  |   |  |   |  |       |
|                |                  |  |                        |          | VKM 85146  |   | 1 |   |  |  |  |   |  |   |  |   |  |       |
|                | G4JP-G           |  | 04/01 → 05/03          | DOHC     | VKPC 95850 |   |   |   |  |  |  | 1 |  |   |  |   |  |       |
| <b>HYUNDAI</b> |                  |  | <b>VERNA 1.5</b>       |          |            |   |   |   |  |  |  |   |  |   |  |   |  |       |
|                | 16V              |  | 09/99 → 01/03          | 3)       | VKMS 95632 | 1 | 1 | 1 |  |  |  |   |  | 2 |  |   |  | T0557 |
|                |                  |  |                        |          | VKMA 95632 | 1 | 1 | 1 |  |  |  |   |  |   |  |   |  |       |
|                |                  |  |                        |          | VKM 75006  | 1 |   |   |  |  |  |   |  |   |  |   |  |       |
|                |                  |  |                        |          | VKM 85145  |   | 1 |   |  |  |  |   |  |   |  |   |  |       |
| <b>HYUNDAI</b> |                  |  | <b>XG 30 2.5</b>       |          |            |   |   |   |  |  |  |   |  |   |  |   |  |       |
|                |                  |  | 12/98 → 11/02          | 2), DOHC | VKPA 95851 |   |   |   |  |  |  | 1 |  |   |  |   |  |       |
| <b>HYUNDAI</b> |                  |  | <b>XG 30 3.0</b>       |          |            |   |   |   |  |  |  |   |  |   |  |   |  |       |
|                | G6CT-G           |  | 12/98 → 11/02          | 2), DOHC | VKPA 95851 |   |   |   |  |  |  | 1 |  |   |  |   |  |       |
| <b>HYUNDAI</b> |                  |  | <b>H-1 2.4</b>         |          |            |   |   |   |  |  |  |   |  |   |  |   |  |       |
|                | G4CS             |  | 10/97 → 04/98          |          | VKMA 95015 | 2 |   | 2 |  |  |  |   |  |   |  |   |  | T0673 |
|                |                  |  |                        |          | VKM 75008  | 1 |   |   |  |  |  |   |  |   |  |   |  |       |
|                |                  |  |                        |          | VKM 75033  | 1 |   |   |  |  |  |   |  |   |  |   |  |       |
|                | G4CS             |  | 07/01 → 11/02          |          | —          |   |   |   |  |  |  | 1 |  |   |  | 1 |  |       |
| <b>HYUNDAI</b> |                  |  | <b>H-1 2.5 D</b>       |          |            |   |   |   |  |  |  |   |  |   |  |   |  |       |
|                | D4CB             |  | 01/02 → 05/07          |          | VKPC 95854 |   |   |   |  |  |  | 1 |  |   |  |   |  |       |
| <b>HYUNDAI</b> |                  |  | <b>H-1 2.5 TD</b>      |          |            |   |   |   |  |  |  |   |  |   |  |   |  |       |
|                | D4BB, D4BH, DABB |  | 10/97 → 08/01          |          | VKMA 95014 | 2 |   | 2 |  |  |  |   |  |   |  |   |  | T0668 |
|                |                  |  |                        |          | VKM 75601  | 1 |   |   |  |  |  |   |  |   |  |   |  |       |
|                |                  |  |                        |          | VKM 75612  | 1 |   |   |  |  |  |   |  |   |  |   |  |       |
|                | D4BH             |  | 07/01 → 05/07          |          | —          |   |   |   |  |  |  | 1 |  |   |  |   |  |       |
|                | D4CB             |  | 01/02 → 05/07          |          | VKPC 95854 |   |   |   |  |  |  | 1 |  |   |  |   |  |       |
| <b>HYUNDAI</b> |                  |  | <b>H100 2.4</b>        |          |            |   |   |   |  |  |  |   |  |   |  |   |  |       |
|                | G4CS             |  | 07/93 → 03/00          |          | VKMA 95015 | 2 |   | 2 |  |  |  |   |  |   |  |   |  | T0673 |
|                |                  |  |                        |          | VKM 75008  | 1 |   |   |  |  |  |   |  |   |  |   |  |       |
|                |                  |  |                        |          | VKM 75033  | 1 |   |   |  |  |  |   |  |   |  |   |  |       |
| <b>HYUNDAI</b> |                  |  | <b>H100 2.5 D</b>      |          |            |   |   |   |  |  |  |   |  |   |  |   |  |       |
|                | D4BA, D4BB, D4BX |  | 07/93 → 06/96          |          | VKMA 95010 | 2 |   | 2 |  |  |  |   |  |   |  |   |  | T0668 |
|                |                  |  |                        |          | VKM 75601  | 1 |   |   |  |  |  |   |  |   |  |   |  |       |
|                |                  |  |                        |          | VKM 75612  | 1 |   |   |  |  |  |   |  |   |  |   |  |       |
|                | D4BB             |  | 06/96 → 05/99          |          | VKMA 95014 | 2 |   | 2 |  |  |  |   |  |   |  |   |  | T0668 |
|                |                  |  |                        |          | VKM 75601  | 1 |   |   |  |  |  |   |  |   |  |   |  |       |
|                |                  |  |                        |          | VKM 75612  | 1 |   |   |  |  |  |   |  |   |  |   |  |       |
|                | D4BX             |  | 06/96 → 03/03          |          | VKMA 95014 | 2 |   | 2 |  |  |  |   |  |   |  |   |  | T0668 |
|                |                  |  |                        |          | VKM 75601  | 1 |   |   |  |  |  |   |  |   |  |   |  |       |
|                |                  |  |                        |          | VKM 75612  | 1 |   |   |  |  |  |   |  |   |  |   |  |       |



































































|  |    |  |  |  |  |  |  |  |  |  |  |  |
|--|---|---|---|--|---|---|---|---|---|---|---|---|
| <b>HYUNDAI</b>   |    | <b>H100 2.5 TD</b>  |   |  |   |   |   |   |   |   |   |   |
|    | D4BB, D4BH  | 06/96 → 03/00   |   | VKMA 95014   | 2   |   | 2   |   |   |   |   | T0668   |
|  |   |   |   | VKM 75601  | 1   |   |   |   |   |   |   |   |
|  |   |   |   | VKM 75612  | 1   |   |   |   |   |   |   |   |
| <b>HYUNDAI</b>   |    | <b>PORTER 2.4 D</b>   |   |  |   |   |   |   |   |   |   |   |
|    | D4BX  | 01/92 → 12/94   |   | VKMA 95010   | 2   |   | 2   |   |   |   |   | T0668   |
|  |   |   |   | VKM 75601  | 1   |   |   |   |   |   |   |   |
|  |   |   |   | VKM 75612  | 1   |   |   |   |   |   |   |   |
| <b>ISUZU</b>   |    | <b>117 COUPE 2.2 D</b>  |   |  |   |   |   |   |   |   |   |   |
|    | C223  | 12/79 → 05/81   | Mod. PAD-96   | VKPC 98000   |   |   |   |   | 1   |   |   |   |
| <b>ISUZU</b>   |    | <b>ASKA 2.0 D</b>   |   |  |   |   |   |   |   |   |   |   |
|    | C190  | 12/79 → 08/83   | Mod. PAD-30   | VKPC 98000   |   |   |   |   | 1   |   |   |   |
| <b>ISUZU</b>   |    | <b>BIGHORN 2.2 D</b>  |   |  |   |   |   |   |   |   |   |   |
|    | C223  | 09/81 → 11/89   | Mod. UBS-52   | VKPC 98000   |   |   |   |   | 1   |   |   |   |
| <b>ISUZU</b>   |    | <b>ELF 350 2.2 D</b>  |   |  |   |   |   |   |   |   |   |   |
|    | C223  | 01/83 → 07/03   | Mod. UFR-52   | VKPC 98000   |   |   |   |   | 1   |   |   |   |
| <b>ISUZU</b>   |    | <b>FASTER RODEO 2.0 D</b>   |   |  |   |   |   |   |   |   |   |   |
|    | C190  | 10/80 → 05/88   | Mod. KBD-21, KBD-22,<br>KBD-26, KBD-40,<br>KBD-41, KBD-46                         | VKPC 98000   |   |   |   |   |   | 1   |   |   |
| <b>ISUZU</b>   |    | <b>FASTER RODEO 2.2 TD</b>  |   |  |   |   |   |   |   |   |   |   |
|    | C223T   | 12/82 → 05/88   | Mod. KBD-22, KBD-27,<br>KBD-42, KBD-47  | VKPC 98000   |   |   |   |   |   | 1   |   |   |
| <b>ISUZU</b>   |   | <b>FLORIAN 2.0 D</b>  |   |  |   |   |   |   |   |   |   |   |
|  | C190  | 12/79 → 08/83   | Mod. PAD-30   | VKPC 98000   |   |   |   |   | 1   |   |   |   |
| <b>ISUZU</b>   |  | <b>TROOPER 2.0</b>  |   |  |   |   |   |   |   |   |   |   |
|  | 4ZC1  | 01/86 → 12/90   | Mod. UBS  | VKMA 99001<br>VKM 79001  | 1<br>1  |   | 1   |   |   |   |   | T0625   |
| <b>ISUZU</b>   |  | <b>TROOPER 2.3</b>  |   |  |   |   |   |   |   |   |   |   |
|  | 4ZD1  | 11/85 → 10/88   | Mod. UBS16  | VKMA 99001<br>VKM 79001  | 1<br>1  |   | 1   |   |   |   |   | T0625   |
| <b>ISUZU</b>   |  | <b>TROOPER 2.6</b>  |   |  |   |   |   |   |   |   |   |   |
|  | 4ZE1  | 10/87 → 09/89   | Mod. UBS17  | VKMA 99003<br>VKM 79000  | 1<br>1  |   | 1   |   |   |   |   | T0627   |
| <b>ISUZU</b>   |  | <b>TROOPER 3.5 V6 24V</b>   |   |  |   |   |   |   |   |   |   |   |
|  | 6VE1  | 04/00 → 02/04   | Mod. RJQ, DOHC  | —<br>—<br>—  | 1<br>1<br>—   | 1   |   | 1   |   |   |   |   |
| <b>ISUZU</b>   |  | <b>TROOPER 2.2 D</b>  |   |  |   |   |   |   |   |   |   |   |
|  | C223  | 01/81 → 10/88   | Mod. UBS52  | —<br>VKM 79003   | 1<br>1  |   | 1   |   |   |   |   |   |
|  | C223  | 09/81 → 11/89   | Mod. UBS52  | VKPC 98000   |   |   |   |   | 1   |   |   |   |
| <b>ISUZU</b>   |  | <b>TROOPER 2.2 TD</b>   |   |  |   |   |   |   |   |   |   |   |
|  | C223T   | 03/84 → 10/88   | Mod. UBS52  | —<br>VKM 79003   | 1<br>1  |   | 1   |   |   |   |   |   |
| <b>ISUZU</b>   |  | <b>TROOPER 2.8 TD</b>   |   |  |   |   |   |   |   |   |   |   |
|  | 4JB1T, 4JB1-TC  | 10/87 → 12/91   | Mod. UBS55  | VKMA 99004<br>VKM 79002<br>VKM 89003   | 1<br>1<br>—   | 1   | 1   | 1   |   |   |   | T0628   |
| <b>ISUZU</b>   |  | <b>TROOPER 3.0 DTI</b>  |   |  |   |   |   |   |   |   |   |   |
|  | 6VD1  | 04/00 → 02/04   | Mod. RLV, DOHC  | —<br>—<br>—  | 1<br>1<br>—   | 1   |   | 1   |   |   |   |   |
| <b>ISUZU</b>   |  | <b>AMIGO 2.3</b>  |   |  |   |   |   |   |   |   |   |   |
|  | 4ZD1  | 09/88 → 12/90   | Mod. UCB  | VKMA 99001<br>VKM 79001  | 1<br>1  |   | 1   |   |   |   |   | T0625   |
| <b>ISUZU</b>   |  | <b>AMIGO 2.6</b>  |   |  |   |   |   |   |   |   |   |   |
|  | 4ZE1  | 09/88 → 12/94   | Mod. UCB, UCS   | VKMA 99003<br>VKM 79000  | 1<br>1  |   | 1   |   |   |   |   | T0627   |

|  |         |  |  |  |  |  |  |  |  |  |  |
|--|--|---|---|--|---|---|---|---|---|---|---|
| <b>ISUZU</b>  <b>FARGO 1.8</b>      |  4ZB1   | 01/82 → 12/83   | <b>Mod.</b> WFR   | —<br>VKM 79001   | 1<br>1  | 1   |   |   |   |   |   |
| <b>ISUZU</b>  <b>FARGO 2.0</b>      |  4ZC1   | 12/85 → 12/87   | <b>Mod.</b> WFR, WFS  | —<br>VKM 79001   | 1<br>1  | 1   |   |   |   |   |   |
| <b>ISUZU</b>  <b>FARGO 2.0 D</b>    |  4FC1   | 01/82 → 12/87   | <b>Mod.</b> WFR   | VKMA 99006<br>VKM 89001<br>VKM 89002   | 2<br>1<br>1   | 1   |   |   |   |   | T0630   |
| <b>ISUZU</b>  <b>FARGO 2.2 D</b>    |  4FD1   | 01/86 → 12/89   | <b>Mod.</b> WFR   | VKMA 99006<br>VKM 89001<br>VKM 89002   | 2<br>1<br>1   | 1   |   |   |   |   | T0630   |
| <b>ISUZU</b>  <b>FARGO 2.4 D</b>    |  4FG1   | 01/90 → 12/91   | <b>Mod.</b> WFR   | VKMA 99006<br>VKM 89001<br>VKM 89002   | 2<br>1<br>1   | 1   |   |   |   |   | T0630   |
| <b>ISUZU</b>  <b>FASTER 1.6</b>     |  4ZA1   | 01/88 → 12/89   | <b>Mod.</b> TFR, TFS  | —<br>VKM 79001   | 1<br>1  | 1   |   |   |   |   |   |
| <b>ISUZU</b>  <b>FASTER 2.3</b>     |  4ZD1   | 01/86 → 12/89   | <b>Mod.</b> KBG#, TFR#, TFS#  | VKMA 99001<br>VKM 79001  | 1<br>1  | 1   |   |   |   |   | T0625   |
| <b>ISUZU</b>  <b>FASTER 2.6</b>     |  4ZE1 | 01/88 → 12/89   | <b>Mod.</b> TFR, TFS  | VKMA 99003<br>VKM 79000  | 1<br>1  | 1   |   |   |   |   | T0627   |
| <b>ISUZU</b>  <b>FASTER 1.9 D</b> |  C190 | 01/77 → 12/87   | <b>Mod.</b> KBD#  | —<br>VKM 79003   | 1<br>1  | 1   |   |   |   |   |   |
| <b>ISUZU</b>  <b>FASTER 2.2 D</b> |  C223 | 01/83 → 12/89   | <b>Mod.</b> KBD#, TFR, TFS  | —<br>VKM 79003   | 1<br>1  | 1   |   |   |   |   |   |
| <b>ISUZU</b>  <b>FASTER 2.5 D</b> |  4JA1 | 01/86 → 12/89   | <b>Mod.</b> KBD#, TFR, TFS  | VKMA 99004<br>VKM 79002<br>VKM 89003   | 1<br>1<br>1   | 1   |   |   |   |   | T0628   |
| <b>ISUZU</b>  <b>IMPULSE 2.0</b>  |  4ZC1 | 01/85 → 12/89   | <b>Mod.</b> JRU07   | —<br>VKM 79001   | 1<br>1  | 1   |   |   |   |   |   |
| <b>ISUZU</b>  <b>IMPULSE 2.3</b>  |  4ZD1 | 03/85 → 12/89   | <b>Mod.</b> JRU07   | VKMA 99001<br>VKM 79001  | 1<br>1  | 1   |   |   |   |   | T0625   |
| <b>ISUZU</b>  <b>KB 2.2 D</b>     |  C223 | 08/86 → 12/87   | <b>Mod.</b> TFB, TFS  | —<br>VKM 79003   | 1<br>1  | 1   |   |   |   |   |   |
| <b>ISUZU</b>  <b>PICKUP 1.6</b>   |  4ZA1 | 01/88 → 12/90   | <b>Mod.</b> KB160, TFR, TFS   | —<br>VKM 79001   | 1<br>1  | 1   |   |   |   |   |   |
| <b>ISUZU</b>  <b>PICKUP 2.3</b>   |  4ZD1 | 12/87 → 12/94   | <b>Mod.</b> TFB, TFC  | VKMA 99001<br>VKM 79001  | 1<br>1  | 1   |   |   |   |   | T0625   |
| <b>ISUZU</b>  <b>PICKUP 2.6</b>   |  4ZE1 | 12/87 → 12/94   | <b>Mod.</b> TFB, TFS  | VKMA 99003<br>VKM 79000  | 1<br>1  | 1   |   |   |   |   | T0627   |
| <b>ISUZU</b>  <b>PICKUP 2.2 D</b> |  C223 | 08/86 → 12/87   | <b>Mod.</b> TFB, TFS  | —<br>VKM 79003   | 1<br>1  | 1   |   |   |   |   |   |
| <b>ISUZU</b>  <b>RODEO 1.6</b>    |  4ZA1 | 01/88 → 12/90   | <b>Mod.</b> KB160, TFR, TFS   | —<br>VKM 79001   | 1<br>1  | 1   |   |   |   |   |   |



ISUZU



































|   |  |  |  |  |  |  |  |  |  |  |  |
|---|---|---|---|--|---|---|---|---|---|---|---|
| <b>ISUZU  RODEO 2.3</b>                                  |   |   |   |  |   |   |   |   |   |   |   |
|   | 4ZD1  | 12/87 → 12/94   | Mod. TFB, TFC   | VKMA 99001<br>VKM 79001  | 1<br>1  | 1   |   |   |   |   | T0625   |
| <b>ISUZU  RODEO 2.6</b>                                  |   |   |   |  |   |   |   |   |   |   |   |
|   | 4ZE1  | 12/87 → 12/94   | Mod. TFB, TFS   | VKMA 99003<br>VKM 79000  | 1<br>1  | 1   |   |   |   |   | T0627   |
| <b>ISUZU  RODEO 2.2 D</b>                                |   |   |   |  |   |   |   |   |   |   |   |
|   | C223  | 08/86 → 12/87   | Mod. TFB, TFS   | —<br>VKM 79003   | 1<br>1  | 1   |   |   |   |   |   |
| <b>IVECO  DAILY / TURBO DAILY 2.5 TDi</b>                |   |   |   |  |   |   |   |   |   |   |   |
|   | 8140.47   | 05/89 → 02/96   | Mod. 35-12, 49-12,<br>59-12   | VKMA 02384<br>VKM 22385<br>VKM 22385   |   | 2<br>1<br>1   | 1   |   |   |   | T0653   |
| <b>IVECO  DAILY / TURBO DAILY 2.8 TD</b>                 |   |   |   |  |   |   |   |   |   |   |   |
|   | 8140.27S  | 05/89 → 02/96   | Mod. 30-12  | VKMA 02384<br>VKM 22385<br>VKM 22385   |   | 2<br>1<br>1   | 1   |   |   |   | T0653   |
| <b>IVECO  DAILY / TURBO DAILY (96) 2.5 D</b>             |   |   |   |  |   |   |   |   |   |   |   |
|   | 8140.47R  | 03/96 → 12/99   | Mod. 30-10  | VKMA 02384<br>VKM 22385<br>VKM 22385   |   | 2<br>1<br>1   | 1   |   |   |   | T0653   |
| <b>IVECO  DAILY / TURBO DAILY (96) 2.5 TDi</b>           |   |   |   |  |   |   |   |   |   |   |   |
|   | 8140.47   | 03/96 → 12/99   | Mod. 49-12  | VKMA 02386<br>VKM 22385<br>VKM 22385   |   | 2<br>1<br>1   | 1   |   |   |   | T0155   |
| <b>IVECO  DAILY / TURBO DAILY (96) 2.8 TD, 2.8 TDi</b> |   |   |   |  |   |   |   |   |   |   |   |
|   | 8140.23, 8140.43  | 03/96 → 12/99   | Mod. 30-10, 35-10,<br>35-12, 49-10, 49-12,<br>59-12                               | VKMA 02386<br>VKM 22385<br>VKM 22385   |   | 2<br>1<br>1   | 1   |   |   |   | T0155   |
| <b>IVECO  NEW DAILY 2.4 D</b>                          |   |   |   |  |   |   |   |   |   |   |   |
|   | 8140.61   | 06/89 → 02/96   |   | VKMA 02381<br>VKM 22380<br>VKM 22385   |   | 2<br>1<br>1   | 1   |   |   |   | T0014   |
|   | 8140.21   | 06/89 → 02/96   | Mod. 35-10, 45-10,<br>49-10   | VKMA 02382<br>VKM 22385<br>VKM 22385   |   | 2<br>1<br>1   | 1   |   |   |   | T0043   |
|   | 8140.61   | 01/90 → 12/95   | Mod. 28-8, 30-8, 32-8,<br>35-10, 35-8, 40-10,<br>40-8, 45-10, 49-10,<br>Auto.FAN  | VKPC 82606   |   |   |   | 1   |   |   |   |
|   | 8140.21, 8140.61  | 01/90 → 12/95   | Mod. 28-8, 30-8, 32-8,<br>35-10, 35-8, 40-10,<br>40-8, 45-10, 49-10               | VKPC 82630   |   |   |   | 1   |   |   |   |
|   | 8140.61   | 06/89 → 12/91   | Mod. 35-12, Auto.FAN  | —  |   |   |   | 1   |   |   |   |
|   | 8140.61   | 01/92 → 12/95   | Mod. 28-8, 30-8, 32-8,<br>35-8, Auto.FAN  | VKPC 82650   |   |   |   | 1   |   |   |   |
|   | 8140.61   | 01/92 → 12/95   | Mod. 35-12, Auto.FAN  | VKPC 82651   |   |   |   | 1   |   |   |   |
|   | 8140.21   | 06/89 → 12/90   | Mod. 35-10, 40-10,<br>45-10, 49-10  | VKPC 82631   |   |   |   | 1   |   |   |   |
| <b>IVECO  NEW DAILY 2.5 D</b>                          |   |   |   |  |   |   |   |   |   |   |   |
|   | 8140.07   | 06/89 → 02/96   | Mod. 30-8, 35-8,<br>→ Mot. 1307400  | VKMA 02382<br>VKM 22385<br>VKM 22385   |   | 2<br>1<br>1   | 1   |   |   |   | T0043   |
|   | 8140.07   | 06/89 → 02/96   | Mod. 30-8, 35-8,<br>Mot. 1307401  →   | VKMA 02384<br>VKM 22385<br>VKM 22385   |   | 2<br>1<br>1   | 1   |   |   |   | T0653   |
|   | 8140.07, 8140.47R   | 06/89 → 02/96   | Mod. 40-8, 49-10  | VKMA 02384<br>VKM 22385<br>VKM 22385   |   | 2<br>1<br>1   | 1   |   |   |   | T0653   |







































|  |  |  |  |  |  |  |  |  |  |  |  |
|--|---|---|---|--|---|---|---|---|---|---|---|
| <b>IVECO  NEW DAILY 2.8 TD</b>      |   |   |   |  |   |   |   |   |   |   |   |
|                                     | 8140.27S  | 06/89 → 02/96   | Mod. 35-10  | VKMA 02384<br>VKM 22385<br>VKM 22385   | 2<br>1<br>1   | 1   |   |   |   |   | T0653   |
|  | 8140.27S  | 06/89 → 02/96   | Mod. 45-10, 49-10,<br>→IMot. 1307400  | VKMA 02382<br>VKM 22385<br>VKM 22385   | 2<br>1<br>1   | 1   |   |   |   |   | T0043   |
| <b>IVECO  NEW DAILY 2.5 TD</b>      |   |   |   |  |   |   |   |   |   |   |   |
|                                     | 8140.27S  | 06/89 → 02/96   | Mod. 45-10, 49-10,<br>Mot. 1307401 I→   | VKMA 02384<br>VKM 22385<br>VKM 22385   | 2<br>1<br>1   | 1   |   |   |   |   | T0653   |
| <b>IVECO  NEW DAILY 2.8 TD</b>      |   |   |   |  |   |   |   |   |   |   |   |
|                                     | 8140.27S  | 06/89 → 02/96   | Mod. 45-10, 49-10,<br>Mot. 1307401 I→   | VKMA 02384<br>VKM 22385<br>VKM 22385   | 2<br>1<br>1   | 1   |   |   |   |   | T0653   |
| <b>IVECO  NEW DAILY (96) 2.5 D</b>  |   |   |   |  |   |   |   |   |   |   |   |
|                                     | 8140.67, 8140.67F   | 03/96 → 12/99   | Mod. 30-10, 35-8  | VKMA 02383<br>VKM 22380<br>VKM 22385   | 2<br>1<br>1   | 1   |   |   |   |   | T0652   |
| <b>IVECO  NEW DAILY (96) 2.8 TD</b> |   |   |   |  |   |   |   |   |   |   |   |
|                                     | 8140.63   | 03/96 → 12/99   | Mod. 35-8   | VKMA 02384<br>VKM 22385<br>VKM 22385   | 2<br>1<br>1   | 1   |   |   |   |   | T0653   |
| <b>IVECO  DAILY II 2.3 JTD</b>    |   |   |   |  |   |   |   |   |   |   |   |
|                                   | F1AE0481  | 01/02 → 12/03   | Mod. 35C10, 35C12,<br>35S10, 35S12, 29L10,<br>29L12                               | VKMA 02390<br>VKM 12390<br>VKM 22390   | 1<br>1  | 1<br>1  | 1   |   |   |   | T0199   |
| <b>IVECO  DAILY II 2.8 D</b>      |   |   |   |  |   |   |   |   |   |   |   |
|                                   | 8140.63   | 06/99 → 12/03   | Mod. 35C9, 35S9   | VKMA 02384<br>VKM 22385<br>VKM 22385   | 2<br>1<br>1   | 1   |   |   |   |   | T0653   |
| <b>IVECO  DAILY II 2.8 TDi</b>    |   |   |   |  |   |   |   |   |   |   |   |
|                                   | 8140.43R  | 06/99 → 12/03   |   | VKMA 02383<br>VKM 22380<br>VKM 22385   | 2<br>1<br>1   | 1   |   |   |   |   | T0652   |
|  | 8140.43B, 8140.43C,<br>8149.03  | 06/99 → 12/03   | Mod. 35C11, 35S11,<br>50C11, 65C11  | VKMA 02386<br>VKM 22385<br>VKM 22385   | 2<br>1<br>1   | 1   |   |   |   |   | T0155   |
|  | 8140.43K, 8140.43N,<br>8140.43S   | 06/99 → 12/03   | Mod. 35C13, 35C15,<br>35S13, 35S15, 50C11,<br>50C13, 50C15, 65C13,<br>65C15       | VKMA 02383<br>VKM 22380<br>VKM 22385   | 2<br>1<br>1   | 1   |   |   |   |   | T0652   |
| <b>JEEP  CHEROKEE 2.1 TD</b>      |   |   |   |  |   |   |   |   |   |   |   |
|                                   | J85   | 10/84 → 08/01   | 3)  | VKMS 06213<br>VKMA 06213<br>VKM 16212<br>VKM 26211                                 | 1<br>1<br>1<br>1  | 1<br>1<br>1   |   |   |   | 3   | T0015   |
| <b>KIA  AVELLA 1.3</b>            |   |   |   |  |   |   |   |   |   |   |   |
|                                   | B3  | 03/94 → 12/94   | 3), SOHC  | VKMS 94102<br>VKMA 94102<br>VKM 74200  | 1<br>1<br>1   | 1<br>1  |   |   |   | 2   | T0697   |
| <b>KIA  CAPITAL 1.5</b>           |   |   |   |  |   |   |   |   |   |   |   |
|                                   | B5  | 05/90 → 12/94   | 3), SOHC  | VKMS 94102<br>VKMA 94102<br>VKM 74200  | 1<br>1<br>1   | 1<br>1  |   |   |   | 2   | T0697   |



IVECO









































|  |  |  |  |  |  |  |  |  |  |  |  |  |
|--|---|---|---|--|---|---|---|---|---|---|---|---|
|  | B5  | 05/90 → 12/94   | DOHC  | VKMA 94201<br>VKM 74201<br>VKM 84201   | 1<br>1  | 1   | 1   |   |   |   |   | T0683   |
| <b>KIA  CAPITAL 1.8</b>         |   |   |   |  |   |   |   |   |   |   |   |   |
|                                  | F8  | 05/90 → 12/94   |   | —<br>VKM 74001   | 1<br>1  |   | 1   |   |   |   |   |   |
| <b>KIA  CARENS 1.8</b>          |   |   |   |  |   |   |   |   |   |   |   |   |
|                                  | OK2CN   | 11/00 → 10/02   |   | VKMA 94506<br>VKM 74502<br>VKM 84201   | 1<br>1  | 1   | 1   |   |   |   |   | T0683   |
| <b>KIA  CARNIVAL 2.5</b>        |   |   |   |  |   |   |   |   |   |   |   |   |
|                                  | OK52  | 08/99 → 05/00   |   | VKMA 94508<br>VKM 74608<br>VKM 84503<br>VKM 84504                                  | 1<br>1  | 2   | 1   |   |   |   |   | T0456   |
|  | OK52  | 10/01 → 01/06   |   | VKMA 94509<br>VKM 74609<br>VKM 84503<br>VKM 84504<br>VKM 84506                     | 1<br>1  | 3   | 1   |   |   |   |   | T0457   |
|  | OK57C   | 08/99 → 10/01   |   | VKMA 94507<br>VKM 74503<br>VKM 74504<br>VKM 74506<br>VKM 84502                     | 3<br>1<br>1<br>1  | 1   | 3   |   |   |   |   | T0455   |
| <b>KIA  CARNIVAL 3.5</b>       |   |   |   |  |   |   |   |   |   |   |   |   |
|                                | G6JY  | 07/02 → 01/06   |   | VKMA 94509<br>VKM 74609<br>VKM 84503<br>VKM 84504<br>VKM 84506                     | 1<br>1  | 3   | 1   |   |   |   |   | T0457   |
| <b>KIA  CARNIVAL 2.9 CRDi</b> |   |   |   |  |   |   |   |   |   |   |   |   |
|                                | OK53  | 10/01 → 01/06   |   | VKMA 94509<br>VKM 74609<br>VKM 84503<br>VKM 84504<br>VKM 84506                     | 1<br>1  | 3   | 1   |   |   |   |   | T0457   |
| <b>KIA  CARNIVAL 2.9 TD</b>   |   |   |   |  |   |   |   |   |   |   |   |   |
|                                | OK53  | 08/99 → 05/00   |   | VKMA 94508<br>VKM 74608<br>VKM 84503<br>VKM 84504                                  | 1<br>1  | 2   | 1   |   |   |   |   | T0456   |
|  | OK57C   | 06/00 → 10/01   |   | VKMA 94509<br>VKM 74609<br>VKM 84503<br>VKM 84504<br>VKM 84506                     | 1<br>1  | 3   | 1   |   |   |   |   | T0457   |
| <b>KIA  CONCORD 1.8</b>       |   |   |   |  |   |   |   |   |   |   |   |   |
|                                | F8  | 02/92 → 12/94   |   | —<br>VKM 74001   | 1<br>1  |   | 1   |   |   |   |   |   |
| <b>KIA  CONCORD 2.0</b>       |   |   |   |  |   |   |   |   |   |   |   |   |
|                                | FE  | 02/92 → 09/94   | 3), DOHC  | VKMS 94601<br>VKMA 94601<br>VKM 74600<br>VKM 84601                                 | 1<br>1<br>1   | 1   | 1   |   |   |   | 3   | T0679   |
|  | FE  | 02/92 → 09/94   | SOHC  | VKMA 94016<br>VKM 74600<br>VKM 84601   | 1<br>1  | 1   | 1   |   |   |   |   | T0664   |
| <b>KIA  MENTOR 1.5</b>        |   |   |   |  |   |   |   |   |   |   |   |   |
|                                | B5  | 10/91 → 07/03   |   | VKPC 94002   |   |   |   |   | 1   |   |   |   |
| <b>KIA  MENTOR 1.6</b>        |   |   |   |  |   |   |   |   |   |   |   |   |
|                                | B6  | 10/91 → 07/03   |   | VKPC 94002   |   |   |   |   | 1   |   |   |   |
| <b>KIA  PICANTO 1.0</b>       |   |   |   |  |   |   |   |   |   |   |   |   |
|                                |   | 09/05 → 12/05   | SOHC  | VKMA 95641<br>VKM 75621  | 1<br>1  |   | 1   |   |   |   |   | T0691   |

|   |  |  |  |  |  |  |  |  |  |  |  |  |
|---|---|---|---|--|---|---|---|---|---|---|---|---|
|                              |   | 09/05 → 12/05   |   | VKPC   |   |   |   |   | 1   |   |   |   |
|                              | B(Alt)  | 09/05 → 12/05   | SOHC  | VKMV   |   | 1   |   |   |   |   |   |   |
|   | B(PS)   | 09/05 → 12/05   | SOHC, AC  | VKMV   |   | 1   |   |   |   |   |   |   |
|   | B(AC)   | 09/05 → 12/05   | SOHC, AC, Ø   | VKMV 4PK675  |   | 1   |   |   |   |   |   |   |
| <b>KIA  PICANTO 1.1</b>      |   |   |   |  |   |   |   |   |   |   |   |   |
|                              | G4HG  | 04/04 → 12/05   | SOHC  | VKMA 95641<br>VKM 75621  | 1<br>1  | 1   |   |   |   |   |   | T0691   |
|                              | G4HG  | 04/04 → 12/05   |   | VKPC   |   |   |   |   | 1   |   |   |   |
|                              | B(Alt) G4HG   | 04/04 → 12/05   | SOHC  | VKMV   |   | 1   |   |   |   |   |   |   |
|   | B(PS) G4HG  | 04/04 → 12/05   | SOHC, AC  | VKMV   |   | 1   |   |   |   |   |   |   |
|   | B(AC) G4HG  | 04/04 → 12/05   | SOHC, AC, Ø   | VKMV 4PK675  |   | 1   |   |   |   |   |   |   |
| <b>KIA  PICANTO 1.1 CRDi</b> |   |   |   |  |   |   |   |   |   |   |   |   |
|                              | D3FA  | 11/05 → 12/05   |   | OXOXOXO  |   |   |   |   |   |   |   |   |
|                              | D3FA  | 11/05 → 12/05   |   | VKPC   |   |   |   |   | 1   |   |   |   |
|                              | B(WP) D3FA  | 11/05 → 12/05   | DOHC, AC  | VKMA   | 1   | 2   | 1   |   |   |   |   |   |
|   | B(WP) D3FA  | 11/05 → 12/05   | DOHC, AC  | VKMA   | 1   | 2   | 1   |   |   |   |   |   |
| <b>KIA  POTENTIA 2.0</b>     |   |   |   |  |   |   |   |   |   |   |   |   |
|                              | FE  | 11/93 → 05/95   | 3), DOHC  | VKMS 94601<br>VKMA 94601<br>VKM 74600<br>VKM 84601                                 | 1<br>1<br>1   | 1<br>1<br>1   | 1   |   |   |   | 3   | T0679   |
| <b>KIA  POTENTIA 2.2</b>     |   |   |   |  |   |   |   |   |   |   |   |   |
|                              | FE  | 11/93 → 05/95   | SOHC  | —<br>VKM 74600<br>VKM 84601  | 1<br>1  | 1<br>1  | 1   |   |   |   |   |   |
| <b>KIA  POTENTIA 3.0</b>   |   |   |   |  |   |   |   |   |   |   |   |   |
|                            | V6  | 11/93 → 05/95   | DOHC  | —<br>VKM 74005<br>—<br>—   | 1<br>1  | 2<br>1  | 1   |   |   |   |   |   |
| <b>KIA  PRIDE 1.1</b>      |   |   |   |  |   |   |   |   |   |   |   |   |
|                            | B1  | 01/92 → 07/03   |   | VKPC 94002   |   |   |   |   | 1   |   |   |   |
| <b>KIA  PRIDE 1.3</b>      |   |   |   |  |   |   |   |   |   |   |   |   |
|                            | B3  | 01/90 → 01/97   |   | VKMA 94102<br>VKM 74200  | 1<br>1  | 1   |   |   |   |   |   | T0697   |
|                            | B3  | 01/91 → 07/03   |   | VKPC 94002   |   |   |   |   | 1   |   |   |   |
|   | E3  | 01/93 → 07/03   |   | VKPC 94202   |   |   |   |   | 1   |   |   |   |
| <b>KIA  RIO 1.3</b>        |   |   |   |  |   |   |   |   |   |   |   |   |
|                            |   | 08/00 → 07/02   | 3), SOHC  | VKMS 94102<br>VKMA 94102<br>VKM 74200  | 1<br>1<br>1   | 1<br>1  |   |   |   |   | 2   | T0697   |
| <b>KIA  SEDONA 2.5</b>     |   |   |   |  |   |   |   |   |   |   |   |   |
|                            | OK52  | 06/99 → 05/00   | Mod. UP75   | VKMA 94508<br>VKM 74608<br>VKM 84503<br>VKM 84504                                  | 1<br>1  | 2<br>1  | 1   |   |   |   |   | T0456   |
|   | OK52  | 06/00 → 06/05   | Mod. UP75   | VKMA 94509<br>VKM 74609<br>VKM 84503<br>VKM 84504<br>VKM 84506                     | 1<br>1  | 3<br>1  | 1   |   |   |   |   | T0457   |
|   | OK57C   | 06/99 → 05/01   | Mod. OK55   | VKMA 94507<br>VKM 74503<br>VKM 74504<br>VKM 74506<br>VKM 84502                     | 3<br>1<br>1<br>1  | 1<br>1  | 3   |   |   |   |   | T0455   |
| <b>KIA  SEDONA 2.9</b>     |   |   |   |  |   |   |   |   |   |   |   |   |
|                            | OK53  | 06/99 → 05/00   | Mod. UP95   | VKMA 94508<br>VKM 74608<br>VKM 84503<br>VKM 84504                                  | 1<br>1  | 2<br>1  | 1   |   |   |   |   | T0456   |
|   | OK53  | 06/00 → 06/05   | Mod. UP95   | VKMA 94509<br>VKM 74609  | 1<br>1  | 3<br>1  | 1   |   |   |   |   | T0457   |









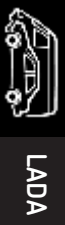





















KIA













































|  |  |  |  |  |  |  |  |  |  |  |  |  |
|--|---|---|---|--|---|---|---|---|---|---|---|---|
|  |   |   |   | VKM 84503<br>VKM 84504<br>VKM 84506  | 1<br>1<br>1   |   |   |   |   |   |   |   |
| <b>KIA  SEPHIA 1.5</b>            |   |   |   |  |   |   |   |   |   |   |   |   |
|                                    | B5  | 01/92 → 12/93   | 3), SOHC  | VKMS 94102<br>VKMA 94102<br>VKM 74200  | 1<br>1<br>1   | 1   | 1   |   |   | 2   |   | T0697   |
|  | B5  | 09/92 → 11/93   | 3), DOHC  | VKMS 94201<br>VKMA 94201<br>VKM 74201<br>VKM 84201                                 | 1<br>1<br>1<br>1  | 1   | 1   | 1   |   | 4   |   | T0683   |
|                                    | B5  | 10/91 → 07/03   |   | VKPC 94002   |   |   |   |   | 1   |   |   |   |
| <b>KIA  SEPHIA 1.6</b>            |   |   |   |  |   |   |   |   |   |   |   |   |
|                                    | B6  | 09/93 → 06/97   | 3), SOHC  | VKMS 94102<br>VKMA 94102<br>VKM 74200  | 1<br>1<br>1   | 1   | 1   |   |   | 2   |   | T0697   |
|  | B6  | 09/93 → 06/97   | 3), DOHC  | VKMS 94201<br>VKMA 94201<br>VKM 74201<br>VKM 84201                                 | 1<br>1<br>1<br>1  | 1   | 1   | 1   |   | 4   |   | T0683   |
|                                    | B6  | 09/93 → 07/03   | SOHC  | VKPC 94002   |   |   |   |   | 1   |   |   |   |
| <b>KIA  SEPHIA 1.8</b>            |   |   |   |  |   |   |   |   |   |   |   |   |
|                                    | BP  | 01/95 → 06/97   | 3), DOHC  | VKMS 94201<br>VKMA 94201<br>VKM 74201<br>VKM 84201                                 | 1<br>1<br>1<br>1  | 1   | 1   | 1   |   | 4   |   | T0683   |
| <b>KIA  SORENTO 2.4</b>          |   |   |   |  |   |   |   |   |   |   |   |   |
|                                  |   | 08/02 → 12/05   | DOHC  | VKMA 95659<br>VKM 75613<br>VKM 75633<br>VKM 85000                                  | 2<br>1<br>1<br>1  | 1   | 2   |   |   |   |   | T0666   |
|                                  |   | 08/02 → 12/05   |   | —  |   |   |   |   | 1   |   | 1   |   |
| <b>KIA  SORENTO 2.5</b>         |   |   |   |  |   |   |   |   |   |   |   |   |
|                                  |   | 08/02 → 12/05   |   | <del>OXOXOX</del>  |   |   |   |   |   |   |   |   |
|                                  |   | 08/02 → 12/05   |   | VKPC 95854   |   |   |   |   | 1   |   |   |   |
| <b>KIA  SPORTAGE 2.0 4X4</b>    |   |   |   |  |   |   |   |   |   |   |   |   |
|                                  | FE  | 04/94 → 12/96   | 3), DOHC  | VKMS 94601<br>VKMA 94601<br>VKM 74600<br>VKM 84601                                 | 1<br>1<br>1<br>1  | 1   | 1   | 1   |   | 3   |   | T0679   |
|  | FE  | 04/94 → 12/96   | SOHC  | VKMA 94016<br>VKM 74600<br>VKM 84601   | 1<br>1<br>1   | 1   | 1   | 1   |   |   |   | T0664   |
|                                  | FE  | 08/94 → 07/03   | SOHC  | VKPC 94424   |   |   |   |   | 1   |   |   |   |
|  | FE  | 08/94 → 07/03   | DOHC  | VKPC 94425   |   |   |   |   | 1   |   |   |   |
| <b>KIA  SPORTAGE 2.2</b>        |   |   |   |  |   |   |   |   |   |   |   |   |
|                                  | FE  | 05/93 → 12/96   |   | VKMA 94016<br>VKM 74600<br>VKM 84601   | 1<br>1<br>1   | 1   | 1   | 1   |   |   |   | T0664   |
| <b>KIA  SPORTAGE 2.2 D</b>      |   |   |   |  |   |   |   |   |   |   |   |   |
|                                  | HW  | 05/93 → 10/94   | 3)  | VKMS 94009<br>VKMA 94009<br>VKM 74004  | 1<br>1<br>1   | 1   | 1   |   |   | 2   |   | T0432   |
| <b>KIA  VISTO 1.0</b>           |   |   |   |  |   |   |   |   |   |   |   |   |
|                                  | G4HC  | 01/99 → 12/03   |   | VKMA 95641<br>VKM 75621  | 1<br>1  | 1   | 1   |   |   |   |   | T0691   |
| <b>LADA  110 2.0 i</b>          |   |   |   |  |   |   |   |   |   |   |   |   |
|                                  | C 20 XE   | 08/96 → 06/04   |   | VKMA 05220<br>VKM 15202<br>VKM 25212<br>VKM 25213                                  | 1<br>1<br>1<br>1  | 2   | 1   |   |   |   |   | T0106   |
| <b>LADA  FORMA / SAMARA 1.1</b> |   |   |   |  |   |   |   |   |   |   |   |   |
|                                  | BA3 21081,<br>BA3 21081 (KAT)   | 02/88 → 12/99   |   | VKMA 08201<br>VKM 18200  | 1<br>1  | 1   | 1   |   |   |   |   | T0002   |

|                                 | BA3 21081   | 01/90 → 12/94    |  | VKPC 88203                           |                          |   |   |  |  |  | 1 |  |  |  |  |  |  |  |   |       |       |
|---------------------------------|---|------------------|--|--------------------------------------|--------------------------|---|---|--|--|--|---|--|--|--|--|--|--|--|---|-------|-------|
| <b>LADA  FORMA / SAMARA 1.3</b> |   |                  |  |                                      |                          |   |   |  |  |  |   |  |  |  |  |  |  |  |   |       |       |
|                                 | BA3 2108,<br>BA3 2108 (KAT),<br>BA3 21115         | 01/86 → 12/99    |  | VKMA 08201<br>VKM 18200              | 1                        |   | 1 |  |  |  |   |  |  |  |  |  |  |  |   | T0002 |       |
|                                 | BA3 2108  | 01/87 → 07/96    |  | VKPC 88203                           |                          |   |   |  |  |  | 1 |  |  |  |  |  |  |  |   |       |       |
| <b>LADA  FORMA / SAMARA 1.5</b> |   |                  |  |                                      |                          |   |   |  |  |  |   |  |  |  |  |  |  |  |   |       |       |
|                                 | BA3 21083,<br>BA3 21083 (KAT),<br>BA3 2111        | 01/88 → 12/99    |  | VKMA 08201<br>VKM 18200              | 1                        |   | 1 |  |  |  |   |  |  |  |  |  |  |  |   | T0002 |       |
|                                 | BA3 21083   | 01/88 → 07/96    |  | VKPC 88203                           |                          |   |   |  |  |  | 1 |  |  |  |  |  |  |  |   |       |       |
| <b>LADA  NIVA 1.6</b>           |   |                  |  |                                      |                          |   |   |  |  |  |   |  |  |  |  |  |  |  |   |       |       |
|                                 | BA3 2121  | 12/76 → 03/95    |  | Опорок                               |                          |   |   |  |  |  |   |  |  |  |  |  |  |  |   |       |       |
|                                 | BA3 2121  | 12/76 → 03/95 2) |  | —                                    |                          |   |   |  |  |  | 1 |  |  |  |  |  |  |  |   |       |       |
|                                 |   |                  |  | VKPC 88200                           |                          |   |   |  |  |  | 1 |  |  |  |  |  |  |  |   |       |       |
| <b>LADA  NIVA 1.7</b>           |   |                  |  |                                      |                          |   |   |  |  |  |   |  |  |  |  |  |  |  |   |       |       |
|                                 | BA3 21214   | 06/96 → 06/04    |  | Опорок                               |                          |   |   |  |  |  |   |  |  |  |  |  |  |  |   |       |       |
| <b>LADA  NIVA 1.9 D</b>         |   |                  |  |                                      |                          |   |   |  |  |  |   |  |  |  |  |  |  |  |   |       |       |
|                                 | XUD9  | 01/93 → 12/93    |  | VKMA 03240<br>VKM 13240<br>VKM 23240 | 1                        | 1 | 1 |  |  |  |   |  |  |  |  |  |  |  | 2 | T0017 |       |
|                                 | XUD9  | 01/94 → 08/01    |  | VKMA 03241<br>VKM 13241<br>VKM 23241 | 1                        | 1 | 1 |  |  |  |   |  |  |  |  |  |  |  |   |       | T0017 |
|                                 | XUD9  | 01/93 → 07/96    |  | VKPC 83424                           |                          |   |   |  |  |  | 1 |  |  |  |  |  |  |  |   |       |       |
| <b>LANCIA  A 112 0.9</b>        |   |                  |  |                                      |                          |   |   |  |  |  |   |  |  |  |  |  |  |  |   |       |       |
|                                 | A112  | 03/81 → 06/86 2) |  | VKPA 82202                           |                          |   |   |  |  |  | 1 |  |  |  |  |  |  |  |   |       |       |
| <b>LANCIA  A 112 1.0</b>        |   |                  |  |                                      |                          |   |   |  |  |  |   |  |  |  |  |  |  |  |   |       |       |
|                                 | A112  | 03/78 → 12/86 2) |  | VKPA 82202                           |                          |   |   |  |  |  | 1 |  |  |  |  |  |  |  |   |       |       |
| <b>LANCIA  BETA 1.3</b>         |   |                  |  |                                      |                          |   |   |  |  |  |   |  |  |  |  |  |  |  |   |       |       |
|                                 | 828 D3.000  | 01/78 → 07/82    |  | —                                    |                          |   |   |  |  |  |   |  |  |  |  |  |  |  |   |       |       |
|                                 | 828 D3.000  | 12/81 → 12/84    |  | VKM 12004                            | 1                        |   |   |  |  |  |   |  |  |  |  |  |  |  |   |       |       |
|                                 |   |                  |  | VKM 12004                            | 1                        |   |   |  |  |  |   |  |  |  |  |  |  |  |   |       |       |
| <b>LANCIA  BETA 1.6</b>         |   |                  |  |                                      |                          |   |   |  |  |  |   |  |  |  |  |  |  |  |   |       |       |
|                                 | 828 B.000   | 01/78 → 12/84    |  | —                                    |                          |   |   |  |  |  |   |  |  |  |  |  |  |  |   |       |       |
|                                 |   |                  |  | VKM 12004                            | 1                        |   |   |  |  |  |   |  |  |  |  |  |  |  |   |       |       |
| <b>LANCIA  BETA 2.0</b>         |   |                  |  |                                      |                          |   |   |  |  |  |   |  |  |  |  |  |  |  |   |       |       |
|                                 | 134 AS.000  | 09/75 → 05/81    |  | —                                    |                          |   |   |  |  |  |   |  |  |  |  |  |  |  |   |       |       |
|                                 |   |                  |  | VKM 12012                            | 1                        |   |   |  |  |  |   |  |  |  |  |  |  |  |   |       |       |
|                                 | 828 B1.000, 828 B4.000                            | 01/78 → 12/84    |  | —                                    |                          |   |   |  |  |  |   |  |  |  |  |  |  |  |   |       |       |
|                                 |   |                  |  | VKM 12004                            | 1                        |   |   |  |  |  |   |  |  |  |  |  |  |  |   |       |       |
|                                 | 828 B4000   | 05/81 → 09/84    |  | —                                    |                          |   |   |  |  |  | 1 |  |  |  |  |  |  |  |   |       |       |
| <b>LANCIA  DEDRA 1.6</b>        |   |                  |  |                                      |                          |   |   |  |  |  |   |  |  |  |  |  |  |  |   |       |       |
|                                 | 159 B9.000, 835 A1.000,<br>835 A1.046, 835 C1.000 | 08/89 → 07/99    |  | VKMA 02410<br>VKM 12200              | 1                        |   | 1 |  |  |  |   |  |  |  |  |  |  |  |   |       | T0052 |
|                                 | 159 B9.000, 835 A1.000                            | 08/89 → 07/99 2) |  | VKPA 82230<br>VKPC 82230             |                          |   |   |  |  |  | 1 |  |  |  |  |  |  |  |   |       |       |
|                                 | 835 A1.046, 835 C1.000                            | 08/89 → 07/99    |  | VKPC 82245                           |                          |   |   |  |  |  | 1 |  |  |  |  |  |  |  |   |       |       |
|                                 | B(Alt) 159 B9.000                                 | 07/94 → 07/99    |  | →IMot. 9673757                       | VKMW 5PK938<br>VKM 32009 |   | 1 |  |  |  |   |  |  |  |  |  |  |  |   |       |       |
|                                 | B(Alt) 159 B9.000                                 | 07/94 → 07/99    |  | Mot. 9673758 I→                      | VKMW 5PK938<br>VKM 32242 |   | 1 |  |  |  |   |  |  |  |  |  |  |  |   |       |       |
|                                 | B(Alt) 159 B9.000                                 | 07/94 → 07/99    |  | →IMot. 9673757                       | VKMW 5PK962<br>VKM 32009 |   | 1 |  |  |  |   |  |  |  |  |  |  |  |   |       |       |
|                                 | B(Alt) 159 B9.000                                 | 07/94 → 07/99    |  | Mot. 9673758 I→                      | VKMW 5PK962<br>VKM 32242 |   | 1 |  |  |  |   |  |  |  |  |  |  |  |   |       |       |
|                                 | B(Alt) 835 A1.000, 835 A1.046                     | 08/89 → 06/94    |  |                                      | →IMot. 8130540           |   | 1 |  |  |  |   |  |  |  |  |  |  |  |   |       |       |



































LADA

|   |  |  |    |  |  |  |  |  |  |  |  |  |  |
|---|---|---|---|--|---|---|---|---|---|---|---|---|---|
| B(Alt)  | 835 A1.000, 835 A1.046  | 08/89 → 06/94   | AC, Ø<br>Mot. 8130541 I→  | VKM 32009  | 1   |   |   |   |   |   |   |   |   |
| B(Alt)  | 835 A1.000, 835 A1.046  | 08/89 → 06/94   | AC, →I Mot. 8130540   | VKMV 5PK962<br>VKM 32242   | 1   | 1   |   |   |   |   |   |   |   |
| B(Alt)  | 835 A1.000, 835 A1.046  | 08/89 → 06/94   | AC, Mot. 8130541 I→   | VKMV 5PK962<br>VKM 32009   | 1   | 1   |   |   |   |   |   |   |   |
| B(Alt)  | 835 C1.000  | 04/93 → 07/99   | AC  | VKM 32009  | 1   |   |   |   |   |   |   |   |   |
| B(Alt)  | 835 C1.000  | 04/93 → 07/99   | AC  | VKMV 5PK962<br>VKM 32009   | 1   | 1   |   |   |   |   |   |   |   |
| B(PS)   | 159 B9.000  | 07/94 → 07/99   |   | VKMV 10AVx690  |   | 1   |   |   |   |   |   |   |   |
| B(AC)   | 159 B9.000, 835 A1.000,<br>835 A1.046, 835 C1.000                                 | 08/89 → 07/99   |   | VKMV 13AVx1050   |   | 1   |   |   |   |   |   |   |   |
| <b>LANCIA  DEDRA 1.6 16V</b>   |   |   |   |  |   |   |   |   |   |   |   |   |   |
|                                 | 182 A4.000  | 01/96 → 07/99   | 3)  | VKMS 02242-1<br>VKMA 02242<br>VKM 12242<br>VKM 22242                               | 1<br>1<br>1<br>1  | 1<br>1<br>1   | 1   |   |   |   | 4   |   | T0130   |
|                                 | 182 A4.000  | 01/96 → 07/99   | 2)  | VKPA 82441<br>VKPC 82441   |   |   |   | 1<br>1  |   |   |   |   |   |
|                                 | B(Alt) 182 A4.000   | 01/96 → 07/99   |   | VKMV 5PK938<br>VKM 32242   |   | 1   |   |   |   |   |   |   |   |
|   | B(AC) 182 A4.000  | 01/96 → 07/99   |   | VKMV 4PK962<br>VKM 32242   |   | 1   |   |   |   |   |   |   |   |
| <b>LANCIA  DEDRA 1.8</b>       |   |   |   |  |   |   |   |   |   |   |   |   |   |
|                                | 835 A2.000, 835 A2.046,<br>835 C5.000   | 09/89 → 12/94   |   | VKMA 02227<br>VKM 12227  | 1<br>1  | 1   |   |   |   |   |   |   | T0035   |
|   | 836 A5.000  | 07/94 → 07/99   |   | VKMA 02227<br>VKM 12227  | 1<br>1  | 1   |   |   |   |   |   |   | T0035   |
|                               | 835 A2.000, 835 A2.046,<br>835 C5.000   | 09/89 → 07/99   | Man. GBX,<br>→I Mot. 1308020  | VKPC 82622   |   |   |   |   | 1   |   |   |   |   |
|   | 835 A2.000, 835 A2.046,<br>835 C5.000   | 09/89 → 07/99   | Man. GBX,<br>Mot. 1308021 I→  | VKPC 82647   |   |   |   |   | 1   |   |   |   |   |
|   | 835 A2.000, 835 A2.046,<br>835 C5.000   | 09/89 → 07/99   | Auto. GBX,<br>→I Mot. 1263035   | VKPC 82622   |   |   |   |   | 1   |   |   |   |   |
|   | 835 A2.000, 835 A2.046,<br>835 C5.000   | 09/89 → 07/99   | Auto. GBX,<br>Mot. 1263036 I→   | VKPC 82647   |   |   |   |   | 1   |   |   |   |   |
|   | 836 A5.000  | 07/94 → 07/99   |   | VKPC 82647   |   |   |   |   | 1   |   |   |   |   |
| <b>LANCIA  DEDRA 1.8 16V</b> |   |   |   |  |   |   |   |   |   |   |   |   |   |
|                               | 182 A2.000, 183 A1.000  | 03/96 → 07/99   |  | VKMC 02177<br>VKMA 02177<br>VKM 12173<br>VKM 22177                                 | 1<br>1<br>1<br>1  | 1<br>1<br>1   | 1   |   | 1   |   |   |   | T0128   |
|   | 182 A2.000, 183 A1.000  | 03/96 → 07/99   | 1)  | VKMA 02277<br>VKM 12173<br>VKM 12277<br>VKM 22177                                  | 2<br>1<br>1<br>1  | 1<br>2  |   |   |   |   |   |   | T0235   |
|                               | 182 A2.000, 183 A1.000  | 03/96 → 07/99   |   | VKPC 82645   |   |   |   |   | 1   |   |   |   |   |
|                               | B(Alt) 182 A2.000   | 03/96 → 07/99   | AC  | VKMV 7PK1080<br>VKM 32022  | 1   |   | 1   |   |   |   |   |   |   |
|   | B(Alt) 182 A2.000   | 03/96 → 07/99   | AC  | VKM 32007<br>VKM 32022   | 1   | 1   |   |   |   |   |   |   |   |
|   | B(Alt) 183 A1.000   | 03/96 → 07/99   |   | VKM 32007<br>VKM 32022   | 1   | 1   |   |   |   |   |   |   |   |
| <b>LANCIA  DEDRA 2.0</b>     |   |   |   |  |   |   |   |   |   |   |   |   |   |
|                               | 835 A5.000, 835 A5.046,<br>835 A7.046   | 09/89 → 07/99   |   | VKMA 02227<br>VKM 12227  | 1<br>1  | 1   |   |   |   |   |   |   | T0035   |
|                               | 835 A5.000, 835 A5.046  | 09/89 → 07/99   | Man. GBX,<br>→I Mot. 1308020  | VKPC 82622   |   |   |   |   | 1   |   |   |   |   |

|   |  |  |  |  |  |  |  |  |  |  |  |
|---|---|---|---|--|---|---|---|---|---|---|---|
|   | 835 A5.000, 835 A5.046  | 09/89 → 07/99   | Man. GBX,<br>Mot. 1308021 I→  | VKPC 82647   |   |   |   | 1   |   |   |   |
|   | 835 A5.000, 835 A5.046  | 09/89 → 07/99   | Auto. GBX,<br>→IMot. 1263035  | VKPC 82622   |   |   |   | 1   |   |   |   |
|   | 835 A5.000, 835 A5.046  | 09/89 → 07/99   | Auto. GBX,<br>Mot. 1263036 I→   | VKPC 82647   |   |   |   | 1   |   |   |   |
|   | 835 A7.046  | 11/90 → 07/94   |   | VKPC 82647   |   |   |   | 1   |   |   |   |
|                                  | B(Alt) 835 A5.000, 835 A5.046   | 09/89 → 12/94   | →IMot. 1308020  | VKPM 4PK1045   |   |   | 1   |   |   |   |   |
|                                  | B(Alt) 835 A5.000, 835 A5.046   | 09/89 → 12/94   | Mot. 1308021 I→,<br>→IMot. 1488440  | VKPM 5PK1042   |   |   | 1   |   |   |   |   |
|                                  | B(Alt) 835 A5.000, 835 A5.046   | 09/89 → 12/94   | Mot. 1488441 I→   | VKPM 5PK1050   |   |   | 1   |   |   |   |   |
|                                  | B(Alt) 835 A7.046   | 11/90 → 07/94   | AC  | VKPM 5PK1042   |   |   | 1   |   |   |   |   |
|                                  | B(Alt) 835 A7.046   | 11/90 → 07/94   | AC  | VKPM 5PK1050   |   |   | 1   |   |   |   |   |
|                                  | B(PS) 835 A5.000, 835 A5.046  | 09/89 → 12/94   | AC  | VKPM 13AVx825  |   |   | 1   |   |   |   |   |
|                                  | B(PS) 835 A7.046  | 11/90 → 07/94   | AC  | VKPM 13AVx875  |   |   | 1   |   |   |   |   |
|                                  | B(PS) 835 A5.000, 835 A5.046,<br>835 A7.046                                       | 09/89 → 12/94   | AC  | VKPM 13AVx750  |   |   | 1   |   |   |   |   |
|                                  | B(PS) 835 A5.046  | 01/95 → 07/99   | AC  | VKPM 13AVx875  |   |   | 1   |   |   |   |   |
|                                  | B(AC) 835 A5.000, 835 A5.046,<br>835 A7.046                                       | 09/89 → 07/99   |   | VKPM 13AVx850  |   |   | 1   |   |   |   |   |
| <b>LANCIA  DEDRA 2.0 16V</b>     |   |   |   |  |   |   |   |   |   |   |   |
|                                  | 836 A3.000  | 07/94 → 07/99   |   | VKMA 02224<br>VKM 12101  | 1<br>1  |   | 1   |   |   |   | T0083   |
|                                  | 836 A3.000  | 07/94 → 07/99   |   | VKPC 82660   |   |   |   | 1   |   |   |   |
|                                 | B(Alt) 836 A3.000   | 07/94 → 07/99   | AC  | VKPM 5PK1042   |   |   | 1   |   |   |   |   |
|                                | B(Alt) 836 A3.000   | 07/94 → 07/99   | AC  | VKPM 5PK1050   |   |   | 1   |   |   |   |   |
|                                | B(PS) 836 A3.000  | 07/94 → 07/99   | AC  | VKPM 13AVx875  |   |   | 1   |   |   |   |   |
|                                | B(PS) 836 A3.000  | 06/95 → 07/99   | Mot. S.W. LS 4x4, AC,<br>VETTno 4078683 I→  | VKPM 13AVx750  |   |   | 1   |   |   |   |   |
|                                | B(AC) 836 A3.000  | 07/94 → 07/99   |   | VKPM 13AVx850  |   |   | 1   |   |   |   |   |
| <b>LANCIA  DEDRA 2.0 Turbo</b> |   |   |   |  |   |   |   |   |   |   |   |
|                                | 835 A7.000, 835 A8.000,<br>835 A8.046   | 05/90 → 12/94   |   | VKMA 02227<br>VKM 12227  | 1<br>1  |   | 1   |   |   |   | T0035   |
|                                | 835 A7.000, 835 A8.000,<br>835 A8.046   | 05/90 → 07/99   |   | VKPC 82647   |   |   |   | 1   |   |   |   |
|                                | B(Alt) 835 A7.000, 835 A8.000,<br>835 A8.046                                      | 05/90 → 07/99   | AC  | VKPM 5PK1042   |   |   | 1   |   |   |   |   |
|                                | B(Alt) 835 A7.000, 835 A8.000,<br>835 A8.046                                      | 05/90 → 07/99   | AC  | VKPM 5PK1050   |   |   | 1   |   |   |   |   |
|                                | B(PS) 835 A7.000, 835 A8.000,<br>835 A8.046                                       | 05/90 → 07/99   | AC  | VKPM 13AVx875  |   |   | 1   |   |   |   |   |
|                                | B(PS) 835 A7.000, 835 A8.000,<br>835 A8.046                                       | 05/90 → 07/99   | AC  | VKPM 13AVx750  |   |   | 1   |   |   |   |   |
|                                | B(AC) 835 A7.000, 835 A8.000,<br>835 A8.046                                       | 05/90 → 07/99   |   | VKPM 13AVx850  |   |   | 1   |   |   |   |   |
| <b>LANCIA  DEDRA 1.9 TD</b>    |   |   |   |  |   |   |   |   |   |   |   |
|                                | 160 D1.000, 835 A4.000,<br>835 A4.046   | 04/89 → 12/94   |   | VKMA 02154<br>VKM 12153<br>VKM 22153   | 1<br>1<br>1   | 1   | 1   |   |   |   | T0055   |
|                                | 160 D1.000, 835 A4.000  | 04/89 → 07/99   | 2), →IMot. 1096004  | —  |   |   |   | 1   |   |   |   |
|                                | 160 D1.000, 835 A4.000  | 04/89 → 07/99   | 2), Mot. 1096005 I→   | VKPA 82666   |   |   |   | 1   |   |   |   |
|                                | B(Alt) 160 D1.000, 835 A4.000,<br>835 A4.046                                      | 04/89 → 07/99   | AC, →IMot. 1723043  | VKPM 5PK907  |   |   | 1   |   |   |   |   |
|                                | B(Alt) 160 D1.000, 835 A4.000,<br>835 A4.046                                      | 04/89 → 07/99   | AC, Mot. 1723044 I→   | VKPM 5PK915  |   |   | 1   |   |   |   |   |
|                                | B(Alt) 160 D1.000, 835 A4.000,<br>835 A4.046                                      | 04/89 → 06/94   | AC, →IMot. 0933346  | VKPM 5PK962<br>VKM 32016   |   |   | 1   | 1   |   |   |   |





























LANCIA































|   |  |  |                                        |  |  |  |  |  |  |  |  |  |  |
|---|---|---|---|--|---|---|---|---|---|---|---|---|---|
| B(Alt)  | 160 D1.000, 835 A4.000,<br>835 A4.046   | 04/89 → 06/94   | AC. Mot. 0933347 I→   | VKMV 5PK970<br>VKM 32009   | 1   | 1   |   |   |   |   |   |   |   |
| B(Alt)  | 160 D1.000, 835 A4.000,<br>835 A4.046   | 07/94 → 07/99   | AC. →IMot. 1723043  | VKMV 5PK970<br>VKM 32242   | 1   | 1   |   |   |   |   |   |   |   |
| B(Alt)  | 160 D1.000, 835 A4.000,<br>835 A4.046   | 07/94 → 07/99   | AC. Mot. 1723044 I→   | VKMV 5PK986<br>VKM 32242   | 1   | 1   |   |   |   |   |   |   |   |
| B(PS)   | 160 D1.000, 835 A4.000,<br>835 A4.046   | 04/89 → 07/99   | →IMot. 1096004  | VKMV 10AVx735  |   | 1   |   |   |   |   |   |   |   |
| B(PS)   | 160 D1.000, 835 A4.000,<br>835 A4.046   | 04/89 → 07/99   | Mot. 1096005 I→   | VKMV 10AVx725  |   | 1   |   |   |   |   |   |   |   |
| B(AC)   | 160 D1.000, 835 A4.000,<br>835 A4.046   | 04/89 → 07/99   | →IMot. 1166365  | VKMV 5PK986  |   | 1   |   |   |   |   |   |   |   |
| B(AC)   | 160 D1.000, 835 A4.000,<br>835 A4.046   | 04/89 → 07/99   | Mot. 1166366 I→   | VKMV 5PK938  |   | 1   |   |   |   |   |   |   |   |
| <b>LANCIA  DELTA I 1.1</b>         |   |   |   |  |   |   |   |   |   |   |   |   |   |
|                                     | 831 B8.000  | 01/86 → 12/90   |   | VKMA 02101<br>VKM 12101  | 1<br>1  | 1   |   |   |   |   |   |   | T0003   |
|                                     | 831 B8.000  | 01/86 → 12/90   | 2)  | VKPA 82222   |   |   | 1   |   |   |   |   |   |   |
|                                     | B(Alt) 831 B8.000   | 01/86 → 12/90   |   | VKMV 10AVx825  |   | 1   |   |   |   |   |   |   |   |
| <b>LANCIA  DELTA I 1.3</b>         |   |   |   |  |   |   |   |   |   |   |   |   |   |
|                                     | 831 A2.000, 831 B.000   | 09/79 → 12/82   |   | —<br>VKM 12100   | 1   |   |   |   |   |   |   |   |   |
|   | 831 A2.000, 831 B.000   | 01/83 → 12/85   | →IMot. 5782815  | VKMA 02140<br>VKM 12003  | 1<br>1  | 1   |   |   |   |   |   |   | T0003   |
|   | 831 B.000   | 01/86 → 08/92   | Mot. 5782816 I→   | VKMA 02101<br>VKM 12101  | 1<br>1  | 1   |   |   |   |   |   |   | T0003   |
|                                   | 831 B.000   | 09/79 → 08/92   | 2)  | —<br>VKPC 82206  |   |   | 1<br>1  |   |   |   |   |   |   |
|                                   | B(Alt) 831 B.000  | 01/86 → 08/92   |   | VKMV 10AVx825  |   | 1   |   |   |   |   |   |   |   |
| <b>LANCIA  DELTA I 1.5</b>       |   |   |   |  |   |   |   |   |   |   |   |   |   |
|                                   | 831 A1.000, 831 B1.000  | 09/79 → 12/85   | →IMot. 5782815  | VKMA 02110<br>VKM 12003  | 1<br>1  | 1   |   |   |   |   |   |   | T0011   |
|   | 831 A1.000, 831 B1.000  | 09/79 → 12/85   | Mot. 5782816 I→   | VKMA 02111<br>VKM 12101  | 1<br>1  | 1   |   |   |   |   |   |   | T0011   |
|   | 831 A1.000, 831 B1.000  | 01/86 → 12/92   |   | VKMA 02111<br>VKM 12101  | 1<br>1  | 1   |   |   |   |   |   |   | T0011   |
|                                   | 831 A1000   | 09/79 → 12/92   | 2)  | VKPA 82222   |   |   | 1   |   |   |   |   |   |   |
|   | 831 B1.000  | 09/79 → 12/92   | 2)  | VKPA 82218<br>VKPC 82218   |   |   | 1<br>1  |   |   |   |   |   |   |
|                                   | B(Alt) 831 B1.000   | 01/86 → 12/92   | →IVETTno 626853   | VKMV 10AVx838  |   | 1   |   |   |   |   |   |   |   |
|   | B(Alt) 831 B1.000   | 01/86 → 12/92   | VETTno 626854 I→  | VKMV 10AVx825  |   | 1   |   |   |   |   |   |   |   |
| <b>LANCIA  DELTA I 1.6</b>       |   |   |   |  |   |   |   |   |   |   |   |   |   |
|                                   | 149 C2.000, 831 B7.000  | 08/86 → 08/92   |   | VKMA 02005<br>VKM 12005  | 1<br>1  | 1   |   |   |   |   |   |   | T0041   |
|   | 831 A4.000  | 11/82 → 04/86   | →IMot. 488950   | —<br>VKM 12001   | 1   |   |   |   |   |   |   |   |   |
|   | 831 A4.000  | 11/82 → 04/86   | Mot. 488951 I→  | —<br>VKM 12003   | 1   |   |   |   |   |   |   |   |   |
|                                   | 149 C2.000, 831 B7.000  | 08/86 → 08/92   | →IMot. 1242367  | VKPC 82424   |   |   | 1   |   |   |   |   |   |   |
|   | 831 A4.000  | 11/82 → 04/86   |   | VKPC 82424   |   |   | 1   |   |   |   |   |   |   |
| <b>LANCIA  DELTA I 1.6 Turbo</b> |   |   |   |  |   |   |   |   |   |   |   |   |   |
|                                   | 831 A7.000  | 10/83 → 12/86   | B(41143x19),  143,<br>Mot. 488956 I→ | —<br>VKM 12003   | 1   |   |   |   |   |   |   |   |   |
|   | 831 A7.000  | 10/83 → 12/86   | B(41144x19),  144,<br>→IMot. 488955  | —<br>VKM 12001   | 1   |   |   |   |   |   |   |   |   |
|   | 831 B3.000, 831 B7.046  | 08/86 → 05/93   |   | VKMA 02005<br>VKM 12005  | 1<br>1  | 1   |   |   |   |   |   |   | T0041   |
|                                   | 831 B3.000, 831 B7.046  | 08/86 → 05/93   | →IMot. 1242367  | VKPC 82424   |   |   | 1   |   |   |   |   |   |   |



| <b>LANCIA  DELTA I 2.0</b>      |  |               |    |                        |  |                  |             |   |  |        |  |  |  |   |  |  |  |       |
|---------------------------------|--|---------------|----|------------------------|--|------------------|-------------|---|--|--------|--|--|--|---|--|--|--|-------|
|                                 | 831 B5.000, 831 C5.000, 831 C5.046               | 11/86 → 12/92 |    |                        | VKMA 02227<br>VKM 12227                              | 1<br>1           | 1           |   |  |        |  |  |  |   |  |  |  | T0035 |
|                                 | 831 B5.000, 831 C5.000, 831 C5.046               | 11/86 → 12/92 |    |                        | —  |                  |             |   |  | 1      |  |  |  |   |  |  |  |       |
|                                 | <b>B(Alt)</b> 831 B5.000, 831 C5.000, 831 C5.046 | 11/86 → 12/92 |    |                        | VKMV 5PK1345<br>VKM 32008                            |                  | 1           | 1 |  |        |  |  |  |   |  |  |  |       |
| <b>LANCIA  DELTA I 2.0 16V</b>  |  |               |    |                        |  |                  |             |   |  |        |  |  |  |   |  |  |  |       |
|                                 | 831 D5.000                                       | 03/89 → 09/91 | →  | <b>Mot.</b> 1036640    | —<br>VKM 12101                                       | 1<br>1           | 1           |   |  |        |  |  |  |   |  |  |  | T0098 |
|                                 | 831 D5.000, 831 E5.000, 831 E5.046               | 03/89 → 01/94 |    | <b>Mot.</b> 1039306 I→ | VKMA 02224<br>VKM 12101                              | 1<br>1           | 1           |   |  |        |  |  |  |   |  |  |  | T0083 |
|                                 | 831 D5.000, 831 E5.000, 831 E5.046               | 03/89 → 01/94 |    |                        | —  |                  |             |   |  | 1      |  |  |  |   |  |  |  |       |
|                                 | <b>B(Alt)</b> 831 D5.000, 831 E5.000, 831 E5.046 | 03/89 → 01/94 |    |                        | VKMV 5PK1345<br>VKM 32008                            |                  | 1           | 1 |  |        |  |  |  |   |  |  |  |       |
| <b>LANCIA  DELTA I 1.9 TD</b>   |  |               |    |                        |  |                  |             |   |  |        |  |  |  |   |  |  |  |       |
|                                 | 831 D1.000                                       | 10/86 → 12/89 |    |                        | —<br>VKM 12150                                       | 1<br>1           | 1           | 1 |  |        |  |  |  |   |  |  |  | T0034 |
|                                 | 831 D1.000                                       | 10/86 → 12/89 | 2) |                        | —  |                  |             | 1 |  |        |  |  |  |   |  |  |  |       |
|                                 | <b>B(PS)</b> 831 D1.000                          | 10/86 → 12/89 |    |                        | VKMV 10AVx735  |                  |             | 1 |  |        |  |  |  |   |  |  |  |       |
| <b>LANCIA  DELTA II 1.4</b>     |  |               |    |                        |  |                  |             |   |  |        |  |  |  |   |  |  |  |       |
|                                 | 160 A1.046, 836 A4.000                           | 10/94 → 08/99 |    |                        | VKMA 02410<br>VKM 12200                              | 1<br>1           | 1           |   |  |        |  |  |  |   |  |  |  | T0052 |
|                                 | 160 A1.046, 836 A4.000                           | 10/94 → 03/95 |    |                        | VKPC 82245   |                  |             |   |  | 1      |  |  |  |   |  |  |  |       |
|                                 | 160 A1.046, 836 A4.000                           | 04/95 → 08/99 | 2) |                        | VKPA 82230<br>VKPC 82230                             |                  |             |   |  | 1<br>1 |  |  |  |   |  |  |  |       |
|                                 | <b>B(Alt)</b> 160 A1.046, 836 A4.000             | 10/94 → 03/95 |    | <b>AC</b>              | VKM 32242  |                  | 1           |   |  |        |  |  |  |   |  |  |  |       |
|                                 | <b>B(Alt)</b> 160 A1.046, 836 A4.000             | 04/95 → 08/99 |    | <b>AC</b>              | VKMV 5PK938<br>VKM 32242                             |                  | 1           | 1 |  |        |  |  |  |   |  |  |  |       |
|                                 | <b>B(Alt)</b> 160 A1.046, 836 A4.000             | 10/94 → 08/99 |    | <b>AC</b>              | VKMV 5PK962<br>VKM 32242                             |                  | 1           | 1 |  |        |  |  |  |   |  |  |  |       |
|                                 | <b>B(PS)</b> 160 A1.046, 836 A4.000              | 10/94 → 08/99 |    |                        | VKMV 10AVx690  |                  |             | 1 |  |        |  |  |  |   |  |  |  |       |
|                                 | <b>B(AC)</b> 160 A1.046, 836 A4.000              | 10/94 → 08/99 |    |                        | VKMV 13AVx1050                                       |                  |             | 1 |  |        |  |  |  |   |  |  |  |       |
| <b>LANCIA  DELTA II 1.6</b>     |  |               |    |                        |  |                  |             |   |  |        |  |  |  |   |  |  |  |       |
|                                 | 835 C1.000                                       | 06/93 → 08/99 |    |                        | VKMA 02410<br>VKM 12200                              | 1<br>1           | 1           |   |  |        |  |  |  |   |  |  |  | T0052 |
|                                 | 835 C1.000                                       | 06/93 → 03/95 |    |                        | VKPC 82245   |                  |             |   |  | 1      |  |  |  |   |  |  |  |       |
|                                 | 835 C1.000                                       | 04/95 → 08/99 | 2) |                        | VKPA 82230<br>VKPC 82230                             |                  |             |   |  | 1<br>1 |  |  |  |   |  |  |  |       |
|                                 | <b>B(Alt)</b> 835 C1.000                         | 06/93 → 03/95 |    | <b>AC</b>              | VKM 32242  |                  | 1           |   |  |        |  |  |  |   |  |  |  |       |
|                                 | <b>B(Alt)</b> 835 C1.000                         | 04/95 → 08/99 |    | <b>AC</b>              | VKMV 5PK938<br>VKM 32242                             |                  | 1           | 1 |  |        |  |  |  |   |  |  |  |       |
|                                 | <b>B(Alt)</b> 835 C1.000                         | 06/93 → 08/99 |    | <b>AC</b>              | VKMV 5PK962<br>VKM 32242                             |                  | 1           | 1 |  |        |  |  |  |   |  |  |  |       |
|                                 | <b>B(PS)</b> 835 C1.000                          | 06/93 → 08/99 |    |                        | VKMV 10AVx690  |                  |             | 1 |  |        |  |  |  |   |  |  |  |       |
|                                 | <b>B(AC)</b> 835 C1.000                          | 06/93 → 08/99 |    |                        | VKMV 13AVx1050                                       |                  |             | 1 |  |        |  |  |  |   |  |  |  |       |
| <b>LANCIA  DELTA II 1.6 16V</b> |  |               |    |                        |  |                  |             |   |  |        |  |  |  |   |  |  |  |       |
|                                 | 182 A4.000, 182 A6.000                           | 01/96 → 08/99 | 3) |                        | VKMS 02242-1<br>VKMA 02242<br>VKM 12242<br>VKM 22242 | 1<br>1<br>1<br>1 | 1<br>1<br>1 | 1 |  |        |  |  |  | 4 |  |  |  | T0130 |
|                                 | 182 A4.000, 182 A6.000                           | 01/96 → 08/99 | 2) |                        | VKPA 82441<br>VKPC 82441                             |                  |             |   |  | 1<br>1 |  |  |  |   |  |  |  |       |
|                                 | <b>B(Alt)</b> 182 A4.000, 182 A6.000             | 01/96 → 08/99 |    |                        | VKMV 5PK938<br>VKM 32242                             |                  | 1           | 1 |  |        |  |  |  |   |  |  |  |       |
|                                 | <b>B(PS)</b> 182 A4.000, 182 A6.000              | 01/96 → 08/99 |    |                        | VKMV 3PK668  |                  |             | 1 |  |        |  |  |  |   |  |  |  |       |









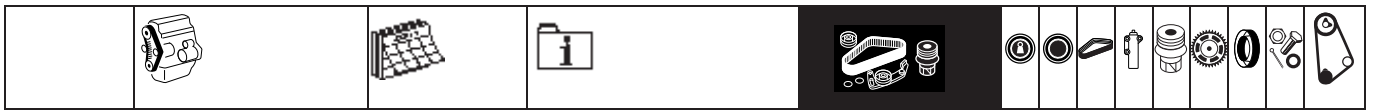











































|  |  |  |    |  |  |  |  |  |  |  |  |  |
|--|---|---|---|--|---|---|---|---|---|---|---|---|
| B(AC)  | 182 A4.000, 182 A6.000  | 01/96 → 08/99   |   | VKMV 4PK962<br>VKM 32242   | 1   | 1   |   |   |   |   |   |   |
| <b>LANCIA  DELTA II 1.8</b>       |   |   |   |  |   |   |   |   |   |   |   |   |
|                                    | 835 C2.000, 835 C4.000,<br>836 A6.000, 836 C4.000                                 | 06/93 → 08/99   |   | VKMA 02227<br>VKM 12227  | 1<br>1  | 1   |   |   |   |   |   | T0035   |
|                                    | 835 C2.000, 835 C4.000,<br>836 A6.000, 836 C4.000                                 | 06/93 → 08/99   |   | VKPC 82647   |   |   | 1   |   |   |   |   |   |
|                                    | B(Alt) 835 C2.000, 835 C4.000,<br>836 A6.000, 836 C4.000                          | 06/93 → 08/99   | AC  | VKMV 5PK1042   |   | 1   |   |   |   |   |   |   |
|  | B(Alt) 835 C2.000, 835 C4.000,<br>836 A6.000, 836 C4.000                          | 06/93 → 08/99   | AC  | VKMV 5PK1050   |   | 1   |   |   |   |   |   |   |
|  | B(PS) 835 C2.000, 835 C4.000,<br>836 A6.000, 836 C4.000                           | 06/93 → 08/99   | AC  | VKMV 13AVx875  |   | 1   |   |   |   |   |   |   |
|  | B(PS) 835 C2.000, 835 C4.000,<br>836 A6.000, 836 C4.000                           | 06/93 → 08/99   | AC  | VKMV 13AVx750  |   | 1   |   |   |   |   |   |   |
|  | B(AC) 835 C2.000, 835 C4.000,<br>836 A6.000, 836 C4.000                           | 06/93 → 08/99   |   | VKMV 13AVx850  |   | 1   |   |   |   |   |   |   |
| <b>LANCIA  DELTA II 1.8 16V</b>   |   |   |   |  |   |   |   |   |   |   |   |   |
|                                    | 182 A2.000  | 03/96 → 08/99   |    | VKMC 02177<br>VKMA 02177<br>VKM 12173<br>VKM 22177                                 | 1<br>1<br>1<br>1  | 1<br>1<br>1<br>1  | 1<br>1<br>1<br>1  | 1<br>1<br>1<br>1  |   |   |   | T0128   |
|  | 183 A1.000  | 03/96 → 04/98   |    | VKMC 02177<br>VKMA 02177<br>VKM 12173<br>VKM 22177                                 | 1<br>1<br>1<br>1  | 1<br>1<br>1<br>1  | 1<br>1<br>1<br>1  | 1<br>1<br>1<br>1  |   |   |   | T0128   |
|  | 183 A1.000  | 05/98 → 08/99   |  | VKMC 02183<br>VKMA 02183<br>VKM 12182<br>VKM 22177                                 | 1<br>1<br>1<br>1  | 1<br>1<br>1<br>1  | 1<br>1<br>1<br>1  | 1<br>1<br>1<br>1  |   |   |   | T0128   |
|  | 182 A2.000  | 03/96 → 08/99   | 1)  | VKMA 02277<br>VKM 12173<br>VKM 12277<br>VKM 22177                                  | 2<br>1<br>1<br>1  | 1<br>1<br>1<br>1  | 2<br>1<br>1<br>1  | 2<br>1<br>1<br>1  |   |   |   | T0235   |
|  | 183 A1.000  | 03/96 → 04/98   | 1)  | VKMA 02277<br>VKM 12173<br>VKM 12277<br>VKM 22177                                  | 2<br>1<br>1<br>1  | 1<br>1<br>1<br>1  | 2<br>1<br>1<br>1  | 2<br>1<br>1<br>1  |   |   |   | T0235   |
|  | 183 A1.000  | 05/98 → 08/99   | 1)  | VKMA 02283<br>VKM 12182<br>VKM 12277<br>VKM 22177                                  | 2<br>1<br>1<br>1  | 1<br>1<br>1<br>1  | 2<br>1<br>1<br>1  | 2<br>1<br>1<br>1  |   |   |   | T0235   |
|                                  | 182 A2.000, 183 A1.000  | 03/96 → 08/99   |   | VKPC 82645   |   |   |   | 1   |   |   |   |   |
|                                  | B(Alt) 182 A2.000   | 03/96 → 08/99   | AC  | VKMV 7PK1080<br>VKM 32022  | 1   |   | 1   |   |   |   |   |   |
|  | B(Alt) 182 A2.000   | 03/96 → 08/99   | AC  | VKM 32007<br>VKM 32022   | 1   | 1   |   |   |   |   |   |   |
|  | B(Alt) 183 A1.000   | 03/96 → 08/99   | AC, →IMot. 1385143  | VKMV 7PK1080<br>VKM 32022  | 1   |   | 1   |   |   |   |   |   |
|  | B(Alt) 183 A1.000   | 03/96 → 08/99   | AC, Mot. 1385144 I→   | VKMV 6PK1080<br>VKM 32022  | 1   |   | 1   |   |   |   |   |   |
|  | B(Alt) 183 A1.000   | 03/96 → 04/98   | AC  | VKM 32007<br>VKM 32022   | 1   | 1   |   |   |   |   |   |   |
|  | B(Alt) 183 A1.000   | 05/98 → 08/99   | AC, →IMot. 1385143  | VKMV 7PK1975<br>VKM 32007<br>VKM 32022   | 1   | 1   | 1   |   |   |   |   |   |
|  | B(Alt) 183 A1.000   | 05/98 → 08/99   | AC, Mot. 1385144 I→   | VKMV 6PK1975<br>VKM 32007<br>VKM 32022   | 1   | 1   | 1   |   |   |   |   |   |
| <b>LANCIA  DELTA II 2.0 16V</b> |   |   |   |  |   |   |   |   |   |   |   |   |
|                                  | 836 A3.000  | 06/93 → 08/99   |   | VKMA 02224<br>VKM 12101  | 1<br>1  | 1   |   |   |   |   |   | T0083   |
|                                  | 836 A3.000  | 06/93 → 08/99   |   | VKPC 82660   |   |   | 1   |   |   |   |   |   |
|                                  | B(Alt) 836 A3.000   | 06/93 → 08/99   | AC  | VKMV 5PK1042   |   | 1   |   |   |   |   |   |   |

|  |  |  |  |  |  |  |  |  |  |  |  |       |
|--|---|---|---|--|---|---|---|---|---|---|---|-------|
|  | B(Alt)  | 836 A3.000  | 06/93 → 08/99   | AC   | VKMV 5PK1050  |   |   | 1   |   |   |   |       |
|  | B(PS)   | 836 A3.000  | 06/93 → 08/99   | AC   | VKMV 13AVx875   |   |   | 1   |   |   |   |       |
|  | B(PS)   | 836 A3.000  | 01/95 → 08/99   | AC, VETTno 0063309 I→  | VKMV 13AVx750   |   |   | 1   |   |   |   |       |
|  | B(AC)   | 836 A3.000  | 06/93 → 08/99   |  | VKMV 13AVx850   |   |   | 1   |   |   |   |       |
| <b>LANCIA  DELTA II 2.0 16V Turbo</b> |   |   |   |  |   |   |   |   |   |   |   |       |
|                                       |   | 175 A4.000, 836 A2.000  | 06/93 → 08/99   |  | VKMA 02224<br>VKM 12101   | 1<br>1  |   | 1   |   |   |   | T0083 |
|                                       |   | 175 A4.000, 836 A2.000  | 06/93 → 08/99   |  | VKPC 82660  |   |   |   | 1   |   |   |       |
|                                       | B(Alt)  | 175 A4.000, 836 A2.000  | 06/93 → 08/99   | AC   | VKMV 5PK1042  |   |   | 1   |   |   |   |       |
|  | B(Alt)  | 175 A4.000, 836 A2.000  | 06/93 → 08/99   | AC   | VKMV 5PK1050  |   |   | 1   |   |   |   |       |
|  | B(PS)   | 175 A4.000, 836 A2.000  | 06/93 → 08/99   | AC   | VKMV 13AVx875   |   |   | 1   |   |   |   |       |
|  | B(AC)   | 175 A4.000, 836 A2.000  | 06/93 → 08/99   |  | VKMV 13AVx850   |   |   | 1   |   |   |   |       |
| <b>LANCIA  DELTA II 1.9 TD</b>        |   |   |   |  |   |   |   |   |   |   |   |       |
|                                       |   | 160 D1.000, 835 A4.000  | 10/94 → 08/99   |  | VKMA 02154<br>VKM 12153<br>VKM 22153  | 1<br>1<br>1   | 1   | 1   |   |   |   | T0055 |
|                                       |   | 160 D1.000, 835 A4.000  | 10/94 → 08/99   | 2)   | VKPA 82666  |   |   |   | 1   |   |   |       |
|                                       | B(Alt)  | 160 D1.000, 835 A4.000  | 10/94 → 08/99   | AC, →IMot. 1723043   | VKMV 5PK907   |   |   | 1   |   |   |   |       |
|  | B(Alt)  | 160 D1.000, 835 A4.000  | 10/94 → 08/99   | AC, Mot. 1723044 I→  | VKMV 5PK915   |   |   | 1   |   |   |   |       |
|  | B(Alt)  | 160 D1.000, 835 A4.000  | 10/94 → 08/99   | AC, →IMot. 1723043   | VKMV 5PK970<br>VKM 32242  |   |   | 1   |   |   |   |       |
|  | B(Alt)  | 160 D1.000, 835 A4.000  | 10/94 → 08/99   | AC, Mot. 1723044 I→  | VKMV 5PK986<br>VKM 32242  |   |   | 1   |   |   |   |       |
|  | B(PS)   | 160 D1.000, 835 A4.000  | 10/94 → 08/99   |  | VKMV 10AVx725   |   |   | 1   |   |   |   |       |
|  | B(AC)   | 160 D1.000, 835 A4.000  | 10/94 → 08/99   |  | VKMV 5PK938   |   |   | 1   |   |   |   |       |
| <b>LANCIA  KAPPA 2.0 16V Turbo</b>  |   |   |   |  |   |   |   |   |   |   |   |       |
|                                     |   | 838 A4.000  | 02/95 → 01/01   |  | VKMA 02224<br>VKM 12101   | 1<br>1  |   | 1   |   |   |   | T0083 |
|                                     |   | 838 A4.000  | 02/95 → 10/01   |  | VKPC 82629  |   |   |   | 1   |   |   |       |
| <b>LANCIA  KAPPA 2.0 20V</b>        |   |   |   |  |   |   |   |   |   |   |   |       |
|                                     |   | 838 A1.000, 838 A6.000  | 10/94 → 10/01   |  | VKMA 02172<br>VKM 12172<br>VKM 22174  | 1<br>1<br>1   | 1   | 1   |   |   |   | T0075 |
|                                     |   | 838 A1.000, 838 A6.000  | 10/94 → 10/01   |  | VKPC 82646  |   |   |   | 1   |   |   |       |
|                                     | B(Alt)  | 838 A1.000, 838 A6.000  | 10/94 → 10/01   | AC, →IMot. 577836  | VKMA 32012<br>VKMV 6PK1036<br>VKM 32012   | 1<br>1<br>1   |   | 1   |   |   |   |       |
|  | B(Alt)  | 838 A1.000, 838 A6.000  | 10/94 → 10/01   | AC, Mot. 577837 I→   | VKMV 6PK1692<br>VKM 32004<br>VKM 32024<br>VKM 32025                                 |   |   | 1   |   |   |   |       |
|  |   |   |   |  |   | 1   |   | 1   |   |   |   |       |
|  |   |   |   |  |   | 1   |   | 1   |   |   |   |       |
| <b>LANCIA  KAPPA 2.0 20V Turbo</b>  |   |   |   |  |   |   |   |   |   |   |   |       |
|                                     |   | 175 A3.000  | 06/98 → 10/01   |  | VKMA 02172<br>VKM 12172<br>VKM 22174  | 1<br>1<br>1   | 1   | 1   |   |   |   | T0075 |
|                                     |   | 175 A3.000  | 06/98 → 10/01   |  | VKPC 82646  |   |   |   | 1   |   |   |       |
|                                     | B(Alt)  | 175 A3.000  | 06/98 → 10/01   | AC, Mot. 577837 I→   | VKMV 6PK1692<br>VKM 32004<br>VKM 32024<br>VKM 32025                                 |   |   | 1   |   |   |   |       |
|  |   |   |   |  |   | 1   |   | 1   |   |   |   |       |
|  |   |   |   |  |   | 1   |   | 1   |   |   |   |       |
| <b>LANCIA  KAPPA 2.4 20V</b>        |   |   |   |  |   |   |   |   |   |   |   |       |
|                                     |   | 838 A2.000  | 08/94 → 10/01   |  | VKMA 02178<br>VKM 12172<br>VKM 22174  | 1<br>1<br>1   | 1   | 1   |   |   |   | T0128 |
|                                     |   | 838 A2.000  | 08/94 → 10/01   |  | VKPC 82646  |   |   |   | 1   |   |   |       |
|                                     | B(Alt)  | 838 A2.000  | 08/94 → 10/01   | AC, →IMot. 577836  | VKMA 32012<br>VKMV 6PK1036<br>VKM 32012   | 1<br>1<br>1   |   | 1   |   |   |   |       |
|  | B(Alt)  | 838 A2.000  | 08/94 → 10/01   | AC, Mot. 577837 I→   | VKMV 6PK1692<br>VKM 32004<br>VKM 32024<br>VKM 32025                                 |   |   | 1   |   |   |   |       |
|  |   |   |   |  |   | 1   |   | 1   |   |   |   |       |
|  |   |   |   |  |   | 1   |   | 1   |   |   |   |       |









































| LANCIA  KAPPA 3.0 24V   |                                    |               |               |   |              |            |   |   |   |       |
|--|------------------------------------|---------------|---------------|---|--------------|------------|---|---|---|-------|
|                          | 838 B.000                          | 08/94 → 12/96 |               |   | —            | 1          | 2 | 1 |   | T0237 |
|  |                                    |               |               |   | VKM 22541    | 1          |   |   |   |       |
|  |                                    |               |               |   | VKM 22541    |            | 1 |   |   |       |
|                          | 838 B.000                          | 08/94 → 10/01 | VETNo 2088055 | I→  | VKPC 82450   |            |   |   | 1 |       |
|                          | B(Alt) 838 B.000                   | 08/94 → 10/01 | →I            | VETNo 2051777   | VKM 32010    | 1          |   |   |   |       |
|  | B(Alt) 838 B.000                   | 08/94 → 10/01 | VETNo 2051778 | I→  | VKMV 6PK1983 |            |   | 1 |   |       |
|  |                                    |               |               |   | VKM 32030    |            | 1 |   |   |       |
|  |                                    |               |               |   | VKM 32082    | 1          |   |   |   |       |
|  |                                    |               |               |   | VKM 32083    |            | 1 |   |   |       |
| LANCIA  KAPPA 2.4 TD    |                                    |               |               |   |              |            |   |   |   |       |
|                          | 838 A3.000, 838 A7.000             | 08/94 → 10/01 |               |   | VKMA 02171   | 1          | 1 | 1 |   | T0140 |
|  |                                    |               |               |   | VKM 12174    | 1          |   |   |   |       |
|  |                                    |               |               |   | VKM 22174    |            | 1 |   |   |       |
|                          | 838 A3.000, 838 A7.000             | 08/94 → 10/01 |               |   | VKPC 82665   |            |   |   | 1 |       |
|                          | B(Alt) 838 A3.000, 838 A7.000      | 08/94 → 10/01 | AC            | →IMot. 577836   | VKMA 32212   | 1          |   | 1 |   |       |
|  |                                    |               |               |   | VKMV 6PK1072 |            |   | 1 |   |       |
|  |                                    |               |               |   | VKM 32012    | 1          |   |   |   |       |
|  | B(Alt) 838 A3.000, 838 A7.000      | 08/94 → 10/01 | AC            | Mot. 597297   | I→           | VKMA 32025 | 1 |   | 1 |       |
|  |                                    |               |               |   | VKMV 6PK1105 |            |   | 1 |   |       |
|  |                                    |               |               |   | VKM 32025    | 1          |   |   |   |       |
|  | B(Alt) 838 A3.000, 838 A7.000      | 08/94 → 10/01 | AC            | Mot. 597297   | I→           | VKMA 32004 | 1 | 2 | 1 |       |
|  |                                    |               |               |   | VKMV 6PK1740 |            |   | 1 |   |       |
|  |                                    |               |               |   | VKM 32004    |            | 1 |   |   |       |
|  |                                    |               |               |   | VKM 32024    |            | 1 |   |   |       |
|  |                                    |               |               |   | VKM 32025    | 1          |   |   |   |       |
| LANCIA  KAPPA 2.4 JTD |                                    |               |               |   |              |            |   |   |   |       |
|                        | 838 A8.000                         | 06/98 → 10/01 |               |  | VKMC 02176   | 1          | 1 | 1 | 1 | T0158 |
|  |                                    |               |               |   | VKMA 02176   | 1          | 1 | 1 |   |       |
|  |                                    |               |               |   | VKM 12174    | 1          |   |   |   |       |
|  |                                    |               |               |   | VKM 22174    |            | 1 |   |   |       |
|                        | 838 A8.000                         | 06/98 → 10/01 |               |   | VKPC 82665   |            |   |   | 1 |       |
|                        | B(Alt) 838 A8.000                  | 06/98 → 10/01 | AC            |   | VKMA 32004   | 1          | 2 | 1 |   |       |
|  |                                    |               |               |   | VKMV 6PK1740 |            |   | 1 |   |       |
|  |                                    |               |               |   | VKM 32004    |            | 1 |   |   |       |
|  |                                    |               |               |   | VKM 32024    |            | 1 |   |   |       |
|  |                                    |               |               |   | VKM 32025    | 1          |   |   |   |       |
|                        | 838 A8.000                         | 06/98 → 10/01 |               |   | VKM_____     |            |   |   | 1 |       |
| LANCIA  LYBRA 1.6 16V |                                    |               |               |   |              |            |   |   |   |       |
|                        | 182 A4.000, 182 B6.000             | 07/99 → 03/07 | 3)            |   | VKMS 02242-2 | 1          | 1 | 1 |   | 4     |
|  |                                    |               |               |   | VKMA 02242   | 1          | 1 | 1 |   | T0130 |
|  |                                    |               |               |   | VKM 12242    | 1          |   |   |   |       |
|  |                                    |               |               |   | VKM 22242    |            | 1 |   |   |       |
|                        | 182 A4.000, 182 B6.000             | 07/99 → 03/07 | 2)            |   | VKPA 82441   |            |   |   | 1 |       |
|  |                                    |               |               |   | VKPC 82441   |            |   |   | 1 |       |
|                        | B(Alt) 182 A4.000, 182 B6.000      | 07/99 → 02/00 |               |   | VKMV 5PK938  |            |   | 1 |   |       |
|  |                                    |               |               |   | VKM 32242    | 1          |   |   |   |       |
|  | B(Alt) 182 A4.000, 182 B6.000      | 03/00 → 03/07 |               |   | VKMV 5PK938  |            |   | 1 |   |       |
|  |                                    |               |               |   | VKM 32243    | 1          |   |   |   |       |
|  | B(PS) 182 A4.000, 182 B6.000       | 07/99 → 03/07 |               |   | VKMV 3PK668  |            |   | 1 |   |       |
|  | B(AC) 182 A4.000, 182 B6.000       | 07/99 → 06/01 |               |   | VKMV 4PK962  |            |   | 1 |   |       |
|  |                                    |               |               |   | VKM 32242    | 1          |   |   |   |       |
| LANCIA  LYBRA 1.8 16V |                                    |               |               |   |              |            |   |   |   |       |
|                        | 839 A4.000, 839 A7.000, 839 A9.000 | 07/99 → 10/07 |               |  | VKMC 02183   | 1          | 1 | 1 | 1 | T0128 |
|  |                                    |               |               |   | VKMA 02183   | 1          | 1 | 1 |   |       |
|  |                                    |               |               |   | VKM 12182    | 1          |   |   |   |       |
|  |                                    |               |               |   | VKM 22177    |            | 1 |   |   |       |
|  | 839 A4.000, 839 A7.000, 839 A9.000 | 07/99 → 10/07 | 1)            |   | VKMA 02283   | 2          | 1 | 2 |   | T0235 |
|  |                                    |               |               |   | VKM 12182    | 1          |   |   |   |       |
|  |                                    |               |               |   | VKM 12277    | 1          |   |   |   |       |
|  |                                    |               |               |   | VKM 22177    |            | 1 |   |   |       |

|   |  |  |    |  |  |  |  |  |  |  |  |  |
|---|---|---|---|--|---|---|---|---|---|---|---|---|
|                                | 839 A4.000, 839 A7.000,<br>839 A9.000   | 07/99 → 10/07   |   | VKPC 82645   |   |   |   |   | 1   |   |   |   |
|                                | <b>B(Alt)</b> 839 A4.000, 839 A7.000,<br>839 A9.000                               | 07/99 → 02/02   | AC, →IMot. 2850151  | VKMOV 6PK1080<br>VKM 32026   | 1   |   | 1   |   |   |   |   |   |
|   | <b>B(Alt)</b> 839 A4.000, 839 A7.000,<br>839 A9.000                               | 03/02 → 10/07   | AC, Mot. 2850152 I→   | VKMOV 6PK1062<br>VKM 32026   | 1   |   | 1   |   |   |   |   |   |
|   | <b>B(Alt)</b> 839 A4.000, 839 A7.000,<br>839 A9.000                               | 07/99 → 02/02   | AC, →IMot. 2850151  | VKMOV 6PK1975<br>VKM 32007<br>VKM 32026  | 1   | 1   |   | 1   |   |   |   |   |
|   | <b>B(Alt)</b> 839 A4.000, 839 A7.000,<br>839 A9.000                               | 03/02 → 10/07   | AC, Mot. 2850152 I→   | VKMOV 6PK1962<br>VKM 32007<br>VKM 32026  | 1   | 1   |   | 1   |   |   |   |   |
| <b>LANCIA  LYBRA 2.0 20V</b>   |   |   |   |  |   |   |   |   |   |   |   |   |
|                                | 182 B7.000  | 07/99 → 09/00   |   | VKMA 02172<br>VKM 12172<br>VKM 22174   | 1<br>1  | 1   | 1   |   |   |   |   | T0075   |
|   | 185 A8.000  | 09/00 → 12/05   |   | VKMA 02185<br>VKM 12172<br>VKM 22174   | 1<br>1  | 1   | 1   |   |   |   |   | T0143   |
|                                | 182 B7.000, 185 A8.000  | 07/99 → 03/07   |   | VKPC 82646   |   |   |   |   | 1   |   |   |   |
|                                | <b>B(Alt)</b> 182 B7.000, 185 A8.000  | 07/99 → 03/07   |   | VKMOV 6PK1139<br>VKM 32015<br>VKM 32036  | 1   |   | 1   |   |   |   |   |   |
| <b>LANCIA  LYBRA 1.9 JTD</b> |   |   |   |  |   |   |   |   |   |   |   |   |
|                              | 937 A2.000, AR 32302,<br>AR 37101   | 07/99 → 07/04   |  | VKMC 02179<br>VKMA 02179<br>VKM 12174<br>VKM 22179                                 | 1<br>1<br>1   | 1<br>1  | 1<br>1  |   | 1   |   |   | 2<br>2<br>2   |
|   | 937 A2.000  | 08/04 → 10/07   |   | VKMA 02192<br>VKM 12174<br>VKM 22180   | 1<br>1  | 1   | 1   |   |   |   |   | T0158   |
|                              | 937 A2.000, AR 32302,<br>AR 37101   | 07/99 → 10/07   |   | VKPC 82665   |   |   |   |   | 1   |   |   |   |
|                              | <b>B(Alt)</b> 937 A2.000, AR 32302,<br>AR 37101                                   | 07/99 → 10/07   | AC  | VKMA 32027<br>VKMOV 6PK1036<br>VKM 32027   | 1   |   | 1   |   |   |   |   |   |
|   | <b>B(Alt)</b> 937 A2.000, AR 32302,<br>AR 37101                                   | 07/99 → 10/07   | AC  | VKMA 32039<br>VKMOV 6PK1836<br>VKM 32006<br>VKM 32027                              | 1   | 1   | 1   |   |   |   |   |   |
|                              | 937 A2.000, AR 32302,<br>AR 37101   | 07/99 → 12/05   |   | VKM_____   |   |   |   |   | 1   |   |   |   |
| <b>LANCIA  LYBRA 2.4 JTD</b> |   |   |   |  |   |   |   |   |   |   |   |   |
|                              | 839 A5.000, 839 A6.000,<br>841 C.000, AR 32501                                    | 07/99 → 03/07   |  | VKMC 02176<br>VKMA 02176<br>VKM 12174<br>VKM 22174                                 | 1<br>1<br>1   | 1<br>1  | 1<br>1  |   | 1   |   |   | T0158   |
|                              | 839 A5.000, 839 A6.000,<br>841 C.000, AR 32501                                    | 07/99 → 03/07   |   | VKPC 82665   |   |   |   |   | 1   |   |   |   |
|                              | <b>B(Alt)</b> 839 A5.000, 839 A6.000,<br>841 C.000, AR 32501                      | 07/99 → 03/07   |   | VKMA 32024<br>VKMOV 6PK1760<br>VKM 32018<br>VKM 32024<br>VKM 32025                 | 1   | 2   | 1   |   |   |   |   |   |
|                              | 839 A5.000, 839 A6.000,<br>841C.000, AR 32501                                     | 07/99 → 12/05   |   | VKM_____   |   |   |   |   | 1   |   |   |   |



LANCIA

































| <b>LANCIA  MUSA 1.4</b>            |                                      |               |           |  |  |             |                  |   |   |   |  |   |       |
|------------------------------------|--------------------------------------|---------------|-----------|--|--|-------------|------------------|---|---|---|--|---|-------|
|                                    | 350 A1.000                           | 09/05 → 03/07 |           |  | VKMA _____<br>VKM 12206  | 1<br>1      | 1                |   |   |   |  |   | T0250 |
|                                    | 350 A1.000                           | 09/05 → 03/07 |           |  | VKPC 82251   |             |                  |   | 1 |   |  |   |       |
|                                    | <b>B(Alt)</b> 350 A1.000             | 09/05 → 03/07 |           |  | VKMA 32040<br>VKMV 5PK1145<br>VKM 32023                        | 1<br><br>1  | 1<br>1           |   |   |   |  |   |       |
| <b>LANCIA  MUSA 1.4 16V</b>        |                                      |               |           |  |  |             |                  |   |   |   |  |   |       |
|                                    | 192 B2.000, 843 A1.000               | 10/04 → 03/07 |           |  | —<br>VKMA 02204<br>VKM 12201                                   | 1<br>1<br>1 | 1<br>1           | 1 |   |   |  |   | T0160 |
|                                    | 192 B2.000, 843 A1.000               | 10/04 → 03/07 |           |  | VKPC 82251   |             |                  | 1 |   |   |  |   |       |
|                                    | <b>B(Alt)</b> 192 B2.000, 843 A1.000 | 10/04 → 03/07 |           |  | VKMA 32040<br>VKMV 5PK1145<br>VKM 32023                        | 1<br><br>1  | 1<br>1           |   |   |   |  |   |       |
| <b>LANCIA  MUSA 1.3 D Multijet</b> |                                      |               |           |  |  |             |                  |   |   |   |  |   |       |
|                                    | 188 A9.000, 199 A3.000               | 10/04 → 10/07 |           |  | <del>OKOKOK</del>  |             |                  |   |   |   |  |   |       |
|                                    | 188 A9.000, 199 A3.000               | 10/04 → 10/07 |           |  | VKPC 85700   |             |                  |   | 1 |   |  |   |       |
|                                    | <b>B(Alt)</b> 188 A9.000, 199 A3.000 | 10/04 → 10/07 | <b>AC</b> |  | VKMV 6PK1180<br>VKM 32080                                      | 1           | 1                |   |   |   |  |   |       |
|                                    | <b>B(Alt)</b> 188 A9.000, 199 A3.000 | 10/04 → 10/07 | <b>AC</b> |  | VKMV 6PK1310<br>VKM 32080                                      | 1           | 1                |   |   |   |  |   |       |
| <b>LANCIA  MUSA 1.9 D Multijet</b> |                                      |               |           |  |  |             |                  |   |   |   |  |   |       |
|                                    | 188 B2.000                           | 10/04 → 10/07 |           |  | VKMA 02192<br>VKM 12174<br>VKM 22180                           | 1<br>1      | 1<br>1           |   |   |   |  |   | T0158 |
|                                    | 188 B2.000                           | 10/04 → 10/07 |           |  | VKPC 82665   |             |                  |   | 1 |   |  |   |       |
|                                    | <b>B(Alt)</b> 188 B2.000             | 10/04 → 06/06 |           |  | VKMV 6PK1195<br>VKM 32006<br>VKM 32027<br>VKM 32030            | 1           | 1<br>1           | 1 |   |   |  |   |       |
|                                    | 188 B2.000                           | 10/04 → 12/05 |           |  | VKM _____  |             |                  |   |   | 1 |  |   |       |
| <b>LANCIA  PHEDRA 2.0 16V</b>      |                                      |               |           |  |  |             |                  |   |   |   |  |   |       |
|                                    | RFN(EW10J4)                          | 09/02 → 03/07 |           |  | VKMA 03235<br>VKM 13234<br>VKM 23230                           | 1<br>1      | 1<br>1           | 1 |   |   |  |   | T0169 |
|                                    | RFN(EW10J4)                          | 09/02 → 06/05 | 16)       |  | VKPC 83650   |             |                  |   | 1 |   |  |   |       |
|                                    | <b>B(Alt)</b> RFN(EW10J4)            | 09/02 → 11/04 | <b>AC</b> |  | VKMA 33055<br>VKMV 6PK1188<br>VKM 33019<br>VKM 33020           | 1<br><br>1  | 1<br>1           | 1 |   |   |  |   |       |
|                                    | <b>B(Alt)</b> RFN(EW10J4)            | 09/02 → 11/04 | <b>AC</b> |  | VKMA 33052<br>VKMV 6PK1706<br>VKM 33019<br>VKM 33020           | 1<br>1      | 1<br>1           | 1 |   |   |  |   |       |
| <b>LANCIA  PHEDRA 3.0 V6</b>       |                                      |               |           |  |  |             |                  |   |   |   |  |   |       |
|                                    | ES9 J4S                              | 09/02 → 12/05 |           |  | VKMA 03902<br>VKM 13902<br>VKM 23900<br>VKM 23900<br>VKM 23901 | 1<br>1      | 3<br>1<br>1<br>1 | 1 |   |   |  |   | T0204 |
|                                    | ES9 J4S                              | 09/02 → 03/07 |           |  | —  |             |                  |   | 1 |   |  |   |       |
|                                    | <b>B(Alt)</b> ES9 J4S                | 09/02 → 06/05 |           |  | VKMV 6PK1585<br>VKM 33075                                      |             | 1                | 1 |   |   |  |   |       |
| <b>LANCIA  PHEDRA 2.0 JTD 16V</b>  |                                      |               |           |  |  |             |                  |   |   |   |  |   |       |
|                                    | RHM, RHW                             | 09/02 → 10/07 |           |  | VKMC 03248<br>VKMA 03248<br>VKM 13246<br>VKM 23246             | 1<br>1<br>1 | 1<br>1<br>1      | 1 | 1 |   |  | 1 | T0196 |
|                                    | RHK, RHR                             | 06/06 → 10/07 |           |  | VKMA 03257<br>VKM 13257<br>VKM 23257                           | 1<br>1      | 1<br>1           | 1 |   |   |  |   | T0205 |
|                                    | RHM, RHW(DW10ATED4)                  | 09/02 → 10/07 |           |  | VKPC 83639   |             |                  |   | 1 |   |  |   |       |
|                                    | RHK, RHR                             | 06/06 → 10/07 |           |  | VKPC 83643   |             |                  |   | 1 |   |  |   |       |

|  |  |  |  |  |  |  |  |  |  |  |  |  |
|--|---|---|---|--|---|---|---|---|---|---|---|---|
|                                   | <b>B(Alt)</b>   | RHM, RHW(DW10ATED4)   | 09/02 → 10/07   | VKMV 6PK1740<br>VKM 33013<br>VKM 33033   | 1<br>1  | 1   |   |   |   |   |   |   |
|  | <b>B(Alt)</b>   | RHK, RHR  | 06/06 → 10/07   | VKMA 33320<br>VKMV 6PK1217<br>VKM 33320  | 1<br>1  | 1   |   |   |   |   |   |   |
|                                   |   | RHK, RHR  | 06/06 → 12/06   | VKM_____   |   |   |   |   | 1   |   |   |   |
| <b>LANCIA  PHEDRA 2.2 JTD 16V</b> |   |   |   |  |   |   |   |   |   |   |   |   |
|                                   |   | 4HW(DW12ATED4)  | 09/02 → 12/05   | VKMA 03252<br>VKM 13246<br>VKM 23246   | 1<br>1  | 1   | 1   |   |   |   | 1   | T0179   |
|                                   |   | 4HW(DW12ATED4)  | 09/02 → 03/07   | VKPC 83643   |   |   |   | 1   |   |   |   |   |
|                                   | <b>B(Alt)</b>   | 4HW(DW12ATED4)  | 09/02 → 03/07   | VKMV 6PK1740<br>VKM 33033<br>VKM 33045   | 1   | 1   |   |   |   |   |   |   |
| <b>LANCIA  PRISMA 1.3</b>         |   |   |   |  |   |   |   |   |   |   |   |   |
|                                   |   |   | 01/83 → 12/86   | →IMot. 5782815   | VKMA 02140<br>VKM 12003   | 1<br>1  | 1   |   |   |   |   | T0003   |
|  |   |   | 01/83 → 12/86   | Mot. 5782816 I→  | VKMA 02101<br>VKM 12101   | 1<br>1  | 1   |   |   |   |   | T0003   |
| <b>LANCIA  PRISMA 1.5</b>         |   |   |   |  |   |   |   |   |   |   |   |   |
|                                   |   | 138 C2.048, 831 A1.000,<br>831 B1.048   | 01/83 → 12/86   | →IMot. 5782815   | VKMA 02110<br>VKM 12003   | 1<br>1  | 1   |   |   |   |   | T0011   |
|  |   | 138 C2.048, 831 A1.000,<br>831 B1.000,<br>831 B1.048                              | 01/83 → 12/89   | Mot. 5782816 I→  | VKMA 02111<br>VKM 12101   | 1<br>1  | 1   |   |   |   |   | T0011   |
| <b>LANCIA  PRISMA 1.6</b>       |   |   |   |  |   |   |   |   |   |   |   |   |
|                                 |   | 149 C2.000, 831 B6.000,<br>831 B7.000   | 01/87 → 12/89   |  | VKMA 02005<br>VKM 12005   | 1<br>1  | 1   |   |   |   |   | T0041   |
|  |   | 831 A4.000  | 01/83 → 04/86   | →IMot. 488950  | —<br>VKM 12001  | 1   |   |   |   |   |   |   |
|  |   | 831 A4.000  | 01/83 → 04/86   | Mot. 488951 I→   | —<br>VKM 12003  | 1   |   |   |   |   |   |   |
|                                 |   | 831 A4.000, 831 B7.000  | 01/83 → 12/89   |  | VKPC 82424  |   |   | 1   |   |   |   |   |
| <b>LANCIA  PRISMA 2.0</b>       |   |   |   |  |   |   |   |   |   |   |   |   |
|                                 |   | 831 B4.000  | 04/86 → 12/89   |  | VKMA 02227<br>VKM 12227   | 1<br>1  | 1   |   |   |   |   | T0035   |
|                                 | <b>B(Alt)</b>   | 831 B4.000  | 04/86 → 12/89   |  | VKMV 5PK1345<br>VKM 32008   |   | 1   |   |   |   |   |   |
| <b>LANCIA  PRISMA 1.9 D</b>     |   |   |   |  |   |   |   |   |   |   |   |   |
|                                 |   | 831 D.000   | 12/84 → 01/89   |  | —<br>VKM 12150<br>—   | 1<br>1  | 1   | 1   |   |   |   | T0034   |
|                                 | <b>B(Alt)</b>   | 831 D.000   | 01/86 → 12/89   | AC   | VKM 32016<br>VKM 32016<br>VKM 32016   |   | 1<br>1<br>1   |   |   |   |   |   |
| <b>LANCIA  PRISMA 1.9 TD</b>    |   |   |   |  |   |   |   |   |   |   |   |   |
|                                 |   | 831 D1000   | 05/85 → 01/86   | 2)   | —   |   |   |   | 1   |   |   |   |
|  |   | 831 D1000   | 01/86 → 12/89   | 2), AC,<br>→ICH CH 694404  | —   |   |   |   | 1   |   |   |   |
|  |   | 831 D1000   | 01/86 → 12/89   | 2), AC, →ICH CH 694404   | —   |   |   |   | 1   |   |   |   |
|                                 | <b>B(Alt)</b>   | 831 D1000   | 01/86 → 12/89   | AC   | VKM 32016<br>VKM 32016<br>VKM 32016   |   | 1<br>1<br>1   |   |   |   |   |   |
| <b>LANCIA  THEMA 2.0</b>        |   |   |   |  |   |   |   |   |   |   |   |   |
|                                 |   | 834 B.000, 834 B.048  | 11/84 → 09/88   | AC, →IMot. 570151  | VKMA 02450<br>VKM 12005   | 1<br>1  | 1   |   |   |   |   | T0035   |



LANCIA



|   |  |  |  |  |  |  |  |  |  |  |  |  |
|---|---|---|---|--|---|---|---|---|---|---|---|---|
|   | 834 B.000, 834 B.048  | 11/84 → 09/88   | AC, Mot. 570152 I→  | VKMA 02227<br>VKM 12227  | 1<br>1  | 1   |   |   |   |   |   | T0035   |
|   | 834 B.000, 834 B.048  | 11/84 → 09/88   | AC  | VKMA 02227<br>VKM 12227  | 1<br>1  | 1   |   |   |   |   |   | T0035   |
|   | 834 B.146, 834 B1.000   | 09/87 → 05/92   |   | VKMA 02227<br>VKM 12227  | 1<br>1  | 1   |   |   |   |   |   | T0035   |
|                                       | 834 B.048, 834 B.146,<br>834 B1.000   | 03/86 → 05/92   |   | VKPC 82622   |   |   |   | 1   |   |   |   |   |
|                                       | B(PS) 834 B.146, 834 B1.000   | 09/87 → 05/92   | AC  | VKMOV 13AVx850   |   | 1   |   |   |   |   |   |   |
|   | B(PS) 834 B.146, 834 B1.000   | 09/87 → 05/92   | AC  | VKMOV 13AVx750   |   | 1   |   |   |   |   |   |   |
|   | B(AC) 834 B.146, 834 B1.000   | 09/87 → 05/92   |   | VKMOV 13AVx875   |   | 1   |   |   |   |   |   |   |
| <b>LANCIA  THEMA 2.0 16V</b>         |   |   |   |  |   |   |   |   |   |   |   |   |
|                                       | 834 B2.000, 834 B2.246  | 05/88 → 10/89   | →IMot. 1036640  | —<br>VKM 12101   | 1<br>1  | 1   |   |   |   |   |   | T0098   |
|   | 834 B2.000, 834 B2.246  | 05/88 → 10/89   | Mot. 1036641 I→   | VKMA 02224<br>VKM 12101  | 1<br>1  | 1   |   |   |   |   |   | T0083   |
|   | 834 F1.000  | 05/92 → 07/94   |   | VKMA 02224<br>VKM 12101  | 1<br>1  | 1   |   |   |   |   |   | T0083   |
|                                       | 834 B2.000, 834 B2.246,<br>834 F1.000   | 05/88 → 07/94   |   | VKPC 82629   |   |   |   | 1   |   |   |   |   |
|                                       | B(Alt) 834 F1.000   | 05/92 → 07/94   |   | VKMOV 5PK1100  |   | 1   |   |   |   |   |   |   |
|   | B(PS) 834 B2.000, 834 B2.246,<br>834 F1.000                                       | 05/88 → 07/94   | AC  | VKMOV 13AVx850   |   | 1   |   |   |   |   |   |   |
|   | B(PS) 834 B2.000, 834 B2.246,<br>834 F1.000                                       | 05/88 → 07/94   | AC  | VKMOV 13AVx750   |   | 1   |   |   |   |   |   |   |
|   | B(AC) 834 B2.000, 834 B2.246,<br>834 F1.000                                       | 05/88 → 07/94   |   | VKMOV 13AVx875   |   | 1   |   |   |   |   |   |   |
| <b>LANCIA  THEMA 2.0 16V Turbo</b> |   |   |   |  |   |   |   |   |   |   |   |   |
|                                     | 834 C1.000, 834 C1.246  | 11/89 → 12/92   | Mot. 1036641 I→   | VKMA 02224<br>VKM 12101  | 1<br>1  | 1   |   |   |   |   |   | T0083   |
|   | 834 F2.000  | 10/92 → 07/94   |   | VKMA 02224<br>VKM 12101  | 1<br>1  | 1   |   |   |   |   |   | T0083   |
|                                     | 834 C1.000, 834 C1.246,<br>834 F2.000   | 12/88 → 07/94   |   | VKPC 82629   |   |   |   | 1   |   |   |   |   |
|                                     | B(Alt) 834 F2.000   | 10/92 → 07/94   |   | VKMOV 5PK1100  |   | 1   |   |   |   |   |   |   |
|   | B(PS) 834 C1.000, 834 C1.246,<br>834 F2.000                                       | 12/88 → 07/94   | AC  | VKMOV 13AVx850   |   | 1   |   |   |   |   |   |   |
|   | B(PS) 834 C1.000, 834 C1.246,<br>834 F2.000                                       | 12/88 → 07/94   | AC  | VKMOV 13AVx750   |   | 1   |   |   |   |   |   |   |
|   | B(AC) 834 C1.000, 834 C1.246,<br>834 F2.000                                       | 12/88 → 07/94   |   | VKMOV 13AVx875   |   | 1   |   |   |   |   |   |   |
| <b>LANCIA  THEMA 2.0 Turbo</b>     |   |   |   |  |   |   |   |   |   |   |   |   |
|                                     | 834 C.000, 834 C.146  | 11/84 → 03/92   |   | VKMA 02227<br>VKM 12227  | 1<br>1  | 1   |   |   |   |   |   | T0035   |
|                                     | 834 C.000   | 11/84 → 12/87   |   | VKPC 82622   |   |   |   | 1   |   |   |   |   |
|   | 834 C.146   | 01/88 → 03/92   | →IMot. 1025363  | VKPC 82622   |   |   |   | 1   |   |   |   |   |
|                                     | B(PS) 834 C.146   | 07/86 → 03/92   | AC  | VKMOV 13AVx850   |   | 1   |   |   |   |   |   |   |
|   | B(PS) 834 C.146   | 07/86 → 03/92   | AC  | VKMOV 13AVx750   |   | 1   |   |   |   |   |   |   |
|   | B(AC) 834 C.146   | 07/86 → 03/92   |   | VKMOV 13AVx875   |   | 1   |   |   |   |   |   |   |
| <b>LANCIA  THEMA 2.8 V6</b>        |   |   |   |  |   |   |   |   |   |   |   |   |
|                                     | 834 E.000, 834 E.146  | 11/84 → 05/92   |   | OXOXOXO  |   |   |   |   |   |   |   |   |
| <b>LANCIA  THEMA 3.0 V6</b>        |   |   |   |  |   |   |   |   |   |   |   |   |
|                                     | 834 F.000   | 08/92 → 07/94   |   | VKMA____<br>VKM____  | 1<br>1  | 1   |   |   |   |   |   |   |
| <b>LANCIA  THEMA 2.5 TD</b>        |   |   |   |  |   |   |   |   |   |   |   |   |
|                                     | 8144. 97S, 8144.97  | 05/88 → 07/92   |   | —<br>—   | 1<br>1  | 1   |   |   |   |   |   |   |
|   | 8144.97 Y   | 05/92 → 12/94   |   | VKMA 02422<br>VKM 12400  | 1<br>1  | 1   |   |   |   |   |   | T0115   |
|                                     | 8144. 97S, 8144.97  | 05/88 → 11/90   | →IVETTno 264226   | VKPC 82616   |   |   |   | 1   |   |   |   |   |
|   | 8144. 97S, 8144.97  | 12/90 → 07/92   | 2), VETTno 264227 I→  | VKPA 82648   |   |   |   | 1   |   |   |   |   |
|   | 8144.97 Y   | 05/92 → 07/94   |   | VKPC 82638   |   |   |   | 1   |   |   |   |   |

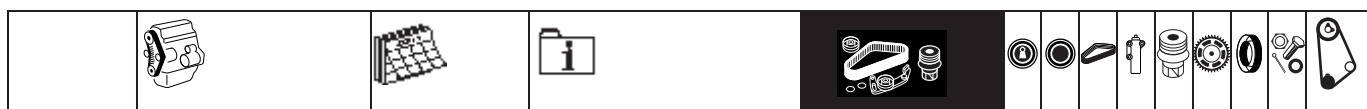

**LANCIA** **THESIS 2.0 Turbo**

|        |          |               |  |        |   |   |  |  |   |  |  |  |  |  |  |  |  |  |  |  |       |
|--------|----------|---------------|--|--------|---|---|--|--|---|--|--|--|--|--|--|--|--|--|--|--|-------|
|        | 841E.000 | 07/02 → 12/05 | VKMA 02185<br>VKM 12172<br>VKM 22174                 | 1<br>1 | 1 | 1 |  |  |   |  |  |  |  |  |  |  |  |  |  |  | T0143 |
|        | 841E.000 | 07/02 → 03/07 | VKPC 82646   |        |   |   |  |  | 1 |  |  |  |  |  |  |  |  |  |  |  |       |
| B(Alt) | 841E.000 | 07/02 → 03/07 | VKMMV 6PK1692<br>VKM 32004<br>VKM 32024<br>VKM 32025 |        |   | 1 |  |  |   |  |  |  |  |  |  |  |  |  |  |  |       |

**LANCIA** **THESIS 2.4 20V**

|        |           |               |  |        |   |   |  |  |   |  |  |  |  |  |  |  |  |  |  |  |  |       |
|--------|-----------|---------------|--|--------|---|---|--|--|---|--|--|--|--|--|--|--|--|--|--|--|--|-------|
|        | 841 D.000 | 07/02 → 12/05 | VKMA 02178<br>VKM 12172<br>VKM 22174                 | 1<br>1 | 1 | 1 |  |  |   |  |  |  |  |  |  |  |  |  |  |  |  | T0128 |
|        | 841D.000  | 07/02 → 03/07 | VKPC 82646   |        |   |   |  |  | 1 |  |  |  |  |  |  |  |  |  |  |  |  |       |
| B(Alt) | 841D.000  | 07/02 → 03/07 | VKMMV 6PK1692<br>VKM 32004<br>VKM 32024<br>VKM 32025 |        |   | 1 |  |  |   |  |  |  |  |  |  |  |  |  |  |  |  |       |

**LANCIA** **THESIS 3.0 V6**

|        |          |               |  |        |   |   |  |  |   |  |  |  |  |  |  |  |  |  |  |  |  |       |
|--------|----------|---------------|--|--------|---|---|--|--|---|--|--|--|--|--|--|--|--|--|--|--|--|-------|
|        | 841A.000 | 07/02 → 03/07 | VKMA _____<br>VKM _____<br>VKM 22540<br>VKM 22540    | 1<br>1 | 2 | 1 |  |  |   |  |  |  |  |  |  |  |  |  |  |  |  | T0238 |
|        | 841A.000 | 07/02 → 03/07 | —  |        |   |   |  |  | 1 |  |  |  |  |  |  |  |  |  |  |  |  |       |
| B(Alt) | 841A.000 | 07/02 → 03/07 | VKMMV 6PK1983<br>VKM 32030<br>VKM 32082<br>VKM 32083 |        |   | 1 |  |  |   |  |  |  |  |  |  |  |  |  |  |  |  |       |

**LANCIA** **THESIS 3.2 V6**

|        |           |               |  |        |   |   |  |  |   |  |  |  |  |  |  |  |  |  |  |  |  |       |
|--------|-----------|---------------|--|--------|---|---|--|--|---|--|--|--|--|--|--|--|--|--|--|--|--|-------|
|        | 841 A.000 | 05/03 → 03/07 | VKMA _____<br>VKM _____<br>VKM 22540<br>VKM 22540    | 1<br>1 | 2 | 1 |  |  |   |  |  |  |  |  |  |  |  |  |  |  |  | T0238 |
|        | 841 A.000 | 05/03 → 03/07 | —  |        |   |   |  |  | 1 |  |  |  |  |  |  |  |  |  |  |  |  |       |
| B(Alt) | 841 A.000 | 05/03 → 03/07 | VKMMV 6PK1983<br>VKM 32030<br>VKM 32082<br>VKM 32083 |        |   | 1 |  |  |   |  |  |  |  |  |  |  |  |  |  |  |  |       |

**LANCIA** **THESIS 2.4 D Multijet**

|        |           |               |   |        |   |   |  |  |   |  |  |  |  |  |  |  |  |  |  |  |  |       |
|--------|-----------|---------------|---|--------|---|---|--|--|---|--|--|--|--|--|--|--|--|--|--|--|--|-------|
|        | 841 P.000 | 04/06 → 03/07 | VKMA 02195<br>VKM 12174<br>VKM 22174    | 1<br>1 | 1 | 1 |  |  |   |  |  |  |  |  |  |  |  |  |  |  |  | T0248 |
|        | 841 P.000 | 04/06 → 03/07 | VKPC 82667                              |        |   |   |  |  | 1 |  |  |  |  |  |  |  |  |  |  |  |  |       |
| B(Alt) | 841 P.000 | 04/06 → 03/07 | VKMMV 6PK1740<br>VKM 32004<br>VKM 32024 |        |   | 1 |  |  |   |  |  |  |  |  |  |  |  |  |  |  |  |       |









































**LANCIA** **THESIS 2.4 JTD**

































|        |          |               |  |             |        |   |  |  |   |  |  |  |  |  |  |  |  |  |  |  |  |       |
|--------|----------|---------------|--|-------------|--------|---|--|--|---|--|--|--|--|--|--|--|--|--|--|--|--|-------|
|        | 841C.000 | 07/02 → 03/07 | VKMC 02176<br>VKMA 02176<br>VKM 12174<br>VKM 22174                 | 1<br>1<br>1 | 1<br>1 | 1 |  |  | 1 |  |  |  |  |  |  |  |  |  |  |  |  | T0158 |
|        | 841C.000 | 07/02 → 03/07 | VKPC 82665   |             |        |   |  |  | 1 |  |  |  |  |  |  |  |  |  |  |  |  |       |
| B(Alt) | 841C.000 | 07/02 → 12/05 | VKMA 32004<br>VKMMV 6PK1740<br>VKM 32004<br>VKM 32024<br>VKM 32025 |             |        | 1 |  |  |   |  |  |  |  |  |  |  |  |  |  |  |  |       |
|        | 841C.000 | 07/02 → 12/05 | VKM _____  |             |        |   |  |  |   |  |  |  |  |  |  |  |  |  |  |  |  |       |

**LANCIA** **THESIS 2.4 JTD 20V**

|  |   |               |                                      |        |   |   |  |  |  |  |  |  |  |  |  |  |  |  |  |  |  |       |
|--|---|---------------|--------------------------------------|--------|---|---|--|--|--|--|--|--|--|--|--|--|--|--|--|--|--|-------|
|  | 841 D.000, 841 G.000,<br>841 M.000, 841 N.000 | 05/03 → 03/07 | VKMA 02191<br>VKM 12174<br>VKM 22174 | 1<br>1 | 1 | 1 |  |  |  |  |  |  |  |  |  |  |  |  |  |  |  | T0203 |
|--|---|---------------|--------------------------------------|--------|---|---|--|--|--|--|--|--|--|--|--|--|--|--|--|--|--|-------|



|   |  |  |                    |  |  |  |  |  |  |  |  |  |  |  |
|---|---|---|---|--|---|---|---|---|---|---|---|---|---|---|
|                             | 841 D.000, 841 G.000,<br>841 M.000, 841 N.000                                     | 05/03 → 03/07   |   | VKPC 82667   |   |   |   |   |   | 1   |   |   |   |   |
|                             | <b>B(Alt)</b> 841 D.000, 841 G.000,<br>841 H.000, 841 M.000,<br>841 N.000         | 05/03 → 03/07   |   | VKMA 32004<br>VKMV 6PK1740<br>VKM 32004<br>VKM 32024<br>VKM 32025                  | 1   | 2   | 1   |   |   |   |   |   |   |   |
|                             | 841 G.000   | 05/03 → 12/05   |   | VKM_____   | 1   |   |   |   |   | 1   |   |   |   |   |
| <b>LANCIA  TREVI 2.0</b>   |   |   |   |  |   |   |   |   |   |   |   |   |   |   |
|                             | 828 B4.000  | 05/80 → 01/87   |   | —  |   |   |   |   |   | 1   |   |   |   |   |
| <b>LANCIA  Y 1.1</b>       |   |   |   |  |   |   |   |   |   |   |   |   |   |   |
|                             | 176 B2.000  | 11/95 → 09/03   |  → IMot. 9042883   | VKMC 02200<br>VKMA 02200<br>VKM 12200  | 1<br>1<br>1   | 1   | 1   | 1   |   |   |   |   |   | T0009   |
|   | 176 B2.000  | 11/95 → 09/03   |  Mot. 9042884 I→   | VKMC 02210<br>VKMA 02210<br>VKM 12200  | 1<br>1<br>1   | 1   | 1   | 1   |   |   |   |   |   | T0174   |
|                             | 176 B2.000  | 11/95 → 09/03   | → IMot. 9042883   | VKPC 82214   |   |   |   |   |   | 1   |   |   |   |   |
|   | 176 B2.000  | 11/95 → 09/03   | Mot. 9042884 I→   | VKPC 82250   |   |   |   |   |   | 1   |   |   |   |   |
|                             | <b>B(Alt)</b> 176 B2.000  | 11/95 → 09/03   | AC  | VKMV 4PK675  |   |   | 1   |   |   |   |   |   |   |   |
| <b>LANCIA  Y 1.2</b>       |   |   |   |  |   |   |   |   |   |   |   |   |   |   |
|                             | 188 A4.000  | 03/96 → 09/03   |                    | VKMC 02203<br>VKMA 02203<br>VKM 12200  | 1<br>1<br>1   | 1   | 1   | 1   |   |   |   |   |   | T0175   |
|   | 840 A3.000  | 03/96 → 09/03   |  → IMot. 9042883  | VKMC 02201<br>VKMA 02201<br>VKM 12200  | 1<br>1<br>1   | 1   | 1   | 1   |   |   |   |   |   | T0117   |
|   | 840 A3.000  | 03/96 → 09/03   |  Mot. 9042884 I→ | VKMC 02203<br>VKMA 02203<br>VKM 12200  | 1<br>1<br>1   | 1   | 1   | 1   |   |   |   |   |   | T0175   |
|                           | 188 A4.000  | 03/96 → 09/03   |   | VKPC 82250   |   |   |   |   |   | 1   |   |   |   |   |
|   | 840 A3.000  | 03/96 → 09/03   | → IMot. 9042883   | VKPC 82214   |   |   |   |   |   | 1   |   |   |   |   |
|   | 840 A3.000  | 03/96 → 09/03   | Mot. 9042884 I→   | VKPC 82250   |   |   |   |   |   | 1   |   |   |   |   |
|                           | <b>B(Alt)</b> 188 A4.000, 840 A3.000  | 03/96 → 09/03   | AC  | VKMV 4PK675  |   |   | 1   |   |   |   |   |   |   |   |
|   | <b>B(Alt)</b> 188 A4.000  | 01/00 → 01/02   | AC  | VKMA 32034<br>VKMV 5PK1585<br>VKM 32033<br>VKM 32034                               | 1<br>1<br>1<br>1  | 1   | 1   | 1   |   |   |   |   |   |   |
|   | <b>B(Alt)</b> 188 A4.000  | 02/02 → 12/02   | AC  | VKMV 5PK1570<br>VKM 32033<br>VKM 32035   | 1<br>1<br>1   |   | 1   |   |   |   |   |   |   |   |
| <b>LANCIA  Y 1.2 16V</b> |   |   |   |  |   |   |   |   |   |   |   |   |   |   |
|                           | 176 B9.000  | 04/97 → 04/99   |                  | —<br>VKMA 02204<br>VKM 12201   | 1<br>1<br>1   | 1   | 1   | 1   |   |   |   |   |   | T0160   |
|   | 176 B9.000, 188 A5.000  | 05/99 → 09/03   |                  | —<br>VKMA 02204<br>VKM 12201   | 1<br>1<br>1   | 1   | 1   | 1   |   |   |   |   |   | T0160   |
|                           | 176 B9.000  | 04/97 → 04/99   |   | VKPC 82249   |   |   |   |   |   | 1   |   |   |   |   |
|   | 176 B9.000, 188 A5.000  | 05/99 → 09/03   |   | VKPC 82251   |   |   |   |   |   | 1   |   |   |   |   |
|                           | <b>B(Alt)</b> 188 A5.000  | 10/00 → 09/03   | AC  | VKMV 4PK675  |   |   | 1   |   |   |   |   |   |   |   |
|   | <b>B(Alt)</b> 188 A5.000  | 10/00 → 09/03   | AC. → IMot. 616579  | VKMA 32034<br>VKMV 5PK1585<br>VKM 32033<br>VKM 32034                               | 1<br>1<br>1<br>1  | 1   | 1   | 1   |   |   |   |   |   |   |
|   | <b>B(Alt)</b> 188 A5.000  | 10/00 → 09/03   | AC. Mot. 616580 I→  | VKMV 5PK1570<br>VKM 32033<br>VKM 32035   | 1<br>1<br>1   |   | 1   |   |   |   |   |   |   |   |
| <b>LANCIA  Y 1.4 12V</b> |   |   |   |  |   |   |   |   |   |   |   |   |   |   |
|                           | 840 A2.000, 840 A4.000  | 03/96 → 09/03   |  → IMot. 705144  | —<br>VKMA 02215<br>VKM 12215   | 1<br>1<br>1   | 1   | 1   | 1   |   |   |   |   |   | T0129   |

|   |  |  |                          |  |  |  |  |  |  |  |  |  |
|---|---|---|---|--|---|---|---|---|---|---|---|---|
|   | 840 A2.000, 840 A4.000  | 03/96 → 09/03   |  Mot. 705145 I→          | —  | 1   |   | 1   |   | 1   |   |   |   |
|   |   |   |   | VKMA 02215   | 1   |   | 1   |   |   |   |   | T0129   |
|   |   |   |   | VKM 12215  | 1   |   |   |   |   |   |   |   |
|   | 840 A2.000, 840 A4.000  | 03/96 → 09/03   | 3)  | VKMS 02215   | 1   |   | 1   |   |   |   | 2   |   |
|   |   |   |   | VKMA 02215   | 1   |   | 1   |   |   |   |   | T0129   |
|   |   |   |   | VKM 12215  | 1   |   |   |   |   |   |   |   |
|                              | 840 A2.000, 840 A4.000  | 03/96 → 09/03   | → IMot. 705144  | VKPC 82437   |   |   |   |   | 1   |   |   |   |
|                              | <b>B(Alt)</b> 840 A2.000, 840 A4.000  | 03/96 → 12/99   | <b>AC</b>   | VKMA 32022   | 1   |   | 1   |   |   |   |   |   |
|   |   |   |   | VKMV 6PK1045   |   |   | 1   |   |   |   |   |   |
|   |   |   |   | VKM 32022  | 1   |   |   |   |   |   |   |   |
|   | <b>B(Alt)</b> 840 A2.000, 840 A4.000  | 03/96 → 12/99   | <b>AC</b>   | VKMA 32020   | 1   | 1   | 1   |   |   |   |   |   |
|   |   |   |   | VKMV 6PK1842   |   |   | 1   |   |   |   |   |   |
|   |   |   |   | VKM 32001  |   | 1   |   |   |   |   |   |   |
|   |   |   |   | VKM 32022  | 1   |   |   |   |   |   |   |   |
| <b>LANCIA  Y10 1.0</b>       |   |   |   |  |   |   |   |   |   |   |   |   |
|                              | 156 A2.000, 156 A2.100,<br>156 A2.246   | 03/85 → 02/92   |                          | VKMC 02200   | 1   |   | 1   |   | 1   |   |   |   |
|   |   |   |   | VKMA 02200   | 1   |   | 1   |   |   |   |   | T0009   |
|   |   |   |   | VKM 12200  | 1   |   |   |   |   |   |   |   |
|   | 156 A2.000, 156 A2.100,<br>156 A2.246   | 03/85 → 02/92   | 3), → IMot. 6315750   | VKMS 02200-1   | 1   |   | 1   |   |   |   | 2   |   |
|   |   |   |   | VKMA 02200   | 1   |   | 1   |   |   |   |   | T0009   |
|   |   |   |   | VKM 12200  | 1   |   |   |   |   |   |   |   |
|   | 156 A2.000, 156 A2.100,<br>156 A2.246   | 03/85 → 02/92   | 3), Mot. 6315751 I→   | VKMS 02200-2   | 1   |   | 1   |   |   |   | 2   |   |
|   |   |   |   | VKMA 02200   | 1   |   | 1   |   |   |   |   | T0009   |
|   |   |   |   | VKM 12200  | 1   |   |   |   |   |   |   |   |
|                             | 156 A2.000, 156 A2.100,<br>156 A2.246   | 03/85 → 02/92   |   | VKPC 82214   |   |   |   |   | 1   |   |   |   |
|                            | <b>B(Alt)</b> 156 A2.000, 156 A2.100,<br>156 A2.246                               | 03/85 → 02/92   |   | VKMV 10AVx675  |   |   | 1   |   |   |   |   |   |
| <b>LANCIA  Y10 1.1</b>     |   |   |   |  |   |   |   |   |   |   |   |   |
|                            | 156 C.000, 156 C.046,<br>176 B2.000   | 07/89 → 12/95   |                        | VKMC 02200   | 1   |   | 1   |   | 1   |   |   |   |
|   |   |   |   | VKMA 02200   | 1   |   | 1   |   |   |   |   | T0009   |
|   |   |   |   | VKM 12200  | 1   |   |   |   |   |   |   |   |
|   | 156 C.000, 156 C.046,<br>176 B2.000   | 07/89 → 12/95   | 3), → IMot. 6315750   | VKMS 02200-1   | 1   |   | 1   |   |   |   | 2   |   |
|   |   |   |   | VKMA 02200   | 1   |   | 1   |   |   |   |   | T0009   |
|   |   |   |   | VKM 12200  | 1   |   |   |   |   |   |   |   |
|   | 156 C.000, 156 C.046,<br>176 B2.000   | 07/89 → 12/95   | 3), Mot. 6315751 I→   | VKMS 02200-2   | 1   |   | 1   |   |   |   | 2   |   |
|   |   |   |   | VKMA 02200   | 1   |   | 1   |   |   |   |   | T0009   |
|   |   |   |   | VKM 12200  | 1   |   |   |   |   |   |   |   |
|                            | 156 C.000, 156 C.046,<br>176 B2.000   | 07/89 → 12/95   |   | VKPC 82214   |   |   |   |   | 1   |   |   |   |
|                            | <b>B(Alt)</b> 156 C.000, 156 C.046  | 07/89 → 09/95   |   | VKMV 10AVx675  |   |   | 1   |   |   |   |   |   |
|   | <b>B(Alt)</b> 176 B2.000  | 01/95 → 12/95   | <b>AC</b>   | VKMV 4PK675  |   |   | 1   |   |   |   |   |   |
| <b>LANCIA  Y10 1.3</b>     |   |   |   |  |   |   |   |   |   |   |   |   |
|                            | 146 A 5.046, 156 B.000  | 11/87 → 02/92   |   | —  | 1   |   | 1   |   |   |   |   | T0039   |
|   |   |   |   | VKM 12010  | 1   |   |   |   |   |   |   |   |
|   | 146 A 5.046, 156 B.000  | 03/92 → 12/95   |   | —  | 1   |   | 1   |   |   |   |   | T0039   |
|   |   |   |   | VKM 12200  | 1   |   |   |   |   |   |   |   |
|                            | 146 A 5.046, 156 B.000  | 11/87 → 12/95   |   | VKPC 82208   |   |   |   |   | 1   |   |   |   |
| <b>LANCIA  YPSILON 1.2</b> |   |   |   |  |   |   |   |   |   |   |   |   |
|                            | 188 A4.000  | 10/03 → 10/07   |  M⊙<br>→ IMot. 2533528 | VKMC 02203   | 1   |   | 1   |   | 1   |   |   |   |
|   |   |   |   | VKMA 02203   | 1   |   | 1   |   |   |   |   | T0175   |
|   |   |   |   | VKM 12200  | 1   |   |   |   |   |   |   |   |
|   | 188 A4.000  | 10/03 → 10/07   | <b>A⊙ Mot. 2533529 I→</b>   | VKMA _____   | 1   |   | 1   |   |   |   |   | T0250   |
|   |   |   |   | VKM 12206  | 1   |   |   |   |   |   |   |   |
|                            | 188 A4.000  | 10/03 → 10/07   | → IMot. 2533528   | VKPC 82250   |   |   |   |   | 1   |   |   |   |
|   | 188 A4.000  | 10/03 → 03/07   | <b>Mot. 2533529 I→</b>  | VKPC 82251   |   |   |   |   | 1   |   |   |   |
|                            | <b>B(Alt)</b> 188 A4.000  | 10/03 → 03/07   | <b>AC</b>   | VKMA 32040   | 1   |   | 1   |   |   |   |   |   |
|   |   |   |   | VKMV 5PK1145   |   |   | 1   |   |   |   |   |   |
|   |   |   |   | VKM 32023  | 1   |   |   |   |   |   |   |   |



























LANCIA



































| <b>LANCIA</b> <b>YPSILON 1.2 16V</b>        |                               |               |             |                    |   |   |   |  |   |  |  |  |  |  |  |  |  |  |   |       |  |
|---|-------------------------------|---------------|-------------|--------------------|---|---|---|--|---|--|--|--|--|--|--|--|--|--|---|-------|--|
|   | 188 A5.000                    | 10/03 → 03/07 |             | —                  | 1 | 1 | 1 |  |   |  |  |  |  |  |  |  |  |  |   | T0160 |  |
|   |                               |               |             | VKMA 02204         | 1 | 1 |   |  |   |  |  |  |  |  |  |  |  |  |   |       |  |
|   |                               |               |             | VKM 12201          | 1 |   |   |  |   |  |  |  |  |  |  |  |  |  |   |       |  |
|   | 188 A5.000                    | 10/03 → 03/07 |             | VKPC 82251         |   |   |   |  | 1 |  |  |  |  |  |  |  |  |  |   |       |  |
|   | B(Alt) 188 A5.000             | 10/03 → 03/07 | AC          | VKMA 32040         | 1 | 1 |   |  |   |  |  |  |  |  |  |  |  |  |   |       |  |
|   |                               |               |             | VKMV 5PK1145       |   | 1 |   |  |   |  |  |  |  |  |  |  |  |  |   |       |  |
|   |                               |               |             | VKM 32023          | 1 |   |   |  |   |  |  |  |  |  |  |  |  |  |   |       |  |
| <b>LANCIA</b> <b>YPSILON 1.4 16V</b>        |                               |               |             |                    |   |   |   |  |   |  |  |  |  |  |  |  |  |  |   |       |  |
|   | 843 A1.000                    | 10/03 → 03/07 |             | —                  | 1 | 1 | 1 |  |   |  |  |  |  |  |  |  |  |  |   | T0160 |  |
|   |                               |               |             | VKMA 02204         | 1 | 1 |   |  |   |  |  |  |  |  |  |  |  |  |   |       |  |
|   |                               |               |             | VKM 12201          | 1 |   |   |  |   |  |  |  |  |  |  |  |  |  |   |       |  |
|   | 843 A1.000                    | 10/03 → 03/07 |             | VKPC 82251         |   |   |   |  | 1 |  |  |  |  |  |  |  |  |  |   |       |  |
|   | B(Alt) 843 A1.000             | 10/03 → 03/07 | AC          | VKMA 32040         | 1 | 1 |   |  |   |  |  |  |  |  |  |  |  |  |   |       |  |
|   |                               |               |             | VKMV 5PK1145       |   | 1 |   |  |   |  |  |  |  |  |  |  |  |  |   |       |  |
|   |                               |               |             | VKM 32023          | 1 |   |   |  |   |  |  |  |  |  |  |  |  |  |   |       |  |
| <b>LANCIA</b> <b>YPSILON 1.3 D Multijet</b> |                               |               |             |                    |   |   |   |  |   |  |  |  |  |  |  |  |  |  |   |       |  |
|   | 199 A2.000, 199 A3.000        | 09/06 → 10/07 |             | <del>OKOKOKO</del> |   |   |   |  |   |  |  |  |  |  |  |  |  |  |   |       |  |
|   | B(Alt) 199 A2.000, 199 A3.000 | 09/06 → 10/07 | AC          | VKMV 6PK1180       |   | 1 |   |  |   |  |  |  |  |  |  |  |  |  |   |       |  |
|   |                               |               |             | VKM 32080          | 1 |   |   |  |   |  |  |  |  |  |  |  |  |  |   |       |  |
|   | B(Alt) 199 A2.000, 199 A3.000 | 09/06 → 10/07 | AC          | VKMV 6PK1310       |   | 1 |   |  |   |  |  |  |  |  |  |  |  |  |   |       |  |
|   |                               |               |             | VKM 32080          | 1 |   |   |  |   |  |  |  |  |  |  |  |  |  |   |       |  |
| <b>LANCIA</b> <b>YPSILON 1.3 JTD</b>        |                               |               |             |                    |   |   |   |  |   |  |  |  |  |  |  |  |  |  |   |       |  |
|   | 188 A9.000                    | 10/03 → 12/05 |             | <del>OKOKOKO</del> |   |   |   |  |   |  |  |  |  |  |  |  |  |  |   |       |  |
|   | 188 A9.000                    | 10/03 → 06/05 |             | VKPC 85700         |   |   |   |  | 1 |  |  |  |  |  |  |  |  |  |   |       |  |
|   | B(Alt) 188 A9.000             | 10/03 → 12/05 | AC          | VKMV 6PK1180       |   | 1 |   |  |   |  |  |  |  |  |  |  |  |  |   |       |  |
|   |                               |               |             | VKM 32080          | 1 |   |   |  |   |  |  |  |  |  |  |  |  |  |   |       |  |
|   | B(Alt) 188 A9.000             | 10/03 → 12/05 | AC          | VKMV 6PK1310       |   | 1 |   |  |   |  |  |  |  |  |  |  |  |  |   |       |  |
|   |                               |               |             | VKM 32080          | 1 |   |   |  |   |  |  |  |  |  |  |  |  |  |   |       |  |
| <b>LANCIA</b> <b>ZETA 2.0 16V</b>           |                               |               |             |                    |   |   |   |  |   |  |  |  |  |  |  |  |  |  |   |       |  |
|   | RFN                           | 07/00 → 09/02 |             | VKMA 03235         | 1 | 1 | 1 |  |   |  |  |  |  |  |  |  |  |  |   | T0169 |  |
|   |                               |               |             | VKM 13234          | 1 |   |   |  |   |  |  |  |  |  |  |  |  |  |   |       |  |
|   |                               |               |             | VKM 23230          |   | 1 |   |  |   |  |  |  |  |  |  |  |  |  |   |       |  |
|   | RFV                           | 05/98 → 07/00 |             | VKMA 03213         | 1 | 1 | 1 |  |   |  |  |  |  |  |  |  |  |  |   | T0142 |  |
|   |                               |               |             | VKM 13202          | 1 |   |   |  |   |  |  |  |  |  |  |  |  |  |   |       |  |
|   |                               |               |             | VKM 23213          |   | 1 |   |  |   |  |  |  |  |  |  |  |  |  | 1 |       |  |
|   | RFN                           | 07/00 → 09/02 | 16)         | VKPC 83650         |   |   |   |  | 1 |  |  |  |  |  |  |  |  |  |   |       |  |
|   | RFV                           | 05/98 → 07/00 |             | VKPC 83636         |   |   |   |  | 1 |  |  |  |  |  |  |  |  |  |   |       |  |
|   | B(Alt) RFN                    | 07/00 → 09/02 | AC          | VKMA 33055         | 1 | 1 | 1 |  |   |  |  |  |  |  |  |  |  |  |   |       |  |
|   |                               |               |             | VKMV 6PK1188       |   |   | 1 |  |   |  |  |  |  |  |  |  |  |  |   |       |  |
|   |                               |               |             | VKM 33019          | 1 |   |   |  |   |  |  |  |  |  |  |  |  |  |   |       |  |
|   |                               |               |             | VKM 33020          |   | 1 |   |  |   |  |  |  |  |  |  |  |  |  |   |       |  |
|   | B(Alt) RFN                    | 07/00 → 09/02 | AC          | VKMA 33052         | 1 | 1 | 1 |  |   |  |  |  |  |  |  |  |  |  |   |       |  |
|   |                               |               |             | VKMV 6PK1706       |   |   | 1 |  |   |  |  |  |  |  |  |  |  |  |   |       |  |
|   |                               |               |             | VKM 33019          | 1 |   |   |  |   |  |  |  |  |  |  |  |  |  |   |       |  |
|   |                               |               |             | VKM 33020          |   | 1 |   |  |   |  |  |  |  |  |  |  |  |  |   |       |  |
|   | B(Alt) RFV                    | 05/98 → 07/00 | AC          | VKMV 6PK1160       |   |   | 1 |  |   |  |  |  |  |  |  |  |  |  |   |       |  |
|   |                               |               |             | VKM 33022          | 1 |   |   |  |   |  |  |  |  |  |  |  |  |  |   |       |  |
|   |                               |               |             | VKM 33025          |   | 1 |   |  |   |  |  |  |  |  |  |  |  |  |   |       |  |
|   | B(Alt) RFV                    | 05/98 → 07/00 | AC          | VKMA 33034         | 1 | 1 | 1 |  |   |  |  |  |  |  |  |  |  |  |   |       |  |
|   |                               |               |             | VKMV 6PK1603       |   |   | 1 |  |   |  |  |  |  |  |  |  |  |  |   |       |  |
|   |                               |               |             | VKM 33028          | 1 |   |   |  |   |  |  |  |  |  |  |  |  |  |   |       |  |
|   |                               |               |             | VKM 33035          |   | 1 |   |  |   |  |  |  |  |  |  |  |  |  |   |       |  |
| <b>LANCIA</b> <b>ZETA 2.0 Turbo</b>         |                               |               |             |                    |   |   |   |  |   |  |  |  |  |  |  |  |  |  |   |       |  |
|   | RGX                           | 05/95 → 09/02 |             | VKMA 03201         | 1 | 1 |   |  |   |  |  |  |  |  |  |  |  |  |   | T0018 |  |
|   |                               |               |             | VKM 13100          | 1 |   |   |  |   |  |  |  |  |  |  |  |  |  |   |       |  |
|   | RGX                           | 05/95 → 09/02 |             | VKPC 83420         |   |   |   |  | 1 |  |  |  |  |  |  |  |  |  |   |       |  |
|   | B(Alt) RGX                    | 05/95 → 01/97 | 70A, AC     | VKMV 6PK1067       |   |   | 1 |  |   |  |  |  |  |  |  |  |  |  |   |       |  |
|   |                               |               |             | VKM 33003          | 1 |   |   |  |   |  |  |  |  |  |  |  |  |  |   |       |  |
|   | B(Alt) RGX                    | 05/95 → 01/97 | 80, 90A, AC | VKMA 33003         | 1 | 1 |   |  |   |  |  |  |  |  |  |  |  |  |   |       |  |
|   |                               |               |             | VKMV 6PK1076       |   |   | 1 |  |   |  |  |  |  |  |  |  |  |  |   |       |  |
|   |                               |               |             | VKM 33003          | 1 |   |   |  |   |  |  |  |  |  |  |  |  |  |   |       |  |



















































| B(Alt)                            | RGX      | 02/97 → 09/02 | AC             | VKMV 6PK1160<br>VKM 33022<br>VKM 33025               | 1   |   | 1 |   |   |  |  |  |   |  |   |  |  |       |
|-----------------------------------|----------|---------------|----------------|--|---|---|---|---|---|--|--|--|---|--|---|--|--|-------|
| B(Alt)                            | RGX      | 05/95 → 01/97 | AC             | VKMA 33030<br>VKMV 6PK1660<br>VKM 33028<br>VKM 33034 | 1   | 1 | 1 |   |   |  |  |  |   |  |   |  |  |       |
| B(Alt)                            | RGX      | 02/97 → 09/02 | AC             | VKMA 33034<br>VKMV 6PK1603<br>VKM 33028<br>VKM 33035 | 1   | 1 | 1 |   |   |  |  |  |   |  |   |  |  |       |
| <b>LANCIA  ZETA 2.0 JTD</b>       |          |               |                |  |   |   |   |   |   |  |  |  |   |  |   |  |  |       |
|                                   | RHW      | 09/99 → 09/02 |                | VKMC 03248<br>VKMA 03248<br>VKM 13246<br>VKM 23246   | 1   | 1 | 1 |   | 1 |  |  |  |   |  | 1 |  |  | T0196 |
|                                   | RHZ      | 09/99 → 04/00 | → IVETno 8561  | VKMC 03246<br>VKMA 03246<br>VKM 13246<br>VKM 23246   | 1   | 1 | 1 |   | 1 |  |  |  |   |  | 1 |  |  | T0168 |
|                                   | RHZ      | 04/00 → 09/02 | VETno 8562 I → | VKMC 03247<br>VKMA 03247<br>VKM 13244<br>VKM 23246   | 1   | 1 | 1 |   | 1 |  |  |  |   |  | 1 |  |  | T0168 |
|                                   | RHW, RHZ | 09/99 → 09/02 |                | VKPC 83639   |   |   |   |   | 1 |  |  |  |   |  |   |  |  |       |
|                                   | B(Alt)   | RHW, RHZ      | 09/99 → 09/02  | AC   | VKMA 33044<br>VKMV 6PK1468<br>VKM 33024<br>VKM 33033<br>VKM 33069 | 2 | 1 | 1 |   |  |  |  |   |  |   |  |  |       |
|                                   | B(Alt)   | RHW, RHZ      | 09/99 → 09/02  | AC Delphi, AC  | VKMA 33037<br>VKMV 6PK1750<br>VKM 33013<br>VKM 33033              | 2 |   | 1 |   |  |  |  |   |  |   |  |  |       |
| <b>LANCIA  ZETA 2.1 TD</b>        |          |               |                |  |   |   |   |   |   |  |  |  |   |  |   |  |  |       |
|                                   | P 8 C    | 05/96 → 09/99 |                | VKMC 03251<br>VKMA 03251<br>VKM 13250<br>VKM 23213   | 1   | 1 | 1 |   | 1 |  |  |  |   |  | 1 |  |  | T0080 |
|                                   | P 8 C    | 05/96 → 09/99 | 3)             | VKMS 03251<br>VKMA 03251<br>VKM 13250<br>VKM 23213   | 1   | 1 | 1 |   |   |  |  |  | 2 |  | 1 |  |  | T0080 |
|                                   | P 8 C    | 05/96 → 09/99 |                | VKPC 83425   |   |   |   |   | 1 |  |  |  |   |  |   |  |  |       |
|                                   | B(Alt)   | P 8 C         | 05/96 → 09/99  | AC   | VKMA 33035<br>VKMV 6PK1102<br>VKM 33002                           | 1 |   | 1 |   |  |  |  |   |  |   |  |  |       |
|                                   | B(Alt)   | P 8 C         | 05/96 → 09/99  | AC   | VKMV 6PK1739<br>VKM 33013<br>VKM 33029                            | 1 |   | 1 |   |  |  |  |   |  |   |  |  |       |
| <b>LAND ROVER  90/110 3.5</b>     |          |               |                |  |   |   |   |   |   |  |  |  |   |  |   |  |  |       |
|                                   |          | 09/83 → 07/90 |                | —  |   |   |   |   | 1 |  |  |  |   |  |   |  |  |       |
| <b>LAND ROVER  90/110 2.5 TD</b>  |          |               |                |  |   |   |   |   |   |  |  |  |   |  |   |  |  |       |
|                                   | 19 J     | 09/86 → 07/90 |                | VKMA 07400<br>VKM 17400                              | 1   |   | 1 |   |   |  |  |  |   |  |   |  |  | T0088 |
| <b>LAND ROVER  DEFENDER I 2.5</b> |          |               |                |  |   |   |   |   |   |  |  |  |   |  |   |  |  |       |
|                                   | 17 H     | 09/90 → 12/94 |                | OXOXOXO  |   |   |   |   |   |  |  |  |   |  |   |  |  |       |
| <b>LAND ROVER  DEFENDER I 3.5</b> |          |               |                |  |   |   |   |   |   |  |  |  |   |  |   |  |  |       |
|                                   | 21 G     | 09/90 → 08/93 |                | OXOXOXO  |   |   |   |   |   |  |  |  |   |  |   |  |  |       |
|                                   | 21 G     | 09/90 → 08/93 |                | —  |   |   |   |   |   |  |  |  | 1 |  |   |  |  |       |
|                                   | 21 G     | 09/90 → 08/93 | AC             | —  |   |   |   |   |   |  |  |  | 1 |  |   |  |  |       |
|                                   | 21 G     | 09/90 → 08/93 | AC             | —  |   |   |   |   |   |  |  |  | 1 |  |   |  |  |       |
|                                   | B(PS)    | 21 G          | 09/90 → 08/93  | VKMV 13AVx925  |   |   |   |   | 1 |  |  |  |   |  |   |  |  |       |
|                                   | B(AC)    | 21 G          | 09/90 → 08/93  | VKMV 13AVx850  |   |   |   |   | 1 |  |  |  |   |  |   |  |  |       |



|   |  |  |  |  |  |  |  |  |  |  |  |  |  |
|---|---|---|---|--|---|---|---|---|---|---|---|---|---|
| B(WP)   | 21 G  | 09/90 → 08/93   | AC  | VKMV 13AVx1000   |   |   | 1   |   |   |   |   |   |   |
| <b>LAND ROVER  DEFENDER I 3.9</b>            |   |   |   |  |   |   |   |   |   |   |   |   |   |
|   | 31 G  | 11/98 → 09/07   |   | OXOXOXO  |   |   |   |   |   |   |   |   |   |
| <b>LAND ROVER  DEFENDER I 2.5 90,110 TDI</b> |   |   |   |  |   |   |   |   |   |   |   |   |   |
|   | 11 L  | 09/90 → 09/07   |   | VKMA____<br>VKM____<br>VKM 27404   | 1<br>1  | 1   |   |   |   |   |   |   | T0236   |
|   | 16 L  | 09/90 → 09/07   | → ICH VA560897  | VKMA____<br>VKM____<br>VKM____   | 1<br>1  | 1   | 1   |   |   |   |   |   | T0641   |
|   | 16 L  | 09/90 → 09/07   | CH VA560898 I→  | —<br>—<br>VKM 27404  | 1<br>1  | 1   | 1   |   |   |   |   |   | T0641   |
|   | 11 L  | 09/90 → 01/08   |   | —  |   |   |   |   | 1   |   |   |   |   |
|   | 16 L  | 09/90 → 09/07   |   | VKPC____   |   |   |   |   | 1   |   |   |   |   |
|   | B(Alt)  | 16 L  | 09/90 → 09/07   | → I Mot. 16L25164  | VKMV 7PK1595<br>VKM____   | 1   |   |   | 1   |   |   |   |   |
|   | B(Alt)  | 16 L  | 09/90 → 09/07   | Mot. 16L25165 I→   | VKMV 7PK1580<br>VKM____   | 1   |   |   | 1   |   |   |   |   |
|   | B(AC)   | 16 L  | 09/90 → 09/07   | VKMV____<br>VKM____  |   |   | 1   |   |   |   |   |   |   |
| <b>LAND ROVER  DEFENDER I 2.5 Td5</b>        |   |   |   |  |   |   |   |   |   |   |   |   |   |
|   | 10 P  | 06/98 → 09/07   |   | OXOXOXO  |   |   |   |   |   |   |   |   |   |
|   | 10 P  | 06/98 → 09/07   | → ICH 15P28777A   | —  |   |   |   |   | 1   |   |   |   |   |
|   | 10 P  | 06/98 → 09/07   | CH 15P27778A I→   | —  |   |   |   |   | 1   |   |   |   |   |
|   | B(Alt)  | 10 P  | 06/98 → 09/07   | AC   | VKMV 7PK1716  |   |   |   | 1   |   |   |   |   |
|   | B(Alt)  | 10 P  | 06/98 → 09/07   | AC   | VKMV 7PK1801  |   |   |   | 1   |   |   |   |   |
| <b>LAND ROVER  DISCOVERY I 2.0 16 V</b>    |   |   |   |  |   |   |   |   |   |   |   |   |   |
|   | 20 T4HG   | 09/93 → 06/94   |   | VKMA____<br>VKM____  | 1<br>1  | 1   |   |   |   |   |   |   | 2   |
|   | 20 T4HG   | 09/93 → 06/94   |   | VKPC 87813   |   |   |   |   | 1   |   |   |   |   |
|   | B(Alt)  | 20 T4HG   | 09/93 → 06/94   | AC   | VKM____   | 1   |   |   |   |   |   |   |   |
| <b>LAND ROVER  DISCOVERY I 3.5</b>         |   |   |   |  |   |   |   |   |   |   |   |   |   |
|   | 22 D, 27 G, 36 L, 38 L  | 09/89 → 06/94   |   | OXOXOXO  |   |   |   |   |   |   |   |   |   |
|   | 22 D, 27 G, 36 L, 38 L  | 09/89 → 06/94   |   | —  |   |   |   |   | 1   |   |   |   |   |
| <b>LAND ROVER  DISCOVERY I 3.9</b>         |   |   |   |  |   |   |   |   |   |   |   |   |   |
|   | 35 L, 37 L  | 09/93 → 06/94   |   | OXOXOXO  |   |   |   |   |   |   |   |   |   |
|   | 35 L, 37 L  | 09/93 → 06/94   | → I Mot. LA081990   | —  |   |   |   |   | 1   |   |   |   |   |
| <b>LAND ROVER  DISCOVERY I 2.5 TDI</b>     |   |   |   |  |   |   |   |   |   |   |   |   |   |
|   | 12 L  | 09/89 → 06/94   |   | VKMA____<br>VKM____<br>VKM 27404   | 1<br>1  | 1   | 1   |   |   |   |   |   | T0236   |
|   | 12 L  | 09/89 → 06/94   |   | VKPC 87835   |   |   |   |   | 1   |   |   |   |   |
|   | B(Alt)  | 12 L  | 09/89 → 06/94   |  | VKMV 10AVx613   |   |   |   | 1   |   |   |   |   |
| <b>LAND ROVER  DISCOVERY II 2.0 16 V</b>   |   |   |   |  |   |   |   |   |   |   |   |   |   |
|   | 20 T4HG   | 06/94 → 09/07   |   | VKMA____<br>VKM____  | 1<br>1  | 1   |   |   |   |   |   |   | 2   |
|   | 20 T4HG   | 06/94 → 09/07   |   | VKPC 87813   |   |   |   |   | 1   |   |   |   |   |
|   | B(Alt)  | 20 T4HG   | 06/94 → 09/07   | AC   | VKM____   | 1   |   |   |   |   |   |   |   |
| <b>LAND ROVER  DISCOVERY II 3.9</b>        |   |   |   |  |   |   |   |   |   |   |   |   |   |
|   | 35 L, 37 L  | 06/94 → 11/98   |   | OXOXOXO  |   |   |   |   |   |   |   |   |   |
|   | 35 L, 37 L  | 06/94 → 11/98   | Mot. MA081991 I→  |  | VKPC 87835  |   |   |   | 1   |   |   |   |   |
| <b>LAND ROVER  DISCOVERY II 4.0</b>        |   |   |   |  |   |   |   |   |   |   |   |   |   |
|   | 56 D  | 11/98 → 09/07   |   | OXOXOXO  |   |   |   |   |   |   |   |   |   |
|   | 56 D  | 11/98 → 09/07   |   |  | VKPC 87835  |   |   |   | 1   |   |   |   |   |
| <b>LAND ROVER  DISCOVERY II 2.5 Td5</b>    |   |   |   |  |   |   |   |   |   |   |   |   |   |
|   | 10 P  | 01/99 → 09/07   |   | OXOXOXO  |   |   |   |   |   |   |   |   |   |
|   | 10 P  | 01/99 → 09/07   | → ICH 15P28777A   | —  |   |   |   |   | 1   |   |   |   |   |
|   | 10 P  | 01/99 → 09/07   | CH 15P27778A I→   | —  |   |   |   |   | 1   |   |   |   |   |
|   | B(Alt)  | 10 P  | 01/99 → 09/07   | ESC, AC  | VKMV 7PK1716  |   |   |   | 1   |   |   |   |   |



|  |  |  |    |  |  |  |  |  |  |  |  |
|--|---|---|---|--|---|---|---|---|---|---|---|
|  | B(Alt) 10 P   | 01/99 → 09/07   | ESC, AC   | VKMV 7PK1820   |   |   | 1   |   |   |   |   |
|  | B(Alt) 10 P   | 01/99 → 09/07   | ESC, AC   | VKMV 7PK1801   |   |   | 1   |   |   |   |   |
|  | B(Alt) 10 P   | 01/99 → 09/07   | ESC, AC   | VKMV 7PK1867   |   |   | 1   |   |   |   |   |
| <b>LAND ROVER  DISCOVERY II 2.5 TDI</b>   |   |   |   |  |   |   |   |   |   |   |   |
|   | 19 L, 21 L  | 10/95 → 09/07   | → ICH VA560897  | VKMA _____<br>VKM _____<br>VKM _____   | 1<br>1<br>1   | 1<br>1  | 1   |   |   |   | T0641   |
|  | 19 L, 21 L  | 10/95 → 09/07   | CH VA560898 I→  | —<br>—<br>VKM 27404  | 1<br>1<br>1   | 1<br>1  | 1   |   |   |   | T0641   |
|   | 19 L, 21 L  | 10/95 → 09/07   |   | VKPC _____   |   |   |   | 1   |   |   |   |
|   | B(Alt) 19 L, 21 L   | 10/95 → 09/07   | → IMot. MA163103  | VKMV 7PK1595<br>VKM _____  | 1   |   | 1   |   |   |   |   |
|  | B(Alt) 19 L, 21 L   | 10/95 → 09/07   | Mot. TA163104,<br>TA501920 I→   | VKMV 7PK1580<br>VKM _____  | 1   |   | 1   |   |   |   |   |
|  | B(AC) 19 L, 21 L  | 10/95 → 09/07   |   | VKMV _____<br>VKM _____  |   | 1   | 1   |   |   |   |   |
| <b>LAND ROVER  DISCOVERY III 4.4</b>      |   |   |   |  |   |   |   |   |   |   |   |
|   | 53 A  | 10/04 → 10/06   |   | OXOXOXO  |   |   |   |   |   |   |   |
|   | 53 A  | 10/04 → 09/07 2)  |   | —  |   |   |   | 1   |   |   |   |
| <b>LAND ROVER  DISCOVERY III 2.7 TD</b>   |   |   |   |  |   |   |   |   |   |   |   |
|   | 27 6DT  | 10/04 → 09/07   |   | VKMA 03261<br>VKM _____<br>VKM 13262<br>VKM 23261<br>VKM 23261                     | 2<br>1<br>1<br>1<br>1   | 2<br>1  | 2   |   |   |   | T0249   |
|   | 27 6DT  | 10/04 → 09/07   |   | VKPC _____   |   |   |   | 1   |   |   |   |
| <b>LAND ROVER  FREELANDER I 1.8 16V</b> |   |   |   |  |   |   |   |   |   |   |   |
|   | 18 K4F  | 02/98 → 09/07   | M⊙  | VKMA _____<br>VKM 17310  | 1<br>1  |   | 1   |   |   |   | 2 T0640   |
|  | 18 K4F  | 02/98 → 09/07   | A⊙  | VKMA 07301<br>VKM 17301  | 1<br>1  |   | 1   |   |   |   | T0072   |
|   | 18 K4F  | 02/98 → 09/07   |   | VKPC 87401   |   |   |   | 1   |   |   |   |
|   | B(Alt) 18 K4F   | 02/98 → 09/07   |   | VKMV 5PK738  |   |   | 1   |   |   |   |   |
|  | B(PS) 18 K4F  | 02/98 → 09/07   |   | VKMV 3PK753<br>VKM 37010   | 1   |   | 1   |   |   |   |   |
|  | B(AC) 18 K4F  | 02/98 → 09/07   | M⊙, → ICH YA999999  | VKMV 5PK1190   |   |   | 1   |   |   |   |   |
|  | B(AC) 18 K4F  | 02/98 → 09/07   | M⊙, CH 1A000001 I→  | VKMV 5PK1200   |   |   | 1   |   |   |   |   |
|  | B(AC) 18 K4F  | 02/98 → 09/07   | A⊙, → ICH YA999999  | VKMV 5PK1190<br>VKM 37011  | 1   |   | 1   |   |   |   |   |
|  | B(AC) 18 K4F  | 02/98 → 09/07   | A⊙, CH 1A000001 I→  | VKMV 5PK1200<br>VKM 37011  | 1   |   | 1   |   |   |   |   |
| <b>LAND ROVER  FREELANDER I 2.5 V6</b>  |   |   |   |  |   |   |   |   |   |   |   |
|   | 25 K4F  | 11/00 → 09/07   |  | —<br>VKMA _____<br>VKM _____<br>VKM 27307  | 1<br>1<br>1   | 1<br>1  | 3<br>3  |   | 1   |   |   |
|   | 25 K4F  | 11/00 → 09/07   |   | VKPC 87410   |   |   |   | 1   |   |   |   |
| <b>LAND ROVER  FREELANDER I 2.0 DI</b>  |   |   |   |  |   |   |   |   |   |   |   |
|   | 20 TCIE   | 02/98 → 09/07   | Mot. 17N000187,<br>18N000244 I→   | VKMA 07304<br>VKM 17303<br>VKM 17304<br>VKM 27303                                  | 2<br>1<br>1<br>1  | 1<br>1  | 2   |   |   |   | 2 T0176   |
|   | 20 TCIE   | 02/98 → 09/07   |   | VKPC 87813   |   |   |   | 1   |   |   |   |
|   | B(Alt) 20 TCIE  | 02/98 → 09/07   | AC  | VKMV 6PK1183<br>VKM 37005  | 1   |   | 1   |   |   |   |   |
|  | B(Alt) 20 TCIE  | 02/98 → 09/07   | AC  | VKMV 6PK1460<br>VKM 37005  | 1   |   | 1   |   |   |   |   |
| <b>LAND ROVER  FREELANDER I 2.0 Td4</b> |   |   |   |  |   |   |   |   |   |   |   |
|   | M 47  | 11/00 → 09/07   |   | OXOXOXO  |   |   |   |   |   |   |   |

|   |  |  |  |  |  |  |  |  |  |  |  |  |
|---|---|---|---|--|---|---|---|---|---|---|---|---|
|   | M 47  | 11/00 → 09/07   |   | VKPC 87420   |   |   |   |   |   | 1   |   |   |
|   | B(Alt) M 47   | 11/00 → 09/07   |   | VKPV 5PK2030<br>VKM 38240  |   | 1   |   |   |   |   |   |   |
|   | B(AC) M 47  | 11/00 → 09/07   | → ICH 1A999999  | VKPV 5PK869  |   |   | 1   |   |   |   |   |   |
|   | B(AC) M 47  | 11/00 → 09/07   | CH 2A000001 I→  | VKPV 5PK882  |   |   | 1   |   |   |   |   |   |
| <b>LAND ROVER  FREELANDER II 3.2</b>       |   |   |   |  |   |   |   |   |   |   |   |   |
|   |   | 10/06 → 09/07   |   | OXOXOXO  |   |   |   |   |   |   |   |   |
|   |   | 10/06 → 09/07   |   | —  |   |   |   |   |   | 1   |   |   |
| <b>LAND ROVER  FREELANDER II 2.2 TD4</b>   |   |   |   |  |   |   |   |   |   |   |   |   |
|   |   | 10/06 → 09/07   |   | —  | 1   | 1   | 1   |   |   |   |   |   |
|   |   |   |   | —  | 1   |   |   |   |   |   |   |   |
|   |   |   |   | —  |   | 1   |   |   |   |   |   |   |
|   |   | 10/06 → 09/07   |   | VKPC ____  |   |   |   |   |   | 1   |   |   |
| <b>LAND ROVER  RANGE ROVER I 3.5</b>       |   |   |   |  |   |   |   |   |   |   |   |   |
|   | 11 D, 24 D, 25 D, 31 D  | 07/70 → 09/90   |   | OXOXOXO  |   |   |   |   |   |   |   |   |
| <b>LAND ROVER  RANGE ROVER I 3.9</b>       |   |   |   |  |   |   |   |   |   |   |   |   |
|   | 35 D, 36 D, 37 D, 38 D  | 11/88 → 07/94   |   | OXOXOXO  |   |   |   |   |   |   |   |   |
| <b>LAND ROVER  RANGE ROVER I 4.3</b>       |   |   |   |  |   |   |   |   |   |   |   |   |
|   | 40 D  | 09/92 → 07/94   |   | OXOXOXO  |   |   |   |   |   |   |   |   |
| <b>LAND ROVER  RANGE ROVER I 2.4 D</b>     |   |   |   |  |   |   |   |   |   |   |   |   |
|   | 11 A  | 04/86 → 12/90   |   | OXOXOXO  |   |   |   |   |   |   |   |   |
|   | 11 A  | 04/86 → 12/90   | 2)  | VKPC ____  |   |   |   |   |   | 1   |   |   |
| <b>LAND ROVER  RANGE ROVER I 2.5 TD</b>    |   |   |   |  |   |   |   |   |   |   |   |   |
|    | 21 L  | 10/89 → 04/94   | CH VA560898 I→  | —  | 1   | 1   | 1   |   |   |   |   | T0641   |
|   |   |   |   | VKM 27404  | 1   |   |   |   |   |   |   |   |
|   | 21 L  | 10/89 → 04/94   |   | VKPC ____  |   |   |   |   |   | 1   |   |   |
| <b>LAND ROVER  RANGE ROVER I 2.5 TDI</b> |   |   |   |  |   |   |   |   |   |   |   |   |
|   | 14 L  | 09/91 → 04/94   | → ICH VA560897  | VKMA ____<br>VKM ____<br>VKM ____  | 1<br>1<br>1   | 1   | 1   |   |   |   |   | T0641   |
|   |   |   |   | —  | 1   | 1   | 1   |   |   |   |   | T0641   |
|   |   |   |   | VKM 27404  | 1   |   |   |   |   |   |   |   |
|   | 14 L  | 09/91 → 04/94   |   | VKPC 87835   |   |   |   |   |   | 1   |   |   |
|   | B(Alt) 14 L   | 09/91 → 04/94   |   | VKPV 7PK1595<br>VKM ____   | 1   |   | 1   |   |   |   |   |   |
|   | B(AC) 14 L  | 09/91 → 04/94   |   | VKPV ____<br>VKM ____  |   |   | 1   |   |   |   |   |   |
| <b>LAND ROVER  RANGE ROVER II 3.9</b>    |   |   |   |  |   |   |   |   |   |   |   |   |
|   | 42 D  | 07/94 → 03/02   |   | OXOXOXO  |   |   |   |   |   |   |   |   |
|   | 42 D  | 07/94 → 03/02   |   | VKPC 87835   |   |   |   |   |   | 1   |   |   |
| <b>LAND ROVER  RANGE ROVER II 4.0</b>    |   |   |   |  |   |   |   |   |   |   |   |   |
|   | 44 D, 58 D, 60 D  | 06/98 → 03/02   |   | OXOXOXO  |   |   |   |   |   |   |   |   |
|   | 44 D, 58 D, 60 D  | 06/98 → 03/02   |   | VKPC 87835   |   |   |   |   |   | 1   |   |   |
| <b>LAND ROVER  RANGE ROVER II 4.6</b>    |   |   |   |  |   |   |   |   |   |   |   |   |
|   | 46 D  | 07/94 → 03/02   |   | OXOXOXO  |   |   |   |   |   |   |   |   |
|   | 46 D  | 07/94 → 03/02   |   | VKPC 87835   |   |   |   |   |   | 1   |   |   |
| <b>LAND ROVER  RANGE ROVER II 2.5 D</b>  |   |   |   |  |   |   |   |   |   |   |   |   |
|   | 25 6T (BMW)<br>65 A   | 07/94 → 03/02<br>08/94 → 03/02  | → ICH VA560897  | OXOXOXO<br>VKMA ____<br>VKM ____<br>VKM ____                                       | 1<br>1<br>1   | 1   | 1   |   |   |   |   | T0641   |
|   |   |   |   | —  | 1   | 1   | 1   |   |   |   |   | T0641   |
|   |   |   |   | VKM 27404  | 1   |   |   |   |   |   |   |   |
|   | 25 6T (BMW)<br>65 A   | 07/94 → 03/02<br>08/94 → 03/02  |   | VKPC 88826<br>VKPC 87835   |   |   |   |   |   | 1<br>1  |   |   |
|   | B(Alt) 25 6T (BMW)  | 07/94 → 03/02   |   | VKPV 10AVx613  |   |   | 1   |   |   |   |   |   |
|   | B(Alt) 65 A   | 08/94 → 03/02   |   | VKPV 7PK1595<br>VKM ____   | 1   |   | 1   |   |   |   |   |   |

| B(AC)                                       | 65 A              | 08/94 → 03/02    |           | VKMOV<br>VKM   |             | 1 | 1 |  |  |   |   |       |
|---|-------------------|------------------|-----------|--|-------------|---|---|--|--|---|---|-------|
| <b>LAND ROVER  RANGE ROVER III 4.2</b>      |                   |                  |           |  |             |   |   |  |  |   |   |       |
|   |                   | 05/05 → 09/07    |           | OKOKOKO  |             |   |   |  |  |   |   |       |
|   |                   | 05/05 → 09/07 2) |           | —  |             |   |   |  |  | 1 |   |       |
| <b>LAND ROVER  RANGE ROVER III 4.4</b>      |                   |                  |           |  |             |   |   |  |  |   |   |       |
|   | B 44, LMS8, M 62  | 03/02 → 09/07    |           | OKOKOKO  |             |   |   |  |  |   |   |       |
|   | B 44, M 62        | 03/02 → 09/07    |           | —  |             |   |   |  |  | 1 |   |       |
|   | LMS8              | 05/05 → 09/07 2) |           | —  |             |   |   |  |  | 1 |   |       |
| <b>LAND ROVER  RANGE ROVER III 3.0 TD 6</b> |                   |                  |           |  |             |   |   |  |  |   |   |       |
|   | D 30, M 57        | 03/02 → 09/07    |           | OKOKOKO  |             |   |   |  |  |   |   |       |
|   | D 30, M 57        | 03/02 → 09/07    |           | VKPC 88430   |             |   |   |  |  | 1 |   |       |
|   | B(Alt) D 30, M 57 | 03/02 → 09/07    | Auto. GBX | VKMOV 5PK2020<br>VKM 38240<br>VKM 38240                  |             | 1 | 1 |  |  |   |   |       |
| <b>LAND ROVER  RANGE ROVER SPORT 4.2</b>    |                   |                  |           |  |             |   |   |  |  |   |   |       |
|   |                   | 02/05 → 09/07    |           | OKOKOKO  |             |   |   |  |  |   |   |       |
|   |                   | 02/05 → 09/07 2) |           | —  |             |   |   |  |  | 1 |   |       |
| <b>LAND ROVER  RANGE ROVER SPORT 4.4</b>    |                   |                  |           |  |             |   |   |  |  |   |   |       |
|   | LMS8              | 02/05 → 09/07    |           | OKOKOKO  |             |   |   |  |  |   |   |       |
|   | LMS8              | 02/05 → 09/07 2) |           | —  |             |   |   |  |  | 1 |   |       |
| <b>LAND ROVER  RANGE ROVER SPORT 2.7 TD</b> |                   |                  |           |  |             |   |   |  |  |   |   |       |
|   | 27 6DTVM          | 02/05 → 09/07    |           | VKMA 03261<br>VKM<br>VKM 13262<br>VKM 23261<br>VKM 23261 | 2<br>1<br>1 | 2 | 2 |  |  |   |   | T0249 |
|   | 27 6DTVM          | 02/05 → 09/07    |           | VKPC   |             |   |   |  |  | 1 |   |       |
| <b>MAZDA  121 (DA) 1.1</b>                  |                   |                  |           |  |             |   |   |  |  |   |   |       |
|   | B1, B116          | 11/87 → 12/88 3) |           | VKMS 94101<br>VKMA 94101<br>VKM 74200                    | 1<br>1<br>1 | 1 | 1 |  |  |   | 2 | T0697 |
|   | B1, B116          | 04/89 → 10/90 3) |           | VKMS 94102<br>VKMA 94102<br>VKM 74200                    | 1<br>1<br>1 | 1 | 1 |  |  |   | 2 | T0697 |
|   | B1, B116          | 10/87 → 10/90    |           | VKPC 94002   |             |   |   |  |  | 1 |   |       |
| <b>MAZDA  121 (DA) 1.3</b>                  |                   |                  |           |  |             |   |   |  |  |   |   |       |
|   | B3                | 11/87 → 12/88 3) |           | VKMS 94101<br>VKMA 94101<br>VKM 74200                    | 1<br>1<br>1 | 1 | 1 |  |  |   | 2 | T0697 |
|   | B3                | 04/89 → 10/90 3) |           | VKMS 94102<br>VKMA 94102<br>VKM 74200                    | 1<br>1<br>1 | 1 | 1 |  |  |   | 2 | T0697 |
|   | B3                | 10/87 → 10/90    |           | VKPC 94002   |             |   |   |  |  | 1 |   |       |
| <b>MAZDA  121 (DB) 1.1</b>                  |                   |                  |           |  |             |   |   |  |  |   |   |       |
|   | B1                | 11/90 → 11/93 3) |           | VKMS 94102<br>VKMA 94102<br>VKM 74200                    | 1<br>1<br>1 | 1 | 1 |  |  |   | 2 | T0697 |
|   | B1                | 11/90 → 11/93    |           | VKPC 94002   |             |   |   |  |  | 1 |   |       |
| <b>MAZDA  121 (DB) 1.3</b>                  |                   |                  |           |  |             |   |   |  |  |   |   |       |
|   | B3                | 11/90 → 12/98 3) |           | VKMS 94102<br>VKMA 94102<br>VKM 74200                    | 1<br>1<br>1 | 1 | 1 |  |  |   | 2 | T0697 |
|   | B3                | 11/90 → 03/96    |           | VKPC 94002   |             |   |   |  |  | 1 |   |       |
| <b>MAZDA  121 (JASM, JBSM) 1.25</b>         |                   |                  |           |  |             |   |   |  |  |   |   |       |
|   | DHF, DHG          | 03/96 → 02/97 3) | GB        | —  | 1           | 1 | 1 |  |  |   |   |       |
|   | DHF, DHG          | 02/97 → 01/02 3) | GB        | —  | 1           | 1 | 1 |  |  |   |   |       |
|   | B(Alt) DHF, DHG   | 03/96 → 01/05    | AC, Ø     | VKMOV 6PK1181<br>VKM 34007<br>VKM 34034                  | 1           | 1 | 1 |  |  |   |   |       |
|   | B(Alt) DHF, DHG   | 03/96 → 01/05    | AC, Ø     | VKMOV 6PK1780<br>VKM 34007<br>VKM 34034                  | 1           | 1 | 1 |  |  |   |   |       |

















































LAND ROVER

|                                      | <b>B(Alt)</b> | DHF, DHG | 03/96 → 01/05 | AC, ⊕   | VKMV 6PK1750<br>VKM 34007<br>VKM 34034               | 1                |   | 1      |   |  |  |   |  |   |  |   |  |       |
|--------------------------------------|---------------|----------|---------------|---------|--|------------------|---|--------|---|--|--|---|--|---|--|---|--|-------|
|                                      | <b>B(Alt)</b> | DHF, DHG | 03/96 → 01/05 | AC, ⊕   | VKMV 6PK1930<br>VKM 34008<br>VKM 34034               | 1                |   | 1      |   |  |  |   |  |   |  |   |  |       |
| <b>MAZDA  121 (JASM, JBSM) 1.3</b>   |               |          |               |         |  |                  |   |        |   |  |  |   |  |   |  |   |  |       |
|                                      |               |          | 03/96 → 01/02 | (GB)    | OXOXOXO  |                  |   |        |   |  |  |   |  |   |  |   |  |       |
|                                      |               |          | 03/96 → 05/99 | 3), (J) | VKMS 94102<br>VKMA 94102<br>VKM 74200                | 1<br>1<br>1      |   | 1      |   |  |  |   |  | 2 |  |   |  | T0697 |
|                                      |               |          | 03/96 → 05/99 | (J)     | VKPC 94002   |                  |   |        |   |  |  | 1 |  |   |  |   |  |       |
|                                      |               |          | 03/96 → 01/02 | (GB)    | VKPC 84216   |                  |   |        |   |  |  | 1 |  |   |  |   |  |       |
|                                      | <b>B(Alt)</b> |          | 03/96 → 01/02 | AC, ⊕   | VKMV 6PK1936<br>VKM 34033<br>VKM 34034               | 1                |   | 1      |   |  |  |   |  |   |  |   |  |       |
| <b>MAZDA  121 (JASM, JBSM) 1.8 D</b> |               |          |               |         |  |                  |   |        |   |  |  |   |  |   |  |   |  |       |
|                                      |               | RTJ, RTK | 03/96 → 07/03 |         | VKPC 84620   |                  |   |        |   |  |  |   |  | 1 |  |   |  |       |
|                                      |               | RTJ, RTK | 01/99 → 01/02 |         | VKMV 5PK1144<br>VKM 34005                            | 1                |   | 1      |   |  |  |   |  |   |  |   |  |       |
| <b>MAZDA  2 1.25</b>                 |               |          |               |         |  |                  |   |        |   |  |  |   |  |   |  |   |  |       |
|                                      |               | FUJA     | 04/03 → 01/05 | 3)      | —<br>VKMA____<br>VKM____                             | 1<br>1<br>1      |   | 1<br>1 |   |  |  |   |  |   |  | 3 |  |       |
|                                      |               | FUJA     | 04/03 → 01/05 |         | VKPC____   |                  |   |        |   |  |  | 1 |  |   |  |   |  |       |
| <b>MAZDA  2 1.4</b>                  |               |          |               |         |  |                  |   |        |   |  |  |   |  |   |  |   |  |       |
|                                      |               | FXJA     | 04/03 → 01/05 | 3)      | —<br>VKMA____<br>VKM____                             | 1<br>1<br>1      |   | 1<br>1 |   |  |  |   |  |   |  | 3 |  |       |
|                                      |               | FXJA     | 04/03 → 01/05 |         | VKPC____   |                  |   |        |   |  |  | 1 |  |   |  |   |  |       |
| <b>MAZDA  2 1.6</b>                  |               |          |               |         |  |                  |   |        |   |  |  |   |  |   |  |   |  |       |
|                                      |               | FYDD     | 04/03 → 01/05 | 3)      | —<br>VKMA____<br>VKM____                             | 1<br>1<br>1      |   | 1<br>1 |   |  |  |   |  |   |  | 3 |  |       |
|                                      |               | FYDD     | 04/03 → 01/05 |         | VKPC____   |                  |   |        |   |  |  | 1 |  |   |  |   |  |       |
| <b>MAZDA  2 1.4 CD</b>               |               |          |               |         |  |                  |   |        |   |  |  |   |  |   |  |   |  |       |
|                                      |               | FYTN     | 04/03 → 01/05 |         | VKMA 03140<br>VKM 13140<br>VKM 23140                 | 1<br>1<br>1      | 1 | 1      | 1 |  |  |   |  |   |  |   |  | T0195 |
|                                      |               | FYTN     | 04/03 → 01/05 |         | —  |                  |   |        |   |  |  | 1 |  |   |  |   |  |       |
|                                      | <b>B(Alt)</b> | FYTN     | 04/03 → 01/05 | AC      | VKMA 33061<br>VKMV 6PK1705<br>VKM 33044<br>VKM 33061 | 1<br>1<br>1<br>1 | 1 | 1      | 1 |  |  |   |  |   |  |   |  | 1     |
| <b>MAZDA  3 1.4</b>                  |               |          |               |         |  |                  |   |        |   |  |  |   |  |   |  |   |  |       |
|                                      |               | HG       | 10/03 → 04/04 |         | OXOXOXO  |                  |   |        |   |  |  |   |  |   |  |   |  |       |
| <b>MAZDA  3 1.6</b>                  |               |          |               |         |  |                  |   |        |   |  |  |   |  |   |  |   |  |       |
|                                      |               | Z6       | 10/03 → 01/05 |         | OXOXOXO  |                  |   |        |   |  |  |   |  |   |  |   |  |       |
|                                      |               | Z6       | 10/03 → 01/05 |         | VKPC____   |                  |   |        |   |  |  | 1 |  |   |  |   |  |       |
| <b>MAZDA  3 2.0</b>                  |               |          |               |         |  |                  |   |        |   |  |  |   |  |   |  |   |  |       |
|                                      |               | LF       | 10/03 → 01/05 |         | OXOXOXO  |                  |   |        |   |  |  |   |  |   |  |   |  |       |
|                                      |               | LF       | 10/03 → 04/04 |         | —  |                  |   |        |   |  |  | 1 |  |   |  |   |  |       |
| <b>MAZDA  3 1.6 DI Turbo</b>         |               |          |               |         |  |                  |   |        |   |  |  |   |  |   |  |   |  |       |
|                                      |               | RFA9     | 06/04 → 01/08 |         | VKMA 03259<br>VKM 13140<br>VKM 23140                 | 1<br>1<br>1      | 1 | 1      | 1 |  |  |   |  |   |  |   |  | T0195 |
|                                      |               | Y601     | 06/04 → 01/05 |         | VKPC 83259   |                  |   |        |   |  |  | 1 |  |   |  |   |  |       |
|                                      | <b>B(Alt)</b> | Y601     | 06/04 → 01/05 | AC      | VKMA 33058<br>VKMV 6PK802<br>VKM 33043<br>VKM 33044  | 1<br>1<br>1<br>1 | 1 | 1      | 1 |  |  |   |  |   |  |   |  | 1     |

|                              | B(Alt)       | Y601 | 06/04 → 01/05 | AC                 | VKMA 33043<br>VKMV 6PK976<br>VKM 33043                          | 1                     |   | 1 |   |  |  |  |  |  |  |  |  |  |  |   |   |  |       |       |       |
|------------------------------|--------------|------|---------------|--------------------|---|-----------------------|---|---|---|--|--|--|--|--|--|--|--|--|--|---|---|--|-------|-------|-------|
| <b>MAZDA  323 (BA) 1.3</b>   |              |      |               |                    |   |                       |   |   |   |  |  |  |  |  |  |  |  |  |  |   |   |  |       |       |       |
|                              | B3           |      | 08/94 → 09/00 | 3)                 | VKMS 94102<br>VKMA 94102<br>VKM 74200                           | 1<br>1<br>1           |   | 1 |   |  |  |  |  |  |  |  |  |  |  | 2 |   |  | T0697 |       |       |
|                              | B(AC)        | B3   | 08/94 → 02/96 | <del>3)</del>      | VKM 64000   |                       |   | 1 |   |  |  |  |  |  |  |  |  |  |  |   |   |  |       |       |       |
|                              | B(AC)        | B3   | 02/96 → 10/96 | <del>3)</del>      | VKMA _____<br>VKM 64000   |                       |   | 1 | 1 |  |  |  |  |  |  |  |  |  |  |   |   |  |       |       |       |
|                              | B(AC)        | B3   | 10/96 → 09/00 | 24), <del>3)</del> | VKMA _____<br>VKM 64000   |                       |   | 1 | 1 |  |  |  |  |  |  |  |  |  |  |   |   |  |       |       |       |
| <b>MAZDA  323 (BA) 1.5</b>   |              |      |               |                    |   |                       |   |   |   |  |  |  |  |  |  |  |  |  |  |   |   |  |       |       |       |
|                              | Z5-DE        |      | 07/94 → 09/97 | 3), DOHC           | VKMS 94609<br>VKMA 94609<br>VKM 74201<br>VKM 84201<br>VKM 84604 | 1<br>1<br>1<br>1<br>1 | 2 | 1 |   |  |  |  |  |  |  |  |  |  |  | 3 | 1 |  |       | T0462 |       |
|                              | Z5-DE        |      | 10/97 → 09/00 | 3), DOHC           | VKMS 94610<br>VKMA 94610<br>VKM 74201<br>VKM 84201              | 1<br>1<br>1<br>1      | 1 | 1 | 1 |  |  |  |  |  |  |  |  |  |  |   | 3 |  |       |       | T0683 |
| <b>MAZDA  323 (BA) 1.6</b>   |              |      |               |                    |   |                       |   |   |   |  |  |  |  |  |  |  |  |  |  |   |   |  |       |       |       |
|                              | B6           |      | 02/97 → 06/98 | 3), DOHC           | VKMS 94201<br>VKMA 94201<br>VKM 74201<br>VKM 84201              | 1<br>1<br>1<br>1      | 1 | 1 | 1 |  |  |  |  |  |  |  |  |  |  |   | 4 |  |       |       | T0683 |
|                              | B6           |      | 05/94 → 09/00 | DOHC               | VKMA 94201<br>VKM 74201<br>VKM 84201                            | 1<br>1<br>1           | 1 | 1 | 1 |  |  |  |  |  |  |  |  |  |  |   |   |  |       |       | T0683 |
| <b>MAZDA  323 (BA) 1.8</b>   |              |      |               |                    |   |                       |   |   |   |  |  |  |  |  |  |  |  |  |  |   |   |  |       |       |       |
|                              | BP           |      | 11/89 → 09/00 | 3), DOHC           | VKMS 94201<br>VKMA 94201<br>VKM 74201<br>VKM 84201              | 1<br>1<br>1<br>1      | 1 | 1 | 1 |  |  |  |  |  |  |  |  |  |  |   | 4 |  |       |       | T0683 |
| <b>MAZDA  323 (BA) 2.0</b>   |              |      |               |                    |   |                       |   |   |   |  |  |  |  |  |  |  |  |  |  |   |   |  |       |       |       |
|                              | KF           |      | 08/94 → 09/98 | 3), DOHC           | VKMS 94000<br>VKMA 94000<br>VKM 74000<br>VKM 84001<br>VKM 84002 | 1<br>1<br>1<br>1<br>1 | 2 | 1 |   |  |  |  |  |  |  |  |  |  |  |   | 3 |  |       |       | T0425 |
| <b>MAZDA  323 (BA) 2.0 D</b> |              |      |               |                    |   |                       |   |   |   |  |  |  |  |  |  |  |  |  |  |   |   |  |       |       |       |
|                              | RF, RF1G     |      | 03/97 → 09/00 | 3)                 | VKMS 94611<br>VKMA 94611<br>VKM 74601<br>VKM 84602<br>VKM 84602 | 1<br>1<br>1<br>1<br>1 | 2 | 1 |   |  |  |  |  |  |  |  |  |  |  |   | 2 |  |       |       | T0464 |
| <b>MAZDA  323 (BD) 1.3</b>   |              |      |               |                    |   |                       |   |   |   |  |  |  |  |  |  |  |  |  |  |   |   |  |       |       |       |
|                              | E3           |      | 11/80 → 10/89 |                    | VKPC 94202  |                       |   |   |   |  |  |  |  |  |  |  |  |  |  |   | 1 |  |       |       |       |
| <b>MAZDA  323 (BD) 1.5</b>   |              |      |               |                    |   |                       |   |   |   |  |  |  |  |  |  |  |  |  |  |   |   |  |       |       |       |
|                              | E5           |      | 11/80 → 09/86 |                    | VKPC 94202  |                       |   |   |   |  |  |  |  |  |  |  |  |  |  |   | 1 |  |       |       |       |
| <b>MAZDA  323 (BF) 1.3</b>   |              |      |               |                    |   |                       |   |   |   |  |  |  |  |  |  |  |  |  |  |   |   |  |       |       |       |
|                              | E3           |      | 04/87 → 05/89 | 3), SOHC           | VKMS 94101<br>VKMA 94101<br>VKM 74200                           | 1<br>1<br>1           |   | 1 |   |  |  |  |  |  |  |  |  |  |  |   | 2 |  |       |       | T0697 |
|                              | E3           |      | 08/85 → 08/89 |                    | VKPC 94202  |                       |   |   |   |  |  |  |  |  |  |  |  |  |  |   | 1 |  |       |       |       |
| <b>MAZDA  323 (BF) 1.5</b>   |              |      |               |                    |   |                       |   |   |   |  |  |  |  |  |  |  |  |  |  |   |   |  |       |       |       |
|                              | B5, E5, E5E3 |      | 04/87 → 10/89 | 3), SOHC           | VKMS 94101<br>VKMA 94101<br>VKM 74200                           | 1<br>1<br>1           |   | 1 |   |  |  |  |  |  |  |  |  |  |  |   | 2 |  |       |       | T0697 |
|                              | B5, E5       |      | 08/85 → 10/89 |                    | VKPC 94202  |                       |   |   |   |  |  |  |  |  |  |  |  |  |  |   | 1 |  |       |       |       |































































|   |  |  |         |  |  |  |  |  |  |  |
|---|---|---|--|--|---|---|---|---|---|---|
| <b>MAZDA  323 (BF) 1.6</b>         |   |   |  |  |   |   |   |   |   |   |
|                                     | B6, B68   | 04/87 → 08/89   | 3), SOHC   | VKMS 94101   | 1   | 1   |   |   | 2   |   |
|   |   |   |  | VKMA 94101   | 1   | 1   |   |   |   | T0697   |
|   |   |   |  | VKM 74200  | 1   |   |   |   |   |   |
|   | B6  | 08/85 → 12/86   |  | VKMA 94100   | 1   | 1   |   |   |   |   |
|   |   |   |  | VKM 74200  | 1   |   |   |   |   |   |
| <b>MAZDA  323 (BF) 1.6 Turbo</b>   |   |   |  |  |   |   |   |   |   |   |
|                                     | B6  | 04/87 → 11/91   | 3), SOHC   | VKMS 94101   | 1   | 1   |   |   | 2   |   |
|   |   |   |  | VKMA 94101   | 1   | 1   |   |   |   | T0697   |
|   |   |   |  | VKM 74200  | 1   |   |   |   |   |   |
| <b>MAZDA  323 (BF) 1.7 D</b>       |   |   |  |  |   |   |   |   |   |   |
|                                     | PN27, PN46  | 04/86 → 12/87   | 3), SOHC   | VKMS 94014   | 1   | 1   |   |   | 2   |   |
|   |   |   |  | VKMA 94014   | 1   | 1   |   |   |   | T0437   |
|   |   |   |  | VKM 74008  | 1   |   |   |   |   |   |
| <b>MAZDA  323 (BG) 1.3</b>         |   |   |  |  |   |   |   |   |   |   |
|                                     | B3, B383, B3E   | 09/89 → 12/95   | 3)   | VKMS 94102   | 1   | 1   |   |   | 2   |   |
|   |   |   |  | VKMA 94102   | 1   | 1   |   |   |   | T0697   |
|   |   |   |  | VKM 74200  | 1   |   |   |   |   |   |
|                                     | B3  | 09/89 → 07/94   |  | VKPC 94002   |   |   |   | 1   |   |   |
|                                     | B(AC) B3, B383, B3E   | 03/91 → 07/94   | 25),    | VKMOV____  |   | 1   |   |   |   |   |
|   |   |   |  | VKM 64000  |   | 1   |   |   |   |   |
|   | B(AC) B3, B383, B3E   | 03/91 → 07/94   | 26),    | VKM 64000  |   | 1   |   |   |   |   |
|   | B(AC) B3E   | 03/91 → 07/94   |         | VKM 64000  |   | 1   |   |   |   |   |
| <b>MAZDA  323 (BG) 1.6</b>         |   |   |  |  |   |   |   |   |   |   |
|                                    | B6, B6E   | 08/89 → 12/95   | 3), SOHC   | VKMS 94102   | 1   | 1   |   |   | 2   |   |
|   |   |   |  | VKMA 94102   | 1   | 1   |   |   |   | T0697   |
|   |   |   |  | VKM 74200  | 1   |   |   |   |   |   |
|                                   | B6, B6E   | 08/89 → 10/94   |  | VKPC 94002   |   |   |   | 1   |   |   |
|                                   | B(AC) B6, B6E   | 03/91 → 10/94   | 25),  | VKMOV____  |   | 1   |   |   |   |   |
|   |   |   |  | VKM 64000  |   | 1   |   |   |   |   |
|   | B(AC) B6, B6E   | 03/91 → 10/94   | 26),  | VKM 64000  |   | 1   |   |   |   |   |
|   | B(AC) B6, B6E   | 03/91 → 10/94   | 25),  | VKM 64000  |   | 1   |   |   |   |   |
|   | B(AC) B6, B6E   | 03/91 → 10/94   | 26),  | VKM 64000  |   | 1   |   |   |   |   |
|   | B(AC) B6, B6E   | 03/91 → 10/94   |       | VKM 64000  |   | 1   |   |   |   |   |
| <b>MAZDA  323 (BG) 1.8</b>       |   |   |  |  |   |   |   |   |   |   |
|                                   | BP, BP52  | 08/89 → 07/94   | 3), SOHC   | VKMS 94102   | 1   | 1   |   |   | 2   |   |
|   |   |   |  | VKMA 94102   | 1   | 1   |   |   |   | T0697   |
|   |   |   |  | VKM 74200  | 1   |   |   |   |   |   |
|   | BP, BP52  | 06/89 → 07/94   | 3), DOHC   | VKMS 94201   | 1   | 1   | 1   |   | 4   |   |
|   |   |   |  | VKMA 94201   | 1   | 1   | 1   |   |   | T0683   |
|   |   |   |  | VKM 74201  | 1   |   |   |   |   |   |
|   |   |   |  | VKM 84201  |   | 1   |   |   |   |   |
|                                   | BP  | 08/89 → 07/94   | SOHC   | VKPC 94002   |   |   |   | 1   |   |   |
|   | BP  | 08/89 → 07/94   | DOHC   | VKPC 94434   |   |   |   | 1   |   |   |
|                                   | B(AC) BP, BP22, BP31, BP52  | 03/91 → 07/94   | 25),  | VKMOV____  |   | 1   |   |   |   |   |
|   |   |   |  | VKM 64000  |   | 1   |   |   |   |   |
|   | B(AC) BP, BP22, BP31, BP52  | 03/91 → 07/94   | 26),  | VKM 64000  |   | 1   |   |   |   |   |
|   | B(AC) BP, BP22, BP31, BP52  | 03/91 → 07/94   |       | VKM 64000  |   | 1   |   |   |   |   |
| <b>MAZDA  323 (BG) 1.8 Turbo</b> |   |   |  |  |   |   |   |   |   |   |
|                                   | BP  | 01/91 → 07/94   | 3), SOHC   | VKMS 94102   | 1   | 1   |   |   | 2   |   |
|   |   |   |  | VKMA 94102   | 1   | 1   |   |   |   | T0697   |
|   |   |   |  | VKM 74200  | 1   |   |   |   |   |   |
| <b>MAZDA  323 (BG) 1.7 D</b>     |   |   |  |  |   |   |   |   |   |   |
|                                   | PN, PN46, PN54, PN62  | 08/89 → 07/94   | 3), SOHC   | VKMS 94014   | 1   | 1   |   |   | 2   |   |
|   |   |   |  | VKMA 94014   | 1   | 1   |   |   |   | T0437   |
|   |   |   |  | VKM 74008  | 1   |   |   |   |   |   |
| <b>MAZDA  323 (BJ) 1.3</b>       |   |   |  |  |   |   |   |   |   |   |
|                                   | B3  | 09/98 → 05/04   | 3)   | VKMS 94102   | 1   | 1   |   |   | 2   |   |
|   |   |   |  | VKMA 94102   | 1   | 1   |   |   |   | T0697   |
|   |   |   |  | VKM 74200  | 1   |   |   |   |   |   |
|                                   | B3  | 09/98 → 05/04   |  | VKPC 94002   |   |   |   | 1   |   |   |

| <b>MAZDA  323 (BJ) 1.5</b>      |                |               |          |            |   |   |   |  |  |  |  |   |  |  |  |  |   |   |  |       |
|---------------------------------|----------------|---------------|----------|------------|---|---|---|--|--|--|--|---|--|--|--|--|---|---|--|-------|
|                                 | ZL             | 09/98 → 01/01 | 3), DOHC | VKMS 94610 | 1 | 1 | 1 |  |  |  |  |   |  |  |  |  | 3 |   |  | T0683 |
|                                 |                |               |          | VKMA 94610 | 1 | 1 | 1 |  |  |  |  |   |  |  |  |  |   |   |  |       |
|                                 |                |               |          | VKM 74201  | 1 |   |   |  |  |  |  |   |  |  |  |  |   |   |  |       |
|                                 |                |               |          | VKM 84201  |   | 1 |   |  |  |  |  |   |  |  |  |  |   |   |  |       |
|                                 | ZL             | 09/98 → 01/01 | DOHC     | VKPC 94617 |   |   |   |  |  |  |  | 1 |  |  |  |  |   |   |  |       |
| <b>MAZDA  323 (BJ) 1.6</b>      |                |               |          |            |   |   |   |  |  |  |  |   |  |  |  |  |   |   |  |       |
|                                 | ZM             | 05/98 → 05/04 | 3), DOHC | VKMS 94610 | 1 | 1 | 1 |  |  |  |  |   |  |  |  |  | 3 |   |  | T0683 |
|                                 |                |               |          | VKMA 94610 | 1 | 1 | 1 |  |  |  |  |   |  |  |  |  |   |   |  |       |
|                                 |                |               |          | VKM 74201  | 1 |   |   |  |  |  |  |   |  |  |  |  |   |   |  |       |
|                                 |                |               |          | VKM 84201  |   | 1 |   |  |  |  |  |   |  |  |  |  |   |   |  |       |
|                                 | ZM             | 05/98 → 05/04 | DOHC     | VKPC 94617 |   |   |   |  |  |  |  | 1 |  |  |  |  |   |   |  |       |
| <b>MAZDA  323 (BJ) 1.8</b>      |                |               |          |            |   |   |   |  |  |  |  |   |  |  |  |  |   |   |  |       |
|                                 | FP             | 05/98 → 08/01 | 3), DOHC | VKMS 94012 | 1 | 1 | 1 |  |  |  |  |   |  |  |  |  | 3 | 1 |  | T0683 |
|                                 |                |               |          | VKMA 94012 | 1 | 1 | 1 |  |  |  |  |   |  |  |  |  |   |   |  |       |
|                                 |                |               |          | VKM 74006  | 1 |   |   |  |  |  |  |   |  |  |  |  |   |   |  |       |
|                                 |                |               |          | VKM 84000  |   | 1 |   |  |  |  |  |   |  |  |  |  |   |   |  |       |
|                                 | FP             | 05/98 → 05/04 | DOHC     | VKPC_____  |   |   |   |  |  |  |  | 1 |  |  |  |  |   |   |  |       |
| <b>MAZDA  323 (BJ) 2.0</b>      |                |               |          |            |   |   |   |  |  |  |  |   |  |  |  |  |   |   |  |       |
|                                 | FS, FS7E, FS7G | 10/00 → 05/04 | 3), DOHC | VKMS 94010 | 1 | 1 | 1 |  |  |  |  |   |  |  |  |  | 3 | 1 |  | T0683 |
|                                 |                |               |          | VKMA 94010 | 1 | 1 | 1 |  |  |  |  |   |  |  |  |  |   |   |  |       |
|                                 |                |               |          | VKM 74002  | 1 |   |   |  |  |  |  |   |  |  |  |  |   |   |  |       |
|                                 |                |               |          | VKM 84000  |   | 1 |   |  |  |  |  |   |  |  |  |  |   |   |  |       |
|                                 | FS, FS7E, FS7G | 01/01 → 05/04 | DOHC     | VKPC_____  |   |   |   |  |  |  |  | 1 |  |  |  |  |   |   |  |       |
| <b>MAZDA  323 (BJ) 2.0 D</b>    |                |               |          |            |   |   |   |  |  |  |  |   |  |  |  |  |   |   |  |       |
|                                 | RF             | 09/98 → 11/00 | 3)       | VKMS 94611 | 1 | 2 | 1 |  |  |  |  |   |  |  |  |  | 2 |   |  | T0464 |
|                                 |                |               |          | VKMA 94611 | 1 | 2 | 1 |  |  |  |  |   |  |  |  |  |   |   |  |       |
|                                 |                |               |          | VKM 74601  | 1 |   |   |  |  |  |  |   |  |  |  |  |   |   |  |       |
|                                 |                |               |          | VKM 84602  |   | 1 |   |  |  |  |  |   |  |  |  |  |   |   |  |       |
|                                 |                |               |          | VKM 84602  |   | 1 |   |  |  |  |  |   |  |  |  |  |   |   |  |       |
|                                 | RF, RF1G       | 09/98 → 11/00 |          | —          |   |   |   |  |  |  |  | 1 |  |  |  |  |   |   |  |       |
| <b>MAZDA  323 (BJ) 2.0 DiTD</b> |                |               |          |            |   |   |   |  |  |  |  |   |  |  |  |  |   |   |  |       |
|                                 | RF4F           | 10/00 → 10/02 |          | VKMA 94612 | 1 | 1 | 1 |  |  |  |  |   |  |  |  |  |   |   |  | T0692 |
|                                 |                |               |          | VKM 74602  | 1 |   |   |  |  |  |  |   |  |  |  |  |   |   |  |       |
|                                 |                |               |          | VKM 84603  |   | 1 |   |  |  |  |  |   |  |  |  |  |   |   |  |       |
|                                 | RF4F           | 10/00 → 10/02 |          | VKPC_____  |   |   |   |  |  |  |  | 1 |  |  |  |  |   |   |  | 1     |
| <b>MAZDA  323 (BJ) 2.0 TD</b>   |                |               |          |            |   |   |   |  |  |  |  |   |  |  |  |  |   |   |  |       |
|                                 | RF             | 09/98 → 05/04 |          | VKMA 94612 | 1 | 1 | 1 |  |  |  |  |   |  |  |  |  |   |   |  | T0692 |
|                                 |                |               |          | VKM 74602  | 1 |   |   |  |  |  |  |   |  |  |  |  |   |   |  |       |
|                                 |                |               |          | VKM 84603  |   | 1 |   |  |  |  |  |   |  |  |  |  |   |   |  |       |
|                                 | RF             | 09/98 → 05/04 |          | VKPC_____  |   |   |   |  |  |  |  | 1 |  |  |  |  |   |   |  | 1     |
| <b>MAZDA  323 (BW) 1.5</b>      |                |               |          |            |   |   |   |  |  |  |  |   |  |  |  |  |   |   |  |       |
|                                 | B5             | 06/87 → 05/89 | 3)       | VKMS 94101 | 1 |   | 1 |  |  |  |  |   |  |  |  |  | 2 |   |  | T0697 |
|                                 |                |               |          | VKMA 94101 | 1 |   | 1 |  |  |  |  |   |  |  |  |  |   |   |  |       |
|                                 |                |               |          | VKM 74200  | 1 |   |   |  |  |  |  |   |  |  |  |  |   |   |  |       |
|                                 | B5             | 09/89 → 12/95 | 3)       | VKMS 94102 | 1 |   | 1 |  |  |  |  |   |  |  |  |  | 2 |   |  | T0697 |
|                                 |                |               |          | VKMA 94102 | 1 |   | 1 |  |  |  |  |   |  |  |  |  |   |   |  |       |
|                                 |                |               |          | VKM 74200  | 1 |   |   |  |  |  |  |   |  |  |  |  |   |   |  |       |
| <b>MAZDA  323 (BW) 1.6</b>      |                |               |          |            |   |   |   |  |  |  |  |   |  |  |  |  |   |   |  |       |
|                                 | B6, B65M, B6E  | 09/89 → 12/96 | 3)       | VKMS 94102 | 1 |   | 1 |  |  |  |  |   |  |  |  |  | 2 |   |  | T0697 |
|                                 |                |               |          | VKMA 94102 | 1 |   | 1 |  |  |  |  |   |  |  |  |  |   |   |  |       |
|                                 |                |               |          | VKM 74200  | 1 |   |   |  |  |  |  |   |  |  |  |  |   |   |  |       |
|                                 | B65M, B6E      | 01/87 → 08/89 | 3)       | VKMS 94101 | 1 |   | 1 |  |  |  |  |   |  |  |  |  | 2 |   |  | T0697 |
|                                 |                |               |          | VKMA 94101 | 1 |   | 1 |  |  |  |  |   |  |  |  |  |   |   |  |       |
|                                 |                |               |          | VKM 74200  | 1 |   |   |  |  |  |  |   |  |  |  |  |   |   |  |       |
|                                 | B65M, B6E      | 09/86 → 10/95 |          | VKPC 94002 |   |   |   |  |  |  |  | 1 |  |  |  |  |   |   |  |       |
| <b>MAZDA  323 (BW) 1.7 D</b>    |                |               |          |            |   |   |   |  |  |  |  |   |  |  |  |  |   |   |  |       |
|                                 | PN, PN26, PN54 | 11/86 → 06/95 | 3)       | VKMS 94014 | 1 |   | 1 |  |  |  |  |   |  |  |  |  | 2 |   |  | T0437 |
|                                 |                |               |          | VKMA 94014 | 1 |   | 1 |  |  |  |  |   |  |  |  |  |   |   |  |       |
|                                 |                |               |          | VKM 74008  | 1 |   |   |  |  |  |  |   |  |  |  |  |   |   |  |       |
| <b>MAZDA  6 (GG) 1.8</b>        |                |               |          |            |   |   |   |  |  |  |  |   |  |  |  |  |   |   |  |       |
|                                 | L813           | 08/02 → 04/04 |          | —          |   |   |   |  |  |  |  |   |  |  |  |  |   |   |  |       |
|                                 | L813           | 08/02 → 04/04 |          | —          |   |   |   |  |  |  |  | 1 |  |  |  |  |   |   |  |       |













































|   |  |  |  |  |  |  |  |  |  |  |  |  |
|---|---|---|---|--|---|---|---|---|---|---|---|---|
| <b>MAZDA  6 (GG) 2.0</b>     |   |   |   |  |   |   |   |   |   |   |   |   |
|                               | LF17, LF18  | 06/02 → 04/04   |   | OKOKOKO  |   |   |   |   |   |   |   |   |
|                               | LF17, LF18  | 06/02 → 04/04   |   | —  |   |   |   |   | 1   |   |   |   |
| <b>MAZDA  6 (GG) 2.3</b>     |   |   |   |  |   |   |   |   |   |   |   |   |
|                               | L3C1  | 06/02 → 04/04   |   | OKOKOKO  |   |   |   |   |   |   |   |   |
|                               | L3C1  | 06/02 → 04/04   |   | —  |   |   |   |   | 1   |   |   |   |
| <b>MAZDA  6 (GG) 2.0 DI</b>  |   |   |   |  |   |   |   |   |   |   |   |   |
|                               | RF  | 06/02 → 01/05 3)  |   | VKMS 94619<br>VKMA 94619<br>VKM 74607<br>VKM 84608                                 | 1<br>1<br>1   | 1<br>1<br>1   | 1<br>1<br>1   |   |   |   | 2   | T0692   |
|                               | RF  | 06/02 → 01/05   |   | VKPC_____  |   |   |   |   | 1   |   | 1   |   |
| <b>MAZDA  6 (GY) 1.8</b>     |   |   |   |  |   |   |   |   |   |   |   |   |
|                               | L813  | 08/02 → 12/06   |   | OKOKOKO  |   |   |   |   |   |   |   |   |
|                               | L813  | 03/05 → 12/06   |   | —  |   |   |   |   | 1   |   | 1   |   |
| <b>MAZDA  6 (GY) 2.0</b>     |   |   |   |  |   |   |   |   |   |   |   |   |
|                               | LF17, LF18  | 08/02 → 12/06   |   | OKOKOKO  |   |   |   |   |   |   |   |   |
|                               | LF17, LF18  | 03/05 → 12/06   |   | —  |   |   |   |   | 1   |   | 1   |   |
| <b>MAZDA  6 (GY) 2.3</b>     |   |   |   |  |   |   |   |   |   |   |   |   |
|                               | L3  | 08/02 → 12/06   |   | OKOKOKO  |   |   |   |   |   |   |   |   |
|                               | L3  | 03/05 → 12/06   |   | —  |   |   |   |   | 1   |   | 1   |   |
| <b>MAZDA  6 (GY) 2.0 DI</b>  |   |   |   |  |   |   |   |   |   |   |   |   |
|                               | RF5C  | 08/02 → 01/05 3)  |   | VKMS 94619<br>VKMA 94619<br>VKM 74607<br>VKM 84608                                 | 1<br>1<br>1   | 1<br>1<br>1   | 1<br>1<br>1   |   |   |   | 2   | T0692   |
|   | RF5C, RF7J  | 03/05 → 12/06   |   | —  | 1   | 1   |   |   |   |   |   |   |
|                               | RF5C, RF7J  | 03/05 → 12/06   |   | VKPC_____  |   |   |   |   | 1   |   | 1   |   |
| <b>MAZDA  626 (GC) 1.6</b>   |   |   |   |  |   |   |   |   |   |   |   |   |
|                              | F6  | 07/85 → 12/86   |   | —<br>VKM 74001   | 1<br>1  | 1   |   |   |   |   |   |   |
|                             | F6  | 11/82 → 09/86   |   | VKPC 94423   |   |   |   |   | 1   |   |   |   |
| <b>MAZDA  626 (GC) 2.0</b> |   |   |   |  |   |   |   |   |   |   |   |   |
|                             | FE  | 03/83 → 07/85 3), Mod. GC24,<br>CH 712584 I→                                      |   | VKMS 94007<br>VKMA 94007<br>VKM 74001  | 1<br>1<br>1   | 1<br>1  |   |   |   |   | 2   | T0681   |
|   | FE  | 03/83 → 07/85 3), Mod. GC31,<br>CH 730443 I→                                      |   | VKMS 94007<br>VKMA 94007<br>VKM 74001  | 1<br>1<br>1   | 1<br>1  |   |   |   |   | 2   | T0681   |
|   | FE  | 03/83 → 07/85 3), Mod. GC22,<br>CH 762175 I→                                      |   | VKMS 94007<br>VKMA 94007<br>VKM 74001  | 1<br>1<br>1   | 1<br>1  |   |   |   |   | 2   | T0681   |
|   | FE  | 01/86 → 09/87 3), Mod. GC24,<br>CH 800032 I→,<br>→ ICH 808274                     |   | VKMS 94007<br>VKMA 94007<br>VKM 74001  | 1<br>1<br>1   | 1<br>1  |   |   |   |   | 2   | T0681   |
|   | FE  | 01/86 → 09/87 3), Mod. GC31,<br>CH 800036 I→,<br>→ ICH 824841                     |   | VKMS 94007<br>VKMA 94007<br>VKM 74001  | 1<br>1<br>1   | 1<br>1  |   |   |   |   | 2   | T0681   |
|   | FE  | 01/86 → 09/87 3), Mod. GC22,<br>CH 800053 I→,<br>→ ICH 857842                     |   | VKMS 94007<br>VKMA 94007<br>VKM 74001  | 1<br>1<br>1   | 1<br>1  |   |   |   |   | 2   | T0681   |
|   | FE  | 11/86 → 09/87 3)  |   | VKMS 94007<br>VKMA 94007<br>VKM 74001  | 1<br>1<br>1   | 1<br>1  |   |   |   |   | 2   | T0681   |
|                             | FE  | 03/83 → 09/87   |   | VKPC 94423   |   |   |   |   | 1   |   |   |   |

|   |  |  |  |  |  |  |  |  |  |  |  |
|---|---|---|---|--|---|---|---|---|---|---|---|
| <b>MAZDA  626 (GC) 2.0 D</b>   |   |   |   |  |   |   |   |   |   |   |   |
|                                | RF46  | 12/83 → 12/86   | 27)   | VKMA 94300<br>VKM 74300  | 1<br>1  | 1   |   |   |   |   | T0447   |
|   | RF46  | 12/83 → 12/86   | Injec.  | —<br>VKM 72000   | 1<br>1  | 1   |   |   |   |   |   |
|                                | RF  | 01/83 → 09/86   |   | VKPC 94452   |   |   |   | 1   |   |   |   |
| <b>MAZDA  626 (GD) 1.6</b>     |   |   |   |  |   |   |   |   |   |   |   |
|                                |   | 08/89 → 10/91   |   | VKMA 94600<br>VKM 74600<br>VKM 84600   | 1<br>1  | 1<br>1  |   |   |   |   | T0664   |
|                                |   | 06/87 → 10/91   |   | VKPC 94424   |   |   |   | 1   |   |   |   |
| <b>MAZDA  626 (GD) 1.8</b>     |   |   |   |  |   |   |   |   |   |   |   |
|                                | F8  | 09/87 → 10/91   |   | VKMA 94600<br>VKM 74600<br>VKM 84600   | 1<br>1  | 1<br>1  |   |   |   |   | T0664   |
|                                | F8  | 11/87 → 10/91   |   | VKPC 94424   |   |   |   | 1   |   |   |   |
| <b>MAZDA  626 (GD) 2.0</b>     |   |   |   |  |   |   |   |   |   |   |   |
|                                | FE, FE Kat.   | 06/87 → 10/91   | 3), SOHC  | VKMS 94230<br>VKMA 94230<br>VKM 74600<br>VKM 84600                                 | 1<br>1<br>1   | 1<br>1<br>1   |   |   |   | 2   | T0664   |
|   | FE, FE Kat.   | 06/87 → 10/91   | 3), DOHC  | VKMS 94601<br>VKMA 94601<br>VKM 74600<br>VKM 84601                                 | 1<br>1<br>1   | 1<br>1<br>1   |   |   |   | 3   | T0679   |
|                               | FE, FE Kat.   | 09/87 → 10/90   | SOHC  | VKPC 94424   |   |   |   | 1   |   |   |   |
|   | FE, FE Kat.   | 09/87 → 10/90   | DOHC  | VKPC 94425   |   |   |   | 1   |   |   |   |
| <b>MAZDA  626 (GD) 2.2</b>   |   |   |   |  |   |   |   |   |   |   |   |
|                              | F2  | 11/87 → 10/91   | 3)  | VKMS 94222<br>VKMA 94222<br>VKM 74600<br>VKM 84600                                 | 1<br>1<br>1   | 1<br>1<br>1   |   |   |   | 2   | T0664   |
|                              | F2  | 11/87 → 04/92   |   | VKPC 94424   |   |   |   | 1   |   |   |   |
| <b>MAZDA  626 (GD) 2.0 D</b> |   |   |   |  |   |   |   |   |   |   |   |
|                              | RF-N  | 07/87 → 07/91   | 3)  | VKMS 94310<br>VKMA 94310<br>VKM 74310<br>VKM 84310                                 | 1<br>1<br>1   | 1<br>1<br>1   |   |   |   | 3   | T0449   |
|   |   |   |   |  |   | 1   |   |   |   |   |   |
| <b>MAZDA  626 (GE) 1.8</b>   |   |   |   |  |   |   |   |   |   |   |   |
|                              | FP  | 08/91 → 04/97   | 3)  | VKMS 94012<br>VKMA 94012<br>VKM 74006<br>VKM 84000                                 | 1<br>1<br>1   | 1<br>1<br>1   |   |   |   | 3<br>1  | T0683   |
|   |   |   |   |  |   | 1   |   |   |   |   |   |
| <b>MAZDA  626 (GE) 2.0</b>   |   |   |   |  |   |   |   |   |   |   |   |
|                              | FS  | 08/91 → 04/97   | 3), DOHC  | VKMS 94010<br>VKMA 94010<br>VKM 74002<br>VKM 84000                                 | 1<br>1<br>1   | 1<br>1<br>1   |   |   |   | 3<br>1  | T0683   |
|   | KF-ZE   | 06/94 → 12/96   | 3), DOHC  | VKMS 94000<br>VKMA 94000<br>VKM 74000<br>VKM 84001<br>VKM 84002                    | 1<br>1<br>1   | 2<br>2<br>1   |   |   |   | 3   | T0425   |
|   |   |   |   |  |   | 1   |   |   |   |   |   |
|   |   |   |   |  |   | 1   |   |   |   |   |   |
| <b>MAZDA  626 (GE) 2.5</b>   |   |   |   |  |   |   |   |   |   |   |   |
|                              | KL  | 01/92 → 04/97   | 3), DOHC  | VKMS 94000<br>VKMA 94000<br>VKM 74000<br>VKM 84001<br>VKM 84002                    | 1<br>1<br>1   | 2<br>2<br>1   |   |   |   | 3   | T0425   |
|   |   |   |   |  |   | 1   |   |   |   |   |   |
|                              | KL  | 01/92 → 04/94   |   | VKPC 94602   |   |   |   | 1   |   |   |   |
|   | KL  | 05/94 → 04/97   |   | VKPC 94603   |   |   |   | 1   |   |   |   |
| <b>MAZDA  626 (GE) 2.0 D</b> |   |   |   |  |   |   |   |   |   |   |   |
|                              | RF  | 10/92 → 04/97   | 3)  | VKMS 94310<br>VKMA 94310   | 1<br>1  | 1<br>1  |   |   |   | 3   | T0449   |



















































|  |   |  |  |  |  |  |  |  |  |  |  |  |       |
|--|--|---|---|--|---|---|---|---|---|---|---|---|-------|
|  |  |   |   | VKM 74310<br>VKM 84310   | 1   | 1   |   |   |   |   |   |   |       |
|    | <b>MAZDA</b>  <b>626 (GF) 1.8</b>                         | FP  | 05/97 → 04/02   | 3), DOHC   | VKMS 94012<br>VKMA 94012<br>VKM 74006<br>VKM 84000                                  | 1<br>1<br>1   | 1<br>1<br>1   |   |   |   | 3   | 1   | T0683 |
|    | <b>MAZDA</b>  <b>626 (GF) 2.0</b>                         | FS, FS2C  | 05/97 → 04/02   | 3), DOHC   | VKMS 94010<br>VKMA 94010<br>VKM 74002<br>VKM 84000                                  | 1<br>1<br>1   | 1<br>1<br>1   |   |   |   | 3   | 1   | T0683 |
|    | <b>MAZDA</b>  <b>626 (GF) 2.0 DITD, 2.0 TD, 2.0 TDI</b>   | RF3F  | 04/98 → 04/02   | 3)   | VKMS 94612<br>VKMA 94612<br>VKM 74602<br>VKM 84603                                  | 1<br>1<br>1   | 1<br>1<br>1   |   |   |   | 2   |   | T0692 |
|    | <b>MAZDA</b>  <b>626 (GV) 1.8</b>                         | F8  | 10/89 → 03/92   |  | VKMA 94600<br>VKM 74600<br>VKM 84600  | 1<br>1  | 1<br>1  |   |   |   |   |   | T0664 |
|    |  | F8  | 01/88 → 03/92   |  | VKPC 94424  |   |   |   | 1   |   |   |   |       |
|    | <b>MAZDA</b>  <b>626 (GV) 2.0</b>                         | FE, FE Kat.   | 10/89 → 09/97   | 3), SOHC   | VKMS 94230<br>VKMA 94230<br>VKM 74600<br>VKM 84600                                  | 1<br>1<br>1   | 1<br>1<br>1   |   |   |   | 2   |   | T0664 |
|  |  | FE, FE Kat.   | 10/89 → 09/97   | 3), DOHC   | VKMS 94601<br>VKMA 94601<br>VKM 74600<br>VKM 84601                                  | 1<br>1<br>1   | 1<br>1<br>1   |   |   |   | 3   |   | T0679 |
|  |  | FE  | 10/88 → 09/97   | SOHC   | VKPC 94424  |   |   |   | 1   |   |   |   |       |
|  |  | FE  | 10/88 → 09/97   | DOHC   | VKPC 94425  |   |   |   | 1   |   |   |   |       |
|  | <b>MAZDA</b>  <b>626 (GV) 2.2</b>                       | F2, F2L1  | 10/89 → 11/96   | 3)   | VKMS 94222<br>VKMA 94222<br>VKM 74600<br>VKM 84600                                  | 1<br>1<br>1   | 1<br>1<br>1   |   |   |   | 2   |   | T0664 |
|  |  | F2  | 03/89 → 11/96   |  | VKPC 94424  |   |   |   | 1   |   |   |   |       |
|  | <b>MAZDA</b>  <b>626 (GV) 2.0 D</b>                     | RF-CX, RF-N   | 10/89 → 09/97   | 3)   | VKMS 94310<br>VKMA 94310<br>VKM 74310<br>VKM 84310                                  | 1<br>1<br>1   | 1<br>1<br>1   |   |   |   | 3   |   | T0449 |
|  | <b>MAZDA</b>  <b>626 (GW) 1.8</b>                       | FP, FP9A  | 02/98 → 04/02   | 3), DOHC   | VKMS 94012<br>VKMA 94012<br>VKM 74006<br>VKM 84000                                  | 1<br>1<br>1   | 1<br>1<br>1   |   |   |   | 3   | 1   | T0683 |
|  | <b>MAZDA</b>  <b>626 (GW) 2.0</b>                       | FS, FS2C  | 02/98 → 04/02   | 3), DOHC   | VKMS 94010<br>VKMA 94010<br>VKM 74002<br>VKM 84000                                  | 1<br>1<br>1   | 1<br>1<br>1   |   |   |   | 3   | 1   | T0683 |
|  | <b>MAZDA</b>  <b>626 (GW) 2.0 DITD, 2.0 TD, 2.0 TDI</b> | RF, RF3F, RF4F  | 04/98 → 04/02   | 3)   | VKMS 94612<br>VKMA 94612<br>VKM 74602<br>VKM 84603                                  | 1<br>1<br>1   | 1<br>1<br>1   |   |   |   | 2   |   | T0692 |
|  | <b>MAZDA</b>  <b>929 (HB) 2.0</b>                       | FE  | 03/84 → 12/84   | CH 500001 I→,<br>→ ICH 520709  | VKMA 94504<br>VKM 74501   | 1<br>1  | 1   |   |   |   |   |   |       |
|  |  | FE  | 03/84 → 12/84   | CH 520710 I→   | VKMA 94501<br>VKM 74501   | 1<br>1  | 1   |   |   |   |   |   | T0681 |

|   |  |  |  |  |  |  |  |  |  |  |  |
|---|---|---|---|--|---|---|---|---|---|---|---|
|                                  | FE  | 03/85 → 09/86   |   | VKPC 94423   |   |   |   | 1   |   |   |   |
| <b>MAZDA  929 (HC) 2.0</b>       |   |   |   |  |   |   |   |   |   |   |   |
|                                  | FE, FEFA  | 03/87 → 12/89   | 3)  | VKMS 94230<br>VKMA 94230<br>VKM 74600<br>VKM 84600                                 | 1<br>1<br>1   | 1<br>1  | 1   |   |   | 2   | T0664   |
|                                  | FE, FEFA  | 06/87 → 12/88   |   | VKPC 94424   |   |   |   | 1   |   |   |   |
| <b>MAZDA  929 (HC) 2.2</b>       |   |   |   |  |   |   |   |   |   |   |   |
|                                  | F2, F21, F2-C, F2E,<br>F2-EGI   | 05/87 → 12/89   | 3)  | VKMS 94222<br>VKMA 94222<br>VKM 74600<br>VKM 84600                                 | 1<br>1<br>1   | 1<br>1  | 1   |   |   | 2   | T0664   |
|                                  | F2, F21, F2E, F2-EGI  | 05/87 → 01/89   |   | VKPC 94424   |   |   |   | 1   |   |   |   |
| <b>MAZDA  929 (HC) 3.0</b>       |   |   |   |  |   |   |   |   |   |   |   |
|                                  | JE, JE3   | 06/87 → 12/90   | SOHC  | VKMA 94017<br>VKM 74007<br>VKM 84007<br>VKM 84007                                  | 1<br>1  | 2<br>1  | 1   |   |   |   | T0440   |
|   | JE, JE3   | 07/89 → 12/90   | DOHC  | —<br>VKM 74005<br>—<br>—   | 1<br>1  | 2<br>1  | 1   |   |   |   |   |
| <b>MAZDA  929 (HD) 3.0</b>       |   |   |   |  |   |   |   |   |   |   |   |
|                                  | JE  | 05/91 → 12/93   |   | —<br>VKM 74005<br>—<br>—   | 1<br>1  | 2<br>1  | 1   |   |   |   |   |
| <b>MAZDA  929 (LV) 3.0</b>     |   |   |   |  |   |   |   |   |   |   |   |
|                                | JE  | 01/92 → 05/93   |   | VKMA 94017<br>VKM 74007<br>VKM 84007<br>VKM 84007                                  | 1<br>1  | 2<br>1  | 1   |   |   |   | T0440   |
| <b>MAZDA  929 (TA12) 2.5</b>   |   |   |   |  |   |   |   |   |   |   |   |
|                                | KL-Z5   | 09/00 → 12/02   | 3)  | VKMS 94000<br>VKMA 94000<br>VKM 74000<br>VKM 84001<br>VKM 84002                    | 1<br>1<br>1   | 2<br>2<br>1   | 1   |   |   | 3   | T0425   |
| <b>MAZDA  COSMO 2.0</b>        |   |   |   |  |   |   |   |   |   |   |   |
|                                | FE  | 09/83 → 05/90   |   | VKMA 94504<br>VKM 74501  | 1<br>1  |   | 1   |   |   |   |   |
| <b>MAZDA  DEMIO (DW) 1.3</b>   |   |   |   |  |   |   |   |   |   |   |   |
|                                | B3  | 08/98 → 12/02   | 3)  | VKMS 94102<br>VKMA 94102<br>VKM 74200  | 1<br>1<br>1   |   | 1<br>1  |   |   | 2   | T0697   |
|                                | B3  | 08/98 → 12/02   |   | VKPC 94002   |   |   |   | 1   |   |   |   |
| <b>MAZDA  DEMIO (DW) 1.5</b>   |   |   |   |  |   |   |   |   |   |   |   |
|                                | B5  | 04/00 → 12/02   | 3)  | VKMS 94102<br>VKMA 94102<br>VKM 74200  | 1<br>1<br>1   |   | 1<br>1  |   |   | 2   | T0697   |
|                                | B5  | 04/00 → 12/02   |   | VKPC 94002   |   |   |   | 1   |   |   |   |
| <b>MAZDA  EUNOS 500 1.6 V6</b> |   |   |   |  |   |   |   |   |   |   |   |
|                                | B6  | 12/91 → 02/99   |   | VKMA 94201<br>VKM 74201<br>VKM 84201   | 1<br>1  | 1   | 1   |   |   |   | T0683   |
| <b>MAZDA  EUNOS 500 2.0 V6</b> |   |   |   |  |   |   |   |   |   |   |   |
|                                | KF  | 12/91 → 02/99   |   | VKMA 94000<br>VKM 74000<br>VKM 84001<br>VKM 84002                                  | 1<br>1  | 2<br>1  | 1   |   |   |   | T0425   |
| <b>MAZDA  EUNOS 800 2.0</b>    |   |   |   |  |   |   |   |   |   |   |   |
|                                | KF  | 12/93 → 12/01   |   | VKMA 94000<br>VKM 74000  | 1<br>1  | 2   | 1   |   |   |   | T0425   |















































MAZDA

|  |    |  |  |  |  |  |  |  |  |  |  |
|--|---|---|---|--|---|---|---|---|---|---|---|
|  |   |   |   | VKM 84001<br>VKM 84002   | 1<br>1  |   |   |   |   |   |   |
| <b>MAZDA</b>   |    | <b>EUNOS ROADSTER (NA) 1.6</b>  |   |  |   |   |   |   |   |   |   |
|    | B6  | 09/89 → 12/90   |   | VKMA 94201<br>VKM 74201<br>VKM 84201   | 1<br>1<br>1   | 1<br>1  | 1   |   |   |   | T0683   |
| <b>MAZDA</b>   |    | <b>MIATA (NA) 1.6</b>   |   |  |   |   |   |   |   |   |   |
|    | B6  | 09/89 → 12/90   |   | VKMA 94201<br>VKM 74201<br>VKM 84201   | 1<br>1<br>1   | 1<br>1  | 1   |   |   |   | T0683   |
| <b>MAZDA</b>   |    | <b>MIATA (NB) 1.6</b>   |   |  |   |   |   |   |   |   |   |
|    | B6-ZE   | 08/00 → 09/02   | 3)  | VKMS 94201<br>VKMA 94201<br>VKM 74201<br>VKM 84201                                 | 1<br>1<br>1<br>1  | 1<br>1<br>1   | 1   |   | 4   |   | T0683   |
| <b>MAZDA</b>   |    | <b>MIATA (NB) 1.8</b>   |   |  |   |   |   |   |   |   |   |
|    | BP-ZE   | 08/00 → 09/02   | 3)  | VKMS 94201<br>VKMA 94201<br>VKM 74201<br>VKM 84201                                 | 1<br>1<br>1<br>1  | 1<br>1<br>1   | 1   |   | 4   |   | T0683   |
| <b>MAZDA</b>   |    | <b>MPV 3.0 V6</b>   |   |  |   |   |   |   |   |   |   |
|    | JE, JE94  | 11/89 → 09/99   |   | VKMA 94017<br>VKM 74007<br>VKM 84007<br>VKM 84007                                  | 1<br>1<br>1<br>1  | 2<br>1  | 1   |   |   |   | T0440   |
| <b>MAZDA</b>   |   | <b>MX-3 (EC) 1.6</b>  |   |  |   |   |   |   |   |   |   |
|  | B69, B6D  | 11/93 → 02/98   | 3)  | VKMS 94201<br>VKMA 94201<br>VKM 74201<br>VKM 84201                                 | 1<br>1<br>1<br>1  | 1<br>1<br>1   | 1   |   | 4   |   | T0683   |
|  | B69   | 07/91 → 12/93   |   | VKPC 94002   |   |   |   | 1   |   |   |   |
| <b>MAZDA</b>   |  | <b>MX-3 (EC) 1.8 V6</b>   |   |  |   |   |   |   |   |   |   |
|  | K819, K838  | 01/92 → 02/98   | 3)  | VKMS 94000<br>VKMA 94000<br>VKM 74000<br>VKM 84001<br>VKM 84002                    | 1<br>1<br>1<br>1<br>1   | 2<br>2<br>1   | 1   |   | 3   |   | T0425   |
|  | K819  | 01/92 → 07/93   |   | VKPC 94602   |   |   |   | 1   |   |   |   |
|  | K819, K838  | 08/93 → 02/98   |   | VKPC 94603   |   |   |   | 1   |   |   |   |
| <b>MAZDA</b>   |  | <b>MX-5 (NA) 1.6</b>  |   |  |   |   |   |   |   |   |   |
|  | B6  | 05/90 → 11/97   | 3), DOHC  | VKMS 94201<br>VKMA 94201<br>VKM 74201<br>VKM 84201                                 | 1<br>1<br>1<br>1  | 1<br>1<br>1   | 1   |   | 4   |   | T0683   |
|  | B64F  | 05/90 → 09/93   | DOHC  | VKPC 94434   |   |   |   | 1   |   |   |   |
| <b>MAZDA</b>   |  | <b>MX-5 (NA) 1.8</b>  |   |  |   |   |   |   |   |   |   |
|  | BP-ZE   | 02/94 → 11/97   | 3), DOHC  | VKMS 94201<br>VKMA 94201<br>VKM 74201<br>VKM 84201                                 | 1<br>1<br>1<br>1  | 1<br>1<br>1   | 1   |   | 4   |   | T0683   |
| <b>MAZDA</b>   |  | <b>MX-5 (NB) 1.6</b>  |   |  |   |   |   |   |   |   |   |
|  | B6  | 05/98 → 01/05   | 3), DOHC  | VKMS 94201<br>VKMA 94201<br>VKM 74201<br>VKM 84201                                 | 1<br>1<br>1<br>1  | 1<br>1<br>1   | 1   |   | 4   |   | T0683   |
|  | B6  | 12/94 → 07/03   | DOHC  | VKPC 94434   |   |   |   | 1   |   |   |   |
| <b>MAZDA</b>   |  | <b>MX-5 (NB) 1.8</b>  |   |  |   |   |   |   |   |   |   |
|  | BP-ZE   | 01/98 → 01/05   | 3), DOHC  | VKMS 94201<br>VKMA 94201<br>VKM 74201<br>VKM 84201                                 | 1<br>1<br>1<br>1  | 1<br>1<br>1   | 1   |   | 4   |   | T0683   |
| <b>MAZDA</b>   |  | <b>MX-6 (GD) 2.2</b>  |   |  |   |   |   |   |   |   |   |
|  | F2  | 01/90 → 10/91   | 3)  | VKMS 94222<br>VKMA 94222   | 1<br>1  | 1<br>1  | 1   |   | 2   |   | T0664   |



























|   |    |  |  |  |  |  |  |  |  |  |  |  |
|---|---|---|---|--|---|---|---|---|---|---|---|---|
|   |   |   |   | VKM 74600<br>VKM 84600   | 1   | 1   |   |   |   |   |   |   |
| <b>MAZDA</b>  |    | <b>MX-6 (GE) 2.0</b>  |   |  |   |   |   |   |   |   |   |   |
|    | FS  | 06/94 → 06/97   | 3)  | VKMS 94010<br>VKMA 94010<br>VKM 74002<br>VKM 84000                                 | 1<br>1<br>1   | 1<br>1  | 1   |   |   | 3   | 1   | T0683   |
| <b>MAZDA</b>  |    | <b>MX-6 (GE) 2.5</b>  |   |  |   |   |   |   |   |   |   |   |
|    | KL  | 06/94 → 06/97   | 3), DOHC  | VKMS 94000<br>VKMA 94000<br>VKM 74000<br>VKM 84001<br>VKM 84002                    | 1<br>1<br>1   | 2<br>2  | 1   |   |   | 3   |   | T0425   |
|    | KL  | 02/92 → 06/94   |   | VKPC 94602   |   |   |   |   | 1   |   |   |   |
|    | KL  | 06/94 → 05/97   |   | VKPC 94603   |   |   |   |   | 1   |   |   |   |
| <b>MAZDA</b>  |    | <b>PREMACY 1.8</b>  |   |  |   |   |   |   |   |   |   |   |
|    | FP  | 07/99 → 08/01   | DOHC  | VKMA 94012<br>VKM 74006<br>VKM 84000   | 1<br>1  | 1   | 1   |   |   |   | 1   | T0683   |
|    | FP  | 07/99 → 08/01   |   | VKPC _____   |   |   |   |   | 1   |   |   |   |
| <b>MAZDA</b>  |    | <b>PREMACY 2.0</b>  |   |  |   |   |   |   |   |   |   |   |
|    | FS7E, FS7G  | 11/01 → 01/05   |   | VKMA 94010<br>VKM 74002<br>VKM 84000   | 1<br>1  | 1   | 1   |   |   |   | 1   | T0683   |
|    | FS7E, FS7G  | 11/01 → 01/05   |   | VKPC _____   |   |   |   |   | 1   |   |   |   |
| <b>MAZDA</b>  |   | <b>PREMACY 2.0 TD</b>   |   |  |   |   |   |   |   |   |   |   |
|  | RF3F, RF4F  | 10/99 → 01/05   | 3)  | VKMS 94612<br>VKMA 94612<br>VKM 74602<br>VKM 84603                                 | 1<br>1<br>1   | 1<br>1  | 1   |   |   | 2   |   | T0692   |
|  | RF3F, RF4F  | 10/99 → 01/05   |   | VKPC _____   |   |   |   |   | 1   |   | 1   |   |
| <b>MAZDA</b>  |  | <b>PROT?G? 1.8</b>  |   |  |   |   |   |   |   |   |   |   |
|  | BP  | 01/92 → 12/94   |   | VKMA 94201<br>VKM 74201<br>VKM 84201   | 1<br>1  | 1   | 1   |   |   |   |   | T0683   |
| <b>MAZDA</b>  |  | <b>TRIBUTE 2.0, 2.0 4WD</b>   |   |  |   |   |   |   |   |   |   |   |
|  | YF  | 01/01 → 01/05   | 3)  | —<br>—   | 1<br>1  | 1<br>1  | 1<br>1  |   |   | 3   |   |   |
| <b>MAZDA</b>  |  | <b>TRIBUTE 2.3 4WD</b>  |   |  |   |   |   |   |   |   |   |   |
|  | L3H5  | 04/04 → 01/05   |   | OXOXOXO  |   |   |   |   |   |   |   |   |
|  | L3H5  | 04/04 → 01/05   |   | —  |   |   |   |   | 1   |   |   |   |
| <b>MAZDA</b>  |  | <b>TRIBUTE 3.0 V6 4WD</b>   |   |  |   |   |   |   |   |   |   |   |
|  | AJ03  | 03/00 → 01/05   |   | OXOXOXO  |   |   |   |   |   |   |   |   |
|  | AJ03  | 04/04 → 01/05   |   | —  |   |   |   |   | 1   |   |   |   |
| <b>MAZDA</b>  |  | <b>XEDOS 6 1.6</b>  |   |  |   |   |   |   |   |   |   |   |
|  | B6, B69   | 08/92 → 02/99   |   | VKMA 94201<br>VKM 74201<br>VKM 84201   | 1<br>1  | 1   | 1   |   |   |   |   | T0683   |
| <b>MAZDA</b>  |  | <b>XEDOS 6 2.0 V6</b>   |   |  |   |   |   |   |   |   |   |   |
|  | KF1   | 01/92 → 02/99   |   | VKMA 94000<br>VKM 74000<br>VKM 84001<br>VKM 84002                                  | 1<br>1  | 2   | 1   |   |   |   |   | T0425   |
|  | KF1   | 01/92 → 05/94   |   | VKPC 94602   |   |   |   |   | 1   |   |   |   |
|  | KF1   | 06/94 → 02/99   |   | VKPC 94603   |   |   |   |   | 1   |   |   |   |
| <b>MAZDA</b>  |  | <b>XEDOS 9 2.0</b>  |   |  |   |   |   |   |   |   |   |   |
|  | KF  | 08/93 → 01/00   |   | VKMA 94000<br>VKM 74000<br>VKM 84001<br>VKM 84002                                  | 1<br>1  | 2   | 1   |   |   |   |   | T0425   |
|  | KF  | 08/93 → 01/00   |   | VKPC 94603   |   |   |   |   | 1   |   |   |   |
| <b>MAZDA</b>  |  | <b>XEDOS 9 2.5</b>  |   |  |   |   |   |   |   |   |   |   |
|  | KL  | 07/93 → 07/00   |   | VKMA 94000<br>VKM 74000  | 1<br>1  | 2   | 1   |   |   |   |   | T0425   |



MAZDA









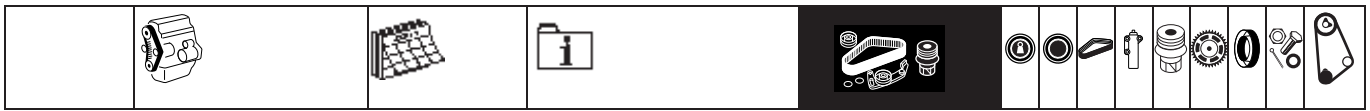





























|   |  |  |  |  |  |  |  |  |  |  |  |  |
|---|---|---|---|--|---|---|---|---|---|---|---|---|
|   |   |   |   | VKM 84001  | 1   |   |   |   |   |   |   |   |
|   |   |   |   | VKM 84002  | 1   |   |   |   |   |   |   |   |
|   | KL  | 07/93 → 07/00   |   | VKPC 94603   |   |   |   | 1   |   |   |   |   |
| <b>MAZDA  XEDOS 9 2.5 V6</b>           |   |   |   |  |   |   |   |   |   |   |   |   |
|   | KL  | 07/00 → 08/02   |   | VKMA 94000   | 1   | 2   | 1   |   |   |   |   | T0425   |
|   |   |   |   | VKM 74000  | 1   |   |   |   |   |   |   |   |
|   |   |   |   | VKM 84001  |   | 1   |   |   |   |   |   |   |
|   |   |   |   | VKM 84002  |   | 1   |   |   |   |   |   |   |
| <b>MAZDA  BONGO 1.8</b>                |   |   |   |  |   |   |   |   |   |   |   |   |
|   | F8  | 02/85 → 09/87   |   | VKPC 94423   |   |   |   | 1   |   |   |   |   |
|   | F8  | 10/87 → 08/95   |   | VKPC 94424   |   |   |   | 1   |   |   |   |   |
| <b>MAZDA  BONGO 2.0</b>                |   |   |   |  |   |   |   |   |   |   |   |   |
|   | FE  | 03/85 → 09/87   |   | VKPC 94423   |   |   |   | 1   |   |   |   |   |
|   | FE  | 10/87 → 08/95   |   | VKPC 94424   |   |   |   | 1   |   |   |   |   |
| <b>MAZDA  B-SERIE (UF) 1.6</b>         |   |   |   |  |   |   |   |   |   |   |   |   |
|   | F6  | 11/89 → 03/96   |   | VKPC 94423   |   |   |   | 1   |   |   |   |   |
| <b>MAZDA  B-SERIE (UF) 2.0</b>         |   |   |   |  |   |   |   |   |   |   |   |   |
|   | FE  | 01/85 → 12/87   | 3), CH 505518 I→  | VKMS 94007   | 1   |   | 1   |   |   |   | 2   | T0681   |
|   |   |   |   | VKMA 94007   | 1   |   | 1   |   |   |   |   |   |
|   |   |   |   | VKM 74001  | 1   |   |   |   |   |   |   |   |
|   | FE  | 11/89 → 02/95   | 3)  | VKMS 94007   | 1   |   | 1   |   |   |   | 2   | T0681   |
|   |   |   |   | VKMA 94007   | 1   |   | 1   |   |   |   |   |   |
|   |   |   |   | VKM 74001  | 1   |   |   |   |   |   |   |   |
|   | FE  | 11/89 → 03/96   |   | VKPC 94423   |   |   |   | 1   |   |   |   |   |
| <b>MAZDA  B-SERIE (UF) 2.2</b>         |   |   |   |  |   |   |   |   |   |   |   |   |
|                                        | F2, F2L8  | 01/89 → 02/99   | 3)  | VKMS 94222   | 1   | 1   | 1   |   |   |   | 2   | T0664   |
|   |   |   |   | VKMA 94222   | 1   | 1   | 1   |   |   |   |   |   |
|   |   |   |   | VKM 74600  | 1   |   |   |   |   |   |   |   |
|   |   |   |   | VKM 84600  |   | 1   |   |   |   |   |   |   |
|                                       | F2L8  | 08/91 → 12/96   |   | VKPC 94424   |   |   |   | 1   |   |   |   |   |
| <b>MAZDA  B-SERIE (UF) 2.2 D</b>     |   |   |   |  |   |   |   |   |   |   |   |   |
|                                       | R290  | 01/85 → 12/95   | 3)  | VKMS 94009   | 1   |   | 1   |   |   |   | 2   | T0432   |
|   |   |   |   | VKMA 94009   | 1   |   | 1   |   |   |   |   |   |
|   |   |   |   | VKM 74004  | 1   |   |   |   |   |   |   |   |
|                                       | R290  | 11/89 → 03/96   |   | VKPC 94425   |   |   |   | 1   |   |   |   |   |
| <b>MAZDA  B-SERIE (UF) 2.5 D</b>     |   |   |   |  |   |   |   |   |   |   |   |   |
|                                       | WL  | 02/96 → 06/99   | 3)  | VKMS 94614   | 1   |   | 1   |   |   |   | 2   | T0661   |
|   |   |   |   | VKMA 94614   | 1   |   | 1   |   |   |   |   |   |
|   |   |   |   | VKM 74606  | 1   |   |   |   |   |   |   |   |
| <b>MAZDA  B-SERIE (UN) 2.2</b>       |   |   |   |  |   |   |   |   |   |   |   |   |
|                                       | F2  | 02/99 → 12/02   | 3)  | VKMS 94222   | 1   | 1   | 1   |   |   |   | 2   | T0664   |
|   |   |   |   | VKMA 94222   | 1   | 1   | 1   |   |   |   |   |   |
|   |   |   |   | VKM 74600  | 1   |   |   |   |   |   |   |   |
|   |   |   |   | VKM 84600  |   | 1   |   |   |   |   |   |   |
| <b>MAZDA  B-SERIE (UN) 2.2 4WD</b>   |   |   |   |  |   |   |   |   |   |   |   |   |
|                                       | F2  | 06/99 → 04/05   |   | VKMA 94222   | 1   | 1   | 1   |   |   |   |   | T0664   |
|   |   |   |   | VKM 74600  | 1   |   |   |   |   |   |   |   |
|   |   |   |   | VKM 84600  |   | 1   |   |   |   |   |   |   |
|   | F5  | 02/99 → 10/99   |   | VKMA 94222   | 1   | 1   | 1   |   |   |   |   | T0664   |
|   |   |   |   | VKM 74600  | 1   |   |   |   |   |   |   |   |
|   |   |   |   | VKM 84600  |   | 1   |   |   |   |   |   |   |
| <b>MAZDA  B-SERIE (UN) 2.6 4WD</b>   |   |   |   |  |   |   |   |   |   |   |   |   |
|                                       | JK26  | 06/99 → 04/05   |   | <del>VKMS 94613</del>  |   |   |   |   |   |   |   |   |
|                                       | JK26  | 06/99 → 04/05   |   | VKPC 94613   |   |   |   | 1   |   |   |   |   |
| <b>MAZDA  B-SERIE (UN) 2.5 D</b>     |   |   |   |  |   |   |   |   |   |   |   |   |
|                                       | WL  | 06/99 → 11/03   | 3)  | VKMS 94616   | 1   |   | 1   |   |   |   | 2   | T0661   |
|   |   |   |   | VKMA 94616   | 1   |   | 1   |   |   |   |   |   |
|   |   |   |   | VKM 74604  | 1   |   |   |   |   |   |   |   |
|                                       | WL  | 01/02 → 04/05   |   | VKPC 94614   |   |   |   | 1   |   |   |   |   |
| <b>MAZDA  B-SERIE (UN) 2.5 D 4WD</b> |   |   |   |  |   |   |   |   |   |   |   |   |
|                                       | WL  | 06/99 → 11/03   | 3)  | VKMS 94616   | 1   |   | 1   |   |   |   | 2   | T0661   |
|   |   |   |   | VKMA 94616   | 1   |   | 1   |   |   |   |   |   |
|   |   |   |   | VKM 74604  | 1   |   |   |   |   |   |   |   |
|                                       | WL  | 06/99 → 04/05   |   | VKPC 94614   |   |   |   | 1   |   |   |   |   |





























|  |  |  |  |  |  |  |  |  |  |       |
|--|---|---|---|--|---|---|---|---|---|-------|
| <b>MAZDA  B-SERIE (UN) 2.5 TD 4WD</b> |   |   |   |  |   |   |   |   |   |       |
|                                       | WL  | 06/99 → 11/03   | 3)  | VKMS 94616<br>VKMA 94616<br>VKM 74604  | 1<br>1<br>1   | 1   |   |   | 2   | T0661 |
|                                       | WL  | 06/99 → 04/05   |   | VKPC 94614   |   |   | 1   |   |   |       |
| <b>MAZDA  E 1800 (SDX) 1.8</b>        |   |   |   |  |   |   |   |   |   |       |
|                                       | F8  | 01/84 → 12/86   | → ICH 500010  | —<br>VKM 74001   | 1<br>1  | 1   |   |   |   |       |
|  | F8  | 01/84 → 12/86   | CH 500011 I→,<br>→ ICH 500058   | —<br>VKM 74001   | 1<br>1  | 1   |   |   |   |       |
|  | F8  | 01/84 → 12/86   | CH 500059 I→,<br>→ ICH 500066   | —<br>VKM 74001   | 1<br>1  | 1   |   |   |   |       |
|  | F8  | 01/84 → 12/86   | CH 500067 I→  | —<br>VKM 74001   | 1<br>1  | 1   |   |   |   |       |
|  | F8  | 03/88 → 02/92   |   | VKMA 94600<br>VKM 74600<br>VKM 84600   | 1<br>1<br>1   | 1<br>1  |   |   |   | T0664 |
| <b>MAZDA  E 1800 (SRW) 1.8</b>        |   |   |   |  |   |   |   |   |   |       |
|                                       | F8  | 01/88 → 12/96   |   | VKMA 94600<br>VKM 74600<br>VKM 84600   | 1<br>1<br>1   | 1<br>1  |   |   |   | T0664 |
| <b>MAZDA  E 1800 (SRX) 1.8</b>        |   |   |   |  |   |   |   |   |   |       |
|                                       | F8  | 01/84 → 12/96   | → ICH 500604  | —<br>VKM 74001   | 1<br>1  | 1   |   |   |   |       |
|  | F8  | 01/84 → 12/96   | CH 500605 I→,<br>→ ICH 505202   | —<br>VKM 74001   | 1<br>1  | 1   |   |   |   |       |
|  | F8  | 01/84 → 12/96   | CH 505203 I→,<br>→ ICH 508515   | —<br>VKM 74001   | 1<br>1  | 1   |   |   |   |       |
|  | F8  | 01/84 → 12/96   | CH 508516 I→  | —<br>VKM 74001   | 1<br>1  | 1   |   |   |   |       |
| <b>MAZDA  E 2000, E 2200 2.0</b>    |   |   |   |  |   |   |   |   |   |       |
|                                     | FE, FE18, FE58, FE60,<br>FE61, FEV4   | 12/87 → 12/96   | 3), Mod. SDY, SRY   | VKMS 94230<br>VKMA 94230<br>VKM 74600<br>VKM 84600                                 | 1<br>1<br>1<br>1  | 1<br>1  | 1   |   | 2   | T0664 |
|  | FE  | 08/94 → 12/96   | 3), Mod. SRW  | VKMS 94230<br>VKMA 94230<br>VKM 74600<br>VKM 84600                                 | 1<br>1<br>1<br>1  | 1<br>1  | 1   |   | 2   | T0664 |
|  | FE  | 06/96 → 10/97   | 3), Mod. SSW  | VKMS 94230<br>VKMA 94230<br>VKM 74600<br>VKM 84600                                 | 1<br>1<br>1<br>1  | 1<br>1  | 1   |   | 2   | T0664 |
|  | FE18, FE58, FEV4  | 11/84 → 12/86   | 3), Mod. SDY,<br>CH 504018 I→   | VKMS 94007<br>VKMA 94007<br>VKM 74001  | 1<br>1<br>1   | 1<br>1  |   |   | 2   | T0681 |
|  | FE18, FE58, FEV4  | 11/84 → 12/86   | 3), Mod. SRY,<br>CH 516783 I→   | VKMS 94007<br>VKMA 94007<br>VKM 74001  | 1<br>1<br>1   | 1<br>1  |   |   | 2   | T0681 |
|                                     | FE18, FE58  | 12/87 → 04/89   | Mod. SD, SR   | VKPC 94424   |   |   | 1   |   |   |       |
| <b>MAZDA  E 2000, E 2200 2.2 D</b>  |   |   |   |  |   |   |   |   |   |       |
|                                     | R203, R207  | 01/84 → 12/96   | 3), Mod. SD, SRY  | VKMS 94009<br>VKMA 94009<br>VKM 74004  | 1<br>1<br>1   | 1   |   |   | 2   | T0432 |
| <b>MERCEDES-BENZ  (W 123) 200</b>   |   |   |   |  |   |   |   |   |   |       |
|                                     | M 102.920, M 102.939,<br>M 115.938, M 115.939                                     | 02/76 → 11/85   |   | <b>ΟΛΟΚΛΟ</b>  |   |   |   |   |   |       |
|                                     | M 102.920, M 102.939  | 06/80 → 11/85   |   | VKPC 88604   |   |   | 1   |   |   |       |
|  | M 115.938, M 115.939  | 02/76 → 08/80   |   | VKPC 88807   |   |   | 1   |   |   |       |

























| MERCEDES-BENZ  (W 123) 230           |   |               |    |   |  |  |  |  |  |  |  |  |  |  |  |  |  |  |   |
|---|---|---------------|----|---|--|--|--|--|--|--|--|--|--|--|--|--|--|--|---|
|                                       | M 102.980, M 115.954                          | 02/76 → 12/85 |    | OKOKOKO                                 |  |  |  |  |  |  |  |  |  |  |  |  |  |  |   |
|                                       | M 102.980                                     | 04/80 → 12/85 |    | VKPC 88604                              |  |  |  |  |  |  |  |  |  |  |  |  |  |  | 1 |
|   | M 115.954                                     | 02/76 → 03/81 |    | VKPC 88807                              |  |  |  |  |  |  |  |  |  |  |  |  |  |  | 1 |
|                                       | <b>B(PS)</b> M 115.954                        | 05/77 → 04/80 |    | VKMV 13AVx750                           |  |  |  |  |  |  |  |  |  |  |  |  |  |  | 1 |
| MERCEDES-BENZ  (W 123) 250           |   |               |    |   |  |  |  |  |  |  |  |  |  |  |  |  |  |  |   |
|                                       | M 123.921                                     | 02/76 → 07/85 |    | OKOKOKO                                 |  |  |  |  |  |  |  |  |  |  |  |  |  |  |   |
|                                       | M 123.921                                     | 02/76 → 07/85 |    | VKPC 88813                              |  |  |  |  |  |  |  |  |  |  |  |  |  |  | 1 |
| MERCEDES-BENZ  (W 123) 280           |   |               |    |   |  |  |  |  |  |  |  |  |  |  |  |  |  |  |   |
|                                       | M 110.923, M 110.984,<br>M 110.988            | 02/76 → 11/85 |    | OKOKOKO                                 |  |  |  |  |  |  |  |  |  |  |  |  |  |  |   |
|                                       | M 110.923, M 110.984,<br>M 110.988            | 02/76 → 11/85 |    | VKPC 88813                              |  |  |  |  |  |  |  |  |  |  |  |  |  |  | 1 |
| MERCEDES-BENZ  (W 123) 200 D         |   |               |    |   |  |  |  |  |  |  |  |  |  |  |  |  |  |  |   |
|                                       | OM 615.940                                    | 07/76 → 11/85 |    | OKOKOKO                                 |  |  |  |  |  |  |  |  |  |  |  |  |  |  |   |
|                                       | OM 615.940                                    | 07/76 → 11/85 |    | VKPC 88807                              |  |  |  |  |  |  |  |  |  |  |  |  |  |  | 1 |
|                                       | <b>B(PS)</b> OM 615.940                       | 03/79 → 11/85 |    | VKMV 13AVx1150                          |  |  |  |  |  |  |  |  |  |  |  |  |  |  | 1 |
| MERCEDES-BENZ  (W 123) 220 D         |   |               |    |   |  |  |  |  |  |  |  |  |  |  |  |  |  |  |   |
|                                       | OM 615.941                                    | 01/76 → 03/79 |    | OKOKOKO                                 |  |  |  |  |  |  |  |  |  |  |  |  |  |  |   |
|                                       | OM 615.941                                    | 01/76 → 03/79 |    | VKPC 88807                              |  |  |  |  |  |  |  |  |  |  |  |  |  |  | 1 |
| MERCEDES-BENZ  (W 123) 240 D         |   |               |    |   |  |  |  |  |  |  |  |  |  |  |  |  |  |  |   |
|                                       | OM 616.912                                    | 02/76 → 12/85 |    | OKOKOKO                                 |  |  |  |  |  |  |  |  |  |  |  |  |  |  |   |
|                                       | OM 616.912                                    | 02/76 → 12/85 |    | VKPC 88807                              |  |  |  |  |  |  |  |  |  |  |  |  |  |  | 1 |
|                                      | <b>B(PS)</b> OM 616.912                       | 02/76 → 12/85 |    | VKMV 13AVx1150                          |  |  |  |  |  |  |  |  |  |  |  |  |  |  | 1 |
| MERCEDES-BENZ  (W 123) 300 D       |   |               |    |   |  |  |  |  |  |  |  |  |  |  |  |  |  |  |   |
|                                     | OM 617.912                                    | 02/76 → 11/85 |    | OKOKOKO                                 |  |  |  |  |  |  |  |  |  |  |  |  |  |  |   |
|                                     | OM 617.912                                    | 02/76 → 11/85 |    | VKPC 88807                              |  |  |  |  |  |  |  |  |  |  |  |  |  |  | 1 |
|                                     | <b>B(PS)</b> OM 617.912                       | 02/76 → 11/85 |    | VKMV 13AVx1150                          |  |  |  |  |  |  |  |  |  |  |  |  |  |  | 1 |
| MERCEDES-BENZ  (W 123) 300 Turbo-D |   |               |    |   |  |  |  |  |  |  |  |  |  |  |  |  |  |  |   |
|                                     | OM 617.952                                    | 10/80 → 11/85 |    | OKOKOKO                                 |  |  |  |  |  |  |  |  |  |  |  |  |  |  |   |
|                                     | OM 617.952                                    | 10/80 → 11/85 |    | VKPC 88807                              |  |  |  |  |  |  |  |  |  |  |  |  |  |  | 1 |
|                                     | <b>B(Alt)</b> OM 617.952                      | 10/80 → 11/85 |    | VKMV 10AVx1025                          |  |  |  |  |  |  |  |  |  |  |  |  |  |  | 1 |
|                                     | <b>B(PS)</b> OM 617.952                       | 10/80 → 11/85 |    | VKMV 13AVx1150                          |  |  |  |  |  |  |  |  |  |  |  |  |  |  | 1 |
| MERCEDES-BENZ  (W 124) 200         |   |               |    |   |  |  |  |  |  |  |  |  |  |  |  |  |  |  |   |
|                                     | M 102.922, M 102.962,<br>M 102.963, M 111.940 | 09/85 → 06/93 |    | OKOKOKO                                 |  |  |  |  |  |  |  |  |  |  |  |  |  |  |   |
|                                     | M 102.922, M 102.962,<br>M 102.963            | 09/85 → 08/92 |    | VKPC 88619                              |  |  |  |  |  |  |  |  |  |  |  |  |  |  | 1 |
|   | M 111.940                                     | 10/92 → 06/93 |    | VKPC 88622                              |  |  |  |  |  |  |  |  |  |  |  |  |  |  | 1 |
|                                     | <b>B(Alt)</b> M 102.922, M 102.963            | 12/85 → 08/92 | AC | VKMA 38001<br>VKMV 6PK1885<br>VKM 38001 |  |  |  |  |  |  |  |  |  |  |  |  |  |  | 1 |
|   |   |               |    |   |  |  |  |  |  |  |  |  |  |  |  |  |  |  | 1 |
|   | <b>B(Alt)</b> M 102.922, M 102.963            | 12/85 → 08/92 | AC | VKMA 38006<br>VKMV 6PK1980<br>VKM 38001 |  |  |  |  |  |  |  |  |  |  |  |  |  |  | 1 |
|   |   |               |    |   |  |  |  |  |  |  |  |  |  |  |  |  |  |  | 1 |
|   | <b>B(Alt)</b> M 111.940                       | 10/92 → 06/93 | AC | VKMV 6PK2040<br>VKM 38022<br>VKM 38027  |  |  |  |  |  |  |  |  |  |  |  |  |  |  | 1 |
|   |   |               |    |   |  |  |  |  |  |  |  |  |  |  |  |  |  |  | 1 |
|   | <b>B(Alt)</b> M 111.940                       | 10/92 → 06/93 | AC | VKMV 6PK2140<br>VKM 38022<br>VKM 38027  |  |  |  |  |  |  |  |  |  |  |  |  |  |  | 1 |
|   |   |               |    |   |  |  |  |  |  |  |  |  |  |  |  |  |  |  | 1 |
| MERCEDES-BENZ  (W 124) 220         |   |               |    |   |  |  |  |  |  |  |  |  |  |  |  |  |  |  |   |
|                                     | M 111.960                                     | 10/92 → 06/93 |    | OKOKOKO                                 |  |  |  |  |  |  |  |  |  |  |  |  |  |  |   |
|                                     | M 111.960                                     | 10/92 → 06/93 |    | VKPC 88622                              |  |  |  |  |  |  |  |  |  |  |  |  |  |  | 1 |
|                                     | <b>B(Alt)</b> M 111.960                       | 10/92 → 06/93 | AC | VKMV 6PK2040<br>VKM 38022<br>VKM 38027  |  |  |  |  |  |  |  |  |  |  |  |  |  |  | 1 |
|   |   |               |    |   |  |  |  |  |  |  |  |  |  |  |  |  |  |  | 1 |
|   | <b>B(Alt)</b> M 111.960                       | 10/92 → 06/93 | AC | VKMV 6PK2140<br>VKM 38022<br>VKM 38027  |  |  |  |  |  |  |  |  |  |  |  |  |  |  | 1 |
|   |   |               |    |   |  |  |  |  |  |  |  |  |  |  |  |  |  |  | 1 |























| MERCEDES-BENZ  (W 124) 230   |   |               |   |   |   |  |   |  |  |   |   |  |  |
|---|---|---------------|---|---|---|--|---|--|--|---|---|--|--|
|                              | M 102.982                                     | 12/84 → 06/93 |   | ΟΛΟΦΟΧΟ                                 |   |  |   |  |  |   |   |  |  |
|                              | M 102.982                                     | 12/84 → 06/93 |   | VKPC 88619                              |   |  |   |  |  | 1 |   |  |  |
|                              | B(Alt) M 102.982                              | 12/84 → 06/93 | AC  | VKMA 38001<br>VKMV 6PK1885<br>VKM 38001 | 1 |  | 1 |  |  |   |   |  |  |
|   | B(Alt) M 102.982                              | 12/84 → 06/93 | AC  | VKMA 38006<br>VKMV 6PK1980<br>VKM 38001 | 1 |  | 1 |  |  |   |   |  |  |
|   |   |               |   |   | 1 |  |   |  |  |   |   |  |  |
| MERCEDES-BENZ  (W 124) 260   |   |               |   |   |   |  |   |  |  |   |   |  |  |
|                              | M 103.940, M 103.943                          | 09/85 → 08/92 |   | ΟΛΟΦΟΧΟ                                 |   |  |   |  |  |   |   |  |  |
|                              | M 103.940, M 103.943                          | 09/85 → 08/92 |   | VKPC 88810                              |   |  |   |  |  | 1 |   |  |  |
|                              | B(Alt) M 103.940, M 103.943                   | 09/85 → 08/92 | AC  | VKMV 6PK2170<br>VKM 38012               |   |  | 1 |  |  |   |   |  |  |
|   | B(Alt) M 103.940, M 103.943                   | 09/85 → 08/92 | AC,    | VKMV 6PK2257<br>VKM 38012               |   |  | 1 |  |  |   |   |  |  |
|   | B(Alt) M 103.940, M 103.943                   | 09/85 → 08/92 | AC,    | VKMV _____<br>VKM 38012                 |   |  | 1 |  |  |   |   |  |  |
|   |   |               |   |   | 1 |  |   |  |  |   |   |  |  |
| MERCEDES-BENZ  (W 124) 280   |   |               |   |   |   |  |   |  |  |   |   |  |  |
|                              | M 104.942                                     | 10/92 → 06/93 |   | ΟΛΟΦΟΧΟ                                 |   |  |   |  |  |   |   |  |  |
|                              | M 104.942                                     | 10/92 → 06/93 | Man. GBX,<br>→ IMot. 005789   | VKPC 88824                              |   |  |   |  |  | 1 |   |  |  |
|   | M 104.942                                     | 10/92 → 06/93 | Man. GBX,<br>Mot. 005790 I→   | VKPC 88836                              |   |  |   |  |  |   | 1 |  |  |
|   | M 104.942                                     | 10/92 → 06/93 | Auto. GBX,<br>→ IMot. 048696  | VKPC 88824                              |   |  |   |  |  |   | 1 |  |  |
|   | M 104.942                                     | 10/92 → 06/93 | Auto. GBX,<br>Mot. 048697 I→  | VKPC 88836                              |   |  |   |  |  |   | 1 |  |  |
|                            | B(Alt) M 104.942                              | 10/92 → 06/93 | AC, Man. GBX,<br>Mot. 005790 I→   | VKMV 6PK2475<br>VKM 38100               | 1 |  | 1 |  |  |   |   |  |  |
|   | B(Alt) M 104.942                              | 10/92 → 06/93 | AC, Auto. GBX,<br>Mot. 048697 I→  | VKMV 6PK2475<br>VKM 38100               | 1 |  | 1 |  |  |   |   |  |  |
| MERCEDES-BENZ  (W 124) 300 |   |               |   |   |   |  |   |  |  |   |   |  |  |
|                            | M 103.980, M 103.983,<br>M 103.985, M 104.980 | 01/85 → 06/93 |   | ΟΛΟΦΟΧΟ                                 |   |  |   |  |  |   |   |  |  |
|                            | M 103.980, M 103.983,<br>M 103.985, M 104.980 | 01/85 → 06/93 |   | VKPC 88810                              |   |  |   |  |  | 1 |   |  |  |
|   | M 104.980                                     | 09/88 → 12/92 |      | VKPC 88816                              |   |  |   |  |  | 1 |   |  |  |
|   | M 104.980                                     | 09/88 → 12/92 |      | VKPC 88825                              |   |  |   |  |  | 1 |   |  |  |
|                            | B(Alt) M 103.980, M 103.983,<br>M 103.985     | 01/85 → 06/93 | AC  | VKMV 6PK2170                            |   |  | 1 |  |  |   |   |  |  |
|   | B(Alt) M 103.980                              | 01/85 → 12/85 | AC  | VKMV 6PK2257                            |   |  | 1 |  |  |   |   |  |  |
|   | B(Alt) M 103.983, M 103.985                   | 06/85 → 06/93 | AC,  | VKMV 6PK2257                            |   |  | 1 |  |  |   |   |  |  |
|   | B(Alt) M 103.983, M 103.985                   | 06/85 → 06/93 | AC,  | VKMV _____                              |   |  | 1 |  |  |   |   |  |  |
|   | B(Alt) M 104.980                              | 09/88 → 08/92 | AC,  | VKMV 6PK2257                            |   |  | 1 |  |  |   |   |  |  |
|   | B(Alt) M 104.980                              | 09/88 → 08/92 | AC,  | VKMV 6PK2257                            |   |  | 1 |  |  |   |   |  |  |
|   | B(Alt) M 104.980                              | 09/88 → 08/92 | AC,  | VKMV _____<br>VKM 38012                 |   |  | 1 |  |  | 1 |   |  |  |
|   | B(Alt) M 104.980                              | 09/88 → 08/92 | AC,  | VKMV _____<br>VKM 38012                 |   |  | 1 |  |  | 1 |   |  |  |
|   | B(Alt) M 104.980                              | 09/89 → 12/92 | AC, Man. GBX,<br>→ IMot. 004956   | VKMV 6PK2285<br>VKM 38012               |   |  | 1 |  |  | 1 |   |  |  |

















































































|  |  |  |            |  |  |  |  |  |  |  |  |
|--|---|---|---|--|---|---|---|---|---|---|---|
| B(Alt)   | M 104.980   | 09/89 → 12/92   | AC, Auto. GBX,<br>→IMot. 021004   | VKMV 6PK2285<br>VKM 38012  | 1   | 1   |   |   |   |   |   |
| <b>MERCEDES-BENZ  (W 124) 300 AMG</b> |   |   |   |  |   |   |   |   |   |   |   |
|  | M 104.980   | 09/88 → 06/93   |   | ΟΧΘΟΧΟ   |   |   |   |   |   |   |   |
|  | M 104.980   | 09/88 → 06/93   |  ABS       | VKPC 88816   |   |   |   | 1   |   |   |   |
|  | M 104.980   | 09/88 → 06/93   |  ABS       | VKPC 88825   |   |   |   | 1   |   |   |   |
| <b>MERCEDES-BENZ  (W 124) 320</b>     |   |   |   |  |   |   |   |   |   |   |   |
|  | M 104.992   | 10/92 → 06/93   |   | ΟΧΘΟΧΟ   |   |   |   |   |   |   |   |
|  | M 104.992   | 10/92 → 05/93   |  Man. GBX, | VKPC 88824   |   |   |   | 1   |   |   |   |
|  | M 104.992   | 10/92 → 06/93   | →IMot. 004356   | VKPC 88824   |   |   |   | 1   |   |   |   |
|  | M 104.992   | 10/92 → 06/93   | Man. GBX,<br>Mot. 004357 I→   | VKPC 88836   |   |   |   | 1   |   |   |   |
|  | M 104.992   | 10/92 → 06/93   | Auto. GBX,<br>→IMot. 072236   | VKPC 88824   |   |   |   | 1   |   |   |   |
|  | M 104.992   | 10/92 → 06/93   | Auto. GBX,<br>Mot. 072237 I→  | VKPC 88836   |   |   |   | 1   |   |   |   |
| B(Alt)   | M 104.992   | 10/92 → 06/93   | AC, Man. GBX,<br>Mot. 004357 I→,<br>→IMot. 005602   | VKMV 6PK2475<br>VKM 38100  | 1   |   | 1   |   |   |   |   |
| B(Alt)   | M 104.992   | 10/92 → 06/93   | AC, Auto. GBX,<br>Mot. 072237 I→,<br>→IMot. 102820  | VKMV 6PK2475<br>VKM 38100  | 1   |   | 1   |   |   |   |   |
| <b>MERCEDES-BENZ  (W 124) 400</b>   |   |   |   |  |   |   |   |   |   |   |   |
|  | M 119.975   | 10/92 → 06/93   |   | ΟΧΘΟΧΟ   |   |   |   |   |   |   |   |
|  | M 119.975   | 10/92 → 06/93   | →IMot. 020770   | —  |   |   |   | 1   |   |   |   |
|  | M 119.975   | 10/92 → 06/93   | Mot. 020771 I→  | —  |   |   |   | 1   |   |   |   |
| B(Alt)   | M 119.975   | 10/92 → 06/93   | AC, →IMot. 009381   | VKM 38012  |   | 1   |   |   |   |   |   |
| <b>MERCEDES-BENZ  (W 124) 500</b>   |   |   |   |  |   |   |   |   |   |   |   |
|  | M 119.974   | 01/91 → 06/93   |   | ΟΧΘΟΧΟ   |   |   |   |   |   |   |   |
|  | M 119.974   | 01/91 → 06/93   | →IMot. 010204   | —  |   |   |   | 1   |   |   |   |
|  | M 119.974   | 01/91 → 06/93   | Mot. 010205 I→  | —  |   |   |   | 1   |   |   |   |
| <b>MERCEDES-BENZ  (W 124) 200 D</b> |   |   |   |  |   |   |   |   |   |   |   |
|  | OM 601.912  | 12/84 → 06/93   |   | ΟΧΘΟΧΟ   |   |   |   |   |   |   |   |
|  | OM 601.912  | 12/84 → 06/93   | Man. GBX,<br>→IMot. 195582  | VKPC 88608   |   |   |   | 1   |   |   |   |
|  | OM 601.912  | 12/84 → 06/93   | Man. GBX,<br>Mot. 195583 I→   | VKPC 88620   |   |   |   | 1   |   |   |   |
|  | OM 601.912  | 12/84 → 06/93   | Auto. GBX,<br>→IMot. 019805   | VKPC 88608   |   |   |   | 1   |   |   |   |
|  | OM 601.912  | 12/84 → 06/93   | Auto. GBX,<br>Mot. 019806 I→  | VKPC 88620   |   |   |   | 1   |   |   |   |
| B(Alt)   | OM 601.912  | 12/84 → 06/93   | AC  | VKMA 38002<br>VKMV 6PK2050<br>VKM 38001  | 1   |   | 1   |   |   |   |   |
| B(Alt)   | OM 601.912  | 12/84 → 06/93   | AC  | VKMA 38003<br>VKMV 6PK2120<br>VKM 38001  | 1   |   | 1   |   |   |   |   |
| B(Alt)   | OM 601.912  | 12/84 → 06/93   | AC  | VKMA 38002<br>VKMV 6PK2050<br>VKM 38001  | 1   |   | 1   |   |   |   |   |
| <b>MERCEDES-BENZ  (W 124) 250 D</b> |   |   |   |  |   |   |   |   |   |   |   |
|  | OM 602.912  | 04/85 → 06/93   |   | ΟΧΘΟΧΟ   |   |   |   |   |   |   |   |
|  | OM 602.912  | 04/85 → 06/93   |   | VKPC 88620   |   |   |   | 1   |   |   |   |
| B(Alt)   | OM 602.912  | 04/85 → 06/93   | AC, ⊕   | VKMA 38004<br>VKMV 6PK2030<br>VKM 38001  | 1   |   | 1   |   |   |   |   |
| B(Alt)   | OM 602.912  | 04/85 → 06/93   | AC, ⊕   | VKMA 38005<br>VKMV 6PK2100<br>VKM 38001  | 1   |   | 1   |   |   |   |   |































































| MERCEDES-BENZ  (W 124) 250 Turbo-D          |   |               |                              |   |
|--|---|---------------|------------------------------|---|
|   | OM 602.962                                    | 09/88 → 06/93 |                              | <b>ΟΛΟΚΛΗΡΟ</b>                         |
|   | OM 602.962                                    | 09/88 → 06/93 | Man. GBX,<br>→IMot. 033729   | VKPC 88620                              |
|  | OM 602.962                                    | 09/88 → 06/93 | Man. GBX,<br>Mot. 033730 I→  | VKPC 88842                              |
|  | OM 602.962                                    | 09/88 → 06/93 | Auto. GBX,<br>→IMot. 020852  | VKPC 88620                              |
|  | OM 602.962                                    | 09/88 → 06/93 | Auto. GBX,<br>Mot. 020853 I→ | VKPC 88842                              |
|   | B(Alt) OM 602.962                             | 09/88 → 06/93 | AC                           | VKMA 38004<br>VKMV 6PK2030<br>VKM 38001 |
|  | B(Alt) OM 602.962                             | 09/88 → 06/93 | AC                           | VKMA 38005<br>VKMV 6PK2100<br>VKM 38001 |
| <b>MERCEDES-BENZ  (W 124) 300 D</b>         |   |               |                              |   |
|   | OM 603.912,<br>OM 603.913                     | 12/84 → 06/93 |                              | <b>ΟΛΟΚΛΗΡΟ</b>                         |
|   | OM 603.912,<br>OM 603.913                     | 12/84 → 06/93 |                              | VKPC 88620                              |
|   | B(Alt) OM 603.912,<br>OM 603.913              | 12/84 → 06/93 | AC                           | VKMA 38007<br>VKMV 6PK2080<br>VKM 38001 |
|  | B(Alt) OM 603.912,<br>OM 603.913              | 12/84 → 06/93 | AC                           | VKMA 38005<br>VKMV 6PK2100<br>VKM 38001 |
| <b>MERCEDES-BENZ  (W 124) 300 Turbo-D</b> |   |               |                              |   |
|   | OM 603.960,<br>OM 603.963                     | 09/86 → 06/93 |                              | <b>ΟΛΟΚΛΗΡΟ</b>                         |
|   | OM 603.960,<br>OM 603.963                     | 09/86 → 06/93 | →IMot. 054622                | VKPC 88620                              |
|  | OM 603.960,<br>OM 603.963                     | 09/86 → 06/93 | Mot. 054623 I→               | VKPC 88842                              |
|   | B(Alt) OM 603.960,<br>OM 603.963              | 09/86 → 06/93 | AC                           | VKMA 38007<br>VKMV 6PK2080<br>VKM 38001 |
|  | B(Alt) OM 603.960,<br>OM 603.963              | 09/86 → 06/93 | AC                           | VKMA 38005<br>VKMV 6PK2100<br>VKM 38001 |
| <b>MERCEDES-BENZ  190 (W201) 1.8</b>      |   |               |                              |   |
|   | M 102.910                                     | 04/90 → 08/93 |                              | <b>ΟΛΟΚΛΗΡΟ</b>                         |
|   | M 102.910                                     | 04/90 → 08/93 |                              | VKPC 88619                              |
|   | B(Alt) M 102.910                              | 04/90 → 08/93 | AC                           | VKMA 38001<br>VKMV 6PK1885<br>VKM 38001 |
|  | B(Alt) M 102.910                              | 04/90 → 08/93 | AC                           | VKMA 38006<br>VKMV 6PK1980<br>VKM 38001 |
| <b>MERCEDES-BENZ  190 (W201) 2.0</b>      |   |               |                              |   |
|   | M 102.921, M 102.924,<br>M 102.961, M 102.962 | 10/82 → 08/93 |                              | <b>ΟΛΟΚΛΗΡΟ</b>                         |
|   | M 102.921, M 102.961                          | 10/82 → 06/93 |                              | VKPC 88604                              |
|  | M 102.924, M 102.962                          | 10/82 → 08/93 |                              | VKPC 88619                              |
|   | B(Alt) M 102.921, M 102.938                   | 10/82 → 06/93 |                              | VKMA 38001<br>VKMV 10AVx1005            |
|  | B(Alt) M 102.924                              | 10/82 → 06/93 | AC, ⊕                        | VKMA 38006<br>VKMV 6PK1980<br>VKM 38001 |
|  | B(Alt) M 102.924, M 102.962                   | 10/82 → 08/93 | AC, ⊕                        | VKMA 38001<br>VKMV 6PK1885<br>VKM 38001 |



































|   |  |  |  |  |  |  |  |  |  |  |  |
|---|---|---|---|--|---|---|---|---|---|---|---|
| B(Alt)  | M 102.924, M 102.962  | 10/82 → 08/93   | AC, ⊕   | VKMA 38006<br>VKMV 6PK1980<br>VKM 38001  | 1   | 1   |   |   |   |   |   |
| B(AC)   | M 102.921   | 10/82 → 10/84   |   | VKMA 38006<br>VKMV 6PK1980<br>VKM 38001  | 1   | 1   |   |   |   |   |   |
| <b>MERCEDES-BENZ</b>  <b>190 (W201) 2.3</b>                |   |   |   |  |   |   |   |   |   |   |   |
|   | M 102.985   | 09/86 → 08/93   |   | ⊗⊗⊗⊗⊗  |   |   |   |   |   |   |   |
|   | M 102.985   | 09/86 → 08/93   |   | VKPC 88619   |   |   |   | 1   |   |   |   |
|   | B(Alt)  | M 102.985   | 09/86 → 08/93   | AC   | VKMA 38001<br>VKMV 6PK1885<br>VKM 38001   | 1   | 1   |   |   |   |   |
| B(Alt)  | M 102.985   | 09/86 → 08/93   | AC  | VKMA 38006<br>VKMV 6PK1980<br>VKM 38001  | 1   | 1   |   |   |   |   |   |
| <b>MERCEDES-BENZ</b>  <b>190 (W201) 2.3-16</b>             |   |   |   |  |   |   |   |   |   |   |   |
|   | M 102.983   | 04/84 → 08/88   |   | ⊗⊗⊗⊗⊗  |   |   |   |   |   |   |   |
|   | M 102.983   | 04/84 → 08/88   |   | VKPC 88619   |   |   |   | 1   |   |   |   |
|   | B(Alt)  | M 102.983   | 04/84 → 08/88   | AC   | VKMA 38001<br>VKMV 6PK1885<br>VKM 38001   | 1   | 1   |   |   |   |   |
| B(Alt)  | M 102.983   | 04/84 → 08/88   | AC  | VKMA 38006<br>VKMV 6PK1980<br>VKM 38001  | 1   | 1   |   |   |   |   |   |
| <b>MERCEDES-BENZ</b>  <b>190 (W201) 2.5-16</b>             |   |   |   |  |   |   |   |   |   |   |   |
|   | M 102.990, M 102.991  | 09/88 → 08/93   |   | ⊗⊗⊗⊗⊗  |   |   |   |   |   |   |   |
|    | M 102.990, M 102.991  | 09/88 → 08/93   |   | VKPC 88619   |   |   |   | 1   |   |   |   |
|   | B(Alt)  | M 102.990, M 102.991  | 09/88 → 08/93   | AC   | VKMA 38001<br>VKMV 6PK1885<br>VKM 38001   | 1   | 1   |   |   |   |   |
| B(Alt)  | M 102.990, M 102.991  | 09/88 → 08/93   | AC  | VKMA 38006<br>VKMV 6PK1980<br>VKM 38001  | 1   | 1   |   |   |   |   |   |
| <b>MERCEDES-BENZ</b>  <b>190 (W201) 2.5 Evolution II</b> |   |   |   |  |   |   |   |   |   |   |   |
|   | M 102.992   | 05/90 → 08/93   |   | ⊗⊗⊗⊗⊗  |   |   |   |   |   |   |   |
|   | M 102.992   | 05/90 → 08/93   |   | VKPC 88619   |   |   |   | 1   |   |   |   |
|   | B(Alt)  | M 102.992   | 05/90 → 08/93   | AC   | VKMA 38001<br>VKMV 6PK1885<br>VKM 38001   | 1   | 1   |   |   |   |   |
| B(Alt)  | M 102.992   | 05/90 → 08/93   | AC  | VKMA 38006<br>VKMV 6PK1980<br>VKM 38001  | 1   | 1   |   |   |   |   |   |
| <b>MERCEDES-BENZ</b>  <b>190 (W201) 2.6</b>              |   |   |   |  |   |   |   |   |   |   |   |
|   | M 103.942   | 09/86 → 08/93   |   | ⊗⊗⊗⊗⊗  |   |   |   |   |   |   |   |
|   | M 103.942   | 09/86 → 08/93   | Man. GBX  | VKPC 88810   |   |   |   | 1   |   |   |   |
|   | M 103.942   | 09/86 → 08/93   | Auto. GBX   | VKPC 88804   |   |   |   | 1   |   |   |   |
|   | B(Alt)  | M 103.942   | 09/86 → 08/93   | AC   | VKMA 38001<br>VKMV 6PK1885<br>VKM 38001   | 1   | 1   |   |   |   |   |
| B(Alt)  | M 103.942   | 09/86 → 08/93   | AC, ⊕   | VKMA 38006<br>VKMV 6PK1980<br>VKM 38001  | 1   | 1   |   |   |   |   |   |
| B(Alt)  | M 103.942   | 09/86 → 08/93   | AC, ⊕   | VKMA 38001<br>VKMV 6PK1885<br>VKM 38001  | 1   | 1   |   |   |   |   |   |
| <b>MERCEDES-BENZ</b>  <b>190 (W201) 2.0 D</b>            |   |   |   |  |   |   |   |   |   |   |   |
|   | OM 601.911  | 08/83 → 08/93   |   | ⊗⊗⊗⊗⊗  |   |   |   |   |   |   |   |
|   | OM 601.911  | 08/83 → 08/93   |   | VKPC 88608   |   |   |   | 1   |   |   |   |
|   | B(Alt)  | OM 601.911  | 08/83 → 08/93   | AC, ⊕  | VKMA 38001<br>VKMV 6PK1885<br>VKM 38001   | 1   | 1   |   |   |   |   |
| B(Alt)  | OM 601.911  | 08/83 → 08/93   | AC, ⊕   | VKMA 38006<br>VKMV 6PK1980<br>VKM 38001  | 1   | 1   |   |   |   |   |   |
| B(Alt)  | OM 601.911  | 08/83 → 08/93   | AC, ⊕   | VKMA 38003<br>VKMV 6PK2120<br>VKM 38001  | 1   | 1   |   |   |   |   |   |
| <b>MERCEDES-BENZ</b>  <b>190 (W201) 2.5 D</b>            |   |   |   |  |   |   |   |   |   |   |   |
|   | OM 602.911  | 04/85 → 08/93   |   | ⊗⊗⊗⊗⊗  |   |   |   |   |   |   |   |
|   | OM 602.911  | 04/85 → 08/93   |   | VKPC 88620   |   |   |   | 1   |   |   |   |





































|   |  |  |  |  |  |  |  |  |  |  |  |
|---|---|---|---|--|---|---|---|---|---|---|---|
|    | B(Alt) OM 602.911   | 04/85 → 08/93   | AC  | VKMA 38004<br>VKMV 6PK2030<br>VKM 38001  | 1   |   | 1   |   |   |   |   |
|   | B(Alt) OM 602.911   | 04/85 → 08/93   | AC  | VKMA 38005<br>VKMV 6PK2100<br>VKM 38001  | 1   |   | 1   |   |   |   |   |
| <b>MERCEDES-BENZ  190 (W201) 2.5 Turbo-D</b>     |   |   |   |  |   |   |   |   |   |   |   |
|    | OM 602.961  | 02/88 → 08/93   |   | OKOKOKO  |   |   |   |   |   |   |   |
|    | OM 602.961  | 02/88 → 08/93   |   | VKPC 88620   |   |   |   | 1   |   |   |   |
|    | B(Alt) OM 602.961   | 02/88 → 08/93   | AC  | VKMA 38004<br>VKMV 6PK2030<br>VKM 38001  | 1   |   | 1   |   |   |   |   |
|   | B(Alt) OM 602.961   | 02/88 → 08/93   | AC  | VKMA 38005<br>VKMV 6PK2100<br>VKM 38001  | 1   |   | 1   |   |   |   |   |
|   | B(Alt) OM 602.961   | 02/88 → 08/93   | AC  | VKMA 38001   | 1   |   |   |   |   |   |   |
| <b>MERCEDES-BENZ  A-class (W168) A 140</b>       |   |   |   |  |   |   |   |   |   |   |   |
|    | M 166.940   | 07/97 → 08/04   |   | OKOKOKO  |   |   |   |   |   |   |   |
|    | M 166.940   | 07/97 → 11/98   | →IMot. 30134436   | VKPC 88206   |   |   |   | 1   |   |   |   |
|   | M 166.940   | 11/98 → 07/04   | Mot. 30134437 I→  | VKPC 88851   |   |   |   | 1   |   |   |   |
|    | B(Alt) M 166.940  | 07/97 → 08/04   | AC  | VKMA 38004<br>VKMV 5PK1290   |   |   | 1   |   |   |   |   |
|   | B(Alt) M 166.940  | 07/97 → 08/04   | AC  | VKMA 38005<br>VKMV 5PK1750   |   |   | 1   |   |   |   |   |
| <b>MERCEDES-BENZ  A-class (W168) A 160</b>       |   |   |   |  |   |   |   |   |   |   |   |
|    | M 166.960   | 07/97 → 08/04   |   | OKOKOKO  |   |   |   |   |   |   |   |
|    | M 166.960   | 07/97 → 11/98   | →IMot. 30134436   | VKPC 88206   |   |   |   | 1   |   |   |   |
|   | M 166.960   | 11/98 → 07/04   | Mot. 30134437 I→  | VKPC 88851   |   |   |   | 1   |   |   |   |
|    | B(Alt) M 166.960  | 07/97 → 08/04   | AC  | VKMA 38004<br>VKMV 5PK1290   |   |   | 1   |   |   |   |   |
|   | B(Alt) M 166.960  | 07/97 → 08/04   | AC  | VKMA 38005<br>VKMV 5PK1750   |   |   | 1   |   |   |   |   |
| <b>MERCEDES-BENZ  A-class (W168) A 190</b>     |   |   |   |  |   |   |   |   |   |   |   |
|    | M 166.990   | 03/99 → 08/04   |   | OKOKOKO  |   |   |   |   |   |   |   |
|    | M 166.990   | 03/99 → 07/04   | →IMot. 30134436   | VKPC 88206   |   |   |   | 1   |   |   |   |
|   | M 166.990   | 03/99 → 07/04   | Mot. 30134437 I→  | VKPC 88851   |   |   |   | 1   |   |   |   |
|    | B(Alt) M 166.990  | 03/99 → 08/04   | AC  | VKMA 38004<br>VKMV 5PK1290   |   |   | 1   |   |   |   |   |
|   | B(Alt) M 166.990  | 03/99 → 08/04   | AC  | VKMA 38005<br>VKMV 5PK1750   |   |   | 1   |   |   |   |   |
| <b>MERCEDES-BENZ  A-class (W168) A 210</b>     |   |   |   |  |   |   |   |   |   |   |   |
|    | M 166.995   | 03/02 → 08/04   |   | OKOKOKO  |   |   |   |   |   |   |   |
|    | M 166.995   | 03/02 → 07/04   | →IMot. 30134436   | VKPC 88206   |   |   |   | 1   |   |   |   |
|   | M 166.995   | 03/02 → 07/04   | Mot. 30134437 I→  | VKPC 88851   |   |   |   | 1   |   |   |   |
|    | B(Alt) M 166.995  | 03/02 → 08/04   | AC  | VKMA 38004<br>VKMV 5PK1290   |   |   | 1   |   |   |   |   |
|   | B(Alt) M 166.995  | 03/02 → 08/04   | AC  | VKMA 38005<br>VKMV 5PK1750   |   |   | 1   |   |   |   |   |
| <b>MERCEDES-BENZ  A-class (W168) A 160 CDI</b> |   |   |   |  |   |   |   |   |   |   |   |
|    | OM 668.940,<br>OM 668.941   | 07/98 → 08/04   |   | OKOKOKO  |   |   |   |   |   |   |   |
|    | OM 668.940,<br>OM 668.941   | 11/98 → 07/04   | Mot. 30014964 I→  | VKPC 88851   |   |   |   | 1   |   |   |   |
|   | OM 668.941  | 07/98 → 11/98   | →IMot. 30014963   | VKPC 88206   |   |   |   | 1   |   |   |   |
|    | B(Alt) OM 668.940,<br>OM 668.941  | 07/98 → 03/01   | AC  | VKMA 38004<br>VKMV 5PK1270   |   |   | 1   |   |   |   |   |
|   | B(Alt) OM 668.940   | 03/01 → 08/04   | AC  | VKMA 38005<br>VKMV 5PK1263   |   |   | 1   |   |   |   |   |
|   | B(Alt) OM 668.940,<br>OM 668.941  | 07/98 → 03/01   | AC  | VKMA 38001<br>VKMV 5PK1720   |   |   | 1   |   |   |   |   |
|   | B(Alt) OM 668.940   | 03/01 → 08/04   | AC  | VKMA 38002<br>VKMV 5PK1715   | 1   | 2   | 1   |   |   |   |   |
|   | B(Alt) OM 668.940   | 03/01 → 08/04   | AC  | VKMA 38003<br>VKMV 5PK1715   |   |   | 1   |   |   |   |   |
| <b>MERCEDES-BENZ  A-class (W168) A 170 CDI</b> |   |   |   |  |   |   |   |   |   |   |   |
|    | OM 668.940,<br>OM 668.942   | 07/98 → 08/04   |   | OKOKOKO  |   |   |   |   |   |   |   |
|    | OM 668.940  | 07/98 → 11/98   | →IMot. 30014963   | VKPC 88206   |   |   |   | 1   |   |   |   |
|   | OM 668.940,<br>OM 668.942   | 11/98 → 07/04   | Mot. 30014964 I→  | VKPC 88851   |   |   |   | 1   |   |   |   |
|    | B(Alt) OM 668.940,<br>OM 668.942  | 07/98 → 03/01   | AC  | VKMA 38004<br>VKMV 5PK1270   |   |   | 1   |   |   |   |   |























































































|  |  |  |  |  |  |  |  |  |  |  |  |  |  |  |
|--|---|---|---|--|---|---|---|---|---|---|---|---|---|---|
| B(Alt)   | OM 668.942  | 03/01 → 08/04   | AC  | VKMV 5PK1263   |   |   |   | 1   |   |   |   |   |   |   |
| B(Alt)   | OM 668.940,<br>OM 668.942   | 07/98 → 03/01   | AC  | VKMV 5PK1720   |   |   |   | 1   |   |   |   |   |   |   |
| B(Alt)   | OM 668.942  | 03/01 → 08/04   | AC  | VKMA____<br>VKMV 5PK1715   | 1   | 2   |   | 1   |   |   |   |   |   |   |
| <b>MERCEDES-BENZ</b>  <b>A-class (W169) A 150</b>       |   |   |   |  |   |   |   |   |   |   |   |   |   |   |
|    | M 266.920   | 09/04 → 01/07   |   | OKOKOKO  |   |   |   |   |   |   |   |   |   |   |
|    | M 266.920   | 09/04 → 07/07   |   | —  |   |   |   |   | 1   |   |   |   |   |   |
|    | B(Alt) M 266.920  | 09/04 → 01/07   | AC  | VKMV 5PK1300   |   |   |   | 1   |   |   |   |   |   |   |
| <b>MERCEDES-BENZ</b>  <b>A-class (W169) A 170</b>       |   |   |   |  |   |   |   |   |   |   |   |   |   |   |
|    | M 266.940   | 09/04 → 01/07   |   | OKOKOKO  |   |   |   |   |   |   |   |   |   |   |
|    | M 266.940   | 09/04 → 07/07   |   | —  |   |   |   |   | 1   |   |   |   |   |   |
|    | B(Alt) M 266.940  | 09/04 → 01/07   | AC  | VKMV 5PK1300   |   |   |   | 1   |   |   |   |   |   |   |
| <b>MERCEDES-BENZ</b>  <b>A-class (W169) A 200</b>       |   |   |   |  |   |   |   |   |   |   |   |   |   |   |
|    | M 266.960   | 09/04 → 01/07   |   | OKOKOKO  |   |   |   |   |   |   |   |   |   |   |
|    | M 266.960   | 09/04 → 07/07   |   | —  |   |   |   |   | 1   |   |   |   |   |   |
|    | B(Alt) M 266.960  | 09/04 → 01/07   | AC  | VKMV 5PK1300   |   |   |   | 1   |   |   |   |   |   |   |
| <b>MERCEDES-BENZ</b>  <b>A-class (W169) A 200 T</b>     |   |   |   |  |   |   |   |   |   |   |   |   |   |   |
|    | M 266.980   | 09/05 → 01/07   |   | OKOKOKO  |   |   |   |   |   |   |   |   |   |   |
|    | M 266.980   | 09/05 → 07/07   |   | —  |   |   |   |   | 1   |   |   |   |   |   |
|    | B(Alt) M 266.980  | 09/05 → 01/07   | AC  | VKMV 5PK1300   |   |   |   | 1   |   |   |   |   |   |   |
| <b>MERCEDES-BENZ</b>  <b>A-class (W169) A 160 CDI</b>   |   |   |   |  |   |   |   |   |   |   |   |   |   |   |
|   | OM 640.942  | 09/04 → 01/07   |   | OKOKOKO  |   |   |   |   |   |   |   |   |   |   |
|    | OM 640.942  | 09/04 → 07/07   |   | —  |   |   |   |   | 1   |   |   |   |   |   |
|    | B(Alt) OM 640.942   | 09/04 → 01/07   | AC  | VKMV 5PK1745   |   |   |   | 1   |   |   |   |   |   |   |
| <b>MERCEDES-BENZ</b>  <b>A-class (W169) A 180 CDI</b> |   |   |   |  |   |   |   |   |   |   |   |   |   |   |
|    | OM 640.940  | 09/04 → 01/07   |   | OKOKOKO  |   |   |   |   |   |   |   |   |   |   |
|    | OM 640.940  | 09/04 → 07/07   |   | —  |   |   |   |   | 1   |   |   |   |   |   |
|    | B(Alt) OM 640.940   | 09/04 → 01/07   | AC  | VKMV 5PK1745   |   |   |   | 1   |   |   |   |   |   |   |
| <b>MERCEDES-BENZ</b>  <b>A-class (W169) A 200 CDI</b> |   |   |   |  |   |   |   |   |   |   |   |   |   |   |
|    | OM 640.941  | 09/04 → 01/07   |   | OKOKOKO  |   |   |   |   |   |   |   |   |   |   |
|    | OM 640.941  | 09/04 → 07/07   |   | —  |   |   |   |   | 1   |   |   |   |   |   |
|    | B(Alt) OM 640.941   | 09/04 → 01/07   | AC  | VKMV 5PK1745   |   |   |   | 1   |   |   |   |   |   |   |
| <b>MERCEDES-BENZ</b>  <b>B-class (W245) B 150</b>     |   |   |   |  |   |   |   |   |   |   |   |   |   |   |
|    | M 266.920   | 03/05 → 01/07   |   | OKOKOKO  |   |   |   |   |   |   |   |   |   |   |
|    | M 266.920   | 03/05 → 07/07   |   | —  |   |   |   |   | 1   |   |   |   |   |   |
|    | B(Alt) M 266.920  | 03/05 → 01/07   | AC  | VKMV 5PK1300   |   |   |   | 1   |   |   |   |   |   |   |
| <b>MERCEDES-BENZ</b>  <b>B-class (W245) B 170</b>     |   |   |   |  |   |   |   |   |   |   |   |   |   |   |
|    | M 266.940   | 03/05 → 01/07   |   | OKOKOKO  |   |   |   |   |   |   |   |   |   |   |
|    | M 266.940   | 03/05 → 07/07   |   | —  |   |   |   |   | 1   |   |   |   |   |   |
|    | B(Alt) M 266.940  | 03/05 → 01/07   | AC  | VKMV 5PK1300   |   |   |   | 1   |   |   |   |   |   |   |
| <b>MERCEDES-BENZ</b>  <b>B-class (W245) B 200</b>     |   |   |   |  |   |   |   |   |   |   |   |   |   |   |
|    | M 266.960   | 03/05 → 01/07   |   | OKOKOKO  |   |   |   |   |   |   |   |   |   |   |
|    | M 266.960   | 03/05 → 07/07   |   | —  |   |   |   |   | 1   |   |   |   |   |   |
|    | B(Alt) M 266.960  | 03/05 → 01/07   | AC  | VKMV 5PK1300   |   |   |   | 1   |   |   |   |   |   |   |
| <b>MERCEDES-BENZ</b>  <b>B-class (W245) B 200 T</b>   |   |   |   |  |   |   |   |   |   |   |   |   |   |   |
|    | M 266.980   | 03/05 → 01/07   |   | OKOKOKO  |   |   |   |   |   |   |   |   |   |   |
|    | M 266.980   | 03/05 → 07/07   |   | —  |   |   |   |   | 1   |   |   |   |   |   |
|    | B(Alt) M 266.980  | 03/05 → 01/07   | AC  | VKMV 5PK1300   |   |   |   | 1   |   |   |   |   |   |   |
| <b>MERCEDES-BENZ</b>  <b>B-class (W245) B 180 CDI</b> |   |   |   |  |   |   |   |   |   |   |   |   |   |   |
|    | OM 640.940  | 03/05 → 01/07   |   | OKOKOKO  |   |   |   |   |   |   |   |   |   |   |
|    | OM 640.940  | 03/05 → 07/07   |   | —  |   |   |   |   | 1   |   |   |   |   |   |
|    | B(Alt) OM 640.940   | 03/05 → 01/07   | AC  | VKMV 5PK1745   |   |   |   | 1   |   |   |   |   |   |   |
| <b>MERCEDES-BENZ</b>  <b>B-class (W245) B 200 CDI</b> |   |   |   |  |   |   |   |   |   |   |   |   |   |   |
|    | OM 640.941  | 03/05 → 01/07   |   | OKOKOKO  |   |   |   |   |   |   |   |   |   |   |
|    | OM 640.941  | 03/05 → 07/07   |   | —  |   |   |   |   | 1   |   |   |   |   |   |













































|  |  |  |                                    |  |  |  |  |  |  |  |
|--|---|---|---|--|---|---|---|---|---|---|
|  B(Alt)   | OM 640.941  | 03/05 → 01/07   | AC  | VKMV 5PK1745   |   | 1   |   |   |   |   |
| <b>MERCEDES-BENZ  C-class (W202) C 180</b>              |   |   |   |  |   |   |   |   |   |   |
|   | M 111.920, M 111.921  | 03/93 → 09/00   |   | OXOXOXO  |   |   |   |   |   |   |
|  | M 111.952   | 09/00 → 03/01   |   | OXOXOXO  |   |   |   |   |   |   |
|   | M 111.920, M 111.921  | 03/93 → 09/00   |   | VKPC 88622   |   |   | 1   |   |   |   |
|  | M 111.952   | 09/00 → 03/01   |   | VKPC 88854   |   |   | 1   |   |   |   |
|  B(Alt)   | M 111.920   | 03/93 → 09/00   | AC, Man. GBX,<br>→IMot. 181391  | VKMV 6PK2040<br>VKM 38022<br>VKM 38027   | 1   |   | 1   |   |   |   |
| B(Alt)   | M 111.920   | 03/93 → 09/00   | AC, Auto. GBX,<br>→IMot. 082686   | VKMV 6PK2040<br>VKM 38022<br>VKM 38027   | 1   | 1   |   |   |   |   |
| B(Alt)   | M 111.920   | 03/93 → 09/00   | AC, Man. GBX,<br>Mot. 181392 I→   | VKMV 6PK2155<br>VKM 38022<br>VKM 38027   | 1   |   | 1   |   |   |   |
| B(Alt)   | M 111.920   | 03/93 → 09/00   | AC, Auto. GBX,<br>Mot. 082687 I→  | VKMV 6PK2155<br>VKM 38022<br>VKM 38027   | 1   | 1   |   |   |   |   |
| B(Alt)   | M 111.952   | 09/00 → 03/01   | AC,                                | VKMV 6PK2135<br>VKM 38022<br>VKM 38027   | 1   |   | 1   |   |   |   |
| B(Alt)   | M 111.952   | 09/00 → 03/01   | AC,                               | VKMV 6PK2125<br>VKM 38022<br>VKM 38027   | 1   |   | 1   |   |   |   |
| <b>MERCEDES-BENZ  C-class (W202) C 200</b>            |   |   |   |  |   |   |   |   |   |   |
|   | M 111.941, M 111.945  | 01/94 → 03/01   |   | OXOXOXO  |   |   |   |   |   |   |
|   | M 111.941, M 111.945  | 01/94 → 03/01   |   | VKPC 88622   |   |   | 1   |   |   |   |
|  B(Alt)   | M 111.941, M 111.945  | 01/94 → 05/00   | AC, Man. GBX,<br>→IMot. 028943  | VKMV 6PK2040<br>VKM 38022<br>VKM 38027   | 1   |   | 1   |   |   |   |
| B(Alt)   | M 111.941, M 111.945  | 06/96 → 03/01   | AC,                              | VKMV 6PK2040<br>VKM 38022<br>VKM 38027   | 1   |   | 1   |   |   |   |
| B(Alt)   | M 111.941   | 06/96 → 03/01   | AC,  Man. GBX,<br>Mot. 028944 I→ | VKMV 6PK2155<br>VKM 38022<br>VKM 38027   | 1   |   | 1   |   |   |   |
| B(Alt)   | M 111.945   | 06/96 → 03/01   | AC,                              | VKMV 6PK2155<br>VKM 38022<br>VKM 38027   | 1   |   | 1   |   |   |   |
| <b>MERCEDES-BENZ  C-class (W202) C 200 Kompressor</b> |   |   |   |  |   |   |   |   |   |   |
|   | M 111.944, M 111.956  | 10/95 → 03/01   |   | OXOXOXO  |   |   |   |   |   |   |
|   | M 111.944   | 10/95 → 03/01   |   | VKPC 88631   |   |   | 1   |   |   |   |
|  | M 111.956   | 09/00 → 03/01   |   | VKPC 88854   |   |   | 1   |   |   |   |
|  B(Alt)   | M 111.944, M 111.956  | 10/95 → 03/01   | AC,                              | VKMV 6PK1775<br>VKM 38022<br>VKM 38027   | 1   |   | 1   |   |   |   |
| B(Alt)   | M 111.944, M 111.956  | 10/95 → 03/01   | AC,                              | VKMV 6PK1760<br>VKM 38022<br>VKM 38027   | 1   |   | 1   |   |   |   |
| B(Alt)   | M 111.944, M 111.956  | 10/95 → 03/01   | AC,                              | VKMV 6PK1875<br>VKM 38022<br>VKM 38027   | 1   |   | 1   |   |   |   |
| B(Alt)   | M 111.944, M 111.956  | 10/95 → 03/01   | AC,                              | VKMV 6PK1860<br>VKM 38022<br>VKM 38027   | 1   |   | 1   |   |   |   |
| B(Comp)  | M 111.944   | 10/95 → 03/01   |   | VKMV 6PK1330   |   |   | 1   |   |   |   |

|   | B(Comp) | M 111.956            | 09/00 → 03/01 |   | VKMOV 6PK1355                           |   |  |  |  | 1 |   |  |  |  |
|---|---------|----------------------|---------------|---|---|---|--|--|--|---|---|--|--|--|
| <b>MERCEDES-BENZ</b> <b>C-class (W202) C 220</b>            |         |                      |               |   |   |   |  |  |  |   |   |  |  |  |
|   |         | M 111.961            | 03/93 → 05/00 |   | OXOXOXO                                 |   |  |  |  |   |   |  |  |  |
|   |         | M 111.961            | 03/93 → 05/00 |   | VKPC 88622                              |   |  |  |  |   | 1 |  |  |  |
|   | B(Alt)  | M 111.961            | 03/93 → 05/00 | AC, Man. GBX,<br>→IMot. 024580                      | VKMOV 6PK2140<br>VKM 38022<br>VKM 38027 | 1 |  |  |  | 1 |   |  |  |  |
| <b>MERCEDES-BENZ</b> <b>C-class (W202) C 230</b>            |         |                      |               |   |   |   |  |  |  |   |   |  |  |  |
|   |         | M 111.974            | 06/96 → 06/98 |   | OXOXOXO                                 |   |  |  |  |   |   |  |  |  |
|   |         | M 111.974            | 06/96 → 06/98 |   | VKPC 88622                              |   |  |  |  |   | 1 |  |  |  |
|   | B(Alt)  | M 111.974            | 06/96 → 06/98 | AC,   | VKMOV 6PK2055<br>VKM 38022<br>VKM 38027 | 1 |  |  |  | 1 |   |  |  |  |
|   | B(Alt)  | M 111.974            | 06/96 → 06/98 | AC,   | VKMOV 6PK2040<br>VKM 38022<br>VKM 38027 | 1 |  |  |  | 1 |   |  |  |  |
|   | B(Alt)  | M 111.974            | 06/96 → 06/98 | AC,   | VKMOV 6PK2155<br>VKM 38022<br>VKM 38027 | 1 |  |  |  | 1 |   |  |  |  |
|   | B(Alt)  | M 111.974            | 06/96 → 06/98 | AC,   | VKMOV 6PK2140<br>VKM 38022<br>VKM 38027 | 1 |  |  |  | 1 |   |  |  |  |
| <b>MERCEDES-BENZ</b> <b>C-class (W202) C 230 Kompressor</b> |         |                      |               |   |   |   |  |  |  |   |   |  |  |  |
|   |         | M 111.975            | 10/95 → 09/00 |   | OXOXOXO                                 |   |  |  |  |   |   |  |  |  |
|   |         | M 111.975            | 10/95 → 09/00 |   | VKPC 88631                              |   |  |  |  |   | 1 |  |  |  |
|   | B(Alt)  | M 111.975            | 10/95 → 09/00 | AC,   | VKMOV 6PK1775<br>VKM 38022<br>VKM 38027 | 1 |  |  |  | 1 |   |  |  |  |
|   | B(Alt)  | M 111.975            | 10/95 → 09/00 | AC,   | VKMOV 6PK1760<br>VKM 38022<br>VKM 38027 | 1 |  |  |  | 1 |   |  |  |  |
|   | B(Alt)  | M 111.975            | 10/95 → 09/00 | AC,   | VKMOV 6PK1875<br>VKM 38022<br>VKM 38027 | 1 |  |  |  | 1 |   |  |  |  |
|   | B(Alt)  | M 111.975            | 10/95 → 09/00 | AC,   | VKMOV 6PK1860<br>VKM 38022<br>VKM 38027 | 1 |  |  |  | 1 |   |  |  |  |
|   | B(Comp) | M 111.975            | 10/95 → 09/00 |   | VKMOV 6PK1330                           |   |  |  |  | 1 |   |  |  |  |
| <b>MERCEDES-BENZ</b> <b>C-class (W202) C 240</b>            |         |                      |               |   |   |   |  |  |  |   |   |  |  |  |
|   |         | M 112.910, M 112.915 | 06/97 → 03/01 |   | OXOXOXO                                 |   |  |  |  |   |   |  |  |  |
|   |         | M 112.910, M 112.915 | 06/97 → 03/01 | (EUR)   | VKPC 88846                              |   |  |  |  |   | 1 |  |  |  |
|   | B(Alt)  | M 112.910, M 112.915 | 06/97 → 03/01 | AC  | VKMOV 6PK2315<br>VKM 31041<br>VKM 38026 | 1 |  |  |  | 1 |   |  |  |  |
|   | B(Alt)  | M 112.910, M 112.915 | 06/97 → 03/01 | AC  | VKMOV 6PK2390<br>VKM 31041<br>VKM 38026 | 1 |  |  |  | 1 |   |  |  |  |
| <b>MERCEDES-BENZ</b> <b>C-class (W202) C 280</b>            |         |                      |               |   |   |   |  |  |  |   |   |  |  |  |
|   |         | M 104.941, M 112.920 | 05/93 → 03/01 |   | OXOXOXO                                 |   |  |  |  |   |   |  |  |  |
|   |         | M 104.941            | 05/93 → 05/00 |   | VKPC 88824                              |   |  |  |  |   | 1 |  |  |  |
|   |         | M 112.920            | 06/97 → 03/01 | (EUR)   | VKPC 88846                              |   |  |  |  |   | 1 |  |  |  |
|   | B(Alt)  | M 104.941            | 05/93 → 05/00 | AC, Man. GBX,<br>→IMot. 004058                      | VKMOV 6PK2176                           |   |  |  |  | 1 |   |  |  |  |
|   | B(Alt)  | M 104.941            | 05/93 → 05/00 | AC, Auto. GBX,<br>→IMot. 034966                     | VKMOV 6PK2176                           |   |  |  |  | 1 |   |  |  |  |
|   | B(Alt)  | M 104.941            | 05/93 → 05/00 | AC, , Man. GBX,<br>Mot. 004059 I→,<br>→IMot. 006600 | VKMOV 6PK2245<br>VKM 38100              | 1 |  |  |  | 1 |   |  |  |  |

















|   |  |  |   |  |  |  |  |  |  |  |  |
|---|---|---|--|--|---|---|---|---|---|---|---|
| B(Alt)  | M 104.941   | 05/93 → 05/00   | AC,  Auto. GBX, Mot. 034967 I→, →IMot. 075764 | VKMV 6PK2245<br>VKM 38100  | 1   |   | 1   |   |   |   |   |
| B(Alt)  | M 112.920   | 06/97 → 03/01   | AC   | VKMV 6PK2315<br>VKM 31041<br>VKM 38026   | 1   | 1   |   |   |   |   |   |
| B(Alt)  | M 112.920   | 06/97 → 03/01   | AC   | VKMV 6PK2390<br>VKM 31041<br>VKM 38026   | 1   | 1   | 1   |   |   |   |   |
| <b>MERCEDES-BENZ  C-class (W202) C 36 AMG</b>    |   |   |  |  |   |   |   |   |   |   |   |
|    | M 104.941 (AMG 3.6)   | 05/94 → 05/00   |  | <b>OXOXOXO</b>   |   |   |   |   |   |   |   |
|    | M 104.941 (AMG 3.6)   | 05/94 → 05/00   |  | VKPC 88824   |   |   |   | 1   |   |   |   |
|    | B(Alt) M 104.941 (AMG 3.6)  | 05/94 → 05/00   | AC, Man. GBX, →IMot. 004058  | VKMV 6PK2176   |   |   | 1   |   |   |   |   |
| B(Alt)  | M 104.941 (AMG 3.6)   | 05/94 → 05/00   | AC, Auto. GBX, →IMot. 034966   | VKMV 6PK2176   |   |   | 1   |   |   |   |   |
| B(Alt)  | M 104.941 (AMG 3.6)   | 05/94 → 05/00   | AC,  Man. GBX, Mot. 004059 I→, →IMot. 006600  | VKMV 6PK2245<br>VKM 38100  | 1   |   | 1   |   |   |   |   |
| B(Alt)  | M 104.941 (AMG 3.6)   | 05/94 → 05/00   | AC,  Auto. GBX, Mot. 034967 I→, →IMot. 075764 | VKMV 6PK2245<br>VKM 38100  | 1   |   | 1   |   |   |   |   |
| <b>MERCEDES-BENZ  C-class (W202) C 43 AMG</b>  |   |   |  |  |   |   |   |   |   |   |   |
|    | M 113.944   | 08/97 → 03/01   |  | <b>OXOXOXO</b>   |   |   |   |   |   |   |   |
|    | M 113.944   | 08/97 → 03/01   | (EUR)  | VKPC 88846   |   |   |   | 1   |   |   |   |
|    | B(Alt) M 113.944  | 08/97 → 03/01   |  | VKMV 6PK2390<br>VKM 31041<br>VKM 38026   | 1   | 1   | 1   |   |   |   |   |
| <b>MERCEDES-BENZ  C-class (W202) C 200 D</b>   |   |   |  |  |   |   |   |   |   |   |   |
|    | OM 601.913,<br>OM 604.915   | 03/93 → 03/01   |  | <b>OXOXOXO</b>   |   |   |   |   |   |   |   |
|    | OM 601.913,<br>OM 604.915   | 03/93 → 03/01   |  | VKPC 88625   |   |   |   | 1   |   |   |   |
|    | B(Alt) OM 601.913,<br>OM 604.915  | 03/93 → 03/01   | AC   | VKMA 38002<br>VKMV 6PK2050<br>VKM 38001  | 1   | 1   | 1   |   |   |   |   |
| B(Alt)  | OM 601.913,<br>OM 604.915   | 03/93 → 03/01   | AC   | VKMA 38003<br>VKMV 6PK2120<br>VKM 38001  | 1   | 1   | 1   |   |   |   |   |
| <b>MERCEDES-BENZ  C-class (W202) C 200 CDI</b> |   |   |  |  |   |   |   |   |   |   |   |
|    | OM 611.960  | 03/98 → 03/01   |  | <b>OXOXOXO</b>   |   |   |   |   |   |   |   |
|    | OM 611.960  | 03/98 → 03/01   |  | VKPC 88843   |   |   |   | 1   |   |   |   |
|    | B(Alt) OM 611.960   | 03/98 → 03/01   | AC,   | VKMV 6PK2196<br>VKM 31041<br>VKM 38020   | 1   | 1   | 1   |   |   |   |   |
| B(Alt)  | OM 611.960  | 03/98 → 03/01   | AC,   | VKMV 6PK2160<br>VKM 31041<br>VKM 38020   | 1   | 1   | 1   |   |   |   |   |
| B(Alt)  | OM 611.960  | 03/98 → 03/01   | AC,   | VKMA 38020<br>VKMV 6PK2270<br>VKM 31041<br>VKM 38020                               | 1   | 1   | 1   |   |   |   |   |
| B(Alt)  | OM 611.960  | 03/98 → 03/01   | AC,   | VKMV 6PK2241<br>VKM 31041<br>VKM 38020   | 1   | 1   | 1   |   |   |   |   |
| <b>MERCEDES-BENZ  C-class (W202) C 220 D</b>   |   |   |  |  |   |   |   |   |   |   |   |
|    | OM 604.910  | 08/93 → 03/01   |  | <b>OXOXOXO</b>   |   |   |   |   |   |   |   |

|   |  |  |              |  |  |  |  |  |  |  |  |  |
|---|---|---|---|--|---|---|---|---|---|---|---|---|
|   | OM 604.910  | 08/93 → 03/01   |   | VKPC 88625   |   |   |   |   |   | 1   |   |   |
|   | <b>B(Alt)</b> OM 604.910  | 08/93 → 03/01   | <b>AC</b>   | VKMA 38002<br>VKMV 6PK2050<br>VKM 38001  | 1   |   | 1   |   |   |   |   |   |
|   | <b>B(Alt)</b> OM 604.910  | 08/93 → 03/01   | <b>AC</b>   | VKMA 38003<br>VKMV 6PK2120<br>VKM 38001  | 1   |   | 1   |   |   |   |   |   |
| <b>MERCEDES-BENZ</b>  <b>C-class (W202) C 220 CDI</b>          |   |   |   |  |   |   |   |   |   |   |   |   |
|   | OM 611.960  | 09/97 → 03/01   |   | <b>OKOKOKO</b>   |   |   |   |   |   |   |   |   |
|   | OM 611.960  | 09/97 → 03/01   |   | VKPC 88843   |   |   |   |   |   | 1   |   |   |
|   | <b>B(Alt)</b> OM 611.960  | 09/97 → 03/01   | <b>AC</b> ,  | VKMV 6PK2196<br>VKM 31041<br>VKM 38020   | 1   |   | 1   |   |   |   |   |   |
|   | <b>B(Alt)</b> OM 611.960  | 09/97 → 03/01   | <b>AC</b> ,  | VKMV 6PK2160<br>VKM 31041<br>VKM 38020   | 1   |   | 1   |   |   |   |   |   |
|   | <b>B(Alt)</b> OM 611.960  | 09/97 → 03/01   | <b>AC</b> ,  | VKMA 38020<br>VKMV 6PK2270<br>VKM 31041<br>VKM 38020                               | 1   |   | 1   |   |   |   |   |   |
|   | <b>B(Alt)</b> OM 611.960  | 09/97 → 03/01   | <b>AC</b> ,  | VKMV 6PK2241<br>VKM 31041<br>VKM 38020   | 1   |   | 1   |   |   |   |   |   |
| <b>MERCEDES-BENZ</b>  <b>C-class (W202) C 250 D</b>            |   |   |   |  |   |   |   |   |   |   |   |   |
|    | OM 605.910  | 05/93 → 05/00   |   | <b>OKOKOKO</b>   |   |   |   |   |   |   |   |   |
|   | OM 605.910  | 05/93 → 05/00   |   | VKPC 88620   |   |   |   |   |   | 1   |   |   |
|   | <b>B(Alt)</b> OM 605.910  | 05/93 → 05/00   | <b>AC</b>   | VKMA 38007<br>VKMV 6PK2080<br>VKM 38001  | 1   |   | 1   |   |   |   |   |   |
|   | <b>B(Alt)</b> OM 605.910  | 05/93 → 05/00   | <b>AC</b>   | VKMV 6PK2140<br>VKM 38001  | 1   |   | 1   |   |   |   |   |   |
| <b>MERCEDES-BENZ</b>  <b>C-class (W202) C 250 Turbo-D</b>    |   |   |   |  |   |   |   |   |   |   |   |   |
|   | OM 605.960  | 10/95 → 03/01   |   | <b>OKOKOKO</b>   |   |   |   |   |   |   |   |   |
|   | OM 605.960  | 10/95 → 03/01   |   | VKPC 88842   |   |   |   |   |   | 1   |   |   |
|   | <b>B(Alt)</b> OM 605.960  | 10/95 → 03/01   | <b>AC</b>   | VKMA 38007<br>VKMV 6PK2080<br>VKM 38001  | 1   |   | 1   |   |   |   |   |   |
|   | <b>B(Alt)</b> OM 605.960  | 10/95 → 03/01   | <b>AC</b>   | VKMV 6PK2140<br>VKM 38001  | 1   |   | 1   |   |   |   |   |   |
| <b>MERCEDES-BENZ</b>  <b>C-class (W203) C 160 Kompressor</b> |   |   |   |  |   |   |   |   |   |   |   |   |
|   | <b>B(Alt)</b> M 271.921   | 05/02 → 01/07   | <b>AC</b>   | VKMV 7PK2420   |   |   | 1   |   |   |   |   |   |
| <b>MERCEDES-BENZ</b>  <b>C-class (W203) C 180</b>            |   |   |   |  |   |   |   |   |   |   |   |   |
|   | M 111.951   | 10/00 → 05/02   |   | <b>OKOKOKO</b>   |   |   |   |   |   |   |   |   |
|   | M 111.951   | 10/00 → 05/02   |   | —  |   |   |   |   |   | 1   |   |   |
|   | <b>B(Alt)</b> M 111.951   | 10/00 → 05/02   | <b>AC</b>   | VKMV 6PK2035<br>VKM 38022<br>VKM 38027   | 1   |   | 1   |   |   |   |   |   |
|   | <b>B(Alt)</b> M 111.951   | 10/00 → 05/02   | <b>AC</b>   | VKMV 6PK2135<br>VKM 38022<br>VKM 38027   | 1   |   | 1   |   |   |   |   |   |
| <b>MERCEDES-BENZ</b>  <b>C-class (W203) C 180 Kompressor</b> |   |   |   |  |   |   |   |   |   |   |   |   |
|   | M 271.946   | 05/02 → 12/05   |   | <b>OKOKOKO</b>   |   |   |   |   |   |   |   |   |
|   | M 271.946   | 05/02 → 07/04   |   | VKPC 88853   |   |   |   |   |   | 1   |   |   |
|   | <b>B(Alt)</b> M 271.946   | 05/02 → 01/07   | <b>AC</b>   | VKMV 7PK2420   |   |   | 1   |   |   |   |   |   |
| <b>MERCEDES-BENZ</b>  <b>C-class (W203) C 200 Kompressor</b> |   |   |   |  |   |   |   |   |   |   |   |   |
|   | M 271.940, M 271.942  | 05/02 → 12/05   |   | <b>OKOKOKO</b>   |   |   |   |   |   |   |   |   |
|   | M 111.955   | 05/00 → 05/02   |   | <b>OKOKOKO</b>   |   |   |   |   |   |   |   |   |
|   | M 271.940, M 271.942  | 05/02 → 07/04   |   | VKPC 88853   |   |   |   |   |   | 1   |   |   |
|   | M 111.955   | 05/00 → 05/02   |   | VKPC 88854   |   |   |   |   |   | 1   |   |   |





|  |  |  |  |  |  |  |  |  |  |  |  |  |
|--|---|---|---|--|---|---|---|---|---|---|---|---|
|  B(Alt)   | M 271.940   | 05/02 → 05/02   | AC  | VKMV 6PK1870<br>VKM 38022<br>VKM 38027   | 1   |   | 1   |   |   |   |   |   |
|  |   |   |   |  |   | 1   |   |   |   |   |   |   |
| B(Alt)   | M 271.940, M 271.942  | 05/02 → 01/07   | AC  | VKMV 7PK2420   |   |   | 1   |   |   |   |   |   |
| B(Alt)   | M 111.955   | 05/00 → 05/02   | AC  | VKMV 6PK1870<br>VKM 38022<br>VKM 38027   | 1   |   | 1   |   |   |   |   |   |
|  |   |   |   |  |   | 1   |   |   |   |   |   |   |
| B(Comp)  | M 111.955   | 05/00 → 05/02   |   | VKMV 6PK1355   |   |   | 1   |   |   |   |   |   |
| <b>MERCEDES-BENZ</b>  C-class (W203) C 230            |   |   |   |  |   |   |   |   |   |   |   |   |
|  B(Alt)   | M 272.920   | 01/05 → 01/07   |   | VKMV 6PK2404   |   |   | 1   |   |   |   |   |   |
| <b>MERCEDES-BENZ</b>  C-class (W203) C 230 Kompressor |   |   |   |  |   |   |   |   |   |   |   |   |
|  M 271.948  |   | 05/02 → 01/07   |   | OXOXOXO  |   |   |   |   |   |   |   |   |
|  | M 111.981   | 03/01 → 05/02   |   | OXOXOXO  |   |   |   |   |   |   |   |   |
|  M 271.948  |   | 05/02 → 07/04   |   | VKPC 88853   |   |   |   |   | 1   |   |   |   |
|  | M 111.981   | 03/01 → 05/02   |   | VKPC 88854   |   |   |   |   | 1   |   |   |   |
|  B(Alt)   | M 271.948   | 05/02 → 01/07   | AC  | VKMV 7PK2420   |   |   | 1   |   |   |   |   |   |
| B(Alt)   | M 111.981   | 03/01 → 05/02   | AC  | VKMV 6PK1870<br>VKM 38022<br>VKM 38027   | 1   |   | 1   |   |   |   |   |   |
|  |   |   |   |  |   | 1   |   |   |   |   |   |   |
| B(Comp)  | M 111.981   | 03/01 → 05/02   |   | VKMV 6PK1355   |   |   | 1   |   |   |   |   |   |
| <b>MERCEDES-BENZ</b>  C-class (W203) C 240            |   |   |   |  |   |   |   |   |   |   |   |   |
|  M 112.912, M 112.916                                 |   | 05/00 → 12/05   |   | OXOXOXO  |   |   |   |   |   |   |   |   |
|  M 112.912, M 112.916                                 |   | 05/00 → 07/04   | (EUR)   | VKPC 88846   |   |   |   |   | 1   |   |   |   |
|  B(Alt)  | M 112.912, M 112.916  | 05/00 → 02/03   |   | VKMV 6PK2390<br>VKM 31041<br>VKM 38026   | 1   |   | 1   |   |   |   |   |   |
|  |   |   |   |  |   | 1   |   |   |   |   |   |   |
| B(Alt)   | M 112.912, M 112.916  | 02/03 → 01/07   |   | VKM 31041<br>VKM 38026   | 1   |   | 1   |   |   |   |   |   |
|  |   |   |   |  |   | 1   |   |   |   |   |   |   |
| <b>MERCEDES-BENZ</b>  C-class (W203) C 280          |   |   |   |  |   |   |   |   |   |   |   |   |
|  B(Alt)   | M 272.940, M 272.941  | 01/05 → 01/07   |   | VKMV 6PK2404   |   |   | 1   |   |   |   |   |   |
| <b>MERCEDES-BENZ</b>  C-class (W203) C 320          |   |   |   |  |   |   |   |   |   |   |   |   |
|  M 112.946, M 112.953                               |   | 05/00 → 12/05   |   | OXOXOXO  |   |   |   |   |   |   |   |   |
|  M 112.946, M 112.953                               |   | 05/00 → 07/04   | (EUR)   | VKPC 88846   |   |   |   |   | 1   |   |   |   |
|  B(Alt)   | M 112.946, M 112.953  | 05/00 → 02/03   |   | VKMV 6PK2390<br>VKM 31041<br>VKM 38026   | 1   |   | 1   |   |   |   |   |   |
|  |   |   |   |  |   | 1   |   |   |   |   |   |   |
| B(Alt)   | M 112.946, M 112.953  | 02/03 → 01/07   |   | VKM 31041<br>VKM 38026   | 1   |   | 1   |   |   |   |   |   |
|  |   |   |   |  |   | 1   |   |   |   |   |   |   |
| <b>MERCEDES-BENZ</b>  C-class (W203) C 32 AMG       |   |   |   |  |   |   |   |   |   |   |   |   |
|  M 112.961  |   | 02/01 → 12/05   |   | OXOXOXO  |   |   |   |   |   |   |   |   |
|  M 112.961  |   | 02/01 → 07/04   |   | —  |   |   |   |   | 1   |   |   |   |
| <b>MERCEDES-BENZ</b>  C-class (W203) C 350          |   |   |   |  |   |   |   |   |   |   |   |   |
|  B(Alt)   | M 272.960, M 272.970  | 01/05 → 01/07   |   | VKMV 6PK2404   |   |   | 1   |   |   |   |   |   |
| <b>MERCEDES-BENZ</b>  C-class (W203) C 55 AMG       |   |   |   |  |   |   |   |   |   |   |   |   |
|  M 113.988  |   | 02/04 → 07/04   |   | VKPC 88846   |   |   |   |   | 1   |   |   |   |
|  B(Alt)   | M 113.988   | 02/04 → 01/07   |   | VKM 31041<br>VKM 38026   | 1   |   | 1   |   |   |   |   |   |
|  |   |   |   |  |   | 1   |   |   |   |   |   |   |
| <b>MERCEDES-BENZ</b>  C-class (W203) C 200 CDI      |   |   |   |  |   |   |   |   |   |   |   |   |
|  OM 611.962,<br>OM 646.962                          |   | 09/00 → 12/05   |   | OXOXOXO  |   |   |   |   |   |   |   |   |
|  OM 611.962,<br>OM 646.962                          |   | 09/00 → 07/04   |   | VKPC 88843   |   |   |   |   | 1   |   |   |   |
|  | OM 646.962  | 04/03 → 07/04   |   | VKPC 88855   |   |   |   |   | 1   |   |   |   |
|  B(Alt)   | OM 611.962,<br>OM 646.962   | 09/00 → 01/07   | AC  | VKMV 6PK2190<br>VKM 31041<br>VKM 38020   | 1   |   | 1   |   |   |   |   |   |
|  |   |   |   |  |   | 1   |   |   |   |   |   |   |
| B(Alt)   | OM 611.962,<br>OM 646.962   | 09/00 → 01/07   | AC  | VKMA 38021<br>VKMV 6PK2260   | 1   | 1   | 1   |   |   |   |   |   |
|  |   |   |   |  |   |   |   |   | 1   |   |   |   |

|   |  |  |  |  |  |  |  |  |  |  |  |  |
|---|---|---|---|--|---|---|---|---|---|---|---|---|
|   |   |   |   | VKM 31041<br>VKM 38020   | 1   | 1   |   |   |   |   |   |   |
| <b>MERCEDES-BENZ</b>  <b>C-class (W203) C 220 CDI</b>          |   |   |   |  |   |   |   |   |   |   |   |   |
|   | OM 611.962  | 05/00 → 12/05   |   | <b>OXOXOXO</b>   |   |   |   |   |   |   |   |   |
|   | OM 611.962  | 05/00 → 07/04   |   | VKPC 88843   |   |   |   | 1   |   |   |   |   |
|   | OM 646.963  | 02/04 → 07/04   |   | VKPC 88855   |   |   |   | 1   |   |   |   |   |
|   | <b>B(Alt)</b> OM 611.962,<br>OM 646.963   | 05/00 → 01/07   | <b>AC</b>   | VKMV 6PK2190<br>VKM 31041<br>VKM 38020   | 1   | 1   | 1   |   |   |   |   |   |
|   | <b>B(Alt)</b> OM 611.962,<br>OM 646.963   | 05/00 → 01/07   | <b>AC</b>   | VKMA 38021<br>VKMV 6PK2260<br>VKM 31041<br>VKM 38020                               | 1   | 1   | 1   | 1   |   |   |   |   |
|   |   |   |   |  | 1   |   | 1   |   |   |   |   |   |
| <b>MERCEDES-BENZ</b>  <b>C-class (W203) C 270 CDI</b>          |   |   |   |  |   |   |   |   |   |   |   |   |
|   | OM 612.962  | 12/00 → 12/05   |   | <b>OXOXOXO</b>   |   |   |   |   |   |   |   |   |
|   | OM 612.962  | 12/00 → 07/04   |   | VKPC 88843   |   |   |   | 1   |   |   |   |   |
|   | <b>B(Alt)</b> OM 612.962  | 12/00 → 01/07   | <b>AC</b>   | VKMV 6PK2190<br>VKM 31041<br>VKM 38020   | 1   | 1   | 1   |   |   |   |   |   |
|   | <b>B(Alt)</b> OM 612.962  | 12/00 → 01/07   | <b>AC</b>   | VKMA 38021<br>VKMV 6PK2260<br>VKM 31041<br>VKM 38020                               | 1   | 1   | 1   | 1   |   |   |   |   |
|   |   |   |   |  | 1   |   | 1   |   |   |   |   |   |
| <b>MERCEDES-BENZ</b>  <b>C-class (W203) C 30 CDI</b>          |   |   |   |  |   |   |   |   |   |   |   |   |
|   | OM 612.990  | 09/02 → 12/05   |   | <b>OXOXOXO</b>   |   |   |   |   |   |   |   |   |
|   | <b>B(Alt)</b> OM 612.990  | 09/02 → 01/07   |   | VKMV 6PK2255<br>VKM 31041<br>VKM 38020   | 1   | 1   | 1   |   |   |   |   |   |
| <b>MERCEDES-BENZ</b>  <b>C-class (W203) C 320 CDI</b>        |   |   |   |  |   |   |   |   |   |   |   |   |
|   | <b>B(Alt)</b> OM 642.910  | 01/05 → 01/07   |   | VKMV 7PK2035   |   |   | 1   |   |   |   |   |   |
| <b>MERCEDES-BENZ</b>  <b>C-class (W204) C 180 Kompressor</b> |   |   |   |  |   |   |   |   |   |   |   |   |
|   | M 271.952   | 01/07 → 07/07   |   | VKPC 88853   |   |   |   | 1   |   |   |   |   |
|   | <b>B(Alt)</b> M 271.952   | 01/07 → 06/07   |   | VKMV 7PK2420   |   |   | 1   |   |   |   |   |   |
| <b>MERCEDES-BENZ</b>  <b>C-class (W204) C 200 Kompressor</b> |   |   |   |  |   |   |   |   |   |   |   |   |
|   | M 271.950   | 01/07 → 07/07   |   | VKPC 88853   |   |   |   | 1   |   |   |   |   |
|   | <b>B(Alt)</b> M 271.950   | 01/07 → 06/07   |   | VKMV 7PK2420   |   |   | 1   |   |   |   |   |   |
| <b>MERCEDES-BENZ</b>  <b>C-class (W204) C 230</b>            |   |   |   |  |   |   |   |   |   |   |   |   |
|   | <b>B(Alt)</b> M 272.921   | 01/07 → 06/07   |   | VKMV 6PK2404   |   |   | 1   |   |   |   |   |   |
| <b>MERCEDES-BENZ</b>  <b>C-class (W204) C 200 CDI</b>        |   |   |   |  |   |   |   |   |   |   |   |   |
|   | OM 646.811  | 01/07 → 07/07   |   | VKPC 88855   |   |   |   | 1   |   |   |   |   |
|   | <b>B(Alt)</b> OM 646.811  | 01/07 → 06/07   |   | VKMA 38021<br>VKMV 6PK2260<br>VKM 31041<br>VKM 38020                               | 1   | 1   | 1   | 1   |   |   |   |   |
|   |   |   |   |  | 1   |   | 1   |   |   |   |   |   |
| <b>MERCEDES-BENZ</b>  <b>C-class (W204) C 220 CDI</b>        |   |   |   |  |   |   |   |   |   |   |   |   |
|   | OM 646.811  | 01/07 → 07/07   |   | VKPC 88855   |   |   |   | 1   |   |   |   |   |
|   | <b>B(Alt)</b> OM 646.811  | 01/07 → 06/07   |   | VKMA 38021<br>VKMV 6PK2260<br>VKM 31041<br>VKM 38020                               | 1   | 1   | 1   | 1   |   |   |   |   |
|   |   |   |   |  | 1   |   | 1   |   |   |   |   |   |
| <b>MERCEDES-BENZ</b>  <b>C-class (W204) C 320 CDI</b>        |   |   |   |  |   |   |   |   |   |   |   |   |
|   | <b>B(Alt)</b> OM 642 960  | 01/07 → 06/07   |   | VKMV 7PK2035   |   |   | 1   |   |   |   |   |   |
| <b>MERCEDES-BENZ</b>  <b>CLK (W208) 200</b>                  |   |   |   |  |   |   |   |   |   |   |   |   |
|   | M 111.941, M 111.945  | 06/97 → 06/02   |   | <b>OXOXOXO</b>   |   |   |   |   |   |   |   |   |
|   | M 111.941, M 111.945  | 06/97 → 06/02   |   | VKPC 88622   |   |   |   | 1   |   |   |   |   |
|   | <b>B(Alt)</b> M 111.941, M 111.945  | 06/97 → 06/02   | <b>AC, <del>AC</del></b>  | VKMV 6PK2055<br>VKM 38022<br>VKM 38027   | 1   |   | 1   |   |   |   |   |   |
|   |   |   |   |  |   | 1   |   |   |   |   |   |   |







|        |  |  |      |  |  |  |  |  |  |  |  |  |  |
|--------|---|---|---|--|---|---|---|---|---|---|---|---|---|
| B(Alt) | M 111.941, M 111.945  | 06/97 → 06/02   | AC,  | VKMV 6PK2040<br>VKM 38022<br>VKM 38027   | 1   | 1   |   |   |   |   |   |   |   |
| B(Alt) | M 111.941, M 111.945  | 06/97 → 06/02   | AC,  | VKMV 6PK2155<br>VKM 38022<br>VKM 38027   | 1   | 1   |   |   |   |   |   |   |   |
| B(Alt) | M 111.941, M 111.945  | 06/97 → 06/02   | AC,  | VKMV 6PK2140<br>VKM 38022<br>VKM 38027   | 1   | 1   |   |   |   |   |   |   |   |
| B(Alt) | M 111.941, M 111.945  | 03/98 → 03/02   | AC,  | VKMV 6PK2055<br>VKM 38022<br>VKM 38027   | 1   | 1   |   |   |   |   |   |   |   |



### MERCEDES-BENZ CLK (W208) 200 Kompressor

|   |                      |               |   |  |   |   |  |   |  |  |  |  |  |
|---|----------------------|---------------|---|--|---|---|--|---|--|--|--|--|--|
|  | M 111.944, M 111.956 | 06/97 → 06/02 |   | <b>OKOKOKO</b>                         |   |   |  |   |  |  |  |  |  |
|  | M 111.944            | 06/97 → 06/00 |   | VKPC 88631                             |   |   |  | 1 |  |  |  |  |  |
|   | M 111.956            | 06/00 → 06/02 |   | VKPC 88854                             |   |   |  | 1 |  |  |  |  |  |
|  | B(Alt) M 111.956     | 06/00 → 06/02 | AC,  | VKMV 6PK1870<br>VKM 38022<br>VKM 38027 | 1 | 1 |  |   |  |  |  |  |  |
| B(Alt)  | M 111.956            | 06/00 → 06/02 | AC,  | VKM 38022<br>VKM 38027                 | 1 | 1 |  |   |  |  |  |  |  |
| B(Comp)   | M 111.944            | 06/97 → 06/00 |   | VKMV 6PK1330                           |   |   |  | 1 |  |  |  |  |  |
| B(Comp)   | M 111.956            | 06/00 → 06/02 |   | VKMV 6PK1355                           |   |   |  | 1 |  |  |  |  |  |



### MERCEDES-BENZ CLK (W208) 230 Kompressor

|   |                                    |               |   |  |   |   |  |   |  |  |  |  |  |
|---|------------------------------------|---------------|---|--|---|---|--|---|--|--|--|--|--|
|   | M 111.973, M 111.975,<br>M 111.982 | 06/97 → 06/02 |   | <b>OKOKOKO</b>                         |   |   |  |   |  |  |  |  |  |
|  | M 111.973, M 111.975<br>M 111.982  | 06/97 → 06/00 |   | VKPC 88631                             |   |   |  | 1 |  |  |  |  |  |
|   |                                    | 06/00 → 06/02 |   | VKPC 88854                             |   |   |  | 1 |  |  |  |  |  |
|  | B(Alt) M 111.973, M 111.975        | 06/97 → 06/00 | AC,  | VKMV 6PK1875<br>VKM 38022<br>VKM 38027 | 1 | 1 |  |   |  |  |  |  |  |
| B(Alt)  | M 111.973, M 111.975               | 06/97 → 06/00 | AC,  | VKMV 6PK1860<br>VKM 38022<br>VKM 38027 | 1 | 1 |  |   |  |  |  |  |  |
| B(Comp)   | M 111.973, M 111.975               | 06/97 → 06/00 |   | VKMV 6PK1330                           |   |   |  | 1 |  |  |  |  |  |
| B(Comp)   | M 111.982                          | 06/00 → 06/02 |   | VKMV 6PK1355                           |   |   |  | 1 |  |  |  |  |  |



### MERCEDES-BENZ CLK (W208) 320

|   |                  |               |       |  |   |   |  |   |  |  |  |  |  |
|---|------------------|---------------|-------|--|---|---|--|---|--|--|--|--|--|
|  | M 112.940        | 06/97 → 06/02 |       | <b>OKOKOKO</b>                         |   |   |  |   |  |  |  |  |  |
|  | M 112.940        | 06/97 → 06/02 | (EUR) | VKPC 88846                             |   |   |  | 1 |  |  |  |  |  |
|  | B(Alt) M 112.940 | 06/97 → 06/02 |       | VKMV 6PK2390<br>VKM 31041<br>VKM 38026 | 1 | 1 |  |   |  |  |  |  |  |

### MERCEDES-BENZ CLK (W208) 430

|   |                  |               |       |  |   |   |  |   |  |  |  |  |  |
|---|------------------|---------------|-------|--|---|---|--|---|--|--|--|--|--|
|  | M 113.943        | 07/98 → 06/02 |       | <b>OKOKOKO</b>                         |   |   |  |   |  |  |  |  |  |
|  | M 113.943        | 07/98 → 06/02 | (EUR) | VKPC 88846                             |   |   |  | 1 |  |  |  |  |  |
|  | B(Alt) M 113.943 | 07/98 → 06/02 |       | VKMV 6PK2390<br>VKM 31041<br>VKM 38026 | 1 | 1 |  |   |  |  |  |  |  |

### MERCEDES-BENZ CLK (W208) 55 AMG

















































|   |                             |               |  |  |   |   |  |   |  |  |  |  |  |
|---|-----------------------------|---------------|--|--|---|---|--|---|--|--|--|--|--|
|  | M 113.981, M 113.984        | 08/99 → 06/02 |  | <b>OKOKOKO</b>                         |   |   |  |   |  |  |  |  |  |
|  | M 113.981, M 113.984        | 08/99 → 06/02 |  | VKPC 88846                             |   |   |  | 1 |  |  |  |  |  |
|  | B(Alt) M 113.981, M 113.984 | 08/99 → 06/02 |  | VKMV 6PK2390<br>VKM 31041<br>VKM 38026 | 1 | 1 |  |   |  |  |  |  |  |







































### MERCEDES-BENZ CLK (W209) 200 CGI







































|   |                  |               |  |                |  |  |  |   |  |  |  |  |  |
|---|------------------|---------------|--|----------------|--|--|--|---|--|--|--|--|--|
|  | M 271.942        | 07/03 → 12/06 |  | <b>OKOKOKO</b> |  |  |  |   |  |  |  |  |  |
|  | M 271.942        | 07/03 → 12/06 |  | VKPC 88853     |  |  |  | 1 |  |  |  |  |  |
|  | B(Alt) M 271.942 | 07/03 → 12/06 |  | VKMV 7PK2420   |  |  |  | 1 |  |  |  |  |  |





































### MERCEDES-BENZ CLK (W209) 200 Kompressor



















































|   |           |               |  |                |  |  |  |   |  |  |  |  |  |
|---|-----------|---------------|--|----------------|--|--|--|---|--|--|--|--|--|
|  | M 271.940 | 09/02 → 12/06 |  | <b>OKOKOKO</b> |  |  |  |   |  |  |  |  |  |
|  | M 271.940 | 09/02 → 12/06 |  | VKPC 88853     |  |  |  | 1 |  |  |  |  |  |













































|   |  |  |  |  |  |  |  |  |  |  |  |  |  |
|---|---|---|---|--|---|---|---|---|---|---|---|---|---|
|  B(Alt)                                       | M 271.940   | 09/02 → 12/06   |   | VKMV 7PK2420   |   |   |   | 1   |   |   |   |   |   |
| <b>MERCEDES-BENZ  CLK (W209) 240</b>         |   |   |   |  |   |   |   |   |   |   |   |   |   |
|   | M 112.912   | 06/02 → 12/06   |   | OXOXOXO  |   |   |   |   |   |   |   |   |   |
|   | M 112.912   | 06/02 → 12/06   | EUR   | VKPC 88846   |   |   |   |   | 1   |   |   |   |   |
|  B(Alt)                                       | M 112.912   | 06/02 → 02/03   |   | VKMV 6PK2390<br>VKM 31041<br>VKM 38026   |   |   |   | 1   | 1   |   |   |   |   |
| B(Alt)  | M 112.912   | 02/03 → 12/06   |   | VKM 31041<br>VKM 38026   | 1   |   |   | 1   |   |   |   |   |   |
| <b>MERCEDES-BENZ  CLK (W209) 280</b>         |   |   |   |  |   |   |   |   |   |   |   |   |   |
|  B(Alt)                                       | M 272.940   | 01/05 → 12/06   |   | VKMV 6PK2404   |   |   |   | 1   |   |   |   |   |   |
| <b>MERCEDES-BENZ  CLK (W209) 320</b>         |   |   |   |  |   |   |   |   |   |   |   |   |   |
|   | M 112.955   | 06/02 → 12/05   |   | OXOXOXO  |   |   |   |   |   |   |   |   |   |
|  B(Alt)                                       | M 112.955   | 06/02 → 12/06   |   | VKMV 6PK2390<br>VKM 31041<br>VKM 38026   |   |   |   | 1   | 1   |   |   |   |   |
|   |   |   |   |  | 1   |   |   |   |   |   |   |   |   |
| <b>MERCEDES-BENZ  CLK (W209) 350</b>         |   |   |   |  |   |   |   |   |   |   |   |   |   |
|  B(Alt)                                       | M 272.960   | 01/05 → 12/06   |   | VKMV 6PK2404   |   |   |   | 1   |   |   |   |   |   |
| <b>MERCEDES-BENZ  CLK (W209) 500</b>         |   |   |   |  |   |   |   |   |   |   |   |   |   |
|   | M 113.968   | 06/02 → 12/06   |   | OXOXOXO  |   |   |   |   |   |   |   |   |   |
|   | M 113.968   | 06/02 → 12/06   | EUR   | VKPC 88846   |   |   |   |   | 1   |   |   |   |   |
|  B(Alt)                                       | M 113.968   | 06/02 → 12/06   |   | VKM 31041<br>VKM 38026   |   |   |   | 1   | 1   |   |   |   |   |
|   |   |   |   |  | 1   |   |   |   |   |   |   |   |   |
| <b>MERCEDES-BENZ  CLK (W209) 55 AMG</b>    |   |   |   |  |   |   |   |   |   |   |   |   |   |
|   | M 113.987   | 09/02 → 12/06   |   | OXOXOXO  |   |   |   |   |   |   |   |   |   |
|   | M 113.987   | 09/02 → 12/06   |   | VKPC 88846   |   |   |   |   | 1   |   |   |   |   |
|  B(Alt)                                     | M 113.987   | 09/02 → 12/06   |   | VKM 31041<br>VKM 38026   |   |   |   | 1   | 1   |   |   |   |   |
|   |   |   |   |  | 1   |   |   |   |   |   |   |   |   |
| <b>MERCEDES-BENZ  CLK (W209) 220 CDI</b>   |   |   |   |  |   |   |   |   |   |   |   |   |   |
|   | OM 646.963  | 01/05 → 12/06   |   | OXOXOXO  |   |   |   |   |   |   |   |   |   |
|   | OM 646.963  | 01/05 → 12/06   |   | VKPC 88855   |   |   |   |   | 1   |   |   |   |   |
|  B(Alt)                                     | OM 646.963  | 01/05 → 12/06   | AC  | VKMV 6PK2190<br>VKM 31041<br>VKM 38020   |   |   |   | 1   | 1   |   |   |   |   |
| B(Alt)  | OM 646.963  | 01/05 → 12/06   | AC  | VKMA 38021<br>VKMV 6PK2260<br>VKM 31041<br>VKM 38020                               | 1   |   |   | 1   | 1   |   |   |   |   |
|   |   |   |   |  | 1   |   |   |   | 1   |   |   |   |   |
| <b>MERCEDES-BENZ  CLK (W209) 270 CDI</b>   |   |   |   |  |   |   |   |   |   |   |   |   |   |
|   | OM 612.962,<br>OM 612.967   | 10/02 → 12/06   |   | OXOXOXO  |   |   |   |   |   |   |   |   |   |
|   | OM 612.962,<br>OM 612.967   | 10/02 → 12/06   |   | VKPC 88843   |   |   |   |   | 1   |   |   |   |   |
|  B(Alt)                                     | OM 612.962,<br>OM 612.967   | 10/02 → 12/06   |   | VKMA 38021<br>VKMV 6PK2260<br>VKM 31041<br>VKM 38020                               |   |   |   | 1   | 1   | 1   |   |   |   |
|   |   |   |   |  | 1   |   |   |   | 1   |   |   |   |   |
| <b>MERCEDES-BENZ  CLK (W209) 320 CDI</b>   |   |   |   |  |   |   |   |   |   |   |   |   |   |
|  B(Alt)                                     | OM 642.910  | 01/05 → 12/06   |   | VKMV 7PK2035   |   |   |   | 1   |   |   |   |   |   |
| <b>MERCEDES-BENZ  CLS</b>                  |   |   |   |  |   |   |   |   |   |   |   |   |   |
|   |   | 10/04 → 10/07   |   | OXOXOXO  |   |   |   |   |   |   |   |   |   |
| <b>MERCEDES-BENZ  E-class (W124) E 200</b> |   |   |   |  |   |   |   |   |   |   |   |   |   |
|   | M 111.940   | 06/93 → 03/98   |   | OXOXOXO  |   |   |   |   |   |   |   |   |   |
|   | M 111.940   | 06/93 → 03/98   |   | VKPC 88622   |   |   |   |   | 1   |   |   |   |   |
|  B(Alt)                                     | M 111.940   | 06/93 → 03/98   | AC  | VKMV 6PK2040<br>VKM 38022<br>VKM 38027   |   |   |   | 1   | 1   |   |   |   |   |
|   |   |   |   |  | 1   |   |   |   | 1   |   |   |   |   |

|  |        |  |  |        |  |  |  |  |  |  |  |
|--|--------|---|---|---|--|---|---|---|---|---|---|
|  | B(Alt) | M 111.940   | 06/93 → 03/98   | AC  | VKMV 6PK2140<br>VKM 38022<br>VKM 38027   | 1   | 1   |   |   |   |   |
| <b>MERCEDES-BENZ  E-class (W124) E 220</b>      |        |   |   |   |  |   |   |   |   |   |   |
|   |        | M 111.960   | 06/93 → 03/98   |   | <b>ΟΛΟΚΛΟΝΟ</b>  |   |   |   |   |   |   |
|   |        | M 111.960   | 06/93 → 03/98   |   | VKPC 88622   |   |   | 1   |   |   |   |
|   | B(Alt) | M 111.960   | 06/93 → 03/98   | AC  | VKMV 6PK2040<br>VKM 38022<br>VKM 38027   | 1   | 1   |   |   |   |   |
|  | B(Alt) | M 111.960   | 06/93 → 03/98   | AC  | VKMV 6PK2140<br>VKM 38022<br>VKM 38027   | 1   | 1   |   |   |   |   |
| <b>MERCEDES-BENZ  E-class (W124) E 280</b>      |        |   |   |   |  |   |   |   |   |   |   |
|   |        | M 104.942   | 06/93 → 06/96   |   | <b>ΟΛΟΚΛΟΝΟ</b>  |   |   |   |   |   |   |
|   |        | M 104.942   | 06/93 → 06/96   | →IMot. 005789, 048696   | VKPC 88824   |   |   | 1   |   |   |   |
|  |        | M 104.942   | 06/93 → 06/96   | Mot. 005790, 048697  →  | VKPC 88836   |   |   | 1   |   |   |   |
|   | B(Alt) | M 104.942   | 06/93 → 06/96   | AC, Man. GBX,<br>Mot. 005790  →   | VKMV 6PK2475<br>VKM 38100  | 1   | 1   |   |   |   |   |
|  | B(Alt) | M 104.942   | 06/93 → 06/96   | AC, Auto. GBX,<br>Mot. 048697  →  | VKMV 6PK2475<br>VKM 38100  | 1   | 1   |   |   |   |   |
| <b>MERCEDES-BENZ  E-class (W124) E 300</b>      |        |   |   |   |  |   |   |   |   |   |   |
|   |        | M 103.985   | 06/93 → 06/96   |   | <b>ΟΛΟΚΛΟΝΟ</b>  |   |   |   |   |   |   |
|    |        | M 103.985   | 06/93 → 06/96   |   | VKPC 88810   |   |   | 1   |   |   |   |
|  |        | M 104.980   | 06/93 → 06/96   | (AUS)   | VKPC 88816   |   |   | 1   |   |   |   |
|  |        | M 104.980   | 06/93 → 06/96   | (AUS)   | VKPC 88825   |   |   | 1   |   |   |   |
|   | B(Alt) | M 103.985   | 06/93 → 06/95   | AC  | VKMV 6PK2170   |   | 1   |   |   |   |   |
|  | B(Alt) | M 103.985   | 06/93 → 06/95   | AC,  | VKMV 6PK2257   |   | 1   |   |   |   |   |
|  | B(Alt) | M 103.985   | 06/93 → 06/95   | AC,  | VKMV _____   |   | 1   |   |   |   |   |
| <b>MERCEDES-BENZ  E-class (W124) E 320</b>    |        |   |   |   |  |   |   |   |   |   |   |
|   |        | M 104.992, M 104.995  | 06/93 → 03/98   |   | <b>ΟΛΟΚΛΟΝΟ</b>  |   |   |   |   |   |   |
|   |        | M 104.992, M 104.995  | 06/93 → 03/98   | →IMot. 004356, 072236   | VKPC 88824   |   |   | 1   |   |   |   |
|  |        | M 104.992, M 104.995  | 06/93 → 03/98   | Mot. 004357, 072237  →  | VKPC 88836   |   |   | 1   |   |   |   |
|   | B(Alt) | M 104.992   | 06/93 → 03/98   | AC, Man. GBX,<br>Mot. 004357  →,<br>→IMot. 005602                                       | VKMV 6PK2475<br>VKM 38100  | 1   | 1   |   |   |   |   |
|  | B(Alt) | M 104.992   | 06/93 → 03/98   | AC, Auto. GBX,<br>Mot. 072237  →,<br>→IMot. 102820                                      | VKMV 6PK2475<br>VKM 38100  | 1   | 1   |   |   |   |   |
| <b>MERCEDES-BENZ  E-class (W124) E 36 AMG</b> |        |   |   |   |  |   |   |   |   |   |   |
|   |        | M 104.992 (AMG 3.6)   | 06/93 → 03/98   |   | <b>ΟΛΟΚΛΟΝΟ</b>  |   |   |   |   |   |   |
|   |        | M 104.992 (AMG 3.6)   | 05/94 → 03/98   | →IMot. 004356, 072236   | VKPC 88824   |   |   | 1   |   |   |   |
|  |        | M 104.992 (AMG 3.6)   | 05/94 → 03/98   | Mot. 004357, 072237  →  | VKPC 88836   |   |   | 1   |   |   |   |
|   | B(Alt) | M 104.992 (AMG 3.6)   | 06/93 → 03/98   | AC, Man. GBX,<br>Mot. 004357  →,<br>→IMot. 005602                                       | VKMV 6PK2475<br>VKM 38100  | 1   | 1   |   |   |   |   |
|  | B(Alt) | M 104.992 (AMG 3.6)   | 06/93 → 03/98   | AC, Auto. GBX,<br>Mot. 072237  →,<br>→IMot. 102820                                      | VKMV 6PK2475<br>VKM 38100  | 1   | 1   |   |   |   |   |
| <b>MERCEDES-BENZ  E-class (W124) E 420</b>    |        |   |   |   |  |   |   |   |   |   |   |
|   |        | M 119.975   | 06/93 → 06/95   |   | <b>ΟΛΟΚΛΟΝΟ</b>  |   |   |   |   |   |   |
|   |        | M 119.975   | 06/93 → 06/95   | →IMot. 020770   | —  |   |   | 1   |   |   |   |
|  |        | M 119.975   | 06/93 → 06/95   | Mot. 020771  →  | —  |   |   | 1   |   |   |   |
| <b>MERCEDES-BENZ  E-class (W124) E 500</b>    |        |   |   |   |  |   |   |   |   |   |   |
|   |        | M 119.974   | 06/93 → 06/95   |   | <b>ΟΛΟΚΛΟΝΟ</b>  |   |   |   |   |   |   |
|   |        | M 119.974   | 06/93 → 06/95   | →IMot. 010204   | —  |   |   | 1   |   |   |   |

|   |  |  |  |  |  |  |  |  |  |  |  |
|---|---|---|---|--|---|---|---|---|---|---|---|
|   | M 119.974   | 06/93 → 06/95   | Mot. 010205 I→  | —  |   |   |   |   |   | 1   |   |
| <b>MERCEDES-BENZ  E-class (W124) E 60 AMG</b>        |   |   |   |  |   |   |   |   |   |   |   |
|   | M 119.974   | 05/94 → 06/95   |   | OKOKOKO  |   |   |   |   |   |   |   |
|   | M 119.974   | 05/94 → 06/95   | →IMot. 010204   | —  |   |   |   |   |   | 1   |   |
|   | M 119.974   | 05/94 → 06/95   | Mot. 010205 I→  | —  |   |   |   |   |   | 1   |   |
| <b>MERCEDES-BENZ  E-class (W124) E 200 D</b>         |   |   |   |  |   |   |   |   |   |   |   |
|   | OM 601.912  | 06/93 → 06/95   |   | OKOKOKO  |   |   |   |   |   |   |   |
|   | OM 601.912  | 06/93 → 06/95   | →IMot. 195582   | VKPC 88608   |   |   |   |   |   | 1   |   |
|   | OM 601.912  | 06/93 → 06/95   | Mot. 195583 I→  | VKPC 88620   |   |   |   |   |   | 1   |   |
|   | <b>B(Alt)</b> OM 601.912  | 06/93 → 06/95   | AC  | VKMA 38002<br>VKMV 6PK2050<br>VKM 38001  | 1   | 1   |   |   |   |   |   |
|   | <b>B(Alt)</b> OM 601.912  | 06/93 → 06/95   | AC  | VKMA 38003<br>VKMV 6PK2120<br>VKM 38001  | 1   | 1   |   |   |   |   |   |
|   | <b>B(Alt)</b> OM 601.912  | 06/93 → 06/95   | AC  | VKMA 38002<br>VKMV 6PK2050<br>VKM 38001  | 1   | 1   |   |   |   |   |   |
| <b>MERCEDES-BENZ  E-class (W124) E 250 D</b>         |   |   |   |  |   |   |   |   |   |   |   |
|   | OM 605.911  | 06/93 → 06/96   |   | OKOKOKO  |   |   |   |   |   |   |   |
|   | OM 605.911  | 06/93 → 06/96   |   | VKPC 88620   |   |   |   |   |   | 1   |   |
|   | <b>B(Alt)</b> OM 605.911  | 06/93 → 06/96   | AC  | VKMA 38007<br>VKMV 6PK2080<br>VKM 38001  | 1   | 1   |   |   |   |   |   |
|   | <b>B(Alt)</b> OM 605.911  | 06/93 → 06/96   | AC  | VKMA 38007<br>VKMV 6PK2080<br>VKM 38001  | 1   | 1   |   |   |   |   |   |
|   | <b>B(Alt)</b> OM 605.911  | 06/93 → 06/96   | AC  | VKMA 38005<br>VKMV 6PK2100<br>VKM 38001  | 1   | 1   |   |   |   |   |   |
|   | <b>B(Alt)</b> OM 605.911  | 06/93 → 06/96   | AC  | VKMA 38007<br>VKMV 6PK2080<br>VKM 38001  | 1   | 1   |   |   |   |   |   |
| <b>MERCEDES-BENZ  E-class (W124) E 250 Turbo-D</b>   |   |   |   |  |   |   |   |   |   |   |   |
|   | OM 602.962  | 06/93 → 06/96   |   | OKOKOKO  |   |   |   |   |   |   |   |
|   | OM 602.962  | 06/93 → 06/96   | →IMot. 020852, 033729   | VKPC 88620   |   |   |   |   |   | 1   |   |
|   | OM 602.962  | 06/93 → 06/96   | Mot. 020853, 033730 I→  | VKPC 88842   |   |   |   |   |   | 1   |   |
|   | <b>B(Alt)</b> OM 602.962  | 06/93 → 06/96   | AC  | VKMA 38004<br>VKMV 6PK2030<br>VKM 38001  | 1   | 1   |   |   |   |   |   |
|   | <b>B(Alt)</b> OM 602.962  | 06/93 → 06/96   | AC  | VKMA 38005<br>VKMV 6PK2100<br>VKM 38001  | 1   | 1   |   |   |   |   |   |
|   | <b>B(Alt)</b> OM 602.962  | 06/93 → 06/96   | AC  | VKMA 38004<br>VKMV 6PK2030<br>VKM 38001  | 1   | 1   |   |   |   |   |   |
| <b>MERCEDES-BENZ  E-class (W124) E 300 D</b>       |   |   |   |  |   |   |   |   |   |   |   |
|   | OM 606.910  | 06/93 → 06/96   |   | OKOKOKO  |   |   |   |   |   |   |   |
|   | OM 606.910  | 06/93 → 06/96   |   | VKPC 88620   |   |   |   |   |   | 1   |   |
|   | <b>B(Alt)</b> OM 606.910  | 06/93 → 06/96   | AC  | VKMA 38007<br>VKMV 6PK2080<br>VKM 38001  | 1   | 1   |   |   |   |   |   |
|   | <b>B(Alt)</b> OM 606.910  | 06/93 → 06/96   | AC  | VKMA 38007<br>VKMV 6PK2080<br>VKM 38001  | 1   | 1   |   |   |   |   |   |
|   | <b>B(Alt)</b> OM 606.910  | 06/93 → 06/96   | AC  | VKMA 38005<br>VKMV 6PK2100<br>VKM 38001  | 1   | 1   |   |   |   |   |   |
|   | <b>B(Alt)</b> OM 606.910  | 06/93 → 06/96   | AC  | VKMA 38007<br>VKMV 6PK2080<br>VKM 38001  | 1   | 1   |   |   |   |   |   |
| <b>MERCEDES-BENZ  E-class (W124) E 300 Turbo-D</b> |   |   |   |  |   |   |   |   |   |   |   |
|   | OM 603.960,<br>OM 603.963   | 06/93 → 06/96   |   | OKOKOKO  |   |   |   |   |   |   |   |
|   | OM 603.960,<br>OM 603.963   | 06/93 → 06/96   | →IMot. 054622   | VKPC 88620   |   |   |   |   |   | 1   |   |
|   | OM 603.960  | 06/93 → 06/96   | Mot. 054623 I→  | VKPC 88842   |   |   |   |   |   | 1   |   |
|   | <b>B(Alt)</b> OM 603.960,<br>OM 603.963   | 06/93 → 06/96   | AC  | VKMA 38007<br>VKMV 6PK2080<br>VKM 38001  | 1   | 1   |   |   |   |   |   |
|   | <b>B(Alt)</b> OM 603.960,<br>OM 603.963   | 06/93 → 06/96   | AC  | VKMA 38007<br>VKMV 6PK2080<br>VKM 38001  | 1   | 1   |   |   |   |   |   |
|   | <b>B(Alt)</b> OM 603.960,<br>OM 603.963   | 06/93 → 06/96   | AC  | VKMA 38005<br>VKMV 6PK2155<br>VKM 38001  | 1   | 1   |   |   |   |   |   |
| <b>MERCEDES-BENZ  E-class (W210) E 200</b>         |   |   |   |  |   |   |   |   |   |   |   |
|   | M 111.942   | 06/95 → 08/00   |   | OKOKOKO  |   |   |   |   |   |   |   |
|   | M 111.942   | 06/95 → 08/00   |   | VKPC 88622   |   |   |   |   |   | 1   |   |
|   | <b>B(Alt)</b> M 111.942   | 06/95 → 08/00   | AC  | VKMA 38022<br>VKMV 6PK2055<br>VKM 38027  | 1   | 1   |   |   |   |   |   |
|   | <b>B(Alt)</b> M 111.942   | 06/95 → 08/00   | AC  | VKMA 38022<br>VKMV 6PK2055<br>VKM 38027  | 1   | 1   |   |   |   |   |   |





















































|  |  |  |  |  |  |  |  |  |  |  |
|--|---|---|---|--|---|---|---|---|---|---|
| B(Alt)   | M 111.942   | 06/95 → 08/00   | AC  | VKMV 6PK2155<br>VKM 38022<br>VKM 38027   | 1   | 1   |   |   |   |   |
| <b>MERCEDES-BENZ  E-class (W210) E 200 Kompressor</b> |   |   |   |  |   |   |   |   |   |   |
|   | M 111.947, M 111.957  | 06/97 → 03/03   |   | <b>ΟΧΘΙΟΧΟ</b>   |   |   |   |   |   |   |
|   | M 111.947   | 06/97 → 03/03   |   | VKPC 88631   |   |   | 1   |   |   |   |
|  | M 111.957   | 08/00 → 03/03   |   | VKPC 88854   |   |   | 1   |   |   |   |
|   | B(Alt) M 111.947  | 06/97 → 03/03   | AC  | VKMV 6PK1775<br>VKM 38022<br>VKM 38027   | 1   | 1   |   |   |   |   |
|  | B(Alt) M 111.947  | 06/97 → 03/03   | AC  | VKMV 6PK1875<br>VKM 38022<br>VKM 38027   | 1   | 1   |   |   |   |   |
|  | B(Alt) M 111.957  | 08/00 → 03/03   |   | VKMV 6PK1870<br>VKM 38022<br>VKM 38027   | 1   | 1   |   |   |   |   |
|  | B(Comp) M 111.947   | 06/97 → 03/03   |   | VKMV 6PK1330   |   | 1   |   |   |   |   |
|  | B(Comp) M 111.957   | 08/00 → 03/03   |   | VKMV 6PK1355   |   | 1   |   |   |   |   |
| <b>MERCEDES-BENZ  E-class (W210) E 230</b>            |   |   |   |  |   |   |   |   |   |   |
|   | M 111.970   | 06/95 → 06/97   |   | <b>ΟΧΘΙΟΧΟ</b>   |   |   |   |   |   |   |
|   | M 111.970   | 06/95 → 06/97   |   | VKPC 88622   |   |   | 1   |   |   |   |
|   | B(Alt) M 111.970  | 06/95 → 06/97   | AC  | VKMV 6PK2055<br>VKM 38022<br>VKM 38027   | 1   | 1   |   |   |   |   |
|  | B(Alt) M 111.970  | 06/95 → 06/97   | AC  | VKMV 6PK2155<br>VKM 38022<br>VKM 38027   | 1   | 1   |   |   |   |   |
| <b>MERCEDES-BENZ  E-class (W210) E 240</b>          |   |   |   |  |   |   |   |   |   |   |
|   | M 112.911, M 112.914  | 06/97 → 03/03   |   | <b>ΟΧΘΙΟΧΟ</b>   |   |   |   |   |   |   |
|   | M 112.911, M 112.914  | 06/97 → 03/03   | (EUR)   | VKPC 88846   |   |   | 1   |   |   |   |
|   | B(Alt) M 112.911, M 112.914   | 06/97 → 03/03   | AC  | VKMV 6PK2390<br>VKM 31041<br>VKM 38026   | 1   | 1   |   |   |   |   |
| <b>MERCEDES-BENZ  E-class (W210) E 280</b>          |   |   |   |  |   |   |   |   |   |   |
|   | M 104.945, M 112.921  | 01/96 → 03/03   |   | <b>ΟΧΘΙΟΧΟ</b>   |   |   |   |   |   |   |
|   | M 104.945   | 01/96 → 06/97   |   | VKPC 88824   |   |   | 1   |   |   |   |
|  | M 112.921   | 12/96 → 03/03   | (EUR)   | VKPC 88846   |   |   | 1   |   |   |   |
|   | B(Alt) M 104.945  | 01/96 → 06/97   | AC, Man. GBX,<br>→IMot. 000500  | VKMV 6PK2245<br>VKM 38100  | 1   | 1   |   |   |   |   |
|  | B(Alt) M 104.945  | 01/96 → 06/97   | AC, Auto. GBX,<br>→IMot. 002627   | VKMV 6PK2245<br>VKM 38100  | 1   | 1   |   |   |   |   |
|  | B(Alt) M 112.921  | 12/96 → 03/03   | AC  | VKMV 6PK2390<br>VKM 31041<br>VKM 38026   | 1   | 1   |   |   |   |   |
| <b>MERCEDES-BENZ  E-class (W210) E 320</b>          |   |   |   |  |   |   |   |   |   |   |
|   | M 104.992, M 112.941  | 06/95 → 03/03   |   | <b>ΟΧΘΙΟΧΟ</b>   |   |   |   |   |   |   |
|   | M 104.992   | 06/95 → 06/97   |   | VKPC 88824   |   |   | 1   |   |   |   |
|  | M 112.941   | 12/96 → 03/03   | (EUR)   | VKPC 88846   |   |   | 1   |   |   |   |
|   | B(Alt) M 104.995  | 06/95 → 06/97   | AC, →IMot. 34379  | VKMV 6PK2245<br>VKM 38100  | 1   | 1   |   |   |   |   |
|  | B(Alt) M 112.941  | 12/96 → 03/03   |   | VKMV 6PK2390<br>VKM 31041<br>VKM 38026   | 1   | 1   |   |   |   |   |
| <b>MERCEDES-BENZ  E-class (W210) E 420</b>          |   |   |   |  |   |   |   |   |   |   |
|   | M 119.985   | 01/96 → 06/97   |   | <b>ΟΧΘΙΟΧΟ</b>   |   |   |   |   |   |   |
|   | M 119.985   | 01/96 → 06/97   |   | —  |   |   | 1   |   |   |   |
|   | B(Alt) M 119.985  | 01/96 → 06/97   | AC  | VKMV 6PK2510   |   | 1   |   |   |   |   |
| <b>MERCEDES-BENZ  E-class (W210) E 430</b>          |   |   |   |  |   |   |   |   |   |   |
|   | M 113.940   | 06/97 → 03/03   |   | <b>ΟΧΘΙΟΧΟ</b>   |   |   |   |   |   |   |

















































|  |  |  |  |  |  |  |  |  |  |  |  |  |
|--|---|---|---|--|---|---|---|---|---|---|---|---|
|    | M 113.940   | 06/97 → 03/03   | (EUR)   | VKPC 88846   |   |   |   |   |   | 1   |   |   |
|    | <b>B(Alt)</b> M 113.940   | 06/97 → 03/03   |   | VKMV 6PK2390<br>VKM 31041<br>VKM 38026   | 1   | 1   | 1   |   |   |   |   |   |
| <b>MERCEDES-BENZ</b>  <b>E-class (W210) E 50 AMG</b>        |   |   |   |  |   |   |   |   |   |   |   |   |
|    | M 119.985 (AMG 5.0)   | 02/96 → 08/97   |   | ΟΧΘΟΧΟ   |   |   |   |   |   |   |   |   |
|    | M 119.985 (AMG 5.0)   | 02/96 → 08/97   |   | —  |   |   |   |   | 1   |   |   |   |
|    | <b>B(Alt)</b> M 119.985 (AMG 5.0)   | 02/96 → 08/97   | AC  | VKMV 6PK2510   |   |   | 1   |   |   |   |   |   |
| <b>MERCEDES-BENZ</b>  <b>E-class (W210) E 55 AMG</b>        |   |   |   |  |   |   |   |   |   |   |   |   |
|    | M 113.980   | 08/97 → 03/03   |   | ΟΧΘΟΧΟ   |   |   |   |   |   |   |   |   |
|    | M 113.980   | 08/97 → 03/03   | (EUR)   | VKPC 88846   |   |   |   |   | 1   |   |   |   |
|    | <b>B(Alt)</b> M 113.980   | 08/97 → 03/03   |   | VKMV 6PK2390<br>VKM 31041<br>VKM 38026   | 1   | 1   | 1   |   |   |   |   |   |
| <b>MERCEDES-BENZ</b>  <b>E-class (W210) E 200 D</b>         |   |   |   |  |   |   |   |   |   |   |   |   |
|    | OM 604.917  | 01/96 → 03/02   |   | ΟΧΘΟΧΟ   |   |   |   |   |   |   |   |   |
|    | OM 604.917  | 01/96 → 03/02   |   | VKPC 88625   |   |   |   |   | 1   |   |   |   |
|    | <b>B(Alt)</b> OM 604.917  | 01/96 → 03/02   | AC  | VKMA 38002<br>VKMV 6PK2050<br>VKM 38001  | 1   | 1   | 1   |   |   |   |   |   |
|    | <b>B(Alt)</b> OM 604.917  | 01/96 → 03/02   | AC  | VKMA 38003<br>VKMV 6PK2120<br>VKM 38001  | 1   | 1   | 1   |   |   |   |   |   |
| <b>MERCEDES-BENZ</b>  <b>E-class (W210) E 200 CDI</b>       |   |   |   |  |   |   |   |   |   |   |   |   |
|   | OM 611.961  | 06/98 → 03/02   |   | ΟΧΘΟΧΟ   |   |   |   |   |   |   |   |   |
|    | OM 611.961  | 06/98 → 03/02   |   | VKPC 88843   |   |   |   |   | 1   |   |   |   |
|    | <b>B(Alt)</b> OM 611.961  | 06/98 → 03/02   | AC  | VKMA 38020<br>VKMV 6PK2270<br>VKM 31041<br>VKM 38020                               | 1   | 1   | 1   |   |   |   |   |   |
|    | <b>B(Alt)</b> OM 611.961  | 06/98 → 03/02   | AC  | VKMA 38002<br>VKMV 6PK2050<br>VKM 38001  | 1   | 1   | 1   |   |   |   |   |   |
|    | <b>B(Alt)</b> OM 604.912  | 06/95 → 03/02   | AC  | VKMA 38003<br>VKMV 6PK2120<br>VKM 38001  | 1   | 1   | 1   |   |   |   |   |   |
| <b>MERCEDES-BENZ</b>  <b>E-class (W210) E 220 D</b>       |   |   |   |  |   |   |   |   |   |   |   |   |
|    | OM 604.912  | 06/95 → 03/02   |   | ΟΧΘΟΧΟ   |   |   |   |   |   |   |   |   |
|    | OM 604.912  | 06/95 → 03/02   |   | VKPC 88625   |   |   |   |   | 1   |   |   |   |
|    | <b>B(Alt)</b> OM 604.912  | 06/95 → 03/02   | AC  | VKMA 38002<br>VKMV 6PK2050<br>VKM 38001  | 1   | 1   | 1   |   |   |   |   |   |
|    | <b>B(Alt)</b> OM 604.912  | 06/95 → 03/02   | AC  | VKMA 38003<br>VKMV 6PK2120<br>VKM 38001  | 1   | 1   | 1   |   |   |   |   |   |
| <b>MERCEDES-BENZ</b>  <b>E-class (W210) E 220 CDI</b>     |   |   |   |  |   |   |   |   |   |   |   |   |
|    | OM 611.961  | 06/98 → 03/03   |   | ΟΧΘΟΧΟ   |   |   |   |   |   |   |   |   |
|    | OM 611.961  | 06/98 → 03/03   |   | VKPC 88843   |   |   |   |   | 1   |   |   |   |
|    | <b>B(Alt)</b> OM 611.961  | 06/98 → 03/03   | AC  | VKMV 6PK2196<br>VKM 31041<br>VKM 38020   | 1   | 1   | 1   |   |   |   |   |   |
|    | <b>B(Alt)</b> OM 611.961  | 06/98 → 03/03   | AC  | VKMA 38020<br>VKMV 6PK2270<br>VKM 31041<br>VKM 38020                               | 1   | 1   | 1   |   |   |   |   |   |
| <b>MERCEDES-BENZ</b>  <b>E-class (W210) E 250 D</b>       |   |   |   |  |   |   |   |   |   |   |   |   |
|    | OM 605.912  | 06/95 → 07/99   |   | ΟΧΘΟΧΟ   |   |   |   |   |   |   |   |   |
|    | OM 605.912  | 06/95 → 07/99   |   | VKPC 88620   |   |   |   |   | 1   |   |   |   |
|    | <b>B(Alt)</b> OM 605.912  | 06/95 → 07/99   | AC  | VKMA 38007<br>VKMV 6PK2080<br>VKM 38001  | 1   | 1   | 1   |   |   |   |   |   |
|    | <b>B(Alt)</b> OM 605.912  | 06/95 → 07/99   | AC  | VKMV 6PK2140<br>VKM 38001  | 1   | 1   | 1   |   |   |   |   |   |
| <b>MERCEDES-BENZ</b>  <b>E-class (W210) E 250 Turbo-D</b> |   |   |   |  |   |   |   |   |   |   |   |   |
|    | OM 605.962  | 06/97 → 07/99   |   | ΟΧΘΟΧΟ   |   |   |   |   |   |   |   |   |
|    | OM 605.962  | 06/97 → 07/99   |   | VKPC 88842   |   |   |   |   | 1   |   |   |   |



















































|   |  |  |  |  |  |  |  |  |  |  |  |  |
|---|---|---|---|--|---|---|---|---|---|---|---|---|
|    | B(Alt)  | OM 605.962  | 06/97 → 07/99   | AC   | VKMA 38007<br>VKMV 6PK2080<br>VKM 38001   | 1   | 1   |   |   |   |   |   |
|   | B(Alt)  | OM 605.962  | 06/97 → 07/99   | AC   | VKMV 6PK2140<br>VKM 38001   | 1   | 1   |   |   |   |   |   |
| <b>MERCEDES-BENZ</b>  <b>E-class (W210) E 270 CDI</b>          |   |   |   |  |   |   |   |   |   |   |   |   |
|    |   | OM 612.961  | 07/99 → 03/03   |  | <b>OXOXOXO</b>  |   |   |   |   |   |   |   |
|    |   | OM 612.961  | 07/99 → 03/03   |  | VKPC 88843  |   |   |   | 1   |   |   |   |
|    | B(Alt)  | OM 612.961  | 07/99 → 03/03   |  | VKMA 38020<br>VKMV 6PK2270<br>VKM 31041<br>VKM 38020                                | 1   | 1   | 1   |   |   |   |   |
|   |   |   |   |  |   | 1   | 1   |   |   |   |   |   |
| <b>MERCEDES-BENZ</b>  <b>E-class (W210) E 290 Turbo-D</b>      |   |   |   |  |   |   |   |   |   |   |   |   |
|    |   | OM 602.982  | 03/96 → 07/99   |  | <b>OXOXOXO</b>  |   |   |   |   |   |   |   |
|    |   | OM 602.982  | 03/96 → 07/99   |  | VKPC 88620  |   |   |   | 1   |   |   |   |
|    | B(Alt)  | OM 602.982  | 03/96 → 07/99   | AC   | VKMV 6PK2100<br>VKM 38001<br>VKM 38012  | 1   |   | 1   |   |   |   |   |
|   | B(Alt)  | OM 602.982  | 06/96 → 07/99   | AC   | VKMV 6PK2140<br>VKM 38001   | 1   |   | 1   |   |   |   |   |
| <b>MERCEDES-BENZ</b>  <b>E-class (W210) E 300 D</b>            |   |   |   |  |   |   |   |   |   |   |   |   |
|    |   | OM 606.912  | 06/95 → 06/97   |  | <b>OXOXOXO</b>  |   |   |   |   |   |   |   |
|    |   | OM 606.912  | 06/95 → 06/97   |  | VKPC 88620  |   |   |   | 1   |   |   |   |
|    | B(Alt)  | OM 606.912  | 06/95 → 06/97   | AC   | VKMA 38007<br>VKMV 6PK2080<br>VKM 38001   | 1   |   | 1   |   |   |   |   |
|   | B(Alt)  | OM 606.912  | 06/95 → 06/97   | AC   | VKMV 6PK2140<br>VKM 38001   | 1   |   | 1   |   |   |   |   |
| <b>MERCEDES-BENZ</b>  <b>E-class (W210) E 300 Turbo-D</b>    |   |   |   |  |   |   |   |   |   |   |   |   |
|    |   | OM 606.962  | 12/96 → 07/99   |  | <b>OXOXOXO</b>  |   |   |   |   |   |   |   |
|    |   | OM 606.962  | 12/96 → 07/99   |  | VKPC 88842  |   |   |   | 1   |   |   |   |
|    | B(Alt)  | OM 606.962  | 12/96 → 07/99   | AC   | VKMV 6PK2065<br>VKM 38001   | 1   |   | 1   |   |   |   |   |
|   | B(Alt)  | OM 606.962  | 12/96 → 07/99   | AC   | VKMV 6PK2130<br>VKM 38001   | 1   |   | 1   |   |   |   |   |
| <b>MERCEDES-BENZ</b>  <b>E-class (W210) E 320 CDI</b>        |   |   |   |  |   |   |   |   |   |   |   |   |
|    |   | OM 613.961  | 07/99 → 03/03   |  | <b>OXOXOXO</b>  |   |   |   |   |   |   |   |
|    | B(Alt)  | OM 613.961  | 07/99 → 03/03   |  | VKMA 38020<br>VKMV 6PK2270<br>VKM 31041<br>VKM 38020                                | 1   | 1   | 1   |   |   |   |   |
|   |   |   |   |  |   | 1   | 1   |   |   |   |   |   |
| <b>MERCEDES-BENZ</b>  <b>E-class (W211) E 200 CGI</b>        |   |   |   |  |   |   |   |   |   |   |   |   |
|    |   | M 271.946   | 11/02 → 12/05   |  | <b>OXOXOXO</b>  |   |   |   |   |   |   |   |
|    | B(Alt)  | M 271.946   | 11/02 → 12/06   |  | VKMV 7PK2420  |   |   | 1   |   |   |   |   |
| <b>MERCEDES-BENZ</b>  <b>E-class (W211) E 200 Kompressor</b> |   |   |   |  |   |   |   |   |   |   |   |   |
|    |   | M 271.941   | 11/02 → 12/06   |  | <b>OXOXOXO</b>  |   |   |   |   |   |   |   |
|    |   | M 271.941   | 11/02 → 07/07   |  | VKPC 88853  |   |   |   | 1   |   |   |   |
|    | B(Alt)  | M 271.941   | 11/02 → 12/06   |  | VKMV 7PK2420  |   |   | 1   |   |   |   |   |
| <b>MERCEDES-BENZ</b>  <b>E-class (W211) E 240</b>            |   |   |   |  |   |   |   |   |   |   |   |   |
|    |   | M 112.913, M 112.917  | 03/02 → 12/05   |  | <b>OXOXOXO</b>  |   |   |   |   |   |   |   |
|    |   | M 112.913, M 112.917  | 03/02 → 07/04   | (EUR)  | VKPC 88846  |   |   |   | 1   |   |   |   |
|    | B(Alt)  | M 112.913, M 112.917  | 03/02 → 07/03   |  | VKMV 6PK2390<br>VKM 31041<br>VKM 38026  | 1   | 1   | 1   |   |   |   |   |
|   | B(Alt)  | M 112.917   | 07/03 → 12/06   |  | VKM 31041<br>VKM 38026  | 1   | 1   |   |   |   |   |   |
| <b>MERCEDES-BENZ</b>  <b>E-class (W211) E 280</b>            |   |   |   |  |   |   |   |   |   |   |   |   |
|    | B(Alt)  | M 272.943   | 03/05 → 12/06   |  | VKMV 6PK2404<br>VKM 31041   |   | 1   | 1   |   |   |   |   |















































































































| <b>MERCEDES-BENZ</b> <b>E-class (W211) E 320</b>     |  |                     |  |  |  |  |   |   |   |  |  |  |   |  |  |  |
|--|--|---------------------|--|--|--|--|---|---|---|--|--|--|---|--|--|--|
|  | M 112.949, M 112.954                                   | 03/02 → 12/05       |  |  |  | <b>OXOXOXO</b>                                       |   |   |   |  |  |  |   |  |  |  |
|  | <b>B(Alt)</b> M 112.949                                | 03/02 → 12/06       |  |  |  | VKMV 6PK2390<br>VKM 31041<br>VKM 38026               | 1 | 1 | 1 |  |  |  |   |  |  |  |
|  | <b>B(Alt)</b> M 112.954                                | 03/03 → 12/06       |  |  |  | VKM 31041<br>VKM 38026                               | 1 | 1 |   |  |  |  |   |  |  |  |
| <b>MERCEDES-BENZ</b> <b>E-class (W211) E 350</b>     |  |                     |  |  |  |  |   |   |   |  |  |  |   |  |  |  |
|  | <b>B(Alt)</b> M 272.964, M 272.972                     | 03/05 → 12/06       |  |  |  | VKMV 6PK2404   |   |   | 1 |  |  |  |   |  |  |  |
| <b>MERCEDES-BENZ</b> <b>E-class (W211) E 500</b>     |  |                     |  |  |  |  |   |   |   |  |  |  |   |  |  |  |
|  | M 113.967, M 113.969                                   | 03/02 → 12/05       |  |  |  | <b>OXOXOXO</b>                                       |   |   |   |  |  |  |   |  |  |  |
|  | M 113.967, M 113.969                                   | 03/02 → 07/04 (EUR) |  |  |  | VKPC 88846   |   |   |   |  |  |  | 1 |  |  |  |
|  | <b>B(Alt)</b> M 113.967                                | 03/02 → 01/08       |  |  |  | VKMV 6PK2390<br>VKM 31041<br>VKM 38026               | 1 | 1 | 1 |  |  |  |   |  |  |  |
|  | <b>B(Alt)</b> M 113.969                                | 10/03 → 12/06       |  |  |  | VKM 31041<br>VKM 38026                               | 1 | 1 |   |  |  |  |   |  |  |  |
| <b>MERCEDES-BENZ</b> <b>E-class (W211) E 55 AMG</b>  |  |                     |  |  |  |  |   |   |   |  |  |  |   |  |  |  |
|  | M 113.990  | 10/02 → 12/05       |  |  |  | <b>OXOXOXO</b>                                       |   |   |   |  |  |  |   |  |  |  |
| <b>MERCEDES-BENZ</b> <b>E-class (W211) E 200 CDI</b> |  |                     |  |  |  |  |   |   |   |  |  |  |   |  |  |  |
|  | OM 646.951   | 07/02 → 12/06       |  |  |  | <b>OXOXOXO</b>                                       |   |   |   |  |  |  |   |  |  |  |
|  | OM 646.951   | 07/02 → 07/04       |  |  |  | VKPC 88855   |   |   |   |  |  |  | 1 |  |  |  |
|  | <b>B(Alt)</b> OM 646.951                               | 07/02 → 07/03       |  |  |  | VKMV 6PK2241<br>VKM 31041<br>VKM 38020<br>VKM 38023  | 1 | 1 | 1 |  |  |  |   |  |  |  |
|  | <b>B(Alt)</b> OM 646.951                               | 07/03 → 12/06       |  |  |  | VKMV 6PK2260<br>VKM 31041<br>VKM 38020<br>VKM 38023  | 1 | 1 | 1 |  |  |  |   |  |  |  |
| <b>MERCEDES-BENZ</b> <b>E-class (W211) E 220 CDI</b> |  |                     |  |  |  |  |   |   |   |  |  |  |   |  |  |  |
|  | OM 646.961   | 03/02 → 12/05       |  |  |  | <b>OXOXOXO</b>                                       |   |   |   |  |  |  |   |  |  |  |
|  | OM 646.821,<br>OM 646.961                              | 03/02 → 07/07       |  |  |  | VKPC 88855   |   |   |   |  |  |  | 1 |  |  |  |
|  | <b>B(Alt)</b> OM 646.961                               | 03/02 → 12/03       |  |  |  | VKMV 6PK2241<br>VKM 31041<br>VKM 38020<br>VKM 38023  | 1 | 1 | 1 |  |  |  |   |  |  |  |
| <b>MERCEDES-BENZ</b> <b>E-class (W211) E 270 CDI</b> |  |                     |  |  |  |  |   |   |   |  |  |  |   |  |  |  |
|  | OM 647.961   | 03/02 → 12/05       |  |  |  | <b>OXOXOXO</b>                                       |   |   |   |  |  |  |   |  |  |  |
|  | OM 647.961   | 03/02 → 07/04       |  |  |  | VKPC 88855   |   |   |   |  |  |  | 1 |  |  |  |
|  | <b>B(Alt)</b> OM 647.961                               | 03/02 → 12/03       |  |  |  | VKMV 6PK2241<br>VKM 31041<br>VKM 38020<br>VKM 38023  | 1 | 1 | 1 |  |  |  |   |  |  |  |
| <b>MERCEDES-BENZ</b> <b>E-class (W211) E 280 CDI</b> |  |                     |  |  |  |  |   |   |   |  |  |  |   |  |  |  |
|  | <b>B(Alt)</b> OM 642.920,<br>OM 642.921,<br>OM 642.910 | 03/05 → 12/06       |  |  |  | VKMV 7PK2035   |   |   | 1 |  |  |  |   |  |  |  |
| <b>MERCEDES-BENZ</b> <b>E-class (W211) E 320 CDI</b> |  |                     |  |  |  |  |   |   |   |  |  |  |   |  |  |  |
|  | OM 648.961   | 11/02 → 12/05       |  |  |  | <b>OXOXOXO</b>                                       |   |   |   |  |  |  |   |  |  |  |
|  | <b>B(Alt)</b> OM 648.961                               | 11/02 → 12/06       |  |  |  | VKMA 38021<br>VKMV 6PK2260<br>VKM 31041<br>VKM 38020 | 1 | 1 | 1 |  |  |  |   |  |  |  |
| <b>MERCEDES-BENZ</b> <b>E-class (W211) E 400 CDI</b> |  |                     |  |  |  |  |   |   |   |  |  |  |   |  |  |  |
|  | OM 628.961   | 02/03 → 12/05       |  |  |  | <b>OXOXOXO</b>                                       |   |   |   |  |  |  |   |  |  |  |
|  | <b>B(Alt)</b> OM 628.961                               | 02/03 → 12/06       |  |  |  | VKMV 7PK2271   |   |   | 1 |  |  |  |   |  |  |  |

|   |                                    |  |  |  |  |  |  |  |  |  |  |  |  |
|---|------------------------------------|---|---|---|--|---|---|---|---|---|---|---|---|
| <b>MERCEDES-BENZ</b>  <b>G-class (W460) 230 G</b>      |                                    |   |   |   |  |   |   |   |   |   |   |   |   |
|    | M 115.973                          |   | 03/79 → 07/93   |   | <b>ΟΧΘΟΧΟ</b>  |   |   |   |   |   |   |   |   |
|    | M 115.973                          |   | 03/79 → 07/93   |   | VKPC 88807   |   |   |   |   |   | 1   |   |   |
| <b>MERCEDES-BENZ</b>  <b>G-class (W460) 230 GE</b>     |                                    |   |   |   |  |   |   |   |   |   |   |   |   |
|    | M 102.979, M 102.981,<br>M 102.987 |   | 04/82 → 08/92   |   | <b>ΟΧΘΟΧΟ</b>  |   |   |   |   |   |   |   |   |
| <b>MERCEDES-BENZ</b>  <b>G-class (W460) 280 GE</b>     |                                    |   |   |   |  |   |   |   |   |   |   |   |   |
|    | M 110.994                          |   | 11/79 → 08/89   |   | <b>ΟΧΘΟΧΟ</b>  |   |   |   |   |   |   |   |   |
|    | M 110.994                          |   | 11/79 → 08/89   |   | VKPC 88807   |   |   |   |   |   | 1   |   |   |
| <b>MERCEDES-BENZ</b>  <b>G-class (W460) 240 GD</b>     |                                    |   |   |   |  |   |   |   |   |   |   |   |   |
|    | OM 616.936                         |   | 03/79 → 08/87   |   | <b>ΟΧΘΟΧΟ</b>  |   |   |   |   |   |   |   |   |
|    | OM 616.936                         |   | 03/79 → 08/87   |   | VKPC 88807   |   |   |   |   |   | 1   |   |   |
| <b>MERCEDES-BENZ</b>  <b>G-class (W460) 250 GD</b>     |                                    |   |   |   |  |   |   |   |   |   |   |   |   |
|    | OM 602.930                         |   | 10/87 → 12/92   |   | <b>ΟΧΘΟΧΟ</b>  |   |   |   |   |   |   |   |   |
|    | OM 602.930                         |   | 10/87 → 12/92   |   | VKPC 88620   |   |   |   |   |   | 1   |   |   |
|    | B(Alt) OM 602.930                  |   | 10/87 → 12/92   | <b>AC</b>   | VKMA 38002<br>VKMV 6PK2050<br>VKM 38001  | 1   |   | 1   |   |   |   |   |   |
|   | B(Alt) OM 602.930                  |   | 10/87 → 12/92   | <b>AC</b>   | VKMA 38002<br>VKMV 6PK2050<br>VKM 38001  | 1   |   | 1   |   |   |   |   |   |
|   | B(Alt) OM 602.930                  |   | 10/87 → 12/92   | <b>AC</b>   | VKMA 38002<br>VKMV 6PK2120<br>VKM 38001<br>VKM 38001                               | 1   |   | 1   |   |   |   |   |   |
|   | B(Alt) OM 602.930                  |   | 10/87 → 12/92   | <b>AC</b>   | VKMA 38002<br>VKMV 6PK2120<br>VKM 38001<br>VKM 38001                               | 1   |   | 1   |   |   |   |   |   |
| <b>MERCEDES-BENZ</b>  <b>G-class (W460) 300 GD</b>     |                                    |   |   |   |  |   |   |   |   |   |   |   |   |
|    | OM 617.931,<br>OM 617.932          |   | 03/79 → 07/93   |   | <b>ΟΧΘΟΧΟ</b>  |   |   |   |   |   |   |   |   |
|   | OM 603.912                         |   | 03/79 → 07/93   |   | VKPC 88620   |   |   |   |   |   | 1   |   |   |
|   | OM 617.931                         |   | 12/79 → 12/91   |   | VKPC 88807   |   |   |   |   |   | 1   |   |   |
| <b>MERCEDES-BENZ</b>  <b>G-class (W461) G 230</b>    |                                    |   |   |   |  |   |   |   |   |   |   |   |   |
|    | M 102.979, M 102.996,<br>M 102.997 |   | 02/93 → 12/06   |   | <b>ΟΧΘΟΧΟ</b>  |   |   |   |   |   |   |   |   |
|    | B(Alt) M 102.979, M 102.996        |   | 02/93 → 12/06   | <b>AC, ⊕</b>  | VKMA 38002<br>VKMV 6PK2245<br>VKM 38001<br>VKM 38002                               | 1   |   | 1   |   |   |   |   |   |
|   | B(Alt) M 102.979, M 102.996        |   | 02/93 → 12/06   | <b>AC, ⊕</b>  | VKMA 38002<br>VKMV 6PK2245<br>VKM 38001<br>VKM 38002                               | 1   |   | 1   |   |   |   |   |   |
| <b>MERCEDES-BENZ</b>  <b>G-class (W461) 250 GD</b>   |                                    |   |   |   |  |   |   |   |   |   |   |   |   |
|    | OM 602.939                         |   | 02/90 → 12/05   |   | <b>ΟΧΘΟΧΟ</b>  |   |   |   |   |   |   |   |   |
|    | OM 602.939                         |   | 02/90 → 05/02   |   | VKPC 88620   |   |   |   |   |   | 1   |   |   |
|    | B(Alt) OM 602.939                  |   | 02/90 → 12/06   | <b>AC</b>   | VKMA 38002<br>VKMV 6PK2120<br>VKM 38001<br>VKM 38001                               | 1   |   | 1   |   |   |   |   |   |
|   | B(Alt) OM 602.939                  |   | 02/90 → 12/06   | <b>AC</b>   | VKMA 38002<br>VKMV 6PK2120<br>VKM 38001<br>VKM 38001                               | 1   |   | 1   |   |   |   |   |   |
| <b>MERCEDES-BENZ</b>  <b>G-class (W461) G 290 D</b>  |                                    |   |   |   |  |   |   |   |   |   |   |   |   |
|    | OM 602.942                         |   | 04/92 → 12/05   |   | <b>ΟΧΘΟΧΟ</b>  |   |   |   |   |   |   |   |   |
|    | OM 602.942                         |   | 04/92 → 05/02   |   | VKPC 88620   |   |   |   |   |   | 1   |   |   |
| <b>MERCEDES-BENZ</b>  <b>G-class (W461) G 290 TD</b> |                                    |   |   |   |  |   |   |   |   |   |   |   |   |
|    | OM 602.983                         |   | 07/97 → 12/06   |   | <b>ΟΧΘΟΧΟ</b>  |   |   |   |   |   |   |   |   |
|    | OM 602.983                         |   | 07/97 → 05/02   |   | VKPC 88620   |   |   |   |   |   | 1   |   |   |
|    | B(Alt) OM 602.983                  |   | 07/97 → 12/06   | <b>AC</b>   | VKMA 38002<br>VKMV 6PK2080<br>VKM 38002<br>VKM 38012                               | 1   |   | 1   |   |   |   |   |   |
|   | B(Alt) OM 602.983                  |   | 07/97 → 12/06   | <b>AC</b>   | VKMA 38002<br>VKMV 6PK2080<br>VKM 38002<br>VKM 38012                               | 1   |   | 1   |   |   |   |   |   |
|   | B(Alt) OM 602.983                  |   | 07/97 → 12/06   | <b>AC</b>   | VKMA 38002<br>VKMV 6PK2155<br>VKM 38002  | 1   |   | 1   |   |   |   |   |   |
|   | B(Alt) OM 602.983                  |   | 07/97 → 12/06   | <b>AC</b>   | VKMA 38002<br>VKMV 6PK2155<br>VKM 38002  | 1   |   | 1   |   |   |   |   |   |
| <b>MERCEDES-BENZ</b>  <b>G-class (W463) G 230</b>    |                                    |   |   |   |  |   |   |   |   |   |   |   |   |
|    | M 102.989                          |   | 06/90 → 06/93   |   | <b>ΟΧΘΟΧΟ</b>  |   |   |   |   |   |   |   |   |
| <b>MERCEDES-BENZ</b>  <b>G-class (W463) G 300</b>    |                                    |   |   |   |  |   |   |   |   |   |   |   |   |
|    | M 103.987                          |   | 09/89 → 12/05   |   | <b>ΟΧΘΟΧΟ</b>  |   |   |   |   |   |   |   |   |
|    | M 103.987                          |   | 09/89 → 07/04   |   | VKPC 88810   |   |   |   |   |   | 1   |   |   |
| <b>MERCEDES-BENZ</b>  <b>G-class (W463) G 320</b>    |                                    |   |   |   |  |   |   |   |   |   |   |   |   |
|    | OM 602.931                         |   | 06/90 → 12/05   |   | <b>ΟΧΘΟΧΟ</b>  |   |   |   |   |   |   |   |   |
|   | M 104.996, M 112.945               |   | 09/94 → 12/05   |   | <b>ΟΧΘΟΧΟ</b>  |   |   |   |   |   |   |   |   |
|    | OM 602.931                         |   | 06/90 → 07/04   |   | VKPC 88620   |   |   |   |   |   | 1   |   |   |
|   | M 104.996                          |   | 09/94 → 12/97   |   | VKPC 88828   |   |   |   |   |   | 1   |   |   |
|   | M 112.945                          |   | 07/97 → 07/04   | <b>EUR</b>  | VKPC 88846   |   |   |   |   |   | 1   |   |   |























































|   |  |  |  |  |  |  |  |  |  |  |  |  |
|---|---|---|---|--|---|---|---|---|---|---|---|---|
|  B(Alt)   | OM 602.931  | 06/90 → 07/01   |   | VKMA 38002<br>VKMV 6PK2050<br>VKM 38001  | 1<br>1<br>1   | 1<br>1  |   |   |   |   |   |   |
| B(Alt)  | M 104.996   | 09/94 → 12/97   | AC, →IMot. 002383   | VKMV 6PK2140<br>VKM 38100  | 1   | 1   |   |   |   |   |   |   |
| B(Alt)  | M 104.996   | 09/94 → 12/97   | AC, Mot. 002384 I→  | VKMV 6PK2120<br>VKM 38100  | 1   | 1   |   |   |   |   |   |   |
| B(Alt)  | M 104.996   | 09/94 → 12/97   | AC, →IMot. 002383   | VKMV____<br>VKM 38100  | 1   | 1   |   |   |   |   |   |   |
| B(Alt)  | M 104.996   | 09/94 → 12/97   | AC, Mot. 002384 I→  | VKM 38100  | 1   |   |   |   |   |   |   |   |
| B(Alt)  | M 112.945   | 07/97 → 12/06   | AC  | VKMV 6PK2315<br>VKM 31041<br>VKM 38026   | 1<br>1<br>1   | 1   |   |   |   |   |   |   |
| B(Alt)  | M 112.945   | 07/97 → 12/06   | AC  | VKMV 6PK2390<br>VKM 31041<br>VKM 38026   | 1<br>1<br>1   | 1   |   |   |   |   |   |   |
| <b>MERCEDES-BENZ  G-class (W463) G 36 AMG</b>    |   |   |   |  |   |   |   |   |   |   |   |   |
|   |   | 01/95 → 12/05   |   | OXOXOXO  |   |   |   |   |   |   |   |   |
| <b>MERCEDES-BENZ  G-class (W463) G 500</b>       |   |   |   |  |   |   |   |   |   |   |   |   |
|   | M 117.965   | 09/93 → 12/05   |   | OXOXOXO  |   |   |   |   |   |   |   |   |
|   | M 117.965   | 09/93 → 07/04   |   | VKPC 88827   |   |   |   | 1   |   |   |   |   |
| <b>MERCEDES-BENZ  G-class (W463) G 55 AMG</b>    |   |   |   |  |   |   |   |   |   |   |   |   |
|   | M113.962, M 113.982   | 04/98 → 12/05   |   | OXOXOXO  |   |   |   |   |   |   |   |   |
|    | M113.962, M 113.982   | 04/98 → 07/04   | EUR   | VKPC 88846   |   |   |   | 1   |   |   |   |   |
| <b>MERCEDES-BENZ  G-class (W463) G 270 CDI</b> |   |   |   |  |   |   |   |   |   |   |   |   |
|   | OM 612.966  | 10/01 → 12/05   |   | OXOXOXO  |   |   |   |   |   |   |   |   |
|   | OM 612.966  | 10/01 → 07/04   |   | VKPC 88850   |   |   |   | 1   |   |   |   |   |
| <b>MERCEDES-BENZ  G-class (W463) 300 GD</b>    |   |   |   |  |   |   |   |   |   |   |   |   |
|   | OM 603.931  | 09/89 → 12/05   |   | OXOXOXO  |   |   |   |   |   |   |   |   |
|   | OM 603.931  | 09/89 → 07/04   |   | VKPC 88620   |   |   |   | 1   |   |   |   |   |
| <b>MERCEDES-BENZ  G-class (W463) G 300 TD</b>  |   |   |   |  |   |   |   |   |   |   |   |   |
|   | OM 606.964  | 08/96 → 12/05   |   | OXOXOXO  |   |   |   |   |   |   |   |   |
|   | OM 606.964  | 08/96 → 07/04   |   | VKPC 88842   |   |   |   | 1   |   |   |   |   |
| <b>MERCEDES-BENZ  G-class (W463) G 350 TD</b>  |   |   |   |  |   |   |   |   |   |   |   |   |
|   | OM 603.972  | 09/91 → 12/05   |   | OXOXOXO  |   |   |   |   |   |   |   |   |
|   | OM 603.972  | 09/91 → 07/04   | →IMot. 004348   | VKPC 88620   |   |   |   | 1   |   |   |   |   |
|   | OM 603.972  | 09/91 → 07/04   | Mot. 004349 I→  | VKPC 88842   |   |   |   | 1   |   |   |   |   |
| <b>MERCEDES-BENZ  G-class (W463) G 400 CDI</b> |   |   |   |  |   |   |   |   |   |   |   |   |
|   | OM 628.962  | 12/00 → 12/05   |   | OXOXOXO  |   |   |   |   |   |   |   |   |
|   | OM 628.962  | 12/00 → 07/04   |   | —  |   |   |   | 1   |   |   |   |   |
| <b>MERCEDES-BENZ  M-class (W163) ML 230</b>    |   |   |   |  |   |   |   |   |   |   |   |   |
|   | M 111.977   | 02/98 → 06/05   |   | OXOXOXO  |   |   |   |   |   |   |   |   |
|   | M 111.977   | 02/98 → 06/05   |   | VKPC 88622   |   |   |   | 1   |   |   |   |   |
|   | B(Alt) M 111.977  | 02/98 → 06/05   | AC  | VKMV 6PK2055<br>VKM 38022<br>VKM 38027   | 1<br>1<br>1   | 1   |   |   |   |   |   |   |
| B(Alt)  | M 111.977   | 02/98 → 06/05   | AC  | VKMV 6PK2155<br>VKM 38022<br>VKM 38027   | 1<br>1<br>1   | 1   |   |   |   |   |   |   |
| <b>MERCEDES-BENZ  M-class (W163) ML 320</b>    |   |   |   |  |   |   |   |   |   |   |   |   |
|   | M 112.942   | 02/98 → 08/02   |   | OXOXOXO  |   |   |   |   |   |   |   |   |
|   | M 112.942   | 02/98 → 08/02   | EUR   | VKPC 88846   |   |   |   | 1   |   |   |   |   |
|   | B(Alt) M 112.942  | 02/98 → 08/02   |   | VKMV 6PK2390<br>VKM 31041<br>VKM 38026   | 1<br>1<br>1   | 1   |   |   |   |   |   |   |
| <b>MERCEDES-BENZ  M-class (W163) ML 350</b>    |   |   |   |  |   |   |   |   |   |   |   |   |
|   | M 112.970   | 08/02 → 06/05   |   | OXOXOXO  |   |   |   |   |   |   |   |   |
|   | M 112.970   | 08/02 → 06/05   | EUR   | VKPC 88846   |   |   |   | 1   |   |   |   |   |

|   |  |  |  |  |  |  |  |  |  |  |
|---|---|---|---|--|---|---|---|---|---|---|
|  B(Alt)  | M 112.970   | 08/02 → 06/05   | → ICHA 429265   | VKMV 6PK2390<br>VKM 31041<br>VKM 38026   | 1   | 1   |   |   |   |   |
| B(Alt)  | M 112.970   | 08/02 → 06/05   | CHA 429266 I→   | VKM 31041<br>VKM 38026   | 1   | 1   |   |   |   |   |
| <b>MERCEDES-BENZ</b>  <b>M-class (W163) ML 430</b>       |   |   |   |  |   |   |   |   |   |   |
|    | M 113.942   | 02/98 → 06/05   |   | <b>ΟΧΘΟΧΟ</b>  |   |   |   |   |   |   |
|    | M 113.942   | 02/98 → 06/05   | EUR   | VKPC 88846   |   |   |   | 1   |   |   |
|  B(Alt)  | M 113.942   | 02/98 → 06/05   |   | VKMV 6PK2390<br>VKM 31041<br>VKM 38026   | 1   | 1   |   |   |   |   |
| <b>MERCEDES-BENZ</b>  <b>M-class (W163) ML 500</b>       |   |   |   |  |   |   |   |   |   |   |
|    | M 113.964, M 113.965  | 09/01 → 06/05   |   | <b>ΟΧΘΟΧΟ</b>  |   |   |   |   |   |   |
|    | M 113.964, M 113.965  | 09/01 → 06/05   |   | VKPC 88846   |   |   |   | 1   |   |   |
|  B(Alt)  | M 113.964, M 113.965  | 09/01 → 06/05   |   | VKM 31041<br>VKM 38026   | 1   | 1   |   |   |   |   |
| <b>MERCEDES-BENZ</b>  <b>M-class (W163) ML 55 AMG</b>    |   |   |   |  |   |   |   |   |   |   |
|    | M 113.981   | 02/00 → 06/05   |   | <b>ΟΧΘΟΧΟ</b>  |   |   |   |   |   |   |
|    | M 113.981   | 02/00 → 06/05   |   | VKPC 88846   |   |   |   | 1   |   |   |
|  B(Alt)  | M 113.981   | 02/00 → 06/05   |   | VKMV 6PK2390<br>VKM 31041<br>VKM 38026   | 1   | 1   | 1   |   |   |   |
| <b>MERCEDES-BENZ</b>  <b>M-class (W163) ML 270 CDI</b>   |   |   |   |  |   |   |   |   |   |   |
|    | OM 612.963  | 12/99 → 06/05   |   | <b>ΟΧΘΟΧΟ</b>  |   |   |   |   |   |   |
|   | OM 612.963  | 12/99 → 06/05   |   | VKPC 88843   |   |   |   | 1   |   |   |
|  B(Alt)  | OM 612.963  | 12/99 → 06/05   |   | VKMA 38020<br>VKMV 6PK2270<br>VKM 31041<br>VKM 38020                               | 1   | 1   | 1   |   |   |   |
| <b>MERCEDES-BENZ</b>  <b>M-class (W163) ML 400 CDI</b> |   |   |   |  |   |   |   |   |   |   |
|    | OM 628.963  | 09/01 → 06/05   |   | <b>ΟΧΘΟΧΟ</b>  |   |   |   |   |   |   |
|    | OM 628.963  | 09/01 → 06/05   |   | —  |   |   |   | 1   |   |   |
|  B(Alt)  | OM 628.963  | 09/01 → 06/05   |   | VKMV 7PK2271   |   |   | 1   |   |   |   |
| <b>MERCEDES-BENZ</b>  <b>M-CLASS (W164) ML 350</b>     |   |   |   |  |   |   |   |   |   |   |
|    | M 272.962, M 272.967  | 07/05 → 12/06   |   | <b>ΟΧΘΟΧΟ</b>  |   |   |   |   |   |   |
|  B(Alt)  | M 272.962, M 272.967  | 07/05 → 12/06   | →  Mot. 30058376  | VKMV 6PK2404<br>VKM 31041  |   | 1   |   |   |   |   |
| B(Alt)  | M 272.962, M 272.967  | 07/05 → 12/06   | Mot. 30058377 I→  | VKMV 6PK2404<br>VKM 31041  |   | 1   |   |   |   |   |
| <b>MERCEDES-BENZ</b>  <b>M-CLASS (W164) ML 500</b>     |   |   |   |  |   |   |   |   |   |   |
|    | M 113.964   | 07/05 → 12/06   |   | <b>ΟΧΘΟΧΟ</b>  |   |   |   |   |   |   |
|    | M 113.964   | 07/05 → 12/06   |   | VKPC 88846   |   |   |   | 1   |   |   |
|  B(Alt)  | M 113.964   | 07/05 → 12/06   |   | VKM 31041<br>VKM 38026   | 1   | 1   |   |   |   |   |
| <b>MERCEDES-BENZ</b>  <b>M-CLASS (W164) ML 63 AMG</b>  |   |   |   |  |   |   |   |   |   |   |
|    | M 156.980   | 01/06 → 12/06   |   | <b>ΟΧΘΟΧΟ</b>  |   |   |   |   |   |   |
| <b>MERCEDES-BENZ</b>  <b>M-CLASS (W164) ML 280 CDI</b> |   |   |   |  |   |   |   |   |   |   |
|    | OM 642.940  | 07/05 → 12/06   |   | <b>ΟΧΘΟΧΟ</b>  |   |   |   |   |   |   |
|  B(Alt)  | OM 642.940  | 07/05 → 12/06   |   | VKMV 8PK2035   |   |   | 1   |   |   |   |
| <b>MERCEDES-BENZ</b>  <b>M-CLASS (W164) ML 320 CDI</b> |   |   |   |  |   |   |   |   |   |   |
|    | OM 642.940  | 07/05 → 12/06   |   | <b>ΟΧΘΟΧΟ</b>  |   |   |   |   |   |   |
|  B(Alt)  | OM 642.940  | 07/05 → 12/06   |   | VKMV 8PK2035   |   |   | 1   |   |   |   |
| <b>MERCEDES-BENZ</b>  <b>M-CLASS (W164) ML 420 CDI</b> |   |   |   |  |   |   |   |   |   |   |
|    | OM 629.912  | 02/06 → 12/06   |   | <b>ΟΧΘΟΧΟ</b>  |   |   |   |   |   |   |
| <b>MERCEDES-BENZ</b>  <b>R-class (W251) R 350</b>      |   |   |   |  |   |   |   |   |   |   |
|    | M 272.967   | 01/06 → 10/07   |   | <b>ΟΧΘΟΧΟ</b>  |   |   |   |   |   |   |
|  B(Alt)  | M 272.967   | 01/06 → 10/07   |   | VKMV 6PK2404   |   |   | 1   |   |   |   |

















































|   |  |  |  |  |  |  |  |  |  |  |
|---|---|---|---|--|---|---|---|---|---|---|
| <b>MERCEDES-BENZ</b>  <b>R-class (W251) R 500</b>        |   |   |   |  |   |   |   |   |   |   |
|   | M 113.971   | 01/06 → 10/07   |   | ОХОХОХО  |   |   |   |   |   |   |
|   | <b>B(Alt)</b> M 113.971   | 01/06 → 10/07   |   | VKM 31041<br>VKM 38026   | 1   | 1   |   |   |   |   |
| <b>MERCEDES-BENZ</b>  <b>R-class (W251) R 63 AMG</b>     |   |   |   |  |   |   |   |   |   |   |
|   | M 156.980   | 02/06 → 10/07   |   | ОХОХОХО  |   |   |   |   |   |   |
| <b>MERCEDES-BENZ</b>  <b>R-class (W251) R 280 CDI</b>    |   |   |   |  |   |   |   |   |   |   |
|   | OM 642.950  | 05/06 → 10/07   |   | ОХОХОХО  |   |   |   |   |   |   |
|   | OM 642.950  | 05/06 → 10/07   |   | —  |   |   |   | 1   |   |   |
|   | <b>B(Alt)</b> OM 642.950  | 05/06 → 10/07   |   | VKMV 8PK2035   |   | 1   |   |   |   |   |
| <b>MERCEDES-BENZ</b>  <b>R-class (W251) R 320 CDI</b>    |   |   |   |  |   |   |   |   |   |   |
|   | OM 642.950  | 01/06 → 10/07   |   | ОХОХОХО  |   |   |   |   |   |   |
|   | OM 642.950  | 01/06 → 10/07   |   | —  |   |   |   | 1   |   |   |
|   | <b>B(Alt)</b> OM 642.950  | 01/06 → 10/07   |   | VKMV 8PK2035   |   | 1   |   |   |   |   |
| <b>MERCEDES-BENZ</b>  <b>S-class (W108 / W109) 280 S</b> |   |   |   |  |   |   |   |   |   |   |
|   | M 130.920, M 130.980  | 10/67 → 08/72   |   | ОХОХОХО  |   |   |   |   |   |   |
|   | M 130.920, M 130.980  | 10/67 → 08/72   |   | VKPC 88807   |   |   |   | 1   |   |   |
| <b>MERCEDES-BENZ</b>  <b>S-class (W116) 280 S</b>        |   |   |   |  |   |   |   |   |   |   |
|   | M 110.922, M 110.985  | 08/72 → 07/80   |   | ОХОХОХО  |   |   |   |   |   |   |
|   | M 110.922, M 110.983,<br>M 110.985  | 08/72 → 07/80   |   | VKPC 88807   |   |   |   | 1   |   |   |
| <b>MERCEDES-BENZ</b>  <b>S-class (W126) 260</b>          |   |   |   |  |   |   |   |   |   |   |
|    | M 103.941   | 09/85 → 06/91   |   | ОХОХОХО  |   |   |   |   |   |   |
|   | M 103.941   | 09/85 → 06/91   |   | VKPC 88810   |   |   |   | 1   |   |   |
|   | <b>B(Alt)</b> M 103.941   | 09/85 → 06/91   | AC  | VKMV 6PK2170   |   | 1   |   |   |   |   |
|   | <b>B(Alt)</b> M 103.941   | 09/85 → 06/91   | AC  | VKMV 6PK2257   |   | 1   |   |   |   |   |
| <b>MERCEDES-BENZ</b>  <b>S-class (W126) 280</b>        |   |   |   |  |   |   |   |   |   |   |
|   | M 110.924, M 110.926,<br>M 110.987, M 110.989                                     | 10/79 → 07/85   |   | ОХОХОХО  |   |   |   |   |   |   |
|   | M 110.924, M 110.926,<br>M 110.987, M 110.989                                     | 10/79 → 07/85   |   | VKPC 88813   |   |   |   | 1   |   |   |
| <b>MERCEDES-BENZ</b>  <b>S-class (W126) 300</b>        |   |   |   |  |   |   |   |   |   |   |
|   | M 103.981   | 09/85 → 06/91   |   | ОХОХОХО  |   |   |   |   |   |   |
|   | M 103.981   | 09/85 → 06/91   | Man. GBX  | VKPC 88810   |   |   |   | 1   |   |   |
|   | M 103.981   | 09/85 → 06/91   | Auto. GBX   | VKPC 88804   |   |   |   | 1   |   |   |
|   | <b>B(Alt)</b> M 103.981   | 09/85 → 06/91   | AC  | VKMV 6PK2170<br>VKM 38012  | 1   | 1   |   |   |   |   |
|   | <b>B(Alt)</b> M 103.981   | 09/85 → 06/91   | AC  | VKMV 6PK2257<br>VKM 38012  | 1   | 1   |   |   |   |   |
| <b>MERCEDES-BENZ</b>  <b>S-class (W126) 380</b>        |   |   |   |  |   |   |   |   |   |   |
|   | M 116.961, M 116.963  | 12/79 → 12/86   |   | ОХОХОХО  |   |   |   |   |   |   |
|   | M 116.961   | 12/85 → 12/86   |   | —  |   |   |   | 1   |   |   |
|   | M 116.963   | 12/79 → 08/85   |   | VKPC 88818   |   |   |   | 1   |   |   |
| <b>MERCEDES-BENZ</b>  <b>S-class (W126) 420</b>        |   |   |   |  |   |   |   |   |   |   |
|   | M 116.965   | 10/85 → 06/91   |   | ОХОХОХО  |   |   |   |   |   |   |
|   | M 116.965   | 10/85 → 06/91   |   | VKPC 88827   |   |   |   | 1   |   |   |
| <b>MERCEDES-BENZ</b>  <b>S-class (W126) 500</b>        |   |   |   |  |   |   |   |   |   |   |
|   | M 117.961, M 117.963,<br>M 117.965  | 12/79 → 06/91   |   | ОХОХОХО  |   |   |   |   |   |   |
|   | M 117.961, M 117.963  | 12/79 → 08/85   |   | VKPC 88818   |   |   |   | 1   |   |   |
|   | M 117.965   | 09/85 → 06/91   |   | VKPC 88827   |   |   |   | 1   |   |   |
| <b>MERCEDES-BENZ</b>  <b>S-class (W126) 560</b>        |   |   |   |  |   |   |   |   |   |   |
|   | M 117.968   | 10/85 → 06/91   |   | ОХОХОХО  |   |   |   |   |   |   |
|   | M 117.968   | 10/85 → 06/91   |   | VKPC 88827   |   |   |   | 1   |   |   |
| <b>MERCEDES-BENZ</b>  <b>S-class (W140) S 280</b>      |   |   |   |  |   |   |   |   |   |   |
|   | M 104.944   | 02/93 → 10/98   |   | ОХОХОХО  |   |   |   |   |   |   |
|   | M 104.944   | 02/93 → 10/98   |   | VKPC 88828   |   |   |   | 1   |   |   |
|   | <b>B(Alt)</b> M 104.944   | 02/93 → 10/98   | AC, →IMot.007447  | VKMV 6PK2330   |   | 1   |   |   |   |   |

|   |  |  |  |  |  |  |  |  |  |  |  |
|---|---|---|---|--|---|---|---|---|---|---|---|
| B(Alt)  | M 104.944   | 02/93 → 10/98   | AC, Man. GBX,<br>→IMot. 001105  | VKMV 6PK2225<br>VKM 38100  | 1   | 1   |   |   |   |   |   |
| B(Alt)  | M 104.944   | 02/93 → 10/98   | AC, Man. GBX,<br>Mot. 001106 I→   | VKMV 6PK2205<br>VKM 38100  | 1   | 1   |   |   |   |   |   |
| B(Alt)  | M 104.944   | 02/93 → 10/98   | AC, Auto. GBX,<br>Mot. 007448 I→,<br>→IMot. 016164                                | VKMV 6PK2225<br>VKM 38100  | 1   | 1   |   |   |   |   |   |
| B(Alt)  | M 104.944   | 02/93 → 10/98   | AC, Auto. GBX,<br>Mot. 016165 I→  | VKMV 6PK2205<br>VKM 38100  | 1   | 1   |   |   |   |   |   |
| B(Alt)  | M 104.944   | 02/93 → 10/98   | AC, →IMot. 007447   | VKMV 6PK2445   |   | 1   |   |   |   |   |   |
| <b>MERCEDES-BENZ  S-class (W140) S 300</b>           |   |   |   |  |   |   |   |   |   |   |   |
|    | M 104.990, M 104.994  | 03/91 → 10/98   |   | <b>ΟΛΟΚΛΟΝΟ</b>  |   |   |   |   |   |   |   |
|    | M 104.990   | 03/91 → 10/98   | →IMot. 000259, 017742   | VKPC 88821   |   |   |   | 1   |   |   |   |
|    | M 104.990   | 03/91 → 10/98   | Mot. 000260, 017743 I→  | VKPC 88828   |   |   |   | 1   |   |   |   |
|    | M 104.994   | 03/91 → 10/98   |   | VKPC 88828   |   |   |   | 1   |   |   |   |
|    | B(Alt) M 104.994  | 03/91 → 10/98   | AC  | VKMV 6PK2330   |   | 1   |   |   |   |   |   |
|    | B(Alt) M 104.994  | 03/91 → 10/98   | AC, →IMot. 031209   | VKMV 6PK2445   |   | 1   |   |   |   |   |   |
|    | B(Alt) M 104.994  | 03/91 → 10/98   | Mot. 031210 I→,<br>→IMot. 067244  | VKMV 6PK2225<br>VKM 38100  | 1   | 1   |   |   |   |   |   |
|    | B(Alt) M 104.994  | 03/91 → 10/98   | Mot. 067245 I→  | VKMV 6PK2205<br>VKM 38100  | 1   | 1   |   |   |   |   |   |
| <b>MERCEDES-BENZ  S-class (W140) S 400</b>         |   |   |   |  |   |   |   |   |   |   |   |
|    | M 119.971   | 02/91 → 10/98   |   | <b>ΟΛΟΚΛΟΝΟ</b>  |   |   |   |   |   |   |   |
|    | M 119.971   | 02/91 → 10/98   | →IMot. 026750   | —  |   |   |   | 1   |   |   |   |
|    | M 119.971   | 02/91 → 10/98   | Mot. 026751 I→  | —  |   |   |   | 1   |   |   |   |
|    | M 119.981   | 02/91 → 10/98   |   | —  |   |   |   | 1   |   |   |   |
| <b>MERCEDES-BENZ  S-class (W140) S 420</b>         |   |   |   |  |   |   |   |   |   |   |   |
|    | M 119.971   | 01/93 → 02/99   |   | <b>ΟΛΟΚΛΟΝΟ</b>  |   |   |   |   |   |   |   |
|    | M 119.971   | 01/93 → 02/99   | →IMot. 026750   | —  |   |   |   | 1   |   |   |   |
|    | M 119.971   | 01/93 → 02/99   | Mot. 026751 I→  | —  |   |   |   | 1   |   |   |   |
|    | M 119.981   | 01/93 → 02/99   |   | —  |   |   |   | 1   |   |   |   |
| <b>MERCEDES-BENZ  S-class (W140) S 500</b>         |   |   |   |  |   |   |   |   |   |   |   |
|    | M 119.970   | 02/91 → 02/99   |   | <b>ΟΛΟΚΛΟΝΟ</b>  |   |   |   |   |   |   |   |
|    | M 119.970, M 119.980  | 02/91 → 02/99   |   | —  |   |   |   | 1   |   |   |   |
|    | M 119.970   | 02/91 → 02/99   | →IMot. 056885   | —  |   |   |   | 1   |   |   |   |
|    | M 119.970   | 02/91 → 02/99   | Mot. 056886 I→  | —  |   |   |   | 1   |   |   |   |
| <b>MERCEDES-BENZ  S-class (W140) S 600</b>         |   |   |   |  |   |   |   |   |   |   |   |
|    | M 120.980, M 120.982  | 04/91 → 02/99   |   | <b>ΟΛΟΚΛΟΝΟ</b>  |   |   |   |   |   |   |   |
| <b>MERCEDES-BENZ  S-class (W140) S 300 Turbo-D</b> |   |   |   |  |   |   |   |   |   |   |   |
|    | OM 606.961  | 05/96 → 10/98   |   | <b>ΟΛΟΚΛΟΝΟ</b>  |   |   |   |   |   |   |   |
|    | OM 606.961  | 05/96 → 10/98   |   | VKPC 88842   |   |   |   | 1   |   |   |   |
|    | B(Alt) OM 606.961   | 05/96 → 10/98   |   | VKMV 6PK2140<br>VKM 38001  | 1   | 1   |   |   |   |   |   |
| <b>MERCEDES-BENZ  S-class (W140) S 350 Turbo-D</b> |   |   |   |  |   |   |   |   |   |   |   |
|    | OM 603.971  | 01/93 → 10/98   |   | <b>ΟΛΟΚΛΟΝΟ</b>  |   |   |   |   |   |   |   |
|    | OM 603.971  | 01/93 → 10/98   | →IMot. 018738   | VKPC 88620   |   |   |   | 1   |   |   |   |
|    | OM 603.971  | 01/93 → 10/98   | Mot. 018739 I→  | VKPC 88842   |   |   |   | 1   |   |   |   |
|    | B(Alt) OM 603.971   | 01/93 → 10/98   | AC  | VKMV 6PK2080<br>VKM 38001  | 1   | 1   |   |   |   |   |   |
|    | B(Alt) OM 603.971   | 01/93 → 10/98   | AC, →IMot. 018393   | VKMV 6PK2145<br>VKM 38001  | 1   | 1   |   |   |   |   |   |
|    | B(Alt) OM 603.971   | 01/93 → 10/98   | AC, Mot. 018394 I→  | VKMV 6PK2140<br>VKM 38001  | 1   | 1   |   |   |   |   |   |
| <b>MERCEDES-BENZ  S-class (W215) CL 500</b>        |   |   |   |  |   |   |   |   |   |   |   |
|    | M 113.960   | 03/99 → 03/06   |   | <b>ΟΛΟΚΛΟΝΟ</b>  |   |   |   |   |   |   |   |











































|  |  |                  |    |   |  |  |  |  |  |  |  |
|--|---|---|---|---|---|---|---|---|---|---|---|
|    | M 113.960   | 03/99 → 07/04   |    | VKPC 88846  |   |   |   |   |   | 1   |   |
|    | <b>B(Alt)</b> M 113.960   | 03/99 → 09/02   |   | VKMV 6PK2390<br>VKM 31041<br>VKM 38026  |   | 1   |   | 1   |   |   |   |
|  | <b>B(Alt)</b> M 113.960   | 09/02 → 03/06   |   | VKM 31041<br>VKM 38026  | 1   |   | 1   |   |   |   |   |
| <b>MERCEDES-BENZ</b>  <b>S-class (W215) CL 55 AMG</b>       |   |   |   |   |   |   |   |   |   |   |   |
|    | M 113.986   | 10/99 → 03/06   |   |    |   |   |   |   |   |   |   |
|    | M 113.986   | 10/99 → 07/04   |   | VKPC 88846  |   |   |   |   |   | 1   |   |
|    | <b>B(Alt)</b> M 113.986   | 10/99 → 09/02   |   | VKMV 6PK2390<br>VKM 31041<br>VKM 38026  | 1   |   | 1   |   |   |   |   |
|  | <b>B(Alt)</b> M 113.986   | 09/02 → 03/06   |   | VKM 31041<br>VKM 38026  | 1   |   | 1   |   |   |   |   |
| <b>MERCEDES-BENZ</b>  <b>S-class (W215) CL 55 AMG Komp.</b> |   |   |   |   |   |   |   |   |   |   |   |
|    | M 113.991   | 06/02 → 03/06   |   |    |   |   |   |   |   |   |   |
|    | <b>B(Alt)</b> M 113.991   | 06/02 → 03/06   |   | VKMV 6PK2462<br>VKM 38026   | 1   |   | 1   |   |   |   |   |
| <b>MERCEDES-BENZ</b>  <b>S-class (W215) CL 600</b>          |   |   |   |   |   |   |   |   |   |   |   |
|    | M 137.970, M 275.950  | 03/99 → 03/06   |   |    |   |   |   |   |   |   |   |
|    | <b>B(Alt)</b> M 137.970, M 275.950  | 03/99 → 03/06   |   | VKMV 7PK2345  |   |   | 1   |   |   |   |   |
| <b>MERCEDES-BENZ</b>  <b>S-class (W215) CL 63 AMG</b>       |   |   |   |   |   |   |   |   |   |   |   |
|    | M 137.980   | 09/01 → 03/06   |   |    |   |   |   |   |   |   |   |
|   | <b>B(Alt)</b> M 137.980   | 09/01 → 03/06   |   | VKMV 7PK2345  |   |   | 1   |   |   |   |   |
| <b>MERCEDES-BENZ</b>  <b>S-class (W215) CL 65 AMG</b>     |   |   |   |   |   |   |   |   |   |   |   |
|    | M 275.980   | 09/03 → 03/06   |   |  |   |   |   |   |   |   |   |
|    | <b>B(Alt)</b> M 275.980   | 09/03 → 03/06   |   | VKMV 7PK2335  |   |   | 1   |   |   |   |   |
| <b>MERCEDES-BENZ</b>  <b>S-class (W220) S 280</b>         |   |   |   |   |   |   |   |   |   |   |   |
|    | M 112.922   | 10/98 → 08/05   |   |  |   |   |   |   |   |   |   |
|    | M 112.922   | 10/98 → 08/05   |  | VKPC 88846  |   |   |   |   |   | 1   |   |
|    | <b>B(Alt)</b> M 112.922   | 10/98 → 01/01 8)  |   | VKMV 6PK2390<br>VKM 31041<br>VKM 38026  | 1   |   | 1   |   |   |   |   |
|  | <b>B(Alt)</b> M 112.922   | 01/01 → 08/05 8)  |   | VKM 31041<br>VKM 38026  | 1   |   | 1   |   |   |   |   |
|  | <b>B(Alt)</b> M 112.922   | 10/98 → 09/02 7)  |   | VKMV 6PK2390<br>VKM 31041<br>VKM 38026  | 1   |   | 1   |   |   |   |   |
|  | <b>B(Alt)</b> M 112.922   | 09/02 → 08/05 7)  |   | VKM 31041<br>VKM 38026  | 1   |   | 1   |   |   |   |   |
| <b>MERCEDES-BENZ</b>  <b>S-class (W220) S 320</b>         |   |   |   |   |   |   |   |   |   |   |   |
|    | M 112.944   | 10/98 → 08/05   |   |  |   |   |   |   |   |   |   |
|    | M 112.944   | 10/98 → 08/05   |  | VKPC 88846  |   |   |   |   |   | 1   |   |
|    | <b>B(Alt)</b> M 112.944   | 10/98 → 01/01 8)  |   | VKMV 6PK2390<br>VKM 31041<br>VKM 38026  | 1   |   | 1   |   |   |   |   |
|  | <b>B(Alt)</b> M 112.944   | 10/98 → 09/02 7)  |   | VKMV 6PK2390<br>VKM 31041<br>VKM 38026  | 1   |   | 1   |   |   |   |   |
|  | <b>B(Alt)</b> M 112.944   | 01/01 → 08/05 8)  |   | VKM 31041<br>VKM 38026  | 1   |   | 1   |   |   |   |   |
|  | <b>B(Alt)</b> M 112.944   | 09/02 → 08/05 7)  |   | VKM 31041<br>VKM 38026  | 1   |   | 1   |   |   |   |   |
| <b>MERCEDES-BENZ</b>  <b>S-class (W220) S 350</b>         |   |   |   |   |   |   |   |   |   |   |   |
|    | M 112.972, M 112.975  | 09/02 → 08/05   |   |  |   |   |   |   |   |   |   |
|    | M 112.972, M 112.975  | 09/02 → 07/04   |  | VKPC 88846  |   |   |   |   |   | 1   |   |
|    | <b>B(Alt)</b> M 112.972, M 112.975  | 09/02 → 08/05  |   | VKM 31041<br>VKM 38026  | 1   |   | 1   |   |   |   |   |

























































































|  |  |  |    |  |  |  |  |  |  |  |  |  |
|--|---|---|---|--|---|---|---|---|---|---|---|---|
| B(Alt)   | M 112.972   | 09/02 → 09/02   |    | VKMV 6PK2390<br>VKM 31041<br>VKM 38026   | 1   | 1   |   |   |   |   |   |   |
| B(Alt)   | M 112.972, M 112.975  | 09/02 → 08/05   |    | VKM 31041<br>VKM 38026   | 1   | 1   |   |   |   |   |   |   |
| <b>MERCEDES-BENZ</b>  <b>S-class (W220) S 430</b>       |   |   |   |  |   |   |   |   |   |   |   |   |
|   | M 113.941, M 113.948  | 10/98 → 08/05   |   | <b>ΟΛΟΚΛΗΡΟ</b>  |   |   |   |   |   |   |   |   |
|   | M 113.941, M 113.948  | 10/98 → 07/04   |    | VKPC 88846   |   |   |   | 1   |   |   |   |   |
|   | B(Alt) M 113.941, M 113.948   | 10/98 → 09/02   |   | VKMV 6PK2390<br>VKM 31041<br>VKM 38026   | 1   | 1   |   | 1   |   |   |   |   |
| B(Alt)   | M 113.941, M 113.948  | 09/02 → 08/05   |   | VKM 31041<br>VKM 38026   | 1   | 1   |   |   |   |   |   |   |
| <b>MERCEDES-BENZ</b>  <b>S-class (W220) S 500</b>       |   |   |   |  |   |   |   |   |   |   |   |   |
|   | M 113.960, M 113.966  | 10/98 → 08/05   |   | <b>ΟΛΟΚΛΗΡΟ</b>  |   |   |   |   |   |   |   |   |
|   | M 113.960, M 113.966  | 10/98 → 07/04   |    | VKPC 88846   |   |   |   | 1   |   |   |   |   |
|   | B(Alt) M 113.960, M 113.966   | 10/98 → 09/02   |   | VKMV 6PK2390<br>VKM 31041<br>VKM 38026   | 1   | 1   |   | 1   |   |   |   |   |
| B(Alt)   | M 113.960, M 113.966  | 09/02 → 08/05   |   | VKM 31041<br>VKM 38026   | 1   | 1   |   |   |   |   |   |   |
| <b>MERCEDES-BENZ</b>  <b>S-class (W220) S 55 AMG</b>    |   |   |   |  |   |   |   |   |   |   |   |   |
|   | M 113.986, M 113.991  | 04/99 → 08/05   |   | <b>ΟΛΟΚΛΗΡΟ</b>  |   |   |   |   |   |   |   |   |
|    | M 113.986   | 04/99 → 07/04   |   | VKPC 88846   |   |   |   | 1   |   |   |   |   |
|    | B(Alt) M 113.986  | 04/99 → 09/02   |   | VKMV 6PK2390<br>VKM 31041<br>VKM 38026   | 1   | 1   |   | 1   |   |   |   |   |
| B(Alt)   | M 113.986   | 09/02 → 08/05   |   | VKM 31041<br>VKM 38026   | 1   | 1   |   |   |   |   |   |   |
| B(Alt)   | M 113.991   | 06/02 → 08/05   |   | VKMV 6PK2462<br>VKM 38026  | 1   | 1   |   | 1   |   |   |   |   |
| <b>MERCEDES-BENZ</b>  <b>S-class (W220) S 600</b>     |   |   |   |  |   |   |   |   |   |   |   |   |
|   | M 137.970, M 275.950  | 01/00 → 08/05   |   | <b>ΟΛΟΚΛΗΡΟ</b>  |   |   |   |   |   |   |   |   |
|   | B(Alt) M 137.970, M 275.950   | 01/00 → 08/05   |   | VKMV 7PK2345   |   |   |   | 1   |   |   |   |   |
| <b>MERCEDES-BENZ</b>  <b>S-class (W220) S 65 AMG</b>  |   |   |   |  |   |   |   |   |   |   |   |   |
|   | B(Alt) M 275.980  | 03/04 → 08/05   |   | VKMV 7PK2335   |   |   |   | 1   |   |   |   |   |
| <b>MERCEDES-BENZ</b>  <b>S-class (W220) S 320 CDI</b> |   |   |   |  |   |   |   |   |   |   |   |   |
|   | OM 613.960,<br>OM 648.960   | 08/99 → 08/05   |   | <b>ΟΛΟΚΛΗΡΟ</b>  |   |   |   |   |   |   |   |   |
|   | OM 613.960  | 08/99 → 09/02   |   | —  |   |   |   | 1   |   |   |   |   |
|   | OM 648.960  | 09/02 → 08/05   |   | —  |   |   |   | 1   |   |   |   |   |
|   | B(Alt) OM 613.960   | 08/99 → 09/02   |   | VKMA 38021<br>VKMV 6PK2260<br>VKM 31041<br>VKM 38020                               | 1   | 1   | 1   | 1   |   |   |   |   |
| B(Alt)   | OM 648.960  | 09/02 → 08/05   |   | VKMV 6PK2260<br>VKM 31041<br>VKM 31041<br>VKM 38020                                | 1   | 1   | 1   |   |   |   |   |   |
| <b>MERCEDES-BENZ</b>  <b>S-class (W220) S 400 CDI</b> |   |   |   |  |   |   |   |   |   |   |   |   |
|   | OM 628.960  | 06/00 → 08/05   |   | <b>ΟΛΟΚΛΗΡΟ</b>  |   |   |   |   |   |   |   |   |
|   | OM 628.960  | 06/00 → 07/04   |   | —  |   |   |   | 1   |   |   |   |   |
|   | B(Alt) OM 628.960   | 06/00 → 08/05   |  | VKMV 7PK2271   |   |   |   | 1   |   |   |   |   |
| <b>MERCEDES-BENZ</b>  <b>S-class (W221) S 350</b>     |   |   |   |  |   |   |   |   |   |   |   |   |
|   | M 272.965   | 10/05 → 12/06   |   | <b>ΟΛΟΚΛΗΡΟ</b>  |   |   |   |   |   |   |   |   |
|   | B(Alt) M 272.965  | 10/05 → 12/06   |   | VKMV 6PK2404<br>VKM 31041  |   | 1   | 1   |   |   |   |   |   |
| <b>MERCEDES-BENZ</b>  <b>S-class (W221) S 450</b>     |   |   |   |  |   |   |   |   |   |   |   |   |
|   | M 273.923   | 12/05 → 12/06   |   | <b>ΟΛΟΚΛΗΡΟ</b>  |   |   |   |   |   |   |   |   |









































|  |   |  | <b>MERCEDES-BENZ S-class (W221) S 500, S 600</b> |  |                           |   |  |   |   |  |  |  |  |  |
|--|---|--|--|--|---------------------------|---|--|---|---|--|--|--|--|--|
|  | M 273.961, M 275.953                          |  | 10/05 → 12/06                                    |  | OXOXOXO                   |   |  |   |   |  |  |  |  |  |
|  |   |  | <b>MERCEDES-BENZ S-class (W221) S 65 AMG</b>     |  |                           |   |  |   |   |  |  |  |  |  |
|  |   |  | 12/05 → 12/06                                    |  | OXOXOXO                   |   |  |   |   |  |  |  |  |  |
|  |   |  | <b>MERCEDES-BENZ S-class (W221) S 320 CDI</b>    |  |                           |   |  |   |   |  |  |  |  |  |
|  | OM 642.930                                    |  | 12/05 → 12/06                                    |  | OXOXOXO                   |   |  |   |   |  |  |  |  |  |
|  | <b>B(Alt)</b> OM 642.930                      |  | 12/05 → 12/06                                    |  | VKMV 8PK2035              |   |  | 1 |   |  |  |  |  |  |
|  |   |  | <b>MERCEDES-BENZ SL (W107) 280 SL</b>            |  |                           |   |  |   |   |  |  |  |  |  |
|  | M 110.982, M 110.986, M 110.990               |  | 08/74 → 07/85                                    |  | OXOXOXO                   |   |  |   |   |  |  |  |  |  |
|  | M 110.982, M 110.986, M 110.990               |  | 08/74 → 07/85                                    |  | VKPC 88807                |   |  |   | 1 |  |  |  |  |  |
|  | <b>B(Alt)</b> M 110.982, M 110.986, M 110.990 |  | 06/76 → 09/81                                    |  | VKMV 10AVx935             |   |  | 1 |   |  |  |  |  |  |
|  |   |  | <b>MERCEDES-BENZ SL (W107) 280 SLC</b>           |  |                           |   |  |   |   |  |  |  |  |  |
|  | M 110.982, M 110.986, M 110.990               |  | 08/74 → 09/81                                    |  | OXOXOXO                   |   |  |   |   |  |  |  |  |  |
|  | M 110.982, M 110.986, M 110.990               |  | 08/74 → 09/81                                    |  | VKPC 88807                |   |  |   | 1 |  |  |  |  |  |
|  |   |  | <b>MERCEDES-BENZ SL (W107) 300 SL</b>            |  |                           |   |  |   |   |  |  |  |  |  |
|  | M 103.982                                     |  | 09/85 → 08/89                                    |  | OXOXOXO                   |   |  |   |   |  |  |  |  |  |
|  | M 103.982                                     |  | 09/85 → 08/89                                    | Man. GBX                                     | VKPC 88810                |   |  |   | 1 |  |  |  |  |  |
|  | M 103.982                                     |  | 09/85 → 08/89                                    | Auto. GBX                                    | VKPC 88804                |   |  |   | 1 |  |  |  |  |  |
|  |   |  | <b>MERCEDES-BENZ SL (W107) 380 SL</b>            |  |                           |   |  |   |   |  |  |  |  |  |
|  | M 116.960, M 116.962                          |  | 09/80 → 08/85                                    |  | OXOXOXO                   |   |  |   |   |  |  |  |  |  |
|  | M 116.960                                     |  | 09/80 → 08/81                                    |  | —                         |   |  |   | 1 |  |  |  |  |  |
|  | M 116.962                                     |  | 09/80 → 08/85                                    |  | VKPC 88818                |   |  |   | 1 |  |  |  |  |  |
|  |   |  | <b>MERCEDES-BENZ SL (W107) 420 SL</b>            |  |                           |   |  |   |   |  |  |  |  |  |
|  | M 116.964                                     |  | 01/86 → 08/89                                    |  | OXOXOXO                   |   |  |   |   |  |  |  |  |  |
|  | M 116.964                                     |  | 01/86 → 08/89                                    |  | VKPC 88827                |   |  |   | 1 |  |  |  |  |  |
|  |   |  | <b>MERCEDES-BENZ SL (W107) 500 SL</b>            |  |                           |   |  |   |   |  |  |  |  |  |
|  | M 117.960, M 117.964                          |  | 05/80 → 08/89                                    |  | OXOXOXO                   |   |  |   |   |  |  |  |  |  |
|  | M 117.960                                     |  | 05/80 → 12/85                                    |  | —                         |   |  |   | 1 |  |  |  |  |  |
|  | M 117.960, M 117.964                          |  | 01/86 → 08/89                                    |  | VKPC 88827                |   |  |   | 1 |  |  |  |  |  |
|  | M 117.962                                     |  | 05/80 → 12/81                                    |  | VKPC 88818                |   |  |   | 1 |  |  |  |  |  |
|  |   |  | <b>MERCEDES-BENZ SL (W121) 190 SL</b>            |  |                           |   |  |   |   |  |  |  |  |  |
|  |   |  | 01/55 → 12/63                                    |  | OXOXOXO                   |   |  |   |   |  |  |  |  |  |
|  |   |  | <b>MERCEDES-BENZ SL (W129) 280</b>               |  |                           |   |  |   |   |  |  |  |  |  |
|  | M 104.943, M 112.923, M 112.925               |  | 08/93 → 10/01                                    |  | OXOXOXO                   |   |  |   |   |  |  |  |  |  |
|  | M 104.943                                     |  | 08/93 → 10/01                                    |  | VKPC 88824                |   |  |   | 1 |  |  |  |  |  |
|  | M 112.923, M 112.925                          |  | 05/98 → 10/01                                    | (EUR)  | VKPC 88846                |   |  |   | 1 |  |  |  |  |  |
|  | <b>B(Alt)</b> M 104.943                       |  | 08/93 → 10/01                                    | AC, Auto. GBX, →IMot. 003620                 | VKMV 6PK2330              |   |  | 1 |   |  |  |  |  |  |
|  | <b>B(Alt)</b> M 104.943                       |  | 08/93 → 10/01                                    | AC. Man. GBX, →IMot. 000900                  | VKMV_____                 |   |  |   | 1 |  |  |  |  |  |
|  | <b>B(Alt)</b> M 104.943                       |  | 08/93 → 10/01                                    | AC. Man. GBX, Mot. 000901 I→, →IMot. 001434  | VKMV 6PK2225<br>VKM 38100 | 1 |  |   | 1 |  |  |  |  |  |
|  | <b>B(Alt)</b> M 104.943                       |  | 08/93 → 10/01                                    | AC. Auto. GBX, →IMot. 003620                 | VKMV_____                 |   |  |   | 1 |  |  |  |  |  |
|  | <b>B(Alt)</b> M 104.943                       |  | 08/93 → 10/01                                    | AC. Auto. GBX, Mot. 003621 I→, →IMot. 006116 | VKMV 6PK2225<br>VKM 38100 | 1 |  |   | 1 |  |  |  |  |  |
|  | <b>B(Alt)</b> M 104.943                       |  | 08/93 → 10/01                                    | Man. GBX, Mot. 001435 I→                     | VKMV 6PK2205<br>VKM 38100 | 1 |  |   | 1 |  |  |  |  |  |

|   |  |  |  |  |  |  |  |  |  |  |  |  |
|---|---|---|---|--|---|---|---|---|---|---|---|---|
| B(Alt)  | M 104.943   | 08/93 → 10/01   | Auto. GBX.<br>Mot. 006117 I→  | VKMV 6PK2205<br>VKM 38100  | 1   |   | 1   |   |   |   |   |   |
| B(Alt)  | M 112.923, M 112.925  | 05/98 → 10/01   |   | VKMV 6PK2390<br>VKM 31041<br>VKM 38026   | 1   | 1   | 1   |   |   |   |   |   |
| <b>MERCEDES-BENZ</b>  <b>SL (W129) 300</b>           |   |   |   |  |   |   |   |   |   |   |   |   |
|    | M 103.984, M 104.981  | 03/89 → 08/93   |   | ΟΧΘΟΧΟ   |   |   |   |   |   |   |   |   |
|    | M 103.984   | 03/89 → 08/93   |   | VKPC 88810   |   |   |   | 1   |   |   |   |   |
|   | M 104.981   | 03/89 → 07/93   |   | VKPC 88816   |   |   |   | 1   |   |   |   |   |
| <b>MERCEDES-BENZ</b>  <b>SL (W129) 320</b>           |   |   |   |  |   |   |   |   |   |   |   |   |
|    | M 104.991, M 112.943  | 09/93 → 10/01   |   | ΟΧΘΟΧΟ   |   |   |   |   |   |   |   |   |
|    | M 104.991   | 09/93 → 10/01   |   | VKPC 88824   |   |   |   | 1   |   |   |   |   |
|   | M 112.943   | 05/98 → 10/01   | (EUR)   | VKPC 88846   |   |   |   | 1   |   |   |   |   |
|    | B(Alt) M 104.991  | 09/93 → 10/01   | AC, →IMot. 009985   | VKMV 6PK2330   |   |   | 1   |   |   |   |   |   |
|   | B(Alt) M 104.991  | 09/93 → 10/01   | AC, →IMot. 009985   | VKMV   |   |   | 1   |   |   |   |   |   |
|   | B(Alt) M 104.991  | 09/93 → 10/01   | AC, Mot. 009986 I→,<br>→IMot. 020513  | VKMV 6PK2225<br>VKM 38100  | 1   |   | 1   |   |   |   |   |   |
|   | B(Alt) M 104.991  | 09/93 → 10/01   | Mot. 020514 I→  | VKMV 6PK2205<br>VKM 38100  | 1   |   | 1   |   |   |   |   |   |
|   | B(Alt) M 112.943  | 05/98 → 10/01   |   | VKMV 6PK2390<br>VKM 31041<br>VKM 38026   | 1   | 1   | 1   |   |   |   |   |   |
| <b>MERCEDES-BENZ</b>  <b>SL (W129) 500</b>          |   |   |   |  |   |   |   |   |   |   |   |   |
|    | M 113.961, M 119.960,<br>M 119.972, M 119.982                                     | 09/89 → 10/01   |   | ΟΧΘΟΧΟ   |   |   |   |   |   |   |   |   |
|    | M 113.961   | 05/98 → 10/01   | (EUR)   | VKPC 88846   |   |   |   | 1   |   |   |   |   |
|   | M 119.960, M 119.972  | 09/89 → 08/92   |   | —  |   |   |   | 1   |   |   |   |   |
|   | M 119.972, M 119.982  | 09/92 → 10/01   | →IMot. 013777   | —  |   |   |   | 1   |   |   |   |   |
|   | M 119.972, M 119.982  | 09/92 → 10/01   | Mot. 013778 I→  | —  |   |   |   | 1   |   |   |   |   |
|    | B(Alt) M 113.961  | 05/98 → 10/01   |   | VKMV 6PK2390<br>VKM 31041<br>VKM 38026   | 1   | 1   | 1   |   |   |   |   |   |
| <b>MERCEDES-BENZ</b>  <b>SL (W129) 55 AMG</b>      |   |   |   |  |   |   |   |   |   |   |   |   |
|    | M 113.985   | 03/00 → 10/01   |   | ΟΧΘΟΧΟ   |   |   |   |   |   |   |   |   |
|    | B(Alt) M 113.985  | 03/00 → 10/01   |   | VKMV 6PK2390<br>VKM 31041<br>VKM 38026   | 1   | 1   | 1   |   |   |   |   |   |
| <b>MERCEDES-BENZ</b>  <b>SL (W129) 60 AMG, 600</b> |   |   |   |  |   |   |   |   |   |   |   |   |
|    | M 120.981, M 120.983  | 07/92 → 10/01   |   | ΟΧΘΟΧΟ   |   |   |   |   |   |   |   |   |
| <b>MERCEDES-BENZ</b>  <b>SL (W198) 300 SL</b>      |   |   |   |  |   |   |   |   |   |   |   |   |
|    | M 198.980, M 198.982  | 05/57 → 02/63   |   | ΟΧΘΟΧΟ   |   |   |   |   |   |   |   |   |
| <b>MERCEDES-BENZ</b>  <b>SL (W230) 350</b>         |   |   |   |  |   |   |   |   |   |   |   |   |
|    | M 112.973   | 03/03 → 12/05   |   | ΟΧΘΟΧΟ   |   |   |   |   |   |   |   |   |
|    | B(Alt) M 112.973  | 03/03 → 01/07   |   | VKM 31041<br>VKM 38026   | 1   | 1   |   |   |   |   |   |   |
| <b>MERCEDES-BENZ</b>  <b>SL (W230) 500</b>         |   |   |   |  |   |   |   |   |   |   |   |   |
|    | M 113.963   | 10/01 → 12/05   |   | ΟΧΘΟΧΟ   |   |   |   |   |   |   |   |   |
|    | M 113.963   | 10/01 → 07/04   | (EUR)   | VKPC 88846   |   |   |   | 1   |   |   |   |   |
|    | B(Alt) M 113.963  | 10/01 → 07/02   |   | VKMV 6PK2390<br>VKM 31041<br>VKM 38026   | 1   | 1   | 1   |   |   |   |   |   |
|   | B(Alt) M 113.963  | 07/02 → 01/07   |   | VKM 31041<br>VKM 38026   | 1   | 1   |   |   |   |   |   |   |
| <b>MERCEDES-BENZ</b>  <b>SL (W230) 55 AMG</b>      |   |   |   |  |   |   |   |   |   |   |   |   |
|    | M 113.992   | 10/01 → 06/02   |   | ΟΧΘΟΧΟ   |   |   |   |   |   |   |   |   |
|    | B(Alt) M 113.992  | 10/01 → 01/07   |   | VKMV 6PK2462<br>VKM 38026  | 1   | 1   | 1   |   |   |   |   |   |



























|   |  |  |  |  |  |  |  |  |  |  |  |  |
|---|---|---|---|--|---|---|---|---|---|---|---|---|
| <b>MERCEDES-BENZ  SL (W230) 600</b>                  |   |   |   |  |   |   |   |   |   |   |   |   |
|   | M 275.951   | 04/03 → 12/05   |   | OKOKOKO  |   |   |   |   |   |   |   |   |
| <b>MERCEDES-BENZ  SL (W230) 65 AMG</b>               |   |   |   |  |   |   |   |   |   |   |   |   |
|   | M 275.981   | 03/04 → 12/05   |   | OKOKOKO  |   |   |   |   |   |   |   |   |
| <b>MERCEDES-BENZ  SLK (R170) 200</b>                 |   |   |   |  |   |   |   |   |   |   |   |   |
|   | M 111.946   | 09/96 → 03/00   |   | OKOKOKO  |   |   |   |   |   |   |   |   |
|   | M 111.946   | 09/96 → 03/00   |   | VKPC 88622   |   |   |   |   |   | 1   |   |   |
|   | <b>B(Alt)</b> M 111.946   | 09/96 → 03/00   | AC  | VKMV 6PK2055<br>VKM 38022<br>VKM 38027   | 1   |   | 1   |   |   |   |   |   |
|   | <b>B(Alt)</b> M 111.946   | 09/96 → 03/00   | AC  | VKMV 6PK2155<br>VKM 38022<br>VKM 38027   | 1   |   | 1   |   |   |   |   |   |
| <b>MERCEDES-BENZ  SLK (R170) 200 Kompressor</b>      |   |   |   |  |   |   |   |   |   |   |   |   |
|   | M 111.943, M 111.958  | 10/96 → 04/04   |   | OKOKOKO  |   |   |   |   |   |   |   |   |
|   | M 111.943   | 10/96 → 03/00   |   | VKPC 88631   |   |   |   |   |   | 1   |   |   |
|   | M 111.958   | 03/00 → 04/04   |   | VKPC 88854   |   |   |   |   |   | 1   |   |   |
|   | <b>B(Alt)</b> M 111.943, M 111.958  | 10/96 → 04/04   | AC  | VKMV 6PK1775<br>VKM 38022<br>VKM 38027   | 1   |   | 1   |   |   |   |   |   |
|   | <b>B(Alt)</b> M 111.943   | 10/96 → 03/00   | AC  | VKMV 6PK1875<br>VKM 38022<br>VKM 38027   | 1   |   | 1   |   |   |   |   |   |
|   | <b>B(Alt)</b> M 111.958   | 03/00 → 04/04   | AC  | VKMV 6PK1870<br>VKM 38022<br>VKM 38027   | 1   |   | 1   |   |   |   |   |   |
|   | <b>B(Comp)</b> M 111.943  | 10/96 → 03/00   |   | VKMV 6PK1330   |   |   | 1   |   |   |   |   |   |
|   | <b>B(Comp)</b> M 111.958  | 03/00 → 04/04   |   | VKMV 6PK1355   |   |   | 1   |   |   |   |   |   |
| <b>MERCEDES-BENZ  SLK (R170) 230 Kompressor</b>    |   |   |   |  |   |   |   |   |   |   |   |   |
|   | M 111.973, M 111.983  | 09/96 → 04/04   |   | OKOKOKO  |   |   |   |   |   |   |   |   |
|   | M 111.973   | 09/96 → 03/00   |   | VKPC 88631   |   |   |   |   |   | 1   |   |   |
|   | M 111.983   | 03/00 → 04/04   |   | VKPC 88854   |   |   |   |   |   | 1   |   |   |
|   | <b>B(Alt)</b> M 111.973, M 111.983  | 09/96 → 04/04   | AC  | VKMV 6PK1775<br>VKM 38022<br>VKM 38027   | 1   |   | 1   |   |   |   |   |   |
|   | <b>B(Alt)</b> M 111.973   | 09/96 → 03/00   | AC  | VKMV 6PK1875<br>VKM 38022<br>VKM 38027   | 1   |   | 1   |   |   |   |   |   |
|   | <b>B(Alt)</b> M 111.983   | 03/00 → 04/04   | AC  | VKMV 6PK1870<br>VKM 38022<br>VKM 38027   | 1   |   | 1   |   |   |   |   |   |
|   | <b>B(Comp)</b> M 111.973  | 09/96 → 03/00   |   | VKMV 6PK1330   |   |   | 1   |   |   |   |   |   |
|   | <b>B(Comp)</b> M 111.983  | 03/00 → 04/04   |   | VKMV 6PK1355   |   |   | 1   |   |   |   |   |   |
| <b>MERCEDES-BENZ  SLK (R170) 320</b>               |   |   |   |  |   |   |   |   |   |   |   |   |
|   | M 112.947   | 03/00 → 04/04   |   | OKOKOKO  |   |   |   |   |   |   |   |   |
|   | M 112.947   | 03/00 → 04/04   | (EUR)   | VKPC 88846   |   |   |   |   |   | 1   |   |   |
|   | <b>B(Alt)</b> M 112.947   | 03/00 → 04/04   |   | VKMV 6PK2390<br>VKM 31041<br>VKM 38026   | 1   |   | 1   |   |   |   |   |   |
| <b>MERCEDES-BENZ  SLK (R170) 32 AMG Kompressor</b> |   |   |   |  |   |   |   |   |   |   |   |   |
|   | M 112.960   | 03/01 → 04/04   |   | OKOKOKO  |   |   |   |   |   |   |   |   |
| <b>MERCEDES-BENZ  SLK (R171) 200 Kompressor</b>    |   |   |   |  |   |   |   |   |   |   |   |   |
|   | M 271.944   | 03/04 → 12/06   |   | OKOKOKO  |   |   |   |   |   |   |   |   |
|   | <b>B(Alt)</b> M 271.944   | 03/04 → 12/06   |   | VKMV 7PK2420   |   |   | 1   |   |   |   |   |   |
| <b>MERCEDES-BENZ  SLK (R171) 280</b>               |   |   |   |  |   |   |   |   |   |   |   |   |
|   | M 272.942   | 01/05 → 12/06   |   | OKOKOKO  |   |   |   |   |   |   |   |   |
|   | <b>B(Alt)</b> M 272.942   | 01/05 → 12/06   |   | VKMV 6PK2404<br>VKM 31041  |   | 1   | 1   |   |   |   |   |   |

|   |  |  |  |  |  |  |  |  |  |  |  |
|---|---|---|---|--|---|---|---|---|---|---|---|
| <b>MERCEDES-BENZ  SLK (R171) 350</b>         |   |   |   |  |   |   |   |   |   |   |   |
|    | M 272.963   | 06/04 → 12/06   |   | <b>ΟΛΟΚΛΗΡΟ</b>  |   |   |   |   |   |   |   |
|    | <b>B(Alt)</b> M 272.963   | 06/04 → 02/05   |   | VKMV 6PK2404<br>VKM 31041  |   | 1   |   | 1   |   |   |   |
|   | <b>B(Alt)</b> M 272.963   | 03/05 → 12/06   |   | VKMV 6PK2404<br>VKM 31041  |   | 1   |   | 1   |   |   |   |
| <b>MERCEDES-BENZ  SLK (R171) 55 AMG</b>      |   |   |   |  |   |   |   |   |   |   |   |
|    | M 113.989   | 06/04 → 12/06   |   | <b>ΟΛΟΚΛΗΡΟ</b>  |   |   |   |   |   |   |   |
|    | <b>B(Alt)</b> M 113.989   | 06/04 → 12/06   |   | VKM 31041<br>VKM 38026   | 1   |   |   | 1   |   |   |   |
| <b>MERCEDES-BENZ  Vaneo (W414) 1.6</b>       |   |   |   |  |   |   |   |   |   |   |   |
|    | M 166.961   | 02/02 → 12/05   |   | <b>ΟΛΟΚΛΗΡΟ</b>  |   |   |   |   |   |   |   |
|    | M 166.961   | 02/02 → 07/07   |   | VKPC 88851   |   |   |   |   | 1   |   |   |
|    | <b>B(Alt)</b> M 166.961   | 02/02 → 12/06   | AC  | VKMV 5PK1290   |   |   |   | 1   |   |   |   |
|   | <b>B(Alt)</b> M 166.961   | 02/02 → 12/06   | AC  | VKMV 5PK1750   |   |   |   | 1   |   |   |   |
| <b>MERCEDES-BENZ  Vaneo (W414) 1.9</b>       |   |   |   |  |   |   |   |   |   |   |   |
|    | M 166.991   | 02/02 → 12/05   |   | <b>ΟΛΟΚΛΗΡΟ</b>  |   |   |   |   |   |   |   |
|    | M 166.991   | 02/02 → 07/07   |   | VKPC 88851   |   |   |   |   | 1   |   |   |
|    | <b>B(Alt)</b> M 166.991   | 02/02 → 12/06   | AC  | VKMV 5PK1290   |   |   |   | 1   |   |   |   |
|   | <b>B(Alt)</b> M 166.991   | 02/02 → 12/06   | AC  | VKMV 5PK1750   |   |   |   | 1   |   |   |   |
| <b>MERCEDES-BENZ  Vaneo (W414) 1.7 CDI</b>   |   |   |   |  |   |   |   |   |   |   |   |
|   | OM 668.914  | 02/02 → 12/05   |   | <b>ΟΛΟΚΛΗΡΟ</b>  |   |   |   |   |   |   |   |
|    | OM 668.914  | 02/02 → 07/07   |   | VKPC 88851   |   |   |   |   | 1   |   |   |
|    | <b>B(Alt)</b> OM 668.914  | 02/02 → 05/03   | AC, → ICH N 231167  | VKMV 5PK1263   |   |   |   | 1   |   |   |   |
|   | <b>B(Alt)</b> OM 668.914  | 05/03 → 12/06   | AC, CH N 231168 I→  | VKMV 5PK1263   |   |   |   | 1   |   |   |   |
|   | <b>B(Alt)</b> OM 668.914  | 02/02 → 12/06   | AC  | VKMV 5PK1715   |   |   |   | 1   |   |   |   |
| <b>MERCEDES-BENZ  VIANO (W639) 3.2</b>     |   |   |   |  |   |   |   |   |   |   |   |
|    | M 112.951   | 09/03 → 12/05   |   | <b>ΟΛΟΚΛΗΡΟ</b>  |   |   |   |   |   |   |   |
|    | M 112.951   | 09/03 → 10/07   |   | VKPC 88846   |   |   |   |   | 1   |   |   |
|    | <b>B(Alt)</b> M 112.951   | 09/03 → 10/07   | AC  | VKMV 6PK2315<br>VKM 31041<br>VKM 38026   | 1   |   |   | 1   |   |   |   |
|   | <b>B(Alt)</b> M 112.951   | 09/03 → 10/07   | AC  | VKM 31041<br>VKM 38026   | 1   |   |   | 1   |   |   |   |
| <b>MERCEDES-BENZ  VIANO (W639) 3.7</b>     |   |   |   |  |   |   |   |   |   |   |   |
|    | M 112.976   | 06/04 → 10/07   |   | <b>ΟΛΟΚΛΗΡΟ</b>  |   |   |   |   |   |   |   |
|    | M 112.976   | 06/04 → 10/07   |   | VKPC 88846   |   |   |   |   | 1   |   |   |
|    | <b>B(Alt)</b> M 112.976   | 06/04 → 10/07   | AC  | VKMV 6PK2315<br>VKM 31041<br>VKM 38026   | 1   |   |   | 1   |   |   |   |
|   | <b>B(Alt)</b> M 112.976   | 06/04 → 10/07   | AC  | VKM 31041<br>VKM 38026   | 1   |   |   | 1   |   |   |   |
| <b>MERCEDES-BENZ  VIANO (W639) 2.2 CDI</b> |   |   |   |  |   |   |   |   |   |   |   |
|    | OM 646.982  | 09/03 → 10/07   |   | <b>ΟΛΟΚΛΗΡΟ</b>  |   |   |   |   |   |   |   |
|    | OM 646.982  | 09/03 → 10/07   |   | —  |   |   |   |   | 1   |   |   |
|    | <b>B(Alt)</b> OM 646.982  | 09/03 → 10/07   | 28), AC   | VKMV 6PK2260<br>VKM 31041<br>VKM 31041<br>VKM 38020                                | 1   |   |   | 1   |   |   |   |
|   | <b>B(Alt)</b> OM 646.982  | 09/03 → 10/07   | 29), AC   | VKMV 6PK2285<br>VKM 31041<br>VKM 38020   | 1   |   |   | 1   |   |   |   |
| <b>MERCEDES-BENZ  VIANO (W639) 3.0 CDI</b> |   |   |   |  |   |   |   |   |   |   |   |
|    | <b>B(Alt)</b>   | 03/06 → 01/07   |   | VKMV 7PK2035   |   |   |   | 1   |   |   |   |
| <b>MERCEDES-BENZ  W110 / W111 190</b>      |   |   |   |  |   |   |   |   |   |   |   |
|    | M 121.924   | 04/61 → 08/65   |   | <b>ΟΛΟΚΛΗΡΟ</b>  |   |   |   |   |   |   |   |
| <b>MERCEDES-BENZ  W110 / W111 200</b>      |   |   |   |  |   |   |   |   |   |   |   |
|    | M 115.926, M 121.940  | 07/65 → 02/68   |   | <b>ΟΛΟΚΛΗΡΟ</b>  |   |   |   |   |   |   |   |

























































































| MERCEDES-BENZ  W110 / W111 220     |  |                                |                               |  |  |  |  |  |  |  |  |  |  |  |  |  |  |  |  |  |
|---|--|--------------------------------|-------------------------------|--|--|--|--|--|--|--|--|--|--|--|--|--|--|--|--|--|
|                                     | M 127.982, M 127.984,<br>M 180.940, M 180.941      | 08/59 → 12/65                  |                               |  |  |  |  |  |  |  |  |  |  |  |  |  |  |  |  |  |
|                                     | 127.982, 127.982/984,<br>180.940/941,<br>M 127.984 | 08/59 → 12/65                  |                               |  |  |  |  |  |  |  |  |  |  |  |  |  |  |  |  |  |
|                                     | M 180.947, M 180.950                               | 07/65 → 01/68                  |                               |  |  |  |  |  |  |  |  |  |  |  |  |  |  |  |  |  |
|                                     | M 180.947, M 180.950<br>M 180.947, M 180.950       | 07/65 → 01/68<br>07/65 → 01/68 |                               |  |  |  |  |  |  |  |  |  |  |  |  |  |  |  |  |  |
| MERCEDES-BENZ  W110 / W111 230     |  |                                |                               |  |  |  |  |  |  |  |  |  |  |  |  |  |  |  |  |  |
|                                     | M 180.945, M 180.949,<br>M 180.950                 | 07/65 → 02/68                  |                               |  |  |  |  |  |  |  |  |  |  |  |  |  |  |  |  |  |
|                                     | M 180.945, M 180.949                               | 07/65 → 02/68                  |                               |  |  |  |  |  |  |  |  |  |  |  |  |  |  |  |  |  |
| MERCEDES-BENZ  W110 / W111 250     |  |                                |                               |  |  |  |  |  |  |  |  |  |  |  |  |  |  |  |  |  |
|                                     | M 129.980, M 129.981                               | 01/65 → 12/67                  |                               |  |  |  |  |  |  |  |  |  |  |  |  |  |  |  |  |  |
|                                     | 116.980/990<br>127.984                             | 01/65 → 12/67<br>01/65 → 12/67 |                               |  |  |  |  |  |  |  |  |  |  |  |  |  |  |  |  |  |
| MERCEDES-BENZ  W110 / W111 280     |  |                                |                               |  |  |  |  |  |  |  |  |  |  |  |  |  |  |  |  |  |
|                                     | M 130.980, M 130.984                               | 01/67 → 12/71                  |                               |  |  |  |  |  |  |  |  |  |  |  |  |  |  |  |  |  |
|                                     | 116.980/990<br>130.980                             | 01/67 → 12/71<br>01/67 → 12/71 |                               |  |  |  |  |  |  |  |  |  |  |  |  |  |  |  |  |  |
|   | 130.980  | 01/67 → 12/71                  | Man. GBX,<br>Mot. 005239 I→   |  |  |  |  |  |  |  |  |  |  |  |  |  |  |  |  |  |
|   | 130.984  | 01/67 → 12/71                  | Auto. GBX,<br>Mot. 009390 I→  |  |  |  |  |  |  |  |  |  |  |  |  |  |  |  |  |  |
|   | 130.984  | 01/67 → 12/71                  | Man. GBX,<br>Mot. 000100 I→   |  |  |  |  |  |  |  |  |  |  |  |  |  |  |  |  |  |
|   | 130.984  | 01/67 → 12/71                  | Auto. GBX,<br>Mot. 000047 I→  |  |  |  |  |  |  |  |  |  |  |  |  |  |  |  |  |  |
| MERCEDES-BENZ  W110 / W111 190 D |  |                                |                               |  |  |  |  |  |  |  |  |  |  |  |  |  |  |  |  |  |
|                                   | OM 621.912   | 06/61 → 08/65                  |                               |  |  |  |  |  |  |  |  |  |  |  |  |  |  |  |  |  |
| MERCEDES-BENZ  W110 / W111 200 D |  |                                |                               |  |  |  |  |  |  |  |  |  |  |  |  |  |  |  |  |  |
|                                   | OM 621.918   | 07/65 → 02/68                  |                               |  |  |  |  |  |  |  |  |  |  |  |  |  |  |  |  |  |
| MERCEDES-BENZ  W113 230 SL       |  |                                |                               |  |  |  |  |  |  |  |  |  |  |  |  |  |  |  |  |  |
|                                   | M 127.981  | 01/63 → 01/67                  |                               |  |  |  |  |  |  |  |  |  |  |  |  |  |  |  |  |  |
| MERCEDES-BENZ  W113 250 SL       |  |                                |                               |  |  |  |  |  |  |  |  |  |  |  |  |  |  |  |  |  |
|                                   | M 129.982  | 01/66 → 01/68                  |                               |  |  |  |  |  |  |  |  |  |  |  |  |  |  |  |  |  |
| MERCEDES-BENZ  W113 280 SL       |  |                                |                               |  |  |  |  |  |  |  |  |  |  |  |  |  |  |  |  |  |
|                                   | M 130.983  | 01/68 → 03/71                  |                               |  |  |  |  |  |  |  |  |  |  |  |  |  |  |  |  |  |
|                                   | M 130.983  | 01/68 → 03/71                  |                               |  |  |  |  |  |  |  |  |  |  |  |  |  |  |  |  |  |
| MERCEDES-BENZ  W114 230          |  |                                |                               |  |  |  |  |  |  |  |  |  |  |  |  |  |  |  |  |  |
|                                   | M 180.954  | 01/68 → 11/76                  |                               |  |  |  |  |  |  |  |  |  |  |  |  |  |  |  |  |  |
|                                   | M 180.954  | 01/68 → 11/76                  | Man. GBX,<br>→ I Mot. 007681  |  |  |  |  |  |  |  |  |  |  |  |  |  |  |  |  |  |
|   | M 180.954  | 01/68 → 11/76                  | Man. GBX,<br>Mot. 007682 I→   |  |  |  |  |  |  |  |  |  |  |  |  |  |  |  |  |  |
|   | M 180.954  | 01/68 → 11/76                  | Auto. GBX,<br>→ I Mot. 003563 |  |  |  |  |  |  |  |  |  |  |  |  |  |  |  |  |  |
|   | M 180.954  | 01/68 → 11/76                  | Auto. GBX,<br>Mot. 003564 I→  |  |  |  |  |  |  |  |  |  |  |  |  |  |  |  |  |  |
| MERCEDES-BENZ  W114 250          |  |                                |                               |  |  |  |  |  |  |  |  |  |  |  |  |  |  |  |  |  |
|                                   | M 114.920, M 114.980                               | 01/68 → 08/72                  |                               |  |  |  |  |  |  |  |  |  |  |  |  |  |  |  |  |  |
|                                   | M 114.920  | 01/68 → 08/72                  |                               |  |  |  |  |  |  |  |  |  |  |  |  |  |  |  |  |  |
| MERCEDES-BENZ  W114 250 2.8      |  |                                |                               |  |  |  |  |  |  |  |  |  |  |  |  |  |  |  |  |  |
|                                   | M 130.923  | 06/72 → 11/76                  |                               |  |  |  |  |  |  |  |  |  |  |  |  |  |  |  |  |  |
|                                   | M 130.923  | 06/72 → 11/76                  |                               |  |  |  |  |  |  |  |  |  |  |  |  |  |  |  |  |  |
| MERCEDES-BENZ  W114 280          |  |                                |                               |  |  |  |  |  |  |  |  |  |  |  |  |  |  |  |  |  |
|                                   | M 110.921, M 110.981                               | 06/72 → 02/77                  |                               |  |  |  |  |  |  |  |  |  |  |  |  |  |  |  |  |  |
|                                   | M 110.921, M 110.981                               | 06/72 → 11/76                  |                               |  |  |  |  |  |  |  |  |  |  |  |  |  |  |  |  |  |
| MERCEDES-BENZ  W115 200          |  |                                |                               |  |  |  |  |  |  |  |  |  |  |  |  |  |  |  |  |  |
|                                   | M 115.923, M 115.926                               | 01/68 → 01/77                  |                               |  |  |  |  |  |  |  |  |  |  |  |  |  |  |  |  |  |











































| MERCEDES-BENZ  W115 220                         |                           |               |                                  |  |  |   |  |  |  |  |   |   |   |   |  |  |  |  |  |
|--|---------------------------|---------------|----------------------------------|--|--|---|--|--|--|--|---|---|---|---|--|--|--|--|--|
|   | M 115.920, M 115.924      | 01/68 → 07/73 |                                  | <b>Οκρίκος</b>                         |  |   |  |  |  |  |   |   |   |   |  |  |  |  |  |
|   | M 115.920, M 115.924      | 01/68 → 07/73 |                                  | VKPC 88807                             |  |   |  |  |  |  |   |   | 1 |   |  |  |  |  |  |
| MERCEDES-BENZ  W115 230                         |                           |               |                                  |  |  |   |  |  |  |  |   |   |   |   |  |  |  |  |  |
|   | M 115.951                 | 08/73 → 12/76 |                                  | <b>Οκρίκος</b>                         |  |   |  |  |  |  |   |   |   |   |  |  |  |  |  |
|   | M 115.951                 | 08/73 → 12/76 |                                  | VKPC 88807                             |  |   |  |  |  |  |   |   | 1 |   |  |  |  |  |  |
| MERCEDES-BENZ  W115 200 D                       |                           |               |                                  |  |  |   |  |  |  |  |   |   |   |   |  |  |  |  |  |
|   | OM 615.913                | 01/68 → 01/77 |                                  | <b>Οκρίκος</b>                         |  |   |  |  |  |  |   |   |   |   |  |  |  |  |  |
|   | OM 615.913                | 01/68 → 01/77 |                                  | VKPC 88807                             |  |   |  |  |  |  |   |   | 1 |   |  |  |  |  |  |
| MERCEDES-BENZ  W115 220 D                       |                           |               |                                  |  |  |   |  |  |  |  |   |   |   |   |  |  |  |  |  |
|   | OM 615.912                | 01/68 → 01/77 |                                  | <b>Οκρίκος</b>                         |  |   |  |  |  |  |   |   |   |   |  |  |  |  |  |
|   | OM 615.912                | 01/68 → 01/77 | Man. GBX,<br>→IMot. 000148       | VKPC 88803                             |  |   |  |  |  |  |   |   | 1 |   |  |  |  |  |  |
|  | OM 615.912                | 01/68 → 01/77 | Man. GBX,<br>Mot. 000149  →      | VKPC 88807                             |  |   |  |  |  |  |   |   |   | 1 |  |  |  |  |  |
|  | OM 615.912                | 01/68 → 01/77 | Auto. GBX,<br>Mot. 000015  →     | VKPC 88807                             |  |   |  |  |  |  |   |   |   | 1 |  |  |  |  |  |
| MERCEDES-BENZ  W115 240 D                       |                           |               |                                  |  |  |   |  |  |  |  |   |   |   |   |  |  |  |  |  |
|   | OM 616.916                | 08/73 → 01/77 |                                  | <b>Οκρίκος</b>                         |  |   |  |  |  |  |   |   |   |   |  |  |  |  |  |
|   | OM 616.916                | 08/73 → 01/77 |                                  | VKPC 88807                             |  |   |  |  |  |  |   |   | 1 |   |  |  |  |  |  |
| MERCEDES-BENZ  W115 240 D 3.0                   |                           |               |                                  |  |  |   |  |  |  |  |   |   |   |   |  |  |  |  |  |
|   | OM 617.910                | 08/74 → 11/76 |                                  | <b>Οκρίκος</b>                         |  |   |  |  |  |  |   |   |   |   |  |  |  |  |  |
|   | OM 617.910                | 08/74 → 11/76 | Man. GBX,<br>Mot. 025170  →      | VKPC 88807                             |  |   |  |  |  |  |   |   | 1 |   |  |  |  |  |  |
|  | OM 617.910                | 08/74 → 11/76 | Auto. GBX,<br>Mot. 023540  →     | VKPC 88807                             |  |   |  |  |  |  |   |   |   | 1 |  |  |  |  |  |
| MERCEDES-BENZ  100 (W631) 2.4 D               |                           |               |                                  |  |  |   |  |  |  |  |   |   |   |   |  |  |  |  |  |
|   | OM 616, OM 616.963        | 02/88 → 02/96 |                                  | <b>Οκρίκος</b>                         |  |   |  |  |  |  |   |   |   |   |  |  |  |  |  |
|   | OM 616, OM 616.963        | 02/88 → 02/96 |                                  | VKPC 88809                             |  |   |  |  |  |  |   |   | 1 |   |  |  |  |  |  |
|   | B(Alt) OM 616, OM 616.963 | 02/88 → 02/96 |                                  | VKMV 13AVx1000                         |  |   |  |  |  |  |   | 1 |   |   |  |  |  |  |  |
| MERCEDES-BENZ  SPRINTER 2-t (W901 / W902) 214 |                           |               |                                  |  |  |   |  |  |  |  |   |   |   |   |  |  |  |  |  |
|   | M 111.979, M 111.984      | 02/95 → 12/05 |                                  | <b>Οκρίκος</b>                         |  |   |  |  |  |  |   |   |   |   |  |  |  |  |  |
|   | M 111.979, M 111.984      | 02/95 → 05/02 |                                  | VKPC 81624                             |  |   |  |  |  |  |   |   | 1 |   |  |  |  |  |  |
|   | B(Alt) M 111.979          | 02/95 → 05/06 | AC, Man. GBX,<br>→IMot. 002028   | VKMV 6PK2100<br>VKM 38022<br>VKM 38027 |  | 1 |  |  |  |  | 1 |   |   |   |  |  |  |  |  |
|  | B(Alt) M 111.979          | 02/95 → 05/06 | AC, Man. GBX,<br>Mot. 002029  →  | VKMV 6PK2115<br>VKM 38022<br>VKM 38027 |  | 1 |  |  |  |  | 1 |   |   |   |  |  |  |  |  |
|  | B(Alt) M 111.979          | 02/95 → 05/06 | AC, Auto. GBX,<br>→IMot. 000441  | VKMV 6PK2100<br>VKM 38022<br>VKM 38027 |  | 1 |  |  |  |  | 1 |   |   |   |  |  |  |  |  |
|  | B(Alt) M 111.979          | 02/95 → 05/06 | AC, Auto. GBX,<br>Mot. 000442  → | VKMV 6PK2115<br>VKM 38022<br>VKM 38027 |  | 1 |  |  |  |  | 1 |   |   |   |  |  |  |  |  |
|  | B(Alt) M 111.979          | 02/95 → 05/06 | AC, Man. GBX,<br>→IMot. 002028   | VKMV 6PK2205<br>VKM 38022<br>VKM 38027 |  | 1 |  |  |  |  | 1 |   |   |   |  |  |  |  |  |
|  | B(Alt) M 111.979          | 02/95 → 05/06 | AC, Man. GBX,<br>Mot. 002029  →  | VKMV 6PK2215<br>VKM 38022<br>VKM 38027 |  | 1 |  |  |  |  | 1 |   |   |   |  |  |  |  |  |
|  | B(Alt) M 111.979          | 02/95 → 05/06 | AC, Auto. GBX,<br>→IMot. 000441  | VKMV 6PK2205<br>VKM 38022<br>VKM 38027 |  | 1 |  |  |  |  | 1 |   |   |   |  |  |  |  |  |











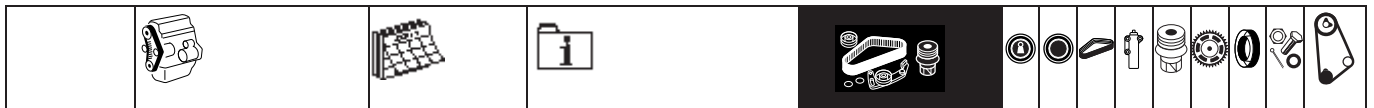





































|   |               |  |  |  |  |  |  |  |  |  |  |  |
|---|---------------|---|---|---|--|---|---|---|---|---|---|---|
|   | <b>B(Alt)</b> | M 111.979   | 02/95 → 05/06   | <b>AC, Auto. GBX,<br/>Mot. 000442 I→</b>  | VKMV 6PK2215<br>VKM 38022<br>VKM 38027   | 1   | 1   |   |   |   |   |   |
| <b>MERCEDES-BENZ  SPRINTER 2-t (W901 / W902) 208 D</b>     |               |   |   |   |  |   |   |   |   |   |   |   |
|   |               | OM 601.943  | 01/95 → 04/00   | <b>ΟΙΧΙΟΙΟ</b>  |  |   |   |   |   |   |   |   |
|   |               | OM 601.943  | 01/95 → 04/00   |   | VKPC 88620   |   |   |   | 1   |   |   |   |
| <b>MERCEDES-BENZ  SPRINTER 2-t (W901 / W902) 210 D</b>     |               |   |   |   |  |   |   |   |   |   |   |   |
|   |               | OM 602.980  | 01/97 → 04/00   | <b>ΟΙΧΙΟΙΟ</b>  |  |   |   |   |   |   |   |   |
|   |               | OM 602.980  | 01/97 → 04/00   |   | VKPC 88620   |   |   |   | 1   |   |   |   |
| <b>MERCEDES-BENZ  SPRINTER 2-t (W901 / W902) 212 D</b>     |               |   |   |   |  |   |   |   |   |   |   |   |
|   |               | OM 602.980  | 02/95 → 04/00   | <b>ΟΙΧΙΟΙΟ</b>  |  |   |   |   |   |   |   |   |
|   |               | OM 602.980  | 02/95 → 04/00   |   | VKPC 88620   |   |   |   | 1   |   |   |   |
| <b>MERCEDES-BENZ  SPRINTER 2-t (W901 / W902) 208 CDI</b>   |               |   |   |   |  |   |   |   |   |   |   |   |
|   |               | OM 611.987  | 04/00 → 12/05   | <b>ΟΙΧΙΟΙΟ</b>  |  |   |   |   |   |   |   |   |
|   |               | OM 611.987  | 04/00 → 05/02   |   | VKPC 88850   |   |   |   | 1   |   |   |   |
|   | <b>B(Alt)</b> | OM 611.987  | 04/00 → 11/02   | <b>AC</b>   | VKMA 38020<br>VKMV 6PK2270<br>VKM 31041<br>VKM 38020                               | 1   | 1   | 1   |   |   |   |   |
|   |               |   |   |   |  |   | 1   |   |   |   |   |   |
| <b>MERCEDES-BENZ  SPRINTER 2-t (W901 / W902) 211 CDI</b>   |               |   |   |   |  |   |   |   |   |   |   |   |
|   |               | OM 611.981  | 04/00 → 12/05   | <b>ΟΙΧΙΟΙΟ</b>  |  |   |   |   |   |   |   |   |
|   |               | OM 611.981  | 04/00 → 05/02   |   | VKPC 88850   |   |   |   | 1   |   |   |   |
|    | <b>B(Alt)</b> | OM 611.981  | 04/00 → 11/02   | <b>AC</b>   | VKMA 38020<br>VKMV 6PK2270<br>VKM 31041<br>VKM 38020                               | 1   | 1   | 1   |   |   |   |   |
|   |               |   |   |   |  |   | 1   |   |   |   |   |   |
| <b>MERCEDES-BENZ  SPRINTER 2-t (W901 / W902) 213 CDI</b> |               |   |   |   |  |   |   |   |   |   |   |   |
|   |               | OM 611.981  | 04/00 → 12/05   | <b>ΟΙΧΙΟΙΟ</b>  |  |   |   |   |   |   |   |   |
|   |               | OM 611.981  | 04/00 → 05/02   |   | VKPC 88850   |   |   |   | 1   |   |   |   |
|   | <b>B(Alt)</b> | OM 611.981  | 04/00 → 11/02   | <b>AC</b>   | VKMA 38020<br>VKMV 6PK2270<br>VKM 31041<br>VKM 38020                               | 1   | 1   | 1   |   |   |   |   |
|   |               |   |   |   |  |   | 1   |   |   |   |   |   |
| <b>MERCEDES-BENZ  SPRINTER 2-t (W901 / W902) 216 CDI</b> |               |   |   |   |  |   |   |   |   |   |   |   |
|   |               | OM 612.981  | 04/00 → 12/05   | <b>ΟΙΧΙΟΙΟ</b>  |  |   |   |   |   |   |   |   |
|   |               | OM 612.981  | 04/00 → 05/02   |   | VKPC 88850   |   |   |   | 1   |   |   |   |
|   | <b>B(Alt)</b> | OM 612.981  | 04/00 → 11/02   | <b>AC</b>   | VKMA 38020<br>VKMV 6PK2270<br>VKM 31041<br>VKM 38020                               | 1   | 1   | 1   |   |   |   |   |
|   |               |   |   |   |  |   | 1   |   |   |   |   |   |
| <b>MERCEDES-BENZ  SPRINTER 3-t (W903) 314</b>            |               |   |   |   |  |   |   |   |   |   |   |   |
|   |               | M 111.979, M 111.984  | 02/95 → 12/05   | <b>ΟΙΧΙΟΙΟ</b>  |  |   |   |   |   |   |   |   |
|   |               | M 111.979, M 111.984  | 02/95 → 07/04   |   | VKPC 81624   |   |   |   | 1   |   |   |   |
|   | <b>B(Alt)</b> | M 111.979   | 02/95 → 05/06   | <b>AC, Man. GBX,<br/>→IMot. 002028</b>  | VKMV 6PK2100<br>VKM 38022<br>VKM 38027   | 1   |   | 1   |   |   |   |   |
|   |               |   |   |   |  |   | 1   |   |   |   |   |   |
|   | <b>B(Alt)</b> | M 111.979   | 02/95 → 05/06   | <b>AC, Man. GBX,<br/>Mot. 002029 I→</b>   | VKMV 6PK2115<br>VKM 38022<br>VKM 38027   | 1   |   | 1   |   |   |   |   |
|   |               |   |   |   |  |   | 1   |   |   |   |   |   |
|   | <b>B(Alt)</b> | M 111.979   | 02/95 → 05/06   | <b>AC, Auto. GBX,<br/>→IMot. 000441</b>   | VKMV 6PK2100<br>VKM 38022<br>VKM 38027   | 1   |   | 1   |   |   |   |   |
|   |               |   |   |   |  |   | 1   |   |   |   |   |   |
|   | <b>B(Alt)</b> | M 111.979   | 02/95 → 05/06   | <b>AC, Auto. GBX,<br/>Mot. 000442 I→</b>  | VKMV 6PK2115<br>VKM 38022<br>VKM 38027   | 1   |   | 1   |   |   |   |   |
|   |               |   |   |   |  |   | 1   |   |   |   |   |   |

|   |  |  |  |  |  |  |  |  |  |  |  |  |  |
|---|---|---|---|--|---|---|---|---|---|---|---|---|---|
| B(Alt)  | M 111.979   | 02/95 → 05/06   | AC, Man. GBX,<br>→IMot. 002028  | VKMV 6PK2205<br>VKM 38022<br>VKM 38027   | 1   |   | 1   |   |   |   |   |   |   |
| B(Alt)  | M 111.979   | 02/95 → 05/06   | AC, Man. GBX,<br>Mot. 002029  →   | VKMV 6PK2215<br>VKM 38022<br>VKM 38027   | 1   |   | 1   |   |   |   |   |   |   |
| B(Alt)  | M 111.979   | 02/95 → 05/06   | AC, Auto. GBX,<br>→IMot. 000441   | VKMV 6PK2205<br>VKM 38022<br>VKM 38027   | 1   |   | 1   |   |   |   |   |   |   |
| B(Alt)  | M 111.979   | 02/95 → 05/06   | AC, Auto. GBX,<br>Mot. 000442  →  | VKMV 6PK2215<br>VKM 38022<br>VKM 38027   | 1   |   | 1   |   |   |   |   |   |   |
| <b>MERCEDES-BENZ</b>  <b>SPRINTER 3-t (W903) 308 E</b>     |   |   |   |  |   |   |   |   |   |   |   |   |   |
|    |   | 04/00 → 12/05   |   | <b>OXOXOXO</b>   |   |   |   |   |   |   |   |   |   |
|    |   | 04/00 → 07/04   |   | VKPC 88620   |   |   |   |   | 1   |   |   |   |   |
| <b>MERCEDES-BENZ</b>  <b>SPRINTER 3-t (W903) 308 D</b>     |   |   |   |  |   |   |   |   |   |   |   |   |   |
|    | OM 601.943  | 02/95 → 04/00   |   | <b>OXOXOXO</b>   |   |   |   |   |   |   |   |   |   |
|    | OM 601.943  | 02/95 → 04/00   |   | VKPC 88620   |   |   |   |   | 1   |   |   |   |   |
| <b>MERCEDES-BENZ</b>  <b>SPRINTER 3-t (W903) 310 D</b>     |   |   |   |  |   |   |   |   |   |   |   |   |   |
|    | OM 602.980  | 02/95 → 08/02   |   | <b>OXOXOXO</b>   |   |   |   |   |   |   |   |   |   |
|   | OM 602.980  | 02/95 → 08/02   |   | VKPC 88620   |   |   |   |   | 1   |   |   |   |   |
| <b>MERCEDES-BENZ</b>  <b>SPRINTER 3-t (W903) 312 D</b>   |   |   |   |  |   |   |   |   |   |   |   |   |   |
|    | OM 602.980  | 02/95 → 08/02   |   | <b>OXOXOXO</b>   |   |   |   |   |   |   |   |   |   |
|    | OM 602.980  | 02/95 → 08/02   |   | VKPC 88620   |   |   |   |   | 1   |   |   |   |   |
| <b>MERCEDES-BENZ</b>  <b>SPRINTER 3-t (W903) 308 CDI</b> |   |   |   |  |   |   |   |   |   |   |   |   |   |
|    | OM 611.987  | 04/00 → 12/05   |   | <b>OXOXOXO</b>   |   |   |   |   |   |   |   |   |   |
|    | OM 611.987  | 04/00 → 07/04   |   | VKPC 88850   |   |   |   |   | 1   |   |   |   |   |
|    | B(Alt) OM 611.987   | 04/00 → 11/02   | AC  | VKMA 38020<br>VKMV 6PK2270<br>VKM 31041<br>VKM 38020                               | 1   | 1   | 1   |   |   |   |   |   |   |
|   |   |   |   |  |   | 1   | 1   |   |   |   |   |   |   |
| <b>MERCEDES-BENZ</b>  <b>SPRINTER 3-t (W903) 311 CDI</b> |   |   |   |  |   |   |   |   |   |   |   |   |   |
|    | OM 611.981  | 04/00 → 12/05   |   | <b>OXOXOXO</b>   |   |   |   |   |   |   |   |   |   |
|    | OM 611.981  | 04/00 → 07/04   |   | VKPC 88850   |   |   |   |   | 1   |   |   |   |   |
|    | B(Alt) OM 611.981   | 04/00 → 11/02   | AC  | VKMA 38020<br>VKMV 6PK2270<br>VKM 31041<br>VKM 38020                               | 1   | 1   | 1   |   |   |   |   |   |   |
|   |   |   |   |  |   | 1   | 1   |   |   |   |   |   |   |
| <b>MERCEDES-BENZ</b>  <b>SPRINTER 3-t (W903) 313 CDI</b> |   |   |   |  |   |   |   |   |   |   |   |   |   |
|    | OM 611.981  | 04/00 → 12/05   |   | <b>OXOXOXO</b>   |   |   |   |   |   |   |   |   |   |
|    | OM 611.981  | 04/00 → 07/04   |   | VKPC 88850   |   |   |   |   | 1   |   |   |   |   |
|    | B(Alt) OM 611.981   | 04/00 → 11/02   | AC  | VKMA 38020<br>VKMV 6PK2270<br>VKM 31041<br>VKM 38020                               | 1   | 1   | 1   |   |   |   |   |   |   |
|   |   |   |   |  |   | 1   | 1   |   |   |   |   |   |   |
| <b>MERCEDES-BENZ</b>  <b>SPRINTER 3-t (W903) 316 CDI</b> |   |   |   |  |   |   |   |   |   |   |   |   |   |
|    | OM 612.981  | 04/00 → 12/05   |   | <b>OXOXOXO</b>   |   |   |   |   |   |   |   |   |   |
|    | OM 612.981  | 04/00 → 07/04   |   | VKPC 88850   |   |   |   |   | 1   |   |   |   |   |
|    | B(Alt) OM 612.981   | 04/00 → 11/02   | AC  | VKMA 38020<br>VKMV 6PK2270<br>VKM 31041<br>VKM 38020                               | 1   | 1   | 1   |   |   |   |   |   |   |
|   |   |   |   |  |   | 1   | 1   |   |   |   |   |   |   |
| <b>MERCEDES-BENZ</b>  <b>SPRINTER 3-t (W906) 209 CDI</b> |   |   |   |  |   |   |   |   |   |   |   |   |   |
|    |   | 06/06 → 10/07   |   | <b>OXOXOXO</b>   |   |   |   |   |   |   |   |   |   |
|    |   | 06/06 → 10/07   |   | —  |   |   |   |   | 1   |   |   |   |   |
| <b>MERCEDES-BENZ</b>  <b>SPRINTER 3-t (W906) 211 CDI</b> |   |   |   |  |   |   |   |   |   |   |   |   |   |
|    |   | 06/06 → 10/07   |   | <b>OXOXOXO</b>   |   |   |   |   |   |   |   |   |   |













































|   |                      |  |  |  |  |  |  |  |  |  |  |  |  |
|---|----------------------|---|---|---|--|---|---|---|---|---|---|---|---|
|   |                      |   | 06/06 → 10/07   |   | —  |   |   |   |   |   | 1   |   |   |
| <b>MERCEDES-BENZ</b>  <b>SPRINTER 3-t (W906) 213 CDI</b>   |                      |   |   |   |  |   |   |   |   |   |   |   |   |
|   |                      |   | 06/06 → 10/07   |   | ΟΧΛΟΧΟ   |   |   |   |   |   |   |   |   |
|   |                      |   | 06/06 → 10/07   |   | —  |   |   |   |   |   | 1   |   |   |
| <b>MERCEDES-BENZ</b>  <b>SPRINTER 3-t (W906) 215 CDI</b>   |                      |   |   |   |  |   |   |   |   |   |   |   |   |
|   |                      |   | 06/06 → 10/07   |   | ΟΧΛΟΧΟ   |   |   |   |   |   |   |   |   |
|   |                      |   | 06/06 → 10/07   |   | —  |   |   |   |   |   | 1   |   |   |
| <b>MERCEDES-BENZ</b>  <b>SPRINTER 3-t (W906) 218 CDI</b>   |                      |   |   |   |  |   |   |   |   |   |   |   |   |
|   |                      |   | 06/06 → 10/07   |   | ΟΧΛΟΧΟ   |   |   |   |   |   |   |   |   |
|   |                      |   | 06/06 → 10/07   |   | —  |   |   |   |   |   | 1   |   |   |
| <b>MERCEDES-BENZ</b>  <b>SPRINTER 3,5-t (W906) 309 CDI</b> |                      |   |   |   |  |   |   |   |   |   |   |   |   |
|   |                      |   | 06/06 → 10/07   |   | ΟΧΛΟΧΟ   |   |   |   |   |   |   |   |   |
|   |                      |   | 06/06 → 10/07   |   | —  |   |   |   |   |   | 1   |   |   |
| <b>MERCEDES-BENZ</b>  <b>SPRINTER 3,5-t (W906) 311 CDI</b> |                      |   |   |   |  |   |   |   |   |   |   |   |   |
|   |                      |   | 06/06 → 10/07   |   | ΟΧΛΟΧΟ   |   |   |   |   |   |   |   |   |
|   |                      |   | 06/06 → 10/07   |   | —  |   |   |   |   |   | 1   |   |   |
| <b>MERCEDES-BENZ</b>  <b>SPRINTER 3,5-t (W906) 315 CDI</b> |                      |   |   |   |  |   |   |   |   |   |   |   |   |
|   |                      |   | 06/06 → 10/07   |   | ΟΧΛΟΧΟ   |   |   |   |   |   |   |   |   |
|   |                      |   | 06/06 → 10/07   |   | —  |   |   |   |   |   | 1   |   |   |
| <b>MERCEDES-BENZ</b>  <b>SPRINTER 3,5-t (W906) 318 CDI</b> |                      |   |   |   |  |   |   |   |   |   |   |   |   |
|   |                      |   | 06/06 → 10/07   |   | ΟΧΛΟΧΟ   |   |   |   |   |   |   |   |   |
|   |                      |   | 06/06 → 10/07   |   | —  |   |   |   |   |   | 1   |   |   |
| <b>MERCEDES-BENZ</b>  <b>SPRINTER 4-t (W904) 414</b>      |                      |   |   |   |  |   |   |   |   |   |   |   |   |
|   | M 111.979, M 111.984 |   | 02/96 → 12/05   |   | ΟΧΛΟΧΟ   |   |   |   |   |   |   |   |   |
|   | B(Alt) M 111.979     |   | 02/96 → 05/06   | AC, Man. GBX,<br>→IMot. 002028  | VKMV 6PK2100<br>VKM 38022<br>VKM 38027   | 1   |   | 1   |   |   |   |   |   |
|   |                      |   |   |   |  |   | 1   |   |   |   |   |   |   |
|   | B(Alt) M 111.979     |   | 02/96 → 05/06   | AC, Man. GBX,<br>Mot. 002029 I→   | VKMV 6PK2115<br>VKM 38022<br>VKM 38027   | 1   |   | 1   |   |   |   |   |   |
|   |                      |   |   |   |  |   | 1   |   |   |   |   |   |   |
|   | B(Alt) M 111.979     |   | 02/96 → 05/06   | AC, Auto. GBX,<br>→IMot. 000441   | VKMV 6PK2100<br>VKM 38022<br>VKM 38027   | 1   |   | 1   |   |   |   |   |   |
|   |                      |   |   |   |  |   | 1   |   |   |   |   |   |   |
|   | B(Alt) M 111.979     |   | 02/96 → 05/06   | AC, Auto. GBX,<br>Mot. 000442 I→  | VKMV 6PK2115<br>VKM 38022<br>VKM 38027   | 1   |   | 1   |   |   |   |   |   |
|   |                      |   |   |   |  |   | 1   |   |   |   |   |   |   |
|   | B(Alt) M 111.979     |   | 02/96 → 05/06   | AC, Man. GBX,<br>→IMot. 002028  | VKMV 6PK2205<br>VKM 38022<br>VKM 38027   | 1   |   | 1   |   |   |   |   |   |
|   |                      |   |   |   |  |   | 1   |   |   |   |   |   |   |
|   | B(Alt) M 111.979     |   | 02/96 → 05/06   | AC, Man. GBX,<br>Mot. 002029 I→   | VKMV 6PK2215<br>VKM 38022<br>VKM 38027   | 1   |   | 1   |   |   |   |   |   |
|   |                      |   |   |   |  |   | 1   |   |   |   |   |   |   |
|   | B(Alt) M 111.979     |   | 02/96 → 05/06   | AC, Auto. GBX,<br>→IMot. 000441   | VKMV 6PK2205<br>VKM 38022<br>VKM 38027   | 1   |   | 1   |   |   |   |   |   |
|   |                      |   |   |   |  |   | 1   |   |   |   |   |   |   |
|   | B(Alt) M 111.979     |   | 02/96 → 05/06   | AC, Auto. GBX,<br>Mot. 000442 I→  | VKMV 6PK2215<br>VKM 38022<br>VKM 38027   | 1   |   | 1   |   |   |   |   |   |
|   |                      |   |   |   |  |   | 1   |   |   |   |   |   |   |
| <b>MERCEDES-BENZ</b>  <b>SPRINTER 4-t (W904) 408 D</b>   |                      |   |   |   |  |   |   |   |   |   |   |   |   |
|   | OM 601.943           |   | 02/96 → 12/05   |   | ΟΧΛΟΧΟ   |   |   |   |   |   |   |   |   |
|   | OM 601.943           |   | 02/96 → 05/02   |   | VKPC 88620   |   |   |   |   |   | 1   |   |   |









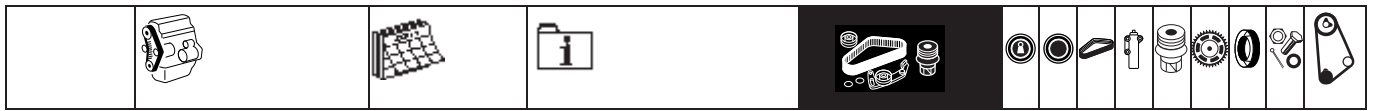















| MERCEDES-BENZ  SPRINTER 4-t (W904) 410 D     |   | ΟΧΛΟΧΩ        |            |              |   |   |   |  |  |  |  |  |  |  |  |  |  |   |
|---|---|---------------|------------|--------------|---|---|---|--|--|--|--|--|--|--|--|--|--|---|
|    | OM 602.980                                    | 02/96 → 12/05 | ΟΧΛΟΧΩ     |              |   |   |   |  |  |  |  |  |  |  |  |  |  |   |
|    | OM 602.980                                    | 02/96 → 05/02 | VKPC 88620 |              |   |   |   |  |  |  |  |  |  |  |  |  |  | 1 |
| MERCEDES-BENZ  SPRINTER 4-t (W904) 412 D     |   | ΟΧΛΟΧΩ        |            |              |   |   |   |  |  |  |  |  |  |  |  |  |  |   |
|    | OM 602.980                                    | 02/96 → 12/05 | ΟΧΛΟΧΩ     |              |   |   |   |  |  |  |  |  |  |  |  |  |  |   |
|    | OM 602.980                                    | 02/96 → 05/02 | VKPC 88620 |              |   |   |   |  |  |  |  |  |  |  |  |  |  | 1 |
| MERCEDES-BENZ  SPRINTER 4-t (W904) 408 CDI   |   | ΟΧΛΟΧΩ        |            |              |   |   |   |  |  |  |  |  |  |  |  |  |  |   |
|    | OM 611.987                                    | 04/00 → 12/05 | ΟΧΛΟΧΩ     |              |   |   |   |  |  |  |  |  |  |  |  |  |  |   |
|    | OM 611.987                                    | 04/00 → 05/02 | VKPC 88850 |              |   |   |   |  |  |  |  |  |  |  |  |  |  | 1 |
|    | B(Alt) OM 611.987                             | 04/00 → 11/02 | AC         | VKMA 38020   | 1 | 1 | 1 |  |  |  |  |  |  |  |  |  |  |   |
|   |   |               |            | VKMN 6PK2270 |   |   | 1 |  |  |  |  |  |  |  |  |  |  |   |
|   |   |               |            | VKM 31041    |   |   | 1 |  |  |  |  |  |  |  |  |  |  |   |
|   |   |               |            | VKM 38020    | 1 |   |   |  |  |  |  |  |  |  |  |  |  |   |
| MERCEDES-BENZ  SPRINTER 4-t (W904) 411 CDI   |   | ΟΧΛΟΧΩ        |            |              |   |   |   |  |  |  |  |  |  |  |  |  |  |   |
|    | OM 611.981                                    | 04/00 → 12/05 | ΟΧΛΟΧΩ     |              |   |   |   |  |  |  |  |  |  |  |  |  |  |   |
|    | OM 611.981                                    | 04/00 → 05/02 | VKPC 88850 |              |   |   |   |  |  |  |  |  |  |  |  |  |  | 1 |
|    | B(Alt) OM 611.981                             | 04/00 → 11/02 | AC         | VKMA 38020   | 1 | 1 | 1 |  |  |  |  |  |  |  |  |  |  |   |
|   |   |               |            | VKMN 6PK2270 |   |   | 1 |  |  |  |  |  |  |  |  |  |  |   |
|   |   |               |            | VKM 31041    |   |   | 1 |  |  |  |  |  |  |  |  |  |  |   |
|   |   |               |            | VKM 38020    | 1 |   |   |  |  |  |  |  |  |  |  |  |  |   |
| MERCEDES-BENZ  SPRINTER 4-t (W904) 413 CDI   |   | ΟΧΛΟΧΩ        |            |              |   |   |   |  |  |  |  |  |  |  |  |  |  |   |
|    | OM 611.981                                    | 04/00 → 12/05 | ΟΧΛΟΧΩ     |              |   |   |   |  |  |  |  |  |  |  |  |  |  |   |
|    | OM 611.981                                    | 04/00 → 05/02 | VKPC 88850 |              |   |   |   |  |  |  |  |  |  |  |  |  |  | 1 |
|   | B(Alt) OM 611.981                             | 04/00 → 11/02 | AC         | VKMA 38020   | 1 | 1 | 1 |  |  |  |  |  |  |  |  |  |  |   |
|   |   |               |            | VKMN 6PK2270 |   |   | 1 |  |  |  |  |  |  |  |  |  |  |   |
|   |   |               |            | VKM 31041    |   |   | 1 |  |  |  |  |  |  |  |  |  |  |   |
|   |   |               |            | VKM 38020    | 1 |   |   |  |  |  |  |  |  |  |  |  |  |   |
| MERCEDES-BENZ  SPRINTER 4-t (W904) 416 CDI |   | ΟΧΛΟΧΩ        |            |              |   |   |   |  |  |  |  |  |  |  |  |  |  |   |
|    | OM 612.981                                    | 04/00 → 12/05 | ΟΧΛΟΧΩ     |              |   |   |   |  |  |  |  |  |  |  |  |  |  |   |
|    | OM 612.981                                    | 04/00 → 05/02 | VKPC 88850 |              |   |   |   |  |  |  |  |  |  |  |  |  |  | 1 |
|    | B(Alt) OM 612.981                             | 04/00 → 11/02 | AC         | VKMA 38020   | 1 | 1 | 1 |  |  |  |  |  |  |  |  |  |  |   |
|   |   |               |            | VKMN 6PK2270 |   |   | 1 |  |  |  |  |  |  |  |  |  |  |   |
|   |   |               |            | VKM 31041    |   |   | 1 |  |  |  |  |  |  |  |  |  |  |   |
|   |   |               |            | VKM 38020    | 1 |   |   |  |  |  |  |  |  |  |  |  |  |   |
| MERCEDES-BENZ  SPRINTER 5-t (W906) 509 CDI |   | ΟΧΛΟΧΩ        |            |              |   |   |   |  |  |  |  |  |  |  |  |  |  |   |
|    |   | 06/06 → 10/07 | ΟΧΛΟΧΩ     |              |   |   |   |  |  |  |  |  |  |  |  |  |  |   |
|    |   | 06/06 → 10/07 | —          |              |   |   |   |  |  |  |  |  |  |  |  |  |  | 1 |
| MERCEDES-BENZ  SPRINTER 5-t (W906) 511 CDI |   | ΟΧΛΟΧΩ        |            |              |   |   |   |  |  |  |  |  |  |  |  |  |  |   |
|    |   | 06/06 → 10/07 | ΟΧΛΟΧΩ     |              |   |   |   |  |  |  |  |  |  |  |  |  |  |   |
|    |   | 06/06 → 10/07 | —          |              |   |   |   |  |  |  |  |  |  |  |  |  |  | 1 |
| MERCEDES-BENZ  SPRINTER 5-t (W906) 515 CDI |   | ΟΧΛΟΧΩ        |            |              |   |   |   |  |  |  |  |  |  |  |  |  |  |   |
|    |   | 06/06 → 10/07 | ΟΧΛΟΧΩ     |              |   |   |   |  |  |  |  |  |  |  |  |  |  |   |
|    |   | 06/06 → 10/07 | —          |              |   |   |   |  |  |  |  |  |  |  |  |  |  | 1 |
| MERCEDES-BENZ  SPRINTER 5-t (W906) 518 CDI |   | ΟΧΛΟΧΩ        |            |              |   |   |   |  |  |  |  |  |  |  |  |  |  |   |
|    |   | 06/06 → 10/07 | ΟΧΛΟΧΩ     |              |   |   |   |  |  |  |  |  |  |  |  |  |  |   |
|    |   | 06/06 → 10/07 | —          |              |   |   |   |  |  |  |  |  |  |  |  |  |  | 1 |
| MERCEDES-BENZ  T1 (W601 / W602) 208 2.3    |   | ΟΧΛΟΧΩ        |            |              |   |   |   |  |  |  |  |  |  |  |  |  |  |   |
|    | M 115.955, M 115.972                          | 05/77 → 12/82 | ΟΧΛΟΧΩ     |              |   |   |   |  |  |  |  |  |  |  |  |  |  |   |
|    | M 115.955, M 115.972                          | 05/77 → 12/82 | VKPC 88807 |              |   |   |   |  |  |  |  |  |  |  |  |  |  | 1 |
| MERCEDES-BENZ  T1 (W601 / W602) 210 2.3    |   | ΟΧΛΟΧΩ        |            |              |   |   |   |  |  |  |  |  |  |  |  |  |  |   |
|    | M 102.942, M 102.945,<br>M 102.946, M 115.955 | 04/77 → 02/96 | ΟΧΛΟΧΩ     |              |   |   |   |  |  |  |  |  |  |  |  |  |  |   |
|    | M 102.942, M 102.946                          | 04/77 → 02/96 | VKPC 88613 |              |   |   |   |  |  |  |  |  |  |  |  |  |  | 1 |
| MERCEDES-BENZ  T1 (W601 / W602) 208 D 2.3  |   | ΟΧΛΟΧΩ        |            |              |   |   |   |  |  |  |  |  |  |  |  |  |  |   |
|    | OM 601.940                                    | 10/88 → 02/96 | ΟΧΛΟΧΩ     |              |   |   |   |  |  |  |  |  |  |  |  |  |  |   |
|    | OM 601.940                                    | 10/88 → 02/96 | VKPC 88620 |              |   |   |   |  |  |  |  |  |  |  |  |  |  | 1 |
| MERCEDES-BENZ  T1 (W601 / W602) 308 D 2.3  |   | ΟΧΛΟΧΩ        |            |              |   |   |   |  |  |  |  |  |  |  |  |  |  |   |
|    | OM 601.940                                    | 11/88 → 02/96 | ΟΧΛΟΧΩ     |              |   |   |   |  |  |  |  |  |  |  |  |  |  |   |
|    | OM 601.940                                    | 11/88 → 02/96 | VKPC 88620 |              |   |   |   |  |  |  |  |  |  |  |  |  |  | 1 |









































|  |  |  |  |  |  |  |  |  |  |  |  |  |  |  |  |
|--|---|---|---|--|---|---|---|---|---|---|---|---|---|---|---|
| <b>MERCEDES-BENZ</b>  <b>T1 (W601 / W602) 207 D 2.4</b>   |   |   |   |  |   |   |   |   |   |   |   |   |   |   |   |
|    |   | OM 616.917,<br>OM 616.934,<br>OM 616.937,<br>OM 616.939                           | 04/77 → 01/90   |  | ΟΧΘΟΧΟ  |   |   |   |   |   |   |   |   |   |   |
|    |   | OM 616.917,<br>OM 616.934   | 04/77 → 12/82   |  | VKPC 88807  |   |   |   |   | 1   |   |   |   |   |   |
|  |   | OM 616.937,<br>OM 616.939   | 06/82 → 01/90   |  | VKPC 88809  |   |   |   |   | 1   |   |   |   |   |   |
| <b>MERCEDES-BENZ</b>  <b>T1 (W601 / W602) 307 D 2.4</b>   |   |   |   |  |   |   |   |   |   |   |   |   |   |   |   |
|    |   | OM 616.937,<br>OM 616.939   | 04/77 → 01/90   |  | ΟΧΘΟΧΟ  |   |   |   |   |   |   |   |   |   |   |
|    |   | 616.917, 616.934  | 04/77 → 01/82   |  | VKPC 88807  |   |   |   |   | 1   |   |   |   |   |   |
|  |   | OM 616.937,<br>OM 616.939   | 06/82 → 01/90   |  | VKPC 88809  |   |   |   |   | 1   |   |   |   |   |   |
| <b>MERCEDES-BENZ</b>  <b>T1 (W601 / W602) 210 D 2.8</b>   |   |   |   |  |   |   |   |   |   |   |   |   |   |   |   |
|    |   | OM 602.940  | 10/88 → 02/96   |  | ΟΧΘΟΧΟ  |   |   |   |   |   |   |   |   |   |   |
|    |   | OM 602.940  | 11/88 → 02/96   |  | VKPC 88620  |   |   |   |   | 1   |   |   |   |   |   |
| <b>MERCEDES-BENZ</b>  <b>T1 (W601 / W602) 209 D 2.9</b>   |   |   |   |  |   |   |   |   |   |   |   |   |   |   |   |
|    |   | OM 617.913  | 12/82 → 01/90   |  | ΟΧΘΟΧΟ  |   |   |   |   |   |   |   |   |   |   |
|    |   | OM 617.913  | 12/82 → 01/90   |  | VKPC 88808  |   |   |   |   | 1   |   |   |   |   |   |
| <b>MERCEDES-BENZ</b>  <b>T1 (W601 / W602) 210 D 2.9</b>   |   |   |   |  |   |   |   |   |   |   |   |   |   |   |   |
|    |   | OM 602.940  | 11/88 → 02/96   |  | ΟΧΘΟΧΟ  |   |   |   |   |   |   |   |   |   |   |
|    |   | OM 602.940  | 11/88 → 02/96   |  | VKPC 88620  |   |   |   |   | 1   |   |   |   |   |   |
| <b>MERCEDES-BENZ</b>  <b>T1 (W601 / W602) 310 D 2.9</b>  |   |   |   |  |   |   |   |   |   |   |   |   |   |   |   |
|    |   | OM 602.940  | 06/89 → 02/96   |  | ΟΧΘΟΧΟ  |   |   |   |   |   |   |   |   |   |   |
|    |   | OM 602.940  | 06/89 → 02/96   |  | VKPC 88620  |   |   |   |   | 1   |   |   |   |   |   |
| <b>MERCEDES-BENZ</b>  <b>T1 (W601 / W602) 309 D 3.0</b> |   |   |   |  |   |   |   |   |   |   |   |   |   |   |   |
|    |   | OM 617.913  | 10/82 → 01/90   |  | ΟΧΘΟΧΟ  |   |   |   |   |   |   |   |   |   |   |
|    |   | OM 617.913  | 10/82 → 01/90   |  | VKPC 88808  |   |   |   |   | 1   |   |   |   |   |   |
| <b>MERCEDES-BENZ</b>  <b>V-class (W638) V 200</b>       |   |   |   |  |   |   |   |   |   |   |   |   |   |   |   |
|    |   | M 111.948   | 02/97 → 07/03   |  | ΟΧΘΟΧΟ  |   |   |   |   |   |   |   |   |   |   |
|    |   | M 111.948   | 02/97 → 07/03   | Man. GBX,<br>→IMot.002353  | VKPC 88844  |   |   |   |   | 1   |   |   |   |   |   |
|  |   | M 111.948   | 02/97 → 07/03   | Man. GBX,<br>Mot.002354  →   | VKPC 88845  |   |   |   |   | 1   |   |   |   |   |   |
|  |   | M 111.948   | 02/97 → 07/03   | Auto. GBX,<br>→IMot.000132   | VKPC 88844  |   |   |   |   | 1   |   |   |   |   |   |
|  |   | M 111.948   | 02/97 → 07/03   | Auto. GBX,<br>Mot.000133  →  | VKPC 88845  |   |   |   |   | 1   |   |   |   |   |   |
|    | <b>B(Alt)</b>   | M 111.948   | 02/97 → 07/03   | AC   | VKMV 6PK2100<br>VKM 38022<br>VKM 38027  | 1   |   | 1   |   |   |   |   |   |   |   |
|  | <b>B(Alt)</b>   | M 111.948   | 02/97 → 07/03   | AC   | VKMV 6PK2205<br>VKM 38022<br>VKM 38027  | 1   |   | 1   |   |   |   |   |   |   |   |
| <b>MERCEDES-BENZ</b>  <b>V-class (W638) V 230</b>       |   |   |   |  |   |   |   |   |   |   |   |   |   |   |   |
|    |   | M 111.978   | 10/96 → 07/03   |  | ΟΧΘΟΧΟ  |   |   |   |   |   |   |   |   |   |   |
|    |   | M 111.978   | 10/96 → 07/03   | Man. GBX,<br>→IMot.001594  | VKPC 88844  |   |   |   |   | 1   |   |   |   |   |   |
|  |   | M 111.978   | 10/96 → 07/03   | Man. GBX,<br>Mot.001595  →   | VKPC 88845  |   |   |   |   | 1   |   |   |   |   |   |
|  |   | M 111.978   | 10/96 → 07/03   | Auto. GBX,<br>→IMot.000128   | VKPC 88844  |   |   |   |   | 1   |   |   |   |   |   |
|  |   | M 111.978   | 10/96 → 07/03   | Auto. GBX,<br>Mot.000129  →  | VKPC 88845  |   |   |   |   | 1   |   |   |   |   |   |
|    | <b>B(Alt)</b>   | M 111.978   | 10/96 → 07/03   | AC   | VKMV 6PK2100<br>VKM 38022<br>VKM 38027  | 1   |   | 1   |   |   |   |   |   |   |   |
|  | <b>B(Alt)</b>   | M 111.978   | 10/96 → 07/03   | AC   | VKMV 6PK2205<br>VKM 38022<br>VKM 38027  | 1   |   | 1   |   |   |   |   |   |   |   |













































































| MERCEDES-BENZ  V-class (W638) V 280      |                   |               |                              |   |   |  |  |  |  |   |  |  |  |  |  |  |  |  |   |  |
|---|-------------------|---------------|------------------------------|---|---|--|--|--|--|---|--|--|--|--|--|--|--|--|---|--|
|    | M 104.900         | 08/97 → 07/03 |                              | <b>ΟΧΘΙΧΟ</b>                           |   |  |  |  |  |   |  |  |  |  |  |  |  |  |   |  |
|    | M 104.900         | 08/97 → 07/03 |                              | VKPC 81611                              |   |  |  |  |  |   |  |  |  |  |  |  |  |  | 1 |  |
|    | B(Alt) M 104.900  | 08/97 → 07/03 | AC                           | VKMV 6PK1290<br>VKM 31060               | 1 |  |  |  |  | 1 |  |  |  |  |  |  |  |  |   |  |
|   | B(Alt) M 104.900  | 08/97 → 07/03 | AC                           | VKMA 31060<br>VKMV 7DK1360<br>VKM 31060 | 1 |  |  |  |  | 1 |  |  |  |  |  |  |  |  |   |  |
|   |                   |               |                              |   | 1 |  |  |  |  |   |  |  |  |  |  |  |  |  |   |  |
| MERCEDES-BENZ  V-class (W638) V 200 CDI  |                   |               |                              |   |   |  |  |  |  |   |  |  |  |  |  |  |  |  |   |  |
|    | OM 611.980        | 03/99 → 07/03 |                              | <b>ΟΧΘΙΧΟ</b>                           |   |  |  |  |  |   |  |  |  |  |  |  |  |  |   |  |
|    | OM 611.980        | 03/99 → 07/03 |                              | VKPC                                    |   |  |  |  |  |   |  |  |  |  |  |  |  |  | 1 |  |
|    | B(Alt) OM 611.980 | 03/99 → 07/03 | AC                           | VKMV 6PK2077<br>VKM 31041<br>VKM 38020  | 1 |  |  |  |  | 1 |  |  |  |  |  |  |  |  |   |  |
|   | B(Alt) OM 611.980 | 03/99 → 07/03 | AC                           | VKMV 6PK2160<br>VKM 31041<br>VKM 38020  | 1 |  |  |  |  | 1 |  |  |  |  |  |  |  |  |   |  |
|   |                   |               |                              |   | 1 |  |  |  |  |   |  |  |  |  |  |  |  |  |   |  |
| MERCEDES-BENZ  V-class (W638) V 220 CDI  |                   |               |                              |   |   |  |  |  |  |   |  |  |  |  |  |  |  |  |   |  |
|    | OM 611.980        | 03/99 → 07/03 |                              | <b>ΟΧΘΙΧΟ</b>                           |   |  |  |  |  |   |  |  |  |  |  |  |  |  |   |  |
|    | OM 611.980        | 03/99 → 07/03 |                              | VKPC                                    |   |  |  |  |  |   |  |  |  |  |  |  |  |  | 1 |  |
|    | B(Alt) OM 611.980 | 03/99 → 07/03 | AC                           | VKMV 6PK2077<br>VKM 31041<br>VKM 38020  | 1 |  |  |  |  | 1 |  |  |  |  |  |  |  |  |   |  |
|   | B(Alt) OM 611.980 | 03/99 → 07/03 | AC                           | VKMV 6PK2160<br>VKM 31041<br>VKM 38020  | 1 |  |  |  |  | 1 |  |  |  |  |  |  |  |  |   |  |
|   |                   |               |                              |   | 1 |  |  |  |  |   |  |  |  |  |  |  |  |  |   |  |
| MERCEDES-BENZ  V-class (W638) V 230 TD |                   |               |                              |   |   |  |  |  |  |   |  |  |  |  |  |  |  |  |   |  |
|                                        | OM 601.970        | 09/96 → 07/03 |                              | <b>ΟΧΘΙΧΟ</b>                           |   |  |  |  |  |   |  |  |  |  |  |  |  |  |   |  |
|                                        | OM 601.970        | 09/96 → 07/03 |                              | VKPC 88620                              |   |  |  |  |  |   |  |  |  |  |  |  |  |  | 1 |  |
|                                        | B(Alt) OM 601.970 | 09/96 → 07/03 | AC                           | VKMV 6PK2020<br>VKM 38001               | 1 |  |  |  |  | 1 |  |  |  |  |  |  |  |  |   |  |
|   | B(Alt) OM 601.970 | 09/96 → 07/03 | AC                           | VKMA 38005<br>VKMV 6PK2100<br>VKM 38001 | 1 |  |  |  |  | 1 |  |  |  |  |  |  |  |  |   |  |
|   |                   |               |                              |   | 1 |  |  |  |  |   |  |  |  |  |  |  |  |  |   |  |
| MERCEDES-BENZ  VITO (W638) 113         |                   |               |                              |   |   |  |  |  |  |   |  |  |  |  |  |  |  |  |   |  |
|                                        | M 111.948         | 02/96 → 07/03 |                              | <b>ΟΧΘΙΧΟ</b>                           |   |  |  |  |  |   |  |  |  |  |  |  |  |  |   |  |
|                                        | M 111.948         | 02/96 → 07/03 | Man. GBX,<br>→IMot. 002353   | VKPC 88844                              |   |  |  |  |  |   |  |  |  |  |  |  |  |  | 1 |  |
|   | M 111.948         | 02/96 → 07/03 | Man. GBX,<br>Mot. 002354 I→  | VKPC 88845                              |   |  |  |  |  |   |  |  |  |  |  |  |  |  | 1 |  |
|   | M 111.948         | 02/96 → 07/03 | Auto. GBX,<br>→IMot. 000132  | VKPC 88844                              |   |  |  |  |  |   |  |  |  |  |  |  |  |  | 1 |  |
|   | M 111.948         | 02/96 → 07/03 | Auto. GBX,<br>Mot. 000133 I→ | VKPC 88845                              |   |  |  |  |  |   |  |  |  |  |  |  |  |  | 1 |  |
|                                        | B(Alt) M 111.948  | 02/96 → 07/03 | AC                           | VKMV 6PK2100<br>VKM 38022<br>VKM 38027  | 1 |  |  |  |  | 1 |  |  |  |  |  |  |  |  |   |  |
|   | B(Alt) M 111.948  | 02/96 → 07/03 | AC                           | VKMV 6PK2205<br>VKM 38022<br>VKM 38027  | 1 |  |  |  |  | 1 |  |  |  |  |  |  |  |  |   |  |
|   |                   |               |                              |   | 1 |  |  |  |  |   |  |  |  |  |  |  |  |  |   |  |
| MERCEDES-BENZ  VITO (W638) 114         |                   |               |                              |   |   |  |  |  |  |   |  |  |  |  |  |  |  |  |   |  |
|                                        | M 111.978         | 12/96 → 07/03 |                              | <b>ΟΧΘΙΧΟ</b>                           |   |  |  |  |  |   |  |  |  |  |  |  |  |  |   |  |
|                                        | M 111.978         | 12/96 → 07/03 | Man. GBX,<br>→IMot. 001594   | VKPC 88844                              |   |  |  |  |  |   |  |  |  |  |  |  |  |  | 1 |  |
|   | M 111.978         | 12/96 → 07/03 | Man. GBX,<br>Mot. 001595 I→  | VKPC 88845                              |   |  |  |  |  |   |  |  |  |  |  |  |  |  | 1 |  |
|   | M 111.978         | 12/96 → 07/03 | Auto. GBX,<br>→IMot. 000128  | VKPC 88844                              |   |  |  |  |  |   |  |  |  |  |  |  |  |  | 1 |  |
|   | M 111.978         | 12/96 → 07/03 | Auto. GBX,<br>Mot. 000129 I→ | VKPC 88845                              |   |  |  |  |  |   |  |  |  |  |  |  |  |  | 1 |  |





















|  |  |  |  |  |  |  |  |  |  |  |  |
|--|---|---|---|--|---|---|---|---|---|---|---|
|  B(Alt)                                      | M 111.978   | 12/96 → 07/03   | AC  | VKMV 6PK2100<br>VKM 38022<br>VKM 38027   | 1   | 1   |   |   |   |   |   |
| B(Alt)   | M 111.978   | 12/96 → 07/03   | AC  | VKMV 6PK2205<br>VKM 38022<br>VKM 38027   | 1   | 1   |   |   |   |   |   |
| <b>MERCEDES-BENZ  VITO (W638) 108 D</b>     |   |   |   |  |   |   |   |   |   |   |   |
|    | OM 601.942  | 02/96 → 07/03   |   | <b>OKOKOKO</b>   |   |   |   |   |   |   |   |
|    | OM 601.942  | 02/96 → 07/03   |   | VKPC 88620   |   |   |   | 1   |   |   |   |
|  B(Alt)                                      | OM 601.942  | 02/96 → 07/03   | AC  | VKMV 6PK2000<br>VKM 38001  | 1   | 1   |   |   |   |   |   |
| B(Alt)   | OM 601.942  | 02/96 → 07/03   | AC  | VKMA 38007<br>VKMV 6PK2080<br>VKM 38001  | 1   | 1   | 1   |   |   |   |   |
| <b>MERCEDES-BENZ  VITO (W638) 110 D</b>     |   |   |   |  |   |   |   |   |   |   |   |
|    | OM 601.970  | 03/97 → 07/03   |   | <b>OKOKOKO</b>   |   |   |   |   |   |   |   |
|    | OM 601.970  | 03/97 → 07/03   |   | VKPC 88620   |   |   |   | 1   |   |   |   |
|  B(Alt)                                      | OM 601.970  | 03/97 → 07/03   | AC  | VKMV 6PK2020<br>VKM 38001  | 1   | 1   |   |   |   |   |   |
| B(Alt)   | OM 601.970  | 03/97 → 07/03   | AC  | VKMA 38005<br>VKMV 6PK2100<br>VKM 38001  | 1   | 1   | 1   |   |   |   |   |
| <b>MERCEDES-BENZ  VITO (W638) 110 TD</b>    |   |   |   |  |   |   |   |   |   |   |   |
|    | OM 601.970  | 02/96 → 07/03   |   | <b>OKOKOKO</b>   |   |   |   |   |   |   |   |
|   | OM 601.970  | 02/96 → 07/03   |   | VKPC 88620   |   |   |   | 1   |   |   |   |
|  B(Alt)                                    | OM 601.970  | 02/96 → 07/03   | AC  | VKMV 6PK2020<br>VKM 38001  | 1   | 1   |   |   |   |   |   |
| B(Alt)   | OM 601.970  | 02/96 → 07/03   | AC  | VKMA 38005<br>VKMV 6PK2100<br>VKM 38001  | 1   | 1   | 1   |   |   |   |   |
| <b>MERCEDES-BENZ  VITO (W638) 108 CDI</b> |   |   |   |  |   |   |   |   |   |   |   |
|    | OM 611A (60 KW CDI)   | 03/99 → 07/03   |   | <b>OKOKOKO</b>   |   |   |   |   |   |   |   |
|    | OM 611A (60 KW CDI)   | 03/99 → 07/03   |   | VKPC_____  |   |   |   | 1   |   |   |   |
|  B(Alt)                                    | OM 611.980  | 03/99 → 07/03   | AC  | VKMV 6PK2077<br>VKM 31041<br>VKM 38020   | 1   | 1   | 1   |   |   |   |   |
| B(Alt)   | OM 611.980  | 03/99 → 07/03   | AC  | VKMV 6PK2160<br>VKM 31041<br>VKM 38020   | 1   | 1   | 1   |   |   |   |   |
| <b>MERCEDES-BENZ  VITO (W638) 110 CDI</b> |   |   |   |  |   |   |   |   |   |   |   |
|    | OM 611LA (75 KW CDI)  | 03/99 → 07/03   |   | <b>OKOKOKO</b>   |   |   |   |   |   |   |   |
|    | OM 611LA (75 KW CDI)  | 03/99 → 07/03   |   | VKPC_____  |   |   |   | 1   |   |   |   |
|  B(Alt)                                    | OM 611.980  | 03/99 → 07/03   | AC  | VKMV 6PK2077<br>VKM 31041<br>VKM 38020   | 1   | 1   | 1   |   |   |   |   |
| B(Alt)   | OM 611.980  | 03/99 → 07/03   | AC  | VKMV 6PK2160<br>VKM 31041<br>VKM 38020   | 1   | 1   | 1   |   |   |   |   |
| <b>MERCEDES-BENZ  VITO (W638) 112 CDI</b> |   |   |   |  |   |   |   |   |   |   |   |
|    | OM 611.980  | 03/99 → 07/03   |   | <b>OKOKOKO</b>   |   |   |   |   |   |   |   |
|    | OM 611.980  | 03/99 → 07/03   |   | VKPC_____  |   |   |   | 1   |   |   |   |
|  B(Alt)                                    | OM 611.980  | 03/99 → 07/03   | AC  | VKMV 6PK2077<br>VKM 31041<br>VKM 38020   | 1   | 1   | 1   |   |   |   |   |
| B(Alt)   | OM 611.980  | 03/99 → 07/03   | AC  | VKMV 6PK2160<br>VKM 31041<br>VKM 38020   | 1   | 1   | 1   |   |   |   |   |
| <b>MERCEDES-BENZ  VITO (W639) 119/122</b> |   |   |   |  |   |   |   |   |   |   |   |
|    | M 112.951   | 09/03 → 10/07   |   | <b>OKOKOKO</b>   |   |   |   |   |   |   |   |
|    | M 112.951   | 09/03 → 10/07   |   | VKPC 88846   |   |   |   | 1   |   |   |   |

















































|  |  |  |  |  |  |  |  |  |  |  |  |  |
|--|---|---|---|--|---|---|---|---|---|---|---|---|
|   | B(Alt) M 112.951  | 09/03 → 10/07   | AC  | VKMW 6PK2315<br>VKM 31041<br>VKM 38026   | 1   | 1   |   |   |   |   |   |   |
|  | B(Alt) M 112.951  | 09/03 → 10/07   | AC  | VKMW 6PK2315<br>VKM 31041<br>VKM 38026   | 1   | 1   |   |   |   |   |   |   |
| <b>MERCEDES-BENZ  VITO (W639) 123</b>         |   |   |   |  |   |   |   |   |   |   |   |   |
|   | M 112.976   | 06/04 → 10/07   |   | ΟΚΦΧΦΧΦ  |   |   |   |   |   |   |   |   |
|   | M 112.976   | 06/04 → 10/07   |   | VKPC 88846   |   |   |   | 1   |   |   |   |   |
|   | B(Alt) M 112.976  | 06/04 → 10/07   | AC  | VKMW 6PK2315<br>VKM 31041<br>VKM 38026   | 1   | 1   |   |   |   |   |   |   |
|  | B(Alt) M 112.976  | 06/04 → 10/07   | AC  | VKMW 6PK2315<br>VKM 31041<br>VKM 38026   | 1   | 1   |   |   |   |   |   |   |
| <b>MERCEDES-BENZ  VITO (W639) 109 CDI 2.2</b> |   |   |   |  |   |   |   |   |   |   |   |   |
|   |   | 09/03 → 10/07   |   | ΟΚΦΧΦΧΦ  |   |   |   |   |   |   |   |   |
|   |   | 09/03 → 10/07   |   | —  |   |   |   | 1   |   |   |   |   |
| <b>MERCEDES-BENZ  VITO (W639) 111 CDI 2.2</b> |   |   |   |  |   |   |   |   |   |   |   |   |
|   | OM 646.982  | 09/03 → 10/07   |   | ΟΚΦΧΦΧΦ  |   |   |   |   |   |   |   |   |
|   | OM 646.982  | 09/03 → 10/07   |   | —  |   |   |   | 1   |   |   |   |   |
| <b>MERCEDES-BENZ  VITO (W639) 115 CDI 2.2</b> |   |   |   |  |   |   |   |   |   |   |   |   |
|   | OM 646.982  | 09/03 → 10/07   |   | ΟΚΦΧΦΧΦ  |   |   |   |   |   |   |   |   |
|   | OM 646.982  | 09/03 → 10/07   |   | —  |   |   |   | 1   |   |   |   |   |
| <b>MG  MG ZR 1.4 16V</b>                      |   |   |   |  |   |   |   |   |   |   |   |   |
|    | 14K4  | 06/01 → 06/05   | M⊙  | VKMA 07310<br>VKM 17310  | 1   | 1   |   |   |   |   | 2   | T0072   |
|  | 14K4  | 06/01 → 06/05   | A⊙  | VKMA 07301<br>VKM 17301  | 1   | 1   |   |   |   |   |   | T0072   |
|   | 14 K4   | 06/01 → 04/05   |   | VKPC 87401   |   |   |   | 1   |   |   |   |   |
|   | B(Alt) 14K4   | 06/01 → 06/05   | AC  | VKMW 5PK738  |   |   | 1   |   |   |   |   |   |
|  | B(Alt) 14K4   | 06/01 → 06/05   | AC  | VKMW 5PK1163<br>VKM 37015  | 1   |   | 1   |   |   |   |   |   |
|  | B(PS) 14K4  | 06/01 → 06/05   | M⊙  | VKMW 3PK753<br>VKM 37014   | 1   |   | 1   |   |   |   |   |   |
|  | B(PS) 14K4  | 06/01 → 06/05   | A⊙  | VKMW 3PK753<br>VKM 37010   | 1   |   | 1   |   |   |   |   |   |
| <b>MG  MG ZR 1.8 16V</b>                    |   |   |   |  |   |   |   |   |   |   |   |   |
|   | 18 K4F  | 06/01 → 06/05   | M⊙, Mot. VVC  | VKMA 07310<br>VKM 17310  | 1   | 1   |   |   |   |   | 2   | T0072   |
|  | 18 K4F  | 06/01 → 06/05   | A⊙, Mot. VVC  | VKMA 07301<br>VKM 17301  | 1   | 1   |   |   |   |   |   | T0072   |
|  | 18 K4K (VVC)  | 06/01 → 06/05   |   | VKMA _____<br>VKM 17310  | 1   | 2   |   |   |   |   | 2   | T0234   |
|   | 18 K4F, 18 K4K  | 06/01 → 04/05   |   | VKPC 87401   |   |   |   | 1   |   |   |   |   |
|   | B(Alt) 18 K4F, 18 K4K   | 06/01 → 06/05   | AC  | VKMW 5PK738  |   |   | 1   |   |   |   |   |   |
|  | B(Alt) 18 K4F, 18 K4K   | 06/01 → 06/05   | AC  | VKMW 5PK1163<br>VKM 37015  | 1   |   | 1   |   |   |   |   |   |
|  | B(PS) 18 K4F, 18 K4K  | 06/01 → 06/05   | M⊙  | VKMW 3PK753<br>VKM 37014   | 1   |   | 1   |   |   |   |   |   |
|  | B(PS) 18 K4F, 18 K4K  | 06/01 → 06/05   | A⊙  | VKMW 3PK753<br>VKM 37010   | 1   |   | 1   |   |   |   |   |   |
| <b>MG  MG ZR 2.0 TD</b>                     |   |   |   |  |   |   |   |   |   |   |   |   |
|   | 20T2N26   | 06/01 → 06/05   | AC, → Mot. 5048,<br>CHYD471564  →   | VKMA 07303<br>VKM 17303<br>VKM 17305<br>VKM 27303                                  | 2<br>1<br>1   | 1   | 2   |   |   |   |   | 2 T0176   |
|  | 20T2N26   | 06/01 → 06/05   | AC, Mot. 5049  →,<br>CHYD471564  →  | VKMA 07304<br>VKM 17303<br>VKM 17304<br>VKM 27303                                  | 2<br>1<br>1   | 1   | 2   |   |   |   |   | 2 T0176   |
|  |   |   |   |  |   | 1   |   |   |   |   |   |   |

























|   |  |  |    |  |  |  |  |  |  |  |  |  |  |  |
|---|---|---|---|--|---|---|---|---|---|---|---|---|---|---|
|   | 20T2N25   | 06/01 → 06/05   | AC, →IMot. 8367,<br>CHYD471564 I→   | VKMA 07303<br>VKM 17303<br>VKM 17305<br>VKM 27303                                  | 2<br>1<br>1   | 1   | 2   |   |   |   |   |   | 2   | T0176   |
|   | 20T2N25   | 06/01 → 06/05   | AC, Mot. 8368 I→,<br>CHYD471564 I→  | VKMA 07304<br>VKM 17303<br>VKM 17304<br>VKM 27303                                  | 2<br>1<br>1   | 1   | 2   |   |   |   |   |   | 2   | T0176   |
|                             | 20T2  | 06/01 → 04/05   |   | VKPC 87813   |   |   |   |   | 1   |   |   |   |   |   |
|                             | B(Alt) 20T2   | 06/01 → 06/05   | AC  | VKMV 6PK1462<br>VKM 37005  | 1   |   | 1   |   |   |   |   |   |   |   |
| <b>MG  MG ZS 1.8 16V</b>   |   |   |   |  |   |   |   |   |   |   |   |   |   |   |
|                             | 18 K4F  | 07/01 → 06/05   | DOHC  | VKMA 07301<br>VKM 17301  | 1<br>1  |   | 1   |   |   |   |   |   |   | T0072   |
|                             | 18 K4F  | 07/01 → 04/05   |   | VKPC 87401   |   |   |   |   | 1   |   |   |   |   |   |
|                             | B(PS) 18 K4F  | 07/01 → 06/05   | A⊙  | VKMV 3PK753<br>VKM 37010   | 1   |   | 1   |   |   |   |   |   |   |   |
| <b>MG  MG ZS 2.5 16V</b>   |   |   |   |  |   |   |   |   |   |   |   |   |   |   |
|                             | 25K4  | 07/01 → 06/05   |    | —<br>VKMA____<br>VKM____<br>VKM 27307  | 1<br>1<br>1   | 1   | 3   |   |   | 1   |   |   |   |   |
|                             | 25K4  | 07/01 → 04/05   |   | VKPC 87410   |   |   |   |   | 1   |   |   |   |   |   |
|                            | B(Alt) 25K4   | 07/01 → 06/05   | AC  | VKMV 6PK1285   |   |   | 1   |   |   |   |   |   |   |   |
|                           | B(Alt) 25K4   | 07/01 → 06/05   | AC  | VKMV 6PK1558   |   |   | 1   |   |   |   |   |   |   |   |
| <b>MG  MG ZS 2.0 TD</b>  |   |   |   |  |   |   |   |   |   |   |   |   |   |   |
|                           | 20T2N22   | 01/04 → 06/05   | AC, →IMot. 1011,<br>CHYD471064 I→   | VKMA 07303<br>VKM 17303<br>VKM 17305<br>VKM 27303                                  | 2<br>1<br>1   | 1   | 2   |   |   |   |   |   | 2   | T0176   |
|   | 20T2N22   | 01/04 → 06/05   | AC, Mot. 1012 I→,<br>CHYD471064 I→  | VKMA 07304<br>VKM 17303<br>VKM 17304<br>VKM 27303                                  | 2<br>1<br>1   | 1   | 2   |   |   |   |   |   | 2   | T0176   |
|   | 20T2N23   | 01/04 → 06/05   | AC, →IMot. 9369,<br>CHYD471064 I→   | VKMA 07303<br>VKM 17303<br>VKM 17305<br>VKM 27303                                  | 2<br>1<br>1   | 1   | 2   |   |   |   |   |   | 2   | T0176   |
|   | 20T2N23   | 01/04 → 06/05   | AC, Mot. 9370 I→,<br>CHYD471064 I→  | VKMA 07304<br>VKM 17303<br>VKM 17304<br>VKM 27303                                  | 2<br>1<br>1   | 1   | 2   |   |   |   |   |   | 2   | T0176   |
|                           | B(Alt) 20T2   | 01/04 → 06/05   | AC  | VKMV 6PK1462<br>VKM 37005  | 1   |   | 1   |   |   |   |   |   |   |   |
|                           | B(Alt) 20T2   | 01/04 → 06/05   | AC  | VKMV 6PK1183<br>VKM 37005  | 1   |   | 1   |   |   |   |   |   |   |   |
| <b>MG  MG ZT 1.8 16V</b> |   |   |   |  |   |   |   |   |   |   |   |   |   |   |
|                           | 18K4, 18K4T   | 01/03 → 06/05   |   | VKMA 07301<br>VKM 17301  | 1<br>1  |   | 1   |   |   |   |   |   |   | T0072   |
|                           | B(Alt) 18K4, 18K4T  | 01/03 → 06/05   | AC  | VKMV 5PK738  |   |   | 1   |   |   |   |   |   |   |   |
|                           | B(Alt) 18K4, 18K4T  | 01/03 → 06/05   | AC  | VKMV 5PK1200<br>VKM 37011  | 1   |   | 1   |   |   |   |   |   |   |   |
|                           | B(PS) 18K4, 18K4T   | 01/03 → 06/05   |   | VKMV 3PK738<br>VKM 37010   | 1   |   | 1   |   |   |   |   |   |   |   |
| <b>MG  MG ZT 2.5 16V</b> |   |   |   |  |   |   |   |   |   |   |   |   |   |   |
|                           | 25 K4F  | 06/01 → 06/05   |  | —<br>VKMA____  | 1<br>1  | 1   | 3   |   |   | 1   |   |   |   |   |

|   |  |  |                             |  |  |  |  |  |  |  |  |  |  |
|---|---|---|--|--|---|---|---|---|---|---|---|---|---|
|   |   |   |  | VKM _____  | 1   |   |   |   |   |   |   |   |   |
|   |   |   |  | VKM 27307  |   | 1   |   |   |   |   |   |   |   |
|                              | 25 K4F  | 06/01 → 04/05   |  | VKPC 87410   |   |   |   |   | 1   |   |   |   |   |
|                              | <b>B(Alt)</b> 25 K4F  | 06/01 → 06/05   | <b>AC</b>  | VKMV 6PK1285   |   |   |   | 1   |   |   |   |   |   |
|                              | <b>B(Alt)</b> 25 K4F  | 06/01 → 06/05   | <b>AC</b>  | VKMV 6PK1558   |   |   |   | 1   |   |   |   |   |   |
| <b>MG  MG ZT 260, 4.6</b>    |   |   |  |  |   |   |   |   |   |   |   |   |   |
|                              | 46F2F   | 10/03 → 06/05   |  | <b>OXOXOXO</b>   |   |   |   |   |   |   |   |   |   |
| <b>MG  MG ZT 2.0 CDTi</b>    |   |   |  |  |   |   |   |   |   |   |   |   |   |
|                              | 204D2   | 06/02 → 12/04   |  | <b>OXOXOXO</b>   |   |   |   |   |   |   |   |   |   |
|                              | 204D2   | 06/02 → 04/05   |  | VKPC 87420   |   |   |   |   | 1   |   |   |   |   |
|                              | <b>B(Alt)</b> 204D2   | 06/02 → 06/05   |  | VKMV 5PK2030   |   |   |   | 1   |   |   |   |   |   |
|   | <b>B(AC)</b> 204D2  | 06/02 → 06/05   |  | VKMV 5PK869  |   |   |   | 1   |   |   |   |   |   |
| <b>MG  MGF 1.6 16V</b>       |   |   |  |  |   |   |   |   |   |   |   |   |   |
|                              | 16 K4F  | 02/00 → 03/02   |  | VKMA 07301   | 1   |   | 1   |   |   |   |   |   | T0072   |
|   |   |   |  | VKM 17301  | 1   |   |   |   |   |   |   |   |   |
|                              | 16 K4F  | 02/00 → 03/02   |  | VKPC 87401   |   |   |   |   | 1   |   |   |   |   |
|                              | <b>B(Alt)</b> 16 K4F  | 02/00 → 03/02   | <b>AC</b>  | VKMV 5PK1200   |   |   |   | 1   |   |   |   |   |   |
|   |   |   |  | VKM 37015  | 1   |   |   |   |   |   |   |   |   |
| <b>MG  MGF 1.8 16V</b>       |   |   |  |  |   |   |   |   |   |   |   |   |   |
|                              | 18 K4F  | 03/95 → 03/02   | <b>M</b>  <b>Mot. VVC</b>   | VKMA 07310   | 1   |   | 1   |   |   |   |   |   | 2 T0072   |
|   |   |   |  | VKM 17310  | 1   |   |   |   |   |   |   |   |   |
|   | 18 K4F  | 03/95 → 03/02   | <b>A</b>  <b>Mot. VVC</b>   | VKMA 07301   | 1   |   | 1   |   |   |   |   |   | T0072   |
|   |   |   |  | VKM 17301  | 1   |   |   |   |   |   |   |   |   |
|   | 18 K4K (VVC)  | 03/95 → 03/02   |  | VKMA _____   | 1   |   | 2   |   |   |   |   |   | 2 T0234   |
|   |   |   |  | VKM 17310  | 1   |   |   |   |   |   |   |   |   |
|                            | 18 K4F, 18 K4K (VVC)  | 03/95 → 03/02   |  | VKPC 87401   |   |   |   |   | 1   |   |   |   |   |
|                            | <b>B(Alt)</b> 18 K4F, 18 K4K (VVC)  | 03/95 → 03/02   | <b>AC</b>  | VKMV 5PK1200   |   |   |   | 1   |   |   |   |   |   |
|   |   |   |  | VKM 37015  | 1   |   |   |   |   |   |   |   |   |
| <b>MG  MGTF 1.6 16V</b>    |   |   |  |  |   |   |   |   |   |   |   |   |   |
|                            | 16 K4F  | 03/02 → 06/05   |  | VKMA 07301   | 1   |   | 1   |   |   |   |   |   | T0072   |
|   |   |   |  | VKM 17301  | 1   |   |   |   |   |   |   |   |   |
|                            | 16 K4F  | 03/02 → 04/05   |  | VKPC 87401   |   |   |   |   | 1   |   |   |   |   |
|                            | <b>B(Alt)</b> 16 K4F  | 03/02 → 06/05   | <b>AC</b>  | VKMV 5PK1200   |   |   |   | 1   |   |   |   |   |   |
|   |   |   |  | VKM 37015  | 1   |   |   |   |   |   |   |   |   |
| <b>MG  MGTF 1.8 16V</b>    |   |   |  |  |   |   |   |   |   |   |   |   |   |
|                            | 18 K4F  | 03/02 → 06/05   | <b>M</b>  <b>Mot. VVC</b> | VKMA 07310   | 1   |   | 1   |   |   |   |   |   | 2 T0072   |
|   |   |   |  | VKM 17310  | 1   |   |   |   |   |   |   |   |   |
|   | 18 K4F  | 03/02 → 06/05   | <b>A</b>  <b>Mot. VVC</b> | VKMA 07301   | 1   |   | 1   |   |   |   |   |   | T0072   |
|   |   |   |  | VKM 17301  | 1   |   |   |   |   |   |   |   |   |
|   | 18 K4K (VVC)  | 03/02 → 06/05   |  | VKMA _____   | 1   |   | 2   |   |   |   |   |   | 2 T0234   |
|   |   |   |  | VKM 17310  | 1   |   |   |   |   |   |   |   |   |
|                            | 18 K4F, 18 K4K  | 03/02 → 04/05   |  | VKPC 87401   |   |   |   |   | 1   |   |   |   |   |
|                            | <b>B(Alt)</b> 18 K4F, 18 K4K  | 03/02 → 06/05   | <b>AC</b>  | VKMV 5PK1200   |   |   |   | 1   |   |   |   |   |   |
|   |   |   |  | VKM 37015  | 1   |   |   |   |   |   |   |   |   |
| <b>MG  MIDGET 1.3</b>      |   |   |  |  |   |   |   |   |   |   |   |   |   |
|                            | 12H   | 01/67 → 09/74   |  | VKPC 87200   |   |   |   |   | 1   |   |   |   |   |
| <b>MINI  MINI Cooper</b>   |   |   |  |  |   |   |   |   |   |   |   |   |   |
|                            | W10B16A   | 06/01 → 03/06   |  | <b>OXOXOXO</b>   |   |   |   |   |   |   |   |   |   |
|                            | W10B16A   | 06/01 → 01/05 2)  |  | —  |   |   |   |   | 1   |   |   |   |   |
|                            | <b>B(Alt)</b> W10B16A   | 06/01 → 07/04   | <b>AC</b>  | VKM 38700  | 1   |   |   |   |   |   |   |   |   |
|   | <b>B(Alt)</b> W10B16A   | 07/04 → 03/06   | <b>AC</b>  | VKM 38700  | 1   |   |   |   |   |   |   |   |   |
|   | <b>B(Alt)</b> W10B16A   | 06/01 → 01/04   | <b>AC</b>  | VKM 38700  | 1   |   |   |   |   |   |   |   |   |
|   | <b>B(Alt)</b> W10B16A   | 01/04 → 03/06   | <b>AC</b>  | VKMV 6PK1033   |   |   |   | 1   |   |   |   |   |   |
|   |   |   |  | VKM 38700  | 1   |   |   |   |   |   |   |   |   |
| <b>MINI  MINI Cooper S</b> |   |   |  |  |   |   |   |   |   |   |   |   |   |
|                            | W11B16A   | 03/02 → 03/06   |  | <b>OXOXOXO</b>   |   |   |   |   |   |   |   |   |   |
|                            | W11B16A   | 03/02 → 01/05   |  | —  |   |   |   |   | 1   |   |   |   |   |
| <b>MINI  MINI One</b>      |   |   |  |  |   |   |   |   |   |   |   |   |   |
|                            | W10B16A   | 06/01 → 03/06   |  | <b>OXOXOXO</b>   |   |   |   |   |   |   |   |   |   |
|                            | W10B16A   | 06/01 → 01/05 2)  |  | —  |   |   |   |   | 1   |   |   |   |   |

































MG







































|   |  |  |  |  |  |  |  |  |  |  |  |  |
|---|---|---|---|--|---|---|---|---|---|---|---|---|
|   | <b>B(Alt)</b> W10B16A   | 06/01 → 07/04   | <b>AC</b>   | VKM 38700  | 1   |   |   |   |   |   |   |   |
|   | <b>B(Alt)</b> W10B16A   | 07/04 → 03/06   | <b>AC</b>   | VKM 38700  | 1   |   |   |   |   |   |   |   |
|   | <b>B(Alt)</b> W10B16A   | 06/01 → 01/04   | <b>AC</b>   | VKM 38700  | 1   |   |   |   |   |   |   |   |
|   | <b>B(Alt)</b> W10B16A   | 01/04 → 03/06   | <b>AC</b>   | VKMV 6PK1033<br>VKM 38700  | 1   | 1   |   |   |   |   |   |   |
| <b>MINI</b>  <b>MINI One D</b>               |   |   |   |  |   |   |   |   |   |   |   |   |
|   | 1ND   | 06/03 → 03/06   |   | <b>OXOXOXO</b>   |   |   |   |   |   |   |   |   |
|   | 1ND   | 06/03 → 01/05   |   | —  |   |   | 1   |   |   |   |   |   |
|   | <b>B(Alt)</b> 1ND   | 06/03 → 03/06   | <b>AC</b>   | VKMV 7PK935  |   | 1   |   |   |   |   |   |   |
|   | <b>B(Alt)</b> 1ND   | 06/03 → 03/06   | <b>AC</b>   | VKMV 7PK1175   |   | 1   |   |   |   |   |   |   |
|   | <b>B(PS)</b> 1ND  | 06/03 → 03/06   |   | VKMV 3PK863  |   | 1   |   |   |   |   |   |   |
| <b>MITSUBISHI</b>  <b>3000 GT 3.0</b>        |   |   |   |  |   |   |   |   |   |   |   |   |
|   | 6G72  | 06/92 → 05/93   |   | VKMA 95000<br>VKM 75000<br>VKM 85002   | 1<br>1  | 1<br>1  |   |   |   |   |   | T0689   |
| <b>MITSUBISHI</b>  <b>CARISMA 1.6</b>        |   |   |   |  |   |   |   |   |   |   |   |   |
|   | 4G92  | 07/95 → 12/99   | <b>SOHC</b>   | VKMA 95623<br>VKM 75616  | 1<br>1  | 1   |   |   |   |   |   | T0678   |
| <b>MITSUBISHI</b>  <b>CARISMA 1.8</b>        |   |   |   |  |   |   |   |   |   |   |   |   |
|   | 4G93  | 07/95 → 12/99   | <b>SOHC</b>   | VKMA 95626<br>VKM 75616  | 1<br>1  | 1   |   |   |   |   |   | T0678   |
|   | 4G93  | 07/95 → 12/99   | <b>DOHC</b>   | VKMA 95624<br>VKM 75009<br>VKM 85000   | 1<br>1  | 1<br>1  |   |   |   |   |   | T0693   |
| <b>MITSUBISHI</b>  <b>CARISMA 1.9 TD</b>   |   |   |   |  |   |   |   |   |   |   |   |   |
|   | F8QT  | 10/96 → 07/03   | <b>Mod. DA4A</b>  | VKPC 86413   |   |   | 1   |   |   |   |   |   |
| <b>MITSUBISHI</b>  <b>CELESTE 1.6</b>      |   |   |   |  |   |   |   |   |   |   |   |   |
|   | G32B  | 04/79 → 12/87   | <b>Mod. A174</b>  | VKPC 95004   |   |   | 1   |   |   |   |   |   |
| <b>MITSUBISHI</b>  <b>CELESTE 2.0</b>      |   |   |   |  |   |   |   |   |   |   |   |   |
|   | G52B  | 06/79 → 12/80   | <b>Mod. A146A</b>   | VKPC 95602   |   |   | 1   |   |   |   |   |   |
| <b>MITSUBISHI</b>  <b>CHALLENGER 3.0</b>   |   |   |   |  |   |   |   |   |   |   |   |   |
|   | 6G72  | 11/98 → 12/02   | <b>Mod. K96W, DOHC</b>  | VKMA 95613<br>VKM 75000<br>VKM 85002   | 1<br>1  | 1<br>1  |   |   |   |   |   | T0540   |
| <b>MITSUBISHI</b>  <b>CHALLENGER 2.5 D</b> |   |   |   |  |   |   |   |   |   |   |   |   |
|   | 4D56  | 11/98 → 09/00   | <b>Mod. K94W</b>  | VKMA 95014<br>VKM 75601<br>VKM 75612   | 2<br>1<br>1   | 2   |   |   |   |   |   | T0668   |
| <b>MITSUBISHI</b>  <b>CHARIOT 1.6</b>      |   |   |   |  |   |   |   |   |   |   |   |   |
|   | G32B  | 01/83 → 10/86   | <b>Mod. D02W</b>  | VKPC 95010   |   |   | 1   |   |   |   |   |   |
| <b>MITSUBISHI</b>  <b>CHARIOT 1.8</b>      |   |   |   |  |   |   |   |   |   |   |   |   |
|   | G37B  | 06/84 → 12/86   | <b>Mod. D05W</b>  | VKMA 95102<br>VKM 75101<br>VKM 75119   | 2<br>1<br>1   | 2   |   |   |   |   |   |   |
|   | 4G37  | 01/83 → 04/91   | <b>Mod. D05V, D05W</b>  | VKPC 95010   |   |   | 1   |   |   |   |   |   |
|   | 4G93  | 05/91 → 05/92   | <b>Mod. N31W, N41W</b>  | VKPC 95426   |   |   | 1   |   |   |   |   |   |
| <b>MITSUBISHI</b>  <b>CHARIOT 2.0</b>      |   |   |   |  |   |   |   |   |   |   |   |   |
|   | 4G63, G63B  | 06/86 → 04/91   | <b>Mod. D04W, D08W</b>  | VKPC 95611   |   |   | 1   |   |   |   |   |   |
|   | 4G63  | 06/92 → 11/00   | <b>Mod. N33W, N43W</b>  | VKPC 95612   |   |   | 1   |   |   |   |   |   |
| <b>MITSUBISHI</b>  <b>CHARIOT 2.4</b>      |   |   |   |  |   |   |   |   |   |   |   |   |
|   | 4G64  | 05/91 → 05/92   | <b>Mod. N34W</b>  | VKPC 95423   |   |   | 1   |   |   |   |   |   |
|   | 4G64  | 06/92 → 05/96   | <b>Mod. N34W</b>  | VKPC 95612   |   |   | 1   |   |   |   |   |   |
| <b>MITSUBISHI</b>  <b>CHARIOT 1.8 D</b>    |   |   |   |  |   |   |   |   |   |   |   |   |
|   | 4D65  | 07/85 → 04/91   | <b>Mod. D09V, D09W, N35W</b>  | VKPC 95402   |   |   | 1   |   |   |   |   |   |
| <b>MITSUBISHI</b>  <b>CHARIOT 2.0 TD</b>   |   |   |   |  |   |   |   |   |   |   |   |   |
|   | 4D68  | 10/92 → 11/00   | <b>Mod. N38W, Turbo</b>   | VKPC 95614   |   |   | 1   |   |   |   |   |   |
| <b>MITSUBISHI</b>  <b>COLT 1.1</b>         |   |   |   |  |   |   |   |   |   |   |   |   |
|   | 3A91  | 10/04 → 04/06   | <b>Mod. Z32A</b>  | <b>OXOXOXO</b>   |   |   |   |   |   |   |   |   |
|   | 3A91  | 10/04 → 10/06   | <b>Mod. Z32A</b>  | VKPC_____  |   |   | 1   |   |   |   | 1   |   |

|   |  |  |  |  |  |  |  |  |  |  |  |
|---|---|---|---|--|---|---|---|---|---|---|---|
| <b>MITSUBISHI  COLT 1.2</b>              |   |   |   |  |   |   |   |   |   |   |   |
|    | 4G16  | 06/87 → 04/88   | 3), Mod. C15A   | VKMS 95207<br>VKMA 95207<br>VKM 75100  | 1<br>1<br>1   | 1   |   |   |   | 2   | T0697   |
|   | 4G11  | 01/81 → 12/83   | Mod. A151A  | VKMA 95206<br>VKM 75100  | 1<br>1  | 1   |   |   |   |   | T0697   |
|   | 4G16  | 02/84 → 05/87   | Mod. C15A   | VKMA 95206<br>VKM 75100  | 1<br>1  | 1   |   |   |   |   | T0697   |
|    | 4G16  | 01/84 → 05/92   | Mod. C15A   | VKPC 95008   |   |   |   |   | 1   |   |   |
| <b>MITSUBISHI  COLT 1.3</b>              |   |   |   |  |   |   |   |   |   |   |   |
|    | 4G13  | 04/88 → 05/90   | 3), Mod. C51A, SOHC   | VKMS 95207<br>VKMA 95207<br>VKM 75100  | 1<br>1<br>1   | 1   |   |   |   | 2   | T0697   |
|   | 4G13  | 06/90 → 06/94   | 3), Mod. C51A, CA1A, SOHC   | VKMS 95012<br>VKMA 95012<br>VKM 75001  | 1<br>1<br>1   | 1   |   |   |   | 2   | T0697   |
|   | 4G19  | 06/03 → 12/06   | 3), Mod. Z25A   | VKMS 95663<br>VKMA 95663<br>VKM 75634<br>VKM 85150                                 | 1<br>1<br>1<br>1  | 1<br>1  | 1   |   |   | 3   | T0680   |
|   | G13B  | 06/86 → 04/88   | 3), Mod. C11A   | VKMS 95207<br>VKMA 95207<br>VKM 75100  | 1<br>1<br>1   | 1   |   |   |   | 2   | T0697   |
|   | 4G13  | 05/96 → 11/98   | Mod. CJ1A   | VKMA 95621<br>VKM 75615  | 1<br>1  | 1   |   |   |   |   | T0691   |
|   | 4G13  | 12/98 → 05/00   | Mod. CJ1A   | VKMA 95650<br>VKM 75625  | 1<br>1  | 1   |   |   |   |   | T0691   |
|   | 4G13  | 06/00 → 09/03   | Mod. CJ1A   | VKMA 95651<br>VKM 75625  | 1<br>1  | 1   |   |   |   |   | T0697   |
|                                        | 4A90  | 06/04 → 10/06   | Mod. Z34A   | VKPC _____   |   |   |   |   | 1   |   | 1   |
|   | 4G13, G13B  | 10/83 → 05/92   | Mod. C11A, C11V, C51A, C51V   | VKPC 95008   |   |   |   |   | 1   |   |   |
| <b>MITSUBISHI  COLT 1.4, 1.4 Turbo</b> |   |   |   |  |   |   |   |   |   |   |   |
|                                        | 4G12, 4G12T   | 01/81 → 12/83   | Mod. A152A  | VKMA 95206<br>VKM 75100  | 1<br>1  | 1   |   |   |   |   | T0697   |
| <b>MITSUBISHI  COLT 1.5</b>            |   |   |   |  |   |   |   |   |   |   |   |
|                                        | 4G15, G15B  | 06/87 → 05/90   | 3), Mod. C12A, C52A   | VKMS 95207<br>VKMA 95207<br>VKM 75100  | 1<br>1<br>1   | 1   |   |   |   | 2   | T0697   |
|   | 4G15  | 06/90 → 05/92   | 3), Mod. C52A   | VKMS 95012<br>VKMA 95012<br>VKM 75001  | 1<br>1<br>1   | 1   |   |   |   | 2   | T0697   |
|   | 4G15  | 06/03 → 12/06   | 3), Mod. Z27A, Z27W   | VKMS 95663<br>VKMA 95663<br>VKM 75634<br>VKM 85150                                 | 1<br>1<br>1<br>1  | 1<br>1  | 1   |   |   | 3   | T0680   |
|   | 4G15, G15B  | 09/84 → 05/87   | Mod. C12A   | VKMA 95206<br>VKM 75100  | 1<br>1  | 1   |   |   |   |   | T0697   |
|   | 4G15  | 11/95 → 01/01   | Mod. CJ2A, SOHC   | VKMA 95621<br>VKM 75615  | 1<br>1  | 1   |   |   |   |   | T0691   |
|   | 4G15  | 11/95 → 12/96   | Mod. CK2A, DOHC   | VKMA 95622<br>VKM 75615<br>VKM 85000   | 1<br>1<br>1   | 1   | 1   |   |   |   | T0680   |
|   | 4G15  | 12/98 → 05/01   | Mod. CK1A, SOHC   | VKMA 95650<br>VKM 75625  | 1<br>1  | 1   |   |   |   |   | T0691   |
|   | 4G91  | 12/91 → 11/94   | Mod. CB3A   | VKMA 95625<br>VKM 75009<br>VKM 85000   | 1<br>1<br>1   | 1   | 1   |   |   |   | T0680   |
|                                        | 4A91  | 06/04 → 10/06   | Mod. Z36A   | VKPC _____   |   |   |   |   | 1   |   | 1   |
|   | 4G15, G15B  | 09/84 → 05/92   | Mod. C12A, C12V, C12W, C32V, C52A, C72A, C84A                                     | VKPC 95008   |   |   |   |   | 1   |   |   |
|   | G31B  | 02/86 → 04/88   | Mod. C18A   | VKPC 95010   |   |   |   |   | 1   |   |   |
| <b>MITSUBISHI  COLT 1.5 CZT</b>        |   |   |   |  |   |   |   |   |   |   |   |
|                                        | 4G15  | 03/05 → 10/06   | Mod. Z37A   | VKMA 95663<br>VKM 75634<br>VKM 85150   | 1<br>1<br>1   | 1   | 1   |   |   |   | T0680   |
|                                        | 4G15  | 03/05 → 10/06   | Mod. Z37A   | VKPC _____   |   |   |   |   | 1   |   | 1   |



MITSUBISHI

































|  |  |  |  |  |  |  |  |  |  |  |  |
|--|---|---|---|--|---|---|---|---|---|---|---|
|  <b>B(Alt)</b>                             | 4G15  | 03/05 → 10/06   | Mod. Z37A   | VKMA _____   | 1   | 1   |   |   |   |   |   |
| <b>MITSUBISHI</b>  <b>COLT 1.6</b>        |   |   |   |  |   |   |   |   |   |   |   |
|    | 4G92  | 04/92 → 11/94   | 3), Mod. CA4A, CC4A, CD4A   | VKMS 95020<br>VKMA 95020<br>VKM 75002  | 1<br>1<br>1   | 1<br>1  |   |   | 2   |   | T0494   |
|  | 4G61  | 04/88 → 05/90   | Mod. C53A   | VKMA 95021<br>VKM 75144<br>VKM 85000   | 1<br>1  | 1<br>1  | 1   |   |   |   | T0495   |
|  | 4G92  | 11/95 → 12/96   | Mod. CK4A, DOHC   | VKMA 95624<br>VKM 75009<br>VKM 85000   | 1<br>1  | 1<br>1  | 1   |   |   |   | T0693   |
|  | 4G92  | 05/96 → 08/03   | Mod. CK4A, SOHC   | VKMA 95623<br>VKM 75616  | 1<br>1  | 1   | 1   |   |   |   | T0678   |
|  | G32B  | 01/81 → 03/82   | Mod. A153A, A157A   | —<br>VKM 75101   | 1<br>1  | 1   |   |   |   |   |   |
|  | G32B  | 04/82 → 12/93   | Mod. A153A, A157A   | VKMA 95105<br>VKM 75101  | 1<br>1  | 1   |   |   |   |   | T0657   |
|    | 4G32, G32B  | 10/83 → 10/90   | Mod. C13A   | VKPC 95010   |   |   |   |   | 1   |   |   |
|  | 4G61  | 04/88 → 05/90   | Mod. C53A, C63A   | VKPC 95427   |   |   |   |   | 1   |   |   |
| <b>MITSUBISHI</b>  <b>COLT 1.6 Turbo</b>  |   |   |   |  |   |   |   |   |   |   |   |
|    | 4G32  | 02/84 → 12/86   | Mod. C13A   | VKMA 95105<br>VKM 75101  | 1<br>1  | 1   |   |   |   |   | T0657   |
|  | 4G32  | 01/87 → 04/88   | Mod. C13A   | VKMA 95031<br>VKM 75108  | 1<br>1  | 1   |   |   |   |   | T0657   |
|    | 4G32, G32B  | 02/84 → 04/88   | Mod. C13A   | VKPC 95010   |   |   |   |   | 1   |   |   |
| <b>MITSUBISHI</b>  <b>COLT 1.8</b>       |   |   |   |  |   |   |   |   |   |   |   |
|    | 4G67  | 06/90 → 05/92   | 3), Mod. C58A   | VKMS 95005<br>VKMA 95005<br>VKM 75044<br>VKM 75144<br>VKM 85000                    | 2<br>2<br>1<br>1  | 1<br>1  | 2   |   | 5   |   | T0479   |
|  | 4G93  | 04/92 → 11/94   | 3), Mod. CA5A, SOHC   | VKMS 95025<br>VKMA 95025<br>VKM 75002  | 1<br>1<br>1   | 1   |   |   | 2   |   | T0678   |
|  | 4G93  | 04/92 → 11/94   | Mod. CA5A, DOHC   | VKMA 95022<br>VKM 75009<br>VKM 85000   | 1<br>1  | 1<br>1  | 1   |   |   |   | T0679   |
|    | 4G67  | 06/90 → 05/92   | Mod. C58A   | VKPC 95424   |   |   |   |   | 1   |   |   |
| <b>MITSUBISHI</b>  <b>COLT 1.5 DI-D</b> |   |   |   |  |   |   |   |   |   |   |   |
|    |   | 08/04 → 10/06   | Mod. Z38A, Z39A, Z39V   | —  |   |   |   |   | 1   |   | 1   |
| <b>MITSUBISHI</b>  <b>COLT 1.8 D</b>    |   |   |   |  |   |   |   |   |   |   |   |
|    | 4D65  | 01/84 → 02/88   | Mod. C14A   | —<br>VKM 75113<br>VKM 75140<br>VKM 85140   | 2<br>1<br>1   | 1   | 2   |   |   |   |   |
|  | 4D65  | 03/88 → 05/92   | Mod. C14A, C54A   | VKMA 95006<br>VKM 75113<br>VKM 75140<br>VKM 85140                                  | 2<br>1<br>1   | 1   | 2   |   |   |   | T0667   |
|  | 4D65  | 04/88 → 05/92   | Mod. C54A   | —<br>VKM 75113   | 1<br>1  | 1   |   |   |   |   |   |
|    | 4D65  | 02/84 → 05/86   | Mod. C14A, C14V, C14W, C34V   | VKPC 95402   |   |   |   |   | 1   |   |   |
|  | 4D65  | 06/86 → 12/94   | Mod. C14A, C14V, C14W, C34V, C54A   | VKPC 95404   |   |   |   |   | 1   |   |   |
| <b>MITSUBISHI</b>  <b>COLT 2.0 D</b>    |   |   |   |  |   |   |   |   |   |   |   |
|    | 4D68  | 12/91 → 11/94   | 3), Mod. CB8A   | VKMS 95023<br>VKMA 95023<br>VKM 75044<br>VKM 75054<br>VKM 85140                    | 2<br>2<br>1<br>1  | 1<br>1  | 2   |   | 3   |   | T0497   |
| <b>MITSUBISHI</b>  <b>CORDIA 1.6</b>    |   |   |   |  |   |   |   |   |   |   |   |
|    | 4G32  | 10/82 → 12/86   | Mod. A212A  | VKMA 95105<br>VKM 75101  | 1<br>1  | 1   |   |   |   |   | T0657   |



























|  |  |  |  |  |  |  |  |  |  |  |  |
|--|---|---|---|--|---|---|---|---|---|---|---|
|  | 4G32  | 06/83 → 12/86   | Mod. A212A  | VKMA 95102<br>VKM 75101<br>VKM 75119   | 2<br>1<br>1   | 2   |   |   |   |   |   |
|  | 4G32  | 01/87 → 11/87   | Mod. A212A  | VKMA 95008<br>VKM 75108<br>VKM 75119   | 2<br>1<br>1   | 2   |   |   |   |   | T0673   |
|  | 4G32 T  | 10/82 → 08/84   | Mod. A212A  | VKMA 95105<br>VKM 75101  | 1<br>1  | 1   |   |   |   |   | T0657   |
|  | 4G32 T  | 07/83 → 08/84   | Mod. A212A  | VKMA 95105<br>VKM 75101  | 1<br>1  | 1   |   |   |   |   | T0657   |
|                                     | G32B  | 02/82 → 12/88   | Mod. A212   | VKPC 95010   |   |   |   | 1   |   |   |   |
| <b>MITSUBISHI  CORDIA 1.6 Turbo</b> |   |   |   |  |   |   |   |   |   |   |   |
|                                     | 4G32  | 01/82 → 12/86   | Mod. A212A  | VKMA 95105<br>VKM 75101  | 1<br>1  | 1   |   |   |   |   | T0657   |
| <b>MITSUBISHI  CORDIA 1.8</b>       |   |   |   |  |   |   |   |   |   |   |   |
|                                     | 4G37  | 10/86 → 12/86   | Mod. A215A  | VKMA 95102<br>VKM 75101<br>VKM 75119   | 2<br>1<br>1   | 2   |   |   |   |   |   |
|                                     | G37B  | 08/84 → 12/87   | Mod. A215   | VKPC 95010   |   |   |   | 1   |   |   |   |
| <b>MITSUBISHI  CORDIA 1.8 Turbo</b> |   |   |   |  |   |   |   |   |   |   |   |
|                                     | 4G62 T  | 10/84 → 12/86   | Mod. A213A  | VKMA 95103<br>VKM 75033<br>VKM 75113   | 2<br>1<br>1   | 2   |   |   |   |   | T0665   |
| <b>MITSUBISHI  DIAMANTE 3.0</b>     |   |   |   |  |   |   |   |   |   |   |   |
|                                     | 6G72  | 02/91 → 12/94   | 3), Mod. F16A, SOHC   | VKMS 95003<br>VKMA 95003<br>VKM 75004  | 1<br>1<br>1   | 1   |   |   | 3   |   | T0695   |
| <b>MITSUBISHI  ECLIPSE 1.8</b>    |   |   |   |  |   |   |   |   |   |   |   |
|                                   | 4G37  | 05/88 → 03/93   | Mod. D21A   | VKMA 95008<br>VKM 75108<br>VKM 75119   | 2<br>1<br>1   | 2   |   |   |   |   | T0673   |
| <b>MITSUBISHI  ECLIPSE 2.0</b>    |   |   |   |  |   |   |   |   |   |   |   |
|                                   | 4G63  | 04/91 → 02/93   | 3), Mod. D22A, D27A   | VKMS 95005<br>VKMA 95005<br>VKM 75044<br>VKM 75144<br>VKM 85000                    | 2<br>2<br>1<br>1<br>1   | 1<br>1<br>2   |   |   | 5   |   | T0479   |
|                                   | 4G63  | 04/91 → 12/94   | Mod. D22A, D27A   | VKPC 95424   |   |   |   | 1   |   |   |   |
|                                   | 4G63  | 12/95 → 12/95   | Mod. D32A, D33A   | VKPC 95612   |   |   |   | 1   |   |   |   |
| <b>MITSUBISHI  EXPO 2.4</b>       |   |   |   |  |   |   |   |   |   |   |   |
|                                   | 4G64  | 06/92 → 12/94   | Mod. N34W, N44W   | —<br>VKM 75044<br>VKM 75064<br>VKM 85000   | 2<br>1<br>1   | 1<br>2  |   |   |   |   |   |
| <b>MITSUBISHI  EXPO-LRV 1.8</b>   |   |   |   |  |   |   |   |   |   |   |   |
|                                   | 4G93  | 05/91 → 05/93   | 3), Mod. N11W, N21W   | VKMS 95025<br>VKMA 95025<br>VKM 75002  | 1<br>1<br>1   | 1   |   |   | 2   |   | T0678   |
| <b>MITSUBISHI  EXPO-LRV 2.4</b>   |   |   |   |  |   |   |   |   |   |   |   |
|                                   | 4G64  | 06/92 → 12/94   | Mod. N14W, N24W   | —<br>VKM 75044<br>VKM 75064<br>VKM 85000   | 2<br>1<br>1   | 1<br>2  |   |   |   |   |   |
| <b>MITSUBISHI  FIORE 1.2</b>      |   |   |   |  |   |   |   |   |   |   |   |
|                                   | 4G16, G11B, G12B  | 02/82 → 05/92   | Mod. A155A, A156, C15A, C65A  | VKPC 95008   |   |   |   | 1   |   |   |   |
| <b>MITSUBISHI  FIORE 1.3</b>      |   |   |   |  |   |   |   |   |   |   |   |
|                                   | 4G13, G13B  | 10/83 → 07/03   | Mod. C11A, C11V, C51A, C61A, CA1, CB1   | VKPC 95008   |   |   |   | 1   |   |   |   |
| <b>MITSUBISHI  FIORE 1.5</b>      |   |   |   |  |   |   |   |   |   |   |   |
|                                   | 4G15, G15B  | 10/83 → 07/03   | Mod. C12A, C12V, C12W, C32V, C62A   | VKPC 95008   |   |   |   | 1   |   |   |   |
|  | G31B  | 02/86 → 12/88   | Mod. C18A   | VKPC 95010   |   |   |   | 1   |   |   |   |



MITSUBISHI































|  |  |  |  |  |  |  |  |  |  |  |  |  |
|--|---|---|---|--|---|---|---|---|---|---|---|---|
| <b>MITSUBISHI  FIORE 1.6</b>    |   |   |   |  |   |   |   |   |   |   |   |   |
|                                  | 4G32, G32B  | 10/83 → 12/88   | Mod. C13A, Turbo  | VKPC 95010   |   |   |   |   |   | 1   |   |   |
|  | 4G61  | 04/88 → 05/90   | Mod. C63A   | VKPC 95427   |   |   |   |   |   | 1   |   |   |
|  | 4G92  | 06/92 → 07/03   | Mod. C66A, C76A   | VKPC 95426   |   |   |   |   |   | 1   |   |   |
|  | G32B  | 04/79 → 12/87   | Mod. A174   | VKPC 95004   |   |   |   |   |   | 1   |   |   |
| <b>MITSUBISHI  FIORE 1.8</b>    |   |   |   |  |   |   |   |   |   |   |   |   |
|                                  | 4G37  | 05/89 → 05/92   | Mod. C77A   | VKPC 95010   |   |   |   |   |   | 1   |   |   |
|  | 4G67  | 11/89 → 05/92   | Mod. C68A   | VKPC 95424   |   |   |   |   |   | 1   |   |   |
|  | 4G93  | 06/92 → 07/03   | Mod. C69A   | VKPC 95426   |   |   |   |   |   | 1   |   |   |
| <b>MITSUBISHI  FIORE 1.8 D</b>  |   |   |   |  |   |   |   |   |   |   |   |   |
|                                  | 4D65  | 01/84 → 05/86   | Mod. C14A, C14V, C14W, C34W   | VKPC 95402   |   |   |   |   |   | 1   |   |   |
|  | 4D65  | 06/86 → 05/92   | Mod. C14A, C14V, C14W, C34W, C64A   | VKPC 95404   |   |   |   |   |   | 1   |   |   |
| <b>MITSUBISHI  FIORE 2.0 D</b>  |   |   |   |  |   |   |   |   |   |   |   |   |
|                                  | 4D68  | 06/92 → 07/03   | Mod. C67A   | VKPC 95614   |   |   |   |   |   | 1   |   |   |
| <b>MITSUBISHI  FORTE 1.6</b>    |   |   |   |  |   |   |   |   |   |   |   |   |
|                                  | 4G32, G32B  | 11/79 → 07/03   | Mod. L021P, L25P  | VKPC 95004   |   |   |   |   |   | 1   |   |   |
| <b>MITSUBISHI  FORTE 2.0</b>    |   |   |   |  |   |   |   |   |   |   |   |   |
|                                  | 4G52  | 10/80 → 09/82   | Mod. L022   | VKPC 95602   |   |   |   |   |   | 1   |   |   |
|  | G63B  | 10/82 → 12/87   | Mod. L026   | VKPC 95422   |   |   |   |   |   | 1   |   |   |
| <b>MITSUBISHI  GALANT 1.6</b>   |   |   |   |  |   |   |   |   |   |   |   |   |
|                                  | 4G32  | 12/80 → 03/82   | Mod. A161A, A161V   | —  | 2   | 2   |   |   |   |   |   |   |
|  |   |   |   | VKM 75101  | 1   |   |   |   |   |   |   |   |
|  |   |   |   | VKM 75119  | 1   |   |   |   |   |   |   |   |
|  | 4G32  | 04/82 → 04/83   | Mod. A161A  | VKMA 95102   | 2   | 2   |   |   |   |   |   |   |
|  |   |   |   | VKM 75101  | 1   |   |   |   |   |   |   |   |
|  |   |   |   | VKM 75119  | 1   |   |   |   |   |   |   |   |
|  | 4G32  | 01/87 → 12/87   | Mod. E11A   | VKMA 95008   | 2   | 2   |   |   |   |   |   | T0673   |
|  |   |   |   | VKM 75108  | 1   |   |   |   |   |   |   |   |
|  |   |   |   | VKM 75119  | 1   |   |   |   |   |   |   |   |
|  | 4G32  | 12/87 → 10/92   | Mod. E31A   | VKMA 95031   | 1   | 1   |   |   |   |   |   | T0657   |
|  |   |   |   | VKM 75108  | 1   |   |   |   |   |   |   |   |
|                                | 4G32, G32B  | 01/77 → 03/84   | Mod. A121, A131, A161   | VKPC 95004   |   |   |   |   |   | 1   |   |   |
|  | 4G32  | 12/87 → 10/92   | Mod. E31A   | VKPC 95010   |   |   |   |   |   | 1   |   |   |
|  | G32B  | 06/84 → 10/87   | Mod. E11A   | VKPC 95010   |   |   |   |   |   | 1   |   |   |
| <b>MITSUBISHI  GALANT 1.8</b> |   |   |   |  |   |   |   |   |   |   |   |   |
|                                | 4G93  | 11/92 → 04/95   | 3), Mod. E52A   | VKMS 95025   | 1   | 1   |   |   |   | 2   |   |   |
|  |   |   |   | VKMA 95025   | 1   | 1   |   |   |   |   |   | T0678   |
|  |   |   |   | VKM 75002  | 1   |   |   |   |   |   |   |   |
|  | 4G37  | 12/83 → 12/86   | Mod. E12A   | VKMA 95102   | 2   | 2   |   |   |   |   |   |   |
|  |   |   |   | VKM 75101  | 1   |   |   |   |   |   |   |   |
|  |   |   |   | VKM 75119  | 1   |   |   |   |   |   |   |   |
|  | 4G37  | 11/87 → 10/92   | Mod. E32A   | VKMA 95008   | 2   | 2   |   |   |   |   |   | T0673   |
|  |   |   |   | VKM 75108  | 1   |   |   |   |   |   |   |   |
|  |   |   |   | VKM 75119  | 1   |   |   |   |   |   |   |   |
|  | 4G93  | 10/96 → 12/97   | Mod. EA1A   | VKMA 95626   | 1   | 1   |   |   |   |   |   | T0678   |
|  |   |   |   | VKM 75616  | 1   |   |   |   |   |   |   |   |
|                                | 4G37, G37B  | 08/83 → 10/92   | Mod. E12A, E32A, E97A   | VKPC 95010   |   |   |   |   |   | 1   |   |   |
|  | 4G67  | 04/89 → 12/94   | Mod. E35A   | VKPC 95424   |   |   |   |   |   | 1   |   |   |
| <b>MITSUBISHI  GALANT 2.0</b> |   |   |   |  |   |   |   |   |   |   |   |   |
|                                | 4G63  | 05/87 → 05/88   | 3), Mod. A183A  | VKMS 95036   | 2   | 2   |   |   |   | 3   |   |   |
|  |   |   |   | VKMA 95036   | 2   | 2   |   |   |   |   |   | T0673   |
|  |   |   |   | VKM 75008  | 1   |   |   |   |   |   |   |   |
|  |   |   |   | VKM 75033  | 1   |   |   |   |   |   |   |   |
|  | 4G63  | 11/87 → 04/92   | 3), Mod. E33A, E38A, E39A, SOHC   | VKMS 95009   | 2   | 2   |   |   |   | 4   |   |   |
|  |   |   |   | VKMA 95009   | 2   | 2   |   |   |   |   |   | T0673   |
|  |   |   |   | VKM 75113  | 1   |   |   |   |   |   |   |   |
|  |   |   |   | VKM 75130  | 1   |   |   |   |   |   |   |   |
|  | 4G63  | 11/89 → 12/92   | 3), Mod. E33A, E38A, E39A, DOHC   | VKMS 95005   | 2   | 1   | 2   |   |   | 5   |   |   |
|  |   |   |   | VKMA 95005   | 2   | 1   | 2   |   |   |   |   | T0479   |
|  |   |   |   | VKM 75044  | 1   |   |   |   |   |   |   |   |
|  |   |   |   | VKM 75144  | 1   |   |   |   |   |   |   |   |
|  |   |   |   | VKM 85000  |   | 1   |   |   |   |   |   |   |

|   |  |  |  |  |  |  |  |  |  |  |  |  |
|---|---|---|---|--|---|---|---|---|---|---|---|---|
| 4G63  |   | 11/92 → 04/95   | 3), Mod. E55A, E75A   | VKMS 95019<br>VKMA 95019<br>VKM 75044<br>VKM 75064<br>VKM 85000                    | 2<br>2<br>1<br>1  | 1<br>1  | 2   |   |   |   | 3   | T0670   |
| 4G63  |   | 09/81 → 12/83   | Mod. A163, A163V  | VKMA 95103<br>VKM 75033<br>VKM 75113   | 2<br>1<br>1   |   | 2   |   |   |   |   | T0665   |
| 4G63, G63B  |   | 06/84 → 04/87   | Mod. E15A   | VKMA 95103<br>VKM 75033<br>VKM 75113   | 2<br>1<br>1   |   | 2   |   |   |   |   | T0665   |
| 4G63  |   | 09/96 → 08/01   | Mod. EA2A, EA2W   | VKMA 95627<br>VKM 75064<br>VKM 75613<br>VKM 85000                                  | 2<br>1<br>1   | 1   | 2   |   |   |   |   | T0670   |
| 6A12  |   | 11/92 → 04/95   | Mod. E54A   | VKMA 95617<br>VKM 75614<br>VKM 85141   | 1<br>1  | 1   | 1   |   |   |   |   | T0544   |
|                                    | 4G52, G52B  | 01/77 → 08/80   | Mod. A123, A133   | VKPC 95602   |   |   |   |   |   | 1   |   |   |
|   | 4G63  | 06/88 → 10/92   | Mod. E33A, E38A, E39A,<br>SOHC  | VKPC 95423   |   |   |   |   |   | 1   |   |   |
|   | 4G63  | 06/88 → 05/91   | Mod. E33A, E38A, E39A,<br>DOHC  | VKPC 95424   |   |   |   |   |   | 1   |   |   |
|   | 6A12  | 11/92 → 08/96   | Mod. E53A   | VKPC 95003   |   |   |   |   |   | 1   |   |   |
|   | G63B  | 09/81 → 09/86   | Mod. A168V  | VKPC 95422   |   |   |   |   |   | 1   |   |   |
| <b>MITSUBISHI  GALANT 2.4</b>      |   |   |   |  |   |   |   |   |   |   |   |   |
|                                    | 4G64  | 02/93 → 06/94   | Mod. E56A, SOHC   | —<br>VKM 75044<br>VKM 75064<br>VKM 85000   | 2<br>1<br>1   | 1   | 2   |   |   |   |   |   |
|   | 4G64  | 02/93 → 07/01   | Mod. E56A, EA3A, DOHC   | VKMA 95620<br>VKM 75064<br>VKM 75613<br>VKM 85000                                  | 2<br>1<br>1   | 1   | 2   |   |   |   |   | T0666   |
|   | G64B  | 01/85 → 01/87   | Mod. E16A   | —<br>VKM 75033<br>VKM 75113  | 2<br>1  |   | 2   |   |   |   |   |   |
| <b>MITSUBISHI  GALANT 2.5</b>    |   |   |   |  |   |   |   |   |   |   |   |   |
|                                  | 6A13  | 09/96 → 08/01   | Mod. EA5A   | VKMA 95628<br>VKM 75614<br>VKM 85141   | 1<br>1  | 1   | 1   |   |   |   |   | T0688   |
|   | 6G73  | 11/92 → 04/95   | Mod. E88A   | VKMA 95000<br>VKM 75000<br>VKM 85002   | 1<br>1  | 1   | 1   |   |   |   |   | T0689   |
| <b>MITSUBISHI  GALANT 2.6</b>    |   |   |   |  |   |   |   |   |   |   |   |   |
|                                  | G54B  | 05/79 → 11/80   | Mod. 166A, A135A  | VKPC 95602   |   |   |   |   |   | 1   |   |   |
| <b>MITSUBISHI  GALANT 3.0</b>    |   |   |   |  |   |   |   |   |   |   |   |   |
|                                  | 6G72  | 01/88 → 12/89   | 3), Mod. E18A   | VKMS 95003<br>VKMA 95003<br>VKM 75004  | 1<br>1  |   | 1   |   |   |   | 3   | T0695   |
| <b>MITSUBISHI  GALANT 1.8 TD</b> |   |   |   |  |   |   |   |   |   |   |   |   |
|                                  | 4D65  | 06/84 → 06/85   | Mod. E14A   | —<br>VKM 75113<br>VKM 75140<br>VKM 85140   | 2<br>1<br>1   | 1   | 2   |   |   |   |   |   |
|   | 4D65  | 12/87 → 10/92   | Mod. E34A   | VKMA 95006<br>VKM 75113<br>VKM 75140<br>VKM 85140                                  | 2<br>1<br>1   | 1   | 2   |   |   |   |   | T0667   |
|                                  | 4D65  | 06/84 → 12/87   | Mod. E14A   | VKPC 95402   |   |   |   |   |   | 1   |   |   |
|   | 4D65  | 12/87 → 10/92   | Mod. E34A   | VKPC 95404   |   |   |   |   |   | 1   |   |   |
| <b>MITSUBISHI  GALANT 2.0</b>    |   |   |   |  |   |   |   |   |   |   |   |   |
|                                  | 4D65, 4D68  | 11/92 → 08/96   | 3), Mod. E57A   | VKMS 95023<br>VKMA 95023<br>VKM 75044<br>VKM 75054<br>VKM 85140                    | 2<br>2<br>1<br>1  | 1<br>1  | 2   |   |   |   | 3   | T0497   |





MITSUBISHI



|  |  |  |  |  |  |  |  |  |  |  |  |  |
|--|---|---|---|--|---|---|---|---|---|---|---|---|
| <b>MITSUBISHI  GALANT 2.0 TDI</b> |   |   |   |  |   |   |   |   |   |   |   |   |
|                                    | 4D68  | 09/96 → 07/01   | Mod. EA6A, EA6W   | VKMA 95649<br>VKM 75613<br>VKM 75624<br>VKM 85140                                  | 2<br>1<br>1   | 1   | 2   |   |   |   |   | T0667   |
| <b>MITSUBISHI  GALANT 2.3 TD</b>  |   |   |   |  |   |   |   |   |   |   |   |   |
|                                    | 4D55  | 09/82 → 12/83   | Mod. A167, A167V  | VKMA 95010<br>VKM 75601<br>VKM 75612   | 2<br>1<br>1   |   | 2   |   |   |   |   | T0668   |
|                                    | 4D55  | 09/80 → 12/83   | Mod. A167A  | VKPC 95010   |   |   |   |   | 1   |   |   |   |
| <b>MITSUBISHI  LANCER 1.2</b>     |   |   |   |  |   |   |   |   |   |   |   |   |
|                                    | 4G16  | 06/87 → 05/92   | 3), Mod. C15A, C65A   | VKMS 95207<br>VKMA 95207<br>VKM 75100  | 1<br>1<br>1   |   | 1   |   |   |   | 2   | T0697   |
|  | 4G11, 4G16  | 01/80 → 10/86   | Mod. A171, A171A, C15AS   | VKMA 95206<br>VKM 75100  | 1<br>1  |   | 1   |   |   |   |   | T0697   |
|                                    | 4G16, G11B, G12B  | 02/82 → 08/92   | Mod. A155A, A156, C15A, C65A  | VKPC 95008   |   |   |   |   | 1   |   |   |   |
| <b>MITSUBISHI  LANCER 1.3</b>     |   |   |   |  |   |   |   |   |   |   |   |   |
|                                    | 4G13  | 04/88 → 05/90   | 3), Mod. C61A   | VKMS 95207<br>VKMA 95207<br>VKM 75100  | 1<br>1<br>1   |   | 1   |   |   |   | 2   | T0697   |
|  | 4G13  | 12/98 → 05/01   | 3), Mod. CK1A, SOHC   | VKMS 95650<br>VKMA 95650<br>VKM 75625  | 1<br>1<br>1   |   | 1   |   |   |   | 2   | T0691   |
|  | 4G13  | 02/85 → 05/86   | Mod. C11V   | VKMA 95206<br>VKM 75100  | 1<br>1  |   | 1   |   |   |   |   | T0697   |
|  | 4G13  | 06/90 → 12/96   | Mod. C11V, C12V, C61A, CA1A, CB1A   | VKMA 95012<br>VKM 75001  | 1<br>1  |   | 1   |   |   |   |   | T0697   |
|  | 4G13  | 12/95 → 11/98   | Mod. CK1A, SOHC   | VKMA 95621<br>VKM 75615  | 1<br>1  |   | 1   |   |   |   |   | T0691   |
|                                  | 4G13, G13B  | 10/83 → 07/95   | Mod. C11A, C11V, C51A, C61A, CA1, CB1, CB1A                                       | VKPC 95008   |   |   |   |   | 1   |   |   |   |
|  | 4G13  | 12/95 → 05/01   | Mod. CK1A   | VKPC 95863   |   |   |   |   | 1   |   |   |   |
| <b>MITSUBISHI  LANCER 1.4</b>   |   |   |   |  |   |   |   |   |   |   |   |   |
|                                  | 4G12  | 09/79 → 10/82   | Mod. A172, A172A  | VKMA 95206<br>VKM 75100  | 1<br>1  |   | 1   |   |   |   |   | T0697   |
| <b>MITSUBISHI  LANCER 1.5</b>   |   |   |   |  |   |   |   |   |   |   |   |   |
|                                  | 4G15, G15B  | 06/87 → 05/90   | 3), Mod. C12AS, C12V, C62A  | VKMS 95207<br>VKMA 95207<br>VKM 75100  | 1<br>1<br>1   |   | 1   |   |   |   | 2   | T0697   |
|  | 4G15  | 06/90 → 11/94   | 3), Mod. C12V, C62A, CA2A, CB2A   | VKMS 95012<br>VKMA 95012<br>VKM 75001  | 1<br>1<br>1   |   | 1   |   |   |   | 2   | T0697   |
|  | 4G15, G15B  | 11/83 → 05/87   | Mod. C12AS, C12V  | VKMA 95206<br>VKM 75100  | 1<br>1  |   | 1   |   |   |   |   | T0697   |
|  | 4G15  | 12/95 → 11/98   | Mod. CK2A, SOHC   | VKMA 95621<br>VKM 75615  | 1<br>1  |   | 1   |   |   |   |   | T0691   |
|  | 4G15  | 12/95 → 01/01   | Mod. CK2A, DOHC   | VKMA 95622<br>VKM 75615<br>VKM 85000   | 1<br>1<br>1   |   | 1   | 1   |   |   |   | T0680   |
|  | 4G15  | 12/98 → 09/00   | Mod. CK2A, SOHC   | VKMA 95650<br>VKM 75625  | 1<br>1  |   | 1   |   |   |   |   | T0691   |
|  | 4G91  | 12/91 → 11/94   | Mod. CB3A   | VKMA 95625<br>VKM 75009<br>VKM 85000   | 1<br>1<br>1   |   | 1   | 1   |   |   |   | T0680   |
|                                  | 4G15, G15B  | 11/83 → 07/03   | Mod. C12A, C12V, C12W, C32V, C62A   | VKPC 95008   |   |   |   |   | 1   |   |   |   |
|  | 4G15  | 12/95 → 08/03   | Mod. CK2A   | VKPC 95863   |   |   |   |   | 1   |   |   |   |
|  | G31B  | 02/86 → 12/88   | Mod. C18A   | VKPC 95010   |   |   |   |   | 1   |   |   |   |





**MITSUBISHI**  **LANCER 1.6**

|  |            |               |  |                                       |             |   |   |  |   |  |  |       |
|--|------------|---------------|--|---------------------------------------|-------------|---|---|--|---|--|--|-------|
|   | 4G92       | 06/92 → 09/00 | 3), <b>Mod.</b> C66A, CA4A, CB4A, CB4W, CD4A, CD4W | VKMS 95020<br>VKMA 95020<br>VKM 75002 | 1<br>1<br>1 | 1 |   |  | 2 |  |  | T0494 |
|  | 4G92       | 12/95 → 08/03 | 3), <b>Mod.</b> CK4A, <b>SOHC</b>                  | VKMS 95623<br>VKMA 95623<br>VKM 75616 | 1<br>1<br>1 | 1 |   |  | 2 |  |  | T0678 |
|  | 4G32       | 01/80 → 03/82 | <b>Mod.</b> A174                                   | —<br>VKM 75101<br>VKM 75119           | 2<br>1<br>1 | 2 |   |  |   |  |  |       |
|  | 4G32       | 04/82 → 10/82 | <b>Mod.</b> A174                                   | VKMA 95102<br>VKM 75101<br>VKM 75119  | 2<br>1<br>1 | 2 |   |  |   |  |  |       |
|  | 4G61       | 04/88 → 05/90 | <b>Mod.</b> C63A                                   | VKMA 95021<br>VKM 75144<br>VKM 85000  | 1<br>1<br>1 | 1 | 1 |  |   |  |  | T0495 |
|  | 4G92       | 12/95 → 01/01 | <b>Mod.</b> CK4A, <b>DOHC</b>                      | VKMA 95624<br>VKM 75009<br>VKM 85000  | 1<br>1<br>1 | 1 | 1 |  |   |  |  | T0693 |
|   | 4G32, G32B | 10/83 → 12/88 | <b>Mod.</b> C13A, <b>Turbo</b>                     | VKPC 95010                            |             |   |   |  | 1 |  |  |       |
|  | 4G61       | 04/88 → 05/90 | <b>Mod.</b> C63A                                   | VKPC 95427                            |             |   |   |  | 1 |  |  |       |
|  | 4G92       | 06/92 → 02/07 | <b>Mod.</b> C66A, C76A, CB4A, CB4W                 | VKPC 95426                            |             |   |   |  | 1 |  |  |       |
|  | 4G92       | 08/95 → 08/03 | <b>Mod.</b> CJK4, CK4A                             | VKPC 95005                            |             |   |   |  | 1 |  |  |       |
|  | G32B       | 09/79 → 12/87 | <b>Mod.</b> A174                                   | VKPC 95004                            |             |   |   |  | 1 |  |  |       |
|  | 4G92       | 12/97 → 05/99 | <b>Mod.</b> CK4A                                   | VKMA _____<br>VKM 65004               | 1<br>1      | 1 |   |  |   |  |  |       |
|  | 4G92       | 06/99 → 09/00 | <b>Mod.</b> CK4A                                   | VKMA _____                            | 1           | 1 |   |  |   |  |  |       |
| <b>B(AC)</b>   | 4G92       | 10/97 → 09/00 | <b>Mod.</b> CB4W, CD4W                             | VKMA _____                            | 1           | 1 |   |  |   |  |  |       |



































**MITSUBISHI**  **LANCER 1.8**

































|   |            |               |   |   |                       |   |   |  |   |   |  |       |
|---|------------|---------------|---|---|-----------------------|---|---|--|---|---|--|-------|
|  | 4G67       | 11/89 → 05/92 | 3), <b>Mod.</b> C68A                    | VKMS 95005<br>VKMA 95005<br>VKM 75044<br>VKM 75144<br>VKM 85000 | 2<br>2<br>1<br>1<br>1 | 1 | 2 |  |   | 5 |  | T0479 |
|   | 4G93       | 06/92 → 12/93 | 3), <b>Mod.</b> CA5A, CB5A, <b>SOHC</b> | VKMS 95025<br>VKMA 95025<br>VKM 75002                           | 1<br>1<br>1           | 1 |   |  | 2 |   |  | T0678 |
|   | 4D65       | 01/84 → 12/88 | <b>Mod.</b> C14A                        | —<br>VKM 75113<br>VKM 75140<br>VKM 85140                        | 2<br>1<br>1           | 1 | 2 |  |   |   |  |       |
|   | 4G37, G37B | 11/86 → 12/86 | <b>Mod.</b> C37V                        | VKMA 95105<br>VKM 75101   | 1<br>1                | 1 |   |  |   |   |  | T0657 |
|   | 4G37, G37B | 01/87 → 06/92 | <b>Mod.</b> C37V, C77A                  | VKMA 95031<br>VKM 75108   | 1<br>1                | 1 |   |  |   |   |  | T0657 |
|   | 4G93       | 06/92 → 05/93 | <b>Mod.</b> C69A                        | VKMA 95022<br>VKM 75009<br>VKM 85000                            | 1<br>1<br>1           | 1 | 1 |  |   |   |  | T0679 |
|   | 4G93       | 06/92 → 12/93 | <b>Mod.</b> CA5A, CB5A, <b>DOHC</b>     | VKMA 95022<br>VKM 75009<br>VKM 85000                            | 1<br>1<br>1           | 1 | 1 |  |   |   |  | T0679 |
|  | 4G37       | 09/89 → 05/92 | <b>Mod.</b> C77A                        | VKPC 95010  |                       |   |   |  | 1 |   |  |       |
|   | 4G67       | 11/89 → 05/92 | <b>Mod.</b> C68A                        | VKPC 95424  |                       |   |   |  | 1 |   |  |       |
|   | 4G93       | 06/92 → 07/03 | <b>Mod.</b> C69A, CB5A                  | VKPC 95426  |                       |   |   |  | 1 |   |  |       |

**MITSUBISHI**  **LANCER 2.0 Turbo**

|   |      |               |                   |                                      |             |   |   |  |   |  |  |       |
|---|------|---------------|-------------------|--------------------------------------|-------------|---|---|--|---|--|--|-------|
|  | 4G32 | 09/81 → 12/82 | <b>Mod.</b> A176  | VKMA 95103<br>VKM 75033<br>VKM 75113 | 2<br>1<br>1 | 2 |   |  |   |  |  | T0665 |
|   | 4G63 | 09/80 → 08/81 | <b>Mod.</b> A176A | —<br>—<br>VKM 75113                  | 2<br>1<br>1 | 2 |   |  |   |  |  |       |
|  | 4G63 | 01/99 → 08/00 | <b>Mod.</b> CP9A  | VKPC 95864                           |             |   |   |  | 1 |  |  |       |
|  | 4G63 | 01/99 → 09/00 | <b>Mod.</b> CP9A  | VKMA _____<br>VKM 65005              | 1<br>1      | 1 | 1 |  |   |  |  |       |







































|  |  |  |  |  |  |  |  |  |  |  |  |  |
|--|---|---|---|--|---|---|---|---|---|---|---|---|
| <b>MITSUBISHI  LANCER 1.8 D</b>       |   |   |   |  |   |   |   |   |   |   |   |   |
|                                        | 4D65  | 01/84 → 02/88   | Mod. C14AS, C14V  | —  | 2   | 1   | 2   |   |   |   |   |   |
|  |   |   |   | VKM 75113  | 1   |   |   |   |   |   |   |   |
|  |   |   |   | VKM 75140  | 1   |   |   |   |   |   |   |   |
|  |   |   |   | VKM 85140  |   | 1   |   |   |   |   |   |   |
|  | 4D65  | 03/88 → 06/92   | Mod. C14AS, C14V, C64A  | VKMA 95006   | 2   | 1   | 2   |   |   |   |   | T0667   |
|  |   |   |   | VKM 75113  | 1   |   |   |   |   |   |   |   |
|  |   |   |   | VKM 75140  | 1   |   |   |   |   |   |   |   |
|  |   |   |   | VKM 85140  |   | 1   |   |   |   |   |   |   |
|                                        | 4D65  | 01/84 → 05/86   | Mod. C14A, C14V, C14W, C34W   | VKPC 95402   |   |   |   |   | 1   |   |   |   |
|  | 4D65  | 06/86 → 12/88   | Mod. C14A, C14V, C14W, C34W   | VKPC 95404   |   |   |   |   | 1   |   |   |   |
|  | 4D65  | 04/88 → 05/92   | Mod. C64A   | VKPC 95404   |   |   |   |   | 1   |   |   |   |
| <b>MITSUBISHI  LANCER 2.0</b>         |   |   |   |  |   |   |   |   |   |   |   |   |
|                                        | 4D68  | 12/92 → 05/96   | 3), Mod. CB8W   | VKMS 95023   | 2   | 1   | 2   |   |   |   | 3   |   |
|  |   |   |   | VKMA 95023   | 2   | 1   | 2   |   |   |   |   | T0497   |
|  |   |   |   | VKM 75044  | 1   |   |   |   |   |   |   |   |
|  |   |   |   | VKM 75054  | 1   |   |   |   |   |   |   |   |
|  |   |   |   | VKM 85140  |   | 1   |   |   |   |   |   |   |
|                                        | 4D68  | 12/92 → 05/96   | Mod. CB8W   | VKPC 95614   |   |   |   |   | 1   |   |   |   |
| <b>MITSUBISHI  LANCER 2.0 D</b>       |   |   |   |  |   |   |   |   |   |   |   |   |
|                                        | 4D68  | 06/92 → 11/94   | 3), Mod. CB8A   | VKMS 95023   | 2   | 1   | 2   |   |   |   | 3   |   |
|  |   |   |   | VKMA 95023   | 2   | 1   | 2   |   |   |   |   | T0497   |
|  |   |   |   | VKM 75044  | 1   |   |   |   |   |   |   |   |
|  |   |   |   | VKM 75054  | 1   |   |   |   |   |   |   |   |
|  |   |   |   | VKM 85140  |   | 1   |   |   |   |   |   |   |
|                                      | 4D68  | 06/92 → 12/96   | Mod. C67A   | VKPC 95614   |   |   |   |   | 1   |   |   |   |
| <b>MITSUBISHI  MAGNA 3.5</b>        |   |   |   |  |   |   |   |   |   |   |   |   |
|                                      | 6G74  | 11/93 → 05/97   | 3), Mod. V75W   | VKMS 95039   | 1   | 1   | 1   |   |   |   | 5   |   |
|  |   |   |   | VKMA 95039   | 1   | 1   | 1   |   |   |   |   | T0689   |
|  |   |   |   | VKM 75000  | 1   |   |   |   |   |   |   |   |
|  |   |   |   | VKM 85002  |   | 1   |   |   |   |   |   |   |
|  | 6G74  | 06/97 → 12/00   | 3), Mod. V75W   | VKMS 95040   | 1   | 1   | 1   |   |   |   | 5   |   |
|  |   |   |   | VKMA 95040   | 1   | 1   | 1   |   |   |   |   | T0689   |
|  |   |   |   | VKM 75000  | 1   |   |   |   |   |   |   |   |
|  |   |   |   | VKM 85002  |   | 1   |   |   |   |   |   |   |
| <b>MITSUBISHI  MIRAGE 1.2</b>       |   |   |   |  |   |   |   |   |   |   |   |   |
|                                      | 4G16  | 01/84 → 05/92   | Mod. C15A   | VKPC 95008   |   |   |   |   | 1   |   |   |   |
| <b>MITSUBISHI  MIRAGE 1.3</b>       |   |   |   |  |   |   |   |   |   |   |   |   |
|                                      | 4G13, G13B  | 10/83 → 05/92   | Mod. C11A, C11V, C51A, C51V   | VKPC 95008   |   |   |   |   | 1   |   |   |   |
| <b>MITSUBISHI  MIRAGE 1.5</b>       |   |   |   |  |   |   |   |   |   |   |   |   |
|                                      | 4G15, G15B  | 06/86 → 12/90   | 3), Mod. C12A, C52A, C62A   | VKMS 95207   | 1   |   | 1   |   |   |   | 2   |   |
|  |   |   |   | VKMA 95207   | 1   |   | 1   |   |   |   |   | T0697   |
|  |   |   |   | VKM 75100  | 1   |   |   |   |   |   |   |   |
|  | 4G15  | 06/90 → 12/93   | 3), Mod. C52A, C62A, C82A, CA2A, CB2A   | VKMS 95012   | 1   |   | 1   |   |   |   | 2   |   |
|  |   |   |   | VKMA 95012   | 1   |   | 1   |   |   |   |   | T0697   |
|  |   |   |   | VKM 75001  | 1   |   |   |   |   |   |   |   |
|  | G15B  | 01/85 → 05/86   | Mod. C12A   | VKMA 95206   | 1   |   | 1   |   |   |   |   | T0697   |
|  |   |   |   | VKM 75100  | 1   |   |   |   |   |   |   |   |
|                                      | 4G15, G15B  | 10/83 → 12/94   | Mod. C12A, C12V, C12W, C32V, C52A, C72A, C84A                                     | VKPC 95008   |   |   |   |   | 1   |   |   |   |
|  | G31B  | 02/86 → 12/88   | Mod. C18A   | VKPC 95010   |   |   |   |   | 1   |   |   |   |
| <b>MITSUBISHI  MIRAGE 1.6</b>       |   |   |   |  |   |   |   |   |   |   |   |   |
|                                      | 4G61  | 04/88 → 05/89   | Mod. C53A   | VKMA 95021   | 1   | 1   | 1   |   |   |   |   | T0495   |
|  |   |   |   | VKM 75144  | 1   |   |   |   |   |   |   |   |
|  |   |   |   | VKM 85000  |   | 1   |   |   |   |   |   |   |
|                                      | 4G32, G32B  | 10/83 → 10/90   | Mod. C13A, Turbo  | VKPC 95010   |   |   |   |   | 1   |   |   |   |
|  | 4G61  | 04/88 → 05/90   | Mod. C53A   | VKPC 95427   |   |   |   |   | 1   |   |   |   |
| <b>MITSUBISHI  MIRAGE 1.6 Turbo</b> |   |   |   |  |   |   |   |   |   |   |   |   |
|                                      | G32B  | 01/85 → 12/86   | Mod. C13A   | VKMA 95105   | 1   |   | 1   |   |   |   |   | T0657   |
|  |   |   |   | VKM 75101  | 1   |   |   |   |   |   |   |   |











































|   |  |  |  |  |  |  |  |  |  |  |  |       |
|---|---|---|---|--|---|---|---|---|---|---|---|-------|
|   | G32B  | 01/87 → 12/88   | Mod. C13A, Turbo  | VKMA 95031<br>VKM 75108  | 1<br>1  |   | 1   |   |   |   |   | T0657 |
| <b>MITSUBISHI  MIRAGE 1.8</b>            |   |   |   |  |   |   |   |   |   |   |   |       |
|    | 4G93  | 06/92 → 12/94   | 3), Mod. CA5A, CB5A   | VKMS 95025<br>VKMA 95025<br>VKM 75002  | 1<br>1<br>1   |   | 1   |   |   |   | 2   | T0678 |
|    | CM5A  | 08/95 → 07/03   | Mod. 4G93   | VKPC 95005   |   |   |   |   | 1   |   |   |       |
| <b>MITSUBISHI  MIRAGE 1.8 D</b>          |   |   |   |  |   |   |   |   |   |   |   |       |
|    | 4D65  | 02/84 → 05/86   | Mod. C14A, C14V, C14W, C34V   | VKPC 95402   |   |   |   |   | 1   |   |   |       |
|   | 4D65  | 06/86 → 05/94   | Mod. C14A, C14V, C14W, C34V, C54A   | VKPC 95404   |   |   |   |   | 1   |   |   |       |
| <b>MITSUBISHI  MONTERO 3.0</b>           |   |   |   |  |   |   |   |   |   |   |   |       |
|    | 6G72  | 05/88 → 05/94   | 3), Mod. L141G, L146G, V23C, V23W, V43W   | VKMS 95003<br>VKMA 95003<br>VKM 75004  | 1<br>1<br>1   |   | 1   |   |   |   | 3   | T0695 |
|   | 6G72  | 06/94 → 12/94   | Mod. V23C, V23W, V43W   | VKMA 95613<br>VKM 75000<br>VKM 85002   | 1<br>1<br>1   | 1   | 1   |   |   |   |   | T0540 |
|   | 6G72  | 11/98 → 12/02   | Mod. K96W, DOHC   | VKMA 95613<br>VKM 75000<br>VKM 85002   | 1<br>1<br>1   | 1   | 1   |   |   |   |   | T0540 |
| <b>MITSUBISHI  MONTERO 3.5</b>           |   |   |   |  |   |   |   |   |   |   |   |       |
|    | 6G74  | 11/93 → 05/97   | 3), Mod. V75W   | VKMS 95039<br>VKMA 95039<br>VKM 75000<br>VKM 85002                                 | 1<br>1<br>1<br>1  | 1   | 1   |   |   |   | 5   | T0689 |
|   | 6G74  | 06/97 → 12/00   | 3), Mod. V75W   | VKMS 95040<br>VKMA 95040<br>VKM 75000<br>VKM 85002                                 | 1<br>1<br>1<br>1  | 1   | 1   |   |   |   | 5   | T0689 |
| <b>MITSUBISHI  MONTERO 2.3 TD</b>      |   |   |   |  |   |   |   |   |   |   |   |       |
|                                        | 4D55  | 01/83 → 04/86   | Mod. L043G, L048G, Turbo  | VKMA 95010<br>VKM 75601<br>VKM 75612   | 2<br>1<br>1   |   | 2   |   |   |   |   | T0668 |
| <b>MITSUBISHI  MONTERO 2.5 TD</b>      |   |   |   |  |   |   |   |   |   |   |   |       |
|                                        | 4D56  | 05/86 → 05/90   | 3), Mod. L044G, L049G, L144G, L149G, Turbo  | VKMS 95010<br>VKMA 95010<br>VKM 75601<br>VKM 75612                                 | 2<br>2<br>1<br>1  |   | 2   |   |   |   | 4   | T0668 |
|   | 4D56T   | 09/99 → 11/00   | Mod. V64W, V74W, Turbo  | VKMA 95014<br>VKM 75601<br>VKM 75612   | 2<br>1<br>1   |   | 2   |   |   |   |   | T0668 |
| <b>MITSUBISHI  MONTERO SPORT 2.5 D</b> |   |   |   |  |   |   |   |   |   |   |   |       |
|                                        | 4D56  | 11/98 → 09/00   | Mod. K94W   | VKMA 95014<br>VKM 75601<br>VKM 75612   | 2<br>1<br>1   |   | 2   |   |   |   |   | T0668 |
| <b>MITSUBISHI  OUTLANDER 2.0</b>       |   |   |   |  |   |   |   |   |   |   |   |       |
|                                        | 4G63  | 05/03 → 04/07   | 3), Mod. CU2W   | VKMS 95666<br>VKMA 95666<br>VKM 75064<br>VKM 75613<br>VKM 85000                    | 2<br>2<br>1<br>1<br>1   | 1   | 2   |   |   |   | 5   | T0666 |
|                                        | 4G63  | 05/03 → 04/07   | Mod. CU2W   | VKPC 95864   |   |   |   |   | 1   |   |   |       |
| <b>MITSUBISHI  OUTLANDER 2.0 Turbo</b> |   |   |   |  |   |   |   |   |   |   |   |       |
|                                        | 4G63  | 05/03 → 04/07   | 3), Mod. CU2W   | VKMS 95666<br>VKMA 95666<br>VKM 75064<br>VKM 75613<br>VKM 85000                    | 2<br>2<br>1<br>1<br>1   | 1   | 2   |   |   |   | 5   | T0666 |
|                                        | 4G63  | 05/03 → 04/07   | Mod. CU2W   | VKPC 95864   |   |   |   |   | 1   |   |   |       |



MITSUBISHI













































|   |  |  |  |  |  |  |  |  |  |  |  |  |  |
|---|---|---|---|--|---|---|---|---|---|---|---|---|---|
| <b>MITSUBISHI  PAJERO 2.4</b>              |   |   |   |  |   |   |   |   |   |   |   |   |   |
|   | 4G64  | 04/91 → 04/92   |   | VKMA 95015   | 2   |   | 2   |   |   |   |   |   | T0673   |
|   |   |   |   | VKM 75008  | 1   |   |   |   |   |   |   |   |   |
|   |   |   |   | VKM 75033  | 1   |   |   |   |   |   |   |   |   |
|   | 4G64  | 05/92 → 05/94   |   | VKMA 95027   | 2   |   | 2   |   |   |   |   |   | T0673   |
|   |   |   |   | VKM 75033  | 1   |   |   |   |   |   |   |   |   |
|   |   |   |   | VKM 75044  | 1   |   |   |   |   |   |   |   |   |
|   | 4G64  | 04/91 → 04/92   | Mod. V21C, V21W, V41W   | VKPC 95422   |   |   |   |   | 1   |   |   |   |   |
| <b>MITSUBISHI  PAJERO 2.6</b>              |   |   |   |  |   |   |   |   |   |   |   |   |   |
|   | 4G54, G54B  | 01/83 → 07/03   | Mod. L042G, L047G   | VKPC 95602   |   |   |   |   | 1   |   |   |   |   |
| <b>MITSUBISHI  PAJERO 3.0</b>              |   |   |   |  |   |   |   |   |   |   |   |   |   |
|   | 6G72  | 11/88 → 05/94   | 3), Mod. L141G, L146G, V23C, V23W, V43W   | VKMS 95003   | 1   |   | 1   |   |   |   | 3   |   | T0695   |
|   |   |   |   | VKMA 95003   | 1   |   | 1   |   |   |   |   |   |   |
|   |   |   |   | VKM 75004  | 1   |   |   |   |   |   |   |   |   |
| <b>MITSUBISHI  PAJERO 3.5</b>              |   |   |   |  |   |   |   |   |   |   |   |   |   |
|   | 6G74  | 06/94 → 05/97   | 3), Mod. V25W, V45W, V65W, V75W   | VKMS 95039   | 1   | 1   | 1   |   |   |   | 5   |   | T0689   |
|   |   |   |   | VKMA 95039   | 1   | 1   | 1   |   |   |   |   |   |   |
|   |   |   |   | VKM 75000  | 1   |   |   |   |   |   |   |   |   |
|   |   |   |   | VKM 85002  |   |   | 1   |   |   |   |   |   |   |
|   | 6G74  | 06/97 → 04/00   | 3), Mod. V65W, V75W   | VKMS 95040   | 1   | 1   | 1   |   |   |   | 5   |   | T0689   |
|   |   |   |   | VKMA 95040   | 1   | 1   | 1   |   |   |   |   |   |   |
|   |   |   |   | VKM 75000  | 1   |   |   |   |   |   |   |   |   |
|   |   |   |   | VKM 85002  |   |   | 1   |   |   |   |   |   |   |
| <b>MITSUBISHI  PAJERO 2.3 TD</b>          |   |   |   |  |   |   |   |   |   |   |   |   |   |
|   | 4D55  | 01/83 → 04/86   | 3), Mod. L043G, L048G   | VKMS 95010   | 2   |   | 2   |   |   |   | 4   |   | T0668   |
|   |   |   |   | VKMA 95010   | 2   |   | 2   |   |   |   |   |   |   |
|   |   |   |   | VKM 75601  | 1   |   |   |   |   |   |   |   |   |
|   |   |   |   | VKM 75612  | 1   |   |   |   |   |   |   |   |   |
|   | 4D55  | 01/83 → 04/86   | Mod. L043G, L048G   | VKPC 95405   |   |   |   |   | 1   |   |   |   |   |
| <b>MITSUBISHI  PAJERO 2.5 D</b>          |   |   |   |  |   |   |   |   |   |   |   |   |   |
|   | 4D56  | 11/89 → 05/90   | 3), Mod. L144G, L149G   | VKMS 95010   | 2   |   | 2   |   |   |   | 4   |   | T0668   |
|   |   |   |   | VKMA 95010   | 2   |   | 2   |   |   |   |   |   |   |
|   |   |   |   | VKM 75601  | 1   |   |   |   |   |   |   |   |   |
|   |   |   |   | VKM 75612  | 1   |   |   |   |   |   |   |   |   |
|   | 4D56  | 06/92 → 10/93   | Mod. V24W, 30)  | VKMA 95014   | 2   |   | 2   |   |   |   |   |   | T0668   |
|   |   |   |   | VKM 75601  | 1   |   |   |   |   |   |   |   |   |
|   |   |   |   | VKM 75612  | 1   |   |   |   |   |   |   |   |   |
|   | 4D56  | 11/93 → 05/94   | Mod. V24C, V24W, V44W   | VKMA 95014   | 2   |   | 2   |   |   |   |   |   | T0668   |
|   |   |   |   | VKM 75601  | 1   |   |   |   |   |   |   |   |   |
|   |   |   |   | VKM 75612  | 1   |   |   |   |   |   |   |   |   |
|   | 4D56  | 05/83 → 11/90   | Mod. L044G  | VKPC 95405   |   |   |   |   | 1   |   |   |   |   |
| <b>MITSUBISHI  PAJERO 2.5 TD</b>         |   |   |   |  |   |   |   |   |   |   |   |   |   |
|   | 4D56  | 05/86 → 12/91   | 3), Mod. L044G, L049G   | VKMS 95010   | 2   |   | 2   |   |   |   | 4   |   | T0668   |
|   |   |   |   | VKMA 95010   | 2   |   | 2   |   |   |   |   |   |   |
|   |   |   |   | VKM 75601  | 1   |   |   |   |   |   |   |   |   |
|   |   |   |   | VKM 75612  | 1   |   |   |   |   |   |   |   |   |
|   | 4D56  | 06/92 → 10/93   | 3), 31), Mod. V24C, V24W  | VKMS 95010   | 2   |   | 2   |   |   |   | 4   |   | T0668   |
|   |   |   |   | VKMA 95010   | 2   |   | 2   |   |   |   |   |   |   |
|   |   |   |   | VKM 75601  | 1   |   |   |   |   |   |   |   |   |
|   |   |   |   | VKM 75612  | 1   |   |   |   |   |   |   |   |   |
|   | 4D56  | 05/86 → 11/90   | Mod. L044G, L049G, L144G, L149G   | VKPC 95405   |   |   |   |   | 1   |   |   |   |   |
|   | 4D56  | 12/90 → 07/03   | Mod. V24C, V24W, V44W   | VKPC 95800   |   |   |   |   | 1   |   |   |   |   |
| <b>MITSUBISHI  PAJERO CLASSIC 2.5 TD</b> |   |   |   |  |   |   |   |   |   |   |   |   |   |
|   | 4D56  | 07/02 → 04/04   | 3), Mod. V24W   | VKMS 95014   | 2   |   | 2   |   |   |   | 4   |   | T0668   |
|   |   |   |   | VKMA 95014   | 2   |   | 2   |   |   |   |   |   |   |
|   |   |   |   | VKM 75601  | 1   |   |   |   |   |   |   |   |   |
|   |   |   |   | VKM 75612  | 1   |   |   |   |   |   |   |   |   |
|   | 4D56  | 07/02 → 04/04   | Mod. V24W   | VKPC 95800   |   |   |   |   | 1   |   |   |   |   |
| <b>MITSUBISHI  PAJERO PININ 1.8</b>      |   |   |   |  |   |   |   |   |   |   |   |   |   |
|   | 4G93  | 10/99 → 06/00   | Mod. H66W, DOHC   | VKMA 95624   | 1   | 1   | 1   |   |   |   |   |   | T0693   |
|   |   |   |   | VKM 75009  | 1   |   |   |   |   |   |   |   |   |
|   |   |   |   | VKM 85000  |   |   | 1   |   |   |   |   |   |   |









































|   |  |  |  |  |  |  |  |  |  |  |  |  |
|---|---|---|---|--|---|---|---|---|---|---|---|---|
|   | 4G93  | 09/01 → 02/05   | Mod. H66W, DOHC   | VKMA 95645<br>VKM 75009<br>VKM 85000   | 1<br>1  | 1<br>1  | 1   |   |   |   |   | T0693   |
| <b>MITSUBISHI</b>  <b>PAJERO SPORT 3.0</b>           |   |   |   |  |   |   |   |   |   |   |   |   |
|    | 6G72  | 11/98 → 12/02   | Mod. K96W, DOHC   | VKMA 95613<br>VKM 75000<br>VKM 85002   | 1<br>1  | 1<br>1  | 1   |   |   |   |   | T0540   |
| <b>MITSUBISHI</b>  <b>PAJERO SPORT 2.5 D, 2.5 TD</b> |   |   |   |  |   |   |   |   |   |   |   |   |
|    | 4D56  | 11/98 → 12/02   | Mod. K90, K94W  | VKMA 95014<br>VKM 75601<br>VKM 75612   | 2<br>1<br>1   |   | 2   |   |   |   |   | T0668   |
| <b>MITSUBISHI</b>  <b>SANTAMO 2.0</b>                |   |   |   |  |   |   |   |   |   |   |   |   |
|    |   | 02/95 → 12/00   | SOHC  | VKMA 95642<br>VKM 75008<br>VKM 75130   | 2<br>1<br>1   |   | 2   |   |   |   |   | T0665   |
|   |   | 04/97 → 12/00   | DOHC  | VKMA 95005<br>VKM 75044<br>VKM 75144<br>VKM 85000                                  | 2<br>1<br>1<br>1  | 1   | 2   |   |   |   |   | T0479   |
| <b>MITSUBISHI</b>  <b>SAPPORO 1.6</b>                |   |   |   |  |   |   |   |   |   |   |   |   |
|    | 4G32  | 09/80 → 03/82   | Mod. A161A  | —<br>VKM 75101<br>VKM 75119  | 2<br>1<br>1   |   | 2   |   |   |   |   |   |
|   | 4G32  | 04/82 → 09/84   | Mod. A161A  | VKMA 95102<br>VKM 75101<br>VKM 75119   | 2<br>1<br>1   |   | 2   |   |   |   |   |   |
|   | 4G32, G32B  | 04/78 → 03/84   | Mod. A121, A131, A161   | VKPC 95004   |   |   |   |   | 1   |   |   |   |
|   | G32B  | 03/84 → 10/87   | Mod. E11A   | VKPC 95010   |   |   |   |   | 1   |   |   |   |
| <b>MITSUBISHI</b>  <b>SAPPORO 1.8</b>              |   |   |   |  |   |   |   |   |   |   |   |   |
|    | G62B  | 08/81 → 07/83   | Mod. A162   | VKPC 95422   |   |   |   |   | 1   |   |   |   |
| <b>MITSUBISHI</b>  <b>SAPPORO 2.0</b>              |   |   |   |  |   |   |   |   |   |   |   |   |
|    | 4G63  | 08/80 → 06/81   | Mod. A164A  | —<br>—<br>VKM 75113  | 2<br>1<br>1   |   | 2   |   |   |   |   | T0673   |
|   | 4G63  | 09/81 → 01/83   | Mod. A164A  | VKMA 95103<br>VKM 75033<br>VKM 75113   | 2<br>1<br>1   |   | 2   |   |   |   |   | T0665   |
|    | 4G52, G52B  | 04/78 → 07/80   | Mod. A123, A133   | VKPC 95602   |   |   |   |   | 1   |   |   |   |
|   | G63B, G63BT   | 08/80 → 09/86   | Mod. 164, A163, A168V   | VKPC 95422   |   |   |   |   | 1   |   |   |   |
| <b>MITSUBISHI</b>  <b>SAPPORO 2.6</b>              |   |   |   |  |   |   |   |   |   |   |   |   |
|    | G54B  | 05/79 → 11/80   | Mod. 166A, A135A  | VKPC 95602   |   |   |   |   | 1   |   |   |   |
| <b>MITSUBISHI</b>  <b>SAPPORO 1.8 D</b>            |   |   |   |  |   |   |   |   |   |   |   |   |
|    | 4D65  | 03/84 → 03/88   | Mod. E14A   | VKPC 95402   |   |   |   |   | 1   |   |   |   |
| <b>MITSUBISHI</b>  <b>SAPPORO 2.3 D</b>            |   |   |   |  |   |   |   |   |   |   |   |   |
|    | 4D55  | 04/80 → 12/83   | Mod. A167A  | VKPC 95010   |   |   |   |   | 1   |   |   |   |
| <b>MITSUBISHI</b>  <b>SHOGUN 2.4</b>               |   |   |   |  |   |   |   |   |   |   |   |   |
|    | 4G64  | 12/90 → 04/92   | Mod. V21C, V21W, V41W   | VKPC 95422   |   |   |   |   | 1   |   |   |   |
| <b>MITSUBISHI</b>  <b>SHOGUN 2.6</b>               |   |   |   |  |   |   |   |   |   |   |   |   |
|    | 4G54, G54B  | 01/83 → 07/03   | Mod. L042G, L047G   | VKPC 95602   |   |   |   |   | 1   |   |   |   |
| <b>MITSUBISHI</b>  <b>SHOGUN 3.5</b>               |   |   |   |  |   |   |   |   |   |   |   |   |
|    | 6G74  | 11/93 → 05/97   | 3), Mod. V75W   | VKMS 95039<br>VKMA 95039<br>VKM 75000<br>VKM 85002                                 | 1<br>1<br>1   | 1<br>1  | 1   |   |   | 5   |   | T0689   |
|   | 6G74  | 06/97 → 12/00   | 3), Mod. V75W   | VKMS 95040<br>VKMA 95040<br>VKM 75000<br>VKM 85002                                 | 1<br>1<br>1   | 1<br>1  | 1   |   |   | 5   |   | T0689   |
| <b>MITSUBISHI</b>  <b>SHOGUN 2.3 D</b>             |   |   |   |  |   |   |   |   |   |   |   |   |
|    | 4D55  | 01/83 → 04/86   | Mod. L043G, L048G   | VKPC 95405   |   |   |   |   | 1   |   |   |   |
| <b>MITSUBISHI</b>  <b>SHOGUN 2.5 D</b>             |   |   |   |  |   |   |   |   |   |   |   |   |
|    | 4D56  | 05/86 → 07/03   | Mod. L044G, L049G,<br>L144G, L149G  | VKPC 95405   |   |   |   |   | 1   |   |   |   |
|   | 4D56  | 12/90 → 07/03   | Mod. V24C, V24W, V44W   | VKPC 95800   |   |   |   |   | 1   |   |   |   |





MITSUBISHI































|  |            |  |  |  |  |  |  |  |  |  |  |  |  |  |  |  |  |  |  |
|--|------------|---|---|---|--|---|---|---|---|---|---|---|---|---|---|---|---|---|---|
| <b>MITSUBISHI</b>  <b>SIGMA 1.6</b>             |            |   |   |   |  |   |   |   |   |   |   |   |   |   |   |   |   |   |   |
|    | 4G32, G32B | 01/77 → 03/84   | Mod. A121, A131, A161   | VKPC 95004  |  |   |   |   |   |   |   |   |   |   |   |   |   |   | 1   |
|  | G32B       | 03/84 → 10/87   | Mod. E11A   | VKPC 95010  |  |   |   |   |   |   |   |   |   |   |   |   |   |   | 1   |
| <b>MITSUBISHI</b>  <b>SIGMA 2.0</b>             |            |   |   |   |  |   |   |   |   |   |   |   |   |   |   |   |   |   |   |
|    | 4G52, G52B | 05/76 → 10/80   | Mod. A123, A133   | VKPC 95602  |  |   |   |   |   |   |   |   |   |   |   |   |   |   | 1   |
|  | G63B       | 09/81 → 09/86   | Mod. A168V  | VKPC 95422  |  |   |   |   |   |   |   |   |   |   |   |   |   |   | 1   |
| <b>MITSUBISHI</b>  <b>SIGMA 2.6</b>             |            |   |   |   |  |   |   |   |   |   |   |   |   |   |   |   |   |   |   |
|    | G54B       | 05/79 → 11/80   | Mod. 166A, A135A  | VKPC 95602  |  |   |   |   |   |   |   |   |   |   |   |   |   |   | 1   |
| <b>MITSUBISHI</b>  <b>SIGMA 3.0</b>             |            |   |   |   |  |   |   |   |   |   |   |   |   |   |   |   |   |   |   |
|    | 6G72       | 12/90 → 03/95   | 3), Mod. F16A, SOHC   | VKMS 95003<br>VKMA 95003<br>VKM 75004   | 1<br>1<br>1  |   | 1   |   |   |   |   |   |   |   |   |   |   | 3   | T0695   |
|  | 6G72       | 12/90 → 03/95   | Mod. F16A, DOHC   | VKMA 95000<br>VKM 75000<br>VKM 85002  | 1<br>1<br>1  | 1   | 1   | 1   |   |   |   |   |   |   |   |   |   |   | T0689   |
|  | 6G72       | 09/96 → 12/97   | Mod. F36A   | VKMA 95613<br>VKM 75000<br>VKM 85002  | 1<br>1<br>1  | 1   | 1   | 1   |   |   |   |   |   |   |   |   |   |   | T0540   |
| <b>MITSUBISHI</b>  <b>SIGMA 1.8 D</b>           |            |   |   |   |  |   |   |   |   |   |   |   |   |   |   |   |   |   |   |
|    | 4D65       | 03/84 → 03/88   | Mod. E14A   | VKPC 95402  |  |   |   |   |   |   |   |   |   |   |   |   |   |   | 1   |
| <b>MITSUBISHI</b>  <b>SIGMA 2.3 D</b>           |            |   |   |   |  |   |   |   |   |   |   |   |   |   |   |   |   |   |   |
|    | 4D55       | 04/80 → 12/83   | Mod. A167A  | VKPC 95010  |  |   |   |   |   |   |   |   |   |   |   |   |   |   | 1   |
| <b>MITSUBISHI</b>  <b>SPACE RUNNER 1.8</b>      |            |   |   |   |  |   |   |   |   |   |   |   |   |   |   |   |   |   |   |
|    | 4G93       | 10/91 → 05/93   | 3), Mod. N11W, N21W   | VKMS 95025<br>VKMA 95025<br>VKM 75002   | 1<br>1<br>1  |   | 1   |   |   |   |   |   |   |   |   |   |   | 2   | T0678   |
| <b>MITSUBISHI</b>  <b>SPACE RUNNER 2.0 TD</b> |            |   |   |   |  |   |   |   |   |   |   |   |   |   |   |   |   |   |   |
|    | 4D68       | 10/92 → 05/93   | 3), Mod. N18W   | VKMS 95023<br>VKMA 95023<br>VKM 75044<br>VKM 75054<br>VKM 85140                   | 2<br>2<br>1<br>1<br>1  | 1   | 1   | 2   |   |   |   |   |   |   |   |   |   | 3   | T0497   |
| <b>MITSUBISHI</b>  <b>SPACE STAR 1.3</b>      |            |   |   |   |  |   |   |   |   |   |   |   |   |   |   |   |   |   |   |
|    | 4G13       | 12/98 → 08/02   | 3), Mod. DG1A   | VKMS 95651-1<br>VKMA 95651<br>VKM 75625   | 1<br>1<br>1  |   | 1   |   |   |   |   |   |   |   |   |   |   | 2   | T0697   |
|  | 4G13       | 09/02 → 12/04   | 3), Mod. DG1A   | VKMS 95651-2<br>VKMA 95651<br>VKM 75625   | 1<br>1<br>1  |   | 1   |   |   |   |   |   |   |   |   |   |   | 2   | T0697   |
|    | 4G13       | 06/98 → 04/07   | Mod. DG1A   | —   |  |   |   |   |   |   |   |   |   |   |   |   |   | 1   |   |
| <b>MITSUBISHI</b>  <b>SPACE STAR 1.6</b>      |            |   |   |   |  |   |   |   |   |   |   |   |   |   |   |   |   |   |   |
|    | 4G18       | 09/01 → 08/02   | 3), Mod. DG3A   | VKMS 95651-1<br>VKMA 95651<br>VKM 75625   | 1<br>1<br>1  |   | 1   |   |   |   |   |   |   |   |   |   |   | 2   | T0697   |
|  | 4G18       | 09/02 → 12/04   | 3), Mod. DG3A   | VKMS 95651-2<br>VKMA 95651<br>VKM 75625   | 1<br>1<br>1  |   | 1   |   |   |   |   |   |   |   |   |   |   | 2   | T0697   |
|    | 4G18       | 09/01 → 04/07   | Mod. DG3A   | —   |  |   |   |   |   |   |   |   |   |   |   |   |   | 1   |   |
| <b>MITSUBISHI</b>  <b>SPACE STAR 1.9 DI-D</b> |            |   |   |   |  |   |   |   |   |   |   |   |   |   |   |   |   |   |   |
|    | F9Q2       | 02/01 → 12/04   | 3), Mod. DG4A   | —   | 1  |   |   |   |   |   |   |   |   |   |   |   |   | 2   |   |
|    | F9Q2       | 02/01 → 12/04   | Mod. DG4A   | —   |  |   |   |   |   |   |   |   |   |   |   |   |   | 1   |   |
| <b>MITSUBISHI</b>  <b>SPACE WAGON 1.6</b>     |            |   |   |   |  |   |   |   |   |   |   |   |   |   |   |   |   |   |   |
|    | G32B       | 01/83 → 10/86   | Mod. D02W   | VKPC 95010  |  |   |   |   |   |   |   |   |   |   |   |   |   |   | 1   |
| <b>MITSUBISHI</b>  <b>SPACE WAGON 1.8</b>     |            |   |   |   |  |   |   |   |   |   |   |   |   |   |   |   |   |   |   |
|    | 4G93       | 10/91 → 12/96   | 3), Mod. N31W, N41W   | VKMS 95025<br>VKMA 95025<br>VKM 75002   | 1<br>1<br>1  |   | 1   |   |   |   |   |   |   |   |   |   |   | 2   | T0678   |
|  | 4G37       | 01/84 → 12/86   | Mod. D05V, D05W   | VKMA 95102<br>VKM 75101<br>VKM 75119  | 2<br>1<br>1  |   | 2   |   |   |   |   |   |   |   |   |   |   |   |   |
|  | 4G37       | 01/87 → 12/88   | Mod. D05V, D05W   | VKMA 95008<br>VKM 75108<br>VKM 75119  | 2<br>1<br>1  |   | 2   |   |   |   |   |   |   |   |   |   |   |   | T0673   |
|    | 4G37       | 10/83 → 07/03   | Mod. D05V, D05W   | VKPC 95010  |  |   |   |   |   |   |   |   |   |   |   |   |   |   | 1   |

|  |  |  |  |  |  |  |  |  |  |  |  |
|--|---|---|---|--|---|---|---|---|---|---|---|
|  | 4G93  | 10/91 → 05/92   | Mod. N31W, N41W   | VKPC 95426   |   |   |   |   |   | 1   |   |
| <b>MITSUBISHI  SPACE WAGON 2.0</b>      |   |   |   |  |   |   |   |   |   |   |   |
|   | 4G63, G63B  | 05/87 → 06/90   | 3), Mod. D04W, D08W   | VKMS 95036<br>VKMA 95036<br>VKM 75008<br>VKM 75033                                 | 2<br>2<br>1<br>1  | 2   |   |   |   | 3   | T0673   |
|  | 4G63, G63B  | 03/85 → 04/87   | Mod. D04W, D08W   | VKMA 95103<br>VKM 75033<br>VKM 75113   | 2<br>1<br>1   | 2   |   |   |   |   | T0665   |
|  | 4G63  | 10/92 → 12/96   | Mod. N33W, N43W   | VKMA 95019<br>VKM 75044<br>VKM 75064<br>VKM 85000                                  | 2<br>1<br>1<br>1  | 1   | 2   |   |   |   | T0670   |
|   | 4G63, G63B  | 06/86 → 10/98   | Mod. D04W, D08W   | VKPC 95611   |   |   |   |   |   | 1   |   |
|  | 4G63  | 10/92 → 10/98   | Mod. N33W, N43W   | VKPC 95612   |   |   |   |   |   | 1   |   |
| <b>MITSUBISHI  SPACE WAGON 2.4</b>      |   |   |   |  |   |   |   |   |   |   |   |
|   | 4G64  | 12/98 → 12/02   | Mod. N84W, DOHC   | VKMA 95620<br>VKM 75064<br>VKM 75613<br>VKM 85000                                  | 2<br>1<br>1<br>1  | 1   | 2   |   |   |   | T0666   |
|   | 4G64  | 06/92 → 07/03   | Mod. N34W   | VKPC 95612   |   |   |   |   |   | 1   |   |
| <b>MITSUBISHI  SPACE WAGON 1.8 D</b>    |   |   |   |  |   |   |   |   |   |   |   |
|   | 4D65  | 06/86 → 04/91   | Mod. D09V, D09W   | VKPC 95402   |   |   |   |   |   | 1   |   |
| <b>MITSUBISHI  SPACE WAGON 1.8 TD</b>   |   |   |   |  |   |   |   |   |   |   |   |
|   | 4D65  | 06/86 → 12/87   | Mod. D09W   | —<br>VKM 75113<br>VKM 75140<br>VKM 85140   | 2<br>1<br>1<br>1  | 1   | 2   |   |   |   |   |
|  | 4D65  | 01/88 → 05/92   | Mod. D09V, D09W, N35W   | VKMA 95006<br>VKM 75113<br>VKM 75140<br>VKM 85140                                  | 2<br>1<br>1<br>1  | 1   | 2   |   |   |   | T0667   |
|                                       | 4D65  | 06/86 → 10/98   | Mod. D09V, D09W, N35W   | VKPC 95402   |   |   |   |   |   | 1   |   |
| <b>MITSUBISHI  SPACE WAGON 2.0 D</b>  |   |   |   |  |   |   |   |   |   |   |   |
|                                       | 4D68  | 10/92 → 10/98   | Mod. N38W   | VKPC 95614   |   |   |   |   |   | 1   |   |
| <b>MITSUBISHI  SPACE WAGON 2.0 TD</b> |   |   |   |  |   |   |   |   |   |   |   |
|                                       | 4D68  | 10/92 → 05/93   | 3), Mod. N38W   | VKMS 95023<br>VKMA 95023<br>VKM 75044<br>VKM 75054<br>VKM 85140                    | 2<br>2<br>1<br>1<br>1   | 1   | 2   |   |   | 3   | T0497   |
|                                       | 4D68  | 10/92 → 10/98   | Mod. N38W   | VKPC 95614   |   |   |   |   |   | 1   |   |
| <b>MITSUBISHI  STARION 2.0</b>        |   |   |   |  |   |   |   |   |   |   |   |
|                                       | 4G63  | 05/87 → 05/88   | 3), Mod. A183A  | VKMS 95036<br>VKMA 95036<br>VKM 75008<br>VKM 75033                                 | 2<br>2<br>1<br>1  | 2   |   |   |   | 3   | T0673   |
|  | 4G63  | 02/82 → 04/87   | Mod. A183A  | VKMA 95103<br>VKM 75033<br>VKM 75113   | 2<br>1<br>1   | 2   |   |   |   |   | T0665   |
| <b>MITSUBISHI  TREDIA 1.4</b>         |   |   |   |  |   |   |   |   |   |   |   |
|                                       | 4G12  | 10/82 → 08/84   | Mod. A211   | VKMA 95206<br>VKM 75100  | 1<br>1  | 1   |   |   |   |   | T0697   |
| <b>MITSUBISHI  TREDIA 1.6</b>         |   |   |   |  |   |   |   |   |   |   |   |
|                                       | 4G32  | 06/83 → 12/86   | Mod. A212   | VKMA 95102<br>VKM 75101<br>VKM 75119   | 2<br>1<br>1   | 2   |   |   |   |   |   |
|                                       | G32B  | 02/82 → 12/88   | Mod. A212   | VKPC 95010   |   |   |   |   |   | 1   |   |
| <b>MITSUBISHI  TREDIA 1.6 Turbo</b>   |   |   |   |  |   |   |   |   |   |   |   |
|                                       | 4G32  | 09/82 → 08/84   | Mod. A212   | VKMA 95105<br>VKM 75101  | 1<br>1  | 1   |   |   |   |   | T0657   |
| <b>MITSUBISHI  TREDIA 1.8</b>         |   |   |   |  |   |   |   |   |   |   |   |
|                                       | 4G37  | 09/85 → 12/86   | Mod. A215, A215A  | VKMA 95102<br>VKM 75101<br>VKM 75119   | 2<br>1<br>1   | 2   |   |   |   |   |   |





































MITSUBISHI



















































|  |  |  |  |  |  |  |  |  |  |  |  |  |  |
|--|---|---|---|--|---|---|---|---|---|---|---|---|---|
|  | 4G37  | 01/87 → 12/88   | Mod. A215A  | VKMA 95008<br>VKM 75108<br>VKM 75119   | 2<br>1<br>1   | 2   |   |   |   |   |   |   | T0673   |
|  | 4G62  | 08/83 → 04/87   | Mod. A213A  | VKMA 95103<br>VKM 75033<br>VKM 75113   | 2<br>1<br>1   | 2   |   |   |   |   |   |   | T0665   |
|    | G37B  | 08/84 → 12/87   | Mod. A215   | VKPC 95010   |   |   |   | 1   |   |   |   |   |   |
| <b>MITSUBISHI  TREDIA 1.8 Turbo</b>         |   |   |   |  |   |   |   |   |   |   |   |   |   |
|    | G62B  | 08/84 → 07/86   |   | VKMA 95103<br>VKM 75033<br>VKM 75113   | 2<br>1<br>1   | 2   |   |   |   |   |   |   | T0665   |
| <b>MITSUBISHI  TREDIA (EUR) 1.6</b>         |   |   |   |  |   |   |   |   |   |   |   |   |   |
|    | 4G32  | 01/87 → 11/87   | Mod. A212A  | VKMA 95008<br>VKM 75108<br>VKM 75119   | 2<br>1<br>1   | 2   |   |   |   |   |   |   | T0673   |
| <b>MITSUBISHI  TREDIA (NON-EUR/SIN) 1.6</b> |   |   |   |  |   |   |   |   |   |   |   |   |   |
|    | 4G32  | 09/84 → 12/86   | Mod. A212A  | VKMA 95105<br>VKM 75101  | 1<br>1  | 1   |   |   |   |   |   |   | T0657   |
|  | 4G32  | 01/87 → 11/87   | Mod. A212A  | VKMA 95031<br>VKM 75108  | 1<br>1  | 1   |   |   |   |   |   |   | T0657   |
| <b>MITSUBISHI  TREDIA (SIN) 1.6</b>         |   |   |   |  |   |   |   |   |   |   |   |   |   |
|    | 4G32  | 09/84 → 12/86   | Mod. A212A  | VKMA 95102<br>VKM 75101<br>VKM 75119   | 2<br>1<br>1   | 2   |   |   |   |   |   |   |   |
| <b>MITSUBISHI  DELICA 1.6</b>               |   |   |   |  |   |   |   |   |   |   |   |   |   |
|    | 4G32  | 11/86 → 05/94   | Mod. P02V, P12V   | VKMA 95031<br>VKM 75108  | 1<br>1  | 1   |   |   |   |   |   |   | T0657   |
|  | G32B  | 10/82 → 06/86   | Mod. L033P  | VKM 75101<br>VKM 75119   | 2<br>1<br>1   | 2   |   |   |   |   |   |   |   |
| <b>MITSUBISHI  DELICA 2.3 D</b>           |   |   |   |  |   |   |   |   |   |   |   |   |   |
|    | 4D55  | 04/83 → 06/86   | Mod. L038G, L038P,<br>L068P   | VKMA 95010<br>VKM 75601<br>VKM 75612   | 2<br>1<br>1   | 2   |   |   |   |   |   |   | T0668   |
| <b>MITSUBISHI  DELICA 2.5 D</b>           |   |   |   |  |   |   |   |   |   |   |   |   |   |
|    | 4D56  | 11/86 → 05/93   | Mod. L039G, L039P,<br>P05V, P05W, P15V,<br>P15W, P25V, P25W,<br>P45V              | VKMA 95010<br>VKM 75601<br>VKM 75612   | 2<br>1<br>1   | 2   |   |   |   |   |   |   | T0668   |
| <b>MITSUBISHI  L 200 1.6</b>              |   |   |   |  |   |   |   |   |   |   |   |   |   |
|    | 4G32  | 04/82 → 12/86   | Mod. K01T, K11T, L021P  | VKMA 95105<br>VKM 75101  | 1<br>1  | 1   |   |   |   |   |   |   | T0657   |
|  | 4G32  | 01/87 → 12/95   | Mod. K01T, K11T   | VKMA 95031<br>VKM 75108  | 1<br>1  | 1   |   |   |   |   |   |   | T0657   |
|    | 4G32, G32B  | 08/78 → 12/86   | Mod. L021, L025   | VKPC 95004   |   |   |   | 1   |   |   |   |   |   |
| <b>MITSUBISHI  L 200 2.0</b>              |   |   |   |  |   |   |   |   |   |   |   |   |   |
|    | 4G63, G63B  | 05/87 → 01/91   | 3), Mod. K02T, K12T,<br>K22T, K32T  | VKMS 95036<br>VKMA 95036<br>VKM 75008<br>VKM 75033                                 | 2<br>2<br>1<br>1  | 2<br>2  |   |   |   | 3   |   |   | T0673   |
|  | 4G63, G63B  | 09/81 → 04/87   | Mod. K02T, K12T, K22T,<br>L022P, L026G, L026P                                     | VKMA 95103<br>VKM 75033<br>VKM 75113   | 2<br>1<br>1   | 2   |   |   |   |   |   |   | T0665   |
|  | 4G63  | 09/96 → 07/01   | Mod. K62T   | VKMA 95019<br>VKM 75044<br>VKM 75064<br>VKM 85000                                  | 2<br>1<br>1<br>1  | 1<br>2  |   |   |   |   |   |   | T0670   |
|    | 4G52  | 09/80 → 08/82   | Mod. L22G   | VKPC 95602   |   |   |   | 1   |   |   |   |   |   |

|   |  |  |  |  |  |  |  |  |  |  |  |  |
|---|---|---|---|--|---|---|---|---|---|---|---|---|
| <b>MITSUBISHI  L 200 2.4</b>   |   |   |   |  |   |   |   |   |   |   |   |   |
|                                | 4G64  | 06/89 → 05/92   | Mod. K05T, K15T   | VKMA 95015<br>VKM 75008<br>VKM 75033   | 2<br>1<br>1   | 2   |   |   |   |   |   | T0673   |
|   | 4G64  | 06/92 → 12/95   | Mod. K05T, K15T, K35T   | VKMA 95027<br>VKM 75033<br>VKM 75044   | 2<br>1<br>1   | 2   |   |   |   |   |   | T0673   |
|   | 4G64  | 11/96 → 07/01   | Mod. K75T   | —<br>VKM 75044<br>VKM 75064<br>VKM 85000   | 2<br>1<br>1   | 1   | 2   |   |   |   |   |   |
| <b>MITSUBISHI  L 200 3.0</b>   |   |   |   |  |   |   |   |   |   |   |   |   |
|                                | 6G72  | 06/89 → 12/94   | 3), Mod. K26T, K36T   | VKMS 95003<br>VKMA 95003<br>VKM 75004  | 1<br>1<br>1   | 1   |   |   |   | 3   |   | T0695   |
| <b>MITSUBISHI  L 200 2.3 D</b> |   |   |   |  |   |   |   |   |   |   |   |   |
|                                | 4D55  | 06/82 → 12/86   | Mod. L028G, L028P   | VKMA 95010<br>VKM 75601<br>VKM 75612   | 2<br>1<br>1   | 2   |   |   |   |   |   | T0668   |
| <b>MITSUBISHI  L 200 2.5 D</b> |   |   |   |  |   |   |   |   |   |   |   |   |
|                                | 4D56  | 11/86 → 05/93   | 3), Mod. K14T, K24T   | VKMS 95010<br>VKMA 95010<br>VKM 75601<br>VKM 75612                                 | 2<br>2<br>1<br>1  | 2   |   |   |   | 4   |   | T0668   |
|   | 4D56  | 06/93 → 03/01   | 3), Mod. K14T, K24T, K34T   | VKMS 95014<br>VKMA 95014<br>VKM 75601<br>VKM 75612                                 | 2<br>2<br>1<br>1  | 2   |   |   |   | 4   |   | T0668   |
|                              | 4D56  | 11/86 → 03/01   | Mod. K14T, K24T   | VKPC 95405   |   |   |   |   | 1   |   |   |   |
| <b>MITSUBISHI  L 300 1.4</b> |   |   |   |  |   |   |   |   |   |   |   |   |
|                              | 4G33, G33B  | 06/79 → 07/03   | Mod. L031P, L031PV, L036P, L036PV, R01  | VKPC 95004   |   |   |   |   | 1   |   |   |   |
| <b>MITSUBISHI  L 300 1.6</b> |   |   |   |  |   |   |   |   |   |   |   |   |
|                              | 4G32  | 05/80 → 03/82   | Mod. L032P, L062P   | —<br>VKM 75101   | 1<br>1  | 1   |   |   |   |   |   |   |
|   | 4G32  | 04/82 → 02/87   | Mod. L032P, L062P   | VKMA 95105<br>VKM 75101  | 1<br>1  | 1   |   |   |   |   |   | T0657   |
|   | 4G32  | 11/86 → 05/94   | Mod. L032P, L062P, P02V, P12V   | VKMA 95031<br>VKM 75108  | 1<br>1  | 1   |   |   |   |   |   | T0657   |
|   | 4G32  | 01/93 → 04/94   | Mod. L062P  | VKMA 95105<br>VKM 75101  | 1<br>1  | 1   |   |   |   |   |   | T0657   |
|                              | 4G32, G32B  | 05/80 → 10/86   | Mod. L032P, L032PV, L034P, L33P, L33PV, L33PW, L63P, L63PV, L63PW, P02, P12       | VKPC 95004   |   |   |   |   | 1   |   |   |   |
|   | G32B  | 12/89 → 07/03   | Mod. L063   | VKPC 95004   |   |   |   |   | 1   |   |   |   |
| <b>MITSUBISHI  L 300 1.8</b> |   |   |   |  |   |   |   |   |   |   |   |   |
|                              | 4G62  | 01/81 → 03/83   | Mod. L035G  | —<br>VKM 75033<br>VKM 75119  | 2<br>1<br>1   | 2   |   |   |   |   |   |   |
| <b>MITSUBISHI  L 300 2.0</b> |   |   |   |  |   |   |   |   |   |   |   |   |
|                              | 4G63, G63B  | 05/87 → 04/92   | 3), Mod. P03V, P03W, P13V, P23V, P23W   | VKMS 95036<br>VKMA 95036<br>VKM 75008<br>VKM 75033                                 | 2<br>2<br>1<br>1  | 2   |   |   |   | 3   |   | T0673   |
|   | 4G63, G63B  | 06/94 → 12/96   | 3), Mod. P03V, P03W, P13V   | VKMS 95019<br>VKMA 95019<br>VKM 75044<br>VKM 75064<br>VKM 85000                    | 2<br>2<br>1<br>1  | 1   | 2   |   |   | 3   |   | T0670   |
|   |   |   |   |  | 1   |   |   |   |   |   |   |   |



MITSUBISHI









































|  |  |  |  |  |  |  |  |  |  |  |  |  |
|--|---|---|---|--|---|---|---|---|---|---|---|---|
|  | 4G63, G63B  | 11/86 → 04/87   | Mod. P03V, P03W, P13V, P23V, P23W   | VKMA 95103<br>VKM 75033<br>VKM 75113   | 2<br>1<br>1   | 2   |   |   |   |   |   | T0665   |
|  | 4G63, G63B  | 05/92 → 05/94   | Mod. P03V, P03W, P13V, P23V, P23W   | VKMA 95016<br>VKM 75033<br>VKM 75044   | 2<br>1<br>1   | 2   |   |   |   |   |   | T0665   |
|                                    | G63B  | 11/83 → 12/94   | Mod. L037, P03, P23   | VKPC 95422   |   |   |   |   | 1   |   |   |   |
| <b>MITSUBISHI  L 300 2.4</b>      |   |   |   |  |   |   |   |   |   |   |   |   |
|                                    | 4G64  | 11/86 → 04/87   | Mod. P24V, P24W   | —<br>VKM 75033<br>VKM 75113  | 2<br>1<br>1   | 2   |   |   |   |   |   |   |
|  | 4G64, G64B  | 05/87 → 04/92   | Mod. P04V, P04W, P14V, P24V, P24W   | VKMA 95015<br>VKM 75008<br>VKM 75033   | 2<br>1<br>1   | 2   |   |   |   |   |   | T0673   |
|  | 4G64, G64B  | 05/92 → 05/94   | Mod. P04V, P04W, P14V, P24V, P24W   | VKMA 95027<br>VKM 75033<br>VKM 75044   | 2<br>1<br>1   | 2   |   |   |   |   |   | T0673   |
| <b>MITSUBISHI  L 300 2.3 D</b>    |   |   |   |  |   |   |   |   |   |   |   |   |
|                                    | 4D55  | 04/83 → 06/86   | Mod. L038P, L068P   | VKMA 95010<br>VKM 75601<br>VKM 75612   | 2<br>1<br>1   | 2   |   |   |   |   |   | T0668   |
|                                    | 4D55  | 09/83 → 08/86   | Mod. L038G, L038GV, L038GW, L038P, L038PV, L038PW, L068P, L068PV, L068PW          | VKPC 95405   |   |   |   |   | 1   |   |   |   |
| <b>MITSUBISHI  L 300 2.5 D</b>  |   |   |   |  |   |   |   |   |   |   |   |   |
|                                  | 4D56  | 11/86 → 05/93   | 3), Mod. L039P, P05V, P05W, P15V  | VKMS 95010<br>VKMA 95010<br>VKM 75601<br>VKM 75612                                 | 2<br>2<br>1<br>1  | 2<br>2  |   |   |   | 4   |   | T0668   |
|  | 4D56  | 06/93 → 12/96   | 3), Mod. L039P, P05V, P05W, P15T, P15V  | VKMS 95014<br>VKMA 95014<br>VKM 75601<br>VKM 75612                                 | 2<br>2<br>1<br>1  | 2<br>2  |   |   |   | 4   |   | T0668   |
|                                  | 4D56  | 11/86 → 05/93   | Mod. L039P, P05V, P05W, P15V  | VKPC 95405   |   |   |   |   | 1   |   |   |   |
| <b>MITSUBISHI  L 300 2.5 TD</b> |   |   |   |  |   |   |   |   |   |   |   |   |
|                                  | 4D56  | 11/88 → 05/93   | 3), Mod. P25V, P25W   | VKMS 95010<br>VKMA 95010<br>VKM 75601<br>VKM 75612                                 | 2<br>2<br>1<br>1  | 2<br>2  |   |   |   | 4   |   | T0668   |
|  | 4D56  | 06/93 → 12/96   | 3), Mod. P25V, P25W   | VKMS 95014<br>VKMA 95014<br>VKM 75601<br>VKM 75612                                 | 2<br>2<br>1<br>1  | 2<br>2  |   |   |   | 4   |   | T0668   |
| <b>MITSUBISHI  PICK UP 1.6</b>  |   |   |   |  |   |   |   |   |   |   |   |   |
|                                  | 4G32, G32B  | 08/78 → 12/86   | Mod. L021, L025   | VKPC 95004   |   |   |   |   | 1   |   |   |   |
| <b>MITSUBISHI  PICK UP 2.0</b>  |   |   |   |  |   |   |   |   |   |   |   |   |
|                                  | 4G52  | 09/80 → 08/82   | Mod. L22G   | VKPC 95602   |   |   |   |   | 1   |   |   |   |
| <b>NISSAN  100 NX 1.6</b>       |   |   |   |  |   |   |   |   |   |   |   |   |
|                                  | GA16  | 03/90 → 10/94   | Mod. FB13   | VKPC 92408   |   |   |   |   | 1   |   |   |   |
|                                  | B(PS) GA16DE, GA16DS  | 03/90 → 10/94   |   | VKMV 4PK810  |   |   | 1   |   |   |   |   |   |
| <b>NISSAN  100 NX 2.0</b>       |   |   |   |  |   |   |   |   |   |   |   |   |
|                                  | SR20DE  | 03/91 → 10/94   | Mod. FB13   | VKPC 92412   |   |   |   |   | 1   |   |   |   |
|                                  | B(PS) SR20DE  | 10/90 → 10/94   |   | VKMV _____   |   |   | 1   |   |   |   |   |   |
| <b>NISSAN  200 SX 1.8 Turbo</b> |   |   |   |  |   |   |   |   |   |   |   |   |
|                                  | CA18DET   | 09/88 → 11/93   | 3)  | VKMS 92101<br>VKMA 92101<br>VKM 72100<br>VKM 82101                                 | 1<br>1<br>1<br>1  | 1<br>1<br>1   |   |   |   | 3   |   | T0680   |



















































|   |  |  |                   |  |  |  |  |  |  |  |  |  |
|---|---|---|--|--|---|---|---|---|---|---|---|---|
|                                      | CA18DT  | 09/88 → 07/93   |  | VKPC 92601   |   |   |   |   | 1   |   |   |   |
|                                      | B(Alt) CA18DT   | 07/88 → 11/93   |  | VKMW 4PK855  |   | 1   |   |   |   |   |   |   |
|   | B(AC) CA18DT  | 07/88 → 11/93   |  | VKMW_____  |   | 1   |   |   |   |   |   |   |
| <b>NISSAN  200 SX 2.0 Turbo</b>      |   |   |  |  |   |   |   |   |   |   |   |   |
|                                      | SR20DET   | 10/93 → 12/99   |  | ΟΛΟΦΘΟ   |   |   |   |   |   |   |   |   |
| <b>NISSAN  280 ZX,ZXT 2.8</b>        |   |   |  |  |   |   |   |   |   |   |   |   |
|                                      | L28E  | 10/78 → 06/83   |  | VKPC 92802   |   |   |   |   | 1   |   |   |   |
| <b>NISSAN  300 ZX 3.0 Turbo</b>      |   |   |  |  |   |   |   |   |   |   |   |   |
|                                      | VG30, VG30T   | 01/84 → 10/90   |  | VKMA 92004<br>VKM 72004  | 1<br>1  |   | 1   |   |   |   |   | T0684   |
| <b>NISSAN  300 ZX 3.0 Twin Turbo</b> |   |   |  |  |   |   |   |   |   |   |   |   |
|                                      | VG30DETT  | 05/90 → 12/93   |  | VKMA 92008<br>VKM 82000  | 3<br>1<br>1<br>1  |   | 1   |   |   |   |   | T0359   |
|   | VG30DETT  | 01/94 → 04/95   |  | VKM 82000  | 3<br>1<br>1<br>1  |   | 1   |   |   |   |   |   |
| <b>NISSAN  350 Z 3.5</b>             |   |   |  |  |   |   |   |   |   |   |   |   |
|                                      | VQ35DE  | 10/03 → 01/08   |  | ΟΛΟΦΘΟ   |   |   |   |   |   |   |   |   |
| <b>NISSAN  ALMERA 1.4</b>            |   |   |  |  |   |   |   |   |   |   |   |   |
|                                      | GA14DE  | 09/95 → 07/00   | Mod. N15   | ΟΛΟΦΘΟ   |   |   |   |   |   |   |   |   |
|                                      | GA14DE  | 07/95 → 07/03   | Mod. N15   | VKPC 92408   |   |   |   |   | 1   |   |   |   |
|                                     | B(PS) GA14DE  | 09/95 → 07/00   | Mod. N15   | VKMW 4PK810  |   |   | 1   |   |   |   |   |   |
| <b>NISSAN  ALMERA 1.5</b>          |   |   |  |  |   |   |   |   |   |   |   |   |
|                                    | QG15DE  | 03/00 → 02/04   | Mod. N16   | ΟΛΟΦΘΟ   |   |   |   |   |   |   |   |   |
|                                    | B(Alt) QG15DE   | 03/00 → 01/01   | Mod. N16,  , AC | VKMW 6PK1110   |   |   | 1   |   |   |   |   |   |
|   | B(Alt) QG15DE   | 01/01 → 08/04   | Mod. N16,  , AC | VKMW 6PK1100   |   |   | 1   |   |   |   |   |   |
| <b>NISSAN  ALMERA 1.6</b>          |   |   |  |  |   |   |   |   |   |   |   |   |
|                                    | GA16DE  | 09/95 → 07/00   | Mod. N15   | ΟΛΟΦΘΟ   |   |   |   |   |   |   |   |   |
|                                    | GA16DE  | 07/95 → 07/03   | Mod. N15   | VKPC 92408   |   |   |   |   | 1   |   |   |   |
|                                    | B(Alt) GA16DE   | 09/95 → 07/00   | Mod. N15, AC   | VKMW 4PK820  |   |   | 1   |   |   |   |   |   |
|   | B(PS) GA16DE  | 09/95 → 07/00   | Mod. N15   | VKMW 4PK810  |   |   | 1   |   |   |   |   |   |
| <b>NISSAN  ALMERA 1.8</b>          |   |   |  |  |   |   |   |   |   |   |   |   |
|                                    | QG18DE  | 03/00 → 02/04   | Mod. N16   | ΟΛΟΦΘΟ   |   |   |   |   |   |   |   |   |
|                                    | B(Alt) QG18DE   | 03/00 → 01/01   | Mod. N16,  , AC | VKMW 6PK1110   |   |   | 1   |   |   |   |   |   |
|   | B(Alt) QG18DE   | 01/01 → 08/04   | Mod. N16,  , AC | VKMW 6PK1100   |   |   | 1   |   |   |   |   |   |
| <b>NISSAN  ALMERA 2.0</b>          |   |   |  |  |   |   |   |   |   |   |   |   |
|                                    | SR20DE  | 07/96 → 03/00   | Mod. N15   | ΟΛΟΦΘΟ   |   |   |   |   |   |   |   |   |
|                                    | SR20DE  | 07/96 → 01/98   | Mod. N15   | VKPC 92412   |   |   |   |   | 1   |   |   |   |
|                                    | B(Alt) SR20DE   | 07/96 → 03/00   | Mod. N15, AC   | VKMW 4PK825  |   |   | 1   |   |   |   |   |   |
|   | B(Alt) SR20DE   | 07/96 → 03/00   | Mod. N15, AC   | VKMW 6PK1030   |   |   | 1   |   |   |   |   |   |
|   | B(PS) SR20DE  | 07/96 → 03/00   | Mod. N15   | VKMW_____  |   |   | 1   |   |   |   |   |   |
| <b>NISSAN  ALMERA 1.5 dCi</b>      |   |   |  |  |   |   |   |   |   |   |   |   |
|                                    | K9K   | 01/03 → 10/03   | Mod. N16E  | VKMA 06130<br>VKM 16102  | 1<br>1  |   | 1   |   |   |   |   | 1 T0191   |
|   | K9K   | 10/03 → 08/04   | Mod. N16E  | VKMA 06132<br>VKM 16102  | 1<br>1  |   | 1   |   |   |   |   | 1 T0191   |
|                                    | K9K   | 01/03 → 08/04   | Mod. N16E  | VKPC 86417   |   |   |   |   | 1   |   |   |   |
|                                    | B(Alt) K9K  | 01/03 → 02/07   | Mod. N16E, AC  | VKMA 36052<br>VKMW 5PK1135<br>VKM 36052<br>VKM 36053                               | 1<br>1<br>1   | 1   | 1   |   |   |   |   |   |
|   | B(Alt) K9K  | 01/03 → 02/07   | Mod. N16E, AC  | VKMA 36050<br>VKMW 5PK1199<br>VKM 36050  | 1<br>1  |   | 1   |   | 1   |   |   |   |



NISSAN













































|  |               |  |  |  |  |  |  |  |  |  |  |  |
|--|---------------|---|---|---|--|---|---|---|---|---|---|---|
| <b>NISSAN</b>  <b>ALMERA 2.0 D</b>          |               |   |   |   |  |   |   |   |   |   |   |   |
|    | CD20          | 11/95 → 04/96   | 3), Mod. N15  | VKMS 92513  | 2  | 1   | 2   |   |   |   | 3   |   |
|  |               |   |   | VKMA 92513  | 2  | 1   | 2   |   |   |   |   | T0672   |
|  |               |   |   | VKM 72303   | 1  |   |   |   |   |   |   |   |
|  |               |   |   | VKM 72310   | 1  |   |   |   |   |   |   |   |
|  |               |   |   | VKM 82302   |  | 1   |   |   |   |   |   |   |
|  | CD20          | 05/96 → 05/98   | Mod. N15  | VKMA 92516  | 2  | 1   | 2   |   |   |   |   | T0672   |
|  |               |   |   | VKM 72303   | 1  |   |   |   |   |   |   |   |
|  |               |   |   | VKM 72310   | 1  |   |   |   |   |   |   |   |
|  |               |   |   | VKM 82502   |  | 1   |   |   |   |   |   |   |
|    | B(Alt) CD20   | 11/95 → 07/00   | Mod. N15  | VKMOV 13AVx850  |  |   | 1   |   |   |   |   |   |
|  | B(PS) CD20    | 11/95 → 07/00   | Mod. N15  | VKMOV 13AVx800  |  |   | 1   |   |   |   |   |   |
|  | B(AC) CD20    | 11/95 → 07/00   | Mod. N15  | VKMOV 13AVx850  |  |   | 1   |   |   |   |   |   |
| <b>NISSAN</b>  <b>ALMERA 2.2 dCi</b>        |               |   |   |   |  |   |   |   |   |   |   |   |
|    | YD22DDT       | 09/03 → 08/04   | Mod. N16E   | OXOXOXO   |  |   |   |   |   |   |   |   |
| <b>NISSAN</b>  <b>ALMERA 2.2 Di</b>         |               |   |   |   |  |   |   |   |   |   |   |   |
|    | YD22DDT       | 03/00 → 08/04   | Mod. N16E   | OXOXOXO   |  |   |   |   |   |   |   |   |
| <b>NISSAN</b>  <b>ALMERA TINO 1.8</b>       |               |   |   |   |  |   |   |   |   |   |   |   |
|    | QG18DE        | 08/00 → 08/04   | Mod. N16E   | OXOXOXO   |  |   |   |   |   |   |   |   |
|    | B(Alt) QG18DE | 08/00 → 01/01   | Mod. N16E, AC   | VKMOV 6PK1110   |  |   | 1   |   |   |   |   |   |
|  | B(Alt) QG18DE | 01/01 → 08/04   | Mod. N16E, AC   | VKMOV 6PK1100   |  |   | 1   |   |   |   |   |   |
| <b>NISSAN</b>  <b>ALMERA TINO 2.0</b>       |               |   |   |   |  |   |   |   |   |   |   |   |
|    | SR20DE        | 08/00 → 08/04   | Mod. V10M   | OXOXOXO   |  |   |   |   |   |   |   |   |
|   | B(Alt) SR20DE | 08/00 → 08/04   | Mod. V10M, AC   | VKMOV 4PK825  |  |   | 1   |   |   |   |   |   |
|  | B(PS) SR20DE  | 08/00 → 08/04   | Mod. V10M   | VKMOV 4PK825  |  |   | 1   |   |   |   |   |   |
| <b>NISSAN</b>  <b>ALMERA TINO 2.2 dCi</b> |               |   |   |   |  |   |   |   |   |   |   |   |
|    | YD22DTI       | 09/03 → 08/04   | Mod. V10M   | OXOXOXO   |  |   |   |   |   |   |   |   |
| <b>NISSAN</b>  <b>ALMERA TINO 2.2 Di</b>  |               |   |   |   |  |   |   |   |   |   |   |   |
|    | YD22DDTi      | 08/00 → 08/04   |   | OXOXOXO   |  |   |   |   |   |   |   |   |
| <b>NISSAN</b>  <b>AVENIR 2.0 D</b>        |               |   |   |   |  |   |   |   |   |   |   |   |
|    | CD20          | 07/90 → 07/94   | 3), Mod. W10  | VKMS 92513  | 2  | 1   | 2   |   |   |   | 3   |   |
|  |               |   |   | VKMA 92513  | 2  | 1   | 2   |   |   |   |   | T0672   |
|  |               |   |   | VKM 72303   | 1  |   |   |   |   |   |   |   |
|  |               |   |   | VKM 72310   | 1  |   |   |   |   |   |   |   |
|  |               |   |   | VKM 82302   |  | 1   |   |   |   |   |   |   |
| <b>NISSAN</b>  <b>BLUEBIRD 1.6</b>        |               |   |   |   |  |   |   |   |   |   |   |   |
|    | L16S.V        | 01/80 → 11/83   | Mod. 910  | OXOXOXO   |  |   |   |   |   |   |   |   |
|  | CA16S         | 03/86 → 06/91   | Mod. T12, T72   | VKMA 92200  | 1  |   | 1   |   |   |   |   | T0697   |
|  |               |   |   | VKM 72200   | 1  |   |   |   |   |   |   |   |
|    | CA16S         | 03/86 → 06/86   | Mod. T12, T72   | VKPC 92401  |  |   |   | 1   |   |   |   |   |
|  | CA16S         | 07/86 → 04/89   | Mod. T12, T72   | VKPC 92404  |  |   |   | 1   |   |   |   |   |
| <b>NISSAN</b>  <b>BLUEBIRD 1.8</b>        |               |   |   |   |  |   |   |   |   |   |   |   |
|    | Z18ET         | 01/80 → 12/83   | Mod. 910  | OXOXOXO   |  |   |   |   |   |   |   |   |
|  | CA18D         | 02/89 → 12/90   | 3), Mod. T12, T72   | VKMS 92101  | 1  | 1   | 1   |   |   |   | 3   |   |
|  |               |   |   | VKMA 92101  | 1  | 1   | 1   |   |   |   |   | T0680   |
|  |               |   |   | VKM 72100   | 1  |   |   |   |   |   |   |   |
|  |               |   |   | VKM 82101   |  | 1   |   |   |   |   |   |   |
|  | CA18S         | 11/83 → 06/88   | Mod. U11  | VKMA 92200  | 1  |   | 1   |   |   |   |   | T0697   |
|  |               |   |   | VKM 72200   | 1  |   |   |   |   |   |   |   |
|    | CA18          | 10/82 → 09/83   | Mod. 910  | VKPC 92601  |  |   |   | 1   |   |   |   |   |
|  | CA18D         | 11/88 → 12/90   | Mod. T12, T72   | VKPC 92404  |  |   |   | 1   |   |   |   |   |
|  | CA18S         | 01/84 → 07/86   | Mod. U11  | VKPC 92401  |  |   |   | 1   |   |   |   |   |
| <b>NISSAN</b>  <b>BLUEBIRD 1.8 Turbo</b>  |               |   |   |   |  |   |   |   |   |   |   |   |
|    | CA18T         | 04/84 → 05/90   | Mod. T12, T72   | VKMA 92200  | 1  |   | 1   |   |   |   |   | T0697   |
|  |               |   |   | VKM 72200   | 1  |   |   |   |   |   |   |   |
|    | CA18T         | 04/84 → 07/86   | Mod. T12, T72   | VKPC 92401  |  |   |   | 1   |   |   |   |   |
|  | CA18T         | 07/86 → 05/90   | Mod. T12, T72   | VKPC 92404  |  |   |   | 1   |   |   |   |   |
| <b>NISSAN</b>  <b>BLUEBIRD 2.0</b>        |               |   |   |   |  |   |   |   |   |   |   |   |
|    | Z20S          | 01/82 → 12/83   | Mod. 910  | OXOXOXO   |  |   |   |   |   |   |   |   |
|  | CA20E, CA20S  | 12/85 → 12/90   | 3), Mod. T12, T72   | VKMS 92210  | 1  |   | 1   |   |   |   | 2   |   |
|  |               |   |   | VKMA 92210  | 1  |   | 1   |   |   |   |   | T0697   |
|  |               |   |   | VKM 72200   | 1  |   |   |   |   |   |   |   |

|  |  |  |            |  |  |  |  |  |  |  |  |  |
|--|---|---|---|--|---|---|---|---|---|---|---|---|
|  | CA20E, CA20S  | 04/84 → 07/88   | Mod. T12, T72   | VKMA 92200<br>VKM 72200  | 1<br>1  |   | 1   |   |   |   |   | T0697   |
|                                   | CA20E, CA20S  | 12/85 → 07/86   | Mod. T12, T72   | VKPC 92401   |   |   |   |   | 1   |   |   |   |
|  | CA20E, CA20S  | 07/86 → 12/90   | Mod. T12, T72   | VKPC 92404   |   |   |   |   | 1   |   |   |   |
|  | Z20E  | 01/82 → 12/83   | Mod. 910  | VKPC 92630   |   |   |   |   | 1   |   |   |   |
| <b>NISSAN  BLUEBIRD 2.0 D</b>     |   |   |   |  |   |   |   |   |   |   |   |   |
|                                   | LD20  | 01/80 → 12/83   | Mod. 910  | ΟΛΟΚΛΟΝΟ   |   |   |   |   |   |   |   |   |
|  | LD20, LD20T   | 04/84 → 12/90   | Mod. T12, T72, U11  | VKMA 92320<br>VKM 72320<br>VKM 82320   | 1<br>1  | 1   | 1   |   |   |   |   | T0686   |
|                                   | LD20, LD20T   | 01/84 → 05/90   | Mod. 910, T12, T72, U11   | VKPC 92615   |   |   |   |   | 1   |   |   |   |
|  | LD20  | 01/80 → 12/83   | Mod. 910,  | VKPC 92610   |   |   |   |   | 1   |   |   |   |
| <b>NISSAN  BLUEBIRD 2.0 TD</b>    |   |   |   |  |   |   |   |   |   |   |   |   |
|                                   | LD20T   | 01/83 → 09/83   | Mod. 910  | ΟΛΟΚΛΟΝΟ   |   |   |   |   |   |   |   |   |
|                                   | LD20T   | 01/83 → 09/83   | Mod. 910,  | VKPC 92610   |   |   |   |   | 1   |   |   |   |
| <b>NISSAN  CEDRIC 2.0</b>         |   |   |   |  |   |   |   |   |   |   |   |   |
|                                   | CA20S   | 09/87 → 01/89   | 3), Mod. Y31  | VKMS 92210<br>VKMA 92210<br>VKM 72200  | 1<br>1<br>1   |   | 1   |   |   |   | 2   | T0697   |
|                                   | CA20S   | 10/83 → 12/87   | Mod. Y30  | VKPC 92601   |   |   |   |   | 1   |   |   |   |
| <b>NISSAN  CEDRIC 3.0</b>         |   |   |   |  |   |   |   |   |   |   |   |   |
|                                   | VG30E, VG30S  | 10/83 → 12/90   | Mod. Y30, Y31   | VKMA 92004<br>VKM 72004  | 1<br>1  |   | 1   |   |   |   |   | T0684   |
| <b>NISSAN  CEFIRO 2.4</b>         |   |   |   |  |   |   |   |   |   |   |   |   |
|                                   | RB24S   | 11/88 → 04/90   | Mod. A31  | —<br>VKM 72004   | 1<br>1  |   | 1   |   |   |   |   |   |
| <b>NISSAN  CEFIRO 2.0 D</b>     |   |   |   |  |   |   |   |   |   |   |   |   |
|                                 | RB20D, RB20DT   | 09/88 → 08/91   | Mod. A31  | —<br>—<br>—  | 1<br>1<br>—   | 1   | 1   | 1   |   |   |   |   |
|  |   |   |   |  |   |   | 1   |   |   |   |   |   |
| <b>NISSAN  CEFIRO 2.5 D</b>     |   |   |   |  |   |   |   |   |   |   |   |   |
|                                 | RB25DE  | 06/92 → 12/93   | Mod. A31  | —<br>—<br>—  | 1<br>1<br>—   | 1   | 1   | 1   |   |   |   |   |
|  |   |   |   |  |   |   | 1   |   |   |   |   |   |
| <b>NISSAN  CHERRY 1.0</b>       |   |   |   |  |   |   |   |   |   |   |   |   |
|                                 | E10   | 05/82 → 05/86   | Mod. N12  | VKMA 92000<br>VKM 72000  | 1<br>1  |   | 1   |   |   |   |   | T0353   |
|                                 | E10S  | 05/82 → 05/86   | Mod. N10, N12   | VKPC 92205   |   |   |   |   | 1   |   |   |   |
| <b>NISSAN  CHERRY 1.2</b>       |   |   |   |  |   |   |   |   |   |   |   |   |
|                                 | A12   | 08/73 → 07/81   | Mod. F10, F11, AC   | VKPC 92203   |   |   |   |   | 1   |   |   |   |
| <b>NISSAN  CHERRY 1.3</b>       |   |   |   |  |   |   |   |   |   |   |   |   |
|                                 | E13   | 05/82 → 08/86   | Mod. N10, N12   | VKMA 92000<br>VKM 72000  | 1<br>1  |   | 1   |   |   |   |   | T0353   |
|                                 | 310 (Alfaromeo)   | 01/83 → 10/86   | Mod. N12  | VKPC 82201   |   |   |   |   | 1   |   |   |   |
|  | E13S  | 08/81 → 10/86   | Mod. N10, N12   | VKPC 92205   |   |   |   |   | 1   |   |   |   |
| <b>NISSAN  CHERRY 1.4</b>       |   |   |   |  |   |   |   |   |   |   |   |   |
|                                 | A14   | 09/74 → 12/78   | Mod. F10, F11, AC   | VKPC 92203   |   |   |   |   | 1   |   |   |   |
|  | A14   | 08/80 → 07/81   | Mod. F10, F11, AC   | VKPC 92203   |   |   |   |   | 1   |   |   |   |
| <b>NISSAN  CHERRY 1.5</b>       |   |   |   |  |   |   |   |   |   |   |   |   |
|                                 | E15S  | 11/83 → 08/86   | 3), Mod. N10, N12   | VKMS 92001<br>VKMA 92001<br>VKM 72000  | 1<br>1<br>1   |   | 1   |   |   |   | 2   | T0354   |
|                                 | 310 (Alfaromeo)   | 11/83 → 10/86   | Mod. N12  | VKPC 82201   |   |   |   |   | 1   |   |   |   |
|  | E15S  | 08/81 → 07/86   | Mod. N10, N12   | VKPC 92205   |   |   |   |   | 1   |   |   |   |
| <b>NISSAN  CHERRY 1.5 Turbo</b> |   |   |   |  |   |   |   |   |   |   |   |   |
|                                 | E15ET   | 01/83 → 12/85   | 3), Mod. N12  | VKMS 92001<br>VKMA 92001<br>VKM 72000  | 1<br>1<br>1   |   | 1   |   |   |   | 2   | T0354   |
|                                 | E15ET, E15S   | 04/82 → 07/86   | Mod. N12  | VKPC 92205   |   |   |   |   | 1   |   |   |   |
| <b>NISSAN  CHERRY 1.6</b>       |   |   |   |  |   |   |   |   |   |   |   |   |
|                                 | E16S  | 06/85 → 06/86   | 3), Mod. N12  | VKMS 92001<br>VKMA 92001<br>VKM 72000  | 1<br>1<br>1   |   | 1   |   |   |   | 2   | T0354   |



NISSAN































|  |  |  |  |  |  |  |  |  |  |  |  |  |
|--|---|---|---|--|---|---|---|---|---|---|---|---|
|                                      | E16S  | 06/85 → 07/86   | Mod. N12  | VKPC 92205   |   |   |   |   |   | 1   |   |   |
| <b>NISSAN  CHERRY 1.7 D</b>         |   |   |   |  |   |   |   |   |   |   |   |   |
|                                      | CD17  | 10/82 → 07/86   |   | VKMA 92300<br>VKM 72300<br>VKM 82300   | 1<br>1  | 1   | 1   |   |   |   |   |   |
| <b>NISSAN  CHERRY VANETTE 2.0 D</b> |   |   |   |  |   |   |   |   |   |   |   |   |
|                                      | LD20  | 07/86 → 01/90   | Mod. C22  | VKMA 92012<br>VKM 72320<br>VKM 82320   | 1<br>1  | 1   | 1   |   |   |   |   | T0686   |
| <b>NISSAN  EXA 1.6</b>              |   |   |   |  |   |   |   |   |   |   |   |   |
|                                      | CA16DE  | 09/86 → 08/87   | 3), Mod. KN13   | VKMS 92101<br>VKMA 92101<br>VKM 72100<br>VKM 82101                                 | 1<br>1<br>1   | 1   | 1   |   |   |   | 3   | T0680   |
|  | E16SPI  | 09/86 → 07/88   | 3), Mod. KN13   | VKMS 92001<br>VKMA 92001<br>VKM 72000  | 1<br>1<br>1   |   | 1   |   |   |   | 2   | T0354   |
| <b>NISSAN  EXA 1.8</b>              |   |   |   |  |   |   |   |   |   |   |   |   |
|                                      | CA18DE  | 08/87 → 09/89   | 3), Mod. KN13   | VKMS 92101<br>VKMA 92101<br>VKM 72100<br>VKM 82101                                 | 1<br>1<br>1   | 1   | 1   |   |   |   | 3   | T0680   |
| <b>NISSAN  LAUREL 2.0</b>           |   |   |   |  |   |   |   |   |   |   |   |   |
|                                      | L20   | 01/81 → 01/84   | Mod. JC31   | <del>OXOXOXO</del>   |   |   |   |   |   |   |   |   |
|  | RB20E   | 10/84 → 12/88   | Mod. C32  | —<br>VKM 72004   | 1<br>1  |   | 1   |   |   |   |   |   |
|                                    | CA20S   | 11/84 → 01/86   | Mod. C32  | VKPC 92601   |   |   |   |   | 1   |   |   |   |
| <b>NISSAN  LAUREL 2.4</b>         |   |   |   |  |   |   |   |   |   |   |   |   |
|                                    | L24E, L24S  | 01/85 → 06/90   | Mod. C32  | VKPC 92802   |   |   |   |   | 1   |   |   |   |
| <b>NISSAN  LAUREL 2.8</b>         |   |   |   |  |   |   |   |   |   |   |   |   |
|                                    | L28   | 01/77 → 02/81   | Mod. C230   | VKPC 92802   |   |   |   |   | 1   |   |   |   |
| <b>NISSAN  LAUREL 2.8 D</b>       |   |   |   |  |   |   |   |   |   |   |   |   |
|                                    | LD28  | 01/81 → 12/87   | Mod. C32  | <del>OXOXOXO</del>   |   |   |   |   |   |   |   |   |
|  | LD28, RD28  | 01/85 → 12/89   | 3), Mod. C33  | VKMS 92500<br>VKMA 92500<br>VKM 72500<br>VKM 82500                                 | 1<br>1<br>1   | 1   | 1   |   |   |   | 2   | T0376   |
| <b>NISSAN  LAUREL ALTIMA 2.4</b>  |   |   |   |  |   |   |   |   |   |   |   |   |
|                                    | RB24S   | 11/88 → 04/90   | Mod. A31  | —<br>VKM 72004   | 1<br>1  |   | 1   |   |   |   |   |   |
| <b>NISSAN  LAUREL SPIRIT 1.5</b>  |   |   |   |  |   |   |   |   |   |   |   |   |
|                                    | E15E  | 08/86 → 09/88   | Mod. B12  | —<br>VKM 72000<br>VKM 82101  | 1<br>1  | 1   | 1   |   |   |   |   |   |
| <b>NISSAN  MARCH 1.0</b>          |   |   |   |  |   |   |   |   |   |   |   |   |
|                                    | MA09ERT, MA10S  | 12/82 → 12/88   | 3), Mod. K10  | VKMS 92400<br>VKMA 92400<br>VKM 72400  | 1<br>1<br>1   |   | 1   |   |   |   | 2   | T0372   |
|  | MA10S   | 12/88 → 11/92   | Mod. K10  | VKMA 92401<br>VKM 72400  | 1<br>1  |   | 1   |   |   |   |   | T0678   |
|                                    | CG10DE  | 08/92 → 07/03   | Mod. K11E   | VKPC 92208   |   |   |   |   | 1   |   |   |   |
|  | MA10S   | 12/82 → 12/88   | Mod. K10  | VKPC 92204   |   |   |   |   | 1   |   |   |   |
|  | MA10S   | 01/89 → 05/91   | Mod. K10  | VKPC 92209   |   |   |   |   | 1   |   |   |   |
| <b>NISSAN  MARCH 1.2</b>          |   |   |   |  |   |   |   |   |   |   |   |   |
|                                    | MA12S   | 01/89 → 11/92   | 3), Mod. K10  | VKMS 92411<br>VKMA 92411<br>VKM 72400  | 1<br>1<br>1   |   | 1   |   |   |   | 2   | T0678   |
|  | MA12S   | 07/86 → 12/88   | Mod. K10  | VKMA 92410<br>VKM 72400  | 1<br>1  |   | 1   |   |   |   |   | T0374   |
|                                    | MA12S   | 07/86 → 12/88   | Mod. K10  | VKPC 92204   |   |   |   |   | 1   |   |   |   |
|  | MA12S   | 12/88 → 07/92   | Mod. K10  | VKPC 92209   |   |   |   |   | 1   |   |   |   |
| <b>NISSAN  MARCH 1.3</b>          |   |   |   |  |   |   |   |   |   |   |   |   |
|                                    | CG13DE  | 08/92 → 11/02   | Mod. K11E   | VKPC 92208   |   |   |   |   | 1   |   |   |   |

|  |              |  |  |  |  |  |  |  |  |  |  |  |  |
|--|--------------|---|---|---|--|---|---|---|---|---|---|---|---|
| <b>NISSAN</b>  <b>MAXIMA 3.0</b>      |              |   |   |   |  |   |   |   |   |   |   |   |   |
|                                       | VG30E        | 07/84 → 08/88   | Mod. U11  | VKMA 92004<br>VKM 72004   | 1<br>1   | 1   |   |   |   |   |   |   | T0684   |
|  | VG30E        | 12/88 → 06/93   | Mod. J30  | VKMA 92501<br>VKM 72004   | 1<br>1   | 1   |   |   |   |   |   |   | T0684   |
|  | VG30E        | 07/93 → 06/94   | Mod. J30  | VKMA 92006<br>VKM 72004   | 1<br>1   | 1   |   |   |   |   |   |   | T0684   |
| <b>NISSAN</b>  <b>MAXIMA QX 2.0</b>   |              |   |   |   |  |   |   |   |   |   |   |   |   |
|                                       | VQ20DE       | 02/95 → 02/04   | Mod. A33  | ΟΧΘΙΟΧΘ   |  |   |   |   |   |   |   |   |   |
|                                       | VQ20DE       | 10/94 → 07/03   | Mod. A32  | VKPC 92822  |  |   |   | 1   |   |   |   |   |   |
| <b>NISSAN</b>  <b>MAXIMA QX 3.0</b>   |              |   |   |   |  |   |   |   |   |   |   |   |   |
|                                       | VQ30DE       | 01/95 → 08/04   | Mod. A32, A33   | ΟΧΘΙΟΧΘ   |  |   |   |   |   |   |   |   |   |
|                                       | VQ30DE       | 10/94 → 07/03   | Mod. A32  | VKPC 92822  |  |   |   | 1   |   |   |   |   |   |
| <b>NISSAN</b>  <b>MICRA 1.0</b>       |              |   |   |   |  |   |   |   |   |   |   |   |   |
|                                       | CG10DE       | 08/92 → 08/04   | Mod. K10, K11   | ΟΧΘΙΟΧΘ   |  |   |   |   |   |   |   |   |   |
|  | MA10S        | 12/82 → 12/88   | 3), Mod. K10  | VKMS 92400<br>VKMA 92400<br>VKM 72400   | 1<br>1<br>1  | 1   |   |   |   | 2   |   |   | T0372   |
|  | MA10S        | 12/88 → 05/91   | Mod. K10  | VKMA 92401<br>VKM 72400   | 1<br>1   | 1   |   |   |   |   |   |   | T0678   |
|                                       | CG10DE       | 08/92 → 07/03   | Mod. K11  | VKPC 92208  |  |   |   | 1   |   |   |   |   |   |
|  | MA10S        | 12/82 → 12/88   | Mod. K10  | VKPC 92204  |  |   |   | 1   |   |   |   |   |   |
|  | MA10S        | 01/89 → 05/91   | Mod. K10  | VKPC 92209  |  |   |   | 1   |   |   |   |   |   |
|                                       | B(Alt) MA10S | 12/82 → 05/91   | Mod. K10  | VKMV 10AVx975   |  |   |   | 1   |   |   |   |   |   |
|  | B(AC) MA10S  | 12/82 → 05/91   | Mod. K10  | VKMV 13AVx825   |  |   |   | 1   |   |   |   |   |   |
| <b>NISSAN</b>  <b>MICRA 1.2</b>      |              |   |   |   |  |   |   |   |   |   |   |   |   |
|                                     | CR12DE       | 01/03 → 08/04   |   | ΟΧΘΙΟΧΘ   |  |   |   |   |   |   |   |   |   |
|  | MA12S        | 01/89 → 07/92   | 3), Mod. K12  | VKMS 92411<br>VKMA 92411<br>VKM 72400   | 1<br>1<br>1  | 1   |   |   |   | 2   |   |   | T0678   |
|  | MA12S        | 07/86 → 12/88   | Mod. K12  | VKMA 92410<br>VKM 72400   | 1<br>1   | 1   |   |   |   |   |   |   | T0374   |
|                                     | MA12S        | 07/86 → 12/88   | Mod. K12  | VKPC 92204  |  |   |   | 1   |   |   |   |   |   |
|  | MA12S        | 01/89 → 07/92   | Mod. K12  | VKPC 92209  |  |   |   | 1   |   |   |   |   |   |
| <b>NISSAN</b>  <b>MICRA 1.3</b>     |              |   |   |   |  |   |   |   |   |   |   |   |   |
|                                     | CG13DE       | 08/92 → 09/00   | Mod. K11  | ΟΧΘΙΟΧΘ   |  |   |   |   |   |   |   |   |   |
|                                     | CG13DE       | 08/92 → 07/03   | Mod. K11  | VKPC 92208  |  |   |   | 1   |   |   |   |   |   |
| <b>NISSAN</b>  <b>MICRA 1.4</b>     |              |   |   |   |  |   |   |   |   |   |   |   |   |
|                                     | CGA3DE       | 09/00 → 08/04   | Mod. K11  | ΟΧΘΙΟΧΘ   |  |   |   |   |   |   |   |   |   |
|                                     | CGA3DE       | 01/01 → 02/03   | Mod. K11  | VKPC 92208  |  |   |   | 1   |   |   |   |   |   |
| <b>NISSAN</b>  <b>MICRA 1.5 D</b>   |              |   |   |   |  |   |   |   |   |   |   |   |   |
|                                     | TD15         | 02/98 → 02/03   | Mod. K11  | VKMA 03122<br>VKM 13120<br>VKM 23122  | 1<br>1<br>1  | 1   | 1   |   |   |   |   |   | T0120   |
|                                     | TD15         | 02/98 → 02/03   | Mod. K11  | VKPC 83428  |  |   |   | 1   |   |   |   |   |   |
|                                     | B(Alt) TD15  | 02/98 → 02/03   | Mod. K11, ⊕   | VKMA 33046<br>VKMV 5PK960<br>VKM 33039  | 1<br>1<br>1  |   | 1   |   |   |   |   |   |   |
| <b>NISSAN</b>  <b>MICRA 1.5 dCi</b> |              |   |   |   |  |   |   |   |   |   |   |   |   |
|                                     | K9K          | 01/03 → 08/03   | Mod. K12  | VKMA 06130<br>VKM 16102   | 1<br>1   |   | 1   |   |   |   |   | 1   | T0191   |
|  | K9K          | 08/03 → 08/04   | Mod. K12  | VKMA 06132<br>VKM 16102   | 1<br>1   |   | 1   |   |   |   |   | 1   | T0191   |
|                                     | K9K          | 01/03 → 08/04   | Mod. K12  | VKPC 86417  |  |   |   | 1   |   |   |   |   |   |
|                                     | B(Alt) K9K   | 01/03 → 08/03   | Mod. K12E, AC   | VKMA 36050<br>VKMV 5PK1199<br>VKM 36050   | 1<br>1<br>1  |   | 1   |   |   |   |   |   |   |
|  | B(Alt) K9K   | 08/03 → 05/05   | Mod. K12E, AC   | VKMA 36052<br>VKMV 5PK1135<br>VKM 36052<br>VKM 36053                              | 1<br>1<br>1<br>1   | 1   | 1   | 1   |   |   |   |   |   |









































NISSAN

| <b>NISSAN</b> |                | <b>MULTI 1.5</b>        |                           |                 |   |   |   |  |  |  |  |  |  |  |  |  |  |  |       |
|---------------|----------------|-------------------------|---------------------------|-----------------|---|---|---|--|--|--|--|--|--|--|--|--|--|--|-------|
|               | E15S           | 09/82 → 07/88           | 3), Mod. M10              | VKMS 92001      | 1 |   | 1 |  |  |  |  |  |  |  |  |  |  |  | T0354 |
|               |                |                         |                           | VKMA 92001      | 1 |   | 1 |  |  |  |  |  |  |  |  |  |  |  |       |
|               |                |                         |                           | VKM 72000       | 1 |   |   |  |  |  |  |  |  |  |  |  |  |  |       |
| <b>NISSAN</b> |                | <b>PATHFINDER 3.0</b>   |                           |                 |   |   |   |  |  |  |  |  |  |  |  |  |  |  |       |
|               | VG30E          | 11/93 → 05/94           | Mod. D21                  | VKMA 92006      | 1 |   | 1 |  |  |  |  |  |  |  |  |  |  |  | T0684 |
|               |                |                         |                           | VKM 72004       | 1 |   |   |  |  |  |  |  |  |  |  |  |  |  |       |
|               | VG30I          | 07/86 → 08/89           | Mod. D21                  | VKMA 92004      | 1 |   | 1 |  |  |  |  |  |  |  |  |  |  |  | T0684 |
|               |                |                         |                           | VKM 72004       | 1 |   |   |  |  |  |  |  |  |  |  |  |  |  |       |
| <b>NISSAN</b> |                | <b>PATHFINDER 3.3</b>   |                           |                 |   |   |   |  |  |  |  |  |  |  |  |  |  |  |       |
|               | VG33E          | 09/97 → 08/02           | Mod. R50                  | VKMA 92006      | 1 |   | 1 |  |  |  |  |  |  |  |  |  |  |  | T0684 |
|               |                |                         |                           | VKM 72004       | 1 |   |   |  |  |  |  |  |  |  |  |  |  |  |       |
| <b>NISSAN</b> |                | <b>PATHFINDER 3.5</b>   |                           |                 |   |   |   |  |  |  |  |  |  |  |  |  |  |  |       |
|               | VQ35           | 11/00 → 08/04           | Mod. R50                  | XXXXXXXXXX      |   |   |   |  |  |  |  |  |  |  |  |  |  |  |       |
| <b>NISSAN</b> |                | <b>PATROL 2.8</b>       |                           |                 |   |   |   |  |  |  |  |  |  |  |  |  |  |  |       |
|               | L28            | 11/79 → 08/88           | Mod. 160                  | VKPC 92802      |   |   |   |  |  |  |  |  |  |  |  |  |  |  |       |
| <b>NISSAN</b> |                | <b>PATROL 2.8 D</b>     |                           |                 |   |   |   |  |  |  |  |  |  |  |  |  |  |  |       |
|               | A428.II, A428E | 09/85 → 06/90           | Mod. 160, 260             | VKPC 92800      |   |   |   |  |  |  |  |  |  |  |  |  |  |  |       |
|               | L28            | 07/80 → 06/90           | Mod. 160                  | VKPC 92802      |   |   |   |  |  |  |  |  |  |  |  |  |  |  |       |
| <b>NISSAN</b> |                | <b>PATROL 3.0</b>       |                           |                 |   |   |   |  |  |  |  |  |  |  |  |  |  |  |       |
|               | RB30S          | 09/88 → 06/91           | Mod. 260, Y30             | —               | 1 |   | 1 |  |  |  |  |  |  |  |  |  |  |  |       |
|               |                |                         |                           | VKM 72004       | 1 |   |   |  |  |  |  |  |  |  |  |  |  |  |       |
| <b>NISSAN</b> |                | <b>PATROL 2.7 D</b>     |                           |                 |   |   |   |  |  |  |  |  |  |  |  |  |  |  |       |
|               | MD27           | 09/85 → 07/03           | Mod. 160, 260             | VKPC 92800      |   |   |   |  |  |  |  |  |  |  |  |  |  |  |       |
| <b>NISSAN</b> |                | <b>PATROL 2.8 D</b>     |                           |                 |   |   |   |  |  |  |  |  |  |  |  |  |  |  |       |
|               | RD28           | 06/89 → 06/91           | 3), Mod. A260, K260, W260 | VKMS 92500      | 1 | 1 | 1 |  |  |  |  |  |  |  |  |  |  |  | T0376 |
|               |                |                         |                           | VKMA 92500      | 1 | 1 | 1 |  |  |  |  |  |  |  |  |  |  |  |       |
|               |                |                         |                           | VKM 72500       | 1 |   |   |  |  |  |  |  |  |  |  |  |  |  |       |
|               |                |                         |                           | VKM 82500       |   |   | 1 |  |  |  |  |  |  |  |  |  |  |  |       |
|               | A428.II, A428E | 09/85 → 07/03           | Mod. 160, 260             | VKPC 92800      |   |   |   |  |  |  |  |  |  |  |  |  |  |  |       |
| <b>NISSAN</b> |                | <b>PATROL 2.8 TD</b>    |                           |                 |   |   |   |  |  |  |  |  |  |  |  |  |  |  |       |
|               | RD28T          | 06/89 → 06/91           | 3), Mod. Y60              | VKMS 92500      | 1 | 1 | 1 |  |  |  |  |  |  |  |  |  |  |  | T0376 |
|               |                |                         |                           | VKMA 92500      | 1 | 1 | 1 |  |  |  |  |  |  |  |  |  |  |  |       |
|               |                |                         |                           | VKM 72500       | 1 |   |   |  |  |  |  |  |  |  |  |  |  |  |       |
|               |                |                         |                           | VKM 82500       |   |   | 1 |  |  |  |  |  |  |  |  |  |  |  |       |
|               | A428N, A428T   | 06/89 → 03/93           | Mod. 160, 260             | VKPC 92800      |   |   |   |  |  |  |  |  |  |  |  |  |  |  |       |
|               | A428N, A428T   | 04/93 → 07/03           | Mod. 160, 260             | VKPC 92802      |   |   |   |  |  |  |  |  |  |  |  |  |  |  |       |
|               | R28T, RD28     | 09/88 → 09/97           | Mod. 260, Y60             | VKPC 92810      |   |   |   |  |  |  |  |  |  |  |  |  |  |  |       |
| <b>NISSAN</b> |                | <b>PATROL 3.2 TD</b>    |                           |                 |   |   |   |  |  |  |  |  |  |  |  |  |  |  |       |
|               | SD33, SD33T    | 11/79 → 07/03           | Mod. 160, 260             | VKPC 92820      |   |   |   |  |  |  |  |  |  |  |  |  |  |  |       |
| <b>NISSAN</b> |                | <b>PATROL GR 4.2</b>    |                           |                 |   |   |   |  |  |  |  |  |  |  |  |  |  |  |       |
|               | TB42E          | 11/88 → 06/97           | Mod. Y60                  | XXXXXXXXXX      |   |   |   |  |  |  |  |  |  |  |  |  |  |  |       |
|               | B(Alt) TB42E   | 11/88 → 06/97           | Mod. Y60                  | VKMOV 10AVx1140 |   |   |   |  |  |  |  |  |  |  |  |  |  |  |       |
|               | B(PS) TB42E    | 11/88 → 06/97           | Mod. Y60                  | VKMOV 13AVx1050 |   |   |   |  |  |  |  |  |  |  |  |  |  |  |       |
|               | B(AC) TB42E    | 11/88 → 06/97           | Mod. Y60                  | VKMOV 13AVx900  |   |   |   |  |  |  |  |  |  |  |  |  |  |  |       |
| <b>NISSAN</b> |                | <b>PATROL GR 4.5</b>    |                           |                 |   |   |   |  |  |  |  |  |  |  |  |  |  |  |       |
|               | TB45E          | 06/97 → 05/02           | Mod. Y61                  | XXXXXXXXXX      |   |   |   |  |  |  |  |  |  |  |  |  |  |  |       |
| <b>NISSAN</b> |                | <b>PATROL GR 2.8 TD</b> |                           |                 |   |   |   |  |  |  |  |  |  |  |  |  |  |  |       |
|               | RD28T          | 09/88 → 12/93           | 3), Mod. Y60A             | VKMS 92500      | 1 | 1 | 1 |  |  |  |  |  |  |  |  |  |  |  | T0376 |
|               |                |                         |                           | VKMA 92500      | 1 | 1 | 1 |  |  |  |  |  |  |  |  |  |  |  |       |
|               |                |                         |                           | VKM 72500       | 1 |   |   |  |  |  |  |  |  |  |  |  |  |  |       |
|               |                |                         |                           | VKM 82500       |   |   | 1 |  |  |  |  |  |  |  |  |  |  |  |       |
|               | RD28T          | 10/94 → 06/97           | 3), Mod. Y60              | VKMS 92518      | 1 | 1 | 1 |  |  |  |  |  |  |  |  |  |  |  | T0387 |
|               |                |                         |                           | VKMA 92518      | 1 | 1 | 1 |  |  |  |  |  |  |  |  |  |  |  |       |
|               |                |                         |                           | VKM 72500       | 1 |   |   |  |  |  |  |  |  |  |  |  |  |  |       |
|               |                |                         |                           | VKM 82500       |   |   | 1 |  |  |  |  |  |  |  |  |  |  |  |       |
|               | R28T           | 09/88 → 09/97           | Mod. Y60                  | VKPC 92810      |   |   |   |  |  |  |  |  |  |  |  |  |  |  |       |
|               | B(AC) RD28T    | 09/88 → 06/97           | Mod. Y60                  | VKMOV 13AVx900  |   |   |   |  |  |  |  |  |  |  |  |  |  |  |       |
| <b>NISSAN</b> |                | <b>PATROL GR 3.0</b>    |                           |                 |   |   |   |  |  |  |  |  |  |  |  |  |  |  |       |
|               | ZD30DDTi       | 05/00 → 08/04           | Mod. Y61                  | XXXXXXXXXX      |   |   |   |  |  |  |  |  |  |  |  |  |  |  |       |

|   |   |  |  |  |  |  |  |  |  |  |  |  |
|---|---|---|---|---|--|---|---|---|---|---|---|---|
| <b>NISSAN</b>   |    | <b>PATROL GR 4.2</b>  |   |   |  |   |   |   |   |   |   |   |
|    | TD42T   | 06/97 → 05/02   | Mod. Y61  |  |  |   |   |   |   |   |   |   |
| <b>NISSAN</b>   |    | <b>PRAIRIE 1.5</b>  |   |   |  |   |   |   |   |   |   |   |
|    | E15S  | 01/84 → 12/87   | 3), Mod. M10  | VKMS 92001  | 1  | 1   |   |   | 2   |   |   | T0354   |
|   |   |   |   | VKMA 92001  | 1  | 1   |   |   |   |   |   |   |
|   |   |   |   | VKM 72000   | 1  |   |   |   |   |   |   |   |
|    | E15S  | 09/82 → 07/03   | Mod. M10  | VKPC 92205  |  |   |   | 1   |   |   |   |   |
| <b>NISSAN</b>   |    | <b>PRAIRIE 1.6</b>  |   |   |  |   |   |   |   |   |   |   |
|    | GA16DS  | 06/90 → 07/03   | Mod. P10E   | VKPC 92408  |  |   |   | 1   |   |   |   |   |
| <b>NISSAN</b>   |    | <b>PRAIRIE 1.8</b>  |   |   |  |   |   |   |   |   |   |   |
|    | CA18S   | 07/83 → 10/87   | Mod. M10  | VKMA 92200  | 1  | 1   |   |   |   |   |   | T0697   |
|   |   |   |   | VKM 72200   | 1  |   |   |   |   |   |   |   |
|    | CA18S   | 07/83 → 12/85   | Mod. M10  | VKPC 92401  |  |   |   | 1   |   |   |   |   |
|   | CA18S   | 07/86 → 10/87   | Mod. M10  | VKPC 92404  |  |   |   | 1   |   |   |   |   |
| <b>NISSAN</b>   |    | <b>PRAIRIE 2.0</b>  |   |   |  |   |   |   |   |   |   |   |
|    | CA20S   | 06/86 → 08/88   | 3), Mod. M10  | VKMS 92210  | 1  | 1   |   |   | 2   |   |   | T0697   |
|   |   |   |   | VKMA 92210  | 1  | 1   |   |   |   |   |   |   |
|   |   |   |   | VKM 72200   | 1  |   |   |   |   |   |   |   |
|    | CA20E, CA20S  | 01/86 → 07/03   | Mod. M10  | VKPC 92404  |  |   |   | 1   |   |   |   |   |
|   | CA20S   | 07/83 → 06/86   | Mod. M10  | VKPC 92401  |  |   |   | 1   |   |   |   |   |
| <b>NISSAN</b>   |    | <b>PRAIRIE PRO 2.0</b>  |   |   |  |   |   |   |   |   |   |   |
|    | CA20E   | 10/88 → 04/92   | 3), Mod. M11  | VKMS 92210  | 1  | 1   |   |   | 2   |   |   | T0697   |
|   |   |   |   | VKMA 92210  | 1  | 1   |   |   |   |   |   |   |
|   |   |   |   | VKM 72200   | 1  |   |   |   |   |   |   |   |
|    | CA20E, CA20S  | 10/88 → 12/88   | Mod. M11  | VKPC 92404  |  |   |   | 1   |   |   |   |   |
|   | SR20D   | 06/90 → 07/03   | Mod. P10E   | VKPC 92412  |  |   |   | 1   |   |   |   |   |
| <b>NISSAN</b>   |  | <b>PRAIRIE PRO 2.4</b>  |   |   |  |   |   |   |   |   |   |   |
|  | KA24E   | 04/92 → 07/94   | Mod. M11  | <b>XXXXXXXX</b>   |  |   |   |   |   |   |   |   |
| <b>NISSAN</b>   |  | <b>PRIMERA 1.6</b>  |   |   |  |   |   |   |   |   |   |   |
|  | GA16DE, GA16DS, QG16DE  | 06/90 → 08/04   | Mod. P10, P11, P12, W10, WP11   | <b>XXXXXXXX</b>   |  |   |   |   |   |   |   |   |
|  | GA16D   | 06/90 → 07/03   | Mod. P10E, P11E, W10, WP11E   | VKPC 92408  |  |   |   | 1   |   |   |   |   |
|  | B(Alt) GA16DE   | 09/96 → 07/02   | Mod. P11, P11E, WP11  | VKMOV   |  | 1   |   |   |   |   |   |   |
|   | B(Alt) QG16DE   | 04/98 → 12/01   | AC  | VKMOV 6PK1100   |  | 1   |   |   |   |   |   |   |
|   | B(Alt) QG16DE   | 01/01 → 07/02   | Mod. P11, AC  | VKMOV 6PK1100   |  | 1   |   |   |   |   |   |   |
|   | B(Alt) QG16DE   | 01/02 → 08/04   | Mod. P12, AC  | VKMOV 6PK1100   |  | 1   |   |   |   |   |   |   |
|   | B(AC) GA16DE  | 09/96 → 07/02   | Mod. P11, P11E, WP11  | VKMOV 4PK825  |  | 1   |   |   |   |   |   |   |
| <b>NISSAN</b>   |  | <b>PRIMERA 1.8</b>  |   |   |  |   |   |   |   |   |   |   |
|  | QG18DE  | 08/99 → 08/04   | Mod. P11, P12   | <b>XXXXXXXX</b>   |  |   |   |   |   |   |   |   |
|  | B(Alt) QG18DE   | 01/01 → 07/02   | Mod. P11, AC  | VKMOV 6PK1100   |  | 1   |   |   |   |   |   |   |
|   | B(Alt) QG18DE   | 03/02 → 08/04   | Mod. P12, AC  | VKMOV 6PK1100   |  | 1   |   |   |   |   |   |   |
| <b>NISSAN</b>   |  | <b>PRIMERA 2.0</b>  |   |   |  |   |   |   |   |   |   |   |
|  | QR20DE, SR20DE, SR20De, SR20DI  | 06/90 → 08/04   | Mod. P10, P11, P12  | <b>XXXXXXXX</b>   |  |   |   |   |   |   |   |   |
|  | SR20D   | 06/90 → 07/03   | Mod. P10E, P11E, W10, WP11E   | VKPC 92412  |  |   |   | 1   |   |   |   |   |
|  | B(Alt) SR20DE, SR20De, SR20VE   | 06/96 → 07/02   | Mod. P11, AC  | VKMOV 4PK825  |  | 1   |   |   |   |   |   |   |
| <b>NISSAN</b>   |  | <b>PRIMERA 1.9 dCi</b>  |   |   |  |   |   |   |   |   |   |   |
|  | F9Q   | 04/03 → 08/04   | Mod. P12  | VKMA 06129  | 1  | 1   |   |   |   |   |   | T0208   |
|   |   |   |   | VKM 16129   | 1  |   |   |   |   |   |   |   |
|  | F9Q   | 04/03 → 08/04   | Mod. P12  | VKPC 86129  |  |   |   | 1   |   |   |   |   |
| <b>NISSAN</b>   |  | <b>PRIMERA 2.0 D</b>  |   |   |  |   |   |   |   |   |   |   |
|  | CD20  | 07/90 → 05/95   | 3), Mod. P10, W10   | VKMS 92513  | 2  | 1   | 2   |   |   | 3   |   | T0672   |
|   |   |   |   | VKMA 92513  | 2  | 1   | 2   |   |   |   |   |   |
|   |   |   |   | VKM 72303   | 1  |   |   |   |   |   |   |   |
|   |   |   |   | VKM 72310   | 1  |   |   |   |   |   |   |   |
|   |   |   |   | VKM 82302   | 1  |   |   |   |   |   |   |   |
|  | B(Alt) CD20   | 07/90 → 01/96   | Mod. P10, W10   | VKMOV 13AVx850  |  | 1   |   |   |   |   |   |   |



NISSAN

|   |  |  |  |  |  |  |  |  |  |  |  |  |
|---|---|---|---|--|---|---|---|---|---|---|---|---|
| B(PS)   | CD20  | 07/90 → 01/96   | Mod. P10, W10   | VKMV 13AVx800  |   | 1   |   |   |   |   |   |   |
| B(AC)   | CD20  | 07/90 → 01/96   | Mod. P10, W10   | VKMV 13AVx850  |   | 1   |   |   |   |   |   |   |
| <b>NISSAN  PRIMERA 2.0 TD</b>          |   |   |   |  |   |   |   |   |   |   |   |   |
|   | B(Alt)  | CD20T   | 09/96 → 07/02   | Mod. P11   | VKMV 13AVx850   |   | 1   |   |   |   |   |   |
|   | B(PS)   | CD20T   | 09/96 → 07/02   | Mod. P11   | VKMV 13AVx850   |   | 1   |   |   |   |   |   |
|   | B(AC)   | CD20T   | 09/96 → 07/02   | Mod. P11   | VKMV 13AVx850   |   | 1   |   |   |   |   |   |
| <b>NISSAN  PRIMERA 2.2 dCi, 2.2 Di</b> |   |   |   |  |   |   |   |   |   |   |   |   |
|   |   | YD22DDT   | 03/02 → 08/04   | Mod. P12   | <del>OXOXOXO</del>  |   |   |   |   |   |   |   |
| <b>NISSAN  PULSAR 1.0</b>              |   |   |   |  |   |   |   |   |   |   |   |   |
|   |   | E10S  | 04/82 → 08/90   | Mod. N12, N13  | VKMA 92000<br>VKM 72000   | 1<br>1  | 1   |   |   |   |   | T0353   |
|   |   | E10S  | 08/81 → 08/86   | Mod. N10, N12  | VKPC 92205  |   |   | 1   |   |   |   |   |
| <b>NISSAN  PULSAR 1.2</b>              |   |   |   |  |   |   |   |   |   |   |   |   |
|   |   | A12   | 03/73 → 12/78   | Mod. F10, F11, AC  | VKPC 92203  |   |   |   | 1   |   |   |   |
| <b>NISSAN  PULSAR 1.3</b>              |   |   |   |  |   |   |   |   |   |   |   |   |
|   |   | E13S  | 04/82 → 08/90   | Mod. N12, N13  | VKMA 92000<br>VKM 72000   | 1<br>1  | 1   |   |   |   |   | T0353   |
|   |   | 310 (Alfaromeo)   | 01/83 → 12/86   | Mod. N12   | VKPC 82201  |   |   |   | 1   |   |   |   |
|   |   | E13S  | 08/81 → 08/86   | Mod. N10, N12  | VKPC 92205  |   |   |   | 1   |   |   |   |
| <b>NISSAN  PULSAR 1.4</b>              |   |   |   |  |   |   |   |   |   |   |   |   |
|   |   | A14   | 09/74 → 12/78   | Mod. F10, F11, AC  | VKPC 92203  |   |   |   | 1   |   |   |   |
| <b>NISSAN  PULSAR 1.5</b>              |   |   |   |  |   |   |   |   |   |   |   |   |
|                                        |   | E15S, E15T  | 08/81 → 08/90   | 3), Mod. N10, N12, N13   | VKMS 92001<br>VKMA 92001<br>VKM 72000   | 1<br>1<br>1   | 1<br>1  |   |   | 2   |   | T0354   |
|                                       |   | 310 (Alfaromeo)   | 01/83 → 12/86   | Mod. N12   | VKPC 82201  |   |   |   | 1   |   |   |   |
|   |   | E15ES, E15ET  | 04/82 → 12/86   | Mod. N12, Turbo  | VKPC 92205  |   |   |   | 1   |   |   |   |
|   |   | E15S  | 08/81 → 08/86   | Mod. N10   | VKPC 92205  |   |   |   | 1   |   |   |   |
| <b>NISSAN  PULSAR 1.6</b>            |   |   |   |  |   |   |   |   |   |   |   |   |
|                                       |   | CA16D, CA16DE   | 09/86 → 10/88   | 3), Mod. KN13, N13   | VKMS 92101<br>VKMA 92101<br>VKM 72100<br>VKM 82101                                  | 1<br>1<br>1<br>1  | 1<br>1<br>1   |   |   | 3   |   | T0680   |
|   |   | E16I, E16S  | 06/85 → 08/90   | 3), Mod. N12, N13  | VKMS 92001<br>VKMA 92001<br>VKM 72000   | 1<br>1<br>1   | 1<br>1  |   |   | 2   |   | T0354   |
|   |   | E16SPI  | 09/86 → 07/88   | Mod. KN13  | VKMA 92001<br>VKM 72000   | 1<br>1  | 1   |   |   |   |   | T0354   |
|                                       |   | E16S  | 06/85 → 08/86   | Mod. N12   | VKPC 92205  |   |   |   | 1   |   |   |   |
| <b>NISSAN  PULSAR 1.8</b>            |   |   |   |  |   |   |   |   |   |   |   |   |
|                                       |   | CA18DE  | 08/87 → 08/90   | 3), Mod. KN13, N13   | VKMS 92101<br>VKMA 92101<br>VKM 72100<br>VKM 82101                                  | 1<br>1<br>1<br>1  | 1<br>1<br>1   |   |   | 3   |   | T0680   |
| <b>NISSAN  PULSAR 1.7 D</b>          |   |   |   |  |   |   |   |   |   |   |   |   |
|                                       |   | CD17  | 06/86 → 08/90   | 3), Mod. N13   | VKMS 92514<br>VKMA 92514<br>VKM 72300<br>VKM 72303<br>VKM 82302                     | 2<br>2<br>1<br>1<br>1   | 1<br>1<br>2   | 2   |   |   | 3   | T0671   |
|   |   | CD17  | 10/82 → 07/86   | Mod. N12   | VKMA 92300<br>VKM 72300<br>VKM 82300  | 1<br>1<br>1   | 1<br>1  | 1   |   |   |   |   |
| <b>NISSAN  PULSAR 2.0 D</b>          |   |   |   |  |   |   |   |   |   |   |   |   |
|                                       |   | CD20  | 10/90 → 04/96   | 3), Mod. N14, N15  | VKMS 92513<br>VKMA 92513<br>VKM 72303<br>VKM 72310<br>VKM 82302                     | 2<br>2<br>1<br>1<br>1   | 1<br>1<br>2   | 2   |   |   | 3   | T0672   |
|   |   | CD20  | 05/96 → 07/00   | Mod. N15   | VKMA 92516<br>VKM 72303<br>VKM 72310<br>VKM 82502                                   | 2<br>1<br>1<br>1  | 1<br>2  | 2   |   |   |   | T0672   |

























































| <b>NISSAN</b> | <b>QUEST 3.0</b>     |               |                           |   |                  |   |   |   |  |  |  |  |  |  |   |  |  |  |  |  |       |  |
|---------------|----------------------|---------------|---------------------------|---|------------------|---|---|---|--|--|--|--|--|--|---|--|--|--|--|--|-------|--|
|               | VG30E                | 04/92 → 04/93 | Mod. V40                  | VKMA 92501<br>VKM 72004   | 1<br>1           |   | 1 |   |  |  |  |  |  |  |   |  |  |  |  |  | T0684 |  |
| <b>NISSAN</b> | <b>SAFARI 2.8 TD</b> |               |                           |   |                  |   |   |   |  |  |  |  |  |  |   |  |  |  |  |  |       |  |
|               | RD28T                | 09/88 → 10/93 | 3), Mod. Y60              | VKMS 92500<br>VKMA 92500<br>VKM 72500<br>VKM 82500              | 1<br>1<br>1      | 1 | 1 | 1 |  |  |  |  |  |  | 2 |  |  |  |  |  | T0376 |  |
| <b>NISSAN</b> | <b>SAFARI 3.0</b>    |               |                           |   |                  |   |   |   |  |  |  |  |  |  |   |  |  |  |  |  |       |  |
|               | RB30S                | 09/88 → 04/90 | Mod. Y30                  | —<br>VKM 72004  | 1<br>1           |   | 1 |   |  |  |  |  |  |  |   |  |  |  |  |  |       |  |
|               | RB30S                | 04/89 → 06/91 | Mod. 260, 4WD             | —<br>VKM 72004  | 1<br>1           |   | 1 |   |  |  |  |  |  |  |   |  |  |  |  |  |       |  |
| <b>NISSAN</b> | <b>SAFARI 2.8 D</b>  |               |                           |   |                  |   |   |   |  |  |  |  |  |  |   |  |  |  |  |  |       |  |
|               | RD28                 | 06/89 → 06/91 | 3), Mod. A260, K260, W260 | VKMS 92500<br>VKMA 92500<br>VKM 72500<br>VKM 82500              | 1<br>1<br>1      | 1 | 1 | 1 |  |  |  |  |  |  | 2 |  |  |  |  |  | T0376 |  |
| <b>NISSAN</b> | <b>SAFARI 2.8 TD</b> |               |                           |   |                  |   |   |   |  |  |  |  |  |  |   |  |  |  |  |  |       |  |
|               | RD28T                | 06/89 → 06/91 | 3), Mod. A260, K260, W260 | VKMS 92500<br>VKMA 92500<br>VKM 72500<br>VKM 82500              | 1<br>1<br>1      | 1 | 1 | 1 |  |  |  |  |  |  | 2 |  |  |  |  |  | T0376 |  |
| <b>NISSAN</b> | <b>SENTRA 1.0</b>    |               |                           |   |                  |   |   |   |  |  |  |  |  |  |   |  |  |  |  |  |       |  |
|               | E10S                 | 02/84 → 04/92 | Mod. B11, B13             | VKMA 92000<br>VKM 72000   | 1<br>1           |   | 1 |   |  |  |  |  |  |  |   |  |  |  |  |  | T0353 |  |
| <b>NISSAN</b> | <b>SENTRA 1.3</b>    |               |                           |   |                  |   |   |   |  |  |  |  |  |  |   |  |  |  |  |  |       |  |
|               | E13S                 | 03/82 → 08/90 | Mod. B11, B13             | VKMA 92000<br>VKM 72000   | 1<br>1           |   | 1 |   |  |  |  |  |  |  |   |  |  |  |  |  | T0353 |  |
| <b>NISSAN</b> | <b>SENTRA 1.5</b>    |               |                           |   |                  |   |   |   |  |  |  |  |  |  |   |  |  |  |  |  |       |  |
|               | E15S                 | 03/82 → 10/88 | 3), Mod. B11, B12         | VKMS 92001<br>VKMA 92001<br>VKM 72000                           | 1<br>1<br>1      |   | 1 | 1 |  |  |  |  |  |  | 2 |  |  |  |  |  | T0354 |  |
| <b>NISSAN</b> | <b>SENTRA 1.6</b>    |               |                           |   |                  |   |   |   |  |  |  |  |  |  |   |  |  |  |  |  |       |  |
|               | E16I, E16S           | 03/82 → 07/88 | 3), Mod. B11, B12         | VKMS 92001<br>VKMA 92001<br>VKM 72000                           | 1<br>1<br>1      |   | 1 | 1 |  |  |  |  |  |  | 2 |  |  |  |  |  | T0354 |  |
| <b>NISSAN</b> | <b>SENTRA 1.7 D</b>  |               |                           |   |                  |   |   |   |  |  |  |  |  |  |   |  |  |  |  |  |       |  |
|               | CD17                 | 08/86 → 05/90 | 3), Mod. B12              | VKMS 92514<br>VKMA 92514<br>VKM 72300<br>VKM 72303<br>VKM 82302 | 2<br>2<br>1<br>1 | 1 | 1 | 2 |  |  |  |  |  |  | 3 |  |  |  |  |  | T0671 |  |
|               | CD17                 | 08/82 → 07/86 | Mod. B11, B12             | VKMA 92300<br>VKM 72300<br>VKM 82300                            | 1<br>1           | 1 | 1 | 1 |  |  |  |  |  |  |   |  |  |  |  |  |       |  |
| <b>NISSAN</b> | <b>SENTRA 2.0 D</b>  |               |                           |   |                  |   |   |   |  |  |  |  |  |  |   |  |  |  |  |  |       |  |
|               | CD20                 | 11/95 → 09/96 | Mod. B14                  | —<br>VKM 72310<br>VKM 82502                                     | 1<br>1           | 1 | 1 | 1 |  |  |  |  |  |  |   |  |  |  |  |  |       |  |
| <b>NISSAN</b> | <b>SERENA 1.6</b>    |               |                           |   |                  |   |   |   |  |  |  |  |  |  |   |  |  |  |  |  |       |  |
|               | GA16DE               | 02/93 → 08/04 |                           | OXOXOXO   |                  |   |   |   |  |  |  |  |  |  |   |  |  |  |  |  |       |  |
|               | GA16DE               | 02/93 → 11/01 | Mod. C23M                 | VKPC 92408  |                  |   |   |   |  |  |  |  |  |  | 1 |  |  |  |  |  |       |  |
| <b>NISSAN</b> | <b>SERENA 2.0</b>    |               |                           |   |                  |   |   |   |  |  |  |  |  |  |   |  |  |  |  |  |       |  |
|               | SR20DE               | 11/92 → 08/04 |                           | OXOXOXO   |                  |   |   |   |  |  |  |  |  |  |   |  |  |  |  |  |       |  |
|               | SR20DE               | 11/92 → 11/93 |                           | VKPC 92412  |                  |   |   |   |  |  |  |  |  |  | 1 |  |  |  |  |  |       |  |
| <b>NISSAN</b> | <b>SERENA 2.0 D</b>  |               |                           |   |                  |   |   |   |  |  |  |  |  |  |   |  |  |  |  |  |       |  |
|               | LD20                 | 11/92 → 12/92 | 3)                        | VKMS 92012<br>VKMA 92012<br>VKM 72320<br>VKM 82320              | 1<br>1<br>1      | 1 | 1 | 1 |  |  |  |  |  |  | 2 |  |  |  |  |  | T0686 |  |



















































|               | LD20             | 11/92 → 12/94 |                                 |  | VKPC 92600   |                  |                  |  |  |  | 1 |  |       |
|---------------|------------------|---------------|---------------------------------|--|--|------------------|------------------|--|--|--|---|--|-------|
| <b>NISSAN</b> | SERENA 2.3 D     |               |                                 |  |  |                  |                  |  |  |  |   |  |       |
|               | LD23             | 01/95 → 11/01 | Mod. C23M                       |  | VKPC 92926   |                  |                  |  |  |  | 1 |  |       |
| <b>NISSAN</b> | SILVIA 1.8       |               |                                 |  |  |                  |                  |  |  |  |   |  |       |
|               | CA18ET           | 10/83 → 05/88 | Mod. S12                        |  | VKPC 92601   |                  |                  |  |  |  | 1 |  |       |
| <b>NISSAN</b> | SILVIA 1.8 Turbo |               |                                 |  |  |                  |                  |  |  |  |   |  |       |
|               | Z18ET            | 01/79 → 05/83 |                                 |  | OXOXOXO  |                  |                  |  |  |  |   |  |       |
|               | CA18ET           | 10/83 → 05/88 | Mod. S12                        |  | VKPC 92601   |                  |                  |  |  |  | 1 |  |       |
| <b>NISSAN</b> | SILVIA 2.0       |               |                                 |  |  |                  |                  |  |  |  |   |  |       |
|               | FJ20E            | 04/84 → 09/88 |                                 |  | OXOXOXO  |                  |                  |  |  |  |   |  |       |
|               | CA20E            | 04/84 → 09/88 |                                 |  | VKPC 92601   |                  |                  |  |  |  | 1 |  |       |
| <b>NISSAN</b> | SKYLINE 2.0      |               |                                 |  |  |                  |                  |  |  |  |   |  |       |
|               | RB20E            | 08/85 → 04/89 | Mod. HR31, KHR31, WHJR31, YHR31 |  | —<br>VKM 72004                                     | 1<br>1           | 1                |  |  |  |   |  |       |
| <b>NISSAN</b> | SKYLINE 3.0      |               |                                 |  |  |                  |                  |  |  |  |   |  |       |
|               | RB30E            | 01/87 → 12/92 |                                 |  | —<br>VKM 72004                                     | 1<br>1           | 1                |  |  |  |   |  |       |
| <b>NISSAN</b> | SKYLINE 2.0 D    |               |                                 |  |  |                  |                  |  |  |  |   |  |       |
|               | RB20DE, RB20DET  | 05/89 → 08/91 | Mod. R32                        |  | —<br>—<br>—  | 1<br>1<br>—      | 1<br>1<br>1      |  |  |  |   |  |       |
| <b>NISSAN</b> | SKYLINE 2.5 D    |               |                                 |  |  |                  |                  |  |  |  |   |  |       |
|               | RB25DE           | 08/91 → 12/92 | Mod. R32                        |  | —<br>—<br>—  | 1<br>1<br>—      | 1<br>1<br>1      |  |  |  |   |  |       |
| <b>NISSAN</b> | STANZA 1.5       |               |                                 |  |  |                  |                  |  |  |  |   |  |       |
|               | E15S             | 09/82 → 07/88 | 3), Mod. M10                    |  | VKMS 92001<br>VKMA 92001<br>VKM 72000              | 1<br>1<br>1      | 1<br>1<br>—      |  |  |  | 2 |  | T0354 |
| <b>NISSAN</b> | STANZA 1.6       |               |                                 |  |  |                  |                  |  |  |  |   |  |       |
|               | CA16S            | 12/85 → 02/92 | Mod. T12                        |  | VKMA 92200<br>VKM 72200                            | 1<br>1           | 1                |  |  |  |   |  | T0697 |
|               | CA16S            | 08/81 → 12/85 | Mod. FPT11, FT11, PT11, T11     |  | VKPC 92401   |                  |                  |  |  |  | 1 |  |       |
|               | CA16S            | 07/86 → 02/90 | Mod. T12                        |  | VKPC 92404   |                  |                  |  |  |  | 1 |  |       |
| <b>NISSAN</b> | STANZA 1.8       |               |                                 |  |  |                  |                  |  |  |  |   |  |       |
|               | CA18DE           | 11/88 → 02/92 | 3), Mod. T12                    |  | VKMS 92101<br>VKMA 92101<br>VKM 72100<br>VKM 82101 | 1<br>1<br>1<br>— | 1<br>1<br>1<br>1 |  |  |  | 3 |  | T0680 |
|               | CA18, CA18S      | 08/81 → 12/85 | Mod. PT11, PT12                 |  | VKPC 92401   |                  |                  |  |  |  | 1 |  |       |
|               | CA18D            | 11/88 → 02/90 | Mod. T12                        |  | VKPC 92615   |                  |                  |  |  |  | 1 |  |       |
|               | CA18S            | 07/86 → 02/90 | Mod. T12                        |  | VKPC 92404   |                  |                  |  |  |  | 1 |  |       |
| <b>NISSAN</b> | STANZA 1.8 Turbo |               |                                 |  |  |                  |                  |  |  |  |   |  |       |
|               | CA18T            | 12/85 → 02/92 | Mod. T12                        |  | VKMA 92200<br>VKM 72200                            | 1<br>1           | 1                |  |  |  |   |  | T0697 |
| <b>NISSAN</b> | STANZA 2.0       |               |                                 |  |  |                  |                  |  |  |  |   |  |       |
|               | CA20E, CA20S     | 12/85 → 02/92 | 3), Mod. T12                    |  | VKMS 92210<br>VKMA 92210<br>VKM 72200              | 1<br>1<br>1      | 1<br>1           |  |  |  | 2 |  | T0697 |
|               | CA20E, CA20S     | 12/85 → 07/86 | Mod. T12                        |  | VKPC 92401   |                  |                  |  |  |  | 1 |  |       |
|               | CA20E, CA20S     | 07/86 → 02/90 | Mod. T12                        |  | VKPC 92404   |                  |                  |  |  |  | 1 |  |       |
| <b>NISSAN</b> | STANZA 1.7 D     |               |                                 |  |  |                  |                  |  |  |  |   |  |       |
|               | CD17             | 01/84 → 11/85 | Mod. T11                        |  | VKMA 92300<br>VKM 72300<br>VKM 82300               | 1<br>1<br>—      | 1<br>1           |  |  |  |   |  |       |
|               | CD17T            | 01/84 → 12/85 | Mod. T11, Turbo                 |  | VKPC 92422   |                  |                  |  |  |  | 1 |  |       |
| <b>NISSAN</b> | STANZA 2.0 D     |               |                                 |  |  |                  |                  |  |  |  |   |  |       |
|               | LD20             | 12/85 → 02/92 | Mod. T12                        |  | VKMA 92320<br>VKM 72320<br>VKM 82320               | 1<br>1<br>—      | 1<br>1           |  |  |  |   |  | T0686 |
|               | LD20             | 12/85 → 02/90 | Mod. T12                        |  | VKPC 92615   |                  |                  |  |  |  | 1 |  |       |

| <b>NISSAN</b> <b>SUNNY 1.0</b>   |                          |               |                         |   |                       |             |   |   |  |   |  |  |       |
|----------------------------------|--------------------------|---------------|-------------------------|---|-----------------------|-------------|---|---|--|---|--|--|-------|
|                                  | E10S                     | 02/84 → 04/92 | Mod. B11, B13, N13      | VKMA 92000<br>VKM 72000   | 1<br>1                | 1           |   |   |  |   |  |  | T0353 |
|                                  | E10S                     | 06/86 → 10/90 | Mod. N13                | VKPC 92205  |                       |             |   | 1 |  |   |  |  |       |
| <b>NISSAN</b> <b>SUNNY 1.2</b>   |                          |               |                         |   |                       |             |   |   |  |   |  |  |       |
|                                  | A14                      | 10/75 → 12/78 | Mod. B210, AC           | VKPC 92203  |                       |             |   | 1 |  |   |  |  |       |
| <b>NISSAN</b> <b>SUNNY 1.3</b>   |                          |               |                         |   |                       |             |   |   |  |   |  |  |       |
|                                  | E13, E13S                | 03/82 → 08/90 | Mod. B11, B13, N13      | VKMA 92000<br>VKM 72000   | 1<br>1                | 1           |   |   |  |   |  |  | T0353 |
|                                  | E13, E13S                | 03/82 → 10/91 | Mod. B11, B13, N13      | VKPC 92205  |                       |             |   | 1 |  |   |  |  |       |
| <b>NISSAN</b> <b>SUNNY 1.4</b>   |                          |               |                         |   |                       |             |   |   |  |   |  |  |       |
|                                  | A14                      | 10/75 → 12/78 | Mod. B210, B310, AC     | VKPC 92203  |                       |             |   | 1 |  |   |  |  |       |
|                                  | GA14DE, GA14DS           | 10/90 → 07/95 | Mod. N14                | VKPC 92408  |                       |             |   | 1 |  |   |  |  |       |
|                                  | GA14S                    | 10/88 → 10/90 | Mod. N13                | VKPC 92406  |                       |             |   | 1 |  |   |  |  |       |
|                                  | B(PS) GA14DE, GA14DS     | 10/90 → 06/95 | Mod. N14                | VKMV 4PK810   |                       | 1           |   |   |  |   |  |  |       |
| <b>NISSAN</b> <b>SUNNY 1.5</b>   |                          |               |                         |   |                       |             |   |   |  |   |  |  |       |
|                                  | GA15#, GA15DS            | 06/86 → 05/95 | Mod. B12, N14           | <b>ОХРОНО</b>   |                       |             |   |   |  |   |  |  |       |
|                                  | E15S                     | 03/82 → 10/88 | 3), Mod. B11, B12, N13  | VKMS 92001<br>VKMA 92001<br>VKM 72000                           | 1<br>1<br>1           | 1           |   |   |  | 2 |  |  | T0354 |
|                                  | E15S                     | 03/82 → 10/88 | Mod. B11, B12, N13      | VKPC 92205  |                       |             |   | 1 |  |   |  |  |       |
| <b>NISSAN</b> <b>SUNNY 1.6</b>   |                          |               |                         |   |                       |             |   |   |  |   |  |  |       |
|                                  | GA16DE, GA16DS,<br>GA16S | 10/88 → 03/00 | Mod. B12, N14, Y10      | <b>ОХРОНО</b>   |                       |             |   |   |  |   |  |  |       |
|                                  | CA16D                    | 02/87 → 10/88 | 3), Mod. B12, N13, DOHC | VKMS 92101<br>VKMA 92101<br>VKM 72100<br>VKM 82101              | 1<br>1<br>1<br>1      | 1<br>1<br>1 |   |   |  | 3 |  |  | T0680 |
|                                  | E16i, E16S, GA16i        | 03/82 → 08/90 | 3), Mod. B11, B12, N13  | VKMS 92001<br>VKMA 92001<br>VKM 72000                           | 1<br>1<br>1           | 1           |   |   |  | 2 |  |  | T0354 |
|                                  | CA16D                    | 02/87 → 10/88 | Mod. B11, B12, N13      | VKPC 92404  |                       |             |   | 1 |  |   |  |  |       |
|                                  | E16i, E16S               | 06/86 → 10/88 | Mod. B11, B12, N13      | VKPC 92205  |                       |             |   | 1 |  |   |  |  |       |
|                                  | GA16DE, GA16DS           | 10/90 → 07/95 | Mod. B13, N14, Y10      | VKPC 92408  |                       |             |   | 1 |  |   |  |  |       |
|                                  | GA16i, GA16S             | 10/88 → 08/90 | Mod. B12, N13           | VKPC 92406  |                       |             |   | 1 |  |   |  |  |       |
|                                  | B(PS) GA16DE, GA16DS     | 10/90 → 06/95 | Mod. N14                | VKMV 4PK810   |                       | 1           |   |   |  |   |  |  |       |
| <b>NISSAN</b> <b>SUNNY 1.8</b>   |                          |               |                         |   |                       |             |   |   |  |   |  |  |       |
|                                  | CA18D                    | 01/89 → 08/90 | 3), Mod. B12, N13, DOHC | VKMS 92101<br>VKMA 92101<br>VKM 72100<br>VKM 82101              | 1<br>1<br>1<br>1      | 1<br>1<br>1 |   |   |  | 3 |  |  | T0680 |
|                                  | CA18D                    | 01/89 → 08/90 | Mod. B12, N13           | VKPC 92404  |                       |             |   | 1 |  |   |  |  |       |
| <b>NISSAN</b> <b>SUNNY 2.0</b>   |                          |               |                         |   |                       |             |   |   |  |   |  |  |       |
|                                  | SR20DET                  | 10/90 → 05/95 |                         | <b>ОХРОНО</b>   |                       |             |   |   |  |   |  |  |       |
|                                  | SR20DE                   | 10/90 → 07/95 | Mod. B13, N14           | VKPC 92412  |                       |             |   | 1 |  |   |  |  |       |
|                                  | B(Alt) SR20DE            | 10/90 → 05/95 | Mod. N14, <b>AE</b>     | VKMV_____   |                       | 1           |   |   |  |   |  |  |       |
| <b>NISSAN</b> <b>SUNNY 1.7 D</b> |                          |               |                         |   |                       |             |   |   |  |   |  |  |       |
|                                  | CD17                     | 06/86 → 08/90 | 3), Mod. B12, N13       | VKMS 92514<br>VKMA 92514<br>VKM 72300<br>VKM 72303<br>VKM 82302 | 2<br>2<br>1<br>1<br>1 | 1<br>1<br>1 | 2 |   |  | 3 |  |  | T0671 |
|                                  | CD17                     | 03/82 → 05/86 | Mod. B11, B12           | VKMA 92300<br>VKM 72300<br>VKM 82300                            | 1<br>1<br>1           | 1           | 1 |   |  |   |  |  |       |
|                                  | CD17                     | 06/86 → 10/90 | Mod. B12, N13, Y10      | VKPC 92422  |                       |             |   | 1 |  |   |  |  |       |
| <b>NISSAN</b> <b>SUNNY 2.0 D</b> |                          |               |                         |   |                       |             |   |   |  |   |  |  |       |
|                                  | CD20                     | 10/90 → 11/95 | 3), Mod. B14, N14, Y10  | VKMS 92513<br>VKMA 92513<br>VKM 72303<br>VKM 72310<br>VKM 82302 | 2<br>2<br>1<br>1<br>1 | 1<br>1<br>1 | 2 |   |  | 3 |  |  | T0672 |
|                                  | CD20                     | 12/95 → 07/97 | Mod. B14                | VKMA 92516<br>VKM 72303   | 2<br>1                | 1           | 2 |   |  |   |  |  | T0672 |











































































































|  |  |  |  |  |  |  |  |  |  |  |  |  |  |  |
|--|---|---|---|--|---|---|---|---|---|---|---|---|---|---|
|  |   |   |   | VKM 72310<br>VKM 82502   | 1   |   | 1   |   |   |   |   |   |   |   |
|                                    | CD20  | 02/96 → 09/00   | Mod. SENTRA, Mod. B14   | VKPC 92928   |   |   |   | 1   |   |   |   |   |   |   |
|                                    | B(Alt) CD20   | 10/90 → 05/95   | Mod. N14  | VKMOV 13AVx850   |   |   | 1   |   |   |   |   |   |   |   |
|                                    | B(PS) CD20  | 10/90 → 05/95   | Mod. N14  | VKMOV 13AVx800   |   |   | 1   |   |   |   |   |   |   |   |
| <b>NISSAN  TERRANO 2.4</b>        |   |   |   |  |   |   |   |   |   |   |   |   |   |   |
|                                    | KA24E, ZD30   | 02/93 → 08/04   | Mod. R20  | XXXXXXXX   |   |   |   |   |   |   |   |   |   |   |
|                                    | KA24E   | 02/93 → 07/03   | Mod. R20  | VKPC 92645   |   |   |   | 1   |   |   |   |   |   |   |
|                                    | Z24i  | 10/87 → 07/92   | Mod. WD21   | VKPC 92630   |   |   |   | 1   |   |   |   |   |   |   |
| <b>NISSAN  TERRANO 3.0</b>        |   |   |   |  |   |   |   |   |   |   |   |   |   |   |
|                                    | VG30E   | 01/90 → 07/93   | Mod. WD21   | VKMA 92004<br>VKM 72004  | 1<br>1  | 1   |   |   |   |   |   |   |   | T0684   |
|  | VG30E   | 08/93 → 05/94   | Mod. WD21   | VKMA 92006<br>VKM 72004  | 1<br>1  | 1   |   |   |   |   |   |   |   | T0684   |
|  | VG30I   | 07/86 → 08/94   | Mod. D21  | VKMA 92004<br>VKM 72004  | 1<br>1  | 1   |   |   |   |   |   |   |   | T0684   |
|                                    | VG30E   | 01/90 → 07/03   | Mod. WD21   | VKPC 92823   |   |   |   | 1   |   |   |   |   |   |   |
| <b>NISSAN  TERRANO 3.3</b>        |   |   |   |  |   |   |   |   |   |   |   |   |   |   |
|                                    | VG33E   | 09/95 → 10/01   | Mod. JR50, R50  | VKPC 92000   |   |   |   | 1   |   |   |   |   |   |   |
| <b>NISSAN  TERRANO 2.7 TD</b>     |   |   |   |  |   |   |   |   |   |   |   |   |   |   |
|                                    | TD27T, ZD30   | 02/89 → 01/02   | Mod. R20  | XXXXXXXX   |   |   |   |   |   |   |   |   |   |   |
|                                    | TD27T   | 10/99 → 01/02   | Mod. R20  | VKPC 92929   |   |   |   | 1   |   |   |   |   |   |   |
| <b>NISSAN  TERRANO 2.7 Tdi</b>    |   |   |   |  |   |   |   |   |   |   |   |   |   |   |
|                                    | ZD30  | 05/96 → 08/04   | Mod. R20  | XXXXXXXX   |   |   |   |   |   |   |   |   |   |   |
|                                   | TD27T   | 10/99 → 02/04   | Mod. R20  | VKPC 92929   |   |   |   | 1   |   |   |   |   |   |   |
| <b>NISSAN  TERRANO 3.0 Di</b>   |   |   |   |  |   |   |   |   |   |   |   |   |   |   |
|                                  | ZD30  | 05/02 → 08/04   |   | XXXXXXXX   |   |   |   |   |   |   |   |   |   |   |
| <b>NISSAN  VIOLET 1.4</b>       |   |   |   |  |   |   |   |   |   |   |   |   |   |   |
|                                  | A14   | 05/77 → 05/81   | Mod. A10, A11, AC   | VKPC 92203   |   |   |   | 1   |   |   |   |   |   |   |
| <b>NISSAN  VIOLET 1.6</b>       |   |   |   |  |   |   |   |   |   |   |   |   |   |   |
|                                  | Z16   | 05/77 → 05/81   | Mod. A10, A11, AC   | VKPC 92630   |   |   |   | 1   |   |   |   |   |   |   |
| <b>NISSAN  VIOLET 1.8 D</b>     |   |   |   |  |   |   |   |   |   |   |   |   |   |   |
|                                  | CADET   | 10/85 → 10/86   | Mod. RT12, Turbo  | VKPC 92601   |   |   |   | 1   |   |   |   |   |   |   |
| <b>NISSAN  X-TRAIL 2.0</b>      |   |   |   |  |   |   |   |   |   |   |   |   |   |   |
|                                  | QR20DE  | 07/01 → 05/02   | Mod. T30  | XXXXXXXX   |   |   |   |   |   |   |   |   |   |   |
| <b>NISSAN  X-TRAIL 2.5</b>      |   |   |   |  |   |   |   |   |   |   |   |   |   |   |
|                                  | QR25DE  | 01/03 → 08/04   | Mod. T30  | XXXXXXXX   |   |   |   |   |   |   |   |   |   |   |
| <b>NISSAN  X-TRAIL 2.2 dCi</b>  |   |   |   |  |   |   |   |   |   |   |   |   |   |   |
|                                  | YD22ETI   | 12/03 → 08/04   | Mod. T30  | XXXXXXXX   |   |   |   |   |   |   |   |   |   |   |
| <b>NISSAN  X-TRAIL 2.2 Di</b>   |   |   |   |  |   |   |   |   |   |   |   |   |   |   |
|                                  | YD22ETI   | 07/01 → 08/04   | Mod. T30  | XXXXXXXX   |   |   |   |   |   |   |   |   |   |   |
| <b>NISSAN  AD MAX VAN 1.7 D</b> |   |   |   |  |   |   |   |   |   |   |   |   |   |   |
|                                  | CD17  | 05/92 → 10/93   | 3), Mod. Y10  | VKMS 92514<br>VKMA 92514<br>VKM 72300<br>VKM 72303<br>VKM 82302                    | 2<br>2<br>1<br>1  | 1<br>1  | 2<br>2  |   |   |   | 3   |   |   | T0671   |
|  | CD17  | 10/93 → 03/94   | Mod. Y10  | VKMA 92515<br>VKM 72300<br>VKM 72303<br>VKM 82302                                  | 2<br>1<br>1   | 1   | 2   |   |   |   |   |   |   | T0671   |
|  |   |   |   |  |   | 1   |   |   |   |   |   |   |   |   |
| <b>NISSAN  AD WAGON 2.0 D</b>   |   |   |   |  |   |   |   |   |   |   |   |   |   |   |
|                                  | CD20  | 11/90 → 07/95   | 3), Mod. Y10  | VKMS 92513<br>VKMA 92513<br>VKM 72303<br>VKM 72310<br>VKM 82302                    | 2<br>2<br>1<br>1  | 1<br>1  | 2<br>2  |   |   |   | 3   |   |   | T0672   |
|  |   |   |   |  |   | 1   |   |   |   |   |   |   |   |   |
| <b>NISSAN  CARAVAN 3.0</b>      |   |   |   |  |   |   |   |   |   |   |   |   |   |   |
|                                  | VG30E   | 10/88 → 10/90   | Mod. E24  | VKMA 92004<br>VKM 72004  | 1<br>1  |   | 1   |   |   |   |   |   |   | T0684   |

|   |  |  |   |  |  |  |  |  |  |  |  |  |
|---|---|---|--|--|---|---|---|---|---|---|---|---|
| <b>NISSAN  CARAVAN 2.0 D</b>           |   |   |  |  |   |   |   |   |   |   |   |   |
|                                        | LD20T   | 09/86 → 10/90   | Mod. E24   | VKMA 92012<br>VKM 72320<br>VKM 82320   | 1<br>1  | 1   | 1   |   |   |   |   | T0686   |
| <b>NISSAN  CARGO 1.5</b>               |   |   |  |  |   |   |   |   |   |   |   |   |
|                                        | A15   | 06/81 → 06/87   | Mod. C120, AC  | VKPC 92203   |   |   |   |   | 1   |   |   |   |
|   | A15S  | 09/86 → 06/92   | Mod. GC22  | VKPC 92203   |   |   |   |   | 1   |   |   |   |
| <b>NISSAN  CARGO 2.0</b>               |   |   |  |  |   |   |   |   |   |   |   |   |
|                                        | Z20S  | 09/86 → 06/92   | Mod. GC22  | VKPC 92802   |   |   |   |   | 1   |   |   |   |
| <b>NISSAN  CARGO 2.4</b>               |   |   |  |  |   |   |   |   |   |   |   |   |
|                                        | Z24I  | 09/86 → 06/92   | Mod. GC22  | VKPC 92634   |   |   |   |   | 1   |   |   |   |
| <b>NISSAN  CARGO 2.0 D</b>             |   |   |  |  |   |   |   |   |   |   |   |   |
|                                        | LD20  | 06/80 → 04/84   | Mod. C120  | VKPC 92610   |   |   |   |   | 1   |   |   |   |
|   | LD20  | 09/86 → 06/92   | Mod. C220, GC22  | VKPC 92600   |   |   |   |   | 1   |   |   |   |
| <b>NISSAN  CARGO 2.3 D</b>             |   |   |  |  |   |   |   |   |   |   |   |   |
|                                        | LD23  | 09/94 → 11/01   | Mod. C23   | VKPC 92926   |   |   |   |   | 1   |   |   |   |
| <b>NISSAN  HOMY VAN 3.0</b>            |   |   |  |  |   |   |   |   |   |   |   |   |
|                                        | VG30E   | 10/88 → 10/90   | Mod. E24   | VKMA 92004<br>VKM 72004  | 1<br>1  |   | 1   |   |   |   |   | T0684   |
| <b>NISSAN  HOMY VAN 2.0 D</b>          |   |   |  |  |   |   |   |   |   |   |   |   |
|                                        | LD20T   | 09/86 → 10/90   | Mod. E24   | VKMA 92012<br>VKM 72320<br>VKM 82320   | 1<br>1  | 1   | 1   |   |   |   |   | T0686   |
| <b>NISSAN  INTERSTAR 1.9 dCi 80</b>    |   |   |  |  |   |   |   |   |   |   |   |   |
|                                       | F9Q 772, F9Q 774  | 07/02 → 08/04   |  | VKMC 06127<br>VKMA 06127<br>VKM 16113  | 1<br>1<br>1   |   | 1   | 1   |   |   |   | T0647   |
|                                      | F9Q 772, F9Q 774  | 07/02 → 08/04   | Mod. X70   | VKPC 85304   |   |   |   |   | 1   |   |   |   |
|                                      | B(Alt) F9Q 772, F9Q 774   | 07/02 → 02/07   | Mod. X70, AC   | VKMV 5PK1125   |   |   | 1   |   |   |   |   |   |
|   | B(Alt) F9Q 772, F9Q 774   | 07/02 → 02/07   | Mod. X70, AC   | VKMA 36033<br>VKMV 6PK1792<br>VKM 36030<br>VKM 36031                               | 1<br>1  | 1   | 1   |   |   |   |   |   |
| <b>NISSAN  INTERSTAR 2.2 dCi 90</b>  |   |   |  |  |   |   |   |   |   |   |   |   |
|                                      | G9T 722, G9T 750  | 07/02 → 08/04   | Mod. X70   | VKMA 06503<br>VKM 16503<br>VKM 26503   | 1<br>1  | 1   | 1   |   |   |   |   | 1 T0187   |
|                                      | G9T 722, G9T 750  | 07/02 → 08/04   | Mod. X70   | VKPC 86305   |   |   |   |   | 1   |   |   |   |
| <b>NISSAN  INTERSTAR 2.5 dCi 100</b> |   |   |  |  |   |   |   |   |   |   |   |   |
|                                      | G9U 720, G9U 724,<br>G9U 750, G9U 754   | 11/03 → 08/04   | Mod. X70   | VKMA 06503<br>VKM 16503<br>VKM 26503   | 1<br>1  | 1   | 1   |   |   |   |   | 1 T0187   |
|                                      | G9U 720, G9U 724,<br>G9U 750, G9U 754   | 11/03 → 08/04   | Mod. X70   | VKPC 86305   |   |   |   |   | 1   |   |   |   |
| <b>NISSAN  INTERSTAR 2.5 dCi 120</b> |   |   |  |  |   |   |   |   |   |   |   |   |
|                                      | G9U 720, G9U 724,<br>G9U 750, G9U 754   | 07/02 → 08/04   | Mod. X70   | VKMA 06503<br>VKM 16503<br>VKM 26503   | 1<br>1  | 1   | 1   |   |   |   |   | 1 T0187   |
|                                      | G9U 720, G9U 724,<br>G9U 750, G9U 754   | 07/02 → 08/04   | Mod. X70   | VKPC 86305   |   |   |   |   | 1   |   |   |   |
| <b>NISSAN  INTERSTAR 3.0 dCi 140</b> |   |   |  |  |   |   |   |   |   |   |   |   |
|                                      |   | 11/03 → 08/04   | Mod. X70   | <b>OXOXOXO</b>   |   |   |   |   |   |   |   |   |
| <b>NISSAN  KUBISTAR 1.2</b>          |   |   |  |  |   |   |   |   |   |   |   |   |
|                                      | D7F 726, D7F 744,<br>D7F 764  | 08/03 → 08/04   | Mod. X76   | VKMA 06010<br>VKM 16000  | 1<br>1  |   | 1   |   |   |   |   | T0136   |
|                                      | D7F 726, D7F 744,<br>D7F 764  | 08/03 → 08/04   | Mod. X76   | VKPC 86215   |   |   |   |   | 1   |   |   |   |
|                                      | B(Alt) D4F 712  | 04/06 → 02/07   | Mod. X76, AC   | VKMV 3PK740  |   |   | 1   |   |   |   |   |   |













































NISSAN

|  |  |  |    |  |  |  |  |  |  |  |  |  |
|--|---|---|---|--|---|---|---|---|---|---|---|---|
| <b>B(Alt)</b>  | D7F 726, D7F 744,<br>D7F 764  | 08/03 → 02/07   | Mod. X76  | VKMV 3PK740  |   | 1   |   |   |   |   |   |   |
| <b>B(PS)</b>   | D7F 726   | 08/03 → 02/07   | Mod. X76, <del>AC</del>   | VKMV 4PK908<br>VKM 36023   |   | 1   |   |   |   |   |   |   |
| <b>B(AC)</b>   | D4F 712, D4F 730  | 04/06 → 02/07   | Mod. X76  | VKMV 4PK928<br>VKM 36023   |   | 1   |   |   |   |   |   |   |
| <b>B(AC)</b>   | D7F 726   | 08/03 → 02/07   | Mod. X76, <del>Ø</del>  | VKMV 4PK928<br>VKM 36023   |   | 1   |   |   |   |   |   |   |
| <b>NISSAN  KUBISTAR 1.6</b>           |   |   |   |  |   |   |   |   |   |   |   |   |
|                                        | K4M 752, K4M 753  | 08/03 → 08/04   | Mod. X76  | VKMA 06020<br>VKM 16020<br>VKM 26020   | 1<br>1  | 1   | 1   |   |   | 2   | 1   | T0159   |
|                                        | K4M 752, K4M 753  | 08/03 → 08/04   | Mod. X76  | VKPC 86416   |   |   |   | 1   |   |   |   |   |
| <b>NISSAN  KUBISTAR 1.5 dCi</b>       |   |   |   |  |   |   |   |   |   |   |   |   |
|                                        | K9K 700, K9K 702,<br>K9K 704, K9K 710   | 08/03 → 08/04   | Mod. X76  | VKMA 06132<br>VKM 16102  | 1<br>1  |   | 1   |   |   |   | 1   | T0191   |
|                                        | K9K 700, K9K 702,<br>K9K 704, K9K 710   | 08/03 → 08/04   | Mod. X76  | VKPC 86417   |   |   |   | 1   |   |   |   |   |
| <b>NISSAN  PICK UP 1.8</b>            |   |   |   |  |   |   |   |   |   |   |   |   |
|                                        | L18   | 01/83 → 03/86   | Mod. 720  | <del>OKOKOKO</del>   |   |   |   |   |   |   |   |   |
|                                        | L18   | 01/83 → 08/85   | Mod. 720, AC  | VKPC 92630   |   |   |   | 1   |   |   |   |   |
| <b>NISSAN  PICK UP 2.0, 2.0 D</b>     |   |   |   |  |   |   |   |   |   |   |   |   |
|                                        | NA20S   | 09/85 → 08/91   | Mod. D21  | <del>OKOKOKO</del>   |   |   |   |   |   |   |   |   |
| <b>NISSAN  PICK UP 2.2</b>           |   |   |   |  |   |   |   |   |   |   |   |   |
|                                      | Z22   | 04/83 → 03/86   | Mod. 720  | <del>OKOKOKO</del>   |   |   |   |   |   |   |   |   |
|                                      | Z22   | 04/83 → 08/85   | Mod. 720  | VKPC 92630   |   |   |   | 1   |   |   |   |   |
| <b>NISSAN  PICK UP 2.4</b>          |   |   |   |  |   |   |   |   |   |   |   |   |
|                                      | KA24DE, KA24E   | 02/98 → 08/04   | Mod. D22  | <del>OKOKOKO</del>   |   |   |   |   |   |   |   |   |
|                                      | KA24E   | 04/92 → 02/98   | Mod. D21  | VKPC 92645   |   |   |   | 1   |   |   |   |   |
| <b>NISSAN  PICK UP 2.2 D</b>        |   |   |   |  |   |   |   |   |   |   |   |   |
|                                      | SD22  | 01/82 → 01/84   | Mod. 720  | <del>OKOKOKO</del>   |   |   |   |   |   |   |   |   |
|                                      | SD22  | 09/79 → 08/85   | Mod. 720  | VKPC 92649   |   |   |   | 1   |   |   |   |   |
| <b>NISSAN  PICK UP 2.3 D</b>        |   |   |   |  |   |   |   |   |   |   |   |   |
|                                      | SD23  | 04/83 → 08/88   | Mod. D21  | <del>OKOKOKO</del>   |   |   |   |   |   |   |   |   |
|                                      | SD23  | 04/83 → 08/85   | Mod. 720  | VKPC 92649   |   |   |   | 1   |   |   |   |   |
|  | SD23  | 09/85 → 10/87   | Mod. D21  | VKPC 92650   |   |   |   | 1   |   |   |   |   |
| <b>NISSAN  PICK UP 2.5 D</b>        |   |   |   |  |   |   |   |   |   |   |   |   |
|                                      | TD25  | 02/98 → 08/04   | Mod. D22  | <del>OKOKOKO</del>   |   |   |   |   |   |   |   |   |
|                                      | TD25  | 10/87 → 02/98   | Mod. D21, Turbo   | VKPC 92651   |   |   |   | 1   |   |   |   |   |
|  | SD25  | 04/83 → 08/85   | Mod. 720  | VKPC 92649   |   |   |   | 1   |   |   |   |   |
|  | SD25  | 09/85 → 10/87   | Mod. D21  | VKPC 92650   |   |   |   | 1   |   |   |   |   |
| <b>NISSAN  PICK UP 2.5 Di</b>       |   |   |   |  |   |   |   |   |   |   |   |   |
|                                      |   | 03/02 → 08/04   | Mod. D22  | <del>OKOKOKO</del>   |   |   |   |   |   |   |   |   |
|  |   | 03/02 → 08/04   | Mod. D22  | <del>OKOKOKO</del>   |   |   |   |   |   |   |   |   |
| <b>NISSAN  PICK UP 2.5 TD</b>       |   |   |   |  |   |   |   |   |   |   |   |   |
|                                      | TD25Ti  | 05/98 → 08/04   | Mod. D22  | <del>OKOKOKO</del>   |   |   |   |   |   |   |   |   |
| <b>NISSAN  PICK UP 3.2 D</b>        |   |   |   |  |   |   |   |   |   |   |   |   |
|                                      | QD32  | 12/98 → 02/04   | Mod. D22  | <del>OKOKOKO</del>   |   |   |   |   |   |   |   |   |
| <b>NISSAN  PICKUP 3.0</b>           |   |   |   |  |   |   |   |   |   |   |   |   |
|                                      | VG30, VG30E   | 11/85 → 07/93   | Mod. D21  | VKMA 92004<br>VKM 72004  | 1<br>1  | 1   |   |   |   |   |   | T0684   |
|  | VG30E   | 08/93 → 11/94   | Mod. D21  | VKMA 92006<br>VKM 72004  | 1<br>1  | 1   |   |   |   |   |   | T0684   |
| <b>NISSAN  PRIMASTAR 2.0</b>        |   |   |   |  |   |   |   |   |   |   |   |   |
|                                      | F4R 720   | 03/01 → 08/04   | Mod. X83  | VKPC 85304   |   |   |   | 1   |   |   |   |   |
| <b>NISSAN  PRIMASTAR 1.9 dCi 80</b> |   |   |   |  |   |   |   |   |   |   |   |   |
|                                      | F9Q 762   | 03/01 → 08/04   |  | VKMC 06127<br>VKMA 06127<br>VKM 16113  | 1<br>1<br>1   | 1   | 1   |   |   |   |   | T0647   |
|                                      | F9Q 760, F9Q 762  | 03/01 → 08/04   | Mod. X83  | VKPC 85304   |   |   |   | 1   |   |   |   |   |









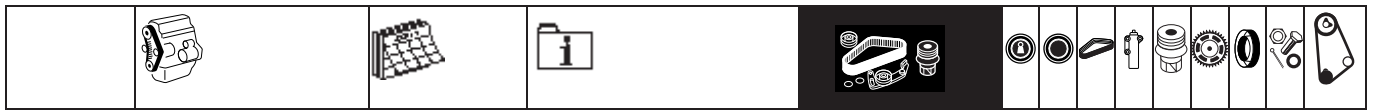































|   |  |  |       |  |  |  |  |  |  |  |  |  |
|---|---|---|--|--|---|---|---|---|---|---|---|---|
|                                      | <b>B(Alt)</b> F9Q 760, F9Q 762  | 03/01 → 02/07   | Mod. X83, AC   | VKMA 36033<br>VKMV 6PK1792<br>VKM 36030<br>VKM 36031                               | 1<br>1<br>1   | 1<br>1  | 1<br>1  |   |   |   |   |   |
|   | <b>B(Alt)</b> F9Q 762   | 03/01 → 02/07   | Mod. X83, AC   | VKMV 5PK1125   |   |   | 1   |   |   |   |   |   |
| <b>NISSAN  PRIMASTAR 2.0 dCi 100</b> |   |   |  |  |   |   |   |   |   |   |   |   |
|                                      | F9Q 760   | 03/01 → 08/04   |  Mod. | VKMC 06127<br>VKMA 06127<br>VKM 16113  | 1<br>1<br>1   |   | 1<br>1  | 1   |   |   |   | T0647   |
|                                      | F9Q 760   | 03/01 → 08/04   | Mod. X83   | VKPC 85304   |   |   |   | 1   |   |   |   |   |
| <b>NISSAN  PRIMASTAR 2.5 dCi 140</b> |   |   |  |  |   |   |   |   |   |   |   |   |
|                                      | G9U 730   | 09/03 → 08/04   | Mod. X83   | VKMA 06503<br>VKM 16503<br>VKM 26503   | 1<br>1  | 1<br>1  | 1   |   |   |   | 1   | T0187   |
|                                      | G9U 730   | 09/03 → 08/04   | Mod. X83   | VKPC 86305   |   |   |   | 1   |   |   |   |   |
| <b>NISSAN  SUNNY 1.6</b>             |   |   |  |  |   |   |   |   |   |   |   |   |
|                                      | GA16DS  | 10/92 → 03/00   | Mod. Y10   | <del>OKOKOKO</del>   |   |   |   |   |   |   |   |   |
| <b>NISSAN  SUNNY 1.7 D</b>           |   |   |  |  |   |   |   |   |   |   |   |   |
|                                      | CD17  | 05/92 → 10/93   | 3), Mod. Y10   | VKMS 92514<br>VKMA 92514<br>VKM 72300<br>VKM 72303<br>VKM 82302                    | 2<br>2<br>1<br>1  | 1<br>1  | 2<br>2  |   |   |   | 3   | T0671   |
|   | CD17  | 10/93 → 03/94   | Mod. Y10   | VKMA 92515<br>VKM 72300<br>VKM 72303<br>VKM 82302                                  | 2<br>1<br>1   | 1<br>1  | 2   |   |   |   |   | T0671   |
|                                    | CD17  | 11/90 → 08/93   | Mod. Y10   | VKPC 92422   |   |   |   | 1   |   |   |   |   |
|                                    | CD17  | 09/93 → 03/00   | Mod. Y10   | VKPC 92001   |   |   |   | 1   |   |   |   |   |
| <b>NISSAN  TRADE 2.0 D</b>         |   |   |  |  |   |   |   |   |   |   |   |   |
|                                    | LD20E   | 11/86 → 06/92   | Mod. PF20  | VKPC 92600   |   |   |   | 1   |   |   |   |   |
| <b>NISSAN  TRADE 2.3 D</b>         |   |   |  |  |   |   |   |   |   |   |   |   |
|                                    | LD23  | 12/96 → 11/01   | Mod. TX75  | VKPC 92926   |   |   |   | 1   |   |   |   |   |
| <b>NISSAN  URVAN 2.0</b>           |   |   |  |  |   |   |   |   |   |   |   |   |
|                                    | H20, Z20S   | 07/81 → 05/97   | Mod. E23, E23B, E24  | <del>OKOKOKO</del>   |   |   |   |   |   |   |   |   |
|                                    | Z20S  | 05/87 → 07/94   | Mod. E24   | VKPC 92802   |   |   |   | 1   |   |   |   |   |
| <b>NISSAN  URVAN 2.4</b>           |   |   |  |  |   |   |   |   |   |   |   |   |
|                                    | Z24S  | 05/89 → 09/93   | Mod. E24   | <del>OKOKOKO</del>   |   |   |   |   |   |   |   |   |
|                                    | Z24i  | 05/89 → 11/95   | Mod. E24   | VKPC 92634   |   |   |   | 1   |   |   |   |   |
| <b>NISSAN  URVAN 3.0</b>           |   |   |  |  |   |   |   |   |   |   |   |   |
|                                    | VG30E   | 10/88 → 10/90   | Mod. E24   | VKMA 92004<br>VKM 72004  | 1<br>1  |   | 1   |   |   |   |   | T0684   |
| <b>NISSAN  URVAN 2.0 D</b>         |   |   |  |  |   |   |   |   |   |   |   |   |
|                                    | LD20T   | 09/86 → 10/90   | Mod. E24   | VKMA 92012<br>VKM 72320<br>VKM 82320   | 1<br>1  | 1<br>1  | 1   |   |   |   |   | T0686   |
| <b>NISSAN  URVAN 2.2 D</b>         |   |   |  |  |   |   |   |   |   |   |   |   |
|                                    | SD22  | 07/81 → 11/82   | Mod. E23   | <del>OKOKOKO</del>   |   |   |   |   |   |   |   |   |
| <b>NISSAN  URVAN 2.3 D</b>         |   |   |  |  |   |   |   |   |   |   |   |   |
|                                    | SD23, TD23  | 11/82 → 05/97   | Mod. E23, E23B, E24  | <del>OKOKOKO</del>   |   |   |   |   |   |   |   |   |
| <b>NISSAN  URVAN 2.5 D</b>         |   |   |  |  |   |   |   |   |   |   |   |   |
|                                    | TD25  | 12/88 → 05/97   | Mod. E24   | <del>OKOKOKO</del>   |   |   |   |   |   |   |   |   |
| <b>NISSAN  VANETTE 1.5</b>         |   |   |  |  |   |   |   |   |   |   |   |   |
|                                    | A15   | 01/83 → 12/87   | Mod. C120  | <del>OKOKOKO</del>   |   |   |   |   |   |   |   |   |
|                                    | A15   | 01/83 → 06/87   | Mod. C120, AC  | VKPC 92203   |   |   |   | 1   |   |   |   |   |
|   | A15S  | 10/86 → 06/92   | Mod. GC22  | VKPC 92203   |   |   |   | 1   |   |   |   |   |
| <b>NISSAN  VANETTE 2.4</b>         |   |   |  |  |   |   |   |   |   |   |   |   |
|                                    | Z24i  | 10/86 → 06/92   | Mod. GC22  | VKPC 92634   |   |   |   | 1   |   |   |   |   |
| <b>NISSAN  VANETTE 2.0 D</b>       |   |   |  |  |   |   |   |   |   |   |   |   |
|                                    | LD20  | 10/86 → 02/94   | 3), Mod. C22   | VKMS 92012<br>VKMA 92012   | 1<br>1  | 1<br>1  | 1<br>1  |   |   |   | 2   | T0686   |

















































































|  |  |  |  |  |  |  |  |  |  |  |  |  |
|--|---|---|---|--|---|---|---|---|---|---|---|---|
|  |   |   |   | VKM 72320  | 1   |   |   |   |   |   |   |   |
|  |   |   |   | VKM 82320  |   | 1   |   |   |   |   |   |   |
|  | LD20II  | 07/91 → 02/94   | 3), Mod. C22  | VKMS 92012   | 1   | 1   | 1   |   |   | 2   |   | T0686   |
|  |   |   |   | VKMA 92012   | 1   | 1   | 1   |   |   |   |   |   |
|  |   |   |   | VKM 72320  | 1   |   |   |   |   |   |   |   |
|  |   |   |   | VKM 82320  |   | 1   |   |   |   |   |   |   |
|                                        | LD20  | 06/80 → 04/84   | Mod. C120   | VKPC 92610   |   |   |   | 1   |   |   |   |   |
|  | LD20  | 10/86 → 12/95   | Mod. GC22   | VKPC 92600   |   |   |   | 1   |   |   |   |   |
|  | LD20  | 04/87 → 06/92   | Mod. C220   | VKPC 92600   |   |   |   | 1   |   |   |   |   |
|  | Z20S  | 10/86 → 06/92   | Mod. GC22   | VKPC 92802   |   |   |   | 1   |   |   |   |   |
|                                        | B(Alt) LD20   | 01/92 → 12/95   | Mod. C22  | VKMV 13AVx1050   |   |   | 1   |   |   |   |   |   |
|  | B(PS) LD20  | 10/86 → 12/95   | Mod. C22  | VKMV 13AVx750  |   |   | 1   |   |   |   |   |   |
|  | B(Alt) LD20II   | 01/92 → 01/95   | Mod. C22  | VKMV 13AVx1050   |   |   | 1   |   |   |   |   |   |
|  | B(PS) LD20II  | 07/91 → 01/95   | Mod. C22  | VKMV 13AVx750  |   |   | 1   |   |   |   |   |   |
| <b>NISSAN  VANETTE 2.3 D</b>          |   |   |   |  |   |   |   |   |   |   |   |   |
|                                        | LD23  | 09/94 → 11/01   | Mod. C23  | VKPC 92926   |   |   |   | 1   |   |   |   |   |
| <b>NISSAN  VANETTE CARGO 1.6</b>      |   |   |   |  |   |   |   |   |   |   |   |   |
|                                        | GA16DE  | 01/95 → 02/04   | Mod. C23  | <del>OKOKOKO</del>   |   |   |   |   |   |   |   |   |
| <b>NISSAN  VANETTE CARGO 2.0 D</b>    |   |   |   |  |   |   |   |   |   |   |   |   |
|                                        | SR20DE  | 01/95 → 02/04   | Mod. C23  | <del>OKOKOKO</del>   |   |   |   |   |   |   |   |   |
|  | CD20ET  | 01/97 → 01/98   | 3), Mod. C23  | VKMS 92517   | 2   | 2   | 2   |   |   | 3   |   | T0671   |
|  |   |   |   | VKMA 92517   | 2   | 2   | 2   |   |   |   |   |   |
|  |   |   |   | VKM 72310  | 1   |   |   |   |   |   |   |   |
|  |   |   |   | VKM 72501  | 1   |   |   |   |   |   |   |   |
|  |   |   |   | VKM 82502  |   | 1   |   |   |   |   |   |   |
|  |   |   |   | VKM 82503  |   | 1   |   |   |   |   |   |   |
|                                      | CD20, CD20ET, CD20T   | 02/96 → 01/98   | Mod. C23  | VKPC 92928   |   |   |   | 1   |   |   |   |   |
|  | SR20DE  | 12/97 → 12/98   | Mod. C23  | —  |   |   |   | 1   |   |   |   |   |
| <b>NISSAN  VANETTE CARGO 2.3 D</b>  |   |   |   |  |   |   |   |   |   |   |   |   |
|                                      | LD23  | 01/95 → 11/01   | Mod. C23  | VKPC 92926   |   |   |   | 1   |   |   |   |   |
| <b>NISSAN  VANETTE SERENA 2.0 D</b> |   |   |   |  |   |   |   |   |   |   |   |   |
|                                      | LD20  | 07/92 → 12/92   | Mod. C23  | VKMA 92012   | 1   | 1   | 1   |   |   |   |   | T0686   |
|  |   |   |   | VKM 72320  | 1   |   |   |   |   |   |   |   |
|  |   |   |   | VKM 82320  |   | 1   |   |   |   |   |   |   |
| <b>OPEL  ADMIRAL A 2.6</b>          |   |   |   |  |   |   |   |   |   |   |   |   |
|                                      | 26 S  | 04/64 → 09/65   |   | <del>OKOKOKO</del>   |   |   |   |   |   |   |   |   |
| <b>OPEL  ADMIRAL A 2.8</b>          |   |   |   |  |   |   |   |   |   |   |   |   |
|                                      | 28 HL, 28 S   | 10/65 → 03/69   |   | <del>OKOKOKO</del>   |   |   |   |   |   |   |   |   |
|                                      | 28 S  | 10/65 → 03/69   |   | VKPC 85600   |   |   |   | 1   |   |   |   |   |
| <b>OPEL  ADMIRAL A 4.6</b>          |   |   |   |  |   |   |   |   |   |   |   |   |
|                                      | 46 S  | 04/65 → 03/69   |   | <del>OKOKOKO</del>   |   |   |   |   |   |   |   |   |
| <b>OPEL  ADMIRAL B 2.8</b>          |   |   |   |  |   |   |   |   |   |   |   |   |
|                                      | 28 E, 28 H, 28 S  | 03/69 → 01/78   |   | <del>OKOKOKO</del>   |   |   |   |   |   |   |   |   |
|                                      | 28 S  | 03/69 → 01/78   |   | VKPC 85600   |   |   |   | 1   |   |   |   |   |
| <b>OPEL  AGILA B 1.0 12V</b>        |   |   |   |  |   |   |   |   |   |   |   |   |
|                                      | Z 10 XE   | 09/00 → 09/07   |   | <del>OKOKOKO</del>   |   |   |   |   |   |   |   |   |
|                                      | Z 10 XE   | 09/00 → 10/07   |   | VKPC 85220   |   |   |   | 1   |   |   |   |   |
|                                      | B(Alt) Z 10 XE  | 09/00 → 09/07   | AC  | VKMA 35113   | 1   |   | 1   |   |   |   |   |   |
|  |   |   |   | VKMV 5PK1230   |   |   | 1   |   |   |   |   |   |
|  |   |   |   | VKM 35013  | 1   |   |   |   |   |   |   |   |
|  | B(Alt) Z 10 XE  | 09/00 → 09/07   | AC  | VKMA 35013   | 1   |   | 1   |   |   |   |   |   |
|  |   |   |   | VKMV 5PK1355   |   |   | 1   |   |   |   |   |   |
|  |   |   |   | VKM 35013  | 1   |   |   |   |   |   |   |   |
| <b>OPEL  AGILA B 1.0 Twinport</b>   |   |   |   |  |   |   |   |   |   |   |   |   |
|                                      | Z 10 XEP  | 08/03 → 09/07   |   | <del>OKOKOKO</del>   |   |   |   |   |   |   |   |   |
|                                      | Z 10 XEP  | 08/03 → 10/07   |   | VKPC 85310   |   |   |   | 1   |   |   |   |   |
|                                      | B(Alt) Z 10 XEP   | 08/03 → 09/07   | AC  | VKMA 35113   | 1   |   | 1   |   |   |   |   |   |
|  |   |   |   | VKMV 5PK1230   |   |   | 1   |   |   |   |   |   |
|  |   |   |   | VKM 35013  | 1   |   |   |   |   |   |   |   |
|  | B(Alt) Z 10 XEP   | 08/03 → 09/07   | AC  | VKMA 35013   | 1   |   | 1   |   |   |   |   |   |
|  |   |   |   | VKMV 5PK1355   |   |   | 1   |   |   |   |   |   |
|  |   |   |   | VKM 35013  | 1   |   |   |   |   |   |   |   |













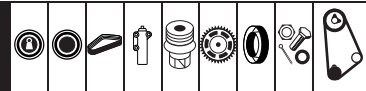



















| OPEL  AGILA B 1.2 16V          |                   |               |            |              |   |   |  |  |  |  |  |  |   |   |  |  |  |  |   |
|---|-------------------|---------------|------------|--------------|---|---|--|--|--|--|--|--|---|---|--|--|--|--|---|
|                                | Z 12 XE           | 09/00 → 09/07 | ΟΛΟΚΛΗΧΟ   |              |   |   |  |  |  |  |  |  |   |   |  |  |  |  |   |
|                                | Z 12 XE           | 09/00 → 10/07 | VKPC 85220 |              |   |   |  |  |  |  |  |  | 1 |   |  |  |  |  |   |
|                                | B(Alt) Z 12 XE    | 09/00 → 09/07 | AC         | VKMA 35113   | 1 |   |  |  |  |  |  |  |   | 1 |  |  |  |  |   |
|   |                   |               |            | VKMV 5PK1230 |   |   |  |  |  |  |  |  |   |   |  |  |  |  |   |
|   |                   |               |            | VKM 35013    | 1 |   |  |  |  |  |  |  |   |   |  |  |  |  |   |
|   | B(Alt) Z 12 XE    | 09/00 → 09/07 | AC         | VKMA 35013   | 1 |   |  |  |  |  |  |  |   | 1 |  |  |  |  |   |
|   |                   |               |            | VKMV 5PK1355 |   |   |  |  |  |  |  |  |   |   |  |  |  |  |   |
|   |                   |               |            | VKM 35013    | 1 |   |  |  |  |  |  |  |   |   |  |  |  |  |   |
| OPEL  AGILA B 1.2 16V Twinport |                   |               |            |              |   |   |  |  |  |  |  |  |   |   |  |  |  |  |   |
|                                | Z 12 XEP          | 07/04 → 09/07 | ΟΛΟΚΛΗΧΟ   |              |   |   |  |  |  |  |  |  |   |   |  |  |  |  |   |
|                                | Z 12 XEP          | 07/04 → 10/07 | VKPC 85310 |              |   |   |  |  |  |  |  |  |   |   |  |  |  |  | 1 |
|                                | B(Alt) Z 12 XEP   | 07/04 → 09/07 | AC         | VKMA 35113   | 1 |   |  |  |  |  |  |  |   |   |  |  |  |  |   |
|   |                   |               |            | VKMV 5PK1230 |   |   |  |  |  |  |  |  |   |   |  |  |  |  |   |
|   |                   |               |            | VKM 35013    | 1 |   |  |  |  |  |  |  |   |   |  |  |  |  |   |
|   | B(Alt) Z 12 XEP   | 07/04 → 09/07 | AC         | VKMA 35013   | 1 |   |  |  |  |  |  |  |   | 1 |  |  |  |  |   |
|   |                   |               |            | VKMV 5PK1355 |   |   |  |  |  |  |  |  |   |   |  |  |  |  |   |
|   |                   |               |            | VKM 35013    | 1 |   |  |  |  |  |  |  |   |   |  |  |  |  |   |
| OPEL  AGILA B 1.3 CDTI         |                   |               |            |              |   |   |  |  |  |  |  |  |   |   |  |  |  |  |   |
|                                | Z 13 DT           | 08/03 → 09/07 | ΟΛΟΚΛΗΧΟ   |              |   |   |  |  |  |  |  |  |   |   |  |  |  |  |   |
|                                | Z 13 DT           | 08/03 → 10/07 | VKPC 85700 |              |   |   |  |  |  |  |  |  |   |   |  |  |  |  | 1 |
|                                | B(Alt) Z 13 DT    | 08/03 → 09/07 | AC         | VKMV 6PK1182 |   |   |  |  |  |  |  |  |   |   |  |  |  |  |   |
|   |                   |               |            | VKM 35023    | 1 |   |  |  |  |  |  |  |   |   |  |  |  |  |   |
|   | B(Alt) Z 13 DT    | 08/03 → 09/07 | AC         | VKMV _____   |   |   |  |  |  |  |  |  |   |   |  |  |  |  |   |
|   |                   |               |            | VKM 35023    | 1 |   |  |  |  |  |  |  |   |   |  |  |  |  |   |
| OPEL  ANTARA 2.4             |                   |               |            |              |   |   |  |  |  |  |  |  |   |   |  |  |  |  |   |
|                              | Z 24 XE           | 05/06 → 03/07 | VKMA 05228 | 1            | 2 | 1 |  |  |  |  |  |  |   |   |  |  |  |  |   |
|   |                   |               | VKM 15230  | 1            |   |   |  |  |  |  |  |  |   |   |  |  |  |  |   |
|   |                   |               | VKM 25212  |              |   | 1 |  |  |  |  |  |  |   |   |  |  |  |  |   |
|   |                   |               | VKM 25212  |              |   | 1 |  |  |  |  |  |  |   |   |  |  |  |  |   |
|                              | Z 24 XE           | 05/06 → 03/07 | VKPC 85611 |              |   |   |  |  |  |  |  |  |   |   |  |  |  |  | 1 |
| OPEL  ANTARA 3.2 V6          |                   |               |            |              |   |   |  |  |  |  |  |  |   |   |  |  |  |  |   |
|                              | Z 32 SE           | 05/06 → 03/07 | ΟΛΟΚΛΗΧΟ   |              |   |   |  |  |  |  |  |  |   |   |  |  |  |  |   |
|                              | Z 32 SE           | 05/06 → 03/07 | —          |              |   |   |  |  |  |  |  |  |   |   |  |  |  |  | 1 |
| OPEL  ANTARA 2.0 CDTI        |                   |               |            |              |   |   |  |  |  |  |  |  |   |   |  |  |  |  |   |
|                              | Z 20 DM, Z 20 DMH | 05/06 → 03/07 | —          | 1            | 1 | 1 |  |  |  |  |  |  |   |   |  |  |  |  |   |
|   |                   |               | VKM _____  | 1            |   |   |  |  |  |  |  |  |   |   |  |  |  |  |   |
|   |                   |               | VKM _____  |              |   | 1 |  |  |  |  |  |  |   |   |  |  |  |  |   |
| OPEL  ASCONA A 1.2           |                   |               |            |              |   |   |  |  |  |  |  |  |   |   |  |  |  |  |   |
|                              | 12 S              | 04/72 → 08/75 | ΟΛΟΚΛΗΧΟ   |              |   |   |  |  |  |  |  |  |   |   |  |  |  |  |   |
|                              | 12 S              | 04/72 → 08/75 | —          |              |   |   |  |  |  |  |  |  |   |   |  |  |  |  | 1 |
| OPEL  ASCONA A 1.6           |                   |               |            |              |   |   |  |  |  |  |  |  |   |   |  |  |  |  |   |
|                              | 16 N, 16 S        | 10/70 → 08/75 | ΟΛΟΚΛΗΧΟ   |              |   |   |  |  |  |  |  |  |   |   |  |  |  |  |   |
|                              | 16 N, 16 S        | 10/70 → 08/75 | VKPC 85600 |              |   |   |  |  |  |  |  |  |   |   |  |  |  |  | 1 |
| OPEL  ASCONA A 1.9           |                   |               |            |              |   |   |  |  |  |  |  |  |   |   |  |  |  |  |   |
|                              | 19 N, 19 S        | 10/70 → 08/75 | ΟΛΟΚΛΗΧΟ   |              |   |   |  |  |  |  |  |  |   |   |  |  |  |  |   |
|                              | 19 N, 19 S        | 10/70 → 08/75 | VKPC 85600 |              |   |   |  |  |  |  |  |  |   |   |  |  |  |  | 1 |
| OPEL  ASCONA B 1.2           |                   |               |            |              |   |   |  |  |  |  |  |  |   |   |  |  |  |  |   |
|                              | 12 N, 12 S        | 09/75 → 02/79 | ΟΛΟΚΛΗΧΟ   |              |   |   |  |  |  |  |  |  |   |   |  |  |  |  |   |
|                              | 12 N, 12 S        | 09/75 → 02/79 | VKPC 85203 |              |   |   |  |  |  |  |  |  |   |   |  |  |  |  | 1 |
| OPEL  ASCONA B 1.3           |                   |               |            |              |   |   |  |  |  |  |  |  |   |   |  |  |  |  |   |
|                              | 13 N, 13 S        | 03/79 → 08/81 | ΟΛΟΚΛΗΧΟ   |              |   |   |  |  |  |  |  |  |   |   |  |  |  |  |   |
|                              | 13 N, 13 S        | 03/79 → 08/81 | VKPC 85202 |              |   |   |  |  |  |  |  |  |   |   |  |  |  |  | 1 |
| OPEL  ASCONA B 1.6           |                   |               |            |              |   |   |  |  |  |  |  |  |   |   |  |  |  |  |   |
|                              | 16 N, 16 S        | 09/75 → 08/81 | ΟΛΟΚΛΗΧΟ   |              |   |   |  |  |  |  |  |  |   |   |  |  |  |  |   |
|                              | 16 N, 16 S        | 09/75 → 08/81 | VKPC 85600 |              |   |   |  |  |  |  |  |  |   |   |  |  |  |  | 1 |
| OPEL  ASCONA B 1.9           |                   |               |            |              |   |   |  |  |  |  |  |  |   |   |  |  |  |  |   |
|                              | 19 N, 19 S        | 09/75 → 08/81 | ΟΛΟΚΛΗΧΟ   |              |   |   |  |  |  |  |  |  |   |   |  |  |  |  |   |
|                              | 19 N, 19 S        | 09/75 → 08/81 | VKPC 85600 |              |   |   |  |  |  |  |  |  |   |   |  |  |  |  | 1 |











































|  |  |               |    |  |  |  |  |  |  |  |  |  |  |  |  |
|--|--|---------------|---|---|---|--|---|---|---|---|---|---|---|---|---|
| <b>OPEL  ASCONA B 2.0</b>   |  |               |   |   |   |  |   |   |   |   |   |   |   |   |   |
|                              | 20 E, 20 N, 20 S   | 08/77 → 08/81 |   |   |   | OKOKOKO  |   |   |   |   |   |   |   |   |   |
|                              | 20 E, 20 N, 20 S   | 08/77 → 08/81 | 2)  |   |   | VKPA 85608   |   |   |   |   |   |   | 1   |   |   |
| <b>OPEL  ASCONA B 2.4</b>   |  |               |   |   |   |  |   |   |   |   |   |   |   |   |   |
|                              | 24 E   | 07/80 → 08/81 |   |   |   | OKOKOKO  |   |   |   |   |   |   |   |   |   |
| <b>OPEL  ASCONA B 2.0 D</b> |  |               |   |   |   |  |   |   |   |   |   |   |   |   |   |
|                              | 20 D   | 08/78 → 08/81 |   |   |   | OKOKOKO  |   |   |   |   |   |   |   |   |   |
|                              | 20 D   | 08/78 → 08/81 | 2), →   | Mot. 102685   |   | VKPA 85605   |   |   |   |   |   |   | 1   |   |   |
|                              | 20 D   | 08/78 → 08/81 | 2),   | Mot. 102686   | ↳   | —  |   |   |   |   |   |   | 1   |   |   |
| <b>OPEL  ASCONA C 1.3</b>   |  |               |   |   |   |  |   |   |   |   |   |   |   |   |   |
|                              | 13 N, 13 S   | 09/81 → 08/88 |    |   |   | VKMC 05103   |   |   | 1   | 1   |   |   |   |   | T0224   |
|                              | 13 N, 13 S   | 09/81 → 08/88 |   |   |   | VKPC 85202   |   |   |   | 1   |   |   |   |   |   |
|                              | <b>B(Alt)</b> 13 N, 13 S   | 09/81 → 08/88 |   |   |   | VKMC 10AVx875  |   |   | 1   |   |   |   |   |   |   |
|  | <b>B(PS)</b> 13 N, 13 S  | 09/81 → 08/88 |   |   |   | VKMC 10AVx850  |   |   | 1   |   |   |   |   |   |   |
| <b>OPEL  ASCONA C 1.6</b>   |  |               |   |   |   |  |   |   |   |   |   |   |   |   |   |
|                              | 16 N   | 09/81 → 08/88 |    | Man. GBX,<br>→  | Mot. 14 054370  | VKMC 05400   |   |   | 1   | 1   |   |   |   |   | T0225   |
|  | 16 N   | 09/81 → 08/88 |    | Man. GBX,<br>Mot. 14 054371   | ↳   | VKMC 05401   |   |   | 1   | 1   |   |   |   |   | T0225   |
|  | 16 N   | 09/81 → 08/88 |    | Auto. GBX,<br>→   | Mot. 14 058556  | VKMC 05400   |   |   | 1   | 1   |   |   |   |   | T0225   |
|  | 16 N   | 09/81 → 08/88 |    | Auto. GBX,<br>Mot. 14 058557  | ↳   | VKMC 05401   |   |   | 1   | 1   |   |   |   |   | T0225   |
|  | 16 SH  | 09/81 → 08/86 |    | Man. GBX,<br>→  | Mot. 14 391114  | VKMC 05400   |   |   | 1   | 1   |   |   |   |   | T0225   |
|  | 16 SH  | 09/81 → 08/86 |  | Man. GBX,<br>Mot. 14 391115   | ↳   | VKMC 05401   |   |   | 1   | 1   |   |   |   |   | T0225   |
|  | 16 SH  | 09/81 → 08/86 |  | Auto. GBX,<br>→   | Mot. 14 387789  | VKMC 05400   |   |   | 1   | 1   |   |   |   |   | T0225   |
|  | 16 SH  | 09/81 → 08/86 |  | Auto. GBX,<br>Mot. 14 387790  | ↳   | VKMC 05401   |   |   | 1   | 1   |   |   |   |   | T0225   |
|  | 16 SV, C 16 LZ, C 16 NZ,<br>E 16 NZ                              | 09/86 → 08/88 |  |   |   | VKMC 05120   |   |   | 1   | 1   |   |   |   |   | T0228   |
|                            | 16 N   | 09/81 → 08/88 |   | Man. GBX,<br>→  | Mot. 14 054370  | VKPC 85400   |   |   |   | 1   |   |   |   |   |   |
|  | 16 N   | 09/81 → 08/88 |   | Man. GBX,<br>Mot. 14 054371   | ↳   | VKPC 85407   |   |   |   | 1   |   |   |   |   |   |
|  | 16 N   | 09/81 → 08/88 |   | Auto. GBX,<br>→   | Mot. 14 058655  | VKPC 85400   |   |   |   | 1   |   |   |   |   |   |
|  | 16 N   | 09/81 → 08/88 |   | Auto. GBX,<br>Mot. 14 058656  | ↳   | VKPC 85407   |   |   |   | 1   |   |   |   |   |   |
|  | 16 S   | 09/81 → 08/86 |   |   |   | VKPC 85400   |   |   |   | 1   |   |   |   |   |   |
|  | 16 SH  | 09/81 → 08/86 |   | Man. GBX,<br>→  | Mot. 14 391114  | VKPC 85400   |   |   |   | 1   |   |   |   |   |   |
|  | 16 SH  | 09/81 → 08/86 |   | Man. GBX,<br>Mot. 14 391115   | ↳   | VKPC 85407   |   |   |   | 1   |   |   |   |   |   |
|  | 16 SH  | 09/81 → 08/86 |   | Auto. GBX,<br>→   | Mot. 14 387789  | VKPC 85400   |   |   |   | 1   |   |   |   |   |   |
|  | 16 SH  | 09/81 → 08/86 |   | Auto. GBX,<br>Mot. 14 387790  | ↳   | VKPC 85407   |   |   |   | 1   |   |   |   |   |   |
|  | 16 SV, C 16 LZ, C 16 NZ,<br>E 16 NZ                              | 09/86 → 08/88 |   |   |   | VKPC 85401   |   |   |   | 1   |   |   |   |   |   |
|                            | <b>B(Alt)</b> 16 N   | 09/81 → 08/88 |  |   |   | VKMC 10AVx925  |   |   | 1   |   |   |   |   |   |   |
|  | <b>B(Alt)</b> 16 SV, C 16 LZ, C 16 NZ,<br>E 16 NZ                | 09/86 → 08/88 |   |   |   | VKMC 10AVx913  |   |   | 1   |   |   |   |   |   |   |
|  | <b>B(PS)</b> 16 N, 16 SH, 16 SV,<br>C 16 LZ, C 16 NZ,<br>E 16 NZ | 09/81 → 08/88 |   |   |   | VKMC 10AVx850  |   |   | 1   |   |   |   |   |   |   |
| <b>OPEL  ASCONA C 1.8</b> |  |               |   |   |   |  |   |   |   |   |   |   |   |   |   |
|                            | 18 E, C 18 NE, S 18 NV<br>E 18 NV                                | 09/82 → 08/86 |  |   |   | VKMC 05400   |   |   | 1   | 1   |   |   |   |   | T0225   |
|                            | 18 E, 18 SE  | 09/82 → 08/86 |   | L.H.D.<br>→   | Mot. 14 237769  | VKPC 85400   |   |   |   | 1   |   |   |   |   |   |

|  |  |  |                                  |  |  |  |  |  |  |  |  |
|--|---|---|---|--|---|---|---|---|---|---|---|
|  | 18 E, 18 SE   | 09/82 → 08/86   | L.H.D.<br>Mot. 14 237770 I→   | VKPC 85407   |   |   |   | 1   |   |   |   |
|  | 18 E, 18 SE   | 09/82 → 08/86   | R.H.D.<br>→IMot. 14 056060  | VKPC 85400   |   |   |   | 1   |   |   |   |
|  | 18 E, 18 SE   | 09/82 → 08/86   | R.H.D.<br>Mot. 14 056061 I→   | VKPC 85407   |   |   |   | 1   |   |   |   |
|  | C 18 NE   | 01/85 → 08/86   |   | VKPC 85400   |   |   |   | 1   |   |   |   |
|  | E 18 NV, S 18 NV  | 01/85 → 08/88   |   | VKPC 85407   |   |   |   | 1   |   |   |   |
|                             | B(Alt) E 18 NV, S 18 NV   | 01/85 → 08/88   |   | VKMV 10AVx925  |   |   | 1   |   |   |   |   |
|  | B(PS) 18 E, C 18 NE, E 18 NV,<br>S 18 NV  | 09/82 → 08/88   |   | VKMV 10AVx850  |   |   | 1   |   |   |   |   |
| <b>OPEL  ASCONA C 2.0</b>   |   |   |   |  |   |   |   |   |   |   |   |
|                             | 20 NE, 20 SEH, C 20 NE  | 09/86 → 08/88   |                                  | VKMC 05401   |   |   | 1   | 1   |   |   | T0225   |
|                             | 20 NE, 20 SEH, C 20 NE  | 09/86 → 08/88   |   | VKPC 85407   |   |   |   | 1   |   |   |   |
|                             | B(Alt) 20 NE, 20 SEH, C 20 NE   | 09/86 → 08/88   |   | VKMV 10AVx925  |   |   | 1   |   |   |   |   |
|  | B(PS) 20 NE, 20 SEH, C 20 NE  | 09/86 → 08/88   |   | VKMV 10AVx850  |   |   | 1   |   |   |   |   |
| <b>OPEL  ASCONA C 1.6 D</b> |   |   |   |  |   |   |   |   |   |   |   |
|                             | 16 D (GM), 16 DA (GM)   | 03/82 → 08/88   |  Man. GBX,<br>Mot. 14 498631 I→  | VKMC 05201<br>VKMA 05201<br>VKM 25201  | 1<br>1<br>1   | 1<br>1<br>1   |   | 1   |   |   | T0045   |
|  | 16 D (GM), 16 DA (GM)   | 03/82 → 08/88   |  Auto. GBX,<br>Mot. 14 503757 I→ | VKMC 05201<br>VKMA 05201<br>VKM 25201  | 1<br>1<br>1   | 1<br>1<br>1   |   | 1   |   |   | T0045   |
|  | 16 D (GM), 16 DA (GM)   | 03/82 → 08/88   | Man. GBX,<br>→IMot. 14 498630   | VKMA 05200<br>VKM 25200  | 1<br>1  | 1   |   |   |   |   | T0016   |
|  | 16 D (GM), 16 DA (GM)   | 03/82 → 08/88   | Auto. GBX,<br>→IMot. 14 503756  | VKMA 05200<br>VKM 25200  | 1<br>1  | 1   |   |   |   |   | T0016   |
|                           | 16 D (GM), 16 DA (GM)   | 03/82 → 08/88   | Man. GBX,<br>→IMot. 14 478630   | VKPC 85406   |   |   |   | 1   |   |   |   |
|  | 16 D (GM), 16 DA (GM)   | 03/82 → 08/88   | Man. GBX,<br>Mot. 14 478631 I→  | VKPC 85408   |   |   |   | 1   |   |   |   |
|  | 16 D (GM), 16 DA (GM)   | 03/82 → 08/88   | Auto. GBX,<br>→IMot. 14 503756  | VKPC 85406   |   |   |   | 1   |   |   |   |
|  | 16 D (GM), 16 DA (GM)   | 03/82 → 08/88   | Auto. GBX,<br>Mot. 14 503757 I→   | VKPC 85408   |   |   |   | 1   |   |   |   |
|                           | B(Alt) 16 D (GM), 16 DA (GM)  | 03/82 → 08/88   |   | VKMV 10AVx913  |   |   | 1   |   |   |   |   |
|  | B(PS) 16 D (GM), 16 DA (GM)   | 03/82 → 08/88   |   | VKMV 10AVx850  |   |   | 1   |   |   |   |   |
| <b>OPEL  ASTRA F 1.4</b>  |   |   |   |  |   |   |   |   |   |   |   |
|                           | 14 NV, 14 SE, C 14 NZ,<br>C 14 SE, X 14 NZ  | 09/91 → 03/01   |                                | VKMC 05121<br>VKMA 05121<br>VKM 15121  | 1<br>1<br>1   | 1<br>1  |   | 1   |   |   | 1<br>1<br>1 T0092   |
|  | 14 NV, 14 SE, C 14 NZ,<br>C 14 SE, X 14 NZ  | 09/91 → 03/01   | 3)  | VKMS 05121<br>VKMA 05121<br>VKM 15121  | 1<br>1<br>1   | 1<br>1  |   |   | 2   |   | 1<br>1<br>1 T0092   |
|                           | 14 NV, 14 SE, C 14 NZ,<br>C 14 SE, X 14 NZ  | 09/91 → 03/01   |   | VKPC 85206   |   |   |   | 1   |   |   |   |
|                           | B(Alt) 14 NV  | 09/91 → 09/93   |                                | VKMV 10AVx875  |   |   | 1   |   |   |   |   |
|  | B(Alt) 14 SE, C 14 SE   | 03/92 → 03/01   | AC,                            | VKMV 6PK1795<br>VKM 35002<br>VKM 35009   | 1   | 1   |   |   |   |   |   |
|  | B(Alt) 14 SE, C 14 SE   | 01/93 → 03/01   | AC,                            | VKMA 35008<br>VKMV 6PK1460<br>VKM 35008  | 1<br>1  | 1<br>1  |   |   |   |   |   |
|  | B(Alt) 14 SE, C 14 SE   | 01/93 → 03/01   | AC,                            | VKMA 35125<br>VKMV 6PK1795<br>VKM 35009  | 1<br>1  | 1<br>1  |   |   |   |   |   |































|   |               |   |               |   |   |  |             |             |  |   |  |   |             |             |  |  |  |       |
|---|---------------|---|---------------|---|---|---|-------------|-------------|--|---|--|---|-------------|-------------|--|--|--|-------|
|   | <b>B(Alt)</b> | C 14 NZ, X 14 NZ                                    | 01/93 → 01/99 |    | VKMA 35008<br>VKMV 6PK1460<br>VKM 35008                         | 1<br>1<br>1   | 1<br>1      |             |  |   |  |   |             |             |  |  |  |       |
| <b>OPEL  ASTRA F 1.4 16V</b>   |               |   |               |   |   |   |             |             |  |   |  |   |             |             |  |  |  |       |
|                                 |               | X 14 XE   | 01/96 → 03/01 | 3)  | VKMS 05150<br>VKMA 05150<br>VKM 15216<br>VKM 25150<br>VKM 25152 | 1<br>1<br>1   | 2<br>2<br>1 | 1<br>1<br>1 |  |   |  |   | 3<br>3<br>1 | 3<br>3<br>1 |  |  |  | T0107 |
|                                 |               | X 14 XE   | 01/96 → 03/01 |   | VKPC 85212  |   |             |             |  | 1 |  |   |             |             |  |  |  |       |
|                                 | <b>B(Alt)</b> | X 14 XE   | 01/96 → 03/01 |       | VKMV 6PK895<br>VKM 35011  | 1   |             | 1           |  |   |  |   |             |             |  |  |  |       |
|   | <b>B(Alt)</b> | X 14 XE   | 01/96 → 03/01 |       | VKMA 35025<br>VKMV 6PK1530<br>VKM 35009                         | 1<br>1  |             | 1<br>1      |  |   |  |   |             |             |  |  |  |       |
|   | <b>B(Alt)</b> | X 14 XE   | 01/96 → 03/01 |       | VKMA 35125<br>VKMV 6PK1795<br>VKM 35009                         | 1<br>1  |             | 1<br>1      |  |   |  |   |             |             |  |  |  |       |
| <b>OPEL  ASTRA F 1.6</b>       |               |   |               |   |   |   |             |             |  |   |  |   |             |             |  |  |  |       |
|                                 |               | C 16 NZ, C 16 NZR,<br>C 16 SE, X 16 SZ,<br>X 16 SZR | 09/91 → 03/01 |    | VKMC 05121<br>VKMA 05121<br>VKM 15121                           | 1<br>1<br>1   |             | 1<br>1      |  | 1 |  |   |             | 1<br>1<br>1 |  |  |  | T0092 |
|   |               | C 16 NZ, C 16 NZR,<br>C 16 SE, X 16 SZ,<br>X 16 SZR | 09/91 → 03/01 | 3)  | VKMS 05121<br>VKMA 05121<br>VKM 15121                           | 1<br>1<br>1   |             | 1<br>1      |  |   |  | 2 |             | 1<br>1<br>1 |  |  |  | T0092 |
|   |               | 16 LZ2, 16 NZ2                                      | 09/95 → 09/98 |   | VKMA 05402<br>VKM 15402   | 1<br>1  |             | 1           |  |   |  |   |             |             |  |  |  | T0105 |
|                               |               | 16 LZ2, 16 NZ2                                      | 09/95 → 09/98 |   | VKPC 85409  |   |             |             |  | 1 |  |   |             |             |  |  |  |       |
|   |               | C 16 NZ, C 16 NZR,<br>C 16 SE, X 16 SZ,<br>X 16 SZR | 09/91 → 03/01 |   | VKPC 85206  |   |             |             |  | 1 |  |   |             |             |  |  |  |       |
|                               | <b>B(Alt)</b> | 16 LZ2, 16 NZ2                                      | 09/95 → 09/98 |    | VKMA 35009<br>VKMV 6PK1725<br>VKM 35009                         | 1<br>1  |             | 1<br>1      |  |   |  |   |             |             |  |  |  |       |
|   | <b>B(Alt)</b> | 16 LZ2, 16 NZ2                                      | 09/95 → 09/98 |    | VKMA 35109<br>VKMV 6PK1900<br>VKM 35009                         | 1<br>1  |             | 1<br>1      |  |   |  |   |             |             |  |  |  |       |
|   | <b>B(Alt)</b> | C 16 NZ, C 16 NZR,<br>C 16 SE, X 16 SZ,<br>X 16 SZR | 09/91 → 03/01 |   | VKMV 6PK1795<br>VKM 35002<br>VKM 35009                          | 1   |             | 1           |  |   |  |   |             |             |  |  |  |       |
|   | <b>B(Alt)</b> | C 16 NZ, C 16 NZR,<br>C 16 SE, X 16 SZ,<br>X 16 SZR | 01/93 → 03/01 |   | VKMA 35008<br>VKMV 6PK1460<br>VKM 35008                         | 1<br>1  |             | 1<br>1      |  |   |  |   |             |             |  |  |  |       |
|   | <b>B(Alt)</b> | C 16 NZ, C 16 NZR,<br>C 16 SE, X 16 SZ,<br>X 16 SZR | 01/93 → 03/01 |   | VKMA 35125<br>VKMV 6PK1795<br>VKM 35009                         | 1<br>1  |             | 1<br>1      |  |   |  |   |             |             |  |  |  |       |
| <b>OPEL  ASTRA F 1.6 16V</b> |               |   |               |   |   |   |             |             |  |   |  |   |             |             |  |  |  |       |
|                               |               | X 16 XEL  | 08/94 → 09/98 | 3)  | VKMS 05150<br>VKMA 05150<br>VKM 15216<br>VKM 25150<br>VKM 25152 | 1<br>1<br>1   | 2<br>2<br>1 | 1<br>1<br>1 |  |   |  |   | 3<br>3<br>1 | 3<br>3<br>1 |  |  |  | T0107 |
|                               |               | X 16 XEL  | 08/94 → 09/98 |   | VKPC 85212  |   |             |             |  | 1 |  |   |             |             |  |  |  |       |
|                               | <b>B(Alt)</b> | X 16 XEL  | 08/94 → 09/98 |   | VKMV 6PK895<br>VKM 35011  | 1   |             | 1           |  |   |  |   |             |             |  |  |  |       |

| B(Alt)                       | X 16 XEL                             | 08/94 → 09/98 | AC, ⊕              | VKMA 35025<br>VKMV 6PK1530<br>VKM 35009                         | 1                     | 1           |        |   |   |   |  |  |   |  |  |  |  |       |
|------------------------------|--------------------------------------|---------------|--------------------|---|-----------------------|-------------|--------|---|---|---|--|--|---|--|--|--|--|-------|
| B(Alt)                       | X 16 XEL                             | 08/94 → 09/98 | AC, ⊕              | VKMA 35125<br>VKMV 6PK1795<br>VKM 35009                         | 1                     | 1           |        |   |   |   |  |  |   |  |  |  |  |       |
| <b>OPEL  ASTRA F 1.8</b>     |                                      |               |                    |   |                       |             |        |   |   |   |  |  |   |  |  |  |  |       |
|                              | C 18 NZ                              | 09/91 → 09/98 | →   Mot. 14 254438 | VKMC 05401  |                       | 1           |        | 1 |   |   |  |  |   |  |  |  |  | T0225 |
|                              | C 18 NZ                              | 09/91 → 09/98 | Mot. 14 254439   → | VKMA 05402<br>VKM 15402   | 1                     | 1           |        |   |   |   |  |  |   |  |  |  |  | T0105 |
|                              | C 18 NZ                              | 09/91 → 09/98 | →   Mot. 14 254438 | VKPC 85407  |                       |             |        |   | 1 |   |  |  |   |  |  |  |  |       |
|                              | C 18 NZ                              | 09/91 → 09/98 | Mot. 14 254439   → | VKPC 85409  |                       |             |        |   | 1 |   |  |  |   |  |  |  |  |       |
|                              | B(Alt) C 18 NZ                       | 01/94 → 09/98 | AC                 | VKMA 35009<br>VKMV 6PK1725<br>VKM 35009                         | 1                     | 1           |        |   |   |   |  |  |   |  |  |  |  |       |
| B(Alt)                       | C 18 NZ                              | 01/94 → 09/98 | AC                 | VKMA 35109<br>VKMV 6PK1900<br>VKM 35009                         | 1                     | 1           |        |   |   |   |  |  |   |  |  |  |  |       |
| <b>OPEL  ASTRA F 1.8 16V</b> |                                      |               |                    |   |                       |             |        |   |   |   |  |  |   |  |  |  |  |       |
|                              | C 18 XE, C 18 XEL,<br>X 18 XE        | 06/93 → 03/01 | 3)                 | VKMS 05222<br>VKMA 05222<br>VKM 15202<br>VKM 25212<br>VKM 25212 | 1<br>1<br>1<br>1<br>1 | 2<br>2<br>1 | 1<br>1 |   |   |   |  |  | 3 |  |  |  |  | T0116 |
|                              | C 18 XE, C 18 XEL,<br>X 18 XE        | 06/93 → 03/01 |                    | VKPC 85611  |                       |             |        |   |   | 1 |  |  |   |  |  |  |  |       |
|                              | B(Alt) C 18 XE, C 18 XEL,<br>X 18 XE | 01/94 → 03/01 | AC                 | VKMA 35009<br>VKMV 6PK1725<br>VKM 35009                         | 1                     | 1           |        |   |   |   |  |  |   |  |  |  |  |       |
| B(Alt)                       | C 18 XE, C 18 XEL,<br>X 18 XE        | 01/94 → 03/01 | AC                 | VKMA 35109<br>VKMV 6PK1900<br>VKM 35009                         | 1                     | 1           |        |   |   |   |  |  |   |  |  |  |  |       |
| <b>OPEL  ASTRA F 2.0</b>     |                                      |               |                    |   |                       |             |        |   |   |   |  |  |   |  |  |  |  |       |
|                              | C 20 NE                              | 09/91 → 09/98 | →   Mot. 14 608700 | VKMC 05401  |                       |             | 1      | 1 |   |   |  |  |   |  |  |  |  | T0225 |
|                              | C 20 NE                              | 09/91 → 09/98 | Mot. 14 608701   → | VKMA 05402<br>VKM 15402   | 1<br>1                | 1           |        |   |   |   |  |  |   |  |  |  |  | T0105 |
|                              | C 20 NE                              | 09/91 → 09/98 | →   Mot. 14 608700 | VKPC 85407  |                       |             |        |   | 1 |   |  |  |   |  |  |  |  |       |
|                              | C 20 NE                              | 09/91 → 09/98 | Mot. 14 608701   → | VKPC 85409  |                       |             |        |   | 1 |   |  |  |   |  |  |  |  |       |
|                              | B(Alt) C 20 NE                       | 01/94 → 09/98 | AC                 | VKMA 35009<br>VKMV 6PK1725<br>VKM 35009                         | 1                     | 1           |        |   |   |   |  |  |   |  |  |  |  |       |
| B(Alt)                       | C 20 NE                              | 01/94 → 09/98 | AC                 | VKMA 35109<br>VKMV 6PK1900<br>VKM 35009                         | 1                     | 1           |        |   |   |   |  |  |   |  |  |  |  |       |
| <b>OPEL  ASTRA F 2.0 16V</b> |                                      |               |                    |   |                       |             |        |   |   |   |  |  |   |  |  |  |  |       |
|                              | X 20 XEV                             | 02/95 → 09/98 | 3)                 | VKMS 05222<br>VKMA 05222<br>VKM 15202<br>VKM 25212<br>VKM 25212 | 1<br>1<br>1<br>1<br>1 | 2<br>2<br>1 | 1<br>1 |   |   |   |  |  | 3 |  |  |  |  | T0116 |
|                              | C 20 XE                              | 09/91 → 09/98 | →   Mot. 14 142838 | VKMA 05211<br>VKM 15211<br>VKM 25211                            | 1<br>1<br>1           | 1<br>1      | 1      |   |   |   |  |  |   |  |  |  |  | T0063 |
|                              | C 20 XE                              | 09/91 → 09/98 | Mot. 14 142839   → | VKMA 05220<br>VKM 15202<br>VKM 25212<br>VKM 25213               | 1<br>1<br>1<br>1      | 2<br>1      | 1      |   |   |   |  |  |   |  |  |  |  | T0106 |
|                              | C 20 XE                              | 09/91 → 01/98 | →   Mot. 14 142839 | VKPC 85610  |                       |             |        |   | 1 |   |  |  |   |  |  |  |  |       |
|                              | C 20 XE                              | 09/91 → 01/98 | Mot. 14 142840   → | VKPC 85611  |                       |             |        |   | 1 |   |  |  |   |  |  |  |  |       |
|                              | X 20 XEV                             | 02/95 → 09/98 |                    | VKPC 85611  |                       |             |        |   | 1 |   |  |  |   |  |  |  |  |       |
|                              | B(Alt) C 20 XE, X 20 XEV             | 09/91 → 09/98 | AC                 | VKMA 35009<br>VKMV 6PK1725<br>VKM 35009                         | 1                     | 1           |        |   |   |   |  |  |   |  |  |  |  |       |





















|   |               |  |  |                          |  |  |  |  |  |  |  |  |
|---|---------------|---|---|---|--|---|---|---|---|---|---|---|
|   | <b>B(Alt)</b> | C 20 XE, X 20 XEV   | 09/91 → 09/98   | AC  | VKMA 35109<br>VKMV 6PK1900<br>VKM 35009  | 1   | 1   |   |   |   |   |   |
| <b>OPEL  ASTRA F 1.7 D</b>             |               |   |   |   |  |   |   |   |   |   |   |   |
|   |               | 17 D (GM)   | 12/91 → 09/92   |  → <b>Mot.</b> 14 363651 | VKMC 05201<br>VKMA 05201<br>VKM 25201  | 1   | 1   | 1   |   |   |   | T0045   |
|   |               | 17 D (GM)   | 12/91 → 09/92   | <b>Mot.</b> 14 363652 <b>I</b> →  | VKMA 05201<br>VKM 25201  | 1   | 1   |   |   |   |   | T0045   |
|   |               | 17 DR (GM)  | 07/92 → 01/99   |   | VKMA 05202<br>VKM 15202<br>VKM 25202   | 1   | 1   | 1   |   |   |   | T0654   |
|   |               | 17 D (GM), 17 DR (GM)   | 12/91 → 01/99   | → <b>Mot.</b> 14 363651   | VKPC 85408   |   |   |   | 1   |   |   |   |
|   |               | 17 D (GM), 17 DR (GM)   | 12/91 → 01/99   | <b>Mot.</b> 14 363652 <b>I</b> →  | VKPC 85611   |   |   |   | 1   |   |   |   |
|   | <b>B(Alt)</b> | 17 D (GM), 17 DR (GM)   | 12/91 → 01/99   |   | VKMV 10AVx925  |   | 1   |   |   |   |   |   |
|   | <b>B(PS)</b>  | 17 D (GM), 17 DR (GM)   | 12/91 → 01/99   |   | VKMV 10AVx813  |   | 1   |   |   |   |   |   |
| <b>OPEL  ASTRA F 1.7 TD</b>            |               |   |   |   |  |   |   |   |   |   |   |   |
|   |               | X 17 DTL (GM)   | 08/94 → 01/99   |   | VKMA 05202<br>VKM 15202<br>VKM 25202   | 1   | 1   | 1   |   |   |   | T0654   |
|   |               | X 17 DTL (GM)   | 08/94 → 01/99   |   | VKPC 85611   |   |   |   | 1   |   |   |   |
|   | <b>B(Alt)</b> | X 17 DTL (GM)   | 08/94 → 01/99   |   | VKMV 10AVx925  |   | 1   |   |   |   |   |   |
|   | <b>B(PS)</b>  | X 17 DTL (GM)   | 08/94 → 01/99   |   | VKMV 10AVx813  |   | 1   |   |   |   |   |   |
| <b>OPEL  ASTRA F 1.7 TDS</b>           |               |   |   |   |  |   |   |   |   |   |   |   |
|                                        |               | 17 TD (ISUZU)   | 12/91 → 12/94   |   | VKMA 05213<br>VKM 15213<br>VKM 25208   | 1   | 1   | 1   |   |   |   | 1 T0062   |
|   |               | 17 TD (ISUZU)   | 01/95 → 09/98   |   | VKMA 05214<br>VKM 15215<br>VKM 25208   | 1   | 1   | 1   |   |   |   | 1 T0062   |
|                                       |               | 17 TD (ISUZU)   | 12/91 → 12/97   | → <b>ICH</b> V2087236,<br>V8141366  | VKPC 85404   |   |   |   | 1   |   |   |   |
|   |               | 17 TD (ISUZU)   | 01/97 → 09/98   | <b>CH</b> V2087237,<br>V8141367 <b>I</b> →  | VKPC 85620   |   |   |   | 1   |   |   |   |
|                                       | <b>B(Alt)</b> | 17 TD (ISUZU)   | 12/91 → 09/98   |   | VKMV 13AVx915  |   | 1   |   |   |   |   |   |
|   | <b>B(PS)</b>  | 17 TD (ISUZU)   | 12/91 → 09/98   |   | VKMV 10AVx950  |   | 1   |   |   |   |   |   |
| <b>OPEL  ASTRA F CLASSIC 1.4</b>     |               |   |   |   |  |   |   |   |   |   |   |   |
|                                       |               | X 14 NZ   | 01/98 → 01/05   |                        | VKMC 05121<br>VKMA 05121<br>VKM 15121  | 1   | 1   | 1   |   |   |   | 1 T0092   |
|   |               | X 14 NZ   | 01/98 → 01/05   | 3)  | VKMS 05121<br>VKMA 05121<br>VKM 15121  | 1   | 1   |   |   | 2   |   | 1 T0092   |
|                                       |               | X 14 NZ   | 01/98 → 01/05   |   | VKPC 85206   |   |   |   | 1   |   |   |   |
|                                       | <b>B(Alt)</b> | X 14 NZ   | 01/98 → 01/05   |                        | VKMV 10AVx925  |   | 1   |   |   |   |   |   |
|   | <b>B(Alt)</b> | X 14 NZ   | 01/98 → 01/05   |                        | VKMA 35008<br>VKMV 6PK1460<br>VKM 35008  | 1   | 1   |   |   |   |   |   |
| <b>OPEL  ASTRA F CLASSIC 1.6</b>     |               |   |   |   |  |   |   |   |   |   |   |   |
|                                       |               | X 16 SZR  | 01/98 → 01/05   |                        | VKMC 05121<br>VKMA 05121<br>VKM 15121  | 1   | 1   | 1   |   |   |   | 1 T0092   |
|   |               | X 16 SZR  | 01/98 → 01/05   | 3)  | VKMS 05121<br>VKMA 05121<br>VKM 15121  | 1   | 1   |   |   | 2   |   | 1 T0092   |
|                                       |               | X 16 SZR  | 01/98 → 01/05   |   | VKPC 85206   |   |   |   | 1   |   |   |   |
|                                       | <b>B(Alt)</b> | X 16 SZR  | 01/98 → 01/05   |                        | VKMV 10AVx925  |   | 1   |   |   |   |   |   |
|   | <b>B(Alt)</b> | X 16 SZR  | 01/98 → 01/05   |                        | VKMA 35008<br>VKMV 6PK1460<br>VKM 35008  | 1   | 1   |   |   |   |   |   |
| <b>OPEL  ASTRA F CLASSIC 1.6 16V</b> |               |   |   |   |  |   |   |   |   |   |   |   |
|                                       |               | X 16 XEL  | 01/98 → 09/98   | 3)  | VKMS 05150<br>VKMA 05150<br>VKM 15216  | 1   | 2   | 1   |   |   | 3   | 3 T0107   |













|   |  |  |                                   |  |  |  |  |  |  |  |  |  |
|---|---|---|--|--|---|---|---|---|---|---|---|---|
|   |   |   |  | VKM 25150<br>VKM 25152   | 1<br>1  |   |   |   |   |   |   |   |
|                              | X 16 XEL  | 01/98 → 01/05   | → Mot. 02 MV7224,<br>20 U75998   | VKPC 85212   |   |   |   | 1   |   |   |   |   |
|   | X 16 XEL  | 01/98 → 01/05   | Mot. 02 MV7225,<br>20 U75999  →  | VKPC 85211   |   |   |   | 1   |   |   |   |   |
|                              | <b>B(Alt)</b> X 16 XEL  | 01/98 → 01/05   |  | VKMA 35025<br>VKMV 6PK1530<br>VKM 35009  | 1<br><br>1  | 1<br>1  |   |   |   |   |   |   |
| <b>OPEL  ASTRA G 1.2 16V</b> |   |   |  |  |   |   |   |   |   |   |   |   |
|                              | X 12 XE, Z 12 XE  | 02/98 → 01/05   |  | <b>OXOXOXO</b>   |   |   |   |   |   |   |   |   |
|                              | X 12 XE, Z 12 XE  | 02/98 → 01/05   |  | VKPC 85220   |   |   |   | 1   |   |   |   |   |
|                              | <b>B(Alt)</b> X 12 XE, Z 12 XE  | 02/98 → 01/05   | <b>AC</b>  | VKMA 35113<br>VKMV 5PK1230<br>VKM 35013  | 1<br><br>1  | 1<br>1  |   |   |   |   |   |   |
|   | <b>B(Alt)</b> X 12 XE, Z 12 XE  | 02/98 → 01/05   | <b>AC</b>  | VKMA 35013<br>VKMV 5PK1355<br>VKM 35013  | 1<br><br>1  | 1<br>1  |   |   |   |   |   |   |
| <b>OPEL  ASTRA G 1.4 16V</b> |   |   |  |  |   |   |   |   |   |   |   |   |
|                              | X 14 XE, Z 14 XE  | 02/98 → 12/04   | 3), → Mot. 02 HL5117,<br>20 041690   | VKMS 05152-1<br>VKMA 05152<br>VKM 15216<br>VKM 25150<br>VKM 25152                  | 1<br>1<br>1<br><br>1  | 2<br>2<br><br>1<br>1  | 1<br>1  |   |   | 3<br>3<br>1   | 3<br>3<br>1   | T0157   |
|   | X 14 XE, Z 14 XE  | 02/98 → 12/04   | 3), Mot. 02 HL5118,<br>20 041691  →,<br>→ Mot. 20 EB2048   | VKMS 05154-1<br>VKMA 05154<br>VKM 15216<br>VKM 25152<br>VKM 25312                  | 1<br>1<br>1<br><br>1  | 2<br>2<br><br>1<br>1  | 1<br>1  |   |   | 3<br>2<br>1   | 3<br>2<br>1   | T0157   |
|   | X 14 XE, Z 14 XE  | 01/05 → 01/05   | Mot. 20 EB2049  →  | VKMA 05156<br>VKM 15216<br>VKM____<br>VKM 25158                                    | 1<br>1<br><br>1   | 2<br><br>1<br>1   | 1   |   |   | 1<br>1  | 1<br>1  | T0157   |
|                            | X 14 XE, Z 14 XE  | 02/98 → 01/05   | → Mot. 02 MV7224,<br>20 U75998   | VKPC 85212   |   |   |   | 1   |   |   |   |   |
|   | X 14 XE, Z 14 XE  | 02/98 → 01/05   | Mot. 02 MV7225,<br>20 U75999  →  | VKPC 85211   |   |   |   | 1   |   |   |   |   |
|                            | <b>B(Alt)</b> X 14 XE, Z 14 XE  | 02/98 → 01/05   | <b>AC</b>  | VKMA 35012<br>VKMV 5PK938<br>VKM 35012   | 1<br><br>1  | 1<br>1  |   |   |   |   |   |   |
|   | <b>B(Alt)</b> X 14 XE, Z 14 XE  | 02/98 → 01/05   | <b>AC</b>  | VKMA 35022<br>VKMV 5PK1212<br>VKM 35012  | 1<br><br>1  | 1<br>1  |   |   |   |   |   |   |
| <b>OPEL  ASTRA G 1.6</b>   |   |   |  |  |   |   |   |   |   |   |   |   |
|                            | X 16 SZR  | 02/98 → 09/00   |  → Mot. 02 MZ5253               | VKMC 05121<br>VKMA 05121<br>VKM 15121  | 1<br>1<br>1   | 1<br>1  | 1   |   |   | 1<br>1<br>1   | 1<br>1<br>1   | T0092   |
|   | Z 16 SE   | 09/00 → 04/05   |  → Mot. 02 MZ5253,<br>20 U75998 | VKMC 05121<br>VKMA 05121<br>VKM 15121  | 1<br>1<br>1   | 1<br>1  | 1   |   |   | 1<br>1<br>1   | 1<br>1<br>1   | T0092   |
|   | X 16 SZR, Z 16 SE   | 02/98 → 04/05   | 3)   | VKMS 05121<br>VKMA 05121<br>VKM 15121  | 1<br>1<br>1   | 1<br>1  |   |   |   | 2<br>1<br>1   | 1<br>1<br>1   | T0092   |
|                            | X 16 SZR  | 02/98 → 09/00   | → Mot. 02 MZ5253   | VKPC 85206   |   |   |   | 1   |   |   |   |   |
|   | X 16 SZR  | 02/98 → 09/00   | Mot. 02 MZ5254  →  | VKPC 85460   |   |   |   | 1   |   |   |   |   |
|   | Z 16 SE   | 09/00 → 04/05   | → Mot. 02 MZ5253,<br>20 U75998   | VKPC 85206   |   |   |   | 1   |   |   |   |   |
|   | Z 16 SE   | 09/00 → 04/05   | Mot. 02 MZ5254,<br>20 U75999  →  | VKPC 85460   |   |   |   | 1   |   |   |   |   |
|                            | <b>B(Alt)</b> X 16 SZR, Z 16 SE   | 02/98 → 04/05   | <b>AC</b>  | VKMA 35012<br>VKMV 5PK938<br>VKM 35012   | 1<br><br>1  | 1<br>1  |   |   |   |   |   |   |





































OPEL







































|   |  |  |  |  |  |  |  |  |  |  |  |  |
|---|---|---|---|--|---|---|---|---|---|---|---|---|
| <b>B(Alt)</b>   | X 16 SZR, Z 16 SE   | 02/98 → 04/05   | <b>AC</b>   | VKMA 35022<br>VKMV 5PK1212<br>VKM 35012  | 1<br>1<br>1   | 1<br>1  |   |   |   |   |   |   |
| <b>OPEL  ASTRA G 1.6 16V</b>       |   |   |   |  |   |   |   |   |   |   |   |   |
|                                     | C 16 SEL, X 16 XEL,<br>Z 16 XE  | 02/98 → 10/05   | 3), → <b>I</b> Mot. 02 HL5117,<br>20 041690                                       | VKMS 05152-1<br>VKMA 05152<br>VKM 15216<br>VKM 25150<br>VKM 25152                  | 1<br>1<br>1   | 2<br>2<br>1   | 1   |   |   | 3   | 3   | T0157   |
|   | C 16 SEL, X 16 XEL,<br>Z 16 XE  | 02/98 → 10/05   | 3), <b>Mot.</b> 02 HL5118,<br>20 041691 <b>I</b> →,<br>→ <b>I</b> Mot. 20 EB2048  | VKMS 05154-1<br>VKMA 05154<br>VKM 15216<br>VKM 25152<br>VKM 25312                  | 1<br>1<br>1   | 2<br>2<br>1   | 1   |   |   | 3   | 3   | T0157   |
|   | C 16 SEL, X 16 XEL,<br>Z 16 XE  | 02/98 → 10/05   | <b>Mot.</b> 20 EB2049 <b>I</b> →  | VKMA 05156<br>VKM 15216<br>VKM____<br>VKM 25158                                    | 1<br>1  | 2<br>1  | 1   |   |   |   | 1   | T0157   |
|   | Z 16 XEP  | 12/02 → 10/05   |   | VKMA____<br>VKM 15260<br>VKM____   | 1<br>1  | 1<br>1  | 1   |   |   |   | 2   | T0244   |
|                                    | C 16 SEL, X 16 XEL,<br>Z 16 XE  | 02/98 → 10/05   | → <b>I</b> Mot. 02 MV7224,<br>20 U75998   | VKPC 85212   |   |   |   |   | 1   |   |   |   |
|   | C 16 SEL, X 16 XEL,<br>Z 16 XE  | 02/98 → 10/05   | <b>Mot.</b> 02 MV7225,<br>20 U75999 <b>I</b> →                                    | VKPC 85211   |   |   |   |   | 1   |   |   |   |
|   | Z 16 XEP  | 03/00 → 10/05   |   | VKPC____   |   |   |   |   | 1   |   |   |   |
|                                   | <b>B(Alt)</b> C 16 SEL, X 16 XEL,<br>Z 16 XE                                      | 02/98 → 10/05   | <b>AC</b>   | VKMA 35012<br>VKMV 5PK938<br>VKM 35012   | 1<br>1  | 1<br>1  |   |   |   |   |   |   |
| <b>B(Alt)</b>   | C 16 SEL, X 16 XEL,<br>Z 16 XE  | 02/98 → 10/05   | <b>AC</b>   | VKMA 35022<br>VKMV 5PK1212<br>VKM 35012  | 1<br>1  | 1<br>1  |   |   |   |   |   |   |
| <b>B(Alt)</b>   | Z 16 XEP  | 12/02 → 10/05   | <b>AC</b>   | VKMV 5PK1450<br>VKM 35260  | 1   | 1   |   |   |   |   |   |   |
| <b>B(Alt)</b>   | Z 16 XEP  | 12/02 → 10/05   | <b>AC</b>   | VKMV 5PK1546<br>VKM 35260  | 1   | 1   |   |   |   |   |   |   |
| <b>OPEL  ASTRA G 1.6 16V CNG</b> |   |   |   |  |   |   |   |   |   |   |   |   |
|                                   | Z 16 YNG  | 03/03 → 07/04   | 3), → <b>I</b> Mot. 20 EB2048   | VKMS 05154-1<br>VKMA 05154<br>VKM 15216<br>VKM 25152<br>VKM 25312                  | 1<br>1<br>1   | 2<br>2<br>1   | 1   |   |   | 3   | 3   | T0157   |
|   | Z 16 YNG  | 03/03 → 07/04   | <b>Mot.</b> 20 EB2049 <b>I</b> →  | VKMA 05156<br>VKM 15216<br>VKM____<br>VKM 25158                                    | 1<br>1  | 2<br>1  | 1   |   |   |   | 1   | T0157   |
|                                   | Z 16 YNG  | 03/03 → 07/04   |   | VKPC 85211   |   |   |   |   | 1   |   |   |   |
|                                   | <b>B(Alt)</b> Z 16 YNG  | 03/03 → 07/04   | <b>AC</b>   | VKMA 35012<br>VKMV 5PK938<br>VKM 35012   | 1<br>1  | 1<br>1  |   |   |   |   |   |   |
| <b>B(Alt)</b>   | Z 16 YNG  | 03/03 → 07/04   | <b>AC</b>   | VKMA 35022<br>VKMV 5PK1212<br>VKM 35012  | 1<br>1  | 1<br>1  |   |   |   |   |   |   |











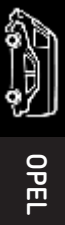





















| OPEL  ASTRA G 1.8 16V         |  |               |  |   |             |             |        |   |             |       |
|--|--|---------------|--|---|-------------|-------------|--------|---|-------------|-------|
|                               | X 18 XE1, Z 18 XE,<br>Z 18 XEL               | 02/98 → 12/02 | 3), → <b>I</b> Mot. 02 HL5117,<br>20 041690                                      | VKMS 05152-2<br>VKMA 05152<br>VKM 15216<br>VKM 25150<br>VKM 25152 | 1<br>1<br>1 | 2<br>2<br>1 | 1<br>1 |   | 3<br>3<br>1 | T0157 |
|  | X 18 XE1, Z 18 XE,<br>Z 18 XEL               | 02/98 → 12/02 | 3), <b>Mot.</b> 02 HL5118,<br>20 041691 <b>I</b> →,<br>→ <b>I</b> Mot. 20 EB2048 | VKMS 05154-2<br>VKMA 05154<br>VKM 15216<br>VKM 25152<br>VKM 25312 | 1<br>1<br>1 | 2<br>2<br>1 | 1<br>1 |   | 3<br>2<br>1 | T0157 |
|  | Z 18 XE                                      | 01/03 → 05/05 | 3), → <b>I</b> Mot. 02 HL5117,<br>20 041690                                      | VKMS 05152-3<br>VKMA 05152<br>VKM 15216<br>VKM 25150<br>VKM 25152 | 1<br>1      | 2<br>2<br>1 | 1<br>1 |   | 3<br>3<br>1 | T0157 |
|  | Z 18 XE                                      | 01/03 → 11/03 | 3), <b>Mot.</b> 02 HL5118,<br>20 041691 <b>I</b> →,<br>→ <b>I</b> Mot. 02 EB2048 | VKMS 05154-3<br>VKMA 05154<br>VKM 15216<br>VKM 25152<br>VKM 25312 | 1<br>1<br>1 | 2<br>2<br>1 | 1<br>1 |   | 3<br>2<br>1 | T0157 |
|  | X 18 XE1, Z 18 XE                            | 02/98 → 10/05 | <b>Mot.</b> 20 EB2049 <b>I</b> →   | VKMA 05156<br>VKM 15216<br>VKM____<br>VKM 25158                   | 1<br>1      | 2<br>1      | 1<br>1 |   | 1<br>1      | T0157 |
|                             | X 18 XE1, Z 18 XE,<br>Z 18 XEL               | 02/98 → 10/05 |  | VKPC 85624  |             |             |        | 1 |             |       |
|                             | <b>B(Alt)</b> X 18 XE1, Z 18 XE,<br>Z 18 XEL | 02/98 → 10/05 | <b>AC</b>  | VKMA 35012<br>VKMV 5PK938<br>VKM 35012                            | 1<br>1      |             | 1<br>1 |   |             |       |
|  | <b>B(Alt)</b> X 18 XE1, Z 18 XE,<br>Z 18 XEL | 02/98 → 10/05 | <b>AC</b>  | VKMA 35022<br>VKMV 5PK1212<br>VKM 35012                           | 1<br>1      |             | 1<br>1 |   |             |       |
| OPEL  ASTRA G 2.0 16V       |  |               |  |   |             |             |        |   |             |       |
|                             | X 20 XER                                     | 11/99 → 09/02 |  | VKMA 05140<br>VKM 15140<br>VKM 25224<br>VKM 25224                 | 1<br>1      | 2<br>1      | 1<br>1 |   |             | T0172 |
|  | X 20 XEV                                     | 02/98 → 01/05 |  | VKMA 05224<br>VKM 15202<br>VKM 25224<br>VKM 25224                 | 1<br>1      | 2<br>1      | 1<br>1 |   |             | T0172 |
|                             | X 20 XER, X 20 XEV                           | 02/98 → 01/05 |  | VKPC 85611  |             |             |        | 1 |             |       |
|                             | <b>B(Alt)</b> X 20 XER, X 20 XEV             | 02/98 → 01/05 | <b>AC</b>  | VKMV 5PK938   |             |             | 1      |   |             |       |
|  | <b>B(Alt)</b> X 20 XER, X 20 XEV             | 02/98 → 01/05 | <b>AC</b>  | VKMA 35119<br>VKMV 5PK1680<br>VKM 35009                           | 1<br>1      |             | 1<br>1 |   |             |       |
| OPEL  ASTRA G 2.0 16V Turbo |  |               |  |   |             |             |        |   |             |       |
|                             | Z 20 LET                                     | 09/00 → 12/03 |  | VKMA 05140<br>VKM 15140<br>VKM 25224<br>VKM 25224                 | 1<br>1      | 2<br>1      | 1<br>1 |   |             | T0172 |
|  | Z 20 LET                                     | 01/04 → 10/05 |  | VKMA____<br>VKM 15140<br>VKM____<br>VKM 25224                     | 1<br>1      | 2<br>1      | 1<br>1 |   |             | T0172 |
|                             | Z 20 LET                                     | 09/00 → 10/05 |  | VKPC 85611  |             |             |        | 1 |             |       |



|   |  |  |            |  |  |  |  |  |  |  |  |
|---|---|---|---|--|---|---|---|---|---|---|---|
|  <b>B(Alt)</b> Z 20 LET             |   |   |   | VKMA 35119<br>VKMV 5PK1680<br>VKM 35009  | 1<br>1<br>1   |   |   |   |   |   |   |
| <b>OPEL  ASTRA G 2.2 16V</b>       |   |   |   |  |   |   |   |   |   |   |   |
|  Z 22 SE                            |   |   |   | <b>OXOXOXO</b>   |   |   |   |   |   |   |   |
|  Z 22 SE                            |   |   |   | VKPC 85308   |   |   |   | 1   |   |   |   |
|  <b>B(Alt)</b> Z 22 SE              |   |   | <b>AC</b>   | VKMV 5PK880<br>VKM 34027   | 1   |   |   | 1   |   |   |   |
| <b>B(Alt)</b> Z 22 SE   |   |   | <b>AC</b>   | VKMA 34027<br>VKMV 5PK1028<br>VKM 34027  | 1<br>1<br>1   |   |   | 1   |   |   |   |
| <b>OPEL  ASTRA G 1.7 TD</b>        |   |   |   |  |   |   |   |   |   |   |   |
|  X 17 DTL (GM)                      |   |   |   | VKMA 05202<br>VKM 15202<br>VKM 25202   | 1<br>1<br>1   | 1   | 1   |   |   |   | T0654   |
|  X 17 DTL (GM)                      |   |   |   | VKPC 85611   |   |   |   | 1   |   |   |   |
|  <b>B(AC)</b> X 17 DTL (GM)         |   |   |   | VKMV 4PK882  |   |   |   | 1   |   |   |   |
| <b>OPEL  ASTRA G 1.7 DTI</b>       |   |   |   |  |   |   |   |   |   |   |   |
|  Y 17 DT (ISUZU)                    |   |   | → <b>IMot.</b> 328704   | VKMA 05606<br>VKM 15215<br>VKM 25208   | 1<br>1<br>1   | 1   | 1   |   |   |   | 1 T0182   |
| Y 17 DT (ISUZU)   |   |   | <b>Mot.</b> 328705  →   | VKMA 05608<br>VKM 15218<br>VKM 25208   | 1<br>1<br>1   | 1   | 1   |   |   |   | 3 T0182   |
|  Y 17 DT (ISUZU)                   |   |   | → <b>IMot.</b> 073532   | VKPC 85620   |   |   |   | 1   |   |   |   |
|  Y 17 DT (ISUZU)                  |   |   | <b>Mot.</b> 073533  →   | VKPC 85300   |   |   |   | 1   |   |   |   |
|  <b>B(Alt)</b> Y 17 DT (ISUZU)    |   |   | <b>AC</b>   | VKMA 35215<br>VKMV 6PK1250<br>VKM 35015  | 1<br>1<br>1   |   |   | 1   |   |   |   |
| <b>B(Alt)</b> Y 17 DT (ISUZU)   |   |   | <b>AC</b>   | VKMA 35315<br>VKMV 6PK1590<br>VKM 35015<br>VKM 35025                               | 1<br>1<br>1<br>1  | 1   | 1   | 1   |   |   |   |
| <b>OPEL  ASTRA G 1.7 CDTI</b>    |   |   |   |  |   |   |   |   |   |   |   |
|  Z 17 DTL (ISUZU)                 |   |   |   | VKMA 05700<br>VKM 15218<br>VKM 25209   | 1<br>1<br>1   | 1   | 1   |   |   |   | 3 T0201   |
|  Z 17 DTL (ISUZU)                 |   |   |   | VKPC 85300   |   |   |   | 1   |   |   | 1   |
|  <b>B(Alt)</b> Z 17 DTL (ISUZU)   |   |   | <b>AC</b>   | VKMA 35015<br>VKMV 6PK1275<br>VKM 35015  | 1<br>1<br>1   |   |   | 1   |   |   |   |
| <b>B(Alt)</b> Z 17 DTL (ISUZU)  |   |   | <b>AC</b>   | VKMV 6PK1605<br>VKM 35015<br>VKM 35025   | 1<br>1<br>1   |   |   | 1   |   |   |   |
| <b>OPEL  ASTRA G 2.0 DI</b>      |   |   |   |  |   |   |   |   |   |   |   |
|  X 20 DTL, Y 20 DTL               |   |   |   | <b>OXOXOXO</b>   |   |   |   |   |   |   |   |
|  X 20 DTL, Y 20 DTL               |   |   |   | VKPC 85623   |   |   |   | 1   |   |   |   |
|  <b>B(Alt)</b> X 20 DTL, Y 20 DTL |   |   | <b>AC</b>   | VKMA 35006<br>VKMV 6PK1805<br>VKM 35007<br>VKM 35016                               | 1<br>1<br>1<br>1  | 1   | 1   |   |   |   |   |
| <b>B(Alt)</b> X 20 DTL, Y 20 DTL  |   |   | <b>AC</b>   | VKMA 35030<br>VKMV 6PK1873<br>VKM 35007<br>VKM 35016                               | 1<br>1<br>1<br>1  | 1   | 1   | 1   |   |   |   |
|  X 20 DTL, Y 20 DTL               |   |   | <b>AC. Man. GBX.</b><br>→ <b>ICH</b> 22999999,<br>25999999, 26999999,<br>28999999, 2H999999 | VKM_____   |   |   |   |   |   | 1   |   |
| X 20 DTL, Y 20 DTL  |   |   | <b>Auto. GBX.</b><br>→ <b>ICH</b> 22999999,<br>25999999, 26999999,<br>28999999, 2H999999    | VKM_____   |   |   |   |   |   | 1   |   |

|   |  |  |  |    |  |  |  |  |  |  |  |  |
|---|---|---|---|--|---|---|---|---|---|---|---|---|
|   | Y 20 DTL  | 02/98 → 01/05   | CH 32000001, 35000001, 36000001, 38000001, 3H000001 I→                            | VKM _____  |   |   |   |   |   |   | 1   |   |
| <b>OPEL  ASTRA G 2.0 DTI</b>         |   |   |   |  |   |   |   |   |   |   |   |   |
|                                      | Y 20 DTH  | 08/99 → 01/05   |   |    |   |   |   |   |   |   |   |   |
|                                      | Y 20 DTH  | 08/99 → 01/05   |   | VKPC 85623   |   |   |   |   |   |   | 1   |   |
|                                      | B(Alt) Y 20 DTH   | 08/99 → 01/05   | AC  | VKMA 35006<br>VKMV 6PK1805<br>VKM 35007<br>VKM 35016                                 | 1   | 1   | 1   |   |   |   |   |   |
|   | B(Alt) Y 20 DTH   | 08/99 → 01/05   | AC  | VKMA 35030<br>VKMV 6PK1873<br>VKM 35007<br>VKM 35016                                 | 1   | 1   | 1   |   |   |   |   |   |
|                                      | Y 20 DTH  | 08/99 → 01/05   | AC, → ICH 22999999, 25999999, 26999999, 28999999, 2H999999                        | VKM _____  |   |   |   |   |   |   | 1   |   |
|   | Y 20 DTH  | 08/99 → 01/05   | CH 32000001, 35000001, 36000001, 38000001, 3H000001 I→                            | VKM _____  |   |   |   |   |   |   | 1   |   |
| <b>OPEL  ASTRA G 2.2 DTI</b>         |   |   |   |  |   |   |   |   |   |   |   |   |
|                                      | Y 22 DTR  | 09/02 → 10/05   |   |    |   |   |   |   |   |   |   |   |
|                                      | Y 22 DTR  | 09/02 → 10/05   |   | VKPC 85623   |   |   |   |   |   |   | 1   |   |
|                                      | B(Alt) Y 22 DTR   | 09/02 → 10/05   | AC  | VKMA 35006<br>VKMV 6PK1805<br>VKM 35007<br>VKM 35016                                 | 1   | 1   | 1   |   |   |   |   |   |
|   | B(Alt) Y 22 DTR   | 09/02 → 10/05   | AC  | VKMA 35030<br>VKMV 6PK1873<br>VKM 35007<br>VKM 35016                                 | 1   | 1   | 1   |   |   |   |   |   |
| <b>OPEL  ASTRA H 1.4 16V</b>       |   |   |   |  |   |   |   |   |   |   |   |   |
|                                    | Z 14 XEL, Z 14 XEP  | 03/04 → 06/07   |   |  |   |   |   |   |   |   |   |   |
|                                    | Z 14 XEL, Z 14 XEP  | 03/04 → 10/07   |   | VKPC 85310   |   |   |   |   |   |   | 1   |   |
|                                    | B(Alt) Z 14 XEL, Z 14 XEP   | 03/04 → 06/07   | AC  | VKMA 35113<br>VKMV 5PK1230<br>VKM 35013  | 1   |   | 1   |   |   |   |   |   |
|   | B(Alt) Z 14 XEL, Z 14 XEP   | 03/04 → 06/07   | AC  | VKMA 35013<br>VKMV 5PK1355<br>VKM 35013  | 1   |   | 1   |   |   |   |   |   |
| <b>OPEL  ASTRA H 1.6 16V</b>       |   |   |   |  |   |   |   |   |   |   |   |   |
|                                    | Z 16 XEP, Z 16 XER  | 03/04 → 06/07   |   | VKMA _____<br>VKM 15260<br>VKM _____   | 1   | 1   | 1   |   |   |   |   | 2 T0244   |
|                                    | Z 16 XEP, Z 16 XER  | 03/04 → 10/07   |   | VKPC _____   |   |   |   |   |   |   | 1   |   |
|                                    | B(Alt) Z 16 XEP, Z 16 XER   | 03/04 → 06/07   | AC  | VKMA 35113<br>VKMV 5PK1230<br>VKM 35013  | 1   |   | 1   |   |   |   |   |   |
|   | B(Alt) Z 16 XEP, Z 16 XER   | 03/04 → 06/07   | AC  | VKMA 35013<br>VKMV 5PK1355<br>VKM 35013  | 1   |   | 1   |   |   |   |   |   |
| <b>OPEL  ASTRA H 1.6 16V Turbo</b> |   |   |   |  |   |   |   |   |   |   |   |   |
|                                    | Z 16 LET  | 02/07 → 06/07   |   | VKMA _____<br>VKM 15260<br>VKM _____   | 1   | 1   | 1   |   |   |   |   | 2 T0244   |
|                                    | Z 16 LET  | 02/07 → 10/07   |   | VKPC _____   |   |   |   |   |   |   | 1   |   |
|                                    | B(Alt) Z 16 LET   | 02/07 → 06/07   | AC  | VKMA 35113<br>VKMV 5PK1230<br>VKM 35013  | 1   |   | 1   |   |   |   |   |   |
|   | B(Alt) Z 16 LET   | 02/07 → 06/07   | AC  | VKMA 35013<br>VKMV 5PK1355<br>VKM 35013  | 1   |   | 1   |   |   |   |   |   |
| <b>OPEL  ASTRA H 1.8 16V</b>       |   |   |   |  |   |   |   |   |   |   |   |   |
|                                    | Z 18 XE   | 03/04 → 06/07   | 3), → I Mot. 20 EB2048  | VKMS 05154-3<br>VKMA 05154<br>VKM 15216<br>VKM 25152<br>VKM 25312                    | 1   | 2   | 1   |   |   |   | 3   | 3 T0157   |



|  |  |  |  |  |  |  |  |  |  |  |  |  |       |
|--|---|---|---|--|---|---|---|---|---|---|---|---|-------|
|  | Z 18 XE   | 03/04 → 06/07   | Mot. 20 EB2049 I→   | VKMA 05156<br>VKM 15216<br>VKM____<br>VKM 25158                                    | 1<br>1  | 2<br>1<br>1   | 1   |   |   |   |   | 1<br>1  | T0157 |
|  | Z 18 XER  | 08/05 → 03/07   |   | —<br>VKM____   | 1<br>1  | 1<br>1  | 1   |   |   |   |   |   |       |
|                                      | Z 18 XE   | 03/04 → 10/07   |   | VKPC 85624   |   |   |   | 1   |   |   |   |   |       |
|  | Z 18 XER  | 08/05 → 10/07   |   | VKPC____   |   |   |   | 1   |   |   |   |   |       |
|                                      | B(Alt) Z 18 XE  | 03/04 → 06/07   | AC  | VKMA 35012<br>VKMV 5PK938<br>VKM 35012   | 1<br>1  | 1<br>1  |   |   |   |   |   |   |       |
|  | B(Alt) Z 18 XE  | 03/04 → 06/07   | AC  | VKMA 35022<br>VKMV 5PK1212<br>VKM 35012  | 1<br>1  | 1<br>1  |   |   |   |   |   |   |       |
|  | B(Alt) Z 18 XER   | 08/05 → 06/07   | AC  | VKMV 5PK1450<br>VKM 35260  | 1   |   | 1   |   |   |   |   |   |       |
|  | B(Alt) Z 18 XER   | 08/05 → 06/07   | AC  | VKMV 5PK1546<br>VKM 35260  | 1   |   | 1   |   |   |   |   |   |       |
| <b>OPEL  ASTRA H 2.0 16V Turbo</b>  |   |   |   |  |   |   |   |   |   |   |   |   |       |
|                                      | Z 20 LEH, Z 20 LEL,<br>Z 20 LER   | 03/04 → 06/07   |   | VKMA____<br>VKM 15140<br>VKM____<br>VKM 25224                                      | 1<br>1  | 2<br>1<br>1   | 1   |   |   |   |   |   | T0172 |
|                                     | Z 20 LEH, Z 20 LEL,<br>Z 20 LER   | 03/04 → 10/07   |   | VKPC 85611   |   |   |   | 1   |   |   |   |   |       |
|                                    | B(Alt) Z 20 LEH, Z 20 LEL,<br>Z 20 LER  | 03/04 → 06/07   |   | VKMA 35119<br>VKMV 5PK1680<br>VKM 35009  | 1<br>1  | 1<br>1  |   |   |   |   |   |   |       |
| <b>OPEL  ASTRA H 1.3 CDTI</b>     |   |   |   |  |   |   |   |   |   |   |   |   |       |
|                                    | Z 13 DTH  | 04/05 → 06/07   |   | <del>XXXXXX</del>  |   |   |   |   |   |   |   |   |       |
|                                    | Z 13 DTH  | 04/05 → 10/07   |   | VKPC 85700   |   |   |   | 1   |   |   |   |   |       |
|                                    | B(Alt) Z 13 DTH   | 04/05 → 06/07   | AC  | VKMV 6PK1182<br>VKM 35023  | 1   | 1   |   |   |   |   |   |   |       |
|  | B(Alt) Z 13 DTH   | 04/05 → 06/07   | AC  | VKMV____<br>VKM 35023  | 1   | 1   |   |   |   |   |   |   |       |
| <b>OPEL  ASTRA H 1.7 CDTI 80</b>  |   |   |   |  |   |   |   |   |   |   |   |   |       |
|                                    | Z 17 DTL  | 03/04 → 06/07   |   | VKMA 05700<br>VKM 15218<br>VKM 25209   | 1<br>1  | 1<br>1  | 1   |   |   |   |   | 3<br>1  | T0201 |
|                                    | Z 17 DTL  | 03/04 → 10/07   |   | VKPC 85300   |   |   |   | 1   |   |   |   |   |       |
|                                    | B(Alt) Z 17 DTL   | 03/04 → 06/07   | AC  | VKMA 35015<br>VKMV 6PK1275<br>VKM 35015  | 1<br>1  | 1<br>1  |   |   |   |   |   |   |       |
|  | B(Alt) Z 17 DTL   | 03/04 → 06/07   | AC, → ICH 1306915   | VKMV 6PK1620<br>VKM 35025<br>VKM____   | 1<br>1  | 1   | 1   |   |   |   |   |   |       |
|  | B(Alt) Z 17 DTL   | 03/04 → 06/07   | AC, CH 1306916 I→   | VKMV 6PK1620<br>VKM____<br>VKM____   | 1<br>1  | 1   | 1   |   |   |   |   |   |       |
| <b>OPEL  ASTRA H 1.7 CDTI 100</b> |   |   |   |  |   |   |   |   |   |   |   |   |       |
|                                    | Z 17 DTH  | 03/04 → 06/07   |   | VKMA 05700<br>VKM 15218<br>VKM 25209   | 1<br>1  | 1<br>1  | 1   |   |   |   |   | 3<br>1  | T0201 |
|                                    | Z 17 DTH  | 03/04 → 10/07   |   | VKPC 85300   |   |   |   | 1   |   |   |   |   |       |
|                                    | B(Alt) Z 17 DTH   | 03/04 → 06/07   | AC  | VKMV 6PK1275   |   | 1   |   |   |   |   |   |   |       |
|  | B(Alt) Z 17 DTH   | 03/04 → 06/07   | AC, → ICH 1306915   | VKMV 6PK1620<br>VKM 35025<br>VKM____   | 1<br>1  | 1   | 1   |   |   |   |   |   |       |
|  | B(Alt) Z 17 DTH   | 03/04 → 06/07   | AC, CH 1306916 I→   | VKMV 6PK1620<br>VKM____<br>VKM____   | 1<br>1  | 1   | 1   |   |   |   |   |   |       |

| <b>OPEL  ASTRA H 1.7 CDTI 110</b> |                          |               |  |  |  |  |  |  |  |  |  |  |  |  |  |  |  |  |  |  |  |  |  |  |  |
|-----------------------------------|--------------------------|---------------|--|--|--|--|--|--|--|--|--|--|--|--|--|--|--|--|--|--|--|--|--|--|--|
|                                   | Z 17 DTJ                 | 02/07 → 09/07 |  |  |  |  |  |  |  |  |  |  |  |  |  |  |  |  |  |  |  |  |  |  |  |
|                                   |                          |               |  |  |  |  |  |  |  |  |  |  |  |  |  |  |  |  |  |  |  |  |  |  |  |
|                                   |                          |               |  |  |  |  |  |  |  |  |  |  |  |  |  |  |  |  |  |  |  |  |  |  |  |
|                                   | Z 17 DTJ                 | 02/07 → 03/07 |  |  |  |  |  |  |  |  |  |  |  |  |  |  |  |  |  |  |  |  |  |  |  |
|                                   | B(Alt) Z 17 DTJ          | 02/07 → 09/07 |  |  |  |  |  |  |  |  |  |  |  |  |  |  |  |  |  |  |  |  |  |  |  |
|                                   | B(Alt) Z 17 DTJ          | 02/07 → 09/07 |  |  |  |  |  |  |  |  |  |  |  |  |  |  |  |  |  |  |  |  |  |  |  |
| <b>OPEL  ASTRA H 1.7 CDTI 125</b> |                          |               |  |  |  |  |  |  |  |  |  |  |  |  |  |  |  |  |  |  |  |  |  |  |  |
|                                   | Z 17 DTR                 | 02/07 → 09/07 |  |  |  |  |  |  |  |  |  |  |  |  |  |  |  |  |  |  |  |  |  |  |  |
|                                   |                          |               |  |  |  |  |  |  |  |  |  |  |  |  |  |  |  |  |  |  |  |  |  |  |  |
|                                   | Z 17 DTR                 | 02/07 → 03/07 |  |  |  |  |  |  |  |  |  |  |  |  |  |  |  |  |  |  |  |  |  |  |  |
|                                   | B(Alt) Z 17 DTR          | 02/07 → 09/07 |  |  |  |  |  |  |  |  |  |  |  |  |  |  |  |  |  |  |  |  |  |  |  |
|                                   | B(Alt) Z 17 DTR          | 02/07 → 09/07 |  |  |  |  |  |  |  |  |  |  |  |  |  |  |  |  |  |  |  |  |  |  |  |
| <b>OPEL  ASTRA H 1.9 CDTI 100</b> |                          |               |  |  |  |  |  |  |  |  |  |  |  |  |  |  |  |  |  |  |  |  |  |  |  |
|                                   | Z 19 DTL                 | 09/05 → 06/07 |  |  |  |  |  |  |  |  |  |  |  |  |  |  |  |  |  |  |  |  |  |  |  |
|                                   |                          |               |  |  |  |  |  |  |  |  |  |  |  |  |  |  |  |  |  |  |  |  |  |  |  |
|                                   | Z 19 DTL                 | 09/05 → 06/07 |  |  |  |  |  |  |  |  |  |  |  |  |  |  |  |  |  |  |  |  |  |  |  |
|                                   | B(Alt) Z 19 DTL          | 09/05 → 12/07 |  |  |  |  |  |  |  |  |  |  |  |  |  |  |  |  |  |  |  |  |  |  |  |
|                                   | B(Alt) Z 19 DTL          | 09/05 → 06/07 |  |  |  |  |  |  |  |  |  |  |  |  |  |  |  |  |  |  |  |  |  |  |  |
| <b>OPEL  ASTRA H 1.9 CDTI 120</b> |                          |               |  |  |  |  |  |  |  |  |  |  |  |  |  |  |  |  |  |  |  |  |  |  |  |
|                                   | Z 19 DT                  | 06/04 → 06/07 |  |  |  |  |  |  |  |  |  |  |  |  |  |  |  |  |  |  |  |  |  |  |  |
|                                   |                          |               |  |  |  |  |  |  |  |  |  |  |  |  |  |  |  |  |  |  |  |  |  |  |  |
|                                   | Z 19 DTJ                 | 04/04 → 06/07 |  |  |  |  |  |  |  |  |  |  |  |  |  |  |  |  |  |  |  |  |  |  |  |
|                                   | Z 19 DT                  | 06/04 → 06/07 |  |  |  |  |  |  |  |  |  |  |  |  |  |  |  |  |  |  |  |  |  |  |  |
|                                   | Z 19 DTJ                 | 04/04 → 10/07 |  |  |  |  |  |  |  |  |  |  |  |  |  |  |  |  |  |  |  |  |  |  |  |
|                                   | B(Alt) Z 19 DT, Z 19 DTJ | 04/04 → 12/07 |  |  |  |  |  |  |  |  |  |  |  |  |  |  |  |  |  |  |  |  |  |  |  |
|                                   | B(Alt) Z 19 DT, Z 19 DTJ | 04/04 → 06/07 |  |  |  |  |  |  |  |  |  |  |  |  |  |  |  |  |  |  |  |  |  |  |  |
| <b>OPEL  ASTRA H 1.9 CDTI 150</b> |                          |               |  |  |  |  |  |  |  |  |  |  |  |  |  |  |  |  |  |  |  |  |  |  |  |
|                                   | Z 19 DTH                 | 09/04 → 06/07 |  |  |  |  |  |  |  |  |  |  |  |  |  |  |  |  |  |  |  |  |  |  |  |
|                                   |                          |               |  |  |  |  |  |  |  |  |  |  |  |  |  |  |  |  |  |  |  |  |  |  |  |
|                                   | Z 19 DTH                 | 09/04 → 10/07 |  |  |  |  |  |  |  |  |  |  |  |  |  |  |  |  |  |  |  |  |  |  |  |
|                                   | B(Alt) Z 19 DTH          | 09/04 → 12/07 |  |  |  |  |  |  |  |  |  |  |  |  |  |  |  |  |  |  |  |  |  |  |  |
|                                   | B(Alt) Z 19 DTH          | 09/04 → 06/07 |  |  |  |  |  |  |  |  |  |  |  |  |  |  |  |  |  |  |  |  |  |  |  |
| <b>OPEL  CALIBRA 2.0</b>          |                          |               |  |  |  |  |  |  |  |  |  |  |  |  |  |  |  |  |  |  |  |  |  |  |  |
|                                   | C 20 NE                  | 06/90 → 07/97 |  |  |  |  |  |  |  |  |  |  |  |  |  |  |  |  |  |  |  |  |  |  |  |
|                                   | C 20 NE                  | 06/90 → 07/97 |  |  |  |  |  |  |  |  |  |  |  |  |  |  |  |  |  |  |  |  |  |  |  |
|                                   | C 20 NE                  | 06/90 → 07/97 |  |  |  |  |  |  |  |  |  |  |  |  |  |  |  |  |  |  |  |  |  |  |  |
|                                   | C 20 NE                  | 06/90 → 07/97 |  |  |  |  |  |  |  |  |  |  |  |  |  |  |  |  |  |  |  |  |  |  |  |
|                                   | B(Alt) C 20 NE           | 06/90 → 12/92 |  |  |  |  |  |  |  |  |  |  |  |  |  |  |  |  |  |  |  |  |  |  |  |
|                                   | B(Alt) C 20 NE           | 01/93 → 07/97 |  |  |  |  |  |  |  |  |  |  |  |  |  |  |  |  |  |  |  |  |  |  |  |
|                                   | B(Alt) C 20 NE           | 01/93 → 07/97 |  |  |  |  |  |  |  |  |  |  |  |  |  |  |  |  |  |  |  |  |  |  |  |







### OPEL CALIBRA 2.0 16V

|  |                          |               |                    |              |   |   |   |  |  |  |  |  |   |  |       |
|--|--------------------------|---------------|--------------------|--------------|---|---|---|--|--|--|--|--|---|--|-------|
|  | X 20 XEV                 | 02/94 → 07/97 | 3)                 | VKMS 05222   | 1 | 2 | 1 |  |  |  |  |  | 3 |  |       |
|  |                          |               |                    | VKMA 05222   | 1 | 2 | 1 |  |  |  |  |  |   |  | T0116 |
|  |                          |               |                    | VKM 15202    | 1 |   |   |  |  |  |  |  |   |  |       |
|  |                          |               |                    | VKM 25212    |   | 1 |   |  |  |  |  |  |   |  |       |
|  |                          |               |                    | VKM 25212    |   | 1 |   |  |  |  |  |  |   |  |       |
|  | C 20 XE                  | 06/90 → 02/94 | →   Mot. 14 142838 | VKMA 05211   | 1 | 1 | 1 |  |  |  |  |  |   |  | T0063 |
|  |                          |               |                    | VKM 15211    | 1 |   |   |  |  |  |  |  |   |  |       |
|  |                          |               |                    | VKM 25211    |   | 1 |   |  |  |  |  |  |   |  |       |
|  | C 20 XE                  | 06/90 → 02/94 | Mot. 14 142839   → | VKMA 05220   | 1 | 2 | 1 |  |  |  |  |  |   |  | T0106 |
|  |                          |               |                    | VKM 15202    | 1 |   |   |  |  |  |  |  |   |  |       |
|  |                          |               |                    | VKM 25212    |   | 1 |   |  |  |  |  |  |   |  |       |
|  |                          |               |                    | VKM 25213    |   | 1 |   |  |  |  |  |  |   |  |       |
|  | C 20 XE                  | 06/90 → 02/94 | →   Mot. 14 142838 | VKPC 85610   |   |   |   |  |  |  |  |  | 1 |  |       |
|  | C 20 XE                  | 06/90 → 02/94 | Mot. 14 142839   → | VKPC 85611   |   |   |   |  |  |  |  |  | 1 |  |       |
|  | X 20 XEV                 | 02/94 → 07/97 |                    | VKPC 85611   |   |   |   |  |  |  |  |  | 1 |  |       |
|  | B(Alt) C 20 XE, X 20 XEV | 01/93 → 07/97 | AC                 | VKMA 35009   | 1 |   | 1 |  |  |  |  |  |   |  |       |
|  |                          |               |                    | VKMV 6PK1725 |   |   | 1 |  |  |  |  |  |   |  |       |
|  |                          |               |                    | VKM 35009    | 1 |   |   |  |  |  |  |  |   |  |       |
|  | B(Alt) C 20 XE, X 20 XEV | 01/93 → 07/97 | AC                 | VKMA 35109   | 1 |   | 1 |  |  |  |  |  |   |  |       |
|  |                          |               |                    | VKMV 6PK1900 |   |   | 1 |  |  |  |  |  |   |  |       |
|  |                          |               |                    | VKM 35009    | 1 |   |   |  |  |  |  |  |   |  |       |

### OPEL CALIBRA 2.0 Turbo

|  |                 |               |                    |               |   |   |   |  |  |  |  |  |   |  |       |
|--|-----------------|---------------|--------------------|---------------|---|---|---|--|--|--|--|--|---|--|-------|
|  | C 20 LET        | 03/92 → 07/97 | →   Mot. 14 002934 | VKMA 05211    | 1 | 1 | 1 |  |  |  |  |  |   |  | T0063 |
|  |                 |               |                    | VKM 15211     | 1 |   |   |  |  |  |  |  |   |  |       |
|  |                 |               |                    | VKM 25211     |   | 1 |   |  |  |  |  |  |   |  |       |
|  | C 20 LET        | 03/92 → 07/97 | Mot. 14 002935   → | VKMA 05220    | 1 | 2 | 1 |  |  |  |  |  |   |  | T0106 |
|  |                 |               |                    | VKM 15202     | 1 |   |   |  |  |  |  |  |   |  |       |
|  |                 |               |                    | VKM 25212     |   | 1 |   |  |  |  |  |  |   |  |       |
|  |                 |               |                    | VKM 25213     |   | 1 |   |  |  |  |  |  |   |  |       |
|  | C 20 LET        | 03/92 → 07/97 | →   Mot. 14 002934 | VKPC 85610    |   |   |   |  |  |  |  |  | 1 |  |       |
|  | C 20 LET        | 03/92 → 07/97 | Mot. 14 002935   → | VKPC 85611    |   |   |   |  |  |  |  |  | 1 |  |       |
|  | B(Alt) C 20 LET | 03/92 → 12/92 |                    | VKMV 10AVx925 |   |   | 1 |  |  |  |  |  |   |  |       |
|  | B(Alt) C 20 LET | 01/93 → 07/97 | AC                 | VKMA 35009    | 1 |   | 1 |  |  |  |  |  |   |  |       |
|  |                 |               |                    | VKMV 6PK1725  |   |   | 1 |  |  |  |  |  |   |  |       |
|  |                 |               |                    | VKM 35009     | 1 |   |   |  |  |  |  |  |   |  |       |
|  | B(Alt) C 20 LET | 01/93 → 07/97 | AC                 | VKMA 35109    | 1 |   | 1 |  |  |  |  |  |   |  |       |
|  |                 |               |                    | VKMV 6PK1900  |   |   | 1 |  |  |  |  |  |   |  |       |
|  |                 |               |                    | VKM 35009     | 1 |   |   |  |  |  |  |  |   |  |       |

### OPEL CALIBRA 2.5 V6

|  |                         |               |    |              |   |   |   |  |  |  |  |  |   |   |       |
|--|-------------------------|---------------|----|--------------|---|---|---|--|--|--|--|--|---|---|-------|
|  | C 25 XE, X 25 XE        | 04/93 → 07/97 | 5) | VKMA 05500   | 1 | 1 | 1 |  |  |  |  |  |   | 5 | T0135 |
|  | C 25 XE, X 25 XE        | 04/93 → 07/97 |    | VKPC 85613   |   |   |   |  |  |  |  |  | 1 |   |       |
|  | B(Alt) C 25 XE, X 25 XE | 04/93 → 07/97 | AC | VKMV 6PK1900 |   |   | 1 |  |  |  |  |  |   |   |       |
|  |                         |               |    | VKM 35500    | 1 |   |   |  |  |  |  |  |   |   |       |
|  | B(Alt) C 25 XE, X 25 XE | 04/93 → 07/97 | AC | VKMA 35500   | 1 |   | 1 |  |  |  |  |  |   |   |       |
|  |                         |               |    | VKMV 6PK2020 |   |   | 1 |  |  |  |  |  |   |   |       |
|  |                         |               |    | VKM 35500    | 1 |   |   |  |  |  |  |  |   |   |       |

### OPEL CAMPO 2.3

|  |    |               |    |            |   |  |   |  |  |  |  |  |   |  |       |
|--|----|---------------|----|------------|---|--|---|--|--|--|--|--|---|--|-------|
|  | 23 | 08/91 → 09/96 |    | VKMA 99001 | 1 |  | 1 |  |  |  |  |  |   |  | T0625 |
|  |    |               |    | VKM 79001  | 1 |  |   |  |  |  |  |  |   |  |       |
|  | 23 | 08/91 → 09/96 | 2) | —          |   |  |   |  |  |  |  |  | 1 |  |       |

### OPEL CAMPO 2.2 D

|  |      |               |  |           |   |  |   |  |  |  |  |  |  |  |  |
|--|------|---------------|--|-----------|---|--|---|--|--|--|--|--|--|--|--|
|  | C223 | 08/91 → 09/96 |  | —         | 1 |  | 1 |  |  |  |  |  |  |  |  |
|  |      |               |  | VKM 79003 | 1 |  |   |  |  |  |  |  |  |  |  |

### OPEL CAMPO 2.5 D

|  |      |               |    |            |   |   |   |  |  |  |  |  |   |  |       |
|--|------|---------------|----|------------|---|---|---|--|--|--|--|--|---|--|-------|
|  | 25 D | 08/91 → 06/94 |    | VKMA 99004 | 1 | 1 | 1 |  |  |  |  |  |   |  | T0628 |
|  |      |               |    | VKM 79002  | 1 |   |   |  |  |  |  |  |   |  |       |
|  |      |               |    | VKM 89003  |   | 1 |   |  |  |  |  |  |   |  |       |
|  | 25 D | 08/91 → 06/94 | 2) | VKPA 85605 |   |   |   |  |  |  |  |  | 1 |  |       |









































### OPEL CAMPO 2.5 TD, 2.5 DTI

|  |               |               |    |            |   |   |   |  |  |  |  |  |   |  |       |
|--|---------------|---------------|----|------------|---|---|---|--|--|--|--|--|---|--|-------|
|  | 25 TD, 25 TDI | 07/94 → 06/07 |    | VKMA 99004 | 1 | 1 | 1 |  |  |  |  |  |   |  | T0628 |
|  |               |               |    | VKM 79002  | 1 |   |   |  |  |  |  |  |   |  |       |
|  |               |               |    | VKM 89003  |   | 1 |   |  |  |  |  |  |   |  |       |
|  | 25 TD         | 07/94 → 10/94 | 2) | VKPA 85605 |   |   |   |  |  |  |  |  | 1 |  |       |

| <b>OPEL  CAMPO 3.1 TD</b>    |               |                              |               |              |              |   |   |   |   |   |   |  |  |   |  |  |  |  |  |       |       |       |  |
|------------------------------|---------------|------------------------------|---------------|--------------|--------------|---|---|---|---|---|---|--|--|---|--|--|--|--|--|-------|-------|-------|--|
|                              |               | 31 TD                        | 12/92 → 06/07 |              | VKMA 99004   | 1 | 1 | 1 |   |   |   |  |  |   |  |  |  |  |  | T0628 |       |       |  |
|                              |               |                              |               |              | VKM 79002    | 1 |   |   |   |   |   |  |  |   |  |  |  |  |  |       |       |       |  |
|                              |               |                              |               |              | VKM 89003    |   |   | 1 |   |   |   |  |  |   |  |  |  |  |  |       |       |       |  |
|                              |               | 31 TD                        | 12/92 → 08/93 | 2)           | VKPA 85605   |   |   |   |   |   | 1 |  |  |   |  |  |  |  |  |       |       |       |  |
|                              |               | 31 TD                        | 12/92 → 10/07 | 2)           | VKPA 85605   |   |   |   |   |   | 1 |  |  |   |  |  |  |  |  |       |       |       |  |
| <b>OPEL  COMBO A 1.2</b>     |               |                              |               |              |              |   |   |   |   |   |   |  |  |   |  |  |  |  |  |       |       |       |  |
|                              |               | C 12 NZ, X 12 SZ             | 07/94 → 10/01 |              | VKMC 05121   | 1 |   | 1 |   | 1 |   |  |  |   |  |  |  |  |  | T0092 |       |       |  |
|                              |               |                              |               |              | VKMA 05121   | 1 |   | 1 |   |   |   |  |  |   |  |  |  |  |  |       |       |       |  |
|                              |               |                              |               |              | VKM 15121    | 1 |   |   |   |   |   |  |  |   |  |  |  |  |  |       |       |       |  |
|                              |               | C 12 NZ, X 12 SZ             | 07/94 → 10/01 | 3)           | VKMS 05121   | 1 |   | 1 |   |   |   |  |  | 2 |  |  |  |  |  |       | T0092 |       |  |
|                              |               |                              |               |              | VKMA 05121   | 1 |   | 1 |   |   |   |  |  |   |  |  |  |  |  |       |       |       |  |
|                              |               |                              |               |              | VKM 15121    | 1 |   |   |   |   |   |  |  |   |  |  |  |  |  |       |       |       |  |
|                              |               | C 12 NZ, X 12 SZ             | 07/94 → 10/01 |              | VKPC 85206   |   |   |   |   |   | 1 |  |  |   |  |  |  |  |  |       |       |       |  |
|                              | <b>B(Alt)</b> | C 12 NZ, X 12 SZ             | 07/94 → 10/01 |              | VKMA 35008   | 1 |   | 1 |   |   |   |  |  |   |  |  |  |  |  |       |       |       |  |
|                              |               |                              |               |              | VKMV 6PK1460 |   |   | 1 |   |   |   |  |  |   |  |  |  |  |  |       |       |       |  |
|                              |               |                              |               |              | VKM 35008    | 1 |   |   |   |   |   |  |  |   |  |  |  |  |  |       |       |       |  |
| <b>OPEL  COMBO A 1.4</b>     |               |                              |               |              |              |   |   |   |   |   |   |  |  |   |  |  |  |  |  |       |       |       |  |
|                              |               | C 14 NZ, C 14 SE, X 14 SZ    | 07/94 → 10/01 |              | VKMC 05121   | 1 |   | 1 |   | 1 |   |  |  |   |  |  |  |  |  |       | T0092 |       |  |
|                              |               |                              |               |              | VKMA 05121   | 1 |   | 1 |   |   |   |  |  |   |  |  |  |  |  |       |       |       |  |
|                              |               |                              |               |              | VKM 15121    | 1 |   |   |   |   |   |  |  |   |  |  |  |  |  |       |       |       |  |
|                              |               | C 14 NZ, C 14 SE, X 14 SZ    | 07/94 → 10/01 | 3)           | VKMS 05121   | 1 |   | 1 |   |   |   |  |  | 2 |  |  |  |  |  |       |       | T0092 |  |
|                              |               |                              |               |              | VKMA 05121   | 1 |   | 1 |   |   |   |  |  |   |  |  |  |  |  |       |       |       |  |
|                              |               |                              |               |              | VKM 15121    | 1 |   |   |   |   |   |  |  |   |  |  |  |  |  |       |       |       |  |
|                              |               | C 14 NZ, C 14 SE, X 14 SZ    | 07/94 → 10/01 |              | VKPC 85206   |   |   |   |   |   | 1 |  |  |   |  |  |  |  |  |       |       |       |  |
|                              | <b>B(Alt)</b> | C 14 NZ, C 14 SE, X 14 SZ    | 07/94 → 10/01 | <b>AC, ⊗</b> | VKMV 6PK1795 |   |   |   | 1 |   |   |  |  |   |  |  |  |  |  |       |       |       |  |
|                              |               |                              |               |              | VKM 35002    | 1 |   | 1 |   |   |   |  |  |   |  |  |  |  |  |       |       |       |  |
|                              |               |                              |               |              | VKM 35009    |   |   |   |   |   |   |  |  |   |  |  |  |  |  |       |       |       |  |
|                              | <b>B(Alt)</b> | C 14 NZ, C 14 SE, X 14 SZ    | 07/94 → 10/01 | <b>AC, ⊗</b> | VKMA 35008   | 1 |   | 1 |   |   |   |  |  |   |  |  |  |  |  |       |       |       |  |
|                              |               |                              |               |              | VKMV 6PK1460 |   |   | 1 |   |   |   |  |  |   |  |  |  |  |  |       |       |       |  |
|                              |               |                              |               |              | VKM 35008    | 1 |   |   |   |   |   |  |  |   |  |  |  |  |  |       |       |       |  |
|                              | <b>B(Alt)</b> | C 14 NZ, C 14 SE, X 14 SZ    | 07/94 → 10/01 | <b>AC, ⊗</b> | VKMA 35125   | 1 |   | 1 |   |   |   |  |  |   |  |  |  |  |  |       |       |       |  |
|                              |               |                              |               |              | VKMV 6PK1795 |   |   | 1 |   |   |   |  |  |   |  |  |  |  |  |       |       |       |  |
|                              |               |                              |               |              | VKM 35009    | 1 |   |   |   |   |   |  |  |   |  |  |  |  |  |       |       |       |  |
| <b>OPEL  COMBO A 1.4 16V</b> |               |                              |               |              |              |   |   |   |   |   |   |  |  |   |  |  |  |  |  |       |       |       |  |
|                              |               | C 14 SEL, X 14 XE            | 08/99 → 10/01 | 3)           | VKMS 05150   | 1 | 2 | 1 |   |   |   |  |  | 3 |  |  |  |  |  |       |       | T0107 |  |
|                              |               |                              |               |              | VKMA 05150   | 1 | 2 | 1 |   |   |   |  |  |   |  |  |  |  |  |       |       |       |  |
|                              |               |                              |               |              | VKM 15216    | 1 |   |   |   |   |   |  |  |   |  |  |  |  |  |       |       |       |  |
|                              |               |                              |               |              | VKM 25150    |   |   | 1 |   |   |   |  |  |   |  |  |  |  |  |       |       |       |  |
|                              |               |                              |               |              | VKM 25152    |   |   | 1 |   |   |   |  |  |   |  |  |  |  |  |       |       |       |  |
|                              |               | C 14 SEL, X 14 XE            | 08/99 → 10/01 |              | VKPC 85212   |   |   |   |   |   | 1 |  |  |   |  |  |  |  |  |       |       |       |  |
|                              | <b>B(Alt)</b> | C 14 SEL, X 14 XE            | 08/99 → 10/01 | <b>AC, ⊗</b> | VKMV 6PK895  |   |   |   | 1 |   |   |  |  |   |  |  |  |  |  |       |       |       |  |
|                              |               |                              |               |              | VKM 35011    | 1 |   |   |   |   |   |  |  |   |  |  |  |  |  |       |       |       |  |
|                              | <b>B(Alt)</b> | C 14 SEL, X 14 XE            | 08/99 → 10/01 | <b>AC, ⊗</b> | VKMV 6PK1795 |   |   |   | 1 |   |   |  |  |   |  |  |  |  |  |       |       |       |  |
|                              |               |                              |               |              | VKM 35002    | 1 |   | 1 |   |   |   |  |  |   |  |  |  |  |  |       |       |       |  |
|                              |               |                              |               |              | VKM 35009    |   |   |   |   |   |   |  |  |   |  |  |  |  |  |       |       |       |  |
|                              | <b>B(Alt)</b> | C 14 SEL, X 14 XE            | 08/99 → 10/01 | <b>AC, ⊗</b> | VKMA 35025   | 1 |   | 1 |   |   |   |  |  |   |  |  |  |  |  |       |       |       |  |
|                              |               |                              |               |              | VKMV 6PK1530 |   |   | 1 |   |   |   |  |  |   |  |  |  |  |  |       |       |       |  |
|                              |               |                              |               |              | VKM 35009    | 1 |   |   |   |   |   |  |  |   |  |  |  |  |  |       |       |       |  |
|                              | <b>B(Alt)</b> | C 14 SEL, X 14 XE            | 08/99 → 10/01 | <b>AC, ⊗</b> | VKMA 35125   | 1 |   | 1 |   |   |   |  |  |   |  |  |  |  |  |       |       |       |  |
|                              |               |                              |               |              | VKMV 6PK1795 |   |   | 1 |   |   |   |  |  |   |  |  |  |  |  |       |       |       |  |
|                              |               |                              |               |              | VKM 35009    | 1 |   |   |   |   |   |  |  |   |  |  |  |  |  |       |       |       |  |
| <b>OPEL  COMBO A 1.7 D</b>   |               |                              |               |              |              |   |   |   |   |   |   |  |  |   |  |  |  |  |  |       |       |       |  |
|                              |               | 17 D (ISUZU), X 17 D (ISUZU) | 07/94 → 12/94 |              | VKMA 05213   | 1 | 1 | 1 |   |   |   |  |  |   |  |  |  |  |  |       |       | T0062 |  |
|                              |               |                              |               |              | VKM 15213    | 1 |   |   |   |   |   |  |  |   |  |  |  |  |  |       |       |       |  |
|                              |               |                              |               |              | VKM 25208    |   |   | 1 |   |   |   |  |  |   |  |  |  |  |  |       |       |       |  |





































OPEL

|   |  |  |  |  |  |  |  |  |  |  |  |  |
|---|---|---|---|--|---|---|---|---|---|---|---|---|
|   | 17 D (ISUZU),<br>X 17 D (ISUZU)   | 01/95 → 10/01   |   | VKMA 05214<br>VKM 15215<br>VKM 25208   | 1<br>1  | 1<br>1  |   |   |   |   | 1<br>1  | T0062   |
|                                     | 17 D (ISUZU),<br>X 17 D (ISUZU)   | 07/94 → 10/01   | →IMot. 877697   | VKPC 85404   |   |   |   | 1   |   |   |   |   |
|                                     | <b>B(Alt)</b> 17 D (ISUZU),<br>X 17 D (ISUZU)                                     | 07/94 → 10/01   | Mot. 877698 I→  | VKPC 85620   |   |   |   | 1   |   |   |   |   |
|                                     | <b>B(Alt)</b> 17 D (ISUZU),<br>X 17 D (ISUZU)                                     | 07/94 → 10/01   |   | VKMV 13AVx915  |   | 1   |   |   |   |   |   |   |
| <b>OPEL  COMBO B 1.4 16V</b>       |   |   |   |  |   |   |   |   |   |   |   |   |
|                                     | Z 14 XEP  | 10/04 → 06/07   |   | <del>OKOKOKO</del>   |   |   |   |   |   |   |   |   |
|                                     | Z 14 XEP  | 10/04 → 10/07   |   | VKPC 85310   |   |   |   | 1   |   |   |   |   |
|                                     | <b>B(Alt)</b> Z 14 XEP  | 10/04 → 06/07   | AC  | VKMA 35113<br>VKMV 5PK1230<br>VKM 35013  | 1<br>1  | 1<br>1  |   |   |   |   |   |   |
|                                     | <b>B(Alt)</b> Z 14 XEP  | 10/04 → 06/07   | AC  | VKMV 5PK1368<br>VKM 35013  | 1   | 1   |   |   |   |   |   |   |
| <b>OPEL  COMBO B 1.6</b>           |   |   |   |  |   |   |   |   |   |   |   |   |
|                                     | Z 16 SE   | 10/01 → 06/07   | 3)  | VKMS 05121<br>VKMA 05121<br>VKM 15121  | 1<br>1<br>1   | 1<br>1  |   |   | 2   | 1<br>1<br>1   |   | T0092   |
|                                     | Z 16 SE   | 10/01 → 10/07   |   | VKPC 85460   |   |   |   | 1   |   |   |   |   |
|                                     | <b>B(Alt)</b> Z 16 SE   | 10/01 → 06/07   | AC  | VKMA 35012<br>VKMV 5PK938<br>VKM 35012   | 1<br>1  | 1<br>1  |   |   |   |   |   |   |
|                                   | <b>B(Alt)</b> Z 16 SE   | 10/01 → 06/07   | AC  | VKMA 35022<br>VKMV 5PK1212<br>VKM 35012  | 1<br>1  | 1<br>1  |   |   |   |   |   |   |
| <b>OPEL  COMBO B 1.6 16V CNG</b> |   |   |   |  |   |   |   |   |   |   |   |   |
|                                   | Z 16 YNG  | 06/06 → 06/07   |   | VKMA 05156<br>VKM 15216<br>VKM____<br>VKM 25158                                    | 1<br>1<br>1<br>1  | 2<br>1<br>1   | 1   |   |   |   | 1<br>1  | T0157   |
|                                   | Z 16 YNG  | 06/06 → 10/07   |   | VKPC 85211   |   |   |   | 1   |   |   |   |   |
| <b>OPEL  COMBO B 1.3 CDTI</b>    |   |   |   |  |   |   |   |   |   |   |   |   |
|                                   | Y 13 DT, Z 13 DT,<br>Z 13 DTJ   | 10/04 → 06/07   |   | <del>OKOKOKO</del>   |   |   |   |   |   |   |   |   |
|                                   | Y 13 DT, Z 13 DT,<br>Z 13 DTJ   | 10/04 → 10/07   |   | VKPC 85700   |   |   |   | 1   |   |   |   |   |
|                                   | <b>B(Alt)</b> Y 13 DT, Z 13 DT,<br>Z 13 DTJ                                       | 10/04 → 06/07   | AC  | VKMV 6PK1182<br>VKM 35023  | 1   | 1   |   |   |   |   |   |   |
|                                   | <b>B(Alt)</b> Y 13 DT, Z 13 DT,<br>Z 13 DTJ                                       | 10/04 → 06/07   | AC  | VKMV____<br>VKM 35023  | 1   | 1   |   |   |   |   |   |   |
| <b>OPEL  COMBO B 1.7 CDTI</b>    |   |   |   |  |   |   |   |   |   |   |   |   |
|                                   | Z 17 DTH (ISUZU)  | 12/04 → 06/07   |   | VKMA 05608<br>VKM 15218<br>VKM 25208   | 1<br>1  | 1<br>1  | 1   |   |   |   | 3<br>1  | T0182   |
|                                   | Z 17 DTH (ISUZU)  | 12/04 → 10/07   |   | VKPC 85300   |   |   |   | 1   |   |   |   |   |
|                                   | <b>B(Alt)</b> Z 17 DTH (ISUZU)  | 12/04 → 06/07   | AC  | VKMA 35015<br>VKMV 6PK1275<br>VKM 35015  | 1<br>1  | 1<br>1  |   |   |   |   |   |   |
|                                   | <b>B(Alt)</b> Z 17 DTH (ISUZU)  | 12/04 → 06/07   | AC, →IMot. 01 260732  | VKMV 6PK1600<br>VKM 35015<br>VKM 35025   | 1<br>1  | 1<br>1  |   |   |   |   |   |   |
| <b>OPEL  COMBO B 1.7 DI</b>      |   |   |   |  |   |   |   |   |   |   |   |   |
|                                   | Y 17 DTL (ISUZU)  | 10/01 → 06/07   | →IMot. 328704   | VKMA 05606<br>VKM 15215<br>VKM 25208   | 1<br>1  | 1<br>1  | 1   |   |   |   | 1<br>1  | T0182   |
|                                   | Y 17 DTL (ISUZU)  | 10/01 → 06/07   | Mot. 328705 I→  | VKMA 05608<br>VKM 15218<br>VKM 25208   | 1<br>1  | 1<br>1  | 1   |   |   |   | 3<br>1  | T0182   |

|                              | Y 17 DTL (ISUZU)               | 10/01 → 10/07 |                | VKPC 85300   |   |   |   |   | 1 |  |   |   |       |
|------------------------------|--------------------------------|---------------|----------------|--|---|---|---|---|---|--|---|---|-------|
|                              | <b>B(Alt)</b> Y 17 DTL (ISUZU) | 10/01 → 06/07 | AC             | VKMA 35215<br>VKMV 6PK1250<br>VKM 35015              | 1 |   | 1 |   |   |  |   |   |       |
|                              | <b>B(Alt)</b> Y 17 DTL (ISUZU) | 10/01 → 06/07 | AC             | VKMA 35315<br>VKMV 6PK1590<br>VKM 35015<br>VKM 35025 | 1 | 1 | 1 |   |   |  |   |   |       |
| <b>OPEL  COMBO B 1.7 DTI</b> |                                |               |                |  |   |   |   |   |   |  |   |   |       |
|                              | Y 17 DT (ISUZU)                | 10/01 → 06/07 | →IMot. 328704  | VKMA 05606<br>VKM 15215<br>VKM 25208                 | 1 | 1 | 1 |   |   |  |   | 1 | T0182 |
|                              | Y 17 DT (ISUZU)                | 10/01 → 06/07 | Mot. 328705  → | VKMA 05608<br>VKM 15218<br>VKM 25208                 | 1 | 1 | 1 |   |   |  |   | 3 | T0182 |
|                              | Y 17 DT (ISUZU)                | 10/01 → 10/07 |                | VKPC 85300   |   |   |   |   | 1 |  |   |   |       |
|                              | <b>B(Alt)</b> Y 17 DT (ISUZU)  | 10/01 → 06/07 | AC             | VKMA 35215<br>VKMV 6PK1250<br>VKM 35015              | 1 |   | 1 |   |   |  |   |   |       |
|                              | <b>B(Alt)</b> Y 17 DT (ISUZU)  | 10/01 → 06/07 | AC             | VKMA 35315<br>VKMV 6PK1590<br>VKM 35015<br>VKM 35025 | 1 | 1 | 1 |   |   |  |   |   |       |
| <b>OPEL  COMMODORE A 2.5</b> |                                |               |                |  |   |   |   |   |   |  |   |   |       |
|                              | 25 H                           | 08/67 → 01/72 |                | XXXXXXXXXX   |   |   |   |   |   |  |   |   |       |
| <b>OPEL  COMMODORE A 2.8</b> |                                |               |                |  |   |   |   |   |   |  |   |   |       |
|                              | 28 HL                          | 05/70 → 01/72 |                | XXXXXXXXXX   |   |   |   |   |   |  |   |   |       |
| <b>OPEL  COMMODORE B 2.5</b> |                                |               |                |  |   |   |   |   |   |  |   |   |       |
|                              | 25 H, 25 S                     | 01/72 → 07/78 |                | XXXXXXXXXX   |   |   |   |   |   |  |   |   |       |
|                              | 25 H, 25 S                     | 01/72 → 07/78 |                | VKPC 85600   |   |   |   |   | 1 |  |   |   |       |
| <b>OPEL  COMMODORE B 2.8</b> |                                |               |                |  |   |   |   |   |   |  |   |   |       |
|                              | 28 E, 28 EC, 28 HC             | 01/72 → 07/78 |                | XXXXXXXXXX   |   |   |   |   |   |  |   |   |       |
|                              | 28 E, 28 EC, 28 HC             | 01/72 → 07/78 |                | VKPC 85600   |   |   |   |   | 1 |  |   |   |       |
| <b>OPEL  COMMODORE C 2.5</b> |                                |               |                |  |   |   |   |   |   |  |   |   |       |
|                              | 25 E, 25 S                     | 08/78 → 12/82 |                | XXXXXXXXXX   |   |   |   |   |   |  |   |   |       |
|                              | 25 E, 25 S                     | 08/78 → 12/82 |                | VKPC 85600   |   |   |   |   | 1 |  |   |   |       |
| <b>OPEL  CORSA A 1.0</b>     |                                |               |                |  |   |   |   |   |   |  |   |   |       |
|                              | 10 S                           | 09/82 → 03/93 |                | XXXXXXXXXX   |   |   |   |   |   |  |   |   |       |
|                              | 10 S                           | 09/82 → 03/93 |                | VKPC 85201   |   |   |   |   | 1 |  |   |   |       |
|                              | <b>B(Alt)</b> 10 S             | 09/82 → 03/93 |                | VKMV 10AVx925  |   |   | 1 |   |   |  |   |   |       |
| <b>OPEL  CORSA A 1.2</b>     |                                |               |                |  |   |   |   |   |   |  |   |   |       |
|                              | 12 NC, E 12 GV                 | 09/82 → 08/90 |                | XXXXXXXXXX   |   |   |   |   |   |  |   |   |       |
|                              | 12 NV, 12 S, 12 ST             | 09/82 → 03/93 |                | VKMC 05100   |   |   | 1 | 1 |   |  |   |   | T0226 |
|                              | C 12 NZ                        | 09/89 → 03/93 |                | VKMA 05121<br>VKM 15121                              | 1 | 1 |   | 1 |   |  |   | 1 | T0092 |
|                              | C 12 NZ                        | 09/89 → 03/93 | 3)             | VKMS 05121<br>VKMA 05121<br>VKM 15121                | 1 | 1 |   |   | 2 |  | 1 | 1 | T0092 |
|                              | 12 N, 12 NC, E 12 GV           | 09/82 → 08/90 |                | VKPC 85201   |   |   |   |   | 1 |  |   |   |       |
|                              | 12 NV, 12 S, 12 ST,<br>C 12 NZ | 09/82 → 03/93 |                | VKPC 85206   |   |   |   |   | 1 |  |   |   |       |
|                              | 12 NV, 12 S, 12 ST,<br>C 12 NZ | 09/82 → 03/93 |                | VKPC 85201   |   |   |   |   | 1 |  |   |   |       |
|                              | <b>B(Alt)</b> 12 NC, E 12 GV   | 09/82 → 08/90 |                | VKMV 10AVx925  |   |   | 1 |   |   |  |   |   |       |
|                              | <b>B(Alt)</b> 12 S             | 09/82 → 10/87 |                | VKMV 10AVx913  |   |   | 1 |   |   |  |   |   |       |
| <b>OPEL  CORSA A 1.3</b>     |                                |               |                |  |   |   |   |   |   |  |   |   |       |
|                              | 13 NB, 13 S, 13 SB,<br>C 13 N  | 09/82 → 09/90 |                | VKMC 05103   |   |   | 1 | 1 |   |  |   |   | T0224 |
|                              | 13 NB, 13 S, 13 SB,<br>C 13 N  | 09/82 → 09/90 |                | —  |   |   | 1 | 1 |   |  |   |   |       |
|                              | 13 NB, 13 S, 13 SB,<br>C 13 N  | 09/82 → 09/90 |                | VKPC 85202   |   |   |   |   | 1 |  |   |   |       |









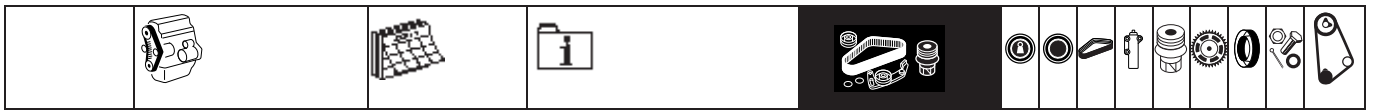

|                          | 13 NB, 13 S, 13 SB,<br>C 13 N      | 09/82 → 09/90                  | ,   | VKPC 85201                            |             |  |  |  |  |             |  |  |  |  | 1 |             |       |
|--------------------------|------------------------------------|--------------------------------|---|---------------------------------------|-------------|--|--|--|--|-------------|--|--|--|--|---|-------------|-------|
| <b>OPEL  CORSA A 1.4</b> |                                    |                                |   |                                       |             |  |  |  |  |             |  |  |  |  |   |             |       |
|                          | 14 NV                              | 09/89 → 03/93                  | ,  ,<br>→ <b>I</b> Mot. 02 J22349,<br>19 307805 | VKMC 05120                            |             |  |  |  |  |             |  |  |  |  | 1 | 1           | T0228 |
|                          | 14 NV                              | 09/89 → 03/93                  | ,  ,<br><b>Mot.</b> 02 J22350,<br>19 307806  →  | VKMC 05121<br>VKMA 05121<br>VKM 15121 | 1<br>1<br>1 |  |  |  |  | 1<br>1<br>1 |  |  |  |  |   | 1<br>1<br>1 | T0092 |
|                          | C 14 NZ                            | 10/89 → 03/93                  | ,  ,<br>→ <b>I</b> Mot. 02 J22349,<br>19 311737 | VKMC 05120                            |             |  |  |  |  |             |  |  |  |  | 1 | 1           | T0228 |
|                          | C 14 NZ                            | 10/89 → 03/93                  | ,  ,<br><b>Mot.</b> 02 J22350,<br>19 311738  →  | VKMC 05121<br>VKMA 05121<br>VKM 15121 | 1<br>1<br>1 |  |  |  |  | 1<br>1<br>1 |  |  |  |  |   | 1<br>1<br>1 | T0092 |
|                          | C 14 SE                            | 09/91 → 03/93                  | ,   | VKMC 05121<br>VKMA 05121<br>VKM 15121 | 1<br>1<br>1 |  |  |  |  | 1<br>1<br>1 |  |  |  |  |   | 1<br>1<br>1 | T0092 |
|                          | 14 NV                              | 09/89 → 03/93                  | 3), <b>Mot.</b> 02 J22350,<br>19 307806  →      | VKMS 05121<br>VKMA 05121<br>VKM 15121 | 1<br>1<br>1 |  |  |  |  | 1<br>1<br>1 |  |  |  |  |   | 2<br>1<br>1 | T0092 |
|                          | C 14 NZ                            | 10/89 → 03/93                  | 3), <b>Mot.</b> 02 J22350,<br>19 311738  →      | VKMS 05121<br>VKMA 05121<br>VKM 15121 | 1<br>1<br>1 |  |  |  |  | 1<br>1<br>1 |  |  |  |  |   | 2<br>1<br>1 | T0092 |
|                          | C 14 SE                            | 09/91 → 03/93                  | 3)  | VKMS 05121<br>VKMA 05121<br>VKM 15121 | 1<br>1<br>1 |  |  |  |  | 1<br>1<br>1 |  |  |  |  |   | 2<br>1<br>1 | T0092 |
|                          | 14 NV                              | 09/89 → 03/93                  | ,  ,<br>→ <b>I</b> Mot. 02 J22349,<br>19 307805 | VKPC 85401                            |             |  |  |  |  |             |  |  |  |  | 1 |             |       |
|                          | 14 NV                              | 09/89 → 03/93                  | ,  ,<br><b>Mot.</b> 02 J22350,<br>19 307806  →  | VKPC 85206                            |             |  |  |  |  |             |  |  |  |  | 1 |             |       |
|                          | 14 NV, C 14 NZ, C 14 SE<br>C 14 NZ | 09/89 → 03/93<br>01/85 → 03/93 | ,   | VKPC 85201                            |             |  |  |  |  |             |  |  |  |  | 1 |             |       |
|                          | C 14 NZ                            | 01/85 → 03/93                  | ,  ,<br>→ <b>I</b> Mot. 02 J22349,<br>19 311737 | VKPC 85401                            |             |  |  |  |  |             |  |  |  |  | 1 |             |       |
|                          | C 14 NZ                            | 01/85 → 03/93                  | ,  ,<br><b>Mot.</b> 02 J22350,<br>19 311738  →  | VKPC 85206                            |             |  |  |  |  |             |  |  |  |  | 1 |             |       |
|                          | C 14 SE                            | 09/91 → 03/93                  | ,   | VKPC 85206                            |             |  |  |  |  |             |  |  |  |  | 1 |             |       |
| <b>OPEL  CORSA A 1.6</b> |                                    |                                |   |                                       |             |  |  |  |  |             |  |  |  |  |   |             |       |
|                          | C 16 NZ, C 16 SE,<br>E 16 SE       | 05/88 → 03/93                  | ,  ,<br>→ <b>I</b> Mot. 02 J22349               | VKMC 05120                            |             |  |  |  |  |             |  |  |  |  | 1 | 1           | T0228 |
|                          | C 16 NZ, C 16 SE,<br>E 16 SE       | 05/88 → 03/93                  | ,  ,<br><b>Mot.</b> 02 J22350  →                | VKMC 05121<br>VKMA 05121<br>VKM 15121 | 1<br>1<br>1 |  |  |  |  | 1<br>1<br>1 |  |  |  |  |   | 1<br>1<br>1 | T0092 |
|                          | C 16 NZ, C 16 SE,<br>E 16 SE       | 05/88 → 03/93                  | 3), <b>Mot.</b> 02 J22350  →                    | VKMS 05121<br>VKMA 05121<br>VKM 15121 | 1<br>1<br>1 |  |  |  |  | 1<br>1<br>1 |  |  |  |  |   | 2<br>1<br>1 | T0092 |
|                          | C 16 NZ, C 16 SE,<br>E 16 SE       | 05/88 → 03/93                  | ,  ,<br>→ <b>I</b> Mot. 02 J22349               | VKPC 85401                            |             |  |  |  |  |             |  |  |  |  | 1 |             |       |
|                          | C 16 NZ, C 16 SE,<br>E 16 SE       | 05/88 → 03/93                  | ,  ,<br><b>Mot.</b> 02 J22350  →                | VKPC 85206                            |             |  |  |  |  |             |  |  |  |  | 1 |             |       |





|   |  |  |    |  |  |  |  |  |  |  |  |
|---|---|---|---|--|---|---|---|---|---|---|---|
|   | C 16 NZ, C 16 SE,<br>E 16 SE  | 05/88 → 03/93   |   | VKPC 85201   |   |   |   | 1   |   |   |   |
| <b>OPEL  CORSA A 1.5 D</b>     |   |   |   |  |   |   |   |   |   |   |   |
|                                | 15 D (ISUZU)  | 06/87 → 03/93   | 3)  | VKMS 05208<br>VKMA 05208<br>VKM 15210<br>VKM 25208                                 | 1<br>1<br>1   | 1<br>1  | 1   |   |   | 3   | 1<br>1<br>1   |
|   | 15 D (ISUZU)  | 06/87 → 03/93   | → IMot. 804794  | VKPC 85403   |   |   |   | 1   |   |   |   |
|                                | 15 D (ISUZU)  | 06/87 → 03/93   | Mot. 804795 I→,   | VKPC 85404   |   |   |   | 1   |   |   |   |
|   | 15 D (ISUZU)  | 06/87 → 03/93   | → IMot. 909999  | VKPC 85410   |   |   |   | 1   |   |   |   |
|   | 15 D (ISUZU)  | 06/87 → 03/93   | Mot. 910000 I→  | VKPC 85410   |   |   |   | 1   |   |   |   |
|                                | B(Alt) 15 D (ISUZU)   | 06/87 → 03/93   |   | VKPMV 13AVx875   |   |   | 1   |   |   |   |   |
| <b>OPEL  CORSA A 1.5 TD</b>    |   |   |   |  |   |   |   |   |   |   |   |
|                                | 15 TD (ISUZU)   | 10/87 → 03/93   | 3)  | VKMS 05208<br>VKMA 05208<br>VKM 15210<br>VKM 25208                                 | 1<br>1<br>1   | 1   |   |   |   | 3   | 1<br>1<br>1   |
|   | 15 TD (ISUZU)   | 10/87 → 03/93   | → IMot. 804794  | VKPC 85403   |   |   |   | 1   |   |   |   |
|                                | 15 TD (ISUZU)   | 10/87 → 03/93   | Mot. 804795 I→,   | VKPC 85404   |   |   |   | 1   |   |   |   |
|   | 15 TD (ISUZU)   | 10/87 → 03/93   | → IMot. 909999  | VKPC 85410   |   |   |   | 1   |   |   |   |
|   | 15 TD (ISUZU)   | 10/87 → 03/93   | Mot. 910000 I→  | VKPC 85410   |   |   |   | 1   |   |   |   |
|                                | B(Alt) 15 TD (ISUZU)  | 10/87 → 03/93   |   | VKPMV 13AVx875   |   |   | 1   |   |   |   |   |
| <b>OPEL  CORSA B 1.0 12V</b>   |   |   |   |  |   |   |   |   |   |   |   |
|                                | X 10 XE   | 11/96 → 09/00   |   | <del>OXOXOXO</del>   |   |   |   |   |   |   |   |
|                                | X 10 XE   | 11/96 → 09/00   |   | VKPC 85220   |   |   |   | 1   |   |   |   |
|                               | B(Alt) X 10 XE  | 11/96 → 09/00   | AC  | VKMA 35113<br>VKMV 5PK1230<br>VKM 35013  | 1   |   | 1   |   |   |   |   |
|   | B(Alt) X 10 XE  | 11/96 → 09/00   | AC  | VKMA 35013<br>VKMV 5PK1355<br>VKM 35013  | 1   |   | 1   |   |   |   |   |
|   | B(Alt) X 10 XE  | 11/96 → 09/00   | AC  | VKMA 35013<br>VKMV 5PK1355<br>VKM 35013  | 1   |   | 1   |   |   |   |   |
| <b>OPEL  CORSA B 1.2</b>     |   |   |   |  |   |   |   |   |   |   |   |
|                              | 12 NZ, C 12 NZ, X 12 SZ   | 03/93 → 09/00   |    | VKMC 05121<br>VKMA 05121<br>VKM 15121  | 1<br>1<br>1   |   | 1   |   |   |   | 1<br>1<br>1   |
|   | 12 NZ, C 12 NZ, X 12 SZ   | 03/93 → 09/00   | 3)  | VKMS 05121<br>VKMA 05121<br>VKM 15121  | 1<br>1<br>1   | 1   |   |   | 2   |   | 1<br>1<br>1   |
|                              | 12 NZ, C 12 NZ, X 12 SZ   | 03/93 → 09/00   |   | VKPC 85206   |   |   |   | 1   |   |   |   |
|                              | B(Alt) 12 NZ, C 12 NZ, X 12 SZ  | 03/93 → 12/94   | AC, ⊗   | VKPMV 10AVx913   |   |   | 1   |   |   |   |   |
|   | B(Alt) C 12 NZ, X 12 SZ   | 01/95 → 09/00   | AC, ⊗   | VKPMV 10AVx925   |   |   | 1   |   |   |   |   |
|   | B(Alt) C 12 NZ, X 12 SZ   | 03/93 → 09/00   | AC, ⊗   | VKPMV 6PK1795<br>VKM 35002<br>VKM 35009  |   |   | 1   |   |   |   |   |
|   | B(Alt) 12 NZ, C 12 NZ, X 12 SZ  | 03/93 → 09/00   | AC, ⊗   | VKMA 35008<br>VKMV 6PK1460<br>VKM 35008  | 1   |   | 1   |   |   |   |   |
|   | B(Alt) 12 NZ, C 12 NZ, X 12 SZ  | 03/93 → 09/00   | AC, ⊗   | VKMA 35125<br>VKMV 6PK1795<br>VKM 35009  | 1   |   | 1   |   |   |   |   |
|   | B(Alt) 12 NZ, C 12 NZ, X 12 SZ  | 03/93 → 09/00   | AC, ⊗   | VKMA 35125<br>VKMV 6PK1795<br>VKM 35009  | 1   |   | 1   |   |   |   |   |
| <b>OPEL  CORSA B 1.2 16V</b> |   |   |   |  |   |   |   |   |   |   |   |
|                              | X 12 XE   | 03/98 → 09/00   |   | <del>OXOXOXO</del>   |   |   |   |   |   |   |   |
|                              | X 12 XE   | 03/98 → 09/00   |   | VKPC 85220   |   |   |   | 1   |   |   |   |
|                              | B(Alt) X 12 XE  | 03/98 → 09/00   | AC  | VKMA 35113<br>VKMV 5PK1230<br>VKM 35013  | 1   |   | 1   |   |   |   |   |
|   | B(Alt) X 12 XE  | 03/98 → 09/00   | AC  | VKMA 35013<br>VKMV 5PK1355<br>VKM 35013  | 1   |   | 1   |   |   |   |   |



































| OPEL  CORSA B 1.4 |  |               |   |  |             |        |   |   |             |       |
|--|--|---------------|---|--|-------------|--------|---|---|-------------|-------|
|                    | C 14 NZ, C 14 SE,<br>X 14 SZ               | 03/93 → 09/00 |  | VKMC 05121<br>VKMA 05121<br>VKM 15121    | 1<br>1<br>1 | 1<br>1 | 1 |   | 1<br>1<br>1 | T0092 |
|  | C 14 NZ, C 14 SE,<br>X 14 SZ               | 03/93 → 09/00 | 3)  | VKMS 05121<br>VKMA 05121<br>VKM 15121    | 1<br>1<br>1 | 1<br>1 |   | 2 | 1<br>1<br>1 | T0092 |
|                    | C 14 NZ, C 14 SE,<br>X 14 SZ               | 03/93 → 09/00 |   | VKPC 85206                               |             |        |   | 1 |             |       |
|                    | <b>B(Alt)</b> C 14 NZ, C 14 SE,<br>X 14 SZ | 03/93 → 12/94 | AC, ⊗   | VKMOV 10AVx913                           |             | 1      |   |   |             |       |
|  | <b>B(Alt)</b> C 14 NZ, C 14 SE,<br>X 14 SZ | 03/93 → 09/00 | AC, ⊗   | VKMOV 6PK1795<br>VKM 35002<br>VKM 35009  | 1           | 1      |   |   |             |       |
|  | <b>B(Alt)</b> C 14 NZ, C 14 SE,<br>X 14 SZ | 03/93 → 09/00 | AC, ⊗   | VKMA 35008<br>VKMOV 6PK1460<br>VKM 35008 | 1<br>1      | 1<br>1 |   |   |             |       |
|  | <b>B(Alt)</b> C 14 NZ, C 14 SE,<br>X 14 SZ | 03/93 → 09/00 | AC, ⊗   | VKMA 35125<br>VKMOV 6PK1795<br>VKM 35009 | 1<br>1      | 1<br>1 |   |   |             |       |

| OPEL  CORSA B 1.4 16V |                                 |               |       |   |             |             |   |   |             |       |
|---|---------------------------------|---------------|-------|---|-------------|-------------|---|---|-------------|-------|
|                       | C 14 SEL, X 14 XE               | 09/94 → 09/00 | 3)    | VKMS 05150<br>VKMA 05150<br>VKM 15216<br>VKM 25150<br>VKM 25152 | 1<br>1<br>1 | 2<br>2<br>1 | 1 |   | 3<br>3<br>1 | T0107 |
|                       | C 14 SEL, X 14 XE               | 09/94 → 09/00 |       | VKPC 85212  |             |             |   | 1 |             |       |
|                       | <b>B(Alt)</b> C 14 SEL, X 14 XE | 09/94 → 09/00 | AC, ⊗ | VKMOV 6PK895<br>VKM 35011                                       | 1           | 1           |   |   |             |       |
|   | <b>B(Alt)</b> C 14 SEL, X 14 XE | 09/94 → 09/00 | AC, ⊗ | VKMOV 6PK1795<br>VKM 35002<br>VKM 35009                         | 1           | 1           |   |   |             |       |
|   | <b>B(Alt)</b> C 14 SEL, X 14 XE | 09/94 → 09/00 | AC, ⊗ | VKMA 35025<br>VKMOV 6PK1530<br>VKM 35009                        | 1<br>1      | 1<br>1      |   |   |             |       |
|   | <b>B(Alt)</b> C 14 SEL, X 14 XE | 09/94 → 09/00 | AC, ⊗ | VKMA 35125<br>VKMOV 6PK1795<br>VKM 35009                        | 1<br>1      | 1<br>1      |   |   |             |       |

| OPEL  CORSA B 1.6 16V |   |               |       |   |             |             |   |   |             |       |
|--|---|---------------|-------|---|-------------|-------------|---|---|-------------|-------|
|                        | C 16 SEL, C 16 XE,<br>X 16 XE               | 03/93 → 09/00 | 3)    | VKMS 05150<br>VKMA 05150<br>VKM 15216<br>VKM 25150<br>VKM 25152 | 1<br>1<br>1 | 2<br>2<br>1 | 1 |   | 3<br>3<br>1 | T0107 |
|                        | C 16 SEL, C 16 XE,<br>X 16 XE               | 03/93 → 09/00 |       | VKPC 85212  |             |             |   | 1 |             |       |
|                        | <b>B(Alt)</b> C 16 SEL, C 16 XE,<br>X 16 XE | 03/93 → 09/00 | AC, ⊗ | VKMOV 6PK895<br>VKM 35011                                       | 1           | 1           |   |   |             |       |
|  | <b>B(Alt)</b> C 16 SEL, C 16 XE,<br>X 16 XE | 03/93 → 09/00 | AC, ⊗ | VKMOV 6PK1795<br>VKM 35002<br>VKM 35009                         | 1           | 1           |   |   |             |       |
|  | <b>B(Alt)</b> C 16 SEL, C 16 XE,<br>X 16 XE | 03/93 → 09/00 | AC, ⊗ | VKMA 35025<br>VKMOV 6PK1530<br>VKM 35009                        | 1<br>1      | 1<br>1      |   |   |             |       |



|   |  |  |      |  |  |  |  |  |  |  |  |
|---|---|---|---|--|---|---|---|---|---|---|---|
| <b>B(Alt)</b>   | C 16 SEL, C 16 XE,<br>X 16 XE   | 03/93 → 09/00   | AC,  | VKMA 35125<br>VKMV 6PK1795<br>VKM 35009  | 1   | 1   | 1   |   |   |   |   |
| <b>OPEL  CORSA B 1.5 D</b>     |   |   |   |  |   |   |   |   |   |   |   |
|                                | 15 D (ISUZU),<br>X 15 D (ISUZU)   | 03/93 → 09/00   | 3)  | VKMS 05208<br>VKMA 05208<br>VKM 15210<br>VKM 25208                                 | 1<br>1<br>1   | 1<br>1<br>1   |   |   |   | 3   | 1<br>1<br>1<br>T0062  |
|                                | 15 D (ISUZU),<br>X 15 D (ISUZU)   | 03/93 → 09/00   | →IMot. 877697   | VKPC 85410   |   |   |   |   | 1   |   |   |
|   | 15 D (ISUZU),<br>X 15 D (ISUZU)   | 03/93 → 09/00   | Mot. 877698 I→  | VKPC 85621   |   |   |   |   | 1   |   |   |
|                                | <b>B(Alt)</b> 15 D (ISUZU),<br>X 15 D (ISUZU)                                     | 03/93 → 09/00   |   | VKMV 13AVx915  |   |   |   |   | 1   |   |   |
|   | <b>B(PS)</b> 15 D (ISUZU),<br>X 15 D (ISUZU)                                      | 03/93 → 09/00   |   | VKMV 10AVx950  |   |   |   |   | 1   |   |   |
| <b>OPEL  CORSA B 1.5 TD</b>    |   |   |   |  |   |   |   |   |   |   |   |
|                                | 15 TD (ISUZU),<br>X 15 TD (ISUZU)   | 03/93 → 09/00   | 3)  | VKMS 05208<br>VKMA 05208<br>VKM 15210<br>VKM 25208                                 | 1<br>1<br>1   | 1<br>1<br>1   |   |   |   | 3   | 1<br>1<br>1<br>T0062  |
|                                | 15 TD (ISUZU),<br>X 15 TD (ISUZU)   | 03/93 → 09/00   | →IMot. 877697   | VKPC 85410   |   |   |   |   | 1   |   |   |
|   | 15 TD (ISUZU),<br>X 15 TD (ISUZU)   | 03/93 → 09/00   | Mot. 877698 I→,<br>→IMot. 076350  | VKPC 85621   |   |   |   |   | 1   |   |   |
|   | 15 TD (ISUZU),<br>X 15 TD (ISUZU)   | 03/93 → 09/00   | Mot. 00076351 I→  | VKPC 85622   |   |   |   |   | 1   |   |   |
|                              | <b>B(Alt)</b> 15 TD (ISUZU),<br>X 15 TD (ISUZU)                                   | 03/93 → 09/00   |   | VKMV 13AVx915  |   |   |   |   | 1   |   |   |
|   | <b>B(PS)</b> 15 TD (ISUZU),<br>X 15 TD (ISUZU)                                    | 03/93 → 09/00   |   | VKMV 10AVx950  |   |   |   |   | 1   |   |   |
| <b>OPEL  CORSA B 1.7 D</b>   |   |   |   |  |   |   |   |   |   |   |   |
|                              | 17 D (ISUZU),<br>X 17 D (ISUZU)   | 02/96 → 09/00   |   | VKMA 05214<br>VKM 15215<br>VKM 25208   | 1<br>1  | 1<br>1  | 1   |   |   |   | 1<br>1<br>T0062   |
|                              | 17 D (ISUZU),<br>X 17 D (ISUZU)   | 02/96 → 09/00   | →IMot. 877697   | VKPC 85404   |   |   |   |   | 1   |   |   |
|   | 17 D (ISUZU),<br>X 17 D (ISUZU)   | 02/96 → 09/00   | Mot. 877698 I→  | VKPC 85620   |   |   |   |   | 1   |   |   |
|                              | <b>B(Alt)</b> 17 D (ISUZU),<br>X 17 D (ISUZU)                                     | 02/96 → 09/00   | AC  | VKMV 13AVx915  |   |   |   |   | 1   |   |   |
|   | <b>B(PS)</b> 17 D (ISUZU),<br>X 17 D (ISUZU)                                      | 02/96 → 09/00   |   | VKMV 10AVx950  |   |   |   |   | 1   |   |   |
| <b>OPEL  CORSA B 1.7 DTI</b> |   |   |   |  |   |   |   |   |   |   |   |
|                              | Y 17 DT (ISUZU)   | 08/01 → 06/07   | →IMot. 328704   | VKMA 05606<br>VKM 15215<br>VKM 25208   | 1<br>1  | 1<br>1  | 1   |   |   |   | 1<br>1<br>T0182   |
|   | Y 17 DT (ISUZU)   | 08/01 → 06/07   | Mot. 328705 I→  | VKMA 05608<br>VKM 15218<br>VKM 25208   | 1<br>1  | 1<br>1  | 1   |   |   |   | 3<br>1<br>T0182   |
|                              | Y 17 DT (ISUZU)   | 08/01 → 10/07   |   | VKPC 85300   |   |   |   |   | 1   |   |   |
|                              | <b>B(Alt)</b> Y 17 DT (ISUZU)   | 08/01 → 06/07   | AC  | VKMA 35215<br>VKMV 6PK1250<br>VKM 35015  | 1   |   | 1   |   | 1   |   |   |
|   | <b>B(Alt)</b> Y 17 DT (ISUZU)   | 08/01 → 06/07   | AC  | VKMA 35315<br>VKMV 6PK1590<br>VKM 35015<br>VKM 35025                               | 1<br>1  | 1<br>1  | 1   |   | 1   |   |   |
| <b>OPEL  CORSA C 1.0</b>     |   |   |   |  |   |   |   |   |   |   |   |
|                              | Z 10 XE   | 09/00 → 06/07   |   | <b>OXOXOXO</b>   |   |   |   |   |   |   |   |







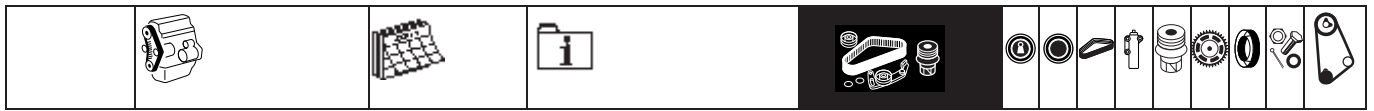





























OPEL

|                                       | Z 10 XE                |  | 09/00 → 10/07 |   | VKPC 85220  |   |   |   |  |  |  |  |  |  |  |   |   | 1     |
|---------------------------------------|------------------------|--|---------------|---|---|---|---|---|--|--|--|--|--|--|--|---|---|-------|
|                                       | <b>B(Alt)</b> Z 10 XE  |  | 09/00 → 06/07 | <b>AC</b>                                 | VKMA 35113<br>VKMV 5PK1230<br>VKM 35013                           | 1 |   | 1 |  |  |  |  |  |  |  |   |   |       |
|                                       | <b>B(Alt)</b> Z 10 XE  |  | 09/00 → 06/07 | <b>AC</b>                                 | VKMA 35013<br>VKMV 5PK1355<br>VKM 35013                           | 1 |   | 1 |  |  |  |  |  |  |  |   |   |       |
| <b>OPEL  CORSA C 1.0 Twinport</b>     |                        |  |               |   |   |   |   |   |  |  |  |  |  |  |  |   |   |       |
|                                       | Z 10 XEP               |  | 06/03 → 06/07 |   | <b>OXOXOXO</b>  |   |   |   |  |  |  |  |  |  |  |   |   |       |
|                                       | Z 10 XEP               |  | 06/03 → 10/07 |   | VKPC 85310  |   |   |   |  |  |  |  |  |  |  |   |   | 1     |
|                                       | <b>B(Alt)</b> Z 10 XEP |  | 06/03 → 06/07 | <b>AC</b>                                 | VKMA 35113<br>VKMV 5PK1230<br>VKM 35013                           | 1 |   | 1 |  |  |  |  |  |  |  |   |   |       |
|                                       | <b>B(Alt)</b> Z 10 XEP |  | 06/03 → 06/07 | <b>AC</b>                                 | VKMA 35013<br>VKMV 5PK1355<br>VKM 35013                           | 1 |   | 1 |  |  |  |  |  |  |  |   |   |       |
| <b>OPEL  CORSA C 1.2 16V</b>          |                        |  |               |   |   |   |   |   |  |  |  |  |  |  |  |   |   |       |
|                                       | Z 12 XE                |  | 09/00 → 06/07 |   | <b>OXOXOXO</b>  |   |   |   |  |  |  |  |  |  |  |   |   |       |
|                                       | Z 12 XE                |  | 09/00 → 10/07 |   | VKPC 85220  |   |   |   |  |  |  |  |  |  |  |   |   | 1     |
|                                       | Z 12 XE                |  | 07/05 → 06/07 |   | VKPC 85310  |   |   |   |  |  |  |  |  |  |  |   |   | 1     |
|                                       | <b>B(Alt)</b> Z 12 XE  |  | 09/00 → 06/07 | <b>AC</b>                                 | VKMA 35113<br>VKMV 5PK1230<br>VKM 35013                           | 1 |   | 1 |  |  |  |  |  |  |  |   |   |       |
|                                       | <b>B(Alt)</b> Z 12 XE  |  | 09/00 → 06/07 | <b>AC, →ICH 36 152608,<br/>44 001048</b>  | VKMA 35013<br>VKMV 5PK1355<br>VKM 35013                           | 1 |   | 1 |  |  |  |  |  |  |  |   |   |       |
|                                       | <b>B(Alt)</b> Z 12 XE  |  | 09/00 → 06/07 | <b>AC, CH 36 152609,<br/>44 001049  →</b> | VKMA 35013<br>VKMV 5PK1368<br>VKM 35013                           | 1 |   | 1 |  |  |  |  |  |  |  |   |   |       |
| <b>OPEL  CORSA C 1.2 16V Twinport</b> |                        |  |               |   |   |   |   |   |  |  |  |  |  |  |  |   |   |       |
|                                       | Z 12 XEP               |  | 07/04 → 06/07 |   | <b>OXOXOXO</b>  |   |   |   |  |  |  |  |  |  |  |   |   |       |
|                                       | Z 12 XEP               |  | 07/04 → 10/07 |   | VKPC 85310  |   |   |   |  |  |  |  |  |  |  |   |   | 1     |
|                                       | <b>B(Alt)</b> Z 12 XEP |  | 07/04 → 06/07 | <b>AC</b>                                 | VKMA 35113<br>VKMV 5PK1230<br>VKM 35013                           | 1 |   | 1 |  |  |  |  |  |  |  |   |   |       |
|                                       | <b>B(Alt)</b> Z 12 XEP |  | 07/04 → 06/07 | <b>AC, →ICH 36 152608,<br/>44 001048</b>  | VKMA 35013<br>VKMV 5PK1355<br>VKM 35013                           | 1 |   | 1 |  |  |  |  |  |  |  |   |   |       |
|                                       | <b>B(Alt)</b> Z 12 XEP |  | 07/04 → 06/07 | <b>AC, CH 36 152609,<br/>44 001049  →</b> | VKMA 35013<br>VKMV 5PK1368<br>VKM 35013                           | 1 |   | 1 |  |  |  |  |  |  |  |   |   |       |
| <b>OPEL  CORSA C 1.4 16V</b>          |                        |  |               |   |   |   |   |   |  |  |  |  |  |  |  |   |   |       |
|                                       | Z 14 XE                |  | 09/00 → 06/07 | 3), → Mot. 20 EB2048                      | VKMS 05154-1<br>VKMA 05154<br>VKM 15216<br>VKM 25152<br>VKM 25312 | 1 | 2 | 1 |  |  |  |  |  |  |  | 3 | 3 | T0157 |
|                                       | Z 14 XE                |  | 09/00 → 06/07 | <b>Mot. 20 EB2049  →</b>                  | VKMA 05156<br>VKM 15216<br>VKM____<br>VKM 25158                   | 1 | 2 | 1 |  |  |  |  |  |  |  |   | 1 | T0157 |
|                                       | Z 14 XE                |  | 09/00 → 10/07 | → Mot. 02 MZ5253,<br>20 U75998            | VKPC 85212  |   |   |   |  |  |  |  |  |  |  |   | 1 |       |
|                                       | Z 14 XE                |  | 09/00 → 10/07 | <b>Mot. 02 MZ5254,<br/>20 U75999  →</b>   | VKPC 85211  |   |   |   |  |  |  |  |  |  |  |   | 1 |       |
|                                       | <b>B(Alt)</b> Z 14 XE  |  | 09/00 → 06/07 | <b>AC</b>                                 | VKMA 35012<br>VKMV 5PK938<br>VKM 35012                            | 1 |   | 1 |  |  |  |  |  |  |  |   |   |       |
|                                       | <b>B(Alt)</b> Z 14 XE  |  | 09/00 → 06/07 | <b>AC</b>                                 | VKMA 35022<br>VKMV 5PK1212<br>VKM 35012                           | 1 |   | 1 |  |  |  |  |  |  |  |   |   |       |



























































| OPEL  CORSA C 1.4 16V Twinport |                                      |               |                      |   |             |        |        |  |  |  |  |   |  |   |   |   |  |       |
|--------------------------------|--------------------------------------|---------------|----------------------|---|-------------|--------|--------|--|--|--|--|---|--|---|---|---|--|-------|
|                                | Z 14 XEP                             | 06/03 → 06/07 |                      | <b>OKOKOKO</b>  |             |        |        |  |  |  |  |   |  |   |   |   |  |       |
|                                | Z 14 XEP                             | 06/03 → 10/07 |                      | VKPC 85310  |             |        |        |  |  |  |  | 1 |  |   |   |   |  |       |
|                                | B(Alt) Z 14 XEP                      | 06/03 → 06/07 | <i>AC</i>            | VKMA 35113<br>VKMV 5PK1230<br>VKM 35013                           | 1           |        | 1      |  |  |  |  |   |  |   |   |   |  |       |
|                                | B(Alt) Z 14 XEP                      | 06/03 → 06/07 | <b>AC</b>            | VKMV 5PK1368<br>VKM 35013   | 1           |        | 1      |  |  |  |  |   |  |   |   |   |  |       |
| OPEL  CORSA C 1.8 16V          |                                      |               |                      |   |             |        |        |  |  |  |  |   |  |   |   |   |  |       |
|                                | Z 18 XE                              | 09/00 → 12/02 | 3), → Mot. 20 EB2048 | VKMS 05154-2<br>VKMA 05154<br>VKM 15216<br>VKM 25152<br>VKM 25312 | 1<br>1<br>1 | 2<br>2 | 1<br>1 |  |  |  |  |   |  | 3 | 3 |   |  | T0157 |
|                                | Z 18 XE                              | 01/03 → 06/07 | 3), → Mot. 20 EB2048 | VKMS 05154-3<br>VKMA 05154<br>VKM 15216<br>VKM 25152<br>VKM 25312 | 1<br>1<br>1 | 2<br>2 | 1<br>1 |  |  |  |  |   |  | 3 | 3 |   |  | T0157 |
|                                | Z 18 XE                              | 01/03 → 06/07 | Mot. 20 EB2049  →    | VKMA 05156<br>VKM 15216<br>VKM____<br>VKM 25158                   | 1<br>1      | 2      | 1      |  |  |  |  |   |  |   |   | 1 |  | T0157 |
|                                | Z 18 XE                              | 09/00 → 10/07 |                      | VKPC 85624  |             |        |        |  |  |  |  | 1 |  |   |   |   |  |       |
|                                | B(Alt) Z 18 XE                       | 09/00 → 06/07 | <i>AC</i>            | VKMA 35012<br>VKMV 5PK938<br>VKM 35012                            | 1           |        | 1      |  |  |  |  |   |  |   |   |   |  |       |
|                                | B(Alt) Z 18 XE                       | 09/00 → 06/07 | <b>AC</b>            | VKMA 35022<br>VKMV 5PK1212<br>VKM 35012                           | 1           |        | 1      |  |  |  |  |   |  |   |   |   |  |       |
| OPEL  CORSA C 1.3 CDTI         |                                      |               |                      |   |             |        |        |  |  |  |  |   |  |   |   |   |  |       |
|                                | Y 13 DT, Z 13 DT,<br>Z 13 DTJ        | 06/03 → 06/07 |                      | <b>OKOKOKO</b>  |             |        |        |  |  |  |  |   |  |   |   |   |  |       |
|                                | Y 13 DT, Z 13 DT,<br>Z 13 DTJ        | 06/03 → 10/07 |                      | VKPC 85700  |             |        |        |  |  |  |  | 1 |  |   |   |   |  |       |
|                                | B(Alt) Y 13 DT, Z 13 DT,<br>Z 13 DTJ | 06/03 → 06/07 | <i>AC</i>            | VKMV 6PK1182<br>VKM 35023   | 1           |        | 1      |  |  |  |  |   |  |   |   |   |  |       |
|                                | B(Alt) Y 13 DT, Z 13 DT,<br>Z 13 DTJ | 06/03 → 06/07 | <b>AC</b>            | VKMV____<br>VKM 35023   | 1           |        | 1      |  |  |  |  |   |  |   |   |   |  |       |
| OPEL  CORSA C 1.7 DI           |                                      |               |                      |   |             |        |        |  |  |  |  |   |  |   |   |   |  |       |
|                                | Y 17 DTL (ISUZU)                     | 09/00 → 06/07 | → Mot. 328704        | VKMA 05606<br>VKM 15215<br>VKM 25208                              | 1<br>1      | 1      | 1      |  |  |  |  |   |  |   |   | 1 |  | T0182 |
|                                | Y 17 DTL (ISUZU)                     | 09/00 → 06/07 | Mot. 328705  →       | VKMA 05608<br>VKM 15218<br>VKM 25208                              | 1<br>1      | 1      | 1      |  |  |  |  |   |  |   |   | 3 |  | T0182 |
|                                | Y 17 DTL (ISUZU)                     | 09/00 → 10/07 |                      | VKPC 85300  |             |        |        |  |  |  |  | 1 |  |   |   |   |  |       |
|                                | B(Alt) Y 17 DTL (ISUZU)              | 09/00 → 06/07 | <i>AC</i>            | VKMA 35215<br>VKMV 6PK1250<br>VKM 35015                           | 1           |        | 1      |  |  |  |  |   |  |   |   |   |  |       |
|                                | B(Alt) Y 17 DTL (ISUZU)              | 09/00 → 06/07 | <b>AC</b>            | VKMA 35315<br>VKMV 6PK1590<br>VKM 35015<br>VKM 35025              | 1<br>1      | 1      | 1      |  |  |  |  |   |  |   |   |   |  |       |
| OPEL  CORSA C 1.7 DTI          |                                      |               |                      |   |             |        |        |  |  |  |  |   |  |   |   |   |  |       |
|                                | Y 17 DT (ISUZU)                      | 09/00 → 06/07 | → Mot. 328704        | VKMA 05606<br>VKM 15215<br>VKM 25208                              | 1<br>1      | 1      | 1      |  |  |  |  |   |  |   |   | 1 |  | T0182 |
|                                | Y 17 DT (ISUZU)                      | 09/00 → 06/07 | Mot. 328705  →       | VKMA 05608<br>VKM 15218<br>VKM 25208                              | 1<br>1      | 1      | 1      |  |  |  |  |   |  |   |   | 3 |  | T0182 |
|                                | Y 17 DT (ISUZU)                      | 09/00 → 10/07 |                      | VKPC 85300  |             |        |        |  |  |  |  | 1 |  |   |   |   |  |       |



|   |        |                    |               |  |  |  |  |  |  |  |  |  |  |
|---|--------|--------------------|---------------|--|---|---|---|---|---|---|---|---|---|
|                                       | B(Alt) | Y 17 DT (ISUZU)    | 09/00 → 06/07 | AC   | VKMA 35215  | 1   |   | 1   |   |   |   |   |   |
|   |        |                    |               |  | VKMA 35215  | 1   |   | 1   |   |   |   |   |   |
|   |        |                    |               |  | VKMV 6PK1250  |   |   | 1   |   |   |   |   |   |
|   |        |                    |               |  | VKM 35015   | 1   |   |   |   |   |   |   |   |
|   | B(Alt) | Y 17 DT (ISUZU)    | 09/00 → 06/07 | AC   | VKMA 35315  | 1   | 1   | 1   |   |   |   |   |   |
|   |        |                    |               |  | VKMA 35315  | 1   |   | 1   |   |   |   |   |   |
|   |        |                    |               |  | VKMV 6PK1590  |   |   | 1   |   |   |   |   |   |
|   |        |                    |               |  | VKM 35015   | 1   |   |   |   |   |   |   |   |
|   |        |                    |               |  | VKM 35025   |   | 1   |   |   |   |   |   |   |
| <b>OPEL  CORSA C 1.7 CDTI</b>        |        |                    |               |  |   |   |   |   |   |   |   |   |   |
|                                       |        | Z 17 DTH (ISUZU)   | 06/03 → 06/07 |  | VKMA 05608  | 1   | 1   | 1   |   |   |   |   | 3 T0182   |
|   |        |                    |               |  | VKMA 05608  | 1   |   |   |   |   |   |   |   |
|   |        |                    |               |  | VKM 15218   |   |   | 1   |   |   |   |   | 1   |
|   |        |                    |               |  | VKM 25208   |   |   |   |   |   |   |   |   |
|                                       |        | Z 17 DTH (ISUZU)   | 06/03 → 10/07 |  | VKPC 85300  |   |   |   | 1   |   |   |   |   |
|                                       | B(Alt) | Z 17 DTH (ISUZU)   | 06/03 → 06/07 | AC   | VKMA 35015  | 1   |   | 1   |   |   |   |   |   |
|   |        |                    |               |  | VKMA 35015  | 1   |   | 1   |   |   |   |   |   |
|   |        |                    |               |  | VKMV 6PK1275  |   |   | 1   |   |   |   |   |   |
|   |        |                    |               |  | VKM 35015   | 1   |   |   |   |   |   |   |   |
|   | B(Alt) | Z 17 DTH (ISUZU)   | 06/03 → 06/07 | AC, →IMot.01 260732  | VKMV 6PK1600  | 1   |   | 1   |   |   |   |   |   |
|   |        |                    |               |  | VKMV 6PK1600  | 1   |   | 1   |   |   |   |   |   |
|   |        |                    |               |  | VKM 35015   |   | 1   |   |   |   |   |   |   |
|   |        |                    |               |  | VKM 35025   |   |   |   |   |   |   |   |   |
| <b>OPEL  CORSA D 1.0 16V</b>         |        |                    |               |  |   |   |   |   |   |   |   |   |   |
|                                       |        | Z 10 XEP           | 07/06 → 09/07 |  | <del>OKOKOK</del>   |   |   |   |   |   |   |   |   |
|                                       |        | Z 10 XEP           | 07/06 → 03/07 |  | VKPC 85310  |   |   |   | 1   |   |   |   |   |
|                                       | B(Alt) | Z 10 XEP           | 07/06 → 09/07 | AC   | VKMA 35113  | 1   |   | 1   |   |   |   |   |   |
|   |        |                    |               |  | VKMA 35113  | 1   |   | 1   |   |   |   |   |   |
|   |        |                    |               |  | VKMV 5PK1230  |   |   | 1   |   |   |   |   |   |
|   |        |                    |               |  | VKM 35013   | 1   |   |   |   |   |   |   |   |
|   | B(Alt) | Z 10 XEP           | 07/06 → 09/07 | AC   | VKMA 35013  | 1   |   | 1   |   |   |   |   |   |
|   |        |                    |               |  | VKMA 35013  | 1   |   | 1   |   |   |   |   |   |
|   |        |                    |               |  | VKMV 5PK1355  |   |   | 1   |   |   |   |   |   |
|   |        |                    |               |  | VKM 35013   | 1   |   |   |   |   |   |   |   |
| <b>OPEL  CORSA D 1.2 16V</b>       |        |                    |               |  |   |   |   |   |   |   |   |   |   |
|                                     |        | Z 12 XEP           | 07/06 → 09/07 |  | <del>OKOKOK</del>   |   |   |   |   |   |   |   |   |
|                                     |        | Z 12 XEP           | 07/06 → 03/07 |  | VKPC 85310  |   |   |   | 1   |   |   |   |   |
|                                     | B(Alt) | Z 12 XEP           | 07/06 → 09/07 | AC   | VKMA 35113  | 1   |   | 1   |   |   |   |   |   |
|   |        |                    |               |  | VKMA 35113  | 1   |   | 1   |   |   |   |   |   |
|   |        |                    |               |  | VKMV 5PK1230  |   |   | 1   |   |   |   |   |   |
|   |        |                    |               |  | VKM 35013   | 1   |   |   |   |   |   |   |   |
|   | B(Alt) | Z 12 XEP           | 07/06 → 09/07 | AC   | VKMA 35013  | 1   |   | 1   |   |   |   |   |   |
|   |        |                    |               |  | VKMA 35013  | 1   |   | 1   |   |   |   |   |   |
|   |        |                    |               |  | VKMV 5PK1355  |   |   | 1   |   |   |   |   |   |
|   |        |                    |               |  | VKM 35013   | 1   |   |   |   |   |   |   |   |
| <b>OPEL  CORSA D 1.4 16V</b>       |        |                    |               |  |   |   |   |   |   |   |   |   |   |
|                                     |        | Z 14 XEP           | 07/06 → 09/07 |  | <del>OKOKOK</del>   |   |   |   |   |   |   |   |   |
|                                     |        | Z 14 XEP           | 07/06 → 03/07 |  | VKPC 85310  |   |   |   | 1   |   |   |   |   |
|                                     | B(Alt) | Z 14 XEP           | 07/06 → 09/07 | AC   | VKMA 35113  | 1   |   | 1   |   |   |   |   |   |
|   |        |                    |               |  | VKMA 35113  | 1   |   | 1   |   |   |   |   |   |
|   |        |                    |               |  | VKMV 5PK1230  |   |   | 1   |   |   |   |   |   |
|   |        |                    |               |  | VKM 35013   | 1   |   |   |   |   |   |   |   |
|   | B(Alt) | Z 14 XEP           | 07/06 → 09/07 | AC   | VKMA 35013  | 1   |   | 1   |   |   |   |   |   |
|   |        |                    |               |  | VKMA 35013  | 1   |   | 1   |   |   |   |   |   |
|   |        |                    |               |  | VKMV 5PK1355  |   |   | 1   |   |   |   |   |   |
|   |        |                    |               |  | VKM 35013   | 1   |   |   |   |   |   |   |   |
| <b>OPEL  CORSA D 1.6 16V Turbo</b> |        |                    |               |  |   |   |   |   |   |   |   |   |   |
|                                     |        | Z 16 LER           | 02/07 → 06/07 |  | VKMA_____   | 1   | 1   | 1   |   |   |   |   | 2 T0244   |
|   |        |                    |               |  | VKMA_____   | 1   |   |   |   |   |   |   |   |
|   |        |                    |               |  | VKM 15260   |   |   | 1   |   |   |   |   |   |
|   |        |                    |               |  | VKM_____  |   |   |   |   |   |   |   |   |
|                                     |        | Z 16 LER           | 02/07 → 10/07 |  | VKPC_____   |   |   |   | 1   |   |   |   |   |
|                                     | B(Alt) | Z 16 LER           | 02/07 → 06/07 | AC   | VKMV 5PK1450  | 1   |   | 1   |   |   |   |   |   |
|   |        |                    |               |  | VKMV 5PK1450  | 1   |   | 1   |   |   |   |   |   |
|   |        |                    |               |  | VKM 35260   |   |   |   |   |   |   |   |   |
|   | B(Alt) | Z 16 LER           | 02/07 → 06/07 | AC   | VKMV 5PK1546  | 1   |   | 1   |   |   |   |   |   |
|   |        |                    |               |  | VKMV 5PK1546  | 1   |   | 1   |   |   |   |   |   |
|   |        |                    |               |  | VKM 35260   |   |   |   |   |   |   |   |   |
| <b>OPEL  CORSA D 1.3 CDTI</b>      |        |                    |               |  |   |   |   |   |   |   |   |   |   |
|                                     |        | Z 13 DTH, Z 13 DTJ | 07/06 → 09/07 |  | <del>OKOKOK</del>   |   |   |   |   |   |   |   |   |
|                                     |        | Z 13 DTH, Z 13 DTJ | 07/06 → 03/07 |  | VKPC 85700  |   |   |   | 1   |   |   |   |   |
|                                     | B(Alt) | Z 13 DTH, Z 13 DTJ | 07/06 → 09/07 | AC   | VKMV 6PK1182  | 1   |   | 1   |   |   |   |   |   |
|   |        |                    |               |  | VKMV 6PK1182  | 1   |   | 1   |   |   |   |   |   |
|   |        |                    |               |  | VKM 35023   |   |   |   |   |   |   |   |   |
|   | B(Alt) | Z 13 DTH, Z 13 DTJ | 07/06 → 09/07 | AC   | VKMV_____   | 1   |   | 1   |   |   |   |   |   |
|   |        |                    |               |  | VKMV_____   | 1   |   | 1   |   |   |   |   |   |
|   |        |                    |               |  | VKM 35023   |   |   |   |   |   |   |   |   |

| <b>OPEL  CORSA D 1.7 CDTI</b>  |                                  |               |                           |  |  |  |   |   |   |   |         |
|--------------------------------|----------------------------------|---------------|---------------------------|--|--|--|---|---|---|---|---------|
|                                | A 17 DTR, Z 17 DTR               | 07/06 → 12/07 | —                         |  |  |  | 1 | 1 | 1 |   | 3 T0182 |
|                                |                                  |               | VKM 15218                 |  |  |  | 1 |   |   |   |         |
|                                |                                  |               | —                         |  |  |  |   | 1 |   |   |         |
|                                | A 17 DTR, Z 17 DTR               | 07/06 → 12/07 | VKPC 85300                |  |  |  |   |   | 1 |   |         |
|                                | <b>B(Alt)</b> A 17 DTR, Z 17 DTR | 07/06 → 12/07 | <b>AC</b>                 |  |  |  |   |   |   |   |         |
|                                |                                  |               | VKMV 6PK1250              |  |  |  | 1 |   |   |   |         |
|                                |                                  |               | VKM_____                  |  |  |  |   |   |   |   |         |
|                                |                                  |               | VKMV 6PK1615              |  |  |  | 1 |   |   |   |         |
|                                |                                  |               | VKM_____                  |  |  |  |   | 1 |   |   |         |
|                                |                                  |               | VKM_____                  |  |  |  |   |   |   |   |         |
| <b>OPEL  DIPLOMAT A 4.6</b>    |                                  |               |                           |  |  |  |   |   |   |   |         |
|                                | 46 S                             | 10/64 → 03/69 | <b>OXOXOXO</b>            |  |  |  |   |   |   |   |         |
| <b>OPEL  DIPLOMAT A 5.3</b>    |                                  |               |                           |  |  |  |   |   |   |   |         |
|                                | 54 S                             | 03/65 → 03/69 | <b>OXOXOXO</b>            |  |  |  |   |   |   |   |         |
| <b>OPEL  DIPLOMAT B 2.8</b>    |                                  |               |                           |  |  |  |   |   |   |   |         |
|                                | 28 E                             | 03/69 → 02/75 | <b>OXOXOXO</b>            |  |  |  |   |   |   |   |         |
|                                | 28 E                             | 03/69 → 02/75 | VKPC 85600                |  |  |  |   |   | 1 |   |         |
| <b>OPEL  DIPLOMAT B 5.3</b>    |                                  |               |                           |  |  |  |   |   |   |   |         |
|                                | 54 S                             | 03/69 → 01/78 | <b>OXOXOXO</b>            |  |  |  |   |   |   |   |         |
| <b>OPEL  FRONTERA A 2.0</b>    |                                  |               |                           |  |  |  |   |   |   |   |         |
|                                | C 20 NE                          | 03/92 → 10/98 | →   Mot. 14 608700        |  |  |  |   |   | 1 |   | T0225   |
|                                | C 20 NE                          | 03/92 → 10/98 | <b>Mot. 14 680701</b>   → |  |  |  | 1 |   | 1 |   | T0105   |
|                                |                                  |               | VKMA 05402                |  |  |  | 1 |   |   |   |         |
|                                |                                  |               | VKM 15402                 |  |  |  |   |   |   |   |         |
|                                | X 20 SE                          | 03/92 → 10/98 | VKMA 05402                |  |  |  | 1 |   | 1 |   | T0105   |
|                                |                                  |               | VKM 15402                 |  |  |  | 1 |   |   |   |         |
|                                | C 20 NE                          | 03/92 → 10/98 | →   Mot. 14 608700        |  |  |  |   |   |   | 1 |         |
|                                | C 20 NE                          | 03/92 → 10/98 | <b>Mot. 14 608701</b>   → |  |  |  |   |   |   | 1 |         |
|                                | X 20 SE                          | 03/92 → 10/98 | VKPC 85409                |  |  |  |   |   |   | 1 |         |
|                                | <b>B(Alt)</b> C 20 NE            | 03/92 → 10/98 | 70A                       |  |  |  |   |   | 1 |   |         |
|                                | <b>B(Alt)</b> C 20 NE            | 03/92 → 10/98 | 90A                       |  |  |  |   |   | 1 |   |         |
|                                | <b>B(Alt)</b> X 20 SE            | 03/92 → 10/98 | <b>AC</b>                 |  |  |  | 1 |   | 1 |   |         |
|                                |                                  |               | VKMA 35009                |  |  |  | 1 |   | 1 |   |         |
|                                |                                  |               | VKMV 6PK1725              |  |  |  |   |   | 1 |   |         |
|                                |                                  |               | VKM 35009                 |  |  |  | 1 |   |   |   |         |
|                                | <b>B(Alt)</b> X 20 SE            | 03/92 → 10/98 | <b>AC</b>                 |  |  |  | 1 |   | 1 |   |         |
|                                |                                  |               | VKMV 6PK2050              |  |  |  |   |   |   |   |         |
|                                |                                  |               | VKM 35009                 |  |  |  | 1 |   |   |   |         |
| <b>OPEL  FRONTERA A 2.2</b>    |                                  |               |                           |  |  |  |   |   |   |   |         |
|                                | X 22 XE                          | 03/95 → 12/96 | →   CH TV 899999          |  |  |  | 1 | 2 | 1 |   | T0139   |
|                                |                                  |               | VKMA 05223                |  |  |  | 1 |   |   |   |         |
|                                |                                  |               | VKM 15202                 |  |  |  |   |   |   |   |         |
|                                |                                  |               | VKM 25212                 |  |  |  |   | 1 |   |   |         |
|                                |                                  |               | VKM 25212                 |  |  |  |   | 1 |   |   |         |
|                                | X 22 XE                          | 01/97 → 10/98 | <b>CH VV 600001</b>   →   |  |  |  | 1 | 2 | 1 |   | T0139   |
|                                |                                  |               | VKMA 05228                |  |  |  | 1 |   |   |   |         |
|                                |                                  |               | VKM 15230                 |  |  |  | 1 |   |   |   |         |
|                                |                                  |               | VKM 25212                 |  |  |  |   |   | 1 |   |         |
|                                |                                  |               | VKM 25212                 |  |  |  |   | 1 |   |   |         |
|                                | X 22 XE                          | 03/95 → 10/98 | VKPC 85611                |  |  |  |   |   |   | 1 |         |
|                                | <b>B(Alt)</b> X 22 XE            | 03/95 → 10/98 | <b>AC</b>                 |  |  |  | 1 |   | 1 |   |         |
|                                |                                  |               | VKMA 35009                |  |  |  |   |   |   | 1 |         |
|                                |                                  |               | VKMV 6PK1725              |  |  |  | 1 |   |   |   |         |
|                                |                                  |               | VKM 35009                 |  |  |  | 1 |   |   |   |         |
|                                | <b>B(Alt)</b> X 22 XE            | 03/95 → 10/98 | <b>AC</b>                 |  |  |  | 1 |   | 1 |   |         |
|                                |                                  |               | VKMV 6PK2050              |  |  |  |   |   |   |   |         |
|                                |                                  |               | VKM 35009                 |  |  |  | 1 |   |   |   |         |
| <b>OPEL  FRONTERA A 2.4</b>    |                                  |               |                           |  |  |  |   |   |   |   |         |
|                                | C 24 NE                          | 03/92 → 10/98 | <b>OXOXOXO</b>            |  |  |  |   |   |   |   |         |
|                                | C 24 NE                          | 03/92 → 10/98 | VKPC 85603                |  |  |  |   |   |   | 1 |         |
|                                | <b>B(Alt)</b> C 24 NE            | 03/92 → 10/98 | 70A                       |  |  |  |   |   | 1 |   |         |
|                                | <b>B(Alt)</b> C 24 NE            | 03/92 → 10/98 | 90A                       |  |  |  |   |   | 1 |   |         |
| <b>OPEL  FRONTERA A 2.3 TD</b> |                                  |               |                           |  |  |  |   |   |   |   |         |
|                                | 23 TD                            | 03/92 → 10/98 | <b>OXOXOXO</b>            |  |  |  |   |   |   |   |         |
|                                | 23 TD                            | 03/92 → 10/98 | VKPC 85603                |  |  |  |   |   |   | 1 |         |
|                                | <b>B(Alt)</b> 23 TD              | 03/92 → 10/98 | VKMV 10AVx900             |  |  |  |   |   | 1 |   |         |
| <b>OPEL  FRONTERA A 2.5 TD</b> |                                  |               |                           |  |  |  |   |   |   |   |         |
|                                | 25 TD                            | 09/96 → 10/98 | VKPC 82810                |  |  |  |   |   |   | 1 |         |







































|  |  |  |  |  |  |  |  |  |  |  |  |  |
|--|---|---|---|--|---|---|---|---|---|---|---|---|
| <b>OPEL  FRONTERA A 2.8 TD</b>  |   |   |   |  |   |   |   |   |   |   |   |   |
|                                  | 28 TD, 28 TDI   | 03/95 → 10/98   |   | VKMA 99004<br>VKM 79002<br>VKM 89003   | 1<br>1  | 1   | 1   |   |   |   |   | T0628   |
| <b>OPEL  FRONTERA B 2.2</b>     |   |   |   |  |   |   |   |   |   |   |   |   |
|                                  | X 22 SE, Y 22 SE  | 10/98 → 09/07   |   | VKMA 05228<br>VKM 15230<br>VKM 25212<br>VKM 25212                                  | 1<br>1  | 2   | 1   |   |   |   |   | T0139   |
|                                  | X 22 SE, Y 22 SE  | 10/98 → 10/07   |   | VKPC 85611   |   |   |   | 1   |   |   |   |   |
|                                  | <b>B(Alt)</b> X 22 SE, Y 22 SE  | 10/98 → 09/07   | <b>AC</b>   | VKMA 35009<br>VKMV 6PK1725<br>VKM 35009  | 1   |   | 1   |   |   |   |   |   |
|  | <b>B(Alt)</b> X 22 SE, Y 22 SE  | 10/98 → 09/07   | <b>AC</b>   | VKMV 6PK1850<br>VKM 35009  | 1   |   | 1   |   |   |   |   |   |
| <b>OPEL  FRONTERA B 3.2</b>     |   |   |   |  |   |   |   |   |   |   |   |   |
|                                  | 32  | 10/98 → 10/07   | 2)  | —  |   |   |   | 1   |   |   |   |   |
|  |   |   |   | —  |   |   |   | 1   |   |   |   |   |
| <b>OPEL  FRONTERA B 2.2 DTI</b> |   |   |   |  |   |   |   |   |   |   |   |   |
|                                  | X 22 DTH, Y 22 DTH  | 10/98 → 09/07   |   | <b>OXOXOXO</b>   |   |   |   |   |   |   |   |   |
|                                  | X 22 DTH, Y 22 DTH  | 10/98 → 10/07   |   | VKPC 85623   |   |   |   | 1   |   |   |   |   |
|                                  | <b>B(Alt)</b> X 22 DTH, Y 22 DTH  | 10/98 → 09/07   | <b>AC</b>   | VKMA 35007<br>VKMV 6PK1805<br>VKM 35007  | 1   |   | 1   |   |   |   |   |   |
|  | <b>B(Alt)</b> X 22 DTH, Y 22 DTH  | 10/98 → 09/07   | <b>AC</b>   | VKMA 35107<br>VKMV 6PK1902<br>VKM 35007  | 1   |   | 1   |   |   |   |   |   |
|                                | X 22 DTH, Y 22 DTH  | 10/98 → 09/02   |   | VKM_____   |   |   |   |   | 1   |   |   |   |
| <b>OPEL  GT 1.1</b>           |   |   |   |  |   |   |   |   |   |   |   |   |
|                                | 11 SR   | 09/68 → 12/70   |   | <b>OXOXOXO</b>   |   |   |   |   |   |   |   |   |
| <b>OPEL  GT 1.9</b>           |   |   |   |  |   |   |   |   |   |   |   |   |
|                                | 19 S  | 09/68 → 08/73   |   | <b>OXOXOXO</b>   |   |   |   |   |   |   |   |   |
|                                | 19 S  | 09/68 → 08/73   |   | VKPC 85600   |   |   |   | 1   |   |   |   |   |
| <b>OPEL  KADETT A 1.0</b>     |   |   |   |  |   |   |   |   |   |   |   |   |
|                                | 10 N, 10 S  | 09/62 → 08/65   |   | <b>OXOXOXO</b>   |   |   |   |   |   |   |   |   |
| <b>OPEL  KADETT B 1.1</b>     |   |   |   |  |   |   |   |   |   |   |   |   |
|                                | 11 N, 11 S, 11 SR   | 09/65 → 08/73   |   | <b>OXOXOXO</b>   |   |   |   |   |   |   |   |   |
|                                | 11 N, 11 S, 11 SR   | 09/65 → 08/73   |   | —  |   |   |   | 1   |   |   |   |   |
| <b>OPEL  KADETT B 1.2</b>     |   |   |   |  |   |   |   |   |   |   |   |   |
|                                | 12 S  | 08/71 → 08/73   |   | <b>OXOXOXO</b>   |   |   |   |   |   |   |   |   |
|                                | 12 S  | 08/71 → 08/73   |   | —  |   |   |   | 1   |   |   |   |   |
| <b>OPEL  KADETT B 1.7</b>     |   |   |   |  |   |   |   |   |   |   |   |   |
|                                | 17 S  | 08/67 → 08/71   |   | <b>OXOXOXO</b>   |   |   |   |   |   |   |   |   |
|                                | 17 S  | 08/67 → 08/71   |   | VKPC 85600   |   |   |   | 1   |   |   |   |   |
| <b>OPEL  KADETT B 1.9</b>     |   |   |   |  |   |   |   |   |   |   |   |   |
|                                | 19 S  | 08/67 → 08/73   |   | <b>OXOXOXO</b>   |   |   |   |   |   |   |   |   |
|                                | 19 S  | 08/67 → 08/73   |   | VKPC 85600   |   |   |   | 1   |   |   |   |   |
| <b>OPEL  KADETT C 1.0</b>     |   |   |   |  |   |   |   |   |   |   |   |   |
|                                | 10 N  | 01/74 → 07/79   |   | <b>OXOXOXO</b>   |   |   |   |   |   |   |   |   |
|                                | 10 N  | 01/74 → 12/75   |   | —  |   |   |   | 1   |   |   |   |   |
|                                | 10 N  | 01/76 → 07/79   |   | VKPC 85203   |   |   |   | 1   |   |   |   |   |
| <b>OPEL  KADETT C 1.2</b>     |   |   |   |  |   |   |   |   |   |   |   |   |
|                                | 12 N, 12 S  | 08/73 → 07/79   |   | <b>OXOXOXO</b>   |   |   |   |   |   |   |   |   |
|                                | 12 N, 12 S  | 08/73 → 08/76   |   | —  |   |   |   | 1   |   |   |   |   |
|                                | 12 N, 12 S  | 09/76 → 07/79   |   | VKPC 85203   |   |   |   | 1   |   |   |   |   |
| <b>OPEL  KADETT C 1.6</b>     |   |   |   |  |   |   |   |   |   |   |   |   |
|                                | 16S CIH, 16S OHV  | 05/77 → 07/79   |   | <b>OXOXOXO</b>   |   |   |   |   |   |   |   |   |
|                                | 16S CIH   | 05/77 → 07/79   | 2)  | —  |   |   |   | 1   |   |   |   |   |
|                                | 16S OHV   | 05/77 → 07/79   |   | VKPC 85201   |   |   |   | 1   |   |   |   |   |









































| <b>OPEL  KADETT C 1.9</b>   |                                       |                  |     |                                 |                                       |             |             |   |   |             |       |
|-----------------------------|---------------------------------------|------------------|-----|---------------------------------|---------------------------------------|-------------|-------------|---|---|-------------|-------|
|                             | 19E CIH                               | 09/75 → 07/77    |     |                                 | OKOKOKO                               |             |             |   |   |             |       |
|                             | 19E CIH                               | 09/75 → 07/77 2) |     |                                 | —                                     |             |             |   | 1 |             |       |
| <b>OPEL  KADETT C 2.0</b>   |                                       |                  |     |                                 |                                       |             |             |   |   |             |       |
|                             | 20 EH, 20E CIH                        | 08/77 → 07/79    |     |                                 | OKOKOKO                               |             |             |   |   |             |       |
|                             | 20 EH, 20E CIH                        | 08/77 → 07/79 2) |     |                                 | —                                     |             |             |   | 1 |             |       |
| <b>OPEL  KADETT D 1.2</b>   |                                       |                  |     |                                 |                                       |             |             |   |   |             |       |
|                             | 12 OHC, 12 OHV                        | 08/79 → 08/84    |     |                                 | VKMC 05100                            |             |             | 1 | 1 |             | T0226 |
|                             | 12 OHC                                | 08/79 → 08/84    |     |                                 | VKPC 85206                            |             |             |   | 1 |             |       |
|                             | 12 OHV                                | 08/79 → 08/84    |     |                                 | VKPC 85201                            |             |             |   | 1 |             |       |
| <b>OPEL  KADETT D 1.3</b>   |                                       |                  |     |                                 |                                       |             |             |   |   |             |       |
|                             | 13 N, 13 S                            | 08/79 → 08/84    |     |                                 | VKMC 05103                            |             |             | 1 | 1 |             | T0224 |
|                             | 13 N, 13 S                            | 08/79 → 08/84    |     |                                 | VKPC 85202                            |             |             |   | 1 |             |       |
| <b>OPEL  KADETT D 1.6</b>   |                                       |                  |     |                                 |                                       |             |             |   |   |             |       |
|                             | 16 SH                                 | 09/81 → 08/84    |     |                                 | VKPC 85400                            |             |             |   | 1 |             |       |
| <b>OPEL  KADETT D 1.8</b>   |                                       |                  |     |                                 |                                       |             |             |   |   |             |       |
|                             | 18 E                                  | 02/83 → 08/84    |     |                                 | VKMC 05400                            |             |             | 1 | 1 |             | T0225 |
|                             | 18 E                                  | 02/83 → 08/84    |     |                                 | VKPC 85400                            |             |             |   | 1 |             |       |
| <b>OPEL  KADETT D 1.6 D</b> |                                       |                  |     |                                 |                                       |             |             |   |   |             |       |
|                             | 16 D (GM)                             | 03/82 → 08/84    |     |                                 | VKMA 05200<br>VKM 25200               | 1<br>1      | 1           |   |   |             | T0016 |
|                             | 16 D (GM)                             | 03/82 → 08/84    |     |                                 | VKPC 85406                            |             |             |   | 1 |             |       |
| <b>OPEL  KADETT E 1.2</b>   |                                       |                  |     |                                 |                                       |             |             |   |   |             |       |
|                             | 12 SC                                 | 09/84 → 07/86    |     |                                 | VKMC 05100                            |             |             | 1 | 1 |             | T0226 |
|                             | 12 SCOHV, 12 SOHV                     | 09/84 → 07/86    |     |                                 | VKPC 85201                            |             |             |   | 1 |             |       |
|                             | 12 SOHC, 12 STOHC                     | 09/84 → 07/86    |     |                                 | VKPC 85206                            |             |             |   | 1 |             |       |
|                             | 12 SOHC, 12 STOHC                     | 09/84 → 07/86    |     |                                 | VKPC 85201                            |             |             |   | 1 |             |       |
|                             | B(Alt) 12SCOHV, 12SOHV                | 09/84 → 07/86    |     |                                 | VKMW 10AVx950                         |             |             | 1 |   |             |       |
|                             | B(Alt) 12SOHC, 12STOHC                | 09/84 → 07/86    |     |                                 | VKMW 10AVx875                         |             |             | 1 |   |             |       |
| <b>OPEL  KADETT E 1.3</b>   |                                       |                  |     |                                 |                                       |             |             |   |   |             |       |
|                             | 13 N, 13 NB, 13 S,<br>C 13 N          | 09/84 → 02/93    |     |                                 | VKMC 05103                            |             |             | 1 | 1 |             | T0224 |
|                             | 13 N, 13 NB, 13 S,<br>C 13 N, C 13 NV | 09/84 → 02/93    |     |                                 | VKPC 85202                            |             |             |   | 1 |             |       |
|                             | B(Alt) 13 N, 13 NB, 13 S,<br>C 13 N   | 09/84 → 08/91    |     |                                 | VKMW 10AVx875                         |             |             | 1 |   |             |       |
| <b>OPEL  KADETT E 1.4</b>   |                                       |                  |     |                                 |                                       |             |             |   |   |             |       |
|                             | 14 NV                                 | 07/89 → 02/93    |     | → Mot. 02 J22349,<br>19 307805  | —                                     |             |             | 1 | 1 |             |       |
|                             | 14 NV                                 | 07/89 → 02/93    |     | Mot. 02 J22350,<br>19 307806 I→ | VKMC 05121<br>VKMA 05121<br>VKM 15121 | 1<br>1<br>1 | 1<br>1<br>1 |   |   | 1<br>1<br>1 | T0092 |
|                             | C 14 NZ                               | 01/90 → 08/91    |     | → Mot. 02 J22349,<br>19 311737  | VKMC 05120                            |             |             | 1 | 1 |             | T0228 |
|                             | C 14 NZ                               | 01/90 → 08/91    |     | Mot. 02 J22350,<br>19 311738 I→ | VKMC 05121<br>VKMA 05121<br>VKM 15121 | 1<br>1<br>1 | 1<br>1<br>1 |   | 1 | 1<br>1<br>1 | T0092 |
|                             | C 14 NZ                               | 01/90 → 08/91    | 3), | Mot. 02 J22350,<br>19 311738 I→ | VKMS 05121<br>VKMA 05121<br>VKM 15121 | 1<br>1<br>1 | 1<br>1<br>1 |   |   | 2<br>1<br>1 | T0092 |
|                             | 14 NV                                 | 07/89 → 02/93    |     |                                 | VKPC 85206                            |             |             |   | 1 |             |       |
|                             | C 14 NZ                               | 01/90 → 07/94    |     | → Mot. 02 J22349,<br>19 311737  | VKPC 85401                            |             |             |   | 1 |             |       |
|                             | C 14 NZ                               | 01/90 → 07/94    |     | Mot. 02 J22350,<br>19 311738 I→ | VKPC 85206                            |             |             |   | 1 |             |       |
| <b>OPEL  KADETT E 1.6</b>   |                                       |                  |     |                                 |                                       |             |             |   |   |             |       |
|                             | 16 S                                  | 09/84 → 08/91    |     |                                 | VKMC 05400                            |             |             | 1 | 1 |             | T0225 |
|                             | 16 SV, C 16 NZ, E 16 NZ               | 09/86 → 07/94    |     | → Mot. 02 J22349                | VKMC 05120                            |             |             | 1 | 1 |             | T0228 |

























|  |  |  |   |  |  |  |  |  |  |  |  |  |
|--|---|---|--|--|---|---|---|---|---|---|---|---|
|  | 16 SV, C 16 NZ, E 16 NZ   | 09/86 → 07/94   |  Mot. 02 J22350  →                      | VKMC 05121<br>VKMA 05121<br>VKM 15121  | 1<br>1<br>1   | 1   | 1   |   |   | 1   |   | T0092   |
|  | 16 SV, C 16 LZ, C 16 NZ   | 09/86 → 07/94   | 3), Mot. 02 J22350  →  | VKMS 05121<br>VKMA 05121<br>VKM 15121  | 1<br>1<br>1   | 1   |   |   | 2   | 1   |   | T0092   |
|  | C 16 LZ   | 09/86 → 02/93   |   | VKMC 05121<br>VKMA 05121<br>VKM 15121  | 1<br>1<br>1   | 1   | 1   |   |   | 1   |   | T0092   |
|                                  | 16 S  | 09/84 → 08/86   |  | VKPC 85400   |   |   |   |   | 1   |   |   |   |
|  | 16 SV, C 16 NZ, E 16 NZ   | 09/86 → 07/94   | → Mot. 02 J22349   | VKPC 85401   |   |   |   |   | 1   |   |   |   |
|  | 16 SV, C 16 NZ, E 16 NZ   | 09/86 → 07/94   | Mot. 02 J22350  →  | VKPC 85206   |   |   |   |   | 1   |   |   |   |
|  | C 16 LZ   | 09/86 → 08/91   |  | VKPC 85401   |   |   |   |   | 1   |   |   |   |
| <b>OPEL  KADETT E 1.8</b>       |   |   |  |  |   |   |   |   |   |   |   |   |
|                                  | 18 E, 18 SE   | 09/84 → 08/86   |  → Mot. 14 056060                       | VKMC 05400   |   |   | 1   | 1   |   |   |   | T0225   |
|  | 18 E, 18 SE   | 09/84 → 08/86   |  Mot. 14 056061  →,<br>→ Mot. 14 270600 | VKMC 05401   |   |   | 1   | 1   |   |   |   | T0225   |
|  | 18 E, 18 SE   | 09/84 → 08/86   | Mot. 14 270601  →  | VKMA 05402<br>VKM 15402  | 1<br>1  | 1   |   |   |   |   |   | T0105   |
|  | 18 SE   | 09/87 → 08/90   |  L.H.D,<br>→ Mot. 14 237770             | VKMC 05400   |   |   | 1   | 1   |   |   |   | T0225   |
|  | 18 SE   | 09/87 → 08/90   |  L.H.D,<br>Mot. 14 237771  →            | VKMC 05401   |   |   | 1   | 1   |   |   |   | T0225   |
|  | 18 SE   | 09/87 → 08/90   |  R.H.D,<br>→ Mot. 14 056060             | VKMC 05400   |   |   | 1   | 1   |   |   |   | T0225   |
|  | 18 SE   | 09/87 → 08/90   |  R.H.D,<br>Mot. 14 056061  →            | VKMC 05401   |   |   | 1   | 1   |   |   |   | T0225   |
|  | C 18 NE, C 18 NT  | 08/84 → 09/92   |                                        | VKMC 05400   |   |   | 1   | 1   |   |   |   | T0225   |
|  | C 18 NZ   | 06/85 → 08/91   |  → Mot. 14 254438                     | VKMC 05401   |   |   | 1   | 1   |   |   |   | T0225   |
|  | C 18 NZ   | 06/85 → 08/91   | Mot. 14 254439  →  | VKMA 05402<br>VKM 15402  | 1<br>1  | 1   |   |   |   |   |   | T0105   |
|  | E 18 NV, S 18 NV  | 09/87 → 08/91   |                                       | VKMC 05401   |   |   | 1   | 1   |   |   |   | T0225   |
|                                | 18 E, 18 SE   | 09/84 → 08/90   | → Mot. 14 056060   | VKPC 85400   |   |   |   | 1   |   |   |   |   |
|  | 18 E, 18 SE   | 09/84 → 08/90   | Mot. 14 056061  →,<br>→ Mot. 14 270600   | VKPC 85407   |   |   |   | 1   |   |   |   |   |
|  | 18 E, 18 SE   | 09/84 → 08/90   | Mot. 14 270601  →  | VKPC 85409   |   |   |   | 1   |   |   |   |   |
|  | C 18 NE, C 18 NT  | 08/84 → 09/92   |  | VKPC 85400   |   |   |   | 1   |   |   |   |   |
|  | C 18 NZ   | 06/85 → 08/91   | → Mot. 14 254438   | VKPC 85407   |   |   |   | 1   |   |   |   |   |
|  | C 18 NZ   | 06/85 → 08/91   | Mot. 14 254439  →  | VKPC 85409   |   |   |   | 1   |   |   |   |   |
|  | E 18 NV, S 18 NV  | 09/87 → 08/91   |  | VKPC 85407   |   |   |   | 1   |   |   |   |   |
| <b>OPEL  KADETT E 2.0</b>     |   |   |  |  |   |   |   |   |   |   |   |   |
|                                | 20 NE, 20 SEH, C 20 NE  | 09/86 → 02/93   |  → Mot. 14 608700                     | VKMC 05401   |   |   | 1   | 1   |   |   |   | T0225   |
|  | 20 NE, 20 SEH, C 20 NE  | 09/86 → 02/93   | Mot. 14 608701  →  | VKMA 05402<br>VKM 15402  | 1<br>1  | 1   |   |   |   |   |   | T0105   |
|                                | 20 NE, 20 SEH, C 20 NE  | 09/86 → 02/93   | → Mot. 14 608700   | VKPC 85407   |   |   |   | 1   |   |   |   |   |
|  | 20 NE, 20 SEH, C 20 NE  | 09/86 → 02/93   | Mot. 14 608701  →  | VKPC 85409   |   |   |   | 1   |   |   |   |   |
| <b>OPEL  KADETT E 2.0 16V</b> |   |   |  |  |   |   |   |   |   |   |   |   |
|                                | 20 XE, C 20 XE  | 12/87 → 08/91   | → Mot. 14 142838   | VKMA 05211<br>VKM 15211<br>VKM 25211   | 1<br>1<br>1   | 1   | 1   |   |   |   |   | T0063   |
|  | 20 XE, C 20 XE  | 12/87 → 08/91   | Mot. 14 142839  →  | VKMA 05220<br>VKM 15202<br>VKM 25212<br>VKM 25213                                  | 1<br>1<br>1<br>1  | 2   | 1   |   |   |   |   | T0106   |
|                                | 20 XE, C 20 XE  | 12/87 → 08/91   | → Mot. 14 142838   | VKPC 85610   |   |   |   | 1   |   |   |   |   |
|  | 20 XE, C 20 XE  | 12/87 → 08/91   | Mot. 14 142839  →  | VKPC 85611   |   |   |   | 1   |   |   |   |   |
| <b>OPEL  KADETT E 1.5 TD</b>  |   |   |  |  |   |   |   |   |   |   |   |   |
|                                | 15 TD (ISUZU)   | 07/88 → 08/91   | 3)   | VKMS 05208<br>VKMA 05208<br>VKM 15210<br>VKM 25208                                 | 1<br>1<br>1<br>1  | 1   | 1   |   |   | 3   | 1   | T0062   |
|                                | 15 TD (ISUZU)   | 07/88 → 08/91   | → Mot. 817252  | VKPC 85403   |   |   |   | 1   |   |   |   |   |
|  | 15 TD (ISUZU)   | 07/88 → 08/91   | Mot. 817253  →   | VKPC 85410   |   |   |   | 1   |   |   |   |   |

































| OPEL  <b>KADETT E 1.6 D</b> |   |
|--|---|
|                             | 16 D, 16 DA 08/84 → 12/89  <b>Man. GBX,</b><br><b>Mot. 14 498631 I→</b> VKMC 05201<br>VKMA 05201<br>VKM 25201 1 1 1 T0045  |
|  | 16 D, 16 DA 08/84 → 12/89 <b>Man. GBX,</b><br><b>→IMot. 14 498630</b> VKMA 05200<br>VKM 25200 1 1 T0016   |
|  | 16 D, 16 DA 08/84 → 12/89  <b>Auto. GBX,</b><br><b>Mot. 14 503757 I→</b> VKMC 05201<br>VKMA 05201<br>VKM 25201 1 1 1 T0045 |
|  | 16 D, 16 DA 08/84 → 12/89 <b>Auto. GBX,</b><br><b>→IMot. 14 503757</b> VKMA 05200<br>VKM 25200 1 1 T0016  |
|                             | 16 D, 16 DA 08/84 → 12/89 <b>Man. GBX,</b><br><b>→IMot. 14 498630</b> VKPC 85406 1  |
|  | 16 D, 16 DA 08/84 → 12/89 <b>Man. GBX,</b><br><b>Mot. 14 498631 I→</b> VKPC 85408 1   |
|  | 16 D, 16 DA 08/84 → 12/89 <b>Auto. GBX,</b><br><b>→IMot. 14 503756</b> VKPC 85406 1   |
|  | 16 D, 16 DA 08/84 → 12/89 <b>Auto. GBX,</b><br><b>Mot. 14 503757 I→</b> VKPC 85408 1  |
| OPEL  <b>KADETT E 1.7 D</b> |   |
|                             | 17 D (GM), 17 DR (GM) 08/88 → 07/94  <b>→IMot. 14 363649</b> VKMC 05201<br>VKMA 05201<br>VKM 25201 1 1 1 T0045             |
|  | 17 D (GM), 17 DR (GM) 08/88 → 07/94 <b>Mot. 14 363650 I→</b> VKMA 05202<br>VKM 15202<br>VKM 25202 1 1 1 T0654   |
|                           | 17 D (GM), 17 DR (GM) 08/88 → 07/94 <b>→IMot. 14 363649</b> VKPC 85408 1  |
|  | 17 D (GM), 17 DR (GM) 08/88 → 07/94 <b>Mot. 14 363650 I→</b> VKPC 85611 1   |
| OPEL  <b>KAPITAEN 2.6</b> |   |
|                           | 05/58 → 12/63 <b>OXOXOXO</b>  |
| OPEL  <b>MANTA A 1.2</b>  |   |
|                           | 12 S 04/72 → 08/75 <b>OXOXOXO</b>   |
|                           | 12 S 04/72 → 08/75 — 1  |
| OPEL  <b>MANTA A 1.6</b>  |   |
|                           | 16 N, 16 S 09/70 → 08/75 <b>OXOXOXO</b>   |
|                           | 16 N, 16 S 09/70 → 08/75 VKPC 85600 1   |
| OPEL  <b>MANTA A 1.9</b>  |   |
|                           | 19 E, 19 S 09/70 → 08/75 <b>OXOXOXO</b>   |
|                           | 19 E, 19 S 09/70 → 08/75 VKPC 85600 1   |
| OPEL  <b>MANTA B 1.2</b>  |   |
|                           | 12 N, 12 S 09/75 → 07/83 <b>OXOXOXO</b>   |
|                           | 12 N, 12 S 09/75 → 07/83 VKPC 85203 1   |
| OPEL  <b>MANTA B 1.3</b>  |   |
|                           | 13 N, 13 S 03/79 → 08/86  VKMC 05103 1 1 T0224   |
|                           | 13 N, 13 S 03/79 → 08/86 VKPC 85202 1   |
| OPEL  <b>MANTA B 1.6</b>  |   |
|                           | 16 N, 16 S 09/75 → 12/81 <b>OXOXOXO</b>   |
|                           | 16 N, 16 S 09/75 → 12/81 VKPC 85600 1   |
| OPEL  <b>MANTA B 1.8</b>  |   |
|                           | 18 S 07/82 → 08/87  VKMC 05400 1 1 T0225   |
|                           | 18 S 07/82 → 08/87 VKPC 85400 1   |
| OPEL  <b>MANTA B 1.9</b>  |   |
|                           | 19 E, 19 N, 19 S 09/75 → 12/81 <b>OXOXOXO</b>   |
|                           | 19 E, 19 N, 19 S 09/75 → 12/81 VKPC 85600 1   |
| OPEL  <b>MANTA B 2.0</b>  |   |
|                           | 20 E, 20 N, 20 S 08/77 → 08/88 <b>OXOXOXO</b>   |
|                           | 20 E, 20 N, 20 S 08/77 → 08/88 2) VKPA 85608 1  |













































| OPEL  MANTA B 2.4             |                 |               |                      |   |   |   |   |  |  |  |  |   |   |   |   |  |  |  |       |
|--|-----------------|---------------|----------------------|---|---|---|---|--|--|--|--|---|---|---|---|--|--|--|-------|
|                                | Z 24 E          | 07/80 → 08/84 |                      | <b>OXOXOXO</b>  |   |   |   |  |  |  |  |   |   |   |   |  |  |  |       |
| OPEL  MERIVA 1.4 16V Twinport |                 |               |                      |   |   |   |   |  |  |  |  |   |   |   |   |  |  |  |       |
|                                | Z 14 XEP        | 07/04 → 03/07 |                      | <b>OXOXOXO</b>  |   |   |   |  |  |  |  |   |   |   |   |  |  |  |       |
|                                | Z 14 XEP        | 07/04 → 10/07 |                      | VKPC 85310  |   |   |   |  |  |  |  | 1 |   |   |   |  |  |  |       |
|                                | B(Alt) Z 14 XEP | 07/04 → 03/07 | AC                   | VKMA 35113<br>VKMV 5PK1230<br>VKM 35013                           | 1 |   | 1 |  |  |  |  |   |   |   |   |  |  |  |       |
|  | B(Alt) Z 14 XEP | 07/04 → 03/07 | AC, → ICH 44 001048  | VKMA 35013<br>VKMV 5PK1355<br>VKM 35013                           | 1 |   | 1 |  |  |  |  |   |   |   |   |  |  |  |       |
|  | B(Alt) Z 14 XEP | 07/04 → 03/07 | AC, CH 44 001049 I→  | VKMV 5PK1368<br>VKM 35013   | 1 |   | 1 |  |  |  |  |   |   |   |   |  |  |  |       |
| OPEL  MERIVA 1.6              |                 |               |                      |   |   |   |   |  |  |  |  |   |   |   |   |  |  |  |       |
|                                | Z 16 SE         | 05/03 → 03/07 | 3)                   | VKMS 05121<br>VKMA 05121<br>VKM 15121                             | 1 | 1 | 1 |  |  |  |  | 2 | 1 |   |   |  |  |  | T0092 |
|                                | Z 16 SE         | 05/03 → 10/07 |                      | VKPC 85460  |   |   |   |  |  |  |  | 1 |   |   |   |  |  |  |       |
|                                | B(Alt) Z 16 SE  | 05/03 → 03/07 | AC                   | VKMA 35012<br>VKMV 5PK938<br>VKM 35012                            | 1 |   | 1 |  |  |  |  |   |   |   |   |  |  |  |       |
|  | B(Alt) Z 16 SE  | 05/03 → 03/07 | AC                   | VKMA 35022<br>VKMV 5PK1212<br>VKM 35012                           | 1 |   | 1 |  |  |  |  |   |   |   |   |  |  |  |       |
| OPEL  MERIVA 1.6 16V         |                 |               |                      |   |   |   |   |  |  |  |  |   |   |   |   |  |  |  |       |
|                              | Z 16 XE         | 05/03 → 03/07 | 3), → Mot. 20 EB2049 | VKMS 05154-1<br>VKMA 05154<br>VKM 15216<br>VKM 25152<br>VKM 25312 | 1 | 2 | 1 |  |  |  |  |   | 3 | 3 |   |  |  |  | T0157 |
|  | Z 16 XE         | 05/03 → 03/07 | Mot. 20 EB2050 I→    | VKMA 05156<br>VKM 15216<br>VKM____<br>VKM 25158                   | 1 | 2 | 1 |  |  |  |  |   |   | 1 | 1 |  |  |  | T0157 |
|  | Z 16 XEP        | 01/06 → 03/07 |                      | VKMA____<br>VKM 15260<br>VKM____                                  | 1 | 1 | 1 |  |  |  |  |   |   |   | 2 |  |  |  | T0244 |
|                              | Z 16 XEP        | 01/06 → 10/07 |                      | VKPC____  |   |   |   |  |  |  |  | 1 |   |   |   |  |  |  |       |
|                              | Z 16 XE         | 05/03 → 10/07 |                      | VKPC 85211  |   |   |   |  |  |  |  | 1 |   |   |   |  |  |  |       |
|                              | B(Alt) Z 16 XEP | 01/06 → 06/07 | AC                   | VKMV 5PK1450<br>VKM 35260   | 1 |   | 1 |  |  |  |  |   |   |   |   |  |  |  |       |
|  | B(Alt) Z 16 XEP | 01/06 → 06/07 | AC                   | VKMV 5PK1546<br>VKM 35260   | 1 |   | 1 |  |  |  |  |   |   |   |   |  |  |  |       |
|  | B(Alt) Z 16 XE  | 05/03 → 03/07 | AC                   | VKMA 35012<br>VKMV 5PK938<br>VKM 35012                            | 1 |   | 1 |  |  |  |  |   |   |   |   |  |  |  |       |
|  | B(Alt) Z 16 XE  | 05/03 → 03/07 | AC                   | VKMA 35022<br>VKMV 5PK1212<br>VKM 35012                           | 1 |   | 1 |  |  |  |  |   |   |   |   |  |  |  |       |
| OPEL  MERIVA 1.6 Turbo      |                 |               |                      |   |   |   |   |  |  |  |  |   |   |   |   |  |  |  |       |
|                              | Z 16 LET        | 09/05 → 03/07 |                      | VKMA____<br>VKM 15260<br>VKM____                                  | 1 | 1 | 1 |  |  |  |  |   |   | 2 |   |  |  |  | T0244 |
|                              | Z 16 LET        | 09/05 → 10/07 |                      | VKPC____  |   |   |   |  |  |  |  | 1 |   |   |   |  |  |  |       |
|                              | B(Alt) Z 16 LET | 09/05 → 06/07 | AC                   | VKMV 5PK1450<br>VKM 35260   | 1 |   | 1 |  |  |  |  |   |   |   |   |  |  |  |       |
|  | B(Alt) Z 16 LET | 09/05 → 06/07 | AC                   | VKMV 5PK1546<br>VKM 35260   | 1 |   | 1 |  |  |  |  |   |   |   |   |  |  |  |       |
| OPEL  MERIVA 1.8 16V        |                 |               |                      |   |   |   |   |  |  |  |  |   |   |   |   |  |  |  |       |
|                              | Z 18 XE         | 05/03 → 03/07 | 3), → Mot. 20 EB2049 | VKMS 05154-3<br>VKMA 05154<br>VKM 15216                           | 1 | 2 | 1 |  |  |  |  |   | 3 | 3 |   |  |  |  | T0157 |

|   |  |  |  |  |  |  |  |  |  |  |  |  |
|---|---|---|---|--|---|---|---|---|---|---|---|---|
|   |   |   |   | VKM 25152  | 1   |   |   |   |   |   |   |   |
|   |   |   |   | VKM 25312  | 1   |   |   |   |   |   |   |   |
|   | Z 18 XE   | 05/03 → 03/07   | Mot. 20 EB2050 I→   | VKMA 05156   | 1   | 2   | 1   |   |   |   | 1   | T0157   |
|   |   |   |   | VKM 15216  | 1   |   |   |   |   |   | 1   |   |
|   |   |   |   | VKM _____  |   | 1   |   |   |   |   |   |   |
|   |   |   |   | VKM 25158  | 1   |   |   |   |   |   |   |   |
|                                      | Z 18 XE   | 05/03 → 10/07   |   | VKPC 85624   |   |   |   | 1   |   |   |   |   |
|                                      | B(Alt) Z 18 XE  | 05/03 → 03/07   | AC  | VKMA 35012   | 1   |   | 1   |   |   |   |   |   |
|   |   |   |   | VKMV 5PK938  |   |   | 1   |   |   |   |   |   |
|   |   |   |   | VKM 35012  | 1   |   |   |   |   |   |   |   |
|   | B(Alt) Z 18 XE  | 05/03 → 03/07   | AC  | VKMA 35022   | 1   |   | 1   |   |   |   |   |   |
|   |   |   |   | VKMV 5PK1212   |   |   | 1   |   |   |   |   |   |
|   |   |   |   | VKM 35012  | 1   |   |   |   |   |   |   |   |
| <b>OPEL  MERIVA 1.3 CDTI</b>         |   |   |   |  |   |   |   |   |   |   |   |   |
|                                      | Y 13 DT, Z 13 DT,<br>Z 13 DTJ   | 09/03 → 03/07   |   |  |   |   |   |   |   |   |   |   |
|                                      | Y 13 DT, Z 13 DT,<br>Z 13 DTJ   | 09/03 → 10/07   |   | VKPC 85700   |   |   |   | 1   |   |   |   |   |
|                                      | B(Alt) Y 13 DT, Z 13 DT,<br>Z 13 DTJ  | 09/03 → 03/07   | AC  | VKMV 6PK1182   |   |   | 1   |   |   |   |   |   |
|   |   |   |   | VKM 35023  | 1   |   |   |   |   |   |   |   |
|   | B(Alt) Y 13 DT, Z 13 DT,<br>Z 13 DTJ  | 09/03 → 03/07   | AC  | VKMV _____   |   |   | 1   |   |   |   |   |   |
|   |   |   |   | VKM 35023  | 1   |   |   |   |   |   |   |   |
| <b>OPEL  MERIVA 1.7 DTI</b>          |   |   |   |  |   |   |   |   |   |   |   |   |
|                                      | Y 17 DT (ISUZU)   | 09/03 → 03/07   |   | VKMA 05608   | 1   | 1   | 1   |   |   |   | 3   | T0182   |
|   |   |   |   | VKM 15218  | 1   |   |   |   |   |   | 1   |   |
|   |   |   |   | VKM 25208  |   | 1   |   |   |   |   |   |   |
|                                    | Y 17 DT (ISUZU)   | 09/03 → 10/07   |   | VKPC 85300   |   |   |   | 1   |   |   |   |   |
|                                    | B(Alt) Y 17 DT (ISUZU)  | 09/03 → 03/07   | AC  | VKMA 35215   | 1   |   | 1   |   |   |   |   |   |
|   |   |   |   | VKMV 6PK1250   |   |   | 1   |   |   |   |   |   |
|   |   |   |   | VKM 35015  | 1   |   |   |   |   |   |   |   |
|   | B(Alt) Y 17 DT (ISUZU)  | 09/03 → 03/07   | AC  | VKMA 35315   | 1   | 1   | 1   |   |   |   |   |   |
|   |   |   |   | VKMV 6PK1590   |   |   | 1   |   |   |   |   |   |
|   |   |   |   | VKM 35015  | 1   |   |   |   |   |   |   |   |
|   |   |   |   | VKM 35025  |   | 1   |   |   |   |   |   |   |
| <b>OPEL  MERIVA 1.7 CDTI</b>       |   |   |   |  |   |   |   |   |   |   |   |   |
|                                    | Z 17 DTH (ISUZU)  | 09/03 → 03/07   |   | VKMA 05608   | 1   | 1   | 1   |   |   |   | 3   | T0182   |
|   |   |   |   | VKM 15218  | 1   |   |   |   |   |   | 1   |   |
|   |   |   |   | VKM 25208  |   | 1   |   |   |   |   |   |   |
|   | Z 17 DTR  | 09/06 → 03/07   |   | —  | 1   | 1   | 1   |   |   |   | 3   | T0182   |
|   |   |   |   | VKM 15218  | 1   |   |   |   |   |   |   |   |
|   |   |   |   | —  |   | 1   |   |   |   |   |   |   |
|                                    | Z 17 DTH (ISUZU),<br>Z 17 DTR   | 09/03 → 10/07   |   | VKPC 85300   |   |   |   | 1   |   |   |   |   |
|                                    | B(Alt) Z 17 DTH (ISUZU)   | 09/03 → 03/07   | AC  | VKMA 35015   | 1   |   | 1   |   |   |   |   |   |
|   |   |   |   | VKMV 6PK1275   |   |   | 1   |   |   |   |   |   |
|   |   |   |   | VKM 35015  | 1   |   |   |   |   |   |   |   |
|   | B(Alt) Z 17 DTH (ISUZU)   | 09/03 → 03/07   | AC  | VKMV 6PK1600   | 1   |   | 1   |   |   |   |   |   |
|   |   |   |   | VKM 35015  |   |   |   |   |   |   |   |   |
|   |   |   |   | VKM 35025  |   | 1   |   |   |   |   |   |   |
|   | B(Alt) Z 17 DTR   | 09/06 → 09/07   | AC  | VKMV 6PK1250   | 1   |   | 1   |   |   |   |   |   |
|   |   |   |   | VKM _____  |   |   |   |   |   |   |   |   |
|   | B(Alt) Z 17 DTR   | 09/06 → 09/07   | AC  | VKMV 6PK1615   |   |   | 1   |   |   |   |   |   |
|   |   |   |   | VKM _____  |   | 1   |   |   |   |   |   |   |
|   |   |   |   | VKM _____  | 1   |   |   |   |   |   |   |   |
| <b>OPEL  MONTEREY A 3.5 V6 24V</b> |   |   |   |  |   |   |   |   |   |   |   |   |
|                                    | 6 VE1   | 07/98 → 08/99   | 2)  | —  |   |   |   | 1   |   |   |   |   |
|   |   |   |   | —  |   |   |   | 1   |   |   |   |   |
| <b>OPEL  MONTEREY A 3.0 DTI</b>    |   |   |   |  |   |   |   |   |   |   |   |   |
|                                    | 4 JX1   | 07/98 → 08/99   | 2)  | —  |   |   |   | 1   |   |   |   |   |
|   |   |   |   | —  |   |   |   | 1   |   |   |   |   |











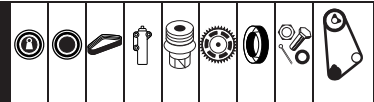



























OPEL

| <b>OPEL  MONTEREY B 3.1 TD</b>  |  |               |                    |  |                    |   |   |   |   |  |  |  |       |
|---------------------------------|--|---------------|--------------------|--|--------------------|---|---|---|---|--|--|--|-------|
|                                 | 4 JG2TC                                  | 09/91 → 07/98 |                    |  | VKMA 99004         | 1 | 1 | 1 |   |  |  |  | T0628 |
|                                 |  |               |                    |  | VKM 79002          | 1 |   |   |   |  |  |  |       |
|                                 |  |               |                    |  | VKM 89003          |   | 1 |   |   |  |  |  |       |
|                                 | 4 JG2TC                                  | 09/91 → 08/93 | 2)                 |  | VKPA 85605         |   |   |   | 1 |  |  |  |       |
| <b>OPEL  MONZA A 2.0</b>        |  |               |                    |  |                    |   |   |   |   |  |  |  |       |
|                                 | 20 E                                     | 03/83 → 10/84 |                    |  | <del>OKOKOKO</del> |   |   |   |   |  |  |  |       |
|                                 | 20 E                                     | 03/83 → 10/84 | 2), AC             |  | VKPA 85608         |   |   |   | 1 |  |  |  |       |
|                                 | 20 E                                     | 03/83 → 10/84 | 2), AC             |  | —                  |   |   |   | 1 |  |  |  |       |
| <b>OPEL  MONZA A 2.2</b>        |  |               |                    |  |                    |   |   |   |   |  |  |  |       |
|                                 | 22 E                                     | 11/84 → 08/86 |                    |  | <del>OKOKOKO</del> |   |   |   |   |  |  |  |       |
|                                 | 22 E                                     | 11/84 → 08/86 | 2), AC             |  | VKPA 85608         |   |   |   | 1 |  |  |  |       |
|                                 | 22 E                                     | 11/84 → 08/86 | 2), AC             |  | —                  |   |   |   | 1 |  |  |  |       |
| <b>OPEL  MONZA A 2.5</b>        |  |               |                    |  |                    |   |   |   |   |  |  |  |       |
|                                 | 25 E                                     | 05/81 → 08/86 |                    |  | <del>OKOKOKO</del> |   |   |   |   |  |  |  |       |
|                                 | 25 E                                     | 05/81 → 08/86 |                    |  | VKPC 85600         |   |   |   | 1 |  |  |  |       |
| <b>OPEL  MONZA A 2.8</b>        |  |               |                    |  |                    |   |   |   |   |  |  |  |       |
|                                 | 28 H                                     | 02/78 → 04/81 |                    |  | <del>OKOKOKO</del> |   |   |   |   |  |  |  |       |
|                                 | 28 H                                     | 02/78 → 04/81 |                    |  | VKPC 85600         |   |   |   | 1 |  |  |  |       |
| <b>OPEL  MONZA A 3.0</b>        |  |               |                    |  |                    |   |   |   |   |  |  |  |       |
|                                 | 30 E, 30 H, C 30 LE                      | 02/78 → 08/86 |                    |  | <del>OKOKOKO</del> |   |   |   |   |  |  |  |       |
|                                 | 30 E, 30 H, C 30 LE                      | 02/78 → 08/86 |                    |  | VKPC 85600         |   |   |   | 1 |  |  |  |       |
| <b>OPEL  OLYMPIA REKORD 1.5</b> |  |               |                    |  |                    |   |   |   |   |  |  |  |       |
|                                 |  | 07/57 → 12/60 |                    |  | <del>OKOKOKO</del> |   |   |   |   |  |  |  |       |
| <b>OPEL  OMEGA A 1.8</b>        |  |               |                    |  |                    |   |   |   |   |  |  |  |       |
|                                 | 18 NV, 18 SEH, 18 SV,<br>E 18 NVR        | 09/86 → 03/94 | → IMot. 14 270600  |  | VKMC 05401         |   |   | 1 | 1 |  |  |  | T0225 |
|                                 | 18 NV, 18 SEH, 18 SV,<br>E 18 NVR        | 09/86 → 03/94 | Mot. 14 270601   → |  | —                  |   |   | 1 | 1 |  |  |  |       |
|                                 | 18 NV, 18 SEH, 18 SV,<br>E 18 NVR        | 09/86 → 03/94 | → IMot. 14 270600  |  | VKPC 85407         |   |   |   | 1 |  |  |  |       |
|                                 | 18 NV, 18 SEH, 18 SV,<br>E 18 NVR        | 09/86 → 03/94 | Mot. 14 270601   → |  | VKPC 85409         |   |   |   | 1 |  |  |  |       |
|                                 | B(Alt) 18 NV, 18 SEH, 18 SV,<br>E 18 NVR | 09/86 → 03/94 | 90A                |  | VKMC 10AVx1000     |   |   | 1 |   |  |  |  |       |
|                                 | B(Alt) 18 NV, 18 SEH, 18 SV,<br>E 18 NVR | 09/86 → 03/94 | 90A                |  | VKMC 10AVx1025     |   |   | 1 |   |  |  |  |       |
|                                 | B(PS) 18 NV, 18 SEH, 18 SV,<br>E 18 NVR  | 09/86 → 03/94 |                    |  | VKMC 10AVx800      |   |   | 1 |   |  |  |  |       |
| <b>OPEL  OMEGA A 2.0</b>        |  |               |                    |  |                    |   |   |   |   |  |  |  |       |
|                                 | 20 SE, C 20 NE                           | 09/86 → 03/94 | → IMot. 14 608700  |  | VKMC 05401         |   |   | 1 | 1 |  |  |  | T0225 |
|                                 | 20 SE, C 20 NE                           | 09/86 → 03/94 | Mot. 14 608701   → |  | VKMA 05402         | 1 |   | 1 |   |  |  |  | T0105 |
|                                 |  |               |                    |  | VKM 15402          | 1 |   |   |   |  |  |  |       |
|                                 | 20 SE, C 20 NE                           | 09/86 → 03/94 | → IMot. 14 608700  |  | VKPC 85407         |   |   |   | 1 |  |  |  |       |
|                                 | 20 SE, C 20 NE                           | 09/86 → 03/94 | Mot. 14 608701   → |  | VKPC 85409         |   |   |   | 1 |  |  |  |       |
|                                 | B(Alt) 20 SE, C 20 NE                    | 09/86 → 03/94 | 90A                |  | VKMC 10AVx1000     |   |   | 1 |   |  |  |  |       |
|                                 | B(Alt) 20 SE, C 20 NE                    | 09/86 → 03/94 | 90A                |  | VKMC 10AVx1025     |   |   | 1 |   |  |  |  |       |
| <b>OPEL  OMEGA A 2.4</b>        |  |               |                    |  |                    |   |   |   |   |  |  |  |       |
|                                 | C 24 NE                                  | 09/88 → 03/94 |                    |  | <del>OKOKOKO</del> |   |   |   |   |  |  |  |       |
|                                 | C 24 NE                                  | 09/88 → 03/94 |                    |  | VKPC 85603         |   |   |   | 1 |  |  |  |       |
| <b>OPEL  OMEGA A 2.6</b>        |  |               |                    |  |                    |   |   |   |   |  |  |  |       |
|                                 | C 26 NE                                  | 09/90 → 03/94 |                    |  | <del>OKOKOKO</del> |   |   |   |   |  |  |  |       |
|                                 | C 26 NE                                  | 09/90 → 03/94 |                    |  | —                  |   |   |   | 1 |  |  |  |       |
| <b>OPEL  OMEGA A 3.0</b>        |  |               |                    |  |                    |   |   |   |   |  |  |  |       |
|                                 | 30 NE, C 30 LE, C 30 NE                  | 03/87 → 03/94 |                    |  | <del>OKOKOKO</del> |   |   |   |   |  |  |  |       |
|                                 | 30 NE, C 30 NE                           | 03/87 → 03/94 | → ICH L1999999     |  | VKPC 85603         |   |   |   | 1 |  |  |  |       |
|                                 | 30 NE, C 30 NE                           | 03/87 → 03/94 | CH M1000001   →    |  | —                  |   |   |   | 1 |  |  |  |       |
|                                 | C 30 LE                                  | 03/87 → 03/94 |                    |  | VKPC 85603         |   |   |   | 1 |  |  |  |       |
| <b>OPEL  OMEGA A 3.0 24V</b>    |  |               |                    |  |                    |   |   |   |   |  |  |  |       |
|                                 | C 30 SE, C 30 SEJ,<br>C 30 XEI           | 09/89 → 03/94 |                    |  | <del>OKOKOKO</del> |   |   |   |   |  |  |  |       |

|   |  |  |  |  |  |  |  |  |  |  |  |
|---|---|---|---|--|---|---|---|---|---|---|---|
|  C 30 SE, C 30 SEJ             | 09/89 → 03/94   |   |   |  |   |   |   |   |   | 1   |   |
| <b>OPEL  OMEGA A 3.6 24V</b>   |   |   |   |  |   |   |   |   |   |   |   |
|  C 36 GET                      | 08/90 → 09/92   |   |   | <b>0X0X0X0</b>   |   |   |   |   |   |   |   |
| <b>OPEL  OMEGA A 2.3 D</b>     |   |   |   |  |   |   |   |   |   |   |   |
|  23 YD                         | 09/86 → 03/94   |   |   | <b>0X0X0X0</b>   |   |   |   |   |   |   |   |
|  23 YD                         | 09/86 → 03/94   |   |   | VKPC 85603   |   |   |   |   |   | 1   |   |
| <b>OPEL  OMEGA A 2.3 TD</b>    |   |   |   |  |   |   |   |   |   |   |   |
|  23 DTR, 23 YDT                | 09/86 → 03/94   |   |   | <b>0X0X0X0</b>   |   |   |   |   |   |   |   |
|  23 DTR, 23 YDT                | 09/86 → 03/94   |   |   | VKPC 85603   |   |   |   |   |   | 1   |   |
| <b>OPEL  OMEGA B 2.0</b>       |   |   |   |  |   |   |   |   |   |   |   |
|  20 SE, X 20 SE                | 03/94 → 12/00   |   |   | VKMA 05402<br>VKM 15402  | 1<br>1  |   | 1   |   |   |   | T0105   |
|  20 SE, X 20 SE                | 03/94 → 12/00   |   |   | VKPC 85409   |   |   |   |   |   | 1   |   |
|  B(Alt) 20 SE, X 20 SE         | 03/94 → 12/00   |   | <b>AC</b>   | VKMA 35009<br>VKMV 6PK1725<br>VKM 35009  | 1<br>1  |   | 1<br>1  |   |   |   |   |
| B(Alt) 20 SE, X 20 SE   | 03/94 → 12/00   |   | <b>AC</b>   | VKMA 35109<br>VKMV 6PK1900<br>VKM 35009  | 1<br>1  |   | 1<br>1  |   |   |   |   |
| <b>OPEL  OMEGA B 2.0 16V</b>   |   |   |   |  |   |   |   |   |   |   |   |
|  X 20 XEV                      | 03/94 → 09/99   | 3)  |   | VKMS 05222<br>VKMA 05222<br>VKM 15202<br>VKM 25212<br>VKM 25212                    | 1<br>1<br>1<br>1<br>1   | 2<br>2  | 1<br>1  |   |   | 3   | T0116   |
|  X 20 XEV                     | 03/94 → 09/99   |   |   | VKPC 85611   |   |   |   |   |   | 1   |   |
|  B(Alt) X 20 XEV             | 03/94 → 09/99   |   | <b>AC</b>   | VKMA 35009<br>VKMV 6PK1725<br>VKM 35009  | 1<br>1  |   | 1<br>1  |   |   |   |   |
| B(Alt) X 20 XEV   | 03/94 → 09/99   |   | <b>AC</b>   | VKMA 35109<br>VKMV 6PK1900<br>VKM 35009  | 1<br>1  |   | 1<br>1  |   |   |   |   |
| <b>OPEL  OMEGA B 2.2 16V</b> |   |   |   |  |   |   |   |   |   |   |   |
|  Y 22 XE, Z 22 XE            | 09/99 → 07/03   |   |   | VKMA 05228<br>VKM 15230<br>VKM 25212<br>VKM 25212                                  | 1<br>1<br>1<br>1  | 2   | 1   |   |   |   | T0139   |
|  Y 22 XE, Z 22 XE            | 09/99 → 07/03   |   |   | VKPC 85611   |   |   |   |   |   | 1   |   |
|  B(Alt) Y 22 XE, Z 22 XE     | 09/99 → 07/03   |   | <b>AC</b>   | VKMA 35009<br>VKMV 6PK1725<br>VKM 35009  | 1<br>1  |   | 1<br>1  |   |   |   |   |
| B(Alt) Y 22 XE, Z 22 XE   | 09/99 → 07/03   |   | <b>AC</b>   | VKMA 35109<br>VKMV 6PK1900<br>VKM 35009  | 1<br>1  |   | 1<br>1  |   |   |   |   |
| <b>OPEL  OMEGA B 2.5 V6</b>  |   |   |   |  |   |   |   |   |   |   |   |
|  X 25 XE                     | 03/94 → 09/00   |   | 5), →IMot. 08 300418  | VKMA 05500   | 1   | 1   | 1   |   |   |   | 5 T0135   |
| X 25 XE   | 03/94 → 09/00   |   | 5), Mot. 08 300419 I→,<br>→IMot. 08 578511  | VKMA 05501   | 1   | 1   | 1   |   |   |   | 5 T0135   |
| X 25 XE   | 03/94 → 09/00   |   | 5), Mot. 08 578512 I→   | VKMA 05502   | 1   | 1   | 1   |   |   |   | 5 T0135   |
|  X 25 XE                     | 03/94 → 09/00   |   |   | VKPC 85613   |   |   |   |   |   | 1   |   |
|  B(Alt) X 25 XE              | 03/94 → 09/00   |   | <b>AC</b>   | VKMV 6PK1900<br>VKM 35500  | 1   |   | 1   |   |   |   |   |
| B(Alt) X 25 XE  | 03/94 → 09/00   |   | <b>AC</b>   | VKMA 35500<br>VKMV 6PK2020<br>VKM 35500  | 1<br>1  |   | 1<br>1  |   |   |   |   |
| <b>OPEL  OMEGA B 2.6 V6</b>  |   |   |   |  |   |   |   |   |   |   |   |
|  Y 26 SE                     | 09/00 → 07/03   |   | 5), →IMot. 08 578511  | VKMA 05501   | 1   | 1   | 1   |   |   |   | 5 T0135   |
| Y 26 SE   | 09/00 → 07/03   |   | 5), Mot. 08 578512 I→   | VKMA 05502   | 1   | 1   | 1   |   |   |   | 5 T0135   |
|  Y 26 SE                     | 09/00 → 07/03   |   |   | VKPC 85613   |   |   |   |   |   | 1   |   |
|  B(Alt) Y 26 SE              | 09/00 → 07/03   |   | <b>AC</b>   | VKMV 6PK1900<br>VKM 35500  | 1   |   | 1   |   |   |   |   |



|   |   |               |                      |  |   |  |   |  |  |  |  |   |   |   |  |  |   |   |       |  |
|---|---|---------------|----------------------|--|---|---|---|--|--|--|--|---|---|---|--|--|---|---|-------|--|
|   |  |               |                      |  |   |   |   |  |  |  |  |   |   |   |  |  |   |   |       |  |
| B(Alt)  | Y 26 SE   | 09/00 → 07/03 | AC                   | VKMA 35500   | 1 | 1   |   |  |  |  |  |   |   |   |  |  |   |   |       |  |
|   |   |               |                      | VKMV 6PK2020   |   | 1   |   |  |  |  |  |   |   |   |  |  |   |   |       |  |
|   |   |               |                      | VKM 35500  | 1 |   |   |  |  |  |  |   |   |   |  |  |   |   |       |  |
| <b>OPEL  OMEGA B 3.0 V6</b>    |   |               |                      |  |   |   |   |  |  |  |  |   |   |   |  |  |   |   |       |  |
|                                 | X 30 XE   | 04/94 → 02/01 | 5), → Mot. 08 300418 | VKMA 05500   | 1 | 1   | 1 |  |  |  |  |   |   |   |  |  |   | 5 | T0135 |  |
|   | X 30 XE   | 04/94 → 02/01 | 5), Mot. 08 300419 → | VKMA 05501   | 1 | 1   | 1 |  |  |  |  |   |   |   |  |  |   | 5 | T0135 |  |
|                                 | X 30 XE   | 04/94 → 02/01 |                      | VKPC 85613   |   |   |   |  |  |  |  | 1 |   |   |  |  |   |   |       |  |
|                                 | B(Alt) X 30 XE  | 04/94 → 02/01 | AC                   | VKMV 6PK1900   |   |   |   |  |  |  |  |   | 1 |   |  |  |   |   |       |  |
|   |   |               |                      | VKM 35500  | 1 |   |   |  |  |  |  |   |   |   |  |  |   |   |       |  |
|   | B(Alt) X 30 XE  | 04/94 → 02/01 | AC                   | VKMA 35500   | 1 |   |   |  |  |  |  |   | 1 |   |  |  |   |   |       |  |
|   |   |               |                      | VKMV 6PK2020   |   |   |   |  |  |  |  |   |   | 1 |  |  |   |   |       |  |
|   |   |               |                      | VKM 35500  | 1 |   |   |  |  |  |  |   |   |   |  |  |   |   |       |  |
| <b>OPEL  OMEGA B 3.2 V6</b>    |   |               |                      |  |   |   |   |  |  |  |  |   |   |   |  |  |   |   |       |  |
|                                 | Y 32 SE   | 02/01 → 07/03 | 5), → Mot. 08 578511 | VKMA 05501   | 1 | 1   | 1 |  |  |  |  |   |   |   |  |  |   | 5 | T0135 |  |
|   | Y 32 SE   | 02/01 → 07/03 | 5), Mot. 08 578512 → | VKMA 05502   | 1 | 1   | 1 |  |  |  |  |   |   |   |  |  |   | 5 | T0135 |  |
|                                 | Y 32 SE   | 02/01 → 07/03 |                      | VKPC 85613   |   |   |   |  |  |  |  | 1 |   |   |  |  |   |   |       |  |
|                                 | B(Alt) Y 32 SE  | 02/01 → 07/03 | AC                   | VKMV 6PK1900   |   |   |   |  |  |  |  |   | 1 |   |  |  |   |   |       |  |
|   |   |               |                      | VKM 35500  | 1 |   |   |  |  |  |  |   |   |   |  |  |   |   |       |  |
|   | B(Alt) Y 32 SE  | 02/01 → 07/03 | AC                   | VKMA 35500   | 1 |   |   |  |  |  |  |   | 1 |   |  |  |   |   |       |  |
|   |   |               |                      | VKMV 6PK2020   |   |   |   |  |  |  |  |   |   | 1 |  |  |   |   |       |  |
|   |   |               |                      | VKM 35500  | 1 |   |   |  |  |  |  |   |   |   |  |  |   |   |       |  |
| <b>OPEL  OMEGA B 2.0 DTI</b>   |   |               |                      |  |   |   |   |  |  |  |  |   |   |   |  |  |   |   |       |  |
|                                 | X 20 DTH  | 09/97 → 09/00 |                      | OXOXOXO  |   |   |   |  |  |  |  |   |   |   |  |  |   |   |       |  |
|                                 | X 20 DTH  | 09/97 → 09/00 |                      | VKPC 85623   |   |   |   |  |  |  |  | 1 |   |   |  |  |   |   |       |  |
|                                | B(Alt) X 20 DTH   | 09/97 → 09/00 | AC                   | VKMA 35007   | 1 |   |   |  |  |  |  |   | 1 |   |  |  |   |   |       |  |
|   |   |               |                      | VKMV 6PK1805   |   |   |   |  |  |  |  |   |   | 1 |  |  |   |   |       |  |
|   |   |               |                      | VKM 35007  | 1 |   |   |  |  |  |  |   |   |   |  |  |   |   |       |  |
|   | B(Alt) X 20 DTH   | 09/97 → 09/00 | AC                   | VKMA 35107   | 1 |   |   |  |  |  |  |   | 1 |   |  |  |   |   |       |  |
|   |   |               |                      | VKMV 6PK1902   |   |   |   |  |  |  |  |   |   | 1 |  |  |   |   |       |  |
|   |   |               |                      | VKM 35007  | 1 |   |   |  |  |  |  |   |   |   |  |  |   |   |       |  |
|                               | X 20 DTH  | 09/97 → 09/00 |                      | VKM_____   |   |   |   |  |  |  |  |   |   |   |  |  | 1 |   |       |  |
| <b>OPEL  OMEGA B 2.2 DTI</b> |   |               |                      |  |   |   |   |  |  |  |  |   |   |   |  |  |   |   |       |  |
|                               | Y 22 DTH  | 09/00 → 07/03 |                      | OXOXOXO  |   |   |   |  |  |  |  |   |   |   |  |  |   |   |       |  |
|                               | Y 22 DTH  | 09/00 → 07/03 |                      | VKPC 85623   |   |   |   |  |  |  |  | 1 |   |   |  |  |   |   |       |  |
|                               | B(Alt) Y 22 DTH   | 09/00 → 07/03 |                      | VKMA 35107   | 1 |   |   |  |  |  |  |   | 1 |   |  |  |   |   |       |  |
|   |   |               |                      | VKMV 6PK1902   |   |   |   |  |  |  |  |   |   | 1 |  |  |   |   |       |  |
|   |   |               |                      | VKM 35007  | 1 |   |   |  |  |  |  |   |   |   |  |  |   |   |       |  |
|                               | Y 22 DTH  | 09/00 → 07/03 |                      | VKM_____   |   |   |   |  |  |  |  |   |   |   |  |  | 1 |   |       |  |
| <b>OPEL  OMEGA B 2.5 DTI</b> |   |               |                      |  |   |   |   |  |  |  |  |   |   |   |  |  |   |   |       |  |
|                               | Y 25 DT   | 09/01 → 07/03 |                      | OXOXOXO  |   |   |   |  |  |  |  |   |   |   |  |  |   |   |       |  |
|                               | Y 25 DT   | 09/01 → 07/03 |                      | VKPC 88430   |   |   |   |  |  |  |  | 1 |   |   |  |  |   |   |       |  |
| <b>OPEL  OMEGA B 2.5 TD</b>  |   |               |                      |  |   |   |   |  |  |  |  |   |   |   |  |  |   |   |       |  |
|                               | U 25 TD, X 25 TD  | 04/94 → 07/03 |                      | OXOXOXO  |   |   |   |  |  |  |  |   |   |   |  |  |   |   |       |  |
|                               | U 25 TD, X 25 TD  | 04/94 → 07/03 |                      | VKPC 88826   |   |   |   |  |  |  |  | 1 |   |   |  |  |   |   |       |  |
|                               | B(Alt) U 25 TD, X 25 TD   | 04/94 → 07/03 |                      | VKMV 5PK1815   |   |   |   |  |  |  |  |   | 1 |   |  |  |   |   |       |  |
|   |   |               |                      | VKM 38220  | 1 |   |   |  |  |  |  |   |   |   |  |  |   |   |       |  |
|   |   |               |                      | VKM 38225  |   |   |   |  |  |  |  |   | 1 |   |  |  |   |   |       |  |
|   | B(AC) U 25 TD, X 25 TD  | 04/94 → 07/03 | → Mot. 39998760      | VKMV 4PK781  |   |   |   |  |  |  |  |   |   | 1 |  |  |   |   |       |  |
|   |   |               |                      | VKM 38230  | 1 |   |   |  |  |  |  |   |   |   |  |  |   |   |       |  |
| <b>OPEL  REKORD D 1.7</b>    |   |               |                      |  |   |   |   |  |  |  |  |   |   |   |  |  |   |   |       |  |
|                               | 17 N, 17 S  | 01/72 → 08/77 |                      | OXOXOXO  |   |   |   |  |  |  |  |   |   |   |  |  |   |   |       |  |
|                               | 17 N  | 01/72 → 08/77 |                      | VKPC 85600   |   |   |   |  |  |  |  | 1 |   |   |  |  |   |   |       |  |
| <b>OPEL  REKORD D 1.9</b>    |   |               |                      |  |   |   |   |  |  |  |  |   |   |   |  |  |   |   |       |  |
|                               | 19 N, 19 SH   | 01/72 → 08/77 |                      | OXOXOXO  |   |   |   |  |  |  |  |   |   |   |  |  |   |   |       |  |
|                               | 19 N  | 03/75 → 08/77 |                      | VKPC 85600   |   |   |   |  |  |  |  | 1 |   |   |  |  |   |   |       |  |
| <b>OPEL  REKORD D 2.0</b>    |   |               |                      |  |   |   |   |  |  |  |  |   |   |   |  |  |   |   |       |  |
|                               | 20 S  | 09/75 → 08/77 |                      | OXOXOXO  |   |   |   |  |  |  |  |   |   |   |  |  |   |   |       |  |
| <b>OPEL  REKORD D 2.0 D</b>  |   |               |                      |  |   |   |   |  |  |  |  |   |   |   |  |  |   |   |       |  |
|                               | 20 D  | 08/74 → 08/77 |                      | OXOXOXO  |   |   |   |  |  |  |  |   |   |   |  |  |   |   |       |  |



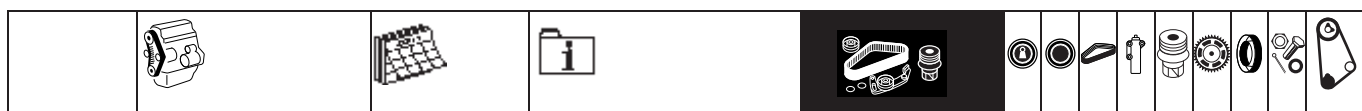

| OPEL  REKORD D 2.1 D |      |               |    |            |  |  |  |  |   |  |
|----------------------|------|---------------|----|------------|--|--|--|--|---|--|
|                      | 21 D | 09/72 → 08/77 |    | ΟΚΘΙΘΟ     |  |  |  |  |   |  |
|                      | 21 D | 09/72 → 08/77 | 2) | VKPA 85605 |  |  |  |  | 1 |  |

| OPEL  REKORD E 1.7 |      |               |                        |            |  |  |  |  |   |  |
|--------------------|------|---------------|------------------------|------------|--|--|--|--|---|--|
|                    | 17 N | 09/77 → 10/82 |                        | ΟΚΘΙΘΟ     |  |  |  |  |   |  |
|                    | 17 N | 09/77 → 10/82 | ΑΕ, → IMot. 442155     | VKPC 85600 |  |  |  |  | 1 |  |
|                    | 17 N | 09/77 → 10/82 | 2), ΑΕ, Mot. 442156 I→ | VKPA 85608 |  |  |  |  | 1 |  |
|                    | 17 N | 09/77 → 10/82 | 2), ΑΕ, → IMot. 442155 | —          |  |  |  |  | 1 |  |
|                    | 17 N | 09/77 → 10/82 | 2), ΑΕ, Mot. 442156 I→ | —          |  |  |  |  | 1 |  |

| OPEL  REKORD E 1.8 |                     |               |  |            |  |  |   |   |  |       |
|--------------------|---------------------|---------------|--|------------|--|--|---|---|--|-------|
|                    | 18 N, 18 S, C 18 NV | 11/82 → 08/86 |  | VKMC 05400 |  |  | 1 | 1 |  | T0225 |
|                    | 18 N, 18 S, C 18 NV | 11/82 → 08/86 |  | VKPC 85400 |  |  |   | 1 |  |       |

| OPEL  REKORD E 1.9 |      |               |                        |            |  |  |  |  |   |  |
|--------------------|------|---------------|------------------------|------------|--|--|--|--|---|--|
|                    | 19 N | 09/77 → 10/82 |                        | ΟΚΘΙΘΟ     |  |  |  |  |   |  |
|                    | 19 N | 09/77 → 10/82 | ΑΕ, → IMot. 545154     | VKPC 85600 |  |  |  |  | 1 |  |
|                    | 19 N | 09/77 → 10/82 | 2), ΑΕ, Mot. 545155 I→ | VKPA 85608 |  |  |  |  | 1 |  |
|                    | 19 N | 09/77 → 10/82 | 2), ΑΕ, → IMot. 545154 | —          |  |  |  |  | 1 |  |
|                    | 19 N | 09/77 → 10/82 | 2), ΑΕ, Mot. 545155 I→ | —          |  |  |  |  | 1 |  |

| OPEL  REKORD E 2.0 |                  |               |                        |            |  |  |  |  |   |  |
|--------------------|------------------|---------------|------------------------|------------|--|--|--|--|---|--|
|                    | 20 E, 20 N, 20 S | 08/77 → 08/86 |                        | ΟΚΘΙΘΟ     |  |  |  |  |   |  |
|                    | 20 E             | 09/77 → 10/84 | ΑΕ, → IMot. 172888     | VKPC 85600 |  |  |  |  | 1 |  |
|                    | 20 E             | 09/77 → 10/84 | 2), ΑΕ, Mot. 172889 I→ | VKPA 85608 |  |  |  |  | 1 |  |
|                    | 20 E             | 09/77 → 10/84 | 2), ΑΕ, → IMot. 172888 | —          |  |  |  |  | 1 |  |
|                    | 20 E             | 09/77 → 10/84 | 2), ΑΕ, Mot. 172889 I→ | —          |  |  |  |  | 1 |  |
|                    | 20 N             | 09/77 → 10/82 | ΑΕ, → IMot. 197858     | VKPC 85600 |  |  |  |  | 1 |  |
|                    | 20 N             | 09/77 → 10/82 | 2), ΑΕ, Mot. 197859 I→ | VKPA 85608 |  |  |  |  | 1 |  |
|                    | 20 N             | 09/77 → 10/82 | 2), ΑΕ, → IMot. 197858 | —          |  |  |  |  | 1 |  |
|                    | 20 N             | 09/77 → 10/82 | 2), ΑΕ, Mot. 197859 I→ | —          |  |  |  |  | 1 |  |
|                    | 20 S             | 08/77 → 08/86 | ΑΕ, → IMot. 665090     | VKPC 85600 |  |  |  |  | 1 |  |
|                    | 20 S             | 08/77 → 08/86 | 2), ΑΕ, Mot. 665091 I→ | VKPA 85608 |  |  |  |  | 1 |  |
|                    | 20 S             | 08/77 → 08/86 | 2), ΑΕ, → IMot. 665090 | —          |  |  |  |  | 1 |  |
|                    | 20 S             | 08/77 → 08/86 | 2), ΑΕ, Mot. 665091 I→ | —          |  |  |  |  | 1 |  |

| OPEL  REKORD E 2.2 |      |               |    |            |  |  |  |  |   |  |
|--------------------|------|---------------|----|------------|--|--|--|--|---|--|
|                    | 22 E | 11/84 → 08/86 |    | ΟΚΘΙΘΟ     |  |  |  |  |   |  |
|                    | 22 E | 11/84 → 08/86 | 2) | VKPA 85608 |  |  |  |  | 1 |  |

| OPEL  REKORD E 2.0 D |      |               |                        |            |  |  |  |  |   |  |
|----------------------|------|---------------|------------------------|------------|--|--|--|--|---|--|
|                      | 20 D | 09/77 → 10/82 |                        | ΟΚΘΙΘΟ     |  |  |  |  |   |  |
|                      | 20 D | 09/77 → 10/82 | 2), ΑΕ, → IMot. 102685 | VKPA 85605 |  |  |  |  | 1 |  |
|                      | 20 D | 09/77 → 10/82 | 2), ΑΕ, Mot. 106686 I→ | —          |  |  |  |  | 1 |  |

| OPEL  REKORD E 2.1 D |      |               |  |        |  |  |  |  |  |  |
|----------------------|------|---------------|--|--------|--|--|--|--|--|--|
|                      | 21 D | 09/77 → 07/78 |  | ΟΚΘΙΘΟ |  |  |  |  |  |  |









































| OPEL  REKORD E 2.2 D |      |               |   |            |  |  |  |  |   |  |
|----------------------|------|---------------|---|------------|--|--|--|--|---|--|
|                      | 23 D | 08/78 → 08/86 |   | ΟΚΘΙΘΟ     |  |  |  |  |   |  |
|                      | 23 D | 08/78 → 08/86 | 2), ΑΕ, → IMot. 55082                     | VKPA 85605 |  |  |  |  | 1 |  |
|                      | 23 D | 08/78 → 08/86 | 2), ΑΕ,<br>Mot. 0121527 I→                | —          |  |  |  |  | 1 |  |
|                      | 23 D | 08/78 → 08/86 | 2), ΑΕ, Mot. 55083 I→,<br>→ IMot. 0121526 | —          |  |  |  |  | 1 |  |

| OPEL  REKORD E 2.2 TD |       |               |    |        |  |  |  |  |   |  |
|-----------------------|-------|---------------|----|--------|--|--|--|--|---|--|
|                       | 23 TD | 06/84 → 08/86 |    | ΟΚΘΙΘΟ |  |  |  |  |   |  |
|                       | 23 TD | 06/84 → 08/86 | 2) | —      |  |  |  |  | 1 |  |
|                       |       |               |    | —      |  |  |  |  | 1 |  |

| OPEL  REKORD E 2.3 D |      |               |   |            |  |  |  |  |   |  |
|----------------------|------|---------------|---|------------|--|--|--|--|---|--|
|                      | 23 D | 11/82 → 08/86 |   | ΟΚΘΙΘΟ     |  |  |  |  |   |  |
|                      | 23 D | 11/82 → 08/86 | 2), ΑΕ, → IMot. 55082                     | VKPA 85605 |  |  |  |  | 1 |  |
|                      | 23 D | 11/82 → 08/86 | 2), ΑΕ,<br>Mot. 0121527 I→                | —          |  |  |  |  | 1 |  |
|                      | 23 D | 11/82 → 08/86 | 2), ΑΕ, Mot. 55083 I→,<br>→ IMot. 0121526 | —          |  |  |  |  | 1 |  |





































































| <b>OPEL  SENATOR A 2.0</b>     |  |                                |               |                        |              |   |   |   |  |  |  |  |  |  |  |  |  |
|--------------------------------|--|--------------------------------|---------------|------------------------|--------------|---|---|---|--|--|--|--|--|--|--|--|--|
|                                |  | 20 E                           | 03/83 → 10/84 |                        |              |   |   |   |  |  |  |  |  |  |  |  |  |
|                                |  | 20 E                           | 03/83 → 10/84 | 2), AC                 |              |   |   |   |  |  |  |  |  |  |  |  |  |
|                                |  | 20 E                           | 03/83 → 10/84 | 2), AC                 |              |   |   |   |  |  |  |  |  |  |  |  |  |
| <b>OPEL  SENATOR A 2.2</b>     |  |                                |               |                        |              |   |   |   |  |  |  |  |  |  |  |  |  |
|                                |  | 22 E                           | 11/84 → 08/87 |                        |              |   |   |   |  |  |  |  |  |  |  |  |  |
|                                |  | 22 E                           | 11/84 → 08/87 | 2), AC                 |              |   |   |   |  |  |  |  |  |  |  |  |  |
|                                |  | 22 E                           | 11/84 → 08/87 | 2), AC                 |              |   |   |   |  |  |  |  |  |  |  |  |  |
| <b>OPEL  SENATOR A 2.5</b>     |  |                                |               |                        |              |   |   |   |  |  |  |  |  |  |  |  |  |
|                                |  | 25 E, 25 S, H 25 E             | 05/78 → 08/87 |                        |              |   |   |   |  |  |  |  |  |  |  |  |  |
|                                |  | 25 E, 25 S                     | 05/78 → 08/87 |                        |              |   |   |   |  |  |  |  |  |  |  |  |  |
| <b>OPEL  SENATOR A 2.8</b>     |  |                                |               |                        |              |   |   |   |  |  |  |  |  |  |  |  |  |
|                                |  | 28 H                           | 02/78 → 04/81 |                        |              |   |   |   |  |  |  |  |  |  |  |  |  |
|                                |  | 28 H                           | 02/78 → 04/81 |                        |              |   |   |   |  |  |  |  |  |  |  |  |  |
| <b>OPEL  SENATOR A 3.0</b>     |  |                                |               |                        |              |   |   |   |  |  |  |  |  |  |  |  |  |
|                                |  | 30 E, 30 H, C 30 LE            | 02/78 → 08/87 |                        |              |   |   |   |  |  |  |  |  |  |  |  |  |
|                                |  | 30 E, 30 H, C 30 LE            | 02/78 → 08/87 |                        |              |   |   |   |  |  |  |  |  |  |  |  |  |
| <b>OPEL  SENATOR A 2.2 TD</b>  |  |                                |               |                        |              |   |   |   |  |  |  |  |  |  |  |  |  |
|                                |  | 23 TD                          | 11/84 → 08/87 |                        |              |   |   |   |  |  |  |  |  |  |  |  |  |
|                                |  | 23 TD                          | 11/84 → 08/87 | 2), 32)                |              |   |   |   |  |  |  |  |  |  |  |  |  |
| <b>OPEL  SENATOR B 2.5</b>     |  |                                |               |                        |              |   |   |   |  |  |  |  |  |  |  |  |  |
|                                |  | 25 NE                          | 09/90 → 09/93 |                        |              |   |   |   |  |  |  |  |  |  |  |  |  |
|                                |  | 25 NE                          | 09/90 → 09/93 |                        |              |   |   |   |  |  |  |  |  |  |  |  |  |
|                                |  | B(Alt) 25 NE                   | 09/90 → 09/93 |                        |              |   |   |   |  |  |  |  |  |  |  |  |  |
| <b>OPEL  SENATOR B 2.6</b>     |  |                                |               |                        |              |   |   |   |  |  |  |  |  |  |  |  |  |
|                                |  | C 26 NE                        | 09/90 → 09/93 |                        |              |   |   |   |  |  |  |  |  |  |  |  |  |
|                                |  | C 26 NE                        | 09/90 → 09/93 |                        |              |   |   |   |  |  |  |  |  |  |  |  |  |
| <b>OPEL  SENATOR B 3.0</b>     |  |                                |               |                        |              |   |   |   |  |  |  |  |  |  |  |  |  |
|                                |  | 30 NE, C 30 LE, C 30 NE        | 09/87 → 09/93 |                        |              |   |   |   |  |  |  |  |  |  |  |  |  |
|                                |  | 30 NE                          | 01/88 → 09/90 | → ICH L1999999         |              |   |   |   |  |  |  |  |  |  |  |  |  |
|                                |  | C 30 LE                        | 09/87 → 09/93 |                        |              |   |   |   |  |  |  |  |  |  |  |  |  |
|                                |  | C 30 NE                        | 01/88 → 12/90 | → ICH L1 999999        |              |   |   |   |  |  |  |  |  |  |  |  |  |
|                                |  | C 30 NE                        | 01/91 → 09/93 | CH M1 000001 I→        |              |   |   |   |  |  |  |  |  |  |  |  |  |
|                                |  | B(Alt) 30 NE, C 30 LE, C 30 NE | 09/87 → 09/93 |                        |              |   |   |   |  |  |  |  |  |  |  |  |  |
| <b>OPEL  SENATOR B 3.0 24V</b> |  |                                |               |                        |              |   |   |   |  |  |  |  |  |  |  |  |  |
|                                |  | C 30 SE                        | 09/89 → 09/93 |                        |              |   |   |   |  |  |  |  |  |  |  |  |  |
|                                |  | C 30 SE                        | 09/89 → 09/93 |                        |              |   |   |   |  |  |  |  |  |  |  |  |  |
| <b>OPEL  SIGNUM 1.8 16V</b>    |  |                                |               |                        |              |   |   |   |  |  |  |  |  |  |  |  |  |
|                                |  | Z 18 XE                        | 05/03 → 01/07 | 3), → I Mot. 20 EB2048 |              |   |   |   |  |  |  |  |  |  |  |  |  |
|                                |  |                                |               |                        | VKMS 05154-3 | 1 | 2 | 1 |  |  |  |  |  |  |  |  |  |
|                                |  |                                |               |                        | VKMA 05154   | 1 | 2 | 1 |  |  |  |  |  |  |  |  |  |
|                                |  |                                |               |                        | VKM 15216    | 1 |   |   |  |  |  |  |  |  |  |  |  |
|                                |  |                                |               |                        | VKM 25152    |   |   | 1 |  |  |  |  |  |  |  |  |  |
|                                |  |                                |               |                        | VKM 25312    |   |   | 1 |  |  |  |  |  |  |  |  |  |
|                                |  | Z 18 XE                        | 05/03 → 01/07 | Mot. 20 EB2049 I→      |              |   |   |   |  |  |  |  |  |  |  |  |  |
|                                |  |                                |               |                        | VKMA 05156   | 1 | 2 | 1 |  |  |  |  |  |  |  |  |  |
|                                |  |                                |               |                        | VKM 15216    | 1 |   |   |  |  |  |  |  |  |  |  |  |
|                                |  |                                |               |                        | VKM_____     |   |   | 1 |  |  |  |  |  |  |  |  |  |
|                                |  |                                |               |                        | VKM 25158    |   |   | 1 |  |  |  |  |  |  |  |  |  |
|                                |  | Z 18 XER                       | 09/05 → 05/07 |                        |              |   |   |   |  |  |  |  |  |  |  |  |  |
|                                |  |                                |               |                        | —            | 1 | 1 | 1 |  |  |  |  |  |  |  |  |  |
|                                |  |                                |               |                        | VKM_____     | 1 |   |   |  |  |  |  |  |  |  |  |  |
|                                |  | Z 18 XE                        | 05/03 → 10/07 |                        |              |   |   |   |  |  |  |  |  |  |  |  |  |
|                                |  | Z 18 XER                       | 09/05 → 05/07 |                        |              |   |   |   |  |  |  |  |  |  |  |  |  |
|                                |  | B(Alt) Z 18 XE                 | 05/03 → 01/07 | AC                     |              |   |   |   |  |  |  |  |  |  |  |  |  |
|                                |  |                                |               |                        | VKMA 35012   | 1 |   | 1 |  |  |  |  |  |  |  |  |  |
|                                |  |                                |               |                        | VKMV 5PK938  |   |   | 1 |  |  |  |  |  |  |  |  |  |
|                                |  |                                |               |                        | VKM 35012    | 1 |   |   |  |  |  |  |  |  |  |  |  |
|                                |  | B(Alt) Z 18 XE                 | 05/03 → 01/07 | AC, → ICH 51 059410    |              |   |   |   |  |  |  |  |  |  |  |  |  |
|                                |  |                                |               |                        | VKMA 35112   | 1 |   | 1 |  |  |  |  |  |  |  |  |  |
|                                |  |                                |               |                        | VKMV 5PK1240 |   |   | 1 |  |  |  |  |  |  |  |  |  |
|                                |  |                                |               |                        | VKM 35012    | 1 |   |   |  |  |  |  |  |  |  |  |  |
|                                |  | B(Alt) Z 18 XE                 | 05/03 → 01/07 | AC, CH 51 059411 I→    |              |   |   |   |  |  |  |  |  |  |  |  |  |
|                                |  |                                |               |                        | VKMV 5PK1255 | 1 |   | 1 |  |  |  |  |  |  |  |  |  |
|                                |  |                                |               |                        | VKM 35012    |   |   |   |  |  |  |  |  |  |  |  |  |

|   |  |  |  |  |  |  |  |  |  |  |  |  |  |  |
|---|---|---|---|--|---|---|---|---|---|---|---|---|---|---|
| B(Alt)  | Z 18 XER  | 09/05 → 03/07   | AC  | VKMV 5PK1450<br>VKM 35260  | 1   |   | 1   |   |   |   |   |   |   |   |
| B(Alt)  | Z 18 XER  | 09/05 → 03/07   | AC, →ICH 51999999,<br>58999999  | VKMV 5PK1546<br>VKM 35260  | 1   |   | 1   |   |   |   |   |   |   |   |
| B(Alt)  | Z 18 XER  | 09/05 → 03/07   | AC, CH 61000001 I→  | VKMV 5PK1570<br>VKM 35260  | 1   |   | 1   |   |   |   |   |   |   |   |
| <b>OPEL  SIGNUM 2.0 Turbo</b>      |   |   |   |  |   |   |   |   |   |   |   |   |   |   |
|                                    | Z 20 NET  | 05/03 → 01/07   |   | OXOXOXO  |   |   |   |   |   |   |   |   |   |   |
|                                    | Z 20 NET  | 05/03 → 10/07   |   | VKPC 85308   |   |   |   |   |   | 1   |   |   |   |   |
|                                    | B(Alt) Z 20 NET   | 05/03 → 01/07   | AC  | VKMV 5PK880<br>VKM 34027   | 1   |   | 1   |   |   |   |   |   |   |   |
| B(Alt)  | Z 20 NET  | 05/03 → 01/07   | AC  | VKMA 34027<br>VKMV 5PK1028<br>VKM 34027  | 1   |   | 1   |   |   | 1   |   |   |   |   |
| <b>OPEL  SIGNUM 2.2</b>            |   |   |   |  |   |   |   |   |   |   |   |   |   |   |
|                                    | Z 22 YH   | 05/03 → 01/07   |   | OXOXOXO  |   |   |   |   |   |   |   |   |   |   |
|                                    | Z 22 YH   | 05/03 → 10/07   |   | VKPC 85308   |   |   |   |   |   | 1   |   |   |   |   |
|                                    | B(Alt) Z 22 YH  | 05/03 → 01/07   | AC  | VKMV 5PK880<br>VKM 34027   | 1   |   | 1   |   |   |   |   |   |   |   |
| B(Alt)  | Z 22 YH   | 05/03 → 01/07   | AC  | VKMA 34027<br>VKMV 5PK1028<br>VKM 34027  | 1   |   | 1   |   |   | 1   |   |   |   |   |
| <b>OPEL  SIGNUM 3.2 V6</b>         |   |   |   |  |   |   |   |   |   |   |   |   |   |   |
|                                   | Z 32 SE   | 05/03 → 01/07   | 5)  | VKMA 05502   | 1   | 1   | 1   |   |   |   |   |   | 5   | T0135   |
|                                  | Z 32 SE   | 05/03 → 10/07   |   | VKPC 85613   |   |   |   |   |   | 1   |   |   |   |   |
|                                  | B(Alt) Z 32 SE  | 05/03 → 01/07   | AC  | VKMV 6PK1992<br>VKM 35016<br>VKM 35500   | 1   |   | 1   |   |   |   |   |   |   |   |
| <b>OPEL  SIGNUM 1.9 CDTI 100</b> |   |   |   |  |   |   |   |   |   |   |   |   |   |   |
|                                  | Z 19 DTL  | 08/05 → 03/07   |   | VKMA 02192<br>VKM 12174<br>VKM 22180   | 1   | 1   | 1   |   |   |   |   |   |   | T0158   |
|                                  | Z 19 DTL  | 08/05 → 10/07   |   | VKPC 82665   |   |   |   |   |   | 1   |   |   |   |   |
|                                  | B(Alt) Z 19 DTL   | 08/05 → 12/07   | AC, →IMot. 71 111927  | VKMV 6PK1050<br>VKM 32046  | 1   |   | 1   |   |   |   |   |   |   |   |
| B(Alt)  | Z 19 DTL  | 08/05 → 12/07   | AC, Mot. 71 111928 I→   | VKMV 6PK1050   |   |   | 1   |   |   |   |   |   |   |   |
| B(Alt)  | Z 19 DTL  | 08/05 → 03/07   | AC  | VKM 32046  | 1   |   |   |   |   |   |   |   |   |   |
| <b>OPEL  SIGNUM 1.9 CDTI 120</b> |   |   |   |  |   |   |   |   |   |   |   |   |   |   |
|                                  | Z 19 DT   | 04/04 → 01/07   |   | VKMA 02192<br>VKM 12174<br>VKM 22180   | 1   | 1   | 1   |   |   |   |   |   |   | T0158   |
|                                  | Z 19 DT   | 04/04 → 10/07   |   | VKPC 82665   |   |   |   |   |   | 1   |   |   |   |   |
|                                  | B(Alt) Z 19 DT  | 04/04 → 12/07   | AC, →IMot. 71 111927  | VKMV 6PK1050<br>VKM 32046  | 1   |   | 1   |   |   |   |   |   |   |   |
| B(Alt)  | Z 19 DT   | 04/04 → 12/07   | AC, Mot. 71 111928 I→   | VKMV 6PK1050   |   |   | 1   |   |   |   |   |   |   |   |
| B(Alt)  | Z 19 DT   | 04/04 → 03/07   | AC  | VKM 32046  | 1   |   |   |   |   |   |   |   |   |   |
| <b>OPEL  SIGNUM 1.9 CDTI 150</b> |   |   |   |  |   |   |   |   |   |   |   |   |   |   |
|                                  | Z 19 DTH  | 04/04 → 01/07   |   | VKMA 02193<br>VKM 12174<br>VKM 22180   | 1   | 1   | 1   |   |   |   |   |   |   | T0248   |
|                                  | Z 19 DTH  | 04/04 → 10/07   |   | VKPC 82667   |   |   |   |   |   | 1   |   |   |   |   |
|                                  | B(Alt) Z 19 DTH   | 04/04 → 12/07   | AC, →IMot. 71 111927  | VKMV 6PK1050<br>VKM 32046  | 1   |   | 1   |   |   |   |   |   |   |   |
| B(Alt)  | Z 19 DTH  | 04/04 → 12/07   | AC, Mot. 71 111928 I→   | VKMV 6PK1050   |   |   | 1   |   |   |   |   |   |   |   |
| B(Alt)  | Z 19 DTH  | 04/04 → 03/07   | AC  | VKM 32046  | 1   |   |   |   |   |   |   |   |   |   |
| <b>OPEL  SIGNUM 2.0 DTI</b>      |   |   |   |  |   |   |   |   |   |   |   |   |   |   |
|                                  | Y 20 DTH  | 05/03 → 01/07   |   | OXOXOXO  |   |   |   |   |   |   |   |   |   |   |
|                                  | Y 20 DTH  | 05/03 → 10/07   |   | VKPC 85623   |   |   |   |   |   | 1   |   |   |   |   |

































OPEL







































|  |  |  |  |  |  |  |  |  |  |  |  |  |
|--|---|---|---|--|---|---|---|---|---|---|---|---|
|  B(Alt)                          | Y 20 DTH  | 05/03 → 01/07   | AC  | VKMA 35006<br>VKMV 6PK1805<br>VKM 35007<br>VKM 35016                               | 1<br>1<br>1   | 1<br>1  | 1<br>1  |   |   |   |   |   |
| B(Alt)   | Y 20 DTH  | 05/03 → 01/07   | AC  | VKMA 35016<br>VKMV 6PK1880<br>VKM 35007<br>VKM 35016                               | 1<br>1<br>1   | 1<br>1  | 1<br>1  |   |   |   |   |   |
|                                  | Y 20 DTH  | 05/03 → 01/07   |   | VKM_____   |   |   |   |   | 1   |   |   |   |
| <b>OPEL  SIGNUM 2.2 DTI</b>     |   |   |   |  |   |   |   |   |   |   |   |   |
|                                  | Y 22 DTR  | 05/03 → 01/07   |   | <del>VKMA 35006</del>  |   |   |   |   |   |   |   |   |
|                                  | Y 22 DTR  | 05/03 → 10/07   |   | VKPC 85623   |   |   |   | 1   |   |   |   |   |
|  B(Alt)                          | Y 22 DTR  | 05/03 → 01/07   | AC  | VKMA 35006<br>VKMV 6PK1805<br>VKM 35007<br>VKM 35016                               | 1<br>1<br>1   | 1<br>1  | 1<br>1  |   |   |   |   |   |
| B(Alt)   | Y 22 DTR  | 05/03 → 01/07   | AC  | VKMA 35016<br>VKMV 6PK1880<br>VKM 35007<br>VKM 35016                               | 1<br>1<br>1   | 1<br>1  | 1<br>1  |   |   |   |   |   |
|                                  | Y 22 DTR  | 05/03 → 01/07   |   | VKM_____   |   |   |   |   | 1   |   |   |   |
| <b>OPEL  SIGNUM 3.0 V6 CDTI</b> |   |   |   |  |   |   |   |   |   |   |   |   |
|                                  | Y 30 DT   | 05/03 → 01/07   |   | VKMA 05230<br>VKM 15220<br>VKM 25222<br>VKM 25226                                  | 1<br>1<br>1<br>1  | 2<br>1<br>1   | 1   |   |   |   |   | T0200   |
|  | Z 30 DT   | 09/05 → 03/07   |   | —<br>—<br>VKM 25222<br>VKM 25226   | 1<br>1<br>1<br>1  | 2<br>1<br>1   | 1   |   |   |   |   | T0200   |
|                                | Y 30 DT, Z 30 DT  | 05/03 → 10/07   |   | VKPC_____  |   |   |   | 1   |   |   |   |   |
|  B(Alt)                        | Y 30 DT   | 05/03 → 01/07   |   | VKMV_____  |   |   | 1   |   |   |   |   |   |
|  |   |   |   | VKM_____   |   | 1   |   |   |   |   |   |   |
|  |   |   |   | VKM_____   |   | 1   |   |   |   |   |   |   |
|  |   |   |   | VKM 35212  |   | 1   |   |   |   |   |   |   |
|  |   |   |   | VKM 35214  |   | 1   |   |   |   |   |   |   |
|  |   |   |   | VKM 35216  | 1   |   |   |   |   |   |   |   |
| B(Alt)   | Z 30 DT   | 09/05 → 03/07   |   | VKMV_____  |   |   | 1   |   |   |   |   |   |
|  |   |   |   | VKM_____   |   | 1   |   |   |   |   |   |   |
|  |   |   |   | VKM_____   |   | 1   |   |   |   |   |   |   |
|  |   |   |   | VKM 35212  |   | 1   |   |   |   |   |   |   |
|  |   |   |   | VKM 35214  |   | 1   |   |   |   |   |   |   |
| <b>OPEL  SINTRA 2.2 16V</b>   |   |   |   |  |   |   |   |   |   |   |   |   |
|                                | X 22 XE   | 11/96 → 04/99   |   | VKMA 05228<br>VKM 15230<br>VKM 25212<br>VKM 25212                                  | 1<br>1<br>1<br>1  | 2<br>1<br>1   | 1   |   |   |   |   | T0139   |
|                                | X 22 XE   | 11/96 → 04/99   |   | VKPC 85611   |   |   |   | 1   |   |   |   |   |
|  B(Alt)                        | X 22 XE   | 11/96 → 04/99   | AC  | VKMA 35009<br>VKMV 6PK1725<br>VKM 35009  | 1<br>1  |   | 1<br>1  |   |   |   |   |   |
| B(Alt)   | X 22 XE   | 11/96 → 04/99   | AC  | VKMA 35109<br>VKMV 6PK1900<br>VKM 35009  | 1<br>1  |   | 1<br>1  |   |   |   |   |   |
| <b>OPEL  SINTRA 3.0 V6</b>    |   |   |   |  |   |   |   |   |   |   |   |   |
|                                | X 30 XE   | 11/96 → 04/99   | 5)  | VKMA 05500   | 1   | 1   | 1   |   |   |   |   | 5 T0135   |
|                                | X 30 XE   | 11/96 → 04/99   |   | VKPC 85613   |   |   |   | 1   |   |   |   |   |
|  B(Alt)                        | X 30 XE   | 11/96 → 04/99   |   | VKMA 35500<br>VKMV 6PK2020<br>VKM 35500  | 1<br>1  |   | 1<br>1  |   |   |   |   |   |
| <b>OPEL  SINTRA 2.2 DTI</b>   |   |   |   |  |   |   |   |   |   |   |   |   |
|                                | X 22 DTH  | 07/97 → 04/99   |   | <del>VKMA 35006</del>  |   |   |   |   |   |   |   |   |
|                                | X 22 DTH  | 07/97 → 04/99   |   | VKPC 85623   |   |   |   | 1   |   |   |   |   |

|  |  |  |  |  |  |  |  |  |  |  |  |
|--|---|---|---|--|---|---|---|---|---|---|---|
|  B(Alt)                               | X 22 DTH  | 07/97 → 04/99   | AC  | VKMA 35007<br>VKMV 6PK1805<br>VKM 35007  | 1<br>1  | 1   |   |   |   |   |   |
| B(Alt)   | X 22 DTH  | 07/97 → 04/99   | AC  | VKMA 35107<br>VKMV 6PK1902<br>VKM 35007  | 1<br>1  | 1   |   |   |   |   |   |
|                                       | X 22 DTH  | 07/97 → 04/99   |   | VKM_____   |   |   |   | 1   |   |   |   |
| <b>OPEL  SPEEDSTER 2.0 Turbo</b>      |   |   |   |  |   |   |   |   |   |   |   |
|                                       | Z 20 LET  | 04/03 → 12/03   |   | VKMA 05140<br>VKM 15140<br>VKM 25224<br>VKM 25224                                  | 1<br>1  | 2   | 1   |   |   |   | T0172   |
|  | Z 20 LET  | 01/04 → 10/07   |   | VKMA_____<br>VKM 15140<br>VKM_____<br>VKM 25224                                    | 1<br>1  | 2   | 1   |   |   |   | T0172   |
|                                       | Z 20 LET  | 04/03 → 10/07   |   | VKPC 85611   |   |   |   | 1   |   |   |   |
|  B(Alt)                               | Z 20 LET  | 04/03 → 10/07   |   | VKMV 5PK1680<br>VKM 35009<br>VKM 35016   | 1   |   | 1   |   |   |   |   |
| <b>OPEL  SPEEDSTER 2.2</b>            |   |   |   |  |   |   |   |   |   |   |   |
|                                       | Z 22 SE   | 09/00 → 10/07   |   | <del>XXXXXX</del>  |   |   |   |   |   |   |   |
|                                       | Z 22 SE   | 09/00 → 10/07   |   | VKPC 85308   |   |   |   | 1   |   |   |   |
|  B(Alt)                               | Z 22 SE   | 09/00 → 10/07   |   | VKMV 5PK880<br>VKM 34027   | 1   |   | 1   |   |   |   |   |
| <b>OPEL  TIGRA 1.4 16V</b>           |   |   |   |  |   |   |   |   |   |   |   |
|                                     | C 14 SEL, X 14 XE   | 07/94 → 12/00 3)  |   | VKMS 05150<br>VKMA 05150<br>VKM 15216<br>VKM 25150<br>VKM 25152                    | 1<br>1<br>1   | 2<br>2  | 1<br>1  |   |   | 3<br>3<br>1   | T0107   |
|                                     | C 14 SEL, X 14 XE   | 07/94 → 12/00   |   | VKPC 85212   |   |   |   | 1   |   |   |   |
|  B(Alt)                             | C 14 SEL, X 14 XE   | 07/94 → 12/00   | AC, ⊗   | VKMV 6PK895<br>VKM 35011   | 1   |   | 1   |   |   |   |   |
| B(Alt)   | C 14 SEL, X 14 XE   | 07/94 → 12/00   | AC, ⊗   | VKMV 6PK1795<br>VKM 35002<br>VKM 35009   | 1   | 1   | 1   |   |   |   |   |
| B(Alt)   | C 14 SEL, X 14 XE   | 07/94 → 12/00   | AC, ⊗   | VKMA 35025<br>VKMV 6PK1530<br>VKM 35009  | 1<br>1  |   | 1<br>1  |   |   |   |   |
| B(Alt)   | C 14 SEL, X 14 XE   | 07/94 → 12/00   | AC, ⊗   | VKMA 35125<br>VKMV 6PK1795<br>VKM 35009  | 1<br>1  |   | 1<br>1  |   |   |   |   |
| <b>OPEL  TIGRA 1.6 16V</b>          |   |   |   |  |   |   |   |   |   |   |   |
|                                     | C 16 SEL, X 16 XE   | 07/94 → 08/98 3)  |   | VKMS 05150<br>VKMA 05150<br>VKM 15216<br>VKM 25150<br>VKM 25152                    | 1<br>1<br>1   | 2<br>2  | 1<br>1  |   |   | 3<br>3<br>1   | T0107   |
|                                     | C 16 SEL, X 16 XE   | 07/94 → 08/98   |   | VKPC 85212   |   |   |   | 1   |   |   |   |
|  B(Alt)                             | C 16 SEL, X 16 XE   | 07/94 → 08/98   | AC, ⊗   | VKMV 6PK895<br>VKM 35011   | 1   |   | 1   |   |   |   |   |
| B(Alt)   | C 16 SEL, X 16 XE   | 07/94 → 08/98   | AC, ⊗   | VKMV 6PK1795<br>VKM 35002<br>VKM 35009   | 1   | 1   | 1   |   |   |   |   |
| B(Alt)   | C 16 SEL, X 16 XE   | 07/94 → 08/98   | AC, ⊗   | VKMA 35025<br>VKMV 6PK1530<br>VKM 35009  | 1<br>1  |   | 1<br>1  |   |   |   |   |
| B(Alt)   | C 16 SEL, X 16 XE   | 07/94 → 08/98   | AC, ⊗   | VKMA 35125<br>VKMV 6PK1795<br>VKM 35009  | 1<br>1  |   | 1<br>1  |   |   |   |   |
| <b>OPEL  TIGRA Twin Top 1.4 16V</b> |   |   |   |  |   |   |   |   |   |   |   |
|                                     | Z 14 XEP  | 06/04 → 06/07   |   | <del>XXXXXX</del>  |   |   |   |   |   |   |   |
|                                     | Z 14 XEP  | 06/04 → 10/07   |   | VKPC 85310   |   |   |   | 1   |   |   |   |



OPEL

































|  |  |  |                                    |  |  |  |  |  |  |  |  |
|--|---|---|---|--|---|---|---|---|---|---|---|
|  B(Alt)                                | Z 14 XEP  | 06/04 → 06/07   | AC  | VKMA 35113<br>VKMV 5PK1230<br>VKM 35013  | 1<br>1  | 1<br>1  |   |   |   |   |   |
| B(Alt)   | Z 14 XEP  | 06/04 → 06/07   | AC  | VKMA 35113<br>VKMV 5PK1230<br>VKM 35013  | 1   | 1   |   |   |   |   |   |
| <b>OPEL  TIGRA Twin Top 1.8 16V</b>   |   |   |   |  |   |   |   |   |   |   |   |
|  Z 18 XE                               | Z 18 XE   | 06/04 → 12/04   | 3), → ICH 4E 999999   | VKMS 05154-3<br>VKMA 05154<br>VKM 15216<br>VKM 25152<br>VKM 25312                  | 1<br>1<br>1   | 2<br>2<br>1   | 1<br>1  |   |   | 3<br>3  | 3<br>2<br>1   |
| Z 18 XE  | Z 18 XE   | 01/05 → 06/07   | CH 5E 000001 I→   | VKMA 05156<br>VKM 15216<br>VKM____<br>VKM 25158                                    | 1<br>1  | 2<br>1<br>1   | 1   |   |   |   | 1<br>1  |
|  Z 18 XE                               | Z 18 XE   | 06/04 → 10/07   |   | VKPC 85624   |   |   |   | 1   |   |   |   |
|  B(Alt)                                | Z 18 XE   | 06/04 → 06/07   | AC  | VKMA 35012<br>VKMV 5PK938<br>VKM 35012   | 1<br>1  | 1<br>1  |   |   |   |   |   |
| B(Alt)   | Z 18 XE   | 06/04 → 06/07   | AC  | VKMA 35012<br>VKMV 5PK938<br>VKM 35012   | 1   | 1<br>1  |   |   |   |   |   |
| <b>OPEL  TIGRA Twin Top 1.3 CDTI</b>  |   |   |   |  |   |   |   |   |   |   |   |
|  Z 13 DT                               | Z 13 DT   | 06/04 → 06/07   |   | <del>XXXXXXXX</del>  |   |   |   |   |   |   |   |
|  Z 13 DT                               | Z 13 DT   | 06/04 → 10/07   |   | VKPC 85700   |   |   |   | 1   |   |   |   |
|  B(Alt)                               | Z 13 DT   | 06/04 → 06/07   | AC  | VKMA 35012<br>VKMV 6PK1182<br>VKM 35023  | 1   |   | 1   |   |   |   |   |
| B(Alt)   | Z 13 DT   | 06/04 → 06/07   | AC  | VKMA 35012<br>VKMV 6PK1182<br>VKM 35023  | 1   |   | 1   |   |   |   |   |
| <b>OPEL  VECTRA A 1.4</b>           |   |   |   |  |   |   |   |   |   |   |   |
|  14 NV                               | 14 NV   | 04/88 → 06/92   |  → IMot. 02 J22349,<br>19 307805 | VKMC 05120   |   |   | 1   | 1   |   |   | T0228   |
| 14 NV  | 14 NV   | 04/88 → 06/92   |  Mot. 02 J22350,<br>19 307806 I→ | VKMC 05121<br>VKMA 05121<br>VKM 15121  | 1<br>1<br>1   | 1<br>1  |   | 1   |   |   | 1<br>1<br>1   |
| 14 NV  | 14 NV   | 04/88 → 06/92   | 3), Mot. 02 J22350,<br>19 307806 I→   | VKMS 05121<br>VKMA 05121<br>VKM 15121  | 1<br>1<br>1   | 1<br>1  |   |   | 2   |   | 1<br>1<br>1   |
|  14 NV                               | 14 NV   | 04/88 → 06/92   | → IMot. 02 J22349,<br>19 307805   | VKPC 85401   |   |   |   | 1   |   |   |   |
| 14 NV  | 14 NV   | 04/88 → 06/92   | Mot. 02 J22350,<br>19 307806 I→   | VKPC 85206   |   |   |   | 1   |   |   |   |
| <b>OPEL  VECTRA A 1.6</b>           |   |   |   |  |   |   |   |   |   |   |   |
|  16 SV, C 16 NZ, E 16 NZ,<br>X 16 SZ | 16 SV, C 16 NZ, E 16 NZ,<br>X 16 SZ   | 09/88 → 11/95   |  → IMot. 02 J22349,<br>19 307805 | VKMC 05120   |   |   | 1   | 1   |   |   | T0228   |
| 16 SV, C 16 NZ, E 16 NZ,<br>X 16 SZ  | 16 SV, C 16 NZ, E 16 NZ,<br>X 16 SZ   | 09/88 → 11/95   |  Mot. 02 J22350,<br>19 307806 I→ | VKMC 05121<br>VKMA 05121<br>VKM 15121  | 1<br>1<br>1   | 1<br>1  |   | 1   |   |   | 1<br>1<br>1   |
| 16 SV, C 16 NZ, E 16 NZ,<br>X 16 SZ  | 16 SV, C 16 NZ, E 16 NZ,<br>X 16 SZ   | 09/88 → 11/95   | 3), Mot. 02 J22350 I→   | VKMS 05121<br>VKMA 05121<br>VKM 15121  | 1<br>1<br>1   | 1<br>1  |   |   | 2   |   | 1<br>1<br>1   |
| C 16 LZ2, C 16 NZ2   | C 16 LZ2, C 16 NZ2  | 09/88 → 11/95   |   | VKMA 05402<br>VKM 15402  | 1<br>1  | 1   |   |   |   |   | T0105   |
|  16 SV, C 16 NZ, E 16 NZ,<br>X 16 SZ | 16 SV, C 16 NZ, E 16 NZ,<br>X 16 SZ   | 09/88 → 11/95   | → IMot. 02 J22349,<br>19 307805   | VKPC 85401   |   |   |   | 1   |   |   |   |
| 16 SV, C 16 NZ, E 16 NZ,<br>X 16 SZ  | 16 SV, C 16 NZ, E 16 NZ,<br>X 16 SZ   | 09/88 → 11/95   | Mot. 02 J22350,<br>19 307806 I→   | VKPC 85206   |   |   |   | 1   |   |   |   |
| C 16 LZ2, C 16 NZ2   | C 16 LZ2, C 16 NZ2  | 09/88 → 11/95   |   | VKPC 85409   |   |   |   | 1   |   |   |   |



























|  |  |  |    |  |  |  |  |  |  |  |  |
|--|---|---|---|--|---|---|---|---|---|---|---|
|                                   | <b>B(Alt)</b> C 16 LZ2, C 16 NZ2  | 09/93 → 11/95   |    | VKMA 35009<br>VKMV 6PK1725<br>VKM 35009  | 1<br>1<br>1   | 1<br>1  |   |   |   |   |   |
|  | <b>B(Alt)</b> X 16 SZ   | 09/93 → 11/95   |    | VKMA 35008<br>VKMV 6PK1460<br>VKM 35008  | 1<br>1<br>1   | 1<br>1  |   |   |   |   |   |
| <b>OPEL  VECTRA A 1.8</b>         |   |   |   |  |   |   |   |   |   |   |   |
|                                   | 18 SV, E 18 NVR   | 09/88 → 10/90   |  →   Mot. 14 270600  | VKMC 05401   |   | 1   | 1   |   |   |   | T0225   |
|  | 18 SV, E 18 NVR   | 09/88 → 10/90   | <b>Mot. 14 270601</b>   →   | VKMA 05402<br>VKM 15402  | 1<br>1  | 1   |   |   |   |   | T0105   |
|  | C 18 NZ   | 03/90 → 11/95   |  →   Mot. 14 254438  | VKMC 05401   |   | 1   | 1   |   |   |   | T0225   |
|  | C 18 NZ   | 03/90 → 11/95   | <b>Mot. 14 254439</b>   →   | VKMA 05402<br>VKM 15402  | 1<br>1  | 1   |   |   |   |   | T0105   |
|                                   | 18 SV, E 18 NVR   | 09/88 → 10/90   | →   Mot. 14 270600  | VKPC 85407   |   |   | 1   |   |   |   |   |
|  | 18 SV, E 18 NVR   | 09/88 → 10/90   | <b>Mot. 14 270601</b>   →   | VKPC 85409   |   |   | 1   |   |   |   |   |
|  | C 18 NZ   | 03/90 → 11/95   | →   Mot. 14 254438  | VKPC 85407   |   |   | 1   |   |   |   |   |
|  | C 18 NZ   | 03/90 → 11/95   | <b>Mot. 14 254439</b>   →   | VKPC 85409   |   |   | 1   |   |   |   |   |
|                                   | <b>B(Alt)</b> C 18 NZ   | 01/93 → 11/95   |    | VKMA 35009<br>VKMV 6PK1725<br>VKM 35009  | 1<br>1<br>1   | 1<br>1  |   |   |   |   |   |
| <b>OPEL  VECTRA A 2.0</b>         |   |   |   |  |   |   |   |   |   |   |   |
|                                   | 20 NE, 20 SEH, C 20 NE  | 04/88 → 11/95   |  →   Mot. 14 608700  | VKMC 05401   |   | 1   | 1   |   |   |   | T0225   |
|  | 20 NE, 20 SEH, C 20 NE  | 04/88 → 11/95   | <b>Mot. 14 608701</b>   →   | VKMA 05402<br>VKM 15402  | 1<br>1  | 1   |   |   |   |   | T0105   |
|                                   | 20 NE, 20 SEH, C 20 NE  | 04/88 → 11/95   | →   Mot. 14 608700  | VKPC 85407   |   |   | 1   |   |   |   |   |
|  | 20 NE, 20 SEH, C 20 NE  | 04/88 → 11/95   | <b>Mot. 14 608701</b>   →   | VKPC 85409   |   |   | 1   |   |   |   |   |
|                                  | <b>B(Alt)</b> C 20 NE   | 01/93 → 11/95   |     | VKMA 35009<br>VKMV 6PK1725<br>VKM 35009  | 1<br>1<br>1   | 1<br>1  |   |   |   |   |   |
|  | <b>B(Alt)</b> C 20 NE   | 01/93 → 11/95   | <b>AC</b>    | VKMA 35109<br>VKMV 6PK1900<br>VKM 35009  | 1<br>1<br>1   | 1<br>1  |   |   |   |   |   |
| <b>OPEL  VECTRA A 2.0 16V</b>   |   |   |   |  |   |   |   |   |   |   |   |
|                                 | X 20 XEV  | 06/94 → 11/95   | 3)  | VKMS 05222<br>VKMA 05222<br>VKM 15202<br>VKM 25212<br>VKM 25212                    | 1<br>1<br>1<br>1<br>1   | 2<br>1  | 1   |   |   | 3   | T0116   |
|  | 20 XE, C 20 XE  | 01/89 → 11/95   | →   Mot. 14 142838  | VKMA 05211<br>VKM 15211<br>VKM 25211   | 1<br>1<br>1   | 1<br>1  | 1   |   |   |   | T0063   |
|  | 20 XE, C 20 XE  | 01/89 → 11/95   | <b>Mot. 14 142839</b>   →   | VKMA 05220<br>VKM 15202<br>VKM 25212<br>VKM 25213                                  | 1<br>1<br>1<br>1  | 2<br>1  | 1   |   |   |   | T0106   |
|                                 | 20 XE, C 20 XE  | 01/89 → 11/95   | →   Mot. 14 142838  | VKPC 85610   |   |   | 1   |   |   |   |   |
|  | 20 XE, C 20 XE  | 01/89 → 11/95   | <b>Mot. 14 142839</b>   →   | VKPC 85611   |   |   | 1   |   |   |   |   |
|  | X 20 XEV  | 06/94 → 11/95   |   | VKPC 85611   |   |   | 1   |   |   |   |   |
|                                 | <b>B(Alt)</b> 20 XE, C 20 XE, X 20 XEV  | 01/93 → 11/95   |   | VKMA 35009<br>VKMV 6PK1725<br>VKM 35009  | 1<br>1<br>1   | 1<br>1  |   |   |   |   |   |
|  | <b>B(Alt)</b> 20 XE, C 20 XE, X 20 XEV  | 01/93 → 11/95   | <b>AC</b>    | VKMA 35109<br>VKMV 6PK1900<br>VKM 35009  | 1<br>1<br>1   | 1<br>1  |   |   |   |   |   |
| <b>OPEL  VECTRA A 2.0 Turbo</b> |   |   |   |  |   |   |   |   |   |   |   |
|                                 | C 20 LET  | 06/94 → 11/95   | →   Mot. 14 002934  | VKMA 05211<br>VKM 15211<br>VKM 25211   | 1<br>1<br>1   | 1<br>1  | 1   |   |   |   | T0063   |
|  | C 20 LET  | 06/94 → 11/95   | <b>Mot. 14 002935</b>   →   | VKMA 05220<br>VKM 15202<br>VKM 25212<br>VKM 25213                                  | 1<br>1<br>1<br>1  | 2<br>1  | 1   |   |   |   | T0106   |
|                                 | C 20 LET  | 06/94 → 11/95   | →   Mot. 14 002934  | VKPC 85610   |   |   | 1   |   |   |   |   |
|  | C 20 LET  | 06/94 → 11/95   | <b>Mot. 14 002935</b>   →   | VKPC 85611   |   |   | 1   |   |   |   |   |



OPEL

















|  |  |  |    |  |  |  |  |  |  |  |  |  |
|--|---|---|---|--|---|---|---|---|---|---|---|---|
|                                  | <b>B(Alt)</b> C 20 LET  | 06/94 → 11/95   | AC, ⊕   | VKMA 35009<br>VKMV 6PK1725<br>VKM 35009  | 1<br>1<br>1   | 1<br>1  |   |   |   |   |   |   |
|  | <b>B(Alt)</b> C 20 LET  | 06/94 → 11/95   | AC, ⊕   | VKMA 35109<br>VKMV 6PK1900<br>VKM 35009  | 1<br>1<br>1   | 1<br>1  |   |   |   |   |   |   |
| <b>OPEL  VECTRA A 2.5 V6</b>    |   |   |   |  |   |   |   |   |   |   |   |   |
|                                  | C 25 XE   | 02/93 → 11/95   | 5)  | VKMA 05500   | 1   | 1   | 1   |   |   |   |   | 5 T0135   |
|                                  | C 25 XE   | 02/93 → 11/95   |   | VKPC 85613   |   |   |   | 1   |   |   |   |   |
|                                  | <b>B(Alt)</b> C 25 XE   | 02/93 → 11/95   | AC  | VKMV 6PK1900<br>VKM 35500  | 1<br>1  | 1   |   |   |   |   |   |   |
|  | <b>B(Alt)</b> C 25 XE   | 02/93 → 11/95   | AC  | VKMA 35500<br>VKMV 6PK2020<br>VKM 35500  | 1<br>1<br>1   | 1<br>1  |   |   |   |   |   |   |
| <b>OPEL  VECTRA A 1.7 D</b>     |   |   |   |  |   |   |   |   |   |   |   |   |
|                                  | 17 D (GM)   | 09/88 → 09/92   |    | VKMC 05201<br>VKMA 05201<br>VKM 25201  |   | 1<br>1<br>1   | 1   | 1   |   |   |   | T0045   |
|  | 17 DR (GM)  | 07/92 → 11/95   |   | VKMA 05202<br>VKM 15202<br>VKM 25202   | 1<br>1<br>1   | 1<br>1  | 1   |   |   |   |   | T0654   |
|                                  | 17 D (GM), 17 DR (GM)   | 09/88 → 11/95   | → IMot. 14 363650   | VKPC 85408   |   |   |   | 1   |   |   |   |   |
|  | 17 D (GM), 17 DR (GM)   | 09/88 → 11/95   | Mot. 14 363651   →  | VKPC 85611   |   |   |   | 1   |   |   |   |   |
| <b>OPEL  VECTRA A 1.7 TD</b>    |   |   |   |  |   |   |   |   |   |   |   |   |
|                                 | 17 TD (ISUZU)   | 03/90 → 11/95   | → IMot. 551390  | VKMA 05213<br>VKM 15213<br>VKM 25208   | 1<br>1<br>1   | 1<br>1  | 1   |   |   |   |   | 1 T0062   |
|  | 17 TD (ISUZU)   | 03/90 → 11/95   | Mot. 551391   →   | VKMA 05214<br>VKM 15215<br>VKM 25208   | 1<br>1<br>1   | 1<br>1  | 1   |   |   |   |   | 1 T0062   |
|                                | 17 TD (ISUZU)   | 03/90 → 11/95   | → IMot. 877696  | VKPC 85404   |   |   |   | 1   |   |   |   |   |
|  | 17 TD (ISUZU)   | 03/90 → 11/95   | Mot. 877697   →   | VKPC 85620   |   |   |   | 1   |   |   |   |   |
|                                | <b>B(Alt)</b> 17 TD (ISUZU)   | 03/90 → 11/95   |   | VKMV 13AVx915  |   |   |   | 1   |   |   |   |   |
| <b>OPEL  VECTRA B 1.6</b>     |   |   |   |  |   |   |   |   |   |   |   |   |
|                                | X 16 SZR  | 10/95 → 07/03   |  | VKMC 05121<br>VKMA 05121<br>VKM 15121  | 1<br>1<br>1   | 1<br>1  | 1   |   |   |   |   | 1 T0092   |
|  | X 16 SZR  | 10/95 → 04/02   | 3)  | VKMS 05121<br>VKMA 05121<br>VKM 15121  | 1<br>1<br>1   | 1<br>1  |   |   | 2   |   |   | 1 T0092   |
|  | 16 LZ2  | 10/95 → 07/03   |   | VKMA 05402<br>VKM 15402  | 1<br>1  | 1   |   |   |   |   |   | T0105   |
|                                | 16 LZ2  | 10/95 → 07/03   |   | VKPC 85409   |   |   |   | 1   |   |   |   |   |
|  | X 16 SZR  | 10/95 → 07/03   |   | VKPC 85206   |   |   |   | 1   |   |   |   |   |
|                                | <b>B(Alt)</b> 16 LZ2  | 10/95 → 07/03   | AC  | VKMA 35009<br>VKMV 6PK1725<br>VKM 35009  | 1<br>1<br>1   | 1<br>1  |   |   |   |   |   |   |
|  | <b>B(Alt)</b> 16 LZ2  | 10/95 → 07/03   | AC  | VKMA 35109<br>VKMV 6PK1900<br>VKM 35009  | 1<br>1<br>1   | 1<br>1  |   |   |   |   |   |   |
|  | <b>B(Alt)</b> X 16 SZR  | 10/95 → 07/03   | AC  | VKMA 35008<br>VKMV 6PK1460<br>VKM 35008  | 1<br>1<br>1   | 1<br>1  |   |   |   |   |   |   |
|  | <b>B(Alt)</b> X 16 SZR  | 10/95 → 07/03   | AC  | VKMA 35125<br>VKMV 6PK1795<br>VKM 35009  | 1<br>1<br>1   | 1<br>1  |   |   |   |   |   |   |
| <b>OPEL  VECTRA B 1.6 16V</b> |   |   |   |  |   |   |   |   |   |   |   |   |
|                                | X 16 XEL, Y 16 XE,<br>Z 16 XE   | 10/95 → 07/02   | 3)  | VKMS 05150<br>VKMA 05150<br>VKM 15216<br>VKM 25150<br>VKM 25152                    | 1<br>1<br>1<br>1<br>1   | 2<br>2<br>1<br>1<br>1   | 1<br>1  |   |   | 3   |   | 3 T0107   |

























|  |  |  |  |  |  |  |  |  |  |  |  |  |
|--|---|---|---|--|---|---|---|---|---|---|---|---|
|                                 | X 16 XEL, Y 16 XE,<br>Z 16 XE   | 10/95 → 07/02   | → I Mot. 02 MZ5253,<br>20 U75998  | VKPC 85212   |   |   |   |   |   | 1   |   |   |
|  | X 16 XEL, Y 16 XE,<br>Z 16 XE   | 10/95 → 07/02   | Mot. 02 MZ5254,<br>20 U75999 I→   | VKPC 85211   |   |   |   |   |   | 1   |   |   |
|                                 | <b>B(Alt)</b> X 16 XEL, Y 16 XE,<br>Z 16 XE                                       | 10/95 → 07/02   | <i>AC</i>   | VKMA 35025<br>VKMV 6PK1530<br>VKM 35009  | 1   |   | 1   |   |   |   |   |   |
|  | <b>B(Alt)</b> X 16 XEL, Y 16 XE,<br>Z 16 XE                                       | 10/95 → 04/02   | <b>AC</b>   | VKMA 35125<br>VKMV 6PK1795<br>VKM 35009  | 1   |   | 1   |   |   |   |   |   |
| <b>OPEL  VECTRA B 1.8 16V</b>   |   |   |   |  |   |   |   |   |   |   |   |   |
|                                 | X 18 XE1, Z 18 XE,<br>Z 18 XEL  | 10/95 → 07/03   |   | VKMC 05150<br>VKMA 05150<br>VKM 15216<br>VKM 25150<br>VKM 25152                    | 1<br>1<br>1   | 2<br>2<br>1   | 1<br>1  |   | 1   |   | 3<br>3<br>1   | T0107   |
|  | X 18 XE   | 10/95 → 09/00 3)  |   | VKMS 05222<br>VKMA 05222<br>VKM 15202<br>VKM 25212<br>VKM 25212                    | 1<br>1<br>1   | 2<br>2<br>1   | 1<br>1  |   |   | 3   |   | T0116   |
|                                 | X 18 XE   | 10/95 → 09/00   |   | VKPC 85611   |   |   |   |   | 1   |   |   |   |
|  | X 18 XE1, Z 18 XE,<br>Z 18 XEL  | 10/95 → 07/03   |   | VKPC 85624   |   |   |   |   | 1   |   |   |   |
|                               | <b>B(Alt)</b> X 18 XE   | 10/95 → 09/00   | <i>AC</i>   | VKMA 35009<br>VKMV 6PK1725<br>VKM 35009  | 1   |   | 1   |   |   |   |   |   |
|  | <b>B(Alt)</b> X 18 XE   | 10/95 → 09/00   | <b>AC</b>   | VKMA 35109<br>VKMV 6PK1900<br>VKM 35009  | 1   |   | 1   |   |   |   |   |   |
|  | <b>B(Alt)</b> X 18 XE1, Z 18 XE,<br>Z 18 XEL                                      | 10/95 → 07/03   | <i>AC</i>   | VKMA 35025<br>VKMV 6PK1530<br>VKM 35009  | 1   |   | 1   |   |   |   |   |   |
|  | <b>B(Alt)</b> X 18 XE1, Z 18 XE,<br>Z 18 XEL                                      | 10/95 → 04/02   | <b>AC</b>   | VKMA 35125<br>VKMV 6PK1795<br>VKM 35009  | 1   |   | 1   |   |   |   |   |   |
| <b>OPEL  VECTRA B 2.0</b>     |   |   |   |  |   |   |   |   |   |   |   |   |
|                               | 20 NEJ  | 10/95 → 04/02   |   | VKMA 05402<br>VKM 15402  | 1<br>1  |   | 1   |   |   |   |   | T0105   |
|                               | 20 NEJ  | 10/95 → 04/02   |   | VKPC 85409   |   |   |   |   | 1   |   |   |   |
|                               | <b>B(Alt)</b> 20 NEJ  | 10/95 → 04/02   | <i>AC</i>   | VKMA 35009<br>VKMV 6PK1725<br>VKM 35009  | 1   |   | 1   |   |   |   |   |   |
|  | <b>B(Alt)</b> 20 NEJ  | 10/95 → 04/02   | <b>AC</b>   | VKMA 35109<br>VKMV 6PK1900<br>VKM 35009  | 1   |   | 1   |   |   |   |   |   |
| <b>OPEL  VECTRA B 2.0 16V</b> |   |   |   |  |   |   |   |   |   |   |   |   |
|                               | C 20 SEL, X 20 XEV  | 10/95 → 09/00 3)  |   | VKMS 05222<br>VKMA 05222<br>VKM 15202<br>VKM 25212<br>VKM 25212                    | 1<br>1<br>1   | 2<br>2<br>1   | 1<br>1  |   |   | 3   |   | T0116   |
|                               | C 20 SEL, X 20 XEV  | 10/95 → 09/00   |   | VKPC 85611   |   |   |   |   | 1   |   |   |   |
|                               | <b>B(Alt)</b> C 20 SEL, X 20 XEV  | 10/95 → 09/00   | <i>AC</i>   | VKMA 35009<br>VKMV 6PK1725<br>VKM 35009  | 1   |   | 1   |   |   |   |   |   |
|  | <b>B(Alt)</b> C 20 SEL, X 20 XEV  | 10/95 → 09/00   | <b>AC</b>   | VKMA 35109<br>VKMV 6PK1900<br>VKM 35009  | 1   |   | 1   |   |   |   |   |   |



OPEL



| OPEL  VECTRA B 2.2 16V   |                                  |               |  |                |   |   |   |   |  |         |
|---|----------------------------------|---------------|--|----------------|---|---|---|---|--|---------|
|                           | Z 22 SE                          | 09/00 → 07/03 |  | <b>OXOXOXO</b> |   |   |   |   |  |         |
|   | C 22 SEL                         | 09/00 → 07/03 |  | VKMA 05228     | 1 | 2 | 1 |   |  | T0139   |
|   |                                  |               |  | VKM 15230      | 1 |   |   |   |  |         |
|   |                                  |               |  | VKM 25212      |   | 1 |   |   |  |         |
|   |                                  |               |  | VKM 25212      |   | 1 |   |   |  |         |
|                           | C 22 SEL                         | 09/00 → 07/03 |  | VKPC 85611     |   |   |   | 1 |  |         |
|   | Z 22 SE                          | 09/00 → 07/03 |  | VKPC 85308     |   |   |   | 1 |  |         |
|                           | <b>B(Alt)</b> C 22 SEL           | 09/00 → 07/03 | <b>AC</b>  | VKMA 35009     | 1 |   | 1 |   |  |         |
|   |                                  |               |  | VKMA 35009     | 1 |   | 1 |   |  |         |
|   |                                  |               |  | VKMV 6PK1725   |   |   | 1 |   |  |         |
| <b>B(Alt)</b>   | C 22 SEL                         | 09/00 → 07/03 | <b>AC</b>  | VKMA 35109     | 1 |   | 1 |   |  |         |
|   |                                  |               |  | VKMV 6PK1900   |   |   | 1 |   |  |         |
|   |                                  |               |  | VKM 35009      | 1 |   |   |   |  |         |
| <b>B(Alt)</b>   | Z 22 SE                          | 09/00 → 07/03 | <b>AC</b>  | VKMV 5PK880    |   |   | 1 |   |  |         |
|   |                                  |               |  | VKM 34027      | 1 |   |   |   |  |         |
| <b>B(Alt)</b>   | Z 22 SE                          | 09/00 → 07/03 | <b>AC</b>  | VKMA 34027     | 1 |   | 1 |   |  |         |
|   |                                  |               |  | VKMV 5PK1028   |   |   | 1 |   |  |         |
|   |                                  |               |  | VKM 34027      | 1 |   |   |   |  |         |
| OPEL  VECTRA B 2.5 V6    |                                  |               |  |                |   |   |   |   |  |         |
|                           | X 25 XE                          | 10/95 → 12/98 | 5), → <b>ICH</b> W1 285446, W5 276825, W7 154528 | VKMA 05500     | 1 | 1 | 1 |   |  | 5 T0135 |
|   | X 25 XE                          | 01/98 → 09/00 | 5), <b>CH</b> W1 285447, W7 154259 <b>I</b> →    | VKMA 05501     | 1 | 1 | 1 |   |  | 5 T0135 |
|                           | X 25 XE                          | 10/95 → 09/00 |  | VKPC 85613     |   |   |   | 1 |  |         |
|                          | <b>B(Alt)</b> X 25 XE            | 10/95 → 09/00 | <b>AC</b>  | VKMV 6PK1900   |   |   | 1 |   |  |         |
|   |                                  |               |  | VKM 35500      | 1 |   |   |   |  |         |
| <b>B(Alt)</b>   | X 25 XE                          | 10/95 → 09/00 | <b>AC</b>  | VKMA 35500     | 1 |   | 1 |   |  |         |
|   |                                  |               |  | VKMV 6PK2020   |   |   | 1 |   |  |         |
|   |                                  |               |  | VKM 35500      | 1 |   |   |   |  |         |
| OPEL  VECTRA B 2.6 V6  |                                  |               |  |                |   |   |   |   |  |         |
|                         | Y 26 SE                          | 09/00 → 07/03 | 5), → <b>I</b> Mot. 11 162841, 17 080724         | VKMA 05501     | 1 | 1 | 1 |   |  | 5 T0135 |
|   | Y 26 SE                          | 09/00 → 07/03 | 5), <b>Mot.</b> 11 162842, 17 080725 <b>I</b> →  | VKMA 05502     | 1 | 1 | 1 |   |  | 5 T0135 |
|                         | Y 26 SE                          | 09/00 → 07/03 |  | VKPC 85613     |   |   |   | 1 |  |         |
|                         | <b>B(Alt)</b> Y 26 SE            | 09/00 → 07/03 | <b>AC</b>  | VKMV 6PK1900   |   |   | 1 |   |  |         |
|   |                                  |               |  | VKM 35500      | 1 |   |   |   |  |         |
| <b>B(Alt)</b>   | Y 26 SE                          | 09/00 → 07/03 | <b>AC</b>  | VKMA 35500     | 1 |   | 1 |   |  |         |
|   |                                  |               |  | VKMV 6PK2020   |   |   | 1 |   |  |         |
|   |                                  |               |  | VKM 35500      | 1 |   |   |   |  |         |
| OPEL  VECTRA B 1.7 TD  |                                  |               |  |                |   |   |   |   |  |         |
|                         | X 17 TD (ISUZU)                  | 10/95 → 12/98 |  | VKMA 05214     | 1 | 1 | 1 |   |  | 1 T0062 |
|   |                                  |               |  | VKM 15215      | 1 |   |   |   |  |         |
|   |                                  |               |  | VKM 25208      |   | 1 |   |   |  | 1       |
|                         | X 17 TD (ISUZU)                  | 10/95 → 12/98 |  | VKPC 85620     |   |   |   | 1 |  |         |
|                         | <b>B(Alt)</b> X 17 TD (ISUZU)    | 10/95 → 12/98 |  | VKMV 13AVx915  |   |   | 1 |   |  |         |
| OPEL  VECTRA B 2.0 DI  |                                  |               |  |                |   |   |   |   |  |         |
|                         | X 20 DTL                         | 11/96 → 04/02 |  | <b>OXOXOXO</b> |   |   |   |   |  |         |
|                         | X 20 DTL                         | 11/96 → 04/02 |  | VKPC 85623     |   |   |   | 1 |  |         |
|                         | <b>B(Alt)</b> X 20 DTL           | 11/96 → 04/02 | <b>AC</b>  | VKMA 35007     | 1 |   | 1 |   |  |         |
|   |                                  |               |  | VKMV 6PK1805   |   |   | 1 |   |  |         |
|   |                                  |               |  | VKM 35007      | 1 |   |   |   |  |         |
| <b>B(Alt)</b>   | X 20 DTL                         | 11/96 → 04/02 | <b>AC</b>  | VKMA 35107     | 1 |   | 1 |   |  |         |
|   |                                  |               |  | VKMV 6PK1902   |   |   | 1 |   |  |         |
|   |                                  |               |  | VKM 35007      | 1 |   |   |   |  |         |
|                         | X 20 DTL                         | 11/96 → 04/02 | <b>AC</b>  | VKM_____       |   |   |   | 1 |  |         |
| OPEL  VECTRA B 2.0 DTI |                                  |               |  |                |   |   |   |   |  |         |
|                         | X 20 DTH, Y 20 DTH               | 06/97 → 07/03 |  | <b>OXOXOXO</b> |   |   |   |   |  |         |
|                         | X 20 DTH, Y 20 DTH               | 06/97 → 07/03 |  | VKPC 85623     |   |   |   | 1 |  |         |
|                         | <b>B(Alt)</b> X 20 DTH, Y 20 DTH | 06/97 → 07/03 | <b>AC</b>  | VKMA 35007     | 1 |   | 1 |   |  |         |
|   |                                  |               |  | VKMV 6PK1805   |   |   | 1 |   |  |         |
|   |                                  |               |  | VKM 35007      | 1 |   |   |   |  |         |





















|  |  |  |  |  |  |  |  |  |  |  |  |  |       |       |
|--|---|---|---|--|---|---|---|---|---|---|---|---|-------|-------|
| <b>B(Alt)</b>  | X 20 DTH, Y 20 DTH  | 06/97 → 07/03   | <b>AC</b>   | VKMA 35107<br>VKMV 6PK1902<br>VKM 35007  | 1   |   | 1   | 1   |   |   |   |   |       |       |
|                                 | X 20 DTH, Y 20 DTH  | 06/97 → 07/03   | <b>AC</b>   | VKM_____   |   |   |   |   |   | 1   |   |   |       |       |
| <b>OPEL  VECTRA B 2.2 DTI</b>   |   |   |   |  |   |   |   |   |   |   |   |   |       |       |
|                                 | Y 22 DTR  | 09/00 → 07/03   |   | <b>OKOKOKO</b>   |   |   |   |   |   |   |   |   |       |       |
|                                 | Y 22 DTR  | 09/00 → 07/03   |   | VKPC 85623   |   |   |   |   |   | 1   |   |   |       |       |
|                                 | <b>B(Alt)</b> Y 22 DTR  | 09/00 → 07/03   | <b>AC</b>   | VKMA 35007<br>VKMV 6PK1805<br>VKM 35007  | 1   |   | 1   | 1   |   |   |   |   |       |       |
|  | <b>B(Alt)</b> Y 22 DTR  | 09/00 → 07/03   | <b>AC</b>   | VKMA 35107<br>VKMV 6PK1902<br>VKM 35007  | 1   |   | 1   | 1   |   |   |   |   |       |       |
|                                 | Y 22 DTR  | 09/00 → 07/03   |   | VKM_____   |   |   |   |   |   | 1   |   |   |       |       |
| <b>OPEL  VECTRA C 1.6 16V</b>   |   |   |   |  |   |   |   |   |   |   |   |   |       |       |
|                                 | Z 16 XE   | 06/04 → 12/07   | 3), → <b>Mot.</b> 20 EB2048   | VKMS 05154-1<br>VKMA 05154<br>VKM 15216<br>VKM 25152<br>VKM 25312                  | 1<br>1<br>1<br>1<br>1   | 2<br>2<br>1<br>1<br>1   | 1<br>1<br>1<br>1<br>1   |   |   |   | 3<br>2<br>1   | 3<br>2<br>1   | T0157 |       |
|  | Z 16 XE   | 06/04 → 12/07   | <b>Mot.</b> 20 EB2049 I→  | VKMA 05156<br>VKM 15216<br>VKM_____<br>VKM 25158                                   | 1<br>1<br>1<br>1  | 2<br>2<br>1<br>1  | 1<br>1<br>1<br>1  |   |   |   |   | 1<br>1  | 1     | T0157 |
|  | Z 16 XEP  | 01/06 → 12/07   |   | VKMA_____<br>VKM 15260<br>VKM_____   | 1<br>1<br>1   | 1<br>1<br>1   | 1<br>1<br>1   |   |   |   |   | 2   |       | T0244 |
|                               | Z 16 XE   | 06/04 → 12/07   |   | VKPC 85211   |   |   |   |   |   | 1   |   |   |       |       |
|  | Z 16 XEP  | 01/06 → 12/07   |   | VKPC_____  |   |   |   |   |   | 1   |   |   |       |       |
|                               | <b>B(Alt)</b> Z 16 XE   | 06/04 → 12/07   | <b>AC</b>   | VKMA 35012<br>VKMV 5PK938<br>VKM 35012   | 1<br>1<br>1   |   | 1<br>1  |   |   |   |   |   |       |       |
|  | <b>B(Alt)</b> Z 16 XE   | 06/04 → 12/07   | <b>AC</b> , → <b>ICH</b> 51 058884  | VKMA 35112<br>VKMV 5PK1240<br>VKM 35012  | 1<br>1<br>1   |   | 1<br>1  |   |   |   |   |   |       |       |
|  | <b>B(Alt)</b> Z 16 XE   | 06/04 → 12/07   | <b>AC</b> , <b>CH</b> 51 058885 I→  | VKMV 5PK1255<br>VKM 35012  | 1   |   | 1   |   |   |   |   |   |       |       |
|  | <b>B(Alt)</b> Z 16 XEP  | 01/06 → 12/07   | <b>AC</b>   | VKMV 5PK1450<br>VKM 35260  | 1   |   | 1   |   |   |   |   |   |       |       |
|  | <b>B(Alt)</b> Z 16 XEP  | 01/06 → 12/07   | <b>AC</b> , → <b>ICH</b> 51999999,<br>58999999                                    | VKMV 5PK1546<br>VKM 35260  | 1   |   | 1   |   |   |   |   |   |       |       |
|  | <b>B(Alt)</b> Z 16 XEP  | 01/06 → 12/07   | <b>AC</b> , <b>CH</b> 61000001 I→   | VKMV 5PK1570<br>VKM 35260  | 1   |   | 1   |   |   |   |   |   |       |       |
| <b>OPEL  VECTRA C 1.8 16V</b> |   |   |   |  |   |   |   |   |   |   |   |   |       |       |
|                               | Z 18 XE, Z 18 XEL   | 04/02 → 12/02   | 3), → <b>Mot.</b> 20 EB2048   | VKMS 05154-2<br>VKMA 05154<br>VKM 15216<br>VKM 25152<br>VKM 25312                  | 1<br>1<br>1<br>1<br>1   | 2<br>2<br>1<br>1<br>1   | 1<br>1<br>1<br>1<br>1   |   |   |   | 3<br>2<br>1   | 3<br>2<br>1   | T0157 |       |
|  | Z 18 XE, Z 18 XEL   | 01/03 → 12/07   | 3), → <b>Mot.</b> 20 EB2048   | VKMS 05154-3<br>VKMA 05154<br>VKM 15216<br>VKM 25152<br>VKM 25312                  | 1<br>1<br>1<br>1<br>1   | 2<br>2<br>1<br>1<br>1   | 1<br>1<br>1<br>1<br>1   |   |   |   | 3<br>2<br>1   | 3<br>2<br>1   | T0157 |       |
|  | Z 18 XE, Z 18 XEL   | 01/03 → 12/07   | <b>Mot.</b> 20 EB2049 I→  | VKMA 05156<br>VKM 15216<br>VKM_____<br>VKM 25158                                   | 1<br>1<br>1<br>1  | 2<br>2<br>1<br>1  | 1<br>1<br>1<br>1  |   |   |   |   | 1<br>1  | 1     | T0157 |
|  | Z 18 XER  | 01/06 → 12/07   |   | —<br>—<br>VKM_____   | 1<br>1<br>1   | 1<br>1<br>1   | 1<br>1<br>1   |   |   |   |   |   |       |       |
|                               | Z 18 XE, Z 18 XEL   | 04/02 → 12/07   |   | VKPC 85624   |   |   |   |   |   | 1   |   |   |       |       |
|  | Z 18 XER  | 01/06 → 12/07   |   | VKPC_____  |   |   |   |   |   | 1   |   |   |       |       |



OPEL

|                                     | B(Alt) | Z 18 XE, Z 18 XEL  | 04/02 → 12/07 | AC                              | VKMA 35012<br>VKMV 5PK938<br>VKM 35012  | 1 | 1 |   |   |  |  |  |   |       |
|-------------------------------------|--------|--------------------|---------------|---------------------------------|---|---|---|---|---|--|--|--|---|-------|
|                                     | B(Alt) | Z 18 XE, Z 18 XEL  | 04/02 → 12/07 | AC, → ICH 51 058884             | VKMA 35112<br>VKMV 5PK1240<br>VKM 35012 | 1 | 1 |   |   |  |  |  |   |       |
|                                     | B(Alt) | Z 18 XE, Z 18 XEL  | 04/02 → 12/07 | AC, CH 51 058885 I→             | VKMV 5PK1255<br>VKM 35012               | 1 | 1 |   |   |  |  |  |   |       |
|                                     | B(Alt) | Z 18 XER           | 01/06 → 12/07 | AC                              | VKMV 5PK1450<br>VKM 35260               | 1 | 1 |   |   |  |  |  |   |       |
|                                     | B(Alt) | Z 18 XER           | 01/06 → 12/07 | AC, → ICH 51999999,<br>58999999 | VKMV 5PK1546<br>VKM 35260               | 1 | 1 |   |   |  |  |  |   |       |
|                                     | B(Alt) | Z 18 XER           | 01/06 → 12/07 | AC, CH 61000001 I→              | VKMV 5PK1570<br>VKM 35260               | 1 | 1 |   |   |  |  |  |   |       |
| <b>OPEL  VECTRA C 2.0 16V Turbo</b> |        |                    |               |                                 |   |   |   |   |   |  |  |  |   |       |
|                                     |        | Z 20 NET           | 03/03 → 12/07 |                                 | OXOXOXO                                 |   |   |   |   |  |  |  |   |       |
|                                     |        | Z 20 NET           | 03/03 → 12/07 |                                 | VKPC 85308                              |   |   |   | 1 |  |  |  |   |       |
|                                     | B(Alt) | Z 20 NET           | 03/03 → 12/07 | AC                              | VKMV 5PK880<br>VKM 34027                | 1 | 1 |   |   |  |  |  |   |       |
|                                     | B(Alt) | Z 20 NET           | 03/03 → 12/07 | AC                              | VKMA 34027<br>VKMV 5PK1028<br>VKM 34027 | 1 | 1 |   |   |  |  |  |   |       |
| <b>OPEL  VECTRA C 2.2 16V</b>       |        |                    |               |                                 |   |   |   |   |   |  |  |  |   |       |
|                                     |        | Z 22 SE, Z 22 YH   | 04/02 → 12/07 |                                 | OXOXOXO                                 |   |   |   |   |  |  |  |   |       |
|                                     |        | Z 22 SE            | 04/02 → 12/07 | → I Mot. 11394429               | VKPC 85308                              |   |   |   | 1 |  |  |  |   |       |
|                                     |        | Z 22 SE            | 04/02 → 12/07 | Mot. 11394430 I→                | —                                       |   |   |   | 1 |  |  |  |   |       |
|                                     |        | Z 22 YH            | 10/03 → 12/07 |                                 | VKPC 85308                              |   |   |   | 1 |  |  |  |   |       |
|                                     | B(Alt) | Z 22 SE, Z 22 YH   | 04/02 → 12/07 | AC                              | VKMV 5PK880<br>VKM 34027                | 1 | 1 |   |   |  |  |  |   |       |
|                                     | B(Alt) | Z 22 SE, Z 22 YH   | 04/02 → 12/07 | AC                              | VKMA 34027<br>VKMV 5PK1028<br>VKM 34027 | 1 | 1 |   |   |  |  |  |   |       |
| <b>OPEL  VECTRA C 2.8 V6 Turbo</b>  |        |                    |               |                                 |   |   |   |   |   |  |  |  |   |       |
|                                     |        | Z 28 NEL, Z 28 NET | 08/05 → 12/07 |                                 | OXOXOXO                                 |   |   |   |   |  |  |  |   |       |
| <b>OPEL  VECTRA C 3.2 V6</b>        |        |                    |               |                                 |   |   |   |   |   |  |  |  |   |       |
|                                     |        | Z 32 SE            | 08/02 → 12/07 | 5)                              | VKMA 05502                              | 1 | 1 | 1 |   |  |  |  | 5 | T0135 |
|                                     |        | Z 32 SE            | 08/02 → 12/07 |                                 | VKPC 85613                              |   |   |   | 1 |  |  |  |   |       |
|                                     | B(Alt) | Z 32 SE            | 08/02 → 12/07 | AC                              | VKMV 6PK1992<br>VKM 35016<br>VKM 35500  | 1 | 1 | 1 |   |  |  |  |   |       |
| <b>OPEL  VECTRA C 1.9 CDTI 100</b>  |        |                    |               |                                 |   |   |   |   |   |  |  |  |   |       |
|                                     |        | Z 19 DTL           | 10/05 → 12/07 |                                 | VKMA 02192<br>VKM 12174<br>VKM 22180    | 1 | 1 | 1 |   |  |  |  |   | T0158 |
|                                     |        | Z 19 DTL           | 10/05 → 12/07 |                                 | VKPC 82665                              |   |   |   | 1 |  |  |  |   |       |
|                                     | B(Alt) | Z 19 DTL           | 10/05 → 12/07 | AC, → I Mot. 71 111927          | VKMV 6PK1050<br>VKM 32046               | 1 |   | 1 |   |  |  |  |   |       |
|                                     | B(Alt) | Z 19 DTL           | 10/05 → 12/07 | AC, Mot. 71 111928 I→           | VKMV 6PK1050                            |   |   | 1 |   |  |  |  |   |       |
|                                     | B(Alt) | Z 19 DTL           | 10/05 → 12/07 | AC                              | VKM 32046                               | 1 |   |   |   |  |  |  |   |       |
| <b>OPEL  VECTRA C 1.9 CDTI 120</b>  |        |                    |               |                                 |   |   |   |   |   |  |  |  |   |       |
|                                     |        | Z 19 DT            | 04/04 → 12/07 |                                 | VKMA 02192<br>VKM 12174<br>VKM 22180    | 1 | 1 | 1 |   |  |  |  |   | T0158 |
|                                     |        | Z 19 DT            | 04/04 → 12/07 |                                 | VKPC 82665                              |   |   |   | 1 |  |  |  |   |       |
|                                     | B(Alt) | Z 19 DT            | 04/04 → 12/07 | AC, → I Mot. 71 111927          | VKMV 6PK1050<br>VKM 32046               | 1 |   | 1 |   |  |  |  |   |       |
|                                     | B(Alt) | Z 19 DT            | 04/04 → 12/07 | AC, Mot. 71 111928 I→           | VKMV 6PK1050                            |   |   | 1 |   |  |  |  |   |       |
|                                     | B(Alt) | Z 19 DT            | 04/04 → 12/07 | AC                              | VKM 32046                               | 1 |   |   |   |  |  |  |   |       |





























| OPEL  VECTRA C 1.9 CDTI 150  |                   |               |                                   |              |   |   |   |  |   |   |       |       |
|---|-------------------|---------------|-----------------------------------|--------------|---|---|---|--|---|---|-------|-------|
|                              | Z 19 DTH          | 04/04 → 12/07 |                                   | VKMA 02193   | 1 | 1 | 1 |  |   |   | T0248 |       |
|   |                   |               |                                   | VKM 12174    | 1 |   |   |  |   |   |       |       |
|   |                   |               |                                   | VKM 22180    |   | 1 |   |  |   |   |       |       |
|                              | Z 19 DTH          | 04/04 → 12/07 |                                   | VKPC 82667   |   |   |   |  | 1 |   |       |       |
|                              | B(Alt) Z 19 DTH   | 04/04 → 12/07 | AC, →   Mot. 71 111927            | VKMV 6PK1050 |   |   | 1 |  |   |   |       |       |
|   |                   |               |                                   | VKM 32046    | 1 |   |   |  |   |   |       |       |
|   | B(Alt) Z 19 DTH   | 04/04 → 12/07 | AC, Mot. 71 111928   →            | VKMV 6PK1050 |   |   | 1 |  |   |   |       |       |
|   | B(Alt) Z 19 DTH   | 04/04 → 12/07 | AC                                | VKM 32046    | 1 |   |   |  |   |   |       |       |
| OPEL  VECTRA C 2.0 DTI       |                   |               |                                   |              |   |   |   |  |   |   |       |       |
|                              | Y 20 DTH          | 04/02 → 12/07 |                                   | ΟΛΟΚΛΟ       |   |   |   |  |   |   |       |       |
|                              | Y 20 DTH          | 04/02 → 12/07 |                                   | VKPC 85623   |   |   |   |  | 1 |   |       |       |
|                              | B(Alt) Y 20 DTH   | 04/02 → 12/07 | AC                                | VKMA 35006   | 1 | 1 | 1 |  |   |   |       |       |
|   |                   |               |                                   | VKMV 6PK1805 |   |   | 1 |  |   |   |       |       |
|   |                   |               |                                   | VKM 35007    | 1 |   |   |  |   |   |       |       |
|   |                   |               |                                   | VKM 35016    |   | 1 |   |  |   |   |       |       |
|   | B(Alt) Y 20 DTH   | 04/02 → 12/07 | AC                                | VKMA 35016   | 1 | 1 | 1 |  |   |   |       |       |
|   |                   |               |                                   | VKMV 6PK1880 |   |   | 1 |  |   |   |       |       |
|   |                   |               |                                   | VKM 35007    | 1 |   |   |  |   |   |       |       |
|   |                   |               |                                   | VKM 35016    |   | 1 |   |  |   |   |       |       |
|                              | Y 20 DTH          | 04/02 → 12/07 |                                   | VKM _____    |   |   |   |  | 1 |   |       |       |
| OPEL  VECTRA C 2.2 DTI       |                   |               |                                   |              |   |   |   |  |   |   |       |       |
|                              | Y 22 DTR          | 04/02 → 12/07 |                                   | ΟΛΟΚΛΟ       |   |   |   |  |   |   |       |       |
|                             | Y 22 DTR          | 04/02 → 12/07 |                                   | VKPC 85623   |   |   |   |  | 1 |   |       |       |
|                            | B(Alt) Y 22 DTR   | 04/02 → 12/07 | AC                                | VKMA 35006   | 1 | 1 | 1 |  |   |   |       |       |
|   |                   |               |                                   | VKMV 6PK1805 |   |   | 1 |  |   |   |       |       |
|   |                   |               |                                   | VKM 35007    | 1 |   |   |  |   |   |       |       |
|   |                   |               |                                   | VKM 35016    |   | 1 |   |  |   |   |       |       |
|   | B(Alt) Y 22 DTR   | 04/02 → 12/07 | AC                                | VKMA 35016   | 1 | 1 | 1 |  |   |   |       |       |
|   |                   |               |                                   | VKMV 6PK1880 |   |   | 1 |  |   |   |       |       |
|   |                   |               |                                   | VKM 35007    | 1 |   |   |  |   |   |       |       |
|   |                   |               |                                   | VKM 35016    |   | 1 |   |  |   |   |       |       |
|                            | Y 22 DTR          | 04/02 → 12/07 |                                   | VKM _____    |   |   |   |  | 1 |   |       |       |
| OPEL  VECTRA C 3.0 V6 CDTI |                   |               |                                   |              |   |   |   |  |   |   |       |       |
|                            | Y 30 DT           | 06/03 → 12/07 |                                   | VKMA 05230   | 1 | 2 | 1 |  |   |   | T0200 |       |
|   |                   |               |                                   | VKM 15220    | 1 |   |   |  |   |   |       |       |
|   |                   |               |                                   | VKM 25222    |   | 1 |   |  |   |   |       |       |
|   |                   |               |                                   | VKM 25226    |   | 1 |   |  |   |   |       |       |
|   | Z 30 DT           | 08/05 → 12/07 |                                   | —            | 1 | 2 | 1 |  |   |   | T0200 |       |
|   |                   |               |                                   | —            | 1 |   |   |  |   |   |       |       |
|   |                   |               |                                   | VKM 25222    |   | 1 |   |  |   |   |       |       |
|   |                   |               |                                   | VKM 25226    |   | 1 |   |  |   |   |       |       |
|                            | Y 30 DT, Z 30 DT  | 06/03 → 12/07 |                                   | VKPC _____   |   |   |   |  | 1 |   |       |       |
|                            | B(Alt) Y 30 DT    | 06/03 → 12/07 |                                   | VKMV _____   |   |   | 1 |  |   |   |       |       |
|   |                   |               |                                   | VKM _____    |   | 1 |   |  |   |   |       |       |
|   |                   |               |                                   | VKM _____    |   | 1 |   |  |   |   |       |       |
|   |                   |               |                                   | VKM 35212    |   | 1 |   |  |   |   |       |       |
|   |                   |               |                                   | VKM 35214    |   | 1 |   |  |   |   |       |       |
|   |                   |               |                                   | VKM 35216    | 1 |   |   |  |   |   |       |       |
|   | B(Alt) Z 30 DT    | 08/05 → 12/07 |                                   | VKMV _____   |   |   | 1 |  |   |   |       |       |
|   |                   |               |                                   | VKM _____    |   | 1 |   |  |   |   |       |       |
|   |                   |               |                                   | VKM _____    |   | 1 |   |  |   |   |       |       |
|   |                   |               |                                   | VKM 35212    |   | 1 |   |  |   |   |       |       |
|   |                   |               |                                   | VKM 35214    |   | 1 |   |  |   |   |       |       |
| OPEL  ZAFIRA A 1.6 16V     |                   |               |                                   |              |   |   |   |  |   |   |       |       |
|                            | X 16 XEL, Z 16 XE | 04/99 → 12/04 | 3), →   Mot. 02 HL5117, 20 041690 | VKMS 05152-1 | 1 | 2 | 1 |  |   | 3 | 3     | T0157 |
|   |                   |               |                                   | VKMA 05152   | 1 | 2 | 1 |  |   |   | 3     |       |
|   |                   |               |                                   | VKM 15216    | 1 |   |   |  |   |   | 1     |       |
|   |                   |               |                                   | VKM 25150    |   | 1 |   |  |   |   |       |       |
|   |                   |               |                                   | VKM 25152    |   | 1 |   |  |   |   |       |       |



























|                                   | X 16 XEL, Z 16 XE               | 04/99 → 12/04 | 3), <b>Mot.</b> 02 HL5118,<br>20 041691 I→,<br>→I <b>Mot.</b> 20 EB2048 | VKMS 05154-1<br>VKMA 05154<br>VKM 15216<br>VKM 25152<br>VKM 25312 | 1<br>1<br>1 | 2<br>2<br>1 | 1<br>1<br>1 |  |  |  |   | 3 | 3<br>2<br>1 | T0157 |  |
|-----------------------------------|---------------------------------|---------------|---|---|-------------|-------------|-------------|--|--|--|---|---|-------------|-------|--|
|                                   | X 16 XEL, Z 16 XE               | 01/05 → 06/05 | <b>Mot.</b> 20 EB2049 I→  | VKMA 05156<br>VKM 15216<br>VKM____<br>VKM 25158                   | 1<br>1      | 2<br>1      | 1<br>1      |  |  |  |   |   | 1<br>1      | T0157 |  |
|                                   | X 16 XEL, Z 16 XE               | 04/99 → 06/05 | →I <b>Mot.</b> 02 MV7224,<br>20 U75998                                  | VKPC 85212  |             |             |             |  |  |  | 1 |   |             |       |  |
|                                   | X 16 XEL, Z 16 XE               | 04/99 → 06/05 | <b>Mot.</b> 02 MV7225,<br>20 U75999 I→                                  | VKPC 85211  |             |             |             |  |  |  | 1 |   |             |       |  |
|                                   | <b>B(Alt)</b> X 16 XEL, Z 16 XE | 04/99 → 06/05 | <b>AC</b>   | VKMA 35012<br>VKMV 5PK938<br>VKM 35012                            | 1<br>1      |             | 1<br>1      |  |  |  |   |   |             |       |  |
|                                   | <b>B(Alt)</b> X 16 XEL, Z 16 XE | 04/99 → 12/01 | <b>AC</b> , → <b>ICH</b> 12 999999,<br>1H 999999                        | VKMV 5PK1255<br>VKM 35012   | 1           |             | 1           |  |  |  |   |   |             |       |  |
|                                   | <b>B(Alt)</b> X 16 XEL, Z 16 XE | 01/02 → 06/05 | <b>AC</b> , <b>CH</b> 22 000001,<br>2H 000001 I→                        | VKMA 35022<br>VKMV 5PK1212<br>VKM 35012                           | 1<br>1      |             | 1<br>1      |  |  |  |   |   |             |       |  |
| <b>OPEL  ZAFIRA A 1.6 16V CNG</b> |                                 |               |   |   |             |             |             |  |  |  |   |   |             |       |  |
|                                   | Z 16 YNG                        | 09/01 → 12/04 | 3), →I <b>Mot.</b> 20 EB2048  | VKMS 05154-1<br>VKMA 05154<br>VKM 15216<br>VKM 25152<br>VKM 25312 | 1<br>1<br>1 | 2<br>2<br>1 | 1<br>1<br>1 |  |  |  |   | 3 | 3<br>2<br>1 | T0157 |  |
|                                   | Z 16 YNG                        | 01/05 → 06/05 | <b>Mot.</b> 20 EB2049 I→  | VKMA 05156<br>VKM 15216<br>VKM____<br>VKM 25158                   | 1<br>1      | 2<br>1      | 1<br>1      |  |  |  |   |   | 1<br>1      | T0157 |  |
|                                   | Z 16 YNG                        | 09/01 → 06/05 |   | VKPC 85211  |             |             |             |  |  |  | 1 |   |             |       |  |
|                                   | <b>B(Alt)</b> Z 16 YNG          | 09/01 → 06/05 | <b>AC</b>   | VKMA 35012<br>VKMV 5PK938<br>VKM 35012                            | 1<br>1      |             | 1<br>1      |  |  |  |   |   |             |       |  |
|                                   | <b>B(Alt)</b> Z 16 YNG          | 09/01 → 12/01 | <b>AC</b> , → <b>ICH</b> 12 999999,<br>1H 999999                        | VKMV 5PK1255<br>VKM 35012   | 1           |             | 1           |  |  |  |   |   |             |       |  |
|                                   | <b>B(Alt)</b> Z 16 YNG          | 01/02 → 06/05 | <b>AC</b> , <b>CH</b> 22 000001,<br>2H 000001 I→                        | VKMA 35022<br>VKMV 5PK1212<br>VKM 35012                           | 1<br>1      |             | 1<br>1      |  |  |  |   |   |             |       |  |
| <b>OPEL  ZAFIRA A 1.8 16V</b>     |                                 |               |   |   |             |             |             |  |  |  |   |   |             |       |  |
|                                   | X 18 XE1, Z 18 XE               | 04/99 → 12/02 | 3), →I <b>Mot.</b> 02 HL5117,<br>20 041690                              | VKMS 05152-2<br>VKMA 05152<br>VKM 15216<br>VKM 25150<br>VKM 25152 | 1<br>1<br>1 | 2<br>2<br>1 | 1<br>1<br>1 |  |  |  |   | 3 | 3<br>3<br>1 | T0157 |  |
|                                   | X 18 XE1, Z 18 XEL              | 04/99 → 06/05 | 3), <b>Mot.</b> 02 HL5118,<br>20 041691 I→                              | VKMS 05154-2<br>VKMA 05154<br>VKM 15216<br>VKM 25152<br>VKM 25312 | 1<br>1<br>1 | 2<br>2<br>1 | 1<br>1<br>1 |  |  |  |   | 3 | 3<br>2<br>1 | T0157 |  |
|                                   | Z 18 XE                         | 09/00 → 12/02 | 3), <b>Mot.</b> 02 HL5118,<br>20 041691 I→,<br>→I <b>Mot.</b> 20 EB2048 | VKMS 05154-2<br>VKMA 05154<br>VKM 15216<br>VKM 25152<br>VKM 25312 | 1<br>1<br>1 | 2<br>2<br>1 | 1<br>1<br>1 |  |  |  |   | 3 | 3<br>2<br>1 | T0157 |  |









































|  |  |  |  |  |  |  |  |  |  |  |  |  |  |
|--|---|---|---|--|---|---|---|---|---|---|---|---|---|
|  | Z 18 XE   | 01/03 → 12/04   | 3), → <b>IMot.</b> 02 HL5117,<br>20 041690  | VKMS 05152-3<br>VKMA 05152<br>VKM 15216<br>VKM 25150<br>VKM 25152                  | 1<br>1<br>1   | 2<br>2  | 1<br>1  |   |   |   |   | 3<br>3<br>1   | T0157   |
|  | Z 18 XE   | 01/03 → 12/04   | 3), <b>Mot.</b> 02 HL5118,<br>20 041691   →,<br>→ <b>IMot.</b> 20 EB2048          | VKMS 05154-3<br>VKMA 05154<br>VKM 15216<br>VKM 25152<br>VKM 25312                  | 1<br>1<br>1   | 2<br>2  | 1<br>1  |   |   |   |   | 3<br>2<br>1   | T0157   |
|  | Z 18 XEL  | 02/03 → 06/05   | 3), → <b>IMot.</b> 02 HL5117,<br>20 041690  | VKMS 05152-2<br>VKMA 05152<br>VKM 15216<br>VKM 25150<br>VKM 25152                  | 1<br>1<br>1   | 2<br>2  | 1<br>1  |   |   |   |   | 3<br>3<br>1   | T0157   |
|  | Z 18 XE   | 01/05 → 06/05   | <b>Mot.</b> 20 EB2049   →   | VKMA 05156<br>VKM 15216<br>VKM _____<br>VKM 25158                                  | 1<br>1  | 2   | 1   |   |   |   |   | 1<br>1  | T0157   |
|                                       | X 18 XE1, Z 18 XE,<br>Z 18 XEL  | 04/99 → 06/05   |   | VKPC 85624   |   |   |   |   |   | 1   |   |   |   |
|                                       | <b>B(Alt)</b> X 18 XE1, Z 18 XE,<br>Z 18 XEL                                      | 04/99 → 06/05   | <b>AC</b>   | VKMA 35012<br>VKMV 5PK938<br>VKM 35012   | 1<br>1  |   | 1<br>1  |   |   |   |   |   |   |
|  | <b>B(Alt)</b> X 18 XE1, Z 18 XE   | 04/99 → 12/01   | <b>AC, → ICH</b> 12 999999,<br>1H 999999  | VKMV 5PK1255<br>VKM 35012  | 1   |   | 1   |   |   |   |   |   |   |
|  | <b>B(Alt)</b> Z 18 XE   | 01/02 → 06/05   | <b>AC, CH</b> 22 000001,<br>2H 000001   →   | VKMA 35022<br>VKMV 5PK1212<br>VKM 35012  | 1<br>1  |   | 1<br>1  |   |   |   |   |   |   |
|  | <b>B(Alt)</b> Z 18 XEL  | 02/03 → 06/05   | <b>AC</b>   | VKMA 35022<br>VKMV 5PK1212<br>VKM 35012  | 1<br>1  |   | 1<br>1  |   |   |   |   |   |   |
| <b>OPEL  ZAFIRA A 2.0 16V Turbo</b> |   |   |   |  |   |   |   |   |   |   |   |   |   |
|                                     | Z 20 LER, Z 20 LET  | 09/01 → 12/03   |   | VKMA 05140<br>VKM 15140<br>VKM 25224<br>VKM 25224                                  | 1<br>1  | 2   | 1   |   |   |   |   |   | T0172   |
|  | Z 20 LER, Z 20 LET  | 01/04 → 06/05   |   | VKMA _____<br>VKM 15140<br>VKM _____<br>VKM 25224                                  | 1<br>1  | 2   | 1   |   |   |   |   |   | T0172   |
|                                     | Z 20 LER, Z 20 LET  | 09/01 → 06/05   |   | VKPC 85611   |   |   |   |   |   | 1   |   |   |   |
|                                     | <b>B(Alt)</b> Z 20 LER, Z 20 LET  | 09/01 → 06/05   |   | VKMA 35119<br>VKMV 5PK1680<br>VKM 35009  | 1<br>1  |   | 1<br>1  |   |   |   |   |   |   |
| <b>OPEL  ZAFIRA A 2.2 16V</b>       |   |   |   |  |   |   |   |   |   |   |   |   |   |
|                                     | Z 22 SE   | 09/00 → 06/05   |   | <b>OXOXOXO</b>   |   |   |   |   |   |   |   |   |   |
|                                     | Z 22 SE   | 09/00 → 06/05   |   | VKPC 85308   |   |   |   |   |   | 1   |   |   |   |
|                                     | <b>B(Alt)</b> Z 22 SE   | 09/00 → 06/05   | <b>AC</b>   | VKMV 5PK880<br>VKM 34027   | 1   |   | 1   |   |   |   |   |   |   |
|  | <b>B(Alt)</b> Z 22 SE   | 09/00 → 06/05   | <b>AC</b>   | VKMA 34027<br>VKMV 5PK1028<br>VKM 34027  | 1<br>1  |   | 1<br>1  |   |   |   |   |   |   |
| <b>OPEL  ZAFIRA A 2.0 DI</b>        |   |   |   |  |   |   |   |   |   |   |   |   |   |
|                                     | X 20 DTL, Y 20 DTL  | 10/99 → 06/05   |   | <b>OXOXOXO</b>   |   |   |   |   |   |   |   |   |   |
|                                     | X 20 DTL, Y 20 DTL  | 10/99 → 06/05   |   | VKPC 85623   |   |   |   |   |   | 1   |   |   |   |
|                                     | <b>B(Alt)</b> X 20 DTL, Y 20 DTL  | 10/99 → 06/05   | <b>AC</b>   | VKMA 35006<br>VKMV 6PK1805   | 1   | 1   | 1   |   |   |   |   |   |   |









































OPEL

|  |  |  |     |  |  |  |  |  |  |  |  |  |
|--|---|---|--|--|---|---|---|---|---|---|---|---|
|  |   |   |  | VKM 35007<br>VKM 35016   | 1   | 1   |   |   |   |   |   |   |
| <b>B(Alt)</b>  | X 20 DTL, Y 20 DTL  | 10/99 → 06/05   | <b>AC</b>  | VKMA 35010<br>VKMV 6PK1863<br>VKM 35007<br>VKM 35016                               | 1   | 1   | 1   |   |   |   |   |   |
|                                  | X 20 DTL  | 10/99 → 06/05   | <b>AC, Man. GBX,</b><br>→ ICH 22999999,<br>25999999, 26999999,<br>28999999, 2H999999 | VKM_____   |   |   |   |   |   |   | 1   |   |
|  | X 20 DTL  | 10/99 → 06/05   | <b>Auto. GBX,</b><br>→ ICH 22999999,<br>25999999, 26999999,<br>28999999, 2H999999    | VKM_____   |   |   |   |   |   |   | 1   |   |
|  | Y 20 DTL  | 10/99 → 06/05   | <b>CH 32000001, 35000001,</b><br>36000001, 38000001,<br>3H000001 I→                  | VKM_____   |   |   |   |   |   |   | 1   |   |
| <b>OPEL  ZAFIRA A 2.0 DTI</b>   |   |   |  |  |   |   |   |   |   |   |   |   |
|                                  | Y 20 DTH  | 09/00 → 06/05   |  | <b>OXOXOXO</b>   |   |   |   |   |   |   | 1   |   |
|                                  | Y 20 DTH  | 09/00 → 06/05   |  | VKPC 85623   |   |   |   |   |   |   | 1   |   |
|                                  | <b>B(Alt)</b> Y 20 DTH  | 09/00 → 06/05   | <b>AC</b>  | VKMA 35006<br>VKMV 6PK1805<br>VKM 35007<br>VKM 35016                               | 1   | 1   | 1   |   |   |   |   |   |
|  | <b>B(Alt)</b> Y 20 DTH  | 09/00 → 12/01   | <b>AC</b>  | VKMA 35010<br>VKMV 6PK1863<br>VKM 35007<br>VKM 35016                               | 1   | 1   | 1   |   |   |   |   |   |
|  | <b>B(Alt)</b> Y 20 DTH  | 01/02 → 06/05   | <b>AC, → ICH 22 109974,</b><br>2H 019030   | VKMA 35010<br>VKMV 6PK1863<br>VKM 35007<br>VKM 35016                               | 1   | 1   | 1   |   |   |   |   |   |
|  | <b>B(Alt)</b> Y 20 DTH  | 01/02 → 06/05   | <b>AC, CH 22 109975,</b><br>2H 019031 I→   | VKMA 35030<br>VKMV 6PK1873<br>VKM 35007<br>VKM 35016                               | 1   | 1   | 1   |   |   |   |   |   |
|                                | Y 20 DTH  | 09/00 → 06/05   | <b>AC, → ICH 22999999,</b><br>25999999, 26999999,<br>28999999, 2H999999              | VKM_____   |   |   |   |   |   |   | 1   |   |
|  | Y 20 DTH  | 09/00 → 06/05   | <b>CH 32000001, 35000001,</b><br>36000001, 38000001,<br>3H000001 I→                  | VKM_____   |   |   |   |   |   |   | 1   |   |
| <b>OPEL  ZAFIRA A 2.2 DTI</b> |   |   |  |  |   |   |   |   |   |   |   |   |
|                                | Y 22 DTR  | 01/02 → 06/05   |  | <b>OXOXOXO</b>   |   |   |   |   |   |   | 1   |   |
|                                | Y 22 DTR  | 01/02 → 06/05   |  | VKPC 85623   |   |   |   |   |   |   | 1   |   |
|                                | <b>B(Alt)</b> Y 22 DTR  | 01/02 → 06/05   | <b>AC</b>  | VKMA 35006<br>VKMV 6PK1805<br>VKM 35007<br>VKM 35016                               | 1   | 1   | 1   |   |   |   |   |   |
|  | <b>B(Alt)</b> Y 22 DTR  | 01/02 → 06/05   | <b>AC, → IMot. 17 C42324</b>   | VKMA 35010<br>VKMV 6PK1863<br>VKM 35007<br>VKM 35016                               | 1   | 1   | 1   |   |   |   |   |   |
|  | <b>B(Alt)</b> Y 22 DTR  | 01/02 → 06/05   | <b>AC, Mot. 17 C42325 I→</b>   | VKMA 35030<br>VKMV 6PK1873<br>VKM 35007<br>VKM 35016                               | 1   | 1   | 1   |   |   |   |   |   |
| <b>OPEL  ZAFIRA B 1.6 16V</b> |   |   |  |  |   |   |   |   |   |   |   |   |
|                                | Z 16 XEP  | 07/05 → 03/07   |  | VKMA_____<br>VKM 15260<br>VKM_____   | 1   | 1   | 1   |   |   |   |   | 2 T0244   |
|                                | Z 16 XEP  | 07/05 → 10/07   |  | VKPC_____  |   |   |   |   |   |   | 1   |   |

|   |  |  |  |  |  |  |  |  |  |  |  |
|---|---|---|---|--|---|---|---|---|---|---|---|
|                                      | B(Alt) Z 16 XEP   | 07/05 → 03/07   | AC  | VKMV 5PK1546<br>VKM 35260  | 1   |   | 1   |   |   |   |   |
|   | B(Alt) Z 16 XEP   | 07/05 → 03/07   | AC  | VKMV 5PK1450<br>VKM 35260  | 1   |   | 1   |   |   |   |   |
| <b>OPEL  ZAFIRA B 1.8 16V</b>        |   |   |   |  |   |   |   |   |   |   |   |
|                                      | Z 18 XER  | 07/05 → 03/07   |   | —<br>—<br>VKM _____  | 1<br>1  | 1   | 1   |   |   |   |   |
|                                      | Z 18 XER  | 07/05 → 10/07   |   | VKPC _____   |   |   |   | 1   |   |   |   |
|                                      | B(Alt) Z 18 XER   | 07/05 → 03/07   | AC  | VKMV 5PK1546<br>VKM 35260  | 1   |   | 1   |   |   |   |   |
|   | B(Alt) Z 18 XER   | 07/05 → 03/07   | AC  | VKMV 5PK1450<br>VKM 35260  | 1   |   | 1   |   |   |   |   |
| <b>OPEL  ZAFIRA B 2.0 16V Turbo</b>  |   |   |   |  |   |   |   |   |   |   |   |
|                                      | Z 20 LEH, Z 20 LER  | 07/05 → 06/07   |   | VKMA _____<br>VKM 15140<br>VKM _____<br>VKM 25224                                  | 1<br>1  | 2   | 1   |   |   |   | T0172   |
|                                      | Z 20 LEH, Z 20 LER  | 07/05 → 10/07   |   | VKPC 85611   |   |   |   | 1   |   |   |   |
|                                      | B(Alt) Z 20 LEH, Z 20 LER   | 07/05 → 03/07   | AC  | VKMA 35119<br>VKMV 5PK1680<br>VKM 35009  | 1<br>1  |   | 1<br>1  |   |   |   |   |
| <b>OPEL  ZAFIRA B 2.2</b>            |   |   |   |  |   |   |   |   |   |   |   |
|                                      | Z 22 YH   | 07/05 → 03/07   |   | <b>OXOXOXO</b>   |   |   |   |   |   |   |   |
|                                     | B(Alt) Z 22 YH  | 07/05 → 03/07   | AC  | VKMV 5PK880<br>VKM 34027   | 1   |   | 1   |   |   |   |   |
|   | B(Alt) Z 22 YH  | 07/05 → 03/07   | AC  | VKMA 34027<br>VKMV 5PK1028<br>VKM 34027  | 1<br>1  |   | 1<br>1  |   |   |   |   |
| <b>OPEL  ZAFIRA B 1.9 CDTI 100</b> |   |   |   |  |   |   |   |   |   |   |   |
|                                    | Z 19 DTL  | 07/05 → 03/07   |   | VKMA 02192<br>VKM 12174<br>VKM 22180   | 1<br>1  | 1   | 1   |   |   |   | T0158   |
|                                    | Z 19 DTL  | 07/05 → 10/07   |   | VKPC 82665   |   |   |   | 1   |   |   |   |
|                                    | B(Alt) Z 19 DTL   | 07/05 → 03/07   | AC  | VKMV 6PK1050<br>VKM 32046  | 1   |   | 1   |   |   |   |   |
|   | B(Alt) Z 19 DTL   | 07/05 → 03/07   | AC  | VKM 32046  | 1   |   |   |   |   |   |   |
| <b>OPEL  ZAFIRA B 1.9 CDTI 120</b> |   |   |   |  |   |   |   |   |   |   |   |
|                                    | Z 19 DT   | 07/05 → 03/07   |   | VKMA 02192<br>VKM 12174<br>VKM 22180   | 1<br>1  | 1   | 1   |   |   |   | T0158   |
|                                    | Z 19 DT   | 07/05 → 10/07   |   | VKPC 82665   |   |   |   | 1   |   |   |   |
|                                    | B(Alt) Z 19 DT  | 07/05 → 03/07   | AC  | VKMV 6PK1050<br>VKM 32046  | 1   |   | 1   |   |   |   |   |
|   | B(Alt) Z 19 DT  | 07/05 → 03/07   | AC  | VKM 32046  | 1   |   |   |   |   |   |   |
| <b>OPEL  ZAFIRA B 1.9 CDTI 150</b> |   |   |   |  |   |   |   |   |   |   |   |
|                                    | Z 19 DTH  | 07/05 → 03/07   |   | VKMA 02193<br>VKM 12174<br>VKM 22180   | 1<br>1  | 1   | 1   |   |   |   | T0248   |
|                                    | Z 19 DTH  | 07/05 → 10/07   |   | VKPC 82667   |   |   |   | 1   |   |   |   |
|                                    | B(Alt) Z 19 DTH   | 07/05 → 03/07   | AC  | VKMV 6PK1050<br>VKM 32046  | 1   |   | 1   |   |   |   |   |
|   | B(Alt) Z 19 DTH   | 07/05 → 03/07   | AC  | VKM 32046  | 1   |   |   |   |   |   |   |
| <b>OPEL  ARENA 1.9 D</b>           |   |   |   |  |   |   |   |   |   |   |   |
|                                    | F8Q 600, F8Q 606  | 03/98 → 08/01   | 3)  | VKMS 06114-2<br>VKMA 06114<br>VKM 16101<br>VKM 26101                               | 1<br>1<br>1   | 1<br>1  | 1<br>1  |   |   | 2   | T0147   |
|                                    | F8Q 600, F8Q 606  | 03/98 → 08/01   |   | VKPC 86413   |   |   |   | 1   |   |   |   |





OPEL

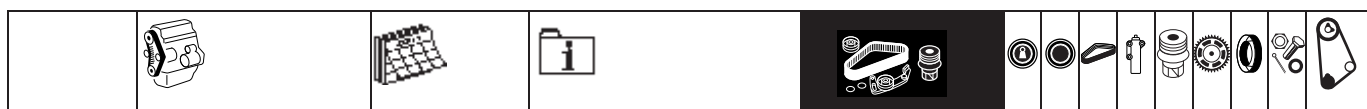



|  |                                       |  |    |  |  |  |  |  |  |  |  |  |
|--|---------------------------------------|---|---|---|--|---|---|---|---|---|---|---|
| <b>OPEL  ARENA 2.5 D</b>      |                                       |   |   |   |  |   |   |   |   |   |   |   |
|                                | S8U 758, S8U 780,<br>S8U 782          | 03/98 → 08/01   |    | VKMA 02983<br>—<br>VKM 22380<br>VKM 22385   | 2<br>1<br>1  | 1   | 1<br>1  |   |   |   |   | T0096   |
|  | S8U 758, S8U 780,<br>S8U 782          | 03/98 → 08/01   |   | VKMA 02383<br>VKM 22380<br>VKM 22385  | 2<br>1<br>1  | 1   |   |   |   |   |   | T0652   |
|                                | S8U 758, S8U 780,<br>S8U 782          | 03/98 → 08/01   |   | VKPC 82630  |  |   |   | 1   |   |   |   |   |
| <b>OPEL  MOVANO 1.9 DTI</b>   |                                       |   |   |   |  |   |   |   |   |   |   |   |
|                                | F9Q 772, F9Q 774                      | 10/01 → 10/07   |    | VKMC 06127<br>VKMA 06127<br>VKM 16113   | 1<br>1<br>1  | 1   | 1   | 1   |   |   |   | T0647   |
|  | F9Q 770                               | 09/00 → 10/01   | c   | VKMA 06117<br>VKM 16551<br>VKM 26117<br>VKM 26128                                 | 1<br>1<br>1<br>1   | 1   | 1   |   | 1   |   |   | T0181   |
|                                | F9Q 770                               | 09/00 → 10/01   |   | VKPC 86413  |  |   |   | 1   |   |   |   |   |
|  | F9Q 772, F9Q 774                      | 10/01 → 10/07   |   | VKPC 85304  |  |   |   | 1   |   |   |   |   |
|                                | <b>B(Alt)</b> F9Q 772, F9Q 774        | 10/01 → 10/07   | <b>AC</b>   | VKMOV 5PK1125   |  |   | 1   |   |   |   |   |   |
| <b>OPEL  MOVANO 2.2 DTI</b>   |                                       |   |   |   |  |   |   |   |   |   |   |   |
|                                | G9T 720, G9T 722,<br>G9T 750          | 09/00 → 10/07   |   | VKMA 06503<br>VKM 16503<br>VKM 26503  | 1<br>1<br>1  | 1   | 1   |   |   |   |   | 1 T0187   |
|                              | G9T 720, G9T 722,<br>G9T 750          | 09/00 → 10/07   |   | VKPC 86305  |  |   |   | 1   |   |   |   |   |
| <b>OPEL  MOVANO 2.5 D</b>   |                                       |   |   |   |  |   |   |   |   |   |   |   |
|                              | S8U 772                               | 07/98 → 09/00   |  | VKMA 02983<br>—<br>VKM 22380<br>VKM 22385   | 2<br>1<br>1  | 1   | 1<br>1  |   |   |   |   | T0096   |
|  | S8U 772                               | 07/98 → 09/00   |   | VKMA 02383<br>VKM 22380<br>VKM 22385  | 2<br>1<br>1  | 1   |   |   |   |   |   | T0652   |
|                              | S8U 772                               | 07/98 → 09/00   |   | VKPC 85302  |  |   |   | 1   |   |   |   |   |
|                              | <b>B(Alt)</b> S8U 772                 | 07/98 → 09/00   | <b>AC, →IMot. 3053818</b>   | VKMA 36017<br>VKMV 6PK860<br>VKM 36017  | 1<br>1<br>1  | 1   | 1   |   |   |   |   |   |
| <b>OPEL  MOVANO 2.5 DTI</b> |                                       |   |   |   |  |   |   |   |   |   |   |   |
|                              | G9U 720, G9U 724,<br>G9U 750, G9U 754 | 10/01 → 10/07   |   | VKMA 06503<br>VKM 16503<br>VKM 26503  | 1<br>1<br>1  | 1   | 1   |   |   |   |   | 1 T0187   |
|                              | G9U 720, G9U 724,<br>G9U 750, G9U 754 | 10/01 → 10/07   |   | VKPC 86305  |  |   |   | 1   |   |   |   |   |
| <b>OPEL  MOVANO 2.8 DTI</b> |                                       |   |   |   |  |   |   |   |   |   |   |   |
|                              | S9W 700, S9W 702                      | 07/98 → 10/01   |  | VKMA 02986<br>—<br>VKM 22385<br>VKM 22385   | 2<br>1<br>1  | 1   | 1<br>1  |   |   |   |   | T0155   |
|  | S9W 700, S9W 702                      | 07/98 → 10/01   |   | VKMA 02386<br>VKM 22385<br>VKM 22385  | 2<br>1<br>1  | 1   |   |   |   |   |   | T0155   |
|                              | S9W 700, S9W 702                      | 07/98 → 10/01   |   | VKPC 85303  |  |   |   | 1   |   |   |   |   |
|                              | <b>B(Alt)</b> S9W 700, S9W 702        | 07/98 → 10/01   | <b>AC, →IMot. 3053818</b>   | VKMA 36117<br>VKMV 6PK841<br>VKM 36017  | 1<br>1<br>1  | 1   | 1   |   |   |   |   |   |
| <b>OPEL  MOVANO 3.0 DTI</b> |                                       |   |   |   |  |   |   |   |   |   |   |   |
|                              | ZD3 200, ZD3 202                      | 10/03 → 10/07   |   | <b>OXOXOXO</b>  |  |   |   |   |   |   |   |   |
|                              | <b>B(Alt)</b> ZD3 200, ZD3 202        | 10/03 → 10/07   | <b>AC</b>   | VKMOV 7PK1922   |  |   | 1   |   |   |   |   |   |







**OPEL  VIVARO 2.0 16V**

|   |                |               |           |              |   |   |   |  |  |  |  |   |   |  |  |  |  |  |  |       |
|---|----------------|---------------|-----------|--------------|---|---|---|--|--|--|--|---|---|--|--|--|--|--|--|-------|
|  | F4R 720        | 08/01 → 10/07 |           | —            | 1 | 1 | 1 |  |  |  |  |   |   |  |  |  |  |  |  | T0177 |
|   |                |               |           | VKM 26105    | 1 |   |   |  |  |  |  |   |   |  |  |  |  |  |  |       |
|   |                |               |           | VKPC 85304   |   |   |   |  |  |  |  |   | 1 |  |  |  |  |  |  |       |
|  | B(Alt) F4R 720 | 08/01 → 10/07 | <i>AC</i> | VKMV 5PK1125 |   |   |   |  |  |  |  |   | 1 |  |  |  |  |  |  |       |
|   | B(Alt) F4R 720 | 08/01 → 02/02 | <b>AC</b> | VKMA 36033   | 1 | 1 | 1 |  |  |  |  |   |   |  |  |  |  |  |  |       |
|   |                |               |           | VKMV 6PK1792 |   |   |   |  |  |  |  |   | 1 |  |  |  |  |  |  |       |
|   |                |               |           | VKM 36030    | 1 |   |   |  |  |  |  |   |   |  |  |  |  |  |  |       |
|   |                |               |           | VKM 36031    |   |   |   |  |  |  |  | 1 |   |  |  |  |  |  |  |       |
|   | B(Alt) F4R 720 | 02/02 → 05/06 | <b>AC</b> | VKMA 36038   | 1 | 1 | 1 |  |  |  |  |   |   |  |  |  |  |  |  |       |
|   |                |               |           | VKMV 6PK1792 |   |   |   |  |  |  |  |   | 1 |  |  |  |  |  |  |       |
|   |                |               |           | VKM 36030    | 1 |   |   |  |  |  |  |   |   |  |  |  |  |  |  |       |
|   |                |               |           | VKM 36038    |   |   |   |  |  |  |  | 1 |   |  |  |  |  |  |  |       |



**OPEL  VIVARO 1.9 DI**

|   |                         |               |   |              |   |   |   |  |   |  |  |   |   |  |  |  |  |  |  |  |       |  |
|---|-------------------------|---------------|---|--------------|---|---|---|--|---|--|--|---|---|--|--|--|--|--|--|--|-------|--|
|  | F9Q 762                 | 08/01 → 10/07 |  | VKMC 06127   | 1 |   |   |  | 1 |  |  |   |   |  |  |  |  |  |  |  | T0647 |  |
|   |                         |               |   | VKMA 06127   | 1 |   |   |  | 1 |  |  |   |   |  |  |  |  |  |  |  |       |  |
|   |                         |               |   | VKM 16113    | 1 |   |   |  |   |  |  |   |   |  |  |  |  |  |  |  |       |  |
|  | F9Q 762                 | 08/01 → 10/07 |   | VKPC 85304   |   |   |   |  |   |  |  |   | 1 |  |  |  |  |  |  |  |       |  |
|  | B(Alt) F9Q 762, F9Q 774 | 08/01 → 10/07 | <i>AC</i>   | VKMV 5PK1125 |   |   |   |  |   |  |  |   | 1 |  |  |  |  |  |  |  |       |  |
|   | B(Alt) F9Q 762, F9Q 774 | 08/01 → 03/02 | <b>AC</b>   | VKMA 36033   | 1 | 1 | 1 |  |   |  |  |   |   |  |  |  |  |  |  |  |       |  |
|   |                         |               |   | VKMV 6PK1792 |   |   |   |  |   |  |  |   |   |  |  |  |  |  |  |  |       |  |
|   |                         |               |   | VKM 36030    | 1 |   |   |  |   |  |  |   |   |  |  |  |  |  |  |  |       |  |
|   |                         |               |   | VKM 36031    |   |   |   |  |   |  |  | 1 |   |  |  |  |  |  |  |  |       |  |
|   | B(Alt) F9Q 762, F9Q 774 | 03/02 → 11/05 | <b>AC</b>   | VKMA 36038   | 1 | 1 | 1 |  |   |  |  |   |   |  |  |  |  |  |  |  |       |  |
|   |                         |               |   | VKMV 6PK1792 |   |   |   |  |   |  |  |   | 1 |  |  |  |  |  |  |  |       |  |
|   |                         |               |   | VKM 36030    | 1 |   |   |  |   |  |  |   |   |  |  |  |  |  |  |  |       |  |
|   |                         |               |   | VKM 36038    |   |   |   |  |   |  |  | 1 |   |  |  |  |  |  |  |  |       |  |



**OPEL  VIVARO 1.9 DTI**

|   |                |               |   |              |   |   |   |  |   |  |  |   |   |  |  |  |  |  |  |  |  |       |  |
|---|----------------|---------------|---|--------------|---|---|---|--|---|--|--|---|---|--|--|--|--|--|--|--|--|-------|--|
|  | F9Q 760        | 08/01 → 10/07 |  | VKMC 06127   | 1 |   |   |  | 1 |  |  |   |   |  |  |  |  |  |  |  |  | T0647 |  |
|   |                |               |   | VKMA 06127   | 1 |   |   |  | 1 |  |  |   |   |  |  |  |  |  |  |  |  |       |  |
|   |                |               |   | VKM 16113    | 1 |   |   |  |   |  |  |   |   |  |  |  |  |  |  |  |  |       |  |
|  | F9Q 760        | 08/01 → 10/07 |   | VKPC 85304   |   |   |   |  |   |  |  |   | 1 |  |  |  |  |  |  |  |  |       |  |
|  | B(Alt) F9Q 760 | 08/01 → 10/07 | <i>AC</i>   | VKMV 5PK1125 |   |   |   |  |   |  |  |   | 1 |  |  |  |  |  |  |  |  |       |  |
|   | B(Alt) F9Q 760 | 08/01 → 03/02 | <b>AC</b>   | VKMA 36033   | 1 | 1 | 1 |  |   |  |  |   |   |  |  |  |  |  |  |  |  |       |  |
|   |                |               |   | VKMV 6PK1792 |   |   |   |  |   |  |  |   |   |  |  |  |  |  |  |  |  |       |  |
|   |                |               |   | VKM 36030    | 1 |   |   |  |   |  |  |   |   |  |  |  |  |  |  |  |  |       |  |
|   |                |               |   | VKM 36031    |   |   |   |  |   |  |  | 1 |   |  |  |  |  |  |  |  |  |       |  |
|   | B(Alt) F9Q 760 | 03/02 → 11/05 | <b>AC</b>   | VKMA 36038   | 1 | 1 | 1 |  |   |  |  |   |   |  |  |  |  |  |  |  |  |       |  |
|   |                |               |   | VKMV 6PK1792 |   |   |   |  |   |  |  |   | 1 |  |  |  |  |  |  |  |  |       |  |
|   |                |               |   | VKM 36030    | 1 |   |   |  |   |  |  |   |   |  |  |  |  |  |  |  |  |       |  |
|   |                |               |   | VKM 36038    |   |   |   |  |   |  |  | 1 |   |  |  |  |  |  |  |  |  |       |  |



**OPEL  VIVARO 2.5 DTI**

|   |                |               |           |              |   |   |   |  |  |  |  |   |   |  |  |  |  |  |  |  |  |   |       |
|---|----------------|---------------|-----------|--------------|---|---|---|--|--|--|--|---|---|--|--|--|--|--|--|--|--|---|-------|
|  | G9U 730        | 05/03 → 10/07 |           | VKMA 06503   | 1 | 1 | 1 |  |  |  |  |   |   |  |  |  |  |  |  |  |  | 1 | T0187 |
|   |                |               |           | VKM 16503    | 1 |   |   |  |  |  |  |   |   |  |  |  |  |  |  |  |  |   |       |
|   |                |               |           | VKM 26503    |   |   |   |  |  |  |  | 1 |   |  |  |  |  |  |  |  |  |   |       |
|  | G9U 730        | 05/03 → 10/07 |           | VKPC 86305   |   |   |   |  |  |  |  |   | 1 |  |  |  |  |  |  |  |  |   |       |
|  | B(Alt) G9U 730 | 05/03 → 10/07 | <i>AC</i> | VKMV 6PK1148 |   |   |   |  |  |  |  |   | 1 |  |  |  |  |  |  |  |  |   |       |
|   |                |               |           | VKM 36040    |   |   |   |  |  |  |  |   | 1 |  |  |  |  |  |  |  |  |   |       |
|   |                |               |           | VKM 36040    |   |   |   |  |  |  |  | 1 |   |  |  |  |  |  |  |  |  |   |       |















































**PEUGEOT  1007 1.4**







































|   |                    |               |           |              |   |  |  |  |   |  |  |  |   |   |  |  |  |  |  |  |  |  |       |
|---|--------------------|---------------|-----------|--------------|---|--|--|--|---|--|--|--|---|---|--|--|--|--|--|--|--|--|-------|
|  | TU3A, TU3JP        | 04/05 → 12/07 |           | VKMA 03254   | 1 |  |  |  | 1 |  |  |  |   |   |  |  |  |  |  |  |  |  | T0189 |
|   |                    |               |           | VKM 13253    | 1 |  |  |  |   |  |  |  |   |   |  |  |  |  |  |  |  |  |       |
|  | TU3A, TU3JP        | 04/05 → 12/07 |           | VKPC 83644   |   |  |  |  |   |  |  |  | 1 |   |  |  |  |  |  |  |  |  |       |
|  | B(Alt) TU3A, TU3JP | 04/05 → 12/07 | <i>AC</i> | VKMV 6PK728  |   |  |  |  |   |  |  |  | 1 |   |  |  |  |  |  |  |  |  |       |
|   | B(Alt) TU3A, TU3JP | 04/05 → 12/07 | <b>AC</b> | VKMV 6PK1049 |   |  |  |  |   |  |  |  |   | 1 |  |  |  |  |  |  |  |  |       |
|   |                    |               |           | VKM 33074    | 1 |  |  |  |   |  |  |  |   |   |  |  |  |  |  |  |  |  |       |

**PEUGEOT  1007 1.4 16V**

|   |              |               |           |             |   |   |   |  |  |  |  |  |   |  |  |  |  |  |  |  |  |  |       |
|---|--------------|---------------|-----------|-------------|---|---|---|--|--|--|--|--|---|--|--|--|--|--|--|--|--|--|-------|
|  | ET3J4        | 10/05 → 12/07 |           | VKMA 03258  | 1 | 1 | 1 |  |  |  |  |  |   |  |  |  |  |  |  |  |  |  | T0209 |
|   |              |               |           | VKM 13258   | 1 |   |   |  |  |  |  |  |   |  |  |  |  |  |  |  |  |  |       |
|   |              |               |           | VKM 23258   |   |   |   |  |  |  |  |  | 1 |  |  |  |  |  |  |  |  |  |       |
|  | ET3J4        | 10/05 → 12/07 |           | VKPC 83258  |   |   |   |  |  |  |  |  | 1 |  |  |  |  |  |  |  |  |  |       |
|  | B(Alt) ET3J4 | 10/05 → 12/07 | <i>AC</i> | VKMV 6PK728 |   |   |   |  |  |  |  |  | 1 |  |  |  |  |  |  |  |  |  |       |















































|   |  |  |    |  |  |  |  |  |  |  |  |
|---|---|---|---|--|---|---|---|---|---|---|---|
| <b>B(Alt)</b>   | ET3J4   | 10/05 → 12/07   | AC  | VKMOV 6PK1049<br>VKM 33074   | 1   | 1   |   |   |   |   |   |
| <b>PEUGEOT  1007 1.6 16V</b> |   |   |   |  |   |   |   |   |   |   |   |
|                               | TU5JP4  | 04/05 → 12/07   |   | VKMA 03256<br>VKM 13256<br>VKM 23256   | 1<br>1  | 1<br>1  |   |   |   |   | T0193   |
|                               | TU5JP4  | 04/05 → 12/07   |   | VKPC 83430   |   |   |   | 1   |   |   |   |
|                               | <b>B(Alt)</b> TU5JP4  | 04/05 → 12/07   | AC  | VKMOV 6PK728   |   | 1   |   |   |   |   |   |
|   | <b>B(Alt)</b> TU5JP4  | 04/05 → 12/07   | AC  | VKMOV 6PK1049<br>VKM 33074   | 1   | 1   |   |   |   |   |   |
| <b>PEUGEOT  1007 1.4 HDi</b> |   |   |   |  |   |   |   |   |   |   |   |
|                               | DV4TD   | 04/05 → 12/07   |   | VKMA 03140<br>VKM 13140<br>VKM 23140   | 1<br>1  | 1<br>1  |   |   |   |   | T0195   |
|                               | DV4TD   | 04/05 → 12/07   |   | VKPC 83140   |   |   |   | 1   |   |   |   |
|                               | <b>B(Alt)</b> DV4TD   | 04/05 → 12/07   | AC  | VKMA 33058<br>VKMV 6PK802<br>VKM 33043<br>VKM 33044                                | 1<br>1  | 1<br>1  |   |   |   |   | 1   |
|   | <b>B(Alt)</b> DV4TD   | 04/05 → 12/07   | AC  | VKMA 33043<br>VKMV 6PK976<br>VKM 33043   | 1<br>1  | 1<br>1  |   |   |   |   |   |
| <b>PEUGEOT  1007 1.6 HDi</b> |   |   |   |  |   |   |   |   |   |   |   |
|                               | DV6TED4   | 06/07 → 12/07   |   | VKMA 03259<br>VKM 13140<br>VKM 23140   | 1<br>1  | 1<br>1  |   |   |   |   | T0195   |
|                             | DV6TED4   | 06/07 → 12/07   |   | VKPC 83259   |   |   |   | 1   |   |   |   |
| <b>PEUGEOT  104 0.9</b>    |   |   |   |  |   |   |   |   |   |   |   |
|                             | XV3, XV5  | 10/72 → 10/83   |   | <del>XXXXXXXX</del>  |   |   |   |   |   |   |   |
|                             | XV3, XV5  | 10/72 → 12/78 2)  |   | VKPA 83200<br>VKPC 83200   |   |   |   | 1<br>1  |   |   |   |
|                             | <b>B(Alt)</b> XV3, XV5  | 10/72 → 10/78   |   | VKMOV 10AVx900   |   | 1   |   |   |   |   |   |
|   | <b>B(Alt)</b> XV3, XV5  | 10/78 → 10/83   |   | VKMOV 10AVx913   |   | 1   |   |   |   |   |   |
| <b>PEUGEOT  104 1.0</b>    |   |   |   |  |   |   |   |   |   |   |   |
|                             | XV8   | 09/83 → 06/88   |   | <del>XXXXXXXX</del>  |   |   |   |   |   |   |   |
|                             | <b>B(Alt)</b> XV8   | 09/83 → 06/88   |   | VKMOV 10AVx913   |   | 1   |   |   |   |   |   |
| <b>PEUGEOT  104 1.1</b>    |   |   |   |  |   |   |   |   |   |   |   |
|                             | XW3, XW3S, XW7  | 09/73 → 06/88   |   | <del>XXXXXXXX</del>  |   |   |   |   |   |   |   |
|                             | XW3, XW3S, XW7  | 09/73 → 06/88 2)  |   | VKPA 83200<br>VKPC 83200   |   |   |   | 1<br>1  |   |   |   |
|                             | <b>B(Alt)</b> XW3, XW3S   | 09/73 → 10/78   |   | VKMOV 10AVx900   |   | 1   |   |   |   |   |   |
|   | <b>B(Alt)</b> XW3, XW3S, XW7  | 10/78 → 06/88   |   | VKMOV 10AVx913   |   | 1   |   |   |   |   |   |
| <b>PEUGEOT  104 1.2</b>    |   |   |   |  |   |   |   |   |   |   |   |
|                             | XZ5   | 08/79 → 06/83   |   | <del>XXXXXXXX</del>  |   |   |   |   |   |   |   |
|                             | XZ5   | 08/79 → 12/82 2)  |   | VKPA 83200<br>VKPC 83200   |   |   |   | 1<br>1  |   |   |   |
|                             | <b>B(Alt)</b> XZ5   | 08/79 → 06/83   |   | VKMOV 10AVx913   |   | 1   |   |   |   |   |   |
| <b>PEUGEOT  104 1.4</b>    |   |   |   |  |   |   |   |   |   |   |   |
|                             | XY6B  | 08/79 → 06/84   |   | <del>XXXXXXXX</del>  |   |   |   |   |   |   |   |
|                             | XY6B  | 08/79 → 06/84 2)  |   | VKPA 83200<br>VKPC 83200   |   |   |   | 1<br>1  |   |   |   |
|                             | <b>B(Alt)</b> XY6B  | 08/79 → 06/84   |   | VKMOV 10AVx913   |   | 1   |   |   |   |   |   |
| <b>PEUGEOT  106   1.0</b>  |   |   |   |  |   |   |   |   |   |   |   |
|                             | TU9, TU9M   | 09/91 → 04/96   |  | VKMC 03100<br>VKMA 03100<br>VKM 13100  | 1<br>1<br>1   | 1<br>1  | 1   |   |   |   | T0044   |
|   | TU9, TU9M   | 09/91 → 04/96 3)  |   | VKMS 03100-1<br>VKMA 03100<br>VKM 13100  | 1<br>1<br>1   | 1<br>1  |   |   | 2   |   | T0044   |
|                             | TU9, TU9M   | 09/91 → 04/96   |   | VKPC 83205   |   |   |   | 1   |   |   |   |
|                             | <b>B(Alt)</b> TU9, TU9M   | 09/91 → 04/96   | AC  | VKMOV 10AVx710   |   | 1   |   |   |   |   |   |









































|   |  |  |            |  |  |  |  |  |  |  |  |  |  |
|---|---|---|---|--|---|---|---|---|---|---|---|---|---|
|   | <b>B(Alt)</b> TU9, TU9M   | 09/91 → 04/96   | <b>AC</b>   | VKMA 33012<br>VKMV 5PK1020<br>VKM 33012  | 1<br>1<br>1   | 1<br>1  |   |   |   |   |   |   |   |
| <b>PEUGEOT</b>  <b>106   1.1</b>     |   |   |   |  |   |   |   |   |   |   |   |   |   |
|                                      | TU1M  | 09/91 → 04/96   |            | VKMC 03100<br>VKMA 03100<br>VKM 13100  | 1<br>1<br>1   | 1<br>1  | 1   |   |   |   |   |   | T0044   |
|   | TU1M  | 09/91 → 04/96   | 3)  | VKMS 03100-1<br>VKMA 03100<br>VKM 13100  | 1<br>1<br>1   | 1<br>1  |   |   |   | 2   |   |   | T0044   |
|                                      | TU1M  | 09/91 → 04/96   |   | VKPC 83205   |   |   | 1   |   |   |   |   |   |   |
|                                      | <b>B(Alt)</b> TU1M  | 09/91 → 04/96   | <b>AC</b>   | VKMA 33012<br>VKMV 5PK1020<br>VKM 33012  | 1<br>1<br>1   | 1<br>1  |   |   |   |   |   |   |   |
|   | <b>B(Alt)</b> TU1M  | 09/91 → 04/96   | <b>AC</b>   | VKMA 33012<br>VKMV 5PK1020<br>VKM 33012  | 1<br>1<br>1   | 1<br>1  |   |   |   |   |   |   |   |
| <b>PEUGEOT</b>  <b>106   1.3</b>     |   |   |   |  |   |   |   |   |   |   |   |   |   |
|                                      | TU2J2   | 10/93 → 04/96   | 3)  | VKMS 03110-1<br>VKMA 03110<br>VKM 13100  | 1<br>1<br>1   | 1<br>1  |   |   |   | 2   |   |   | T0044   |
|                                      | TU2J2   | 10/93 → 04/96   | <b>Mot. Cast.</b>   | VKPC 83428   |   |   | 1   |   |   |   |   |   |   |
|   | TU2J2   | 10/93 → 04/96   | <b>Mot. Alu.</b>  | VKPC 83205   |   |   | 1   |   |   |   |   |   |   |
|                                      | <b>B(Alt)</b> TU2J2   | 10/93 → 04/96   | <b>AC</b>   | VKMA 33012<br>VKMV 5PK1020<br>VKM 33012  | 1<br>1<br>1   | 1<br>1  |   |   |   |   |   |   |   |
|   | <b>B(Alt)</b> TU2J2   | 10/93 → 04/96   | <b>AC</b>   | VKMA 33012<br>VKMV 5PK1020<br>VKM 33012  | 1<br>1<br>1   | 1<br>1  |   |   |   |   |   |   |   |
| <b>PEUGEOT</b>  <b>106   1.4</b>    |   |   |   |  |   |   |   |   |   |   |   |   |   |
|                                    | TU3, TU3-2, TU3M,<br>TU3MC  | 09/91 → 04/96   | 3),  108 | VKMS 03110-1<br>VKMA 03110<br>VKM 13100  | 1<br>1<br>1   | 1<br>1  |   |   |   | 2   |   |   | T0044   |
|   | TU3J, TU3M, TU3MC   | 09/91 → 04/96   |  101     | VKMA 03111<br>VKM 13100  | 1<br>1  | 1   |   |   |   |   |   |   | T0044   |
|                                    | TU3J2/Z   | 09/91 → 04/96   |   | VKPC 83428   |   |   | 1   |   |   |   |   |   |   |
|   | TU3M, TU3MC   | 09/91 → 04/96   | <b>Mot. Cast.</b>   | VKPC 83428   |   |   | 1   |   |   |   |   |   |   |
|   | TU3M, TU3MC   | 09/91 → 04/96   | <b>Mot. Alu.</b>  | VKPC 83205   |   |   | 1   |   |   |   |   |   |   |
|                                    | <b>B(Alt)</b> TU3J2/Z, TU3M, TU3MC  | 09/91 → 04/96   | <b>AC</b>   | VKMA 33012<br>VKMV 5PK1020<br>VKM 33012  | 1<br>1<br>1   | 1<br>1  |   |   |   |   |   |   |   |
|   | <b>B(Alt)</b> TU3J2/Z, TU3M, TU3MC  | 09/91 → 04/96   | <b>AC</b>   | VKMA 33012<br>VKMV 5PK1020<br>VKM 33012  | 1<br>1<br>1   | 1<br>1  |   |   |   |   |   |   |   |
| <b>PEUGEOT</b>  <b>106   1.6</b>   |   |   |   |  |   |   |   |   |   |   |   |   |   |
|                                    | TU5J2, TU5JP  | 06/93 → 04/96   |   | VKMA 03111<br>VKM 13100  | 1<br>1  | 1   |   |   |   |   |   |   | T0044   |
|                                    | TU5J2, TU5JP  | 06/93 → 04/96   |   | VKPC 83428   |   |   | 1   |   |   |   |   |   |   |
|                                    | <b>B(Alt)</b> TU5J2, TU5JP  | 06/93 → 04/96   | <b>AC</b>   | VKMA 33012<br>VKMV 5PK1020<br>VKM 33012  | 1<br>1<br>1   | 1<br>1  |   |   |   |   |   |   |   |
|   | <b>B(Alt)</b> TU5J2, TU5JP  | 06/93 → 04/96   | <b>AC</b>   | VKMA 33012<br>VKMV 5PK1020<br>VKM 33012  | 1<br>1<br>1   | 1<br>1  |   |   |   |   |   |   |   |
| <b>PEUGEOT</b>  <b>106   1.4 D</b> |   |   |   |  |   |   |   |   |   |   |   |   |   |
|                                    | TUD3  | 09/92 → 04/96   |   | VKMA 03120<br>VKM 13120<br>VKM 23120   | 1<br>1<br>1   | 1<br>1  |   |   |   |   |   |   | T0120   |
|   | TUD3  | 09/92 → 04/96   |   | VKPC 83205   |   |   | 1   |   |   |   |   | 2   |   |
|                                    | TUD3  | 09/92 → 04/96   |   | VKPC 83205   |   |   | 1   |   |   |   |   |   |   |
|                                    | <b>B(Alt)</b> TUD3  | 09/92 → 04/96   | 9), <b>AC</b>   | VKMA 33012<br>VKMV 5PK1020<br>VKM 33012  | 1<br>1<br>1   | 1   |   |   |   |   |   |   |   |
|   | <b>B(Alt)</b> TUD3  | 09/92 → 04/96   | 10), <b>AC</b>  | VKMA 33012<br>VKMV 5PK1020<br>VKM 33012  | 1<br>1<br>1   | 1   |   |   |   |   |   |   |   |
|   | <b>B(Alt)</b> TUD3  | 09/92 → 04/96   | <b>AC</b>   | VKMA 33012<br>VKMV 5PK1020<br>VKM 33012  | 1<br>1<br>1   | 1<br>1  |   |   |   |   |   |   |   |
| <b>PEUGEOT</b>  <b>106   1.5 D</b> |   |   |   |  |   |   |   |   |   |   |   |   |   |
|                                    | TUD5  | 06/94 → 04/96   |          | VKMC 03121<br>VKMA 03121<br>VKM 13120<br>VKM 23120                                 | 1<br>1<br>1<br>1  | 1<br>1<br>1<br>1  | 1   |   |   |   |   | 2<br>2<br>2   | T0120   |
|   |   |   |   |  |   | 1   |   |   |   |   |   | 2   |   |



PEUGEOT











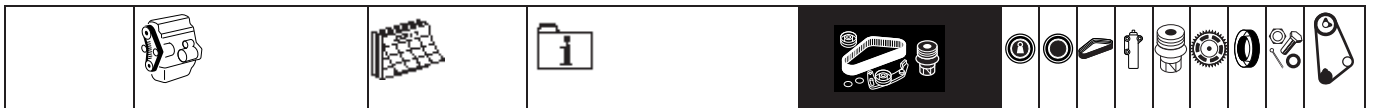













|   |  |  |   |  |  |  |  |  |  |  |  |  |
|---|---|---|--|--|---|---|---|---|---|---|---|---|
|   | TUD5  | 06/94 → 04/96   | 3)   | VKMS 03121<br>VKMA 03121<br>VKM 13120<br>VKM 23120                                 | 1<br>1<br>1<br>1  | 1<br>1<br>1   |   |   |   | 2<br>2  | 2<br>2  | T0120   |
|                               | TUD5  | 06/94 → 04/96   |  | VKPC 83428   |   |   |   | 1   |   |   |   |   |
|                               | B(Alt) TUD5   | 06/94 → 04/96   |   | VKMA 33045<br>VKMV 5PK775<br>VKM 33009   | 1<br>1  | 1<br>1  |   |   |   |   |   |   |
|   | B(Alt) TUD5   | 06/94 → 04/96   |   | VKMA 33046<br>VKMV 5PK960<br>VKM 33039   | 1<br>1  | 1<br>1  |   |   |   |   |   |   |
|                               | TUD5  | 06/94 → 04/96   |  | VKM 93305  |   |   |   |   | 1   |   |   |   |
| <b>PEUGEOT  106 II 1.0</b>   |   |   |  |  |   |   |   |   |   |   |   |   |
|                               | TU9M  | 05/96 → 12/07   |   | VKMC 03100<br>VKMA 03100<br>VKM 13100  | 1<br>1<br>1   | 1<br>1  |   | 1   |   |   |   | T0044   |
|   | TU9M  | 05/96 → 12/07   | 3)   | VKMS 03100-1<br>VKMA 03100<br>VKM 13100  | 1<br>1<br>1   | 1<br>1  |   |   |   | 2   |   | T0044   |
|                               | TU9M  | 05/96 → 12/07   |  | VKPC 83205   |   |   |   | 1   |   |   |   |   |
|                               | B(Alt) TU9M   | 05/96 → 12/07   | 10),    | VKMV 10AVx710  |   |   | 1   |   |   |   |   |   |
|   | B(Alt) TU9M   | 05/96 → 12/07   | AC   | VKMA 33012<br>VKMV 5PK1020<br>VKM 33012  | 1<br>1  | 1<br>1  |   |   |   |   |   |   |
| <b>PEUGEOT  106 II 1.1</b>   |   |   |  |  |   |   |   |   |   |   |   |   |
|                               | TU1JP   | 05/96 → 12/07   |  M, <br>→   Mot. 3762433 | VKMC 03100<br>VKMA 03100<br>VKM 13100  | 1<br>1<br>1   | 1<br>1  |   | 1   |   |   |   | T0044   |
|   | TU1JP   | 05/96 → 12/07   | 3), M, <br>→   Mot. 3762433   | VKMS 03100-1<br>VKMA 03100<br>VKM 13100  | 1<br>1<br>1   | 1<br>1  |   |   |   | 2   |   | T0044   |
|   | TU1JP   | 05/96 → 12/07   | A,  Mot. 3762434   →  | VKMA 03253<br>VKM 13253  | 1<br>1  | 1   |   |   |   |   |   | T0188   |
|   | TU1M, TU1M+   | 01/97 → 12/07   |   | VKMC 03100<br>VKMA 03100<br>VKM 13100  | 1<br>1<br>1   | 1<br>1  |   | 1   |   |   |   | T0044   |
|   | TU1M, TU1M+   | 01/97 → 12/07   | 3)   | VKMS 03100-1<br>VKMA 03100<br>VKM 13100  | 1<br>1<br>1   | 1<br>1  |   |   |   | 2   |   | T0044   |
|                             | TU1JP   | 05/96 → 12/07   |  18,<br>Mot. 3762434   →  | VKPC 83644   |   |   |   |   | 1   |   |   |   |
|   | TU1JP   | 05/96 → 12/07   |  20,<br>→   Mot. 3762433  | VKPC 83205   |   |   |   |   | 1   |   |   |   |
|   | TU1M+   | 05/96 → 12/07   |  | VKPC 83205   |   |   |   |   | 1   |   |   |   |
|                             | B(Alt) TU1JP, TU1M  | 05/96 → 12/07   | 10),    | VKMV 10AVx710  |   |   | 1   |   |   |   |   |   |
|   | B(Alt) TU1JP, TU1M  | 05/96 → 12/07   | AC   | VKMA 33012<br>VKMV 5PK1020<br>VKM 33012  | 1<br>1  | 1<br>1  |   |   |   |   |   |   |
| <b>PEUGEOT  106 II 1.4</b> |   |   |  |  |   |   |   |   |   |   |   |   |
|                             | TU3-2   | 05/96 → 12/07   | 3)   | VKMS 03110-1<br>VKMA 03110<br>VKM 13100  | 1<br>1<br>1   | 1<br>1  |   |   |   | 2   |   | T0044   |
|   | TU3JP   | 05/96 → 12/07   | 3), M, <br>→   Mot. 3666765   | VKMS 03110-1<br>VKMA 03110<br>VKM 13100  | 1<br>1<br>1   | 1<br>1  |   |   |   | 2   |   | T0044   |
|   | TU3JP   | 05/96 → 12/07   | A,  Mot. 3666766   →  | VKMA 03254<br>VKM 13253  | 1<br>1  | 1   |   |   |   |   |   | T0189   |
|                             | TU3-2, TU3JP  | 05/96 → 12/07   |  20,<br>→   Mot. 3666765  | VKPC 83205   |   |   |   |   | 1   |   |   |   |
|   | TU3JP   | 05/96 → 12/07   |  18,<br>Mot. 3666766   →  | VKPC 83644   |   |   |   |   | 1   |   |   |   |
|                             | B(Alt) TU3JP  | 05/96 → 12/07   | 10),    | VKMV 10AVx710  |   |   | 1   |   |   |   |   |   |





































|   |  |  |   |  |  |  |  |  |  |  |  |  |  |
|---|---|---|--|--|---|---|---|---|---|---|---|---|---|
|   | B(Alt) TU3JP  | 05/96 → 12/07   | AC   | VKMA 33012<br>VKMV 5PK1020<br>VKM 33012  | 1   |   | 1   |   |   |   |   |   |   |
| <b>PEUGEOT  106 II 1.6</b>     |   |   |  |  |   |   |   |   |   |   |   |   |   |
|                                | TU5J2, TU5JP  | 05/96 → 12/07   |  | VKMA 03111<br>VKM 13100  | 1   |   | 1   |   |   |   |   |   | T0044   |
|                                | TU5J2, TU5JP  | 05/96 → 12/07   |  | VKPC 83428   |   |   |   |   | 1   |   |   |   |   |
|                                | B(Alt) TU5J2  | 05/96 → 12/07   | AC   | VKMA 33012<br>VKMV 5PK780<br>VKM 33012   | 1   |   | 1   |   |   |   |   |   |   |
|   | B(Alt) TU5J2  | 05/96 → 12/07   | AC   | VKMA 33012<br>VKMV 5PK1050<br>VKM 33012  | 1   |   | 1   |   |   |   |   |   |   |
|   | B(Alt) TU5JP  | 05/96 → 12/07   | AC   | VKMA 33012<br>VKMV 5PK1020<br>VKM 33012  | 1   |   | 1   |   |   |   |   |   |   |
| <b>PEUGEOT  106 II 1.6 16V</b> |   |   |  |  |   |   |   |   |   |   |   |   |   |
|                                | TU5J4   | 05/96 → 12/07   |  | VKMA 03130<br>VKM 13130<br>VKM 23130   | 1   | 1   | 1   |   |   |   |   |   | 2 T0137   |
|                                | TU5J4   | 05/96 → 12/07   |  | VKPC 83430   |   |   |   |   | 1   |   |   |   |   |
|                                | B(Alt) TU5J4  | 05/96 → 12/07   | AC   | VKMA 33012<br>VKMV 5PK780<br>VKM 33012   | 1   |   | 1   |   |   |   |   |   |   |
|   | B(Alt) TU5J4  | 05/96 → 12/07   | AC   | VKMA 33012<br>VKMV 5PK1050<br>VKM 33012  | 1   |   | 1   |   |   |   |   |   |   |
| <b>PEUGEOT  106 II 1.5 D</b>   |   |   |  |  |   |   |   |   |   |   |   |   |   |
|                               | TUD5  | 05/96 → 12/07   |    | VKMC 03121<br>VKMA 03121<br>VKM 13120<br>VKM 23120                                 | 1   | 1   | 1   |   | 1   |   |   |   | 2 T0120   |
|   | TUD5  | 05/96 → 12/07   | 3)   | VKMS 03121<br>VKMA 03121<br>VKM 13120<br>VKM 23120                                 | 1   | 1   | 1   |   |   |   | 2   |   | 2 T0120   |
|   | TUD5B   | 10/00 → 12/07   |  | VKMA 03122<br>VKM 13120<br>VKM 23122   | 1   | 1   | 1   |   |   |   |   |   | T0120   |
|                              | TUD5, TUD5B   | 05/96 → 12/07   |  | VKPC 83428   |   |   |   |   | 1   |   |   |   |   |
|                              | B(Alt) TUD5, TUD5B  | 05/96 → 12/07   |  59.4 mm, AC,  | VKMA 33045<br>VKMV 5PK775<br>VKM 33009   | 1   |   | 1   |   |   |   |   |   |   |
|   | B(Alt) TUD5, TUD5B  | 05/96 → 12/07   |  66 mm, AC,    | VKMA 33046<br>VKMV 5PK960<br>VKM 33039   | 1   |   | 1   |   |   |   |   |   |   |
|   | B(Alt) TUD5, TUD5B  | 05/96 → 12/07   | EHPS, AC,   | VKMA 33046<br>VKMV 5PK960<br>VKM 33039   | 1   |   | 1   |   |   |   |   |   |   |
|   | B(Alt) TUD5, TUD5B  | 05/96 → 12/07   | EHPS, AC,   | VKMA 33046<br>VKMV 5PK960<br>VKM 33039   | 1   |   | 1   |   |   |   |   |   |   |
|   | B(Alt) TUD5, TUD5B  | 05/96 → 12/07   | AC   | VKMA 33023<br>VKMV 5PK1030<br>VKM 33038  | 1   |   | 1   |   |   |   |   |   |   |
|                              | TUD5, TUD5B   | 05/96 → 12/07   |  | VKMA 93305   |   |   |   |   | 1   |   |   |   |   |
| <b>PEUGEOT  107 1.0</b>      |   |   |  |  |   |   |   |   |   |   |   |   |   |
|                              | 1KR-FE  | 06/05 → 12/07   |  | —  |   |   |   |   |   |   |   |   |   |
|                              | 384 F   | 06/05 → 11/07   |  | —  |   |   |   |   | 1   |   |   |   |   |
| <b>PEUGEOT  107 1.4 HDi</b>  |   |   |  |  |   |   |   |   |   |   |   |   |   |
|                              | DV4TD   | 06/05 → 12/07   |  | VKMA 03140<br>VKM 13140<br>VKM 23140   | 1   | 1   | 1   |   |   |   |   |   | T0195   |
|                              | DV4TD   | 06/05 → 11/07   |  | VKPC 83140   |   |   |   |   | 1   |   |   |   |   |
|                              | B(Alt) DV4TD  | 06/05 → 12/07   | AC   | VKMA 33058<br>VKMV 6PK802<br>VKM 33043<br>VKM 33044                                | 1   | 1   | 1   |   |   |   |   |   | 1   |
|   | B(Alt) DV4TD  | 06/05 → 12/07   | AC   | VKMA 33058<br>VKMV 6PK966<br>VKM 33043   | 1   |   | 1   |   |   |   |   |   |   |



PEUGEOT





























| PEUGEOT  204 1.1   |                  |               |   |                |   |  |   |  |  |   |  |  |   |   |  |  |  |       |
|---|------------------|---------------|---|----------------|---|--|---|--|--|---|--|--|---|---|--|--|--|-------|
|                     | XK4, XK5         | 05/69 → 10/77 | Auto.FAN  | VKPC 83203     |   |  |   |  |  |   |  |  |   | 1 |  |  |  |       |
| PEUGEOT  204 1.2 D |                  |               |   |                |   |  |   |  |  |   |  |  |   |   |  |  |  |       |
|                     | XLD              | 01/70 → 05/73 | Auto.FAN  | VKPC 83203     |   |  |   |  |  |   |  |  |   | 1 |  |  |  |       |
| PEUGEOT  205 1.0   |                  |               |   |                |   |  |   |  |  |   |  |  |   |   |  |  |  |       |
|                     | XV8              | 02/83 → 10/87 |   | <b>OXOXOXO</b> |   |  |   |  |  |   |  |  |   |   |  |  |  |       |
|   | TU9              | 10/87 → 09/98 |                    | VKMC 03100     | 1 |  | 1 |  |  | 1 |  |  |   |   |  |  |  | T0044 |
|   |                  |               |   | VKMA 03100     | 1 |  | 1 |  |  |   |  |  |   |   |  |  |  |       |
|   |                  |               |   | VKM 13100      | 1 |  |   |  |  |   |  |  |   |   |  |  |  |       |
|   | TU9              | 10/87 → 09/98 | 3)  | VKMS 03100-1   | 1 |  | 1 |  |  |   |  |  | 2 |   |  |  |  | T0044 |
|   |                  |               |   | VKMA 03100     | 1 |  | 1 |  |  |   |  |  |   |   |  |  |  |       |
|   |                  |               |   | VKM 13100      | 1 |  |   |  |  |   |  |  |   |   |  |  |  |       |
|                     | TU9              | 10/87 → 09/98 |   | VKPC 83205     |   |  |   |  |  | 1 |  |  |   |   |  |  |  |       |
|   | XV8              | 02/83 → 10/87 | 2)  | VKPA 83200     |   |  |   |  |  | 1 |  |  |   |   |  |  |  |       |
|   |                  |               |   | VKPC 83200     |   |  |   |  |  | 1 |  |  |   |   |  |  |  |       |
|                     | B(Alt) TU9       | 10/87 → 09/98 | AC  | VKMOV 10AVx710 |   |  |   |  |  | 1 |  |  |   |   |  |  |  |       |
|   | B(Alt) TU9       | 10/87 → 09/98 | AC  | VKMOV 4PK855   |   |  |   |  |  | 1 |  |  |   |   |  |  |  |       |
|   | B(Alt) XV8       | 02/83 → 10/87 | AC  | VKMOV 10AVx913 |   |  |   |  |  | 1 |  |  |   |   |  |  |  |       |
|   | B(Alt) XV8       | 02/83 → 10/87 | AC  | VKMOV 10AVx925 |   |  |   |  |  | 1 |  |  |   |   |  |  |  |       |
|   | B(AC) TU9        | 10/87 → 09/98 |   | VKMA 33112     | 1 |  | 1 |  |  |   |  |  |   |   |  |  |  |       |
|   |                  |               |   | VKMOV 4PK810   |   |  | 1 |  |  |   |  |  |   |   |  |  |  |       |
|   |                  |               |   | VKM 33012      | 1 |  |   |  |  |   |  |  |   |   |  |  |  |       |
| PEUGEOT  205 1.1   |                  |               |   |                |   |  |   |  |  |   |  |  |   |   |  |  |  |       |
|                     | XW7              | 02/83 → 10/90 |   | <b>OXOXOXO</b> |   |  |   |  |  |   |  |  |   |   |  |  |  |       |
|   | TU1, TU1M        | 10/87 → 09/98 |                   | VKMC 03100     | 1 |  | 1 |  |  | 1 |  |  |   |   |  |  |  | T0044 |
|   |                  |               |   | VKMA 03100     | 1 |  | 1 |  |  |   |  |  |   |   |  |  |  |       |
|   |                  |               |   | VKM 13100      | 1 |  |   |  |  |   |  |  |   |   |  |  |  |       |
|   | TU1, TU1M        | 10/87 → 09/98 | 3)  | VKMS 03100-1   | 1 |  | 1 |  |  |   |  |  | 2 |   |  |  |  | T0044 |
|   |                  |               |   | VKMA 03100     | 1 |  | 1 |  |  |   |  |  |   |   |  |  |  |       |
|   |                  |               |   | VKM 13100      | 1 |  |   |  |  |   |  |  |   |   |  |  |  |       |
|                   | TU1, TU1M        | 10/87 → 09/98 |   | VKPC 83205     |   |  |   |  |  | 1 |  |  |   |   |  |  |  |       |
|   | XW7              | 02/83 → 10/90 | 2)  | VKPA 83200     |   |  |   |  |  | 1 |  |  |   |   |  |  |  |       |
|   |                  |               |   | VKPC 83200     |   |  |   |  |  | 1 |  |  |   |   |  |  |  |       |
|                   | B(Alt) TU1, TU1M | 10/87 → 09/98 | AC  | VKMOV 10AVx710 |   |  |   |  |  | 1 |  |  |   |   |  |  |  |       |
|   | B(Alt) TU1, TU1M | 10/87 → 09/98 | AC  | VKMOV 4PK855   |   |  |   |  |  | 1 |  |  |   |   |  |  |  |       |
|   | B(Alt) XW7       | 02/83 → 10/87 | AC  | VKMOV 10AVx913 |   |  |   |  |  | 1 |  |  |   |   |  |  |  |       |
|   | B(Alt) XW7       | 02/83 → 10/87 | AC  | VKMOV 10AVx925 |   |  |   |  |  | 1 |  |  |   |   |  |  |  |       |
|   | B(AC) TU1, TU1M  | 10/87 → 12/94 |   | VKMA 33112     | 1 |  | 1 |  |  |   |  |  |   |   |  |  |  |       |
|   |                  |               |   | VKMOV 4PK810   |   |  | 1 |  |  |   |  |  |   |   |  |  |  |       |
|   |                  |               |   | VKM 33012      | 1 |  |   |  |  |   |  |  |   |   |  |  |  |       |
|   | B(AC) TU1M       | 07/89 → 09/98 | AC  | VKMA 33112     | 1 |  | 1 |  |  |   |  |  |   |   |  |  |  |       |
|   |                  |               |   | VKMOV 4PK810   |   |  | 1 |  |  |   |  |  |   |   |  |  |  |       |
|   |                  |               |   | VKM 33012      | 1 |  |   |  |  |   |  |  |   |   |  |  |  |       |
| PEUGEOT  205 1.3 |                  |               |   |                |   |  |   |  |  |   |  |  |   |   |  |  |  |       |
|                   | G1               | 02/84 → 10/87 |   | <b>OXOXOXO</b> |   |  |   |  |  |   |  |  |   |   |  |  |  |       |
|   | TU24             | 10/87 → 10/90 |                  | VKMC 03100     | 1 |  | 1 |  |  | 1 |  |  |   |   |  |  |  | T0044 |
|   |                  |               |   | VKMA 03100     | 1 |  | 1 |  |  |   |  |  |   |   |  |  |  |       |
|   |                  |               |   | VKM 13100      | 1 |  |   |  |  |   |  |  |   |   |  |  |  |       |
|   | TU24             | 10/87 → 10/90 | 3)  | VKMS 03100-1   | 1 |  | 1 |  |  |   |  |  | 2 |   |  |  |  | T0044 |
|   |                  |               |   | VKMA 03100     | 1 |  | 1 |  |  |   |  |  |   |   |  |  |  |       |
|   |                  |               |   | VKM 13100      | 1 |  |   |  |  |   |  |  |   |   |  |  |  |       |
|                   | G1               | 02/84 → 10/87 |   | VKPC 83206     |   |  |   |  |  | 1 |  |  |   |   |  |  |  |       |
|   | TU24             | 10/87 → 10/90 |   | VKPC 83205     |   |  |   |  |  | 1 |  |  |   |   |  |  |  |       |
|                   | B(Alt) TU24      | 10/87 → 10/90 | AC  | VKMOV 10AVx710 |   |  |   |  |  | 1 |  |  |   |   |  |  |  |       |
|   | B(Alt) TU24      | 10/87 → 10/90 | AC  | VKMOV 4PK855   |   |  |   |  |  | 1 |  |  |   |   |  |  |  |       |
|   | B(AC) TU24       | 10/87 → 10/90 |   | VKMA 33112     | 1 |  | 1 |  |  |   |  |  |   |   |  |  |  |       |
|   |                  |               |   | VKMOV 4PK810   |   |  | 1 |  |  |   |  |  |   |   |  |  |  |       |
|   |                  |               |   | VKM 33012      | 1 |  |   |  |  |   |  |  |   |   |  |  |  |       |
| PEUGEOT  205 1.4 |                  |               |   |                |   |  |   |  |  |   |  |  |   |   |  |  |  |       |
|                   | XY6B, XY7, XY8   | 02/83 → 05/89 |   | <b>OXOXOXO</b> |   |  |   |  |  |   |  |  |   |   |  |  |  |       |
|   | TU3, TU3-2, TU3M | 06/87 → 09/98 | Mot. Cast.,  101 | VKMA 03111     | 1 |  | 1 |  |  |   |  |  |   |   |  |  |  | T0044 |
|   |                  |               |   | VKM 13100      | 1 |  |   |  |  |   |  |  |   |   |  |  |  |       |

|   |  |  |                     |  |  |  |  |  |  |  |  |  |
|---|---|---|--|--|---|---|---|---|---|---|---|---|
|   | TU3, TU3A, TU3CP,<br>TU3S, TU3-2, TU3M  | 06/87 → 09/98   | 3), Mot. Alu.,  108 | VKMS 03110-1<br>VKMA 03110<br>VKM 13100  | 1<br>1<br>1   | 1<br>1  |   |   |   | 2   |   | T0044   |
|                                    | TU3A, TU3CP, TU3JP,<br>TU3S   | 06/87 → 09/98   |  | VKPC 83205   |   |   |   |   | 1   |   |   |   |
|   | TU3M  | 06/87 → 09/98   | Mot. Cast.   | VKPC 83428   |   |   |   |   | 1   |   |   |   |
|   | TU3M  | 06/87 → 09/98   | Mot. Alu.  | VKPC 83205   |   |   |   |   | 1   |   |   |   |
|   | XY6B, XY7, XY8  | 02/83 → 05/89   | 2)   | VKPA 83200<br>VKPC 83200   |   |   |   |   | 1<br>1  |   |   |   |
|                                    | <b>B(Alt)</b> TU3A, TU3CP, TU3JP,<br>TU3M, TU3S                                   | 06/87 → 09/98   |  AC                 | VKMW 10AVx710  |   |   |   |   | 1   |   |   |   |
|   | <b>B(Alt)</b> TU3A, TU3CP, TU3JP,<br>TU3M, TU3S                                   | 06/87 → 09/98   | AC   | VKMW 4PK855  |   |   |   |   | 1   |   |   |   |
|   | <b>B(Alt)</b> XY6B, XY7, XY8  | 02/83 → 10/87   |  AC                 | VKMW 10AVx913  |   |   |   |   | 1   |   |   |   |
|   | <b>B(Alt)</b> XY6B, XY7, XY8  | 02/83 → 10/87   | AC   | VKMW 10AVx925  |   |   |   |   | 1   |   |   |   |
|   | <b>B(AC)</b> TU3A, TU3CP, TU3JP,<br>TU3M, TU3S                                    | 06/87 → 09/98   |  | VKMA 33112<br>VKMW 4PK810<br>VKM 33012   | 1<br>1  | 1<br>1  |   |   |   |   |   |   |
| <b>PEUGEOT</b>  <b>205 1.6</b>     |   |   |  |  |   |   |   |   |   |   |   |   |
|                                    | XU51C, XU5CP, XU5J,<br>XU5M2Z, XU5M3Z   | 12/84 → 01/92   |  113                | VKMA 03200<br>VKM 13200  | 1<br>1  | 1   |   |   |   |   |   | T0018   |
|   | XU51C, XU5CP, XU5M2Z,<br>XU5M3Z   | 02/92 → 09/98   |  114                | VKMA 03201<br>VKM 13100  | 1<br>1  | 1   |   |   |   |   |   | T0018   |
|                                  | XU5   | 12/84 → 01/92   |  | VKPC 83401   |   |   |   |   | 1   |   |   |   |
|   | XU5   | 01/92 → 09/98   |  | VKPC 83615   |   |   |   |   | 1   |   |   |   |
|                                  | <b>B(Alt)</b> XU51C, XU5CP, XU5J,<br>XU5M2Z, XU5M3Z                               | 12/84 → 09/98   |  ⌀                | VKMW 4PK698  |   |   |   |   | 1   |   |   |   |
|   | <b>B(Alt)</b> XU51C, XU5CP, XU5J,<br>XU5M2Z, XU5M3Z                               | 12/84 → 09/98   |  ⌀                | VKMW 4PK954  |   |   |   |   | 1   |   |   |   |
|   | <b>B(AC)</b> XU51C, XU5CP, XU5J,<br>XU5M2Z, XU5M3Z                                | 12/84 → 09/98   |  | VKMA 33010<br>VKMW 4PK841<br>VKM 33010   | 1<br>1  | 1<br>1  |   |   |   |   |   |   |
| <b>PEUGEOT</b>  <b>205 1.9</b>   |   |   |  |  |   |   |   |   |   |   |   |   |
|                                  | XU92C, XU9J1, XU9JA,<br>XU9JAZ  | 10/86 → 10/94   |  113              | VKMA 03200<br>VKM 13200  | 1<br>1  | 1   |   |   |   |   |   | T0018   |
|   | XU9J1, XU9JA, XU9JAZ  | 01/92 → 09/98   |  114              | VKMA 03201<br>VKM 13100  | 1<br>1  | 1   |   |   |   |   |   | T0018   |
|                                  | XU92C, XU9J1, XU9JA,<br>XU9JAZ  | 10/86 → 01/92   |  | VKPC 83401   |   |   |   |   | 1   |   |   |   |
|   | XU9J1, XU9JA, XU9JAZ  | 01/92 → 09/98   |  | VKPC 83615   |   |   |   |   | 1   |   |   |   |
|                                  | <b>B(Alt)</b> XU92C, XU9J1, XU9JA,<br>XU9JAZ                                      | 10/86 → 09/98   |  ⌀                | VKMW 4PK698  |   |   |   |   | 1   |   |   |   |
|   | <b>B(Alt)</b> XU92C, XU9J1, XU9JA,<br>XU9JAZ                                      | 10/86 → 09/98   |  ⌀                | VKMW 4PK954  |   |   |   |   | 1   |   |   |   |
|   | <b>B(AC)</b> XU92C, XU9J1, XU9JA,<br>XU9JAZ                                       | 10/86 → 09/98   |  | VKMA 33010<br>VKMW 4PK841<br>VKM 33010   | 1<br>1  | 1<br>1  |   |   |   |   |   |   |
| <b>PEUGEOT</b>  <b>205 1.8 D</b> |   |   |  |  |   |   |   |   |   |   |   |   |
|                                  | XUD7  | 10/86 → 01/94   |  ⌀                | VKMC 03240<br>VKMA 03240<br>VKM 13240<br>VKM 23240                                 | 1<br>1<br>1   | 1<br>1<br>1   |   |   | 1   |   |   | 2<br>2<br>T0017   |
|   | XUD7  | 01/94 → 05/04   |  ⌀                | VKMC 03241<br>VKMA 03241<br>VKM 13241<br>VKM 23241                                 | 1<br>1<br>1   | 1<br>1<br>1   |   |   | 1   |   |   | T0017   |
|   | XUD7  | 08/83 → 01/94   | 3)   | VKMS 03240<br>VKMA 03240   | 1<br>1  | 1<br>1  |   |   |   | 2<br>2  |   | 2<br>2<br>T0017   |



PEUGEOT

|  |  |  |    |  |  |  |  |  |  |  |  |  |
|--|---|---|---|--|---|---|---|---|---|---|---|---|
|  |   |   |   | VKM 13240<br>VKM 23240   | 1   | 1   |   |   |   |   |   |   |
|  | XUD7  | 01/94 → 05/04   | 3)  | VKMS 03241<br>VKMA 03241<br>VKM 13241<br>VKM 23241                                 | 1<br>1<br>1   | 1<br>1<br>1   |   |   |   | 2   |   | T0017   |
|                              | XUD7  | 08/83 → 10/86   |   | VKPC 83401   |   |   |   | 1   |   |   |   |   |
|  | XUD7  | 10/86 → 01/94   |   | VKPC 83424   |   |   |   | 1   |   |   |   |   |
|  | XUD7  | 01/94 → 12/04   |   | VKPC 83420   |   |   |   | 1   |   |   |   |   |
|                              | B(Alt) XUD7   | 08/83 → 10/87   | 33), AC   | VKMOV _____  |   |   | 1   |   |   |   |   |   |
|  | B(Alt) XUD7   | 08/83 → 09/05   | 34), AC   | VKMOV 4PK698   |   |   | 1   |   |   |   |   |   |
|  | B(Alt) XUD7   | 08/83 → 10/87   | AC  | VKMOV 4PK1230<br>VKM 33010<br>VKM 33091  | 1   | 1   |   |   |   |   |   |   |
|  | B(Alt) XUD7   | 07/87 → 09/05   | ES, AC  | VKMA 33106<br>VKMV 4PK1230<br>VKM 33006<br>VKM 33010                               | 1<br>1<br>1   | 1<br>1  |   |   |   |   |   |   |
|  | B(Alt) XUD7   | 03/94 → 12/97   | ES, AC  | VKM 33006  | 1   | 1   |   |   |   |   |   |   |
|  | B(PS) XUD7  | 08/83 → 10/87   |   | VKMOV 10AVx613   |   |   | 1   |   |   |   |   |   |
|  | B(VP) XUD7  | 08/83 → 09/98   |   | VKMOV 10AVx550   |   |   | 1   |   |   |   |   |   |
|                              | XUD7  | 08/83 → 07/06   |   | —  |   |   |   |   | 1   |   |   |   |
| <b>PEUGEOT  205 1.8 TD</b>  |   |   |   |  |   |   |   |   |   |   |   |   |
|                              | XUD7TE  | 01/90 → 01/94   |    | VKMC 03240<br>VKMA 03240<br>VKM 13240<br>VKM 23240                                 | 1<br>1<br>1   | 1<br>1<br>1   |   | 1   |   |   | 2   | T0017   |
|  | XUD7TE  | 01/90 → 01/94   | 3)  | VKMS 03240<br>VKMA 03240<br>VKM 13240<br>VKM 23240                                 | 1<br>1<br>1   | 1<br>1<br>1   |   |   |   | 2   | 2   | T0017   |
|  | XUD7TE  | 01/94 → 09/98   |  | VKMC 03241<br>VKMA 03241<br>VKM 13241<br>VKM 23241                                 | 1<br>1<br>1   | 1<br>1<br>1   |   | 1   |   |   |   | T0017   |
|  | XUD7TE  | 01/94 → 09/98   | 3)  | VKMS 03241<br>VKMA 03241<br>VKM 13241<br>VKM 23241                                 | 1<br>1<br>1   | 1<br>1<br>1   |   |   |   | 2   |   | T0017   |
|                            | XUD7TE  | 01/90 → 01/94   |   | VKPC 83424   |   |   |   | 1   |   |   |   |   |
|  | XUD7TE  | 01/94 → 09/98   |   | VKPC 83420   |   |   |   | 1   |   |   |   |   |
|                            | B(Alt) XUD7TE   | 01/90 → 12/97   | ES, AC  | VKM 33010  | 1   |   |   |   |   |   |   |   |
|  | B(Alt) XUD7TE   | 01/90 → 09/98   | AC  | VKMOV 4PK720<br>VKM 33082  | 1   |   | 1   |   |   |   |   |   |
| <b>PEUGEOT  205 1.9 D</b> |   |   |   |  |   |   |   |   |   |   |   |   |
|                            | XUD9Y   | 10/87 → 01/94   |  | VKMC 03240<br>VKMA 03240<br>VKM 13240<br>VKM 23240                                 | 1<br>1<br>1   | 1<br>1<br>1   |   | 1   |   |   | 2   | T0017   |
|  | XUD9Y   | 10/87 → 01/94   | 3)  | VKMS 03240<br>VKMA 03240<br>VKM 13240<br>VKM 23240                                 | 1<br>1<br>1   | 1<br>1<br>1   |   |   |   | 2   | 2   | T0017   |
|  | XUD9Y   | 01/94 → 09/98   |  | VKMC 03241<br>VKMA 03241<br>VKM 13241<br>VKM 23241                                 | 1<br>1<br>1   | 1<br>1<br>1   |   | 1   |   |   |   | T0017   |
|  | XUD9Y   | 01/94 → 09/98   | 3)  | VKMS 03241<br>VKMA 03241<br>VKM 13241<br>VKM 23241                                 | 1<br>1<br>1   | 1<br>1<br>1   |   |   |   | 2   |   | T0017   |
|                            | XUD9  | 10/87 → 01/94   |   | VKPC 83424   |   |   |   | 1   |   |   |   |   |
|  | XUD9  | 01/94 → 09/98   |   | VKPC 83420   |   |   |   | 1   |   |   |   |   |
|                            | B(Alt) XUD9Y  | 10/87 → 09/98   | 34), AC   | VKMOV 4PK698   |   |   | 1   |   |   |   |   |   |
|  | B(Alt) XUD9Y  | 10/87 → 09/98   | ES  | VKMA 33106<br>VKMV 4PK1230   | 1   | 1   | 1   |   |   |   |   |   |



|  |  |  |  |           |  |   |  |  |  |  |  |  |  |  |  |
|--|--|--|--|-----------|--|---|--|--|--|--|--|--|--|--|--|
|  |  |  |  | VKM 33006 |  | 1 |  |  |  |  |  |  |  |  |  |
|  |  |  |  | VKM 33010 |  | 1 |  |  |  |  |  |  |  |  |  |

**PEUGEOT** **206 1.1**

|  |              |               |                            |  |             |  |   |   |   |  |  |  |   |   |  |       |
|--|--------------|---------------|----------------------------|--|-------------|--|---|---|---|--|--|--|---|---|--|-------|
|  | TU1JP        | 09/98 → 12/07 | M, ⊕<br>→ IMot. 3762433    | VKMC 03100<br>VKMA 03100<br>VKM 13100                | 1<br>1<br>1 |  | 1 |   | 1 |  |  |  |   |   |  | T0044 |
|  | TU1JP        | 09/98 → 12/07 | 3), M ⊕<br>→ IMot. 3762433 | VKMS 03100-1<br>VKMA 03100<br>VKM 13100              | 1<br>1<br>1 |  | 1 |   | 1 |  |  |  | 2 |   |  | T0044 |
|  | TU1JP        | 09/98 → 12/07 | A ⊕, Mot. 3762434   →      | VKMA 03253<br>VKM 13253                              | 1<br>1      |  | 1 |   |   |  |  |  |   |   |  | T0188 |
|  | TU1JP        | 09/98 → 12/07 | 20,<br>→ IMot. 3762433     | VKPC 83205   |             |  |   |   |   |  |  |  | 1 |   |  |       |
|  | TU1JP        | 09/98 → 12/07 | 18,<br>Mot. 3762434   →    | VKPC 83644   |             |  |   |   |   |  |  |  |   | 1 |  |       |
|  | B(Alt) TU1JP | 09/98 → 07/02 | AC, ⊕                      | VKMV 10AVx710  |             |  |   |   | 1 |  |  |  |   |   |  |       |
|  | B(Alt) TU1JP | 07/02 → 12/07 | AC, ⊕                      | VKMV 6PK733  |             |  |   |   | 1 |  |  |  |   |   |  |       |
|  | B(Alt) TU1JP | 09/98 → 12/07 | AC, ⊕                      | VKMA 33025<br>VKMV 6PK1010<br>VKM 33018              |             |  |   | 1 | 1 |  |  |  |   |   |  |       |
|  | B(Alt) TU1JP | 09/98 → 12/07 | AC, ⊕                      | VKMA 33024<br>VKMV 6PK1451<br>VKM 33018              |             |  |   | 1 | 1 |  |  |  |   |   |  |       |
|  | B(Alt) TU1JP | 09/98 → 04/02 | AC, ⊕                      | VKMA 33026<br>VKMV 6PK1564<br>VKM 33023<br>VKM 33037 | 1<br>1<br>1 |  | 1 |   | 1 |  |  |  |   |   |  |       |
|  | B(Alt) TU1JP | 04/02 → 12/07 | AC, ⊕                      | VKMV 6PK1560<br>VKM 33100<br>VKM 33101               |             |  |   | 1 | 1 |  |  |  |   |   |  |       |



























**PEUGEOT** **206 1.4**

|  |              |               |                            |  |             |  |   |   |   |  |  |  |   |   |  |       |
|--|--------------|---------------|----------------------------|--|-------------|--|---|---|---|--|--|--|---|---|--|-------|
|  | TU3JP        | 09/98 → 12/07 | 3), M ⊕<br>→ IMot. 3666765 | VKMS 03110-1<br>VKMA 03110<br>VKM 13100              | 1<br>1<br>1 |  | 1 |   |   |  |  |  | 2 |   |  | T0044 |
|  | TU3JP        | 09/98 → 12/07 | A ⊕, Mot. 3666766   →      | VKMA 03254<br>VKM 13253                              | 1<br>1      |  | 1 |   |   |  |  |  |   |   |  | T0189 |
|  | TU3JP        | 09/98 → 12/07 | 20,<br>→ IMot. 3666765     | VKPC 83205   |             |  |   |   |   |  |  |  | 1 |   |  |       |
|  | TU3JP        | 09/98 → 12/07 | 18,<br>Mot. 3666766   →    | VKPC 83644   |             |  |   |   |   |  |  |  |   | 1 |  |       |
|  | B(Alt) TU3JP | 09/98 → 07/02 | AC, ⊕                      | VKMV 10AVx710  |             |  |   |   | 1 |  |  |  |   |   |  |       |
|  | B(Alt) TU3JP | 07/02 → 12/07 | AC, ⊕                      | VKMV 6PK733  |             |  |   |   | 1 |  |  |  |   |   |  |       |
|  | B(Alt) TU3JP | 09/98 → 12/07 | AC, ⊕                      | VKMA 33025<br>VKMV 6PK1010<br>VKM 33018              |             |  |   | 1 | 1 |  |  |  |   |   |  |       |
|  | B(Alt) TU3JP | 09/98 → 12/07 | AC, ⊕                      | VKMA 33024<br>VKMV 6PK1451<br>VKM 33018              |             |  |   | 1 | 1 |  |  |  |   |   |  |       |
|  | B(Alt) TU3JP | 09/98 → 04/02 | AC, ⊕                      | VKMA 33026<br>VKMV 6PK1564<br>VKM 33023<br>VKM 33037 | 1<br>1<br>1 |  | 1 |   | 1 |  |  |  |   |   |  |       |
|  | B(Alt) TU3JP | 04/02 → 12/07 | AC, ⊕                      | VKMV 6PK1560<br>VKM 33100<br>VKM 33101               |             |  |   | 1 | 1 |  |  |  |   |   |  |       |

































**PEUGEOT** **206 1.4 16V**

|  |       |               |  |                                      |             |  |   |  |   |  |  |  |   |  |  |       |
|--|-------|---------------|--|--------------------------------------|-------------|--|---|--|---|--|--|--|---|--|--|-------|
|  | ET3J4 | 10/03 → 12/07 |  | VKMA 03258<br>VKM 13258<br>VKM 23258 | 1<br>1<br>1 |  | 1 |  | 1 |  |  |  |   |  |  | T0209 |
|  | ET3J4 | 10/03 → 12/07 |  | VKPC 83258                           |             |  |   |  |   |  |  |  | 1 |  |  |       |









































|  |  |  |  |  |  |  |  |  |  |  |  |  |
|--|---|---|---|--|---|---|---|---|---|---|---|---|
|                                | B(Alt)  | ET3J4   | 10/03 → 12/07   | AC   | VKM 33100<br>VKM_____   | 1   | 1   |   |   |   |   |   |
|  | B(Alt)  | ET3J4   | 10/03 → 12/07   | AC   | VKMV 6PK1564<br>VKM 33100<br>VKM_____   | 1   | 1   |   |   |   |   |   |
| <b>PEUGEOT  206 1.6</b>       |   |   |   |  |   |   |   |   |   |   |   |   |
|                                |   | TU5JP   | 09/98 → 12/00   |  | VKMA 03111<br>VKM 13100   | 1   | 1   |   |   |   |   | T0044   |
|                                |   | TU5JP   | 09/98 → 12/00   |  | VKPC 83428  |   |   |   | 1   |   |   |   |
|                                | B(Alt)  | TU5JP   | 09/98 → 12/00   | AC, ⊗  | VKMA 33025<br>VKMV 6PK1010<br>VKM 33018   |   | 1   | 1   |   |   |   |   |
|  | B(Alt)  | TU5JP   | 09/98 → 12/00   | AC, ⊗  | VKMA 33024<br>VKMV 6PK1451<br>VKM 33018   |   | 1   | 1   |   |   |   |   |
|  | B(Alt)  | TU5JP   | 09/98 → 12/00   | AC, ⊗  | VKMA 33026<br>VKMV 6PK1564<br>VKM 33023<br>VKM 33037                                | 1   | 1   | 1   |   |   |   |   |
| <b>PEUGEOT  206 1.6 16V</b>   |   |   |   |  |   |   |   |   |   |   |   |   |
|                                |   | TU5JP4  | 09/00 → 12/07   | →   Mot. 1806404   | VKMA 03132<br>VKM 13132<br>VKM 23130  | 1   | 1   | 1   |   |   |   | 1 T0193   |
|  |   | TU5JP4  | 09/00 → 12/07   | Mot. 1806405   →   | VKMA 03256<br>VKM 13256<br>VKM 23256  | 1   | 1   | 1   |   |   |   | 1 T0193   |
|                              |   | TU5JP4  | 09/00 → 12/07   | <del>ARG</del> <del>BR</del>   | VKPC 83430  |   |   |   | 1   |   |   |   |
|  |   | TU5JP4  | 09/00 → 12/07   | <del>ARG</del> <del>BR</del>   | —   |   |   |   | 1   |   |   |   |
|                              | B(Alt)  | TU5JP4  | 09/00 → 12/07   | AC, ⊗  | VKMA 33024<br>VKMV 6PK1451<br>VKM 33018   |   | 1   | 1   |   |   |   |   |
|  | B(Alt)  | TU5JP4  | 12/00 → 12/07   | AC, ⊗  | VKMA 33025<br>VKMV 6PK1010<br>VKM 33018   |   | 1   | 1   |   |   |   |   |
|  | B(Alt)  | TU5JP4  | 09/00 → 04/02   | AC, ⊗  | VKMA 33026<br>VKMV 6PK1564<br>VKM 33023<br>VKM 33037                                | 1   | 1   | 1   |   |   |   |   |
|  | B(Alt)  | TU5JP4  | 04/02 → 12/07   | AC, ⊗  | VKMV 6PK1560<br>VKM 33100<br>VKM 33101  |   | 1   | 1   |   |   |   |   |
| <b>PEUGEOT  206 2.0 S16</b> |   |   |   |  |   |   |   |   |   |   |   |   |
|                              |   | EW10J4  | 04/99 → 12/07   |  | VKMA 03235<br>VKM 13234<br>VKM 23230  | 1   | 1   | 1   |   |   |   | T0169   |
|                              |   | EW10J4  | 04/99 → 12/07   | 16)  | VKPC 83650  |   |   |   | 1   |   |   |   |
|                              | B(Alt)  | EW10J4  | 04/99 → 12/04   | AC   | VKMA 33019<br>VKMV 6PK1205<br>VKM 33019<br>VKM 33020                                | 1   | 1   | 1   |   |   |   |   |
|  | B(Alt)  | EW10J4  | 04/99 → 12/04   | AC   | VKMA 33020<br>VKMV 6PK1726<br>VKM 33019<br>VKM 33020                                | 1   | 1   | 1   |   |   |   |   |
|  | B(Alt)  | EW10J4  | 12/04 → 12/07   | AC   | VKMV 6PK1205<br>VKM 33019<br>VKM_____   | 1   |   | 1   |   |   |   |   |
|  | B(Alt)  | EW10J4  | 12/04 → 12/07   | AC   | VKMV 6PK1726<br>VKM 33019<br>VKM_____   | 1   |   | 1   |   |   |   |   |
| <b>PEUGEOT  206 2.0 RC</b>  |   |   |   |  |   |   |   |   |   |   |   |   |
|                              |   | EW10J4S   | 07/03 → 12/07   |  | VKMA 03260<br>VKM 13234<br>VKM 23230  | 1   | 1   | 1   |   |   |   | T0169   |



|   |  |  |                    |  |  |  |  |  |  |  |  |  |
|---|---|---|---|--|---|---|---|---|---|---|---|---|
|                                      | EW10J4S   | 07/03 → 12/07   | 16)   | VKPC 83650   |   |   |   | 1   |   |   |   |   |
|                                      | <b>B(Alt)</b> EW10J4S   | 07/03 → 12/04   | <del>AC</del>   | VKMOV 6PK1205<br>VKM 33020<br>VKM 33063  | 1   | 1   | 1   |   |   |   |   |   |
|   | <b>B(Alt)</b> EW10J4S   | 07/03 → 12/04   | AC  | VKMOV 6PK1726<br>VKM 33020<br>VKM 33063  | 1   | 1   | 1   |   |   |   |   |   |
|   | <b>B(Alt)</b> EW10J4S   | 12/04 → 12/07   | <del>AC</del>   | VKMOV 6PK1205<br>VKM _____<br>VKM 33063  | 1   | 1   | 1   |   |   |   |   |   |
|   | <b>B(Alt)</b> EW10J4S   | 12/04 → 12/07   | AC  | VKMOV 6PK1726<br>VKM _____<br>VKM 33063  | 1   | 1   | 1   |   |   |   |   |   |
| <b>PEUGEOT</b>  <b>206 1.4 HDi</b>   |   |   |   |  |   |   |   |   |   |   |   |   |
|                                      | DV4TD   | 09/01 → 12/07   |   | VKMA 03140<br>VKM 13140<br>VKM 23140   | 1<br>1  | 1<br>1  | 1   |   |   |   |   | T0195   |
|                                      | DV4TD   | 09/01 → 12/07   |   | VKPC 83140   |   |   |   | 1   |   |   |   |   |
|                                      | <b>B(Alt)</b> DV4TD   | 09/01 → 12/07   | <del>AC</del>   | VKMA 33060<br>VKMOV 6PK1341<br>VKM 33060<br>VKM 33060<br>VKM 33061                 | 1<br>1<br>1<br>1  | 2<br>1  | 1<br>1  |   |   |   | 1<br>1  |   |
|   | <b>B(Alt)</b> DV4TD   | 09/01 → 12/07   | AC  | VKMA 33061<br>VKMOV 6PK1705<br>VKM 33044<br>VKM 33061                              | 1<br>1<br>1   | 1<br>1  | 1<br>1  |   |   |   | 1   |   |
| <b>PEUGEOT</b>  <b>206 1.6 Hdi</b> |   |   |   |  |   |   |   |   |   |   |   |   |
|                                    | DV6TED4   | 05/04 → 12/07   |   | VKMA 03259<br>VKM 13140<br>VKM 23140   | 1<br>1  | 1<br>1  | 1   |   |   |   |   | T0195   |
|                                    | DV6TED4   | 05/04 → 12/07   |   | VKPC 83259   |   |   |   | 1   |   |   |   |   |
|                                    | <b>B(Alt)</b> DV6TED4   | 05/04 → 12/07   | <del>AC</del>   | VKMA 33058<br>VKMOV 6PK802<br>VKM 33043<br>VKM 33044                               | 1<br>1  | 1<br>1  | 1<br>1  |   |   |   | 1   |   |
|   | <b>B(Alt)</b> DV6TED4   | 05/04 → 12/07   | AC  | VKMA 33043<br>VKMOV 6PK976<br>VKM 33043  | 1<br>1  | 1   | 1<br>1  |   |   |   |   |   |
| <b>PEUGEOT</b>  <b>206 1.9 D</b>   |   |   |   |  |   |   |   |   |   |   |   |   |
|                                    | DW8, DW8B   | 09/98 → 11/01   |                  | VKMC 03244<br>VKMA 03244<br>VKM 13244<br>VKM 23246                                 | 1<br>1<br>1   | 1<br>1<br>1   | 1   | 1   |   |   | 1<br>1<br>1   | T0167   |
|                                    | DW8, DW8B   | 09/98 → 11/01   |   | VKPC 83639   |   |   |   | 1   |   |   |   |   |
|                                    | <b>B(Alt)</b> DW8, DW8B   | 09/98 → 11/01   | <del>AC</del> ,  | VKMOV 6PK866<br>VKM 33004  | 1   |   | 1   |   |   |   |   |   |
|   | <b>B(Alt)</b> DW8, DW8B   | 09/98 → 11/01   | AC,              | VKMOV 6PK1030<br>VKM 33004   | 1   |   | 1   |   |   |   |   |   |
|   | <b>B(Alt)</b> DW8, DW8B   | 09/98 → 09/99   | <del>AC</del> ,  | VKMA 33021<br>VKMOV 6PK1388<br>VKM 33017<br>VKM 33017<br>VKM 33042                 | 1<br>1<br>1<br>1  | 2<br>1<br>1   | 1<br>1  |   |   |   |   |   |
|   | <b>B(Alt)</b> DW8, DW8B   | 09/99 → 11/01   | <del>AC</del> ,  | VKMA 33027<br>VKMOV 6PK1437<br>VKM 33017<br>VKM 33031<br>VKM 33032                 | 1<br>1<br>1<br>1  | 2<br>1<br>1   | 1<br>1  |   |   |   |   |   |
|   | <b>B(Alt)</b> DW8, DW8B   | 09/98 → 11/01   | AC,              | VKMOV 6PK1736<br>VKM 33013<br>VKM 33029<br>VKM 33311                               | 1<br>1  |   | 1   |   |   |   | 1   |   |
|                                    | DW8, DW8B   | 09/98 → 11/01   | AC  | VKM 93301  |   |   |   |   |   |   | 1<br>1  |   |



PEUGEOT













|  |  |  |  |  |  |  |  |  |  |  |  |
|--|---|---|---|--|---|---|---|---|---|---|---|
| <b>PEUGEOT  206 2.0 HDi</b>                           |   |   |   |  |   |   |   |   |   |   |   |
|    | DW10TD  | 12/99 → 10/00   |  | VKMC 03246<br>VKMA 03246<br>VKM 13246<br>VKM 23246                                 | 1<br>1<br>1<br>1  | 1<br>1<br>1<br>1  | 1<br>1<br>1<br>1  | 1<br>1<br>1<br>1  |   |   | T0168   |
|  | DW10TD  | 12/99 → 10/00   | 3)  | VKMS 03246<br>VKMA 03246<br>VKM 13246<br>VKM 23246                                 | 1<br>1<br>1<br>1  | 1<br>1<br>1<br>1  | 1<br>1<br>1<br>1  |   | 2   |   | T0168   |
|  | DW10TD  | 10/00 → 12/07   |  | VKMC 03247<br>VKMA 03247<br>VKM 13244<br>VKM 23246                                 | 1<br>1<br>1<br>1  | 1<br>1<br>1<br>1  | 1<br>1<br>1<br>1  |   |   |   | T0168   |
|    | DW10TD  | 12/99 → 12/07   |   | VKPC 83639   |   |   |   | 1   |   |   |   |
|    | <b>B(Alt)</b> DW10TD  | 12/99 → 12/07   | <b>AC</b>   | VKMA 33044<br>VKMV 6PK1468<br>VKM 33024<br>VKM 33033<br>VKM 33069                  | 2<br>1<br>1<br>1<br>1   | 1<br>1<br>1<br>1<br>1   | 1<br>1<br>1<br>1<br>1   |   |   |   |   |
|  | <b>B(Alt)</b> DW10TD  | 12/99 → 07/02   | <b>AC</b>   | VKMV 6PK1740<br>VKM 33013<br>VKM 33033   | 1<br>1<br>1   |   | 1<br>1<br>1   |   |   |   |   |
|  | <b>B(Alt)</b> DW10TD  | 07/02 → 12/07   | <b>AC</b>   | VKMV 6PK1744<br>VKM 33013<br>VKM 33033   | 1<br>1<br>1   |   | 1<br>1<br>1   |   |   |   |   |
|    | DW10TD  | 12/99 → 06/02   |   | VKM 93301  |   |   |   | 1   |   |   |   |
|  | DW10TD  | 06/02 → 12/07   |   | VKM_____   |   |   |   | 1   |   |   |   |
| <b>PEUGEOT  207 / 207 CC / 207 SW 1.4</b>           |   |   |   |  |   |   |   |   |   |   |   |
|    | TU3A  | 02/06 → 12/07   |   | VKMA 03254<br>VKM 13253  | 1<br>1  | 1<br>1  | 1<br>1  |   |   |   | T0189   |
|    | TU3A  | 02/06 → 12/07   |   | VKPC 83644   |   |   |   | 1   |   |   |   |
|    | <b>B(Alt)</b> TU3A  | 02/06 → 12/07   | <b>AC</b>   | VKMV 6PK728  |   |   | 1   |   |   |   |   |
|  | <b>B(Alt)</b> TU3A  | 02/06 → 12/07   | <b>AC</b>   | VKMV 6PK1049<br>VKM 33074  | 1   |   | 1   |   |   |   |   |
| <b>PEUGEOT  207 / 207 CC / 207 SW 1.4 16V</b>       |   |   |   |  |   |   |   |   |   |   |   |
|    | EP3   | 02/06 → 12/07   |   | <b>ΟΧΛΟΧΩ</b>  |   |   |   |   |   |   |   |
|  | ET3J4   | 02/06 → 12/07   |   | VKMA 03258<br>VKM 13258<br>VKM 23258   | 1<br>1<br>1   | 1<br>1<br>1   | 1<br>1<br>1   |   |   |   | T0209   |
|    | EP3   | 02/06 → 12/07   |   | —  |   |   |   | 1   |   |   | 1   |
|  | ET3J4   | 02/06 → 12/07   |   | VKPC 83258   |   |   |   | 1   |   |   |   |
|    | <b>B(Alt)</b> ET3J4   | 02/06 → 12/07   | <b>AC</b>   | VKMV 6PK728  |   |   | 1   |   |   |   |   |
|  | <b>B(Alt)</b> ET3J4   | 02/06 → 12/07   | <b>AC</b>   | VKMV 6PK1049<br>VKM 33074  | 1   |   | 1   |   |   |   |   |
| <b>PEUGEOT  207 / 207 CC / 207 SW 1.6 16V</b>       |   |   |   |  |   |   |   |   |   |   |   |
|    | EP6   | 02/07 → 12/07   |   | <b>ΟΧΛΟΧΩ</b>  |   |   |   |   |   |   |   |
|  | TU5JP4  | 02/06 → 12/07   |   | VKMA 03256<br>VKM 13256<br>VKM 23256   | 1<br>1<br>1   | 1<br>1<br>1   | 1<br>1<br>1   |   |   |   | T0193   |
|    | EP6   | 02/07 → 12/07   |   | —  |   |   |   | 1   |   |   | 1   |
|  | TU5JP4  | 02/06 → 12/07   |   | VKPC 83430   |   |   |   | 1   |   |   |   |
|    | <b>B(Alt)</b> TU5JP4  | 02/06 → 12/07   |   | VKMV 6PK1049<br>VKM 33074  | 1   |   | 1   |   |   |   |   |
| <b>PEUGEOT  207 / 207 CC / 207 SW 1.6 16V RC</b>    |   |   |   |  |   |   |   |   |   |   |   |
|    | EP6DTS  | 02/07 → 12/07   |   | <b>ΟΧΛΟΧΩ</b>  |   |   |   |   |   |   |   |
|    | EP6DTS  | 02/07 → 12/07   |   | —  |   |   |   | 1   |   |   | 1   |
| <b>PEUGEOT  207 / 207 CC / 207 SW 1.6 16V Turbo</b> |   |   |   |  |   |   |   |   |   |   |   |
|    | EP6DT   | 02/06 → 12/07   |   | <b>ΟΧΛΟΧΩ</b>  |   |   |   |   |   |   |   |
|    | EP6DT   | 02/06 → 12/07   |   | —  |   |   |   | 1   |   |   | 1   |
| <b>PEUGEOT  207 / 207 CC / 207 SW 1.6 16V VTi</b>   |   |   |   |  |   |   |   |   |   |   |   |
|    | EP6   | 02/07 → 12/07   |   | <b>ΟΧΛΟΧΩ</b>  |   |   |   |   |   |   |   |
|    | EP6   | 02/07 → 12/07   |   | —  |   |   |   | 1   |   |   | 1   |

| <b>PEUGEOT</b> <b>207 / 207 CC / 207 SW 1.4 HDi</b> |                          |               |          |               |   |   |   |   |  |   |       |
|---|--------------------------|---------------|----------|---------------|---|---|---|---|--|---|-------|
|   | DV4TD                    | 02/06 → 12/07 |          | VKMA 03140    | 1 | 1 | 1 |   |  |   | T0195 |
|   |                          |               |          | VKM 13140     | 1 |   |   |   |  |   |       |
|   |                          |               |          | VKM 23140     |   | 1 |   |   |  |   |       |
|   | DV4TD                    | 02/06 → 12/07 |          | VKPC 83140    |   |   |   | 1 |  |   |       |
|   | B(Alt) DV4TD             | 02/06 → 12/07 | AC       | VKM ____      |   | 1 |   |   |  |   |       |
| <b>PEUGEOT</b> <b>207 / 207 CC / 207 SW 1.6 HDi</b> |                          |               |          |               |   |   |   |   |  |   |       |
|   | DV6ATED4, DV6TED4        | 02/06 → 12/07 |          | VKMA 03259    | 1 | 1 | 1 |   |  |   | T0195 |
|   |                          |               |          | VKM 13140     | 1 |   |   |   |  |   |       |
|   |                          |               |          | VKM 23140     |   | 1 |   |   |  |   |       |
|   | DV6ATED4, DV6TED4        | 02/06 → 12/07 |          | VKPC 83259    |   |   |   | 1 |  |   |       |
|   | B(Alt) DV6ATED4, DV6TED4 | 02/06 → 12/07 | AC       | VKM ____      |   | 1 |   |   |  |   |       |
| <b>PEUGEOT</b> <b>304 1.1</b>                       |                          |               |          |               |   |   |   |   |  |   |       |
|   | XK5                      | 10/76 → 10/80 | Auto.FAN | VKPC 83203    |   |   |   | 1 |  |   |       |
| <b>PEUGEOT</b> <b>304 1.3</b>                       |                          |               |          |               |   |   |   |   |  |   |       |
|   | XL3, XL3S, XL5, XL5S     | 01/70 → 10/80 | Auto.FAN | VKPC 83203    |   |   |   | 1 |  |   |       |
| <b>PEUGEOT</b> <b>304 1.4 D</b>                     |                          |               |          |               |   |   |   |   |  |   |       |
|   | XL4D                     | 10/76 → 10/79 |          | οχι οχι οχι   |   |   |   |   |  |   |       |
|   | XL4D                     | 10/76 → 10/79 | Auto.FAN | VKPC 83203    |   |   |   | 1 |  |   |       |
| <b>PEUGEOT</b> <b>305 1.3</b>                       |                          |               |          |               |   |   |   |   |  |   |       |
|   | 118 XL5, XL5             | 11/77 → 08/86 | Auto.FAN | VKPC 83203    |   |   |   | 1 |  |   |       |
| <b>PEUGEOT</b> <b>305 1.5</b>                       |                          |               |          |               |   |   |   |   |  |   |       |
|   | XR5, XR5A, XR5S          | 11/79 → 07/90 | Auto.FAN | VKPC 83203    |   |   |   | 1 |  |   |       |
| <b>PEUGEOT</b> <b>305 1.6</b>                       |                          |               |          |               |   |   |   |   |  |   |       |
|   | XU51C, XU5CP, XU5S       | 10/82 → 12/88 |          | VKMA 03200    | 1 |   | 1 |   |  |   | T0018 |
|   |                          |               |          | VKM 13200     | 1 |   |   |   |  |   |       |
|   | XU51C, XU5S              | 10/82 → 09/86 |          | VKPC 83401    |   |   |   | 1 |  |   |       |
|   | XU51C, XU5CP, XU5S       | 10/86 → 12/88 |          | VKPC 83424    |   |   |   | 1 |  |   |       |
| <b>PEUGEOT</b> <b>305 1.9</b>                       |                          |               |          |               |   |   |   |   |  |   |       |
|   | XU9J1, XU9S              | 10/82 → 12/88 |          | VKMA 03200    | 1 |   | 1 |   |  |   | T0018 |
|   |                          |               |          | VKM 13200     | 1 |   |   |   |  |   |       |
|   | XU9J1, XU9S              | 10/86 → 12/88 |          | VKPC 83424    |   |   |   | 1 |  |   |       |
|   | XU9S                     | 10/82 → 09/86 |          | VKPC 83401    |   |   |   | 1 |  |   |       |
| <b>PEUGEOT</b> <b>305 1.5 D</b>                     |                          |               |          |               |   |   |   |   |  |   |       |
|   | XID                      | 01/80 → 09/82 | Auto.FAN | VKPC 83203    |   |   |   | 1 |  |   |       |
| <b>PEUGEOT</b> <b>305 1.9 D</b>                     |                          |               |          |               |   |   |   |   |  |   |       |
|   | XUD9                     | 10/86 → 12/88 |          | VKMC 03240    | 1 | 1 | 1 | 1 |  |   | 2     |
|   |                          |               |          | VKMA 03240    | 1 | 1 | 1 |   |  |   | 2     |
|   |                          |               |          | VKM 13240     | 1 |   |   |   |  |   |       |
|   |                          |               |          | VKM 23240     |   | 1 |   |   |  |   |       |
|   | XUD9                     | 10/82 → 09/86 |          | VKMA 03240    | 1 | 1 | 1 |   |  |   | 2     |
|   |                          |               |          | VKM 13240     | 1 |   |   |   |  |   |       |
|   |                          |               |          | VKM 23240     |   | 1 |   |   |  |   |       |
|   | XUD9                     | 10/82 → 09/86 |          | VKPC 83401    |   |   |   | 1 |  |   |       |
|   | XUD9                     | 10/86 → 12/88 |          | VKPC 83424    |   |   |   | 1 |  |   |       |
| <b>PEUGEOT</b> <b>306 1.1</b>                       |                          |               |          |               |   |   |   |   |  |   |       |
|   | TU1M                     | 05/93 → 05/01 |          | VKMC 03100    | 1 |   | 1 | 1 |  |   | T0044 |
|   |                          |               |          | VKMA 03100    | 1 |   | 1 |   |  |   |       |
|   |                          |               |          | VKM 13100     | 1 |   |   |   |  |   |       |
|   | TU1M                     | 05/93 → 05/01 | 3)       | VKMS 03100-1  | 1 |   | 1 |   |  | 2 |       |
|   |                          |               |          | VKMA 03100    | 1 |   | 1 |   |  |   | T0044 |
|   |                          |               |          | VKM 13100     | 1 |   |   |   |  |   |       |
|   | TU1M                     | 05/93 → 05/01 |          | VKPC 83205    |   |   |   | 1 |  |   |       |
|   | B(Alt) TU1M              | 05/93 → 05/01 | AC, ⊗    | VKMV 10AVx710 |   |   | 1 |   |  |   |       |
|   | B(Alt) TU1M              | 05/93 → 05/01 | AC, ⊗    | VKMV 4PK855   |   |   | 1 |   |  |   |       |
|   | B(Alt) TU1M              | 05/93 → 05/01 | AC       | VKMV 4PK855   |   |   | 1 |   |  |   |       |
|   | B(PS) TU1M               | 05/93 → 05/01 | AC       | VKMA 33212    | 1 |   | 1 |   |  |   |       |
|   |                          |               |          | VKMV 5PK881   |   |   | 1 |   |  |   |       |
|   |                          |               |          | VKM 33012     | 1 |   |   |   |  |   |       |
|   | B(AC) TU1M               | 05/93 → 05/01 | ⊗        | VKM 33012     | 1 |   |   |   |  |   |       |
|   | B(AC) TU1M               | 05/93 → 05/01 | ⊗        | VKMA 33312    | 1 |   | 1 |   |  |   |       |
|   |                          |               |          | VKM 33012     | 1 |   |   |   |  |   |       |



PEUGEOT



| PEUGEOT  306 1.4   |                     |               |                           |                |   |   |   |  |  |   |  |  |  |  |  |  |  |       |
|---|---------------------|---------------|---------------------------|----------------|---|---|---|--|--|---|--|--|--|--|--|--|--|-------|
|                     | TU3-2, TU3MC        | 05/93 → 04/02 | 3)                        | VKMS 03110-1   | 1 | 1 |   |  |  | 2 |  |  |  |  |  |  |  | T0044 |
|   |                     |               |                           | VKMA 03110     | 1 | 1 |   |  |  |   |  |  |  |  |  |  |  |       |
|   |                     |               |                           | VKM 13100      | 1 |   |   |  |  |   |  |  |  |  |  |  |  |       |
|   | TU3JP               | 05/93 → 04/02 | 3), M⊗,<br>→IMot. 3666765 | VKMS 03110-1   | 1 | 1 |   |  |  | 2 |  |  |  |  |  |  |  | T0044 |
|   |                     |               |                           | VKMA 03110     | 1 | 1 |   |  |  |   |  |  |  |  |  |  |  |       |
|   |                     |               |                           | VKM 13100      | 1 |   |   |  |  |   |  |  |  |  |  |  |  |       |
|   | TU3JP               | 05/93 → 04/02 | A⊗, Mot. 3666766  →       | VKMA 03254     | 1 | 1 |   |  |  |   |  |  |  |  |  |  |  | T0189 |
|   |                     |               |                           | VKM 13253      | 1 |   |   |  |  |   |  |  |  |  |  |  |  |       |
|                     | TU3-2, TU3JP        | 05/93 → 04/02 | →IMot. 3666765            | VKPC 83205     |   |   |   |  |  | 1 |  |  |  |  |  |  |  |       |
|   | TU3-2, TU3JP        | 05/93 → 04/02 | Mot. 3666766  →           | VKPC 83644     |   |   |   |  |  | 1 |  |  |  |  |  |  |  |       |
|   | TU3MC               | 05/93 → 05/01 |                           | VKPC 83205     |   |   |   |  |  | 1 |  |  |  |  |  |  |  |       |
|                     | B(Alt) TU3JP, TU3MC | 05/93 → 04/02 | AC, ⊗                     | VKMOV 10AVx710 |   |   |   |  |  | 1 |  |  |  |  |  |  |  |       |
|   | B(Alt) TU3JP, TU3MC | 05/93 → 04/02 | AC, ⊗                     | VKMOV 4PK855   |   |   |   |  |  | 1 |  |  |  |  |  |  |  |       |
|   | B(Alt) TU3JP, TU3MC | 05/93 → 04/02 | AC                        | VKMOV 4PK855   |   |   |   |  |  | 1 |  |  |  |  |  |  |  |       |
|   | B(PS) TU3JP, TU3MC  | 05/93 → 04/02 | AC                        | VKMA 33212     | 1 | 1 |   |  |  |   |  |  |  |  |  |  |  |       |
|   |                     |               |                           | VKMOV 5PK881   |   | 1 |   |  |  |   |  |  |  |  |  |  |  |       |
|   |                     |               |                           | VKM 33012      | 1 |   |   |  |  |   |  |  |  |  |  |  |  |       |
|   | B(AC) TU3JP, TU3MC  | 05/93 → 04/02 | ⊗                         | VKM 33012      | 1 |   |   |  |  |   |  |  |  |  |  |  |  |       |
|   | B(AC) TU3JP, TU3MC  | 05/93 → 04/02 | ⊗                         | VKMA 33312     | 1 | 1 |   |  |  |   |  |  |  |  |  |  |  |       |
|   |                     |               |                           | VKM 33012      | 1 |   |   |  |  |   |  |  |  |  |  |  |  |       |
| PEUGEOT  306 1.6   |                     |               |                           |                |   |   |   |  |  |   |  |  |  |  |  |  |  |       |
|                     | TU5JP               | 05/93 → 04/02 |                           | VKMA 03111     | 1 | 1 |   |  |  |   |  |  |  |  |  |  |  | T0044 |
|   |                     |               |                           | VKM 13100      | 1 |   |   |  |  |   |  |  |  |  |  |  |  |       |
|                    | TU5JP               | 05/93 → 04/02 |                           | VKPC 83428     |   |   |   |  |  | 1 |  |  |  |  |  |  |  |       |
|                   | B(Alt) TU5JP        | 05/93 → 04/02 | AC, ⊗                     | VKMOV 10AVx710 |   |   |   |  |  | 1 |  |  |  |  |  |  |  |       |
|   | B(Alt) TU5JP        | 05/93 → 04/02 | AC, ⊗                     | VKMOV 4PK855   |   |   |   |  |  | 1 |  |  |  |  |  |  |  |       |
|   | B(Alt) TU5JP        | 05/93 → 04/02 | AC                        | VKMOV 4PK855   |   |   |   |  |  | 1 |  |  |  |  |  |  |  |       |
|   | B(PS) TU5JP         | 05/93 → 04/02 | AC                        | VKMA 33212     | 1 | 1 |   |  |  |   |  |  |  |  |  |  |  |       |
|   |                     |               |                           | VKMOV 5PK881   |   | 1 |   |  |  |   |  |  |  |  |  |  |  |       |
|   |                     |               |                           | VKM 33012      | 1 |   |   |  |  |   |  |  |  |  |  |  |  |       |
|   | B(AC) TU5JP         | 05/93 → 04/02 | ⊗                         | VKM 33012      | 1 |   |   |  |  |   |  |  |  |  |  |  |  |       |
|   | B(AC) TU5JP         | 05/93 → 04/02 | ⊗                         | VKMA 33312     | 1 | 1 |   |  |  |   |  |  |  |  |  |  |  |       |
|   |                     |               |                           | VKM 33012      | 1 |   |   |  |  |   |  |  |  |  |  |  |  |       |
| PEUGEOT  306 1.8 |                     |               |                           |                |   |   |   |  |  |   |  |  |  |  |  |  |  |       |
|                   | XU7JP               | 05/93 → 04/02 |                           | VKMA 03201     | 1 | 1 |   |  |  |   |  |  |  |  |  |  |  | T0018 |
|   |                     |               |                           | VKM 13100      | 1 |   |   |  |  |   |  |  |  |  |  |  |  |       |
|                   | XU7JP               | 05/93 → 04/02 |                           | VKPC 83615     |   |   |   |  |  | 1 |  |  |  |  |  |  |  |       |
|                   | B(Alt) XU7JP        | 05/93 → 04/02 | 11), AC, ⊗                | VKMOV 6PK698   |   |   |   |  |  | 1 |  |  |  |  |  |  |  |       |
|   | B(Alt) XU7JP        | 05/93 → 04/02 | 11), AC, ⊗                | VKMOV 6PK1094  |   |   |   |  |  | 1 |  |  |  |  |  |  |  |       |
|   |                     |               |                           | VKM 33003      | 1 |   |   |  |  |   |  |  |  |  |  |  |  |       |
|   | B(Alt) XU7JP        | 05/93 → 04/02 | 11), ⊗ 70, 80A, AC, ⊗     | VKMOV 6PK1067  |   |   |   |  |  | 1 |  |  |  |  |  |  |  |       |
|   |                     |               |                           | VKM 33003      | 1 |   |   |  |  |   |  |  |  |  |  |  |  |       |
|   | B(Alt) XU7JP        | 05/93 → 04/02 | 11), ⊗ 90A, AC, ⊗         | VKMA 33003     | 1 | 1 |   |  |  |   |  |  |  |  |  |  |  |       |
|   |                     |               |                           | VKMOV 6PK1076  |   | 1 |   |  |  |   |  |  |  |  |  |  |  |       |
|   |                     |               |                           | VKM 33003      | 1 |   |   |  |  |   |  |  |  |  |  |  |  |       |
|   | B(Alt) XU7JP        | 05/93 → 06/98 | 12), ⊗ 70A, AC, ⊗         | VKMOV 6PK1067  |   |   |   |  |  | 1 |  |  |  |  |  |  |  |       |
|   |                     |               |                           | VKM 33003      | 1 |   |   |  |  |   |  |  |  |  |  |  |  |       |
|   | B(Alt) XU7JP        | 07/98 → 04/02 | 12), ⊗ 70A, AC, ⊗         | VKMOV 6PK1067  |   |   |   |  |  | 1 |  |  |  |  |  |  |  |       |
|   |                     |               |                           | VKM 33021      | 1 |   |   |  |  |   |  |  |  |  |  |  |  |       |
|   | B(Alt) XU7JP        | 05/93 → 06/98 | 12), ⊗ 80, 90A, AC, ⊗     | VKMA 33003     | 1 | 1 |   |  |  |   |  |  |  |  |  |  |  |       |
|   |                     |               |                           | VKMOV 6PK1076  |   | 1 |   |  |  |   |  |  |  |  |  |  |  |       |
|   |                     |               |                           | VKM 33003      | 1 |   |   |  |  |   |  |  |  |  |  |  |  |       |
|   | B(Alt) XU7JP        | 07/98 → 04/02 | 12), ⊗ 80, 90A            | VKMA 33031     | 1 | 1 |   |  |  |   |  |  |  |  |  |  |  |       |
|   |                     |               |                           | VKMOV 6PK1076  |   | 1 |   |  |  |   |  |  |  |  |  |  |  |       |
|   |                     |               |                           | VKM 33021      | 1 |   |   |  |  |   |  |  |  |  |  |  |  |       |
|   | B(Alt) XU7JP        | 05/93 → 04/02 | AC, ⊗                     | VKMA 33030     | 1 | 1 | 1 |  |  |   |  |  |  |  |  |  |  |       |
|   |                     |               |                           | VKMOV 6PK1660  |   |   | 1 |  |  |   |  |  |  |  |  |  |  |       |
|   |                     |               |                           | VKM 33028      | 1 |   |   |  |  |   |  |  |  |  |  |  |  |       |
|   |                     |               |                           | VKM 33034      |   | 1 |   |  |  |   |  |  |  |  |  |  |  |       |

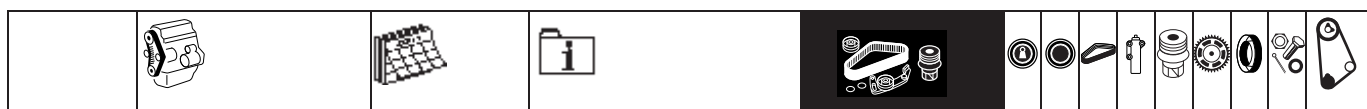

**PEUGEOT** **306 1.8 16V**

|  |               |               |                   |  |        |   |   |  |  |  |   |  |  |  |  |  |  |   |       |
|--|---------------|---------------|-------------------|--|--------|---|---|--|--|--|---|--|--|--|--|--|--|---|-------|
|  | XU7JP4        | 03/97 → 04/02 | Dep. CEE 2000, A⊙ | VKMA 03216<br>VKM 13216<br>VKM 23214                 | 1<br>1 | 1 | 1 |  |  |  |   |  |  |  |  |  |  | 2 | T0142 |
|  | XU7JP4        | 03/97 → 04/02 | Dep. CEE 95, A⊙   | VKMA 03214<br>VKM 13214<br>VKM 23214                 | 1<br>1 | 1 | 1 |  |  |  |   |  |  |  |  |  |  | 2 | T0142 |
|  | XU7JP4        | 03/97 → 04/02 |                   | VKPC 83635   |        |   |   |  |  |  | 1 |  |  |  |  |  |  |   |       |
|  | B(Alt) XU7JP4 | 03/97 → 06/98 | AC                | VKMA 33003<br>VKMV 6PK1076<br>VKM 33003              | 1      |   | 1 |  |  |  |   |  |  |  |  |  |  |   |       |
|  | B(Alt) XU7JP4 | 07/98 → 04/02 | AC                | VKMA 33031<br>VKMV 6PK1076<br>VKM 33021              | 1      |   | 1 |  |  |  |   |  |  |  |  |  |  |   |       |
|  | B(Alt) XU7JP4 | 03/97 → 04/02 | AC                | VKMA 33032<br>VKMV 6PK1660<br>VKM 33026<br>VKM 33028 | 1      | 1 | 1 |  |  |  |   |  |  |  |  |  |  |   |       |

**PEUGEOT** **306 2.0**

|  |               |               |                  |  |        |   |   |  |  |  |   |  |  |  |  |  |  |  |       |
|--|---------------|---------------|------------------|--|--------|---|---|--|--|--|---|--|--|--|--|--|--|--|-------|
|  | XU10J2        | 05/93 → 04/02 |                  | VKMA 03201<br>VKM 13100                              | 1<br>1 |   | 1 |  |  |  |   |  |  |  |  |  |  |  | T0018 |
|  | XU10J2        | 05/93 → 04/02 |                  | VKPC 83420   |        |   |   |  |  |  | 1 |  |  |  |  |  |  |  |       |
|  | B(Alt) XU10J2 | 05/93 → 06/96 | ⊗ 70, 80A, AC, ⊙ | VKMV 6PK1067<br>VKM 33003                            | 1      |   | 1 |  |  |  |   |  |  |  |  |  |  |  |       |
|  | B(Alt) XU10J2 | 05/93 → 06/96 | ⊗ 90A, AC, ⊙     | VKMA 33003<br>VKMV 6PK1076<br>VKM 33003              | 1      |   | 1 |  |  |  |   |  |  |  |  |  |  |  |       |
|  | B(Alt) XU10J2 | 07/96 → 04/02 | AC, ⊙            | VKMV 6PK1160<br>VKM 33022<br>VKM 33025               | 1      |   | 1 |  |  |  |   |  |  |  |  |  |  |  |       |
|  | B(Alt) XU10J2 | 05/93 → 06/96 | AC, ⊙            | VKMA 33030<br>VKMV 6PK1660<br>VKM 33028<br>VKM 33034 | 1<br>1 | 1 | 1 |  |  |  |   |  |  |  |  |  |  |  |       |
|  | B(Alt) XU10J2 | 07/96 → 04/02 | AC, ⊙            | VKMA 33034<br>VKMV 6PK1603<br>VKM 33028<br>VKM 33035 | 1<br>1 | 1 | 1 |  |  |  |   |  |  |  |  |  |  |  |       |

**PEUGEOT** **306 2.0 16V**

















































|  |                |               |         |  |        |   |   |  |  |  |   |  |  |  |  |  |  |  |       |
|--|----------------|---------------|---------|--|--------|---|---|--|--|--|---|--|--|--|--|--|--|--|-------|
|  | XU10J4R        | 03/97 → 04/02 |         | VKMA 03213<br>VKM 13202<br>VKM 23213                 | 1<br>1 | 1 | 1 |  |  |  |   |  |  |  |  |  |  |  | T0142 |
|  | XU10J4R        | 03/97 → 04/02 |         | VKPC 83636   |        |   |   |  |  |  | 1 |  |  |  |  |  |  |  |       |
|  | B(Alt) XU10J4R | 03/97 → 04/02 | 12), AC | VKMV 6PK1160<br>VKM 33022<br>VKM 33025               | 1      |   | 1 |  |  |  |   |  |  |  |  |  |  |  |       |
|  | B(Alt) XU10J4R | 03/97 → 04/02 | 12), AC | VKMA 33034<br>VKMV 6PK1603<br>VKM 33028<br>VKM 33035 | 1<br>1 | 1 | 1 |  |  |  |   |  |  |  |  |  |  |  |       |





















**PEUGEOT** **306 2.0 S16**

|  |               |               |                       |                                      |             |   |   |  |  |  |   |  |  |  |  |  |  |  |       |
|--|---------------|---------------|-----------------------|--------------------------------------|-------------|---|---|--|--|--|---|--|--|--|--|--|--|--|-------|
|  | XU10J4        | 05/93 → 05/01 |                       | VKMA 03211<br>VKM 13210<br>VKM 13211 | 2<br>1<br>1 |   | 1 |  |  |  |   |  |  |  |  |  |  |  | T0118 |
|  | XU10J4RS      | 03/96 → 04/00 | M⊙                    | VKMA 03213<br>VKM 13202<br>VKM 23213 | 1<br>1      | 1 | 1 |  |  |  |   |  |  |  |  |  |  |  | T0142 |
|  | XU10J4RS      | 04/00 → 05/01 | A⊙                    | VKMA 03218<br>VKM 13218<br>VKM 23218 | 1<br>1      | 1 | 1 |  |  |  |   |  |  |  |  |  |  |  | T0242 |
|  | XU10J4        | 05/93 → 05/01 |                       | VKPC 83420                           |             |   |   |  |  |  | 1 |  |  |  |  |  |  |  |       |
|  | XU10J4RS      | 03/96 → 05/01 |                       | VKPC 83636                           |             |   |   |  |  |  | 1 |  |  |  |  |  |  |  |       |
|  | B(Alt) XU10J4 | 05/93 → 05/01 | 11), ⊗ 70, 80A, AC, ⊙ | VKMV 6PK1067<br>VKM 33003            | 1           |   | 1 |  |  |  |   |  |  |  |  |  |  |  |       |































































PEUGEOT

|  |  |  |   |  |  |  |  |  |  |  |  |  |       |
|--|---|---|--|--|---|---|---|---|---|---|---|---|-------|
| B(Alt)   | XU10J4  | 05/93 → 05/01   | 11),  ,  ,                | VKMA 33003<br>VKMV 6PK1076<br>VKM 33003  | 1<br>1  | 1<br>1  |   |   |   |   |   |   |       |
| B(Alt)   | XU10J4, XU10J4Z   | 06/94 → 06/96   | 11),  , 70, 80A,   | VKMA 33003<br>VKMV 6PK1076<br>VKM 33003  | 1   | 1   |   |   |   |   |   |   |       |
| B(Alt)   | XU10J4, XU10J4Z   | 07/96 → 05/01   | 11),  , 90A,   | VKMA 33003<br>VKMV 6PK1076<br>VKM 33003  | 1   | 1   |   |   |   |   |   |   |       |
| B(Alt)   | XU10J4RS  | 03/96 → 05/01   | 11),    | VKMA 33003<br>VKMV 6PK1076<br>VKM 33003  | 1   | 1   |   |   |   |   |   |   |       |
|  |   |   |  | VKM 33022<br>VKM 33025   | 1   | 1   |   |   |   |   |   |   |       |
| <b>PEUGEOT  306 1.8 D</b>   |   |   |  |  |   |   |   |   |   |   |   |   |       |
|                              | XUD7  | 05/93 → 01/94   |   | VKMC 03240<br>VKMA 03240<br>VKM 13240<br>VKM 23240                                 | 1<br>1<br>1   | 1<br>1<br>1   | 1   | 1   |   |   | 2<br>2  | T0017   |       |
|  | XUD7  | 01/94 → 05/01   |   | VKMC 03241<br>VKMA 03241<br>VKM 13241<br>VKM 23241                                 | 1<br>1<br>1   | 1<br>1<br>1   | 1   |   |   |   |   | T0017   |       |
|  | XUD7  | 05/93 → 01/94   | 3)   | VKMS 03240<br>VKMA 03240<br>VKM 13240<br>VKM 23240                                 | 1<br>1<br>1   | 1<br>1<br>1   |   |   |   | 2   | 2   | T0017   |       |
|  | XUD7  | 01/94 → 05/01   | 3)   | VKMS 03241<br>VKMA 03241<br>VKM 13241<br>VKM 23241                                 | 1<br>1<br>1   | 1<br>1<br>1   |   |   |   | 2   |   | T0017   |       |
|                            | XUD7  | 05/93 → 01/94   |  | VKPC 83424   |   |   |   | 1   |   |   |   |   |       |
|  | XUD7  | 01/94 → 05/01   |  | VKPC 83420   |   |   |   | 1   |   |   |   |   |       |
|                            | B(Alt) XUD7   | 05/93 → 05/01   |  ,   | VKMA 33003<br>VKMV 6PK1076<br>VKM 33003  | 1   | 1   |   |   |   |   |   |   |       |
|  | B(Alt) XUD7   | 05/93 → 06/95   | 11),  ,    | VKMA 33003<br>VKMV 6PK1076<br>VKM 33003  | 1   | 1   |   |   |   |   |   |   |       |
|  | B(Alt) XUD7   | 06/95 → 05/01   | 11),  , 117 mm,  ,  | VKMA 33035<br>VKMV 6PK1102<br>VKM 33002  | 1<br>1  | 1<br>1  |   |   |   |   |   |   |       |
|  | B(Alt) XUD7   | 06/95 → 05/01   | 11),  , 135 mm,  ,  | VKMA 33202<br>VKMV 6PK1130<br>VKM 33002  | 1<br>1  | 1<br>1  |   |   |   |   |   |   |       |
|  | B(Alt) XUD7   | 05/93 → 06/95   | 11),  ,    | VKMA 33048<br>VKMV 6PK1700<br>VKM 33002<br>VKM 33040                               | 2<br>1<br>1   | 1<br>1  |   |   |   |   |   |   |       |
|  | B(Alt) XUD7   | 06/95 → 05/01   | 11),  ,    | VKMA 33048<br>VKMV 6PK1700<br>VKM 33002<br>VKM 33040                               | 2<br>1<br>1   | 1<br>1  |   |   |   |   |   |   |       |
|  | B(Alt) XUD7   | 06/95 → 05/01   | 11),  ,    | VKMA 33048<br>VKMV 6PK1700<br>VKM 33002<br>VKM 33040                               | 2<br>1<br>1   | 1<br>1  |   |   |   |   |   |   |       |
|                            | XUD7  | 05/93 → 05/01   |  | VKMA 33048<br>VKMV 6PK1700<br>VKM 33002<br>VKM 33040                               | 2<br>1<br>1   | 1<br>1  |   |   |   |   |   |   |       |
|  | XUD7  | 05/93 → 05/01   |  | VKM 93302  | 1   |   |   | 1   |   |   |   |   |       |
| <b>PEUGEOT  306 1.9 D</b> |   |   |  |  |   |   |   |   |   |   |   |   |       |
|                            | DW8, DW8B   | 09/98 → 04/02   |   | VKMC 03244<br>VKMA 03244<br>VKM 13244<br>VKM 23246                                 | 1<br>1<br>1   | 1<br>1<br>1   | 1   |   |   |   | 1   | 1<br>1  | T0167 |
|  | XUD9Y   | 05/93 → 12/93   |   | VKMC 03240<br>VKMA 03240<br>VKM 13240<br>VKM 23240                                 | 1<br>1<br>1   | 1<br>1<br>1   | 1   |   |   |   | 2   | 2   | T0017 |
|  | XUD9Y   | 05/93 → 12/93   | 3)   | VKMS 03240<br>VKMA 03240<br>VKM 13240<br>VKM 23240                                 | 1<br>1<br>1   | 1<br>1<br>1   |   |   |   | 2   | 2   | T0017   |       |
|  | XUD9A, XUD9BSD,<br>XUD9Y  | 01/94 → 04/02   |   | VKMC 03241<br>VKMA 03241<br>VKM 13241<br>VKM 23241                                 | 1<br>1<br>1   | 1<br>1<br>1   | 1   |   |   |   |   |   | T0017 |





























|   |  |  |    |  |  |  |  |  |  |  |  |  |  |  |
|---|---|---|---|--|---|---|---|---|---|---|---|---|---|---|
|   | XUD9A, XUD9BSD,<br>XUD9Y  | 01/94 → 04/02   | 3)  | VKMS 03241<br>VKMA 03241<br>VKM 13241<br>VKM 23241                                 | 1<br>1<br>1<br>1  | 1<br>1<br>1   | 1   |   |   |   |   | 2   |   | T0017   |
|                              | DW8, DW8B   | 09/98 → 04/02   |   | VKPC 83639   |   |   |   |   | 1   |   |   |   |   |   |
|   | XUD9  | 05/93 → 01/94   |   | VKPC 83424   |   |   |   |   | 1   |   |   |   |   |   |
|   | XUD9, XUD9BSD   | 01/94 → 04/02   |   | VKPC 83420   |   |   |   |   | 1   |   |   |   |   |   |
|                              | B(Alt) DW8  | 09/98 → 04/02   | 12), AC, ⊗  | VKMW 6PK866<br>VKM 33004   | 1   |   | 1   |   |   |   |   |   |   |   |
|   | B(Alt) DW8  | 09/98 → 04/02   | 12), AC, ⊗  | VKMW 6PK1042<br>VKM 33004  | 1   |   | 1   |   |   |   |   |   |   |   |
|   | B(Alt) DW8  | 09/98 → 10/99   | 12), AC, ⊗  | VKMA 33021<br>VKMW 6PK1388<br>VKM 33017<br>VKM 33017<br>VKM 33042                  | 1<br>1<br>1<br>1  | 2   | 1   |   |   |   |   |   |   |   |
|   | B(Alt) DW8  | 09/98 → 04/02   | 12), AC, ⊗  | VKMA 33093<br>VKMW 6PK1750<br>VKM 33013<br>VKM 33029<br>VKM 33311                  | 2<br>1<br>1   |   | 1   |   |   | 1   |   |   |   |   |
|   | B(Alt) DW8  | 10/99 → 04/02   | 12), AC, ⊗  | VKMA 33027<br>VKMW 6PK1437<br>VKM 33017<br>VKM 33031<br>VKM 33032                  | 1<br>1<br>1<br>1  | 2   | 1   |   |   |   |   |   |   |   |
|   | B(Alt) XUD9A, XUD9Y   | 05/93 → 04/02   | 11), AC, ⊗  | VKMW 6PK1170<br>VKM 33002  | 1   |   | 1   |   |   |   |   |   |   |   |
|   | B(Alt) XUD9A, XUD9Y   | 05/93 → 06/95   | 11), AC, ⊗  | VKMW 6PK1146<br>VKM 33002  | 1   |   | 1   |   |   |   |   |   |   |   |
|   | B(Alt) XUD9A, XUD9Y   | 05/93 → 06/95   | 11), AC, ⊗  | VKMA 33048<br>VKMW 6PK1700<br>VKM 33002<br>VKM 33040                               | 2<br>1<br>1   |   | 1   |   |   |   |   |   |   |   |
|   | B(Alt) XUD9A, XUD9BSD,<br>XUD9Y   | 05/93 → 04/02   | AC, ⊗   | VKMW 6PK730  |   |   | 1   |   |   |   |   |   |   |   |
|   | B(Alt) XUD9A, XUD9Y   | 06/95 → 05/01   | 11), ⊗ 117 mm, AC, ⊗  | VKMA 33035<br>VKMW 6PK1102<br>VKM 33002  | 1<br>1  |   | 1   |   |   |   |   |   |   |   |
|   | B(Alt) XUD9A, XUD9Y   | 06/95 → 05/01   | 11), ⊗ 135 mm, AC, ⊗  | VKMA 33202<br>VKMW 6PK1130<br>VKM 33002  | 1<br>1  |   | 1   |   |   |   |   |   |   |   |
|   | B(Alt) XUD9A, XUD9Y   | 06/95 → 04/02   | 11), AC, ⊗  | VKMW 6PK1740<br>VKM 33013<br>VKM 33033   | 1<br>1  |   | 1   |   |   |   |   |   |   |   |
|   | B(Alt) XUD9A, XUD9Y   | 06/95 → 05/01   | 11), ⊗ 135 mm   | VKMA 33202<br>VKMW 6PK1130<br>VKM 33002  | 1<br>1  |   | 1   |   |   |   |   |   |   |   |
|   | B(Alt) XUD9A  | 03/97 → 04/02   | 11), AC, ⊗  | VKMA 33202<br>VKMW 6PK1130<br>VKM 33002  | 1<br>1  |   | 1   |   |   |   |   |   |   |   |
|   | B(Alt) XUD9BSD  | 03/98 → 04/02   | 12), AC, ⊗  | VKMA 33202<br>VKMW 6PK1130<br>VKM 33002  | 1<br>1  |   | 1   |   |   |   |   |   |   |   |
|   | B(Alt) XUD9BSD  | 03/98 → 04/02   | 12), AC, ⊗  | VKMW 6PK1740<br>VKM 33013<br>VKM 33033   | 1<br>1  |   | 1   |   |   |   |   |   |   |   |
|                            | DW8B  | 12/02 → 04/02   |   | VKM 93301  |   |   |   |   |   | 1   |   |   |   |   |
|   | XUD9A, XUD9BSD,<br>XUD9Y  | 05/93 → 04/02   |   | VKM 93302  |   |   |   |   |   | 1   |   |   |   |   |
| <b>PEUGEOT  306 1.9 TD</b> |   |   |   |  |   |   |   |   |   |   |   |   |   |   |
|                            | XUD9TE  | 05/93 → 01/94   |  | VKMC 03240<br>VKMA 03240   | 1<br>1  | 1<br>1  | 1<br>1  |   | 1   |   |   |   | 2<br>2  | T0017   |















































|  |  |  |    |  |  |  |  |  |  |  |  |  |  |  |
|--|---|---|---|--|---|---|---|---|---|---|---|---|---|---|
|  |   |   |   | VKM 13240  | 1   |   |   |   |   |   |   |   |   |   |
|  |   |   |   | VKM 23240  |   | 1   |   |   |   |   |   |   |   |   |
|  | XUD9TE  | 05/93 → 12/93   | 3)  | VKMS 03240   | 1   | 1   | 1   |   |   |   | 2   | 2   |   | T0017   |
|  |   |   |   | VKMA 03240   | 1   | 1   | 1   |   |   |   |   |   |   |   |
|  |   |   |   | VKM 13240  | 1   |   |   |   |   |   |   |   |   |   |
|  |   |   |   | VKM 23240  |   | 1   |   |   |   |   |   |   |   |   |
|  | XUD9TE  | 01/94 → 04/02   |    | VKMC 03241   | 1   | 1   | 1   |   | 1   |   |   |   |   | T0017   |
|  |   |   |   | VKMA 03241   | 1   | 1   | 1   |   |   |   |   |   |   |   |
|  |   |   |   | VKM 13241  | 1   |   |   |   |   |   |   |   |   |   |
|  |   |   |   | VKM 23241  |   | 1   |   |   |   |   |   |   |   |   |
|  | XUD9TE  | 01/94 → 04/02   | 3)  | VKMS 03241   | 1   | 1   | 1   |   |   |   | 2   |   |   | T0017   |
|  |   |   |   | VKMA 03241   | 1   | 1   | 1   |   |   |   |   |   |   |   |
|  |   |   |   | VKM 13241  | 1   |   |   |   |   |   |   |   |   |   |
|  |   |   |   | VKM 23241  |   | 1   |   |   |   |   |   |   |   |   |
|                                | XUD9TE  | 05/93 → 01/94   |   | VKPC 83424   |   |   |   |   | 1   |   |   |   |   |   |
|  | XUD9TE  | 01/94 → 04/02   |   | VKPC 83420   |   |   |   |   | 1   |   |   |   |   |   |
|                                | <b>B(Alt)</b> XUD9TE  | 05/93 → 05/01   | AC,    | VKMV 6PK730  |   |   |   | 1   |   |   |   |   |   |   |
|  | <b>B(Alt)</b> XUD9TE  | 05/93 → 04/02   | AC,    | VKMV 6PK1170   |   |   |   | 1   |   |   |   |   |   |   |
|  |   |   |   | VKM 33002  | 1   |   |   |   |   |   |   |   |   |   |
|  | <b>B(Alt)</b> XUD9TE  | 05/93 → 06/95   | AC,    | VKMV 6PK1146   |   |   |   | 1   |   |   |   |   |   |   |
|  |   |   |   | VKM 33002  | 1   |   |   |   |   |   |   |   |   |   |
|  | <b>B(Alt)</b> XUD9TE  | 06/95 → 05/01   |  117 mm, AC,  | VKMA 33035   | 1   |   | 1   |   |   |   |   |   |   |   |
|  |   |   |   | VKMV 6PK1102   |   |   | 1   |   |   |   |   |   |   |   |
|  |   |   |   | VKM 33002  | 1   |   |   |   |   |   |   |   |   |   |
|  | <b>B(Alt)</b> XUD9TE  | 06/95 → 04/02   |  135 mm, AC,  | VKMA 33202   | 1   |   | 1   |   |   |   |   |   |   |   |
|  |   |   |   | VKMV 6PK1130   |   |   | 1   |   |   |   |   |   |   |   |
|  |   |   |   | VKM 33002  | 1   |   |   |   |   |   |   |   |   |   |
|  | <b>B(Alt)</b> XUD9TE  | 05/93 → 06/95   | AC,    | VKMA 33048   | 2   |   | 1   |   |   |   |   |   |   |   |
|  |   |   |   | VKMV 6PK1700   |   |   | 1   |   |   |   |   |   |   |   |
|  |   |   |   | VKM 33002  | 1   |   |   |   |   |   |   |   |   |   |
|  |   |   |   | VKM 33040  | 1   |   |   |   |   |   |   |   |   |   |
|  | <b>B(Alt)</b> XUD9TE  | 06/95 → 04/02   | AC,    | VKMV 6PK1739   |   |   | 1   |   |   |   |   |   |   |   |
|  |   |   |   | VKM 33013  | 1   |   |   |   |   |   |   |   |   |   |
|  |   |   |   | VKM 33029  | 1   |   |   |   |   |   |   |   |   |   |
|                              | XUD9TE  | 05/93 → 04/02   |   | VKM 93302  |   |   |   |   |   | 1   |   |   |   |   |
| <b>PEUGEOT  306 2.0 HDi</b> |   |   |   |  |   |   |   |   |   |   |   |   |   |   |
|                              | DW10TD  | 06/99 → 04/00   |    | VKMC 03246   | 1   | 1   | 1   |   | 1   |   |   |   | 1   | T0168   |
|  |   |   |   | VKMA 03246   | 1   | 1   | 1   |   |   |   |   |   | 1   |   |
|  |   |   |   | VKM 13246  | 1   |   |   |   |   |   |   |   | 1   |   |
|  |   |   |   | VKM 23246  |   | 1   |   |   |   |   |   |   |   |   |
|  | DW10TD  | 06/99 → 04/00   | 3)  | VKMS 03246   | 1   | 1   | 1   |   |   |   | 2   | 1   |   | T0168   |
|  |   |   |   | VKMA 03246   | 1   | 1   | 1   |   |   |   |   | 1   |   |   |
|  |   |   |   | VKM 13246  | 1   |   |   |   |   |   |   | 1   |   |   |
|  |   |   |   | VKM 23246  |   | 1   |   |   |   |   |   |   |   |   |
|  | DW10TD  | 04/00 → 04/02   |    | VKMC 03247   | 1   | 1   | 1   |   | 1   |   |   |   | 1   | T0168   |
|  |   |   |   | VKMA 03247   | 1   | 1   | 1   |   |   |   |   |   | 1   |   |
|  |   |   |   | VKM 13244  | 1   |   |   |   |   |   |   |   | 1   |   |
|  |   |   |   | VKM 23246  |   | 1   |   |   |   |   |   |   |   |   |
|                              | DW10TD  | 06/99 → 04/02   |   | VKPC 83639   |   |   |   |   | 1   |   |   |   |   |   |
|                              | <b>B(Alt)</b> DW10TD  | 06/99 → 04/02   | AC  | VKMA 33044   | 2   | 1   | 1   |   |   |   |   |   |   |   |
|  |   |   |   | VKMV 6PK1468   |   |   | 1   |   |   |   |   |   |   |   |
|  |   |   |   | VKM 33024  | 1   |   |   |   |   |   |   |   |   |   |
|  |   |   |   | VKM 33033  | 1   |   |   |   |   |   |   |   |   |   |
|  |   |   |   | VKM 33069  |   | 1   |   |   |   |   |   |   |   |   |
|  | <b>B(Alt)</b> DW10TD  | 06/99 → 04/02   | AC  | VKMA 33037   | 2   |   | 1   |   |   |   |   |   |   |   |
|  |   |   |   | VKMV 6PK1750   |   |   | 1   |   |   |   |   |   |   |   |
|  |   |   |   | VKM 33013  | 1   |   |   |   |   |   |   |   |   |   |
|  |   |   |   | VKM 33033  | 1   |   |   |   |   |   |   |   |   |   |
|                              | DW10TD  | 06/99 → 04/02   |   | VKM 93301  |   |   |   |   |   | 1   |   |   |   |   |
| <b>PEUGEOT  307 1.4</b>     |   |   |   |  |   |   |   |   |   |   |   |   |   |   |
|                              | TU3JP   | 08/00 → 12/07   | 3), M $\otimes$ ,<br>→IMot. 3666765   | VKMS 03110-1   | 1   |   | 1   |   |   |   | 2   |   |   | T0044   |
|  |   |   |   | VKMA 03110   | 1   |   | 1   |   |   |   |   |   |   |   |
|  |   |   |   | VKM 13100  | 1   |   |   |   |   |   |   |   |   |   |
|  | TU3JP   | 08/00 → 12/07   | A $\otimes$ , Mot. 3666766 I→   | VKMA 03254   | 1   |   | 1   |   |   |   |   |   |   | T0189   |
|  |   |   |   | VKM 13253  | 1   |   |   |   |   |   |   |   |   |   |
|                              | TU3JP   | 08/00 → 11/07   | →IMot. 3666765  | VKPC 83205   |   |   |   |   | 1   |   |   |   |   |   |

|  |  |  |  |  |  |  |  |  |  |  |  |  |  |
|--|---|---|---|--|---|---|---|---|---|---|---|---|---|
|  | TU3JP   | 08/00 → 11/07   | Mot. 3666766 I→   | VKPC 83644   |   |   |   |   |   |   | 1   |   |   |
|                               | B(Alt) TU3JP  | 08/00 → 12/07   | AC  | VKMA 6PK730  |   |   | 1   |   |   |   |   |   |   |
|  | B(Alt) TU3JP  | 08/00 → 12/03   | 70, 80, 90A, AC   | VKMA 33059   | 2   |   | 1   |   |   |   |   |   |   |
|  |   |   |   | VKMA 6PK1125   |   |   | 1   |   |   |   |   |   |   |
|  |   |   |   | VKM 33042  | 1   |   |   |   |   |   |   |   |   |
|  |   |   |   | VKM 33042  | 1   |   |   |   |   |   |   |   |   |
|  | B(Alt) TU3JP  | 12/03 → 12/07   | 80A, AC   | VKMA 6PK1049   |   |   | 1   |   |   |   |   |   |   |
|  |   |   |   | VKM 33074  | 1   |   |   |   |   |   |   |   |   |
|  | B(Alt) TU3JP  | 08/00 → 12/03   | 120A, AC  | VKMA 33067   | 2   |   | 1   |   |   |   |   |   |   |
|  |   |   |   | VKMA 6PK1147   |   |   | 1   |   |   |   |   |   |   |
|  |   |   |   | VKM 33042  | 1   |   |   |   |   |   |   |   |   |
|  |   |   |   | VKM 33042  | 1   |   |   |   |   |   |   |   |   |
|  | B(Alt) TU3JP  | 12/03 → 12/07   | 120A, AC  | VKMA 6PK1069   |   |   | 1   |   |   |   |   |   |   |
|  |   |   |   | VKM 33074  | 1   |   |   |   |   |   |   |   |   |
| <b>PEUGEOT  307 1.4 16V</b>   |   |   |   |  |   |   |   |   |   |   |   |   |   |
|                               | ET3J4   | 11/03 → 12/07   |   | VKMA 03258   | 1   | 1   | 1   |   |   |   |   |   | T0209   |
|  |   |   |   | VKM 13258  | 1   |   |   |   |   |   |   |   |   |
|  |   |   |   | VKM 23258  |   | 1   |   |   |   |   |   |   |   |
|                               | ET3J4   | 11/03 → 11/07   |   | VKPC 83258   |   |   |   |   | 1   |   |   |   |   |
|                               | B(Alt) ET3J4  | 11/03 → 12/07   | AC  | VKMA 6PK728  |   |   | 1   |   |   |   |   |   |   |
|  | B(Alt) ET3J4  | 11/03 → 12/03   | 80A, AC   | VKMA 33059   | 2   |   | 1   |   |   |   |   |   |   |
|  |   |   |   | VKMA 6PK1125   |   |   | 1   |   |   |   |   |   |   |
|  |   |   |   | VKM 33042  | 1   |   |   |   |   |   |   |   |   |
|  |   |   |   | VKM 33042  | 1   |   |   |   |   |   |   |   |   |
|  | B(Alt) ET3J4  | 12/03 → 12/07   | 80A, AC   | VKMA 6PK1049   |   |   | 1   |   |   |   |   |   |   |
|  |   |   |   | VKM 33074  | 1   |   |   |   |   |   |   |   |   |
|  | B(Alt) ET3J4  | 11/03 → 12/03   | 120A, AC  | VKMA 33067   | 2   |   | 1   |   |   |   |   |   |   |
|  |   |   |   | VKMA 6PK1147   |   |   | 1   |   |   |   |   |   |   |
|  |   |   |   | VKM 33042  | 1   |   |   |   |   |   |   |   |   |
|  |   |   |   | VKM 33042  | 1   |   |   |   |   |   |   |   |   |
|  | B(Alt) ET3J4  | 12/03 → 12/07   | 120A, AC  | VKMA 6PK1069   |   |   | 1   |   |   |   |   |   |   |
|  |   |   |   | VKM 33074  | 1   |   |   |   |   |   |   |   |   |
| <b>PEUGEOT  307 1.6 16V</b> |   |   |   |  |   |   |   |   |   |   |   |   |   |
|                             | TU5JP4  | 08/00 → 12/07   | → Mot. 1806404  | VKMA 03132   | 1   | 1   | 1   |   |   |   |   |   | 1 T0193   |
|  |   |   |   | VKM 13132  | 1   |   |   |   |   |   |   |   |   |
|  |   |   |   | VKM 23130  |   | 1   |   |   |   |   |   |   | 1   |
|  | TU5JP4  | 08/00 → 12/07   | Mot. 1806405 I→   | VKMA 03256   | 1   | 1   | 1   |   |   |   |   |   | T0193   |
|  |   |   |   | VKM 13256  | 1   |   |   |   |   |   |   |   |   |
|  |   |   |   | VKM 23256  |   | 1   |   |   |   |   |   |   |   |
|                             | TU5JP4  | 08/00 → 11/07   |   | VKPC 83430   |   |   |   |   | 1   |   |   |   |   |
|                             | B(Alt) TU5JP4   | 08/00 → 12/07   | AC  | VKMA 6PK728  |   |   | 1   |   |   |   |   |   |   |
|  | B(Alt) TU5JP4   | 08/00 → 12/03   | 70, 80, 90A, AC   | VKMA 33059   | 2   |   | 1   |   |   |   |   |   |   |
|  |   |   |   | VKMA 6PK1125   |   |   | 1   |   |   |   |   |   |   |
|  |   |   |   | VKM 33042  | 1   |   |   |   |   |   |   |   |   |
|  |   |   |   | VKM 33042  | 1   |   |   |   |   |   |   |   |   |
|  | B(Alt) TU5JP4   | 12/03 → 12/07   | 80A, AC   | VKMA 6PK1049   |   |   | 1   |   |   |   |   |   |   |
|  |   |   |   | VKM 33074  | 1   |   |   |   |   |   |   |   |   |
|  | B(Alt) TU5JP4   | 08/00 → 12/03   | 120A, AC  | VKMA 33067   | 2   |   | 1   |   |   |   |   |   |   |
|  |   |   |   | VKMA 6PK1147   |   |   | 1   |   |   |   |   |   |   |
|  |   |   |   | VKM 33042  | 1   |   |   |   |   |   |   |   |   |
|  |   |   |   | VKM 33042  | 1   |   |   |   |   |   |   |   |   |
|  | B(Alt) TU5JP4   | 12/03 → 12/07   | 120A, AC  | VKMA 6PK1069   |   |   | 1   |   |   |   |   |   |   |
|  |   |   |   | VKM 33074  | 1   |   |   |   |   |   |   |   |   |
| <b>PEUGEOT  307 2.0 16V</b> |   |   |   |  |   |   |   |   |   |   |   |   |   |
|                             | EW10A   | 03/05 → 12/07   |   | VKMA 03263   | 1   | 1   | 1   |   |   |   |   |   | T0169   |
|  |   |   |   | VKM 13263  | 1   |   |   |   |   |   |   |   |   |
|  |   |   |   | VKM 23230  |   | 1   |   |   |   |   |   |   |   |
|  | EW10J4  | 08/00 → 12/07   |   | VKMA 03235   | 1   | 1   | 1   |   |   |   |   |   | T0169   |
|  |   |   |   | VKM 13234  | 1   |   |   |   |   |   |   |   |   |
|  |   |   |   | VKM 23230  |   | 1   |   |   |   |   |   |   |   |
|  | EW10J4S   | 10/03 → 12/07   |   | VKMA 03260   | 1   | 1   | 1   |   |   |   |   |   | T0169   |
|  |   |   |   | VKM 13234  | 1   |   |   |   |   |   |   |   |   |
|  |   |   |   | VKM 23230  |   | 1   |   |   |   |   |   |   |   |

















































































|  |  |  |    |  |  |  |  |  |  |  |  |       |
|--|---|---|---|--|---|---|---|---|---|---|---|-------|
|                                    | EW10A, EW10J4,<br>EW10J4S   | 08/00 → 11/07   | 16)   | VKPC 83650   |   |   |   | 1   |   |   |   |       |
|                                    | <b>B(Alt)</b> EW10A, EW10J4   | 11/04 → 12/07   |   | VKMOV 6PK998<br>VKM_____   | 1   |   | 1   |   |   |   |   |       |
|  | <b>B(Alt)</b> EW10J4  | 08/00 → 02/02   | <b>AC</b>   | VKMOV 6PK1188<br>VKM 33020<br>VKM 33063<br>VKM 33064                               | 1   | 1   | 1   |   |   |   |   |       |
|  | <b>B(Alt)</b> EW10J4  | 02/02 → 11/04   | <b>AC</b>   | VKMA 33065<br>VKMOV 6PK1188<br>VKM 33019<br>VKM 33020<br>VKM 33065                 | 1   | 2   | 1   |   |   |   |   |       |
|  | <b>B(Alt)</b> EW10J4  | 08/00 → 02/02   | <b>AC</b>   | VKMOV 6PK1706<br>VKM 33020<br>VKM 33063<br>VKM 33064                               | 1   | 1   | 1   |   |   |   |   |       |
|  | <b>B(Alt)</b> EW10J4  | 02/02 → 11/04   | <b>AC</b>   | VKMA 33066<br>VKMOV 6PK1710<br>VKM 33019<br>VKM 33020<br>VKM 33065                 | 1   | 2   | 1   |   |   |   |   |       |
|  | <b>B(Alt)</b> EW10J4S   | 10/03 → 11/04   |   | VKMOV 6PK1710<br>VKM 33020<br>VKM 33063<br>VKM 33064                               | 1   | 1   | 1   |   |   |   |   |       |
|  | <b>B(Alt)</b> EW10J4S   | 11/04 → 12/07   |   | VKMOV 6PK1710<br>VKM_____  | 1   | 1   | 1   |   |   |   |   |       |
|  |   |   |   | VKM 33063<br>VKM 33064   | 1   | 1   |   |   |   |   |   |       |
| <b>PEUGEOT  307 1.4 HDi</b>     |   |   |   |  |   |   |   |   |   |   |   |       |
|                                  | DV4TD   | 10/01 → 12/07   |   | VKMA 03140<br>VKM 13140<br>VKM 23140   | 1   | 1   | 1   |   |   |   |   | T0195 |
|                                  | DV4TD   | 10/01 → 11/07   |   | VKPC 83140   |   |   |   | 1   |   |   |   |       |
|                                  | <b>B(Alt)</b> DV4TD   | 10/01 → 12/07   | <b>AC</b>   | VKMA 33058<br>VKMOV 6PK802<br>VKM 33043<br>VKM 33044                               | 1   | 1   | 1   |   |   |   |   | 1     |
|  | <b>B(Alt)</b> DV4TD   | 10/01 → 12/07   | <b>AC</b>   | VKMA 33043<br>VKMOV 6PK976<br>VKM 33043  | 1   | 1   | 1   |   |   |   |   |       |
|  |   |   |   |  | 1   |   |   |   |   |   |   |       |
| <b>PEUGEOT  307 1.6 HDi 90</b>  |   |   |   |  |   |   |   |   |   |   |   |       |
|                                  | DV6ATED4  | 04/05 → 12/07   |   | VKMA 03259<br>VKM 13140<br>VKM 23140   | 1   | 1   | 1   |   |   |   |   | T0195 |
|                                  | DV6ATED4  | 04/05 → 12/07   |   | VKPC 83259   |   |   |   | 1   |   |   |   |       |
|                                  | <b>B(Alt)</b> DV6ATED4  | 04/05 → 12/07   | <b>AC</b>   | VKM_____   |   | 1   |   |   |   |   |   |       |
| <b>PEUGEOT  307 1.6 HDi 110</b> |   |   |   |  |   |   |   |   |   |   |   |       |
|                                  | DV6TED4   | 02/04 → 12/07   |   | VKMA 03259<br>VKM 13140<br>VKM 23140   | 1   | 1   | 1   |   |   |   |   | T0195 |
|                                  | DV6TED4   | 02/04 → 11/07   |   | VKPC 83259   |   |   |   | 1   |   |   |   |       |
|                                  | <b>B(Alt)</b> DV6TED4   | 02/04 → 12/07   | <b>AC</b>   | VKMA 33058<br>VKMOV 6PK802<br>VKM 33043<br>VKM 33044                               | 1   | 1   | 1   |   |   |   |   | 1     |
|  | <b>B(Alt)</b> DV6TED4   | 02/04 → 12/07   | <b>AC</b>   | VKMA 33043<br>VKMOV 6PK976<br>VKM 33043  | 1   | 1   | 1   |   |   |   |   |       |
|  |   |   |   |  | 1   |   |   |   |   |   |   |       |
| <b>PEUGEOT  307 2.0 HDi 90</b>  |   |   |   |  |   |   |   |   |   |   |   |       |
|                                  | DW10TD  | 08/00 → 12/07   |  | VKMC 03247<br>VKMA 03247<br>VKM 13244<br>VKM 23246                                 | 1   | 1   | 1   | 1   |   |   | 1   | 1     |
|  |   |   |   |  | 1   | 1   | 1   |   |   |   |   | 1     |
|  |   |   |   |  | 1   |   |   |   |   |   |   | 1     |
|  |   |   |   |  |   | 1   |   |   |   |   |   |       |

|   |  |  |    |  |  |  |  |  |  |  |  |  |  |
|---|---|---|---|--|---|---|---|---|---|---|---|---|---|
|                                  | DW10TD  | 08/00 → 11/07   |   | VKPC 83639   |   |   |   |   |   | 1   |   |   |   |
|                                  | <b>B(Alt)</b> DW10TD  | 08/00 → 12/07   | AC  | VKMA 33068<br>VKMV 6PK872<br>VKM 33032   | 1   |   | 1   |   |   |   |   |   |   |
|   | <b>B(Alt)</b> DW10TD  | 08/00 → 12/07   | AC  | VKMA 33069<br>VKMV 6PK1156<br>VKM 33032<br>VKM 33069                               | 1   | 1   | 1   |   |   |   |   |   |   |
|                                  | DW10TD  | 08/00 → 02/02   |   | VKM 93301  |   |   |   |   |   | 1   |   |   |   |
|   | DW10TD  | 02/02 → 12/07   |   | VKM_____   |   |   |   |   |   | 1   |   |   |   |
| <b>PEUGEOT  307 2.0 HDi 110</b>  |   |   |   |  |   |   |   |   |   |   |   |   |   |
|                                  | DW10ATED  | 08/00 → 12/07   |    | VKMC 03247<br>VKMA 03247<br>VKM 13244<br>VKM 23246                                 | 1   | 1   | 1   |   | 1   |   |   | 1   | T0168   |
|                                  | DW10ATED  | 08/00 → 11/07   |   | VKPC 83639   |   |   |   |   | 1   |   |   |   |   |
|                                  | <b>B(Alt)</b> DW10ATED  | 08/00 → 12/07   | AC  | VKMA 33068<br>VKMV 6PK872<br>VKM 33032   | 1   |   | 1   |   |   |   |   |   |   |
|   | <b>B(Alt)</b> DW10ATED  | 08/00 → 12/07   | AC  | VKMA 33069<br>VKMV 6PK1156<br>VKM 33032<br>VKM 33069                               | 1   | 1   | 1   |   |   |   |   |   |   |
|                                  | DW10ATED  | 08/00 → 02/02   |   | VKM 93301  |   |   |   |   |   | 1   |   |   |   |
|   | DW10ATED,<br>DW10ATED4  | 02/02 → 12/07   |   | VKM_____   |   |   |   |   |   | 1   |   |   |   |
| <b>PEUGEOT  307 2.0 HDi 136</b> |   |   |   |  |   |   |   |   |   |   |   |   |   |
|                                | DW10BTED4   | 10/03 → 12/07   |   | VKMA 03257<br>VKM 13257<br>VKM 23257   | 1   | 1   | 1   |   |   |   |   |   | T0205   |
|                                | DW10BTED4   | 10/03 → 11/07   |   | VKPC 83643   |   |   |   |   | 1   |   |   |   |   |
|                                | <b>B(Alt)</b> DW10BTED4   | 10/03 → 12/07   |   | VKMA 33320<br>VKMV 6PK1217<br>VKM 33320  | 1   |   | 1   |   |   |   |   |   |   |
|                                | DW10BTED4   | 10/03 → 12/07   |   | VKM_____   |   |   |   |   |   | 1   |   |   |   |
| <b>PEUGEOT  308 1.4 16V</b>    |   |   |   |  |   |   |   |   |   |   |   |   |   |
|                                | EP3   | 09/07 → 11/07   |   | ΟΧΛΟΧΟ   |   |   |   |   |   |   |   |   |   |
|                                | EP3   | 09/07 → 11/07   |   | —  |   |   |   |   | 1   |   |   | 1   |   |
| <b>PEUGEOT  308 1.6 16V</b>    |   |   |   |  |   |   |   |   |   |   |   |   |   |
|                                | EP6, EP6DT  | 09/07 → 12/07   |   | ΟΧΛΟΧΟ   |   |   |   |   |   |   |   |   |   |
|                                | EP6, EP6DT  | 09/07 → 11/07   |   | —  |   |   |   |   | 1   |   |   | 1   |   |
| <b>PEUGEOT  308 1.6 HDi</b>    |   |   |   |  |   |   |   |   |   |   |   |   |   |
|                                | DV6TED4, DV6TED4B   | 09/07 → 11/07   |   | VKMA 03259<br>VKM 13140<br>VKM 23140   | 1   | 1   | 1   |   |   |   |   |   | T0195   |
|                                | DV6TED4, DV6TED4B   | 09/07 → 11/07   |   | VKPC 83259   |   |   |   |   | 1   |   |   |   |   |
| <b>PEUGEOT  308 2.0 HDi</b>    |   |   |   |  |   |   |   |   |   |   |   |   |   |
|                                | DW10BTED4   | 09/07 → 11/07   |   | VKMA 03257<br>VKM 13257<br>VKM 23257   | 1   | 1   | 1   |   |   |   |   |   | T0205   |
|                                | DW10BTED4   | 09/07 → 11/07   |   | VKPC 83643   |   |   |   |   | 1   |   |   |   |   |
|                                | <b>B(Alt)</b> DW10BTED4   | 09/07 → 11/07   |   | VKMV 6PK1217   |   |   | 1   |   |   |   |   |   |   |
| <b>PEUGEOT  309 1.1</b>        |   |   |   |  |   |   |   |   |   |   |   |   |   |
|                                | E1  | 10/85 → 07/89   |   | ΟΧΛΟΧΟ   |   |   |   |   |   |   |   |   |   |
|   | TU1M  | 08/90 → 12/93   |  | VKMC 03100<br>VKMA 03100<br>VKM 13100  | 1   |   | 1   |   | 1   |   |   |   | T0044   |
|   | TU1M  | 08/90 → 12/93   | 3)  | VKMS 03100-1<br>VKMA 03100<br>VKM 13100  | 1   |   | 1   |   |   |   | 2   |   | T0044   |
|                                | E1  | 10/85 → 07/89   |   | VKPC 83206   |   |   |   |   | 1   |   |   |   |   |
|   | TU1M  | 08/90 → 12/93   |   | VKPC 83205   |   |   |   |   | 1   |   |   |   |   |
|                                | <b>B(Alt)</b> E1  | 10/85 → 07/89   |   | VKMV 10AVx775  |   |   | 1   |   |   |   |   |   |   |
|   | <b>B(Alt)</b> TU1M  | 08/90 → 12/93   |   | VKMV 10AVx710  |   |   | 1   |   |   |   |   |   |   |













































PEUGEOT

|   |  |  |          |  |  |  |  |  |  |  |  |  |  |
|---|---|---|---|--|---|---|---|---|---|---|---|---|---|
| <b>B(AC)</b>  | TU1M  | 08/90 → 12/93   |   | VKMA 33112<br>VKMV 4PK810<br>VKM 33012   | 1<br>1<br>1   | 1<br>1  |   |   |   |   |   |   |   |
| <b>PEUGEOT</b>  <b>309 1.3</b>       |   |   |   |  |   |   |   |   |   |   |   |   |   |
|                                       | G1  | 10/85 → 07/89   |   | <del>OXOXOX</del>  |   |   |   |   |   |   |   |   |   |
|                                       | G1  | 10/85 → 07/89   |   | VKPC 83206   |   |   |   | 1   |   |   |   |   |   |
|                                       | <b>B(Alt)</b> G1  | 10/85 → 07/89   |   | VKMV 10AVx775  |   | 1   |   |   |   |   |   |   |   |
| <b>PEUGEOT</b>  <b>309 1.4</b>       |   |   |   |  |   |   |   |   |   |   |   |   |   |
|                                       | TU3A, TU3S  | 03/89 → 12/93   |  101     | VKMA 03111<br>VKM 13100  | 1<br>1  | 1   |   |   |   |   |   |   | T0044   |
|   | TU3A, TU3M, TU3S  | 03/89 → 12/93   | 3),  108 | VKMS 03110-1<br>VKMA 03110<br>VKM 13100  | 1<br>1<br>1   | 1<br>1  |   |   | 2   |   |   |   | T0044   |
|                                       | TU3A  | 03/89 → 12/93   |   | VKPC 83205   |   |   |   | 1   |   |   |   |   |   |
|   | TU3M  | 03/89 → 12/93   | <b>Mot. Cast.</b>   | VKPC 83428   |   |   |   | 1   |   |   |   |   |   |
|   | TU3M, TU3S  | 03/89 → 12/93   | <b>Mot. Alu.</b>  | VKPC 83205   |   |   |   | 1   |   |   |   |   |   |
|                                       | <b>B(Alt)</b> TU3A, TU3M, TU3S  | 03/89 → 07/89   |   | VKMV 10AVx710  |   | 1   |   |   |   |   |   |   |   |
| <b>B(AC)</b>  | TU3A, TU3M, TU3S  | 03/89 → 12/93   |   | VKMA 33112<br>VKMV 4PK810<br>VKM 33012   | 1<br>1<br>1   | 1<br>1  |   |   |   |   |   |   |   |
| <b>PEUGEOT</b>  <b>309 1.6</b>       |   |   |   |  |   |   |   |   |   |   |   |   |   |
|                                       | XU51C, XU52C/K,<br>XU5CP, XU5J, XU5M,<br>XU5M2Z, XU5M3Z                           | 10/85 → 01/92   |   | VKMA 03200<br>VKM 13200  | 1<br>1  | 1   |   |   |   |   |   |   | T0018   |
|   | XU52C/K, XU5M,<br>XU5M2Z, XU5M3Z  | 02/92 → 12/93   |   | VKMA 03201<br>VKM 13100  | 1<br>1  | 1   |   |   |   |   |   |   | T0018   |
|                                     | XU51C, XU52C/K,<br>XU5CP, XU5J, XU5M,<br>XU5M2Z, XU5M3Z                           | 10/85 → 01/92   |   | VKPC 83401   |   |   |   | 1   |   |   |   |   |   |
|   | XU52C/K, XU5M,<br>XU5M2Z, XU5M3Z  | 01/92 → 12/93   |   | VKPC 83615   |   |   |   | 1   |   |   |   |   |   |
|                                     | <b>B(Alt)</b> XU51C, XU52C/K,<br>XU5CP, XU5J, XU5M,<br>XU5M2Z, XU5M3Z             | 10/85 → 12/93   |        | VKMV 4PK698  |   | 1   |   |   |   |   |   |   |   |
| <b>B(Alt)</b>   | XU51C, XU52C/K,<br>XU5CP, XU5J, XU5M,<br>XU5M2Z, XU5M3Z                           | 10/85 → 12/93   |        | VKMV 4PK954  |   | 1   |   |   |   |   |   |   |   |
| <b>B(AC)</b>  | XU51C, XU52C/K,<br>XU5CP, XU5J, XU5M,<br>XU5M2Z, XU5M3Z                           | 10/85 → 12/93   |   | VKMA 33010<br>VKMV 4PK841<br>VKM 33010   | 1<br>1<br>1   | 1<br>1  |   |   |   |   |   |   |   |
| <b>PEUGEOT</b>  <b>309 1.9</b>     |   |   |   |  |   |   |   |   |   |   |   |   |   |
|                                     | XU9J1, XU9JA, XU9JAZ,<br>XU9M, XU9S   | 10/85 → 01/92   |   | VKMA 03200<br>VKM 13200  | 1<br>1  | 1   |   |   |   |   |   |   | T0018   |
|   | XU9J1, XU9JAZ, XU9M   | 02/92 → 12/93   |   | VKMA 03201<br>VKM 13100  | 1<br>1  | 1   |   |   |   |   |   |   | T0018   |
|                                     | XU9J1, XU9JA, XU9JAZ,<br>XU9M, XU9S   | 10/85 → 01/92   |   | VKPC 83401   |   |   |   | 1   |   |   |   |   |   |
|   | XU9J1, XU9JAZ, XU9M   | 01/92 → 12/93   |   | VKPC 83615   |   |   |   | 1   |   |   |   |   |   |
|                                     | <b>B(Alt)</b> XU9J1, XU9JA, XU9JAZ,<br>XU9M, XU9S                                 | 10/85 → 12/93   |        | VKMV 4PK698  |   | 1   |   |   |   |   |   |   |   |
| <b>B(Alt)</b>   | XU9J1, XU9JA, XU9JAZ,<br>XU9M, XU9S   | 10/85 → 12/93   |        | VKMV 4PK954  |   | 1   |   |   |   |   |   |   |   |
| <b>B(AC)</b>  | XU9J1, XU9JA, XU9JAZ,<br>XU9M, XU9S   | 10/85 → 12/93   |   | VKMA 33010<br>VKMV 4PK841<br>VKM 33010   | 1<br>1<br>1   | 1<br>1  |   |   |   |   |   |   |   |
| <b>PEUGEOT</b>  <b>309 1.9 16V</b> |   |   |   |  |   |   |   |   |   |   |   |   |   |
|                                     | XU9J4   | 08/89 → 12/93   |   | VKMA 03210<br>VKM 13210<br>VKM 13210   | 2<br>1<br>1   | 1   |   |   |   |   |   |   | T0064   |

|  |  |  |   |  |  |  |  |  |  |  |  |  |  |
|--|---|---|--|--|---|---|---|---|---|---|---|---|---|
|                             | XU9J4   | 08/89 → 12/93   |  | VKPC 83615   |   |   |   |   |   | 1   |   |   |   |
|                             | B(PS) XU9J4   | 08/89 → 12/93   |  | VKVM 10AVx550  |   |   | 1   |   |   |   |   |   |   |
| <b>PEUGEOT  309 1.8 D</b>   |   |   |  |  |   |   |   |   |   |   |   |   |   |
|                             | XUD7  | 07/89 → 12/93   |   | VKMC 03240<br>VKMA 03240<br>VKM 13240<br>VKM 23240                                 | 1<br>1<br>1<br>1  | 1<br>1<br>1<br>1  | 1<br>1<br>1<br>1  |   |   | 1   |   | 2<br>2  | T0017   |
|  | XUD7  | 07/89 → 12/93   | 3)   | VKMS 03240<br>VKMA 03240<br>VKM 13240<br>VKM 23240                                 | 1<br>1<br>1<br>1  | 1<br>1<br>1<br>1  | 1<br>1<br>1<br>1  |   |   |   |   | 2<br>2  | T0017   |
|                             | XUD7  | 07/89 → 12/93   |  | VKPC 83424   |   |   |   |   |   | 1   |   |   |   |
|                             | B(Alt) XUD7   | 07/89 → 12/93   | 34), AC  | VKVM 4PK698  |   |   | 1   |   |   |   |   |   |   |
|  | B(Alt) XUD7   | 07/89 → 12/93   | 33), AC  | VKVM _____   |   |   | 1   |   |   |   |   |   |   |
|  | B(Alt) XUD7   | 07/89 → 12/93   |  ,  , AC     | VKMA 33106<br>VKMV 4PK1230<br>VKM 33006<br>VKM 33010                               | 1<br>1<br>1<br>1  | 1<br>1<br>1<br>1  | 1<br>1<br>1<br>1  |   |   |   |   |   |   |
|  | B(Alt) XUD7   | 07/89 → 12/93   |  ,  , AC     | VKVM _____<br>VKM 33006<br>VKM 33010   | 1<br>1<br>1   | 1<br>1<br>1   | 1<br>1<br>1   |   |   |   |   |   |   |
|  | B(PS) XUD7  | 07/89 → 06/91   |  | VKVM 10AVx613  |   |   | 1   |   |   |   |   |   |   |
|  | B(PS) XUD7  | 06/91 → 12/93   |  | VKVM 10AVx650  |   |   | 1   |   |   |   |   |   |   |
|  | B(VP) XUD7  | 07/89 → 12/93   |  | VKVM 10AVx550  |   |   | 1   |   |   |   |   |   |   |
|                             | XUD7  | 07/89 → 12/93   |  | —  |   |   |   |   |   | 1   |   |   |   |
| <b>PEUGEOT  309 1.8 TD</b> |   |   |  |  |   |   |   |   |   |   |   |   |   |
|                           | XUD7TE  | 08/89 → 12/93   |   | VKMC 03240<br>VKMA 03240<br>VKM 13240<br>VKM 23240                                 | 1<br>1<br>1<br>1  | 1<br>1<br>1<br>1  | 1<br>1<br>1<br>1  |   |   | 1   |   | 2<br>2  | T0017   |
|  | XUD7TE  | 08/89 → 12/93   | 3)   | VKMS 03240<br>VKMA 03240<br>VKM 13240<br>VKM 23240                                 | 1<br>1<br>1<br>1  | 1<br>1<br>1<br>1  | 1<br>1<br>1<br>1  |   |   |   |   | 2<br>2  | T0017   |
|                           | XUD7TE  | 08/89 → 12/93   |  | VKPC 83424   |   |   |   |   |   | 1   |   |   |   |
|                           | B(Alt) XUD7TE   | 08/89 → 12/93   | 34), AC  | VKVM 4PK698  |   |   | 1   |   |   |   |   |   |   |
|  | B(Alt) XUD7TE   | 08/89 → 12/93   | 33), AC  | VKVM _____   |   |   | 1   |   |   |   |   |   |   |
|  | B(Alt) XUD7TE   | 08/89 → 12/93   |  ,  , AC | VKMA 33106<br>VKMV 4PK1230<br>VKM 33006<br>VKM 33010                               | 1<br>1<br>1<br>1  | 1<br>1<br>1<br>1  | 1<br>1<br>1<br>1  |   |   |   |   |   |   |
|  | B(Alt) XUD7TE   | 08/89 → 12/93   |  ,  , AC | VKVM _____<br>VKM 33006<br>VKM 33010   | 1<br>1<br>1   | 1<br>1<br>1   | 1<br>1<br>1   |   |   |   |   |   |   |
|  | B(PS) XUD7TE  | 08/89 → 12/93   |  | VKVM 10AVx650  |   |   | 1   |   |   |   |   |   |   |
|  | B(VP) XUD7TE  | 08/89 → 12/93   |  | VKVM 10AVx600  |   |   | 1   |   |   |   |   |   |   |
| <b>PEUGEOT  309 1.9 D</b> |   |   |  |  |   |   |   |   |   |   |   |   |   |
|                           | XUD9, XUD9Y   | 10/86 → 12/93   |   | VKMC 03240<br>VKMA 03240<br>VKM 13240<br>VKM 23240                                 | 1<br>1<br>1<br>1  | 1<br>1<br>1<br>1  | 1<br>1<br>1<br>1  |   |   | 1   |   | 2<br>2  | T0017   |
|  | XUD9, XUD9Y   | 06/86 → 12/93   | 3)   | VKMS 03240<br>VKMA 03240<br>VKM 13240<br>VKM 23240                                 | 1<br>1<br>1<br>1  | 1<br>1<br>1<br>1  | 1<br>1<br>1<br>1  |   |   |   |   | 2<br>2  | T0017   |
|                           | XUD9  | 06/86 → 10/86   |  | VKPC 83401   |   |   |   |   |   | 1   |   |   |   |
|  | XUD9, XUD9Y   | 10/86 → 12/93   |  | VKPC 83424   |   |   |   |   |   | 1   |   |   |   |
|                           | B(Alt) XUD9, XUD9Y  | 06/86 → 12/93   | 34), AC  | VKVM 4PK698  |   |   | 1   |   |   |   |   |   |   |
|  | B(Alt) XUD9, XUD9Y  | 06/86 → 12/93   | 33), AC  | VKVM _____   |   |   | 1   |   |   |   |   |   |   |
|  | B(Alt) XUD9   | 06/86 → 04/89   |  ,  , AC | VKVM 4PK1230<br>VKM 33010<br>VKM 33091   | 1<br>1<br>1   | 1<br>1<br>1   | 1<br>1<br>1   |   |   |   |   |   |   |



PEUGEOT

|   |  |  |   |  |  |  |  |  |  |  |  |  |  |  |
|---|---|---|--|--|---|---|---|---|---|---|---|---|---|---|
| <b>B(Alt)</b>   | XUD9  | 06/86 → 04/89   |  ,  , AC | VKMOV____<br>VKM 33010<br>VKM 33091  | 1   | 1   |   |   |   |   |   |   |   |   |
| <b>B(Alt)</b>   | XUD9, XUD9Y   | 04/89 → 12/93   |  ,  , AC | VKMA 33106<br>VKMV 4PK1230<br>VKM 33006<br>VKM 33010                               | 1   | 1   | 1   |   |   |   |   |   |   |   |
| <b>B(Alt)</b>   | XUD9, XUD9Y   | 04/89 → 12/93   |  ,  , AC | VKMOV____<br>VKM 33006<br>VKM 33010  | 1   | 1   |   |   |   |   |   |   |   |   |
| <b>B(PS)</b>  | XUD9, XUD9Y   | 06/86 → 06/91   |  | VKMOV 10AVx613   |   |   | 1   |   |   |   |   |   |   |   |
| <b>B(PS)</b>  | XUD9, XUD9Y   | 06/91 → 12/93   |  | VKMOV 10AVx650   |   |   | 1   |   |   |   |   |   |   |   |
| <b>B(VP)</b>  | XUD9, XUD9Y   | 06/86 → 12/93   |  | VKMOV 10AVx550   |   |   | 1   |   |   |   |   |   |   |   |
|                               | XUD9, XUD9Y   | 06/86 → 12/93   |  | —  |   |   |   |   |   | 1   |   |   |   |   |
| <b>PEUGEOT  4007 2.2 HDi</b> |   |   |  |  |   |   |   |   |   |   |   |   |   |   |
|                               | DW12MTED4   | 02/07 → 12/07   |  | —  | 1   | 1   | 1   |   |   |   |   |   |   |   |
|   | DW12MTED4   | 02/07 → 12/07   |  | —  | 1   |   |   |   |   | 1   |   |   |   |   |
|                               | DW12MTED4   | 02/07 → 12/07   |  | —  |   |   |   |   |   | 1   |   |   |   |   |
| <b>PEUGEOT  404 1.6</b>      |   |   |  |  |   |   |   |   |   |   |   |   |   |   |
|                               | THW, XB, XC, XC6  | 04/63 → 12/71   | Auto.FAN   | VKPC 83612   |   |   |   |   |   | 1   |   |   |   |   |
| <b>PEUGEOT  405 I 1.4</b>    |   |   |  |  |   |   |   |   |   |   |   |   |   |   |
|                               | TU3, TU3A   | 01/87 → 07/92   | 3),  108  | VKMS 03110-1<br>VKMA 03110<br>VKM 13100  | 1   | 1   |   |   |   |   | 2   |   |   | T0044   |
|   | TU3F2   | 01/87 → 07/92   |  101  | VKMA 03111<br>VKM 13100  | 1   | 1   |   |   |   |   |   |   |   | T0044   |
|                             | TU3, TU3A   | 01/87 → 07/92   |  | VKPC 83205   |   |   |   |   |   | 1   |   |   |   |   |
|   | TU3F2   | 01/87 → 07/92   |  | VKPC 83428   |   |   |   |   |   | 1   |   |   |   |   |
|                             | <b>B(Alt)</b> TU3, TU3A, TU3F2  | 01/87 → 07/92   |  | VKMOV 10AVx710   |   |   | 1   |   |   |   |   |   |   |   |
| <b>PEUGEOT  405 I 1.6</b>  |   |   |  |  |   |   |   |   |   |   |   |   |   |   |
|                             | XU51C, XU5CP, XU5M,<br>XU5M2Z, XU5M3Z   | 01/87 → 01/92   |  | VKMA 03200<br>VKM 13200  | 1   | 1   |   |   |   |   |   |   |   | T0018   |
|   | XU51C, XU5CP, XU5M,<br>XU5M2Z, XU5M3Z   | 01/92 → 12/92   |  | VKMA 03201<br>VKM 13100  | 1   | 1   |   |   |   |   |   |   |   | T0018   |
|                             | XU51C, XU5CP, XU5M,<br>XU5M2Z, XU5M3Z   | 01/87 → 01/92   |  | VKPC 83401   |   |   |   |   |   | 1   |   |   |   |   |
|   | XU51C, XU5CP, XU5M,<br>XU5M2Z, XU5M3Z   | 01/92 → 12/92   |  | VKPC 83615   |   |   |   |   |   | 1   |   |   |   |   |
|                             | <b>B(Alt)</b> XU51C, XU5CP, XU5M,<br>XU5M2Z, XU5M3Z                               | 07/87 → 12/92   |   | VKMOV 4PK698   |   |   | 1   |   |   |   |   |   |   |   |
| <b>B(Alt)</b>   | XU51C, XU5CP, XU5M,<br>XU5M2Z, XU5M3Z   | 07/87 → 12/92   |   | VKMOV 4PK954   |   |   | 1   |   |   |   |   |   |   |   |
| <b>B(AC)</b>  | XU51C, XU5CP, XU5M,<br>XU5M2Z, XU5M3Z   | 07/87 → 12/92   |  | VKMA 33010<br>VKMV 4PK841<br>VKM 33010   | 1   | 1   |   |   |   |   |   |   |   |   |
| <b>PEUGEOT  405 I 1.9</b>  |   |   |  |  |   |   |   |   |   |   |   |   |   |   |
|                             | XU92C, XU9J1, XU9JAZ,<br>XU9M   | 06/87 → 01/92   |  | VKMA 03200<br>VKM 13200  | 1   | 1   |   |   |   |   |   |   |   | T0018   |
|   | XU92C, XU9J1, XU9JAZ,<br>XU9M   | 01/92 → 12/93   |  | VKMA 03201<br>VKM 13100  | 1   | 1   |   |   |   |   |   |   |   | T0018   |
|   | XU9J1   | 02/92 → 12/92   |  | VKMA 03201<br>VKM 13100  | 1   | 1   |   |   |   |   |   |   |   | T0018   |
|                             | XU92C, XU9J1, XU9JAZ,<br>XU9M   | 06/87 → 01/92   |  | VKPC 83401   |   |   |   |   |   | 1   |   |   |   |   |
|   | XU92C, XU9J1, XU9JAZ,<br>XU9M   | 01/92 → 12/93   |  | VKPC 83615   |   |   |   |   |   | 1   |   |   |   |   |
|   | XU9J1   | 07/87 → 12/92   | → ICH 70521462   | VKPC 83401   |   |   |   |   |   | 1   |   |   |   |   |
|   | XU9J1   | 07/87 → 12/92   | CH 70521463 I→   | VKPC 83615   |   |   |   |   |   | 1   |   |   |   |   |
|                             | <b>B(Alt)</b> XU92C, XU9J1, XU9JAZ,<br>XU9M                                       | 07/87 → 12/93   |   | VKMOV 4PK698   |   |   | 1   |   |   |   |   |   |   |   |





























|                               | <b>B(Alt)</b> | XU92C, XU9J1, XU9JAZ, XU9M | 07/87 → 12/93 |                                 | VKMV 4PK954  |                  |        |        | 1 |  |   |   |  |   |  |  |  |  |        |       |       |
|-------------------------------|---------------|----------------------------|---------------|---------------------------------|--|------------------|--------|--------|---|--|---|---|--|---|--|--|--|--|--------|-------|-------|
|                               | <b>B(AC)</b>  | XU92C, XU9J1, XU9JAZ, XU9M | 07/87 → 12/93 |                                 | VKMA 33010<br>VKMV 4PK841<br>VKM 33010             | 1                |        |        | 1 |  |   |   |  |   |  |  |  |  |        |       |       |
| <b>PEUGEOT  405   1.9 16V</b> |               |                            |               |                                 |  |                  |        |        |   |  |   |   |  |   |  |  |  |  |        |       |       |
|                               |               | XU9J4, XU9J4Z              | 07/87 → 12/92 |                                 | VKMA 03210<br>VKM 13210<br>VKM 13210               | 2<br>1<br>1      |        |        | 1 |  |   |   |  |   |  |  |  |  |        | T0064 |       |
|                               |               | XU9J4, XU9J4Z              | 07/87 → 12/92 |                                 | VKPC 83615   |                  |        |        |   |  |   | 1 |  |   |  |  |  |  |        |       |       |
|                               | <b>B(Alt)</b> | XU9J4, XU9J4Z              | 07/87 → 12/92 | <b>AC</b> , → ICH 8077225       | VKMV 5PK1010<br>VKM 33010                          | 1                |        |        | 1 |  |   |   |  |   |  |  |  |  |        |       |       |
|                               | <b>B(Alt)</b> | XU9J4, XU9J4Z              | 07/87 → 12/92 | <b>AC</b> , CH 8077226 I→       | VKMV 5PK1270<br>VKM 33001                          | 1                |        |        | 1 |  |   |   |  |   |  |  |  |  |        |       |       |
|                               | <b>B(PS)</b>  | XU9J4, XU9J4Z              | 07/87 → 12/92 |                                 | VKMV 10AVx550                                      |                  |        |        | 1 |  |   |   |  |   |  |  |  |  |        |       |       |
| <b>PEUGEOT  405   1.8 TD</b>  |               |                            |               |                                 |  |                  |        |        |   |  |   |   |  |   |  |  |  |  |        |       |       |
|                               |               | XUD7TE, XUD7TEY            | 03/88 → 12/92 |                                 | VKMC 03240<br>VKMA 03240<br>VKM 13240<br>VKM 23240 | 1<br>1<br>1<br>1 | 1<br>1 | 1<br>1 |   |  | 1 |   |  |   |  |  |  |  | 2<br>2 | T0017 |       |
|                               |               | XUD7TE, XUD7TEY            | 03/88 → 12/92 | 3)                              | VKMS 03240<br>VKMA 03240<br>VKM 13240<br>VKM 23240 | 1<br>1<br>1<br>1 | 1<br>1 | 1<br>1 |   |  |   |   |  | 2 |  |  |  |  | 2      |       | T0017 |
|                               |               | XUD7TE, XUD7TEY            | 03/88 → 12/92 |                                 | VKPC 83424   |                  |        |        |   |  | 1 |   |  |   |  |  |  |  |        |       |       |
|                               | <b>B(Alt)</b> | XUD7TE, XUD7TEY            | 03/88 → 12/92 | → IMot. 8424517                 | VKMV 5PK1230<br>VKM 33006<br>VKM 33091             |                  |        |        | 1 |  |   |   |  |   |  |  |  |  |        |       |       |
|                               | <b>B(Alt)</b> | XUD7TE, XUD7TEY            | 03/88 → 12/92 | <b>AC</b> , , CH 8424518 I→     | VKM 33006<br>VKM 33010                             | 1                |        |        | 1 |  |   |   |  |   |  |  |  |  |        |       |       |
|                               | <b>B(PS)</b>  | XUD7TE, XUD7TEY            | 03/88 → 12/92 | <b>CH</b> 70514985 I→           | VKMA 33202<br>VKMV 6PK1130<br>VKM 33002            | 1                |        |        | 1 |  |   |   |  |   |  |  |  |  |        |       |       |
|                               | <b>B(PS)</b>  | XUD7TE, XUD7TEY            | 10/88 → 08/92 | → IMot. 8424517                 | VKMV 5PK1230<br>VKM 33006<br>VKM 33091             |                  |        |        | 1 |  |   |   |  |   |  |  |  |  |        |       |       |
|                               | <b>B(VP)</b>  | XUD7TE, XUD7TEY            | 03/88 → 12/92 |                                 | VKMV 10AVx650                                      |                  |        |        | 1 |  |   |   |  |   |  |  |  |  |        |       |       |
|                               | <b>B(VP)</b>  | XUD7TE, XUD7TEY            | 03/88 → 12/92 |                                 | VKMV 10AVx550                                      |                  |        |        | 1 |  |   |   |  |   |  |  |  |  |        |       |       |
|                               |               | XUD7TE, XUD7TEY            | 03/88 → 12/92 | <b>AC</b>                       | VKM 93302  |                  |        |        |   |  |   | 1 |  |   |  |  |  |  |        |       |       |
| <b>PEUGEOT  405   1.9 D</b>   |               |                            |               |                                 |  |                  |        |        |   |  |   |   |  |   |  |  |  |  |        |       |       |
|                               |               | XUD9A, XUD9Y               | 03/88 → 12/92 |                                 | VKMC 03240<br>VKMA 03240<br>VKM 13240<br>VKM 23240 | 1<br>1<br>1<br>1 | 1<br>1 | 1<br>1 |   |  | 1 |   |  |   |  |  |  |  | 2<br>2 | T0017 |       |
|                               |               | XUD9A, XUD9Y               | 03/88 → 12/92 | 3)                              | VKMS 03240<br>VKMA 03240<br>VKM 13240<br>VKM 23240 | 1<br>1<br>1<br>1 | 1<br>1 | 1<br>1 |   |  |   |   |  | 2 |  |  |  |  | 2      |       | T0017 |
|                               |               | XUD9A, XUD9Y               | 03/88 → 12/92 |                                 | VKPC 83424   |                  |        |        |   |  | 1 |   |  |   |  |  |  |  |        |       |       |
|                               | <b>B(Alt)</b> | XUD9A, XUD9Y               | 03/88 → 12/92 | <b>AC</b> , , → ICH 8424517     | VKM 33010  | 1                |        |        |   |  |   |   |  |   |  |  |  |  |        |       |       |
|                               | <b>B(Alt)</b> | XUD9A, XUD9Y               | 03/88 → 12/92 | <b>AC</b> , , CH 8424518 I→     | VKM 33006<br>VKM 33010                             | 1                |        |        | 1 |  |   |   |  |   |  |  |  |  |        |       |       |
|                               | <b>B(PS)</b>  | XUD9A, XUD9Y               | 03/88 → 12/92 | <b>CH</b> 70514985 I→           | VKMA 33202<br>VKMV 6PK1130<br>VKM 33002            | 1                |        |        | 1 |  |   |   |  |   |  |  |  |  |        |       |       |
|                               | <b>B(PS)</b>  | XUD9A                      | 10/88 → 08/92 | <b>AC</b> , ,<br>CH 70514985 I→ | VKMA 33202<br>VKMV 6PK1130<br>VKM 33002            | 1                |        |        | 1 |  |   |   |  |   |  |  |  |  |        |       |       |
|                               | <b>B(VP)</b>  | XUD9A, XUD9Y               | 03/88 → 12/92 |                                 | VKMV 10AVx650                                      |                  |        |        | 1 |  |   |   |  |   |  |  |  |  |        |       |       |
|                               | <b>B(VP)</b>  | XUD9A, XUD9Y               | 03/88 → 12/92 |                                 | VKMV 10AVx550                                      |                  |        |        | 1 |  |   |   |  |   |  |  |  |  |        |       |       |
|                               |               | XUD9A, XUD9Y               | 03/88 → 12/92 | <b>AC</b> ,                     | —  |                  |        |        |   |  |   |   |  | 1 |  |  |  |  |        |       |       |
|                               |               | XUD9A, XUD9Y               | 03/88 → 12/92 | <b>AC</b> ,                     | VKM 93302  |                  |        |        |   |  |   |   |  | 1 |  |  |  |  |        |       |       |









































PEUGEOT



























| <b>PEUGEOT</b> <b>405 II 1.4</b>     |                            |               |   |             |        |  |   |  |  |  |  |  |  |  |       |
|--------------------------------------|----------------------------|---------------|---|-------------|--------|--|---|--|--|--|--|--|--|--|-------|
|                                      | TU3-2, TU3MC               | 08/92 → 10/96 | VKMA 03111<br>VKM 13100                                       | 1<br>1      | 1      |  |   |  |  |  |  |  |  |  | T0044 |
|                                      | TU3-2, TU3MC               | 08/92 → 10/96 | VKPC 83428  |             |        |  | 1 |  |  |  |  |  |  |  |       |
|                                      | <b>B(Alt)</b> TU3-2, TU3MC | 08/92 → 10/96 | VKMOV 10AVx710  |             | 1      |  |   |  |  |  |  |  |  |  |       |
| <b>PEUGEOT</b> <b>405 II 1.6</b>     |                            |               |   |             |        |  |   |  |  |  |  |  |  |  |       |
|                                      | XU52C, XU5JP, XU5M         | 08/92 → 10/96 | VKMA 03201<br>VKM 13100                                       | 1<br>1      | 1      |  |   |  |  |  |  |  |  |  | T0018 |
|                                      | XU52C, XU5JP, XU5M         | 08/92 → 10/96 | VKPC 83615  |             |        |  | 1 |  |  |  |  |  |  |  |       |
|                                      | <b>B(Alt)</b> XU52C, XU5M  | 08/92 → 10/96 | ∅<br>VKMV 4PK698  |             | 1      |  |   |  |  |  |  |  |  |  |       |
|                                      | <b>B(Alt)</b> XU52C, XU5M  | 08/92 → 10/96 | ⊖<br>VKMV 4PK954  |             | 1      |  |   |  |  |  |  |  |  |  |       |
|                                      | <b>B(Alt)</b> XU5JP        | 08/92 → 10/96 | AC, ∅<br>VKMV 6PK698  |             | 1      |  |   |  |  |  |  |  |  |  |       |
|                                      | <b>B(Alt)</b> XU5JP        | 08/92 → 10/96 | AC, ∅<br>VKMV 6PK1094<br>VKM 33003                            | 1           | 1      |  |   |  |  |  |  |  |  |  |       |
|                                      | <b>B(Alt)</b> XU5JP        | 08/92 → 10/96 | ∅ 70A, AC, ⊖<br>VKMV 6PK1067<br>VKM 33003                     | 1           | 1      |  |   |  |  |  |  |  |  |  |       |
|                                      | <b>B(Alt)</b> XU5JP        | 08/92 → 10/96 | ∅ 80, 90A, AC, ⊖<br>VKMA 33003<br>VKMV 6PK1076<br>VKM 33003   | 1<br>1      | 1<br>1 |  |   |  |  |  |  |  |  |  |       |
|                                      | <b>B(Alt)</b> XU5JP        | 08/92 → 10/96 | AC, ⊖<br>VKMA 33030<br>VKMV 6PK1660<br>VKM 33028<br>VKM 33034 | 1<br>1      | 1<br>1 |  |   |  |  |  |  |  |  |  |       |
|                                      | <b>B(AC)</b> XU52C, XU5M   | 08/92 → 10/96 | VKMA 33010<br>VKMV 4PK841<br>VKM 33010                        | 1<br>1      | 1<br>1 |  |   |  |  |  |  |  |  |  |       |
| <b>PEUGEOT</b> <b>405 II 1.8</b>     |                            |               |   |             |        |  |   |  |  |  |  |  |  |  |       |
|                                      | XU7JP                      | 08/92 → 10/96 | VKMA 03201<br>VKM 13100                                       | 1<br>1      | 1      |  |   |  |  |  |  |  |  |  | T0018 |
|                                      | XU7JP                      | 08/92 → 10/96 | VKPC 83615  |             |        |  | 1 |  |  |  |  |  |  |  |       |
|                                      | <b>B(Alt)</b> XU7JP        | 08/92 → 10/96 | AC, ∅<br>VKMV 6PK698  |             | 1      |  |   |  |  |  |  |  |  |  |       |
|                                      | <b>B(Alt)</b> XU7JP        | 08/92 → 10/96 | AC, ∅<br>VKMV 6PK1094<br>VKM 33003                            | 1           | 1      |  |   |  |  |  |  |  |  |  |       |
|                                      | <b>B(Alt)</b> XU7JP        | 08/92 → 10/96 | ∅ 70A, AC, ⊖<br>VKMV 6PK1067<br>VKM 33003                     | 1           | 1      |  |   |  |  |  |  |  |  |  |       |
|                                      | <b>B(Alt)</b> XU7JP        | 08/92 → 10/96 | ∅ 80, 90A, AC, ⊖<br>VKMA 33003<br>VKMV 6PK1076<br>VKM 33003   | 1<br>1      | 1<br>1 |  |   |  |  |  |  |  |  |  |       |
|                                      | <b>B(Alt)</b> XU7JP        | 08/92 → 10/96 | AC, ⊖<br>VKMA 33030<br>VKMV 6PK1660<br>VKM 33028<br>VKM 33034 | 1<br>1      | 1<br>1 |  |   |  |  |  |  |  |  |  |       |
| <b>PEUGEOT</b> <b>405 II 2.0</b>     |                            |               |   |             |        |  |   |  |  |  |  |  |  |  |       |
|                                      | XU10J2                     | 08/92 → 10/96 | VKMA 03201<br>VKM 13100                                       | 1<br>1      | 1      |  |   |  |  |  |  |  |  |  | T0018 |
|                                      | XU10J2                     | 08/92 → 10/96 | VKPC 83420  |             |        |  | 1 |  |  |  |  |  |  |  |       |
|                                      | <b>B(Alt)</b> XU10J2       | 08/92 → 10/96 | AC, ∅<br>VKMV 6PK1094<br>VKM 33003                            | 1           | 1      |  |   |  |  |  |  |  |  |  |       |
|                                      | <b>B(Alt)</b> XU10J2       | 08/92 → 10/96 | ∅ 120, 90A, AC, ⊖<br>VKMA 33003<br>VKMV 6PK1076<br>VKM 33003  | 1<br>1      | 1<br>1 |  |   |  |  |  |  |  |  |  |       |
|                                      | <b>B(Alt)</b> XU10J2       | 08/92 → 10/96 | ∅ 50, 70, 80A, AC, ⊖<br>VKMV 6PK1067<br>VKM 33003             | 1           | 1      |  |   |  |  |  |  |  |  |  |       |
|                                      | <b>B(Alt)</b> XU10J2       | 08/92 → 10/96 | AC, ⊖<br>VKMA 33030<br>VKMV 6PK1660<br>VKM 33028<br>VKM 33034 | 1<br>1      | 1<br>1 |  |   |  |  |  |  |  |  |  |       |
| <b>PEUGEOT</b> <b>405 II 2.0 16V</b> |                            |               |   |             |        |  |   |  |  |  |  |  |  |  |       |
|                                      | XU10J4, XU10J4Z            | 08/92 → 10/95 | VKMA 03211<br>VKM 13210<br>VKM 13211                          | 2<br>1<br>1 | 1      |  |   |  |  |  |  |  |  |  | T0118 |
|                                      | XU10J4, XU10J4Z            | 08/92 → 10/95 | VKPC 83420  |             |        |  | 1 |  |  |  |  |  |  |  |       |

|   |  |  |  |   |  |  |  |  |  |  |  |  |       |
|---|---|---|---|---|---|---|---|---|---|---|---|---|-------|
|                                      | B(Alt)  | XU10J4  | 08/92 → 10/95   | AC, ⊗   | VKMV 6PK1094<br>VKM 33003   | 1   |   | 1   |   |   |   |   |       |
|   | B(Alt)  | XU10J4, XU10J4Z   | 08/92 → 10/95   | ⊗ 120, 90A, AC, ⊗   | VKMA 33003<br>VKMV 6PK1076<br>VKM 33003   | 1   |   | 1   |   |   |   |   |       |
|   | B(Alt)  | XU10J4  | 08/92 → 10/95   | ⊗ 70, 80A, AC, ⊗  | VKMV 6PK1067<br>VKM 33003   | 1   |   | 1   |   |   |   |   |       |
|   | B(Alt)  | XU10J4  | 08/92 → 10/95   | AC, ⊗   | VKMA 33030<br>VKMV 6PK1660<br>VKM 33028<br>VKM 33034                                | 1   | 1   | 1   |   |   |   |   |       |
| <b>PEUGEOT  405 II 2.0 Turbo 16V</b> |   |   |   |   |   |   |   |   |   |   |   |   |       |
|                                      |   | XU10J4TE  | 08/92 → 10/95   |   | VKMA 03211<br>VKM 13210<br>VKM 13211  | 2<br>1<br>1   |   | 1   |   |   |   | T0118   |       |
|                                      |   | XU10J4TE  | 08/92 → 10/95   |   | VKPC 83420  |   |   |   | 1   |   |   |   |       |
|                                      | B(Alt)  | XU10J4TE  | 08/92 → 10/95   | ⊗ 70, 80A, AC   | VKMV 6PK1067<br>VKM 33003   | 1   |   | 1   |   |   |   |   |       |
|   | B(Alt)  | XU10J4TE  | 08/92 → 10/95   | ⊗ 120, 90A, AC, ⊗   | VKMA 33003<br>VKMV 6PK1076<br>VKM 33003   | 1   |   | 1   |   |   |   |   |       |
|   | B(Alt)  | XU10J4TE  | 08/92 → 10/95   | AC, ⊗   | VKMA 33030<br>VKMV 6PK1660<br>VKM 33028<br>VKM 33034                                | 1   | 1   | 1   |   |   |   |   |       |
| <b>PEUGEOT  405 II 1.9 D</b>        |   |   |   |   |   |   |   |   |   |   |   |   |       |
|                                    |   | XUD9Y   | 08/92 → 01/94   |  | VKMC 03240<br>VKMA 03240<br>VKM 13240<br>VKM 23240                                  | 1<br>1<br>1<br>1  | 1<br>1<br>1   | 1   |   | 1   |   | 2<br>2  | T0017 |
|   |   | XUD9A, XUD9Y  | 01/94 → 10/96   |  | VKMC 03241<br>VKMA 03241<br>VKM 13241<br>VKM 23241                                  | 1<br>1<br>1<br>1  | 1<br>1<br>1   | 1   |   | 1   |   |   | T0017 |
|   |   | XUD9Y   | 08/92 → 01/94   | 3)  | VKMS 03240<br>VKMA 03240<br>VKM 13240<br>VKM 23240                                  | 1<br>1<br>1<br>1  | 1<br>1<br>1   |   |   |   |   | 2<br>2  | T0017 |
|   |   | XUD9A, XUD9Y  | 01/94 → 10/96   | 3)  | VKMS 03241<br>VKMA 03241<br>VKM 13241<br>VKM 23241                                  | 1<br>1<br>1<br>1  | 1<br>1<br>1   |   |   |   |   | 2   | T0017 |
|                                    |   | XUD9, XUD9Y   | 08/92 → 01/94   |   | VKPC 83424  |   |   |   | 1   |   |   |   |       |
|   |   | XUD9, XUD9A, XUD9Y  | 01/94 → 10/96   |   | VKPC 83420  |   |   |   | 1   |   |   |   |       |
|                                    | B(Alt)  | XUD9A, XUD9Y  | 08/92 → 10/96   | AC, ⊗   | VKMV 6PK730   |   |   | 1   |   |   |   |   |       |
|   | B(Alt)  | XUD9A, XUD9Y  | 08/92 → 10/96   | AC, ⊗   | VKMV 6PK1170<br>VKM 33002   | 1   |   | 1   |   |   |   |   |       |
|   | B(Alt)  | XUD9A, XUD9Y  | 08/92 → 10/96   | AC, ⊗,<br>→ ICH 70980931  | VKMA 33202<br>VKMV 6PK1130<br>VKM 33002   | 1<br>1  |   | 1<br>1  |   |   |   |   |       |
|   | B(Alt)  | XUD9A, XUD9Y  | 08/92 → 10/96   | AC, ⊗,<br>CH 70980932 I →   | VKMV 6PK1146<br>VKM 33002   | 1   |   | 1   |   |   |   |   |       |
|   | B(Alt)  | XUD9Y   | 08/92 → 02/94   | AC, ⊗   | VKMV 6PK1700<br>VKM 33002<br>VKM 33040  | 1<br>1  |   | 1   |   |   |   |   |       |
|   | B(Alt)  | XUD9A, XUD9Y  | 02/94 → 10/96   | AC, ⊗   | VKMV 6PK1700<br>VKM 33002<br>VKM 33008<br>VKM 33040                                 | 1<br>1  |   | 1<br>1  |   |   |   |   |       |
|                                    |   | XUD9A, XUD9Y  | 08/92 → 10/96   |   | VKM 93302   |   |   |   |   | 1   |   |   |       |
| <b>PEUGEOT  405 II 1.9 TD</b>      |   |   |   |   |   |   |   |   |   |   |   |   |       |
|                                    |   | XUD9TE  | 08/92 → 01/94   |  | VKMC 03240<br>VKMA 03240  | 1<br>1  | 1<br>1  | 1   |   | 1   |   | 2<br>2  | T0017 |









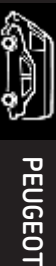

























PEUGEOT

|  |  |  |                        |  |  |  |  |  |  |  |  |  |  |  |
|--|---|---|---|--|---|---|---|---|---|---|---|---|---|---|
|  |   |   |   | VKM 13240<br>VKM 23240   | 1   |   |   |   |   |   |   |   |   |   |
|  | XUD9TE  | 01/94 → 10/96   |                        | VKMC 03241<br>VKMA 03241<br>VKM 13241<br>VKM 23241                                 | 1<br>1<br>1   | 1<br>1  | 1<br>1  |   | 1   |   |   |   |   | T0017   |
|  | XUD9TE  | 08/92 → 01/94   | 3)  | VKMS 03240<br>VKMA 03240<br>VKM 13240<br>VKM 23240                                 | 1<br>1<br>1   | 1<br>1  | 1<br>1  |   |   |   | 2<br>2  |   |   | T0017   |
|  | XUD9TE  | 01/94 → 10/96   | 3)  | VKMS 03241<br>VKMA 03241<br>VKM 13241<br>VKM 23241                                 | 1<br>1<br>1   | 1<br>1  | 1<br>1  |   |   |   | 2   |   |   | T0017   |
|                            | XUD9TE  | 08/92 → 01/94   |   | VKPC 83424   |   |   |   |   | 1   |   |   |   |   |   |
|  | XUD9TE  | 01/94 → 10/96   |   | VKPC 83420   |   |   |   |   | 1   |   |   |   |   |   |
|                            | B(Alt) XUD9TE   | 08/92 → 10/96   | AC,                    | VKMV 6PK730  |   |   | 1   |   |   |   |   |   |   |   |
|  | B(Alt) XUD9TE   | 08/92 → 10/96   | AC,                    | VKMV 6PK1170<br>VKM 33002  | 1   |   | 1   |   |   |   |   |   |   |   |
|  | B(Alt) XUD9TE   | 08/92 → 10/96   | AC, <br>→ ICH 70980931 | VKMA 33202<br>VKMV 6PK1130<br>VKM 33002  | 1<br>1  |   | 1<br>1  |   |   |   |   |   |   |   |
|  | B(Alt) XUD9TE   | 08/92 → 10/96   | AC, <br>CH 70980932 I→ | VKMV 6PK1146<br>VKM 33002  | 1   |   | 1   |   |   |   |   |   |   |   |
|  | B(Alt) XUD9TE   | 08/92 → 02/94   | AC,                   | VKMV 6PK1700<br>VKM 33002<br>VKM 33040   | 1<br>1  |   | 1   |   |   |   |   |   |   |   |
|  | B(Alt) XUD9TE   | 02/94 → 10/96   | AC,                  | VKMV 6PK1700<br>VKM 33002<br>VKM 33008<br>VKM 33040                                | 1<br>1<br>1   |   | 1   |   |   |   |   |   |   |   |
|                          | XUD9TE  | 08/92 → 10/96   |   | VKM 93302  |   |   |   |   | 1   |   |   |   |   |   |
| <b>PEUGEOT  406 1.6</b> |   |   |   |  |   |   |   |   |   |   |   |   |   |   |
|                          | XU5JP   | 11/95 → 05/04   |   | VKMA 03201<br>VKM 13100  | 1<br>1  |   | 1   |   |   |   |   |   |   | T0018   |
|                          | XU5JP   | 11/95 → 05/04   |   | VKPC 83615   |   |   |   |   | 1   |   |   |   |   |   |
|                          | B(Alt) XU5JP  | 11/95 → 06/98   |  70, 80A, AC         | VKMV 6PK1067<br>VKM 33003  | 1   |   | 1   |   |   |   |   |   |   |   |
|  | B(Alt) XU5JP  | 07/98 → 05/04   |  70, 80A, AC         | VKMV 6PK1067<br>VKM 33021  | 1   |   | 1   |   |   |   |   |   |   |   |
|  | B(Alt) XU5JP  | 11/95 → 06/98   |  90A, AC             | VKMA 33003<br>VKMV 6PK1076<br>VKM 33003  | 1<br>1  |   | 1<br>1  |   |   |   |   |   |   |   |
|  | B(Alt) XU5JP  | 07/98 → 05/04   |  90A, AC             | VKMA 33031<br>VKMV 6PK1076<br>VKM 33021  | 1<br>1  |   | 1<br>1  |   |   |   |   |   |   |   |
|  | B(Alt) XU5JP  | 11/95 → 05/04   | AC  | VKMA 33030<br>VKMV 6PK1660<br>VKM 33028<br>VKM 33034                               | 1<br>1  | 1   | 1<br>1  |   |   |   |   |   |   |   |
| <b>PEUGEOT  406 1.8</b> |   |   |   |  |   |   |   |   |   |   |   |   |   |   |
|                          | XU7JB, XU7JP  | 10/96 → 10/04   |   | VKMA 03201<br>VKM 13100  | 1<br>1  |   | 1   |   |   |   |   |   |   | T0018   |
|                          | XU7JB, XU7JP  | 10/96 → 10/04   |   | VKPC 83615   |   |   |   |   | 1   |   |   |   |   |   |
|                          | B(Alt) XU7JP  | 10/96 → 06/98   |  70, 80A, AC         | VKMV 6PK1067<br>VKM 33003  | 1   |   | 1   |   |   |   |   |   |   |   |
|  | B(Alt) XU7JP  | 07/98 → 10/04   |  70, 80A, AC         | VKMV 6PK1067<br>VKM 33021  | 1   |   | 1   |   |   |   |   |   |   |   |
|  | B(Alt) XU7JP  | 10/96 → 06/98   |  90A, AC             | VKMA 33003<br>VKMV 6PK1076<br>VKM 33003  | 1<br>1  |   | 1<br>1  |   |   |   |   |   |   |   |

|  |  |  |       |      |  |  |  |  |  |  |  |  |  |       |
|--|---|---|--|--|---|---|---|---|---|---|---|---|---|-------|
| B(Alt)   | XU7JP   | 07/98 → 10/04   |       | VKMA 33031<br>VKMV 6PK1076<br>VKM 33021  | 1   |   | 1   |   |   |   |   |   |   |       |
| B(Alt)   | XU7JP   | 10/96 → 10/04   | AC   | VKMA 33030<br>VKMV 6PK1660<br>VKM 33028<br>VKM 33034                                   | 1   | 1   | 1   |   |   |   |   |   |   |       |
| <b>PEUGEOT  406 1.8 16V</b>   |   |   |  |  |   |   |   |   |   |   |   |   |   |       |
|                               | EW7J4   | 10/00 → 10/04   |  | VKMA 03235<br>VKM 13234<br>VKM 23230   | 1   | 1   | 1   |   |   |   |   |   | T0169   |       |
|  | XU7JP4  | 11/95 → 03/99   | A⊙   | VKMA 03214<br>VKM 13214<br>VKM 23214   | 1   | 1   | 1   |   |   |   |   |   | 2<br>1<br>1   | T0142 |
|  | XU7JP4  | 04/99 → 10/00   | Dep. CEE 2000, A⊙  | VKMA 03216<br>VKM 13216<br>VKM 23214   | 1   | 1   | 1   |   |   |   |   |   | 2<br>1<br>1   | T0142 |
|  | XU7JP4  | 04/99 → 10/00   | Dep. CEE 95, A⊙  | VKMA 03214<br>VKM 13214<br>VKM 23214   | 1   | 1   | 1   |   |   |   |   |   | 2<br>1<br>1   | T0142 |
|                               | EW7J4   | 10/00 → 10/04   | 16)  | VKPC 83650   |   |   |   |   |   |   | 1   |   |   |       |
|  | XU7JP4  | 11/95 → 10/00   |  | VKPC 83635   |   |   |   |   |   |   | 1   |   |   |       |
|                               | B(Alt)  | EW7J4   | 10/00 → 10/04  | AC   | VKMA 33019<br>VKMV 6PK1205<br>VKM 33019<br>VKM 33020                                | 1   | 1   | 1   |   |   |   |   |   |       |
| B(Alt)   | EW7J4   | 10/00 → 10/04   | AC   | VKMA 33020<br>VKMV 6PK1726<br>VKM 33019<br>VKM 33020                                   | 1   | 1   | 1   |   |   |   |   |   |   |       |
| B(Alt)   | XU7JP4  | 11/95 → 06/98   | AC   | VKMA 33003<br>VKMV 6PK1076<br>VKM 33003  | 1   |   | 1   |   |   |   |   |   |   |       |
| B(Alt)   | XU7JP4  | 07/98 → 10/00   | AC   | VKMA 33031<br>VKMV 6PK1076<br>VKM 33021  | 1   |   | 1   |   |   |   |   |   |   |       |
| B(Alt)   | XU7JP4  | 11/95 → 10/00   |     | VKMA 33033<br>VKMV 6PK1660<br>VKM 33027<br>VKM 33028                                   | 1   | 1   | 1   |   |   |   |   |   |   |       |
| B(Alt)   | XU7JP4  | 11/95 → 10/00   |     | VKMA 33032<br>VKMV 6PK1660<br>VKM 33026<br>VKM 33028                                   | 1   | 1   | 1   |   |   |   |   |   |   |       |
| <b>PEUGEOT  406 2.0 16V</b> |   |   |  |  |   |   |   |   |   |   |   |   |   |       |
|                             | EW10J4  | 01/99 → 12/04   |  | VKMA 03235<br>VKM 13234<br>VKM 23230   | 1   | 1   | 1   |   |   |   |   |   | T0169   |       |
|  | XU10J4R   | 11/95 → 12/04   |  | VKMA 03213<br>VKM 13202<br>VKM 23213   | 1   | 1   | 1   |   |   |   |   |   | 1   | T0142 |
|                             | EW10J4  | 01/99 → 12/04   | 16)  | VKPC 83650   |   |   |   |   |   |   | 1   |   |   |       |
|  | XU10J4R   | 11/95 → 12/04   |  | VKPC 83636   |   |   |   |   |   |   | 1   |   |   |       |
|                             | B(Alt)  | EW10J4  | 01/99 → 05/04  |  AC | VKMA 33019<br>VKMV 6PK1205<br>VKM 33019<br>VKM 33020                                | 1   | 1   | 1   |   |   |   |   |   |       |
| B(Alt)   | EW10J4  | 01/99 → 05/04   |  AC | VKMA 33020<br>VKMV 6PK1726<br>VKM 33019<br>VKM 33020                                   | 1   | 1   | 1   |   |   |   |   |   |   |       |
| B(Alt)   | EW10J4  | 01/99 → 10/04   |  AC | VKMA 33019<br>VKMV 6PK1205<br>VKM 33019<br>VKM 33020                                   | 1   | 1   | 1   |   |   |   |   |   |   |       |



PEUGEOT

























|  |  |  |          |  |  |  |  |  |  |  |  |  |
|--|---|---|---|--|---|---|---|---|---|---|---|---|
| B(Alt)   | EW10J4  | 01/99 → 10/04   |  AC      | VKMA 33020<br>VKMV 6PK1726<br>VKM 33019<br>VKM 33020                               | 1<br>1<br>1   | 1<br>1  | 1<br>1  |   |   |   |   |   |
| B(Alt)   | EW10J4  | 01/99 → 12/04   |          | VKMA 33020<br>VKMV 6PK1726<br>VKM 33019<br>VKM 33020                               | 1<br>1<br>1   | 1<br>1  | 1<br>1  |   |   |   |   |   |
| B(Alt)   | XU10J4R   | 11/95 → 05/04   |  11), AC | VKMV 6PK1160<br>VKM 33022<br>VKM 33025   | 1<br>1  | 1   | 1   |   |   |   |   |   |
| B(Alt)   | XU10J4R   | 11/95 → 05/04   |  11), AC | VKMA 33034<br>VKMV 6PK1603<br>VKM 33028<br>VKM 33035                               | 1<br>1<br>1   | 1<br>1  | 1<br>1  |   |   |   |   |   |
| B(Alt)   | XU10J4R   | 11/95 → 05/04   |  12)     | VKMA 33034<br>VKMV 6PK1603<br>VKM 33028<br>VKM 33035                               | 1<br>1<br>1   | 1<br>1  | 1<br>1  |   |   |   |   |   |
| B(Alt)   | XU10J4R   | 10/96 → 10/04   |  11), AC | VKMV 6PK1160<br>VKM 33022<br>VKM 33025   | 1<br>1  | 1   | 1   |   |   |   |   |   |
| B(Alt)   | XU10J4R   | 10/96 → 10/04   |  11), AC | VKMA 33034<br>VKMV 6PK1603<br>VKM 33028<br>VKM 33035                               | 1<br>1<br>1   | 1<br>1  | 1<br>1  |   |   |   |   |   |
| B(Alt)   | XU10J4R   | 10/96 → 10/04   |  12)   | VKMA 33034<br>VKMV 6PK1603<br>VKM 33028<br>VKM 33035                               | 1<br>1<br>1   | 1<br>1  | 1<br>1  |   |   |   |   |   |
| B(Alt)   | XU10J4R   | 03/97 → 12/04   |        | VKMA 33034<br>VKMV 6PK1603<br>VKM 33028<br>VKM 33035                               | 1<br>1<br>1   | 1<br>1  | 1<br>1  |   |   |   |   |   |
| <b>PEUGEOT  406 2.0 16V HPi</b> |   |   |   |  |   |   |   |   |   |   |   |   |
|                                  | EW10D   | 05/01 → 10/04   |   | VKMA 03231<br>VKM 13231<br>VKM 23230   | 1<br>1<br>1   | 1<br>1  | 1<br>1  |   |   |   |   | T0194   |
|                                  | EW10D   | 05/01 → 10/04   | 16)   | VKPC 83650   |   |   | 1   |   |   |   |   |   |
|                                  | B(Alt)  | EW10D   | 05/01 → 10/04   | AC   | VKMA 33019<br>VKMV 6PK1205<br>VKM 33019<br>VKM 33020                                | 1<br>1<br>1   | 1<br>1  | 1<br>1  |   |   |   |   |
|  | B(Alt)  | EW10D   | 05/01 → 10/04   | AC   | VKMA 33020<br>VKMV 6PK1726<br>VKM 33019<br>VKM 33020                                | 1<br>1<br>1   | 1<br>1  | 1<br>1  |   |   |   |   |
| <b>PEUGEOT  406 2.0 Turbo</b>   |   |   |   |  |   |   |   |   |   |   |   |   |
|                                  | XU10J2TE  | 04/96 → 10/04   |   | VKMA 03201<br>VKM 13100  | 1<br>1  | 1   |   |   |   |   |   | T0018   |
|                                  | XU10J2TE  | 04/96 → 10/04   |   | VKPC 83420   |   |   | 1   |   |   |   |   |   |
|                                  | B(Alt)  | XU10J2TE  | 04/96 → 10/04   | 11), AC  | VKMV 6PK1160<br>VKM 33022<br>VKM 33025  | 1<br>1  | 1   | 1   |   |   |   |   |
|  | B(Alt)  | XU10J2TE  | 04/96 → 10/04   | 11), AC  | VKMA 33034<br>VKMV 6PK1603<br>VKM 33028<br>VKM 33035                                | 1<br>1<br>1   | 1<br>1  | 1<br>1  |   |   |   |   |
| <b>PEUGEOT  406 2.2 16V</b>     |   |   |   |  |   |   |   |   |   |   |   |   |
|                                  | EW12J4  | 07/00 → 12/04   |   | VKMA 03235<br>VKM 13234<br>VKM 23230   | 1<br>1<br>1   | 1<br>1  | 1<br>1  |   |   |   |   | T0169   |
|                                  | EW12J4  | 07/00 → 12/04   | 16)   | VKPC 83650   |   |   | 1   |   |   |   |   |   |
|                                  | B(Alt)  | EW12J4  | 07/00 → 10/04   | 12), AC  | VKMA 33019<br>VKMV 6PK1205  | 1<br>1  | 1<br>1  | 1<br>1  |   |   |   |   |

































|                                |               |               |                          | VKM 33019    | 1 |   |   |  |  |   |  |   |  |   |   |  |  |  |  |  |       |  |
|--------------------------------|---------------|---------------|--------------------------|--------------|---|---|---|--|--|---|--|---|--|---|---|--|--|--|--|--|-------|--|
|                                |               |               |                          | VKM 33020    |   | 1 |   |  |  |   |  |   |  |   |   |  |  |  |  |  |       |  |
| B(Alt)                         | EW12J4        | 07/00 → 12/04 | 12), AC                  | VKMA 33020   | 1 | 1 | 1 |  |  |   |  |   |  |   |   |  |  |  |  |  |       |  |
|                                |               |               |                          | VKMV 6PK1726 |   |   | 1 |  |  |   |  |   |  |   |   |  |  |  |  |  |       |  |
|                                |               |               |                          | VKM 33019    | 1 |   |   |  |  |   |  |   |  |   |   |  |  |  |  |  |       |  |
|                                |               |               |                          | VKM 33020    |   | 1 |   |  |  |   |  |   |  |   |   |  |  |  |  |  |       |  |
| <b>PEUGEOT  406 3.0 V6 24V</b> |               |               |                          |              |   |   |   |  |  |   |  |   |  |   |   |  |  |  |  |  |       |  |
|                                | ES9J4         | 10/96 → 12/04 |                          | —            |   |   |   |  |  |   |  |   |  |   |   |  |  |  |  |  |       |  |
|                                |               |               |                          | VKM 23900    |   | 1 |   |  |  |   |  |   |  |   |   |  |  |  |  |  |       |  |
|                                |               |               |                          | VKM 23900    |   | 1 |   |  |  |   |  |   |  |   |   |  |  |  |  |  |       |  |
|                                |               |               |                          | VKM 23901    |   | 1 |   |  |  |   |  |   |  |   |   |  |  |  |  |  |       |  |
|                                | ES9J4S        | 03/00 → 12/04 |                          | VKMA 03902   | 1 | 3 | 1 |  |  |   |  |   |  |   |   |  |  |  |  |  | T0204 |  |
|                                |               |               |                          | VKM 13902    | 1 |   |   |  |  |   |  |   |  |   |   |  |  |  |  |  |       |  |
|                                |               |               |                          | VKM 23900    |   | 1 |   |  |  |   |  |   |  |   |   |  |  |  |  |  |       |  |
|                                |               |               |                          | VKM 23900    |   | 1 |   |  |  |   |  |   |  |   |   |  |  |  |  |  |       |  |
|                                |               |               |                          | VKM 23901    |   | 1 |   |  |  |   |  |   |  |   |   |  |  |  |  |  |       |  |
|                                | ES9J4         | 10/96 → 12/04 |                          | VKPC 83637   |   |   |   |  |  |   |  | 1 |  |   |   |  |  |  |  |  |       |  |
|                                | ES9J4S        | 03/00 → 04/00 |                          | —            |   |   |   |  |  |   |  | 1 |  |   |   |  |  |  |  |  |       |  |
|                                | ES9J4S        | 04/00 → 12/04 |                          | —            |   |   |   |  |  |   |  | 1 |  |   |   |  |  |  |  |  |       |  |
|                                | B(Alt) ES9J4  | 10/96 → 12/04 | AC                       | VKM 33075    |   | 1 |   |  |  |   |  |   |  |   |   |  |  |  |  |  |       |  |
|                                | B(Alt) ES9J4  | 10/96 → 12/04 | AC                       | VKM 33075    |   | 1 |   |  |  |   |  |   |  |   |   |  |  |  |  |  |       |  |
|                                | B(Alt) ES9J4S | 03/00 → 12/04 |                          | VKMV 6PK1585 |   |   | 1 |  |  |   |  |   |  |   |   |  |  |  |  |  |       |  |
|                                |               |               |                          | VKM 33075    |   | 1 |   |  |  |   |  |   |  |   |   |  |  |  |  |  |       |  |
| <b>PEUGEOT  406 1.9 D</b>      |               |               |                          |              |   |   |   |  |  |   |  |   |  |   |   |  |  |  |  |  |       |  |
|                                | XUD9SD        | 10/96 → 10/04 |                          | VKMC 03241   | 1 | 1 | 1 |  |  | 1 |  |   |  |   |   |  |  |  |  |  | T0017 |  |
|                                |               |               |                          | VKMA 03241   | 1 | 1 | 1 |  |  |   |  |   |  |   |   |  |  |  |  |  |       |  |
|                                |               |               |                          | VKM 13241    | 1 |   |   |  |  |   |  |   |  |   |   |  |  |  |  |  |       |  |
|                                |               |               |                          | VKM 23241    |   | 1 |   |  |  |   |  |   |  |   |   |  |  |  |  |  |       |  |
|                                | XUD9SD        | 10/96 → 10/04 | 3)                       | VKMS 03241   | 1 | 1 | 1 |  |  |   |  |   |  |   | 2 |  |  |  |  |  | T0017 |  |
|                                |               |               |                          | VKMA 03241   | 1 | 1 | 1 |  |  |   |  |   |  |   |   |  |  |  |  |  |       |  |
|                                |               |               |                          | VKM 13241    | 1 |   |   |  |  |   |  |   |  |   |   |  |  |  |  |  |       |  |
|                                |               |               |                          | VKM 23241    |   | 1 |   |  |  |   |  |   |  |   |   |  |  |  |  |  |       |  |
|                                | XUD9SD        | 10/96 → 10/04 |                          | VKPC 83420   |   |   |   |  |  |   |  | 1 |  |   |   |  |  |  |  |  |       |  |
|                                | B(Alt) XUD9SD | 10/96 → 10/04 | $\varnothing$ 110 mm, AC | VKMA 33035   | 1 |   | 1 |  |  |   |  |   |  |   |   |  |  |  |  |  |       |  |
|                                |               |               |                          | VKMV 6PK1102 |   |   | 1 |  |  |   |  |   |  |   |   |  |  |  |  |  |       |  |
|                                |               |               |                          | VKM 33002    | 1 |   |   |  |  |   |  |   |  |   |   |  |  |  |  |  |       |  |
|                                | B(Alt) XUD9SD | 10/96 → 10/04 | $\varnothing$ 117 mm, AC | VKMA 33102   | 1 |   | 1 |  |  |   |  |   |  |   |   |  |  |  |  |  |       |  |
|                                |               |               |                          | VKMV 6PK1110 |   |   | 1 |  |  |   |  |   |  |   |   |  |  |  |  |  |       |  |
|                                |               |               |                          | VKM 33002    | 1 |   |   |  |  |   |  |   |  |   |   |  |  |  |  |  |       |  |
|                                | B(Alt) XUD9SD | 10/96 → 10/04 | AC Delphi, AC            | VKMA 33093   | 2 |   | 1 |  |  |   |  |   |  | 1 |   |  |  |  |  |  |       |  |
|                                |               |               |                          | VKMV 6PK1750 |   |   | 1 |  |  |   |  |   |  |   |   |  |  |  |  |  |       |  |
|                                |               |               |                          | VKM 33013    | 1 |   |   |  |  |   |  |   |  |   |   |  |  |  |  |  |       |  |
|                                |               |               |                          | VKM 33029    | 1 |   |   |  |  |   |  |   |  |   |   |  |  |  |  |  |       |  |
|                                |               |               |                          | VKM 33311    |   |   |   |  |  |   |  |   |  | 1 |   |  |  |  |  |  |       |  |
|                                | B(Alt) XUD9SD | 10/96 → 10/04 | AC Sanden, AC            | VKMV 6PK1740 |   |   | 1 |  |  |   |  |   |  |   |   |  |  |  |  |  |       |  |
|                                |               |               |                          | VKM 33013    | 1 |   |   |  |  |   |  |   |  |   |   |  |  |  |  |  |       |  |
|                                |               |               |                          | VKM 33029    | 1 |   |   |  |  |   |  |   |  |   |   |  |  |  |  |  |       |  |
|                                |               |               |                          | VKM 33311    |   |   |   |  |  |   |  |   |  | 1 |   |  |  |  |  |  |       |  |
|                                | XUD9SD        | 10/96 → 10/04 |                          | VKM 93302    |   |   |   |  |  |   |  | 1 |  |   |   |  |  |  |  |  |       |  |
| <b>PEUGEOT  406 1.9 TD</b>     |               |               |                          |              |   |   |   |  |  |   |  |   |  |   |   |  |  |  |  |  |       |  |
|                                | XUD9TE        | 01/96 → 10/04 |                          | VKMC 03241   | 1 | 1 | 1 |  |  | 1 |  |   |  |   |   |  |  |  |  |  | T0017 |  |
|                                |               |               |                          | VKMA 03241   | 1 | 1 | 1 |  |  |   |  |   |  |   |   |  |  |  |  |  |       |  |
|                                |               |               |                          | VKM 13241    | 1 |   |   |  |  |   |  |   |  |   |   |  |  |  |  |  |       |  |
|                                |               |               |                          | VKM 23241    |   | 1 |   |  |  |   |  |   |  |   |   |  |  |  |  |  |       |  |
|                                | XUD9TE        | 01/96 → 10/04 | 3)                       | VKMS 03241   | 1 | 1 | 1 |  |  |   |  |   |  |   | 2 |  |  |  |  |  | T0017 |  |
|                                |               |               |                          | VKMA 03241   | 1 | 1 | 1 |  |  |   |  |   |  |   |   |  |  |  |  |  |       |  |
|                                |               |               |                          | VKM 13241    | 1 |   |   |  |  |   |  |   |  |   |   |  |  |  |  |  |       |  |
|                                |               |               |                          | VKM 23241    |   | 1 |   |  |  |   |  |   |  |   |   |  |  |  |  |  |       |  |
|                                | XUD9TE        | 01/96 → 10/04 |                          | VKPC 83420   |   |   |   |  |  |   |  | 1 |  |   |   |  |  |  |  |  |       |  |
|                                | B(Alt) XUD9TE | 01/96 → 10/04 | $\varnothing$ 110 mm, AC | VKMA 33035   | 1 |   | 1 |  |  |   |  |   |  |   |   |  |  |  |  |  |       |  |
|                                |               |               |                          | VKMV 6PK1102 |   |   | 1 |  |  |   |  |   |  |   |   |  |  |  |  |  |       |  |
|                                |               |               |                          | VKM 33002    | 1 |   |   |  |  |   |  |   |  |   |   |  |  |  |  |  |       |  |
|                                | B(Alt) XUD9TE | 01/96 → 10/04 | $\varnothing$ 117 mm, AC | VKMA 33102   | 1 |   | 1 |  |  |   |  |   |  |   |   |  |  |  |  |  |       |  |
|                                |               |               |                          | VKMV 6PK1110 |   |   | 1 |  |  |   |  |   |  |   |   |  |  |  |  |  |       |  |
|                                |               |               |                          | VKM 33002    | 1 |   |   |  |  |   |  |   |  |   |   |  |  |  |  |  |       |  |



PEUGEOT



|   |  |  |    |  |  |  |  |  |  |  |  |  |
|---|---|---|---|--|---|---|---|---|---|---|---|---|
| <b>B(Alt)</b>   | XUD9TE  | 01/96 → 10/04   | AC Delphi, AC   | VKMA 33093<br>VKMV 6PK1750<br>VKM 33013<br>VKM 33029<br>VKM 33311                  | 2<br>1<br>1   | 1<br>1  |   |   | 1   |   |   |   |
| <b>B(Alt)</b>   | XUD9TE  | 01/96 → 10/04   | AC Sanden, AC   | VKMA 33093<br>VKMV 6PK1739<br>VKM 33013<br>VKM 33029<br>VKM 33311                  | 1<br>1  |   | 1   |   |   |   | 1   |   |
|                               | XUD9TE  | 01/96 → 10/04   |   | VKM 93302  |   |   |   |   | 1   |   |   |   |
| <b>PEUGEOT  406 2.0 HDi</b>  |   |   |   |  |   |   |   |   |   |   |   |   |
|                               | DW10ATED, DW10TD  | 06/98 → 10/00   |    | VKMC 03246<br>VKMA 03246<br>VKM 13246<br>VKM 23246                                 | 1<br>1<br>1   | 1<br>1  | 1<br>1  |   | 1   |   |   | 1<br>1<br>1<br>1 T0168  |
|   | DW10ATED, DW10TD  | 06/98 → 10/00   | 3)  | VKMS 03246<br>VKMA 03246<br>VKM 13246<br>VKM 23246                                 | 1<br>1<br>1   | 1<br>1  | 1<br>1  |   |   |   | 2   | 1<br>1<br>1<br>1 T0168  |
|   | DW10ATED, DW10TD  | 10/00 → 10/04   |    | VKMC 03247<br>VKMA 03247<br>VKM 13244<br>VKM 23246                                 | 1<br>1<br>1   | 1<br>1  | 1<br>1  |   | 1   |   |   | 1<br>1<br>1<br>1 T0168  |
|                               | DW10ATED, DW10TD  | 06/98 → 10/04   |   | VKPC 83639   |   |   |   |   | 1   |   |   |   |
|                               | <b>B(Alt)</b> DW10ATED, DW10TD  | 06/98 → 10/04   | AC  | VKMA 33044<br>VKMV 6PK1468<br>VKM 33024<br>VKM 33033<br>VKM 33069                  | 2<br>1<br>1   | 1<br>1  | 1<br>1  |   |   |   |   |   |
| <b>B(Alt)</b>   | DW10ATED, DW10TD  | 06/98 → 10/04   | AC Delphi, AC   | VKMA 33037<br>VKMV 6PK1750<br>VKM 33013<br>VKM 33033                               | 2<br>1<br>1   |   | 1<br>1  |   |   |   |   |   |
| <b>B(Alt)</b>   | DW10ATED, DW10TD  | 06/98 → 06/02   | AC Sanden, AC   | VKMA 33044<br>VKMV 6PK1740<br>VKM 33013<br>VKM 33033                               | 1<br>1  |   | 1   |   |   |   |   |   |
| <b>B(Alt)</b>   | DW10ATED, DW10TD  | 06/02 → 10/04   | AC Sanden, AC   | VKMA 33044<br>VKMV 6PK1744<br>VKM 33013<br>VKM 33033                               | 1<br>1  |   | 1   |   |   |   |   |   |
|                             | DW10ATED  | 08/01 → 06/02   | Man. GBX  | VKM 93301  |   |   |   |   |   |   | 1   |   |
|   | DW10ATED  | 08/01 → 07/02   | Auto. GBX   | VKM 93301  |   |   |   |   |   |   | 1   |   |
|   | DW10ATED  | 06/02 → 05/04   | Man. GBX  | VKM _____  |   |   |   |   |   |   | 1   |   |
|   | DW10ATED  | 07/02 → 10/04   | Auto. GBX   | VKM _____  |   |   |   |   |   |   | 1   |   |
|   | DW10TD  | 02/99 → 10/04   |   | VKM _____  |   |   |   |   |   |   | 1   |   |
| <b>PEUGEOT  406 2.1 TD</b> |   |   |   |  |   |   |   |   |   |   |   |   |
|                             | XUD11BTE  | 01/96 → 10/04   |  | VKMC 03251<br>VKMA 03251<br>VKM 13250<br>VKM 23213                                 | 1<br>1<br>1   | 1<br>1  | 1<br>1  |   | 1   |   |   | 1<br>1<br>1<br>1 T0080  |
|   | XUD11BTE  | 01/96 → 10/04   | 3)  | VKMS 03251<br>VKMA 03251<br>VKM 13250<br>VKM 23213                                 | 1<br>1<br>1   | 1<br>1  | 1<br>1  |   |   |   | 2   | 1<br>1<br>1<br>1 T0080  |
|                             | XUD11BTE  | 01/96 → 10/04   |   | VKPC 83425   |   |   |   |   | 1   |   |   |   |
|                             | <b>B(Alt)</b> XUD11BTE  | 01/96 → 10/04   | $\varnothing$ 110 mm, AC  | VKMA 33035<br>VKMV 6PK1102<br>VKM 33002  | 1<br>1  |   | 1<br>1  |   |   |   |   |   |
| <b>B(Alt)</b>   | XUD11BTE  | 01/96 → 10/04   | $\varnothing$ 117 mm, AC  | VKMA 33102<br>VKMV 6PK1110<br>VKM 33002  | 1<br>1  |   | 1<br>1  |   |   |   |   |   |
| <b>B(Alt)</b>   | XUD11BTE  | 01/96 → 10/04   | AC Delphi, AC   | VKMA 33093<br>VKMV 6PK1750<br>VKM 33013<br>VKM 33029<br>VKM 33311                  | 2<br>1<br>1   |   | 1<br>1  |   |   |   | 1   |   |
| <b>B(Alt)</b>   | XUD11BTE  | 01/96 → 10/04   | AC Sanden, AC   | VKMA 33093<br>VKMV 6PK1740<br>VKM 33013  | 1   |   | 1   |   |   |   |   |   |

































|  |  |  |  |  |  |  |  |  |  |  |  |  |
|--|---|---|---|--|---|---|---|---|---|---|---|---|
|  |   |   |   | VKM 33029  | 1   |   |   |   |   |   |   |   |
|  |   |   |   | VKM 33311  |   |   |   |   | 1   |   |   |   |
| ⊙  | XUD11BTE  | 01/96 → 10/04   |   | VKM 93306  |   |   |   |   | 1   |   |   |   |
| <b>PEUGEOT  406 2.2 HDi 16V</b> |   |   |   |  |   |   |   |   |   |   |   |   |
|                                 | DW12TED4/FAP  | 03/00 → 04/04   |   | VKMA 03252   | 1   | 1   | 1   |   |   |   | 1   | T0179   |
|  |   |   |   | VKM 13246  | 1   |   |   |   |   |   | 1   |   |
|  |   |   |   | VKM 23246  |   | 1   |   |   |   |   |   |   |
|  | DW12TED4/FAP  | 04/04 → 12/04   |   | VKMA 03264   | 1   | 1   | 1   |   |   |   |   | T0179   |
|  |   |   |   | VKM 13264  | 1   |   |   |   |   |   |   |   |
|  |   |   |   | VKM 23264  |   | 1   |   |   |   |   |   |   |
|                                 | DW12TED4/FAP  | 03/00 → 12/04   |   | VKPC 83643   |   |   |   |   | 1   |   |   |   |
|                                 | <b>B(Alt)</b> DW12TED4/FAP  | 03/00 → 12/04   |   | VKMMV 6PK1740  | 1   |   | 1   |   |   |   |   |   |
|  |   |   |   | VKM 33033  |   |   |   |   |   |   |   |   |
|  |   |   |   | VKM 33045  |   | 1   |   |   |   |   |   |   |
| ⊙  | DW12TED4/FAP  | 03/00 → 12/04   |   | VKM 93301  |   |   |   |   | 1   |   |   |   |
| <b>PEUGEOT  407 1.8 16V</b>     |   |   |   |  |   |   |   |   |   |   |   |   |
|                                 | EW7A  | 09/05 → 12/07   |   | VKMA 03263   | 1   | 1   | 1   |   |   |   |   | T0169   |
|  |   |   |   | VKM 13263  | 1   |   |   |   |   |   |   |   |
|  |   |   |   | VKM 23230  |   | 1   |   |   |   |   |   |   |
|  | EW7J4   | 05/04 → 12/07   |   | VKMA 03235   | 1   | 1   | 1   |   |   |   |   | T0169   |
|  |   |   |   | VKM 13234  | 1   |   |   |   |   |   |   |   |
|  |   |   |   | VKM 23230  |   | 1   |   |   |   |   |   |   |
|                                 | EW7A, EW7J4   | 05/04 → 12/07 16)   |   | VKPC 83650   |   |   |   |   | 1   |   |   |   |
|                                 | <b>B(Alt)</b> EW7A  | 09/05 → 12/07   |   | VKMMV 6PK998   | 1   |   | 1   |   |   |   |   |   |
|  |   |   |   | VKM_____   |   |   |   |   |   |   |   |   |
|  | <b>B(Alt)</b> EW7J4   | 05/04 → 12/07   |   | VKMMV 6PK1710  | 1   |   | 1   |   |   |   |   |   |
|  |   |   |   | VKM 33019  |   |   |   |   |   |   |   |   |
|  |   |   |   | VKM 33020  |   | 1   |   |   |   |   |   |   |
|  |   |   |   | VKM 33020  |   |   |   |   |   |   |   |   |
|  |   |   |   | VKM 33064  |   | 1   |   |   |   |   |   |   |
| <b>PEUGEOT  407 2.0 16V</b>   |   |   |   |  |   |   |   |   |   |   |   |   |
|                               | EW10A   | 09/05 → 12/07   |   | VKMA 03263   | 1   | 1   | 1   |   |   |   |   | T0169   |
|  |   |   |   | VKM 13263  | 1   |   |   |   |   |   |   |   |
|  |   |   |   | VKM 23230  |   | 1   |   |   |   |   |   |   |
|  | EW10J4  | 05/04 → 12/07   |   | VKMA 03235   | 1   | 1   | 1   |   |   |   |   | T0169   |
|  |   |   |   | VKM 13234  | 1   |   |   |   |   |   |   |   |
|  |   |   |   | VKM 23230  |   | 1   |   |   |   |   |   |   |
|                               | EW10A, EW10J4   | 05/04 → 12/07 16)   |   | VKPC 83650   |   |   |   |   | 1   |   |   |   |
|                               | <b>B(Alt)</b> EW10A   | 09/05 → 12/07   |   | VKMMV 6PK998   | 1   |   | 1   |   |   |   |   |   |
|  |   |   |   | VKM_____   |   |   |   |   |   |   |   |   |
|  | <b>B(Alt)</b> EW10J4  | 05/04 → 12/07   |   | VKMMV 6PK1710  | 1   |   | 1   |   |   |   |   |   |
|  |   |   |   | VKM 33019  |   |   |   |   |   |   |   |   |
|  |   |   |   | VKM 33020  |   | 1   |   |   |   |   |   |   |
|  |   |   |   | VKM 33064  |   |   | 1   |   |   |   |   |   |
| <b>PEUGEOT  407 2.2 16V</b>   |   |   |   |  |   |   |   |   |   |   |   |   |
|                               | EW12J4  | 05/04 → 12/07   |   | VKMA 03235   | 1   | 1   | 1   |   |   |   |   | T0169   |
|  |   |   |   | VKM 13234  | 1   |   |   |   |   |   |   |   |
|  |   |   |   | VKM 23230  |   | 1   |   |   |   |   |   |   |
|                               | EW12J4  | 05/04 → 12/07 16)   |   | VKPC 83650   |   |   |   |   | 1   |   |   |   |
|                               | <b>B(Alt)</b> EW12J4  | 05/04 → 11/04 <b>Dep. CEE 2000</b>  |   | VKMMV 6PK1710  | 1   |   | 1   |   |   |   |   |   |
|  |   |   |   | VKM 33019  |   |   |   |   |   |   |   |   |
|  |   |   |   | VKM 33020  |   | 1   |   |   |   |   |   |   |
|  |   |   |   | VKM 33064  |   |   | 1   |   |   |   |   |   |
|  | <b>B(Alt)</b> EW12J4  | 11/04 → 12/07 <b>Dep. CEE 2000</b>  |   | VKMMV 6PK998   | 1   |   | 1   |   |   |   |   |   |
|  |   |   |   | VKM_____   |   |   |   |   |   |   |   |   |
|  | <b>B(Alt)</b> EW12J4  | 09/05 → 12/07 <b>Dep. L5</b>  |   | VKMMV 6PK998   | 1   |   | 1   |   |   |   |   |   |
|  |   |   |   | VKM_____   |   |   |   |   |   |   |   |   |
| <b>PEUGEOT  407 3.0 V6</b>    |   |   |   |  |   |   |   |   |   |   |   |   |
|                               | ES9A  | 05/04 → 12/07   |   | VKMA 03902   | 1   | 3   | 1   |   |   |   |   | T0204   |
|  |   |   |   | VKM 13902  | 1   |   |   |   |   |   |   |   |
|  |   |   |   | VKM 23900  |   | 1   |   |   |   |   |   |   |
|  |   |   |   | VKM 23900  |   | 1   |   |   |   |   |   |   |
|  |   |   |   | VKM 23901  |   | 1   |   |   |   |   |   |   |
|                               | ES9A  | 05/04 → 12/07   |   | —  |   |   |   |   | 1   |   |   |   |
|                               | <b>B(Alt)</b> ES9A  | 05/04 → 05/04   |   | VKMMV 6PK1585  |   |   | 1   |   |   |   |   |   |
|  |   |   |   | VKM 33075  |   | 1   |   |   |   |   |   |   |
|  | <b>B(Alt)</b> ES9A  | 05/04 → 12/07   |   | VKMMV 6PK1590  |   |   | 1   |   |   |   |   |   |





























PEUGEOT

| <b>PEUGEOT  407 1.6 HDi</b>     |                         |               |                      |  |  |             |        |        |   |   |  |  |  |  |       |
|---------------------------------|-------------------------|---------------|----------------------|--|--|-------------|--------|--------|---|---|--|--|--|--|-------|
|                                 | DV6TED4                 | 05/04 → 12/07 |                      |  | VKMA 03259<br>VKM 13140<br>VKM 23140                 | 1<br>1      | 1<br>1 |        |   |   |  |  |  |  | T0195 |
|                                 | DV6TED4                 | 05/04 → 12/07 |                      |  | VKPC 83259   |             |        |        | 1 |   |  |  |  |  |       |
|                                 | DV6TED4                 | 10/05 → 12/07 |                      |  | VKMN 6PK1710<br>VKM_____                             | 1           | 1      |        |   |   |  |  |  |  |       |
|                                 | <b>B(Alt)</b> DV6TED4   | 05/04 → 10/05 |                      |  | VKMA 33061<br>VKMN 6PK1705<br>VKM 33044<br>VKM 33061 | 1<br>1<br>1 | 1<br>1 | 1<br>1 |   |   |  |  |  |  | 1     |
| <b>PEUGEOT  407 2.0 HDi 136</b> |                         |               |                      |  |  |             |        |        |   |   |  |  |  |  |       |
|                                 | DW10BTED4               | 05/04 → 12/07 |                      |  | VKMA 03257<br>VKM 13257<br>VKM 23257                 | 1<br>1      | 1<br>1 |        |   |   |  |  |  |  | T0205 |
|                                 | DW10BTED4               | 05/04 → 12/07 |                      |  | VKPC 83643   |             |        |        | 1 |   |  |  |  |  |       |
|                                 | <b>B(Alt)</b> DW10BTED4 | 05/04 → 12/07 |                      |  | VKMA 33320<br>VKMN 6PK1217<br>VKM 33320              | 1<br>1      | 1<br>1 |        |   |   |  |  |  |  |       |
|                                 | DW10BTED4               | 05/04 → 12/07 |                      |  | VKM_____   |             |        |        |   | 1 |  |  |  |  |       |
| <b>PEUGEOT  407 2.2 HDi 170</b> |                         |               |                      |  |  |             |        |        |   |   |  |  |  |  |       |
|                                 | DW12BTED4               | 05/06 → 12/07 |                      |  | —  | 1<br>1      | 1<br>1 |        |   |   |  |  |  |  |       |
|                                 | DW12BTED4               | 05/06 → 04/07 |                      |  | —  |             |        |        | 1 |   |  |  |  |  |       |
|                                 | <b>B(Alt)</b> DW12BTED4 | 05/06 → 12/07 |                      |  | VKMN 6PK1205   |             |        | 1      |   |   |  |  |  |  |       |
| <b>PEUGEOT  407 2.7 V6 HDi</b>  |                         |               |                      |  |  |             |        |        |   |   |  |  |  |  |       |
|                                 | DT17TED4                | 10/05 → 12/07 |                      |  | VKMA 03261<br>VKM_____                               | 2<br>1      | 2<br>1 | 2<br>1 |   |   |  |  |  |  | T0249 |
|                                 | DT17TED4                | 10/05 → 12/07 |                      |  | VKMA 13262<br>VKM 23261<br>VKM 23261                 | 1<br>1      | 1<br>1 |        |   |   |  |  |  |  |       |
|                                 | DT17TED4                | 10/05 → 12/07 |                      |  | VKPC_____  |             |        |        | 1 |   |  |  |  |  |       |
|                                 | <b>B(Alt)</b> DT17TED4  | 10/05 → 12/07 |                      |  | VKMN 6PK1887<br>VKM_____                             | 1           | 1      |        |   |   |  |  |  |  |       |
|                                 |                         |               |                      |  | VKM_____   |             | 1      |        |   |   |  |  |  |  |       |
| <b>PEUGEOT  504 1.6</b>         |                         |               |                      |  |  |             |        |        |   |   |  |  |  |  |       |
|                                 | XC7P                    | 01/80 → 12/82 | <b>THT. Fix.FAN</b>  |  | VKPC 83403   |             |        |        | 1 |   |  |  |  |  |       |
|                                 | XC7P                    | 01/80 → 12/82 | <b>THT. Auto.FAN</b> |  | VKPC 83612   |             |        |        | 1 |   |  |  |  |  |       |
|                                 | XC7P                    | 01/80 → 12/82 | <b>THT. Auto.FAN</b> |  | VKPC 83618   |             |        |        | 1 |   |  |  |  |  |       |
| <b>PEUGEOT  504 1.8</b>         |                         |               |                      |  |  |             |        |        |   |   |  |  |  |  |       |
|                                 | KF5, KF6, XM, XM7       | 07/68 → 12/89 |                      |  | XXXXXXXXXX   |             |        |        |   |   |  |  |  |  |       |
|                                 | KF5, KF6, XM, XM7       | 07/68 → 12/82 | <b>THT. Fix.FAN</b>  |  | VKPC 83403   |             |        |        | 1 |   |  |  |  |  |       |
|                                 | KF5, KF6, XM, XM7       | 07/68 → 12/82 | <b>THT. Auto.FAN</b> |  | VKPC 83612   |             |        |        | 1 |   |  |  |  |  |       |
|                                 | KF5, KF6, XM, XM7       | 07/68 → 12/82 | <b>THT. Auto.FAN</b> |  | VKPC 83618   |             |        |        | 1 |   |  |  |  |  |       |
| <b>PEUGEOT  504 2.0</b>         |                         |               |                      |  |  |             |        |        |   |   |  |  |  |  |       |
|                                 | XN1, XN2                | 01/71 → 07/86 |                      |  | XXXXXXXXXX   |             |        |        |   |   |  |  |  |  |       |
|                                 | XN, XN1, XN2            | 01/71 → 12/82 | <b>THT. Fix.FAN</b>  |  | VKPC 83403   |             |        |        | 1 |   |  |  |  |  |       |
|                                 | XN, XN1, XN2            | 01/71 → 12/82 | <b>THT. Auto.FAN</b> |  | VKPC 83612   |             |        |        | 1 |   |  |  |  |  |       |
|                                 | XN, XN1, XN2            | 01/71 → 12/82 | <b>THT. Auto.FAN</b> |  | VKPC 83618   |             |        |        | 1 |   |  |  |  |  |       |
| <b>PEUGEOT  504 1.9 D</b>       |                         |               |                      |  |  |             |        |        |   |   |  |  |  |  |       |
|                                 | XD4x88                  | 03/73 → 12/89 |                      |  | XXXXXXXXXX   |             |        |        |   |   |  |  |  |  |       |
|                                 | XD4x88                  | 03/73 → 12/76 |                      |  | —  |             |        |        | 1 |   |  |  |  |  |       |
|                                 | XD4x88                  | 01/77 → 12/82 |                      |  | VKPC 83616   |             |        |        | 1 |   |  |  |  |  |       |
| <b>PEUGEOT  504 2.1 D</b>       |                         |               |                      |  |  |             |        |        |   |   |  |  |  |  |       |
|                                 | XD4x90                  | 02/71 → 07/86 |                      |  | XXXXXXXXXX   |             |        |        |   |   |  |  |  |  |       |
|                                 | XD4x90                  | 02/71 → 12/76 |                      |  | —  |             |        |        | 1 |   |  |  |  |  |       |
|                                 | XD4x90                  | 01/77 → 12/82 |                      |  | VKPC 83616   |             |        |        | 1 |   |  |  |  |  |       |
| <b>PEUGEOT  504 2.3 D</b>       |                         |               |                      |  |  |             |        |        |   |   |  |  |  |  |       |
|                                 | XD2                     | 07/75 → 12/89 |                      |  | XXXXXXXXXX   |             |        |        |   |   |  |  |  |  |       |
|                                 | XD2                     | 01/76 → 12/80 |                      |  | VKPC 83605   |             |        |        | 1 |   |  |  |  |  |       |
| <b>PEUGEOT  505 1.8</b>         |                         |               |                      |  |  |             |        |        |   |   |  |  |  |  |       |
|                                 | XM7                     | 06/81 → 10/86 | <b>Fix.FAN</b>       |  | VKPC 83403   |             |        |        | 1 |   |  |  |  |  |       |
|                                 | XM7                     | 06/81 → 10/86 | <b>Auto.FAN</b>      |  | VKPC 83618   |             |        |        | 1 |   |  |  |  |  |       |











































|   |  |  |    |  |  |  |  |  |  |  |  |  |  |  |
|---|---|---|---|--|---|---|---|---|---|---|---|---|---|---|
| B(Alt)  | XU10J4R   | 07/94 → 06/95   | AC  | VKMOV 6PK1660<br>VKM 33028<br>VKM 33034  | 1   | 1   |   |   |   |   |   |   |   |   |
| B(Alt)  | XU10J4R   | 06/95 → 09/99   | AC  | VKMOV 6PK1160<br>VKM 33022<br>VKM 33025  | 1   | 1   |   |   |   |   |   |   |   |   |
| B(Alt)  | XU10J4R   | 06/95 → 09/99   | AC  | VKMA 33034<br>VKMOV 6PK1603<br>VKM 33028<br>VKM 33035                              | 1   | 1   | 1   |   |   |   |   |   |   |   |
| <b>PEUGEOT  605 2.0 Turbo</b>    |   |   |   |  |   |   |   |   |   |   |   |   |   |   |
|                                   | XU10J2TE  | 07/91 → 09/99   |   | VKMA 03201<br>VKM 13100  | 1   | 1   |   |   |   |   |   |   |   | T0018   |
|                                   | XU10J2TE  | 07/91 → 09/99   |   | VKPC 83420   |   |   |   | 1   |   |   |   |   |   |   |
|                                   | B(Alt) XU10J2TE   | 07/91 → 06/95   | AC  | VKMOV 5PK710   |   |   | 1   |   |   |   |   |   |   |   |
|   | B(Alt) XU10J2TE   | 07/91 → 06/95   | AC  | VKMOV 5PK1151<br>VKM 33007   |   |   | 1   |   |   |   |   |   |   |   |
|   | B(Alt) XU10J2TE   | 06/95 → 09/99   | AC  | VKMOV 6PK1160<br>VKM 33022<br>VKM 33025  | 1   | 1   |   |   |   |   |   |   |   |   |
|   | B(Alt) XU10J2TE   | 06/95 → 09/99   | AC  | VKMA 33034<br>VKMOV 6PK1603<br>VKM 33028<br>VKM 33035                              | 1   | 1   | 1   |   |   |   |   |   |   |   |
| <b>PEUGEOT  605 3.0 V6</b>       |   |   |   |  |   |   |   |   |   |   |   |   |   |   |
|                                 | ES9J4   | 04/97 → 09/99   |   | VKMA 03902<br>VKM 13902<br>VKM 23900<br>VKM 23900<br>VKM 23901                     | 1   | 3   | 1   |   |   |   |   |   |   | T0204   |
|                                 | ES9J4   | 04/97 → 09/99   |   | VKPC 83637   |   |   |   | 1   |   |   |   |   |   |   |
| <b>PEUGEOT  605 3.0 V6 24V</b> |   |   |   |  |   |   |   |   |   |   |   |   |   |   |
|                                 | ZPJ, ZPJ4/Z   | 08/89 → 09/99   |   | OKOKOKO  |   |   |   |   |   |   |   |   |   |   |
|                                 | ZPJ, ZPJ4   | 08/89 → 07/90   |   | —  |   |   |   | 1   |   |   |   |   |   |   |
|   | ZPJ, ZPJ4   | 07/90 → 09/99   |   | —  |   |   |   | 1   |   |   |   |   |   |   |
| <b>PEUGEOT  605 2.1 D</b>      |   |   |   |  |   |   |   |   |   |   |   |   |   |   |
|                                 | XUD11A  | 06/89 → 07/95   |   | VKMA 03250<br>VKM 13250<br>VKM 23120   | 1   | 1   | 1   |   |   |   |   |   | 1   | T0079   |
|                                 | XUD11A  | 06/89 → 07/95   |   | VKPC 83420   |   |   |   | 1   |   |   |   |   |   |   |
|                                 | B(Alt) XU11A  | 06/89 → 07/95   | 11), AC   | VKMOV 5PK715   |   |   | 1   |   |   |   |   |   |   |   |
|   | B(Alt) XU11A  | 06/89 → 07/95   | 11), AC, Man. GBX   | VKMOV 5PK740   |   |   | 1   |   |   |   |   |   |   |   |
|   | B(Alt) XU11A  | 06/89 → 07/95   | 11), Ø 59.4 mm, AC  | VKMOV 5PK1160<br>VKM 33007   |   |   | 1   |   | 1   |   |   |   |   |   |
|   | B(Alt) XU11A  | 06/89 → 07/95   | 11), Ø 66 mm, AC  | VKMOV 5PK1195<br>VKM 33007   |   |   | 1   |   | 1   |   |   |   |   |   |
|   | B(Alt) XU11A  | 06/95 → 07/95   | 12), AC   | VKMA 33035<br>VKMOV 6PK1102<br>VKM 33002   | 1   |   | 1   |   |   |   |   |   |   |   |
|   | B(Alt) XU11A  | 06/95 → 07/95   | 12), AC   | VKMOV 6PK1726<br>VKM 33013<br>VKM 33029<br>VKM 33311                               | 1   |   | 1   |   |   |   |   | 1   |   |   |
|                                 | XUD11A  | 06/95 → 07/95   |   | VKM 93306  |   |   |   |   |   |   |   | 1   |   |   |
| <b>PEUGEOT  605 2.1 TD</b>     |   |   |   |  |   |   |   |   |   |   |   |   |   |   |
|                                 | XUD11ATE, XUD11BTE  | 06/89 → 09/99   |  | VKMC 03251<br>VKMA 03251<br>VKM 13250<br>VKM 23213                                 | 1   | 1   | 1   |   | 1   |   |   |   | 1   | T0080   |
|   | XUD11ATE, XUD11BTE  | 06/89 → 09/99   | 3)  | VKMS 03251<br>VKMA 03251<br>VKM 13250<br>VKM 23213                                 | 1   | 1   | 1   |   |   |   | 2   |   | 1   | T0080   |































|  |  |  |  |  |  |  |  |  |  |  |  |
|--|---|---|---|--|---|---|---|---|---|---|---|
|                               | XUD11ATE, XUD11BTE  | 06/89 → 09/99   |   | VKPC 83425   |   |   |   |   |   | 1   |   |
|                               | <b>B(Alt)</b> XUD11ATE, XUD11BTE  | 06/89 → 09/99   | 11), AC   | VKMOV 5PK715   |   | 1   |   |   |   |   |   |
|  | <b>B(Alt)</b> XUD11ATE, XUD11BTE  | 06/89 → 09/99   | 11), AC, Man. GBX   | VKMOV 5PK740   |   | 1   |   |   |   |   |   |
|  | <b>B(Alt)</b> XUD11ATE, XUD11BTE  | 06/89 → 09/99   | 11), Ø 59.4 mm, AC  | VKMOV 5PK1160<br>VKM 33007   |   | 1   |   |   |   |   |   |
|  | <b>B(Alt)</b> XUD11ATE, XUD11BTE  | 06/89 → 09/99   | 11), Ø 66 mm, AC  | VKMOV 5PK1195<br>VKM 33007   |   | 1   |   |   |   |   |   |
|  | <b>B(Alt)</b> XUD11ATE, XUD11BTE  | 06/95 → 09/99   | 12), AC   | VKMA 33035<br>VKMV 6PK1102<br>VKM 33002  | 1   |   | 1   |   |   |   |   |
|  | <b>B(Alt)</b> XUD11ATE, XUD11BTE  | 06/95 → 09/99   | 12), AC   | VKMOV 6PK1726<br>VKM 33013<br>VKM 33029<br>VKM 33311                               | 1<br>1  |   | 1   |   |   |   |   |
|                               | XUD11ATE  | 06/95 → 09/99   |   | VKM 93306  |   |   |   |   |   | 1   |   |
|  | XUD11BTE  | 08/94 → 09/99   |   | VKM 93306  |   |   |   |   |   | 1   |   |
| <b>PEUGEOT  605 2.5 TD</b>    |   |   |   |  |   |   |   |   |   |   |   |
|                               | DK5ATE  | 07/94 → 09/99   | 3)  | VKMS 03300<br>VKMA 03300<br>VKM 13300<br>VKM 23300                                 | 1<br>1<br>1   | 1<br>1<br>1   |   |   |   | 2   | T0121   |
|  | DK5ATE  | 07/94 → 09/99   | 1)  | VKMA 03301<br>VKM 13300<br>VKM 13301<br>VKM 23300                                  | 2<br>1<br>1   | 1<br>1<br>1   |   |   |   |   | T0646   |
|                              | DK5ATE  | 07/94 → 05/96   |   | VKPC 83810   |   |   |   |   |   | 1   |   |
|  | DK5ATE  | 05/96 → 09/99   |   | VKPC 83811   |   |   |   |   |   | 1   |   |
|                             | <b>B(Alt)</b> DK5ATE  | 07/94 → 09/99   | AC  | VKMOV 6PK1198<br>VKM 33014   |   | 1   |   |   |   |   |   |
|  | <b>B(Alt)</b> DK5ATE  | 07/94 → 09/99   | AC  | VKMOV 6PK1862<br>VKM 33083   | 1   |   | 1   |   |   |   |   |
|  | <b>B(WP)</b> DK5ATE   | 07/94 → 05/96   |   | VKMOV 4PK946<br>VKM 33086  | 1   |   | 1   |   |   |   |   |
|  | <b>B(WP)</b> DK5ATE   | 05/96 → 09/99   |   | VKMOV 3PK946<br>VKM 33086  | 1   |   | 1   |   |   |   |   |
| <b>PEUGEOT  607 2.0 16V</b> |   |   |   |  |   |   |   |   |   |   |   |
|                             | EW10J4  | 02/00 → 12/07   |   | VKMA 03235<br>VKM 13234<br>VKM 23230   | 1<br>1  | 1<br>1  |   |   |   |   | T0169   |
|                             | EW10J4  | 02/00 → 12/07   | 16)   | VKPC 83650   |   |   |   |   |   | 1   |   |
|                             | <b>B(Alt)</b> EW10J4  | 02/00 → 10/03   |   | VKMA 33052<br>VKMV 6PK1706<br>VKM 33019<br>VKM 33020                               | 1<br>1  | 1<br>1  |   |   |   |   |   |
|  | <b>B(Alt)</b> EW10J4  | 10/03 → 12/07   |   | VKMOV 6PK1710<br>VKM 33019<br>VKM 33020  | 1   |   | 1   |   |   |   |   |
|  |   |   |   |  |   | 1   |   |   |   |   |   |
| <b>PEUGEOT  607 2.2 16V</b> |   |   |   |  |   |   |   |   |   |   |   |
|                             | EW12J4  | 02/00 → 12/07   |   | VKMA 03235<br>VKM 13234<br>VKM 23230   | 1<br>1  | 1<br>1  |   |   |   |   | T0169   |
|                             | EW12J4  | 02/00 → 12/07   | 16)   | VKPC 83650   |   |   |   |   |   | 1   |   |
|                             | <b>B(Alt)</b> EW12J4  | 02/00 → 10/03   | 11)   | VKMA 33052<br>VKMV 6PK1706<br>VKM 33019<br>VKM 33020                               | 1<br>1  | 1<br>1  |   |   |   |   |   |
|  | <b>B(Alt)</b> EW12J4  | 10/03 → 12/07   | 11)   | VKMOV 6PK1710<br>VKM 33019<br>VKM 33020  | 1   |   | 1   |   |   |   |   |
|  |   |   |   |  |   | 1   |   |   |   |   |   |
|  | <b>B(Alt)</b> EW12J4  | 09/05 → 12/07   | 12), Dep. 15-04, Dep. IFL5  | VKMOV 6PK1710<br>VKM 33019<br>VKM_____   | 1   |   | 1   |   |   |   |   |
|  | <b>B(Alt)</b> EW12J4  | 09/05 → 12/07   | 12), Dep. EURO 4  | VKMOV 6PK998<br>VKM_____   | 1   |   | 1   |   |   |   |   |



PEUGEOT

|  |  |  |  |  |  |   |  |  |  |  |  |  |  |  |  |       |
|--|--|---|---|---|--|---|---|---|---|---|---|---|---|---|---|-------|
| <b>PEUGEOT  607 3.0 V6</b>        |  |   |   |   |  |   |   |   |   |   |   |   |   |   |   |       |
|                                    |  | ES9J4S  | 02/00 → 12/07   |   | VKMA 03902   | 1 | 3   | 1   |   |   |   |   |   |   |   | T0204 |
|  |  |   |   |   | VKM 13902  | 1 |   |   |   |   |   |   |   |   |   |       |
|  |  |   |   |   | VKM 23900  |   | 1   |   |   |   |   |   |   |   |   |       |
|  |  |   |   |   | VKM 23900  |   | 1   |   |   |   |   |   |   |   |   |       |
|  |  |   |   |   | VKM 23901  |   | 1   |   |   |   |   |   |   |   |   |       |
|                                    |    | ES9J4S  | 02/00 → 04/00   |   | —  |   |   |   |   |   |   | 1   |   |   |   |       |
|  |  | ES9J4S  | 04/00 → 12/07   |   | —  |   |   |   |   |   |   | 1   |   |   |   |       |
|                                    | <b>B(Alt)</b>  | ES9J4S  | 02/00 → 12/07   | 11)   | VKMV 6PK1585<br>VKM 33075  |   | 1   |   | 1   |   |   |   |   |   |   |       |
| <b>PEUGEOT  607 3.0 V6 24V</b>    |  |   |   |   |  |   |   |   |   |   |   |   |   |   |   |       |
|                                    |  | ES9A  | 03/04 → 12/07   |   | VKMA 03902   | 1 | 3   | 1   |   |   |   |   |   |   |   | T0204 |
|  |  |   |   |   | VKM 13902  | 1 |   |   |   |   |   |   |   |   |   |       |
|  |  |   |   |   | VKM 23900  |   | 1   |   |   |   |   |   |   |   |   |       |
|  |  |   |   |   | VKM 23900  |   | 1   |   |   |   |   |   |   |   |   |       |
|  |  |   |   |   | VKM 23901  |   | 1   |   |   |   |   |   |   |   |   |       |
|                                    |    | ES9A  | 03/04 → 12/07   |   | —  |   |   |   |   |   |   | 1   |   |   |   |       |
| <b>PEUGEOT  607 2.0 HDi 110</b>   |  |   |   |   |  |   |   |   |   |   |   |   |   |   |   |       |
|                                    |  | DW10ATED  | 05/00 → 12/07   |  | VKMC 03247   | 1 | 1   | 1   |   | 1   |   |   |   |   |   | T0168 |
|  |  |   |   |   | VKMA 03247   | 1 | 1   | 1   |   |   |   |   |   |   |   |       |
|  |  |   |   |   | VKM 13244  | 1 |   |   |   |   |   |   |   |   |   |       |
|  |  |   |   |   | VKM 23246  |   |   | 1   |   |   |   |   |   |   |   |       |
|                                    |    | DW10ATED  | 05/00 → 12/07   |   | VKPC 83639   |   |   |   |   | 1   |   |   |   |   |   |       |
|                                    | <b>B(Alt)</b>  | DW10ATED  | 05/00 → 12/07   | 11)   | VKMV 6PK1740   |   |   |   | 1   |   |   |   |   |   |   |       |
|  |  |   |   |   | VKM 33033  | 1 |   |   |   |   |   |   |   |   |   |       |
|  |  |   |   |   | VKM 33045  |   | 1   |   |   |   |   |   |   |   |   |       |
|  | <b>B(Alt)</b>  | DW10ATED  | 05/00 → 12/07   | 12)   | VKMV 6PK1744   |   |   |   | 1   |   |   |   |   |   |   |       |
|  |  |   |   |   | VKM 33013  | 1 |   |   |   |   |   |   |   |   |   |       |
|  |  |   |   |   | VKM 33033  | 1 |   |   |   |   |   |   |   |   |   |       |
| <b>PEUGEOT  607 2.0 HDi 136</b> |  |   |   |   |  |   |   |   |   |   |   |   |   |   |   |       |
|                                  |  | DW10BTD4  | 09/05 → 12/07   |   | VKMA 03257   | 1 | 1   | 1   |   |   |   |   |   |   |   | T0205 |
|  |  |   |   |   | VKM 13257  | 1 |   |   |   |   |   |   |   |   |   |       |
|  |  |   |   |   | VKM 23257  |   |   | 1   |   |   |   |   |   |   |   |       |
|                                  |  | DW10BTD4  | 09/05 → 12/07   |   | VKPC 83643   |   |   |   |   | 1   |   |   |   |   |   |       |
|                                  | <b>B(Alt)</b>  | DW10BTD4  | 09/05 → 12/07   | 12)   | VKMA 33320   |   |   |   | 1   |   |   |   |   |   |   |       |
|  |  |   |   |   | VKMV 6PK1217   |   |   |   |   | 1   |   |   |   |   |   |       |
|  |  |   |   |   | VKM 33320  | 1 |   |   |   |   |   |   |   |   |   |       |
|                                  |  |   | 09/05 → 12/07   |   | VKM  |   |   |   |   |   |   | 1   |   |   |   |       |
| <b>PEUGEOT  607 2.2 HDi 133</b> |  |   |   |   |  |   |   |   |   |   |   |   |   |   |   |       |
|                                  |  | DW12TED4  | 02/00 → 04/04   |   | VKMA 03252   | 1 | 1   | 1   |   |   |   |   |   |   |   | T0179 |
|  |  |   |   |   | VKM 13246  | 1 |   |   |   |   |   |   |   |   |   |       |
|  |  |   |   |   | VKM 23246  |   |   | 1   |   |   |   |   |   |   |   |       |
|  |  | DW12TED4  | 04/04 → 12/07   |   | VKMA 03264   | 1 | 1   | 1   |   |   |   |   |   |   |   | T0179 |
|  |  |   |   |   | VKM 13264  | 1 |   |   |   |   |   |   |   |   |   |       |
|  |  |   |   |   | VKM 23264  |   |   | 1   |   |   |   |   |   |   |   |       |
|                                  |  | DW12TED4  | 02/00 → 12/07   |   | VKPC 83643   |   |   |   |   | 1   |   |   |   |   |   |       |
|                                  | <b>B(Alt)</b>  | DW12TED4  | 02/00 → 12/07   | 11)   | VKMV 6PK1740   |   |   |   | 1   |   |   |   |   |   |   |       |
|  |  |   |   |   | VKM 33033  | 1 |   |   |   |   |   |   |   |   |   |       |
|  |  |   |   |   | VKM 33045  |   | 1   |   |   |   |   |   |   |   |   |       |
|  | <b>B(Alt)</b>  | DW12TED4  | 02/00 → 11/04   | 12), Man. GBX   | VKMV 6PK1740   |   |   |   | 1   |   |   |   |   |   |   |       |
|  |  |   |   |   | VKM 33033  | 1 |   |   |   |   |   |   |   |   |   |       |
|  |  |   |   |   | VKM 33045  |   | 1   |   |   |   |   |   |   |   |   |       |
|  | <b>B(Alt)</b>  | DW12TED4  | 02/00 → 12/04   | 12), Auto. GBX  | VKMV 6PK1740   |   |   |   | 1   |   |   |   |   |   |   |       |
|  |  |   |   |   | VKM 33033  | 1 |   |   |   |   |   |   |   |   |   |       |
|  |  |   |   |   | VKM 33045  |   | 1   |   |   |   |   |   |   |   |   |       |
|  | <b>B(Alt)</b>  | DW12TED4  | 11/04 → 12/07   | 12), Man. GBX   | VKMV 6PK1744   |   |   |   | 1   |   |   |   |   |   |   |       |
|  |  |   |   |   | VKM 33033  | 1 |   |   |   |   |   |   |   |   |   |       |
|  |  |   |   |   | VKM 33045  |   | 1   |   |   |   |   |   |   |   |   |       |
|  | <b>B(Alt)</b>  | DW12TED4  | 12/04 → 12/07   | 12), Auto. GBX  | VKMV 6PK1744   |   |   |   | 1   |   |   |   |   |   |   |       |
|  |  |   |   |   | VKM 33033  | 1 |   |   |   |   |   |   |   |   |   |       |
|  |  |   |   |   | VKM 33045  |   | 1   |   |   |   |   |   |   |   |   |       |
| <b>PEUGEOT  607 2.2 HDi 170</b> |  |   |   |   |  |   |   |   |   |   |   |   |   |   |   |       |
|                                  |  | DW12BTD4  | 05/06 → 12/07   |   | —  | 1 | 1   | 1   |   |   |   |   |   |   |   |       |
|  |  |   |   |   | —  | 1 |   |   |   |   |   |   |   |   |   |       |



|   |  |  |  |  |  |  |  |  |  |  |  |  |
|---|---|---|---|--|---|---|---|---|---|---|---|---|
|                                | DW12BTED4   | 05/06 → 12/07   |   |  |   |   |   |   |   |   |   | 1   |
|                                | <b>B(Alt)</b> DW12BTED4   | 05/06 → 12/07   | 12)   | VKMV 6PK1205   |   |   | 1   |   |   |   |   |   |
| <b>PEUGEOT  607 2.7 V6 HDi</b> |   |   |   |  |   |   |   |   |   |   |   |   |
|                                | DT17TED4  | 12/04 → 12/07   |   | VKMA 03261<br>VKM____<br>VKM 13262<br>VKM 23261<br>VKM 23261                       | 2<br>1<br>1<br>1  | 2   | 2   |   |   |   |   | T0249   |
|                                | DT17TED4  | 12/04 → 12/07   |   | VKPC____   |   |   |   |   |   |   | 1   |   |
|                                | <b>B(Alt)</b> DT17TED4  | 12/04 → 12/07   |   | VKMV 6PK1887<br>VKM____<br>VKM____   | 1   |   | 1   |   |   |   |   |   |
| <b>PEUGEOT  806 1.8</b>        |   |   |   |  |   |   |   |   |   |   |   |   |
|                                | XU7JP   | 07/95 → 08/02   |   | VKMA 03201<br>VKM 13100  | 1<br>1  |   | 1   |   |   |   |   | T0018   |
|                                | XU7JP   | 07/95 → 08/02   |   | VKPC 83615   |   |   |   |   |   |   | 1   |   |
|                                | <b>B(Alt)</b> XU7JP   | 07/95 → 06/98   | <i>AC</i>   | VKMV 6PK1067<br>VKM 33003  | 1   |   | 1   |   |   |   |   |   |
| <b>B(Alt)</b>   | XU7JP   | 07/98 → 08/02   | <i>AC</i>   | VKMA 33031<br>VKMV 6PK1076<br>VKM 33021  | 1<br>1  |   | 1<br>1  |   |   |   |   |   |
| <b>B(Alt)</b>   | XU7JP   | 07/95 → 08/02   | <b>AC</b>   | VKMA 33030<br>VKMV 6PK1660<br>VKM 33028<br>VKM 33034                               | 1<br>1<br>1   | 1   | 1<br>1  |   |   |   |   |   |
| <b>PEUGEOT  806 2.0</b>       |   |   |   |  |   |   |   |   |   |   |   |   |
|                              | XU10J2  | 06/94 → 08/02   |   | VKMA 03201<br>VKM 13100  | 1<br>1  |   | 1   |   |   |   |   | T0018   |
|                              | XU10J2  | 06/94 → 08/02   |   | VKPC 83420   |   |   |   |   |   |   | 1   |   |
|                              | <b>B(Alt)</b> XU10J2  | 06/94 → 06/98   | <i>AC</i>   | VKMV 6PK1067<br>VKM 33003  | 1   |   | 1   |   |   |   |   |   |
| <b>B(Alt)</b>   | XU10J2  | 07/98 → 08/02   | <i>AC</i>   | VKMA 33031<br>VKMV 6PK1076<br>VKM 33021  | 1<br>1  |   | 1<br>1  |   |   |   |   |   |
| <b>B(Alt)</b>   | XU10J2  | 06/94 → 08/02   | <b>AC</b>   | VKMA 33030<br>VKMV 6PK1660<br>VKM 33028<br>VKM 33034                               | 1<br>1<br>1   | 1   | 1<br>1  |   |   |   |   |   |
| <b>PEUGEOT  806 2.0 16V</b>  |   |   |   |  |   |   |   |   |   |   |   |   |
|                              | EW10J4  | 09/00 → 08/02   |   | VKMA 03235<br>VKM 13234<br>VKM 23230   | 1<br>1  | 1   | 1   |   |   |   |   | T0169   |
|   | XU10J4R   | 05/98 → 09/00   |   | VKMA 03213<br>VKM 13202<br>VKM 23213   | 1<br>1  | 1   | 1   |   |   |   |   | T0142   |
|                              | EW10J4  | 09/00 → 08/02   | 16)   | VKPC 83650   |   |   |   |   |   |   | 1   |   |
|   | XU10J4R   | 05/98 → 09/00   |   | VKPC 83636   |   |   |   |   |   |   | 1   |   |
|                              | <b>B(Alt)</b> EW10J4  | 09/00 → 08/02   | <i>AC</i>   | VKMA 33055<br>VKMV 6PK1188<br>VKM 33019<br>VKM 33020                               | 1<br>1  | 1   | 1<br>1  |   |   |   |   |   |
| <b>B(Alt)</b>   | EW10J4  | 09/00 → 08/02   | <b>AC</b>   | VKMA 33052<br>VKMV 6PK1706<br>VKM 33019<br>VKM 33020                               | 1<br>1  | 1   | 1<br>1  |   |   |   |   |   |
| <b>B(Alt)</b>   | XU10J4R   | 05/98 → 09/00   | <i>AC</i>   | VKMV 6PK1160<br>VKM 33022<br>VKM 33025   | 1   |   | 1   |   |   |   |   |   |
| <b>B(Alt)</b>   | XU10J4R   | 05/98 → 09/00   | <b>AC</b>   | VKMA 33034<br>VKMV 6PK1603<br>VKM 33028<br>VKM 33035                               | 1<br>1  | 1   | 1<br>1  |   |   |   |   |   |





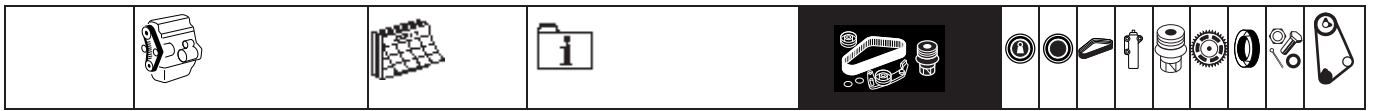

















PEUGEOT









































| PEUGEOT  806 2.0 Turbo |                        |               |             |  |        |   |        |  |  |       |
|------------------------|------------------------|---------------|-------------|--|--------|---|--------|--|--|-------|
|                        | XU10J2TE               | 06/94 → 08/02 |             | VKMA 03201<br>VKM 13100                              | 1<br>1 | 1 |        |  |  | T0018 |
|                        | XU10J2TE               | 06/94 → 08/02 |             | VKPC 83420   |        |   | 1      |  |  |       |
|                        | <b>B(Alt)</b> XU10J2TE | 06/94 → 01/97 | 70A, AC     | VKMA 6PK1067<br>VKM 33003                            | 1      |   | 1      |  |  |       |
|                        | <b>B(Alt)</b> XU10J2TE | 06/94 → 01/97 | 80, 90A, AC | VKMA 33003<br>VKMV 6PK1076<br>VKM 33003              | 1<br>1 |   | 1<br>1 |  |  |       |
|                        | <b>B(Alt)</b> XU10J2TE | 02/97 → 08/02 | AC          | VKMA 33003<br>VKMV 6PK1160<br>VKM 33022<br>VKM 33025 | 1<br>1 |   | 1<br>1 |  |  |       |
|                        | <b>B(Alt)</b> XU10J2TE | 06/94 → 01/97 | AC          | VKMA 33030<br>VKMV 6PK1660<br>VKM 33028<br>VKM 33034 | 1<br>1 | 1 | 1<br>1 |  |  |       |
|                        | <b>B(Alt)</b> XU10J2TE | 02/97 → 08/02 | AC          | VKMA 33034<br>VKMV 6PK1603<br>VKM 33028<br>VKM 33035 | 1<br>1 | 1 | 1<br>1 |  |  |       |

| PEUGEOT  806 1.9 TD |                     |               |    |  |             |             |        |   |   |       |
|---------------------|---------------------|---------------|----|--|-------------|-------------|--------|---|---|-------|
|                     | XUD9TE              | 07/95 → 08/02 |    | VKMC 03241<br>VKMA 03241<br>VKM 13241<br>VKM 23241                             | 1<br>1<br>1 | 1<br>1<br>1 |        | 1 |   | T0017 |
|                     | XUD9TE              | 07/95 → 08/02 | 3) | VKMS 03241<br>VKMA 03241<br>VKM 13241<br>VKM 23241                             | 1<br>1<br>1 | 1<br>1<br>1 |        |   | 2 | T0017 |
|                     | XUD9TE              | 07/95 → 08/02 |    | VKPC 83420   |             |             |        | 1 |   |       |
|                     | <b>B(Alt)</b> XU9TE | 07/95 → 08/02 | AC | VKMA 33035<br>VKMV 6PK1102<br>VKM 33002  | 1<br>1      |             | 1<br>1 |   |   |       |
|                     | <b>B(Alt)</b> XU9TE | 07/95 → 08/02 | AC | VKMA 33035<br>VKMV 6PK1739<br>VKM 33013<br>VKM 33029<br>VKM 33311              | 1<br>1      |             | 1      |   |   |       |
|                     | XUD9TE              | 07/95 → 08/02 |    | VKMA 33035<br>VKMV 6PK1739<br>VKM 33013<br>VKM 33029<br>VKM 33311<br>VKM 93302 | 1<br>1      |             |        |   | 1 |       |

| PEUGEOT  806 2.0 HDi |                        |               |               |   |             |             |        |   |   |       |
|----------------------|------------------------|---------------|---------------|---|-------------|-------------|--------|---|---|-------|
|                      | DW10ATED               | 08/99 → 04/00 |               | VKMC 03246<br>VKMA 03246<br>VKM 13246<br>VKM 23246                | 1<br>1<br>1 | 1<br>1<br>1 |        | 1 |   | T0168 |
|                      | DW10ATED               | 04/00 → 08/02 |               | VKMC 03247<br>VKMA 03247<br>VKM 13244<br>VKM 23246                | 1<br>1<br>1 | 1<br>1<br>1 |        | 1 |   | T0168 |
|                      | DW10ATED4              | 08/99 → 08/02 |               | VKMC 03248<br>VKMA 03248<br>VKM 13246<br>VKM 23246                | 1<br>1<br>1 | 1<br>1<br>1 |        | 1 |   | T0196 |
|                      | DW10ATED               | 08/99 → 04/00 | 3)            | VKMS 03246<br>VKMA 03246<br>VKM 13246<br>VKM 23246                | 1<br>1<br>1 | 1<br>1<br>1 |        |   | 2 | T0168 |
|                      | DW10ATED               | 08/99 → 08/02 |               | VKPC 83639  |             |             |        | 1 |   |       |
|                      | DW10ATED4              | 08/99 → 08/02 |               | VKPC 83639  |             |             |        | 1 |   |       |
|                      | <b>B(Alt)</b> DW10ATED | 08/99 → 08/02 | AC            | VKMA 33044<br>VKMV 6PK1468<br>VKM 33024<br>VKM 33033<br>VKM 33069 | 2<br>1<br>1 | 1           | 1<br>1 |   |   |       |
|                      | <b>B(Alt)</b> DW10ATED | 08/99 → 08/02 | AC Delphi, AC | VKMA 33037<br>VKMV 6PK1750<br>VKM 33013<br>VKM 33033              | 2<br>1<br>1 |             | 1<br>1 |   |   |       |

|  |  |  |  |  |  |  |  |  |  |  |  |  |
|--|---|---|---|--|---|---|---|---|---|---|---|---|
| B(Alt)   | DW10ATED  | 08/99 → 08/02   | AC Sanden, AC   | VKMV 6PK1740<br>VKM 33013<br>VKM 33033   | 1<br>1  |   | 1   |   |   |   |   |   |
| B(Alt)   | DW10ATED4   | 08/99 → 08/02   | AC  | VKMA 33044<br>VKMV 6PK1468<br>VKM 33024<br>VKM 33033<br>VKM 33069                  | 2<br>1<br>1   | 1<br>1  |   |   |   |   |   |   |
| B(Alt)   | DW10ATED4   | 08/99 → 08/02   | AC Delphi, AC   | VKMA 33037<br>VKMV 6PK1750<br>VKM 33013<br>VKM 33033                               | 2<br>1<br>1   |   | 1<br>1  |   |   |   |   |   |
| B(Alt)   | DW10ATED4   | 08/99 → 08/02   | AC Sanden, AC   | VKMV 6PK1740<br>VKM 33013<br>VKM 33033   | 1<br>1  |   | 1   |   |   |   |   |   |
| ⊙  | DW10ATED  | 08/99 → 08/02   |   | VKM 93301  |   |   |   |   |   | 1   |   |   |
|  | DW10ATED4   | 08/99 → 08/02   |   | VKM 93301  |   |   |   |   |   | 1   |   |   |
| <b>PEUGEOT  806 2.1 TD</b>    |   |   |   |  |   |   |   |   |   |   |   |   |
|                               | XUD11BTE  | 06/96 → 08/99   | ⊙   | VKMC 03251<br>VKMA 03251<br>VKM 13250<br>VKM 23213                                 | 1<br>1<br>1   | 1<br>1  | 1<br>1  | 1   |   |   | 1   | T0080   |
|  | XUD11BTE  | 06/96 → 08/99   | 3)  | VKMS 03251<br>VKMA 03251<br>VKM 13250<br>VKM 23213                                 | 1<br>1<br>1   | 1<br>1  | 1   |   |   | 2   | 1   | T0080   |
| ⊙  | XUD11BTE  | 06/96 → 08/99   |   | VKPC 83425   |   |   |   | 1   |   |   |   |   |
|                             | B(Alt) XUD11BTE   | 06/96 → 08/99   | AC  | VKMA 33035<br>VKMV 6PK1102<br>VKM 33002  | 1<br>1  |   | 1<br>1  |   |   |   |   |   |
|  | B(Alt) XUD11BTE   | 06/96 → 08/99   | AC  | VKMV 6PK1740<br>VKM 33013<br>VKM 33029<br>VKM 33311                                | 1<br>1  |   | 1   |   |   | 1   |   |   |
| ⊙  | XUD11BTE  | 06/96 → 08/99   |   | VKM 93306  |   |   |   |   |   | 1   |   |   |
| <b>PEUGEOT  807 2.0 16V</b> |   |   |   |  |   |   |   |   |   |   |   |   |
|                             | EW10A   | 09/05 → 12/07   |   | VKMA 03263<br>VKM 13263<br>VKM 23230   | 1<br>1  | 1   | 1   |   |   |   |   | T0169   |
|  | EW10J4  | 06/02 → 12/07   |   | VKMA 03235<br>VKM 13234<br>VKM 23230   | 1<br>1  | 1   | 1   |   |   |   |   | T0169   |
| ⊙  | EW10A   | 09/05 → 12/07   |   | —  |   |   |   |   |   | 1   |   |   |
|  | EW10J4  | 06/02 → 12/07   | 16)   | VKPC 83650   |   |   |   |   |   | 1   |   |   |
|                             | B(Alt) EW10A  | 09/05 → 12/07   |   | VKMV 6PK998<br>VKM_____  | 1   |   | 1   |   |   |   |   |   |
|  | B(Alt) EW10J4   | 06/02 → 11/04   |   | VKMV 6PK1710<br>VKM 33019<br>VKM 33020   | 1   |   | 1   |   |   |   |   |   |
|  | B(Alt) EW10J4   | 11/04 → 12/07   |   | VKMV 6PK1710<br>VKM 33019<br>VKM_____  | 1   |   | 1   |   |   |   |   |   |
| <b>PEUGEOT  807 2.2 16V</b> |   |   |   |  |   |   |   |   |   |   |   |   |
|                             | EW12J4  | 06/02 → 12/07   |   | VKMA 03235<br>VKM 13234<br>VKM 23230   | 1<br>1  | 1   | 1   |   |   |   |   | T0169   |
| ⊙  | EW12J4  | 06/02 → 12/07   | 16)   | VKPC 83650   |   |   |   |   |   | 1   |   |   |
|                             | B(Alt) EW12J4   | 06/02 → 11/04   |   | VKMV 6PK1710<br>VKM 33019<br>VKM 33020   | 1   |   | 1   |   |   |   |   |   |
|  | B(Alt) EW12J4   | 11/04 → 12/07   |   | VKMV 6PK1710<br>VKM 33019<br>VKM_____  | 1   |   | 1   |   |   |   |   |   |



















| <b>PEUGEOT</b> <b>807 3.0 V6</b>      |                                       |               |                |   |   |   |  |  |  |   |  |   |  |  |  |  |  |  |  |   |       |
|---------------------------------------|---------------------------------------|---------------|----------------|---|---|---|--|--|--|---|--|---|--|--|--|--|--|--|--|---|-------|
|                                       | ES9J4S                                | 06/02 → 12/07 | VKMA 03902     | 1 | 3 | 1 |  |  |  |   |  |   |  |  |  |  |  |  |  |   | T0204 |
|                                       |                                       |               | VKM 13902      | 1 |   |   |  |  |  |   |  |   |  |  |  |  |  |  |  |   |       |
|                                       |                                       |               | VKM 23900      |   | 1 |   |  |  |  |   |  |   |  |  |  |  |  |  |  |   |       |
|                                       |                                       |               | VKM 23900      |   | 1 |   |  |  |  |   |  |   |  |  |  |  |  |  |  |   |       |
|                                       |                                       |               | VKM 23901      |   | 1 |   |  |  |  |   |  |   |  |  |  |  |  |  |  |   |       |
|                                       | ES9J4S                                | 06/02 → 12/07 | —              |   |   |   |  |  |  |   |  | 1 |  |  |  |  |  |  |  |   |       |
|                                       | <b>B(Alt)</b> ES9J4S                  | 06/02 → 12/07 | VKMOV 6PK1585  |   |   | 1 |  |  |  |   |  |   |  |  |  |  |  |  |  |   |       |
|                                       |                                       |               | VKM 33075      |   | 1 |   |  |  |  |   |  |   |  |  |  |  |  |  |  |   |       |
| <b>PEUGEOT</b> <b>807 2.0 HDi 110</b> |                                       |               |                |   |   |   |  |  |  |   |  |   |  |  |  |  |  |  |  |   |       |
|                                       | DW10ATED4                             | 06/02 → 12/07 | VKMC 03248     | 1 | 1 | 1 |  |  |  | 1 |  |   |  |  |  |  |  |  |  | 1 | T0196 |
|                                       |                                       |               | VKMA 03248     | 1 | 1 | 1 |  |  |  |   |  |   |  |  |  |  |  |  |  |   | 1     |
|                                       |                                       |               | VKM 13246      | 1 |   |   |  |  |  |   |  |   |  |  |  |  |  |  |  |   | 1     |
|                                       |                                       |               | VKM 23246      |   | 1 |   |  |  |  |   |  |   |  |  |  |  |  |  |  |   |       |
|                                       | DW10ATED4                             | 06/02 → 12/07 | VKPC 83639     |   |   |   |  |  |  | 1 |  |   |  |  |  |  |  |  |  |   |       |
|                                       | <b>B(Alt)</b> DW10ATED4               | 06/02 → 12/07 | VKMOV 6PK1740  |   |   | 1 |  |  |  |   |  |   |  |  |  |  |  |  |  |   |       |
|                                       |                                       |               | VKM 33013      | 1 |   |   |  |  |  |   |  |   |  |  |  |  |  |  |  |   |       |
|                                       |                                       |               | VKM 33033      | 1 |   |   |  |  |  |   |  |   |  |  |  |  |  |  |  |   |       |
| <b>PEUGEOT</b> <b>807 2.0 HDi 136</b> |                                       |               |                |   |   |   |  |  |  |   |  |   |  |  |  |  |  |  |  |   |       |
|                                       | DW10BTED4,<br>DW10UTED4               | 06/06 → 12/07 | VKMA 03257     | 1 | 1 | 1 |  |  |  |   |  |   |  |  |  |  |  |  |  |   | T0205 |
|                                       |                                       |               | VKM 13257      | 1 |   |   |  |  |  |   |  |   |  |  |  |  |  |  |  |   |       |
|                                       |                                       |               | VKM 23257      |   | 1 |   |  |  |  |   |  |   |  |  |  |  |  |  |  |   |       |
|                                       | DW10BTED4,<br>DW10UTED4               | 06/06 → 12/07 | VKPC 83643     |   |   |   |  |  |  | 1 |  |   |  |  |  |  |  |  |  |   |       |
|                                       | <b>B(Alt)</b> DW10BTED4,<br>DW10UTED4 | 06/06 → 12/07 | VKMA 33320     | 1 |   | 1 |  |  |  |   |  |   |  |  |  |  |  |  |  |   |       |
|                                       |                                       |               | VKMOV 6PK1217  |   |   | 1 |  |  |  |   |  |   |  |  |  |  |  |  |  |   |       |
|                                       |                                       |               | VKM 33320      | 1 |   |   |  |  |  |   |  |   |  |  |  |  |  |  |  |   |       |
|                                       |                                       | 06/06 → 12/07 | VKM_____       |   |   |   |  |  |  |   |  | 1 |  |  |  |  |  |  |  |   |       |
| <b>PEUGEOT</b> <b>807 2.2 HDi 16V</b> |                                       |               |                |   |   |   |  |  |  |   |  |   |  |  |  |  |  |  |  |   |       |
|                                       | DW12TED4                              | 06/02 → 04/04 | VKMA 03252     | 1 | 1 | 1 |  |  |  |   |  |   |  |  |  |  |  |  |  | 1 | T0179 |
|                                       |                                       |               | VKM 13246      | 1 |   |   |  |  |  |   |  |   |  |  |  |  |  |  |  |   | 1     |
|                                       |                                       |               | VKM 23246      |   | 1 |   |  |  |  |   |  |   |  |  |  |  |  |  |  |   |       |
|                                       | DW12TED4                              | 04/04 → 12/07 | VKMA 03264     | 1 | 1 | 1 |  |  |  |   |  |   |  |  |  |  |  |  |  |   | T0179 |
|                                       |                                       |               | VKM 13264      | 1 |   |   |  |  |  |   |  |   |  |  |  |  |  |  |  |   |       |
|                                       |                                       |               | VKM 23264      |   | 1 |   |  |  |  |   |  |   |  |  |  |  |  |  |  |   |       |
|                                       | DW12TED4                              | 06/02 → 12/07 | VKPC 83643     |   |   |   |  |  |  | 1 |  |   |  |  |  |  |  |  |  |   |       |
|                                       | <b>B(Alt)</b> DW12TED4                | 06/02 → 12/07 | VKMOV 6PK1740  |   |   | 1 |  |  |  |   |  |   |  |  |  |  |  |  |  |   |       |
|                                       |                                       |               | VKM 33033      | 1 |   |   |  |  |  |   |  |   |  |  |  |  |  |  |  |   |       |
|                                       |                                       |               | VKM 33045      |   | 1 |   |  |  |  |   |  |   |  |  |  |  |  |  |  |   |       |
| <b>PEUGEOT</b> <b>BOXER   2.0</b>     |                                       |               |                |   |   |   |  |  |  |   |  |   |  |  |  |  |  |  |  |   |       |
|                                       | XU10J2                                | 03/94 → 04/02 | VKMA 03202     | 1 |   | 1 |  |  |  |   |  |   |  |  |  |  |  |  |  |   | T0119 |
|                                       |                                       |               | VKM 13202      | 1 |   |   |  |  |  |   |  |   |  |  |  |  |  |  |  |   |       |
|                                       | XU10J2                                | 03/94 → 04/02 | VKPC 83420     |   |   |   |  |  |  | 1 |  |   |  |  |  |  |  |  |  |   |       |
|                                       | <b>B(Alt)</b> XU10J2                  | 03/94 → 04/02 | VKMOV 6PK698   |   |   | 1 |  |  |  |   |  |   |  |  |  |  |  |  |  |   |       |
|                                       | <b>B(Alt)</b> XU10J2                  | 03/94 → 04/02 | VKMOV 6PK1094  |   |   | 1 |  |  |  |   |  |   |  |  |  |  |  |  |  |   |       |
|                                       |                                       |               | VKM 33003      | 1 |   |   |  |  |  |   |  |   |  |  |  |  |  |  |  |   |       |
|                                       | <b>B(PS)</b> XU10J2                   | 03/94 → 12/96 | VKMOV 10AVx710 |   |   | 1 |  |  |  |   |  |   |  |  |  |  |  |  |  |   |       |
|                                       | <b>B(PS)</b> XU10J2                   | 12/96 → 04/02 | VKMOV 4PK755   |   |   | 1 |  |  |  |   |  |   |  |  |  |  |  |  |  |   |       |
| <b>PEUGEOT</b> <b>BOXER   1.9 D</b>   |                                       |               |                |   |   |   |  |  |  |   |  |   |  |  |  |  |  |  |  |   |       |
|                                       | XUD9A, XUD9AU                         | 03/94 → 04/02 | VKMC 03241     | 1 | 1 | 1 |  |  |  | 1 |  |   |  |  |  |  |  |  |  |   | T0017 |
|                                       |                                       |               | VKMA 03241     | 1 | 1 | 1 |  |  |  |   |  |   |  |  |  |  |  |  |  |   |       |
|                                       |                                       |               | VKM 13241      | 1 |   |   |  |  |  |   |  |   |  |  |  |  |  |  |  |   |       |
|                                       |                                       |               | VKM 23241      |   | 1 |   |  |  |  |   |  |   |  |  |  |  |  |  |  |   |       |
|                                       | XUD9A, XUD9AU                         | 03/94 → 04/02 | VKMS 03241     | 1 | 1 | 1 |  |  |  |   |  |   |  |  |  |  |  |  |  | 2 | T0017 |
|                                       |                                       |               | VKMA 03241     | 1 | 1 | 1 |  |  |  |   |  |   |  |  |  |  |  |  |  |   |       |
|                                       |                                       |               | VKM 13241      | 1 |   |   |  |  |  |   |  |   |  |  |  |  |  |  |  |   |       |
|                                       |                                       |               | VKM 23241      |   | 1 |   |  |  |  |   |  |   |  |  |  |  |  |  |  |   |       |
|                                       | XUD9A, XUD9AU                         | 03/94 → 04/02 | VKPC 83420     |   |   |   |  |  |  | 1 |  |   |  |  |  |  |  |  |  |   |       |
|                                       | <b>B(Alt)</b> XUD9A, XUD9AU           | 03/94 → 04/02 | VKMOV 6PK730   |   |   | 1 |  |  |  |   |  |   |  |  |  |  |  |  |  |   |       |
|                                       | <b>B(Alt)</b> XUD9A, XUD9AU           | 03/94 → 04/02 | VKMOV 6PK1155  |   |   | 1 |  |  |  |   |  |   |  |  |  |  |  |  |  |   |       |
|                                       |                                       |               | VKM 33002      | 1 |   |   |  |  |  |   |  |   |  |  |  |  |  |  |  |   |       |

|  |  |  |           |  |  |  |  |  |  |  |  |
|--|---|---|--|--|---|---|---|---|---|---|---|
| <b>B(Alt)</b>  | XUD9A, XUD9AU   | 03/94 → 04/02   |  80A, AC  | VKMA 33002<br>VKMV 6PK1151<br>VKM 33002  | 1   | 1   | 1   |   |   |   |   |
| <b>B(PS)</b>   | XUD9A, XUD9AU   | 12/96 → 04/02   |  | VKMA 33002   | 1   |   |   |   |   |   |   |
| <b>B(PS)</b>   | XUD9AU  | 03/94 → 12/96   |  | VKMA 33002   |   | 1   |   |   |   |   |   |
|                                   | XUD9, XUD9A, XUD9AU   | 03/94 → 04/02   |           | VKMA 33002   |   |   |   |   | 1   |   |   |
| <b>PEUGEOT  BOXER   1.9 TD</b>    |   |   |  |  |   |   |   |   |   |   |   |
|                                   | XUD9TE, XUD9UTF   | 03/94 → 04/02   |           | VKMC 03241<br>VKMA 03241<br>VKM 13241<br>VKM 23241                                 | 1<br>1<br>1   | 1<br>1  | 1   | 1   |   |   | T0017   |
|  | XUD9TE, XUD9UTF   | 03/94 → 04/02   | 3)   | VKMS 03241<br>VKMA 03241<br>VKM 13241<br>VKM 23241                                 | 1<br>1<br>1   | 1<br>1  | 1   |   | 2   |   | T0017   |
|                                   | XUD9TE, XUD9UTF   | 03/94 → 04/02   |  | VKPC 83420   |   |   |   | 1   |   |   |   |
|                                   | <b>B(Alt)</b> XUD9TE, XUD9UTF   | 03/94 → 04/02   |           | VKMA 33002   |   | 1   |   |   |   |   |   |
| <b>B(Alt)</b>  | XUD9TE, XUD9UTF   | 03/94 → 04/02   |  80A, AC  | VKMA 33002<br>VKMV 6PK1151<br>VKM 33002  | 1   | 1   |   |   |   |   |   |
| <b>B(Alt)</b>  | XUD9TE, XUD9UTF   | 03/94 → 04/02   |  120A, AC | VKMA 33002   | 1   |   | 1   |   |   |   |   |
| <b>B(PS)</b>   | XUD9TE, XUD9UTF   | 03/94 → 12/96   |  | VKMA 33002   |   | 1   |   |   |   |   |   |
| <b>B(PS)</b>   | XUD9TE, XUD9UTF   | 12/96 → 04/02   |  | VKMA 33002   |   | 1   |   |   |   |   |   |
|                                  | XUD9TE, XUD9UTF   | 03/94 → 04/02   |          | VKMA 33002   |   |   |   |   | 1   |   |   |
| <b>PEUGEOT  BOXER   2.0 HDi</b> |   |   |  |  |   |   |   |   |   |   |   |
|                                 | DW10TD  | 08/01 → 04/02   |         | VKMC 03246<br>VKMA 03246<br>VKM 13246<br>VKM 23246                                 | 1<br>1<br>1   | 1<br>1  | 1   | 1   |   |   | T0168   |
|  | DW10TD  | 08/01 → 04/02   | 3)   | VKMS 03246<br>VKMA 03246<br>VKM 13246<br>VKM 23246                                 | 1<br>1<br>1   | 1<br>1  | 1   |   | 2   | 1   | T0168   |
|                                 | DW10TD  | 08/01 → 04/02   |  | VKPC 83639   |   |   |   | 1   |   |   |   |
|                                 | <b>B(Alt)</b> DW10TD  | 08/01 → 04/02   |         | VKMA 33002   | 1   |   | 1   |   |   |   |   |
|  | DW10TD  | 08/01 → 04/02   |  | VKMA 33002<br>VKMV 6PK1468<br>VKM 33024<br>VKM 33033<br>VKM 33314                  | 1<br>1  |   | 1   |   |   |   |   |
| <b>B(Alt)</b>  | DW10TD  | 08/01 → 04/02   | <b>AC</b>  | VKMA 33002   | 1   |   | 1   |   |   |   |   |
| <b>B(PS)</b>   | DW10TD  | 08/01 → 04/02   |  | VKMA 33002   |   | 1   |   |   |   |   |   |
|                                 | DW10TD  | 08/01 → 04/02   |         | VKMA 33002   |   |   |   |   | 1   |   |   |
| <b>PEUGEOT  BOXER   2.5 D</b>   |   |   |  |  |   |   |   |   |   |   |   |
|                                 | DJ5   | 03/94 → 04/02   | 3)   | VKMS 03300<br>VKMA 03300<br>VKM 13300<br>VKM 23300                                 | 1<br>1<br>1   | 1<br>1  | 1   |   | 2   |   | T0121   |
|                                 | DJ5   | 03/94 → 05/96   |  | VKPC 83810   |   |   |   | 1   |   |   |   |
|  | DJ5   | 05/96 → 04/02   |  | VKPC 83811   |   |   |   | 1   |   |   |   |
|                                 | <b>B(Alt)</b> DJ5   | 03/94 → 04/02   |         | VKMA 33002   |   |   | 1   |   |   |   |   |
| <b>B(Alt)</b>  | DJ5   | 03/94 → 04/02   |         | VKMA 33002   |   |   | 1   |   |   |   |   |
| <b>B(AC)</b>   | DJ5   | 03/94 → 04/02   |  | VKMA 33002   |   | 1   |   | 1   |   |   |   |
| <b>B(WP)</b>   | DJ5   | 03/94 → 05/96   |  | VKMA 33002   |   | 1   |   | 1   |   |   |   |
| <b>B(WP)</b>   | DJ5   | 05/96 → 04/02   |  | VKMA 33002   |   | 1   |   | 1   |   |   |   |
| <b>B(VP)</b>   | DJ5   | 03/94 → 11/95   |  | VKMA 33002   |   | 1   |   | 1   |   |   |   |



PEUGEOT

| <b>PEUGEOT  BOXER I 2.5 TD</b>   |                |               |               |            |               |   |   |   |  |   |  |  |   |  |   |  |  |       |
|----------------------------------|----------------|---------------|---------------|------------|---------------|---|---|---|--|---|--|--|---|--|---|--|--|-------|
|                                  | DJ5T           | 03/94 → 04/02 | 3)            | VKMS 03300 | 1             | 1 | 1 |   |  |   |  |  |   |  | 2 |  |  | T0121 |
|                                  |                |               |               | VKMA 03300 | 1             | 1 | 1 |   |  |   |  |  |   |  |   |  |  |       |
|                                  |                |               |               | VKM 13300  | 1             |   |   |   |  |   |  |  |   |  |   |  |  |       |
|                                  |                |               |               | VKM 23300  |               | 1 |   |   |  |   |  |  |   |  |   |  |  |       |
|                                  | DJ5T           | 03/94 → 05/96 |               | VKPC 83810 |               |   |   |   |  | 1 |  |  |   |  |   |  |  |       |
|                                  | DJ5T           | 05/96 → 04/02 |               | VKPC 83811 |               |   |   |   |  | 1 |  |  |   |  |   |  |  |       |
|                                  | B(Alt)         | DJ5T          | 03/94 → 04/02 | ⊘          | VKMOV 6PK802  |   |   |   |  | 1 |  |  |   |  |   |  |  |       |
|                                  | B(Alt)         | DJ5T          | 03/94 → 04/02 | ⊘          | VKMOV 6PK1012 |   |   |   |  | 1 |  |  |   |  |   |  |  |       |
|                                  |                |               |               |            | VKM 33015     |   | 1 |   |  |   |  |  |   |  |   |  |  |       |
|                                  | B(AC)          | DJ5T          | 03/94 → 04/02 |            | VKMOV 6PK915  |   |   |   |  | 1 |  |  |   |  |   |  |  |       |
|                                  |                |               |               |            | VKM 33014     |   | 1 |   |  |   |  |  |   |  |   |  |  |       |
|                                  | B(WP)          | DJ5T          | 03/94 → 05/96 |            | VKMOV 4PK946  |   |   |   |  | 1 |  |  |   |  |   |  |  |       |
|                                  |                |               |               |            | VKM 33016     | 1 |   |   |  |   |  |  |   |  |   |  |  |       |
|                                  | B(WP)          | DJ5T          | 05/96 → 04/02 |            | VKMOV 3PK946  |   |   |   |  | 1 |  |  |   |  |   |  |  |       |
|                                  |                |               |               |            | VKM 33016     | 1 |   |   |  |   |  |  |   |  |   |  |  |       |
|                                  | B(VP)          | DJ5T          | 03/94 → 11/95 |            | VKMOV 6PK915  |   |   |   |  | 1 |  |  |   |  |   |  |  |       |
|                                  |                |               |               |            | VKM 33014     |   | 1 |   |  |   |  |  |   |  |   |  |  |       |
| <b>PEUGEOT  BOXER I 2.5 TDi</b>  |                |               |               |            |               |   |   |   |  |   |  |  |   |  |   |  |  |       |
|                                  | DJ5TED         | 01/98 → 04/02 |               | VKMA 03304 | 1             | 1 | 1 |   |  |   |  |  |   |  |   |  |  | T0189 |
|                                  |                |               |               | VKM 13304  | 1             |   |   |   |  |   |  |  |   |  |   |  |  |       |
|                                  |                |               |               | VKM 23304  |               | 1 |   |   |  |   |  |  |   |  |   |  |  |       |
|                                  | DJ5TED         | 01/97 → 04/02 |               | VKPC 83811 |               |   |   |   |  | 1 |  |  |   |  |   |  |  |       |
|                                  | B(Alt)         | DJ5TED        | 01/97 → 04/02 | ⊘          | VKMOV 6PK802  |   |   |   |  | 1 |  |  |   |  |   |  |  |       |
|                                  | B(Alt)         | DJ5TED        | 01/97 → 04/02 | ⊘          | VKMOV 6PK1012 |   |   |   |  | 1 |  |  |   |  |   |  |  |       |
|                                  |                |               |               |            | VKM 33015     |   | 1 |   |  |   |  |  |   |  |   |  |  |       |
|                                  | B(AC)          | DJ5TED        | 01/97 → 04/02 |            | VKMOV 6PK915  |   |   |   |  | 1 |  |  |   |  |   |  |  |       |
|                                  |                |               |               |            | VKM 33041     | 1 |   |   |  |   |  |  |   |  |   |  |  |       |
|                                  | B(WP)          | DJ5TED        | 01/97 → 04/02 |            | VKMOV 3PK946  |   |   |   |  | 1 |  |  |   |  |   |  |  |       |
|                                  |                |               |               |            | VKM 33016     | 1 |   |   |  |   |  |  |   |  |   |  |  |       |
| <b>PEUGEOT  BOXER I 2.8 HDi</b>  |                |               |               |            |               |   |   |   |  |   |  |  |   |  |   |  |  |       |
|                                  | Sofim 2800 HDi | 11/00 → 04/02 |               | VKMA 02983 |               | 2 | 1 | 1 |  |   |  |  |   |  |   |  |  | T0096 |
|                                  |                |               |               | VKM 22380  |               | 1 |   | 1 |  |   |  |  |   |  |   |  |  |       |
|                                  |                |               |               | VKM 22385  |               | 1 |   |   |  |   |  |  |   |  |   |  |  |       |
|                                  | Sofim 2800 HDi | 11/00 → 04/02 |               | VKMA 02383 |               | 2 | 1 |   |  |   |  |  |   |  |   |  |  | T0652 |
|                                  |                |               |               | VKM 22380  |               | 1 |   |   |  |   |  |  |   |  |   |  |  |       |
|                                  |                |               |               | VKM 22385  |               | 1 |   |   |  |   |  |  |   |  |   |  |  |       |
|                                  | Sofim 2800 HDi | 11/00 → 04/02 |               | VKPC 82652 |               |   |   |   |  | 1 |  |  |   |  |   |  |  |       |
| <b>PEUGEOT  BOXER II 2.0</b>     |                |               |               |            |               |   |   |   |  |   |  |  |   |  |   |  |  |       |
|                                  | XU10J2U        | 04/02 → 12/07 |               | VKMA 03202 | 1             |   | 1 |   |  |   |  |  |   |  |   |  |  | T0119 |
|                                  |                |               |               | VKM 13202  | 1             |   |   |   |  |   |  |  |   |  |   |  |  |       |
|                                  | XU10J2U        | 04/02 → 12/07 |               | VKPC 83420 |               |   |   |   |  | 1 |  |  |   |  |   |  |  |       |
|                                  | B(Alt)         | XU10J2U       | 04/02 → 12/07 | AC         | VKMOV 6PK698  |   |   |   |  | 1 |  |  |   |  |   |  |  |       |
|                                  | B(Alt)         | XU10J2U       | 04/02 → 12/07 | AC         | VKMOV 6PK1094 |   |   |   |  | 1 |  |  |   |  |   |  |  |       |
|                                  |                |               |               |            | VKM 33003     | 1 |   |   |  |   |  |  |   |  |   |  |  |       |
|                                  | B(PS)          | XU10J2U       | 04/02 → 12/07 |            | VKMOV 4PK755  |   |   |   |  | 1 |  |  |   |  |   |  |  |       |
| <b>PEUGEOT  BOXER II 2.0 HDi</b> |                |               |               |            |               |   |   |   |  |   |  |  |   |  |   |  |  |       |
|                                  | DW10TD         | 04/02 → 12/07 |               | VKMC 03246 | 1             | 1 | 1 |   |  | 1 |  |  |   |  |   |  |  | T0168 |
|                                  |                |               |               | VKMA 03246 | 1             | 1 | 1 |   |  |   |  |  |   |  |   |  |  |       |
|                                  |                |               |               | VKM 13246  | 1             |   |   |   |  |   |  |  |   |  |   |  |  |       |
|                                  |                |               |               | VKM 23246  |               | 1 |   |   |  |   |  |  |   |  |   |  |  |       |
|                                  | DW10TD         | 04/02 → 12/07 | 3)            | VKMS 03246 | 1             | 1 | 1 |   |  |   |  |  | 2 |  | 1 |  |  | T0168 |
|                                  |                |               |               | VKMA 03246 | 1             | 1 | 1 |   |  |   |  |  |   |  | 1 |  |  |       |
|                                  |                |               |               | VKM 13246  | 1             |   |   |   |  |   |  |  |   |  | 1 |  |  |       |
|                                  |                |               |               | VKM 23246  |               | 1 |   |   |  |   |  |  |   |  |   |  |  |       |
|                                  | DW10TD         | 04/02 → 12/07 |               | VKPC 83639 |               |   |   |   |  | 1 |  |  |   |  |   |  |  |       |
|                                  | B(Alt)         | DW10TD        | 04/02 → 05/04 | AC         | VKMOV 6PK1468 |   |   |   |  | 1 |  |  |   |  |   |  |  |       |
|                                  |                |               |               |            | VKM 33024     | 1 |   |   |  |   |  |  |   |  |   |  |  |       |
|                                  |                |               |               |            | VKM 33033     | 1 |   |   |  |   |  |  |   |  |   |  |  |       |
|                                  |                |               |               |            | VKM 33314     |   | 1 |   |  |   |  |  |   |  |   |  |  |       |

















|  |  |  |  |  |  |  |  |  |  |  |  |  |  |  |
|--|---|---|---|--|---|---|---|---|---|---|---|---|---|---|
| B(Alt)   | DW10TD  | 05/04 → 12/07   | AC  | VKMA 33068<br>VKMV 6PK872<br>VKM 33032   | 1   |   | 1   |   |   |   |   |   |   |   |
| B(Alt)   | DW10TD  | 04/02 → 05/04   | AC  | VKMA 33024<br>VKM 33032<br>VKM 33314   | 1   |   | 1   |   |   |   |   |   |   |   |
| B(Alt)   | DW10TD  | 05/04 → 12/07   | AC  | VKMA 33032<br>VKM 33314  | 1   |   | 1   |   |   |   |   |   |   |   |
| B(PS)  | DW10TD  | 04/02 → 12/07   |   | VKMA 4PK755  |   |   | 1   |   |   |   |   |   |   |   |
|  | DW10TD  | 04/02 → 04/04   | AC  | VKM 93301  |   |   |   |   |   | 1   |   |   |   |   |
| <b>PEUGEOT  BOXER II 2.2 HDi</b>        |   |   |   |  |   |   |   |   |   |   |   |   |   |   |
|  | DW12TED   | 04/02 → 04/04   |   | VKMA 03255<br>VKM 13246<br>VKM 23246   | 1   | 1   | 1   |   |   |   |   |   | 1   | T0198   |
|  | DW12TED   | 04/04 → 12/07   |   | VKMA 03266<br>VKM 13264<br>VKM 23264   | 1   | 1   | 1   |   |   |   |   |   | 1   | T0198   |
|  | DW12TED   | 04/02 → 12/07   |   | VKPC 83643   |   |   |   |   |   | 1   |   |   |   |   |
| B(Alt)   | DW12TED   | 04/02 → 05/04   | AC  | VKMA 6PK1468<br>VKM 33024<br>VKM 33033<br>VKM 33314                                | 1   |   | 1   |   |   |   |   |   |   |   |
| B(Alt)   | DW12TED   | 05/04 → 12/07   | AC  | VKMA 33068<br>VKMV 6PK872<br>VKM 33032   | 1   |   | 1   |   |   |   |   |   |   |   |
| B(Alt)   | DW12TED   | 04/02 → 05/04   | AC  | VKMA 6PK1182<br>VKM 33024<br>VKM 33032<br>VKM 33314                                | 1   |   | 1   |   |   |   |   |   |   |   |
| B(Alt)   | DW12TED   | 05/04 → 12/07   | AC  | VKMA 6PK1182<br>VKM 33032<br>VKM 33314   | 1   |   | 1   |   |   |   |   |   |   |   |
| B(PS)  | DW12TED   | 04/02 → 12/07   |   | VKMA 4PK755  |   |   | 1   |   |   |   |   |   |   |   |
|  | DW12TED   | 04/02 → 12/07   | AC  | VKM 93301  |   |   |   |   |   | 1   |   |   |   |   |
| <b>PEUGEOT  BOXER II 2.8 HDi</b>      |   |   |   |  |   |   |   |   |   |   |   |   |   |   |
|  | Sofim 2800 HDi  | 04/02 → 12/07   |   | VKMA 02983<br>VKM 22380<br>VKM 22385   | 2   | 1   | 1   |   |   |   |   |   |   | T0096   |
|  | Sofim 2800 HDi  | 04/02 → 12/07   |   | VKMA 02383<br>VKM 22380<br>VKM 22385   | 2   | 1   |   |   |   |   |   |   |   | T0652   |
|  | Sofim 2800 HDi  | 04/02 → 12/07   |   | VKPC 82652   |   |   |   |   |   | 1   |   |   |   |   |
| B(Alt)   | Sofim 2800 HDi  | 04/02 → 12/07   | Man. GBX  | VKMA 6PK950  |   |   | 1   |   |   |   |   |   |   |   |
| B(AC)  | Sofim 2800 HDi  | 04/02 → 12/07   |   | VKMA 5PK1100<br>VKM _____  | 1   |   | 1   |   |   |   |   |   |   |   |
| <b>PEUGEOT  BOXER III 2.2 HDi</b>     |   |   |   |  |   |   |   |   |   |   |   |   |   |   |
|  | 22DT  | 04/06 → 12/07   |   | VKPA _____   |   |   |   |   |   | 1   |   |   |   |   |
|  | 22DT  | 04/06 → 12/07   | 2)  | VKMA 6PK1670<br>VKM 34030<br>VKM _____<br>VKM _____                                | 1   |   | 1   |   |   |   |   |   |   |   |
| <b>PEUGEOT  BOXER III 3.0 HDi 160</b> |   |   |   |  |   |   |   |   |   |   |   |   |   |   |
|  | F30DT   | 04/06 → 12/07   |   | VKMA _____   |   |   |   |   |   |   |   |   |   |   |
| <b>PEUGEOT  EXPERT I 1.6</b>          |   |   |   |  |   |   |   |   |   |   |   |   |   |   |
|  | 1580 SPI  | 02/96 → 12/07   |   | VKMA 02410<br>VKM 12200  | 1   |   | 1   |   |   |   |   |   |   | T0052   |
|  | 1580SPI   | 02/96 → 12/07   | 2),   | VKPA 83431   |   |   |   |   |   | 1   |   |   |   |   |
|  | 1580SPI   | 02/96 → 12/07   | 2),   | VKPA 83432   |   |   |   |   |   | 1   |   |   |   |   |
| B(Alt)   | 1580 SPI  | 02/96 → 12/05   | AC  | VKMA 4PK903<br>VKM 32154   | 1   |   | 1   |   |   |   |   |   |   |   |























































































PEUGEOT



| B(PS)                            | 1580 SPI      | 02/96 → 12/06 |       | VKMM 10AVx690   |                  |        |        |  | 1 |   |   |             |       |
|----------------------------------|---------------|---------------|-------|---|------------------|--------|--------|--|---|---|---|-------------|-------|
| <b>PEUGEOT  EXPERT I 1.8</b>     |               |               |       |   |                  |        |        |  |   |   |   |             |       |
|                                  | XU7JP         | 10/96 → 09/00 |       | VKMA 03201<br>VKM 13100   | 1<br>1           |        | 1      |  |   |   |   |             | T0018 |
|                                  | XU7JP         | 10/96 → 09/00 |       | VKPC 83615  |                  |        |        |  | 1 |   |   |             |       |
|                                  | B(Alt) XU7JP  | 10/96 → 06/98 |       | VKMM 6PK1067<br>VKM 33003   | 1                |        | 1      |  |   |   |   |             |       |
| <b>PEUGEOT  EXPERT I 2.0 16V</b> |               |               |       |   |                  |        |        |  |   |   |   |             |       |
|                                  | EW10J4        | 07/00 → 12/07 |       | VKMA 03235<br>VKM 13234<br>VKM 23230                              | 1<br>1<br>1      | 1      | 1      |  |   |   |   |             | T0169 |
|                                  | EW10J4        | 07/00 → 12/07 | 16)   | VKPC 83650  |                  |        |        |  | 1 |   |   |             |       |
|                                  | B(Alt) EW10J4 | 07/00 → 11/05 | AC    | VKMA 33055<br>VKMM 6PK1188<br>VKM 33019<br>VKM 33020              | 1<br>1<br>1      | 1      | 1      |  |   |   |   |             |       |
|                                  | B(Alt) EW10J4 | 11/05 → 12/07 | AC    | VKMM 6PK1188<br>VKM 33019<br>VKM _____                            | 1<br>1           |        | 1      |  |   |   |   |             |       |
|                                  | B(Alt) EW10J4 | 07/00 → 11/05 | AC    | VKMM 6PK1710<br>VKM 33019<br>VKM 33020                            | 1<br>1           |        | 1      |  |   |   |   |             |       |
|                                  | B(Alt) EW10J4 | 11/05 → 12/07 | AC    | VKMM 6PK1710<br>VKM 33019<br>VKM _____                            | 1<br>1           |        | 1      |  |   |   |   |             |       |
| <b>PEUGEOT  EXPERT I 1.9 D</b>   |               |               |       |   |                  |        |        |  |   |   |   |             |       |
|                                  | DW8, DW8B     | 12/98 → 12/07 |       | VKMC 03244<br>VKMA 03244<br>VKM 13244<br>VKM 23246                | 1<br>1<br>1<br>1 | 1<br>1 | 1<br>1 |  | 1 |   |   | 1<br>1<br>1 | T0167 |
|                                  | XUD9AU        | 02/96 → 12/07 |       | VKMC 03241<br>VKMA 03241<br>VKM 13241<br>VKM 23241                | 1<br>1<br>1<br>1 | 1<br>1 | 1<br>1 |  | 1 |   |   |             | T0017 |
|                                  | XUD9AU        | 02/96 → 12/07 | 3)    | VKMS 03241<br>VKMA 03241<br>VKM 13241<br>VKM 23241                | 1<br>1<br>1<br>1 | 1<br>1 | 1<br>1 |  |   |   | 2 |             | T0017 |
|                                  | DW8, DW8B     | 12/98 → 12/07 |       | VKPC 83639  |                  |        |        |  | 1 |   |   |             |       |
|                                  | XUD9AU        | 02/96 → 12/07 |       | VKPC 83420  |                  |        |        |  | 1 |   |   |             |       |
|                                  | B(Alt) DW8    | 12/98 → 12/07 | AC, ⊗ | VKMM 6PK866<br>VKM 33004  | 1                |        | 1      |  |   |   |   |             |       |
|                                  | B(Alt) DW8    | 12/98 → 12/07 | AC, ⊗ | VKMM 6PK1042<br>VKM 33004   | 1                |        | 1      |  |   |   |   |             |       |
|                                  | B(Alt) DW8    | 12/98 → 10/99 | AC, ⊗ | VKMA 33021<br>VKMM 6PK1388<br>VKM 33017<br>VKM 33017<br>VKM 33042 | 1<br>1<br>1<br>1 | 2      | 1<br>1 |  |   |   |   |             |       |
|                                  | B(Alt) DW8    | 10/99 → 12/07 | AC, ⊗ | VKMA 33027<br>VKMM 6PK1437<br>VKM 33017<br>VKM 33031<br>VKM 33032 | 1<br>1<br>1<br>1 | 2      | 1<br>1 |  |   |   |   |             |       |
|                                  | B(Alt) DW8    | 12/98 → 12/07 | AC, ⊗ | VKMA 33093<br>VKMM 6PK1750<br>VKM 33013<br>VKM 33029<br>VKM 33311 | 2<br>1<br>1      |        | 1<br>1 |  |   | 1 |   |             |       |
|                                  | B(Alt) DW8B   | 12/98 → 12/07 | AC    | VKMA 33027<br>VKMM 6PK1437<br>VKM 33017<br>VKM 33031<br>VKM 33032 | 1<br>1<br>1<br>1 | 2      | 1<br>1 |  |   |   |   |             |       |



|   |  |  |  |  |  |  |  |  |  |  |  |  |
|---|---|---|---|--|---|---|---|---|---|---|---|---|
| B(Alt)  | DW8B  | 12/98 → 12/02   | AC  | VKMV 6PK1736<br>VKM 33013<br>VKM 33029<br>VKM 33311                                | 1<br>1  |   | 1   |   |   |   | 1   |   |
| B(Alt)  | DW8B  | 12/02 → 12/07   | AC  | VKMV 6PK872<br>VKM 33013   | 1   |   | 1   |   |   |   |   |   |
| B(Alt)  | XUD9AU  | 02/96 → 12/07   | AC, ⊗   | VKMV 6PK730  |   |   | 1   |   |   |   |   |   |
| B(Alt)  | XUD9AU  | 02/96 → 12/07   | AC, ⊗   | VKMA 33040<br>VKMV 6PK1160<br>VKM 33002  | 1<br>1  |   | 1<br>1  |   |   |   |   |   |
| B(Alt)  | XUD9AU  | 02/96 → 12/07   | AC, ⊗   | VKMA 33102<br>VKMV 6PK1110<br>VKM 33002  | 1<br>1  |   | 1<br>1  |   |   |   |   |   |
| B(Alt)  | XUD9AU  | 02/96 → 12/07   | AC, ⊗   | VKMV 6PK1740<br>VKM 33013<br>VKM 33029<br>VKM 33311                                | 1<br>1  |   | 1   |   |   |   | 1   |   |
| ⊗   | DW8B  | 12/98 → 09/04   | AC  | VKM 93301  |   |   |   |   |   |   | 1   |   |
|   | DW8B  | 09/04 → 12/07   | AC  | VKM  |   |   |   |   |   |   | 1   |   |
|   | XUD9AU  | 02/96 → 12/07   |   | VKM 93302  |   |   |   |   |   |   | 1   |   |
| <b>PEUGEOT  EXPERT   1.9 TD</b>    |   |   |   |  |   |   |   |   |   |   |   |   |
|                                    | XUD9TE  | 02/96 → 12/07   | ⊗   | VKMC 03241<br>VKMA 03241<br>VKM 13241<br>VKM 23241                                 | 1<br>1<br>1   | 1<br>1  | 1<br>1  |   | 1   |   |   | T0017   |
|   | XUD9TE  | 02/96 → 12/07   | 3)  | VKMS 03241<br>VKMA 03241<br>VKM 13241<br>VKM 23241                                 | 1<br>1<br>1   | 1<br>1  | 1<br>1  |   |   |   | 2   | T0017   |
| ⊗   | XUD9TE  | 02/96 → 12/07   |   | VKPC 83420   |   |   |   |   | 1   |   |   |   |
|                                  | B(Alt) XUD9TE   | 02/96 → 12/07   | AC, ⊗   | VKMV 6PK730  |   |   | 1   |   |   |   |   |   |
|   | B(Alt) XUD9TE   | 02/96 → 12/07   | AC, ⊗   | VKMA 33040<br>VKMV 6PK1160<br>VKM 33002  | 1<br>1  |   | 1<br>1  |   |   |   |   |   |
|   | B(Alt) XUD9TE   | 02/96 → 12/07   | AC, ⊗   | VKMA 33102<br>VKMV 6PK1110<br>VKM 33002  | 1<br>1  |   | 1<br>1  |   |   |   |   |   |
|   | B(Alt) XUD9TE   | 02/96 → 12/07   | AC, ⊗   | VKMV 6PK1739<br>VKM 33013<br>VKM 33029<br>VKM 33311                                | 1<br>1  |   | 1   |   |   |   | 1   |   |
| ⊗   | XUD9TE  | 02/96 → 12/07   |   | VKM 93302  |   |   |   |   |   |   | 1   |   |
| <b>PEUGEOT  EXPERT   2.0 HDi</b> |   |   |   |  |   |   |   |   |   |   |   |   |
|                                  | DW10ATED,<br>DW10BTED "W3"  | 07/00 → 12/07   | ⊗   | VKMC 03247<br>VKMA 03247<br>VKM 13244<br>VKM 23246                                 | 1<br>1<br>1   | 1<br>1  | 1<br>1  |   | 1   |   |   | 1<br>1<br>1<br>1  |
|   | DW10ATED4   | 07/00 → 04/04   | ⊗   | VKMC 03248<br>VKMA 03248<br>VKM 13246<br>VKM 23246                                 | 1<br>1<br>1   | 1<br>1  | 1<br>1  |   | 1   |   |   | 1<br>1<br>1<br>1  |
|   | DW10BTED "W4",<br>DW10BTED+   | 07/00 → 11/03   | ⊗   | VKMC 03247<br>VKMA 03247<br>VKM 13244<br>VKM 23246                                 | 1<br>1<br>1   | 1<br>1  | 1<br>1  |   | 1   |   |   | 1<br>1<br>1<br>1  |
|   | DW10BTED "W4",<br>DW10BTED+   | 11/03 → 12/07   | ⊗   | VKMC 03246<br>VKMA 03246<br>VKM 13246<br>VKM 23246                                 | 1<br>1<br>1   | 1<br>1  | 1<br>1  |   | 1   |   |   | 1<br>1<br>1<br>1  |
|   | DW10ATED4   | 04/04 → 12/07   |   | VKMA 03265<br>VKM 13264<br>VKM 23264   | 1<br>1  | 1<br>1  | 1   |   |   |   |   | T0196   |

|   |  |  |    |  |  |  |  |  |  |  |  |  |
|---|---|---|---|--|---|---|---|---|---|---|---|---|
|   | DW10ATED,<br>DW10ATED4,<br>DW10BTED   | 07/00 → 12/07   |   | VKPC 83639   |   |   |   |   |   | 1   |   |   |
|   | <b>B(Alt)</b> DW10ATED,<br>DW10ATED4,<br>DW10BTED                                 | 07/00 → 12/07   | AC  | VKMA 33044<br>VKMV 6PK1468<br>VKM 33024<br>VKM 33033<br>VKM 33069                  | 2   | 1   | 1   |   |   |   |   |   |
|   | <b>B(Alt)</b> DW10ATED,<br>DW10ATED4,<br>DW10BTED                                 | 07/00 → 12/07   | AC  | VKMV 6PK1740<br>VKM 33013<br>VKM 33033   |   |   | 1   |   |   |   |   |   |
|   | DW10ATED,<br>DW10BTED "W3"  | 07/00 → 12/07   |   | VKM 93301  |   |   |   |   |   |   | 1   |   |
|   | DW10ATED4,<br>DW10BTED "W4",<br>DW10BTED+   | 07/00 → 11/02   |   | VKM 93301  |   |   |   |   |   |   | 1   |   |
|   | DW10ATED4,<br>DW10BTED "W4",<br>DW10BTED+   | 12/02 → 12/07   |   | VKM_____   |   |   |   |   |   |   | 1   |   |
| <b>PEUGEOT  EXPERT II / EXPERT Tepee 2.0 16V</b>   |   |   |   |  |   |   |   |   |   |   |   |   |
|   | EW10A   | 01/07 → 12/07   |   | —  |   |   |   |   |   | 1   |   |   |
|   | <b>B(Alt)</b> EW10A   | 01/07 → 12/07   |   | VKMV 6PK998<br>VKM_____  | 1   |   | 1   |   |   |   |   |   |
| <b>PEUGEOT  EXPERT II / EXPERT Tepee 1.6 HDi</b> |   |   |   |  |   |   |   |   |   |   |   |   |
|   | DV6UTED4  | 01/07 → 12/07   |   | VKPC 83259   |   |   |   |   |   | 1   |   |   |
|   | <b>B(Alt)</b> DV6UTED4  | 01/07 → 12/07   | AC  | VKM_____   | 1   |   |   |   |   |   |   |   |
| <b>PEUGEOT  EXPERT II / EXPERT Tepee 2.0 HDi</b> |   |   |   |  |   |   |   |   |   |   |   |   |
|   | DW10BTED4,<br>DW10UTED4   | 01/07 → 12/07   |   | VKMA 03257<br>VKM 13257<br>VKM 23257   | 1   | 1   | 1   |   |   |   |   | T0205   |
|   | DW10BTED4,<br>DW10UTED4   | 01/07 → 12/07   |   | VKPC 83643   |   |   |   |   |   | 1   |   |   |
|   | <b>B(Alt)</b> DW10BTED4,<br>DW10UTED4   | 01/07 → 07/07   |   | VKMA 33320<br>VKMV 6PK1217<br>VKM 33320  | 1   |   | 1   |   |   |   |   |   |
|   |   |   |   |  | 1   |   | 1   |   |   |   |   |   |
| <b>PEUGEOT  J5 1.8</b>                           |   |   |   |  |   |   |   |   |   |   |   |   |
|   | XM7T  | 01/83 → 11/88   |   | XXXXXXXXXX   |   |   |   |   |   |   |   |   |
|   | XM7T  | 01/83 → 11/88   |   | VKPC 83630   |   |   |   |   |   | 1   |   |   |
|   | <b>B(Alt)</b> XM7T  | 01/83 → 11/88   |   | VKMV 10AVx925  |   |   | 1   |   |   |   |   |   |
| <b>PEUGEOT  J5 2.0</b>                           |   |   |   |  |   |   |   |   |   |   |   |   |
|   | XN1T, XN1TACP   | 09/81 → 05/04   |   | XXXXXXXXXX   |   |   |   |   |   |   |   |   |
|   | XN1T  | 09/81 → 12/04   |   | VKPC 83630   |   |   |   |   |   | 1   |   |   |
|   | <b>B(Alt)</b> XN1T, XN1TACP   | 09/81 → 12/06   |   | VKMV 10AVx925  |   |   | 1   |   |   |   |   |   |
|   | <b>B(PS)</b> XN1TACP  | 10/90 → 12/06   |   | VKMV 10AVx775  |   |   | 1   |   |   |   |   |   |
| <b>PEUGEOT  J5 1.9 D</b>                         |   |   |   |  |   |   |   |   |   |   |   |   |
|   | XUD9  | 10/90 → 05/04   |  | VKMC 03240<br>VKMA 03240<br>VKM 13240<br>VKM 23240                                 | 1   | 1   | 1   |   |   | 1   |   | 2<br>2<br>T0017   |
|   | XUD9  | 10/90 → 12/04   |   | VKPC 83424   |   |   |   |   |   | 1   |   |   |
|   | <b>B(Alt)</b> XUD9  | 10/90 → 12/06   |   | VKMV 4PK795  |   |   | 1   |   |   |   |   |   |
|   | <b>B(PS)</b> XUD9   | 10/90 → 12/06   |   | VKMV 10AVx800  |   |   | 1   |   |   |   |   |   |
|   | XUD9  | 10/90 → 07/06   |   | —  |   |   |   |   |   | 1   |   |   |
| <b>PEUGEOT  J5 2.5 D</b>                         |   |   |   |  |   |   |   |   |   |   |   |   |
|   | CRD93   | 09/81 → 05/04   |   | VKMA 03050<br>VKM 12200<br>VKM 13050   | 2   |   | 2   |   |   |   |   | T0021   |
|   |   |   |   |  | 1   |   |   |   |   |   |   |   |
|   |   |   |   |  | 1   |   |   |   |   |   |   |   |



|  |  |  |                         |  |  |  |  |  |  |  |  |  |
|--|---|---|--|--|---|---|---|---|---|---|---|---|
|                               | CRD93   | 09/81 → 12/04   |  | VKPC 83617   |   |   |   |   | 1   |   |   |   |
|                               | B(Alt) CRD93  | 09/81 → 12/06   |  | VKMV 10AVx700  |   | 1   |   |   |   |   |   |   |
|  | B(PS) CRD93   | 10/90 → 12/06   |  | VKMV 10AVx800  |   | 1   |   |   |   |   |   |   |
|  | B(VP) CRD93   | 09/81 → 12/06   |  | VKMV 10AVx600  |   | 1   |   |   |   |   |   |   |
| <b>PEUGEOT  J5 2.5 TD</b>     |   |   |  |  |   |   |   |   |   |   |   |   |
|                               | CRD93S  | 10/90 → 05/04   |  | VKMA 03050<br>VKM 12200<br>VKM 13050   | 2<br>1<br>1   | 2   |   |   |   |   |   | T0021   |
|                               | CRD93S  | 10/90 → 12/04   |  | VKPC 83617   |   |   |   |   | 1   |   |   |   |
|                               | B(Alt) CRD93S   | 10/90 → 12/06   |  | VKMV 10AVx700  |   | 1   |   |   |   |   |   |   |
|  | B(PS) CRD93S  | 10/90 → 12/06   |  | VKMV 10AVx800  |   | 1   |   |   |   |   |   |   |
|  | B(VP) CRD93S  | 10/90 → 12/06   |  | VKMV 10AVx600  |   | 1   |   |   |   |   |   |   |
| <b>PEUGEOT  J7 1.9 D</b>      |   |   |  |  |   |   |   |   |   |   |   |   |
|                               | XDP88   | 08/68 → 07/78   |  | VKPC 83622   |   |   |   |   | 1   |   |   |   |
| <b>PEUGEOT  J7 2.1 D</b>      |   |   |  |  |   |   |   |   |   |   |   |   |
|                               | XDP90   | 01/77 → 07/77   | Fix.FAN  | VKPC 83622   |   |   |   |   | 1   |   |   |   |
| <b>PEUGEOT  J9 1.6</b>        |   |   |  |  |   |   |   |   |   |   |   |   |
|                               | XC7P  | 03/80 → 03/87   |  | —  |   |   |   |   | 1   |   |   |   |
|                               | B(Fan) XC7P   | 03/80 → 06/87   |  | VKMV 10AVx888  |   | 1   |   |   |   |   |   |   |
| <b>PEUGEOT  J9 2.0</b>        |   |   |  |  |   |   |   |   |   |   |   |   |
|                               | XN1P  | 03/80 → 06/87   |  | —  |   |   |   |   | 1   |   |   |   |
|                               | B(Fan) XN1P   | 03/80 → 06/87   |  | VKMV 10AVx888  |   | 1   |   |   |   |   |   |   |
| <b>PEUGEOT  J9 2.1 D</b>      |   |   |  |  |   |   |   |   |   |   |   |   |
|                             | XDPX90  | 03/80 → 06/87   |  | VKPC 83622   |   |   |   |   | 1   |   |   |   |
|                             | B(VP) XDPX90  | 03/80 → 05/84   |  | VKMV 10AVx650  |   | 1   |   |   |   |   |   |   |
|  | B(Fan) XDPX90   | 03/80 → 06/87   |  | VKMV 10AVx1025   |   | 1   |   |   |   |   |   |   |
| <b>PEUGEOT  J9 2.3 D</b>    |   |   |  |  |   |   |   |   |   |   |   |   |
|                             | XD2PX94   | 03/80 → 07/82   |  | —  |   |   |   |   | 1   |   |   |   |
|                             | B(VP) XD2PX94   | 03/80 → 07/82   |  | VKMV 10AVx650  |   | 1   |   |   |   |   |   |   |
|  | B(Fan) XD2PX94  | 03/80 → 07/82   |  | VKMV 10AVx1025   |   | 1   |   |   |   |   |   |   |
| <b>PEUGEOT  J9 2.5 D</b>    |   |   |  |  |   |   |   |   |   |   |   |   |
|                             | XD3P  | 07/82 → 06/87   | Fix.FAN  | VKPC 83622   |   |   |   |   | 1   |   |   |   |
|  | XD3P  | 07/82 → 06/87   | Auto.FAN   | VKPC 83628   |   |   |   |   | 1   |   |   |   |
|                             | B(VP) XD3P  | 07/82 → 05/84   |  | VKMV 10AVx650  |   | 1   |   |   |   |   |   |   |
|  | B(Fan) XD3P   | 07/82 → 06/87   |  | VKMV 10AVx1025   |   | 1   |   |   |   |   |   |   |
| <b>PEUGEOT  PARTNER 1.1</b> |   |   |  |  |   |   |   |   |   |   |   |   |
|                             | TU1JP   | 06/96 → 12/07   |  M⊙<br>→IMot. 3762433 | VKMC 03100<br>VKMA 03100<br>VKM 13100  | 1<br>1<br>1   | 1<br>1  | 1   |   |   |   |   | T0044   |
|  | TU1JP   | 06/96 → 12/07   | 3), M⊙<br>→IMot. 3762433   | VKMS 03100-1<br>VKMA 03100<br>VKM 13100  | 1<br>1<br>1   | 1<br>1  |   |   | 2   |   |   | T0044   |
|  | TU1JP   | 06/96 → 12/07   | A⊙, Mot. 3762434   →   | VKMA 03253<br>VKM 13253  | 1<br>1  | 1   |   |   |   |   |   | T0188   |
|  | TU1M+   | 06/96 → 12/07   |                       | VKMC 03100<br>VKMA 03100<br>VKM 13100  | 1<br>1<br>1   | 1<br>1  | 1   |   |   |   |   | T0044   |
|  | TU1M+   | 06/96 → 12/07   | 3)   | VKMS 03100-1<br>VKMA 03100<br>VKM 13100  | 1<br>1<br>1   | 1<br>1  |   |   | 2   |   |   | T0044   |
|                             | TU1JP   | 06/96 → 12/07   | →IMot. 3762433   | VKPC 83205   |   |   |   |   | 1   |   |   |   |
|  | TU1JP   | 06/96 → 12/07   | Mot. 3762434   →   | VKPC 83644   |   |   |   |   | 1   |   |   |   |
|  | TU1M+   | 06/96 → 12/07   |  | VKPC 83205   |   |   |   |   | 1   |   |   |   |
|                             | B(PS) TU1JP, TU1M   | 06/96 → 07/01   | 11)  | VKMA 33212<br>VKMV 5PK881<br>VKM 33012   | 1<br>1  | 1<br>1  |   |   |   |   |   |   |
|  | B(PS) TU1JP, TU1M   | 07/01 → 12/07   | 11)  | VKM 33012  | 1   |   |   |   |   |   |   |   |
|  | B(PS) TU1M+   | 06/96 → 12/07   | 11), AC  | VKMA 33312<br>VKM 33012  | 1<br>1  | 1   |   |   |   |   |   |   |





**PEUGEOT  PARTNER 1.4**

|  |             |               |                           |   |             |   |   |  |  |   |  |  |  |  |  |  |  |  |       |
|--|-------------|---------------|---------------------------|---|-------------|---|---|--|--|---|--|--|--|--|--|--|--|--|-------|
|  | TU3-2       | 06/96 → 12/07 | 3)                        | VKMS 03110-1<br>VKMA 03110<br>VKM 13100 | 1<br>1<br>1 | 1 |   |  |  | 2 |  |  |  |  |  |  |  |  | T0044 |
|  | TU3JP       | 06/96 → 12/07 | 3), M⊙,<br>→IMot. 3666765 | VKMS 03110-1<br>VKMA 03110<br>VKM 13100 | 1<br>1<br>1 | 1 | 1 |  |  | 2 |  |  |  |  |  |  |  |  | T0044 |
|  | TU3JP       | 06/96 → 12/07 | A⊙, Mot. 3666766  →       | VKMA 03254<br>VKM 13253                 | 1<br>1      | 1 |   |  |  |   |  |  |  |  |  |  |  |  | T0189 |
|  | TU3-2       | 06/96 → 12/07 |                           | VKPC 83205                              |             |   |   |  |  | 1 |  |  |  |  |  |  |  |  |       |
|  | TU3JP       | 06/96 → 12/07 | →IMot. 3666765            | VKPC 83205                              |             |   |   |  |  | 1 |  |  |  |  |  |  |  |  |       |
|  | TU3JP       | 06/96 → 12/07 | Mot. 3666766  →           | VKPC 83644                              |             |   |   |  |  | 1 |  |  |  |  |  |  |  |  |       |
|  | B(PS) TU3JP | 06/96 → 07/01 | 11)                       | VKMA 33212<br>VKMV 5PK881<br>VKM 33012  | 1<br>1<br>1 | 1 | 1 |  |  |   |  |  |  |  |  |  |  |  |       |
|  | B(PS) TU3JP | 07/01 → 12/07 | 11)                       | VKM 33012                               | 1           |   |   |  |  |   |  |  |  |  |  |  |  |  |       |
|  | B(PS) TU3JP | 06/96 → 12/07 | 11)                       | VKMA 33312<br>VKM 33012                 | 1<br>1      | 1 | 1 |  |  |   |  |  |  |  |  |  |  |  |       |



**PEUGEOT  PARTNER 1.4 BiFuel**

|   |             |               |                           |   |             |   |   |  |  |   |  |  |  |  |  |  |  |  |       |       |
|---|-------------|---------------|---------------------------|---|-------------|---|---|--|--|---|--|--|--|--|--|--|--|--|-------|-------|
|   | TU3A        | 04/03 → 12/07 | 3), M⊙,<br>→IMot. 3666765 | VKMS 03110-1<br>VKMA 03110<br>VKM 13100 | 1<br>1<br>1 | 1 | 1 |  |  | 2 |  |  |  |  |  |  |  |  | T0044 |       |
|   | TU3A        | 04/03 → 12/07 | A⊙, Mot. 3666766  →       | VKMA 03254<br>VKM 13253                 | 1<br>1      | 1 | 1 |  |  |   |  |  |  |  |  |  |  |  |       | T0189 |
|  | B(Alt) TU3A | 04/03 → 12/07 | AC                        | VKMA 33024<br>VKMV 6PK1451<br>VKM 33018 |             | 1 | 1 |  |  |   |  |  |  |  |  |  |  |  |       |       |
|   | B(Alt) TU3A | 04/03 → 12/07 | AC                        | VKMV 6PK1564<br>VKM 33100<br>VKM_____   |             | 1 | 1 |  |  |   |  |  |  |  |  |  |  |  |       |       |



**PEUGEOT  PARTNER 1.6 16V**































|  |               |               |                 |   |             |   |   |   |  |   |  |  |  |  |   |  |  |  |       |       |
|--|---------------|---------------|-----------------|---|-------------|---|---|---|--|---|--|--|--|--|---|--|--|--|-------|-------|
|  | TU5JP4        | 07/01 → 12/07 | →IMot. 1806404  | VKMA 03132<br>VKM 13132<br>VKM 23130    | 1<br>1<br>1 | 1 | 1 |   |  |   |  |  |  |  | 1 |  |  |  | T0193 |       |
|  | TU5JP4        | 07/01 → 12/07 | Mot. 1806405  → | VKMA 03256<br>VKM 13256<br>VKM 23256    | 1<br>1<br>1 | 1 | 1 | 1 |  |   |  |  |  |  |   |  |  |  |       | T0193 |
|  | TU5JP4        | 07/01 → 12/07 |                 | VKPC 83430                              |             |   |   |   |  | 1 |  |  |  |  |   |  |  |  |       |       |
|  | B(Alt) TU5JP4 | 07/01 → 12/07 | AC              | VKMA 33024<br>VKMV 6PK1451<br>VKM 33018 |             | 1 | 1 |   |  |   |  |  |  |  |   |  |  |  |       |       |
|  | B(Alt) TU5JP4 | 07/01 → 01/05 | AC              | VKMV 6PK1560<br>VKM 33100<br>VKM 33101  |             | 1 | 1 |   |  |   |  |  |  |  |   |  |  |  |       |       |

**PEUGEOT  PARTNER 1.8**

|  |              |               |            |  |                  |   |   |   |  |   |  |  |  |  |  |  |  |  |  |       |
|--|--------------|---------------|------------|--|------------------|---|---|---|--|---|--|--|--|--|--|--|--|--|--|-------|
|  | XU7JB        | 05/97 → 12/07 |            | VKMA 03201<br>VKM 13100                              | 1<br>1           | 1 | 1 |   |  |   |  |  |  |  |  |  |  |  |  | T0018 |
|  | XU7JB        | 05/97 → 12/07 |            | VKPC 83615   |                  |   |   |   |  | 1 |  |  |  |  |  |  |  |  |  |       |
|  | B(Alt) XU7JB | 05/97 → 12/07 | ⊙ 90A, AC  | VKMA 33032<br>VKMV 6PK1660<br>VKM 33026<br>VKM 33028 | 1<br>1<br>1<br>1 | 1 | 1 | 1 |  |   |  |  |  |  |  |  |  |  |  |       |
|  | B(Alt) XU7JB | 05/97 → 12/07 | ⊙ 120A, AC | VKMA 33033<br>VKMV 6PK1660<br>VKM 33027<br>VKM 33028 | 1<br>1<br>1<br>1 | 1 | 1 | 1 |  |   |  |  |  |  |  |  |  |  |  |       |





















**PEUGEOT  PARTNER 1.6 HDi 75**

|  |          |               |  |                                      |             |   |   |   |  |   |  |  |  |  |  |  |  |  |  |       |
|--|----------|---------------|--|--------------------------------------|-------------|---|---|---|--|---|--|--|--|--|--|--|--|--|--|-------|
|  | DV6BTED4 | 07/05 → 12/07 |  | VKMA 03259<br>VKM 13140<br>VKM 23140 | 1<br>1<br>1 | 1 | 1 | 1 |  |   |  |  |  |  |  |  |  |  |  | T0195 |
|  | DV6BTED4 | 07/05 → 12/07 |  | VKPC 83259                           |             |   |   |   |  | 1 |  |  |  |  |  |  |  |  |  |       |













































|   |  |  |             |  |  |  |  |  |  |  |  |  |
|---|---|---|--|--|---|---|---|---|---|---|---|---|
|  B(Alt)                            | DV6BTED4  | 07/05 → 10/05   | AC   | VKMA 33060<br>VKMV 6PK1341<br>VKM 33060<br>VKM 33060<br>VKM 33061                  | 1<br>2<br>1<br>1<br>1   | 1<br>1<br>1   |   |   |   |   |   |   |
| B(Alt)  | DV6BTED4  | 10/05 → 12/07   | AC   | VKM_____   | 1   |   |   |   |   |   |   |   |
| B(Alt)  | DV6BTED4  | 07/05 → 10/05   | AC   | VKMA 33061<br>VKMV 6PK1705<br>VKM 33044<br>VKM 33061                               | 1<br>1<br>1<br>1  | 1<br>1  |   |   |   |   |   | 1   |
| B(Alt)  | DV6BTED4  | 10/05 → 12/07   | AC   | VKMV 6PK1710<br>VKM_____   | 1<br>1  | 1   |   |   |   |   |   |   |
| <b>PEUGEOT  PARTNER 1.6 HDi 90</b> |   |   |  |  |   |   |   |   |   |   |   |   |
|                                    | DV6ATED4  | 07/05 → 12/07   |  | VKMA 03259<br>VKM 13140<br>VKM 23140   | 1<br>1<br>1   | 1<br>1  | 1   |   |   |   |   | T0195   |
|                                    | DV6ATED4  | 07/05 → 12/07   |  | VKPC 83259   |   |   |   | 1   |   |   |   |   |
|  B(Alt)                            | DV6ATED4  | 07/05 → 10/05   | AC   | VKMA 33060<br>VKMV 6PK1341<br>VKM 33060<br>VKM 33060<br>VKM 33061                  | 1<br>2<br>1<br>1<br>1   | 1<br>1  |   |   |   |   |   | 1<br>1  |
| B(Alt)  | DV6ATED4  | 10/05 → 12/07   | AC   | VKM_____   | 1   |   |   |   |   |   |   |   |
| B(Alt)  | DV6ATED4  | 07/05 → 10/05   | AC   | VKMA 33061<br>VKMV 6PK1705<br>VKM 33044<br>VKM 33061                               | 1<br>1<br>1<br>1  | 1<br>1  | 1   |   |   |   |   | 1   |
| B(Alt)  | DV6ATED4  | 10/05 → 12/07   | AC   | VKMV 6PK1710<br>VKM_____   | 1<br>1  | 1   |   |   |   |   |   |   |
| <b>PEUGEOT  PARTNER 1.8 D</b>    |   |   |  |  |   |   |   |   |   |   |   |   |
|                                  | XUD7  | 06/96 → 12/07   |           | VKMC 03241<br>VKMA 03241<br>VKM 13241<br>VKM 23241                                 | 1<br>1<br>1<br>1  | 1<br>1<br>1   | 1   | 1   |   |   |   | T0017   |
|   | XUD7  | 06/96 → 12/07   | 3)   | VKMS 03241<br>VKMA 03241<br>VKM 13241<br>VKM 23241                                 | 1<br>1<br>1<br>1  | 1<br>1<br>1   |   |   |   | 2   |   | T0017   |
|                                  | XUD7  | 06/96 → 12/07   |  | VKPC 83420   |   |   |   | 1   |   |   |   |   |
|  B(Alt)                          | XUD7  | 06/96 → 12/07   | 11), AC,  | VKMA 33040<br>VKMV 6PK1160<br>VKM 33002  | 1<br>1<br>1   | 1<br>1  |   |   |   |   |   |   |
| B(Alt)  | XUD7  | 06/96 → 12/07   | 11), AC,  | VKMA 33102<br>VKMV 6PK1110<br>VKM 33002  | 1<br>1<br>1   | 1<br>1  |   |   |   |   |   |   |
| B(Alt)  | XUD7  | 06/96 → 12/07   | 11), AC,  | VKMV 6PK1736<br>VKM 33013<br>VKM 33029<br>VKM 33311                                | 1<br>1<br>1<br>1  | 1   |   |   |   | 1   |   |   |
|                                  | XUD7  | 06/96 → 12/07   |  | VKM 93302  |   |   |   | 1   |   |   |   |   |
| <b>PEUGEOT  PARTNER 1.9 D</b>    |   |   |  |  |   |   |   |   |   |   |   |   |
|                                  | DW8, DW8B   | 06/96 → 12/07   |           | VKMC 03244<br>VKMA 03244<br>VKM 13244<br>VKM 23246                                 | 1<br>1<br>1<br>1  | 1<br>1<br>1   | 1   | 1   |   |   |   | 1<br>1<br>1<br>T0167  |
|   | XUD9A   | 06/96 → 12/07   |           | VKMC 03241<br>VKMA 03241<br>VKM 13241<br>VKM 23241                                 | 1<br>1<br>1<br>1  | 1<br>1<br>1   |   | 1   |   |   |   | T0017   |
|   | XUD9A   | 06/96 → 12/07   | 3)   | VKMS 03241<br>VKMA 03241<br>VKM 13241<br>VKM 23241                                 | 1<br>1<br>1<br>1  | 1<br>1<br>1   |   |   |   | 2   |   | T0017   |
|                                  | DW8, DW8B   | 06/96 → 12/07   |  | VKPC 83639   |   |   |   | 1   |   |   |   |   |
|   | XUD9A   | 06/96 → 12/07   |  | VKPC 83420   |   |   |   | 1   |   |   |   |   |



PEUGEOT

|  |  |  |    |  |  |  |  |  |  |  |  |  |  |
|--|---|---|---|--|---|---|---|---|---|---|---|---|---|
|  B(Alt)                            | DW8, DW8B   | 06/96 → 12/07   | 11), AC, ⊗  | VKMOV 6PK866<br>VKM 33004  | 1   | 1   |   |   |   |   |   |   |   |
| B(Alt)   | DW8, DW8B   | 06/96 → 12/07   | 11), AC, ⊗  | VKMOV 6PK1042<br>VKM 33004   | 1   | 1   |   |   |   |   |   |   |   |
| B(Alt)   | DW8   | 06/96 → 11/99   | 11), AC, ⊗  | VKMA 33021<br>VKMV 6PK1388<br>VKM 33017<br>VKM 33017<br>VKM 33042                  | 1<br>1<br>1<br>1  | 2<br>1  | 1<br>1  |   |   |   |   |   |   |
| B(Alt)   | DW8   | 06/96 → 07/02   | 11), AC, ⊗  | VKMA 33093<br>VKMV 6PK1750<br>VKM 33013<br>VKM 33029<br>VKM 33311                  | 2<br>1<br>1   | 1<br>1  |   | 1   |   |   | 1   |   |   |
| B(Alt)   | DW8   | 11/99 → 12/07   | 11), AC, ⊗  | VKMA 33027<br>VKMV 6PK1437<br>VKM 33017<br>VKM 33031<br>VKM 33032                  | 1<br>1<br>1<br>1  | 2<br>1<br>1   | 1<br>1  |   |   |   |   |   |   |
| B(Alt)   | DW8B  | 06/96 → 12/07   | 11), AC, ⊗  | VKMA 33027<br>VKMV 6PK1437<br>VKM 33017<br>VKM 33031<br>VKM 33032                  | 1<br>1<br>1<br>1  | 2<br>1<br>1   | 1<br>1  |   |   |   |   |   |   |
| B(Alt)   | DW8B  | 06/96 → 12/07   | 12), AC   | VKMA 33027<br>VKMV 6PK1437<br>VKM 33017<br>VKM 33031<br>VKM 33032                  | 1<br>1<br>1<br>1  | 2<br>1<br>1   | 1<br>1  |   |   |   |   |   |   |
| B(Alt)   | DW8B  | 06/96 → 12/07   | 12), AC   | VKMOV 6PK1680<br>VKM 33013   | 1   | 1   | 1   |   |   |   |   |   |   |
| B(Alt)   | DW8B  | 07/02 → 12/07   | 11), AC, ⊗  | VKMOV 6PK1695<br>VKM 33013   | 1   | 1   | 1   |   |   |   |   |   |   |
| B(Alt)   | XUD9A   | 06/96 → 12/07   | 11), AC, ⊗  | VKMA 33040<br>VKMV 6PK1160<br>VKM 33002  | 1<br>1  | 1<br>1  | 1<br>1  |   |   |   |   |   |   |
| B(Alt)   | XUD9A   | 06/96 → 12/07   | 11), AC, ⊗  | VKMA 33102<br>VKMV 6PK1110<br>VKM 33002  | 1<br>1  | 1<br>1  | 1<br>1  |   |   |   |   |   |   |
| B(Alt)   | XUD9A   | 06/96 → 12/07   | 11), AC, ⊗  | VKMOV 6PK1736<br>VKM 33013<br>VKM 33029<br>VKM 33311                               | 1<br>1<br>1   | 1   | 1   |   |   |   | 1   |   |   |
| ⊗  | DW8   | 07/02 → 12/07   | AC  | VKM 93301  |   |   |   |   |   |   | 1   |   |   |
|  | DW8B  | 12/01 → 12/07   | AC  | VKM 93301  |   |   |   |   |   |   | 1   |   |   |
|  | XUD9A   | 06/96 → 12/07   |   | VKM 93302  |   |   |   |   |   |   | 1   |   |   |
| <b>PEUGEOT  PARTNER 2.0 HDi</b> |   |   |   |  |   |   |   |   |   |   |   |   |   |
|                                  | DW10TD  | 02/00 → 10/00   |  | VKMC 03246<br>VKMA 03246<br>VKM 13246<br>VKM 23246                                 | 1<br>1<br>1<br>1  | 1<br>1<br>1   | 1<br>1  | 1   |   |   |   | 1<br>1  | T0168   |
|  | DW10TD  | 10/00 → 12/07   |  | VKMC 03247<br>VKMA 03247<br>VKM 13244<br>VKM 23246                                 | 1<br>1<br>1<br>1  | 1<br>1<br>1   | 1   | 1   |   |   |   | 1<br>1  | T0168   |
|  | DW10TD  | 02/00 → 10/00   | 3)  | VKMS 03246<br>VKMA 03246<br>VKM 13246<br>VKM 23246                                 | 1<br>1<br>1<br>1  | 1<br>1<br>1   | 1   |   |   |   | 2   | 1<br>1  | T0168   |
|                                  | DW10TD  | 02/00 → 12/07   |   | VKPC 83639   |   |   |   | 1   |   |   |   |   |   |
|  B(Alt)                          | DW10TD  | 02/00 → 12/07   | AC  | VKMA 33044<br>VKMV 6PK1468<br>VKM 33024<br>VKM 33033<br>VKM 33069                  | 2<br>1<br>1<br>1  | 1<br>1  | 1<br>1  |   |   |   |   |   |   |



























|  |  |  |  |  |  |  |  |  |  |  |   |       |
|--|---|---|---|--|---|---|---|---|---|---|---|-------|
| B(Alt)   | DW10TD  | 02/00 → 12/07   | AC  | VKMV 6PK1740<br>VKM 33013<br>VKM 33033   | 1<br>1  |   | 1   |   |   |   |   |       |
| ⊙  | DW10TD  | 02/00 → 12/07   |   | VKM 93301  |   |   |   | 1   |   |   |   |       |
| <b>PORSCHE 911</b>   |   |   |   |  |   |   |   |   |   |   |   |       |
|   |   | 01/63 → 02/72   |   | OXOXOXO  |   |   |   |   |   |   |   |       |
|   |   | 01/63 → 02/72   |   | —  |   |   |   |   |   |   |   |       |
| <b>PORSCHE 924 2.0</b>   |   |   |   |  |   |   |   |   |   |   |   |       |
|   | XJ, XK  | 11/75 → 08/89   |   | VKMA 01000<br>VKM 11000  | 1<br>1  | 1   |   |   |   |   | 3 | T0005 |
|   | XJ, XK  | 11/75 → 08/89   |   | VKPC 81601   |   |   | 1   |   |   |   |   |       |
| <b>PORSCHE 924 2.0 Turbo</b>   |   |   |   |  |   |   |   |   |   |   |   |       |
|   | M 31.01   | 11/78 → 06/80   |   | VKMA 01000<br>VKM 11000  | 1<br>1  | 1   |   |   |   |   | 3 | T0005 |
|   | M 31.01   | 11/78 → 06/80   |   | VKPC 81601   |   |   | 1   |   |   |   |   |       |
| <b>PROTON  PERDANA 2.0</b>              |   |   |   |  |   |   |   |   |   |   |   |       |
|   | 4G93  | 12/94 → 12/95   | Mod. E55A   | VKMA 95019<br>VKM 75044<br>VKM 75064<br>VKM 85000                                  | 2<br>1<br>1   | 1   | 2   |   |   |   |   | T0670 |
| <b>PROTON  PERSONA 1.6</b>              |   |   |   |  |   |   |   |   |   |   |   |       |
|   | 4G92  | 05/93 → 12/95   | Mod. C98  | VKMA 95020<br>VKM 75002  | 1<br>1  | 1   |   |   |   |   |   | T0494 |
| <b>PROTON  PERSONA 300 1.3</b>          |   |   |   |  |   |   |   |   |   |   |   |       |
|                                        | 4G13  | 01/95 → 07/03   |   | VKPC 95008   |   |   |   | 1   |   |   |   |       |
| <b>PROTON  PERSONA 300 1.5</b>        |   |   |   |  |   |   |   |   |   |   |   |       |
|                                       | G15   | 11/93 → 07/03   |   | VKPC 95008   |   |   |   | 1   |   |   |   |       |
| <b>PROTON  PERSONA 300 1.6</b>        |   |   |   |  |   |   |   |   |   |   |   |       |
|                                       | 4G92  | 01/93 → 07/03   |   | VKPC 95426   |   |   |   | 1   |   |   |   |       |
| <b>PROTON  PERSONA 300 1.8</b>        |   |   |   |  |   |   |   |   |   |   |   |       |
|                                       | 4G93  | 03/96 → 07/03   |   | VKPC 95426   |   |   |   | 1   |   |   |   |       |
| <b>PROTON  PERSONA 400 1.3</b>        |   |   |   |  |   |   |   |   |   |   |   |       |
|                                       | 4G13  | 01/95 → 07/03   |   | VKPC 95008   |   |   |   | 1   |   |   |   |       |
| <b>PROTON  PERSONA 400 1.5</b>        |   |   |   |  |   |   |   |   |   |   |   |       |
|                                       | G15   | 11/93 → 07/03   |   | VKPC 95008   |   |   |   | 1   |   |   |   |       |
| <b>PROTON  PERSONA 400 1.6, 1.6 D</b> |   |   |   |  |   |   |   |   |   |   |   |       |
|                                       | 4G92  | 01/93 → 07/03   |   | VKPC 95426   |   |   |   | 1   |   |   |   |       |
| <b>PROTON  PERSONA 400 1.8, 1.8 D</b> |   |   |   |  |   |   |   |   |   |   |   |       |
|                                       | 4G93  | 01/96 → 07/03   |   | VKPC 95426   |   |   |   | 1   |   |   |   |       |
| <b>PROTON  PERSONA 400 2.0 D</b>      |   |   |   |  |   |   |   |   |   |   |   |       |
|                                       | 4D68  | 05/96 → 07/03   |   | VKPC 95614   |   |   |   | 1   |   |   |   |       |
| <b>PROTON  PERSONA 400 2.0 TD</b>     |   |   |   |  |   |   |   |   |   |   |   |       |
|                                       | 4D68  | 09/96 → 07/03   |   | VKPC 95614   |   |   |   | 1   |   |   |   |       |
| <b>PROTON  SAGA 1.3</b>               |   |   |   |  |   |   |   |   |   |   |   |       |
|                                       | 4G13  | 01/86 → 06/87   | Mod. C21A   | VKMA 95206<br>VKM 75100  | 1<br>1  | 1   |   |   |   |   |   | T0697 |
|  | 4G13  | 07/87 → 08/90   | Mod. C21A   | VKMA 95207<br>VKM 75100  | 1<br>1  | 1   |   |   |   |   |   | T0697 |
|  | 4G13  | 09/90 → 12/91   | Mod. C21A   | VKMA 95012<br>VKM 75001  | 1<br>1  | 1   |   |   |   |   |   | T0697 |
| <b>PROTON  SAGA 1.5</b>               |   |   |   |  |   |   |   |   |   |   |   |       |
|                                       | 4G15  | 01/86 → 06/87   | Mod. C22A   | VKMA 95206<br>VKM 75100  | 1<br>1  | 1   |   |   |   |   |   | T0697 |
|  | 4G15  | 07/87 → 08/90   | Mod. C22A   | VKMA 95207<br>VKM 75100  | 1<br>1  | 1   |   |   |   |   |   | T0697 |
|  | 4G15  | 09/90 → 12/91   | Mod. C22A   | VKMA 95012<br>VKM 75001  | 1<br>1  | 1   |   |   |   |   |   | T0697 |
| <b>PROTON  SATRIA 1.3</b>             |   |   |   |  |   |   |   |   |   |   |   |       |
|                                       | 4G13  | 09/94 → 12/95   | Mod. C96  | VKMA 95012<br>VKM 75001  | 1<br>1  | 1   |   |   |   |   |   | T0697 |































PEUGEOT

| <b>PROTON  SATRIA 1.6</b>              |  |               |                |  |                       |                  |        |        |        |   |  |  |  |   |       |
|--|--|---------------|----------------|--|-----------------------|------------------|--------|--------|--------|---|--|--|--|---|-------|
|  | 4G92   | 09/94 → 12/95 | Mod. C98       | VKMA 95020<br>VKM 75002  | 1<br>1                | 1                |        |        |        |   |  |  |  |   | T0494 |
| <b>PROTON  WIRA 1.3</b>                |  |               |                |  |                       |                  |        |        |        |   |  |  |  |   |       |
|  | 4G13   | 05/93 → 12/95 | Mod. C96       | VKMA 95012<br>VKM 75001  | 1<br>1                | 1                |        |        |        |   |  |  |  |   | T0697 |
| <b>PROTON  WIRA 1.5</b>                |  |               |                |  |                       |                  |        |        |        |   |  |  |  |   |       |
|  | 4G15   | 05/93 → 12/95 | Mod. C97       | VKMA 95012<br>VKM 75001  | 1<br>1                | 1                |        |        |        |   |  |  |  |   | T0697 |
| <b>PROTON  WIRA 1.6</b>                |  |               |                |  |                       |                  |        |        |        |   |  |  |  |   |       |
|  | 4G92   | 05/93 → 12/95 | Mod. C98       | VKMA 95020<br>VKM 75002  | 1<br>1                | 1                |        |        |        |   |  |  |  |   | T0494 |
| <b>PROTON  WIRA 1.8</b>                |  |               |                |  |                       |                  |        |        |        |   |  |  |  |   |       |
|  | 4G93   | 09/95 → 12/96 | Mod. C99, SOHC | VKMA 95025<br>VKM 75002  | 1<br>1                | 1                |        |        |        |   |  |  |  |   | T0678 |
|  | 4G93   | 09/95 → 12/96 | Mod. C99, DOHC | VKMA 95022<br>VKM 75009<br>VKM 85000                           | 1<br>1<br>1           | 1                | 1      | 1      |        |   |  |  |  |   | T0679 |
| <b>RENAULT  AVANTIME 2.0 16V Turbo</b> |  |               |                |  |                       |                  |        |        |        |   |  |  |  |   |       |
|  | F4R 760, F4R 761   | 11/01 → 05/03 |                | VKMC 06106<br>VKMA 06106<br>VKM 16550<br>VKM 26105             | 1<br>1<br>1<br>1      | 1<br>1           | 1<br>1 | 1<br>1 | 2<br>2 |   |  |  |  |   | T0177 |
|  | F4R 760, F4R 761   | 11/01 → 05/03 |                | VKPC 85304   |                       |                  |        | 1      |        |   |  |  |  |   |       |
|  | <b>B(Alt)</b> F4R 760, F4R 761   | 11/01 → 05/03 |                | VKMA 36033<br>VKMV 6PK1792<br>VKM 36030<br>VKM 36031           | 1<br>1<br>1<br>1      | 1<br>1           | 1<br>1 |        |        |   |  |  |  |   |       |
| <b>RENAULT  AVANTIME 3.0 V6</b>        |  |               |                |  |                       |                  |        |        |        |   |  |  |  |   |       |
|  | L7X 721, L7X 722   | 09/01 → 05/03 |                | VKMA 03902<br>VKM 13902<br>VKM 23900<br>VKM 23900<br>VKM 23901 | 1<br>1<br>1<br>1<br>1 | 3<br>1<br>1<br>1 | 1      |        |        |   |  |  |  |   | T0204 |
|  | L7X 721, L7X 722   | 09/01 → 05/03 |                | —  |                       |                  |        | 1      |        |   |  |  |  |   |       |
|  | <b>B(Alt)</b> L7X 721, L7X 722   | 09/01 → 05/03 |                | VKMV 6PK1585<br>VKM 33075                                      |                       | 1                | 1      |        |        |   |  |  |  |   |       |
| <b>RENAULT  AVANTIME 2.2 dCi</b>       |  |               |                |  |                       |                  |        |        |        |   |  |  |  |   |       |
|  | G9T 712  | 05/02 → 05/03 |                | VKMA 06503<br>VKM 16503<br>VKM 26503                           | 1<br>1<br>1           | 1<br>1           | 1      |        |        |   |  |  |  | 1 | T0187 |
|  | G9T 712  | 05/02 → 05/03 |                | VKPC 86305   |                       |                  |        | 1      |        |   |  |  |  |   |       |
|  | <b>B(Alt)</b> G9T 712  | 05/02 → 05/03 |                | VKMA 36040<br>VKMV 6PK1778<br>VKM 36040<br>VKM 36040           |                       | 2<br>1<br>1      | 1<br>1 |        |        |   |  |  |  |   |       |
| <b>RENAULT  CLIO I 1.1</b>             |  |               |                |  |                       |                  |        |        |        |   |  |  |  |   |       |
|  | C1E 700  | 01/91 → 09/98 |                | <del>VKMA 06010</del>  |                       |                  |        |        |        |   |  |  |  |   |       |
|  | C1E 700  | 01/91 → 09/98 |                | VKPC 86206   |                       |                  |        | 1      |        |   |  |  |  |   |       |
|  | <b>B(Alt)</b> C1E 700  | 01/91 → 09/98 |                | VKMV 10AVx1140   |                       |                  | 1      |        |        |   |  |  |  |   |       |
| <b>RENAULT  CLIO I 1.2</b>             |  |               |                |  |                       |                  |        |        |        |   |  |  |  |   |       |
|  | C3G 720  | 01/96 → 12/96 |                | <del>VKMA 06010</del>  |                       |                  |        |        |        |   |  |  |  |   |       |
|  | D7F 730  | 01/96 → 09/98 |                | VKMC 06010<br>VKMA 06010<br>VKM 16000                          | 1<br>1<br>1           | 1<br>1           | 1      |        |        |   |  |  |  |   | T0136 |
|  | D7F 730  | 01/96 → 09/98 | 3)             | VKMS 06010-1<br>VKMA 06010<br>VKM 16000                        | 1<br>1<br>1           | 1<br>1           |        |        |        | 2 |  |  |  |   | T0136 |
|  | E5F 710, E5F 716,<br>E7F 700, E7F 704,<br>E7F 706, E7F 708,<br>E7F 750 | 05/90 → 09/98 |                | VKMC 06000<br>VKMA 06000<br>VKM 16000                          | 1<br>1<br>1           | 1<br>1           | 1      |        |        |   |  |  |  |   | T0061 |

|   |     |  |    |  |  |  |  |  |  |  |  |
|---|--|---|---|--|---|---|---|---|---|---|---|
|   | E5F 710, E5F 716,<br>E7F 700, E7F 704,<br>E7F 706, E7F 708,<br>E7F 750               | 05/90 → 09/98   | 3)  | VKMS 06000<br>VKMA 06000<br>VKM 16000  | 1<br>1<br>1   | 1<br>1  |   |   |   | 2   | T0061   |
|                              | C3G 720  | 01/96 → 12/96   | 2)  | VKPA 86212<br>VKPC 86212   |   |   |   | 1<br>1  |   |   |   |
|   | D7F 730  | 01/96 → 09/98   |   | VKPC 86215   |   |   |   | 1   |   |   |   |
|   | E5F 710, E5F 716,<br>E7F 700, E7F 704,<br>E7F 706, E7F 708,<br>E7F 750               | 05/90 → 09/98   |   | VKPC 86409   |   |   |   | 1   |   |   |   |
|                              | <b>B(Alt)</b> C3G 720  | 01/96 → 12/96   |   | VKMV 10AVx1140   |   | 1   |   |   |   |   |   |
|   | <b>B(Alt)</b> D7F 730  | 01/96 → 09/98   |   | VKMV 4PK735  |   | 1   |   |   |   |   |   |
|   | <b>B(Alt)</b> E5F 710, E5F 716,<br>E7F 700, E7F 704,<br>E7F 706, E7F 708,<br>E7F 750 | 05/90 → 09/98   | AC  | VKMV 10AVx690  |   | 1   |   |   |   |   |   |
|   | <b>B(Alt)</b> E5F 710, E5F 716,<br>E7F 700, E7F 704,<br>E7F 706, E7F 708,<br>E7F 750 | 05/90 → 09/98   | AC  | VKMV 3PK712  |   | 1   |   |   |   |   |   |
|   | <b>B(PS)</b> D7F 730   | 01/96 → 09/98   | AC  | VKMV 5PK880<br>VKM 36023   |   | 1   |   |   |   |   |   |
|   | <b>B(PS)</b> D7F 730   | 01/96 → 09/98   | AC  | VKMV 5PK910<br>VKM 36023   |   | 1   |   |   |   |   |   |
|   | <b>B(AC)</b> E5F 710, E5F 716,<br>E7F 700, E7F 704,<br>E7F 706, E7F 708,<br>E7F 750  | 05/90 → 09/98   | ⊘   | VKMV 4PK1072   |   | 1   |   |   |   |   |   |
| <b>RENAULT  CLIO I 1.4</b> |  |   |   |  |   |   |   |   |   |   |   |
|                            | E6J, E7J   | 01/91 → 09/98   |  | VKMC 06000<br>VKMA 06000<br>VKM 16000  | 1<br>1<br>1   | 1<br>1  | 1   |   |   |   | T0061   |
|   | E6J, E7J   | 01/91 → 09/98   | 3)  | VKMS 06000<br>VKMA 06000<br>VKM 16000  | 1<br>1<br>1   | 1<br>1  |   |   | 2   |   | T0061   |
|                            | E6J, E7J   | 01/91 → 09/98   |   | VKPC 86409   |   |   |   | 1   |   |   |   |
|                            | <b>B(Alt)</b> E6J, E7J   | 01/91 → 09/98   | AC  | VKMV 10AVx690  |   | 1   |   |   |   |   |   |
|   | <b>B(Alt)</b> E6J, E7J   | 01/91 → 09/98   | AC  | VKMV 3PK712  |   | 1   |   |   |   |   |   |
|   | <b>B(AC)</b> E6J, E7J  | 01/91 → 09/98   | ⊘   | VKMV 4PK1072   |   | 1   |   |   |   |   |   |
|   | <b>B(AC)</b> E6J, E7J  | 01/91 → 09/98   | ⊘   | VKMA 36002<br>VKMV 4PK1218<br>VKM 36002  |   | 1<br>1<br>1   | 1<br>1  |   |   |   |   |
| <b>RENAULT  CLIO I 1.7</b> |  |   |   |  |   |   |   |   |   |   |   |
|                            | F2N 770  | 01/91 → 12/93   | 3)  | VKMS 06101<br>VKMA 06101<br>VKM 16101<br>VKM 26101                                 | 1<br>1<br>1<br>1  | 1<br>1<br>1   | 1   |   |   | 3   | T0046   |
|                            | F2N 770  | 01/91 → 12/93   |   | VKPC 86413   |   |   |   | 1   |   |   |   |
|                            | <b>B(Alt)</b> F2N 770  | 01/91 → 12/93   | AC, ⊘   | VKMV 5PK847  |   | 1   |   |   |   |   |   |
|   | <b>B(Alt)</b> F2N 770  | 01/91 → 12/93   | AC, ⊘   | VKMA 36013<br>VKMV 6PK1095<br>VKM 36013  |   | 1<br>1<br>1   | 1<br>1  |   |   |   |   |
|   | <b>B(Alt)</b> F2N 770  | 01/91 → 12/93   | AC, ⊘   | VKMV 6PK1190   |   | 1   |   |   |   |   |   |
| <b>RENAULT  CLIO I 1.8</b> |  |   |   |  |   |   |   |   |   |   |   |
|                            | F3P 710, F3P 712,<br>F3P 714, F3P 754,<br>F3P 755, F3P 758                           | 01/91 → 09/98   | 3)  | VKMS 06101<br>VKMA 06101<br>VKM 16101<br>VKM 26101                                 | 1<br>1<br>1<br>1  | 1<br>1<br>1   | 1   |   |   | 3   | T0046   |







RENAULT





|  |  |  |                                      |  |  |  |  |  |  |  |  |  |
|--|---|---|---|--|---|---|---|---|---|---|---|---|
|    | F3P 710, F3P 712,<br>F3P 714, F3P 754,<br>F3P 755, F3P 758                        | 01/91 → 09/98   |   | VKPC 86413   |   |   | 1   |   |   |   |   |   |
|    | <b>B(Alt)</b> F3P 710, F3P 714  | 01/91 → 06/93   | AC, Ø   | VKMOV 5PK847   |   | 1   |   |   |   |   |   |   |
|  | <b>B(Alt)</b> F3P 710, F3P 714  | 06/93 → 09/98   | AC, Ø   | VKMOV 6PK850   |   | 1   |   |   |   |   |   |   |
|  | <b>B(Alt)</b> F3P 710, F3P 712,<br>F3P 714, F3P 754,<br>F3P 755, F3P 758          | 01/91 → 09/98   | AC, ⊕   | VKMA 36013<br>VKMOV 6PK1095<br>VKM 36013   | 1   | 1   |   |   |   |   |   |   |
|  | <b>B(Alt)</b> F3P 710   | 01/91 → 12/92   | AC, ⊕   | VKMOV 6PK1190  |   | 1   |   |   |   |   |   |   |
|  | <b>B(Alt)</b> F3P 710, F3P 712,<br>F3P 714, F3P 754,<br>F3P 755, F3P 758          | 01/93 → 09/98   | AC  | VKMOV 6PK1165  |   | 1   |   |   |   |   |   |   |
| <b>RENAULT  CLIO I 1.8 16V</b>          |   |   |   |  |   |   |   |   |   |   |   |   |
|    | F7P 720, F7P 722  | 08/91 → 06/94   |   | VKMA 06112<br>VKM 16112<br>VKM 26102   | 1<br>1  | 1<br>1  | 1   |   |   |   |   | T0076   |
|    | F7P 720, F7P 722  | 08/91 → 06/94   |   | VKPC 86413   |   |   | 1   |   |   |   |   |   |
|    | <b>B(Alt)</b> F7P 720, F7P 722  | 08/91 → 06/94   | Ø   | VKMOV 6PK1007<br>VKM 36006   |   | 1   | 1   |   |   |   |   |   |
|  | <b>B(Alt)</b> F7P 720, F7P 722  | 08/91 → 06/94   | ⊕   | VKMOV 6PK1007<br>VKM 36006   | 1   | 1   |   |   |   |   |   |   |
| <b>RENAULT  CLIO I 2.0 16V Williams</b> |   |   |   |  |   |   |   |   |   |   |   |   |
|   | F7R 700   | 01/94 → 09/98   |   | VKMA 06112<br>VKM 16112<br>VKM 26102   | 1<br>1  | 1<br>1  | 1   |   |   |   |   | T0076   |
|                                        | F7R 700   | 01/94 → 09/98   |   | VKPC 86413   |   |   | 1   |   |   |   |   |   |
|                                        | <b>B(Alt)</b> F7R 700   | 01/94 → 09/98   |   | VKMOV 6PK1007<br>VKM 36006   |   | 1   | 1   |   |   |   |   |   |
| <b>RENAULT  CLIO I 1.9 D</b>          |   |   |   |  |   |   |   |   |   |   |   |   |
|                                        | F8Q 676, F8Q 678,<br>F8Q 714, F8Q 730,<br>F8Q 732                                 | 01/91 → 09/96   | 3), <b>B</b> (58151x25.4),<br> 151 | VKMS 06113<br>VKMA 06113<br>VKM 16101<br>VKM 26102                                 | 1<br>1<br>1   | 1<br>1<br>1   | 1   |   |   | 3   |   | T0090   |
|  | F8Q 676, F8Q 678,<br>F8Q 692, F8Q 696,<br>F8Q 714, F8Q 730,<br>F8Q 732            | 09/96 → 09/98   | <b>B</b> (76151x25.4),  151        | VKMA 06116<br>VKM 16101<br>VKM 26102   | 1<br>1  | 1<br>1  | 1   |   |   |   |   | T0090   |
|                                        | F8Q 676, F8Q 678,<br>F8Q 692, F8Q 696,<br>F8Q 714, F8Q 730,<br>F8Q 732            | 01/91 → 09/98   |   | VKPC 86413   |   |   | 1   |   |   |   |   |   |
|                                        | <b>B(Alt)</b> F8Q 676, F8Q 692,<br>F8Q 696  | 01/97 → 09/98   |   | VKMOV 6PK894   |   | 1   |   |   |   |   |   |   |
|  | <b>B(Alt)</b> F8Q 714, F8Q 730,<br>F8Q 732  | 01/91 → 04/94   |   | VKMOV 6PK903   |   | 1   |   |   |   |   |   |   |
|  | <b>B(Alt)</b> F8Q 678, F8Q 714,<br>F8Q 730, F8Q 732                               | 04/94 → 09/98   | Ø   | VKMOV 6PK903   |   | 1   |   |   |   |   |   |   |
|  | <b>B(Alt)</b> F8Q 678, F8Q 714,<br>F8Q 730, F8Q 732                               | 04/94 → 09/98   | ⊕   | VKMOV 6PK894   |   | 1   |   |   |   |   |   |   |
|                                        | F8Q 676, F8Q 678,<br>F8Q 692, F8Q 696,<br>F8Q 714, F8Q 730,<br>F8Q 732            | 01/91 → 09/98   |   | VKM_____   |   |   |   |   | 1   |   |   |   |



**RENAULT**  **CLIO II 1.2**













|   |   |               |   |   |             |        |   |   |   |  |  |  |   |  |  |  |   |       |
|---|---|---------------|---|---|-------------|--------|---|---|---|--|--|--|---|--|--|--|---|-------|
|  | D7F 720, D7F 722,<br>D7F 726, D7F 744,<br>D7F 746, D7F 764,<br>D7F 766                      | 09/98 → 09/07 |  | VKMC 06010<br>VKMA 06010<br>VKM 16000   | 1<br>1<br>1 | 1<br>1 | 1 |   |   |  |  |  |   |  |  |  |   | T0136 |
|   | D7F 720, D7F 722,<br>D7F 726, D7F 744,<br>D7F 746, D7F 764,<br>D7F 766                      | 09/98 → 12/00 | 3)  | VKMS 06010-1<br>VKMA 06010<br>VKM 16000 | 1<br>1<br>1 | 1<br>1 |   |   |   |  |  |  | 2 |  |  |  |   | T0136 |
|   | D7F 720, D7F 722,<br>D7F 726, D7F 744,<br>D7F 746, D7F 764,<br>D7F 766                      | 01/01 → 09/07 | 3)  | VKMS 06010-2<br>VKMA 06010<br>VKM 16000 | 1<br>1<br>1 | 1<br>1 |   |   |   |  |  |  | 2 |  |  |  |   | T0136 |
|  | D7F 720, D7F 722,<br>D7F 726, D7F 744,<br>D7F 746, D7F 764,<br>D7F 766                      | 09/98 → 09/07 |   | VKPC 86215                              |             |        |   |   |   |  |  |  | 1 |  |  |  |   |       |
|  | <b>B(Alt), B(PS)</b> D7F 720, D7F 722,<br>D7F 726, D7F 744,<br>D7F 746, D7F 764,<br>D7F 766 | 04/00 → 09/07 | <b>EHP, AC</b>  | VKMA 36023                              |             | 1      | 2 |   |   |  |  |  |   |  |  |  |   |       |
|   | <b>B(Alt), B(PS)</b> D7F 720, D7F 726,<br>D7F 746   | 04/00 → 09/07 | <b>EHP, AC</b>  | VKMA 36025                              |             | 2      | 2 |   |   |  |  |  |   |  |  |  | 1 |       |
|   | <b>B(Alt)</b> D7F 720, D7F 722  | 09/98 → 10/99 |   | VKMV 4PK735                             |             |        |   | 1 |   |  |  |  |   |  |  |  |   |       |
|   | <b>B(Alt)</b> D7F 720, D7F 722  | 10/99 → 04/00 |   | VKMV 4PK730                             |             |        |   | 1 |   |  |  |  |   |  |  |  |   |       |
|   | <b>B(Alt)</b> D7F 726   | 09/98 → 04/00 |   | VKMV 4PK735                             |             |        |   | 1 |   |  |  |  |   |  |  |  |   |       |
|   | <b>B(Alt)</b> D7F 720, D7F 722,<br>D7F 726, D7F 744,<br>D7F 746, D7F 764,<br>D7F 766        | 04/00 → 09/07 |   | VKMV 3PK740                             |             |        |   |   | 1 |  |  |  |   |  |  |  |   |       |
|   | <b>B(PS)</b> D7F 720, D7F 722,<br>D7F 726   | 09/98 → 04/00 | <b>EHP, AC</b>  | VKMV 5PK880<br>VKM 36023                |             | 1      |   | 1 |   |  |  |  |   |  |  |  |   |       |
|   | <b>B(PS)</b> D7F 720, D7F 726   | 09/98 → 04/00 | <b>EHP, AC</b>  | VKMV 5PK1515<br>VKM 36023<br>VKM _____  |             | 1<br>1 |   | 1 |   |  |  |  |   |  |  |  |   |       |
|   | <b>B(PS)</b> D7F 720, D7F 722,<br>D7F 726, D7F 744,<br>D7F 746, D7F 764,<br>D7F 766         | 04/00 → 09/07 | <b>EHP, AC</b>  | VKMV 4PK908<br>VKM 36023                |             | 1      |   | 1 |   |  |  |  |   |  |  |  |   |       |
|   | <b>B(PS)</b> D7F 720, D7F 726,<br>D7F 746   | 04/00 → 09/07 | <b>EHP, AC</b>  | VKMV 4PK1538<br>VKM 36023<br>VKM 36025  |             | 1<br>1 |   | 1 |   |  |  |  |   |  |  |  | 1 |       |
|   | <b>B(AC)</b> D7F 720, D7F 726   | 09/98 → 04/00 | <b>EHP</b>  | VKMV 5PK910<br>VKM 36023                |             | 1      |   | 1 |   |  |  |  |   |  |  |  |   |       |
|   | <b>B(AC)</b> D7F 720, D7F 726,<br>D7F 746, D7F 766  | 04/00 → 09/07 | <b>EHP</b>  | VKMV 4PK928<br>VKM 36023                |             | 1      |   | 1 |   |  |  |  |   |  |  |  |   |       |











**RENAULT**  **CLIO II 1.2 16V**



|   |                                       |               |   |                                       |             |        |   |   |  |  |  |  |   |  |  |  |  |       |
|---|---------------------------------------|---------------|---|---------------------------------------|-------------|--------|---|---|--|--|--|--|---|--|--|--|--|-------|
|  | D4F 706, D4F 712                      | 06/01 → 09/07 |  | VKMC 06002<br>VKMA 06002<br>VKM 16002 | 1<br>1<br>1 | 1<br>1 | 1 |   |  |  |  |  |   |  |  |  |  | T0190 |
|   | D4F 722, D4F 728                      | 06/01 → 09/07 |   | VKMA 06002<br>VKM 16002               | 1<br>1      | 1      |   | 1 |  |  |  |  |   |  |  |  |  | T0190 |
|  | D4F 706, D4F 712,<br>D4F 722, D4F 728 | 06/01 → 09/07 |   | VKPC 86810                            |             |        |   |   |  |  |  |  | 1 |  |  |  |  |       |
|  | <b>B(Alt), B(PS)</b> D4F 706, D4F 712 | 06/01 → 09/07 | <b>AC</b>   | VKMA 36023                            |             | 1      | 2 |   |  |  |  |  |   |  |  |  |  |       |



























RENAULT

|  |  |  |  |  |  |  |  |  |  |  |  |
|---|---|---|--|---|---|---|---|---|---|---|---|
| B(Alt), B(PS)   | D4F 706, D4F 712  | 06/01 → 09/07   | AC   | VKMA 36025  | 2   | 2   |   |   |   |   | 1   |
| B(Alt)  | D4F 706, D4F 712,<br>D4F 722, D4F 728   | 06/01 → 09/07   |  | VKMOV 3PK740  |   | 1   |   |   |   |   |   |
| B(PS)   | D4F 706, D4F 712  | 06/01 → 11/05   | AC   | VKMOV 4PK908<br>VKM 36023   | 1   | 1   |   |   |   |   |   |
| B(PS)   | D4F 706, D4F 712  | 11/05 → 09/07   | AC   | VKMOV 4PK928<br>VKM 36023   | 1   | 1   |   |   |   |   |   |
| B(PS)   | D4F 706, D4F 712  | 06/01 → 09/07   | AC   | VKMOV 4PK1538<br>VKM 36023<br>VKM 36025   | 1<br>1  | 1   |   |   |   |   | 1   |
| B(AC)   | D4F 722, D4F 728  | 06/01 → 09/07   |  | VKMOV 4PK928<br>VKM 36023   | 1   | 1   |   |   |   |   |   |

| RENAULT  CLIO II 1.4 |                              |               |   |  |             |             |   |  |  |  |       |
|---|------------------------------|---------------|---|--|-------------|-------------|---|--|--|--|-------|
|                       | E7J 634, E7J 635,<br>E7J 780 | 09/98 → 09/07 |              | VKMC 06005<br>VKMA 06003<br>VKM 16003                | 1<br>1<br>1 | 1<br>1      | 1 |  |  |  | T0145 |
|   | K7J 700                      | 09/98 → 09/07 |              | VKMC 06003<br>VKMA 06003<br>VKM 16003                | 1<br>1<br>1 | 1<br>1      | 1 |  |  |  | T0145 |
|                       | E7J 634, E7J 635,<br>E7J 780 | 09/98 → 09/07 |   | VKPC 86216   |             |             | 1 |  |  |  |       |
|   | K7J 700                      | 09/98 → 09/07 |   | VKPC 86415   |             |             | 1 |  |  |  |       |
|                       | B(Alt) E7J 634, E7J 635      | 09/98 → 09/07 | EHPS, AC,    | VKMOV 5PK1110<br>VKM 36053<br>VKM 36091              | 1           | 1           | 1 |  |  |  |       |
| B(Alt)  | E7J 634, E7J 635             | 09/98 → 09/07 | EHPS, AC,  | VKMA 36091<br>VKMOV 5PK1110<br>VKM 36091             | 1<br>1      | 1<br>1      |   |  |  |  |       |
| B(Alt)  | E7J 634, E7J 635             | 09/98 → 09/07 | EHPS, AC  | VKMOV 6PK1750<br>VKM 36031<br>VKM 36031              |             | 1<br>1      | 1 |  |  |  |       |
| B(Alt)  | E7J 634, E7J 635             | 09/98 → 09/07 | EHPS, AC,  | VKMOV 5PK1110<br>VKM 36053<br>VKM 36091              | 1           | 1           | 1 |  |  |  |       |
| B(Alt)  | E7J 634, E7J 635             | 09/98 → 09/07 | EHPS, AC  | VKMOV 6PK1750<br>VKM 36031<br>VKM 36031<br>VKM 36053 |             | 1<br>1<br>1 | 1 |  |  |  |       |
| B(Alt)  | K7J 700                      | 09/98 → 09/07 | AC,        | VKMOV 5PK1110<br>VKM 36053<br>VKM 36091              | 1           | 1           | 1 |  |  |  |       |
| B(Alt)  | K7J 700                      | 09/98 → 09/07 | AC,        | VKMA 36091<br>VKMOV 5PK1110<br>VKM 36091             | 1<br>1      | 1<br>1      |   |  |  |  |       |
| B(Alt)  | K7J 700                      | 09/98 → 09/01 | AC  | VKMOV 6PK1750<br>VKM 36031<br>VKM 36031              |             | 1<br>1      | 1 |  |  |  |       |
| B(Alt)  | K7J 700                      | 09/01 → 09/07 | AC  | VKMA 36020<br>VKM 36031<br>VKM 36031                 |             | 2<br>1<br>1 | 1 |  |  |  |       |
| B(Alt)  | E7J 780                      | 09/98 → 09/07 |   | VKMOV 3PK1040<br>VKM 36080                           |             | 1           | 1 |  |  |  |       |
| B(PS)   | E7J 780                      | 09/98 → 09/07 | AC  | VKMOV 4PK995<br>VKM 36081                            | 1           |             | 1 |  |  |  |       |
| B(PS)   | E7J 780                      | 09/98 → 09/07 | AC  | VKMOV 4PK1238<br>VKM 36082                           | 1           |             | 1 |  |  |  |       |





















| RENAULT  CLIO II 1.4 16V |                                       |               |   |  |             |             |   |   |   |   |       |
|---|---------------------------------------|---------------|---|--|-------------|-------------|---|---|---|---|-------|
|                           | K4J 710, K4J 711,<br>K4J 712, K4J 713 | 10/99 → 09/07 |  | VKMC 06020<br>VKMA 06020<br>VKM 16020<br>VKM 26020 | 1<br>1<br>1 | 1<br>1<br>1 | 1 | 1 | 2 | 1 | T0159 |

|  |              |  |    |  |  |  |  |  |  |  |  |  |  |
|--|---|---|---|--|---|---|---|---|---|---|---|---|---|
|                                   | K4J 710, K4J 711,<br>K4J 712, K4J 713   | 10/99 → 09/07   |   | VKPC 86416   |   |   | 1   |   |   |   |   |   |   |
|                                   | <b>B(Alt)</b> K4J 710, K4J 711  | 10/99 → 09/07   | <i>AC</i>   | VKMV 5PK1110<br>VKM 36053<br>VKM 36091   | 1   | 1   |   | 1   |   |   |   |   |   |
|  | <b>B(Alt)</b> K4J 710, K4J 711  | 10/99 → 09/01   | <b>AC</b>   | VKMV 6PK1750<br>VKM 36031<br>VKM 36031<br>VKM 36053                                |   |   |   | 1   |   |   |   |   |   |
|  | <b>B(Alt)</b> K4J 710, K4J 711  | 09/01 → 06/04   | <b>AC</b>   | VKM 36031<br>VKM 36031<br>VKM 36053  |   |   |   | 1   |   |   |   |   |   |
|  | <b>B(Alt)</b> K4J 710, K4J 711  | 06/04 → 09/07   | <b>AC</b>   | VKMV 5PK1199   |   |   |   | 1   |   |   |   |   |   |
|  | <b>B(Alt)</b> K4J 712, K4J 713  | 10/99 → 09/07   | <i>AC</i>   | VKMA 36091<br>VKMV 5PK1110<br>VKM 36091  | 1   |   |   | 1   |   |   |   |   |   |
|  | <b>B(Alt)</b> K4J 712, K4J 713  | 10/99 → 06/01   | <b>AC</b>   | VKMV 6PK1750<br>VKM 36031<br>VKM 36031   |   |   |   | 1   |   |   |   |   |   |
|  | <b>B(Alt)</b> K4J 712, K4J 713  | 06/01 → 09/07   | <b>AC</b>   | VKMA 36020<br>VKM 36031<br>VKM 36031   |   |   |   | 2   | 1   |   |   |   |   |
| <b>RENAULT  CLIO II 1.6</b>       |   |   |   |  |   |   |   |   |   |   |   |   |   |
|                                   | K7M 744, K7M 745,<br>K7M 746  | 09/98 → 09/07   |   | VKMA 06003<br>VKM 16003  | 1   |   | 1   |   |   |   |   |   | T0145   |
|                                 | K7M 744, K7M 745,<br>K7M 746  | 09/98 → 09/07   |   | VKPC 86415   |   |   |   | 1   |   |   |   |   |   |
|                                 | <b>B(Alt)</b> K7M 744, K7M 745  | 09/98 → 09/07   |   | VKMV 3PK1040<br>VKM 36080  |   |   |   | 1   |   |   |   |   |   |
|  | <b>B(Alt)</b> K7M 746   | 09/98 → 09/07   | <i>AC, ⊕</i>  | VKMV 5PK1110<br>VKM 36053<br>VKM 36091   |   |   |   | 1   |   |   |   |   |   |
|  | <b>B(Alt)</b> K7M 746   | 09/98 → 09/07   | <i>AC, ⊕</i>  | VKMA 36091<br>VKMV 5PK1110<br>VKM 36091  | 1   |   |   | 1   |   |   |   |   |   |
|  | <b>B(Alt)</b> K7M 746   | 09/98 → 09/07   | <b>AC</b>   | VKMV 6PK1750<br>VKM 36031<br>VKM 36031   |   |   |   | 1   |   |   |   |   |   |
|  | <b>B(PS)</b> K7M 744, K7M 745   | 09/98 → 09/07   | <i>AC</i>   | VKMV 4PK995<br>VKM 36081   | 1   |   |   | 1   |   |   |   |   |   |
|  | <b>B(PS)</b> K7M 744, K7M 745   | 09/98 → 09/07   | <b>AC</b>   | VKMV 4PK1238<br>VKM 36082  | 1   |   |   | 1   |   |   |   |   |   |
| <b>RENAULT  CLIO II 1.6 16V</b> |   |   |   |  |   |   |   |   |   |   |   |   |   |
|                                 | K4M 708, K4M 736,<br>K4M 740, K4M 742,<br>K4M 743, K4M 744,<br>K4M 745, K4M 748               | 09/98 → 09/07   |  | VKMC 06020<br>VKMA 06020<br>VKM 16020<br>VKM 26020                                 | 1   | 1   | 1   |   | 1   |   | 2   | 1   | T0159   |
|                                 | K4M 708, K4M 736,<br>K4M 740, K4M 742,<br>K4M 743, K4M 744,<br>K4M 745, K4M 748               | 09/98 → 09/07   |   | VKPC 86416   |   |   |   |   | 1   |   |   |   |   |
|                                 | <b>B(Alt)</b> K4M 708, K4M 736,<br>K4M 740, K4M 742,<br>K4M 743, K4M 744,<br>K4M 745, K4M 748 | 09/98 → 09/07   | <i>EHPS, AC</i>   | VKMA 36091<br>VKMV 5PK1110<br>VKM 36091  | 1   |   |   | 1   |   |   |   |   |   |









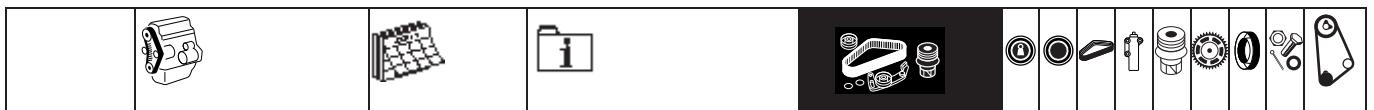





RENAULT



|  |  |  |  |  |  |  |  |  |  |  |  |  |
|--|---|---|---|--|---|---|---|---|---|---|---|---|
| <b>B(Alt)</b>  | K4M 708, K4M 736,<br>K4M 740, K4M 742,<br>K4M 743, K4M 744,<br>K4M 745, K4M 748   | 09/98 → 09/07   | EHPS, AC  | VKMV 5PK1110<br>VKM 36053<br>VKM 36091   | 1   | 1   |   |   |   |   |   |   |
| <b>B(Alt)</b>  | K4M 708   | 09/98 → 09/01   | AC  | VKMV 6PK1750<br>VKM 36031<br>VKM 36031   |   | 1   |   |   |   |   |   |   |
| <b>B(Alt)</b>  | K4M 708   | 09/01 → 09/07   | AC  | VKMA 36020<br>VKM 36031<br>VKM 36031   | 2   | 1   |   |   |   |   |   |   |
| <b>B(Alt)</b>  | K4M 736, K4M 742,<br>K4M 743  | 09/98 → 09/07   | EHPS, AC  | VKMA 36020<br>VKM 36031<br>VKM 36031   | 2   | 1   |   |   |   |   |   |   |
| <b>B(Alt)</b>  | K4M 736, K4M 742,<br>K4M 743  | 09/98 → 09/07   | EHPS, AC  | VKM 36031<br>VKM 36031<br>VKM 36053  | 1   | 1   |   |   |   |   |   |   |
| <b>B(Alt)</b>  | K4M 740, K4M 748  | 09/98 → 04/02   | AC  | VKMV 6PK1750<br>VKM 36031<br>VKM 36031   | 1   | 1   |   |   |   |   |   |   |
| <b>B(Alt)</b>  | K4M 740   | 04/02 → 09/07   | AC  | VKMA 36020<br>VKM 36031<br>VKM 36031   | 2   | 1   |   |   |   |   |   |   |
| <b>B(Alt)</b>  | K4M 744, K4M 745  | 09/98 → 06/01   | AC  | VKMV 6PK1750<br>VKM 36031<br>VKM 36031<br>VKM 36053                                | 1   | 1   |   |   |   |   |   |   |
| <b>B(Alt)</b>  | K4M 744, K4M 745  | 06/01 → 09/04   | AC  | VKM 36031<br>VKM 36031<br>VKM 36053  | 1   | 1   |   |   |   |   |   |   |
| <b>B(Alt)</b>  | K4M 744, K4M 745  | 09/04 → 09/07   | AC  | VKMV 5PK1199   |   | 1   |   |   |   |   |   |   |
| <b>RENAULT  CLIO II 2.0 16V Sport</b> |   |   |   |  |   |   |   |   |   |   |   |   |
|                                        | F4R 730, F4R 732,<br>F4R 736  | 02/00 → 04/01   |   | VKMA 06107<br>VKM 16550<br>VKM 26020<br>VKM 26310                                  | 1   | 2   | 1   |   |   | 2   |   | T0161   |
|  | F4R 730, F4R 732,<br>F4R 736, F4R 738   | 04/01 → 09/07   |   | VKMA 06108<br>VKM 16550<br>VKM 26105<br>VKM 26310                                  | 1   | 2   | 1   |   |   | 2   |   | T0161   |
|                                        | F4R 730, F4R 732,<br>F4R 736, F4R 738   | 02/00 → 09/07   |   | VKPC 86413   |   |   |   | 1   |   |   |   |   |
|                                        | <b>B(Alt)</b> F4R 730, F4R 732,<br>F4R 736, F4R 738                               | 02/00 → 09/07   | AC  | VKMA 36070<br>VKMV 6PK1658<br>VKM 36016<br>VKM 36070                               | 1   | 1   | 1   |   |   |   |   | 1   |
| <b>B(Alt)</b>  | F4R 736, F4R 738  | 02/00 → 09/07   | AC  | VKMV 6PK1127   | 1   |   | 1   |   |   |   |   | 1   |
| <b>RENAULT  CLIO II 3.0 V6 Sport</b>  |   |   |   |  |   |   |   |   |   |   |   |   |
|                                        | L7X 760, L7X 762  | 11/00 → 09/07   |   | VKMA 03902<br>VKM 13902<br>VKM 23900<br>VKM 23900<br>VKM 23901                     | 1   | 3   | 1   |   |   |   |   | T0204   |
|                                        | L7X 760, L7X 762  | 11/00 → 09/07   |   | —  |   |   |   | 1   |   |   |   |   |
|                                        | <b>B(Alt)</b> L7X 760, L7X 762  | 11/00 → 05/04   |   | VKMV 6PK1585<br>VKM 33075  |   | 1   | 1   |   |   |   |   |   |









































| RENAULT  CLIO II 1.5 dCi   |   |               |              |  |             |        |        |  |   |   |       |
|---|---|---------------|--------------|--|-------------|--------|--------|--|---|---|-------|
|                            | K9K 700, K9K 702,<br>K9K 704, K9K 710   | 06/01 → 08/03 |              | VKMA 06130<br>VKM 16102  | 1<br>1      | 1      |        |  |   | 1 | T0191 |
|   | K9K 700, K9K 702,<br>K9K 704, K9K 710,<br>K9K 712, K9K 714,<br>K9K 716, K9K 718               | 08/03 → 09/07 |              | VKMA 06132<br>VKM 16102  | 1<br>1      | 1      |        |  |   | 1 | T0191 |
|                            | K9K 700, K9K 702,<br>K9K 704, K9K 710,<br>K9K 712   | 06/01 → 04/04 |              | VKPC 86417   |             |        |        |  | 1 |   |       |
|   | K9K 700, K9K 702,<br>K9K 704, K9K 710,<br>K9K 712, K9K 714,<br>K9K 716, K9K 718               | 04/04 → 01/07 |              | VKPC_____  |             |        |        |  | 1 |   |       |
|                            | <b>B(Alt)</b> K9K 700, K9K 702,<br>K9K 704, K9K 710,<br>K9K 712, K9K 714,<br>K9K 718          | 06/01 → 09/05 | <i>AC</i>    | VKMA 36052<br>VKMV 5PK1135<br>VKM 36052<br>VKM 36053           | 1<br>1      | 1<br>1 | 1<br>1 |  |   |   |       |
|   | <b>B(Alt)</b> K9K 700, K9K 702,<br>K9K 704, K9K 710,<br>K9K 714, K9K 716,<br>K9K 718          | 09/05 → 09/07 | <i>AC</i>    | VKMV 6PK1199<br>VKM 36053                                      |             | 1      | 1      |  |   |   |       |
|   | <b>B(Alt)</b> K9K 700, K9K 702,<br>K9K 704, K9K 710,<br>K9K 712, K9K 714                      | 06/01 → 01/05 | <b>AC</b>    | VKMA 36050<br>VKMV 5PK1199<br>VKM 36050                        | 1<br>1      |        | 1<br>1 |  |   |   |       |
|   | <b>B(Alt)</b> K9K 700, K9K 702,<br>K9K 704, K9K 710,<br>K9K 712, K9K 714,<br>K9K 716, K9K 718 | 01/05 → 09/07 | <b>AC</b>    | VKMV 6PK1199   |             |        | 1      |  |   |   |       |
|                          | K9K 700, K9K 702,<br>K9K 704, K9K 710,<br>K9K 712, K9K 714                                    | 06/01 → 09/07 |              | —  |             |        |        |  | 1 |   |       |
| RENAULT  CLIO II 1.9 D   |   |               |              |  |             |        |        |  |   |   |       |
|                          | F8Q 630, F8Q 632,<br>F8Q 662  | 09/98 → 09/07 | 3)           | VKMS 06116<br>VKMA 06116<br>VKM 16101<br>VKM 26102             | 1<br>1<br>1 | 1<br>1 | 1<br>1 |  |   | 2 | T0090 |
|   | F8Q 630, F8Q 632,<br>F8Q 662  | 09/98 → 09/07 | <b>P</b>     | VKMA 06126<br>VKM 16101<br>VKM 26102<br>VKM 26125              | 1<br>1      | 2      | 1      |  |   |   | T0090 |
|                          | F8Q 630, F8Q 632,<br>F8Q 662  | 09/98 → 09/07 |              | VKPC 86413   |             |        |        |  | 1 |   |       |
|                          | <b>B(Alt)</b> F8Q 630, F8Q 632,<br>F8Q 662  | 09/98 → 09/07 | <i>AC, Ø</i> | VKMV 6PK894  |             |        | 1      |  |   |   |       |
|   | <b>B(Alt)</b> F8Q 630, F8Q 632,<br>F8Q 662  | 09/98 → 09/07 | <i>AC, Ø</i> | VKMV 6PK1400   |             |        | 1      |  |   |   |       |
|   | <b>B(Alt)</b> F8Q 630, F8Q 632  | 09/98 → 09/07 | <b>AC</b>    | VKMV 6PK1193   |             |        | 1      |  |   |   |       |
|                          | F8Q 630, F8Q 632,<br>F8Q 662  | 09/98 → 09/07 |              | VKM_____   |             |        |        |  | 1 |   |       |
| RENAULT  CLIO II 1.9 dTi |   |               |              |  |             |        |        |  |   |   |       |
|                          | F9Q 780, F9Q 782  | 02/00 → 09/07 | <b>c, P</b>  | VKMA 06137<br>VKM 16551<br>VKM 26117<br>VKM 26125<br>VKM 26128 | 1<br>1      | 2      | 1      |  |   | 1 | T0181 |
|   |   |               |              |  |             |        | 1<br>1 |  |   | 1 |       |



RENAULT



























|  | F9Q 780, F9Q 782   | 02/00 → 09/07 | c         | VKMA 06117<br>VKM 16551<br>VKM 26117<br>VKM 26128    | 1<br>1      | 1 | 1 |  |  | 1 |  |   |   | T0181   |
|--|--|---------------|-----------|--|-------------|---|---|--|--|---|--|---|---|---------|
|  | F9Q 780, F9Q 782   | 02/00 → 09/07 |           | VKPC 86413   |             |   |   |  |  | 1 |  |   |   |         |
|  | <b>B(Alt)</b> F9Q 780, F9Q 782                             | 02/00 → 09/07 | <b>AC</b> | VKMV 6PK1127   |             |   | 1 |  |  |   |  |   |   |         |
|  | <b>B(Alt)</b> F9Q 780, F9Q 782                             | 02/00 → 09/07 | <b>AC</b> | VKMV 6PK1209   |             |   | 1 |  |  |   |  |   |   |         |
|  | F9Q 780, F9Q 782   | 02/00 → 09/07 |           | VKM_____   |             |   |   |  |  | 1 |  |   |   |         |
| <b>RENAULT  CLIO III 1.2 16V</b>       |  |               |           |  |             |   |   |  |  |   |  |   |   |         |
|  | D4F 740, D4F 764,<br>D4F 784                               | 06/05 → 12/07 |           | VKMA 06002<br>VKM 16002                              | 1<br>1      |   | 1 |  |  |   |  |   |   | T0190   |
|  | D4F 740, D4F 764   | 06/05 → 02/07 |           | VKPC_____  |             |   |   |  |  | 1 |  |   |   |         |
|  | <b>B(Alt)</b> D4F 740, D4F 764                             | 06/05 → 12/07 | <b>AC</b> | VKMV 7PK880  |             |   | 1 |  |  |   |  |   |   |         |
|  | <b>B(Alt)</b> D4F 740, D4F 764                             | 06/05 → 12/07 | <b>AC</b> | VKMV 7PK1035   |             |   | 1 |  |  |   |  |   |   |         |
|  | <b>B(Alt)</b> D4F 784                                      | 05/07 → 12/07 |           | VKMV 7PK1035   |             |   | 1 |  |  |   |  |   |   |         |
| <b>RENAULT  CLIO III 1.4 16V</b>       |  |               |           |  |             |   |   |  |  |   |  |   |   |         |
|  | K4J 780  | 06/05 → 12/07 |           | VKMA 06020<br>VKM 16020<br>VKM 26020                 | 1<br>1      | 1 | 1 |  |  |   |  | 2 | 1 | T0159   |
|  | K4J 780  | 06/05 → 12/07 |           | VKPC 86416   |             |   |   |  |  | 1 |  |   |   |         |
|  | <b>B(Alt)</b> K4J 780                                      | 06/05 → 05/06 | <b>AC</b> | VKMA 36052<br>VKMV 5PK1135<br>VKM 36052<br>VKM 36053 | 1<br>1      | 1 | 1 |  |  |   |  |   |   |         |
|  | <b>B(Alt)</b> K4J 780                                      | 05/06 → 11/07 | <b>AC</b> | VKMV 6PK1199<br>VKM 36053                            |             |   | 1 |  |  |   |  |   |   |         |
|  | <b>B(Alt)</b> K4J 780                                      | 06/05 → 12/07 | <b>AC</b> | VKMV 6PK1199   |             |   | 1 |  |  |   |  |   |   |         |
| <b>RENAULT  CLIO III 1.6 16V</b>       |  |               |           |  |             |   |   |  |  |   |  |   |   |         |
|  | K4M 800, K4M 801,<br>K4M 804                               | 06/05 → 12/07 |           | VKMA 06021<br>VKM 16021<br>VKM 26020                 | 1<br>1      | 1 | 1 |  |  |   |  | 2 | 1 | T0159   |
|  | K4M 800, K4M 801,<br>K4M 804                               | 06/05 → 12/07 |           | VKPC 86416   |             |   |   |  |  | 1 |  |   |   |         |
|  | <b>B(Alt)</b> K4M 800, K4M 801,<br>K4M 804                 | 06/05 → 05/06 | <b>AC</b> | VKMA 36052<br>VKMV 5PK1135<br>VKM 36052<br>VKM 36053 | 1<br>1      | 1 | 1 |  |  |   |  |   |   |         |
|  | <b>B(Alt)</b> K4M 800, K4M 801,<br>K4M 804                 | 05/06 → 11/07 | <b>AC</b> | VKMV 6PK1199<br>VKM 36053                            |             |   | 1 |  |  |   |  |   |   |         |
|  | <b>B(Alt)</b> K4M 800, K4M 801,<br>K4M 804                 | 06/05 → 12/07 | <b>AC</b> | VKMV 6PK1199   |             |   | 1 |  |  |   |  |   |   |         |
| <b>RENAULT  CLIO III 2.0 16V</b>       |  |               |           |  |             |   |   |  |  |   |  |   |   |         |
|  | M4R 700, M4R 701   | 09/06 → 12/07 |           | <b>XXXXXX</b>  |             |   |   |  |  |   |  |   |   |         |
| <b>RENAULT  CLIO III 2.0 16V Sport</b> |  |               |           |  |             |   |   |  |  |   |  |   |   |         |
|  | F4R 830  | 02/06 → 12/07 |           | VKMC 06106<br>VKMA 06106<br>VKM 16550<br>VKM 26105   | 1<br>1<br>1 | 1 | 1 |  |  | 1 |  | 2 | 2 | T0177   |
|  | F4R 830  | 02/06 → 12/07 |           | VKPC 85304   |             |   |   |  |  | 1 |  |   |   |         |
|  | <b>B(Alt)</b> F4R 830                                      | 02/06 → 12/07 |           | VKMV 7PK1135<br>VKM 36072                            | 1           |   | 1 |  |  |   |  |   |   |         |
| <b>RENAULT  CLIO III 1.5 dCi</b>       |  |               |           |  |             |   |   |  |  |   |  |   |   |         |
|  | K9K 750, K9K 752,<br>K9K 764, K9K 766,<br>K9K 768, K9K 772 | 06/05 → 12/07 |           | VKMA 06132<br>VKM 16102                              | 1<br>1      |   | 1 |  |  |   |  |   |   | 1 T0191 |
|  | K9K 750, K9K 752,<br>K9K 764, K9K 766,<br>K9K 768, K9K 772 | 06/05 → 12/07 |           | VKPC_____  |             |   |   |  |  | 1 |  |   |   |         |

|   |  |  |  |  |  |  |  |  |  |  |  |  |
|---|---|---|---|--|---|---|---|---|---|---|---|---|
|  <b>B(Alt)</b>                     | K9K 750, K9K 752,<br>K9K 764, K9K 766,<br>K9K 768                                 | 06/05 → 09/05   | <i>AC</i>   | VKMA 36052<br>VKMV 5PK1135<br>VKM 36052<br>VKM 36053                               | 1<br>1  | 1<br>1  |   |   |   |   |   |   |
| <b>B(Alt)</b>   | K9K 750, K9K 752,<br>K9K 764, K9K 766,<br>K9K 768                                 | 09/05 → 11/07   | <i>AC</i>   | VKMV 6PK1199<br>VKM 36053  |   | 1   |   |   |   |   |   |   |
| <b>B(Alt)</b>   | K9K 750, K9K 752,<br>K9K 764, K9K 766,<br>K9K 768, K9K 772                        | 06/05 → 12/07   | <b>AC</b>   | VKMV 6PK1199   |   | 1   |   |   |   |   |   |   |
| <b>RENAULT  ESPACE I 2.0</b>       |   |   |   |  |   |   |   |   |   |   |   |   |
|                                    | J6R 234, J6R 236,<br>J6R 734, J7R 760   | 07/84 → 12/92   |   | VKMA 06201<br>VKM 16200  | 1<br>1  | 1   |   |   |   |   |   | T0024   |
|                                    | J6R 234, J6R 236,<br>J6R 734, J7R 760   | 07/84 → 12/92   |   | VKPC 86602   |   |   | 1   |   |   |   |   |   |
|  <b>B(Alt)</b>                     | J6R 234, J6R 236,<br>J6R 734, J7R 760   | 07/84 → 12/92   |   | VKMV 10AVx1000   |   | 1   |   |   |   |   |   |   |
| <b>RENAULT  ESPACE I 2.2</b>       |   |   |   |  |   |   |   |   |   |   |   |   |
|                                    | J7T 770   | 07/86 → 12/90   |   | VKMA 06203<br>VKM 16200  | 1<br>1  | 1   |   |   |   |   |   | T0024   |
|                                    | J7T 770   | 07/86 → 12/90   |   | VKPC 86602   |   |   | 1   |   |   |   |   |   |
|  <b>B(Alt)</b>                    | J7T 770   | 07/86 → 12/90   |   | VKMV 10AVx1000   |   | 1   |   |   |   |   |   |   |
| <b>RENAULT  ESPACE I 2.1 TD</b>  |   |   |   |  |   |   |   |   |   |   |   |   |
|                                  | J8S 240, J8S 774  | 10/84 → 12/90   | 3)  | VKMS 06213<br>VKMA 06213<br>VKM 16212<br>VKM 26211                                 | 1<br>1<br>1<br>1  | 1<br>1<br>1   |   |   |   | 3   |   | T0015   |
|                                  | J8S 240, J8S 774  | 10/84 → 12/90   |   | VKPC 86602   |   |   | 1   |   |   |   |   |   |
|  <b>B(Alt)</b>                   | J8S 240, J8S 774  | 10/84 → 12/90   |   | VKMV 11.9x1010   |   | 1   |   |   |   |   |   |   |
|  <b>B(Alt)</b>                   | J8S 240, J8S 774  | 10/84 → 12/90   |   | —  |   |   | 1   |   |   |   |   |   |
| <b>RENAULT  ESPACE II 2.0</b>    |   |   |   |  |   |   |   |   |   |   |   |   |
|                                  | J7R 768   | 01/91 → 10/96   |   | VKMA 06205<br>VKM 16204  | 1<br>1  | 1   |   |   |   |   |   | T0024   |
|                                  | J7R 768   | 01/91 → 10/96   |   | VKPC 86605   |   |   | 1   |   |   |   |   |   |
|  <b>B(Alt)</b>                   | J7R 768   | 01/91 → 10/96   | <i>AC</i>   | VKMV 10AVx1000   |   | 1   |   |   |   |   |   |   |
| <b>B(Alt)</b>   | J7R 768   | 01/91 → 10/96   | <b>AC</b>   | VKMV 10AVx1005   |   | 1   |   |   |   |   |   |   |
| <b>B(PS)</b>  | J7R 768   | 01/91 → 10/96   |   | VKMV 11.9x758  |   | 1   |   |   |   |   |   |   |
| <b>RENAULT  ESPACE II 2.2</b>    |   |   |   |  |   |   |   |   |   |   |   |   |
|                                  | J7T 772, J7T 773,<br>J7T 776  | 01/91 → 12/96   |   | VKMA 06204<br>VKM 16204  | 1<br>1  | 1   |   |   |   |   |   | T0024   |
|                                  | J7T 772, J7T 773,<br>J7T 776  | 01/91 → 12/96   |   | VKPC 86605   |   |   | 1   |   |   |   |   |   |
|  <b>B(Alt)</b>                   | J7T 772, J7T 773,<br>J7T 776  | 01/91 → 12/96   | <i>AC</i>   | VKMV 10AVx1000   |   | 1   |   |   |   |   |   |   |
| <b>B(Alt)</b>   | J7T 772, J7T 773,<br>J7T 776  | 01/91 → 12/96   | <b>AC</b>   | VKMV 10AVx1005   |   | 1   |   |   |   |   |   |   |
| <b>B(PS)</b>  | J7T 772, J7T 773,<br>J7T 776  | 01/91 → 12/96   |   | VKMV 11.9x758  |   | 1   |   |   |   |   |   |   |
| <b>RENAULT  ESPACE II 2.8 V6</b> |   |   |   |  |   |   |   |   |   |   |   |   |
|                                  | Z7W 712, Z7W 713,<br>Z7W 717  | 01/91 → 10/96   |   | <b>OXOXOXO</b>   |   |   |   |   |   |   |   |   |
|                                  | Z7W 712, Z7W 713,<br>Z7W 717  | 01/91 → 10/96   |   | —  |   |   | 1   |   |   |   |   |   |
|  <b>B(PS)</b>                    | Z7W 712, Z7W 713,<br>Z7W 717  | 01/91 → 10/96   |   | VKMV 13AVx925  |   | 1   |   |   |   |   |   |   |
| <b>B(AC)</b>  | Z7W 712, Z7W 713,<br>Z7W 717  | 01/91 → 10/96   |   | VKMV 13AVx925  |   | 1   |   |   |   |   |   |   |



RENAULT

| <b>RENAULT  ESPACE II 2.1 TD</b>   |   |               |           |  |                  |                  |                  |  |  |  |             |   |        |  |  |  |   |  |  |       |
|------------------------------------|---|---------------|-----------|--|------------------|------------------|------------------|--|--|--|-------------|---|--------|--|--|--|---|--|--|-------|
|                                    | J8S 610, J8S 612,<br>J8S 772, J8S 776,<br>J8S 778               | 01/91 → 10/96 | 3)        | VKMS 06213<br>VKMA 06213<br>VKM 16212<br>VKM 26211 | 1<br>1<br>1<br>1 | 1<br>1<br>1<br>1 | 1<br>1<br>1<br>1 |  |  |  |             |   |        |  |  |  | 3 |  |  | T0015 |
|                                    | J8S 610, J8S 612,<br>J8S 772, J8S 776,<br>J8S 778               | 01/91 → 10/96 |           | VKPC 86621   |                  |                  |                  |  |  |  |             |   | 1      |  |  |  |   |  |  |       |
|                                    | <b>B(Alt)</b> J8S 610, J8S 612,<br>J8S 772, J8S 776,<br>J8S 778 | 01/91 → 10/96 |           | VKMOV 11.9x1010                                    |                  |                  |                  |  |  |  | 1           |   |        |  |  |  |   |  |  |       |
|                                    | <b>B(PS)</b> J8S 610, J8S 612,<br>J8S 772, J8S 776,<br>J8S 778  | 01/91 → 10/96 |           | VKMOV 11.9x758                                     |                  |                  |                  |  |  |  | 1           |   |        |  |  |  |   |  |  |       |
|                                    | <b>B(AC)</b> J8S 610, J8S 612,<br>J8S 772, J8S 776,<br>J8S 778  | 01/91 → 10/96 |           | VKMOV 4PK878                                       |                  |                  |                  |  |  |  | 1           |   |        |  |  |  |   |  |  |       |
|                                    | J8S 610, J8S 612,<br>J8S 772, J8S 776,<br>J8S 778               | 01/91 → 10/96 |           | —  |                  |                  |                  |  |  |  |             |   |        |  |  |  | 1 |  |  |       |
| <b>RENAULT  ESPACE III 2.0</b>     |   |               |           |  |                  |                  |                  |  |  |  |             |   |        |  |  |  |   |  |  |       |
|                                    | F3R 728, F3R 729,<br>F3R 742, F3R 768,<br>F3R 769               | 11/96 → 10/00 |           | VKMA 06103<br>VKM 16101<br>VKM 26101               | 1<br>1<br>1      | 1<br>1<br>1      | 1<br>1<br>1      |  |  |  |             |   |        |  |  |  |   |  |  | T0108 |
|                                    | F3R 742, F3R 768,<br>F3R 769                                    | 11/96 → 10/00 | <b>p</b>  | VKMA 06123<br>VKM 16101<br>VKM 26101<br>VKM 26123  | 1<br>1<br>1<br>1 | 2<br>1<br>1      | 1<br>1<br>1      |  |  |  |             |   |        |  |  |  |   |  |  | T0655 |
|                                    | F3R 728, F3R 729,<br>F3R 742, F3R 768,<br>F3R 769               | 11/96 → 10/00 |           | VKPC 86413   |                  |                  |                  |  |  |  |             |   | 1      |  |  |  |   |  |  |       |
|                                    | <b>B(Alt)</b> F3R 728, F3R 729,<br>F3R 742, F3R 768,<br>F3R 769 | 11/96 → 10/00 | <b>AC</b> | VKMOV 6PK1125                                      |                  |                  |                  |  |  |  | 1           |   |        |  |  |  |   |  |  |       |
|                                    | <b>B(Alt)</b> F3R 728, F3R 729,<br>F3R 742, F3R 768,<br>F3R 769 | 11/96 → 10/00 | <b>AC</b> | VKMA 36006<br>VKMOV 6PK1658<br>VKM 36006           |                  |                  |                  |  |  |  | 1<br>1<br>1 |   | 1<br>1 |  |  |  |   |  |  |       |
| <b>RENAULT  ESPACE III 2.0 16V</b> |   |               |           |  |                  |                  |                  |  |  |  |             |   |        |  |  |  |   |  |  |       |
|                                    | F4R 700, F4R 701  | 10/98 → 05/99 |           | VKMA 06109<br>VKM 16550<br>VKM 26310<br>VKM 26310  | 1<br>1<br>1<br>1 | 2<br>1<br>1      | 1<br>1<br>1      |  |  |  |             |   |        |  |  |  | 2 |  |  | T0161 |
|                                    | F4R 700, F4R 701  | 06/99 → 04/01 |           | VKMA 06107<br>VKM 16550<br>VKM 26020<br>VKM 26310  | 1<br>1<br>1<br>1 | 2<br>1<br>1      | 1<br>1<br>1      |  |  |  |             |   |        |  |  |  | 2 |  |  | T0161 |
|                                    | F4R 700, F4R 701  | 04/01 → 10/02 |           | VKMA 06108<br>VKM 16550<br>VKM 26105<br>VKM 26310  | 1<br>1<br>1<br>1 | 2<br>1<br>1      | 1<br>1<br>1      |  |  |  |             |   |        |  |  |  | 2 |  |  | T0161 |
|                                    | F4R 700, F4R 701  | 10/98 → 10/02 |           | VKPC 86413   |                  |                  |                  |  |  |  |             |   | 1      |  |  |  |   |  |  |       |
|                                    | <b>B(Alt)</b> F4R 700, F4R 701                                  | 10/98 → 10/02 | <b>AC</b> | VKMOV 5PK1125                                      |                  |                  |                  |  |  |  | 1           |   |        |  |  |  |   |  |  |       |
|                                    | <b>B(Alt)</b> F4R 700, F4R 701                                  | 10/98 → 10/02 | <b>AC</b> | VKMA 36020<br>VKM 36031<br>VKM 36031               |                  |                  |                  |  |  |  | 2<br>1<br>1 |   | 1<br>1 |  |  |  |   |  |  |       |
| <b>RENAULT  ESPACE III 3.0 V6</b>  |   |               |           |  |                  |                  |                  |  |  |  |             |   |        |  |  |  |   |  |  |       |
|                                    | L7X 727   | 10/98 → 12/99 |           | —<br>VKM 23900<br>VKM 23900                        | 1<br>1<br>1      | 3<br>1<br>1      | 1<br>1<br>1      |  |  |  |             | 1 |        |  |  |  |   |  |  |       |

































|   |  |  |    |  |  |  |  |  |  |  |  |  |
|---|---|---|---|--|---|---|---|---|---|---|---|---|
|   |   |   |   | VKM 23900  | 1   |   |   |   |   |   |   |   |
|   |   |   |   | VKM 23901  | 1   |   |   |   |   |   |   |   |
|   | L7X 727   | 12/99 → 10/02   |   | VKMA 03902   | 1   | 3   | 1   |   |   |   |   | T0204   |
|   |   |   |   | VKM 13902  | 1   |   |   |   |   |   |   |   |
|   |   |   |   | VKM 23900  |   |   | 1   |   |   |   |   |   |
|   |   |   |   | VKM 23900  |   |   | 1   |   |   |   |   |   |
|   |   |   |   | VKM 23901  |   |   | 1   |   |   |   |   |   |
|   | Z7X 775   | 11/96 → 10/98   |   | <del>OKOKOK</del>  |   |   |   |   |   |   |   |   |
|                                      | L7X 727   | 10/98 → 12/99   |   | VKPC 83637   |   |   |   |   | 1   |   |   |   |
|   | L7X 727   | 12/99 → 10/02   |   | —  |   |   |   |   | 1   |   |   |   |
|   | Z7X 775   | 11/96 → 10/98   |   | —  |   |   |   |   | 1   |   |   |   |
| <b>RENAULT  ESPACE III 1.9 dTi</b>   |   |   |   |  |   |   |   |   |   |   |   |   |
|                                      | F9Q 722   | 02/99 → 10/00   | 3)  | VKMS 06115   | 1   | 1   | 1   |   |   |   | 2   | T0148   |
|   |   |   |   | VKMA 06115   | 1   | 1   | 1   |   |   |   |   |   |
|   |   |   |   | VKM 16101  | 1   |   |   |   |   |   |   |   |
|   |   |   |   | VKM 26115  |   |   | 1   |   |   |   |   |   |
|   | F9Q 722   | 02/99 → 10/00   | <b>p</b>  | VKMA 06125   | 1   | 2   | 1   |   |   |   |   | T0148   |
|   |   |   |   | VKM 16101  | 1   |   |   |   |   |   |   |   |
|   |   |   |   | VKM 26115  |   |   | 1   |   |   |   |   |   |
|   |   |   |   | VKM 26125  |   |   | 1   |   |   |   |   |   |
|   | F9Q 722   | 10/00 → 06/01   | <b>c, p</b>   | VKMA 06137   | 1   | 2   | 1   |   |   | 1   |   | T0181   |
|   |   |   |   | VKM 16551  | 1   |   |   |   |   |   |   |   |
|   |   |   |   | VKM 26117  |   |   |   |   |   | 1   |   |   |
|   |   |   |   | VKM 26125  |   |   | 1   |   |   |   |   |   |
|   |   |   |   | VKM 26128  |   |   | 1   |   |   |   |   |   |
|   | F9Q 722   | 10/00 → 06/01   | <b>c</b>  | VKMA 06117   | 1   | 1   | 1   |   |   | 1   |   | T0181   |
|   |   |   |   | VKM 16551  | 1   |   |   |   |   |   |   |   |
|   |   |   |   | VKM 26117  |   |   |   |   |   | 1   |   |   |
|   |   |   |   | VKM 26128  |   |   | 1   |   |   |   |   |   |
|   | F9Q 722   | 06/01 → 10/02   |   | VKMA 06128   | 1   | 1   | 1   |   |   |   |   | T0181   |
|   |   |   |   | VKM 16551  | 1   |   |   |   |   |   |   |   |
|   |   |   |   | VKM 26128  |   |   | 1   |   |   |   |   |   |
|                                    | F9Q 722   | 02/99 → 10/02   |   | VKPC 86413   |   |   |   |   |   | 1   |   |   |
|                                    | <b>B(Alt)</b> F9Q 722   | 02/99 → 10/02   | <b>AC</b>   | VKMV 6PK1135   |   |   | 1   |   |   |   |   |   |
|   | <b>B(Alt)</b> F9Q 722   | 02/99 → 03/01   | <b>AC</b>   | VKMA 36032   | 1   | 1   | 1   |   |   |   |   | 1   |
|   |   |   |   | VKMV 6PK1640   |   |   | 1   |   |   |   |   |   |
|   |   |   |   | VKM 36016  |   |   | 1   |   |   |   |   | 1   |
|   |   |   |   | VKM 36032  | 1   |   |   |   |   |   |   |   |
|   | <b>B(Alt)</b> F9Q 722   | 03/01 → 10/02   | <b>AC</b>   | VKMA 36035   | 1   | 1   | 1   |   |   |   |   | 1   |
|   |   |   |   | VKMV 6PK1606   |   |   | 1   |   |   |   |   |   |
|   |   |   |   | VKM 36016  |   |   | 1   |   |   |   |   | 1   |
|   |   |   |   | VKM 36035  | 1   |   |   |   |   |   |   |   |
| <b>RENAULT  ESPACE III 2.2 dT</b>  |   |   |   |  |   |   |   |   |   |   |   |   |
|                                    | G8T 714, G8T 716  | 11/96 → 10/00   |  | VKMC 06501   | 1   | 1   | 1   |   | 1   |   |   | T0133   |
|   |   |   |   | VKMA 06501   | 1   | 1   | 1   |   |   |   |   |   |
|   |   |   |   | VKM 16501  | 1   |   |   |   |   |   |   |   |
|   |   |   |   | VKM 26501  |   |   | 1   |   |   |   |   |   |
|   | G8T 714, G8T 716  | 11/96 → 10/00   | 3)  | VKMS 06501   | 1   | 1   | 1   |   |   |   | 2   | T0133   |
|   |   |   |   | VKMA 06501   | 1   | 1   | 1   |   |   |   |   |   |
|   |   |   |   | VKM 16501  | 1   |   |   |   |   |   |   |   |
|   |   |   |   | VKM 26501  |   |   | 1   |   |   |   |   |   |
|                                    | G8T 714, G8T 716  | 11/96 → 10/00   |   | VKPC 86633   |   |   |   |   | 1   |   |   |   |
|                                    | <b>B(Alt)</b> G8T 714, G8T 716  | 11/96 → 10/00   | <b>AC</b>   | VKMA 36024   | 1   |   | 1   |   |   |   |   |   |
|   |   |   |   | VKMV 6PK1010   |   |   | 1   |   |   |   |   |   |
|   |   |   |   | VKM 36024  | 1   |   |   |   |   |   |   |   |
|   | <b>B(Alt)</b> G8T 714, G8T 716  | 11/96 → 10/00   | <b>AC</b>   | VKMA 36026   | 2   | 1   | 1   |   |   |   |   |   |
|   |   |   |   | VKMV 6PK1949   |   |   | 1   |   |   |   |   |   |
|   |   |   |   | VKM 36019  |   | 1   |   |   |   |   |   |   |
|   |   |   |   | VKM 36022  | 1   |   |   |   |   |   |   |   |
|   |   |   |   | VKM 36026  | 1   |   |   |   |   |   |   |   |
|                                    | G8T 714, G8T 716  | 11/96 → 10/00   |   | —  |   |   |   |   |   | 1   |   |   |
| <b>RENAULT  ESPACE III 2.2 dCi</b> |   |   |   |  |   |   |   |   |   |   |   |   |
|                                    | G9T 710   | 10/00 → 10/02   |   | VKMA 06503   | 1   | 1   | 1   |   |   |   |   | 1 T0187   |
|   |   |   |   | VKM 16503  | 1   |   |   |   |   |   |   |   |
|   |   |   |   | VKM 26503  |   |   | 1   |   |   |   |   |   |
|                                    | G9T 710   | 10/00 → 10/02   |   | VKPC 86305   |   |   |   |   |   | 1   |   |   |



























RENAULT

|                                     | <b>B(Alt)</b> | G9T 710  | 10/00 → 10/02 |  | VKMA 36040<br>VKMV 6PK1778<br>VKM 36040<br>VKM 36040 | 2<br>1<br>1<br>1 | 1<br>1      |        |  |   |   |        |  |         |
|-------------------------------------|---------------|--|---------------|--|--|------------------|-------------|--------|--|---|---|--------|--|---------|
|                                     |               | G9T 710  | 10/00 → 10/02 |  | —  |                  |             |        |  |   | 1 |        |  |         |
| <b>RENAULT  ESPACE IV 2.0 16V</b>   |               |  |               |  |  |                  |             |        |  |   |   |        |  |         |
|                                     |               | F4R 790, F4R 792   | 11/02 → 11/07 |  | VKMC 06106<br>VKMA 06106<br>VKM 16550<br>VKM 26105   | 1<br>1<br>1      | 1<br>1<br>1 | 1      |  | 1 |   | 2<br>2 |  | T0177   |
|                                     |               | F4R 790, F4R 792   | 11/02 → 11/07 |  | VKPC 85304   |                  |             |        |  | 1 |   |        |  |         |
|                                     | <b>B(Alt)</b> | F4R 790, F4R 792   | 11/02 → 11/07 |  | VKMA____<br>VKMV 7PK1784<br>VKM 36030<br>VKM 36038   | 1<br>1           | 1<br>1      | 1      |  |   |   |        |  |         |
| <b>RENAULT  ESPACE IV 2.0 Turbo</b> |               |  |               |  |  |                  |             |        |  |   |   |        |  |         |
|                                     |               | F4R 794, F4R 795,<br>F4R 796, F4R 797,<br>F4R 896, F4R 897 | 11/02 → 11/07 |  | VKMC 06106<br>VKMA 06106<br>VKM 16550<br>VKM 26105   | 1<br>1<br>1      | 1<br>1<br>1 | 1      |  | 1 |   | 2<br>2 |  | T0177   |
|                                     |               | F4R 794, F4R 795,<br>F4R 796, F4R 797,<br>F4R 896, F4R 897 | 11/02 → 11/07 |  | VKPC 85304   |                  |             |        |  | 1 |   |        |  |         |
|                                     | <b>B(Alt)</b> | F4R 794, F4R 795,<br>F4R 796, F4R 797,<br>F4R 896, F4R 897 | 11/02 → 11/07 |  | VKMA____<br>VKMV 7PK1784<br>VKM 36030<br>VKM 36038   | 1<br>1           | 1<br>1      | 1      |  |   |   |        |  |         |
| <b>RENAULT  ESPACE IV 3.5 V6</b>    |               |  |               |  |  |                  |             |        |  |   |   |        |  |         |
|                                     |               | V4Y 711, V4Y 715   | 11/02 → 11/07 |  | <del>OXOXOXO</del>                                   |                  |             |        |  |   |   |        |  |         |
|                                     |               | V4Y 715  | 11/02 → 11/07 |  | —  |                  |             |        |  | 1 |   |        |  |         |
|                                     | <b>B(Alt)</b> | V4Y 711, V4Y 715   | 11/02 → 12/06 |  | VKMV 6PK1095   |                  |             | 1      |  |   |   |        |  |         |
|                                     | <b>B(AC)</b>  | V4Y 711, V4Y 715   | 11/02 → 11/07 |  | VKMV 4PK775  |                  |             | 1      |  |   |   |        |  |         |
| <b>RENAULT  ESPACE IV 1.9 dCi</b>   |               |  |               |  |  |                  |             |        |  |   |   |        |  |         |
|                                     |               | F9Q 820  | 11/02 → 11/07 |  | VKMC 06127<br>VKMA 06127<br>VKM 16113                | 1<br>1<br>1      | 1<br>1      | 1      |  |   |   |        |  | T0647   |
|                                     |               | F9Q 820  | 11/02 → 11/07 |  | VKPC 85304   |                  |             |        |  | 1 |   |        |  |         |
|                                     | <b>B(Alt)</b> | F9Q 820  | 11/02 → 11/07 |  | VKMA____<br>VKMV 7PK1784<br>VKM 36030<br>VKM 36038   | 1<br>1           | 1<br>1      | 1      |  |   |   |        |  |         |
| <b>RENAULT  ESPACE IV 2.0 dCi</b>   |               |  |               |  |  |                  |             |        |  |   |   |        |  |         |
|                                     |               | M9R 740, M9R 760,<br>M9R 761                               | 01/06 → 11/07 |  | <del>OXOXOXO</del>                                   |                  |             |        |  |   |   |        |  |         |
|                                     |               | M9R 740, M9R 760,<br>M9R 761                               | 01/06 → 11/07 |  | VKPC____   |                  |             |        |  | 1 |   |        |  |         |
|                                     | <b>B(Alt)</b> | M9R 740, M9R 760,<br>M9R 761                               | 01/06 → 11/07 |  | VKMV 7PK1970<br>VKM____<br>VKM____                   | 1                |             | 1      |  |   |   |        |  | 1       |
| <b>RENAULT  ESPACE IV 2.2 dCi</b>   |               |  |               |  |  |                  |             |        |  |   |   |        |  |         |
|                                     |               | G9T 645, G9T 742,<br>G9T 743                               | 11/02 → 06/07 |  | VKMA 06503<br>VKM 16503<br>VKM 26503                 | 1<br>1           | 1<br>1      | 1      |  |   |   |        |  | 1 T0177 |
|                                     |               | G9T 645, G9T 742,<br>G9T 743                               | 11/02 → 11/07 |  | VKPC 86305   |                  |             |        |  | 1 |   |        |  |         |
|                                     | <b>B(Alt)</b> | G9T 645, G9T 742,<br>G9T 743                               | 11/02 → 11/07 |  | VKMA 36041<br>VKMV 7PK1770                           |                  | 2           | 1<br>1 |  |   |   |        |  |         |



























|  |     |                  |  |  |  |  |  |  |  |  |  |  |
|--|--|---|---|--|---|---|---|---|---|---|---|---|
|  |  |   |   | VKM 36040<br>VKM 36040   | 1<br>1  |   |   |   |   |   |   |   |
| <b>RENAULT  ESPACE IV 3.0 dCi</b>         |  |   |   |  |   |   |   |   |   |   |   |   |
|   | P9X 701, P9X 715   | 11/02 → 11/07   |   | VKMA 05230<br>VKM 15220<br>VKM 25222<br>VKM 25226                                  | 1<br>1<br>1<br>1  | 2   | 1   |   |   |   |   | T0200   |
|   | P9X 701, P9X 715   | 11/02 → 11/07   |   | VKPC _____   |   |   |   | 1   |   |   |   |   |
|   | <b>B(Alt)</b> P9X 701  | 11/02 → 07/06   |   | VKMMV _____<br>VKM _____<br>VKM _____<br>VKM 35212<br>VKM 35214<br>VKM 35216       | 1<br>1<br>1<br>1<br>1   |   | 1   |   |   |   |   |   |
| <b>RENAULT  EXPRESS/EXTRA/RAPID 1.0</b>   |  |   |   |  |   |   |   |   |   |   |   |   |
|   | C1C 706  | 02/86 → 05/92   |   | XXXXXXXXXX   |   |   |   |   |   |   |   |   |
|   | C1C 706  | 02/86 → 05/92 2)  |   | VKPA 86206<br>VKPC 86206   |   |   |   | 1<br>1  |   |   |   |   |
|   | <b>B(Alt)</b> C1C 706  | 02/86 → 05/92   |   | VKMMV 10AVx1140  |   |   | 1   |   |   |   |   |   |
| <b>RENAULT  EXPRESS/EXTRA/RAPID 1.1</b>   |  |   |   |  |   |   |   |   |   |   |   |   |
|   | C1E 750, C1E 752,<br>C1E 754, C1E 756,<br>C1E 760, C1E 762,<br>C1E 792               | 07/85 → 04/95   |   | XXXXXXXXXX   |   |   |   |   |   |   |   |   |
|   | C1E 750, C1E 752,<br>C1E 754, C1E 756,<br>C1E 760, C1E 762,<br>C1E 792               | 07/85 → 04/95 2)  |   | VKPA 86206<br>VKPC 86206   |   |   |   | 1<br>1  |   |   |   |   |
|   | <b>B(Alt)</b> C1E 750, C1E 752,<br>C1E 754, C1E 756,<br>C1E 760, C1E 762,<br>C1E 792 | 07/85 → 04/95   |   | VKMMV 10AVx1140  |   |   | 1   |   |   |   |   |   |
| <b>RENAULT  EXPRESS/EXTRA/RAPID 1.2</b> |  |   |   |  |   |   |   |   |   |   |   |   |
|   | C1G 726, C3G 710,<br>C3G 712   | 09/91 → 03/98   |   | XXXXXXXXXX   |   |   |   |   |   |   |   |   |
|   | C1G 726  | 09/91 → 03/98 2)  |   | VKPA 86206<br>VKPC 86206   |   |   |   | 1<br>1  |   |   |   |   |
|  | C3G 710, C3G 712   | 09/91 → 03/98   |   | VKPC 86212   |   |   |   | 1   |   |   |   |   |
|   | <b>B(Alt)</b> C1G 726, C3G 710,<br>C3G 712   | 09/91 → 03/98   |   | VKMMV 10AVx1140  |   |   | 1   |   |   |   |   |   |
| <b>RENAULT  EXPRESS/EXTRA/RAPID 1.4</b> |  |   |   |  |   |   |   |   |   |   |   |   |
|   | C1J 768, C1J 780,<br>C2J 784, C3J 700,<br>C3J 702, C3J 760,<br>C3J 762               | 07/85 → 03/98   |   | XXXXXXXXXX   |   |   |   |   |   |   |   |   |
|  | E6J 734, E6J 738,<br>E7J 720, E7J 724,<br>E7J 726, E7J 728,<br>E7J 773               | 09/91 → 03/98  |   | VKMC 06000<br>VKMA 06000<br>VKM 16000  | 1<br>1<br>1   |   | 1   |   | 1   |   |   | T0061   |
|  | E6J 734, E6J 738,<br>E7J 720, E7J 724,<br>E7J 726, E7J 728,<br>E7J 773               | 09/91 → 03/98 3)  |   | VKMS 06000<br>VKMA 06000<br>VKM 16000  | 1<br>1<br>1   |   | 1   |   |   | 2   |   | T0061   |
|   | C1J 768, C1J 780,<br>C2J 784, C3J 700,<br>C3J 702, C3J 760,<br>C3J 762               | 07/85 → 03/98 2)  |   | VKPA 86206<br>VKPC 86206   |   |   |   | 1<br>1  |   |   |   |   |
|  | E6J 734, E6J 738,<br>E7J 720, E7J 724,<br>E7J 726, E7J 728,<br>E7J 773               | 09/91 → 03/98   |   | VKPC 86409   |   |   |   | 1   |   |   |   |   |

|   | E7J 770, E7J 771   | 09/91 → 03/98 |     | VKPC 86216   |                  |                  |                  |  |  |  |  |  |  |  |  |  |   | 1           |       |
|---|--|---------------|-----|--|------------------|------------------|------------------|--|--|--|--|--|--|--|--|--|---|-------------|-------|
|   | <b>B(Alt)</b> C1J 768, C1J 780,<br>C2J 784, C3J 700,<br>C3J 702, C3J 760,<br>C3J 762                 | 07/85 → 03/98 |     | VKMV 10AVx1140                                       |                  |                  |                  |  |  |  |  |  |  |  |  |  |   | 1           |       |
|   | <b>B(Alt)</b> E7J 728  | 01/94 → 03/98 |     | VKMV 10AVx690  |                  |                  |                  |  |  |  |  |  |  |  |  |  |   | 1           |       |
|   | <b>B(PS)</b> E7J 720, E7J 724,<br>E7J 726, E7J 770,<br>E7J 771, E7J 773                              | 09/91 → 03/98 |     | VKMA 36002<br>VKMV 4PK1218<br>VKM 36002              |                  |                  |                  |  |  |  |  |  |  |  |  |  |   | 1<br>1<br>1 |       |
| <b>RENAULT  EXPRESS/EXTRA/RAPID 1.6 D</b> |  |               |     |  |                  |                  |                  |  |  |  |  |  |  |  |  |  |   |             |       |
|   | F8M 720, F8M 730,<br>F8M 736, F8M 760  | 02/88 → 08/98 | 3)  | VKMS 06111-1<br>VKMA 06111<br>VKM 16101<br>VKM 26101 | 1<br>1<br>1<br>1 | 1<br>1<br>1<br>1 | 1<br>1<br>1<br>1 |  |  |  |  |  |  |  |  |  | 3 | T0066       |       |
|   | F8M 720, F8M 730,<br>F8M 736, F8M 760  | 03/86 → 08/98 |     | VKPC 86413   |                  |                  |                  |  |  |  |  |  |  |  |  |  |   | 1           |       |
|   | <b>B(Alt)</b> F8M 720, F8M 730,<br>F8M 736, F8M 760  | 03/86 → 08/98 |     | VKMV 5PK884  |                  |                  |                  |  |  |  |  |  |  |  |  |  |   | 1           |       |
|   | <b>B(AC)</b> F8M 720, F8M 730,<br>F8M 736, F8M 760   | 03/86 → 08/98 |     | VKMV 5PK884  |                  |                  |                  |  |  |  |  |  |  |  |  |  |   | 1           |       |
| <b>RENAULT  EXPRESS/EXTRA/RAPID 1.9 D</b> |  |               |     |  |                  |                  |                  |  |  |  |  |  |  |  |  |  |   |             |       |
|   | F8Q 640, F8Q 646,<br>F8Q 776   | 09/91 → 08/96 | 3), | VKMS 06113<br>VKMA 06113<br>VKM 16101<br>VKM 26102   | 1<br>1<br>1<br>1 | 1<br>1<br>1<br>1 | 1<br>1<br>1<br>1 |  |  |  |  |  |  |  |  |  |   | 3           | T0090 |
|   | F8Q 640, F8Q 644,<br>F8Q 646, F8Q 648,<br>F8Q 680, F8Q 682,<br>F8Q 684, F8Q 776                      | 09/96 → 03/98 | 3), | VKMS 06116<br>VKMA 06116<br>VKM 16101<br>VKM 26102   | 1<br>1<br>1<br>1 | 1<br>1<br>1<br>1 | 1<br>1<br>1<br>1 |  |  |  |  |  |  |  |  |  |   | 2           | T0090 |
|   | F8Q 722, F8Q 724,<br>F8Q 774   | 09/91 → 03/98 | 3), | VKMS 06113<br>VKMA 06113<br>VKM 16101<br>VKM 26102   | 1<br>1<br>1<br>1 | 1<br>1<br>1<br>1 | 1<br>1<br>1<br>1 |  |  |  |  |  |  |  |  |  |   | 3           | T0090 |
|   | F8Q 648, F8Q 680,<br>F8Q 682, F8Q 684  | 09/91 → 03/98 |     | VKMA 06126<br>VKM 16101<br>VKM 26102<br>VKM 26125    | 1<br>1<br>1<br>1 | 2<br>1<br>1<br>1 | 1<br>1<br>1<br>1 |  |  |  |  |  |  |  |  |  |   |             | T0090 |
|   | F8Q 640, F8Q 644,<br>F8Q 646, F8Q 648,<br>F8Q 680, F8Q 684,<br>F8Q 722, F8Q 724,<br>F8Q 774, F8Q 776 | 09/91 → 03/98 |     | VKPC 86413   |                  |                  |                  |  |  |  |  |  |  |  |  |  |   | 1           |       |
|   | <b>B(Alt)</b> F8Q 644, F8Q 648,<br>F8Q 684   | 09/94 → 03/98 |     | VKMV 6PK903  |                  |                  |                  |  |  |  |  |  |  |  |  |  |   | 1           |       |
|   | <b>B(Alt)</b> F8Q 644, F8Q 648,<br>F8Q 684   | 09/94 → 03/98 |     | VKMV 6PK894  |                  |                  |                  |  |  |  |  |  |  |  |  |  |   | 1           |       |
|   | <b>B(Alt)</b> F8Q 722, F8Q 724,<br>F8Q 774, F8Q 776  | 09/91 → 03/98 |     | VKMV 6PK903  |                  |                  |                  |  |  |  |  |  |  |  |  |  |   | 1           |       |
|   | F8Q 640, F8Q 682,<br>F8Q 684, F8Q 722,<br>F8Q 724, F8Q 774,<br>F8Q 776                               | 09/91 → 03/98 |     | VKM_____   |                  |                  |                  |  |  |  |  |  |  |  |  |  |   | 1           |       |
| <b>RENAULT  FUEGO 1.4</b>                 |  |               |     |  |                  |                  |                  |  |  |  |  |  |  |  |  |  |   |             |       |
|   | 847 720  | 02/80 → 12/84 |     | VKPC 86401   |                  |                  |                  |  |  |  |  |  |  |  |  |  |   | 1           |       |







|  |            |  |  |  |  |  |  |  |  |  |  |
|--|---|---|---|--|---|---|---|---|---|---|---|
|  | 847 720   | 01/84 → 10/85   |   | VKPC 86402   |   |   |   |   | 1   |   |   |
| <b>RENAULT  FUEGO 1.6</b>       |   |   |   |  |   |   |   |   |   |   |   |
|                                 | 843 723, 843 724,<br>A6M 725, A6M 726   | 10/80 → 10/85   | CH 43401  | VKPC 86407   |   |   |   |   | 1   |   |   |
| <b>RENAULT  FUEGO 1.6 Turbo</b> |   |   |   |  |   |   |   |   |   |   |   |
|                                 | A5L 750   | 08/83 → 10/85   |   | VKPC 86407   |   |   |   |   | 1   |   |   |
| <b>RENAULT  FUEGO 2.0</b>       |   |   |   |  |   |   |   |   |   |   |   |
|                                 | 829 710, J6R 710,<br>J6R 712, J6R 713,<br>J6R 715, J6R 726                                  | 10/80 → 10/85   |   | VKPC 86602   |   |   |   |   | 1   |   |   |
| <b>RENAULT  FUEGO 2.1 TD</b>    |   |   |   |  |   |   |   |   |   |   |   |
|                                 | J8S 712   | 08/82 → 10/85   |   | VKPC 86602   |   |   |   |   | 1   |   |   |
| <b>RENAULT  KANGOO 1.2</b>      |   |   |   |  |   |   |   |   |   |   |   |
|                                 | D7F 710, D7F 720,<br>D7F 722, D7F 726,<br>D7F 744, D7F 746,<br>D7F 764, D7F 766             | 03/98 → 11/07   |  | VKMC 06010<br>VKMA 06010<br>VKM 16000  | 1<br>1<br>1   | 1<br>1  | 1   |   |   |   | T0136   |
|  | D7F 710, D7F 720,<br>D7F 722, D7F 726,<br>D7F 744   | 03/98 → 12/00   | 3)  | VKMS 06010-1<br>VKMA 06010<br>VKM 16000  | 1<br>1<br>1   | 1<br>1  |   | 2   |   |   | T0136   |
|  | D7F 720, D7F 722,<br>D7F 726, D7F 744,<br>D7F 746, D7F 764,<br>D7F 766                      | 01/01 → 11/07   | 3)  | VKMS 06010-2<br>VKMA 06010<br>VKM 16000  | 1<br>1<br>1   | 1<br>1  |   | 2   |   |   | T0136   |
|                               | D7F 710, D7F 720,<br>D7F 722, D7F 726,<br>D7F 744, D7F 746,<br>D7F 764, D7F 766             | 03/98 → 11/07   |   | VKPC 86215   |   |   |   | 1   |   |   |   |
|                               | <b>B(Alt), B(PS)</b> D7F 720, D7F 722,<br>D7F 726, D7F 744,<br>D7F 746, D7F 764,<br>D7F 766 | 04/00 → 11/07   | <b>EHPS, AC</b>   | VKMA 36023   |   | 1 2   |   |   |   |   |   |
|  | <b>B(Alt), B(PS)</b> D7F 720, D7F 726,<br>D7F 746   | 04/00 → 11/07   | <b>EHPS, AC</b>   | VKMA 36025   |   | 2 2   |   |   | 1   |   |   |
|  | <b>B(Alt)</b> D7F 710, D7F 726  | 03/98 → 04/00   |   | VKMV 4PK735  |   |   | 1   |   |   |   |   |
|  | <b>B(Alt)</b> D7F 720, D7F 722  | 03/98 → 10/99   |   | VKMV 4PK735  |   |   | 1   |   |   |   |   |
|  | <b>B(Alt)</b> D7F 720, D7F 722  | 10/99 → 04/00   |   | VKMV 4PK730  |   |   | 1   |   |   |   |   |
|  | <b>B(Alt)</b> D7F 720, D7F 722,<br>D7F 726, D7F 744,<br>D7F 746, D7F 764,<br>D7F 766        | 04/00 → 11/07   |   | VKMV 3PK740  |   |   | 1   |   |   |   |   |
|  | <b>B(PS)</b> D7F 710, D7F 720,<br>D7F 722, D7F 726  | 03/98 → 04/00   | <b>EHPS, AC</b>   | VKMV 5PK880<br>VKM 36023   |   | 1   | 1   |   |   |   |   |
|  | <b>B(PS)</b> D7F 720, D7F 726   | 03/98 → 04/00   | <b>EHPS, AC</b>   | VKMV 5PK1515<br>VKM 36023<br>VKM_____  |   | 1<br>1  | 1   |   |   |   |   |
|  | <b>B(PS)</b> D7F 720, D7F 722,<br>D7F 726, D7F 744,<br>D7F 746, D7F 764,<br>D7F 766         | 04/00 → 11/07   | <b>EHPS, AC</b>   | VKMV 4PK908<br>VKM 36023   |   | 1   | 1   |   |   |   |   |
|  | <b>B(PS)</b> D7F 720, D7F 726,<br>D7F 746   | 04/00 → 11/07   | <b>EHPS, AC</b>   | VKMV 4PK1538<br>VKM 36023<br>VKM 36025   |   | 1<br>1  | 1   |   |   | 1   |   |
|  | <b>B(AC)</b> D7F 710, D7F 720,<br>D7F 726   | 03/98 → 04/00   | EHPS  | VKMV 5PK910<br>VKM 36023   |   | 1   | 1   |   |   |   |   |











RENAULT

|   |  |  |    |  |  |  |  |  |  |  |  |  |  |  |
|---|---|---|---|--|---|---|---|---|---|---|---|---|---|---|
| B(AC)   | D7F 720, D7F 726,<br>D7F 746, D7F 766   | 04/00 → 11/07   | EHPS  | VKMOV 4PK928<br>VKM 36023  | 1   | 1   |   |   |   |   |   |   |   |   |
| <b>RENAULT  KANGOO 1.2 16V</b> |   |   |   |  |   |   |   |   |   |   |   |   |   |   |
|                                 | D4F 712   | 06/01 → 11/07   |    | VKMC 06002<br>VKMA 06002<br>VKM 16002  | 1<br>1<br>1   | 1   | 1   |   |   |   |   |   |   | T0190   |
|   | D4F 730   | 06/01 → 11/07   |   | VKMA 06002<br>VKM 16002  | 1<br>1  | 1   |   |   |   |   |   |   |   | T0190   |
|                                 | D4F 712   | 06/01 → 11/07   |   | VKPC 86810   |   |   |   |   | 1   |   |   |   |   |   |
|   | D4F 730   | 06/01 → 11/07   |   | VKPC   |   |   |   |   | 1   |   |   |   |   |   |
|                                 | B(Alt), B(PS) D4F 712, D4F 730  | 06/01 → 11/07   | EHPS, 35), AC   | VKMA 36023   |   | 1   | 2   |   |   |   |   |   |   |   |
|   | B(Alt), B(PS) D4F 712, D4F 730  | 06/01 → 11/07   | EHPS, 35), AC   | VKMA 36025   |   | 2   | 2   |   |   |   |   |   | 1   |   |
|   | B(Alt) D4F 712, D4F 730   | 06/01 → 11/07   | 35)   | VKMOV 3PK740   |   |   | 1   |   |   |   |   |   |   |   |
|   | B(PS) D4F 712, D4F 730  | 06/01 → 11/07   | EHPS, AC  | VKMOV 4PK908<br>VKM 36023  |   | 1   |   | 1   |   |   |   |   |   |   |
|   | B(PS) D4F 712, D4F 730  | 06/01 → 11/07   | EHPS, AC  | VKMOV 4PK1538<br>VKM 36023<br>VKM 36025  |   | 1<br>1  |   | 1   |   |   |   |   |   | 1   |
|   | B(AC) D4F 712, D4F 730  | 06/01 → 11/07   | EHPS  | VKMOV 4PK928<br>VKM 36023  |   | 1   |   | 1   |   |   |   |   |   |   |
| <b>RENAULT  KANGOO 1.4</b>     |   |   |   |  |   |   |   |   |   |   |   |   |   |   |
|                                 | E7J 634, E7J 635,<br>E7J 780  | 03/98 → 11/07   |    | VKMC 06005<br>VKMA 06003<br>VKM 16003  | 1<br>1<br>1   | 1   | 1   |   | 1   |   |   |   |   | T0145   |
|   | K7J 700, K7J 701  | 03/98 → 11/07   |  | VKMC 06003<br>VKMA 06003<br>VKM 16003  | 1<br>1<br>1   | 1   | 1   |   | 1   |   |   |   |   | T0145   |
|                               | E7J 634, E7J 635,<br>E7J 780  | 03/98 → 11/07   |   | VKPC 86216   |   |   |   |   | 1   |   |   |   |   |   |
|   | K7J 700, K7J 701  | 03/98 → 11/07   |   | VKPC 86415   |   |   |   |   | 1   |   |   |   |   |   |
|                               | B(Alt) E7J 634, E7J 635,<br>K7J 700, K7J 701                                      | 03/98 → 11/07   | AC, ⊗   | VKMOV 5PK1110<br>VKM 36053<br>VKM 36091  |   | 1   |   | 1   |   |   |   |   |   |   |
|   | B(Alt) E7J 634, E7J 635   | 03/98 → 11/07   | EHPS, AC, ⊗   | VKMOV 5PK1110<br>VKM 36053<br>VKM 36091  |   | 1   |   | 1   |   |   |   |   |   |   |
|   | B(Alt) E7J 634, E7J 635,<br>K7J 700, K7J 701                                      | 03/98 → 11/07   | EHPS, AC, ⊗   | VKMA 36091<br>VKMOV 5PK1110<br>VKM 36091   | 1<br>1  |   | 1   | 1   |   |   |   |   |   |   |
|   | B(Alt) E7J 634, E7J 635   | 03/98 → 11/07   | EHPS, AC, ⊗   | VKMOV 6PK1750<br>VKM 36031<br>VKM 36031<br>VKM 36053                               |   |   | 1   | 1   |   |   |   |   |   |   |
|   | B(Alt) E7J 634, E7J 635   | 03/98 → 11/07   | EHPS, AC, ⊗   | VKMOV 6PK1750<br>VKM 36031<br>VKM 36031  |   | 1<br>1  |   | 1   |   |   |   |   |   |   |
|   | B(Alt) K7J 700, K7J 701   | 03/98 → 09/01   | AC, ⊗   | VKMOV 6PK1750<br>VKM 36031<br>VKM 36031  |   | 1<br>1  |   | 1   |   |   |   |   |   |   |
|   | B(Alt) K7J 700, K7J 701   | 09/01 → 11/07   | AC, ⊗   | VKMA 36020<br>VKM 36031<br>VKM 36031   |   | 2<br>1<br>1   |   | 1   |   |   |   |   |   |   |
|   | B(Alt) E7J 780  | 03/98 → 11/07   |   | VKMOV 3PK1040<br>VKM 36080   |   | 1   |   | 1   |   |   |   |   |   |   |
|   | B(PS) E7J 780   | 03/98 → 11/07   | AC  | VKMOV 4PK995<br>VKM 36081  |   | 1   |   | 1   |   |   |   |   |   |   |
|   | B(PS) E7J 780   | 03/98 → 11/07   | AC  | VKMOV 4PK1238<br>VKM 36082   |   | 1   |   | 1   |   |   |   |   |   |   |





























| RENAULT  KANGOO 1.6 |                       |               |   |   |             |        |   |  |  |       |
|--|-----------------------|---------------|---|---|-------------|--------|---|--|--|-------|
|                     | K7M 746               | 09/99 → 06/01 |              | VKMC 06003<br>VKMA 06003<br>VKM 16003   | 1<br>1<br>1 | 1<br>1 | 1 |  |  | T0145 |
|                     | K7M 746               | 09/99 → 06/01 |   | VKPC 86415                              |             |        | 1 |  |  |       |
|                     | <b>B(Alt)</b> K7M 746 | 09/99 → 06/01 | <i>AC</i> ,  | VKMV 5PK1110<br>VKM 36053<br>VKM 36091  | 1           | 1      |   |  |  |       |
|  | <b>B(Alt)</b> K7M 746 | 09/99 → 06/01 | <i>AC</i> ,  | VKMA 36091<br>VKMV 5PK1110<br>VKM 36091 | 1<br>1      | 1<br>1 |   |  |  |       |
|  | <b>B(Alt)</b> K7M 746 | 09/99 → 06/01 | <b>AC</b>   | VKMV 6PK1750<br>VKM 36031<br>VKM 36031  |             | 1<br>1 | 1 |  |  |       |

























| RENAULT  KANGOO 1.6 16V |   |               |   |  |                  |             |   |        |        |       |
|--|---|---------------|---|--|------------------|-------------|---|--------|--------|-------|
|                         | K4M 708, K4M 730,<br>K4M 732, K4M 750,<br>K4M 752, K4M 753,<br>K4M 754, K4M 850               | 06/01 → 11/07 |  | VKMC 06020<br>VKMA 06020<br>VKM 16020<br>VKM 26020 | 1<br>1<br>1<br>1 | 1<br>1<br>1 | 1 | 2<br>2 | 1<br>1 | T0159 |
|                         | K4M 708, K4M 730,<br>K4M 732, K4M 750,<br>K4M 752, K4M 753,<br>K4M 754, K4M 850               | 06/01 → 11/07 |   | VKPC 86416   |                  |             | 1 |        |        |       |
|                       | <b>B(Alt)</b> K4M 708, K4M 730,<br>K4M 732, K4M 750,<br>K4M 752, K4M 753,<br>K4M 754, K4M 850 | 06/01 → 11/07 | <i>AC</i>   | VKMA 36091<br>VKMV 5PK1110<br>VKM 36091            | 1<br>1           | 1<br>1      |   |        |        |       |
|  | <b>B(Alt)</b> K4M 708, K4M 750,<br>K4M 752  | 06/01 → 09/01 | <b>AC</b>   | VKMV 6PK1750<br>VKM 36031<br>VKM 36031             |                  | 1<br>1      | 1 |        |        |       |
|  | <b>B(Alt)</b> K4M 708, K4M 730,<br>K4M 732, K4M 750,<br>K4M 752, K4M 753,<br>K4M 754, K4M 850 | 09/01 → 11/07 | <b>AC</b>   | VKMA 36020<br>VKM 36031<br>VKM 36031               | 2<br>1<br>1      | 1           |   |        |        |       |

| RENAULT  KANGOO 1.5 dCi |  |               |           |  |             |        |        |  |   |       |
|--|--|---------------|-----------|--|-------------|--------|--------|--|---|-------|
|                         | K9K 700, K9K 702,<br>K9K 704, K9K 710  | 12/01 → 08/03 |           | VKMA 06130<br>VKM 16102                              | 1<br>1      | 1      |        |  | 1 | T0191 |
|  | K9K 700, K9K 702,<br>K9K 704, K9K 710,<br>K9K 714, K9K 716,<br>K9K 718               | 08/03 → 11/07 |           | VKMA 06132<br>VKM 16102                              | 1<br>1      | 1      |        |  | 1 | T0191 |
|                         | K9K 700, K9K 702,<br>K9K 704, K9K 710  | 12/01 → 04/04 |           | VKPC 86417   |             |        | 1      |  |   |       |
|  | K9K 700, K9K 702,<br>K9K 704, K9K 710,<br>K9K 714, K9K 716,<br>K9K 718               | 04/04 → 11/07 |           | VKPC_____  |             |        | 1      |  |   |       |
|                         | <b>B(Alt)</b> K9K 700, K9K 702,<br>K9K 704, K9K 710,<br>K9K 714, K9K 716,<br>K9K 718 | 12/01 → 09/05 | <i>AC</i> | VKMA 36052<br>VKMV 5PK1135<br>VKM 36052<br>VKM 36053 | 1<br>1<br>1 | 1<br>1 | 1<br>1 |  |   |       |



RENAULT

























|   |  |  |    |  |  |  |  |  |  |  |  |
|---|---|---|---|--|---|---|---|---|---|---|---|
| <b>B(Alt)</b>   | K9K 700, K9K 702,<br>K9K 704, K9K 710,<br>K9K 714, K9K 716,<br>K9K 718            | 09/05 → 11/07   | AC  | VKMOV 6PK1199<br>VKM 36053   | 1   | 1   |   |   |   |   |   |
| <b>B(Alt)</b>   | K9K 700, K9K 702,<br>K9K 704, K9K 710   | 12/01 → 01/05   | AC  | VKMOV 5PK1199  |   | 1   |   |   |   |   |   |
| <b>B(Alt)</b>   | K9K 700, K9K 702,<br>K9K 704, K9K 710,<br>K9K 714, K9K 716,<br>K9K 718            | 01/05 → 11/07   | AC  | VKMOV 6PK1199  |   | 1   |   |   |   |   |   |
| ⊙   | K9K 700, K9K 702,<br>K9K 704, K9K 710   | 12/01 → 11/07   |   | —  |   |   |   | 1   |   |   |   |
| <b>RENAULT  KANGOO 1.9 D</b>       |   |   |   |  |   |   |   |   |   |   |   |
|                                     | F8Q 630, F8Q 632,<br>F8Q 662  | 03/98 → 11/07   | 3)  | VKMS 06116<br>VKMA 06116<br>VKM 16101<br>VKM 26102                                 | 1<br>1<br>1   | 1<br>1<br>1   | 1   |   |   | 2   | T0090   |
|   | F8Q 630, F8Q 632,<br>F8Q 662  | 03/98 → 11/07   | P   | VKMA 06126<br>VKM 16101<br>VKM 26102<br>VKM 26125                                  | 1<br>1  | 2<br>1<br>1   | 1   |   |   |   | T0090   |
|                                     | F8Q 630, F8Q 632,<br>F8Q 662  | 03/98 → 11/07   |   | VKPC 86413   |   |   |   | 1   |   |   |   |
|                                    | <b>B(Alt)</b> F8Q 630, F8Q 632,<br>F8Q 662  | 03/98 → 11/07   | AC, ⊙   | VKMOV 6PK894   |   | 1   |   |   |   |   |   |
|   | <b>B(Alt)</b> F8Q 630, F8Q 632,<br>F8Q 662  | 03/98 → 11/07   | AC, ⊙   | VKMOV 6PK1400  |   | 1   |   |   |   |   |   |
|   | <b>B(Alt)</b> F8Q 630, F8Q 632,<br>F8Q 662  | 03/98 → 11/07   | AC  | VKMOV 6PK1193  |   | 1   |   |   |   |   |   |
| ⊙   | F8Q 630, F8Q 632,<br>F8Q 662  | 03/98 → 11/07   |   | VKM_____   |   |   |   |   | 1   |   |   |
| <b>RENAULT  KANGOO 1.9 dCi</b>   |   |   |   |  |   |   |   |   |   |   |   |
|                                   | F9Q 790   | 10/01 → 11/07   |   | VKMA 06115<br>VKM 16101<br>VKM 26115   | 1<br>1  | 1<br>1  | 1   |   |   |   | T0148   |
|   | F9Q 790   | 10/01 → 11/07   | P   | VKMA 06125<br>VKM 16101<br>VKM 26115<br>VKM 26125                                  | 1<br>1  | 2<br>1<br>1   | 1   |   |   |   | T0148   |
|                                   | F9Q 790   | 10/01 → 11/07   |   | VKPC 86413   |   |   |   | 1   |   |   |   |
|                                   | <b>B(Alt)</b> F9Q 790   | 10/01 → 11/07   | AC  | VKMOV 6PK1127  |   | 1   |   |   |   |   |   |
|   | <b>B(Alt)</b> F9Q 790   | 10/01 → 11/07   | AC  | VKMOV 6PK1209  |   | 1   |   |   |   |   |   |
| ⊙   | F9Q 790   | 10/01 → 11/07   |   | VKM_____   |   |   |   |   | 1   |   |   |
| <b>RENAULT  KANGOO 1.9 dTi</b>   |   |   |   |  |   |   |   |   |   |   |   |
|                                   | F9Q 780, F9Q 782  | 02/00 → 11/07   | c, P  | VKMA 06137<br>VKM 16551<br>VKM 26117<br>VKM 26125<br>VKM 26128                     | 1<br>1  | 2<br>1<br>1   | 1   |   | 1   |   | T0181   |
|   | F9Q 780, F9Q 782  | 02/00 → 11/07   | c   | VKMA 06117<br>VKM 16551<br>VKM 26117<br>VKM 26128                                  | 1<br>1  | 1<br>1  | 1   |   | 1   |   | T0181   |
|                                   | F9Q 780, F9Q 782  | 02/00 → 11/07   |   | VKPC 86413   |   |   |   | 1   |   |   |   |
|                                   | <b>B(Alt)</b> F9Q 780, F9Q 782  | 02/00 → 11/07   | AC  | VKMOV 6PK1127  |   | 1   |   |   |   |   |   |
|   | <b>B(Alt)</b> F9Q 780, F9Q 782  | 02/00 → 11/07   | AC  | VKMOV 6PK1209  |   | 1   |   |   |   |   |   |
| ⊙   | F9Q 780, F9Q 782  | 02/00 → 11/07   |   | VKM_____   |   |   |   |   | 1   |   |   |
| <b>RENAULT  LAGUNA I 1.6 16V</b> |   |   |   |  |   |   |   |   |   |   |   |
|                                   | K4M 720   | 05/98 → 03/01   |  | VKMC 06020<br>VKMA 06020<br>VKM 16020<br>VKM 26020                                 | 1<br>1<br>1   | 1<br>1<br>1   | 1   | 1   | 2<br>2  | 1<br>1  | T0159   |



























|   |  |  |  |  |  |  |  |  |  |  |  |  |  |       |
|---|---|---|---|--|---|---|---|---|---|---|---|---|---|-------|
|   | K4M 720   | 11/97 → 05/98   |   |  | 1   | 1   | 1   |   |   |   |   | 2   | 1   | T0159 |
|   |   |   |   | VKM 16020<br>VKM 26020   | 1<br>1  |   | 1   |   |   |   |   |   |   |       |
|                                    | K4M 720   | 11/97 → 03/01   |   | VKPC 86416   |   |   |   |   | 1   |   |   |   |   |       |
|                                    | <b>B(Alt)</b> K4M 720   | 11/97 → 03/01   | <i>AC</i>   | VKMA 36091<br>VKMV 5PK1110<br>VKM 36091  | 1<br>1  |   | 1<br>1  |   |   |   |   |   |   |       |
|   | <b>B(Alt)</b> K4M 720   | 11/97 → 03/01   | <b>AC</b>   | VKMV 6PK1750<br>VKM 36031<br>VKM 36031   |   |   | 1<br>1  |   |   |   |   |   |   |       |
| <b>RENAULT  LAGUNA I 1.8</b>       |   |   |   |  |   |   |   |   |   |   |   |   |   |       |
|                                    | F3P 670, F3P 674,<br>F3P 676, F3P 678,<br>F3P 720, F3P 724                        | 11/93 → 03/01   | 3)  | VKMS 06101<br>VKMA 06101<br>VKM 16101<br>VKM 26101                                 | 1<br>1<br>1   | 1<br>1<br>1   | 1<br>1  |   |   |   |   | 3   |   | T0046 |
|   | F3P 674, F3P 676  | 09/95 → 03/01   | <b>p</b>  | VKM 16101<br>VKM 26101<br>VKM 26123  | 1<br>1  | 2<br>1  | 1<br>1  |   |   |   |   |   |   | T0046 |
|                                    | F3P 670, F3P 674,<br>F3P 676, F3P 678,<br>F3P 720, F3P 724                        | 11/93 → 03/01   |   | VKPC 86413   |   |   |   |   | 1   |   |   |   |   |       |
|                                    | <b>B(Alt)</b> F3P 670, F3P 674,<br>F3P 676  | 08/95 → 03/01   | <i>AC</i>   | VKMV 6PK1125<br>VKM 36006  |   |   | 1<br>1  |   |   |   |   |   |   |       |
|   | <b>B(Alt)</b> F3P 678, F3P 724  | 11/93 → 11/95   | <i>AC</i>   | VKMV 6PK1425<br>VKM 36006  |   |   | 1<br>1  |   |   |   |   |   |   |       |
|   | <b>B(Alt)</b> F3P 678, F3P 724  | 11/95 → 03/01   | <i>AC</i>   | VKMV 6PK1125<br>VKM 36006  |   |   | 1<br>1  |   |   |   |   |   |   |       |
|   | <b>B(Alt)</b> F3P 720   | 11/93 → 03/01   | <i>AC</i>   | VKMV 6PK1425<br>VKM 36006  |   |   | 1<br>1  |   |   |   |   |   |   |       |
|   | <b>B(Alt)</b> F3P 670, F3P 674,<br>F3P 676, F3P 678,<br>F3P 720, F3P 724          | 11/93 → 03/01   | <b>AC</b>   | VKMA 36006<br>VKMV 6PK1658<br>VKM 36006  |   |   | 1<br>1<br>1   | 1<br>1  |   |   |   |   |   |       |
| <b>RENAULT  LAGUNA I 1.8 16V</b> |   |   |   |  |   |   |   |   |   |   |   |   |   |       |
|                                  | F4P 760   | 04/98 → 05/99   |   | VKMA 06109<br>VKM 16550<br>VKM 26310<br>VKM 26310                                  | 1<br>1  | 2<br>1  | 1<br>1  |   |   |   |   | 2   |   | T0161 |
|   | F4P 760   | 06/99 → 03/01   |   | VKMA 06107<br>VKM 16550<br>VKM 26020<br>VKM 26310                                  | 1<br>1  | 2<br>1  | 1<br>1  |   |   |   |   | 2   |   | T0161 |
|                                  | F4P 760   | 04/98 → 03/01   |   | VKPC 86413   |   |   |   |   | 1   |   |   |   |   |       |
|                                  | <b>B(Alt)</b> F4P 760   | 04/98 → 03/01   | <i>AC</i>   | VKMV 5PK1125   |   |   | 1   |   |   |   |   |   |   |       |
|   | <b>B(Alt)</b> F4P 760   | 04/98 → 03/01   | <b>AC</b>   | VKMA 36020<br>VKM 36031<br>VKM 36031   |   |   | 2<br>1<br>1   | 1   |   |   |   |   |   |       |
| <b>RENAULT  LAGUNA I 2.0</b>     |   |   |   |  |   |   |   |   |   |   |   |   |   |       |
|                                  | F3R 611, F3R 722,<br>F3R 723, F3R 728,<br>F3R 729, F3R 768,<br>F3R 769            | 11/93 → 03/01   |   | VKMA 06103<br>VKM 16101<br>VKM 26101   | 1<br>1  | 1<br>1  | 1<br>1  |   |   |   |   |   |   | T0108 |
|   | F3R 611, F3R 768,<br>F3R 769  | 11/93 → 03/01   | <b>p</b>  | VKMA 06123<br>VKM 16101<br>VKM 26101<br>VKM 26123                                  | 1<br>1  | 2<br>1  | 1<br>1  |   |   |   |   |   |   | T0655 |



RENAULT

































|   |     |  |  |  |  |  |  |  |  |  |  |  |
|---|--|---|---|--|---|---|---|---|---|---|---|---|
|                                     | F3R 611, F3R 722,<br>F3R 723, F3R 728,<br>F3R 729, F3R 768,<br>F3R 769               | 11/93 → 03/01   |   | VKPC 86413   |   |   |   |   |   | 1   |   |   |
|                                     | <b>B(Alt)</b> F3R 611, F3R 722,<br>F3R 723, F3R 728,<br>F3R 729, F3R 768,<br>F3R 769 | 11/93 → 03/01   | AC  | VKPV 5PK1125   |   |   |   |   |   | 1   |   |   |
|                                     | <b>B(Alt)</b> F3R 611, F3R 722,<br>F3R 723, F3R 728,<br>F3R 729, F3R 768,<br>F3R 769 | 11/93 → 03/01   | AC  | VKMA 36006<br>VKMV 6PK1658<br>VKM 36006  |   |   |   |   |   | 1   | 1   |   |
| <b>RENAULT  LAGUNA I 2.0 16V</b>   |  |   |   |  |   |   |   |   |   |   |   |   |
|                                     | F4R 780  | 09/99 → 03/01   |   | VKMA 06107<br>VKM 16550<br>VKM 26020<br>VKM 26310                                  | 1<br>1  | 2   | 1   |   |   |   | 2   | T0161   |
|   | N7Q 700  | 06/95 → 03/01   |   | VKMA 06602<br>VKM 16602<br>VKM 26602   | 1<br>1  | 1   | 1   |   |   |   |   | 1 T0163   |
|   | N7Q 704  | 06/95 → 12/97   |   | VKMA 06602<br>VKM 16602<br>VKM 26602   | 1<br>1  | 1   | 1   |   |   |   |   | 1 T0163   |
|   | N7Q 704  | 01/98 → 03/01   |   | VKMA 06604<br>VKM 16604<br>VKM 26602   | 1<br>1  | 1   | 1   |   |   |   |   | T0163   |
|                                   | F4R 780<br>N7Q 700, N7Q 704  | 09/99 → 03/01<br>06/95 → 03/01  |   | VKPC 85304<br>VKPC 86618   |   |   |   |   |   | 1<br>1  |   |   |
|                                   | <b>B(Alt)</b> F4R 780  | 09/99 → 03/01   |   | VKMA 36020<br>VKM 36031<br>VKM 36031   |   | 2<br>1<br>1   | 1   |   |   |   |   |   |
|   | <b>B(Alt)</b> N7Q 700, N7Q 704   | 06/95 → 03/01   | AC  | VKPV 6PK1235<br>VKM 36003<br>VKM 36120   |   |   | 1   |   |   | 1   |   |   |
|   | <b>B(Alt)</b> N7Q 700, N7Q 704   | 06/95 → 03/01   | AC  | VKPV 6PK1605<br>VKM 36003<br>VKM 36120   |   |   | 1   |   |   | 1   |   |   |
| <b>RENAULT  LAGUNA I 3.0 V6</b>  |  |   |   |  |   |   |   |   |   |   |   |   |
|                                   | Z7X 760, Z7X 765<br>L7X 700, L7X 701   | 11/93 → 03/01<br>03/97 → 07/99  |   | —<br>VKM 23900<br>VKM 23900<br>VKM 23901   |   |   |   |   |   |   |   |   |
|   | L7X 700, L7X 701   | 07/99 → 03/01   |   | VKMA 03902<br>VKM 13902<br>VKM 23900<br>VKM 23900<br>VKM 23901                     | 1<br>1  | 3   | 1   |   |   |   |   | T0204   |
|                                   | L7X 700, L7X 701<br>L7X 700, L7X 701<br>Z7X 760, Z7X 765,<br>Z7X 767                 | 03/97 → 12/99<br>12/99 → 03/01<br>11/93 → 03/01                                   |   | VKPC 83637<br>—<br>—   |   |   |   |   |   | 1<br>1<br>1   |   |   |
|                                   | <b>B(Alt)</b> L7X 700, L7X 701   | 03/97 → 03/01   |   | VKM 33075  |   | 1   |   |   |   |   |   |   |
| <b>RENAULT  LAGUNA I 1.9 dTi</b> |  |   |   |  |   |   |   |   |   |   |   |   |
|                                   | F9Q 710  | 10/97 → 10/00   | 3)  | VKMS 06115<br>VKMA 06115<br>VKM 16101<br>VKM 26115                                 | 1<br>1<br>1   | 1<br>1  | 1   |   |   |   | 2   | T0148   |
|   | F9Q 710  | 10/97 → 10/00   | p   | VKMA 06125<br>VKM 16101<br>VKM 26115<br>VKM 26125                                  | 1<br>1  | 2   | 1   |   |   |   |   | T0148   |
|   | F9Q 710  | 10/00 → 03/01   | c   | VKMA 06117<br>VKM 16551  | 1<br>1  | 1   | 1   |   |   | 1   |   | T0181   |

|   |  |  |    |  |  |  |  |  |  |  |  |
|---|---|---|---|--|---|---|---|---|---|---|---|
|   |   |   |   | VKM 26117  |   |   |   |   | 1   |   |   |
|   |   |   |   | VKM 26128  |   | 1   |   |   |   |   |   |
|   | F9Q 716   | 10/97 → 03/01   | 3)  | VKMS 06115   | 1   | 1   | 1   |   |   | 2   | T0148   |
|   |   |   |   | VKMA 06115   | 1   | 1   | 1   |   |   |   |   |
|   |   |   |   | VKM 16101  | 1   |   |   |   |   |   |   |
|   |   |   |   | VKM 26115  |   | 1   |   |   |   |   |   |
|   | F9Q 716   | 10/97 → 03/01   | <b>p</b>  | VKMA 06125   | 1   | 2   | 1   |   |   |   | T0148   |
|   |   |   |   | VKM 16101  | 1   |   |   |   |   |   |   |
|   |   |   |   | VKM 26115  |   | 1   |   |   |   |   |   |
|   |   |   |   | VKM 26125  |   | 1   |   |   |   |   |   |
|   | F9Q 717   | 10/97 → 03/01   | <b>c, p</b>   | VKMA 06137   | 1   | 2   | 1   |   | 1   |   | T0181   |
|   |   |   |   | VKM 16551  | 1   |   |   |   | 1   |   |   |
|   |   |   |   | VKM 26117  |   |   |   |   |   |   |   |
|   |   |   |   | VKM 26125  |   | 1   |   |   |   |   |   |
|   |   |   |   | VKM 26128  |   | 1   |   |   |   |   |   |
|   | F9Q 717   | 10/97 → 03/01   | <b>c</b>  | VKMA 06117   | 1   | 1   | 1   |   | 1   |   | T0181   |
|   |   |   |   | VKM 16551  | 1   |   |   |   | 1   |   |   |
|   |   |   |   | VKM 26117  |   |   |   |   |   |   |   |
|   |   |   |   | VKM 26128  |   | 1   |   |   |   |   |   |
|                                    | F9Q 710, F9Q 716,<br>F9Q 717  | 10/97 → 03/01   |   | VKPC 86413   |   |   |   |   | 1   |   |   |
|                                    | <b>B(Alt)</b> F9Q 710, F9Q 716,<br>F9Q 717  | 10/97 → 03/01   | <b>AC</b>   | VKMV 6PK1135   |   |   | 1   |   |   |   |   |
|                                    | <b>B(Alt)</b> F9Q 710, F9Q 716,<br>F9Q 717  | 10/97 → 03/01   | <b>AC</b>   | VKMA 36032   | 1   | 1   | 1   |   |   | 1   |   |
|   |   |   |   | VKMV 6PK1640   |   | 1   | 1   |   |   |   |   |
|   |   |   |   | VKM 36016  |   | 1   |   |   |   | 1   |   |
|   |   |   |   | VKM 36032  | 1   |   |   |   |   |   |   |
|                                   | F9Q 710, F9Q 716,<br>F9Q 717  | 10/97 → 03/01   |   | VKM_____   |   |   |   |   | 1   |   |   |
| <b>RENAULT  LAGUNA I 1.9 dCi</b> |   |   |   |  |   |   |   |   |   |   |   |
|                                  | F9Q 718   | 09/99 → 03/01   |  | VKMC 06127   | 1   |   | 1   |   | 1   |   |   |
|   |   |   |   | VKMA 06127   | 1   |   | 1   |   |   |   | T0647   |
|   |   |   |   | VKM 16113  | 1   |   |   |   |   |   |   |
|                                  | F9Q 718   | 09/99 → 03/01   |   | VKPC 85304   |   |   |   |   | 1   |   |   |
|                                  | <b>B(Alt)</b> F9Q 718   | 09/99 → 03/01   |   | VKMA 36033   | 1   | 1   | 1   |   |   |   |   |
|   |   |   |   | VKMV 6PK1792   |   |   | 1   |   |   |   |   |
|   |   |   |   | VKM 36030  | 1   |   |   |   |   |   |   |
|   |   |   |   | VKM 36031  |   | 1   |   |   |   |   |   |
|                                  | F9Q 718   | 09/99 → 03/01   | <b>AC</b>   | —  |   |   |   |   | 1   |   |   |
|   | F9Q 718   | 09/99 → 03/01   | <b>AC</b>   | —  |   |   |   |   | 1   |   |   |
| <b>RENAULT  LAGUNA I 2.2 D</b>   |   |   |   |  |   |   |   |   |   |   |   |
|                                  | G8T 752, G8T 792,<br>G8T 794  | 11/93 → 03/01   |  | VKMC 06501   | 1   | 1   | 1   |   | 1   |   |   |
|   |   |   |   | VKMA 06501   | 1   | 1   | 1   |   |   |   | T0133   |
|   |   |   |   | VKM 16501  | 1   |   |   |   |   |   |   |
|   |   |   |   | VKM 26501  |   | 1   |   |   |   |   |   |
|   | G8T 752, G8T 792,<br>G8T 794  | 11/93 → 03/01   | 3)  | VKMS 06501   | 1   | 1   | 1   |   |   | 2   | T0133   |
|   |   |   |   | VKMA 06501   | 1   | 1   | 1   |   |   |   |   |
|   |   |   |   | VKM 16501  | 1   |   |   |   |   |   |   |
|   |   |   |   | VKM 26501  |   | 1   |   |   |   |   |   |
|   | G8T 706, G8T 790  | 11/93 → 03/01   |   | VKMA 06500   | 1   | 1   | 1   |   |   |   | T0111   |
|   |   |   |   | VKM 16501  | 1   |   |   |   |   |   |   |
|   |   |   |   | VKM 26500  |   | 1   |   |   |   |   |   |
|   | G8T 706, G8T 790  | 11/93 → 03/01   | <b>p</b>  | VKMA 06502   | 1   | 2   | 1   |   |   |   | T0656   |
|   |   |   |   | VKM 16501  | 1   |   |   |   |   |   |   |
|   |   |   |   | VKM 26500  |   | 1   |   |   |   |   |   |
|   |   |   |   | VKM 26502  |   | 1   |   |   |   |   |   |
|                                  | G8T 706, G8T 790  | 11/93 → 03/01   |   | VKPC 86631   |   |   |   |   | 1   |   |   |
|   | G8T 752, G8T 792,<br>G8T 794  | 11/93 → 03/01   |   | VKPC 86633   |   |   |   |   | 1   |   |   |
|                                  | <b>B(Alt)</b> G8T 706, G8T 790  | 11/93 → 03/01   |   | VKMA 36008   |   | 2   | 1   |   |   |   |   |
|   |   |   |   | VKMV 6PK1682   |   |   | 1   |   |   |   |   |
|   |   |   |   | VKM 36008  | 1   |   |   |   |   |   |   |
|   |   |   |   | VKM 36011  | 1   |   |   |   |   |   |   |





























RENAULT

| <b>B(Alt)</b>                     | G8T 752, G8T 792,<br>G8T 794                      | 11/93 → 03/01 | <b>AC</b> | VKMA 36024<br>VKMV 6PK1010<br>VKM 36024                           | 1<br>1           | 1<br>1      |        |  |  |   |  |        |        |  |  |  |  |  |  |       |       |
|-----------------------------------|---|---------------|-----------|---|------------------|-------------|--------|--|--|---|--|--------|--------|--|--|--|--|--|--|-------|-------|
| <b>B(Alt)</b>                     | G8T 752, G8T 792,<br>G8T 794                      | 11/93 → 03/01 | <b>AC</b> | VKMA 36026<br>VKMV 6PK1949<br>VKM 36019<br>VKM 36022<br>VKM 36026 | 2<br>1<br>1<br>1 | 1<br>1      | 1<br>1 |  |  |   |  |        |        |  |  |  |  |  |  |       |       |
|                                   | G8T 752, G8T 792,<br>G8T 794                      | 11/93 → 03/01 |           | —   |                  |             |        |  |  |   |  | 1      |        |  |  |  |  |  |  |       |       |
| <b>RENAULT  LAGUNA I 2.2 dT</b>   |   |               |           |   |                  |             |        |  |  |   |  |        |        |  |  |  |  |  |  |       |       |
|                                   | G8T 760   | 03/96 → 03/01 |           | VKMC 06501<br>VKMA 06501<br>VKM 16501<br>VKM 26501                | 1<br>1<br>1      | 1<br>1<br>1 | 1<br>1 |  |  | 1 |  |        |        |  |  |  |  |  |  | T0133 |       |
|                                   | G8T 760   | 03/96 → 03/01 | 3)        | VKMS 06501<br>VKMA 06501<br>VKM 16501<br>VKM 26501                | 1<br>1<br>1      | 1<br>1<br>1 | 1<br>1 |  |  |   |  | 2      |        |  |  |  |  |  |  | T0133 |       |
|                                   | G8T 760   | 03/96 → 03/01 |           | VKPC 86633  |                  |             |        |  |  | 1 |  |        |        |  |  |  |  |  |  |       |       |
|                                   | <b>B(Alt)</b> G8T 760                             | 03/96 → 03/01 | <b>AC</b> | VKMA 36024<br>VKMV 6PK1010<br>VKM 36024                           | 1<br>1           | 1<br>1      |        |  |  |   |  |        |        |  |  |  |  |  |  |       |       |
| <b>B(Alt)</b>                     | G8T 760   | 03/96 → 03/01 | <b>AC</b> | VKMA 36026<br>VKMV 6PK1949<br>VKM 36019<br>VKM 36022<br>VKM 36026 | 2<br>1<br>1<br>1 | 1<br>1      | 1<br>1 |  |  |   |  |        |        |  |  |  |  |  |  |       |       |
|                                   | G8T 760   | 03/96 → 03/01 |           | —   |                  |             |        |  |  |   |  | 1      |        |  |  |  |  |  |  |       |       |
| <b>RENAULT  LAGUNA II 1.6 16V</b> |   |               |           |   |                  |             |        |  |  |   |  |        |        |  |  |  |  |  |  |       |       |
|                                   | K4M 710, K4M 714                                  | 03/01 → 09/07 |           | VKMC 06020<br>VKMA 06020<br>VKM 16020<br>VKM 26020                | 1<br>1<br>1      | 1<br>1<br>1 | 1<br>1 |  |  | 1 |  | 2<br>2 | 1<br>1 |  |  |  |  |  |  | T0159 |       |
|                                   | K4M 716   | 02/05 → 09/07 |           | VKMA 06021<br>VKM 16021<br>VKM 26020                              | 1<br>1           | 1<br>1      | 1      |  |  |   |  | 2      | 1      |  |  |  |  |  |  |       | T0159 |
|                                   | K4M 710, K4M 714,<br>K4M 716                      | 03/01 → 09/07 |           | VKPC 86416  |                  |             |        |  |  | 1 |  |        |        |  |  |  |  |  |  |       |       |
|                                   | <b>B(Alt)</b> K4M 710, K4M 714                    | 03/01 → 09/07 | <b>AC</b> | VKMA 36091<br>VKMV 5PK1110<br>VKM 36091                           | 1<br>1           | 1<br>1      |        |  |  |   |  |        |        |  |  |  |  |  |  |       |       |
| <b>B(Alt)</b>                     | K4M 710, K4M 714                                  | 03/01 → 09/01 | <b>AC</b> | VKMV 6PK1750<br>VKM 36031<br>VKM 36031                            |                  |             | 1<br>1 |  |  |   |  |        |        |  |  |  |  |  |  |       |       |
| <b>B(Alt)</b>                     | K4M 710, K4M 714                                  | 09/01 → 09/07 | <b>AC</b> | VKMA 36020<br>VKM 36031<br>VKM 36031                              |                  | 2<br>1<br>1 | 1      |  |  |   |  |        |        |  |  |  |  |  |  |       |       |
| <b>B(Alt)</b>                     | K4M 716   | 02/05 → 12/07 |           | VKMV 6PK1815<br>VKM 36031<br>VKM 36031                            |                  |             | 1<br>1 |  |  | 1 |  |        |        |  |  |  |  |  |  |       |       |
| <b>RENAULT  LAGUNA II 1.8 16V</b> |   |               |           |   |                  |             |        |  |  |   |  |        |        |  |  |  |  |  |  |       |       |
|                                   | F4P 770, F4P 771,<br>F4P 772, F4P 774,<br>F4P 775 | 03/01 → 12/07 |           | VKMC 06106<br>VKMA 06106<br>VKM 16550<br>VKM 26105                | 1<br>1<br>1      | 1<br>1<br>1 | 1<br>1 |  |  | 1 |  | 2<br>2 |        |  |  |  |  |  |  | T0177 |       |
|                                   | F4P 770, F4P 771,<br>F4P 772, F4P 775             | 03/01 → 03/01 |           | VKMA 06104<br>VKM 16550<br>VKM 26020                              | 1<br>1           | 1<br>1      | 1      |  |  |   |  | 2      |        |  |  |  |  |  |  |       | T0177 |
|                                   | F4P 770, F4P 771,<br>F4P 772, F4P 774,<br>F4P 775 | 03/01 → 09/07 |           | VKPC 85304  |                  |             |        |  |  | 1 |  |        |        |  |  |  |  |  |  |       |       |

|   |  |  |    |  |  |  |  |  |  |  |  |
|---|---|---|---|--|---|---|---|---|---|---|---|
|    | <b>B(Alt)</b> F4P 770, F4P 771, F4P 772   | 03/01 → 12/07   |   | VKM 36030<br>VKM 36038   | 1   | 1   |   |   |   |   |   |
|   | <b>B(Alt)</b> F4P 774, F4P 775  | 03/01 → 12/07   |   | VKMA 36038<br>VKMV 6PK1792<br>VKM 36030<br>VKM 36038                               | 1   | 1   | 1   | 1   |   |   |   |
| <b>RENAULT  LAGUNA II 2.0 16V</b>              |   |   |   |  |   |   |   |   |   |   |   |
|    | F4R 712, F4R 713, F4R 714, F4R 715  | 08/02 → 12/07   |    | VKMC 06106<br>VKMA 06106<br>VKM 16550<br>VKM 26105                                 | 1   | 1   | 1   | 1   | 2   | 2   | T0177   |
|    | F4R 712, F4R 713, F4R 714, F4R 715  | 08/02 → 12/07   |   | VKPC 85304   |   |   |   | 1   |   |   |   |
|    | <b>B(Alt)</b> F4R 712, F4R 713  | 08/02 → 12/07   |   | VKMA 36038<br>VKMV 6PK1792<br>VKM 36030<br>VKM 36038                               | 1   | 1   | 1   | 1   |   |   |   |
|   | <b>B(Alt)</b> F4R 714, F4R 715  | 08/02 → 09/07   |   | VKMV 7PK1792<br>VKM 36030<br>VKM 36038   | 1   | 1   | 1   |   |   |   |   |
| <b>RENAULT  LAGUNA II 2.0 16V IDE</b>          |   |   |   |  |   |   |   |   |   |   |   |
|    | F5R 700   | 04/01 → 04/01   |   | —<br>—<br>VKM 26020  | 1   | 1   | 1   |   |   |   | T0241   |
|   | F5R 700   | 04/01 → 12/07   |   | —<br>—<br>VKM 26105  | 1   | 1   | 1   |   |   |   | T0241   |
|    | F5R 700   | 04/01 → 12/07   |   | VKPC 85304   |   |   |   | 1   |   |   |   |
|    | <b>B(Alt)</b> F5R 700   | 04/01 → 12/07   |   | VKMA 36038<br>VKMV 6PK1792<br>VKM 36030<br>VKM 36038                               | 1   | 1   | 1   | 1   |   |   |   |
| <b>RENAULT  LAGUNA II 2.0 16V Turbo / GT</b> |   |   |   |  |   |   |   |   |   |   |   |
|    | F4R 764, F4R 765, F4R 784, F4R 786, F4R 787, F4R 886, F4R 887                     | 01/03 → 12/07   |  | VKMC 06106<br>VKMA 06106<br>VKM 16550<br>VKM 26105                                 | 1   | 1   | 1   | 1   | 2   | 2   | T0177   |
|    | F4R 764, F4R 765, F4R 784, F4R 786, F4R 787, F4R 886, F4R 887                     | 01/03 → 12/07   |   | VKPC 85304   |   |   |   | 1   |   |   |   |
|    | <b>B(Alt)</b> F4R 764, F4R 765  | 01/03 → 12/07   |   | VKMA 36038<br>VKMV 6PK1792<br>VKM 36030<br>VKM 36038                               | 1   | 1   | 1   | 1   |   |   |   |
|   | <b>B(Alt)</b> F4R 784, F4R 786, F4R 787, F4R 886, F4R 887                         | 01/05 → 09/07   |   | VKMV 7PK1792<br>VKM 36030<br>VKM 36038   | 1   | 1   | 1   |   |   |   |   |
| <b>RENAULT  LAGUNA II 3.0 V6</b>             |   |   |   |  |   |   |   |   |   |   |   |
|    | L7X 731, L7X 733  | 03/01 → 09/07   |   | VKMA 03902<br>VKM 13902<br>VKM 23900<br>VKM 23900<br>VKM 23901                     | 1   | 3   | 1   |   |   |   | T0204   |
|    | L7X 731, L7X 733  | 03/01 → 09/07   |   | —  |   |   |   | 1   |   |   |   |
|    | <b>B(Alt)</b> L7X 731   | 03/01 → 05/04   |   | VKMV 6PK1585<br>VKM 33075  | 1   | 1   | 1   |   |   |   |   |

























RENAULT

|  |  |  |  |  |  |  |  |  |  |  |  |  |
|--|---|---|---|--|---|---|---|---|---|---|---|---|
| <b>RENAULT  LAGUNA II 1.9 dCi</b>   |   |   |   |  |   |   |   |   |   |   |   |   |
|                                      | F9Q 650, F9Q 670,<br>F9Q 750, F9Q 752,<br>F9Q 754                                 | 03/01 → 09/07   |  | VKMC 06127<br>VKMA 06127<br>VKM 16113  | 1<br>1<br>1   | 1<br>1  | 1   |   |   |   |   | T0647   |
|  | F9Q 664, F9Q 674,<br>F9Q 758, F9Q 759   | 03/01 → 09/07   |   | VKMA 06129<br>VKM 16129  | 1<br>1  | 1   |   |   |   |   |   | T0208   |
|                                      | F9Q 650, F9Q 670,<br>F9Q 750, F9Q 752,<br>F9Q 754                                 | 03/01 → 09/07   |   | VKPC 85304   |   |   |   | 1   |   |   |   |   |
|  | F9Q 664, F9Q 674,<br>F9Q 758, F9Q 759   | 03/01 → 09/07   |   | VKPC 86129   |   |   |   | 1   |   |   |   |   |
|                                      | <b>B(Alt)</b> F9Q 650, F9Q 750,<br>F9Q 754  | 03/02 → 09/07   |   | VKMA 36038<br>VKMV 6PK1792<br>VKM 36030<br>VKM 36038                               | 1<br>1  | 1<br>1  | 1   |   |   |   |   |   |
|  | <b>B(Alt)</b> F9Q 664, F9Q 670,<br>F9Q 674, F9Q 758,<br>F9Q 759                   | 03/01 → 09/07   |   | VKMV 7PK1792<br>VKM 36030<br>VKM 36038   | 1   | 1   |   |   |   |   |   |   |
|  | <b>B(Alt)</b> F9Q 750, F9Q 754  | 03/01 → 03/02   |   | VKMA 36033<br>VKMV 6PK1792<br>VKM 36030<br>VKM 36031                               | 1<br>1  | 1<br>1  | 1   |   |   |   |   |   |
|  | <b>B(Alt)</b> F9Q 752   | 06/01 → 09/07   | <b>AC</b>   | VKMV 5PK1125   |   |   | 1   |   |   |   |   |   |
|  | <b>B(Alt)</b> F9Q 752   | 06/01 → 03/02   | <b>AC</b>   | VKMA 36033<br>VKMV 6PK1792<br>VKM 36030<br>VKM 36031                               | 1<br>1  | 1<br>1  | 1   |   |   |   |   |   |
|  | <b>B(Alt)</b> F9Q 752   | 03/02 → 09/07   | <b>AC</b>   | VKMA 36038<br>VKMV 6PK1792<br>VKM 36030<br>VKM 36038                               | 1<br>1  | 1<br>1  | 1   |   |   |   |   |   |
|                                    | F9Q 750, F9Q 752,<br>F9Q 754  | 03/01 → 09/07   | <b>AC</b>   | —  |   |   |   | 1   |   |   |   |   |
|  | F9Q 750, F9Q 752,<br>F9Q 754  | 03/01 → 09/07   | <b>AC</b>   | —  |   |   |   | 1   |   |   |   |   |
| <b>RENAULT  LAGUNA II 2.0 dCi</b> |   |   |   |  |   |   |   |   |   |   |   |   |
|                                    | M9R 740, M9R 760  | 08/05 → 09/07   |   | <b>OXOXOXO</b>   |   |   |   |   |   |   |   |   |
|                                    | M9R 740, M9R 760  | 08/05 → 09/07   |   | VKPC _____   |   |   |   | 1   |   |   |   |   |
|                                    | <b>B(Alt)</b> M9R 740, M9R 760  | 08/05 → 09/07   |   | VKMV 7PK1970<br>VKM _____<br>VKM _____   | 1   | 1   |   |   |   |   |   | 1   |
| <b>RENAULT  LAGUNA II 2.2 dCi</b> |   |   |   |  |   |   |   |   |   |   |   |   |
|                                    | G9T 600, G9T 605,<br>G9T 702, G9T 703,<br>G9T 706, G9T 707                        | 10/01 → 09/07   |   | VKMA 06503<br>VKM 16503<br>VKM 26503   | 1<br>1  | 1<br>1  | 1   |   |   |   |   | 1 T0187   |
|                                    | G9T 600, G9T 605,<br>G9T 702, G9T 703,<br>G9T 706, G9T 707                        | 10/01 → 09/07   |   | VKPC 86305   |   |   |   | 1   |   |   |   |   |
|                                    | <b>B(Alt)</b> G9T 600, G9T 605,<br>G9T 702, G9T 703,<br>G9T 706, G9T 707          | 10/01 → 09/07   |   | VKMA 36040<br>VKMV 6PK1778<br>VKM 36040<br>VKM 36040                               |   | 2<br>1<br>1   | 1<br>1  |   |   |   |   |   |
|                                    | G9T 702, G9T 703,<br>G9T 706, G9T 707   | 10/01 → 09/07   |   | —  |   |   |   | 1   |   |   |   |   |

| <b>RENAULT</b> <b>LAGUNA III 2.0 16V Turbo</b> |   |               |    |              |   |   |   |  |   |  |   |   |   |       |
|--|---|---------------|----|--------------|---|---|---|--|---|--|---|---|---|-------|
|  | F4R 811                                     | 10/07 → 01/08 |    | VKMC 06106   | 1 | 1 | 1 |  | 1 |  | 2 |   |   |       |
|  |   |               |    | VKMA 06106   | 1 | 1 | 1 |  |   |  | 2 |   |   | T0177 |
|  |   |               |    | VKM 16550    | 1 |   |   |  |   |  |   |   |   |       |
|  |   |               |    | VKM 26105    |   | 1 |   |  |   |  |   |   |   |       |
|  | F4R 811                                     | 10/07 → 01/08 |    | VKPC 85304   |   |   |   |  | 1 |  |   |   |   |       |
| <b>RENAULT</b> <b>LAGUNA III 1.5 dCi</b>       |   |               |    |              |   |   |   |  |   |  |   |   |   |       |
|  | K9K 780                                     | 10/07 → 01/08 |    | VKMA 06132   | 1 |   | 1 |  |   |  |   |   | 1 | T0191 |
|  |   |               |    | VKM 16102    | 1 |   |   |  |   |  |   |   |   |       |
| <b>RENAULT</b> <b>MEGANE I 1.4</b>             |   |               |    |              |   |   |   |  |   |  |   |   |   |       |
|  | E7J 626                                     | 01/96 → 08/03 |    | VKMC 06005   | 1 |   | 1 |  | 1 |  |   |   |   | T0145 |
|  |   |               |    | VKMA 06003   | 1 |   | 1 |  |   |  |   |   |   |       |
|  |   |               |    | VKM 16003    | 1 |   |   |  |   |  |   |   |   |       |
|  | E7J 624, E7J 764                            | 01/96 → 08/03 | 3) | VKMS 06000   | 1 |   | 1 |  |   |  | 2 |   |   | T0061 |
|  |   |               |    | VKMA 06000   | 1 |   | 1 |  |   |  |   |   |   |       |
|  |   |               |    | VKM 16000    | 1 |   |   |  |   |  |   |   |   |       |
|  | E7J 624, E7J 626, E7J 764                   | 01/96 → 08/03 |    | VKPC 86216   |   |   |   |  | 1 |  |   |   |   |       |
|  | B(Alt) E7J 624, E7J 764                     | 01/96 → 08/03 |    | VKMV 3PK712  |   |   | 1 |  |   |  |   |   |   |       |
|  | B(Alt) E7J 626                              | 01/96 → 08/03 | AC | VKMA 36091   | 1 |   | 1 |  |   |  |   |   |   |       |
|  |   |               |    | VKMA 5PK1110 |   |   | 1 |  |   |  |   |   |   |       |
|  |   |               |    | VKM 36091    | 1 |   |   |  |   |  |   |   |   |       |
|  | B(Alt) E7J 626                              | 01/96 → 08/03 | AC | VKMA 6PK1750 |   |   | 1 |  |   |  |   |   |   |       |
|  |   |               |    | VKM 36031    |   | 1 |   |  |   |  |   |   |   |       |
|  |   |               |    | VKM 36031    |   | 1 |   |  |   |  |   |   |   |       |
|  | B(PS) E7J 764                               | 01/96 → 08/03 | AC | VKMA 3PK835  |   |   | 1 |  |   |  |   |   |   |       |
|  | B(PS) E7J 764                               | 01/96 → 06/96 | AC | VKMA 36010   | 1 |   | 1 |  |   |  |   |   |   |       |
|  |   |               |    | VKMA 5PK1260 |   |   | 1 |  |   |  |   |   |   |       |
|  |   |               |    | VKM 36010    | 1 |   |   |  |   |  |   |   |   |       |
|  | B(PS) E7J 764                               | 06/96 → 06/97 | AC | VKMA 36005   | 1 |   | 1 |  |   |  |   |   |   |       |
|  |   |               |    | VKMA _____   |   |   | 1 |  |   |  |   |   |   |       |
|  |   |               |    | VKM 36005    | 1 |   |   |  |   |  |   |   |   |       |
|  | B(PS) E7J 626, E7J 764                      | 07/97 → 08/03 | AC | VKMA 4PK1272 |   |   | 1 |  |   |  |   |   |   |       |
|  |   |               |    | VKM _____    | 1 |   |   |  |   |  |   |   |   |       |
| <b>RENAULT</b> <b>MEGANE I 1.4 16V</b>         |   |               |    |              |   |   |   |  |   |  |   |   |   |       |
|  | K4J 714, K4J 750                            | 03/99 → 08/03 |    | VKMC 06020   | 1 | 1 | 1 |  | 1 |  | 2 | 1 |   | T0159 |
|  |   |               |    | VKMA 06020   | 1 | 1 | 1 |  |   |  | 2 | 1 |   |       |
|  |   |               |    | VKM 16020    | 1 |   |   |  |   |  |   |   |   |       |
|  |   |               |    | VKM 26020    |   | 1 |   |  |   |  |   |   |   |       |
|  | K4J 714, K4J 750                            | 03/99 → 08/03 |    | VKPC 86416   |   |   |   |  | 1 |  |   |   |   |       |
|  | B(Alt) K4J 714, K4J 750                     | 03/99 → 08/03 | AC | VKMA 36091   | 1 |   | 1 |  |   |  |   |   |   |       |
|  |   |               |    | VKMA 5PK1110 |   |   | 1 |  |   |  |   |   |   |       |
|  |   |               |    | VKM 36091    | 1 |   |   |  |   |  |   |   |   |       |
|  | B(Alt) K4J 714, K4J 750                     | 03/99 → 09/01 | AC | VKMA 6PK1750 |   |   | 1 |  |   |  |   |   |   |       |
|  |   |               |    | VKM 36031    |   | 1 |   |  |   |  |   |   |   |       |
|  |   |               |    | VKM 36031    |   | 1 |   |  |   |  |   |   |   |       |
|  | B(Alt) K4J 714, K4J 750                     | 09/01 → 08/03 | AC | VKMA 36020   |   | 2 | 1 |  |   |  |   |   |   |       |
|  |   |               |    | VKM 36031    |   | 1 |   |  |   |  |   |   |   |       |
|  |   |               |    | VKM 36031    |   | 1 |   |  |   |  |   |   |   |       |
| <b>RENAULT</b> <b>MEGANE I 1.6</b>             |   |               |    |              |   |   |   |  |   |  |   |   |   |       |
|  | K7M 702, K7M 703, K7M 790                   | 01/96 → 08/03 |    | VKMC 06415   | 1 |   | 1 |  | 1 |  |   |   |   | T0061 |
|  |   |               |    | VKMA 06000   | 1 |   | 1 |  |   |  |   |   |   |       |
|  |   |               |    | VKM 16000    | 1 |   |   |  |   |  |   |   |   |       |
|  | K7M 704, K7M 720                            | 01/96 → 03/99 |    | VKMC 06003   | 1 |   | 1 |  | 1 |  |   |   |   | T0145 |
|  |   |               |    | VKMA 06003   | 1 |   | 1 |  |   |  |   |   |   |       |
|  |   |               |    | VKM 16003    | 1 |   |   |  |   |  |   |   |   |       |
|  | K7M 702, K7M 703, K7M 790                   | 01/96 → 08/03 | 3) | VKMS 06000   | 1 |   | 1 |  |   |  | 2 |   |   | T0061 |
|  |   |               |    | VKMA 06000   | 1 |   | 1 |  |   |  |   |   |   |       |
|  |   |               |    | VKM 16000    | 1 |   |   |  |   |  |   |   |   |       |
|  | K7M 702, K7M 703, K7M 704, K7M 720, K7M 790 | 01/96 → 08/03 |    | VKPC 86415   |   |   |   |  | 1 |  |   |   |   |       |





|   |  |  |   |  |  |  |  |  |  |  |  |  |
|---|---|---|--|--|---|---|---|---|---|---|---|---|
|  <b>B(Alt)</b>                      | K7M 702, K7M 703,<br>K7M 720, K7M 790   | 01/96 → 08/03   |  | VKMV 3PK712  |   | 1   |   |   |   |   |   |   |
| <b>B(Alt)</b>   | K7M 704   | 01/96 → 03/99   | AC   | VKMA 36091<br>VKMV 5PK1110<br>VKM 36091  | 1   | 1   |   |   |   |   |   |   |
| <b>B(Alt)</b>   | K7M 704   | 01/96 → 03/99   | AC   | VKMV 6PK1750<br>VKM 36031<br>VKM 36031   |   | 1   |   |   |   |   |   |   |
| <b>B(PS)</b>  | K7M 702, K7M 703,<br>K7M 720, K7M 790   | 01/96 → 08/03   | AC   | VKMV 3PK835  |   | 1   |   |   |   |   |   |   |
| <b>B(PS)</b>  | K7M 702, K7M 703,<br>K7M 720, K7M 790   | 01/96 → 06/96   | AC   | VKMA 36010<br>VKMV 5PK1260<br>VKM 36010  | 1   | 1   |   |   |   |   |   |   |
| <b>B(PS)</b>  | K7M 702, K7M 703,<br>K7M 720, K7M 790   | 06/96 → 06/97   | AC   | VKMA 36005<br>VKMV____<br>VKM 36005  | 1   | 1   |   |   |   |   |   |   |
| <b>B(PS)</b>  | K7M 702, K7M 703,<br>K7M 720, K7M 790   | 07/97 → 08/03   | AC   | VKMV 4PK1272<br>VKM____  | 1   | 1   |   |   |   |   |   |   |
| <b>RENAULT  MEGANE I 1.6 16V</b>   |   |   |  |  |   |   |   |   |   |   |   |   |
|  <b>B(Alt)</b>                      | K4M 700, K4M 701,<br>K4M 704, K4M 706,<br>K4M 708, K4M 709,<br>K4M 712            | 03/99 → 08/03   |  | VKMC 06020<br>VKMA 06020<br>VKM 16020<br>VKM 26020                                 | 1   | 1   | 1   | 1   |   | 2   | 1   | T0159   |
|                                   | K4M 700, K4M 701,<br>K4M 704, K4M 706,<br>K4M 708, K4M 709,<br>K4M 712            | 03/99 → 08/03   |  | VKPC 86416   |   |   |   | 1   |   |   |   |   |
|  <b>B(Alt)</b>                    | K4M 700, K4M 701,<br>K4M 704, K4M 706,<br>K4M 708, K4M 709,<br>K4M 712            | 03/99 → 08/03   | AC   | VKMA 36091<br>VKMV 5PK1110<br>VKM 36091  | 1   | 1   |   |   |   |   |   |   |
| <b>B(Alt)</b>   | K4M 700, K4M 701,<br>K4M 704, K4M 706,<br>K4M 708, K4M 709,<br>K4M 712            | 03/99 → 09/01   | AC   | VKMV 6PK1750<br>VKM 36031<br>VKM 36031   |   | 1   |   |   |   |   |   |   |
| <b>B(Alt)</b>   | K4M 700, K4M 701,<br>K4M 704, K4M 706,<br>K4M 708, K4M 709,<br>K4M 712            | 09/01 → 08/03   | AC   | VKMA 36020<br>VKM 36031<br>VKM 36031   |   | 2   | 1   |   |   |   |   |   |
| <b>RENAULT  MEGANE I 1.8 16V</b> |   |   |  |  |   |   |   |   |   |   |   |   |
|                                   | F4P 720, F4P 722  | 01/01 → 04/01   |  | VKMA 06107<br>VKM 16550<br>VKM 26020<br>VKM 26310                                  | 1   | 2   | 1   |   |   | 2   |   | T0161   |
|   | F4P 720, F4P 722  | 04/01 → 08/03   |  | VKMA 06108<br>VKM 16550<br>VKM 26105<br>VKM 26310                                  | 1   | 2   | 1   |   |   | 2   |   | T0161   |
|                                   | F4P 720, F4P 722  | 01/01 → 08/03   |  | VKPC 86413   |   |   |   | 1   |   |   |   |   |
|  <b>B(Alt)</b>                    | F4P 720, F4P 722  | 01/01 → 08/03   |  | VKMA 36020<br>VKM 36031<br>VKM 36031   |   | 2   | 1   |   |   |   |   |   |

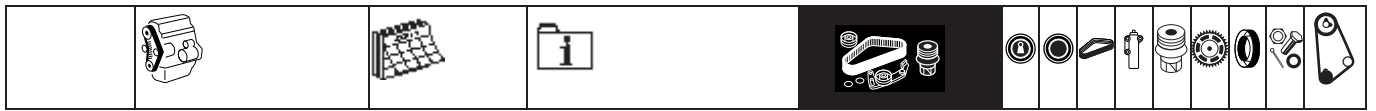









**RENAULT  MEGANE I 2.0**

|   |  |               |           |   |        |        |   |  |  |  |  |        |        |  |  |  |  |       |
|---|--|---------------|-----------|---|--------|--------|---|--|--|--|--|--------|--------|--|--|--|--|-------|
|  | F3R 750, F3R 751,<br>F3R 752, F3R 791,<br>F3R 796, F3R 797,<br>F3R 798               | 01/96 → 08/03 |           | VKMA 06103<br>VKM 16101<br>VKM 26101              | 1<br>1 | 1<br>1 | 1 |  |  |  |  |        |        |  |  |  |  | T0108 |
|   | F3R 791, F3R 796,<br>F3R 797, F3R 798  | 03/99 → 08/03 | <b>p</b>  | VKMA 06123<br>VKM 16101<br>VKM 26101<br>VKM 26123 | 1<br>1 | 2<br>1 | 1 |  |  |  |  |        |        |  |  |  |  | T0655 |
|  | F3R 750, F3R 751,<br>F3R 752, F3R 791,<br>F3R 796, F3R 797,<br>F3R 798               | 01/96 → 08/03 |           | VKPC 86413  |        |        |   |  |  |  |  | 1      |        |  |  |  |  |       |
|  | <b>B(Alt)</b> F3R 750, F3R 751,<br>F3R 791, F3R 796,<br>F3R 797, F3R 798             | 01/96 → 08/03 | <b>AC</b> | VKMV 6PK1125                                      |        |        |   |  |  |  |  | 1      |        |  |  |  |  |       |
|   | <b>B(Alt)</b> F3R 750, F3R 751,<br>F3R 752, F3R 791,<br>F3R 796, F3R 797,<br>F3R 798 | 01/96 → 08/03 | <b>AC</b> | VKMA 36006<br>VKMV 6PK1658<br>VKM 36006           |        |        |   |  |  |  |  | 1<br>1 | 1<br>1 |  |  |  |  |       |

**RENAULT  MEGANE I 2.0 16V**

|   |  |               |           |   |        |        |             |   |  |  |  |  |   |   |  |  |   |       |
|---|--|---------------|-----------|---|--------|--------|-------------|---|--|--|--|--|---|---|--|--|---|-------|
|   | F4R 740, F4R 741   | 03/99 → 05/99 |           | VKMA 06109<br>VKM 16550<br>VKM 26310<br>VKM 26310 | 1<br>1 | 2<br>1 | 1<br>1      |   |  |  |  |  |   | 2 |  |  |   | T0161 |
|   | F4R 740, F4R 741,<br>F4R 747                               | 06/99 → 04/01 |           | VKMA 06107<br>VKM 16550<br>VKM 26020<br>VKM 26310 | 1<br>1 | 2<br>1 | 1<br>1      |   |  |  |  |  |   | 2 |  |  |   | T0161 |
|   | F4R 740, F4R 741,<br>F4R 746, F4R 747                      | 04/01 → 08/03 |           | VKMA 06108<br>VKM 16550<br>VKM 26105<br>VKM 26310 | 1<br>1 | 2<br>1 | 1<br>1      |   |  |  |  |  |   | 2 |  |  |   | T0161 |
|   | F7R 710, F7R 714   | 03/96 → 08/03 |           | VKMA 06112<br>VKM 16112<br>VKM 26102              | 1<br>1 | 1<br>1 | 1           |   |  |  |  |  |   |   |  |  |   | T0076 |
|   | F7R 714  | 03/96 → 08/03 | <b>p</b>  | VKMA 06122<br>VKM 16112<br>VKM 26102<br>VKM 26125 | 1<br>1 | 2<br>1 | 1<br>1      |   |  |  |  |  |   |   |  |  |   | T0651 |
|  | F4R 740, F4R 741,<br>F4R 746, F4R 747,<br>F7R 710, F7R 714 | 03/96 → 08/03 |           | VKPC 86413  |        |        |             |   |  |  |  |  | 1 |   |  |  |   |       |
|  | <b>B(Alt)</b> F4R 740, F4R 741,<br>F4R 746, F4R 747        | 03/99 → 08/03 |           | VKMA 36020<br>VKM 36031<br>VKM 36031              |        |        | 2<br>1<br>1 | 1 |  |  |  |  |   |   |  |  |   |       |
|   | <b>B(Alt)</b> F7R 710, F7R 714                             | 03/96 → 08/03 | <b>AC</b> | VKMV 6PK1637<br>VKM 36016<br>VKM 36075            | 1      | 1      | 1           |   |  |  |  |  |   |   |  |  | 1 |       |









**RENAULT  MEGANE I 2.0 16V IDE**







|   |                       |               |  |  |        |        |             |   |  |  |  |  |   |  |  |  |  |       |
|---|-----------------------|---------------|--|--|--------|--------|-------------|---|--|--|--|--|---|--|--|--|--|-------|
|  | F5R 740               | 11/99 → 08/03 |  | —<br>VKM 26310<br>VKM 26310<br>VKM 26310 | 1<br>1 | 3<br>1 | 1<br>1<br>1 |   |  |  |  |  |   |  |  |  |  | T0239 |
|  | F5R 740               | 11/99 → 08/03 |  | VKPC 86413                               |        |        |             |   |  |  |  |  | 1 |  |  |  |  |       |
|  | <b>B(Alt)</b> F5R 740 | 11/99 → 08/03 |  | VKMA 36020<br>VKM 36031<br>VKM 36031     |        |        | 2<br>1<br>1 | 1 |  |  |  |  |   |  |  |  |  |       |























RENAULT



























| RENAULT  |   | MEGANE I 1.9 D |   |  |             |             |        |  |  |  |  |   |   |  |       |
|---|---|----------------|---|--|-------------|-------------|--------|--|--|--|--|---|---|--|-------|
|           | F8Q 620   | 01/96 → 09/96  | 3), <b>B</b> (58153x25.4),<br> 153     | VKMS 06111-1<br>VKMA 06111<br>VKM 16101<br>VKM 26101 | 1<br>1<br>1 | 1<br>1<br>1 | 1<br>1 |  |  |  |  |   | 3 |  | T0066 |
|   | F8Q 620   | 09/96 → 08/03  | 3), <b>B</b> (76153x25.4 HSN),<br> 153 | VKMS 06114-1<br>VKMA 06114<br>VKM 16101<br>VKM 26101 | 1<br>1<br>1 | 1<br>1<br>1 | 1<br>1 |  |  |  |  |   | 3 |  | T0147 |
|   | F8Q 622, F8Q 624,<br>F8Q 790                        | 01/96 → 08/03  | 3), <b>B</b> (76153x25.4 HSN),<br> 153 | VKMS 06114-2<br>VKMA 06114<br>VKM 16101<br>VKM 26101 | 1<br>1<br>1 | 1<br>1<br>1 | 1<br>1 |  |  |  |  |   | 2 |  | T0147 |
|   | F8Q 622, F8Q 624,<br>F8Q 790                        | 01/96 → 08/03  | <b>P, B</b> (76153x25.4 HSN),<br> 153  | VKMA 06124<br>VKM 16101<br>VKM 26101<br>VKM 26125    | 1<br>1      | 2<br>1<br>1 | 1<br>1 |  |  |  |  |   |   |  | T0147 |
|           | F8Q 620, F8Q 622,<br>F8Q 624, F8Q 790               | 01/96 → 08/03  |   | VKPC 86413   |             |             |        |  |  |  |  | 1 |   |  |       |
|           | <b>B(Alt)</b> F8Q 620, F8Q 622,<br>F8Q 624, F8Q 790 | 01/96 → 08/03  | <b>AC</b>   | VKMA 36016<br>VKMV 6PK1640<br>VKM 36016<br>VKM 36018 | 1<br>1      | 1<br>1      | 1<br>1 |  |  |  |  |   |   |  | 1     |
|   | <b>B(Alt)</b> F8Q 620                               | 01/96 → 09/96  | <b>AC</b>   | VKMA 36016<br>VKMV 6PK1640<br>VKM 36016<br>VKM 36018 | 1           | 1           | 1      |  |  |  |  |   |   |  | 1     |
|   | <b>B(Alt)</b> F8Q 620, F8Q 622,<br>F8Q 624, F8Q 790 | 09/96 → 03/01  | <b>AC</b>   | VKMA 36032<br>VKMV 6PK1640<br>VKM 36016<br>VKM 36032 | 1<br>1      | 1<br>1      | 1<br>1 |  |  |  |  |   |   |  | 1     |
|   | <b>B(Alt)</b> F8Q 620, F8Q 624                      | 03/01 → 08/03  | <b>AC</b>   | VKMA 36034<br>VKMV 6PK1606<br>VKM 36016<br>VKM 36032 | 1<br>1      | 1<br>1      | 1<br>1 |  |  |  |  |   |   |  | 1     |
|   | <b>B(Alt)</b> F8Q 622, F8Q 790                      | 03/01 → 08/03  | <b>AC</b>   | VKMA 36035<br>VKMV 6PK1606<br>VKM 36016<br>VKM 36035 | 1<br>1      | 1<br>1      | 1<br>1 |  |  |  |  |   |   |  | 1     |
|         | F8Q 620, F8Q 622,<br>F8Q 624, F8Q 790               | 01/96 → 08/03  |   | VKM_____   |             |             |        |  |  |  |  | 1 |   |  |       |

































| RENAULT  |                  | MEGANE I 1.9 dT |   |  |             |             |        |  |  |  |  |   |   |  |       |
|---|------------------|-----------------|---|--|-------------|-------------|--------|--|--|--|--|---|---|--|-------|
|           | F8Q 784          | 01/96 → 09/96   | 3), <b>B</b> (58153x25.4),<br> 153     | VKMS 06111-1<br>VKMA 06111<br>VKM 16101<br>VKM 26101 | 1<br>1<br>1 | 1<br>1<br>1 | 1<br>1 |  |  |  |  |   | 3 |  | T0066 |
|   | F8Q 784          | 09/96 → 08/03   | 3), <b>B</b> (76153x25.4 HSN),<br> 153 | VKMS 06114-1<br>VKMA 06114<br>VKM 16101<br>VKM 26101 | 1<br>1<br>1 | 1<br>1<br>1 | 1<br>1 |  |  |  |  |   | 3 |  | T0147 |
|   | F8Q 786          | 01/96 → 08/03   | 3), <b>B</b> (76153x25.4 HSN),<br> 153 | VKMS 06114-2<br>VKMA 06114<br>VKM 16101<br>VKM 26101 | 1<br>1<br>1 | 1<br>1<br>1 | 1<br>1 |  |  |  |  |   | 2 |  | T0147 |
|   | F8Q 786          | 01/96 → 08/03   | <b>P, B</b> (76153x25.4 HSN),<br> 153  | VKMA 06124<br>VKM 16101<br>VKM 26101<br>VKM 26125    | 1<br>1      | 2<br>1<br>1 | 1<br>1 |  |  |  |  |   |   |  | T0147 |
|           | F8Q 784, F8Q 786 | 01/96 → 08/03   |   | VKPC 86413   |             |             |        |  |  |  |  | 1 |   |  |       |

|   |  |  |  |  |  |  |  |  |  |  |  |
|---|---|---|---|--|---|---|---|---|---|---|---|
|                                    | <b>B(Alt)</b> F8Q 784, F8Q 786  | 01/96 → 08/03   | <b>AC</b>   | VKMV 6PK1135   |   |   | 1   |   |   |   |   |
|   | <b>B(Alt)</b> F8Q 784   | 01/96 → 09/96   | <b>AC</b>   | VKMA 36016<br>VKMV 6PK1640<br>VKM 36016<br>VKM 36018                               | 1   | 1   | 1   |   |   |   | 1   |
|   | <b>B(Alt)</b> F8Q 784, F8Q 786  | 09/96 → 03/01   | <b>AC</b>   | VKMA 36032<br>VKMV 6PK1640<br>VKM 36016<br>VKM 36032                               | 1   | 1   | 1   |   |   |   | 1   |
|   | <b>B(Alt)</b> F8Q 784, F8Q 786  | 03/01 → 08/03   | <b>AC</b>   | VKMA 36034<br>VKMV 6PK1606<br>VKM 36016<br>VKM 36032                               | 1   | 1   | 1   |   |   |   | 1   |
|                                    | F8Q 784, F8Q 786  | 01/96 → 08/03   |   | VKM_____   |   |   |   |   | 1   |   |   |
| <b>RENAULT  MEGANE I 1.9 dTi</b>   |   |   |   |  |   |   |   |   |   |   |   |
|                                    | F9Q 734, F9Q 738,<br>F9Q 748  | 03/97 → 02/01   | 3)  | VKMS 06115<br>VKMA 06115<br>VKM 16101<br>VKM 26115                                 | 1   | 1   | 1   |   |   | 2   | T0148   |
|   | F9Q 734, F9Q 738,<br>F9Q 748  | 03/97 → 02/01   | <b>P</b>  | VKMA 06125<br>VKM 16101<br>VKM 26115<br>VKM 26125                                  | 1   | 2   | 1   |   |   |   | T0148   |
|   | F9Q 731, F9Q 744  | 03/97 → 08/03   | <b>c, P</b>   | VKMA 06137<br>VKM 16551<br>VKM 26117<br>VKM 26125<br>VKM 26128                     | 1   | 2   | 1   |   | 1   |   | T0181   |
|   | F9Q 731, F9Q 744  | 03/97 → 08/03   | <b>c</b>  | VKMA 06117<br>VKM 16551<br>VKM 26117<br>VKM 26128                                  | 1   | 1   | 1   |   | 1   |   | T0181   |
|   | F9Q 736   | 03/97 → 10/00   | 3)  | VKMS 06115<br>VKMA 06115<br>VKM 16101<br>VKM 26115                                 | 1   | 1   | 1   |   |   | 2   | T0148   |
|   | F9Q 736   | 03/97 → 10/00   | <b>P</b>  | VKMA 06125<br>VKM 16101<br>VKM 26115<br>VKM 26125                                  | 1   | 2   | 1   |   |   |   | T0148   |
|                                  | F9Q 730, F9Q 731,<br>F9Q 734, F9Q 736,<br>F9Q 744                                 | 03/97 → 08/03   |   | VKPC 86413   |   |   |   |   | 1   |   |   |
|                                  | <b>B(Alt)</b> F9Q 731, F9Q 734,<br>F9Q 736  | 03/97 → 02/01   | <b>AC</b>   | VKMV 6PK1135   |   |   | 1   |   |   |   |   |
|   | <b>B(Alt)</b> F9Q 730, F9Q 731,<br>F9Q 734, F9Q 736,<br>F9Q 744                   | 03/97 → 03/01   | <b>AC</b>   | VKMA 36032<br>VKMV 6PK1640<br>VKM 36016<br>VKM 36032                               | 1   | 1   | 1   |   |   |   | 1   |
|   | <b>B(Alt)</b> F9Q 744   | 03/01 → 08/03   | <b>AC</b>   | VKMA 36035<br>VKMV 6PK1606<br>VKM 36016<br>VKM 36035                               | 1   | 1   | 1   |   |   |   | 1   |
|                                  | F9Q 730, F9Q 731,<br>F9Q 734, F9Q 736,<br>F9Q 744                                 | 03/97 → 08/03   |   | VKM_____   |   |   |   |   | 1   |   |   |
| <b>RENAULT  MEGANE I 1.9 dCi</b> |   |   |   |  |   |   |   |   |   |   |   |
|                                  | F9Q 732, F9Q 733  | 02/01 → 08/03   | 3)  | VKMS 06115<br>VKMA 06115<br>VKM 16101<br>VKM 26115                                 | 1   | 1   | 1   |   |   | 2   | T0148   |
|   | F9Q 732, F9Q 733  | 02/01 → 08/03   | <b>P</b>  | VKMA 06125<br>VKM 16101  | 1   | 2   | 1   |   |   |   | T0148   |



































RENAULT







































|   |  |  |    |  |  |  |  |  |  |  |  |  |       |
|---|---|---|---|--|---|---|---|---|---|---|---|---|-------|
|   |   |   |   | VKM 26115<br>VKM 26125   | 1<br>1  |   |   |   |   |   |   |   |       |
|   | F9Q 732, F9Q 733  | 02/01 → 08/03   |   | VKPC 86413   |   |   | 1   |   |   |   |   |   |       |
|   | <b>B(Alt)</b> F9Q 732, F9Q 733  | 02/01 → 08/03   | <i>AC</i>   | VKMV 6PK1135   |   | 1   |   |   |   |   |   |   |       |
|   | <b>B(Alt)</b> F9Q 732   | 02/01 → 03/01   | <b>AC</b>   | VKMA 36032<br>VKMV 6PK1640<br>VKM 36016<br>VKM 36032                               | 1<br>1<br>1<br>1  | 1<br>1  | 1<br>1  |   |   |   | 1<br>1  |   |       |
|   | <b>B(Alt)</b> F9Q 732, F9Q 733,<br>F9Q 738  | 03/01 → 08/03   | <b>AC</b>   | VKMA 36035<br>VKMV 6PK1606<br>VKM 36016<br>VKM 36035                               | 1<br>1<br>1<br>1  | 1<br>1  | 1<br>1  |   |   |   | 1<br>1  |   |       |
|   | F9Q 732, F9Q 733  | 02/01 → 08/03   |   | VKM_____   |   |   |   |   | 1   |   |   |   |       |
| <b>RENAULT</b>  <b>MEGANE II 1.4 16V</b>   |   |   |   |  |   |   |   |   |   |   |   |   |       |
|   | K4J 730, K4J 732,<br>K4J 740  | 11/02 → 09/07   |    | VKMC 06020<br>VKMA 06020<br>VKM 16020<br>VKM 26020                                 | 1<br>1<br>1<br>1  | 1<br>1<br>1   | 1<br>1  |   | 1   |   | 2<br>2  | 1<br>1  | T0159 |
|   | K4J 730, K4J 732,<br>K4J 740  | 11/02 → 09/07   |   | VKPC 86416   |   |   |   |   | 1   |   |   |   |       |
|   | <b>B(Alt)</b> K4J 730, K4J 732,<br>K4J 740  | 11/02 → 05/06   | <i>AC</i>   | VKMA 36052<br>VKMV 5PK1135<br>VKM 36052<br>VKM 36053                               | 1<br>1<br>1<br>1  | 1<br>1  | 1<br>1  |   |   |   |   |   |       |
|   | <b>B(Alt)</b> K4J 730, K4J 732,<br>K4J 740  | 05/06 → 09/07   | <i>AC</i>   | VKMV 6PK1199<br>VKM 36053  |   | 1   | 1   |   |   |   |   |   |       |
|   | <b>B(Alt)</b> K4J 730, K4J 740  | 11/02 → 04/03   | <b>AC</b>   | VKMA 36050<br>VKMV 5PK1199<br>VKM 36050  | 1<br>1<br>1   | 1   | 1   |   |   |   |   |   |       |
|   | <b>B(Alt)</b> K4J 730, K4J 732,<br>K4J 740  | 04/03 → 04/05   | <b>AC</b>   | VKMV 5PK1199   |   |   | 1   |   |   |   |   |   |       |
|   | <b>B(Alt)</b> K4J 730, K4J 732,<br>K4J 740  | 04/05 → 09/07   | <b>AC</b>   | VKMV 6PK1199   |   |   | 1   |   |   |   |   |   |       |
| <b>RENAULT</b>  <b>MEGANE II 1.6 16V</b> |   |   |   |  |   |   |   |   |   |   |   |   |       |
|   | K4M 762, K4M 764,<br>K4M 768, K4M 788,<br>K4M 856                                 | 11/02 → 09/07   |  | VKMC 06020<br>VKMA 06020<br>VKM 16020<br>VKM 26020                                 | 1<br>1<br>1<br>1  | 1<br>1<br>1   | 1   |   | 1   |   | 2<br>2  | 1<br>1  | T0159 |
|   | K4M 760, K4M 761,<br>K4M 812, K4M 813   | 11/02 → 09/07   |   | VKMA 06021<br>VKM 16021<br>VKM 26020   | 1<br>1<br>1   | 1<br>1  | 1   |   |   |   | 2   | 1   | T0159 |
|   | K4M 760, K4M 761,<br>K4M 764, K4M 768,<br>K4M 788, K4M 812,<br>K4M 813, K4M 856   | 11/02 → 09/07   |   | VKPC 86416   |   |   |   |   | 1   |   |   |   |       |
|   | <b>B(Alt)</b> K4M 760, K4M 761,<br>K4M 812, K4M 813                               | 11/02 → 05/06   | <i>AC</i>   | VKMA 36052<br>VKMV 5PK1135<br>VKM 36052<br>VKM 36053                               | 1<br>1<br>1<br>1  | 1<br>1  | 1<br>1  |   |   |   |   |   |       |
|   | <b>B(Alt)</b> K4M 760, K4M 761,<br>K4M 812, K4M 813                               | 05/06 → 09/07   | <i>AC</i>   | VKMV 6PK1199<br>VKM 36053  |   | 1   | 1   |   |   |   |   |   |       |
|   | <b>B(Alt)</b> K4M 760, K4M 761  | 11/02 → 04/03   | <b>AC</b>   | VKMA 36050<br>VKMV 5PK1199<br>VKM 36050  | 1<br>1<br>1   | 1   | 1   |   |   |   |   |   |       |
|   | <b>B(Alt)</b> K4M 760, K4M 761  | 04/03 → 04/05   | <b>AC</b>   | VKMV 5PK1199   |   |   | 1   |   |   |   |   |   |       |

|  |  |  |  |  |  |  |  |  |  |  |  |  |
|--|---|---|---|--|---|---|---|---|---|---|---|---|
| <b>B(Alt)</b>  | K4M 760, K4M 761,<br>K4M 856  | 04/05 → 09/07   | AC  | VKMOV 6PK1199  |   | 1   |   |   |   |   |   |   |
| <b>B(Alt)</b>  | K4M 762, K4M 768,<br>K4M 788  | 11/02 → 09/07   |   | VKMOV 6PK1199  |   | 1   |   |   |   |   |   |   |
| <b>B(Alt)</b>  | K4M 764   | 11/02 → 04/05   |   | VKMOV 5PK1199  |   | 1   |   |   |   |   |   |   |
| <b>B(Alt)</b>  | K4M 764   | 04/05 → 09/07   |   | VKMOV 6PK1199  |   | 1   |   |   |   |   |   |   |
| <b>RENAULT  MEGANE II 2.0 16V</b>       |   |   |   |  |   |   |   |   |   |   |   |   |
|   | F4R 770, F4R 771  | 11/02 → 07/05   |  | VKMC 06106<br>VKMA 06106<br>VKM 16550<br>VKM 26105                                 | 1<br>1<br>1   | 1<br>1<br>1   | 1<br>1<br>1   | 1   | 2<br>2  |   |   | T0177   |
|   | F4R 770, F4R 771  | 11/02 → 09/07   |   | VKPC 85304   |   |   |   | 1   |   |   |   |   |
|   | <b>B(Alt)</b> F4R 770, F4R 771  | 11/02 → 09/07   |   | VKMA 36072<br>VKMV 7PK1127<br>VKM 36072  | 1<br>1  | 1<br>1  | 1<br>1  |   |   |   |   |   |
| <b>RENAULT  MEGANE II 2.0 16V Turbo</b> |   |   |   |  |   |   |   |   |   |   |   |   |
|   | F4R 774, F4R 776  | 05/04 → 09/07   |  | VKMC 06106<br>VKMA 06106<br>VKM 16550<br>VKM 26105                                 | 1<br>1<br>1   | 1<br>1<br>1   | 1<br>1<br>1   | 1   | 2<br>2  |   |   | T0177   |
|   | F4R 774, F4R 776  | 05/04 → 09/07   |   | VKPC 85304   |   |   |   | 1   |   |   |   |   |
|   | <b>B(Alt)</b> F4R 774, F4R 776  | 05/04 → 09/07   |   | VKMA 36072<br>VKMV 7PK1127<br>VKM 36072  | 1<br>1  | 1<br>1  | 1<br>1  |   |   |   |   |   |
| <b>RENAULT  MEGANE II 1.5 dCi</b>       |   |   |   |  |   |   |   |   |   |   |   |   |
|                                       | K9K 722   | 11/02 → 08/03   |   | VKMA 06130<br>VKM 16102  | 1<br>1  | 1   | 1   |   |   |   |   | 1 T0191   |
|  | K9K 722, K9K 724,<br>K9K 728, K9K 729,<br>K9K 732, K9K 734                        | 08/03 → 09/07   |   | VKMA 06132<br>VKM 16102  | 1<br>1  | 1   | 1   |   |   |   |   | 1 T0191   |
|                                       | K9K 722, K9K 728  | 11/02 → 04/04   |   | VKPC 86417   |   |   |   | 1   |   |   |   |   |
|  | K9K 722, K9K 724,<br>K9K 728, K9K 732   | 04/04 → 01/07   |   | VKPC_____  |   |   |   | 1   |   |   |   |   |
|                                       | <b>B(Alt)</b> K9K 722, K9K 724,<br>K9K 728, K9K 729,<br>K9K 732                   | 11/02 → 09/05   | AC  | VKMA 36052<br>VKMV 5PK1135<br>VKM 36052<br>VKM 36053                               | 1<br>1  | 1<br>1  | 1<br>1  |   |   |   |   |   |
| <b>B(Alt)</b>  | K9K 722, K9K 724,<br>K9K 728, K9K 729,<br>K9K 732, K9K 734                        | 09/05 → 09/07   | AC  | VKMOV 6PK1199<br>VKM 36053   |   | 1   | 1   |   |   |   |   |   |
| <b>B(Alt)</b>  | K9K 722, K9K 728,<br>K9K 729  | 11/02 → 01/05   | AC  | VKMA 36050<br>VKMV 5PK1199<br>VKM 36050  | 1<br>1  | 1<br>1  | 1<br>1  |   |   |   |   |   |
| <b>B(Alt)</b>  | K9K 722, K9K 724,<br>K9K 728, K9K 729,<br>K9K 732, K9K 734                        | 01/05 → 09/07   | AC  | VKMOV 6PK1199  |   |   | 1   |   |   |   |   |   |
| <b>RENAULT  MEGANE II 1.9 dCi</b>     |   |   |   |  |   |   |   |   |   |   |   |   |
|                                       | F9Q 800, F9Q 803,<br>F9Q 804, F9Q 808   | 11/02 → 09/07   |   | VKMA 06129<br>VKM 16129  | 1<br>1  | 1   | 1   |   |   |   |   | T0208   |
|                                       | F9Q 800, F9Q 803,<br>F9Q 804, F9Q 808   | 11/02 → 09/07   |   | VKPC 86129   |   |   |   | 1   |   |   |   |   |
|                                       | <b>B(Alt)</b> F9Q 800, F9Q 803,<br>F9Q 804, F9Q 808                               | 11/02 → 09/07   |   | VKMA 36072<br>VKMV 7PK1127<br>VKM 36072  | 1<br>1  | 1<br>1  | 1<br>1  |   |   |   |   |   |
| <b>RENAULT  MEGANE II 2.0 dCi</b>     |   |   |   |  |   |   |   |   |   |   |   |   |
|                                       | M9R 700, M9R 722,<br>M9R 724  | 09/05 → 09/07   |   | OXOXOXO  |   |   |   |   |   |   |   |   |



RENAULT



















































|   |     |  |  |  |  |  |  |  |  |  |  |  |  |  |
|---|--|---|---|--|---|---|---|---|---|---|---|---|---|---|
|   | M9R 700, M9R 722,<br>M9R 724   | 09/05 → 09/07   |   | VKPC_____  |   |   |   | 1   |   |   |   |   |   |   |
|   | <b>B(Alt)</b> M9R 700, M9R 722,<br>M9R 724   | 09/05 → 09/07   |   | VKMA_____<br>VKMV 7PK1705<br>VKM_____<br>VKM_____                                  | 1<br>1  | 1<br>1  | 1<br>1  |   |   |   |   |   | 1<br>1  |   |
| <b>RENAULT</b>  <b>MODUS 1.2 16V</b>   |  |   |   |  |   |   |   |   |   |   |   |   |   |   |
|   | D4F 740, D4F 764,<br>D4F 784   | 12/04 → 12/07   |   | VKMA 06002<br>VKM 16002  | 1<br>1  |   | 1   |   |   |   |   |   |   | T0190   |
|   | D4F 740, D4F 764,<br>D4F 784   | 12/04 → 12/07   |   | VKPC_____  |   |   |   | 1   |   |   |   |   |   |   |
|   | <b>B(Alt)</b> D4F 740  | 12/04 → 12/07   | <b>AC</b>   | VKMV 7PK880  |   |   | 1   |   |   |   |   |   |   |   |
|   | <b>B(Alt)</b> D4F 740  | 12/04 → 12/07   | <b>AC</b>   | VKMV 7PK1035   |   |   | 1   |   |   |   |   |   |   |   |
|   | <b>B(Alt)</b> D4F 764  | 05/05 → 12/07   |   | VKMV 7PK880  |   |   | 1   |   |   |   |   |   |   |   |
|   | <b>B(Alt)</b> D4F 784  | 05/07 → 12/07   |   | VKMV 7PK1035   |   |   | 1   |   |   |   |   |   |   |   |
| <b>RENAULT</b>  <b>MODUS 1.4 16V</b>   |  |   |   |  |   |   |   |   |   |   |   |   |   |   |
|   | K4J 770, K4J 780   | 12/04 → 12/07   |  | VKMC 06020<br>VKMA 06020<br>VKM 16020<br>VKM 26020                                 | 1<br>1<br>1   | 1<br>1  | 1<br>1  |   | 1   |   | 2<br>2  | 1<br>1  |   | T0159   |
|   | K4J 770, K4J 780   | 12/04 → 12/07   |   | VKPC 86416   |   |   |   |   | 1   |   |   |   |   |   |
|   | <b>B(Alt)</b> K4J 770, K4J 780   | 12/04 → 05/06   | <b>AC</b>   | VKMA 36052<br>VKMV 5PK1135<br>VKM 36052<br>VKM 36053                               | 1<br>1  | 1   | 1<br>1  |   |   |   |   |   |   |   |
|   | <b>B(Alt)</b> K4J 770, K4J 780   | 05/06 → 12/07   | <b>AC</b>   | VKMV 6PK1199<br>VKM 36053  |   |   | 1<br>1  |   |   |   |   |   |   |   |
|   | <b>B(Alt)</b> K4J 770, K4J 780   | 12/04 → 04/05   | <b>AC</b>   | VKMV 5PK1199   |   |   | 1   |   |   |   |   |   |   |   |
|   | <b>B(Alt)</b> K4J 770, K4J 780   | 04/05 → 12/07   | <b>AC</b>   | VKMV 6PK1199   |   |   | 1   |   |   |   |   |   |   |   |
| <b>RENAULT</b>  <b>MODUS 1.6 16V</b> |  |   |   |  |   |   |   |   |   |   |   |   |   |   |
|                                       | K4M 790, K4M 791,<br>K4M 794, K4M 800,<br>K4M 801                                    | 12/04 → 12/07   |   | VKMA 06021<br>VKM 16021<br>VKM 26020   | 1<br>1  | 1   | 1<br>1  |   |   |   | 2   | 1   |   | T0159   |
|                                       | K4M 790, K4M 791,<br>K4M 794, K4M 800,<br>K4M 801                                    | 12/04 → 12/07   |   | VKPC 86416   |   |   |   |   | 1   |   |   |   |   |   |
|                                       | <b>B(Alt)</b> K4M 790, K4M 791,<br>K4M 794, K4M 800,<br>K4M 801                      | 12/04 → 12/07   | <b>AC</b>   | VKMA 36052<br>VKMV 5PK1135<br>VKM 36052<br>VKM 36053                               | 1<br>1  | 1   | 1<br>1  |   |   |   |   |   |   |   |
|   | <b>B(Alt)</b> K4M 790, K4M 791,<br>K4M 794   | 12/04 → 12/07   | <b>AC</b>   | VKMA 36050<br>VKMV 5PK1199<br>VKM 36050  | 1<br>1  |   | 1<br>1  |   |   |   |   |   |   |   |
| <b>RENAULT</b>  <b>MODUS 1.5 dCi</b> |  |   |   |  |   |   |   |   |   |   |   |   |   |   |
|                                       | K9K 750, K9K 752,<br>K9K 760, K9K 762,<br>K9K 764, K9K 766,<br>K9K 768, K9K 772      | 12/04 → 12/07   |   | VKMA 06132<br>VKM 16102  | 1<br>1  |   | 1   |   |   |   |   |   | 1   | T0191   |
|                                       | K9K 750, K9K 752,<br>K9K 760, K9K 762,<br>K9K 764                                    | 12/04 → 12/07   |   | VKPC_____  |   |   |   |   | 1   |   |   |   |   |   |
|                                       | <b>B(Alt)</b> K9K 750, K9K 752,<br>K9K 760, K9K 762,<br>K9K 764, K9K 766,<br>K9K 768 | 12/04 → 09/05   | <b>AC</b>   | VKMA 36052<br>VKMV 5PK1135   | 1   | 1   | 1<br>1  |   |   |   |   |   |   |   |

|  |                     |  |                                    |  |  |  |  |  |  |  |  |  |  |
|--|--|---|---|--|---|---|---|---|---|---|---|---|---|
|  |  |   |   | VKM 36052<br>VKM 36053   | 1   | 1   |   |   |   |   |   |   |   |
| <b>B(Alt)</b>  | K9K 750, K9K 752,<br>K9K 760, K9K 762  | 12/04 → 01/05   | AC  | VKMA 36050<br>VKMV 5PK1199<br>VKM 36050  | 1   | 1   | 1   |   |   |   |   |   |   |
| <b>B(Alt)</b>  | K9K 750, K9K 752,<br>K9K 760, K9K 762  | 01/05 → 12/07   | AC  | VKMV 6PK1199   |   | 1   |   |   |   |   |   |   |   |
| <b>RENAULT  R10 1.1</b>         |  |   |   |  |   |   |   |   |   |   |   |   |   |
|                                 | 688  | 05/66 → 10/72   |   | VKPC 86203   |   |   |   | 1   |   |   |   |   |   |
| <b>RENAULT  R10 1.3</b>         |  |   |   |  |   |   |   |   |   |   |   |   |   |
|                                 | 810  | 07/69 → 10/72   |   | VKPC 86203   |   |   |   | 1   |   |   |   |   |   |
| <b>RENAULT  R11 1.1</b>         |  |   |   |  |   |   |   |   |   |   |   |   |   |
|                                 | C1E 715, C1E 720   | 03/83 → 06/86   |   | OKOKOKO  |   |   |   |   |   |   |   |   |   |
|                                 | C1E 715, C1E 720   | 03/83 → 06/86   | 2)  | VKPA 86206<br>VKPC 86206   |   |   |   | 1   | 1   |   |   |   |   |
|                                 | <b>B(Alt)</b> C1E 715, C1E 720   | 03/83 → 06/86   |   | VKMV 10AVx1140   |   |   | 1   |   |   |   |   |   |   |
| <b>RENAULT  R11 1.2</b>         |  |   |   |  |   |   |   |   |   |   |   |   |   |
|                                 | C1G 700, C1G 710   | 10/84 → 12/88   |   | OKOKOKO  |   |   |   |   |   |   |   |   |   |
|                                 | C1G 700, C1G 710   | 10/84 → 12/88   | 2)  | VKPA 86206<br>VKPC 86206   |   |   |   | 1   | 1   |   |   |   |   |
|                                 | <b>B(Alt)</b> C1G 700, C1G 710   | 10/84 → 12/88   |   | VKMV 10AVx1140   |   |   | 1   |   |   |   |   |   |   |
| <b>RENAULT  R11 1.4</b>         |  |   |   |  |   |   |   |   |   |   |   |   |   |
|                                | C1J, C2J   | 03/83 → 12/88   |   | OKOKOKO  |   |   |   |   |   |   |   |   |   |
|                               | C1J 715, C2J 717,<br>C2J 718, C2J 720,<br>C2J 730, C2J 755,<br>C2J 757, C2J 766,<br>C2J 767, C2J 768 | 03/83 → 12/88   | 2)  | VKPA 86206<br>VKPC 86206   |   |   |   | 1   | 1   |   |   |   |   |
|                               | <b>B(Alt)</b> C1J 715, C2J 730   | 03/83 → 12/88   | AC  | VKMV 10AVx1140   |   |   | 1   |   |   |   |   |   |   |
| <b>RENAULT  R11 1.4 Turbo</b> |  |   |   |  |   |   |   |   |   |   |   |   |   |
|                               | C1J  | 04/84 → 12/88   |   | OKOKOKO  |   |   |   |   |   |   |   |   |   |
|                               | C1J 760, C1J 764,<br>C1J 770, C1J 782  | 04/84 → 12/88   | 2)  | VKPA 86206<br>VKPC 86206   |   |   |   | 1   | 1   |   |   |   |   |
| <b>RENAULT  R11 1.7</b>       |  |   |   |  |   |   |   |   |   |   |   |   |   |
|                               | F2N 700, F2N 704,<br>F2N 708, F2N 710,<br>F2N 730, F2N 732,<br>F2N 742, F2N 798,<br>F3N 708, F3N 718 | 10/83 → 01/88   |  124, <b>B</b> (58124x19)        | VKMA 06100<br>VKM 16100<br>VKM 26100   | 1<br>1  | 1<br>1  | 1   |   |   |   |   |   | T0023   |
|  | F2N 708, F2N 710,<br>F2N 730, F2N 732,<br>F2N 742, F2N 798,<br>F3N 708, F3N 718                      | 02/88 → 12/88   |  125,<br><b>B</b> (58125x19 HSN) | VKMA 06101<br>VKM 16101<br>VKM 26101   | 1<br>1  | 1<br>1  | 1   |   |   |   |   |   | T0046   |
|                               | F2N 700, F2N 704,<br>F2N 708, F2N 710,<br>F2N 730, F2N 732,<br>F2N 742, F2N 798,<br>F3N 708, F3N 718 | 10/83 → 12/88   |   | VKPC 86413   |   |   |   | 1   |   |   |   |   |   |
|                               | <b>B(Alt)</b> F2N 700  | 10/83 → 12/87   | AC, Ø,<br>CH C00152039 I→   | VKMV 5PK847  |   |   | 1   |   |   |   |   |   |   |
| <b>B(Alt)</b>  | F2N 708, F2N 730,<br>F2N 732   | 10/86 → 12/88   | AC, Ø   | VKMV 5PK847  |   |   | 1   |   |   |   |   |   |   |
| <b>B(Alt)</b>  | F3N 718  | 10/84 → 12/88   | CH C00001729 I→   | VKMV 5PK847  |   |   | 1   |   |   |   |   |   |   |



RENAULT





































































|  |  |  |   |  |  |  |  |  |  |  |  |  |  |  |  |  |  |  |
|--|---|---|--|--|---|---|---|---|---|---|---|---|---|---|---|---|---|---|
| <b>RENAULT  R11 1.6 D</b>       |   |   |  |  |   |   |   |   |   |   |   |   |   |   |   |   |   |   |
|                                  | F8M 700, F8M 720,<br>F8M 730  | 08/83 → 01/88   |  | VKMA 06110<br>VKM 16110<br>VKM 26100   | 1<br>1  | 1<br>1  |   |   |   |   |   |   |   |   |   |   |   | T0019   |
|  | F8M 700, F8M 720,<br>F8M 730  | 02/88 → 12/88   |  | VKMA 06111<br>VKM 16101<br>VKM 26101   | 1<br>1  | 1<br>1  |   |   |   |   |   |   |   |   |   |   |   | T0066   |
|                                  | F8M 700, F8M 720,<br>F8M 730  | 08/83 → 12/88   |  | VKPC 86413   |   |   |   |   | 1   |   |   |   |   |   |   |   |   |   |
|                                  | <b>B(Alt)</b> F8M 700   | 08/83 → 12/88   |  CH C00219440 I→                                    | VKMV 5PK884  |   |   |   | 1   |   |   |   |   |   |   |   |   |   |   |
|  | <b>B(Alt)</b> F8M 730   | 08/83 → 12/88   |   | VKMV 5PK884  |   |   |   | 1   |   |   |   |   |   |   |   |   |   |   |
| <b>RENAULT  R12 1.3</b>         |   |   |  |  |   |   |   |   |   |   |   |   |   |   |   |   |   |   |
|                                  | 810-02, 810-02/97,<br>810-06  | 10/69 → 08/80   |  | VKPC 86403   |   |   |   |   | 1   |   |   |   |   |   |   |   |   |   |
| <b>RENAULT  R12 1.6</b>         |   |   |  |  |   |   |   |   |   |   |   |   |   |   |   |   |   |   |
|                                  | 807 20, 821 20  | 08/70 → 12/74   |  | —  |   |   |   |   | 1   |   |   |   |   |   |   |   |   |   |
| <b>RENAULT  R14 1.2</b>         |   |   |  |  |   |   |   |   |   |   |   |   |   |   |   |   |   |   |
|                                  | 129   | 05/76 → 12/83   |  | VKPC 83200   |   |   |   |   | 1   |   |   |   |   |   |   |   |   |   |
|                                  | <b>B(Alt)</b> 129   | 05/76 → 12/83   |  | VKMV 10AVx900  |   |   |   | 1   |   |   |   |   |   |   |   |   |   |   |
| <b>RENAULT  R14 1.4</b>         |   |   |  |  |   |   |   |   |   |   |   |   |   |   |   |   |   |   |
|                                  | 150, X5J  | 09/79 → 12/83   |  | VKPC 83200   |   |   |   |   | 1   |   |   |   |   |   |   |   |   |   |
|                                 | <b>B(Alt)</b> 150, X5J  | 09/79 → 12/83   |  | VKMV 10AVx900  |   |   |   | 1   |   |   |   |   |   |   |   |   |   |   |
| <b>RENAULT  R15 1.3</b>       |   |   |  |  |   |   |   |   |   |   |   |   |   |   |   |   |   |   |
|                                | 810   | 03/72 → 10/80   |  | VKPC 86403   |   |   |   |   | 1   |   |   |   |   |   |   |   |   |   |
| <b>RENAULT  R16 1.6</b>       |   |   |  |  |   |   |   |   |   |   |   |   |   |   |   |   |   |   |
|                                | 807, 821, 843   | 09/68 → 12/79   |  | —  |   |   |   |   | 1   |   |   |   |   |   |   |   |   |   |
| <b>RENAULT  R18 1.4</b>       |   |   |  |  |   |   |   |   |   |   |   |   |   |   |   |   |   |   |
|                                | 847 720, 847 722  | 04/78 → 07/86   |  | <del>OXOXOXO</del>   |   |   |   |   |   |   |   |   |   |   |   |   |   |   |
|                                | 847 720, 847 722  | 04/78 → 07/86   | → I Mot. 544000  | VKPC 86401   |   |   |   |   | 1   |   |   |   |   |   |   |   |   |   |
|  | 847 720, 847 722  | 04/78 → 07/86   | Mot. 544001 I→   | VKPC 86402   |   |   |   |   | 1   |   |   |   |   |   |   |   |   |   |
| <b>RENAULT  R18 1.6</b>       |   |   |  |  |   |   |   |   |   |   |   |   |   |   |   |   |   |   |
|                                | 841 717, 841 725,<br>841 726, A2M 723   | 04/78 → 07/86   |  | <del>OXOXOXO</del>   |   |   |   |   |   |   |   |   |   |   |   |   |   |   |
|                                | 841 717, 841 725,<br>841 726, A2M 723   | 04/78 → 07/86 2)  |  | —  |   |   |   |   | 1   |   |   |   |   |   |   |   |   |   |
|  |   |   |  | VKPC 86407   |   |   |   |   | 1   |   |   |   |   |   |   |   |   |   |
| <b>RENAULT  R18 1.6 Turbo</b> |   |   |  |  |   |   |   |   |   |   |   |   |   |   |   |   |   |   |
|                                | 807 727, A5L 717,<br>A5L 718, A6M 725,<br>A6M 726, A7L 752                        | 10/80 → 07/86   |  | <del>OXOXOXO</del>   |   |   |   |   |   |   |   |   |   |   |   |   |   |   |
|                                | 807 727   | 10/80 → 07/86   |  | —  |   |   |   |   | 1   |   |   |   |   |   |   |   |   |   |
|  | A5L 717, A5L 718,<br>A6M 725, A6M 726,<br>A7L 752                                 | 05/82 → 07/86 2)  |  | —  |   |   |   |   | 1   |   |   |   |   |   |   |   |   |   |
|  |   |   |  | VKPC 86407   |   |   |   |   | 1   |   |   |   |   |   |   |   |   |   |
| <b>RENAULT  R18 2.0</b>       |   |   |  |  |   |   |   |   |   |   |   |   |   |   |   |   |   |   |
|                                | J6R 716   | 10/81 → 12/86   | <b>B(41116x19),  116,</b><br>→ I Mot. 24260       | VKMA 06200<br>VKM 16200  | 1<br>1  | 1   |   |   |   |   |   |   |   |   |   |   |   | T0003   |
|  | J6R 716   | 10/81 → 12/86   |  116,<br><b>B(58116x19 HSN),</b><br>Mot. 24261 I→ | VKMA 06201<br>VKM 16200  | 1<br>1  | 1   |   |   |   |   |   |   |   |   |   |   |   | T0024   |
|                                | J6R 716   | 10/81 → 12/86   |  | VKPC 86602   |   |   |   |   | 1   |   |   |   |   |   |   |   |   |   |
|                                | <b>B(Alt)</b> J6R 716   | 05/82 → 07/86   |  | VKMV 10AVx1000   |   |   |   | 1   |   |   |   |   |   |   |   |   |   |   |
| <b>RENAULT  R18 2.1 D</b>     |   |   |  |  |   |   |   |   |   |   |   |   |   |   |   |   |   |   |
|                                | 852 710, J85 711  | 05/79 → 07/86   |  | VKMA 06213<br>VKM 16212<br>VKM 26211   | 1<br>1  | 1<br>1  |   |   |   |   |   |   |   |   |   |   |   | T0015   |

|                            | 852 710, J85 711, J85/852   | 05/79 → 07/86 |       | VKPC 86602   |                  |   |   |   | 1      |   |            |
|----------------------------|---|---------------|-------|--|------------------|---|---|---|--------|---|------------|
| <b>RENAULT  R18 2.1 TD</b> |   |               |       |  |                  |   |   |   |        |   |            |
|                            | J85 712   | 11/81 → 07/86 |       | VKMA 06213<br>VKM 16212<br>VKM 26211               | 1<br>1           | 1 | 1 |   |        |   | T0015      |
|                            | J85   | 11/81 → 07/86 |       | VKPC 86602   |                  |   |   |   | 1      |   |            |
| <b>RENAULT  R19 1.2</b>    |   |               |       |  |                  |   |   |   |        |   |            |
|                            | C1G 730   | 01/88 → 12/95 |       | XXXXXXXX   |                  |   |   |   |        |   |            |
|                            | E7F 730   | 03/92 → 12/95 |       | VKMC 06000<br>VKMA 06000<br>VKM 16000              | 1<br>1<br>1      | 1 | 1 |   | 1      |   | T0061      |
|                            | E7F 730   | 03/92 → 12/95 | 3)    | VKMS 06000<br>VKMA 06000<br>VKM 16000              | 1<br>1<br>1      | 1 | 1 |   |        | 2 | T0061      |
|                            | C1G 730   | 01/88 → 12/95 | 2)    | VKPA 86206<br>VKPC 86206                           |                  |   |   |   | 1<br>1 |   |            |
|                            | E7F 730   | 03/92 → 12/95 |       | VKPC 86409   |                  |   |   |   | 1      |   |            |
|                            | <b>B(Alt)</b> C1G 730   | 01/88 → 12/95 |       | VKMV 10AVx1140                                     |                  |   | 1 |   |        |   |            |
|                            | <b>B(Alt)</b> E7F 730   | 01/88 → 12/95 |       | VKMV 10AVx690                                      |                  |   | 1 |   |        |   |            |
| <b>RENAULT  R19 1.4</b>    |   |               |       |  |                  |   |   |   |        |   |            |
|                            | C2J 772, C2J 776,<br>C2J 790, C3J 710   | 07/88 → 12/95 |       | XXXXXXXX   |                  |   |   |   |        |   |            |
|                            | E6J 700, E6J 701,<br>E6J 706, E7J 700,<br>E7J 706, E7J 742,<br>E7J 745  | 01/88 → 12/95 |       | VKMC 06000<br>VKMA 06000<br>VKM 16000              | 1<br>1<br>1      | 1 | 1 |   | 1      |   | T0061      |
|                            | E6J 700, E6J 701,<br>E6J 706, E7J 700,<br>E7J 706, E7J 742,<br>E7J 745  | 01/88 → 12/95 | 3)    | VKMS 06000<br>VKMA 06000<br>VKM 16000              | 1<br>1<br>1      | 1 | 1 |   |        | 2 | T0061      |
|                            | C1J 742, C2J 772,<br>C2J 776, C2J 790,<br>C3J 710   | 01/88 → 12/95 | 2)    | VKPA 86206<br>VKPC 86206                           |                  |   |   |   | 1<br>1 |   |            |
|                            | E6J 700, E6J 701,<br>E6J 706, E7J 700,<br>E7J 706, E7J 742,<br>E7J 745  | 01/88 → 12/95 |       | VKPC 86409   |                  |   |   |   | 1      |   |            |
|                            | <b>B(Alt)</b> C2J 772, C3J 710  | 01/89 → 12/95 |       | VKMV 10AVx1140                                     |                  |   | 1 |   |        |   |            |
|                            | <b>B(Alt)</b> E6J 700, E6J 701,<br>E7J 742  | 01/88 → 12/95 | AC    | VKMV 10AVx690                                      |                  |   | 1 |   |        |   |            |
| <b>RENAULT  R19 1.7</b>    |   |               |       |  |                  |   |   |   |        |   |            |
|                            | F2N 720, F2N 721,<br>F2N 722, F2N 724,<br>F2N 726, F2N 727,<br>F2N 728, F3N 740,<br>F3N 741, F3N 742,<br>F3N 743, F3N 746               | 07/88 → 12/95 | 3)    | VKMS 06101<br>VKMA 06101<br>VKM 16101<br>VKM 26101 | 1<br>1<br>1<br>1 | 1 | 1 | 1 |        |   | 3<br>T0046 |
|                            | F3N 740, F3N 741,<br>F3N 742, F3N 743,<br>F3N 746   | 07/88 → 12/95 |       | VKPC 86413   |                  |   |   |   | 1      |   |            |
|                            | <b>B(Alt)</b> F2N 720, F2N 721,<br>F2N 722, F2N 724,<br>F2N 726, F2N 727,<br>F2N 728, F3N 740,<br>F3N 741, F3N 742,<br>F3N 743, F3N 746 | 07/88 → 12/95 | AC, ⊗ | VKMV 6PK1462<br>VKM 36013                          |                  |   | 1 |   |        |   |            |

























RENAULT

































|  |    |  |  |  |  |  |  |  |  |  |  |
|--|---|---|---|--|---|---|---|---|---|---|---|
| <b>B(Alt)</b>  | F2N 720, F2N 721,<br>F2N 722, F2N 724,<br>F2N 726, F2N 727,<br>F2N 728, F3N 740,<br>F3N 741, F3N 742,<br>F3N 743, F3N 746 | 07/88 → 12/95   | AC, ⊕   | VKMOV 6PK1690<br>VKM 36013   | 1   | 1   |   |   |   |   |   |
| <b>B(Alt)</b>  | F3N 740, F3N 741,<br>F3N 742, F3N 743   | 07/88 → 12/95   | AC, ⊕   | VKMOV 5PK847   | 1   |   |   |   |   |   |   |
| <b>RENAULT  R19 1.8</b>       |   |   |   |  |   |   |   |   |   |   |   |
|                                | F3P 682, F3P 700,<br>F3P 704, F3P 705,<br>F3P 706, F3P 707,<br>F3P 708, F3P 760,<br>F3P 765                               | 04/92 → 06/96   | 3)  | VKMS 06101<br>VKMA 06101<br>VKM 16101<br>VKM 26101                                 | 1<br>1<br>1   | 1<br>1<br>1   |   |   |   | 3   | T0046   |
|                                | F3P 682, F3P 700,<br>F3P 704, F3P 705,<br>F3P 706, F3P 707,<br>F3P 708, F3P 742,<br>F3P 743, F3P 760,<br>F3P 765          | 04/92 → 06/96   |   | VKPC 86413   |   |   |   | 1   |   |   |   |
|                                | <b>B(Alt)</b> F3P 682, F3P 700,<br>F3P 704, F3P 705,<br>F3P 706, F3P 707,<br>F3P 708, F3P 760,<br>F3P 765                 | 04/92 → 06/96   | AC, ⊕   | VKMOV 6PK1690<br>VKM 36013   | 1   | 1   |   |   |   |   |   |
| <b>RENAULT  R19 1.8 16V</b> |   |   |   |  |   |   |   |   |   |   |   |
|                              | F7P 700, F7P 704  | 06/89 → 06/96   |   | VKMA 06112<br>VKM 16112<br>VKM 26102   | 1<br>1  | 1<br>1  |   |   |   |   | T0076   |
|                              | F7P 700, F7P 704  | 06/89 → 06/96   |   | VKPC 86413   |   |   |   | 1   |   |   |   |
|                              | <b>B(Alt)</b> F7P 700   | 04/92 → 12/95   |   | VKMOV 6PK1416  |   | 1   |   |   |   |   |   |
|  | <b>B(Alt)</b> F7P 704   | 06/89 → 12/95   | AC  | VKMOV 6PK1416  |   | 1   |   |   |   |   |   |
|  | <b>B(Alt)</b> F7P 704   | 07/91 → 04/92   | AC  | VKMOV 6PK1145  |   | 1   |   |   |   |   |   |
| <b>RENAULT  R19 1.9 D</b>   |   |   |   |  |   |   |   |   |   |   |   |
|                              | F8Q 706, F8Q 742,<br>F8Q 764  | 01/88 → 12/95   | 3)  | VKMS 06111-1<br>VKMA 06111<br>VKM 16101<br>VKM 26101                               | 1<br>1<br>1   | 1<br>1<br>1   |   |   |   | 3   | T0066   |
|                              | F8Q 706, F8Q 742,<br>F8Q 764  | 01/88 → 12/95   |   | VKPC 86413   |   |   |   | 1   |   |   |   |
|                              | <b>B(Alt)</b> F8Q 706, F8Q 742,<br>F8Q 764  | 01/88 → 12/95   | AC, ⊕   | VKMOV 6PK870   |   | 1   |   |   |   |   |   |
|  | <b>B(Alt)</b> F8Q 706, F8Q 742,<br>F8Q 764  | 01/88 → 01/94   | AC, ⊕   | VKMOV 6PK1690  |   | 1   |   |   |   |   |   |
|  | <b>B(Alt)</b> F8Q 706, F8Q 742,<br>F8Q 764  | 01/94 → 12/95   | AC, ⊕   | VKMOV 6PK1173  |   | 1   |   |   |   |   |   |
|  | <b>B(Alt)</b> F8Q 706   | 01/88 → 05/94   | AC  | VKMA 36012<br>VKMOV 6PK1545<br>VKM 36012<br>VKM 36014                              |   | 2<br>1<br>1   | 1   |   |   |   |   |
|                              | F8Q 706, F8Q 742,<br>F8Q 764  | 01/88 → 12/95   |   | VKM_____   |   |   |   |   | 1   |   |   |
| <b>RENAULT  R19 1.9 dT</b>  |   |   |   |  |   |   |   |   |   |   |   |
|                              | F8Q 610, F8Q 740,<br>F8Q 744, F8Q 768   | 09/90 → 12/95   | 3)  | VKMS 06111-1<br>VKMA 06111<br>VKM 16101<br>VKM 26101                               | 1<br>1<br>1   | 1<br>1<br>1   |   |   |   | 3   | T0066   |

















|   |  |  |  |  |  |  |  |  |  |  |  |  |
|---|---|---|---|--|---|---|---|---|---|---|---|---|
|                              | F8Q 610, F8Q 740,<br>F8Q 744  | 09/90 → 12/95   |   | VKPC 86413   |   |   |   | 1   |   |   |   |   |
|                              | <b>B(Alt)</b> F8Q 610, F8Q 740,<br>F8Q 744, F8Q 768                               | 09/90 → 12/95   | AC  | VKPV 6PK1173   |   |   | 1   |   |   |   |   |   |
|   | <b>B(Alt)</b> F8Q 610, F8Q 740,<br>F8Q 744, F8Q 768                               | 04/92 → 12/95   | AC  | VKPV 6PK1690   |   |   | 1   |   |   |   |   |   |
|                              | F8Q 610, F8Q 740,<br>F8Q 744, F8Q 768   | 09/90 → 12/95   |   | VKM____  |   |   |   |   | 1   |   |   |   |
| <b>RENAULT  R20 1.6</b>      |   |   |   |  |   |   |   |   |   |   |   |   |
|                              | 843, 843 720, 843 721   | 10/75 → 12/83   |   | OKOKOKO  |   |   |   |   |   |   |   |   |
|                              | <b>B(Alt)</b> 843, 843 720, 843 721   | 10/75 → 12/83   |   | VKPV 11.9x1010   |   |   | 1   |   |   |   |   |   |
| <b>RENAULT  R20 2.0</b>      |   |   |   |  |   |   |   |   |   |   |   |   |
|                              | 829 700, 829 701,<br>829 702, 829 703   | 10/77 → 12/83   |   | VKMA 06200<br>VKM 16200  | 1<br>1  |   | 1   |   |   |   |   | T0003   |
|                              | 829 700, 829 701, 829/<br>J6R   | 10/77 → 12/83   |   | VKPC 86405   |   |   |   | 1   |   |   |   |   |
|                              | <b>B(Alt)</b> 829 700, 829 701,<br>829 702, 829 703                               | 10/77 → 12/83   |   | VKPV 10AVx1000   |   |   | 1   |   |   |   |   |   |
| <b>RENAULT  R20 2.2</b>      |   |   |   |  |   |   |   |   |   |   |   |   |
|                              | 851 700   | 10/80 → 12/83   |   | —<br>VKM 16200   | 1<br>1  |   | 1   |   |   |   |   | T0011   |
|                              | 851 700   | 10/80 → 12/83   |   | VKPC 86405   |   |   |   | 1   |   |   |   |   |
|                              | <b>B(Alt)</b> 851 700   | 10/80 → 12/83   |   | VKPV 10AVx1000   |   |   | 1   |   |   |   |   |   |
| <b>RENAULT  R20 2.1 D</b>   |   |   |   |  |   |   |   |   |   |   |   |   |
|                            | 852   | 10/80 → 12/83   |   | VKMA 06213<br>VKM 16212<br>VKM 26211   | 1<br>1  | 1   | 1   |   |   |   |   | T0015   |
|                            | 852   | 10/80 → 12/83   |   | VKPC 86601   |   |   |   | 1   |   |   |   |   |
|                            | <b>B(Alt)</b> 852   | 10/80 → 12/83   |   | VKPV 11.9x1010   |   |   | 1   |   |   |   |   |   |
| <b>RENAULT  R20 2.1 TD</b> |   |   |   |  |   |   |   |   |   |   |   |   |
|                            |   | 01/82 → 12/83   |   | VKMA 06213<br>VKM 16212<br>VKM 26211   | 1<br>1  | 1   | 1   |   |   |   |   | T0015   |
|                            | J85   | 01/82 → 12/83   |   | VKPC 86623   |   |   |   | 1   |   |   |   |   |
|                            | <b>B(Alt)</b>   | 01/82 → 12/83   |   | VKPV 11.9x1010   |   |   | 1   |   |   |   |   |   |
| <b>RENAULT  R21 1.4</b>    |   |   |   |  |   |   |   |   |   |   |   |   |
|                            | C2J 770   | 06/88 → 10/93   |   | OKOKOKO  |   |   |   |   |   |   |   |   |
|                            | C2J 770   | 06/88 → 10/93   | 2), AC  | VKPA 86206<br>VKPC 86206   |   |   |   | 1<br>1  |   |   |   |   |
|   | C2J 770   | 06/88 → 10/93   | AC  | VKPC 86209   |   |   |   | 1   |   |   |   |   |
|                            | <b>B(Alt)</b> C2J 770   | 06/88 → 10/93   |   | VKPV 10AVx1140   |   |   | 1   |   |   |   |   |   |
| <b>RENAULT  R21 1.7</b>    |   |   |   |  |   |   |   |   |   |   |   |   |
|                            | F2N 710   | 03/86 → 04/95   | →IMot. C290918  | VKMA 06100<br>VKM 16100<br>VKM 26100   | 1<br>1  | 1   | 1   |   |   |   |   | T0023   |
|   | F2N 710   | 03/86 → 04/95   | 3), Mot. C290919  →   | VKMS 06101<br>VKMA 06101<br>VKM 16101<br>VKM 26101                                 | 1<br>1<br>1   | 1   | 1   |   |   |   | 3   | T0046   |
|   | F2N 712   | 03/86 → 04/95   | →IMot. C028797  | VKMA 06100<br>VKM 16100<br>VKM 26100   | 1<br>1  | 1   | 1   |   |   |   |   | T0023   |
|   | F2N 712   | 03/86 → 04/95   | 3), Mot. C028798  →   | VKMS 06101<br>VKMA 06101<br>VKM 16101<br>VKM 26101                                 | 1<br>1<br>1   | 1   | 1   |   |   |   | 3   | T0046   |
|   | F2N 750   | 06/86 → 02/94   | →IMot. C001322  | VKMA 06100<br>VKM 16100<br>VKM 26100   | 1<br>1  | 1   | 1   |   |   |   |   | T0023   |
|   | F2N 750   | 06/86 → 02/94   | 3), Mot. C0013023  →  | VKMS 06101<br>VKMA 06101<br>VKM 16101<br>VKM 26101                                 | 1<br>1<br>1   | 1   | 1   |   |   |   | 3   | T0046   |













































RENAULT

|  |                     |  |  |  |  |  |  |  |  |  |  |  |
|--|--|---|---|--|---|---|---|---|---|---|---|---|
|  | F2N 752  | 06/87 → 04/89   | → Mot. C000415  | VKMA 06100<br>VKM 16100<br>VKM 26100   | 1<br>1  | 1   | 1   |   |   |   |   | T0023   |
|  | F2N 752  | 06/87 → 04/89   | 3), Mot. C000416  →   | VKMS 06101<br>VKMA 06101<br>VKM 16101<br>VKM 26101                                 | 1<br>1<br>1   | 1   | 1   |   |   |   | 3   | T0046   |
|  | F2N 754, F3N 723,<br>F3N 726   | 06/86 → 04/95   | 3)  | VKMS 06101<br>VKMA 06101<br>VKM 16101<br>VKM 26101                                 | 1<br>1<br>1   | 1   | 1   |   |   |   | 3   | T0046   |
|  | F3N 722  | 03/86 → 11/87   | → Mot. C012126  | VKMA 06100<br>VKM 16100<br>VKM 26100   | 1<br>1  | 1   | 1   |   |   |   |   | T0023   |
|  | F3N 722  | 02/88 → 02/94   | 3), Mot. C012127  →   | VKMS 06101<br>VKMA 06101<br>VKM 16101<br>VKM 26101                                 | 1<br>1<br>1   | 1   | 1   |   |   |   | 3   | T0046   |
|                                  | F2N 710, F2N 711,<br>F2N 712, F2N 722,<br>F2N 750, F2N 752,<br>F2N 754, F3N 722,<br>F3N 723, F3N 726 | 03/86 → 04/95   |   | VKPC 86413   |   |   |   |   |   |   | 1   |   |
|                                  | B(Alt) F3N 722, F3N 723  | 09/89 → 06/94   | AC, Ø   | VKMV 5PK847  |   |   | 1   |   |   |   |   |   |
|  | B(Alt) F3N 722, F3N 723  | 09/89 → 06/94   | AC, Ø   | VKMV 6PK1690   |   |   | 1   |   |   |   |   |   |
| <b>RENAULT  R21 2.0</b>         |  |   |   |  |   |   |   |   |   |   |   |   |
|                                 | J6R 758, J6R 792,<br>J6R 793, J7R 740,<br>J7R 746, J7R 747   | 03/86 → 06/94   |   | VKMA 06205<br>VKM 16204  | 1<br>1  |   | 1   |   |   |   |   | T0024   |
|  | J6R 759  | 03/86 → 10/93   |   | VKMA 06201<br>VKM 16200  | 1<br>1  |   | 1   |   |   |   |   | T0024   |
|  | J7R 750  | 03/86 → 12/88   | → Mot. F197763  | VKMA 06201<br>VKM 16200  | 1<br>1  |   | 1   |   |   |   |   | T0024   |
|  | J7R 750  | 03/86 → 12/88   | Mot. F197764  →   | VKMA 06205<br>VKM 16204  | 1<br>1  |   | 1   |   |   |   |   | T0024   |
|  | J7R 751  | 03/86 → 12/88   | → Mot. F197767  | VKMA 06201<br>VKM 16200  | 1<br>1  |   | 1   |   |   |   |   | T0024   |
|  | J7R 751  | 03/86 → 12/88   | Mot. F197768  →   | VKMA 06205<br>VKM 16204  | 1<br>1  |   | 1   |   |   |   |   | T0024   |
|                                | J6R 758, J6R 792,<br>J6R 793   | 03/86 → 10/93   |   | VKPC 86408   |   |   |   |   |   |   | 1   |   |
|  | J6R 759  | 03/86 → 10/93   |   | —  |   |   |   |   |   |   | 1   |   |
|  | J7R 740, J7R 746,<br>J7R 747, J7R 754  | 03/86 → 06/94   |   | VKPC 86605   |   |   |   |   |   |   | 1   |   |
|  | J7R 740  | 12/89 → 02/94   |   | VKPC 86603   |   |   |   |   |   |   | 1   |   |
|  | J7R 750  | 03/86 → 12/88   | → Mot. F197763  | VKPC 86603   |   |   |   |   |   |   | 1   |   |
|  | J7R 750  | 03/86 → 12/88   | Mot. F197764  →   | VKPC 86605   |   |   |   |   |   |   | 1   |   |
|  | J7R 751  | 03/86 → 12/88   | → Mot. F197767  | VKPC 86603   |   |   |   |   |   |   | 1   |   |
|  | J7R 751  | 03/86 → 12/88   | Mot. F197768  →   | VKPC 86605   |   |   |   |   |   |   | 1   |   |
|                                | B(Alt) J7R 740, J7R 746,<br>J7R 747  | 09/89 → 06/94   |   | VKMV 10AVx1000   |   |   | 1   |   |   |   |   |   |
|  | B(PS) J7R 740, J7R 746,<br>J7R 747   | 09/89 → 06/94   |   | VKMV 11.9x758  |   |   | 1   |   |   |   |   |   |
|  | B(AC) J7R 740, J7R 746,<br>J7R 747   | 09/89 → 06/94   |   | VKMV 4PK878  |   |   | 1   |   |   |   |   |   |
| <b>RENAULT  R21 2.0 Turbo</b> |  |   |   |  |   |   |   |   |   |   |   |   |
|                                | J7R 752  | 04/87 → 10/93   | → Mot. F209862  | VKMA 06206<br>VKM 16200  | 1<br>1  |   | 1   |   |   |   |   | T0047   |
|  | J7R 752  | 04/87 → 10/93   | Mot. F209863  →   | VKMA 06207<br>VKM 16204  | 1<br>1  |   | 1   |   |   |   |   | T0047   |
|  | J7R 756  | 02/90 → 10/92   |   | VKMA 06207<br>VKM 16204  | 1<br>1  |   | 1   |   |   |   |   | T0047   |
|                                | J7R 752  | 04/87 → 10/93   | → Mot. F209862  | —  |   |   |   |   |   |   | 1   |   |
|  | J7R 752  | 04/87 → 10/93   | Mot. F209863  →   | VKPC 86408   |   |   |   |   |   |   | 1   |   |
|  | J7R 756  | 02/90 → 10/92   |   | VKPC 86408   |   |   |   |   |   |   | 1   |   |
|                                | B(Alt) J7R 752, J7R 756  | 04/87 → 10/93   |   | VKMV 10AVx1000   |   |   | 1   |   |   |   |   |   |

|   |  |  |  |  |  |  |  |  |  |  |  |  |  |
|---|---|---|---|--|---|---|---|---|---|---|---|---|---|
|   | B(PS)   | J7R 752, J7R 756  | 04/87 → 10/93   |  | VKMW 11.9x758   |   |   | 1   |   |   |   |   |   |
|   | B(AC)   | J7R 752, J7R 756  | 04/87 → 10/93   |  | VKMW 4PK878   |   |   | 1   |   |   |   |   |   |
| <b>RENAULT  R21 2.2</b>      |   |   |   |  |   |   |   |   |   |   |   |   |   |
|                              |   | J7T 754, J7T 755  | 06/86 → 06/94   | →IMot. F241442   | VKMA 06203<br>VKM 16200   | 1<br>1  |   | 1   |   |   |   |   | T0024   |
|   |   | J7T 754, J7T 755  | 06/86 → 06/94   | Mot. F241443 I→  | VKMA 06204<br>VKM 16204   | 1<br>1  |   | 1   |   |   |   |   | T0024   |
|   |   | J7T 756   | 06/86 → 12/93   |  | VKMA 06204<br>VKM 16204   | 1<br>1  |   | 1   |   |   |   |   | T0024   |
|                              |   | J7T 754, J7T 755  | 06/86 → 06/94   | →IMot. F241442   | VKPC 86603  |   |   |   |   | 1   |   |   |   |
|   |   | J7T 754, J7T 755  | 06/86 → 06/94   | Mot. F241443 I→  | VKPC 86605  |   |   |   |   | 1   |   |   |   |
|   |   | J7T 756   | 06/86 → 12/93   |  | VKPC 86605  |   |   |   |   | 1   |   |   |   |
|                              | B(Alt)  | J7T 754, J7T 755,<br>J7T 756  | 06/86 → 06/94   |  | VKMW 10AVx1000  |   |   |   |   | 1   |   |   |   |
|   | B(PS)   | J7T 754, J7T 755,<br>J7T 756  | 06/86 → 06/94   |  | VKMW 11.9x758   |   |   |   |   | 1   |   |   |   |
|   | B(AC)   | J7T 754, J7T 755,<br>J7T 756  | 06/86 → 06/94   |  | VKMW 4PK878   |   |   |   |   | 1   |   |   |   |
| <b>RENAULT  R21 1.9 D</b>    |   |   |   |  |   |   |   |   |   |   |   |   |   |
|                              |   | F8Q 710   | 03/86 → 08/94   | 3)   | VKMS 06111-1<br>VKMA 06111<br>VKM 16101<br>VKM 26101                                | 1<br>1<br>1<br>1  | 1<br>1  | 1<br>1  |   |   |   | 3   | T0066   |
|                              |   | F8Q 710   | 03/86 → 08/94   |  | VKPC 86413  |   |   |   |   | 1   |   |   |   |
|                              | B(Alt)  | F8Q 710   | 03/86 → 08/94   | ⊘  | VKMW 6PK870   |   |   |   |   | 1   |   |   |   |
|   | B(Alt)  | F8Q 710   | 03/86 → 08/94   | ⊘  | VKMW 6PK1690  |   |   |   |   | 1   |   |   |   |
| <b>RENAULT  R21 2.1 D</b>  |   |   |   |  |   |   |   |   |   |   |   |   |   |
|                            |   | J8S 600, J8S 704,<br>J8S 740, J8S 784   | 03/86 → 09/95   | 3)   | VKMS 06213<br>VKMA 06213<br>VKM 16212<br>VKM 26211                                  | 1<br>1<br>1<br>1  | 1<br>1  | 1<br>1  |   |   |   | 3   | T0015   |
|                            |   | J8S 600, J8S 704,<br>J8S 740, J8S 784   | 03/86 → 09/95   |  | VKPC 86603  |   |   |   |   | 1   |   |   |   |
|                            | B(Alt)  | J8S 600, J8S 704,<br>J8S 740, J8S 784   | 06/86 → 09/95   |  | VKMW 11.9x1010  |   |   |   |   | 1   |   |   |   |
|   | B(PS)   | J8S 600, J8S 704,<br>J8S 740, J8S 784   | 03/86 → 09/95   |  | VKMW 11.9x758   |   |   |   |   | 1   |   |   |   |
|   | B(AC)   | J8S 600, J8S 704,<br>J8S 740, J8S 784   | 03/86 → 09/95   |  | VKMW 4PK878   |   |   |   |   | 1   |   |   |   |
|                            |   | J8S 600, J8S 704,<br>J8S 740, J8S 784   | 03/86 → 09/95   | ⊘  | —   |   |   |   |   |   |   | 1   |   |
|   |   | J8S 600, J8S 704,<br>J8S 740, J8S 784   | 03/86 → 09/95   | ⊘  | —   |   |   |   |   |   |   | 1   |   |
| <b>RENAULT  R21 2.1 TD</b> |   |   |   |  |   |   |   |   |   |   |   |   |   |
|                            |   | J8S 714, J8S 786,<br>J8S 788  | 03/86 → 06/94   | 3)   | VKMS 06213<br>VKMA 06213<br>VKM 16212<br>VKM 26211                                  | 1<br>1<br>1<br>1  | 1<br>1  | 1<br>1  |   |   |   | 3   | T0015   |
|                            |   | J8S 714, J8S 786,<br>J8S 788  | 03/86 → 06/94   |  | VKPC 86603  |   |   |   |   | 1   |   |   |   |
|                            | B(Alt)  | J8S 714, J8S 786,<br>J8S 788  | 03/86 → 06/94   |  | VKMW 11.9x1010  |   |   |   |   | 1   |   |   |   |
|   | B(PS)   | J8S 714, J8S 786,<br>J8S 788  | 03/86 → 06/94   |  | VKMW 11.9x758   |   |   |   |   | 1   |   |   |   |
|   | B(AC)   | J8S 714, J8S 786,<br>J8S 788  | 03/86 → 06/94   |  | VKMW 4PK878   |   |   |   |   | 1   |   |   |   |
|                            |   | J8S 714, J8S 786,<br>J8S 788  | 03/86 → 06/94   | ⊘  | —   |   |   |   |   |   |   | 1   |   |
|   |   | J8S 714, J8S 786,<br>J8S 788  | 03/86 → 06/94   | ⊘  | —   |   |   |   |   |   |   | 1   |   |
| <b>RENAULT  R25 2.0</b>    |   |   |   |  |   |   |   |   |   |   |   |   |   |
|                            |   | J6R 706   | 04/84 → 12/92   | →IMot. F308131   | VKMA 06201<br>VKM 16200   | 1<br>1  |   | 1   |   |   |   |   | T0024   |









































|  |                                   |  |  |  |  |  |  |  |  |  |  |  |
|--|--|---|---|--|---|---|---|---|---|---|---|---|
|  | J6R 706  | 04/84 → 12/92   | Mot. F308132 I→   | VKMA 06205<br>VKM 16204  | 1<br>1  |   | 1   |   |   |   |   | T0024   |
|  | J6R 707  | 04/84 → 12/92   | →IMot. F308120  | VKMA 06201<br>VKM 16200  | 1<br>1  |   | 1   |   |   |   |   | T0024   |
|  | J6R 707  | 04/84 → 12/92   | Mot. F308121 I→   | VKMA 06205<br>VKM 16204  | 1<br>1  |   | 1   |   |   |   |   | T0024   |
|  | J7R 720, J7R 721,<br>J7R 723, J7R 726  | 06/88 → 12/93   |   | VKMA 06205<br>VKM 16204  | 1<br>1  |   | 1   |   |   |   |   | T0024   |
|                            | J6R 706, J6R 707,<br>J6R 760, J6R 762,<br>J6R 763, J7R 722,<br>J7R 723   | 04/84 → 05/88   |   | VKPC 86405   |   |   |   |   | 1   |   |   |   |
|  | J6R 706  | 06/88 → 12/92   | →IMot. F308131  | VKPC 86405   |   |   |   |   | 1   |   |   |   |
|  | J6R 706  | 06/88 → 12/92   | Mot. F308132 I→   | VKPC 86408   |   |   |   |   | 1   |   |   |   |
|  | J6R 707  | 06/88 → 12/92   | →IMot. F308120  | VKPC 86405   |   |   |   |   | 1   |   |   |   |
|  | J6R 707  | 06/88 → 12/92   | Mot. F308121 I→   | VKPC 86408   |   |   |   |   | 1   |   |   |   |
|  | J7R 720, J7R 721,<br>J7R 726   | 06/88 → 12/93   |   | VKPC 86605   |   |   |   |   | 1   |   |   |   |
|                            | <b>B(Alt)</b> J6R 706, J6R 707,<br>J6R 760, J6R 762,<br>J6R 763, J7R 720,<br>J7R 721, J7R 722,<br>J7R 723, J7R 726 | 04/84 → 12/93   |   | VKMOV 11.9x1010  |   |   | 1   |   |   |   |   |   |
|  | <b>B(PS)</b> J6R 706, J6R 707,<br>J6R 760, J6R 762,<br>J6R 763, J7R 720,<br>J7R 721, J7R 722,<br>J7R 723, J7R 726  | 04/84 → 12/93   |   | VKMOV 11.9x758   |   |   | 1   |   |   |   |   |   |
|  | <b>B(AC)</b> J7R 720, J7R 721,<br>J7R 722, J7R 723,<br>J7R 726   | 03/87 → 12/93   |   | VKMOV 4PK878   |   |   | 1   |   |   |   |   |   |
| <b>RENAULT  R25 2.2</b> |  |   |   |  |   |   |   |   |   |   |   |   |
|                          | J7T 706, J7T 707,<br>J7T 714, J7T 715  | 04/84 → 06/88   |   | VKMA 06203<br>VKM 16200  | 1<br>1  |   | 1   |   |   |   |   | T0024   |
|  | J7T 708  | 09/86 → 12/92   |   | VKMA 06203<br>VKM 16200  | 1<br>1  |   | 1   |   |   |   |   | T0024   |
|  | J7T 730  | 04/84 → 12/89   | →IMot. F259593  | VKMA 06203<br>VKM 16200  | 1<br>1  |   | 1   |   |   |   |   | T0024   |
|  | J7T 730  | 04/84 → 12/89   | Mot. F259594 I→   | VKMA 06204<br>VKM 16204  | 1<br>1  |   | 1   |   |   |   |   | T0024   |
|  | J7T 731  | 04/84 → 12/89   | →IMot. F259572  | VKMA 06203<br>VKM 16200  | 1<br>1  |   | 1   |   |   |   |   | T0024   |
|  | J7T 731  | 04/84 → 12/89   | Mot. F259573 I→   | VKMA 06204<br>VKM 16204  | 1<br>1  |   | 1   |   |   |   |   | T0024   |
|  | J7T 732  | 09/86 → 12/92   | →IMot. F259468  | VKMA 06203<br>VKM 16200  | 1<br>1  |   | 1   |   |   |   |   | T0024   |
|  | J7T 732  | 09/86 → 12/92   | Mot. F259469 I→   | VKMA 06204<br>VKM 16204  | 1<br>1  |   | 1   |   |   |   |   | T0024   |
|  | J7T 733  | 09/86 → 12/92   | →IMot. F259622  | VKMA 06203<br>VKM 16200  | 1<br>1  |   | 1   |   |   |   |   | T0024   |
|  | J7T 733  | 09/86 → 12/92   | Mot. F259623 I→   | VKMA 06204<br>VKM 16204  | 1<br>1  |   | 1   |   |   |   |   | T0024   |
|                          | J7T 706, J7T 707,<br>J7T 708, J7T 714,<br>J7T 715, J7T 730,<br>J7T 731, J7T 732,<br>J7T 733                        | 04/84 → 05/88   |   | VKPC 86405   |   |   |   |   | 1   |   |   |   |
|  | J7T 730  | 06/88 → 12/89   | →IMot. F259593  | VKPC 86405   |   |   |   |   | 1   |   |   |   |
|  | J7T 730  | 06/88 → 12/89   | Mot. F259594 I→   | VKPC 86605   |   |   |   |   | 1   |   |   |   |
|  | J7T 731  | 06/88 → 12/89   | →IMot. F259572  | VKPC 86405   |   |   |   |   | 1   |   |   |   |
|  | J7T 731  | 06/88 → 12/89   | Mot. F259573 I→   | VKPC 86605   |   |   |   |   | 1   |   |   |   |
|  | J7T 732  | 06/88 → 12/92   | →IMot. F259468  | VKPC 86405   |   |   |   |   | 1   |   |   |   |
|  | J7T 732  | 06/88 → 12/92   | Mot. F259469 I→   | VKPC 86605   |   |   |   |   | 1   |   |   |   |
|  | J7T 733  | 06/88 → 12/92   | →IMot. F259622  | VKPC 86405   |   |   |   |   | 1   |   |   |   |
|  | J7T 733  | 06/88 → 12/92   | Mot. F259623 I→   | VKPC 86605   |   |   |   |   | 1   |   |   |   |









































|   |            |  |    |  |  |  |  |  |  |  |
|---|---|---|---|--|---|---|---|---|---|---|
|  <b>B(Alt)</b>                   | J7T 706, J7T 707,<br>J7T 708, J7T 714,<br>J7T 715, J7T 730,<br>J7T 731, J7T 732,<br>J7T 733 | 04/84 → 12/92   |   | VKMV 11.9x1010   |   | 1   |   |   |   |   |
| <b>B(PS)</b>  | J7T 706, J7T 707,<br>J7T 708, J7T 714,<br>J7T 715, J7T 730,<br>J7T 731, J7T 732,<br>J7T 733 | 04/84 → 12/92   |   | VKMV 11.9x758  |   | 1   |   |   |   |   |
| <b>RENAULT  R25 2.5 V6 Turbo</b> |   |   |   |  |   |   |   |   |   |   |
|                                  | Z7U 702   | 10/84 → 05/90   |   | OKOKOKO  |   |   |   |   |   |   |
|                                  | Z7U 702   | 10/84 → 05/90   | 2)  | —  |   |   | 1   |   |   |   |
|                                  | Z7U 700   | 01/90 → 12/92   |   | OKOKOKO  |   |   |   |   |   |   |
|                                  | Z7U 700   | 01/90 → 12/92   | 2)  | —  |   |   | 1   |   |   |   |
| <b>RENAULT  R25 2.7 V6</b>       |   |   |   |  |   |   |   |   |   |   |
|                                  | Z7V 708   | 04/84 → 08/89   |   | OKOKOKO  |   |   |   |   |   |   |
|                                  | Z7V 708   | 04/84 → 08/89   | 2)  | —  |   |   | 1   |   |   |   |
| <b>RENAULT  R25 2.8 V6</b>       |   |   |   |  |   |   |   |   |   |   |
|                                  | Z7W 700, Z7W 702,<br>Z7W 706, Z7W 707,<br>Z7W 709   | 06/86 → 12/92   |   | OKOKOKO  |   |   |   |   |   |   |
|                                  | Z7W 700, Z7W 701,<br>Z7W 706, Z7W 707,<br>Z7W 709   | 06/87 → 12/92   |   | —  |   |   |   | 1   |   |   |
|   | Z7W 702   | 06/86 → 02/88   | 2)  | —  |   |   |   | 1   |   |   |
| <b>RENAULT  R25 2.1 D</b>      |   |   |   |  |   |   |   |   |   |   |
|                                | J8S 706, J8S 736  | 04/84 → 12/92   | 3)  | VKMS 06213<br>VKMA 06213<br>VKM 16212<br>VKM 26211                                 | 1<br>1<br>1   | 1<br>1<br>1   |   |   | 3   | T0015   |
|                                | J8S 706   | 04/84 → 06/88   |   | VKPC 86601   |   |   |   | 1   |   |   |
|   | J8S 736   | 07/88 → 05/89   |   | VKPC 86623   |   |   |   | 1   |   |   |
|   | J8S 736   | 06/89 → 12/92   |   | VKPC 86601   |   |   |   | 1   |   |   |
|                                | <b>B(Alt)</b> J8S 706   | 04/84 → 05/89   |   | VKMV 11.9x1010   |   |   | 1   |   |   |   |
|   | <b>B(PS)</b> J8S 736  | 06/89 → 12/92   |   | VKMV 11.9x758  |   |   | 1   |   |   |   |
|                                | J8S 706, J8S 736  | 04/84 → 12/92   |  | —  |   |   |   |   | 1   |   |
| <b>RENAULT  R25 2.1 TD</b>     |   |   |   |  |   |   |   |   |   |   |
|                                | J8S 708, J8S 738  | 04/84 → 12/92   | 3)  | VKMS 06213<br>VKMA 06213<br>VKM 16212<br>VKM 26211                                 | 1<br>1<br>1   | 1<br>1<br>1   |   |   | 3   | T0015   |
|                                | J8S 708   | 04/84 → 12/92   | → Mot. F397289  | VKPC 86622   |   |   |   | 1   |   |   |
|   | J8S 708   | 04/84 → 12/92   | Mot. F397290 I→   | VKPC 86604   |   |   |   | 1   |   |   |
|   | J8S 738   | 04/84 → 12/92   |   | VKPC 86604   |   |   |   | 1   |   |   |
|                                | <b>B(Alt)</b> J8S 708   | 04/84 → 12/92   |   | VKMV 11.9x1010   |   |   | 1   |   |   |   |
|   | <b>B(PS)</b> J8S 708  | 04/84 → 12/92   |   | VKMV 11.9x758  |   |   | 1   |   |   |   |
|                                | J8S 708, J8S 738  | 04/84 → 12/92   |  | —  |   |   |   |   | 1   |   |
| <b>RENAULT  R30 2.6</b>        |   |   |   |  |   |   |   |   |   |   |
|                                | 112, 140, 144   | 02/75 → 01/84   |   | OKOKOKO  |   |   |   |   |   |   |
| <b>RENAULT  R30 2.1 TD</b>     |   |   |   |  |   |   |   |   |   |   |
|                                | J8S 702   | 02/82 → 03/86   |   | VKMA 06213<br>VKM 16212<br>VKM 26211   | 1<br>1  | 1<br>1  |   |   |   | T0015   |
|                                | J8S 702   | 02/82 → 03/86   |   | VKPC 86623   |   |   |   | 1   |   |   |
| <b>RENAULT  R4 0.8</b>         |   |   |   |  |   |   |   |   |   |   |
|                                | 800 705, B1B 707  | 04/83 → 07/89   |   | OKOKOKO  |   |   |   |   |   |   |
|                                | 680/690/800/839/BB1B,<br>800, 800 01, 800 705   | 10/62 → 12/88   | 2)  | VKPA 86200<br>VKPC 86200   |   |   |   | 1<br>1  |   |   |
|   | B1B 705, B1B 707  | 01/83 → 07/89   | 2)  | VKPA 86200<br>VKPC 86200   |   |   |   | 1<br>1  |   |   |
|                                | <b>B(Alt)</b> B1B 705, B1B 707  | 10/83 → 10/88   |   | VKMV 10AVx690  |   |   | 1   |   |   |   |







































RENAULT

































|   |  |  |  |  |  |  |  |  |  |  |  |  |
|---|--|---|---|---|--|---|---|---|---|---|---|---|
| <b>RENAULT  R4 1.0</b>         |  |   |   |   |  |   |   |   |   |   |   |   |
|                                 | C1C 708  | 12/85 → 12/93   |   |   | OXOXOXO  |   |   |   |   |   |   |   |
|                                 | C1C 708  | 12/85 → 12/93   |   |   | VKPC 86205   |   |   |   | 1   |   |   |   |
|                                 | B(Alt) C1C 708   | 12/85 → 12/93   |   |   | VKMV 10AVx625  |   |   |   | 1   |   |   |   |
| <b>RENAULT  R4 1.1</b>         |  |   |   |   |  |   |   |   |   |   |   |   |
|                                 | 688 711, 688 712,<br>C1E 714, C1E 718,<br>C1E 719        | 10/76 → 06/90   |   |   | OXOXOXO  |   |   |   |   |   |   |   |
|                                 | 688  | 10/76 → 12/82   |   |   | VKPC 86201   |   |   |   | 1   |   |   |   |
|   | 688 712, C1E 718,<br>C1E 719                             | 01/83 → 06/90   |   |   | VKPC 86201   |   |   |   | 1   |   |   |   |
|   | C1E 714  | 01/83 → 06/90   |   |   | VKPC 86205   |   |   |   | 1   |   |   |   |
|                                 | B(Alt) 688 711, 688 712,<br>C1E 714, C1E 718,<br>C1E 719 | 10/76 → 06/90   |   |   | VKMV 10AVx625  |   |   |   | 1   |   |   |   |
| <b>RENAULT  R5 0.8</b>         |  |   |   |   |  |   |   |   |   |   |   |   |
|                                 | 800 710  | 10/72 → 12/84   |   |   | —  |   |   |   | 1   |   |   |   |
|                                 | B(Alt) 800 710   | 10/72 → 12/84   | Mod. R 1391   |   | VKMV 10AVx825  |   |   |   | 1   |   |   |   |
| <b>RENAULT  R5 1.0</b>         |  |   |   |   |  |   |   |   |   |   |   |   |
|                                 | 689 710  | 01/72 → 12/85   |   |   | VKPC 86201   |   |   |   | 1   |   |   |   |
|                                 | B(Alt) 689 710   | 01/72 → 12/85   | Mod. R 1392,<br>→ ICH 8619  |   | VKMV 10AVx700  |   |   |   | 1   |   |   |   |
|   | B(Alt) 689 710   | 01/72 → 12/85   | Mod. R 1392,<br>CH 8620 I →   |   | VKMV 10AVx600  |   |   |   | 1   |   |   |   |
|   | B(WP) 689 710  | 01/72 → 12/85   | Mod. R 1392   |   | VKMV 10AVx666  |   |   |   | 1   |   |   |   |
| <b>RENAULT  R5 1.1</b>       |  |   |   |   |  |   |   |   |   |   |   |   |
|                               | 688 713, C1E 726   | 09/80 → 12/85   |   |   | VKPC 86205   |   |   |   | 1   |   |   |   |
|   | 688 713, C1E 726   | 09/80 → 12/85   |   |   | VKPC 86201   |   |   |   | 1   |   |   |   |
|                               | B(Alt) 688 713, C1E 726                                  | 09/80 → 12/85   | Mod. R 1397,<br>→ ICH 116382  |   | VKMV 10AVx700  |   |   |   | 1   |   |   |   |
|   | B(Alt) 688 713, C1E 726                                  | 09/80 → 12/85   | Mod. R 1397,<br>CH 116383 I →   |   | VKMV 10AVx600  |   |   |   | 1   |   |   |   |
|   | B(WP) 688 713, C1E 726                                   | 09/80 → 12/85   | Mod. R 1397   |   | VKMV 10AVx666  |   |   |   | 1   |   |   |   |
| <b>RENAULT  R5 1.3</b>       |  |   |   |   |  |   |   |   |   |   |   |   |
|                               | 810 719, 810 725,<br>810 726, 810 729                    | 09/75 → 09/84   |   |   | VKPC 86201   |   |   |   | 1   |   |   |   |
|                               | B(Alt) 810 719, 810 729                                  | 06/79 → 09/84   | Mod. R 1395,<br>→ ICH 27425   |   | VKMV 10AVx700  |   |   |   | 1   |   |   |   |
|   | B(Alt) 810 719, 810 729                                  | 06/79 → 09/84   | Mod. R 1395,<br>CH 27426 I →  |   | VKMV 10AVx600  |   |   |   | 1   |   |   |   |
|   | B(Alt) 810 725   | 09/75 → 09/84   | Mod. R 1394,<br>CH 1517 I →   |   | VKMV 10AVx600  |   |   |   | 1   |   |   |   |
|   | B(WP) 810 719, 810 725,<br>810 729                       | 09/75 → 09/84   | Mod. R 1394, R 1395   |   | VKMV 10AVx666  |   |   |   | 1   |   |   |   |
| <b>RENAULT  R5 1.4</b>       |  |   |   |   |  |   |   |   |   |   |   |   |
|                               | 847 725, C2J, C2J 713,<br>C6J/50                         | 09/77 → 12/85   | ⊗   |   | VKPC 86201   |   |   |   | 1   |   |   |   |
|   | 847 725, C2J, C2J 713                                    | 09/77 → 12/85   | ⊗   |   | VKPC 86206   |   |   |   | 1   |   |   |   |
|   | C6J/28   | 09/77 → 09/84   | ⊗   |   | VKPC 86205   |   |   |   | 1   |   |   |   |
|                               | B(Alt) 847 725, C2J 713                                  | 01/82 → 12/85   | Mod. R 1399   |   | VKMV 10AVx600  |   |   |   | 1   |   |   |   |
| <b>RENAULT  R5 1.4 Turbo</b> |  |   |   |   |  |   |   |   |   |   |   |   |
|                               | C2J, C6J/50  | 06/80 → 01/85   | ⊗   |   | VKPC 86201   |   |   |   | 1   |   |   |   |
|   | C2J  | 06/80 → 01/85   | ⊗   |   | VKPC 86206   |   |   |   | 1   |   |   |   |
|   | C6J/28   | 06/80 → 01/85   | ⊗   |   | VKPC 86205   |   |   |   | 1   |   |   |   |
| <b>RENAULT  R6 0.8</b>       |  |   |   |   |  |   |   |   |   |   |   |   |
|                               | 800  | 10/69 → 04/80   | 2)  |   | VKPA 86200   |   |   |   | 1   |   |   |   |
|   |  |   |   |   | VKPC 86200   |   |   |   | 1   |   |   |   |
| <b>RENAULT  R6 1.1</b>       |  |   |   |   |  |   |   |   |   |   |   |   |
|                               | 688  | 08/70 → 12/80   |   |   | VKPC 86201   |   |   |   | 1   |   |   |   |

|  |    |  |                                    |  |  |  |  |  |  |  |  |
|--|---|---|---|--|---|---|---|---|---|---|---|
| <b>RENAULT  R8 1.1</b>          |   |   |   |  |   |   |   |   |   |   |   |
|                                 | 688   | 11/62 → 10/72   |   | VKPC 86203   |   |   |   |   |   | 1   |   |
| <b>RENAULT  R9 1.1</b>          |   |   |   |  |   |   |   |   |   |   |   |
|                                 | C1E 715, C1E 720  | 09/81 → 05/87   |   | <b>ΟΛΟΦΩΟ</b>  |   |   |   |   |   |   |   |
|                                 | C1E 715, C1E 720  | 09/81 → 05/87 2)  |   | VKPA 86206<br>VKPC 86206   |   |   |   |   |   | 1<br>1  |   |
|                                 | <b>B(Alt)</b> C1E 715, C1E 720  | 09/81 → 05/87   |   | VKPV 10AVx1140   |   |   | 1   |   |   |   |   |
| <b>RENAULT  R9 1.2</b>          |   |   |   |  |   |   |   |   |   |   |   |
|                                 | C1G 700, C1G 710  | 09/85 → 12/88   |   | <b>ΟΛΟΦΩΟ</b>  |   |   |   |   |   |   |   |
|                                 | C1G 700, C1G 710  | 09/85 → 12/88 2)  |   | VKPA 86206<br>VKPC 86206   |   |   |   |   |   | 1<br>1  |   |
|                                 | <b>B(Alt)</b> C1G 700, C1G 710  | 09/85 → 12/88   |   | VKPV 10AVx1140   |   |   | 1   |   |   |   |   |
| <b>RENAULT  R9 1.4</b>          |   |   |   |  |   |   |   |   |   |   |   |
|                                 | C1J 715, C1J 792,<br>C1J 796, C2J 717,<br>C2J 718, C2J 720,<br>C2J 730, C2J 755,<br>C2J 757, C2J 766,<br>C2J 767, C2J 768 | 09/81 → 12/88   |   | <b>ΟΛΟΦΩΟ</b>  |   |   |   |   |   |   |   |
|                                 | C1J 715, C1J 792,<br>C1J 796, C2J 717,<br>C2J 718, C2J 720,<br>C2J 730, C2J 755,<br>C2J 757, C2J 766,<br>C2J 767, C2J 768 | 09/81 → 12/88 2)  |   | VKPA 86206<br>VKPC 86206   |   |   |   |   |   | 1<br>1  |   |
| <b>RENAULT  R9 1.4 Turbo</b>  |   |   |   |  |   |   |   |   |   |   |   |
|                               | C1J 760, C1J 764  | 04/84 → 12/89   |   | <b>ΟΛΟΦΩΟ</b>  |   |   |   |   |   |   |   |
|                               | C1J 760, C1J 764  | 04/84 → 12/89 2)  |   | VKPA 86206<br>VKPC 86206   |   |   |   |   |   | 1<br>1  |   |
|                               | <b>B(PS)</b> C1J 770  | 04/84 → 12/86   |   | VKPV 10AVx800  |   |   | 1   |   |   |   |   |
| <b>RENAULT  R9 1.7</b>        |   |   |   |  |   |   |   |   |   |   |   |
|                               | F2N 700, F2N 704,<br>F2N 708, F2N 710,<br>F2N 730, F2N 798,<br>F3N 708, F3N 718   | 09/84 → 01/88   |  124, <b>B</b> (58124x19)        | VKMA 06100<br>VKM 16100<br>VKM 26100   | 1<br>1  | 1<br>1  | 1   |   |   |   | T0023   |
|  | F2N 700, F2N 704,<br>F2N 708, F2N 710,<br>F2N 730, F2N 798,<br>F3N 708, F3N 718   | 02/88 → 12/88   |  125,<br><b>B</b> (58125x19 HSN) | VKMA 06101<br>VKM 16101<br>VKM 26101   | 1<br>1  | 1<br>1  | 1   |   |   |   | T0046   |
|                               | F2N 700, F2N 704,<br>F2N 708, F2N 710,<br>F2N 730, F2N 798,<br>F3N 708, F3N 718   | 09/84 → 12/88   |   | VKPC 86413   |   |   |   |   |   | 1   |   |
| <b>RENAULT  R9 1.6 D</b>      |   |   |   |  |   |   |   |   |   |   |   |
|                               | F8M 700, F8M 720,<br>F8M 730  | 10/82 → 01/88   |   | VKMA 06110<br>VKM 16110<br>VKM 26100   | 1<br>1  | 1<br>1  | 1   |   |   |   | T0019   |
|                               | F8M 700, F8M 720,<br>F8M 730  | 10/82 → 12/88   |   | VKPC 86413   |   |   |   |   |   | 1   |   |
| <b>RENAULT  SAFRANE   2.0</b> |   |   |   |  |   |   |   |   |   |   |   |
|                               | J7R 732, J7R 733,<br>J7R 734, J7R 735,<br>J7R 738, J7R 739  | 04/92 → 07/96   |   | VKMA 06205<br>VKM 16204  | 1<br>1  |   | 1   |   |   |   | T0024   |
|                               | J7R 732, J7R 733,<br>J7R 734, J7R 735,<br>J7R 738, J7R 739  | 04/92 → 07/96   |   | VKPC 86606   |   |   |   |   |   | 1   |   |





























RENAULT





























|   |  |  |  |  |  |  |  |  |  |  |  |  |
|---|---|---|---|--|---|---|---|---|---|---|---|---|
|  <b>B(Alt)</b>                            | J7R 732, J7R 733,<br>J7R 734, J7R 735,<br>J7R 738, J7R 739                        | 04/92 → 07/96   | <b>AC</b>   | VKMV 4PK1205<br>VKM_____   | 1   | 1   |   |   |   |   |   |   |
| <b>B(PS)</b>  | J7R 732, J7R 733,<br>J7R 734, J7R 735,<br>J7R 738, J7R 739                        | 04/92 → 07/96   |   | VKMV 10AVx1250   |   | 1   |   |   |   |   |   |   |
| <b>RENAULT  SAFRANE I 2.2</b>            |   |   |   |  |   |   |   |   |   |   |   |   |
|   | J7T 760, J7T 761,<br>J7T 762  | 04/92 → 07/96   |   | VKMA 06204<br>VKM 16204  | 1<br>1  | 1   |   |   |   |   |   | T0024   |
|   | J7T 760, J7T 761,<br>J7T 762  | 04/92 → 07/96   |   | VKPC 86606   |   |   |   | 1   |   |   |   |   |
|  <b>B(Alt)</b>                            | J7T 760, J7T 761,<br>J7T 762  | 04/92 → 07/96   | <b>AC</b>   | VKMV 4PK1205<br>VKM_____   | 1   | 1   |   |   |   |   |   |   |
| <b>B(PS)</b>  | J7T 760, J7T 761,<br>J7T 762  | 04/92 → 07/96   |   | VKMV 10AVx1250   |   | 1   |   |   |   |   |   |   |
| <b>RENAULT  SAFRANE I 3.0 V6</b>         |   |   |   |  |   |   |   |   |   |   |   |   |
|   | Z7X 721, Z7X 722,<br>Z7X 723  | 12/92 → 07/96   |   | <del>OKOKOKO</del>   |   |   |   |   |   |   |   |   |
|   | Z7X 721, Z7X 722,<br>Z7X 723  | 12/92 → 07/96   |   | —  |   |   |   | 1   |   |   |   |   |
| <b>RENAULT  SAFRANE I 3.0 V6 Biturbo</b> |   |   |   |  |   |   |   |   |   |   |   |   |
|   | Z7X 726   | 02/93 → 07/96   |   | <del>OKOKOKO</del>   |   |   |   |   |   |   |   |   |
|   | Z7X 726   | 02/93 → 07/96   |   | —  |   |   |   | 1   |   |   |   |   |
| <b>RENAULT  SAFRANE I 2.1 dT</b>       |   |   |   |  |   |   |   |   |   |   |   |   |
|   | J8S 760   | 11/93 → 07/96   | 3)  | —<br>VKMA 06212<br>VKM 16212<br>VKM 26212  | 1<br>1<br>1   | 1<br>1<br>1   | 1   |   |   |   | 3   | T0015   |
|   | J8S 760   | 11/93 → 07/96   |   | VKPC 86616   |   |   |   | 1   |   |   |   |   |
|  <b>B(Alt)</b>                          | J8S 760   | 11/93 → 07/96   | <b>AC</b>   | VKMV 6PK1740<br>VKM_____   | 1   | 1   |   |   |   |   |   |   |
| <b>RENAULT  SAFRANE I 2.5 dT</b>       |   |   |   |  |   |   |   |   |   |   |   |   |
|   | S8U 762, S8U 763  | 12/92 → 07/96   |   | VKMA 02422<br>VKM 12400  | 1<br>1  | 1   |   |   |   |   |   | T0115   |
|   | S8U 762, S8U 763  | 12/92 → 07/96   |   | VKPC 82638   |   |   |   | 1   |   |   |   |   |
|  <b>B(Alt)</b>                          | S8U 762, S8U 763  | 12/92 → 07/96   |   | VKMV 4PK560  |   |   |   | 1   |   |   |   |   |
| <b>B(AC)</b>  | S8U 762, S8U 763  | 12/92 → 07/96   |   | VKMV 5PK820<br>VKM 36001   |   |   |   | 1   |   |   |   |   |
| <b>B(WP)</b>  | S8U 762, S8U 763  | 12/92 → 04/93   |   | VKMV 5PK850  |   |   |   | 1   |   |   |   |   |
| <b>B(WP)</b>  | S8U 762, S8U 763  | 04/93 → 07/96   |   | VKMV 5PK1110<br>VKM 36001  |   |   |   | 1   |   |   |   |   |
| <b>RENAULT  SAFRANE II 2.0 16V</b>     |   |   |   |  |   |   |   |   |   |   |   |   |
|   | N7Q 710, N7Q 711  | 07/96 → 12/97   |   | VKMA 06602<br>VKM 16602<br>VKM 26602   | 1<br>1  | 1<br>1  | 1   |   |   |   |   | 1 T0163   |
|   | N7Q 710, N7Q 711  | 01/98 → 12/00   |   | VKMA 06604<br>VKM 16604<br>VKM 26602   | 1<br>1  | 1<br>1  | 1   |   |   |   |   | T0163   |
|   | N7Q 710, N7Q 711  | 07/96 → 12/00   |   | VKPC 86618   |   |   |   | 1   |   |   |   |   |
|  <b>B(Alt)</b>                          | N7Q 710, N7Q 711  | 07/96 → 12/00   | <b>AC</b>   | VKMV 6PK1235<br>VKM 36003<br>VKM 36120   |   |   |   | 1   |   |   |   |   |
| <b>B(Alt)</b>   | N7Q 710, N7Q 711  | 07/96 → 12/00   | <b>AC</b>   | VKMV 6PK1605<br>VKM 36003<br>VKM 36120   |   |   |   | 1   |   |   |   |   |
| <b>RENAULT  SAFRANE II 2.5 20V</b>     |   |   |   |  |   |   |   |   |   |   |   |   |
|   | N7U 700, N7U 701  | 07/96 → 12/97   |   | VKMA 06602<br>VKM 16602<br>VKM 26602   | 1<br>1  | 1<br>1  | 1   |   |   |   |   | 1 T0163   |
|   |   |   |   |  |   |   |   | 1   |   |   |   |   |

|   |  |  |    |  |  |  |  |  |  |  |  |  |  |
|---|---|---|---|--|---|---|---|---|---|---|---|---|---|
|   | N7U 700, N7U 701  | 01/98 → 12/00   |   | VKMA 06604<br>VKM 16604<br>VKM 26602   | 1<br>1  | 1<br>1  | 1   |   |   |   |   |   | T0163   |
|                                    | N7U 700, N7U 701  | 07/96 → 12/00   |   | VKPC 86618   |   |   |   |   | 1   |   |   |   |   |
|                                    | <b>B(Alt)</b> N7U 700, N7U 701  | 07/96 → 12/00   |   | VKMV 6PK1605<br>VKM 36003<br>VKM 36120   | 1   | 1   | 1   |   |   |   |   |   |   |
| <b>RENAULT  SAFRANE II 3.0 V6</b>  |   |   |   |  |   |   |   |   |   |   |   |   |   |
|                                    | L7X 713   | 03/99 → 12/99   |   | —<br>VKM 23900<br>VKM 23900<br>VKM 23901   |   | 1<br>1<br>1   |   |   |   |   |   |   |   |
|   | L7X 713   | 12/99 → 12/00   |   | VKMA 03902<br>VKM 13902<br>VKM 23900<br>VKM 23900<br>VKM 23901                     | 1<br>1  | 3<br>1  | 1   |   |   |   |   |   | T0204   |
|   | Z7X 721, Z7X 722,<br>Z7X 723, Z7X 753,<br>Z7X 755                                 | 07/96 → 12/00   |   | —  |   |   |   |   |   |   |   |   |   |
|                                    | L7X 713   | 03/99 → 12/99   |   | VKPC 83637   |   |   |   |   | 1   |   |   |   |   |
|   | L7X 713   | 12/99 → 12/00   |   | —  |   |   |   |   | 1   |   |   |   |   |
|   | Z7X 721, Z7X 722,<br>Z7X 723, Z7X 753,<br>Z7X 755                                 | 07/96 → 12/00   |   | —  |   |   |   |   | 1   |   |   |   |   |
| <b>RENAULT  SAFRANE II 2.2 dT</b>  |   |   |   |  |   |   |   |   |   |   |   |   |   |
|                                   | G8T 740   | 07/96 → 12/00   |   | VKMC 06501<br>VKMA 06501<br>VKM 16501<br>VKM 26501                                 | 1<br>1<br>1   | 1<br>1  | 1   | 1   |   |   |   |   | T0133   |
|   | G8T 740   | 07/96 → 12/00   | 3)  | VKMS 06501<br>VKMA 06501<br>VKM 16501<br>VKM 26501                                 | 1<br>1<br>1   | 1<br>1  | 1   |   |   | 2   |   |   | T0133   |
|                                  | G8T 740   | 07/96 → 12/00   |   | VKPC 86633   |   |   |   |   | 1   |   |   |   |   |
|                                  | <b>B(Alt)</b> G8T 740   | 07/96 → 12/00   | <b>AC</b>   | VKMA 36024<br>VKMV 6PK1010<br>VKM 36024  | 1<br>1  | 1<br>1  | 1   |   |   |   |   |   |   |
|   | <b>B(Alt)</b> G8T 740   | 07/96 → 12/00   | <b>AC</b>   | VKMA 36026<br>VKMV 6PK1949<br>VKM 36019<br>VKM 36022<br>VKM 36026                  | 2<br>1<br>1<br>1  | 1<br>1  | 1   |   |   |   |   |   |   |
|                                  | G8T 740   | 07/96 → 12/00   |   | —  |   |   |   |   | 1   |   |   |   |   |
| <b>RENAULT  SCENIC I 1.4</b>     |   |   |   |  |   |   |   |   |   |   |   |   |   |
|                                  | E7J 764   | 01/97 → 09/99   | 3)  | VKMS 06000<br>VKMA 06000<br>VKM 16000  | 1<br>1<br>1   | 1<br>1  | 1   |   |   | 2   |   |   | T0061   |
|                                  | E7J 764   | 01/97 → 09/99   |   | VKPC 86216   |   |   |   |   | 1   |   |   |   |   |
|                                  | <b>B(Alt)</b> E7J 764   | 01/97 → 09/99   |   | VKMV 3PK712  |   |   | 1   |   |   |   |   |   |   |
|   | <b>B(PS)</b> E7J 764  | 01/97 → 09/99   | <b>AC</b>   | VKMV 3PK835  |   |   | 1   |   |   |   |   |   |   |
|   | <b>B(PS)</b> E7J 764  | 01/97 → 06/97   | <b>AC</b>   | VKMA 36005<br>VKMV____<br>VKM 36005  | 1<br>1  | 1<br>1  |   |   |   |   |   |   |   |
|   | <b>B(AC)</b> E7J 764  | 07/97 → 09/99   |   | VKMV 4PK1272<br>VKM____  | 1   | 1   | 1   |   |   |   |   |   |   |
| <b>RENAULT  SCENIC I 1.4 16V</b> |   |   |   |  |   |   |   |   |   |   |   |   |   |
|                                  | K4J 714, K4J 750  | 09/99 → 08/03   |  | VKMC 06020<br>VKMA 06020<br>VKM 16020<br>VKM 26020                                 | 1<br>1<br>1   | 1<br>1<br>1   | 1   | 1   |   | 2<br>2  | 1<br>1  |   | T0159   |
|                                  | K4J 714, K4J 750  | 09/99 → 08/03   |   | VKPC 86416   |   |   |   |   | 1   |   |   |   |   |
|                                  | <b>B(Alt)</b> K4J 714, K4J 750  | 09/99 → 08/03   | <b>AC</b>   | VKMA 36091<br>VKMV 5PK1110<br>VKM 36091  | 1<br>1  | 1<br>1  |   |   |   |   |   |   |   |



RENAULT





















|   |              |  |    |  |  |  |  |  |  |  |  |  |  |
|---|---|---|---|--|---|---|---|---|---|---|---|---|---|
| <b>B(Alt)</b>   | K4J 714, K4J 750  | 09/99 → 09/01   | <b>AC</b>   | VKMOV 6PK1750<br>VKM 36031<br>VKM 36031  |   | 1   |   |   |   |   |   |   |   |
| <b>B(Alt)</b>   | K4J 714, K4J 750  | 09/01 → 08/03   | <b>AC</b>   | VKMA 36020<br>VKM 36031<br>VKM 36031   |   | 2   | 1   |   |   |   |   |   |   |
| <b>RENAULT  SCENIC I 1.6</b>       |   |   |   |  |   |   |   |   |   |   |   |   |   |
|                                     | K7M 702, K7M 703  | 01/97 → 09/99   |    | VKMC 06415<br>VKMA 06000<br>VKM 16000  | 1   | 1   | 1   |   |   |   |   |   | T0061   |
|   | K7M 720   | 01/97 → 09/99   |    | VKMC 06003<br>VKMA 06003<br>VKM 16003  | 1   | 1   | 1   |   |   |   |   |   | T0145   |
|   | K7M 702, K7M 703  | 01/97 → 09/99   | 3)  | VKMS 06000<br>VKMA 06000<br>VKM 16000  | 1   | 1   |   |   | 2   |   |   |   | T0061   |
|                                     | K7M 702, K7M 703,<br>K7M 720  | 01/97 → 09/99   |   | VKPC 86415   |   |   |   | 1   |   |   |   |   |   |
|                                     | <b>B(Alt)</b> K7M 702, K7M 703,<br>K7M 720  | 01/97 → 09/99   |   | VKMOV 3PK712   |   |   | 1   |   |   |   |   |   |   |
|   | <b>B(PS)</b> K7M 702, K7M 703,<br>K7M 720   | 01/97 → 09/99   | <b>AC</b>   | VKMOV 3PK835   |   |   | 1   |   |   |   |   |   |   |
|   | <b>B(PS)</b> K7M 702, K7M 703,<br>K7M 720   | 01/97 → 06/97   | <b>AC</b>   | VKMA 36005<br>VKMV____<br>VKM 36005  | 1   | 1   |   |   |   |   |   |   |   |
|   | <b>B(AC)</b> K7M 702, K7M 703,<br>K7M 720   | 07/97 → 09/99   |   | VKMOV 4PK1272<br>VKM____   | 1   | 1   |   |   |   |   |   |   |   |
| <b>RENAULT  SCENIC I 1.6 16V</b> |   |   |   |  |   |   |   |   |   |   |   |   |   |
|                                   | K4M 700, K4M 701,<br>K4M 704, K4M 706,<br>K4M 707, K4M 708,<br>K4M 709, K4M 712,<br>K4M 776   | 09/99 → 08/03   |  | VKMC 06020<br>VKMA 06020<br>VKM 16020<br>VKM 26020                                 | 1   | 1   | 1   | 1   |   | 2   | 1   |   | T0159   |
|                                   | K4M 700, K4M 701,<br>K4M 704, K4M 706,<br>K4M 707, K4M 708,<br>K4M 709, K4M 712,<br>K4M 776   | 09/99 → 08/03   |   | VKPC 86416   |   |   |   | 1   |   |   |   |   |   |
|                                   | <b>B(Alt)</b> K4M 700, K4M 701,<br>K4M 704, K4M 706,<br>K4M 708, K4M 709,<br>K4M 712, K4M 776 | 09/99 → 08/03   | <b>AC</b>   | VKMA 36091<br>VKMV 5PK1110<br>VKM 36091  | 1   | 1   |   |   |   |   |   |   |   |
|   | <b>B(Alt)</b> K4M 700, K4M 701,<br>K4M 704, K4M 706,<br>K4M 708, K4M 709,<br>K4M 712, K4M 776 | 09/99 → 09/01   | <b>AC</b>   | VKMOV 6PK1750<br>VKM 36031<br>VKM 36031  |   |   | 1   |   |   |   |   |   |   |
|   | <b>B(Alt)</b> K4M 700, K4M 701,<br>K4M 704, K4M 706,<br>K4M 708, K4M 709,<br>K4M 712, K4M 776 | 09/01 → 08/03   | <b>AC</b>   | VKMA 36020<br>VKM 36031<br>VKM 36031   |   | 2   | 1   |   |   |   |   |   |   |
| <b>RENAULT  SCENIC I 1.8 16V</b> |   |   |   |  |   |   |   |   |   |   |   |   |   |
|                                   | F4P 720, F4P 722  | 01/01 → 04/01   |   | VKMA 06107<br>VKM 16550<br>VKM 26020<br>VKM 26310                                  | 1   | 2   | 1   |   |   | 2   |   |   | T0161   |

























|   |  |  |    |  |  |  |  |  |  |  |  |  |
|---|---|---|---|--|---|---|---|---|---|---|---|---|
|   | F4P 720, F4P 722  | 04/01 → 08/03   |   | VKMA 06108<br>VKM 16550<br>VKM 26105<br>VKM 26310                                  | 1<br>1  | 2<br>1  | 1<br>1  |   |   | 2   |   | T0161   |
|                                    | F4P 720, F4P 722  | 01/01 → 08/03   |   | VKPC 86413   |   |   |   | 1   |   |   |   |   |
|                                    | <b>B(Alt)</b> F4P 720, F4P 722  | 01/01 → 08/03   |   | VKMA 36020<br>VKM 36031<br>VKM 36031   |   | 2<br>1<br>1   | 1   |   |   |   |   |   |
| <b>RENAULT  SCENIC I 2.0</b>       |   |   |   |  |   |   |   |   |   |   |   |   |
|                                    | F3R 750, F3R 751,<br>F3R 791, F3R 796,<br>F3R 797, F3R 798                        | 01/97 → 09/99   |   | VKMA 06103<br>VKM 16101<br>VKM 26101   | 1<br>1  | 1<br>1  | 1   |   |   |   |   | T0108   |
|   | F3R 791, F3R 796,<br>F3R 797, F3R 798   | 01/99 → 09/99   | <b>P</b>  | VKMA 06123<br>VKM 16101<br>VKM 26101<br>VKM 26123                                  | 1<br>1  | 2<br>1  | 1<br>1  |   |   |   |   | T0655   |
|                                    | F3R 750, F3R 751,<br>F3R 791, F3R 796,<br>F3R 797, F3R 798                        | 01/97 → 09/99   |   | VKPC 86413   |   |   |   | 1   |   |   |   |   |
|                                    | <b>B(Alt)</b> F3R 750, F3R 751,<br>F3R 791, F3R 796,<br>F3R 797, F3R 798          | 01/97 → 09/99   | <b>AC</b>   | VKMA 6PK1125<br>VKM 36006  |   | 1   | 1   |   |   |   |   |   |
|   | <b>B(Alt)</b> F3R 750, F3R 751,<br>F3R 791, F3R 796,<br>F3R 797, F3R 798          | 01/97 → 09/99   | <b>AC</b>   | VKMA 36006<br>VKMV 6PK1658<br>VKM 36006  |   | 1<br>1  | 1<br>1  |   |   |   |   |   |
| <b>RENAULT  SCENIC I 2.0 16V</b> |   |   |   |  |   |   |   |   |   |   |   |   |
|                                  | F4R 740, F4R 741,<br>F4R 744, F4R 746,<br>F4R 747                                 | 09/99 → 04/01   |   | VKMA 06107<br>VKM 16550<br>VKM 26020<br>VKM 26310                                  | 1<br>1  | 2<br>1  | 1<br>1  |   |   | 2   |   | T0161   |
|   | F4R 740, F4R 741,<br>F4R 744, F4R 746,<br>F4R 747                                 | 04/01 → 08/03   |   | VKMA 06108<br>VKM 16550<br>VKM 26105<br>VKM 26310                                  | 1<br>1  | 2<br>1  | 1<br>1  |   |   | 2   |   | T0161   |
|                                  | F4R 740, F4R 741,<br>F4R 744, F4R 746,<br>F4R 747                                 | 09/99 → 08/03   |   | VKPC 86413   |   |   |   | 1   |   |   |   |   |
|                                  | <b>B(Alt)</b> F4R 740, F4R 741,<br>F4R 744, F4R 746,<br>F4R 747                   | 09/99 → 08/03   |   | VKMA 36020<br>VKM 36031<br>VKM 36031   |   | 2<br>1<br>1   | 1   |   |   |   |   |   |
| <b>RENAULT  SCENIC I 1.9 D</b>   |   |   |   |  |   |   |   |   |   |   |   |   |
|                                  | F8Q 788, F8Q 790  | 03/97 → 09/99   | 3), <b>B</b> (76153x25.4 HSN),<br> 153 | VKMS 06114-2<br>VKMA 06114<br>VKM 16101<br>VKM 26101                               | 1<br>1<br>1   | 1<br>1<br>1   | 1<br>1  |   |   | 2   |   | T0147   |
|   | F8Q 788, F8Q 790  | 03/97 → 09/99   | <b>P, B</b> (76153x25.4 HSN),<br> 153  | VKMA 06124<br>VKM 16101<br>VKM 26101<br>VKM 26125                                  | 1<br>1  | 2<br>1  | 1<br>1  |   |   |   |   | T0147   |
|                                  | F8Q 788, F8Q 790  | 03/97 → 09/99   |   | VKPC 86413   |   |   |   | 1   |   |   |   |   |
|                                  | <b>B(Alt)</b> F8Q 788, F8Q 790  | 03/97 → 09/99   | <b>AC</b>   | VKMA 6PK1135   |   |   | 1   |   |   |   |   |   |
|   | <b>B(Alt)</b> F8Q 788, F8Q 790  | 03/97 → 09/99   | <b>AC</b>   | VKMA 36032<br>VKMV 6PK1640   | 1   | 1   | 1<br>1  |   |   |   | 1   |   |



RENAULT



|   |  |  |                                        |  |  |  |  |  |  |  |  |  |
|---|---|---|---|--|---|---|---|---|---|---|---|---|
|   |   |   |   | VKM 36016<br>VKM 36032   | 1   | 1   |   |   |   |   |   | 1   |
| ⊙   | F8Q 788, F8Q 790  | 03/97 → 09/99   |   | VKM_____   |   |   |   | 1   |   |   |   |   |
| <b>RENAULT  SCENIC I 1.9 dT</b>    |   |   |   |  |   |   |   |   |   |   |   |   |
|                                     | F8Q 784   | 01/97 → 09/99   | 3), <b>B</b> (76153x25.4 HSN),<br> 153 | VKMS 06114-1<br>VKMA 06114<br>VKM 16101<br>VKM 26101                               | 1<br>1<br>1   | 1<br>1<br>1   | 1<br>1  |   |   |   | 3   | T0147   |
|   | F8Q 786, F8Q 788,<br>F8Q 790  | 01/97 → 09/99   | 3), <b>B</b> (76153x25.4 HSN),<br> 153 | VKMS 06114-2<br>VKMA 06114<br>VKM 16101<br>VKM 26101                               | 1<br>1<br>1   | 1<br>1<br>1   | 1   |   |   |   | 2   | T0147   |
|   | F8Q 786, F8Q 788,<br>F8Q 790  | 01/97 → 09/99   | <b>P, B</b> (76153x25.4 HSN),<br> 153  | VKMA 06124<br>VKM 16101<br>VKM 26101<br>VKM 26125                                  | 1<br>1  | 2<br>1  | 1<br>1  |   |   |   |   | T0147   |
| ⊙   | F8Q 784, F8Q 786,<br>F8Q 788, F8Q 790   | 01/97 → 09/99   |   | VKPC 86413   |   |   |   | 1   |   |   |   |   |
|                                     | <b>B(Alt)</b> F8Q 784, F8Q 786,<br>F8Q 788, F8Q 790                               | 01/97 → 09/99   | <b>AC</b>   | VKMA 36032<br>VKMV 6PK1640<br>VKM 36016<br>VKM 36032                               | 1<br>1  | 1<br>1  | 1<br>1  |   |   |   |   | 1<br>1  |
|   | <b>B(Alt)</b> F8Q 784, F8Q 786,<br>F8Q 788, F8Q 790                               | 01/97 → 09/99   | <b>AC</b>   | VKMA 36032<br>VKMV 6PK1640<br>VKM 36016<br>VKM 36032                               | 1<br>1  | 1<br>1  | 1<br>1  |   |   |   |   | 1<br>1  |
| ⊙   | F8Q 784, F8Q 786  | 01/97 → 09/99   |   | VKM_____   |   |   |   | 1   |   |   |   |   |
| <b>RENAULT  SCENIC I 1.9 dTi</b> |   |   |   |  |   |   |   |   |   |   |   |   |
|                                   | F9Q 734, F9Q 736  | 04/97 → 10/00   | 3)  | VKMS 06115<br>VKMA 06115<br>VKM 16101<br>VKM 26115                                 | 1<br>1<br>1   | 1<br>1<br>1   | 1   |   |   |   | 2   | T0148   |
|   | F9Q 734, F9Q 736  | 04/97 → 10/00   | <b>P</b>  | VKMA 06125<br>VKM 16101<br>VKM 26115<br>VKM 26125                                  | 1<br>1  | 2<br>1  | 1   |   |   |   |   | T0148   |
|   | F9Q 731, F9Q 736  | 10/00 → 06/01   | <b>c, P</b>   | VKMA 06137<br>VKM 16551<br>VKM 26117<br>VKM 26125<br>VKM 26128                     | 1<br>1  | 2<br>1  | 1<br>1  |   |   | 1   |   | T0181   |
|   | F9Q 731, F9Q 736  | 10/00 → 06/01   | <b>c</b>  | VKMA 06117<br>VKM 16551<br>VKM 26117<br>VKM 26128                                  | 1<br>1  | 1<br>1  | 1   |   |   | 1   |   | T0181   |
|   | F9Q 736   | 06/01 → 08/03   |   | VKMA 06128<br>VKM 16551<br>VKM 26128   | 1<br>1  | 1<br>1  | 1   |   |   |   |   | T0181   |
|   | F9Q 744   | 02/01 → 08/03   | <b>c, P</b>   | VKMA 06137<br>VKM 16551<br>VKM 26117<br>VKM 26125<br>VKM 26128                     | 1<br>1  | 2<br>1  | 1<br>1  |   |   | 1   |   | T0181   |
|   | F9Q 744   | 02/01 → 08/03   | <b>c</b>  | VKMA 06117<br>VKM 16551<br>VKM 26117<br>VKM 26128                                  | 1<br>1  | 1<br>1  | 1   |   |   | 1   |   | T0181   |
| ⊙   | F9Q 731, F9Q 734,<br>F9Q 736, F9Q 744   | 04/97 → 08/03   |   | VKPC 86413   |   |   |   | 1   |   |   |   |   |
|                                   | <b>B(Alt)</b> F9Q 731, F9Q 734,<br>F9Q 736, F9Q 744                               | 04/97 → 08/03   | <b>AC</b>   | VKMA 36032<br>VKMV 6PK1640<br>VKM 36016<br>VKM 36032                               | 1<br>1  | 1<br>1  | 1<br>1  |   |   |   |   | 1<br>1  |
|   | <b>B(Alt)</b> F9Q 731, F9Q 734,<br>F9Q 736, F9Q 744                               | 05/97 → 03/01   | <b>AC</b>   | VKMA 36032<br>VKMV 6PK1640   | 1<br>1  | 1<br>1  | 1<br>1  |   |   |   |   | 1<br>1  |

|   |  |  |    |  |  |  |  |  |  |  |  |  |
|---|---|---|---|--|---|---|---|---|---|---|---|---|
|   |   |   |   | VKM 36016<br>VKM 36032   | 1   | 1   |   |   |   |   |   | 1   |
| <b>B(Alt)</b>   | F9Q 731   | 03/01 → 08/03   | <b>AC</b>   | VKMA 36034<br>VKMV 6PK1606<br>VKM 36016<br>VKM 36032                               | 1   | 1   | 1   |   |   |   |   | 1   |
| <b>B(Alt)</b>   | F9Q 736, F9Q 744  | 03/01 → 08/03   | <b>AC</b>   | VKMA 36035<br>VKMV 6PK1606<br>VKM 36016<br>VKM 36035                               | 1   | 1   | 1   |   |   |   |   | 1   |
|    | F9Q 734   | 04/97 → 09/99   |   | VKM _____  |   |   |   |   |   | 1   |   |   |
| <b>RENAULT  SCENIC I 1.9 dCi</b>                   |   |   |   |  |   |   |   |   |   |   |   |   |
|    | F9Q 732, F9Q 733,<br>F9Q 740, F9Q 748   | 11/00 → 08/03   | 3)  | VKMS 06115<br>VKMA 06115<br>VKM 16101<br>VKM 26115                                 | 1   | 1   | 1   |   |   |   | 2   | T0148   |
|   | F9Q 732, F9Q 733,<br>F9Q 740, F9Q 748,<br>F9Q 796                                 | 11/00 → 08/03   | <b>P</b>  | VKMA 06125<br>VKM 16101<br>VKM 26115<br>VKM 26125                                  | 1   | 2   | 1   |   |   |   |   | T0148   |
|   | F9Q 796   | 11/00 → 08/03   |   | VKMA 06115<br>VKM 16101<br>VKM 26115   | 1   | 1   | 1   |   |   |   |   | T0148   |
|    | F9Q 732, F9Q 733,<br>F9Q 740, F9Q 748,<br>F9Q 796                                 | 11/00 → 08/03   |   | VKPC 86413   |   |   |   |   |   | 1   |   |   |
|    | <b>B(Alt)</b> F9Q 732, F9Q 733,<br>F9Q 740  | 11/00 → 08/03   | <b>AC</b>   | VKMV 6PK1135   |   |   | 1   |   |   |   |   |   |
| <b>B(Alt)</b>   | F9Q 732, F9Q 740  | 11/00 → 03/01   | <b>AC</b>   | VKMA 36032<br>VKMV 6PK1640<br>VKM 36016<br>VKM 36032                               | 1   | 1   | 1   |   |   |   |   | 1   |
| <b>B(Alt)</b>   | F9Q 732, F9Q 740,<br>F9Q 748  | 03/01 → 08/03   | <b>AC</b>   | VKMA 36035<br>VKMV 6PK1606<br>VKM 36016<br>VKM 36035                               | 1   | 1   | 1   |   |   |   |   | 1   |
| <b>B(Alt)</b>   | F9Q 733, F9Q 738,<br>F9Q 796  | 11/00 → 08/03   | <b>AC</b>   | VKMA 36035<br>VKMV 6PK1606<br>VKM 36016<br>VKM 36035                               | 1   | 1   | 1   |   |   |   |   | 1   |
| <b>RENAULT  SCENIC II / GRAND SCENIC 1.4 16V</b> |   |   |   |  |   |   |   |   |   |   |   |   |
|    | K4J 730, K4J 740  | 06/03 → 10/05   |  | VKMC 06020<br>VKMA 06020<br>VKM 16020<br>VKM 26020                                 | 1   | 1   | 1   |   | 1   |   | 2   | 1   |
|   | K4J 730, K4J 740  | 06/03 → 09/07   |   | VKPC 86416   |   |   |   |   | 1   |   |   |   |
|    | <b>B(Alt)</b> K4J 730, K4J 740  | 06/03 → 05/06   | <b>AC</b>   | VKMA 36052<br>VKMV 5PK1135<br>VKM 36052<br>VKM 36053                               | 1   | 1   | 1   |   |   |   |   |   |
| <b>B(Alt)</b>   | K4J 730, K4J 740  | 05/06 → 09/07   | <b>AC</b>   | VKMV 6PK1199<br>VKM 36053  |   |   | 1   |   |   |   |   |   |
| <b>B(Alt)</b>   | K4J 730   | 06/03 → 04/05   | <b>AC</b>   | VKMV 5PK1199   |   |   | 1   |   |   |   |   |   |
| <b>B(Alt)</b>   | K4J 730   | 04/05 → 09/07   | <b>AC</b>   | VKMV 6PK1199   |   |   | 1   |   |   |   |   |   |
| <b>B(Alt)</b>   | K4J 740   | 06/03 → 09/07   | <b>AC</b>   | VKMV 6PK1199   |   |   | 1   |   |   |   |   |   |
| <b>RENAULT  SCENIC II / GRAND SCENIC 1.6 16V</b> |   |   |   |  |   |   |   |   |   |   |   |   |
|    | K4M 764, K4M 788  | 06/03 → 09/07   |  | VKMC 06020<br>VKMA 06020<br>VKM 16020<br>VKM 26020                                 | 1   | 1   | 1   |   | 1   |   | 2   | 1   |
|   |   |   |   |  |   |   |   |   |   |   | 2   | 1   |
|   |   |   |   |  |   |   |   |   |   |   |   | T0159   |























RENAULT

































|  | K4M 761, K4M 782,<br>K4M 812, K4M 813                           | 06/03 → 09/07 |           | VKMA 06021<br>VKM 16021<br>VKM 26020                 | 1<br>1<br>1 | 1 | 1 |  |   |  | 2 | 1 | T0159   |
|--|---|---------------|-----------|--|-------------|---|---|--|---|--|---|---|---------|
|  | K4M 761, K4M 764,<br>K4M 782                                    | 06/03 → 09/07 |           | VKPC 86416   |             |   |   |  | 1 |  |   |   |         |
|  | <b>B(Alt)</b> K4M 761, K4M 782,<br>K4M 812, K4M 813             | 06/03 → 05/06 | <b>AC</b> | VKMA 36052<br>VKMV 5PK1135<br>VKM 36052<br>VKM 36053 | 1<br>1<br>1 | 1 | 1 |  |   |  |   |   |         |
|  | <b>B(Alt)</b> K4M 761, K4M 782                                  | 04/05 → 09/07 | <b>AC</b> | VKMV 6PK1199   |             |   | 1 |  |   |  |   |   |         |
| <b>RENAULT  SCENIC II / GRAND SCENIC 2.0 16V</b>       |   |               |           |  |             |   |   |  |   |  |   |   |         |
|  | F4R 770, F4R 771  | 06/03 → 09/07 |           | VKMC 06106<br>VKMA 06106<br>VKM 16550<br>VKM 26105   | 1<br>1<br>1 | 1 | 1 |  | 1 |  | 2 | 2 | T0177   |
|  | F4R 770, F4R 771  | 06/03 → 09/07 |           | VKPC 85304   |             |   |   |  | 1 |  |   |   |         |
|  | <b>B(Alt)</b> F4R 770, F4R 771                                  | 06/03 → 09/07 |           | VKMA 36072<br>VKMV 7PK1127<br>VKM 36072              | 1<br>1      |   | 1 |  |   |  |   |   |         |
| <b>RENAULT  SCENIC II / GRAND SCENIC 2.0 16V Turbo</b> |   |               |           |  |             |   |   |  |   |  |   |   |         |
|  | F4R 776   | 04/04 → 09/07 |           | VKMC 06106<br>VKMA 06106<br>VKM 16550<br>VKM 26105   | 1<br>1<br>1 | 1 | 1 |  | 1 |  | 2 | 2 | T0177   |
|  | F4R 776   | 04/04 → 09/07 |           | VKPC 85304   |             |   |   |  | 1 |  |   |   |         |
|  | <b>B(Alt)</b> F4R 776   | 04/04 → 09/07 |           | VKMA 36072<br>VKMV 7PK1127<br>VKM 36072              | 1<br>1      |   | 1 |  |   |  |   |   |         |
| <b>RENAULT  SCENIC II / GRAND SCENIC 1.5 dCi</b>       |   |               |           |  |             |   |   |  |   |  |   |   |         |
|  | K9K 722   | 06/03 → 08/03 |           | VKMA 06130<br>VKM 16102                              | 1<br>1      |   | 1 |  |   |  |   |   | 1 T0191 |
|  | K9K 722, K9K 724,<br>K9K 728, K9K 729,<br>K9K 732, K9K 734      | 08/03 → 09/07 |           | VKMA 06132<br>VKM 16102                              | 1<br>1      |   | 1 |  |   |  |   |   | 1 T0191 |
|  | K9K 722, K9K 728  | 06/03 → 04/04 |           | VKPC 86417   |             |   |   |  | 1 |  |   |   |         |
|  | K9K 722, K9K 724,<br>K9K 728, K9K 732,<br>K9K 734               | 04/04 → 01/07 |           | VKPC_____  |             |   |   |  | 1 |  |   |   |         |
|  | <b>B(Alt)</b> K9K 722, K9K 724,<br>K9K 728, K9K 732             | 06/03 → 09/05 | <b>AC</b> | VKMA 36052<br>VKMV 5PK1135<br>VKM 36052<br>VKM 36053 | 1<br>1<br>1 | 1 | 1 |  |   |  |   |   |         |
|  | <b>B(Alt)</b> K9K 722, K9K 724,<br>K9K 728, K9K 732,<br>K9K 734 | 09/05 → 11/07 | <b>AC</b> | VKMV 6PK1199<br>VKM 36053                            |             |   | 1 |  |   |  |   |   |         |
|  | <b>B(Alt)</b> K9K 722, K9K 728                                  | 06/03 → 01/05 | <b>AC</b> | VKMA 36050<br>VKMV 5PK1199<br>VKM 36050              | 1<br>1      |   | 1 |  |   |  |   |   |         |
|  | <b>B(Alt)</b> K9K 722, K9K 724,<br>K9K 728, K9K 732,<br>K9K 734 | 01/05 → 12/07 | <b>AC</b> | VKMV 6PK1199   |             |   | 1 |  |   |  |   |   |         |
| <b>RENAULT  SCENIC II / GRAND SCENIC 1.9 dCi</b>       |   |               |           |  |             |   |   |  |   |  |   |   |         |
|  | F9Q 803, F9Q 804,<br>F9Q 812, F9Q 816,<br>F9Q 818               | 06/03 → 09/07 |           | VKMA 06129<br>VKM 16129                              | 1<br>1      |   | 1 |  |   |  |   |   | T0208   |
|  | F9Q 803, F9Q 804,<br>F9Q 812, F9Q 816,<br>F9Q 818               | 06/03 → 09/07 |           | VKPC 86129   |             |   |   |  | 1 |  |   |   |         |

|  | <b>B(Alt)</b> F9Q 803, F9Q 804, F9Q 812, F9Q 816, F9Q 818 | 06/03 → 09/07 |        | VKMA 36072<br>VKMV 7PK1127<br>VKM 36072           | 1<br>1<br>1      | 1<br>1 |        |   |        |  |        |       |
|--|---|---------------|--------|---|------------------|--------|--------|---|--------|--|--------|-------|
| <b>RENAULT  SCENIC II / GRAND SCENIC 2.0 dCi</b> |   |               |        |   |                  |        |        |   |        |  |        |       |
|  | M9R 700, M9R 720, M9R 721, M9R 722                        | 09/05 → 09/07 |        | <b>OXOXOXO</b>                                    |                  |        |        |   |        |  |        |       |
|  | M9R 700, M9R 720, M9R 721, M9R 722                        | 09/05 → 09/07 |        | VKPC_____   |                  |        |        |   | 1      |  |        |       |
|  | <b>B(Alt)</b> M9R 700, M9R 720, M9R 721, M9R 722          | 09/05 → 09/07 |        | VKMA_____<br>VKMV 7PK1705<br>VKM_____<br>VKM_____ | 1<br>1<br>1<br>1 | 1<br>1 | 1<br>1 |   |        |  | 1<br>1 |       |
| <b>RENAULT  SPORT SPIDER 2.0 16V</b>             |   |               |        |   |                  |        |        |   |        |  |        |       |
|  | F7R 710, F7R 712, F7R 720                                 | 03/95 → 10/99 |        | VKMA 06112<br>VKM 16112<br>VKM 26102              | 1<br>1<br>1      | 1<br>1 | 1<br>1 |   |        |  |        | T0076 |
|  | F7R 720   | 03/95 → 10/99 |        | VKMA 06122<br>VKM 16112<br>VKM 26102<br>VKM 26125 | 1<br>1<br>1<br>1 | 2<br>1 | 1<br>1 |   |        |  |        | T0651 |
|  | F7R 710, F7R 712, F7R 720                                 | 03/95 → 10/99 |        | VKPC 86413  |                  |        |        |   | 1      |  |        |       |
| <b>RENAULT  SUPER 5 1.0</b>                      |   |               |        |   |                  |        |        |   |        |  |        |       |
|  | C1C 700   | 10/84 → 10/88 |        | <b>OXOXOXO</b>                                    |                  |        |        |   |        |  |        |       |
|  | C1C 700   | 10/84 → 10/88 | 2), AC | VKPA 86206<br>VKPC 86206                          |                  |        |        |   | 1<br>1 |  |        |       |
|  | C1C 700   | 10/84 → 10/88 | AC     | VKPC 86209  |                  |        |        |   | 1      |  |        |       |
|  | <b>B(Alt)</b> C1C 700                                     | 10/84 → 10/88 | AC, Ø  | VKMV 10AVx1140                                    |                  |        |        | 1 |        |  |        |       |
|  | <b>B(Alt)</b> C1C 700                                     | 10/84 → 10/88 | AC, Ø  | VKMV 10AVx1150                                    |                  |        |        | 1 |        |  |        |       |
|  | <b>B(Alt)</b> C1C 700                                     | 10/84 → 10/88 | AC     | VKMV 6PK1710                                      |                  |        |        | 1 |        |  |        |       |
| <b>RENAULT  SUPER 5 1.1</b>                      |   |               |        |   |                  |        |        |   |        |  |        |       |
|  | C1E 750, C1E 752, C1E 754, C1E 756, C1E 760               | 10/84 → 12/96 |        | <b>OXOXOXO</b>                                    |                  |        |        |   |        |  |        |       |
|  | C1E 750, C1E 752, C1E 754, C1E 756, C1E 760               | 10/84 → 12/96 | 2), AC | VKPA 86206<br>VKPC 86206                          |                  |        |        |   | 1<br>1 |  |        |       |
|  | C1E 750, C1E 752, C1E 754, C1E 756, C1E 760               | 10/84 → 12/96 | AC     | VKPC 86209  |                  |        |        |   | 1      |  |        |       |
|  | <b>B(Alt)</b> C1E 750, C1E 752, C1E 754, C1E 756, C1E 760 | 10/84 → 12/96 | AC, Ø  | VKMV 10AVx1140                                    |                  |        |        | 1 |        |  |        |       |
|  | <b>B(Alt)</b> C1E 750, C1E 752, C1E 754, C1E 756, C1E 760 | 10/84 → 12/96 | AC, Ø  | VKMV 10AVx1150                                    |                  |        |        | 1 |        |  |        |       |
|  | <b>B(Alt)</b> C1E 750, C1E 752, C1E 754, C1E 756, C1E 760 | 10/84 → 12/96 | AC     | VKMV 6PK1710                                      |                  |        |        | 1 |        |  |        |       |
| <b>RENAULT  SUPER 5 1.2</b>                      |   |               |        |   |                  |        |        |   |        |  |        |       |
|  | C1G 702, C1G 720, C1G 722                                 | 01/87 → 12/96 |        | <b>OXOXOXO</b>                                    |                  |        |        |   |        |  |        |       |
|  | C1G 702, C1G 720, C1G 722, C3J 760                        | 01/87 → 12/96 | 2), AC | VKPA 86206<br>VKPC 86206                          |                  |        |        |   | 1<br>1 |  |        |       |
|  | C1G 702, C1G 720, C1G 722, C3G 760                        | 01/87 → 12/96 | AC     | VKPC 86209  |                  |        |        |   | 1      |  |        |       |
|  | <b>B(Alt)</b> C1G 702, C1G 720, C1G 722                   | 01/87 → 12/96 | AC, Ø  | VKMV 10AVx1140                                    |                  |        |        | 1 |        |  |        |       |



RENAULT

|  |   |  |  |  |  |  |  |  |  |  |  |  |
|--|--|---|---|--|---|---|---|---|---|---|---|---|
| B(Alt)   | C1G 702, C1G 720,<br>C1G 722   | 01/87 → 12/96   | AC, ⊕   | VKMV 10AVx1150   |   |   | 1   |   |   |   |   |   |
| B(Alt)   | C1G 702, C1G 720,<br>C1G 722   | 01/87 → 12/96   | AC  | VKMV 6PK1710   |   |   | 1   |   |   |   |   |   |
| <b>RENAULT  SUPER 5 1.4</b>         |  |   |   |  |   |   |   |   |   |   |   |   |
|                                      | C1J 768, C1J 780,<br>C2J 700, C2J 780,<br>C2J 781, C2J 782,<br>C2J 784, C2J 788,<br>C2J 789, C2J 798,<br>C3J 700, C3J 702,<br>C3J 760          | 10/84 → 12/96   |   | OXOXOXO  |   |   |   |   |   |   |   |   |
|                                      | C1J 768, C1J 780,<br>C2J 700, C2J 780,<br>C2J 781, C2J 784,<br>C2J 788, C2J 789,<br>C2J 798, C3J 700,<br>C3J 702, C3J 760,<br>C3J 782, C3J 789 | 10/84 → 12/96   | 2), AC  | VKPA 86206<br>VKPC 86206   |   |   |   |   |   | 1<br>1  |   |   |
|  | C1J 768, C1J 780,<br>C2J 700, C2J 780,<br>C2J 781, C2J 784,<br>C2J 788, C2J 789,<br>C2J 798, C3J 700,<br>C3J 702, C3J 760,<br>C3J 782, C3J 789 | 10/84 → 12/96   | AC  | VKPC 86209   |   |   |   |   |   | 1   |   |   |
|                                     | B(Alt) C1J 768, C1J 780,<br>C2J 700, C2J 780,<br>C2J 781, C2J 782,<br>C2J 784, C2J 788,<br>C2J 789, C2J 798,<br>C3J 700, C3J 702,<br>C3J 760   | 10/84 → 12/96   | AC, ⊕   | VKMV 10AVx1140   |   |   | 1   |   |   |   |   |   |
|  | B(Alt) C1J 768, C1J 780,<br>C2J 700, C2J 780,<br>C2J 781, C2J 782,<br>C2J 784, C2J 788,<br>C2J 789, C2J 798,<br>C3J 700, C3J 702,<br>C3J 760   | 10/84 → 12/96   | AC, ⊕   | VKMV 10AVx1150   |   |   | 1   |   |   |   |   |   |
|  | B(Alt) C1J 768, C1J 780,<br>C2J 700, C2J 780,<br>C2J 781, C2J 782,<br>C2J 784, C2J 788,<br>C2J 789, C2J 798,<br>C3J 700, C3J 702,<br>C3J 760   | 10/84 → 12/96   | AC  | VKMV 6PK1710   |   |   | 1   |   |   |   |   |   |
| <b>RENAULT  SUPER 5 1.4 Turbo</b> |  |   |   |  |   |   |   |   |   |   |   |   |
|                                    | C1J 782, C1J 784,<br>C1J 788   | 01/85 → 05/91   |   | OXOXOXO  |   |   |   |   |   |   |   |   |
|                                    | C1J 782, C1J 784,<br>C1J 788   | 01/85 → 05/91   | 2), AC  | VKPA 86206<br>VKPC 86206   |   |   |   |   |   | 1<br>1  |   |   |
|  | C1J 782, C1J 784,<br>C1J 788   | 01/85 → 05/91   | AC  | VKPC 86209   |   |   |   |   |   | 1   |   |   |
| <b>RENAULT  SUPER 5 1.7</b>       |  |   |   |  |   |   |   |   |   |   |   |   |
|                                    | F2N 740, F2N 742,<br>F3N 702, F3N 716,<br>F3N 717  | 02/88 → 03/95   | 3)  | VKMS 06101<br>VKMA 06101<br>VKM 16101<br>VKM 26101                                 | 1<br>1<br>1   | 1<br>1<br>1   | 1<br>1<br>1   |   |   |   | 3   | T0046   |
|  | F2N 740, F2N 742,<br>F3N 702, F3N 716,<br>F3N 717  | 10/86 → 01/88   |   | VKMA 06100<br>VKM 16100<br>VKM 26100   | 1<br>1  | 1<br>1  | 1<br>1  |   |   |   |   | T0023   |



















|   |  |  |                |  |  |  |  |  |  |  |  |  |
|---|---|---|---|--|---|---|---|---|---|---|---|---|
|                                  | F2N 740, F2N 742,<br>F3N 702, F3N 716,<br>F3N 717                                 | 10/86 → 03/95   |   | VKPC 86413   |   |   |   |   | 1   |   |   |   |
|                                  | <b>B(Alt)</b> F2N 740, F2N 742,<br>F3N 702, F3N 716,<br>F3N 717                   | 10/86 → 03/95   |                | VKMV 5PK847  |   |   | 1   |   |   |   |   |   |
|   | <b>B(Alt)</b> F2N 740, F2N 742,<br>F3N 702, F3N 716,<br>F3N 717                   | 10/86 → 03/95   |                | VKMA 36013<br>VKMV 6PK1095<br>VKM 36013  |   | 1   | 1   |   | 1   |   |   |   |
| <b>RENAULT  SUPER 5 1.6 D</b>    |   |   |   |  |   |   |   |   |   |   |   |   |
|                                  | F8M 720   | 03/88 → 12/96   | 3), <b>Mot.</b> C216376 I→  | VKMS 06111-1<br>VKMA 06111<br>VKM 16101<br>VKM 26101                               | 1<br>1<br>1<br>1  | 1<br>1<br>1   | 1   |   |   | 3   |   | T0066   |
|   | F8M 730   | 03/88 → 12/96   | 3), <b>Mot.</b> C093597 I→  | VKMS 06111-1<br>VKMA 06111<br>VKM 16101<br>VKM 26101                               | 1<br>1<br>1<br>1  | 1<br>1<br>1   | 1   |   |   | 3   |   | T0066   |
|   | F8M 720   | 10/84 → 02/88   | → <b>I</b> Mot. C216375   | VKMA 06110<br>VKM 16110<br>VKM 26100   | 1<br>1<br>1   | 1   | 1   |   |   |   |   | T0019   |
|   | F8M 730   | 10/84 → 02/88   | → <b>I</b> Mot. C093596   | VKMA 06110<br>VKM 16110<br>VKM 26100   | 1<br>1<br>1   | 1   | 1   |   |   |   |   | T0019   |
|                                  | F8M 720, F8M 730  | 10/84 → 12/96   |   | VKPC 86413   |   |   |   |   | 1   |   |   |   |
|                                 | <b>B(Alt)</b> F8M 720, F8M 730  | 10/84 → 12/96   |   | VKMV 5PK884  |   |   | 1   |   |   |   |   |   |
| <b>RENAULT  THALIA 1.2 16V</b> |   |   |   |  |   |   |   |   |   |   |   |   |
|                                | D4F 706, D4F 712  | 04/02 → 09/07   |              | VKMC 06002<br>VKMA 06002<br>VKM 16002  | 1<br>1<br>1   | 1   | 1   |   | 1   |   |   | T0190   |
|   | D4F 722, D4F 728  | 04/02 → 09/07   |   | VKMA 06002<br>VKM 16002  | 1<br>1  | 1   | 1   |   |   |   |   | T0190   |
|                                | D4F 706, D4F 712,<br>D4F 722, D4F 728   | 04/02 → 09/07   |   | VKPC 86810   |   |   |   |   | 1   |   |   |   |
|                                | <b>B(Alt)</b> D4F 706, D4F 712,<br>D4F 722, D4F 728                               | 04/02 → 09/07   |   | VKMV 3PK740  |   |   | 1   |   |   |   |   |   |
|   | <b>B(PS)</b> D4F 706, D4F 712   | 04/02 → 11/05   | <b>AC</b>   | VKMV 4PK908<br>VKM 36023   |   |   | 1   |   |   |   |   |   |
|   | <b>B(PS)</b> D4F 706, D4F 712   | 11/05 → 09/07   | <b>AC</b>   | VKMV 4PK928<br>VKM 36023   |   |   | 1   |   |   |   |   |   |
|   | <b>B(PS)</b> D4F 706, D4F 712   | 04/02 → 09/07   | <b>AC</b>   | VKMV 4PK1538<br>VKM 36023<br>VKM 36025   |   |   | 1   |   |   |   |   | 1   |
|   | <b>B(AC)</b> D4F 722, D4F 728   | 04/02 → 09/07   |   | VKMV 4PK928<br>VKM 36023   |   |   | 1   |   |   |   |   |   |
| <b>RENAULT  THALIA 1.4</b>     |   |   |   |  |   |   |   |   |   |   |   |   |
|                                | K7J 700   | 08/00 → 09/07   |              | VKMC 06003<br>VKMA 06003<br>VKM 16003  | 1<br>1<br>1   | 1   | 1   |   | 1   |   |   | T0145   |
|                                | K7J 700   | 08/00 → 09/07   |   | VKPC 86415   |   |   |   |   | 1   |   |   |   |
|                                | <b>B(Alt)</b> K7J 700   | 08/00 → 09/07   | <b>AC</b> ,  | VKMV 5PK1110<br>VKM 36053<br>VKM 36091   |   |   | 1   |   |   |   |   |   |
|   | <b>B(Alt)</b> K7J 700   | 08/00 → 09/07   | <b>AC</b> ,  | VKMA 36091<br>VKMV 5PK1110<br>VKM 36091  |   |   | 1   |   | 1   |   |   |   |
|   | <b>B(Alt)</b> K7J 700   | 08/00 → 09/01   | <b>AC</b>   | VKMV 6PK1750<br>VKM 36031<br>VKM 36031   |   |   | 1   |   | 1   |   |   |   |
|   | <b>B(Alt)</b> K7J 700   | 09/01 → 09/07   | <b>AC</b>   | VKMA 36020<br>VKM 36031<br>VKM 36031   |   |   | 2<br>1<br>1   |   | 1   |   |   |   |



RENAULT





































| <b>RENAULT  THALIA 1.4 16V</b> |  |               |                 |              |   |   |   |  |   |  |   |   |  |  |  |  |  |  |  |       |       |
|--------------------------------|--|---------------|-----------------|--------------|---|---|---|--|---|--|---|---|--|--|--|--|--|--|--|-------|-------|
|                                | K4J 712, K4J 713   | 08/00 → 09/07 |                 | VKMC 06020   | 1 | 1 | 1 |  | 1 |  | 2 | 1 |  |  |  |  |  |  |  |       |       |
|                                |  |               |                 | VKMA 06020   | 1 | 1 | 1 |  |   |  | 2 | 1 |  |  |  |  |  |  |  | T0159 |       |
|                                |  |               |                 | VKM 16020    | 1 |   |   |  |   |  |   |   |  |  |  |  |  |  |  |       |       |
|                                |  |               |                 | VKM 26020    |   | 1 |   |  |   |  |   |   |  |  |  |  |  |  |  |       |       |
|                                | K4J 712, K4J 713   | 08/00 → 09/07 |                 | VKPC 86416   |   |   |   |  | 1 |  |   |   |  |  |  |  |  |  |  |       |       |
|                                | <b>B(Alt)</b> K4J 712, K4J 713   | 08/00 → 09/07 | <b>AC</b>       | VKMA 36091   | 1 |   | 1 |  |   |  |   |   |  |  |  |  |  |  |  |       |       |
|                                |  |               |                 | VKMV 5PK1110 |   |   | 1 |  |   |  |   |   |  |  |  |  |  |  |  |       |       |
|                                |  |               |                 | VKM 36091    | 1 |   |   |  |   |  |   |   |  |  |  |  |  |  |  |       |       |
|                                | <b>B(Alt)</b> K4J 712, K4J 713   | 08/00 → 06/01 | <b>AC</b>       | VKMV 6PK1750 |   |   | 1 |  |   |  |   |   |  |  |  |  |  |  |  |       |       |
|                                |  |               |                 | VKM 36031    |   | 1 |   |  |   |  |   |   |  |  |  |  |  |  |  |       |       |
|                                |  |               |                 | VKM 36031    |   | 1 |   |  |   |  |   |   |  |  |  |  |  |  |  |       |       |
|                                | <b>B(Alt)</b> K4J 712, K4J 713   | 06/01 → 09/07 | <b>AC</b>       | VKMA 36020   |   | 2 | 1 |  |   |  |   |   |  |  |  |  |  |  |  |       |       |
|                                |  |               |                 | VKM 36031    |   | 1 |   |  |   |  |   |   |  |  |  |  |  |  |  |       |       |
|                                |  |               |                 | VKM 36031    |   | 1 |   |  |   |  |   |   |  |  |  |  |  |  |  |       |       |
| <b>RENAULT  THALIA 1.6</b>     |  |               |                 |              |   |   |   |  |   |  |   |   |  |  |  |  |  |  |  |       |       |
|                                | K7M 746  | 03/98 → 05/01 |                 | VKMA 06003   | 1 |   | 1 |  |   |  |   |   |  |  |  |  |  |  |  | T0145 |       |
|                                |  |               |                 | VKM 16003    | 1 |   |   |  |   |  |   |   |  |  |  |  |  |  |  |       |       |
|                                | K7M 746  | 03/98 → 05/01 |                 | VKPC 86415   |   |   |   |  | 1 |  |   |   |  |  |  |  |  |  |  |       |       |
|                                | <b>B(Alt)</b> K7M 746  | 03/98 → 05/01 | <b>AC, ⊕</b>    | VKMV 5PK1110 |   |   | 1 |  |   |  |   |   |  |  |  |  |  |  |  |       |       |
|                                |  |               |                 | VKM 36053    |   | 1 |   |  |   |  |   |   |  |  |  |  |  |  |  |       |       |
|                                |  |               |                 | VKM 36091    | 1 |   |   |  |   |  |   |   |  |  |  |  |  |  |  |       |       |
|                                | <b>B(Alt)</b> K7M 746  | 03/98 → 05/01 | <b>AC, ⊕</b>    | VKMA 36091   | 1 |   | 1 |  |   |  |   |   |  |  |  |  |  |  |  |       |       |
|                                |  |               |                 | VKMV 5PK1110 |   |   | 1 |  |   |  |   |   |  |  |  |  |  |  |  |       |       |
|                                |  |               |                 | VKM 36091    | 1 |   |   |  |   |  |   |   |  |  |  |  |  |  |  |       |       |
|                                | <b>B(Alt)</b> K7M 746  | 03/98 → 05/01 | <b>AC</b>       | VKMV 6PK1750 |   |   | 1 |  |   |  |   |   |  |  |  |  |  |  |  |       |       |
|                                |  |               |                 | VKM 36031    |   | 1 |   |  |   |  |   |   |  |  |  |  |  |  |  |       |       |
|                                |  |               |                 | VKM 36031    |   | 1 |   |  |   |  |   |   |  |  |  |  |  |  |  |       |       |
| <b>RENAULT  THALIA 1.6 16V</b> |  |               |                 |              |   |   |   |  |   |  |   |   |  |  |  |  |  |  |  |       |       |
|                                | K4M 732, K4M 734,<br>K4M 736, K4M 740,<br>K4M 742, K4M 743               | 04/02 → 09/07 |                 | VKMC 06020   | 1 | 1 | 1 |  | 1 |  | 2 | 1 |  |  |  |  |  |  |  |       |       |
|                                |  |               |                 | VKMA 06020   | 1 | 1 | 1 |  |   |  | 2 | 1 |  |  |  |  |  |  |  |       | T0159 |
|                                |  |               |                 | VKM 16020    | 1 |   |   |  |   |  |   |   |  |  |  |  |  |  |  |       |       |
|                                |  |               |                 | VKM 26020    |   | 1 |   |  |   |  |   |   |  |  |  |  |  |  |  |       |       |
|                                | K4M 732, K4M 734,<br>K4M 736, K4M 740,<br>K4M 742, K4M 743               | 04/02 → 09/07 |                 | VKPC 86416   |   |   |   |  | 1 |  |   |   |  |  |  |  |  |  |  |       |       |
|                                | <b>B(Alt)</b> K4M 732, K4M 734,<br>K4M 736, K4M 740,<br>K4M 742, K4M 743 | 04/02 → 09/07 | <b>EHPS, AC</b> | VKMA 36091   | 1 |   | 1 |  |   |  |   |   |  |  |  |  |  |  |  |       |       |
|                                |  |               |                 | VKMV 5PK1110 |   |   | 1 |  |   |  |   |   |  |  |  |  |  |  |  |       |       |
|                                |  |               |                 | VKM 36091    | 1 |   |   |  |   |  |   |   |  |  |  |  |  |  |  |       |       |
|                                | <b>B(Alt)</b> K4M 732, K4M 734,<br>K4M 736, K4M 740,<br>K4M 742, K4M 743 | 04/02 → 09/07 | <b>EHPS, AC</b> | VKMV 5PK1110 |   |   | 1 |  |   |  |   |   |  |  |  |  |  |  |  |       |       |
|                                |  |               |                 | VKM 36053    |   | 1 |   |  |   |  |   |   |  |  |  |  |  |  |  |       |       |
|                                |  |               |                 | VKM 36091    | 1 |   |   |  |   |  |   |   |  |  |  |  |  |  |  |       |       |
|                                | <b>B(Alt)</b> K4M 732, K4M 734,<br>K4M 736, K4M 740,<br>K4M 742, K4M 743 | 04/02 → 09/07 | <b>EHPS, AC</b> | VKMA 36020   |   | 2 | 1 |  |   |  |   |   |  |  |  |  |  |  |  |       |       |
|                                |  |               |                 | VKM 36031    |   | 1 |   |  |   |  |   |   |  |  |  |  |  |  |  |       |       |
|                                |  |               |                 | VKM 36031    |   | 1 |   |  |   |  |   |   |  |  |  |  |  |  |  |       |       |
|                                | <b>B(Alt)</b> K4M 736, K4M 742,<br>K4M 743                               | 04/02 → 09/07 | <b>EHPS, AC</b> | VKM 36031    |   | 1 |   |  |   |  |   |   |  |  |  |  |  |  |  |       |       |
|                                |  |               |                 | VKM 36031    |   | 1 |   |  |   |  |   |   |  |  |  |  |  |  |  |       |       |
|                                |  |               |                 | VKM 36053    |   | 1 |   |  |   |  |   |   |  |  |  |  |  |  |  |       |       |
| <b>RENAULT  THALIA 1.5 dCi</b> |  |               |                 |              |   |   |   |  |   |  |   |   |  |  |  |  |  |  |  |       |       |
|                                | K9K 700  | 04/02 → 08/03 |                 | VKMA 06130   | 1 |   | 1 |  |   |  |   |   |  |  |  |  |  |  |  | T0191 |       |
|                                |  |               |                 | VKM 16102    | 1 |   |   |  |   |  |   |   |  |  |  |  |  |  |  |       |       |
|                                | K9K 700, K9K 706,<br>K9K 714, K9K 718                                    | 08/03 → 09/07 |                 | VKMA 06132   | 1 |   | 1 |  |   |  |   |   |  |  |  |  |  |  |  |       |       |
|                                |  |               |                 | VKM 16102    | 1 |   |   |  |   |  |   |   |  |  |  |  |  |  |  |       |       |
|                                | K9K 700  | 04/02 → 04/04 |                 | VKPC 86417   |   |   |   |  | 1 |  |   |   |  |  |  |  |  |  |  |       |       |



|   |  |  |  |  |  |  |  |  |  |  |  |  |
|---|---|---|---|--|---|---|---|---|---|---|---|---|
|   | K9K 700, K9K 706,<br>K9K 714, K9K 718   | 04/04 → 01/07   |   | VKPC_____  |   |   |   |   | 1   |   |   |   |
|                            | <b>B(Alt)</b> K9K 700, K9K 706,<br>K9K 714, K9K 718                               | 06/01 → 09/05   | <i>AC</i>   | VKMA 36052<br>VKMV 5PK1135<br>VKM 36052<br>VKM 36053                               | 1<br>1  | 1<br>1  |   |   |   |   |   |   |
|   | <b>B(Alt)</b> K9K 700, K9K 706,<br>K9K 714, K9K 718                               | 09/05 → 09/07   | <i>AC</i>   | VKMV 6PK1199<br>VKM 36053  |   |   | 1   |   |   |   |   |   |
|   | <b>B(Alt)</b> K9K 700, K9K 706,<br>K9K 714  | 06/01 → 01/05   | <b>AC</b>   | VKMA 36050<br>VKMV 5PK1199<br>VKM 36050  | 1<br>1  |   | 1<br>1  |   |   |   |   |   |
|   | <b>B(Alt)</b> K9K 700, K9K 706,<br>K9K 714, K9K 718                               | 01/05 → 09/07   | <b>AC</b>   | VKMV 6PK1199   |   |   | 1   |   |   |   |   |   |
| <b>RENAULT  TWINGO 1.2</b> |   |   |   |  |   |   |   |   |   |   |   |   |
|                            | C3G 700, C3G 702  | 03/93 → 10/96   |   | <del>OKOKOKO</del>   |   |   |   |   |   |   |   |   |
|   | D7F 700, D7F 701,<br>D7F 702, D7F 703,<br>D7F 704, D7F 706,<br>D7F 708            | 05/96 → 11/07   |  | VKMC 06010<br>VKMA 06010<br>VKM 16000  | 1<br>1<br>1   |   | 1<br>1  |   | 1   |   |   | T0136   |
|   | D7F 700, D7F 701,<br>D7F 702, D7F 703,<br>D7F 704, D7F 706                        | 05/96 → 12/00   | 3)  | VKMS 06010-1<br>VKMA 06010<br>VKM 16000  | 1<br>1<br>1   |   | 1<br>1  |   |   | 2   |   | T0136   |
|   | D7F 700, D7F 701,<br>D7F 702, D7F 703,<br>D7F 704, D7F 706,<br>D7F 708            | 01/01 → 11/07   | 3)  | VKMS 06010-2<br>VKMA 06010<br>VKM 16000  | 1<br>1<br>1   |   | 1<br>1  |   |   | 2   |   | T0136   |
|                          | C3G 700, C3G 702  | 03/93 → 10/96   | 2), <i>AC</i>   | VKPA 86212<br>VKPC 86212   |   |   |   |   | 1<br>1  |   |   |   |
|   | C3G 700, C3G 702  | 03/93 → 10/96   | 2), <b>AC</b>   | VKPA 86217<br>VKPC 86217   |   |   |   |   | 1<br>1  |   |   |   |
|   | D7F 700, D7F 701,<br>D7F 702, D7F 703,<br>D7F 704, D7F 706,<br>D7F 708            | 05/96 → 11/07   |   | VKPC 86215   |   |   |   |   |   | 1   |   |   |
|                          | <b>B(Alt)</b> C3G 700, C3G 702  | 03/93 → 10/96   | <i>AC</i>   | VKMV 10AVx1150<br>VKM 36007  | 1   |   | 1   |   |   |   |   |   |
|   | <b>B(Alt)</b> C3G 700, C3G 702  | 03/93 → 10/96   | <b>AC</b>   | VKMV 4PK1165<br>VKM 36004  | 1   |   | 1   |   |   |   |   |   |
|   | <b>B(Alt)</b> D7F 700, D7F 701,<br>D7F 702, D7F 706                               | 05/96 → 06/99   |   | VKMV 4PK735  |   |   | 1   |   |   |   |   |   |
|   | <b>B(Alt)</b> D7F 700, D7F 701,<br>D7F 702, D7F 706                               | 07/99 → 11/99   |   | VKMV 4PK730  |   |   | 1   |   |   |   |   |   |
|   | <b>B(Alt)</b> D7F 700, D7F 701,<br>D7F 702, D7F 706                               | 11/99 → 04/00   |   | VKMV 4PK735  |   |   | 1   |   |   |   |   |   |
|   | <b>B(Alt)</b> D7F 700, D7F 701,<br>D7F 702, D7F 706                               | 04/00 → 11/07   |   | VKMV 3PK740  |   |   | 1   |   |   |   |   |   |
|   | <b>B(Alt)</b> D7F 703, D7F 704,<br>D7F 708  | 05/96 → 11/07   |   | VKMV 3PK740  |   |   | 1   |   |   |   |   |   |
|   | <b>B(AC)</b> C3G 700, C3G 702   | 03/93 → 10/96   |   | VKMV 5PK905<br>VKM 36009   | 1   |   | 1   |   |   |   |   |   |
|   | <b>B(AC)</b> D7F 700, D7F 701,<br>D7F 702, D7F 706                                | 05/96 → 04/00   |   | VKMV 5PK910<br>VKM 36023   |   | 1   | 1   |   |   |   |   |   |
|   | <b>B(AC)</b> D7F 700, D7F 701,<br>D7F 702, D7F 706                                | 04/00 → 11/07   |   | VKMV 4PK928<br>VKM 36023   |   | 1   | 1   |   |   |   |   |   |



RENAULT





























|  |  |  |  |  |  |  |  |  |  |  |  |  |  |
|--|---|---|---|--|---|---|---|---|---|---|---|---|---|
| <b>B(AC)</b>   | D7F 703, D7F 704,<br>D7F 708  |   | 05/96 → 11/07   | VKMV 4PK928<br>VKM 36023   |   | 1   |   |   |   |   |   |   |   |
| <b>RENAULT  TWINGO 1.2 16V</b>          |   |   |   |  |   |   |   |   |   |   |   |   |   |
|    | D4F 702, D4F 708  |   | 01/01 → 11/07   | VKMA 06002<br>VKM 16002  | 1   | 1   |   |   |   |   |   |   | T0190   |
|    | D4F 702, D4F 708  |   | 01/01 → 11/07   | VKPC_____  |   |   |   | 1   |   |   |   |   |   |
|    | <b>B(Alt)</b> D4F 702   |   | 01/01 → 11/07   | VKMV 3PK740  |   |   | 1   |   |   |   |   |   |   |
|  | <b>B(Alt)</b> D4F 708   |   | 08/04 → 11/07   | VKMV 3PK740  |   |   | 1   |   |   |   |   |   |   |
|  | <b>B(AC)</b> D4F 702, D4F 708   |   | 01/01 → 11/07   | VKMV 4PK928<br>VKM 36023   |   | 1   |   |   |   |   |   |   |   |
| <b>RENAULT  TWINGO II 1.2 Turbo</b>     |   |   |   |  |   |   |   |   |   |   |   |   |   |
|    | D4F 772, D4F 780  |   | 03/07 → 09/07   | VKMA 06002<br>VKM 16002  | 1   | 1   |   |   |   |   |   |   | T0190   |
| <b>RENAULT  VEL SATIS 2.0 16V Turbo</b> |   |   |   |  |   |   |   |   |   |   |   |   |   |
|    | F4R 762, F4R 763,<br>F4R 766, F4R 767,<br>F4R 867                                 |   | 06/02 → 09/07   | VKMC 06106<br>VKMA 06106<br>VKM 16550<br>VKM 26105                                 | 1   | 1   | 1   |   | 1   |   | 2   |   | T0177   |
|    | F4R 762, F4R 763,<br>F4R 766, F4R 767,<br>F4R 867                                 |   | 06/02 → 09/07   | VKPC 85304   |   |   |   |   | 1   |   |   |   |   |
|    | <b>B(Alt)</b> F4R 762, F4R 763  |   | 06/02 → 09/07   | VKMA 36038<br>VKMV 6PK1792<br>VKM 36030<br>VKM 36038                               | 1   | 1   | 1   |   |   |   |   |   |   |
|  | <b>B(Alt)</b> F4R 766, F4R 767,<br>F4R 867  |   | 04/04 → 09/07   | VKMV 7PK1792<br>VKM 36030<br>VKM 36038   | 1   |   | 1   |   |   |   |   |   |   |
| <b>RENAULT  VEL SATIS 3.5 V6</b>      |   |   |   |  |   |   |   |   |   |   |   |   |   |
|                                        | V4Y 701, V4Y 711,<br>V4Y 715  |   | 06/02 → 09/07   | <del>OXOXOXO</del>   |   |   |   |   |   |   |   |   |   |
|                                        | V4Y 701, V4Y 715  |   | 06/02 → 09/07   | —  |   |   |   | 1   |   |   |   |   |   |
|                                        | <b>B(Alt)</b> V4Y 701, V4Y 711  |   | 06/02 → 08/05   | VKMV 6PK1105   |   |   | 1   |   |   |   |   |   |   |
|  | <b>B(Alt)</b> V4Y 715   |   | 06/02 → 08/05   | VKMV 6PK1095   |   |   | 1   |   |   |   |   |   |   |
|  | <b>B(AC)</b> V4Y 701, V4Y 711,<br>V4Y 715   |   | 06/02 → 09/07   | VKMV 4PK775  |   |   | 1   |   |   |   |   |   |   |
| <b>RENAULT  VEL SATIS 2.0 dCi</b>     |   |   |   |  |   |   |   |   |   |   |   |   |   |
|                                        | M9R 760   |   | 08/05 → 09/07   | <del>OXOXOXO</del>   |   |   |   |   |   |   |   |   |   |
|                                        | M9R 760   |   | 08/05 → 09/07   | VKPC_____  |   |   |   | 1   |   |   |   |   |   |
|                                        | <b>B(Alt)</b> M9R 760   |   | 08/05 → 09/07   | VKMV 7PK1970<br>VKM_____<br>VKM_____   | 1   |   | 1   |   |   |   |   | 1   |   |
| <b>RENAULT  VEL SATIS 2.2 dCi</b>     |   |   |   |  |   |   |   |   |   |   |   |   |   |
|                                        | G9T 600, G9T 606,<br>G9T 702, G9T 703   |   | 06/02 → 09/07   | VKMA 06503<br>VKM 16503<br>VKM 26503   | 1   | 1   | 1   |   |   |   |   | 1   | T0187   |
|                                        | G9T 600, G9T 606,<br>G9T 702, G9T 703   |   | 06/02 → 09/07   | VKPC 86305   |   |   |   |   | 1   |   |   |   |   |
|                                        | <b>B(Alt)</b> G9T 600, G9T 606,<br>G9T 702, G9T 703                               |   | 06/02 → 09/07   | VKMA 36040<br>VKMV 6PK1778<br>VKM 36040<br>VKM 36040                               |   | 2   | 1   |   |   |   |   |   |   |
| <b>RENAULT  VEL SATIS 3.0 dCi</b>     |   |   |   |  |   |   |   |   |   |   |   |   |   |
|                                        | P9X 701, P9X 715  |   | 06/02 → 09/07   | VKMA 05230<br>VKM 15220<br>VKM 25222<br>VKM 25226                                  | 1   | 2   | 1   |   |   |   |   |   | T0200   |

|                                      | P9X 701  | 06/02 → 09/07 |  |                         | VKPC   |                  |                  |                  |   |   |  |  |  | 1 |   |  |  |   |  |       |       |       |
|--------------------------------------|--|---------------|--|-------------------------|--|------------------|------------------|------------------|---|---|--|--|--|---|---|--|--|---|--|-------|-------|-------|
|                                      | B(Alt) P9X 701   | 06/02 → 07/06 |  |                         | VKMV   |                  |                  | 1                |   |   |  |  |  |   |   |  |  |   |  |       |       |       |
|                                      |  |               |  |                         | VKM  |                  | 1                |                  |   |   |  |  |  |   |   |  |  |   |  |       |       |       |
|                                      |  |               |  |                         | VKM  |                  | 1                |                  |   |   |  |  |  |   |   |  |  |   |  |       |       |       |
|                                      |  |               |  |                         | VKM 35212  |                  | 1                |                  |   |   |  |  |  |   |   |  |  |   |  |       |       |       |
|                                      |  |               |  |                         | VKM 35214  |                  | 1                |                  |   |   |  |  |  |   |   |  |  |   |  |       |       |       |
|                                      |  |               |  |                         | VKM 35216  |                  | 1                |                  |   |   |  |  |  |   |   |  |  |   |  |       |       |       |
| <b>RENAULT</b> <b>ESTAFETTE 1.1</b>  |  |               |  |                         |  |                  |                  |                  |   |   |  |  |  |   |   |  |  |   |  |       |       |       |
|                                      |  | 02/62 → 02/81 |  | Mot. 23489 →            | VKPC 86208   |                  |                  |                  |   |   |  |  |  |   | 1 |  |  |   |  |       |       |       |
| <b>RENAULT</b> <b>ESTAFETTE 1.3</b>  |  |               |  |                         |  |                  |                  |                  |   |   |  |  |  |   |   |  |  |   |  |       |       |       |
|                                      |  | 08/69 → 02/81 |  |                         | VKPC 86208   |                  |                  |                  |   |   |  |  |  |   | 1 |  |  |   |  |       |       |       |
| <b>RENAULT</b> <b>MASTER I 2.0</b>   |  |               |  |                         |  |                  |                  |                  |   |   |  |  |  |   |   |  |  |   |  |       |       |       |
|                                      | 829 731  | 08/80 → 07/84 |  | B(41116x19),  116       | VKMA 06200<br>VKM 16200                            | 1<br>1           |                  | 1                |   |   |  |  |  |   |   |  |  |   |  | T0003 |       |       |
|                                      | 829 731  | 07/84 → 10/86 |  | 116,<br>B(58116x19 HSN) | VKMA 06201<br>VKM 16200                            | 1<br>1           |                  | 1                |   |   |  |  |  |   |   |  |  |   |  |       | T0024 |       |
|                                      | J5R 718  | 10/86 → 07/89 |  |                         | VKMA 06201<br>VKM 16200                            | 1<br>1           |                  | 1                |   |   |  |  |  |   |   |  |  |   |  |       | T0024 |       |
|                                      | J5R 718  | 07/89 → 07/98 |  |                         | VKMA 06205<br>VKM 16204                            | 1<br>1           |                  | 1                |   |   |  |  |  |   |   |  |  |   |  |       | T0024 |       |
|                                      | J5R 728  | 10/86 → 07/98 |  |                         | VKMA 06201<br>VKM 16200                            | 1<br>1           |                  | 1                |   |   |  |  |  |   |   |  |  |   |  |       | T0024 |       |
|                                      | 829 731, J5R 718   | 08/80 → 07/89 |  |                         | VKPC 86405   |                  |                  |                  |   |   |  |  |  |   | 1 |  |  |   |  |       |       |       |
|                                      | J5R 718  | 07/89 → 07/98 |  |                         | VKPC 86408   |                  |                  |                  |   |   |  |  |  |   | 1 |  |  |   |  |       |       |       |
|                                      | J5R 728  | 10/86 → 07/98 |  |                         | VKPC 86405   |                  |                  |                  |   |   |  |  |  |   | 1 |  |  |   |  |       |       |       |
| <b>RENAULT</b> <b>MASTER I 2.2</b>   |  |               |  |                         |  |                  |                  |                  |   |   |  |  |  |   |   |  |  |   |  |       |       |       |
|                                      | J7T 782  | 08/80 → 07/91 |  |                         | VKMA 06203<br>VKM 16200                            | 1<br>1           |                  | 1                |   |   |  |  |  |   |   |  |  |   |  |       | T0024 |       |
|                                      | J7T 782  | 07/91 → 07/98 |  |                         | VKMA 06204<br>VKM 16204                            | 1<br>1           |                  | 1                |   |   |  |  |  |   |   |  |  |   |  |       |       | T0024 |
|                                      | J7T 788  | 08/80 → 07/98 |  |                         | VKMA 06204<br>VKM 16204                            | 1<br>1           |                  | 1                |   |   |  |  |  |   |   |  |  |   |  |       |       | T0024 |
|                                      | J7T 782  | 08/80 → 07/91 |  |                         | VKPC 86405   |                  |                  |                  |   |   |  |  |  |   | 1 |  |  |   |  |       |       |       |
|                                      | J7T 782  | 07/91 → 07/98 |  |                         | VKPC 86605   |                  |                  |                  |   |   |  |  |  |   | 1 |  |  |   |  |       |       |       |
|                                      | J7T 788  | 08/80 → 07/98 |  |                         | VKPC 86605   |                  |                  |                  |   |   |  |  |  |   | 1 |  |  |   |  |       |       |       |
|                                      | B(Alt) J7T 782, J7T 788  | 08/80 → 07/98 |  |                         | VKMV 10AVx1000                                     |                  |                  | 1                |   |   |  |  |  |   |   |  |  |   |  |       |       |       |
|                                      | B(PS) J7T 782, J7T 788   | 08/80 → 07/98 |  |                         | VKMV 11.9x758                                      |                  |                  | 1                |   |   |  |  |  |   |   |  |  |   |  |       |       |       |
| <b>RENAULT</b> <b>MASTER I 2.1 D</b> |  |               |  |                         |  |                  |                  |                  |   |   |  |  |  |   |   |  |  |   |  |       |       |       |
|                                      | J8S 330  | 08/80 → 07/98 |  | 3)                      | VKMS 06213<br>VKMA 06213<br>VKM 16212<br>VKM 26211 | 1<br>1<br>1<br>1 | 1<br>1<br>1<br>1 | 1<br>1<br>1<br>1 |   |   |  |  |  |   |   |  |  | 3 |  |       | T0015 |       |
|                                      | J8S 330  | 08/80 → 07/98 |  |                         | VKPC 86602   |                  |                  |                  |   |   |  |  |  |   | 1 |  |  |   |  |       |       |       |
|                                      | B(Alt) J8S 330   | 08/80 → 07/98 |  |                         | VKMV 11.9x1010                                     |                  |                  | 1                |   |   |  |  |  |   |   |  |  |   |  |       |       |       |
|                                      | J8S 330  | 08/80 → 07/98 |  |                         | —  |                  |                  |                  |   |   |  |  |  |   | 1 |  |  |   |  |       |       |       |
| <b>RENAULT</b> <b>MASTER I 2.4 D</b> |  |               |  |                         |  |                  |                  |                  |   |   |  |  |  |   |   |  |  |   |  |       |       |       |
|                                      | 8140.61.2300, S8U 731  | 08/80 → 08/89 |  |                         | VKMA 02381<br>VKM 22380<br>VKM 22385               |                  | 2<br>1<br>1      | 1                |   |   |  |  |  |   |   |  |  |   |  |       | T0014 |       |
|                                      | S8U 731  | 08/80 → 08/89 |  |                         | VKPC 82630   |                  |                  |                  |   |   |  |  |  |   | 1 |  |  |   |  |       |       |       |
| <b>RENAULT</b> <b>MASTER I 2.5 D</b> |  |               |  |                         |  |                  |                  |                  |   |   |  |  |  |   |   |  |  |   |  |       |       |       |
|                                      | S8U 730, S8U 748,<br>S8U 758, S8U 770,<br>S8U 772, S8U 780,<br>S8U 782 | 08/89 → 07/98 |  | 152,<br>B(98152x30 HSN) | VKMA 02983<br>—<br>VKM 22380<br>VKM 22385          |                  | 2<br>1<br>1      | 1                | 1 | 1 |  |  |  |   |   |  |  |   |  |       | T0096 |       |
|                                      | S8U 742, S8U 750,<br>S8U 752   | 10/90 → 07/98 |  | 152,<br>B(98152x30 HSN) | VKMA 02983<br>—<br>VKM 22380<br>VKM 22385          |                  | 2<br>1<br>1      | 1                | 1 | 1 |  |  |  |   |   |  |  |   |  |       | T0096 |       |





























**RENAULT**

| Sofim-8140.61.2300   | 10/90 → 09/97                         |               | 152,<br>B(98152x30 HSN),<br>Mot. 1307402  → | VKMA 02983<br>—<br>VKM 22380<br>VKM 22385 | 2<br>1<br>1  | 1                | 1<br>1 |        |   |  |  |   |  |  |  |  |  |  |  | T0096 |
|--|---------------------------------------|---------------|---|---|--|------------------|--------|--------|---|--|--|---|--|--|--|--|--|--|--|-------|
| S8U 730  | 09/80 → 07/98                         |               | 152,<br>B(97152x30)                         | VKMA 02381<br>VKM 22380<br>VKM 22385      | 2<br>1<br>1  | 1                |        |        |   |  |  |   |  |  |  |  |  |  |  | T0014 |
| S8U 730, S8U 748,<br>S8U 758, S8U 770,<br>S8U 772, S8U 780,<br>S8U 782 | 08/89 → 07/98                         |               | 152,<br>B(98152x30 HSN)                     | VKMA 02383<br>VKM 22380<br>VKM 22385      | 2<br>1<br>1  | 1                |        |        |   |  |  |   |  |  |  |  |  |  |  | T0652 |
| S8U 742, S8U 750,<br>S8U 752   | 09/80 → 09/90                         |               | 152,<br>B(97152x30)                         | VKMA 02381<br>VKM 22380<br>VKM 22385      | 2<br>1<br>1  | 1                |        |        |   |  |  |   |  |  |  |  |  |  |  | T0014 |
| S8U 742, S8U 750,<br>S8U 752   | 10/90 → 07/98                         |               | 152,<br>B(98152x30 HSN)                     | VKMA 02383<br>VKM 22380<br>VKM 22385      | 2<br>1<br>1  | 1                |        |        |   |  |  |   |  |  |  |  |  |  |  | T0652 |
| Sofim-8140.61.2300   | 08/89 → 09/90                         |               | 152,<br>B(97152x30),<br>→ Mot. 1307401      | VKMA 02381<br>VKM 22380<br>VKM 22385      | 2<br>1<br>1  | 1                |        |        |   |  |  |   |  |  |  |  |  |  |  | T0014 |
| Sofim-8140.61.2300   | 10/90 → 09/97                         |               | 152,<br>B(98152x30 HSN),<br>Mot. 1307402  → | VKMA 02383<br>VKM 22380<br>VKM 22385      | 2<br>1<br>1  | 1                |        |        |   |  |  |   |  |  |  |  |  |  |  | T0652 |
|  | 8140.61.2300, S8U 731,<br>S8U 742     | 09/80 → 07/98 |   | VKPC 82630                                |  |                  |        |        |   |  |  | 1 |  |  |  |  |  |  |  |       |
| <b>RENAULT  MASTER I 2.5 TD</b>  |                                       |               |   |   |  |                  |        |        |   |  |  |   |  |  |  |  |  |  |  |       |
|  | S9U 702, S9U 704,<br>S9U 714, S9U 740 | 08/89 → 07/98 |   | 153,<br>B(98153x30 HSN)                   | VKMA 02984<br>—<br>VKM 22385<br>VKM 22385            | 2<br>1<br>1      | 1      | 1<br>1 |   |  |  |   |  |  |  |  |  |  |  | T0097 |
| S9U 700  | 08/89 → 07/98                         |               | 153,<br>B(97153x30)                         | VKMA 02382<br>VKM 22385<br>VKM 22385      | 2<br>1<br>1  | 1                |        |        |   |  |  |   |  |  |  |  |  |  |  | T0043 |
| S9U 702, S9U 704,<br>S9U 714, S9U 740                                  | 08/89 → 07/98                         |               | 153,<br>B(98153x30 HSN)                     | VKMA 02384<br>VKM 22385<br>VKM 22385      | 2<br>1<br>1  | 1                |        |        |   |  |  |   |  |  |  |  |  |  |  | T0653 |
|  | S9U 702, S9U 714                      | 08/89 → 07/98 |   | VKPC 82630                                |  |                  |        |        |   |  |  | 1 |  |  |  |  |  |  |  |       |
| <b>RENAULT  MASTER II 1.9 dCi</b>                                      |                                       |               |   |   |  |                  |        |        |   |  |  |   |  |  |  |  |  |  |  |       |
|  | F9Q 772, F9Q 774                      | 11/01 → 12/07 |   |   | VKMC 06127<br>VKMA 06127<br>VKM 16113                | 1<br>1<br>1      |        | 1      | 1 |  |  | 1 |  |  |  |  |  |  |  | T0647 |
|  | F9Q 772, F9Q 774                      | 11/01 → 12/07 |   |   | VKPC 85304   |                  |        |        |   |  |  | 1 |  |  |  |  |  |  |  |       |
|  | B(Alt) F9Q 772, F9Q 774               | 11/01 → 12/07 |   |   | VKMC 5PK1125   |                  |        |        | 1 |  |  |   |  |  |  |  |  |  |  |       |
|  | B(Alt) F9Q 772                        | 11/01 → 03/02 |   |   | VKMA 36033<br>VKMV 6PK1792<br>VKM 36030<br>VKM 36031 | 1<br>1<br>1<br>1 | 1      | 1      | 1 |  |  |   |  |  |  |  |  |  |  |       |

|  |  |  |    |  |  |  |  |  |  |  |  |  |
|--|---|---|---|--|---|---|---|---|---|---|---|---|
|  | B(Alt) F9Q 772  | 03/02 → 12/07   | AC  | VKMA 36038<br>VKMV 6PK1792<br>VKM 36030<br>VKM 36038                               | 1<br>1<br>1   | 1<br>1  | 1   |   |   |   |   |   |
|  | B(Alt) F9Q 774  | 11/01 → 12/07   | AC  | VKMA 36038<br>VKMV 6PK1792<br>VKM 36030<br>VKM 36038                               | 1<br>1<br>1   | 1<br>1  | 1   |   |   |   |   |   |
| ⊙  | F9Q 772, F9Q 774  | 11/01 → 05/06   |   | —  |   |   |   |   | 1   |   |   |   |
| <b>RENAULT  MASTER II 1.9 dTi</b>   |   |   |   |  |   |   |   |   |   |   |   |   |
|                                     | F9Q 770   | 09/00 → 02/06   | c, P  | VKMA 06137<br>VKM 16551<br>VKM 26117<br>VKM 26125<br>VKM 26128                     | 1<br>1<br>1<br>1  | 2<br>1  | 1   |   | 1   |   |   | T0181   |
|  | F9Q 770   | 09/00 → 02/06   | c   | VKMA 06117<br>VKM 16551<br>VKM 26117<br>VKM 26128                                  | 1<br>1<br>1   | 1   | 1   |   | 1   |   |   | T0181   |
|                                     | F9Q 770   | 09/00 → 06/05   |   | VKPC 86413   |   |   |   |   | 1   |   |   |   |
|                                     | B(Alt) F9Q 770  | 09/00 → 05/06   |   | VKMV 6PK1127   |   |   | 1   |   |   |   |   |   |
| ⊙  | F9Q 770   | 09/00 → 05/06   |   | VKM_____   |   |   |   |   | 1   |   |   |   |
| <b>RENAULT  MASTER II 2.2 dCi</b>   |   |   |   |  |   |   |   |   |   |   |   |   |
|                                     | G9T 720, G9T 722,<br>G9T 750  | 09/00 → 12/07   |   | VKMA 06503<br>VKM 16503<br>VKM 26503   | 1<br>1  | 1   | 1   |   |   |   |   | 1 T0187   |
|                                   | G9T 720, G9T 722,<br>G9T 750  | 09/00 → 12/07   |   | VKPC 86305   |   |   |   |   | 1   |   |   |   |
|                                   | B(Alt) G9T 720, G9T 722   | 09/00 → 05/06   | 29)   | VKMV 6PK1795<br>VKM 36040<br>VKM 36040   |   | 1<br>1  | 1   |   |   |   |   |   |
|  | B(Alt) G9T 720, G9T 722   | 09/00 → 02/06   | 28), AC   | VKMV 6PK1148<br>VKM 36040<br>VKM 36040   |   | 1<br>1  | 1   |   |   |   |   |   |
|  | B(Alt) G9T 720, G9T 722   | 09/00 → 02/06   | 28), AC   | VKMV 6PK1795<br>VKM 36040<br>VKM 36040   |   | 1<br>1  | 1   |   |   |   |   |   |
| <b>RENAULT  MASTER II 2.5 D</b>   |   |   |   |  |   |   |   |   |   |   |   |   |
|                                   | S8U 770, S8U 772  | 07/98 → 01/01   |  | VKMA 02983<br>—<br>VKM 22380<br>VKM 22385  |   | 2<br>1<br>1   | 1   | 1<br>1  |   |   |   | T0096   |
|  | S8U 770, S8U 772  | 07/98 → 01/01   |   | VKMA 02383<br>VKM 22380<br>VKM 22385   |   | 2<br>1<br>1   | 1   |   |   |   |   | T0652   |
|                                   | S8U 770, S8U 772  | 07/98 → 01/01   |   | VKPC 85302   |   |   |   |   | 1   |   |   |   |
|                                   | B(Alt) S8U 770, S8U 772   | 07/98 → 03/00   |   | VKMA 36017<br>VKMV 6PK860<br>VKM 36017   |   | 1<br>1  | 1   |   |   |   |   |   |
|  | B(Alt) S8U 770, S8U 772   | 03/00 → 01/01   |   | VKMV 6PK871  |   |   | 1   |   |   |   |   |   |
|  | B(AC) S8U 770, S8U 772  | 07/98 → 01/01   |   | VKMV 5PK1200<br>VKM 36064  | 1   |   | 1   |   |   |   |   |   |
| <b>RENAULT  MASTER II 2.5 dCi</b> |   |   |   |  |   |   |   |   |   |   |   |   |
|                                   | G9U 720, G9U 724,<br>G9U 750, G9U 754   | 10/01 → 12/07   |   | VKMA 06503<br>VKM 16503<br>VKM 26503   | 1<br>1  | 1   | 1   |   |   |   |   | 1 T0187   |
|                                   | G9U 720, G9U 724,<br>G9U 750, G9U 754   | 10/01 → 12/07   |   | VKPC 86305   |   |   |   |   | 1   |   |   |   |
|                                   | B(Alt) G9U 720, G9U 724   | 10/01 → 02/06   | 28), AC   | VKMV 6PK1795<br>VKM 36040<br>VKM 36040   |   | 1<br>1  | 1   |   |   |   |   |   |



RENAULT

| <b>RENAULT</b>  <b>MASTER II 2.8 dTi</b> |  |               |   |                       |   |   |   |  |  |  |  |   |  |  |  |  |  |  |   |       |  |       |
|---|--|---------------|---|-----------------------|---|---|---|--|--|--|--|---|--|--|--|--|--|--|---|-------|--|-------|
|   | S9W 700, S9W 702                           | 07/98 → 10/01 |  | VKMA 02986            | 2 | 1 | 1 |  |  |  |  |   |  |  |  |  |  |  |   | T0155 |  |       |
|   |  |               |   | VKM 22385             | 1 |   | 1 |  |  |  |  |   |  |  |  |  |  |  |   |       |  |       |
|   |  |               |   | VKM 22385             | 1 |   |   |  |  |  |  |   |  |  |  |  |  |  |   |       |  |       |
|   | S9W 700, S9W 702                           | 07/98 → 10/01 |   | VKMA 02386            | 2 | 1 |   |  |  |  |  |   |  |  |  |  |  |  |   | T0155 |  |       |
|   |  |               |   | VKM 22385             | 1 |   |   |  |  |  |  |   |  |  |  |  |  |  |   |       |  |       |
|   |  |               |   | VKM 22385             | 1 |   |   |  |  |  |  |   |  |  |  |  |  |  |   |       |  |       |
|   | S9W 700, S9W 702                           | 07/98 → 10/01 |   | VKPC 85303            |   |   |   |  |  |  |  | 1 |  |  |  |  |  |  |   |       |  |       |
|   | <b>B(Alt)</b> S9W 700, S9W 702             | 07/98 → 03/00 |   | VKMA 36117            | 1 | 1 |   |  |  |  |  |   |  |  |  |  |  |  |   |       |  |       |
|   |  |               |   | VKMV 6PK841           |   | 1 |   |  |  |  |  |   |  |  |  |  |  |  |   |       |  |       |
|   |  |               |   | VKM 36017             | 1 |   |   |  |  |  |  |   |  |  |  |  |  |  |   |       |  |       |
|   | <b>B(AC)</b> S9W 700, S9W 702              | 07/98 → 10/01 |   | VKMV 5PK1200          |   | 1 |   |  |  |  |  |   |  |  |  |  |  |  |   |       |  |       |
|   |  |               |   | VKM 36064             | 1 |   |   |  |  |  |  |   |  |  |  |  |  |  |   |       |  |       |
| <b>RENAULT</b>  <b>TRAFIC I 1.4</b>      |  |               |   |                       |   |   |   |  |  |  |  |   |  |  |  |  |  |  |   |       |  |       |
|   | C1J 700                                    | 05/89 → 06/91 |   | <del>VKMA 02386</del> |   |   |   |  |  |  |  |   |  |  |  |  |  |  |   |       |  |       |
|   | C1J 700                                    | 05/89 → 06/91 |   | VKPC 86402            |   |   |   |  |  |  |  | 1 |  |  |  |  |  |  |   |       |  |       |
| <b>RENAULT</b>  <b>TRAFIC I 1.6</b>      |  |               |   |                       |   |   |   |  |  |  |  |   |  |  |  |  |  |  |   |       |  |       |
|   | 841 705, A1M 705                           | 03/80 → 06/86 | 2)  | —                     |   |   |   |  |  |  |  | 1 |  |  |  |  |  |  |   |       |  |       |
|   |  |               |   | VKPC 86407            |   |   |   |  |  |  |  | 1 |  |  |  |  |  |  |   |       |  |       |
|   | A1M 707, A1M 708                           | 01/83 → 06/86 |   | VKPC 86407            |   |   |   |  |  |  |  | 1 |  |  |  |  |  |  |   |       |  |       |
| <b>RENAULT</b>  <b>TRAFIC I 1.7</b>      |  |               |   |                       |   |   |   |  |  |  |  |   |  |  |  |  |  |  |   |       |  |       |
|   | F1N 720, F1N 722,<br>F1N 724               | 02/88 → 08/94 | 3)  | VKMS 06101            | 1 | 1 | 1 |  |  |  |  |   |  |  |  |  |  |  | 3 |       |  | T0046 |
|   |  |               |   | VKMA 06101            | 1 | 1 | 1 |  |  |  |  |   |  |  |  |  |  |  |   |       |  |       |
|   |  |               |   | VKM 16101             | 1 |   |   |  |  |  |  |   |  |  |  |  |  |  |   |       |  |       |
|   |  |               |   | VKM 26101             |   | 1 |   |  |  |  |  |   |  |  |  |  |  |  |   |       |  |       |
|   | F1N 722, F1N 724                           | 06/86 → 01/88 |   | VKMA 06100            | 1 | 1 | 1 |  |  |  |  |   |  |  |  |  |  |  |   |       |  | T0023 |
|   |  |               |   | VKM 16100             | 1 |   |   |  |  |  |  |   |  |  |  |  |  |  |   |       |  |       |
|   |  |               |   | VKM 26100             |   | 1 |   |  |  |  |  |   |  |  |  |  |  |  |   |       |  |       |
|   | F1N 720                                    | 08/92 → 08/94 |   | VKPC 86413            |   |   |   |  |  |  |  | 1 |  |  |  |  |  |  |   |       |  |       |
|   | F1N 722                                    | 05/89 → 08/94 | <b>Mod.</b> P318, P358  | VKPC 86413            |   |   |   |  |  |  |  | 1 |  |  |  |  |  |  |   |       |  |       |
|   | F1N 724                                    | 08/92 → 08/94 | <b>Mod.</b> T8, TB  | VKPC 86413            |   |   |   |  |  |  |  | 1 |  |  |  |  |  |  |   |       |  |       |
|   | <b>B(Alt)</b> F1N 720, F1N 722,<br>F1N 724 | 05/89 → 07/92 |   | VKMV 5PK847           |   |   | 1 |  |  |  |  |   |  |  |  |  |  |  |   |       |  |       |
|   | <b>B(Alt)</b> F1N 720, F1N 722,<br>F1N 724 | 07/92 → 08/94 |   | VKMV 6PK850           |   |   | 1 |  |  |  |  |   |  |  |  |  |  |  |   |       |  |       |
| <b>RENAULT</b>  <b>TRAFIC I 2.0</b>    |  |               |   |                       |   |   |   |  |  |  |  |   |  |  |  |  |  |  |   |       |  |       |
|   | J5R 716, J5R 726                           | 05/89 → 07/89 |   | VKMA 06201            | 1 |   | 1 |  |  |  |  |   |  |  |  |  |  |  |   |       |  | T0024 |
|   |  |               |   | VKM 16200             | 1 |   |   |  |  |  |  |   |  |  |  |  |  |  |   |       |  |       |
|   | J5R 716, J5R 726                           | 07/89 → 10/97 |   | VKMA 06205            | 1 |   | 1 |  |  |  |  |   |  |  |  |  |  |  |   |       |  | T0024 |
|   |  |               |   | VKM 16204             | 1 |   |   |  |  |  |  |   |  |  |  |  |  |  |   |       |  |       |
|   | J5R 716, J5R 726                           | 05/89 → 07/89 |   | VKPC 86405            |   |   |   |  |  |  |  | 1 |  |  |  |  |  |  |   |       |  |       |
|   | J5R 716, J5R 726                           | 07/89 → 10/97 |   | VKPC 86605            |   |   |   |  |  |  |  | 1 |  |  |  |  |  |  |   |       |  |       |
|   | <b>B(Alt)</b> J5R 716, J5R 726             | 05/89 → 10/97 |   | VKMV 10AVx1000        |   |   | 1 |  |  |  |  |   |  |  |  |  |  |  |   |       |  |       |
| <b>RENAULT</b>  <b>TRAFIC I 2.2</b>    |  |               |   |                       |   |   |   |  |  |  |  |   |  |  |  |  |  |  |   |       |  |       |
|   | J7T 600, J7T 780                           | 07/91 → 10/97 |   | VKMA 06204            | 1 |   | 1 |  |  |  |  |   |  |  |  |  |  |  |   |       |  | T0024 |
|   |  |               |   | VKM 16204             | 1 |   |   |  |  |  |  |   |  |  |  |  |  |  |   |       |  |       |
|   | J7T 780                                    | 05/89 → 07/91 |   | VKMA 06203            | 1 |   | 1 |  |  |  |  |   |  |  |  |  |  |  |   |       |  | T0024 |
|   |  |               |   | VKM 16200             | 1 |   |   |  |  |  |  |   |  |  |  |  |  |  |   |       |  |       |
|   | J7T 600, J7T 780                           | 07/91 → 10/97 |   | VKPC 86605            |   |   |   |  |  |  |  | 1 |  |  |  |  |  |  |   |       |  |       |
|   | J7T 780                                    | 05/89 → 07/91 |   | VKPC 86405            |   |   |   |  |  |  |  | 1 |  |  |  |  |  |  |   |       |  |       |
| <b>RENAULT</b>  <b>TRAFIC I 1.9 D</b>  |  |               |   |                       |   |   |   |  |  |  |  |   |  |  |  |  |  |  |   |       |  |       |
|   | F8Q 600, F8Q 606                           | 06/97 → 03/01 | 3)  | VKMS 06114-2          | 1 | 1 | 1 |  |  |  |  |   |  |  |  |  |  |  | 2 |       |  | T0147 |
|   |  |               |   | VKMA 06114            | 1 | 1 | 1 |  |  |  |  |   |  |  |  |  |  |  |   |       |  |       |
|   |  |               |   | VKM 16101             | 1 |   |   |  |  |  |  |   |  |  |  |  |  |  |   |       |  |       |
|   |  |               |   | VKM 26101             |   | 1 |   |  |  |  |  |   |  |  |  |  |  |  |   |       |  |       |
|   | F8Q 600, F8Q 606                           | 06/97 → 03/01 | <b>P</b>  | VKMA 06124            | 1 | 2 | 1 |  |  |  |  |   |  |  |  |  |  |  |   |       |  | T0147 |
|   |  |               |   | VKM 16101             | 1 |   |   |  |  |  |  |   |  |  |  |  |  |  |   |       |  |       |
|   |  |               |   | VKM 26101             |   | 1 |   |  |  |  |  |   |  |  |  |  |  |  |   |       |  |       |
|   |  |               |   | VKM 26125             |   | 1 |   |  |  |  |  |   |  |  |  |  |  |  |   |       |  |       |
|   | F8Q 600, F8Q 606                           | 06/97 → 03/01 |   | VKPC 86413            |   |   |   |  |  |  |  | 1 |  |  |  |  |  |  |   |       |  |       |
|   | <b>B(Alt)</b> F8Q 600, F8Q 606             | 06/97 → 03/01 |   | VKMV 6PK1135          |   |   | 1 |  |  |  |  |   |  |  |  |  |  |  |   |       |  |       |
|   | F8Q 600, F8Q 606                           | 06/97 → 03/01 |   | VKM_____              |   |   |   |  |  |  |  |   |  |  |  |  |  |  | 1 |       |  |       |

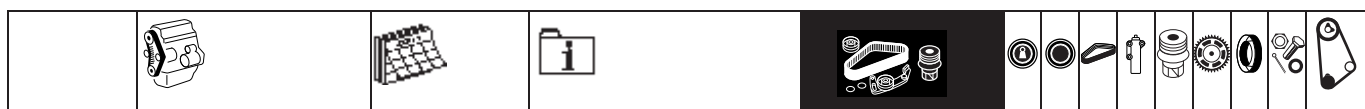

**RENAULT** **TRAFIC I 2.1 D**

|  |  |                                |    |  |             |             |   |  |  |  |        |  |  |  |  |  |  |  |       |
|--|--|--------------------------------|----|--|-------------|-------------|---|--|--|--|--------|--|--|--|--|--|--|--|-------|
|  | 852 720, 852 750,<br>J8S 620, J8S 758            | 05/89 → 10/97                  | 3) | VKMS 06213<br>VKMA 06213<br>VKM 16212<br>VKM 26211 | 1<br>1<br>1 | 1<br>1<br>1 |   |  |  |  | 3      |  |  |  |  |  |  |  | T0015 |
|  | 852 720, 852 750                                 | 03/80 → 04/89                  |    | VKMA 06213<br>VKM 16212<br>VKM 26211               | 1<br>1      | 1<br>1      |   |  |  |  |        |  |  |  |  |  |  |  | T0015 |
|  | 852 720, 852 750<br>J8S 620, J8S 622,<br>J8S 758 | 05/89 → 06/94<br>06/94 → 10/97 |    | VKPC 86623<br>VKPC 86603                           |             |             |   |  |  |  | 1<br>1 |  |  |  |  |  |  |  |       |
|  | <b>B(Alt)</b> 852 750                            | 05/89 → 06/94                  |    | VKMW 11.9x1010                                     |             |             | 1 |  |  |  |        |  |  |  |  |  |  |  |       |
|  | 852 720, 852 750<br>J8S 620, J8S 758             | 05/89 → 06/94<br>06/94 → 10/97 |    | —<br>—   |             |             |   |  |  |  | 1<br>1 |  |  |  |  |  |  |  |       |

**RENAULT** **TRAFIC I 2.5 D**

|  |  |               |  |   |             |        |        |  |  |  |   |  |  |  |  |  |  |  |       |
|--|--|---------------|--|---|-------------|--------|--------|--|--|--|---|--|--|--|--|--|--|--|-------|
|  | S8U 750, S8U 752,<br>S8U 758   | 09/90 → 03/01 |  | VKMA 02983<br>—<br>VKM 22380<br>VKM 22385 | 2<br>1<br>1 | 1<br>1 | 1<br>1 |  |  |  |   |  |  |  |  |  |  |  | T0096 |
|  | S8U 750, S8U 752   | 05/89 → 09/90 |  | VKMA 02381<br>VKM 22380<br>VKM 22385      | 2<br>1<br>1 | 1      |        |  |  |  |   |  |  |  |  |  |  |  | T0014 |
|  | S8U 750, S8U 752,<br>S8U 758   | 09/90 → 03/01 |  | VKMA 02383<br>VKM 22380<br>VKM 22385      | 2<br>1<br>1 | 1      |        |  |  |  |   |  |  |  |  |  |  |  | T0652 |
|  | 8140.67.2500,<br>8140.67.2550,<br>8140.67.2580, S8U 722,<br>S8U 750, S8U 752,<br>S8U 758 | 05/89 → 03/01 |  | VKPC 82630                                |             |        |        |  |  |  | 1 |  |  |  |  |  |  |  |       |































**RENAULT** **TRAFIC II 2.0 16V**

|  |                                |               |           |  |        |        |   |  |  |  |   |  |  |  |  |  |  |  |       |
|--|--------------------------------|---------------|-----------|--|--------|--------|---|--|--|--|---|--|--|--|--|--|--|--|-------|
|  | F4R 720                        | 03/01 → 04/01 |           | —<br>—<br>VKM 26020                                  | 1<br>1 | 1<br>1 | 1 |  |  |  |   |  |  |  |  |  |  |  | T0177 |
|  | F4R 720, F4R 820               | 04/01 → 12/07 |           | —<br>—<br>VKM 26105                                  | 1<br>1 | 1<br>1 | 1 |  |  |  |   |  |  |  |  |  |  |  | T0177 |
|  | F4R 720, F4R 820               | 03/01 → 12/07 |           | VKPC 85304   |        |        |   |  |  |  | 1 |  |  |  |  |  |  |  |       |
|  | <b>B(Alt)</b> F4R 720, F4R 820 | 03/01 → 12/07 | <b>AC</b> | VKMW 5PK1125   |        |        | 1 |  |  |  |   |  |  |  |  |  |  |  |       |
|  | <b>B(Alt)</b> F4R 720, F4R 820 | 03/01 → 12/07 | <b>AC</b> | VKMA 36038<br>VKMW 6PK1792<br>VKM 36030<br>VKM 36038 | 1<br>1 | 1<br>1 | 1 |  |  |  |   |  |  |  |  |  |  |  |       |































**RENAULT** **TRAFIC II 1.9 dCi**

|  |                                |               |                |  |             |        |        |   |  |  |   |  |  |  |  |  |  |  |       |
|--|--------------------------------|---------------|----------------|--|-------------|--------|--------|---|--|--|---|--|--|--|--|--|--|--|-------|
|  | F9Q 760, F9Q 762               | 03/01 → 12/07 |                | VKMC 06127<br>VKMA 06127<br>VKM 16113                | 1<br>1<br>1 |        | 1<br>1 | 1 |  |  |   |  |  |  |  |  |  |  | T0647 |
|  | F9Q 760, F9Q 762               | 03/01 → 12/07 |                | VKPC 85304   |             |        |        | 1 |  |  |   |  |  |  |  |  |  |  |       |
|  | <b>B(Alt)</b> F9Q 760          | 03/01 → 12/07 | 28), <b>AC</b> | VKMW 5PK1125   |             |        | 1      |   |  |  |   |  |  |  |  |  |  |  |       |
|  | <b>B(Alt)</b> F9Q 760, F9Q 762 | 03/01 → 03/02 | <b>AC</b>      | VKMA 36033<br>VKMW 6PK1792<br>VKM 36030<br>VKM 36031 | 1<br>1      | 1<br>1 | 1<br>1 |   |  |  |   |  |  |  |  |  |  |  |       |
|  | <b>B(Alt)</b> F9Q 760, F9Q 762 | 03/02 → 12/07 | <b>AC</b>      | VKMA 36038<br>VKMW 6PK1792<br>VKM 36030<br>VKM 36038 | 1<br>1      | 1<br>1 | 1<br>1 |   |  |  |   |  |  |  |  |  |  |  |       |
|  | <b>B(Alt)</b> F9Q 762          | 03/01 → 12/07 | <b>AC</b>      | VKMW 5PK1125   |             |        | 1      |   |  |  |   |  |  |  |  |  |  |  |       |
|  | F9Q 760, F9Q 762               | 03/01 → 05/06 | <b>AC</b>      | —  |             |        |        |   |  |  | 1 |  |  |  |  |  |  |  |       |
|  | F9Q 760, F9Q 762               | 03/01 → 05/06 | <b>AC</b>      | —  |             |        |        |   |  |  | 1 |  |  |  |  |  |  |  |       |





































| <b>RENAULT</b>  <b>TRAFIC II 2.5 dCi</b> |                                      |               |   |               |   |   |   |  |  |   |  |   |  |  |  |  |  |   |       |       |  |
|---|--------------------------------------|---------------|---|---------------|---|---|---|--|--|---|--|---|--|--|--|--|--|---|-------|-------|--|
|   | G9U 630, G9U 730                     | 03/01 → 12/07 | VKMA 06503  | 1             | 1 | 1 |   |  |  |   |  |   |  |  |  |  |  | 1 | T0187 |       |  |
|   |                                      |               | VKM 16503   | 1             |   |   |   |  |  |   |  |   |  |  |  |  |  |   |       |       |  |
|   |                                      |               | VKM 26503   |               | 1 |   |   |  |  |   |  |   |  |  |  |  |  |   |       |       |  |
|   | G9U 630, G9U 730                     | 03/01 → 12/07 | VKPC 86305  |               |   |   |   |  |  | 1 |  |   |  |  |  |  |  |   |       |       |  |
|   | <b>B(Alt)</b> G9U 730                | 03/01 → 12/07 | 28), <b>AC</b>  | VKMOV 6PK1148 |   |   |   |  |  | 1 |  |   |  |  |  |  |  |   |       |       |  |
|   |                                      |               |   | VKM 36040     |   | 1 |   |  |  |   |  |   |  |  |  |  |  |   |       |       |  |
|   |                                      |               |   | VKM 36040     |   | 1 |   |  |  |   |  |   |  |  |  |  |  |   |       |       |  |
|   | <b>B(Alt)</b> G9U 730                | 03/01 → 05/06 | 28), <b>AC</b>  | VKMOV 6PK1795 |   |   |   |  |  | 1 |  |   |  |  |  |  |  |   |       |       |  |
|   |                                      |               |   | VKM 36040     |   | 1 |   |  |  |   |  |   |  |  |  |  |  |   |       |       |  |
|   |                                      |               |   | VKM 36040     |   | 1 |   |  |  |   |  |   |  |  |  |  |  |   |       |       |  |
| <b>ROVER</b>  <b>100 1.1</b>             |                                      |               |   |               |   |   |   |  |  |   |  |   |  |  |  |  |  |   |       |       |  |
|   | 11 K2A, 11 K2D                       | 03/90 → 06/04 | VKMA 07300  | 1             |   |   |   |  |  | 1 |  |   |  |  |  |  |  |   | 2     | T0082 |  |
|   |                                      |               | VKM 17300   | 1             |   |   |   |  |  |   |  |   |  |  |  |  |  |   |       |       |  |
|   | 11 K2A, 11 K2D                       | 03/90 → 04/05 | VKPC 87400  |               |   |   |   |  |  |   |  | 1 |  |  |  |  |  |   |       |       |  |
|   | <b>B(Alt)</b> 11 K2A, 11 K2D         | 03/90 → 12/98 | <b>Carbu.</b>   | VKMOV 4PK780  |   |   |   |  |  | 1 |  |   |  |  |  |  |  |   |       |       |  |
|   | <b>B(Alt)</b> 11 K2A, 11 K2D         | 03/90 → 06/05 | <b>Injec.</b>   | VKMOV 4PK736  |   |   |   |  |  | 1 |  |   |  |  |  |  |  |   |       |       |  |
| <b>ROVER</b>  <b>100 1.4</b>             |                                      |               |   |               |   |   |   |  |  |   |  |   |  |  |  |  |  |   |       |       |  |
|   | 14 K2A, 14 K2D                       | 03/90 → 06/04 | VKMA 07300  | 1             |   |   |   |  |  | 1 |  |   |  |  |  |  |  |   | 2     | T0082 |  |
|   |                                      |               | VKM 17300   | 1             |   |   |   |  |  |   |  |   |  |  |  |  |  |   |       |       |  |
|   | 14 K2A, 14 K2D                       | 03/90 → 04/05 | VKPC 87400  |               |   |   |   |  |  |   |  | 1 |  |  |  |  |  |   |       |       |  |
|   | <b>B(Alt)</b> 14 K2A, 14 K2D         | 03/90 → 12/98 | <b>Carbu.</b>   | VKMOV 4PK780  |   |   |   |  |  | 1 |  |   |  |  |  |  |  |   |       |       |  |
|   | <b>B(Alt)</b> 14 K2A, 14 K2D         | 03/90 → 06/05 | <b>Injec.</b>   | VKMOV 4PK736  |   |   |   |  |  | 1 |  |   |  |  |  |  |  |   |       |       |  |
| <b>ROVER</b>  <b>100 1.4 16V</b>        |                                      |               |   |               |   |   |   |  |  |   |  |   |  |  |  |  |  |   |       |       |  |
|   | 14 K4C, 14 K4D, 14 K4F               | 03/90 → 12/98 | VKMA 07310  | 1             |   |   |   |  |  | 1 |  |   |  |  |  |  |  |   | 2     | T0072 |  |
|   |                                      |               | VKM 17310   | 1             |   |   |   |  |  |   |  |   |  |  |  |  |  |   |       |       |  |
|   | 14 K4C, 14 K4D, 14 K4F               | 03/90 → 12/98 | VKPC 87401  |               |   |   |   |  |  |   |  | 1 |  |  |  |  |  |   |       |       |  |
|   | <b>B(Alt)</b> 14 K4C, 14 K4D, 14 K4F | 03/90 → 12/98 |   | VKMOV 4PK736  |   |   |   |  |  | 1 |  |   |  |  |  |  |  |   |       |       |  |
| <b>ROVER</b>  <b>100 1.4 D</b>         |                                      |               |   |               |   |   |   |  |  |   |  |   |  |  |  |  |  |   |       |       |  |
|   | TUD 3                                | 10/92 → 12/94 | VKMA 03120  | 1             | 1 | 1 |   |  |  |   |  |   |  |  |  |  |  |   |       | T0120 |  |
|   |                                      |               | VKM 13120   | 1             |   |   |   |  |  |   |  |   |  |  |  |  |  |   |       |       |  |
|   |                                      |               | VKM 23120   |               | 1 |   |   |  |  |   |  |   |  |  |  |  |  |   | 2     |       |  |
|   | TUD 3                                | 10/92 → 12/94 | VKPC 83205  |               |   |   |   |  |  |   |  | 1 |  |  |  |  |  |   |       |       |  |
| <b>ROVER</b>  <b>100 1.5 D</b>         |                                      |               |   |               |   |   |   |  |  |   |  |   |  |  |  |  |  |   |       |       |  |
|   | TUD 5                                | 12/94 → 12/98 |  | VKMC 03121    | 1 | 1 | 1 |  |  | 1 |  |   |  |  |  |  |  |   | 2     | T0120 |  |
|   |                                      |               |   | VKMA 03121    | 1 | 1 | 1 |  |  |   |  |   |  |  |  |  |  |   | 2     |       |  |
|   |                                      |               |   | VKM 13120     | 1 |   |   |  |  |   |  |   |  |  |  |  |  |   |       |       |  |
|   |                                      |               |   | VKM 23120     |   | 1 |   |  |  |   |  |   |  |  |  |  |  |   | 2     |       |  |
|   | TUD 5                                | 12/94 → 12/98 | 3)  | VKMS 03121    | 1 | 1 | 1 |  |  |   |  |   |  |  |  |  |  | 2 | 2     |       |  |
|   |                                      |               |   | VKMA 03121    | 1 | 1 | 1 |  |  |   |  |   |  |  |  |  |  |   | 2     | T0120 |  |
|   |                                      |               |   | VKM 13120     | 1 |   |   |  |  |   |  |   |  |  |  |  |  |   |       |       |  |
|   |                                      |               |   | VKM 23120     |   | 1 |   |  |  |   |  |   |  |  |  |  |  |   | 2     |       |  |
|   | TUD 5                                | 12/94 → 12/98 |   | VKPC 83428    |   |   |   |  |  |   |  | 1 |  |  |  |  |  |   |       |       |  |
|   | <b>B(Alt)</b> TUD 5                  | 12/94 → 12/98 |   | VKMA 33045    | 1 |   |   |  |  | 1 |  |   |  |  |  |  |  |   |       |       |  |
|   |                                      |               |   | VKMOV 5PK775  |   |   |   |  |  | 1 |  |   |  |  |  |  |  |   |       |       |  |
|   |                                      |               |   | VKM 33009     | 1 |   |   |  |  |   |  |   |  |  |  |  |  |   |       |       |  |
| <b>ROVER</b>  <b>200 (RF) 1.1</b>      |                                      |               |   |               |   |   |   |  |  |   |  |   |  |  |  |  |  |   |       |       |  |
|   | 11 K2D                               | 01/98 → 03/00 | VKMA 07300  | 1             |   |   |   |  |  | 1 |  |   |  |  |  |  |  |   | 2     | T0082 |  |
|   |                                      |               | VKM 17300   | 1             |   |   |   |  |  |   |  |   |  |  |  |  |  |   |       |       |  |
|   | 11 K2D                               | 01/98 → 03/00 | VKPC 87400  |               |   |   |   |  |  |   |  | 1 |  |  |  |  |  |   |       |       |  |
|   | 11 K2D                               | 01/98 → 03/00 |   | VKPC 87401    |   |   |   |  |  |   |  | 1 |  |  |  |  |  |   |       |       |  |
|   | <b>B(Alt)</b> 11 K2D                 | 01/98 → 03/00 | <b>AC</b>   | VKMOV 5PK738  |   |   |   |  |  | 1 |  |   |  |  |  |  |  |   |       |       |  |
|   | <b>B(Alt)</b> 11 K2D                 | 01/98 → 03/00 | <b>AC</b>   | VKMOV 5PK1148 |   |   |   |  |  | 1 |  |   |  |  |  |  |  |   |       |       |  |
|   |                                      |               |   | VKM 37015     | 1 |   |   |  |  |   |  |   |  |  |  |  |  |   |       |       |  |
|   | <b>B(PS)</b> 11 K2D                  | 01/98 → 03/00 | <b>M⊙</b>   | VKMOV 3PK753  |   |   |   |  |  | 1 |  |   |  |  |  |  |  |   |       |       |  |
|   |                                      |               |   | VKM 37014     | 1 |   |   |  |  |   |  |   |  |  |  |  |  |   |       |       |  |
|   | <b>B(PS)</b> 11 K2D                  | 01/98 → 03/00 | <b>A⊙</b>   | VKMOV 3PK753  |   |   |   |  |  | 1 |  |   |  |  |  |  |  |   |       |       |  |
|   |                                      |               |   | VKM 37010     | 1 |   |   |  |  |   |  |   |  |  |  |  |  |   |       |       |  |
| <b>ROVER</b>  <b>200 (RF) 1.4</b>      |                                      |               |   |               |   |   |   |  |  |   |  |   |  |  |  |  |  |   |       |       |  |
|   | 14 K2F                               | 11/95 → 03/00 | VKMA 07300  | 1             |   |   |   |  |  | 1 |  |   |  |  |  |  |  |   | 2     | T0082 |  |
|   |                                      |               | VKM 17300   | 1             |   |   |   |  |  |   |  |   |  |  |  |  |  |   |       |       |  |
|   | 14 K2F                               | 11/95 → 03/00 | VKPC 87400  |               |   |   |   |  |  |   |  | 1 |  |  |  |  |  |   |       |       |  |



|   |  |  |  |  |  |  |  |  |  |  |  |  |
|---|---|---|---|--|---|---|---|---|---|---|---|---|
|  B(Alt) 14 K2F                   | 14 K2F  | 11/95 → 03/00   | AC  | VKMV 5PK738  |   |   | 1   |   |   |   |   |   |
| B(Alt) 14 K2F   | 14 K2F  | 11/95 → 03/00   | AC  | VKMV 5PK1148<br>VKM 37015  | 1   |   | 1   |   |   |   |   |   |
| B(PS) 14 K2F  | 14 K2F  | 11/95 → 03/00   | M⊙  | VKMV 3PK753<br>VKM 37014   | 1   |   | 1   |   |   |   |   |   |
| B(PS) 14 K2F  | 14 K2F  | 11/95 → 03/00   | A⊙  | VKMV 3PK753<br>VKM 37010   | 1   |   | 1   |   |   |   |   |   |
| <b>ROVER  200 (RF) 1.4 16V</b>   |   |   |   |  |   |   |   |   |   |   |   |   |
|  14 K4F                          | 14 K4F  | 11/95 → 03/00   | M⊙  | VKMA 07310<br>VKM 17310  | 1   |   | 1   |   |   |   | 2   | T0072   |
| 14 K4F  | 14 K4F  | 11/95 → 03/00   | A⊙  | VKMA 07301<br>VKM 17301  | 1   |   | 1   |   |   |   |   | T0072   |
|  14 K4F                          | 14 K4F  | 11/95 → 03/00   |   | VKPC 87401   |   |   |   | 1   |   |   |   |   |
|  B(Alt) 14 K4F                   | 14 K4F  | 11/95 → 03/00   | AC  | VKMV 5PK738  |   |   | 1   |   |   |   |   |   |
| B(Alt) 14 K4F   | 14 K4F  | 11/95 → 03/00   | AC  | VKMV 5PK1148<br>VKM 37015  | 1   |   | 1   |   |   |   |   |   |
| B(PS) 14 K4F  | 14 K4F  | 11/95 → 03/00   | M⊙  | VKMV 3PK753<br>VKM 37014   | 1   |   | 1   |   |   |   |   |   |
| B(PS) 14 K4F  | 14 K4F  | 11/95 → 03/00   | A⊙  | VKMV 3PK753<br>VKM 37010   | 1   |   | 1   |   |   |   |   |   |
| <b>ROVER  200 (RF) 1.6 16V</b>   |   |   |   |  |   |   |   |   |   |   |   |   |
|  16 K4F                          | 16 K4F  | 11/95 → 03/00   | M⊙  | VKMA 07310<br>VKM 17310  | 1   |   | 1   |   |   |   | 2   | T0072   |
| 16 K4F  | 16 K4F  | 11/95 → 03/00   | A⊙  | VKMA 07301<br>VKM 17301  | 1   |   | 1   |   |   |   |   | T0072   |
|  16 K4F                         | 16 K4F  | 11/95 → 03/00   |   | VKPC 87401   |   |   |   | 1   |   |   |   |   |
|  B(Alt) 16 K4F                 | 16 K4F  | 11/95 → 03/00   | AC  | VKMV 5PK738  |   |   | 1   |   |   |   |   |   |
| B(Alt) 16 K4F   | 16 K4F  | 11/95 → 03/00   | AC  | VKMV 5PK1148<br>VKM 37015  | 1   |   | 1   |   |   |   |   |   |
| B(PS) 16 K4F  | 16 K4F  | 11/95 → 03/00   | M⊙  | VKMV 3PK753<br>VKM 37014   | 1   |   | 1   |   |   |   |   |   |
| B(PS) 16 K4F  | 16 K4F  | 11/95 → 03/00   | A⊙  | VKMV 3PK753<br>VKM 37010   | 1   |   | 1   |   |   |   |   |   |
| <b>ROVER  200 (RF) 1.8 16V</b> |   |   |   |  |   |   |   |   |   |   |   |   |
|  18 K4K (VVC)                  | 18 K4K (VVC)  | 11/95 → 03/00   |   | VKMA ____<br>VKM 17310   | 1   |   | 2   |   |   |   | 2   | T0234   |
| 18 K4K (VVC)  | 18 K4K (VVC)  | 11/95 → 03/00   |   | VKPC 87401   | 1   |   |   | 1   |   |   |   |   |
|  B(Alt) 18 K4K (VVC)           | 18 K4K (VVC)  | 11/95 → 03/00   | AC  | VKMV 5PK738  |   |   | 1   |   |   |   |   |   |
| B(Alt) 18 K4K (VVC)   | 18 K4K (VVC)  | 11/95 → 03/00   | AC  | VKMV 5PK1148<br>VKM 37015  | 1   |   | 1   |   |   |   |   |   |
| B(PS) 18 K4K (VVC)  | 18 K4K (VVC)  | 11/95 → 03/00   | M⊙  | VKMV 3PK753<br>VKM 37014   | 1   |   | 1   |   |   |   |   |   |
| B(PS) 18 K4K (VVC)  | 18 K4K (VVC)  | 11/95 → 03/00   | A⊙  | VKMV 3PK753<br>VKM 37010   | 1   |   | 1   |   |   |   |   |   |
| <b>ROVER  200 (RF) 2.0 D</b>   |   |   |   |  |   |   |   |   |   |   |   |   |
|  20 T2N, 20 T2R                | 20 T2N, 20 T2R  | 11/95 → 03/00   | → ICHYD471564   | VKMA 07302<br>VKM 17302<br>VKM 17304<br>VKM 27302                                  | 2   | 1   | 2   |   |   |   | 2   | T0141   |
| 20 T2N, 20 T2R  | 20 T2N, 20 T2R  | 11/95 → 03/00   |   | VKPC 87813   |   |   |   | 1   |   |   |   |   |
|  B(Alt) 20 T2N, 20 T2R         | 20 T2N, 20 T2R  | 11/95 → 03/00   | AC  | VKMV 6PK1462<br>VKM 37005  | 1   |   | 1   |   |   |   |   |   |
| <b>ROVER  200 (XH) 1.3</b>     |   |   |   |  |   |   |   |   |   |   |   |   |
|  EV 2                          | EV 2  | 09/85 → 09/89   |   | VKMA 93101<br>VKM 73101  | 1   |   | 1   |   |   |   |   | T0682   |
| EV 2  | EV 2  | 09/85 → 09/89   |   | VKPC 93205   |   |   |   | 1   |   |   |   |   |
| <b>ROVER  200 (XH) 1.6</b>     |   |   |   |  |   |   |   |   |   |   |   |   |
|  16 H                          | 16 H  | 03/85 → 09/89   |   | VKMA 07200<br>VKM 17200  | 1   |   | 1   |   |   |   |   | T0031   |
| 16 H  | 16 H  | 03/85 → 09/89   |   | VKPC 87403   |   |   |   | 1   |   |   |   |   |



































ROVER

|   |                                       |  |  |  |  |  |  |  |  |  |  |  |  |
|---|---------------------------------------|---|---|---|--|---|---|---|---|---|---|---|---|
| <b>ROVER  200 (XW) 1.4</b>             |                                       |   |   |   |  |   |   |   |   |   |   |   |   |
|   | 14 K2A, 14 K2D                        | 09/93 → 10/95   |   |   | VKMA 07300<br>VKM 17300  | 1<br>1  | 1   |   |   |   |   |   | 2 T0082   |
|   | 14 K2A, 14 K2D                        | 09/93 → 10/95   |   |   | VKPC 87400   |   |   |   | 1   |   |   |   |   |
|   | <b>B(Alt)</b> 14 K2A, 14 K2D          | 09/93 → 10/95   | <b>AC</b>   |   | VKMV 4PK736  |   | 1   |   |   |   |   |   |   |
|   | <b>B(Alt)</b> 14 K2A, 14 K2D          | 09/93 → 10/95   | <b>AC</b>   |   | VKMV 5PK1148   |   | 1   |   |   |   |   |   |   |
|   | <b>B(PS)</b> 14 K2A, 14 K2D           | 09/93 → 10/95   | <b>CH 822624 I→</b>   |   | VKMV 3PK753<br>VKM 37014   | 1   | 1   |   |   |   |   |   |   |
| <b>ROVER  200 (XW) 1.4 16V</b>         |                                       |   |   |   |  |   |   |   |   |   |   |   |   |
|   | 14 K4C, 14 K4D, 14 K4F                | 10/89 → 10/95   | <b>M0, 143, B(70264x23 HSN)</b>   |   | VKMA 07310<br>VKM 17310  | 1<br>1  | 1   |   |   |   |   |   | 2 T0072   |
|   | 14 K4C, 14 K4D, 14 K4F                | 10/89 → 10/95   |   |   | VKPC 87401   |   |   |   | 1   |   |   |   |   |
|   | 14 K4C                                | 01/90 → 10/95   |   |   | VKPC 87400   |   |   |   | 1   |   |   |   |   |
|   | <b>B(Alt)</b> 14 K4C, 14 K4D, 14 K4F  | 10/89 → 10/95   | <b>AC</b>   |   | VKMV 4PK736  |   | 1   |   |   |   |   |   |   |
|   | <b>B(Alt)</b> 14 K4C, 14 K4D, 14 K4F  | 10/89 → 10/95   | <b>AC</b>   |   | VKMV 5PK1148   |   | 1   |   |   |   |   |   |   |
|   | <b>B(PS)</b> 14 K4C, 14 K4D, 14 K4F   | 10/89 → 10/95   | <b>CH 822624 I→</b>   |   | VKMV 3PK753<br>VKM 37014   | 1   | 1   |   |   |   |   |   |   |
| <b>ROVER  200 (XW) 1.6</b>             |                                       |   |   |   |  |   |   |   |   |   |   |   |   |
|   | D 16 A7, D 16 A9,<br>D 16 Z2          | 10/89 → 10/95   | <b>SOHC</b>   |   | VKMA 93001<br>VKM 73000  | 1<br>1  | 1   |   |   |   |   |   | T0682   |
|   | D 16 A7, D 16 A8,<br>D 16 A9, D 16 Z2 | 10/89 → 06/99   | <b>DOHC</b>   |   | VKMA 93002<br>VKM 73000  | 1<br>1  | 1   |   |   |   |   |   | T0677   |
|                                       | D 16 A7, D 16 A8,<br>D 16 A9, D 16 Z2 | 10/89 → 06/99   |   |   | VKPC 87404   |   |   |   | 1   |   |   |   |   |
| <b>ROVER  200 (XW) 2.0</b>           |                                       |   |   |   |  |   |   |   |   |   |   |   |   |
|                                       | 20 T4H                                | 01/93 → 12/94   | 5)  |   | VKMA 07100<br>VKM 17000  | 1<br>1  | 1   |   |   |   |   |   | T0044   |
|                                       | 20 M4F, 20 T4H                        | 09/91 → 02/96   |   |   | VKPC 87813   |   |   |   | 1   |   |   |   |   |
|                                       | <b>B(Alt)</b> 20 M4F, 20 T4H          | 09/91 → 10/95   | <b>AC</b>   |   | VKMV 5PK1163<br>VKM_____   | 1   | 1   |   |   |   |   |   |   |
|   | <b>B(Alt)</b> 20 M4F, 20 T4H          | 09/91 → 10/95   | <b>AC</b>   |   | VKMV 6PK1445<br>VKM_____   | 1   | 1   |   |   |   |   |   |   |
| <b>ROVER  200 (XW) 2.0 Turbo</b>     |                                       |   |   |   |  |   |   |   |   |   |   |   |   |
|                                       | 20 T4G                                | 10/92 → 06/99   |   |   | VKMA_____<br>VKM_____  | 1<br>1  | 1   |   |   |   |   |   | 2   |
|                                       | 20 T4G                                | 10/92 → 02/96   |   |   | VKPC 87813   |   |   |   | 1   |   |   |   |   |
|                                       | <b>B(Alt)</b> 20 T4G                  | 01/93 → 10/95   | <b>AC</b>   |   | VKMV 5PK1163<br>VKM_____   | 1   | 1   |   |   |   |   |   |   |
|   | <b>B(Alt)</b> 20 T4G                  | 01/93 → 10/95   | <b>AC</b>   |   | VKMV 6PK1445<br>VKM_____   | 1   | 1   |   |   |   |   |   |   |
| <b>ROVER  200 (XW) 1.8 TD</b>        |                                       |   |   |   |  |   |   |   |   |   |   |   |   |
|                                       | XUD 7TE                               | 09/91 → 12/93   |   |   | VKMA 03240<br>VKM 13240<br>VKM 23240   | 1<br>1<br>1   | 1<br>1  | 1   |   |   |   |   | 2 T0017   |
|   | XUD 7TE                               | 01/94 → 10/95   |   |   | VKMA 03241<br>VKM 13241<br>VKM 23241   | 1<br>1<br>1   | 1<br>1  | 1   |   |   |   |   | T0017   |
|                                       | XUD 7TE                               | 09/91 → 10/95   | <b>→ Mot. 4016153</b>   |   | VKPC 83424   |   |   |   | 1   |   |   |   |   |
|   | XUD 7TE                               | 09/91 → 10/95   | <b>Mot. 4016154 I→</b>  |   | VKPC 83420   |   |   |   | 1   |   |   |   |   |
| <b>ROVER  200 (XW) 1.9 D</b>         |                                       |   |   |   |  |   |   |   |   |   |   |   |   |
|                                       | XUD9                                  | 09/91 → 12/93   |   |   | VKMA 03240<br>VKM 13240<br>VKM 23240   | 1<br>1<br>1   | 1<br>1  | 1   |   |   |   |   | 2 T0017   |
|   | XUD9                                  | 01/94 → 10/95   |   |   | VKMA 03241<br>VKM 13241<br>VKM 23241   | 1<br>1<br>1   | 1<br>1  | 1   |   |   |   |   | T0017   |
|                                       | XUD9                                  | 09/91 → 10/95   |   |   | VKPC 83420   |   |   |   | 1   |   |   |   |   |
| <b>ROVER  200 cabriolet (XW) 1.4</b> |                                       |   |   |   |  |   |   |   |   |   |   |   |   |
|                                       | 14 K4C, 14 K4D                        | 01/92 → 11/99   |   |   | VKMA 07300<br>VKM 17300  | 1<br>1  | 1   |   |   |   |   |   | 2 T0082   |

|  | 14 K4C, 14 K4D        | 01/92 → 11/99 |                         | VKPC 87401                |        |   |  | 1 |  |         |
|--|-----------------------|---------------|-------------------------|---------------------------|--------|---|--|---|--|---------|
| <b>ROVER  200 cabriolet (XW) 1.4 16V</b> |                       |               |                         |                           |        |   |  |   |  |         |
|  | 14 K4F                | 01/93 → 07/96 | 143,<br>B(70264x23 HSN) | VKMA 07310<br>VKM 17310   | 1<br>1 | 1 |  |   |  | 2 T0072 |
|  | 14 K4F                | 01/93 → 11/99 |                         | VKPC 87401                |        |   |  | 1 |  |         |
| <b>ROVER  200 cabriolet (XW) 1.6</b>     |                       |               |                         |                           |        |   |  |   |  |         |
|  | D 16 A8               | 01/92 → 07/96 |                         | VKMA 93002<br>VKM 73000   | 1<br>1 | 1 |  |   |  | T0677   |
|  | D 16 A8               | 01/92 → 11/99 |                         | VKPC 87404                |        |   |  | 1 |  |         |
| <b>ROVER  200 cabriolet (XW) 1.6 16V</b> |                       |               |                         |                           |        |   |  |   |  |         |
|  | 16 K4F                | 01/96 → 11/99 | 143,<br>B(70264x23 HSN) | VKMA 07310<br>VKM 17310   | 1<br>1 | 1 |  |   |  | 2 T0072 |
|  | 16 K4F                | 01/96 → 11/99 |                         | VKPC 87404                |        |   |  | 1 |  |         |
| <b>ROVER  200 coupe (RF) 1.6 16V</b>     |                       |               |                         |                           |        |   |  |   |  |         |
|  | 16 K4F                | 03/96 → 11/99 | M⊙                      | VKMA 07310<br>VKM 17310   | 1<br>1 | 1 |  |   |  | 2 T0072 |
|  | 16 K4F                | 03/96 → 11/99 | A⊙                      | VKMA 07301<br>VKM 17301   | 1<br>1 | 1 |  |   |  | T0072   |
|  | 16 K4F                | 03/96 → 11/99 |                         | VKPC 87401                |        |   |  | 1 |  |         |
|  | B(Alt) 16 K4F         | 03/96 → 11/99 | AC                      | VKMA 5PK738               |        | 1 |  |   |  |         |
|  | B(Alt) 16 K4F         | 03/96 → 11/99 | AC                      | VKMA 5PK1148<br>VKM 37015 | 1      | 1 |  |   |  |         |
|  | B(PS) 16 K4F          | 03/96 → 11/99 | M⊙                      | VKMA 3PK753<br>VKM 37014  | 1      | 1 |  |   |  |         |
|  | B(PS) 16 K4F          | 03/96 → 11/99 | A⊙                      | VKMA 3PK753<br>VKM 37010  | 1      | 1 |  |   |  |         |
| <b>ROVER  200 coupe (RF) 1.8 16V</b>     |                       |               |                         |                           |        |   |  |   |  |         |
|  | 18 K4K (VVC)          | 03/96 → 11/99 |                         | VKMA _____<br>VKM 17310   | 1<br>1 | 2 |  |   |  | 2 T0234 |
|  | 18 K4K                | 03/96 → 11/99 |                         | VKPC 87401                |        |   |  | 1 |  |         |
|  | B(Alt) 18 K4K (VVC)   | 03/96 → 11/99 | AC                      | VKMA 5PK738               |        | 1 |  |   |  |         |
|  | B(Alt) 18 K4K (VVC)   | 03/96 → 11/99 | AC                      | VKMA 5PK1148<br>VKM 37015 | 1      | 1 |  |   |  |         |
|  | B(PS) 18 K4K (VVC)    | 03/96 → 11/99 | M⊙                      | VKMA 3PK753<br>VKM 37014  | 1      | 1 |  |   |  |         |
|  | B(PS) 18 K4K (VVC)    | 03/96 → 11/99 | A⊙                      | VKMA 3PK753<br>VKM 37010  | 1      | 1 |  |   |  |         |
| <b>ROVER  2000-3500 2.4 TD</b>           |                       |               |                         |                           |        |   |  |   |  |         |
|  |                       | 05/82 → 10/86 |                         |                           |        |   |  |   |  |         |
|  |                       | 05/82 → 10/86 |                         | —                         |        |   |  | 1 |  |         |
| <b>ROVER  25 1.1 16V</b>                 |                       |               |                         |                           |        |   |  |   |  |         |
|  | 11 K4F                | 01/04 → 06/05 |                         | VKMA 07301<br>VKM 17301   | 1<br>1 | 1 |  |   |  | T0072   |
|  | B(Alt) 11 K4F         | 01/04 → 06/05 | AC                      | VKMA 5PK738               |        | 1 |  |   |  |         |
|  | B(Alt) 11 K4F         | 01/04 → 06/05 | AC                      | VKMA 5PK1163<br>VKM 37015 | 1      | 1 |  |   |  |         |
|  | B(PS) 11 K4F          | 01/04 → 06/05 | M⊙                      | VKMA 3PK753<br>VKM 37014  | 1      | 1 |  |   |  |         |
|  | B(PS) 11 K4F          | 01/04 → 06/05 | A⊙                      | VKMA 3PK753<br>VKM 37010  | 1      | 1 |  |   |  |         |
| <b>ROVER  25 1.4 16V</b>                 |                       |               |                         |                           |        |   |  |   |  |         |
|  | 14 K4F, 14 K4M        | 10/99 → 06/05 | M⊙                      | VKMA 07310<br>VKM 17310   | 1<br>1 | 1 |  |   |  | 2 T0072 |
|  | 14 K4F, 14 K4M        | 10/99 → 06/05 | A⊙                      | VKMA 07301<br>VKM 17301   | 1<br>1 | 1 |  |   |  | T0072   |
|  | 14 K4F                | 10/99 → 04/05 |                         | VKPC 87401                |        |   |  | 1 |  |         |
|  | 14 K4M                | 10/99 → 04/05 |                         | VKPC 87400                |        |   |  | 1 |  |         |
|  | B(Alt) 14 K4F, 14 K4M | 10/99 → 06/05 | AC                      | VKMA 5PK738               |        | 1 |  |   |  |         |
|  | B(Alt) 14 K4F, 14 K4M | 10/99 → 06/05 | AC                      | VKMA 5PK1163<br>VKM 37015 | 1      | 1 |  |   |  |         |







































|   |  |  |  |  |  |  |  |  |  |  |  |  |  |  |  |  |  |
|---|---|---|---|--|---|---|---|---|---|---|---|---|---|---|---|---|---|
| B(PS)   | 14 K4F, 14 K4M  | 10/99 → 06/05   | M⊙  | VKMOV 3PK753<br>VKM 37014  | 1   |   | 1   |   |   |   |   |   |   |   |   |   |   |
| B(PS)   | 14 K4F, 14 K4M  | 10/99 → 06/05   | A⊙  | VKMOV 3PK753<br>VKM 37010  | 1   |   | 1   |   |   |   |   |   |   |   |   |   |   |
| <b>ROVER  25 1.6 16V</b>         |   |   |   |  |   |   |   |   |   |   |   |   |   |   |   |   |   |
|                                   | 16 K4F  | 10/99 → 06/05   | M⊙  | VKMA 07310<br>VKM 17310  | 1<br>1  |   | 1   |   |   |   |   |   |   |   | 2   | T0072   |   |
|   | 16 K4F  | 10/99 → 06/05   | A⊙  | VKMA 07301<br>VKM 17301  | 1<br>1  |   | 1   |   |   |   |   |   |   |   |   | T0072   |   |
|                                   | 16 K4F  | 10/99 → 04/05   |   | VKPC 87401   |   |   |   |   |   | 1   |   |   |   |   |   |   |   |
|                                   | B(Alt) 16 K4F   | 10/99 → 06/05   | AC  | VKMOV 5PK738   |   |   | 1   |   |   |   |   |   |   |   |   |   |   |
|   | B(Alt) 16 K4F   | 10/99 → 06/05   | AC  | VKMOV 5PK1163<br>VKM 37015   | 1   |   | 1   |   |   |   |   |   |   |   |   |   |   |
|   | B(PS) 16 K4F  | 10/99 → 06/05   | M⊙  | VKMOV 3PK753<br>VKM 37014  | 1   |   | 1   |   |   |   |   |   |   |   |   |   |   |
|   | B(PS) 16 K4F  | 10/99 → 06/05   | A⊙  | VKMOV 3PK753<br>VKM 37010  | 1   |   | 1   |   |   |   |   |   |   |   |   |   |   |
| <b>ROVER  25 1.8 16V</b>         |   |   |   |  |   |   |   |   |   |   |   |   |   |   |   |   |   |
|                                   | 18 K4F  | 10/99 → 06/05   | M⊙, Mot. VVC  | VKMA 07310<br>VKM 17310  | 1<br>1  |   | 1   |   |   |   |   |   |   |   | 2   | T0072   |   |
|   | 18 K4F  | 10/99 → 06/05   | A⊙, Mot. VVC  | VKMA 07301<br>VKM 17301  | 1<br>1  |   | 1   |   |   |   |   |   |   |   |   | T0072   |   |
|   | 18 K4K (VVC)  | 02/00 → 06/05   |   | VKMA _____<br>VKM 17310  | 1<br>1  |   | 2   |   |   |   |   |   |   |   | 2   | T0234   |   |
|                                   | 18 K4F, 18 K4K (VVC)  | 10/99 → 04/05   |   | VKPC 87401   |   |   |   |   |   | 1   |   |   |   |   |   |   |   |
|                                  | B(Alt) 18 K4F, 18 K4K (VVC)   | 10/99 → 06/05   | AC  | VKMOV 5PK738   |   |   | 1   |   |   |   |   |   |   |   |   |   |   |
|   | B(Alt) 18 K4F, 18 K4K (VVC)   | 10/99 → 06/05   | AC  | VKMOV 5PK1163<br>VKM 37015   | 1   |   | 1   |   |   |   |   |   |   |   |   |   |   |
|   | B(PS) 18 K4F, 18 K4K (VVC)  | 10/99 → 06/05   | M⊙  | VKMOV 3PK753<br>VKM 37014  | 1   |   | 1   |   |   |   |   |   |   |   |   |   |   |
|   | B(PS) 18 K4F, 18 K4K (VVC)  | 10/99 → 06/05   | A⊙  | VKMOV 3PK753<br>VKM 37010  | 1   |   | 1   |   |   |   |   |   |   |   |   |   |   |
| <b>ROVER  25 2.0 iDT</b>       |   |   |   |  |   |   |   |   |   |   |   |   |   |   |   |   |   |
|                                 | 20 T2N  | 10/99 → 06/05   | AC, →IMot. 5048,<br>CHYD471565 I→   | VKMA 07303<br>VKM 17303<br>VKM 17305<br>VKM 27303                                  | 2<br>1<br>1<br>1  |   | 1   | 2   |   |   |   |   |   |   | 2   | T0176   |   |
|   | 20 T2N  | 10/99 → 06/05   | AC, Mot. 5049 I→  | VKMA 07304<br>VKM 17303<br>VKM 17304<br>VKM 27303                                  | 2<br>1<br>1<br>1  |   | 1   | 2   |   |   |   |   |   |   |   | 2   | T0176   |
|   | 20 T2N  | 10/99 → 06/05   | AC, →IMot. 8367,<br>CHYD471565 I→   | VKMA 07303<br>VKM 17303<br>VKM 17305<br>VKM 27303                                  | 2<br>1<br>1<br>1  |   | 1   | 2   |   |   |   |   |   |   |   | 2   | T0176   |
|   | 20 T2N  | 10/99 → 06/05   | AC, Mot. 8368 I→  | VKMA 07304<br>VKM 17303<br>VKM 17304<br>VKM 27303                                  | 2<br>1<br>1<br>1  |   | 1   | 2   |   |   |   |   |   |   |   | 2   | T0176   |
|                                 | 20 T2N  | 10/99 → 04/05   |   | VKPC 87813   |   |   |   |   |   | 1   |   |   |   |   |   |   |   |
|                                 | B(Alt) 20 T2N   | 10/99 → 06/05   | AC  | VKMOV 6PK1462<br>VKM 37005   | 1   |   | 1   |   |   |   |   |   |   |   |   |   |   |
| <b>ROVER  400 (RT) 1.4 16V</b> |   |   |   |  |   |   |   |   |   |   |   |   |   |   |   |   |   |
|                                 | 14 K4F  | 05/95 → 03/00   | M⊙  | VKMA 07310<br>VKM 17310  | 1<br>1  |   | 1   |   |   |   |   |   |   |   | 2   | T0072   |   |
|   | 14 K4F  | 05/95 → 03/00   | A⊙  | VKMA 07301<br>VKM 17301  | 1<br>1  |   | 1   |   |   |   |   |   |   |   |   | T0072   |   |
|                                 | 14 K2   | 05/95 → 03/00   |   | VKPC 87400   |   |   |   |   |   | 1   |   |   |   |   |   |   |   |
|   | 14 K4F  | 05/95 → 03/00   |   | VKPC 87401   |   |   |   |   |   | 1   |   |   |   |   |   |   |   |
|                                 | B(PS) 14 K4F  | 05/95 → 03/00   | A⊙  | VKMOV 3PK753<br>VKM 37010  | 1   |   | 1   |   |   |   |   |   |   |   |   |   |   |

| <b>ROVER  400 (RT) 1.6 16V</b> |                                      |               |  |  |   |                  |   |   |  |   |  |  |  |         |
|--------------------------------|--------------------------------------|---------------|--|--|---|------------------|---|---|--|---|--|--|--|---------|
|                                | 16 K4F                               | 05/95 → 03/00 |  |  | VKMA 07310<br>VKM 17310                           | 1<br>1           | 1 |   |  |   |  |  |  | 2 T0072 |
|                                | 16 K4F                               | 05/95 → 03/00 |  |  | VKPC 87401  |                  |   |   |  | 1 |  |  |  |         |
|                                | <b>B(PS)</b> 16 K4F                  | 05/95 → 03/00 | <b>A</b> Man. GBX                          |  | VKMV 3PK753<br>VKM 37010                          | 1                | 1 |   |  |   |  |  |  |         |
|                                | <b>B(AC)</b> 16 K4F, 16K4F           | 05/95 → 03/00 | <b>Auto. GBX,</b><br><b>CH WD250029 I→</b> |  | VKMV 4PK820                                       |                  | 1 |   |  |   |  |  |  |         |
| <b>ROVER  400 (RT) 2.0</b>     |                                      |               |  |  |   |                  |   |   |  |   |  |  |  |         |
|                                | 20 T4H                               | 12/95 → 03/00 |  |  | VKMA _____<br>VKM _____                           | 1<br>1           | 1 |   |  |   |  |  |  | 2       |
|                                | 20 T4H                               | 12/95 → 03/00 |  |  | VKPC 87813  |                  |   |   |  | 1 |  |  |  |         |
| <b>ROVER  400 (RT) 2.0 16V</b> |                                      |               |  |  |   |                  |   |   |  |   |  |  |  |         |
|                                | 20 T4H                               | 12/95 → 03/00 |  |  | VKPC 87813  |                  |   |   |  | 1 |  |  |  |         |
| <b>ROVER  400 (RT) 2.0 D</b>   |                                      |               |  |  |   |                  |   |   |  |   |  |  |  |         |
|                                | 20 T2N, 20 T2R                       | 05/95 → 03/00 | → ICH YD471063                             |  | VKMA 07302<br>VKM 17302<br>VKM 17304<br>VKM 27302 | 2<br>1<br>1<br>1 | 1 | 2 |  |   |  |  |  | 2 T0141 |
|                                | 20 T2R                               | 11/95 → 03/00 | 39), → ICH YD471063                        |  | VKMA 07302<br>VKM 17302<br>VKM 17304<br>VKM 27302 | 2<br>1<br>1<br>1 | 1 | 2 |  |   |  |  |  | 2 T0141 |
|                                | 20 T2N, 20 T2R                       | 05/95 → 03/00 |  |  | VKPC 87813  |                  |   |   |  | 1 |  |  |  |         |
|                                | <b>B(Alt)</b> 20 T2N, 20 T2R         | 05/95 → 03/00 | <b>AC</b>                                  |  | VKMV 6PK1183<br>VKM 37005                         | 1                | 1 |   |  |   |  |  |  |         |
|                                | <b>B(Alt)</b> 20 T2N, 20 T2R         | 05/95 → 03/00 | <b>AC</b>                                  |  | VKMV 6PK1462<br>VKM 37005                         | 1                | 1 |   |  |   |  |  |  |         |
| <b>ROVER  400 (XW) 1.4 16V</b> |                                      |               |  |  |   |                  |   |   |  |   |  |  |  |         |
|                                | 14 K4C, 14 K4D, 14 K4F               | 04/90 → 04/95 |  |  | VKMA 07310<br>VKM 17310                           | 1<br>1           | 1 |   |  |   |  |  |  | 2 T0072 |
|                                | 14 K4C, 14 K4D, 14 K4F               | 04/90 → 04/95 |  |  | VKPC 87401  |                  |   |   |  | 1 |  |  |  |         |
|                                | 14K2                                 | 01/93 → 04/95 |  |  | VKPC 87400  |                  |   |   |  | 1 |  |  |  |         |
|                                | <b>B(Alt)</b> 14 K4C, 14 K4D, 14 K4F | 04/90 → 04/95 | <b>AC</b>                                  |  | VKMV 4PK736                                       |                  | 1 |   |  |   |  |  |  |         |
|                                | <b>B(Alt)</b> 14 K4C, 14 K4D, 14 K4F | 04/90 → 04/95 | <b>AC</b>                                  |  | VKMV 5PK1148                                      |                  | 1 |   |  |   |  |  |  |         |
|                                | <b>B(PS)</b> 14 K4C, 14 K4D, 14 K4F  | 04/90 → 04/95 | <b>CH 822624 I→</b>                        |  | VKMV 3PK753<br>VKM 37014                          | 1                | 1 |   |  |   |  |  |  |         |
| <b>ROVER  400 (XW) 1.6 16V</b> |                                      |               |  |  |   |                  |   |   |  |   |  |  |  |         |
|                                | 16 K4F                               | 05/95 → 11/98 |  |  | VKMA 07310<br>VKM 17310                           | 1<br>1           | 1 |   |  |   |  |  |  | 2 T0072 |
|                                | D 16 A8, D 16 A9,<br>D 16 Z2         | 04/90 → 12/95 | <b>SOHC</b>                                |  | VKMA 93001<br>VKM 73000                           | 1<br>1           | 1 |   |  |   |  |  |  | T0682   |
|                                | D 16 A8, D 16 A9,<br>D 16 Z2         | 04/90 → 12/95 | <b>DOHC</b>                                |  | VKMA 93002<br>VKM 73000                           | 1<br>1           | 1 |   |  |   |  |  |  | T0677   |
|                                | D 16 A8, D 16 A9,<br>D 16 Z2         | 04/90 → 04/95 |  |  | VKPC 87404  |                  |   |   |  | 1 |  |  |  |         |
|                                | D 16 A8                              | 05/94 → 11/98 |  |  | VKPC 87401  |                  |   |   |  | 1 |  |  |  |         |
| <b>ROVER  400 (XW) 1.8 16V</b> |                                      |               |  |  |   |                  |   |   |  |   |  |  |  |         |
|                                | 18 K4K (VVC)                         | 06/96 → 11/98 |  |  | VKPC 87401  |                  |   |   |  | 1 |  |  |  |         |
| <b>ROVER  400 (XW) 2.0</b>     |                                      |               |  |  |   |                  |   |   |  |   |  |  |  |         |
|                                | 20 M4F, 20 T4H                       | 02/92 → 11/98 |  |  | VKPC 87813  |                  |   |   |  | 1 |  |  |  |         |
|                                | <b>B(Alt)</b> 20 M4F                 | 02/92 → 04/95 | <b>AC</b>                                  |  | VKMV 5PK1163<br>VKM _____                         | 1                | 1 |   |  |   |  |  |  |         |
|                                | <b>B(Alt)</b> 20 M4F                 | 02/92 → 04/95 | <b>AC</b>                                  |  | VKMV 6PK1445<br>VKM _____                         | 1                | 1 |   |  |   |  |  |  |         |
| <b>ROVER  400 (XW) 2.0 16V</b> |                                      |               |  |  |   |                  |   |   |  |   |  |  |  |         |
|                                | 20 T4H                               | 01/93 → 04/95 |  |  | VKPC 87813  |                  |   |   |  | 1 |  |  |  |         |
|                                | <b>B(Alt)</b> 20 T4H                 | 01/93 → 04/95 | <b>AC</b>                                  |  | VKMV 5PK1163<br>VKM _____                         | 1                | 1 |   |  |   |  |  |  |         |















































|                                  | <b>B(Alt)</b> | 20 T4H  | 01/93 → 04/95 | AC                                 | VKMV 6PK1445<br>VKM_____                          | 1                | 1 |   |   |  |   |         |
|----------------------------------|---------------|---------|---------------|------------------------------------|---|------------------|---|---|---|--|---|---------|
| <b>ROVER  400 (XW) 2.0 Turbo</b> |               |         |               |                                    |   |                  |   |   |   |  |   |         |
|                                  |               | 20 T4G  | 01/93 → 04/95 |                                    | VKMA_____<br>VKM_____                             | 1<br>1           | 1 |   |   |  |   | 2       |
|                                  |               | 20 T4G  | 01/93 → 04/95 |                                    | VKPC 87813  |                  |   |   | 1 |  |   |         |
|                                  | <b>B(Alt)</b> | 20 T4G  | 01/93 → 04/95 | AC                                 | VKMV 5PK1163<br>VKM_____                          | 1                | 1 |   |   |  |   |         |
|                                  | <b>B(Alt)</b> | 20 T4G  | 01/93 → 04/95 | AC                                 | VKMV 6PK1445<br>VKM_____                          | 1                | 1 |   |   |  |   |         |
| <b>ROVER  400 (XW) 1.8 D</b>     |               |         |               |                                    |   |                  |   |   |   |  |   |         |
|                                  |               | XUD7    | 09/91 → 04/95 |                                    | VKMA 03241<br>VKM 13241<br>VKM 23241              | 1<br>1<br>1      | 1 | 1 |   |  |   | T0017   |
|                                  |               | XUD7    | 09/91 → 04/95 |                                    | VKPC 83420  |                  |   |   | 1 |  |   |         |
| <b>ROVER  400 (XW) 1.8 TD</b>    |               |         |               |                                    |   |                  |   |   |   |  |   |         |
|                                  |               | XUD 7TE | 09/91 → 12/93 |                                    | VKMA 03240<br>VKM 13240<br>VKM 23240              | 1<br>1<br>1      | 1 | 1 |   |  |   | 2 T0017 |
|                                  |               | XUD 7TE | 01/94 → 11/98 |                                    | VKMA 03241<br>VKM 13241<br>VKM 23241              | 1<br>1<br>1      | 1 | 1 |   |  |   | T0017   |
|                                  |               | XUD 7TE | 09/91 → 04/95 | → IMot. 4016153                    | VKPC 83424  |                  |   |   | 1 |  |   |         |
|                                  |               | XUD 7TE | 09/91 → 11/98 | Mot. 4016154  →                    | VKPC 83420  |                  |   |   | 1 |  |   |         |
| <b>ROVER  45 1.4 16V</b>         |               |         |               |                                    |   |                  |   |   |   |  |   |         |
|                                  |               | 14 K4F  | 02/00 → 06/05 | M⊙                                 | VKMA 07310<br>VKM 17310                           | 1<br>1           | 1 |   |   |  |   | 2 T0072 |
|                                  |               | 14 K4F  | 02/00 → 06/05 | A⊙                                 | VKMA 07301<br>VKM 17301                           | 1<br>1           | 1 |   |   |  |   | T0072   |
|                                  |               | 14 K4F  | 02/00 → 04/05 |                                    | VKPC 87401  |                  |   |   | 1 |  |   |         |
|                                  | <b>B(Alt)</b> | 14 K4F  | 02/00 → 06/05 | AC                                 | VKMV 5PK738                                       |                  |   | 1 |   |  |   |         |
|                                  | <b>B(PS)</b>  | 14 K4F  | 02/00 → 06/05 | M⊙                                 | VKMV 3PK753<br>VKM 37014                          | 1                |   | 1 |   |  |   |         |
|                                  | <b>B(PS)</b>  | 14 K4F  | 02/00 → 06/05 | A⊙                                 | VKMV 3PK753<br>VKM 37010                          | 1                |   | 1 |   |  |   |         |
| <b>ROVER  45 1.6 16V</b>         |               |         |               |                                    |   |                  |   |   |   |  |   |         |
|                                  |               | 16 K4F  | 02/00 → 06/05 | M⊙                                 | VKMA 07310<br>VKM 17310                           | 1<br>1           | 1 |   |   |  |   | 2 T0072 |
|                                  |               | 16 K4F  | 02/00 → 06/05 | A⊙                                 | VKMA 07301<br>VKM 17301                           | 1<br>1           | 1 |   |   |  |   | T0072   |
|                                  |               | 16 K4F  | 02/00 → 04/05 |                                    | VKPC 87401  |                  |   |   | 1 |  |   |         |
|                                  | <b>B(PS)</b>  | 16 K4F  | 02/00 → 06/05 | A⊙, Man. GBX                       | VKMV 3PK753<br>VKM 37010                          | 1                |   | 1 |   |  |   |         |
| <b>ROVER  45 1.8 16V</b>         |               |         |               |                                    |   |                  |   |   |   |  |   |         |
|                                  |               | 18 K4F  | 02/00 → 06/05 |                                    | VKMA 07301<br>VKM 17301                           | 1<br>1           | 1 |   |   |  |   | T0072   |
|                                  |               | 18 K4F  | 02/00 → 04/05 |                                    | VKPC 87401  |                  |   |   | 1 |  |   |         |
|                                  | <b>B(PS)</b>  | 18 K4F  | 02/00 → 06/05 | A⊙                                 | VKMV 3PK753<br>VKM 37010                          | 1                |   | 1 |   |  |   |         |
| <b>ROVER  45 2.0 V6</b>          |               |         |               |                                    |   |                  |   |   |   |  |   |         |
|                                  |               | 20 K4F  | 02/00 → 06/05 |                                    | —<br>VKMA_____<br>VKM_____<br>VKM 27307           | 1<br>1<br>1      | 1 | 3 |   |  | 1 |         |
|                                  |               | 20 K4F  | 02/00 → 04/05 |                                    | VKPC 87410  |                  |   |   | 1 |  |   |         |
|                                  | <b>B(Alt)</b> | 20 K4F  | 02/00 → 06/05 | AC                                 | VKMV 6PK1285                                      |                  |   | 1 |   |  |   |         |
|                                  | <b>B(Alt)</b> | 20 K4F  | 02/00 → 06/05 | AC                                 | VKMV 6PK1558                                      |                  |   | 1 |   |  |   |         |
| <b>ROVER  45 2.0 iDT</b>         |               |         |               |                                    |   |                  |   |   |   |  |   |         |
|                                  |               | 20 T2N  | 02/00 → 06/05 | AC, → IMot. 1011,<br>CHYD471064  → | VKMA 07303<br>VKM 17303<br>VKM 17305<br>VKM 27303 | 2<br>1<br>1<br>1 | 1 | 2 |   |  |   | 2 T0176 |

|   |  |  |  |  |  |  |  |  |  |  |  |  |  |
|---|---|---|---|--|---|---|---|---|---|---|---|---|---|
|   | 20 T2N  | 02/00 → 06/05   | AC, Mot. 1012 I→,<br>CHYD471064 I→  | VKMA 07304<br>VKM 17303<br>VKM 17304<br>VKM 27303                                  | 2<br>1<br>1   | 1   | 2   |   |   |   |   |   | 2 T0176   |
|   | 20 T2N  | 02/00 → 06/05   | AC, →IMot. 9369,<br>CHYD471064 I→   | VKMA 07303<br>VKM 17303<br>VKM 17305<br>VKM 27303                                  | 2<br>1<br>1   | 1   | 2   |   |   |   |   |   | 2 T0176   |
|   | 20 T2N  | 02/00 → 06/05   | AC, Mot. 9370 I→,<br>CHYD471064 I→  | VKMA 07304<br>VKM 17303<br>VKM 17304<br>VKM 27303                                  | 2<br>1<br>1   | 1   | 2   |   |   |   |   |   | 2 T0176   |
|                              | 20 T2N  | 02/00 → 04/05   |   | VKPC 87813   |   |   |   |   |   | 1   |   |   |   |
|                              | B(Alt) 20 T2N   | 02/00 → 06/05   | AC  | VKMV 6PK1183<br>VKM 37005  | 1   |   | 1   |   |   |   |   |   |   |
|   | B(Alt) 20 T2N   | 02/00 → 06/05   | AC  | VKMV 6PK1462<br>VKM 37005  | 1   |   | 1   |   |   |   |   |   |   |
| <b>ROVER  600 1.8 16V</b>    |   |   |   |  |   |   |   |   |   |   |   |   |   |
|                              | F 18 A3   | 03/96 → 02/99   |   | VKMA 93600<br>VKM 73011<br>VKM 73600   | 2<br>1<br>1   |   | 2   |   |   |   |   |   | T0669   |
|                              | F 18 A3   | 03/96 → 02/99   |   | VKPC 93601   |   |   |   |   | 1   |   |   |   |   |
| <b>ROVER  600 2.0 16V</b>    |   |   |   |  |   |   |   |   |   |   |   |   |   |
|                             | 20 T4G  | 07/94 → 02/99   |   | VKMA _____<br>VKM _____  | 1<br>1  |   | 1   |   |   |   |   |   | 2   |
|   | F 20 Z1, F 20 Z2  | 08/93 → 02/99   |   | VKMA 93600<br>VKM 73011<br>VKM 73600   | 2<br>1<br>1   |   | 2   |   |   |   |   |   | T0669   |
|                            | 20 T4G  | 07/94 → 02/99   |   | VKPC 87813   |   |   |   |   | 1   |   |   |   |   |
|   | F 20 Z1, F 20 Z2  | 08/93 → 02/99   |   | VKPC 93601   |   |   |   |   | 1   |   |   |   |   |
|                            | B(Alt) 20 T4G   | 07/94 → 02/99   | AC  | VKMV 5PK1163<br>VKM _____  | 1   |   | 1   |   |   |   |   |   |   |
|   | B(Alt) 20 T4G   | 07/94 → 02/99   | AC  | VKMV 6PK1445<br>VKM _____  | 1   |   | 1   |   |   |   |   |   |   |
| <b>ROVER  600 2.3 16V</b>  |   |   |   |  |   |   |   |   |   |   |   |   |   |
|                            | H 23 A3   | 08/93 → 02/99   |   | VKMA 93013<br>VKM 73011<br>VKM 73600   | 2<br>1<br>1   |   | 2   |   |   |   |   |   | T0669   |
|                            | H 23 A3   | 08/93 → 02/99   |   | —  |   |   |   |   | 1   |   |   |   |   |
| <b>ROVER  600 2.0 SDI</b>  |   |   |   |  |   |   |   |   |   |   |   |   |   |
|                            | 20 T2N  | 12/94 → 02/99   |   | VKMA 07302<br>VKM 17302<br>VKM 17304<br>VKM 27302                                  | 2<br>1<br>1   | 1   | 2   |   |   |   |   |   | 2 T0141   |
|                            | 20 T2N  | 12/94 → 02/99   |   | VKPC 87813   |   |   |   |   | 1   |   |   |   |   |
|                            | B(Alt) 20 T2N   | 12/94 → 02/99   | AC, CHBM246797 I→   | VKMV 6PK1462<br>VKM 37005  | 1   |   | 1   |   |   |   |   |   |   |
| <b>ROVER  75 1.8</b>       |   |   |   |  |   |   |   |   |   |   |   |   |   |
|                            | 18 K4F, 18 K4FT   | 02/99 → 06/05   |   | VKMA 07301<br>VKM 17301  | 1<br>1  |   | 1   |   |   |   |   |   | T0072   |
|                            | 18 K4F, 18 K4FT   | 02/99 → 04/05   |   | VKPC 87401   |   |   |   |   | 1   |   |   |   |   |
|                            | B(Alt) 18 K4F, 18 K4FT  | 02/99 → 06/05   | AC  | VKMV 5PK738  |   |   | 1   |   |   |   |   |   |   |
|   | B(Alt) 18 K4F, 18 K4FT  | 02/99 → 06/05   | AC  | VKMV 5PK1200<br>VKM 37011  | 1   |   | 1   |   |   |   |   |   |   |
|   | B(PS) 18 K4F, 18 K4FT   | 02/99 → 06/05   |   | VKMV 3PK738<br>VKM 37010   | 1   |   | 1   |   |   |   |   |   |   |
| <b>ROVER  75 1.8 Turbo</b> |   |   |   |  |   |   |   |   |   |   |   |   |   |
|                            | 18 K4FT   | 05/03 → 06/05   |   | VKMA 07301<br>VKM 17301  | 1<br>1  |   | 1   |   |   |   |   |   | T0072   |
|                            | 18 K4FT   | 05/03 → 04/05   |   | VKPC 87401   |   |   |   |   | 1   |   |   |   |   |
|                            | B(Alt) 18 K4FT  | 05/03 → 06/05   | AC  | VKMV 5PK738  |   |   | 1   |   |   |   |   |   |   |

















































ROVER



|  |  |  |    |  |  |  |  |  |  |  |  |  |
|--|---|---|---|--|---|---|---|---|---|---|---|---|
| B(Alt)   | 18 K4FT   | 05/03 → 06/05   | AC  | VKMOV 5PK1200<br>VKM 37011   | 1   |   | 1   |   |   |   |   |   |
| B(PS)  | 18 K4FT   | 05/03 → 06/05   |   | VKMOV 3PK738<br>VKM 37010  | 1   |   | 1   |   |   |   |   |   |
| <b>ROVER  75 2.0 V6</b>       |   |   |   |  |   |   |   |   |   |   |   |   |
|                                | 20 K4F  | 02/99 → 06/05   |    | —<br>VKMA____<br>VKM____<br>VKM 27307  | 1<br>1<br>1   | 1<br>1  | 3<br>3  |   |   | 1   |   |   |
|                                | 20 K4F  | 02/99 → 04/05   |   | VKPC 87410   |   |   |   |   | 1   |   |   |   |
|                                | B(Alt) 20 K4F   | 02/99 → 06/05   | AC  | VKMOV 6PK1285  |   |   | 1   |   |   |   |   |   |
|  | B(Alt) 20 K4F   | 02/99 → 06/05   | AC  | VKMOV 6PK1558  |   |   | 1   |   |   |   |   |   |
| <b>ROVER  75 2.5 V6</b>       |   |   |   |  |   |   |   |   |   |   |   |   |
|                                | 25 K4F, KV 6  | 02/99 → 06/05   |    | —<br>VKMA____<br>VKM____<br>VKM 27307  | 1<br>1<br>1   | 1<br>1  | 3<br>3  |   |   | 1   |   |   |
|                                | 25 K4F, KV 6  | 02/99 → 04/05   |   | VKPC 87410   |   |   |   |   | 1   |   |   |   |
|                                | B(Alt) 25 K4F, KV 6   | 02/99 → 06/05   | AC  | VKMOV 6PK1285  |   |   | 1   |   |   |   |   |   |
|  | B(Alt) 25 K4F, KV 6   | 02/99 → 06/05   | AC  | VKMOV 6PK1558  |   |   | 1   |   |   |   |   |   |
| <b>ROVER  75 2.0 CDT</b>      |   |   |   |  |   |   |   |   |   |   |   |   |
|                                | M 47 R  | 02/99 → 12/04   |   | <del>OXOXOXO</del>   |   |   |   |   |   |   |   |   |
|                                | M 47 R  | 02/99 → 04/05   |   | VKPC 87420   |   |   |   |   | 1   |   |   |   |
|                                | B(Alt) M 47 R   | 02/99 → 06/05   |   | VKMOV 5PK2030<br>VKM 38240   |   | 1   | 1   |   |   |   |   |   |
|  | B(AC) M 47 R  | 02/99 → 06/05   |   | VKMOV 5PK869   |   |   | 1   |   |   |   |   |   |
| <b>ROVER  75 2.0 CDTi</b>   |   |   |   |  |   |   |   |   |   |   |   |   |
|                              | 204D2   | 02/03 → 12/04   |   | <del>OXOXOXO</del>   |   |   |   |   |   |   |   |   |
|                              | 204D2   | 02/03 → 04/05   |   | VKPC 87420   |   |   |   |   | 1   |   |   |   |
|                              | B(Alt) 204D2  | 02/03 → 06/05   |   | VKMOV 5PK2030<br>VKM 38240   |   | 1   | 1   |   |   |   |   |   |
|  | B(AC) 204D2   | 02/03 → 06/05   |   | VKMOV 5PK869   |   |   | 1   |   |   |   |   |   |
| <b>ROVER  800 2.0</b>       |   |   |   |  |   |   |   |   |   |   |   |   |
|                              | 20 T4H  | 01/92 → 02/99   |   | VKMA____<br>VKM____  | 1<br>1  | 1   |   |   |   |   |   | 2   |
|                              | 20 HD, 20 HD M 16   | 10/88 → 10/91   |   | VKPC 87813   |   |   |   |   | 1   |   |   |   |
|  | 20 HD M 16  | 10/88 → 12/91   |   | —  |   |   |   |   | 1   |   |   |   |
|  | 20 HS   | 10/86 → 12/91   |   | —  |   |   |   |   | 1   |   |   |   |
|  | 20 HS   | 10/88 → 10/91   |   | —  |   |   |   |   | 1   |   |   |   |
|  | 20 T4H  | 10/88 → 10/91   |   | VKPC 87607   |   |   |   |   | 1   |   |   |   |
|  | 20 T4H  | 01/92 → 02/99   |   | VKPC 87813   |   |   |   |   | 1   |   |   |   |
|                              | B(Alt) 20 T4H   | 01/96 → 02/99   | AC  | VKMOV 6PK1415<br>VKM____   | 1   |   | 1   |   |   |   |   |   |
| <b>ROVER  800 2.0 16V</b>   |   |   |   |  |   |   |   |   |   |   |   |   |
|                              | 20 HD   | 10/86 → 10/88   |   | —  |   |   |   |   | 1   |   |   |   |
| <b>ROVER  800 2.0 Turbo</b> |   |   |   |  |   |   |   |   |   |   |   |   |
|                              | T 16  | 01/92 → 02/99   |   | VKMA____<br>VKM____  | 1<br>1  | 1   |   |   |   |   |   | 2   |
|                              | T 16  | 01/92 → 02/99   |   | VKPC 87813   |   |   |   |   | 1   |   |   |   |
|                              | B(Alt) T 16   | 01/96 → 02/99   | AC  | VKMOV 6PK1415<br>VKM____   | 1   |   | 1   |   |   |   |   |   |
| <b>ROVER  800 2.5 V6</b>    |   |   |   |  |   |   |   |   |   |   |   |   |
|                              | 25 K4F  | 04/96 → 02/99   |  | —<br>VKMA____<br>VKM____<br>VKM 27307  | 1<br>1<br>1   | 1<br>1  | 3<br>3  |   |   | 1   |   |   |
|  | C 25 A1, C 25 A2, C 25  | 10/86 → 02/99   |   | VKMA 93302<br>VKM 73001  | 1<br>1  |   | 1   |   |   |   |   | T0416   |
|                              | 25 K4F, C 25 A1,<br>C 25 A2   | 10/86 → 02/99   |   | VKPC 87610   |   |   |   |   | 1   |   |   |   |
|                              | B(Alt) 25 K4F   | 04/96 → 02/99   | AC  | VKMOV 6PK1290  |   |   | 1   |   |   |   |   |   |
|  | B(Alt) 25 K4F   | 04/96 → 02/99   | AC  | VKMOV 6PK1558  |   |   | 1   |   |   |   |   |   |









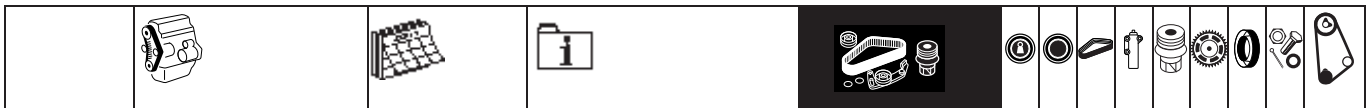







































































|   |  |  |  |  |  |  |  |  |  |  |  |
|---|---|---|---|--|---|---|---|---|---|---|---|
| <b>ROVER  800 2.7 V6</b>           |   |   |   |  |   |   |   |   |   |   |   |
|                                    | C 27 A1, C 27 A2  | 02/88 → 02/99   |   | VKMA 93302<br>VKM 73001  | 1<br>1  | 1   |   |   |   |   | T0416   |
|                                    | C 27 A1, C 27 A2  | 02/88 → 10/91   |   | VKPC 87610   |   |   |   | 1   |   |   |   |
| <b>ROVER  800 2.5 D</b>            |   |   |   |  |   |   |   |   |   |   |   |
|                                    | 425 SL1RR, 492 4 SHIRG  | 01/90 → 02/99   |   |   |   |   |   |   |   |   |   |
|                                    | 425 SL1RR, 492 4 SHIRG  | 01/90 → 02/99   |   | VKPC 82642   |   |   |   | 1   |   |   |   |
|                                    | <b>B(Alt)</b> 425 SL1RR, 492 4 SHIRG  | 10/91 → 02/99   | <b>AC</b>   | VKMV _____<br>VKM 37002  |   | 1   | 1   |   |   |   |   |
|   | <b>B(Alt)</b> 425 SL1RR, 492 4 SHIRG  | 10/91 → 02/99   | <b>AC</b>   | VKMV 5PK1790<br>VKM 37002  |   | 1   | 1   |   |   |   |   |
| <b>ROVER  CITYROVER 1.4</b>        |   |   |   |  |   |   |   |   |   |   |   |
|                                    | T475SI  | 01/04 → 06/05   |   | —  | 1   | 1   | 1   |   |   |   |   |
|   |   |   |   | —  | 1   |   |   |   |   |   |   |
|                                    | T475SI  | 01/04 → 01/08   |   | —  |   |   |   | 1   |   |   |   |
| <b>ROVER  MAESTRO 1.3</b>          |   |   |   |  |   |   |   |   |   |   |   |
|                                    | 12H   | 09/90 → 01/95   |   | VKPC 87205   |   |   |   | 1   |   |   |   |
| <b>ROVER  MAESTRO 1.6</b>          |   |   |   |  |   |   |   |   |   |   |   |
|                                    | 16H   | 09/90 → 01/95   |   | VKMA 07200<br>VKM 17200  | 1<br>1  | 1   |   |   |   |   | T0031   |
|                                    | 16H   | 09/90 → 01/95   |   | VKPC 87403   |   |   |   | 1   |   |   |   |
| <b>ROVER  MAESTRO 2.0 D</b>        |   |   |   |  |   |   |   |   |   |   |   |
|                                   | 20D   | 09/90 → 10/92   |   | VKMA 07110<br>VKM 17110<br>VKM 27110   | 1<br>1<br>1   | 1   | 1   |   |   |   | T0059   |
| <b>ROVER  MAESTRO 2.0 TD</b>     |   |   |   |  |   |   |   |   |   |   |   |
|                                  | 20TD  | 09/90 → 01/95   |   | VKMA 07110<br>VKM 17110<br>VKM 27110   | 1<br>1<br>1   | 1   | 1   |   |   |   | T0059   |
| <b>ROVER  MINI 1.0</b>           |   |   |   |  |   |   |   |   |   |   |   |
|                                  | 99 HD 81  | 01/92 → 06/93   |   | <b>XXXXXXXX</b>  |   |   |   |   |   |   |   |
| <b>ROVER  MINI 1.3</b>           |   |   |   |  |   |   |   |   |   |   |   |
|                                  | 12 A2A, 12 A2B, 12 A2D,<br>12 A2E, 12 A2L   | 01/91 → 12/04   |   | <b>XXXXXXXX</b>  |   |   |   |   |   |   |   |
|                                  | 12 A2A, 12 A2B, 12 A2D,<br>12 A2E, 12 A2L   | 01/91 → 04/05   | → IMot. 134454  | VKPC 87200   |   |   |   | 1   |   |   |   |
| <b>ROVER  MONTEGO 1.3</b>        |   |   |   |  |   |   |   |   |   |   |   |
|                                  | 12 H  | 10/84 → 10/88   |   | <b>XXXXXXXX</b>  |   |   |   |   |   |   |   |
|                                  | 12 H  | 10/84 → 10/88   |   | VKPC 87205   |   |   |   | 1   |   |   |   |
| <b>ROVER  MONTEGO 2.0</b>        |   |   |   |  |   |   |   |   |   |   |   |
|                                  | 20 H  | 10/88 → 10/94   |   | VKPC 87609   |   |   |   | 1   |   |   |   |
| <b>ROVER  MONTEGO 2.0 TD</b>     |   |   |   |  |   |   |   |   |   |   |   |
|                                  | 20TD, BB  | 10/88 → 12/94   |   | VKMA 07110<br>VKM 17110<br>VKM 27110   | 1<br>1<br>1   | 1   | 1   |   |   |   | T0059   |
| <b>ROVER  STREETWISE 1.4 16V</b> |   |   |   |  |   |   |   |   |   |   |   |
|                                  | 14 K4F, 14 K4M  | 08/03 → 06/05   | <b>M⊙</b>   | VKMA 07310<br>VKM 17310  | 1<br>1  |   | 1   |   |   |   | 2 T0072   |
|   | 14 K4F, 14 K4M  | 08/03 → 06/05   | <b>A⊙</b>   | VKMA 07301<br>VKM 17301  | 1<br>1  |   | 1   |   |   |   | T0072   |
|                                  | 14 K4F  | 08/03 → 04/05   |   | VKPC 87401   |   |   |   | 1   |   |   |   |
|   | 14 K4M  | 08/03 → 04/05   |   | VKPC 87400   |   |   |   | 1   |   |   |   |
|                                  | <b>B(Alt)</b> 14 K4F, 14 K4M  | 08/03 → 06/05   | <b>AC</b>   | VKMV 5PK738  |   |   | 1   |   |   |   |   |
|   | <b>B(Alt)</b> 14 K4F, 14 K4M  | 08/03 → 06/05   | <b>AC</b>   | VKMV 5PK1163<br>VKM 37015  |   | 1   | 1   |   |   |   |   |
|   | <b>B(PS)</b> 14 K4F, 14 K4M   | 08/03 → 06/05   | <b>M⊙</b>   | VKMV 3PK753<br>VKM 37014   | 1   |   | 1   |   |   |   |   |
|   | <b>B(PS)</b> 14 K4F, 14 K4M   | 08/03 → 06/05   | <b>A⊙</b>   | VKMV 3PK753<br>VKM 37010   | 1   |   | 1   |   |   |   |   |



ROVER







| ROVER          |  | STREETWISE 2.0 TD           |                                    |              |   |   |   |  |  |  |   |   |  |  |  |  |  |         |
|---|--|-----------------------------|------------------------------------|--------------|---|---|---|--|--|--|---|---|--|--|--|--|--|---------|
|                 | 20 T2N   | 08/03 → 06/05               | AC, →IMot. 5048,<br>CHYD471564 I→  | VKMA 07303   | 2 | 1 | 2 |  |  |  |   |   |  |  |  |  |  | 2 T0176 |
|   |  |                             |                                    | VKM 17303    | 1 |   |   |  |  |  |   |   |  |  |  |  |  |         |
|   |  |                             |                                    | VKM 17305    | 1 |   | 1 |  |  |  |   |   |  |  |  |  |  |         |
|   |  |                             |                                    | VKM 27303    |   |   |   |  |  |  |   |   |  |  |  |  |  |         |
|   | 20 T2N   | 08/03 → 06/05               | AC, Mot. 5049 I→,<br>CHYD471564 I→ | VKMA 07304   | 2 | 1 | 2 |  |  |  |   |   |  |  |  |  |  | 2 T0176 |
|   |  |                             |                                    | VKM 17303    | 1 |   |   |  |  |  |   |   |  |  |  |  |  |         |
|   |  |                             |                                    | VKM 17304    | 1 |   |   |  |  |  |   |   |  |  |  |  |  |         |
|   |  |                             |                                    | VKM 27303    |   |   | 1 |  |  |  |   |   |  |  |  |  |  |         |
|   | 20 T2N   | 08/03 → 06/05               | AC, →IMot. 8367,<br>CHYD471564 I→  | VKMA 07303   | 2 | 1 | 2 |  |  |  |   |   |  |  |  |  |  | 2 T0176 |
|   |  |                             |                                    | VKM 17303    | 1 |   |   |  |  |  |   |   |  |  |  |  |  |         |
|   |  |                             |                                    | VKM 17305    | 1 |   |   |  |  |  |   |   |  |  |  |  |  |         |
|   |  |                             |                                    | VKM 27303    |   |   | 1 |  |  |  |   |   |  |  |  |  |  |         |
|   | 20 T2N   | 08/03 → 06/05               | AC, Mot. 8368 I→,<br>CHYD471564 I→ | VKMA 07304   | 2 | 1 | 2 |  |  |  |   |   |  |  |  |  |  | 2 T0176 |
|   |  |                             |                                    | VKM 17303    | 1 |   |   |  |  |  |   |   |  |  |  |  |  |         |
|   |  |                             |                                    | VKM 17304    | 1 |   |   |  |  |  |   |   |  |  |  |  |  |         |
|   |  |                             |                                    | VKM 27303    |   |   | 1 |  |  |  |   |   |  |  |  |  |  |         |
|                 | 20 T2N   | 08/03 → 04/05               |                                    | VKPC 87813   |   |   |   |  |  |  |   | 1 |  |  |  |  |  |         |
|                 | B(Alt) 20 T2N  | 08/03 → 06/05               | AC                                 | VKMV 6PK1183 |   |   |   |  |  |  | 1 |   |  |  |  |  |  |         |
|   |  |                             |                                    | VKM 37005    | 1 |   |   |  |  |  |   |   |  |  |  |  |  |         |
|   | B(Alt) 20 T2N  | 08/03 → 06/05               | AC                                 | VKMV 6PK1462 |   |   |   |  |  |  | 1 |   |  |  |  |  |  |         |
|   |  |                             |                                    | VKM 37005    | 1 |   |   |  |  |  |   |   |  |  |  |  |  |         |
| <b>SAAB </b>  |  | <b>90 2.0</b>               |                                    |              |   |   |   |  |  |  |   |   |  |  |  |  |  |         |
|               | B 20 I   | 08/84 → 08/87               |                                    | OXOXOXO      |   |   |   |  |  |  |   |   |  |  |  |  |  |         |
|               | B 20 I   | 08/84 → 08/87               |                                    | VKPC 84611   |   |   |   |  |  |  |   | 1 |  |  |  |  |  |         |
| <b>SAAB </b> |  | <b>900 I 2.0</b>            |                                    |              |   |   |   |  |  |  |   |   |  |  |  |  |  |         |
|               | B 20, B201, B201XC,<br>B201XI, B20T, BI 20,<br>BT 20 | 09/78 → 08/90               |                                    | OXOXOXO      |   |   |   |  |  |  |   |   |  |  |  |  |  |         |
|               | B 20, B201, B201XC,<br>B201XI, B20T, BI 20,<br>BT 20 | 09/78 → 08/90               |                                    | VKPC 84611   |   |   |   |  |  |  |   | 1 |  |  |  |  |  |         |
| <b>SAAB </b> |  | <b>900 I 2.0 16V</b>        |                                    |              |   |   |   |  |  |  |   |   |  |  |  |  |  |         |
|               | B202I, B202XI  | 01/86 → 06/94               |                                    | OXOXOXO      |   |   |   |  |  |  |   |   |  |  |  |  |  |         |
|               | B202I, B202XI  | 01/86 → 06/94               |                                    | VKPC 84611   |   |   |   |  |  |  |   | 1 |  |  |  |  |  |         |
| <b>SAAB </b> |  | <b>900 I 2.0 Turbo</b>      |                                    |              |   |   |   |  |  |  |   |   |  |  |  |  |  |         |
|               | B201S, B201XL, BSI 20                                | 09/78 → 12/91               |                                    | OXOXOXO      |   |   |   |  |  |  |   |   |  |  |  |  |  |         |
|               | B201S, B201XL, BSI 20                                | 09/78 → 12/91               |                                    | VKPC 84611   |   |   |   |  |  |  |   | 1 |  |  |  |  |  |         |
| <b>SAAB </b> |  | <b>900 I 2.0 16V Turbo</b>  |                                    |              |   |   |   |  |  |  |   |   |  |  |  |  |  |         |
|               | B202L, B202S, B202XL                                 | 01/84 → 06/94               |                                    | OXOXOXO      |   |   |   |  |  |  |   |   |  |  |  |  |  |         |
|               | B202L, B202S, B202XL                                 | 01/84 → 06/94               |                                    | VKPC 84611   |   |   |   |  |  |  |   | 1 |  |  |  |  |  |         |
| <b>SAAB </b> |  | <b>900 I 2.1 16V</b>        |                                    |              |   |   |   |  |  |  |   |   |  |  |  |  |  |         |
|               | B212I  | 08/90 → 06/94               |                                    | OXOXOXO      |   |   |   |  |  |  |   |   |  |  |  |  |  |         |
|               | B212I  | 08/90 → 06/94               |                                    | VKPC 84611   |   |   |   |  |  |  |   | 1 |  |  |  |  |  |         |
| <b>SAAB </b> |  | <b>900 II 2.0</b>           |                                    |              |   |   |   |  |  |  |   |   |  |  |  |  |  |         |
|               | B204I, B206I   | 07/93 → 02/98               |                                    | OXOXOXO      |   |   |   |  |  |  |   |   |  |  |  |  |  |         |
|               | B204I, B206I   | 07/93 → 02/98               |                                    | VKPC 86630   |   |   |   |  |  |  |   | 1 |  |  |  |  |  |         |
|               | B(Alt) B204I, B206I                                  | 07/93 → 02/98               | AC, Mot. V088653 I→                | VKMV 6PK2622 |   |   |   |  |  |  | 1 |   |  |  |  |  |  |         |
|   |  |                             |                                    | VKM 34501    |   |   |   |  |  |  | 1 |   |  |  |  |  |  |         |
|   |  |                             |                                    | VKM 34502    |   |   |   |  |  |  | 1 |   |  |  |  |  |  |         |
| <b>SAAB </b> |  | <b>900 II 2.0 16V Turbo</b> |                                    |              |   |   |   |  |  |  |   |   |  |  |  |  |  |         |
|               | B204L  | 07/93 → 02/98               |                                    | OXOXOXO      |   |   |   |  |  |  |   |   |  |  |  |  |  |         |
|               | B204L  | 07/93 → 02/98               |                                    | VKPC 86630   |   |   |   |  |  |  |   | 1 |  |  |  |  |  |         |
|               | B(Alt) B204L   | 07/93 → 02/98               | AC, Mot. V088653 I→                | VKMV 6PK2622 |   |   |   |  |  |  | 1 |   |  |  |  |  |  |         |
|   |  |                             |                                    | VKM 34501    |   |   |   |  |  |  | 1 |   |  |  |  |  |  |         |
|   |  |                             |                                    | VKM 34502    |   |   |   |  |  |  | 1 |   |  |  |  |  |  |         |
| <b>SAAB </b> |  | <b>900 II 2.3 16V</b>       |                                    |              |   |   |   |  |  |  |   |   |  |  |  |  |  |         |
|               | B234I  | 07/93 → 02/98               |                                    | OXOXOXO      |   |   |   |  |  |  |   |   |  |  |  |  |  |         |





|  |  |  |  |  |  |  |  |  |  |  |
|--|---|---|---|--|---|---|---|---|---|---|
|                                   | B234I   | 07/93 → 02/98   |   | VKPC 86630   |   |   |   |   | 1   |   |
|                                   | <b>B(Alt)</b> B234I   | 07/93 → 02/98   | <b>AC, Mot.</b> V088653 I→  | VKMV 6PK2622<br>VKM 34501<br>VKM 34502   |   | 1   |   |   |   |   |
| <b>SAAB  900 II 2.5 V6</b>        |   |   |   |  |   |   |   |   |   |   |
|                                   | B258I   | 07/93 → 02/98   | 5)  | VKMA 05500   | 1   | 1   | 1   |   |   | 5 T0135   |
|                                   | B258I   | 07/93 → 02/98   |   | VKPC 85613   |   |   |   | 1   |   |   |
| <b>SAAB  9000 2.0 16V</b>         |   |   |   |  |   |   |   |   |   |   |
|                                   | B202I, B202XI,<br>B202XI (KAT), B204E,<br>B204I                                   | 12/85 → 12/98   |   | <b>ΟΧΘΙΧΟ</b>  |   |   |   |   |   |   |
|                                   | B202I, B202XI,<br>B202XI (KAT)  | 12/85 → 12/93   |   | VKPC 84612   |   |   |   | 1   |   |   |
|                                   | B204E, B204I  | 09/93 → 12/98   |   | VKPC 84613   |   |   |   | 1   |   |   |
|                                   | <b>B(Alt)</b> B202I, B204E, B204I   | 01/94 → 12/98   | <b>AC, →</b> ICH V1030032   | VKM 34500<br>VKM 34502   |   | 1   |   |   |   |   |
|                                   | <b>B(Alt)</b> B202I, B204E, B204I   | 01/94 → 12/98   | <b>AC, CH</b> V1030033 I→   | VKM 34500  |   | 1   |   |   |   |   |
| <b>SAAB  9000 2.0 16V Turbo</b>   |   |   |   |  |   |   |   |   |   |   |
|                                   | B202, B202L, B202S,<br>B202XL, B204E  | 09/84 → 12/98   |   | <b>ΟΧΘΙΧΟ</b>  |   |   |   |   |   |   |
|                                   | B202, B202XL  | 09/84 → 08/93   |   | VKPC 84612   |   |   |   | 1   |   |   |
|                                   | B202L, B202S, B204E   | 01/90 → 12/98   |   | VKPC 84613   |   |   |   | 1   |   |   |
|                                   | <b>B(Alt)</b> B202L, B202S, B204E   | 01/94 → 12/98   | <b>AC, →</b> ICH V1030032   | VKM 34500<br>VKM 34502   |   | 1   |   |   |   |   |
|                                 | <b>B(Alt)</b> B202L, B202S, B204E   | 01/94 → 12/98   | <b>AC, CH</b> V1030033 I→   | VKM 34500  |   | 1   |   |   |   |   |
| <b>SAAB  9000 2.3 16V</b>       |   |   |   |  |   |   |   |   |   |   |
|                                 | B234E, B234I, B234R   | 08/89 → 12/98   |   | <b>ΟΧΘΙΧΟ</b>  |   |   |   |   |   |   |
|                                 | B234E, B234I, B234R   | 08/89 → 12/98   |   | VKPC 84613   |   |   |   | 1   |   |   |
|                                 | <b>B(Alt)</b> B234E, B234I, B234R   | 01/94 → 12/98   | <b>AC, →</b> ICH V1030032   | VKM 34500<br>VKM 34502   |   | 1   |   |   |   |   |
|                                 | <b>B(Alt)</b> B234E, B234I, B234R   | 01/94 → 12/98   | <b>AC, CH</b> V1030033 I→   | VKM 34500  |   | 1   |   |   |   |   |
| <b>SAAB  9000 2.3 16V Turbo</b> |   |   |   |  |   |   |   |   |   |   |
|                                 | B234L   | 07/90 → 12/98   |   | <b>ΟΧΘΙΧΟ</b>  |   |   |   |   |   |   |
|                                 | B234L   | 07/90 → 12/98   |   | VKPC 84613   |   |   |   | 1   |   |   |
|                                 | <b>B(Alt)</b> B234L   | 01/94 → 12/98   | <b>AC, →</b> ICH V1030032   | VKM 34500<br>VKM 34502   |   | 1   |   |   |   |   |
|                                 | <b>B(Alt)</b> B234L   | 01/94 → 12/98   | <b>AC, CH</b> V1030033 I→   | VKM 34500  |   | 1   |   |   |   |   |
| <b>SAAB  9000 3.0 V6</b>        |   |   |   |  |   |   |   |   |   |   |
|                                 | B308I   | 07/94 → 12/98   | 5)  | VKMA 05500   | 1   | 1   | 1   |   |   | 5 T0135   |
|                                 | B308I   | 07/94 → 12/98   |   | VKPC 85613   |   |   |   | 1   |   |   |
| <b>SAAB  9-3 I 2.0</b>          |   |   |   |  |   |   |   |   |   |   |
|                                 | B204I   | 02/98 → 08/03   |   | <b>ΟΧΘΙΧΟ</b>  |   |   |   |   |   |   |
|                                 | B204I   | 02/98 → 08/03   |   | VKPC 86630   |   |   |   | 1   |   |   |
|                                 | <b>B(Alt)</b> B204I   | 02/98 → 08/03   | <b>AC, →</b> ICH X2028400,<br>X7022778  | VKMV 6PK1805<br>VKM 34501<br>VKM 34510   |   | 1   |   | 1   |   |   |
|                                 | <b>B(Alt)</b> B204I   | 02/98 → 08/03   | <b>AC, CH</b> X2028401,<br>X7022779 I→  | VKMV 6PK1805<br>VKM 34023<br>VKM 34510   |   | 1   |   | 1   |   |   |
|                                 | <b>B(Alt)</b> B204I   | 02/98 → 08/03   | <b>AC, →</b> ICH X2028400,<br>X7022778  | VKMA 34511<br>VKMV 6PK2345<br>VKM 34501<br>VKM 34510                               |   | 1   | 1   | 1   |   |   |
|                                 | <b>B(Alt)</b> B204I   | 02/98 → 08/03   | <b>AC, CH</b> X2028401,<br>X7022779 I→  | VKMA 34123<br>VKMV 6PK2345<br>VKM 34023<br>VKM 34510                               |   | 1   | 1   | 1   |   |   |







SAAB







































| SAAB  9-3   2.0 Turbo |  |               |  |  |  |  |  |  |   |  |
|--|--|---------------|--|--|--|--|--|--|---|--|
|                        | B204E, B204L, B204R,<br>B205E, B205R               | 02/98 → 08/03 |  |  |  |  |  |  |   |  |
|                        | B204E, B204L, B204R,<br>B205E, B205R               | 02/98 → 08/03 |  |  |  |  |  |  | 1 |  |
|                        | <b>B(Alt)</b> B204E, B204L, B204R,<br>B205E, B205R | 02/98 → 08/03 | <b>AC</b> , → <b>ICH</b> X2028400,<br>X7022778 |  |  |  |  |  |   |  |
|  |  |               |  |  |  |  |  |  |   |  |
|  | <b>B(Alt)</b> B204E, B204L, B204R,<br>B205E, B205R | 02/98 → 08/03 | <b>AC</b> , <b>CH</b> X2028401,<br>X7022779  → |  |  |  |  |  |   |  |
|  |  |               |  |  |  |  |  |  |   |  |
|  | <b>B(Alt)</b> B204E, B204L, B204R,<br>B205E, B205R | 02/98 → 08/03 | <b>AC</b> , → <b>ICH</b> X2028400,<br>X7022778 |  |  |  |  |  |   |  |
|  |  |               |  |  |  |  |  |  |   |  |
|  | <b>B(Alt)</b> B204E, B204L, B204R,<br>B205E, B205R | 02/98 → 08/03 | <b>AC</b> , <b>CH</b> X2028401,<br>X7022779  → |  |  |  |  |  |   |  |
|  |  |               |  |  |  |  |  |  |   |  |

| SAAB  9-3   2.3 |                     |               |  |  |  |  |  |  |   |  |
|--|---------------------|---------------|--|--|--|--|--|--|---|--|
|                  | B234I               | 02/98 → 08/03 |  |  |  |  |  |  |   |  |
|                  | B234I               | 02/98 → 08/03 |  |  |  |  |  |  | 1 |  |
|                  | <b>B(Alt)</b> B234I | 02/98 → 08/03 | <b>AC</b> , → <b>ICH</b> X2028400,<br>X7022778 |  |  |  |  |  |   |  |
|  |                     |               |  |  |  |  |  |  |   |  |
|  | <b>B(Alt)</b> B234I | 02/98 → 08/03 | <b>AC</b> , <b>CH</b> X2028401,<br>X7022779  → |  |  |  |  |  |   |  |
|  |                     |               |  |  |  |  |  |  |   |  |
|  | <b>B(Alt)</b> B234I | 02/98 → 08/03 | <b>AC</b> , → <b>ICH</b> X2028400,<br>X7022778 |  |  |  |  |  |   |  |
|  |                     |               |  |  |  |  |  |  |   |  |
|  | <b>B(Alt)</b> B234I | 02/98 → 08/03 | <b>AC</b> , <b>CH</b> X2028401,<br>X7022779  → |  |  |  |  |  |   |  |
|  |                     |               |  |  |  |  |  |  |   |  |

| SAAB  9-3   2.3 Turbo |                     |               |  |  |  |  |  |  |   |  |
|--|---------------------|---------------|--|--|--|--|--|--|---|--|
|                        | B235R               | 10/98 → 08/03 |  |  |  |  |  |  |   |  |
|                        | B235R               | 10/98 → 08/03 |  |  |  |  |  |  | 1 |  |
|                        | <b>B(Alt)</b> B235R | 10/98 → 08/03 | <b>AC</b> , → <b>ICH</b> X2028400,<br>X7022778 |  |  |  |  |  |   |  |
|  |                     |               |  |  |  |  |  |  |   |  |
|  | <b>B(Alt)</b> B235R | 10/98 → 08/03 | <b>AC</b> , <b>CH</b> X2028401,<br>X7022779  → |  |  |  |  |  |   |  |
|  |                     |               |  |  |  |  |  |  |   |  |
|  | <b>B(Alt)</b> B235R | 10/98 → 08/03 | <b>AC</b> , → <b>ICH</b> X2028400,<br>X7022778 |  |  |  |  |  |   |  |
|  |                     |               |  |  |  |  |  |  |   |  |

| <b>B(Alt)</b>                 | B235R                             | 10/98 → 08/03 | <b>AC, CH</b> X2028401,<br>X7022779 I→      | VKMA 34123<br>VKMV 6PK2345<br>VKM 34023<br>VKM 34510              | 1 | 1 | 1 | 1 |  |   |  |   |   |   |       |
|-------------------------------|-----------------------------------|---------------|---|---|---|---|---|---|--|---|--|---|---|---|-------|
| <b>SAAB  9-3 I 2.2 TiD</b>    |                                   |               |   |   |   |   |   |   |  |   |  |   |   |   |       |
|                               | D223L, X 22 DTH                   | 02/98 → 09/02 | <b>ΟΛΟΚΛΗΟ</b>                              |   |   |   |   |   |  |   |  |   |   |   |       |
|                               | D223L, X 22 DTH                   | 02/98 → 09/02 | VKPC 85623                                  |   |   |   |   |   |  | 1 |  |   |   |   |       |
|                               | <b>B(Alt)</b> D223L, X 22 DTH     | 02/98 → 09/02 | <b>AC</b>                                   | VKMA 35007<br>VKMV 6PK1805<br>VKM 35007                           | 1 |   | 1 | 1 |  |   |  |   |   |   |       |
|                               | <b>B(Alt)</b> D223L, X 22 DTH     | 02/98 → 09/02 | <b>AC</b>                                   | VKMA 35107<br>VKMV 6PK1902<br>VKM 35007                           | 1 |   | 1 | 1 |  |   |  |   |   |   |       |
| <b>SAAB  9-3 II 1.8</b>       |                                   |               |   |   |   |   |   |   |  |   |  |   |   |   |       |
|                               | Z 18 XE                           | 01/04 → 10/07 | 3)  | VKMS 05154-3<br>VKMA 05154<br>VKM 15216<br>VKM 25152<br>VKM 25312 | 1 | 2 | 1 | 1 |  |   |  | 3 | 3 | 2 | T0157 |
|                               | Z 18 XE                           | 01/04 → 10/07 |   | VKPC 85624  |   |   |   |   |  | 1 |  |   |   |   |       |
|                               | <b>B(Alt)</b> Z 18 XE             | 01/04 → 10/07 |   | VKMA 35112<br>VKMV 5PK1240<br>VKM 35012                           | 1 |   | 1 | 1 |  |   |  |   |   |   |       |
| <b>SAAB  9-3 II 2.0 Turbo</b> |                                   |               |   |   |   |   |   |   |  |   |  |   |   |   |       |
|                               | B207E, B207L, B207R               | 09/02 → 10/07 | <b>ΟΛΟΚΛΗΟ</b>                              |   |   |   |   |   |  |   |  |   |   |   |       |
|                               | B207E, B207L, B207R               | 09/02 → 10/07 | VKPC 85308                                  |   |   |   |   |   |  | 1 |  |   |   |   |       |
|                               | <b>B(Alt)</b> B207E, B207L, B207R | 09/02 → 10/07 |   | VKMA 34027<br>VKMV 5PK1028<br>VKM 34027                           | 1 |   | 1 | 1 |  |   |  |   |   |   |       |
| <b>SAAB  9-3 II 1.9 TiD</b>   |                                   |               |   |   |   |   |   |   |  |   |  |   |   |   |       |
|                               | Z 19 DTH                          | 09/04 → 10/07 |   | VKMA 02193<br>VKM 12174<br>VKM 22180                              | 1 | 1 | 1 | 1 |  |   |  |   |   |   | T0248 |
|                               | Z 19 DT                           | 09/04 → 10/07 |   | VKPC 82665  |   |   |   |   |  | 1 |  |   |   |   |       |
|                               | Z 19 DTH                          | 09/04 → 10/07 |   | VKPC 82667  |   |   |   |   |  | 1 |  |   |   |   |       |
| <b>SAAB  9-3 II 2.2 TiD</b>   |                                   |               |   |   |   |   |   |   |  |   |  |   |   |   |       |
|                               | D223L                             | 09/02 → 10/07 | <b>ΟΛΟΚΛΗΟ</b>                              |   |   |   |   |   |  |   |  |   |   |   |       |
|                               | D223L                             | 09/02 → 10/07 | VKPC 85623                                  |   |   |   |   |   |  | 1 |  |   |   |   |       |
|                               | <b>B(Alt)</b> D223L               | 09/02 → 10/07 |   | VKMA 35107<br>VKMV 6PK1902<br>VKM 35007                           | 1 |   | 1 | 1 |  |   |  |   |   |   |       |
| <b>SAAB  95 1.5 V4</b>        |                                   |               |   |   |   |   |   |   |  |   |  |   |   |   |       |
|                               | Ford V4, Ford V4 (EGR)            | 10/65 → 12/78 | <b>ΟΛΟΚΛΗΟ</b>                              |   |   |   |   |   |  |   |  |   |   |   |       |
|                               | Ford V4, Ford V4 (EGR)            | 10/65 → 12/78 | VKPC 84400                                  |   |   |   |   |   |  | 1 |  |   |   |   |       |
| <b>SAAB  9-5 2.0 Turbo</b>    |                                   |               |   |   |   |   |   |   |  |   |  |   |   |   |       |
|                               | B205E                             | 09/97 → 10/07 | <b>ΟΛΟΚΛΗΟ</b>                              |   |   |   |   |   |  |   |  |   |   |   |       |
|                               | B205E                             | 09/97 → 10/07 | VKPC 86630                                  |   |   |   |   |   |  | 1 |  |   |   |   |       |
|                               | <b>B(Alt)</b> B205E               | 09/97 → 10/07 | <b>AC, →ICH</b> X3022043                    | VKMV 6PK1980<br>VKM 34501<br>VKM 34502<br>VKM 34510               | 1 |   | 1 | 1 |  |   |  |   |   |   |       |
|                               | <b>B(Alt)</b> B205E               | 09/97 → 10/07 | <b>AC, CH</b> X3022044 I→,<br>→ICH 43505871 | VKMV 6PK1980<br>VKM 34023<br>VKM 34502<br>VKM 34510               | 1 |   | 1 | 1 |  |   |  |   |   |   |       |
|                               | <b>B(Alt)</b> B205E               | 09/97 → 10/07 | <b>AC, →ICH</b> X3022043                    | VKMA 34502<br>VKMV_____<br>VKM 34501<br>VKM 34502<br>VKM 34510    | 1 | 2 | 1 | 1 |  |   |  |   |   |   |       |



|   |               |  |  |  |  |  |  |  |  |  |  |  |  |  |  |  |  |  |  |       |
|---|---------------|---|---|---|--|---|---|---|---|---|---|---|---|---|---|---|---|---|---|-------|
|   | <b>B(Alt)</b> | B205E   | 09/97 → 10/07   | AC, CH 3022044 I→,<br>→ICH X43505871  | VKMA 34522<br>VKMV____<br>VKM 34023<br>VKM 34502<br>VKM 34510                      | 1   | 2   | 1   |   |   |   |   |   |   |   |   |   |   |   |       |
| <b>SAAB  9-5 2.3 Turbo</b> |               |   |   |   |  |   |   |   |   |   |   |   |   |   |   |   |   |   |   |       |
|                             |               | B235E, B235L, B235R   | 09/97 → 10/07   |   | <b>OXOXOXO</b>   |   |   |   |   |   |   |   |   |   |   |   |   |   |   |       |
|                             |               | B235E, B235L, B235R   | 09/97 → 10/07   |   | VKPC 86630   |   |   |   |   |   |   |   | 1   |   |   |   |   |   |   |       |
|                             | <b>B(Alt)</b> | B235E, B235L, B235R   | 09/97 → 10/07   | AC, →ICH X3022043   | VKMV 6PK1980<br>VKM 34501<br>VKM 34502<br>VKM 34510                                |   | 1   |   | 1   |   |   |   |   |   |   |   |   |   |   |       |
|   | <b>B(Alt)</b> | B235E, B235L, B235R   | 09/97 → 10/07   | AC, CH X3022044 I→,<br>→ICH 43505871  | VKMV 6PK1980<br>VKM 34023<br>VKM 34502<br>VKM 34510                                |   | 1   |   | 1   |   |   |   |   |   |   |   |   |   |   |       |
|   | <b>B(Alt)</b> | B235E, B235L, B235R   | 09/97 → 10/07   | AC, →ICH X3022043   | VKMA 34502<br>VKMV____<br>VKM 34501<br>VKM 34502<br>VKM 34510                      | 1   | 2   | 1   |   |   |   |   |   |   |   |   |   |   |   |       |
|   | <b>B(Alt)</b> | B235E, B235L, B235R   | 09/97 → 10/07   | AC, CH 3022044 I→,<br>→ICH X43505871  | VKMA 34522<br>VKMV____<br>VKM 34023<br>VKM 34502<br>VKM 34510                      | 1   | 2   | 1   |   |   |   |   |   |   |   |   |   |   |   |       |
| <b>SAAB  9-5 3.0 V6</b>  |               |   |   |   |  |   |   |   |   |   |   |   |   |   |   |   |   |   |   |       |
|                           |               | B308E   | 01/98 → 10/07   | 5), →IMot. 578511   | VKMA 05501   | 1   | 1   | 1   |   |   |   |   |   |   |   |   |   |   | 5   | T0135 |
|   |               | B308E   | 01/98 → 10/07   | 5), Mot. 578512 I→  | VKMA 05502   | 1   | 1   | 1   |   |   |   |   |   |   |   |   |   |   | 5   | T0135 |
|                           |               | B308E   | 01/98 → 10/07   |   | VKPC 85613   |   |   |   |   |   |   |   | 1   |   |   |   |   |   |   |       |
|                           | <b>B(Alt)</b> | B308E   | 01/98 → 10/07   |   | VKMA 35500<br>VKMV 6PK2020<br>VKM 35500  | 1   |   | 1   |   |   |   |   |   |   |   |   |   |   |   |       |
| <b>SAAB  9-5 2.2 TiD</b> |               |   |   |   |  |   |   |   |   |   |   |   |   |   |   |   |   |   |   |       |
|                           |               | D223L   | 03/02 → 10/07   |   | <b>OXOXOXO</b>   |   |   |   |   |   |   |   |   |   |   |   |   |   |   |       |
|                           |               | D223L   | 03/02 → 10/07   |   | VKPC 85623   |   |   |   |   |   |   |   | 1   |   |   |   |   |   |   |       |
|                           | <b>B(Alt)</b> | D223L   | 03/02 → 10/07   |   | VKMA 35107<br>VKMV 6PK1902<br>VKM 35007  | 1   |   | 1   |   |   |   |   |   |   |   |   |   |   |   |       |
| <b>SAAB  9-5 3.0 TiD</b> |               |   |   |   |  |   |   |   |   |   |   |   |   |   |   |   |   |   |   |       |
|                           |               | D308L   | 07/01 → 10/07   |   | VKMA 05230<br>VKM 15220<br>VKM 25222<br>VKM 25226                                  | 1   | 2   | 1   |   |   |   |   |   |   |   |   |   |   |   |       |
|   |               | D308L   | 07/01 → 10/07   |   | VKPC____   | 1   |   |   |   |   |   |   | 1   |   |   |   |   |   |   |       |
|                           | <b>B(Alt)</b> | D308L   | 07/01 → 10/07   |   | VKM 35216  | 1   |   |   |   |   |   |   |   |   |   |   |   |   |   |       |
| <b>SAAB  96 1.5 V4</b>   |               |   |   |   |  |   |   |   |   |   |   |   |   |   |   |   |   |   |   |       |
|                           |               | Ford V4, Ford V4 (EGR)  | 10/65 → 08/80   |   | <b>OXOXOXO</b>   |   |   |   |   |   |   |   |   |   |   |   |   |   |   |       |
|                           |               | Ford V4, Ford V4 (EGR)  | 10/65 → 08/80   |   | VKPC 84400   |   |   |   |   |   |   |   | 1   |   |   |   |   |   |   |       |
| <b>SAAB  99 1.7</b>      |               |   |   |   |  |   |   |   |   |   |   |   |   |   |   |   |   |   |   |       |
|                           |               |   | 08/68 → 05/71   |   | <b>OXOXOXO</b>   |   |   |   |   |   |   |   |   |   |   |   |   |   |   |       |
| <b>SAAB  99 1.8</b>      |               |   |   |   |  |   |   |   |   |   |   |   |   |   |   |   |   |   |   |       |
|                           |               |   | 10/70 → 05/74   |   | <b>OXOXOXO</b>   |   |   |   |   |   |   |   |   |   |   |   |   |   |   |       |
| <b>SAAB  99 2.0</b>      |               |   |   |   |  |   |   |   |   |   |   |   |   |   |   |   |   |   |   |       |
|                           |               | B 20 C, B 20 I, B 20 P,<br>BI 20  | 04/72 → 12/84   |   | <b>OXOXOXO</b>   |   |   |   |   |   |   |   |   |   |   |   |   |   |   |       |
|                           |               | B 20 C, B 20 I, B 20 P,<br>BI 20  | 04/72 → 12/84   |   | VKPC 84611   |   |   |   |   |   |   |   | 1   |   |   |   |   |   |   |       |





























| <b>SAAB</b> <b>99 2.0 Turbo</b> |  |  |  |               |                  |  |  |  |  |  |  |  |  |  |  |  |  |  |  |  |  |  |  |  |
|---------------------------------|--|--|--|---------------|------------------|--|--|--|--|--|--|--|--|--|--|--|--|--|--|--|--|--|--|--|
|                                 |  |  |  |               |                  |  |  |  |  |  |  |  |  |  |  |  |  |  |  |  |  |  |  |  |
|                                 |  |  |  | 10/77 → 06/80 |                  |  |  |  |  |  |  |  |  |  |  |  |  |  |  |  |  |  |  |  |
|                                 |  |  |  | 10/77 → 06/80 |                  |  |  |  |  |  |  |  |  |  |  |  |  |  |  |  |  |  |  |  |
|                                 |  |  |  |               |                  |  |  |  |  |  |  |  |  |  |  |  |  |  |  |  |  |  |  |  |
| <b>SEAT</b> <b>124 1.2</b>      |  |  |  |               |                  |  |  |  |  |  |  |  |  |  |  |  |  |  |  |  |  |  |  |  |
|                                 |  |  |  | FA12          | 01/68 → 10/80    |  |  |  |  |  |  |  |  |  |  |  |  |  |  |  |  |  |  |  |
|                                 |  |  |  | FA12          | 01/68 → 10/80    |  |  |  |  |  |  |  |  |  |  |  |  |  |  |  |  |  |  |  |
|                                 |  |  |  |               |                  |  |  |  |  |  |  |  |  |  |  |  |  |  |  |  |  |  |  |  |
| <b>SEAT</b> <b>124 1.4</b>      |  |  |  |               |                  |  |  |  |  |  |  |  |  |  |  |  |  |  |  |  |  |  |  |  |
|                                 |  |  |  |               | 01/70 → 12/76    |  |  |  |  |  |  |  |  |  |  |  |  |  |  |  |  |  |  |  |
|                                 |  |  |  |               | 01/70 → 12/76    |  |  |  |  |  |  |  |  |  |  |  |  |  |  |  |  |  |  |  |
|                                 |  |  |  |               |                  |  |  |  |  |  |  |  |  |  |  |  |  |  |  |  |  |  |  |  |
| <b>SEAT</b> <b>124 1.6</b>      |  |  |  |               |                  |  |  |  |  |  |  |  |  |  |  |  |  |  |  |  |  |  |  |  |
|                                 |  |  |  |               | 01/70 → 12/76    |  |  |  |  |  |  |  |  |  |  |  |  |  |  |  |  |  |  |  |
|                                 |  |  |  |               | 01/70 → 12/76    |  |  |  |  |  |  |  |  |  |  |  |  |  |  |  |  |  |  |  |
|                                 |  |  |  |               |                  |  |  |  |  |  |  |  |  |  |  |  |  |  |  |  |  |  |  |  |
| <b>SEAT</b> <b>127 0.9</b>      |  |  |  |               |                  |  |  |  |  |  |  |  |  |  |  |  |  |  |  |  |  |  |  |  |
|                                 |  |  |  |               | 04/72 → 12/82    |  |  |  |  |  |  |  |  |  |  |  |  |  |  |  |  |  |  |  |
|                                 |  |  |  |               | 04/72 → 12/82 2) |  |  |  |  |  |  |  |  |  |  |  |  |  |  |  |  |  |  |  |
|                                 |  |  |  |               |                  |  |  |  |  |  |  |  |  |  |  |  |  |  |  |  |  |  |  |  |
| <b>SEAT</b> <b>127 1.0</b>      |  |  |  |               |                  |  |  |  |  |  |  |  |  |  |  |  |  |  |  |  |  |  |  |  |
|                                 |  |  |  |               | 04/72 → 12/82    |  |  |  |  |  |  |  |  |  |  |  |  |  |  |  |  |  |  |  |
|                                 |  |  |  |               | 04/72 → 12/82    |  |  |  |  |  |  |  |  |  |  |  |  |  |  |  |  |  |  |  |
|                                 |  |  |  |               |                  |  |  |  |  |  |  |  |  |  |  |  |  |  |  |  |  |  |  |  |
| <b>SEAT</b> <b>128 1.2</b>      |  |  |  |               |                  |  |  |  |  |  |  |  |  |  |  |  |  |  |  |  |  |  |  |  |
|                                 |  |  |  |               | 01/76 → 12/80    |  |  |  |  |  |  |  |  |  |  |  |  |  |  |  |  |  |  |  |
|                                 |  |  |  |               | 01/76 → 12/80 2) |  |  |  |  |  |  |  |  |  |  |  |  |  |  |  |  |  |  |  |
|                                 |  |  |  |               |                  |  |  |  |  |  |  |  |  |  |  |  |  |  |  |  |  |  |  |  |
| <b>SEAT</b> <b>128 1.4</b>      |  |  |  |               |                  |  |  |  |  |  |  |  |  |  |  |  |  |  |  |  |  |  |  |  |
|                                 |  |  |  |               | 01/76 → 12/80    |  |  |  |  |  |  |  |  |  |  |  |  |  |  |  |  |  |  |  |
|                                 |  |  |  |               | 01/76 → 12/80 2) |  |  |  |  |  |  |  |  |  |  |  |  |  |  |  |  |  |  |  |
|                                 |  |  |  |               |                  |  |  |  |  |  |  |  |  |  |  |  |  |  |  |  |  |  |  |  |
| <b>SEAT</b> <b>131 1.5</b>      |  |  |  |               |                  |  |  |  |  |  |  |  |  |  |  |  |  |  |  |  |  |  |  |  |
|                                 |  |  |  |               | 03/82 → 01/85    |  |  |  |  |  |  |  |  |  |  |  |  |  |  |  |  |  |  |  |
|                                 |  |  |  |               | 03/82 → 01/85    |  |  |  |  |  |  |  |  |  |  |  |  |  |  |  |  |  |  |  |
|                                 |  |  |  |               |                  |  |  |  |  |  |  |  |  |  |  |  |  |  |  |  |  |  |  |  |
| <b>SEAT</b> <b>131 1.6</b>      |  |  |  |               |                  |  |  |  |  |  |  |  |  |  |  |  |  |  |  |  |  |  |  |  |
|                                 |  |  |  | 132 BB OA 0   | 03/82 → 01/85    |  |  |  |  |  |  |  |  |  |  |  |  |  |  |  |  |  |  |  |
|                                 |  |  |  |               | 03/82 → 01/85    |  |  |  |  |  |  |  |  |  |  |  |  |  |  |  |  |  |  |  |
|                                 |  |  |  |               |                  |  |  |  |  |  |  |  |  |  |  |  |  |  |  |  |  |  |  |  |
| <b>SEAT</b> <b>131 2.0</b>      |  |  |  |               |                  |  |  |  |  |  |  |  |  |  |  |  |  |  |  |  |  |  |  |  |
|                                 |  |  |  | 131 C4.000    | 06/78 → 12/85    |  |  |  |  |  |  |  |  |  |  |  |  |  |  |  |  |  |  |  |
|                                 |  |  |  |               | 06/78 → 12/85    |  |  |  |  |  |  |  |  |  |  |  |  |  |  |  |  |  |  |  |
|                                 |  |  |  |               |                  |  |  |  |  |  |  |  |  |  |  |  |  |  |  |  |  |  |  |  |
| <b>SEAT</b> <b>131 2.4 D</b>    |  |  |  |               |                  |  |  |  |  |  |  |  |  |  |  |  |  |  |  |  |  |  |  |  |
|                                 |  |  |  | 8144.61       | 01/81 → 12/86    |  |  |  |  |  |  |  |  |  |  |  |  |  |  |  |  |  |  |  |
|                                 |  |  |  |               | 01/81 → 12/86    |  |  |  |  |  |  |  |  |  |  |  |  |  |  |  |  |  |  |  |
|                                 |  |  |  |               |                  |  |  |  |  |  |  |  |  |  |  |  |  |  |  |  |  |  |  |  |
| <b>SEAT</b> <b>132 1.6</b>      |  |  |  |               |                  |  |  |  |  |  |  |  |  |  |  |  |  |  |  |  |  |  |  |  |
|                                 |  |  |  |               | 05/73 → 12/80    |  |  |  |  |  |  |  |  |  |  |  |  |  |  |  |  |  |  |  |
|                                 |  |  |  |               | 05/73 → 12/80    |  |  |  |  |  |  |  |  |  |  |  |  |  |  |  |  |  |  |  |
|                                 |  |  |  |               |                  |  |  |  |  |  |  |  |  |  |  |  |  |  |  |  |  |  |  |  |
| <b>SEAT</b> <b>132 1.8</b>      |  |  |  |               |                  |  |  |  |  |  |  |  |  |  |  |  |  |  |  |  |  |  |  |  |
|                                 |  |  |  |               | 05/73 → 12/80    |  |  |  |  |  |  |  |  |  |  |  |  |  |  |  |  |  |  |  |
|                                 |  |  |  |               | 05/73 → 12/80    |  |  |  |  |  |  |  |  |  |  |  |  |  |  |  |  |  |  |  |
|                                 |  |  |  |               |                  |  |  |  |  |  |  |  |  |  |  |  |  |  |  |  |  |  |  |  |
| <b>SEAT</b> <b>132 1.9</b>      |  |  |  |               |                  |  |  |  |  |  |  |  |  |  |  |  |  |  |  |  |  |  |  |  |
|                                 |  |  |  |               | 05/79 → 12/82    |  |  |  |  |  |  |  |  |  |  |  |  |  |  |  |  |  |  |  |
|                                 |  |  |  |               | 05/79 → 12/82    |  |  |  |  |  |  |  |  |  |  |  |  |  |  |  |  |  |  |  |
|                                 |  |  |  |               |                  |  |  |  |  |  |  |  |  |  |  |  |  |  |  |  |  |  |  |  |
| <b>SEAT</b> <b>132 2.0 D</b>    |  |  |  |               |                  |  |  |  |  |  |  |  |  |  |  |  |  |  |  |  |  |  |  |  |
|                                 |  |  |  |               | 05/73 → 12/80    |  |  |  |  |  |  |  |  |  |  |  |  |  |  |  |  |  |  |  |
|                                 |  |  |  |               | 05/73 → 12/80    |  |  |  |  |  |  |  |  |  |  |  |  |  |  |  |  |  |  |  |
|                                 |  |  |  |               |                  |  |  |  |  |  |  |  |  |  |  |  |  |  |  |  |  |  |  |  |
| <b>SEAT</b> <b>132 2.2 D</b>    |  |  |  |               |                  |  |  |  |  |  |  |  |  |  |  |  |  |  |  |  |  |  |  |  |
|                                 |  |  |  |               | 05/79 → 12/82    |  |  |  |  |  |  |  |  |  |  |  |  |  |  |  |  |  |  |  |
|                                 |  |  |  |               | 05/79 → 12/82    |  |  |  |  |  |  |  |  |  |  |  |  |  |  |  |  |  |  |  |
|                                 |  |  |  |               |                  |  |  |  |  |  |  |  |  |  |  |  |  |  |  |  |  |  |  |  |
| <b>SEAT</b> <b>133 0.8</b>      |  |  |  |               |                  |  |  |  |  |  |  |  |  |  |  |  |  |  |  |  |  |  |  |  |
|                                 |  |  |  | DG            | 05/74 → 11/79    |  |  |  |  |  |  |  |  |  |  |  |  |  |  |  |  |  |  |  |
|                                 |  |  |  |               | 05/74 → 11/79    |  |  |  |  |  |  |  |  |  |  |  |  |  |  |  |  |  |  |  |
|                                 |  |  |  |               |                  |  |  |  |  |  |  |  |  |  |  |  |  |  |  |  |  |  |  |  |













































SAAB



























|             |               | DG       | 05/74 → 11/79              |                    |   |        |   |        |  |  |  |        |   |  | 1 |         |
|-------------|---------------|----------|----------------------------|--------------------|---|--------|---|--------|--|--|--|--------|---|--|---|---------|
| <b>SEAT</b> |               |          | <b>600 D 0.8</b>           |                    |   |        |   |        |  |  |  |        |   |  |   |         |
|             |               |          | 09/63 → 04/70              |                    | OXOXOXO   |        |   |        |  |  |  |        |   |  |   |         |
|             |               |          | 09/63 → 04/70              |                    | VKPC 82205  |        |   |        |  |  |  |        |   |  | 1 |         |
| <b>SEAT</b> |               |          | <b>850 0.9</b>             |                    |   |        |   |        |  |  |  |        |   |  |   |         |
|             |               |          | 01/66 → 07/75              |                    | OXOXOXO   |        |   |        |  |  |  |        |   |  |   |         |
| <b>SEAT</b> |               |          | <b>ALHAMBRA 1.8 Turbo</b>  |                    |   |        |   |        |  |  |  |        |   |  |   |         |
|             |               | AJH      | 10/97 → 12/00              |                    | VKMA 01115<br>VKM 11115<br>VKM 21115              | 1<br>1 | 1 | 1      |  |  |  |        |   |  |   | T0151   |
|             |               | AWC      | 01/01 → 10/07              |                    | VKMA 01116<br>VKM 11116<br>VKM 21115              | 1<br>1 | 1 | 1      |  |  |  |        |   |  |   | T0151   |
|             |               | AJH, AWC | 10/97 → 10/07              |                    | VKPC 81620  |        |   |        |  |  |  | 1      |   |  |   |         |
|             | <b>B(Alt)</b> | AJH      | 10/97 → 12/00              | <b>AC</b>          | VKMA 31203<br>VKMV 6PK1120<br>VKM 31011           | 1<br>1 |   | 1      |  |  |  |        |   |  |   |         |
|             | <b>B(Alt)</b> | AJH      | 10/97 → 12/00              | <b>AC</b>          | VKMA 31204<br>VKMV 6DK1195<br>VKM 31011           | 1<br>1 |   | 1      |  |  |  |        |   |  |   |         |
|             | <b>B(Alt)</b> | AWC      | 01/01 → 10/07              |                    | VKMA 31204<br>VKMV 6DK1195<br>VKM 31011           | 1<br>1 |   | 1      |  |  |  |        |   |  |   |         |
| <b>SEAT</b> |               |          | <b>ALHAMBRA 2.0</b>        |                    |   |        |   |        |  |  |  |        |   |  |   |         |
|             |               | ADY      | 04/96 → 12/00              |                    | VKMA 01002<br>VKM 11000                           | 1<br>1 |   | 1      |  |  |  |        |   |  | 3 | T0091   |
|             |               | ATM      | 01/01 → 10/07              |                    | VKMA 01113<br>VKM 11113                           | 1<br>1 |   | 1      |  |  |  |        |   |  |   | T0149   |
|             |               | ADY      | 04/96 → 12/00              | 2)                 | VKPA 81401<br>VKPC 81401                          |        |   |        |  |  |  | 1<br>1 |   |  |   |         |
|             |               | ATM      | 01/01 → 10/07              |                    | VKPC 81620  |        |   |        |  |  |  | 1      |   |  |   |         |
|             | <b>B(Alt)</b> | ADY      | 04/96 → 12/00              | <b>A@</b>          | VKMV 6PK894                                       |        |   | 1      |  |  |  |        |   |  |   |         |
|             | <b>B(Alt)</b> | ADY      | 04/96 → 12/00              | <b>A@, AC</b>      | VKMV 6PK1033<br>VKM 31004<br>VKM 31210            | 1<br>1 |   | 1      |  |  |  |        |   |  |   |         |
|             | <b>B(Alt)</b> | ADY      | 04/96 → 12/00              | <b>A@, AC</b>      | VKMV 6PK1153<br>VKM 31004<br>VKM 31210            | 1<br>1 |   | 1      |  |  |  |        |   |  |   |         |
|             | <b>B(Alt)</b> | ATM      | 01/01 → 10/07              |                    | VKMA 31204<br>VKMV 6DK1195<br>VKM 31011           | 1<br>1 |   | 1<br>1 |  |  |  |        |   |  |   |         |
|             | <b>B(PS)</b>  | ADY      | 04/96 → 12/00              | <b>AC</b>          | VKMV 11.5x685                                     |        |   | 1      |  |  |  |        |   |  |   |         |
|             | <b>B(PS)</b>  | ADY      | 04/96 → 12/00              | <b>AC</b>          | VKMV 11.5x745                                     |        |   | 1      |  |  |  |        |   |  |   |         |
| <b>SEAT</b> |               |          | <b>ALHAMBRA 2.8 V6</b>     |                    |   |        |   |        |  |  |  |        |   |  |   |         |
|             |               | AYL      | 06/00 → 10/07              |                    | OXOXOXO   |        |   |        |  |  |  |        |   |  |   |         |
|             |               | AYL      | 06/00 → 10/07              | → ICH 7M-2-525 000 | VKPC 81611  |        |   |        |  |  |  | 1      |   |  |   |         |
|             |               | AYL      | 06/00 → 10/07              | CH 7M-2-525 001 →  | —   |        |   |        |  |  |  | 1      |   |  |   |         |
| <b>SEAT</b> |               |          | <b>ALHAMBRA 1.9 TDI 90</b> |                    |   |        |   |        |  |  |  |        |   |  |   |         |
|             |               | ANU      | 01/01 → 12/02              |                    | VKMA 01942<br>VKM 11142<br>VKM 11145<br>VKM 21142 | 1<br>1 | 1 | 1      |  |  |  |        | 1 |  |   | 3 T0184 |
|             |               | ANU      | 01/01 → 12/02              |                    | VKMA 01142<br>VKM 11142<br>VKM 21142              | 1<br>1 | 1 | 1      |  |  |  |        |   |  |   | 3 T0184 |
|             |               | ANU      | 01/03 → 10/07              |                    | VKMA 01250<br>VKM 11250<br>VKM 21147              | 1<br>1 | 1 | 1      |  |  |  |        |   |  |   | T0184   |
|             |               | 1Z, AHU  | 04/96 → 12/00              |                    | VKMA 01019<br>VKM 11014<br>VKM 21012              | 1<br>1 | 1 | 1      |  |  |  |        |   |  |   | 5 T0650 |
|             |               | 1Z, AHU  | 04/96 → 12/00              | 2)                 | VKPA 81401<br>VKPC 81401                          |        |   |        |  |  |  | 1<br>1 |   |  |   |         |
|             |               | ANU      | 01/01 → 10/07              |                    | VKPC 81626  |        |   |        |  |  |  | 1      |   |  |   |         |



|  |  |  |    |  |  |  |  |  |  |  |  |  |
|--|---|---|---|--|---|---|---|---|---|---|---|---|
|                                     | B(Alt) ANU  | 01/01 → 10/07   |   | VKMA 31001<br>VKMV 6DK1195<br>VKM 31019  | 1<br>1  | 1<br>1  |   |   |   |   |   |   |
|  | B(Alt), B(PS)1Z, AHU  | 04/96 → 12/00   | A⊙, AC,<br>→ ICH 7M-Y-509 291   | VKMA 31028<br>VKMV 10AVx730<br>VKMV 6PK1045<br>VKM 31004<br>VKM 31030              | 2<br>1<br>1   | 2<br>1<br>1   |   |   |   |   |   |   |
|  | B(Alt), B(PS)1Z, AHU  | 04/96 → 12/00   | A⊙, AC  | VKMA 31030<br>VKMV 11.5x790<br>VKMV 6PK1145<br>VKM 31004<br>VKM 31030              | 2<br>1<br>1   | 2<br>1<br>1   |   |   |   |   |   |   |
| ⊙  | 1Z, AHU   | 04/96 → 12/00   |   | VKM _____  |   |   |   |   | 1   |   |   |   |
|  | ANU   | 01/01 → 10/07   | → ICH 7M-4-507 000  | VKM _____  |   |   |   |   | 1   |   |   |   |
|  | ANU   | 01/01 → 10/07   | CH 7M-4-507 001 I→  | VKM _____  |   |   |   |   | 1   |   |   |   |
| <b>SEAT  ALHAMBRA 1.9 TDI 110</b>   |   |   |   |  |   |   |   |   |   |   |   |   |
|                                     | AFN   | 08/96 → 06/00   |   | VKMA 01019<br>VKM 11014<br>VKM 21012   | 1<br>1  | 1<br>1  |   |   |   |   |   | 5 T0650   |
|                                     | AFN   | 08/96 → 06/00   | 2)  | VKPA 81401<br>VKPC 81401   |   |   |   |   | 1<br>1  |   |   |   |
|                                     | B(Alt), B(PS)AFN  | 08/96 → 06/00   | A⊙, AC,<br>→ ICH 7M-Y-509 291   | VKMA 31028<br>VKMV 10AVx730<br>VKMV 6PK1045<br>VKM 31004<br>VKM 31030              | 2<br>1<br>1   | 2<br>1<br>1   |   |   |   |   |   |   |
|  | B(Alt), B(PS)AFN  | 08/96 → 06/00   | A⊙, AC  | VKMA 31030<br>VKMV 11.5x790<br>VKMV 6PK1145<br>VKM 31004<br>VKM 31030              | 2<br>1<br>1   | 2<br>1<br>1   |   |   |   |   |   |   |
| ⊙  | AFN   | 08/96 → 06/00   |   | VKM _____  |   |   |   |   | 1   |   |   |   |
| <b>SEAT  ALHAMBRA 1.9 TDI 115</b> |   |   |   |  |   |   |   |   |   |   |   |   |
|                                   | AUY   | 06/00 → 12/02   |  | VKMA 01942<br>VKM 11142<br>VKM 11145<br>VKM 21142                                  | 1<br>1  | 1<br>1  | 1<br>1  |   |   |   |   | 3 T0184   |
|  | AUY   | 06/00 → 12/02   |   | VKMA 01142<br>VKM 11142<br>VKM 21142   | 1<br>1  | 1<br>1  | 1   |   |   |   |   | 3 T0184   |
|  | AUY   | 01/03 → 10/07   |   | VKMA 01250<br>VKM 11250<br>VKM 21147   | 1<br>1  | 1<br>1  | 1   |   |   |   |   | T0184   |
|                                   | AUY   | 06/00 → 10/07   |   | VKPC 81626   |   |   |   |   | 1   |   |   |   |
|                                   | B(Alt) AUY  | 06/00 → 10/07   |   | VKMA 31001<br>VKMV 6DK1195<br>VKM 31019  | 1<br>1  | 1<br>1  |   |   |   |   |   |   |
| ⊙  | AUY   | 06/00 → 10/07   | → ICH 7M-4-507 000  | VKM _____  |   |   |   |   | 1   |   |   |   |
|  | AUY   | 06/00 → 10/07   | CH 7M-4-507 001 I→  | VKM _____  |   |   |   |   | 1   |   |   |   |
| <b>SEAT  ALHAMBRA 1.9 TDI 130</b> |   |   |   |  |   |   |   |   |   |   |   |   |
|                                   | ASZ   | 11/02 → 10/07   |   | VKMA 01250<br>VKM 11250<br>VKM 21147   | 1<br>1  | 1<br>1  |   |   |   |   |   | T0184   |
|                                   | ASZ   | 11/02 → 10/07   |   | VKPC 81418   |   |   |   |   | 1   |   |   |   |
|                                   | B(Alt) ASZ  | 11/02 → 10/07   |   | VKMA 31001<br>VKMV 6DK1195<br>VKM 31019  | 1<br>1  | 1<br>1  |   |   |   |   |   |   |
| ⊙  | ASZ   | 11/02 → 10/07   | → ICH 7M-4-507 000  | VKM _____  |   |   |   |   | 1   |   |   |   |
|  | ASZ   | 11/02 → 10/07   | CH 7M-4-507 001 I→  | VKM _____  |   |   |   |   | 1   |   |   |   |
| <b>SEAT  ALHAMBRA 1.9 TDI 150</b> |   |   |   |  |   |   |   |   |   |   |   |   |
|                                   | BTB   | 05/05 → 10/07   |   | VKMA 01250<br>VKM 11250<br>VKM 21147   | 1<br>1  | 1<br>1  |   |   |   |   |   | T0184   |



















































|  |  |  |  |  |  |  |  |  |  |  |  |  |
|--|---|---|---|--|---|---|---|---|---|---|---|---|
|    | BTB   | 05/05 → 10/07   |   | VKPC 81418   |   |   |   |   |   | 1   |   |   |
|    | <b>B(Alt)</b> BTB   | 05/05 → 10/07   |   | VKMA 31001<br>VKMV 6DK1195<br>VKM 31019  | 1   |   | 1   |   |   |   |   |   |
| <b>SEAT  ALHAMBRA 2.0 TDI</b>               |   |   |   |  |   |   |   |   |   |   |   |   |
|    | BRT   | 11/05 → 10/07   |   | VKMA 01250<br>VKM 11250<br>VKM 21147   | 1   | 1   | 1   |   |   |   |   | T0184   |
|    | BRT   | 11/05 → 10/07   |   | VKPC 81626   |   |   |   |   | 1   |   |   |   |
|    | <b>B(Alt)</b> BRT   | 11/05 → 10/07   |   | VKMV 6DK1215<br>VKM 31054  | 1   |   | 1   |   |   |   |   |   |
| <b>SEAT  ALTEA / ALTEA XL 1.6</b>           |   |   |   |  |   |   |   |   |   |   |   |   |
|    | BGU, BSE, BSF   | 03/04 → 10/07   |   | VKMA 01113<br>VKM 11113  | 1   |   | 1   |   |   |   |   | T0149   |
|    | BGU, BSE, BSF   | 03/04 → 10/07   |   | VKPC 81408   |   |   |   |   | 1   |   |   |   |
|    | <b>B(Alt)</b> BGU, BSE, BSF   | 03/04 → 10/07   | <b>AC</b>   | VKMV 6PK900<br>VKM 31011   | 1   |   | 1   |   |   |   |   |   |
|  | <b>B(Alt)</b> BGU, BSE, BSF   | 03/04 → 10/07   | <b>AC</b>   | VKMV 6PK1042<br>VKM 31011  | 1   |   | 1   |   |   |   |   |   |
| <b>SEAT  ALTEA / ALTEA XL 1.8 TFSI</b>      |   |   |   |  |   |   |   |   |   |   |   |   |
|    | BYT   | 01/07 → 10/07   |   | <b>OXOXOXO</b>   |   |   |   |   |   |   |   |   |
| <b>SEAT  ALTEA / ALTEA XL 2.0 FSI</b>       |   |   |   |  |   |   |   |   |   |   |   |   |
|    | BLR, BLY, BVY, BVZ  | 05/04 → 10/07   |   | VKMA 01222<br>VKM 11222<br>VKM 21220<br>VKM _____                                  | 1   | 2   | 1   |   |   |   |   | 2 T0247   |
|    | BLR, BLY, BVY, BVZ  | 05/04 → 10/07   |   | VKPC 81220   |   |   |   |   | 1   |   |   |   |
|    | <b>B(Alt)</b> BLR, BLY, BVY, BVZ  | 05/04 → 10/07   | <b>AC</b>   | VKMV 6PK900<br>VKM 31011   | 1   |   | 1   |   |   |   |   |   |
|  | <b>B(Alt)</b> BLR, BLY, BVY, BVZ  | 05/04 → 10/07   | <b>AC</b>   | VKMV 6PK1042<br>VKM 31011  | 1   |   | 1   |   |   |   |   |   |
| <b>SEAT  ALTEA / ALTEA XL 2.0 TFSI</b>    |   |   |   |  |   |   |   |   |   |   |   |   |
|    | BWA   | 04/06 → 10/07   |   | VKMA 01222<br>VKM 11222<br>VKM 21220<br>VKM _____                                  | 1   | 2   | 1   |   |   |   |   | 2 T0247   |
|    | BWA   | 04/06 → 10/07   |   | —  |   |   |   |   | 1   |   |   |   |
|    | <b>B(Alt)</b> BWA   | 04/06 → 10/07   | <b>AC</b>   | VKMV 6PK953  |   |   | 1   |   |   |   |   |   |
|  | <b>B(Alt)</b> BWA   | 04/06 → 10/07   | <b>AC</b>   | VKMV 6PK1054   |   |   | 1   |   |   |   |   |   |
| <b>SEAT  ALTEA / ALTEA XL 1.9 TDI</b>     |   |   |   |  |   |   |   |   |   |   |   |   |
|    | BJB, BKC, BLS, BXE  | 04/04 → 10/07   |   | VKMA 01250<br>VKM 11250<br>VKM 21147   | 1   | 1   | 1   |   |   |   |   | T0184   |
|    | BJB, BKC, BLS, BXE  | 04/04 → 10/07   |   | VKPC 81418   |   |   |   |   | 1   |   |   |   |
|    | <b>B(Alt)</b> BJB, BKC, BLS, BXE  | 04/04 → 12/05   | <b>AC, →ICH 5P-5-165 000</b>  | VKMV 6PK1050<br>VKM 31022  | 1   |   | 1   |   |   |   |   |   |
|  | <b>B(Alt)</b> BJB, BKC, BLS, BXE  | 01/06 → 10/07   | <b>AC, CH 5P-6-000 001 I→</b>   | VKMV 6PK1050<br>VKM 31054  | 1   |   | 1   |   |   |   |   |   |
| <b>SEAT  ALTEA / ALTEA XL 2.0 TDI 136</b> |   |   |   |  |   |   |   |   |   |   |   |   |
|    | AZV   | 03/04 → 10/07   |   | VKMA 01255<br>VKM 11255<br>VKM 21147<br>VKM 21256                                  | 1   | 2   | 1   |   |   |   |   | 5 T0184   |
|    | AZV   | 03/04 → 10/07   |   | VKPC 81627   |   |   |   |   | 1   |   |   |   |
|    | <b>B(Alt)</b> AZV   | 03/04 → 10/07   | <b>AC</b>   | VKMV 6PK950<br>VKM 31022   | 1   |   | 1   |   |   |   |   |   |
|  | <b>B(Alt)</b> AZV   | 03/04 → 10/07   | <b>AC</b>   | VKMV 6PK1050<br>VKM 31022  | 1   |   | 1   |   |   |   |   |   |
| <b>SEAT  ALTEA / ALTEA XL 2.0 TDI 140</b> |   |   |   |  |   |   |   |   |   |   |   |   |
|    | BKD   | 03/04 → 10/07   |   | VKMA 01255<br>VKM 11255  | 1   | 2   | 1   |   |   |   |   | 5 T0184   |

|  |  |  |                               |  |  |  |  |  |  |  |   |       |
|--|---|---|--|--|---|---|---|---|---|---|---|-------|
|  |   |   |  | VKM 21147  | 1   |   |   |   |   |   |   |       |
|  |   |   |  | VKM 21256  | 1   |   |   |   |   |   |   |       |
|  | BMM   | 11/05 → 10/07   |  | VKMA 01250   | 1   | 1   | 1   |   |   |   |   | T0184 |
|  |   |   |  | VKM 11250  | 1   |   |   |   |   |   |   |       |
|  |   |   |  | VKM 21147  |   | 1   |   |   |   |   |   |       |
|   | BKD   | 03/04 → 10/07   |  | VKPC 81627   |   |   |   | 1   |   |   |   |       |
|  | BMM   | 11/05 → 10/07   |  | VKPC 81303   |   |   |   | 1   |   |   |   |       |
|   | <b>B(Alt)</b> BKD   | 03/04 → 10/07   | $\mathcal{A}^{\mathcal{C}}$  | VKMV 6PK950  |   |   | 1   |   |   |   |   |       |
|  |   |   |  | VKM 31022  | 1   |   |   |   |   |   |   |       |
|  | <b>B(Alt)</b> BKD   | 03/04 → 10/07   | <b>AC</b>  | VKMV 6PK1050   |   |   | 1   |   |   |   |   |       |
|  |   |   |  | VKM 31022  | 1   |   |   |   |   |   |   |       |
|  | <b>B(Alt)</b> BMM   | 11/05 → 10/07   | <b>AC, → ICH 5P-5-165 000</b>  | VKMV 6PK1050   |   |   | 1   |   |   |   |   |       |
|  |   |   |  | VKM 31022  | 1   |   |   |   |   |   |   |       |
|  | <b>B(Alt)</b> BMM   | 11/05 → 10/07   | <b>AC, CH 5P-6-000 001 I →</b>   | VKMV 6PK1050   |   |   | 1   |   |   |   |   |       |
|  |   |   |  | VKM 31054  | 1   |   |   |   |   |   |   |       |
| <b>SEAT  ALTEA / ALTEA XL 2.0 TDI 170</b> |   |   |  |  |   |   |   |   |   |   |   |       |
|   | BMN   | 03/06 → 10/07   |  | VKMA _____   | 1   | 2   | 1   |   |   |   | 5 | T0184 |
|  |   |   |  | VKM 11255  | 1   |   |   |   |   |   |   |       |
|  |   |   |  | VKM 21147  |   | 1   |   |   |   |   |   |       |
|  |   |   |  | VKM _____  |   | 1   |   |   |   |   |   |       |
|   | BMN   | 03/06 → 10/07   |  | VKPC _____   |   |   |   | 1   |   |   |   |       |
|   | <b>B(Alt)</b> BMN   | 03/06 → 10/07   | $\mathcal{A}^{\mathcal{C}}$  | VKMV 6PK950  |   |   | 1   |   |   |   |   |       |
|  |   |   |  | VKM 31022  | 1   |   |   |   |   |   |   |       |
|  | <b>B(Alt)</b> BMN   | 03/06 → 10/07   | <b>AC</b>  | VKMV 6PK1050   |   |   | 1   |   |   |   |   |       |
|  |   |   |  | VKM 31022  | 1   |   |   |   |   |   |   |       |
| <b>SEAT  AROSA 1.0</b>                   |   |   |  |  |   |   |   |   |   |   |   |       |
|   | AHT   | 05/97 → 06/04   |  | <del>OKOKOKO</del>   |   |   |   |   |   |   |   |       |
|  | ALD, ANV, AUC   | 05/97 → 06/04   | <b>→ ICH 6H-Y-014 000</b>  | VKMA 01106   | 1   |   | 1   |   |   |   |   | T0126 |
|  |   |   |  | VKM 11106  | 1   |   |   |   |   |   |   |       |
|  | ALD, ANV, AUC   | 05/97 → 06/04   |  <b>CH 6H-Y-014 001 I →</b> | VKMC 01107   | 1   |   | 1   | 1   |   |   | 2 |       |
|  |   |   |  | VKMA 01107   | 1   |   | 1   |   |   |   | 2 | T0126 |
|  |   |   |  | VKM 11107  | 1   |   |   |   |   |   |   |       |
|  | AER, ALL  | 05/97 → 06/04   |  | VKMA 01106   | 1   |   | 1   |   |   |   |   | T0126 |
|  |   |   |  | VKM 11106  | 1   |   |   |   |   |   |   |       |
|   | AER, ALD, ALL, ANV, AUC   | 05/97 → 08/98   |  | VKPC 81215   |   |   |   | 1   |   |   |   |       |
|  | AHT   | 05/97 → 06/04   |  | —  |   |   |   | 1   |   |   |   |       |
|   | <b>B(Alt)</b> AER, AHT, ALD, ALL, ANV, AUC  | 05/97 → 06/04   | $\emptyset$  | VKMV 6PK751  |   |   | 1   |   |   |   |   |       |
|  | <b>B(Alt)</b> AER, AHT, ALD, ALL, ANV, AUC  | 05/97 → 06/04   | $\mathcal{A}^{\mathcal{C}}, \ominus$   | VKMA 31202   | 1   |   | 1   |   |   |   |   |       |
|  |   |   |  | VKMV 6PK1068   |   |   | 1   |   |   |   |   |       |
|  |   |   |  | VKM 31015  | 1   |   |   |   |   |   |   |       |
|  | <b>B(Alt)</b> AER, AHT, ALD, ALL, ANV, AUC  | 05/97 → 06/04   | <b>AC, <math>\ominus</math></b>  | VKMA 31219   | 1   |   | 1   |   |   |   |   |       |
|  |   |   |  | VKMV 6PK1123   |   |   | 1   |   |   |   |   |       |
|  |   |   |  | VKM 31015  | 1   |   |   |   |   |   |   |       |
| <b>SEAT  AROSA 1.4</b>                  |   |   |  |  |   |   |   |   |   |   |   |       |
|   | AKK, ANW, AUD   | 05/97 → 06/04   | <b>→ ICH 6H-Y-014 000</b>  | VKMA 01106   | 1   |   | 1   |   |   |   |   | T0126 |
|  |   |   |  | VKM 11106  | 1   |   |   |   |   |   |   |       |
|  | AKK, ANW, AUD   | 05/97 → 06/04   |  <b>CH 6H-Y-014 001 I →</b> | VKMC 01107   | 1   |   | 1   | 1   |   |   | 2 |       |
|  |   |   |  | VKMA 01107   | 1   |   | 1   |   |   |   | 2 | T0126 |
|  |   |   |  | VKM 11107  | 1   |   |   |   |   |   |   |       |
|  | AEX, AKV, APQ   | 05/97 → 06/04   |  | VKMA 01106   | 1   |   | 1   |   |   |   |   | T0126 |
|  |   |   |  | VKM 11106  | 1   |   |   |   |   |   |   |       |
|   | AEX, AKV, APQ   | 05/97 → 06/04   |  | VKPC 81210   |   |   |   | 1   |   |   |   |       |
|  | AKK, ANW, AUD   | 05/97 → 06/04   |  | VKPC 81215   |   |   |   | 1   |   |   |   |       |
|   | <b>B(Alt)</b> AEX, AKK, AKV, ANW, APQ, AUD  | 05/97 → 06/04   | $\emptyset$  | VKMV 6PK751  |   |   | 1   |   |   |   |   |       |
|  | <b>B(Alt)</b> AEX, AKK, AKV, ANW, APQ, AUD  | 05/97 → 06/04   | $\mathcal{A}^{\mathcal{C}}, \ominus$   | VKMA 31202   | 1   |   | 1   |   |   |   |   |       |
|  |   |   |  | VKMV 6PK1068   |   |   | 1   |   |   |   |   |       |
|  |   |   |  | VKM 31015  | 1   |   |   |   |   |   |   |       |



SEAT

| <b>B(Alt)</b>                                     | AEX, AKK, AKV, ANW,<br>APQ, AUD | 05/97 → 06/04 | AC, ⊕               | VKMA 31219<br>VKMV 6PK1123<br>VKM 31015                        | 1<br>1<br>1           | 1<br>1      |        |        |   |        |  |  |  |              |
|---|---------------------------------|---------------|---------------------|--|-----------------------|-------------|--------|--------|---|--------|--|--|--|--------------|
| <b>SEAT  AROSA 1.4 16V</b>                        |                                 |               |                     |  |                       |             |        |        |   |        |  |  |  |              |
|   | AFK, AQQ, AUB                   | 01/00 → 06/04 |                     | VKMA 01121<br>VKM 11120<br>VKM 11124<br>VKM 21120<br>VKM 21121 | 2<br>1<br>1<br>1<br>1 | 2<br>1<br>1 | 2<br>1 |        |   |        |  |  |  | T0165        |
|   | AFK, AQQ, AUB                   | 01/00 → 06/04 |                     | VKPC 81407   |                       |             |        |        | 1 |        |  |  |  |              |
|   | <b>B(Alt)</b> AFK, AQQ, AUB     | 01/00 → 06/04 | ⊗                   | VKMV 6PK751  |                       |             | 1      |        |   |        |  |  |  |              |
|   | <b>B(Alt)</b> AFK, AQQ, AUB     | 01/00 → 06/04 | AC, ⊕               | VKMA 31202<br>VKMV 6PK1068<br>VKM 31015                        | 1<br>1<br>1           | 1<br>1      |        |        |   |        |  |  |  |              |
|   | <b>B(Alt)</b> AFK, AQQ, AUB     | 01/00 → 06/04 | AC, ⊕               | VKMA 31219<br>VKMV 6PK1123<br>VKM 31015                        | 1<br>1<br>1           | 1<br>1      |        |        |   |        |  |  |  |              |
| <b>SEAT  AROSA 1.4 TDI</b>                        |                                 |               |                     |  |                       |             |        |        |   |        |  |  |  |              |
|   | AMF                             | 01/00 → 12/03 | →   Mot. 011 494    | VKMA 01941<br>VKM 11141<br>VKM 11144<br>VKM 21142              | 1<br>1<br>1<br>1      | 1<br>1      | 1<br>1 | 1<br>1 |   | 1<br>1 |  |  |  | 2 T0184      |
|   | AMF                             | 01/00 → 12/03 | →   Mot. 011 494    | VKMA 01141<br>VKM 11141<br>VKM 21142                           | 1<br>1<br>1           | 1<br>1      | 1<br>1 |        |   |        |  |  |  | 1 T0184      |
|   | AMF                             | 01/00 → 12/03 | Mot. 011 495   →    | VKMA 01942<br>VKM 11142<br>VKM 11145<br>VKM 21142              | 1<br>1<br>1<br>1      | 1<br>1      | 1<br>1 | 1<br>1 |   |        |  |  |  | 3 T0184      |
|   | AMF                             | 01/00 → 12/03 | Mot. 011 495   →    | VKMA 01142<br>VKM 11142<br>VKM 21142                           | 1<br>1<br>1           | 1<br>1      | 1<br>1 |        |   |        |  |  |  | 3 T0184      |
|   | AMF                             | 01/04 → 06/04 |                     | VKMA 01250<br>VKM 11250<br>VKM 21147                           | 1<br>1<br>1           | 1<br>1      | 1<br>1 |        |   |        |  |  |  | T0184        |
|   | AMF                             | 01/00 → 06/04 | →   CH 6H-3-000 001 | VKPC 81417   |                       |             |        |        | 1 |        |  |  |  |              |
|   | AMF                             | 01/00 → 06/04 | CH 6H-3-000 002   → | VKPC 81418   |                       |             |        |        | 1 |        |  |  |  |              |
|   | <b>B(Alt)</b> AMF               | 01/00 → 06/04 | AC                  | VKMA 31203<br>VKMV 6PK1120<br>VKM 31011                        | 1<br>1<br>1           | 1<br>1      |        |        |   |        |  |  |  |              |
|   | <b>B(Alt)</b> AMF               | 01/00 → 06/04 | AC                  | VKMV 6DK1188<br>VKM 31011                                      | 1<br>1                | 1           |        |        |   |        |  |  |  |              |
| <b>SEAT  AROSA 1.7 SDI</b>                        |                                 |               |                     |  |                       |             |        |        |   |        |  |  |  |              |
|   | AKU                             | 08/97 → 06/04 |                     | VKMA 01016<br>VKM 11015<br>VKM 21012                           | 1<br>1<br>1           | 1<br>1      | 1<br>1 |        |   |        |  |  |  | 4 T0183      |
|   | AKU                             | 08/97 → 06/04 |                     | VKPC 81615   |                       |             |        |        | 1 |        |  |  |  |              |
|   | <b>B(Alt)</b> AKU               | 08/97 → 06/04 |                     | VKMA 31017<br>VKMV 5PK1219<br>VKM 31025                        | 1<br>1<br>1           | 1<br>1      |        |        |   |        |  |  |  |              |
| <b>SEAT  CORDOBA (6K2) / CORDOBA (6K2/C2) 1.0</b> |                                 |               |                     |  |                       |             |        |        |   |        |  |  |  |              |
|   | AAU                             | 02/93 → 06/96 |                     | VKMC 01103   |                       |             | 1      | 1      |   |        |  |  |  | T0231        |
|   | ALD                             | 06/99 → 10/02 | →   Mot. 037 797    | VKMA 01106<br>VKM 11106  | 1<br>1                | 1           |        |        |   |        |  |  |  | T0126        |
|   | ALD                             | 06/99 → 10/02 | Mot. 037 798   →    | VKMC 01107<br>VKMA 01107<br>VKM 11107                          | 1<br>1<br>1           | 1<br>1      | 1<br>1 | 1      |   |        |  |  |  | 2<br>2 T0126 |
|   | AUC                             | 06/99 → 10/02 |                     | VKMC 01107<br>VKMA 01107<br>VKM 11107                          | 1<br>1<br>1           | 1<br>1      | 1<br>1 | 1      |   |        |  |  |  | 2<br>2 T0126 |
|   | AER, ANV                        | 09/96 → 10/02 |                     | VKMA 01106<br>VKM 11106  | 1<br>1                | 1           |        |        |   |        |  |  |  | T0126        |
|   | AAU                             | 02/93 → 06/96 |                     | VKPC 81204   |                       |             |        |        | 1 |        |  |  |  |              |
|   | AER, ALD, ANV, AUC              | 09/96 → 10/02 |                     | VKPC 81215   |                       |             |        |        | 1 |        |  |  |  |              |
|   | <b>B(Alt)</b> AAU               | 02/93 → 06/96 |                     | VKMV 11.9x710  |                       |             | 1      |        |   |        |  |  |  |              |

|  |  |  |                   |  |  |  |  |  |  |  |  |
|--|---|---|--|--|---|---|---|---|---|---|---|
| B(Alt)   | AER, ALD, ANV, AUC  | 09/96 → 10/02   |                   | VKMC 6PK751  |   |   | 1   |   |   |   |   |
| B(Alt)   | AER, ALD, ANV, AUC  | 09/96 → 10/02   |                   | VKMA 31202<br>VKMV 6PK1068<br>VKM 31015  | 1   |   | 1   |   |   |   |   |
| <b>SEAT  CORDOBA (6K2) / CORDOBA (6K2/C2) 1.0 16V</b>   |   |   |  |  |   |   |   |   |   |   |   |
|   | AST, AVZ  | 05/00 → 10/02   |                   | VKMC 01114<br>VKMA 01114<br>VKM 11114<br>VKM 21122                                 | 1<br>1<br>1   | 1<br>1  | 1<br>1  |   | 1   |   | T0150   |
|   | AST, AVZ  | 05/00 → 10/02   |                   | VKPC 81411   |   |   |   |   | 1   |   |   |
|   | B(Alt) AST, AVZ   | 05/00 → 10/02   |                   | VKMA 31202<br>VKMV 6PK1068<br>VKM 31015  | 1   |   | 1   |   |   |   |   |
|  | B(Alt) AST, AVZ   | 05/00 → 10/02   |                   | VKMC 6PK1185<br>VKM 31023  | 1   |   | 1   |   |   |   |   |
| <b>SEAT  CORDOBA (6K2) / CORDOBA (6K2/C2) 1.3</b>       |   |   |  |  |   |   |   |   |   |   |   |
|   | 2G, AAV   | 02/93 → 08/94   |                   | VKMC 01103   |   |   | 1   |   | 1   |   | T0231   |
|   | 2G, AAV   | 02/93 → 08/94   |                   | VKPC 81204   |   |   |   |   | 1   |   |   |
|   | B(Alt) 2G, AAV  | 02/93 → 08/94   |  | VKMC 11.9x710  |   |   | 1   |   |   |   |   |
| <b>SEAT  CORDOBA (6K2) / CORDOBA (6K2/C2) 1.4</b>       |   |   |  |  |   |   |   |   |   |   |   |
|   | ABD   | 06/94 → 06/99   |                   | VKMC 01103   |   |   | 1   |   | 1   |   | T0231   |
|  | AKK   | 06/99 → 10/02   | → Mot. 127 806   | VKMA 01106<br>VKM 11106  | 1<br>1  |   | 1   |   |   |   | T0126   |
|  | AKK   | 06/99 → 10/02   |  Mot. 127 807 I → | VKMC 01107<br>VKMA 01107<br>VKM 11107  | 1<br>1<br>1   | 1   | 1   |   | 1   |   | 2<br>2<br>T0126   |
|  | ANW, AUD  | 06/99 → 10/02   |                 | VKMC 01107<br>VKMA 01107<br>VKM 11107  | 1<br>1<br>1   | 1   | 1   |   | 1   |   | 2<br>2<br>T0126   |
|  | AEX, ANX, APQ   | 06/94 → 06/99   |  | VKMA 01106<br>VKM 11106  | 1<br>1  |   | 1   |   |   |   | T0126   |
|   | ABD   | 06/94 → 06/99   |  | VKPC 81204   |   |   |   |   | 1   |   |   |
|  | AEX, AKV, ANX, APQ  | 06/94 → 06/99   |  | VKPC 81210   |   |   |   |   | 1   |   |   |
|  | AKK, ANW, AUD   | 06/99 → 10/02   |  | VKPC 81215   |   |   |   |   | 1   |   |   |
|   | B(Alt) ABD, AKK, ANW, AUD   | 06/94 → 10/02   |                 | VKMA 31202<br>VKMV 6PK1068<br>VKM 31015  | 1<br>1  |   | 1   |   | 1   |   |   |
|  | B(Alt) AKK, ANW, AUD  | 06/99 → 10/02   |                 | VKMC 6PK1185<br>VKM 31023  | 1   |   | 1   |   |   |   |   |
|  | B(Alt) ANX  | 12/97 → 04/99   |                 | VKMC 6PK751  |   |   | 1   |   |   |   |   |
|  | B(Alt) ANX  | 12/97 → 04/99   |                 | VKMA 31202<br>VKMV 6PK1068<br>VKM 31015  | 1   |   | 1   |   | 1   |   |   |
| <b>SEAT  CORDOBA (6K2) / CORDOBA (6K2/C2) 1.4 16V</b> |   |   |  |  |   |   |   |   |   |   |   |
|   | AFH   | 09/96 → 06/99   |                 | VKMC 01114<br>VKMA 01114<br>VKM 11114<br>VKM 21122                                 | 1<br>1<br>1   | 1<br>1  | 1<br>1  |   | 1   |   | T0150   |
|  | APE, AQQ, AUA, AUB  | 02/00 → 10/02   |  | VKMA 01121<br>VKM 11120<br>VKM 11124<br>VKM 21120<br>VKM 21121                     | 2<br>1<br>1   | 2   | 2   |   |   |   | T0165   |
|   | AFH   | 09/96 → 06/99   |  | VKPC 81411   |   |   |   |   | 1   |   |   |
|  | APE, AUA  | 05/00 → 10/02   |  | VKPC 81407   |   |   |   |   | 1   |   |   |
|  | AQQ, AUB  | 02/00 → 10/02   |  | VKPC 81210   |   |   |   |   | 1   |   |   |
|   | B(Alt) AFH, APE, AQQ, AUA, AUB  | 09/96 → 10/02   |                 | VKMA 31202<br>VKMV 6PK1068<br>VKM 31015  | 1<br>1  |   | 1   |   | 1   |   |   |
|  | B(Alt) APE, AQQ, AUA, AUB   | 02/00 → 10/02   |                 | VKMC 6PK1185<br>VKM 31023  | 1   |   | 1   |   |   |   |   |
| <b>SEAT  CORDOBA (6K2) / CORDOBA (6K2/C2) 1.6</b>     |   |   |  |  |   |   |   |   |   |   |   |
|   | ABU   | 02/93 → 08/94   |                 | VKMC 01104   |   |   | 1   |   | 1   |   | T0233   |























SEAT

|   | 1F                        | 05/94 → 06/99 | 3)                 | VKMS 01000    | 1 |  | 1 |  |  |   |  | 3 | 4 |       |
|---|---------------------------|---------------|--------------------|---------------|---|--|---|--|--|---|--|---|---|-------|
|   |                           |               |                    | VKMA 01000    | 1 |  | 1 |  |  |   |  |   | 3 | T0005 |
|   |                           |               |                    | VKM 11000     | 1 |  |   |  |  |   |  |   |   |       |
|   | AEE, ALM                  | 02/93 → 10/02 |                    | VKMA 01110    | 1 |  | 1 |  |  |   |  |   |   | T0127 |
|   |                           |               |                    | VKM 11106     | 1 |  |   |  |  |   |  |   |   |       |
|   | AEH, AKL, APF, AUR        | 06/99 → 10/02 |                    | VKMA 01113    | 1 |  | 1 |  |  |   |  |   |   | T0149 |
|   |                           |               |                    | VKM 11113     | 1 |  |   |  |  |   |  |   |   |       |
|   | AFT                       | 07/96 → 12/96 |                    | VKMA 01009    | 1 |  | 1 |  |  |   |  |   | 3 | T0124 |
|   |                           |               |                    | VKM 11000     | 1 |  |   |  |  |   |  |   |   |       |
|   | 1F, AFT                   | 02/93 → 06/99 | 2)                 | VKPA 81401    |   |  |   |  |  | 1 |  |   |   |       |
|   |                           |               |                    | VKPC 81401    |   |  |   |  |  | 1 |  |   |   |       |
|   | ABU                       | 02/93 → 06/99 |                    | VKPC 81204    |   |  |   |  |  | 1 |  |   |   |       |
|   | AEE, ALM                  | 02/93 → 10/02 |                    | VKPC 81210    |   |  |   |  |  | 1 |  |   |   |       |
|   | AEH, AKL, APF, AUR        | 06/99 → 10/02 |                    | VKPC 81408    |   |  |   |  |  | 1 |  |   |   |       |
|   | B(Alt) 1F, AFT            | 05/94 → 06/99 | <del>AC</del> , AC | VKMV 6PK894   |   |  | 1 |  |  |   |  |   |   |       |
|   | B(Alt) 1F, AFT            | 05/94 → 06/99 | AC, AC             | VKMV 6PK1153  |   |  | 1 |  |  |   |  |   |   |       |
|   |                           |               |                    | VKM 31004     | 1 |  |   |  |  |   |  |   |   |       |
|   |                           |               |                    | VKM 31210     | 1 |  |   |  |  |   |  |   |   |       |
|   | B(Alt) ABU                | 02/93 → 06/99 | AC, <del>AC</del>  | VKMV 6PK737   |   |  | 1 |  |  |   |  |   |   |       |
|   | B(Alt) ABU                | 02/93 → 06/99 | AC, <del>AC</del>  | VKMV 6PK1100  |   |  | 1 |  |  |   |  |   |   |       |
|   |                           |               |                    | VKM 31023     | 1 |  |   |  |  |   |  |   |   |       |
|   | B(Alt) AEH, AKL, APF, AUR | 06/99 → 10/02 | AC                 | VKMA 31203    | 1 |  | 1 |  |  |   |  |   |   |       |
|   |                           |               |                    | VKMV 6PK1120  |   |  | 1 |  |  |   |  |   |   |       |
|   |                           |               |                    | VKM 31011     | 1 |  |   |  |  |   |  |   |   |       |
|   | B(Alt) AEH, AKL, APF, AUR | 06/99 → 10/02 | AC                 | VKMA 31204    | 1 |  | 1 |  |  |   |  |   |   |       |
|   |                           |               |                    | VKMV 6DK1195  |   |  | 1 |  |  |   |  |   |   |       |
|   |                           |               |                    | VKM 31011     | 1 |  |   |  |  |   |  |   |   |       |
|   | B(Alt) ALM                | 06/99 → 10/02 | AC, <del>AC</del>  | VKMA 31202    | 1 |  | 1 |  |  |   |  |   |   |       |
|   |                           |               |                    | VKMV 6PK1068  |   |  | 1 |  |  |   |  |   |   |       |
|   |                           |               |                    | VKM 31015     | 1 |  |   |  |  |   |  |   |   |       |
|   | B(Alt) ALM                | 06/99 → 10/02 | AC, <del>AC</del>  | VKMV 6PK1185  |   |  | 1 |  |  |   |  |   |   |       |
|   |                           |               |                    | VKM 31023     | 1 |  |   |  |  |   |  |   |   |       |
|   | B(PS) 1F, AFT             | 05/94 → 06/99 | AC                 | VKMV 11.5x685 |   |  | 1 |  |  |   |  |   |   |       |
|   | B(PS) 1F, AFT             | 05/94 → 06/99 | AC                 | VKMV 11.5x755 |   |  | 1 |  |  |   |  |   |   |       |
| <b>SEAT  CORDOBA (6K2) / CORDOBA (6K2/C2) 1.8</b>     |                           |               |                    |               |   |  |   |  |  |   |  |   |   |       |
|   | ABS, ADZ                  | 02/93 → 06/99 | 3)                 | VKMS 01000    | 1 |  | 1 |  |  |   |  | 3 | 4 |       |
|   |                           |               |                    | VKMA 01000    | 1 |  | 1 |  |  |   |  |   | 3 | T0005 |
|   |                           |               |                    | VKM 11000     | 1 |  |   |  |  |   |  |   |   |       |
|   | ABS, ADZ                  | 02/93 → 06/99 | 2)                 | VKPA 81401    |   |  |   |  |  | 1 |  |   |   |       |
|   |                           |               |                    | VKPC 81401    |   |  |   |  |  | 1 |  |   |   |       |
|   | B(Alt) ABS, ADZ           | 02/93 → 06/99 | <del>AC</del> , AC | VKMV 6PK894   |   |  | 1 |  |  |   |  |   |   |       |
|   | B(Alt) ABS, ADZ           | 02/93 → 06/99 | AC, AC             | VKMV 6PK1153  |   |  | 1 |  |  |   |  |   |   |       |
|   |                           |               |                    | VKM 31004     | 1 |  |   |  |  |   |  |   |   |       |
|   |                           |               |                    | VKM 31210     | 1 |  |   |  |  |   |  |   |   |       |
|   | B(PS) ABS, ADZ            | 02/93 → 06/99 | AC                 | VKMV 11.5x685 |   |  | 1 |  |  |   |  |   |   |       |
|   | B(PS) ABS, ADZ            | 02/93 → 06/99 | AC                 | VKMV 11.5x755 |   |  | 1 |  |  |   |  |   |   |       |
| <b>SEAT  CORDOBA (6K2) / CORDOBA (6K2/C2) 1.8 16V</b> |                           |               |                    |               |   |  |   |  |  |   |  |   |   |       |
|   | ADL                       | 10/93 → 08/96 |                    | VKMA 01023    | 1 |  | 1 |  |  |   |  |   |   | T0057 |
|   |                           |               |                    | VKM 11021     | 1 |  |   |  |  |   |  |   |   |       |
|   | ADL                       | 10/93 → 08/96 | 2)                 | VKPA 81401    |   |  |   |  |  | 1 |  |   |   |       |
|   |                           |               |                    | VKPC 81401    |   |  |   |  |  | 1 |  |   |   |       |
|   | B(Alt) ADL                | 10/93 → 08/96 | <del>AC</del>      | VKMV 6PK894   |   |  | 1 |  |  |   |  |   |   |       |
|   | B(Alt) ADL                | 10/93 → 08/96 | AC, AC             | VKMV 6PK1033  |   |  | 1 |  |  |   |  |   |   |       |
|   |                           |               |                    | VKM 31004     | 1 |  |   |  |  |   |  |   |   |       |
|   |                           |               |                    | VKM 31210     | 1 |  |   |  |  |   |  |   |   |       |
|   | B(Alt) ADL                | 10/93 → 08/96 | AC, AC             | VKMV 6PK1153  |   |  | 1 |  |  |   |  |   |   |       |
|   |                           |               |                    | VKM 31004     | 1 |  |   |  |  |   |  |   |   |       |
|   |                           |               |                    | VKM 31210     | 1 |  |   |  |  |   |  |   |   |       |
|   | B(PS) ADL                 | 10/93 → 08/96 | AC                 | VKMV 11.5x685 |   |  | 1 |  |  |   |  |   |   |       |
|   | B(PS) ADL                 | 10/93 → 08/96 | AC                 | VKMV 11.5x755 |   |  | 1 |  |  |   |  |   |   |       |

| <b>SEAT  CORDOBA (6K2) / CORDOBA (6K2/C2) 1.8 Turbo</b> |                        |               |                 |               |   |   |   |  |   |   |  |  |         |
|---|------------------------|---------------|-----------------|---------------|---|---|---|--|---|---|--|--|---------|
|   | AQX, AYP               | 07/00 → 10/02 |                 | VKMA 01116    | 1 | 1 | 1 |  |   |   |  |  | T0151   |
|   |                        |               |                 | VKM 11116     | 1 |   |   |  |   |   |  |  |         |
|   |                        |               |                 | VKM 21115     |   | 1 |   |  |   |   |  |  |         |
|   | AQX, AYP               | 07/00 → 10/02 |                 | VKPC 81620    |   |   |   |  | 1 |   |  |  |         |
|   | <b>B(Alt)</b> AQX, AYP | 07/00 → 10/02 |                 | VKMA 31203    | 1 |   | 1 |  |   |   |  |  |         |
|   |                        |               |                 | VKMV 6PK1120  |   |   | 1 |  |   |   |  |  |         |
|   |                        |               |                 | VKM 31011     | 1 |   |   |  |   |   |  |  |         |
|   | <b>B(Alt)</b> AQX, AYP | 07/00 → 10/02 | <b>AC</b>       | VKMA 31204    | 1 |   | 1 |  |   |   |  |  |         |
|   |                        |               |                 | VKMV 6DK1195  |   |   | 1 |  |   |   |  |  |         |
|   |                        |               |                 | VKM 31011     | 1 |   |   |  |   |   |  |  |         |
| <b>SEAT  CORDOBA (6K2) / CORDOBA (6K2/C2) 2.0</b>       |                        |               |                 |               |   |   |   |  |   |   |  |  |         |
|   | 2E, AGG                | 02/93 → 06/99 |                 | VKMA 01002    | 1 |   | 1 |  |   |   |  |  | 3 T0091 |
|   |                        |               |                 | VKM 11000     | 1 |   |   |  |   |   |  |  |         |
|   | 2E, AGG                | 02/93 → 06/99 | 2)              | VKPA 81401    |   |   |   |  | 1 |   |  |  |         |
|   |                        |               |                 | VKPC 81401    |   |   |   |  | 1 |   |  |  |         |
|   | <b>B(Alt)</b> 2E, AGG  | 02/93 → 06/99 |                 | VKMV 6PK894   |   |   | 1 |  |   |   |  |  |         |
|   | <b>B(Alt)</b> 2E, AGG  | 02/93 → 06/99 | <b>A ⊙, AC</b>  | VKMV 6PK1153  |   |   | 1 |  |   |   |  |  |         |
|   |                        |               |                 | VKM 31004     | 1 |   |   |  |   |   |  |  |         |
|   |                        |               |                 | VKM 31210     | 1 |   |   |  |   |   |  |  |         |
|   | <b>B(PS)</b> 2E, AGG   | 02/93 → 06/99 |                 | VKMV 11.5x685 |   |   | 1 |  |   |   |  |  |         |
|   | <b>B(PS)</b> 2E, AGG   | 02/93 → 06/99 | <b>AC</b>       | VKMV 11.5x755 |   |   | 1 |  |   |   |  |  |         |
| <b>SEAT  CORDOBA (6K2) / CORDOBA (6K2/C2) 2.0 16V</b>   |                        |               |                 |               |   |   |   |  |   |   |  |  |         |
|   | ABF                    | 08/96 → 06/99 |                 | VKMA 01024    | 1 |   | 1 |  |   |   |  |  | T0114   |
|   |                        |               |                 | VKM 11021     | 1 |   |   |  |   |   |  |  |         |
|   | ABF                    | 08/96 → 06/99 | 2)              | VKPA 81401    |   |   |   |  | 1 |   |  |  |         |
|   |                        |               |                 | VKPC 81401    |   |   |   |  | 1 |   |  |  |         |
|   | <b>B(Alt)</b> ABF      | 08/96 → 06/99 |                 | VKMV 6PK894   |   |   | 1 |  |   |   |  |  |         |
|   | <b>B(Alt)</b> ABF      | 08/96 → 06/99 | <b>A ⊙, AC</b>  | VKMV 6PK1033  |   |   | 1 |  |   |   |  |  |         |
|   |                        |               |                 | VKM 31004     | 1 |   |   |  |   |   |  |  |         |
|   |                        |               |                 | VKM 31210     | 1 |   |   |  |   |   |  |  |         |
|   | <b>B(Alt)</b> ABF      | 08/96 → 06/99 | <b>A ⊙, AC</b>  | VKMV 6PK1153  |   |   | 1 |  |   |   |  |  |         |
|   |                        |               |                 | VKM 31004     | 1 |   |   |  |   |   |  |  |         |
|   |                        |               |                 | VKM 31210     | 1 |   |   |  |   |   |  |  |         |
|   | <b>B(PS)</b> ABF       | 08/96 → 06/99 |                 | VKMV 11.5x685 |   |   | 1 |  |   |   |  |  |         |
|   | <b>B(PS)</b> ABF       | 08/96 → 06/99 | <b>AC</b>       | VKMV 11.5x755 |   |   | 1 |  |   |   |  |  |         |
| <b>SEAT  CORDOBA (6K2) / CORDOBA (6K2/C2) 1.9 D</b>     |                        |               |                 |               |   |   |   |  |   |   |  |  |         |
|   | 1Y                     | 02/93 → 08/96 | → Mot. 378 364  | VKMA 01011    | 1 |   | 1 |  |   |   |  |  | 4 T0069 |
|   |                        |               |                 | VKM 11010     | 1 |   |   |  |   |   |  |  |         |
|   | 1Y                     | 02/93 → 08/96 | Mot. 378 365  → | VKMA 01013    | 1 |   | 1 |  |   |   |  |  | 4 T0069 |
|   |                        |               |                 | VKM 11014     | 1 |   |   |  |   |   |  |  |         |
|   | 1Y                     | 02/93 → 08/96 | 2)              | VKPA 81401    |   |   |   |  | 1 |   |  |  |         |
|   |                        |               |                 | VKPC 81401    |   |   |   |  | 1 |   |  |  |         |
|   | <b>B(Alt), B(PS)1Y</b> | 02/93 → 08/96 | <b>A ⊙, AC</b>  | VKMA 31028    | 2 |   | 2 |  |   |   |  |  |         |
|   |                        |               |                 | VKMV 10AVx730 |   |   | 1 |  |   |   |  |  |         |
|   |                        |               |                 | VKMV 6PK1045  |   |   | 1 |  |   |   |  |  |         |
|   |                        |               |                 | VKM 31004     | 1 |   |   |  |   |   |  |  |         |
|   |                        |               |                 | VKM 31030     | 1 |   |   |  |   |   |  |  |         |
|   | <b>B(Alt), B(PS)1Y</b> | 02/93 → 08/96 | <b>A ⊙, AC</b>  | VKMA 31030    | 2 |   | 2 |  |   |   |  |  |         |
|   |                        |               |                 | VKMV 11.5x790 |   |   | 1 |  |   |   |  |  |         |
|   |                        |               |                 | VKMV 6PK1145  |   |   | 1 |  |   |   |  |  |         |
|   |                        |               |                 | VKM 31004     | 1 |   |   |  |   |   |  |  |         |
|   |                        |               |                 | VKM 31030     | 1 |   |   |  |   |   |  |  |         |
|   | 1Y                     | 02/93 → 08/96 |                 | VKM_____      |   |   |   |  |   | 1 |  |  |         |
| <b>SEAT  CORDOBA (6K2) / CORDOBA (6K2/C2) 1.9 SDI</b>   |                        |               |                 |               |   |   |   |  |   |   |  |  |         |
|   | AEY                    | 08/96 → 06/99 |                 | VKMA 01019    | 1 | 1 | 1 |  |   |   |  |  | 5 T0650 |
|   |                        |               |                 | VKM 11014     | 1 |   |   |  |   |   |  |  |         |
|   |                        |               |                 | VKM 21012     |   |   | 1 |  |   |   |  |  |         |
|   | AGP                    | 06/99 → 10/02 | → Mot. 229 902  | VKMA 01130    | 1 | 2 | 1 |  |   |   |  |  | 5 T0173 |
|   |                        |               |                 | VKM 11130     | 1 |   |   |  |   |   |  |  |         |
|   |                        |               |                 | VKM 21004     |   |   | 1 |  |   |   |  |  |         |
|   |                        |               |                 | VKM 21130     |   |   | 1 |  |   |   |  |  |         |





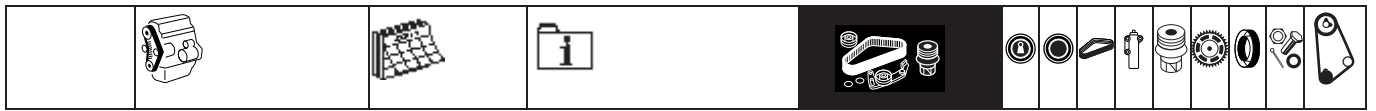

|   |  |  |  |  |  |  |  |  |  |  |  |  |  |
|---|---|---|---|--|---|---|---|---|---|---|---|---|---|
|   | AGP   | 06/99 → 10/02   | Mot. 229 903 I→,<br>→ I Mot. 595 000  | VKMA 01131<br>VKM 11130<br>VKM 21004<br>VKM 21130<br>VKM 21131                     | 1<br>1  | 3<br>1  | 1<br>1  |   |   |   |   |   | 8<br>T0173  |
|   | AGP   | 06/99 → 10/02   | Mot. 595 001 I→   | VKMA 01251<br>VKM 11130<br>VKM 21004<br>VKM 21130<br>VKM 21131                     | 1<br>1  | 3<br>1  | 1<br>1  |   |   |   |   |   | 8<br>T0173  |
|   | AQM   | 06/99 → 10/02   | → I Mot. 004 131  | VKMA 01130<br>VKM 11130<br>VKM 21004<br>VKM 21130                                  | 1<br>1  | 2<br>1  | 1<br>1  |   |   |   |   |   | 5<br>T0173  |
|   | AQM   | 06/99 → 10/02   | Mot. 004 132 I→,<br>→ I Mot. 045 000  | VKMA 01131<br>VKM 11130<br>VKM 21004<br>VKM 21130<br>VKM 21131                     | 1<br>1  | 3<br>1  | 1<br>1  |   |   |   |   |   | 8<br>T0173  |
|   | AQM   | 06/99 → 10/02   | Mot. 045 001 I→   | VKMA 01251<br>VKM 11130<br>VKM 21004<br>VKM 21130<br>VKM 21131                     | 1<br>1  | 3<br>1  | 1<br>1  |   |   |   |   |   | 8<br>T0173  |
|   | AEY   | 08/96 → 06/99   | 2)  | VKPA 81401<br>VKPC 81401   |   |   |   |   | 1<br>1  |   |   |   |   |
|   | AGP, AQM  | 06/99 → 10/02   |   | VKPC 81623   |   |   |   |   | 1   |   |   |   |   |
|   | B(Alt) AGP, AQM   | 06/99 → 10/02   | AC  | VKMV 6PK906<br>VKM 31018   | 1   |   | 1   |   |   |   |   |   | 1   |
|   | B(Alt) AGP, AQM   | 06/99 → 10/02   | AC  | VKMA 31005<br>VKMV 6PK1660<br>VKM 31002<br>VKM 31018                               | 1<br>1  | 1<br>1  | 1<br>1  |   |   |   |   |   | 2<br>1<br>1   |
|   | B(Alt), B(PS)AEY  | 08/96 → 06/99   | A ⊙, AC   | VKMA 31028<br>VKMV 10AVx730<br>VKMV 6PK1045<br>VKM 31004<br>VKM 31030              | 2<br>1<br>1   |   | 2<br>1  |   |   |   |   |   |   |
|   | B(Alt), B(PS)AEY  | 08/96 → 06/99   | A ⊙, AC   | VKMA 31030<br>VKMV 11.5x790<br>VKMV 6PK1145<br>VKM 31004<br>VKM 31030              | 2<br>1<br>1   |   | 2<br>1  |   |   |   |   |   |   |
|   | AEY   | 08/96 → 06/99   |   | VKM _____  |   |   |   |   | 1   |   |   |   |   |
|   | AGP, AQM  | 06/99 → 10/02   |   | VKM _____  |   |   |   |   | 1   |   |   |   |   |
| <b>SEAT  CORDOBA (6K2) / CORDOBA (6K2/C2) 1.9 TD</b> |   |   |   |  |   |   |   |   |   |   |   |   |   |
|   | AAZ   | 02/93 → 08/96   | → I Mot. 552 765  | VKMA 01011<br>VKM 11010  | 1<br>1  |   | 1   |   |   |   |   |   | 4<br>T0069  |
|   | AAZ   | 02/93 → 08/96   | Mot. 552 766 I→   | VKMA 01013<br>VKM 11014  | 1<br>1  |   | 1   |   |   |   |   |   | 4<br>T0069  |
|   | AAZ   | 02/93 → 08/96   | 2)  | VKPA 81401<br>VKPC 81401   |   |   |   |   | 1<br>1  |   |   |   |   |
|   | B(Alt), B(PS)AAZ  | 02/93 → 08/96   | A ⊙, AC   | VKMA 31028<br>VKMV 10AVx730<br>VKMV 6PK1045<br>VKM 31004<br>VKM 31030              | 2<br>1<br>1   |   | 2<br>1  |   |   |   |   |   |   |
|   | B(Alt), B(PS)AAZ  | 02/93 → 08/96   | A ⊙, AC   | VKMA 31030<br>VKMV 11.5x790<br>VKMV 6PK1145<br>VKM 31004<br>VKM 31030              | 2<br>1<br>1   |   | 2<br>1  |   |   |   |   |   |   |
|   | AAZ   | 02/93 → 08/96   |   | VKM _____  |   |   |   |   | 1   |   |   |   |   |









**SEAT**  **CORDOBA (6K2) / CORDOBA (6K2/C2) 1.9 TDI**

|   |                                   |               |                  |               |   |   |   |  |  |  |   |  |   |       |
|---|-----------------------------------|---------------|------------------|---------------|---|---|---|--|--|--|---|--|---|-------|
|    | 1Z, AFN, AHU                      | 08/96 → 06/99 |                  | VKMA 01014    | 1 | 1 | 1 |  |  |  |   |  | 5 | T0650 |
|   |                                   |               |                  | VKM 11014     | 1 |   |   |  |  |  |   |  |   |       |
|   |                                   |               |                  | VKM 21012     |   |   | 1 |  |  |  |   |  |   |       |
|   | AGR                               | 06/99 → 10/02 | →   Mot. 565 000 | VKMA 01131    | 1 | 3 | 1 |  |  |  |   |  | 8 | T0173 |
|   |                                   |               |                  | VKM 11130     | 1 |   |   |  |  |  |   |  |   |       |
|   |                                   |               |                  | VKM 21004     |   |   | 1 |  |  |  |   |  |   |       |
|   |                                   |               |                  | VKM 21130     |   |   | 1 |  |  |  |   |  |   |       |
|   |                                   |               |                  | VKM 21131     |   |   | 1 |  |  |  |   |  |   |       |
|   | AGR                               | 06/99 → 10/02 | Mot. 565 001   → | VKMA 01251    | 1 | 3 | 1 |  |  |  |   |  | 8 | T0173 |
|   |                                   |               |                  | VKM 11130     | 1 |   |   |  |  |  |   |  |   |       |
|   |                                   |               |                  | VKM 21004     |   |   | 1 |  |  |  |   |  |   |       |
|   |                                   |               |                  | VKM 21130     |   |   | 1 |  |  |  |   |  |   |       |
|   |                                   |               |                  | VKM 21131     |   |   | 1 |  |  |  |   |  |   |       |
|   | ALH                               | 06/99 → 10/02 | →   Mot. 500 000 | VKMA 01131    | 1 | 3 | 1 |  |  |  |   |  | 8 | T0173 |
|   |                                   |               |                  | VKM 11130     | 1 |   |   |  |  |  |   |  |   |       |
|   |                                   |               |                  | VKM 21004     |   |   | 1 |  |  |  |   |  |   |       |
|   |                                   |               |                  | VKM 21130     |   |   | 1 |  |  |  |   |  |   |       |
|   |                                   |               |                  | VKM 21131     |   |   | 1 |  |  |  |   |  |   |       |
|   | ALH                               | 06/99 → 10/02 | Mot. 500 001   → | VKMA 01251    | 1 | 3 | 1 |  |  |  |   |  | 8 | T0173 |
|   |                                   |               |                  | VKM 11130     | 1 |   |   |  |  |  |   |  |   |       |
|   |                                   |               |                  | VKM 21004     |   |   | 1 |  |  |  |   |  |   |       |
|   |                                   |               |                  | VKM 21130     |   |   | 1 |  |  |  |   |  |   |       |
|   |                                   |               |                  | VKM 21131     |   |   | 1 |  |  |  |   |  |   |       |
|   | ASV                               | 06/99 → 10/02 | →   Mot. 150 000 | VKMA 01131    | 1 | 3 | 1 |  |  |  |   |  | 8 | T0173 |
|   |                                   |               |                  | VKM 11130     | 1 |   |   |  |  |  |   |  |   |       |
|   |                                   |               |                  | VKM 21004     |   |   | 1 |  |  |  |   |  |   |       |
|   |                                   |               |                  | VKM 21130     |   |   | 1 |  |  |  |   |  |   |       |
|   |                                   |               |                  | VKM 21131     |   |   | 1 |  |  |  |   |  |   |       |
|   | ASV                               | 06/99 → 10/02 | Mot. 150 001   → | VKMA 01251    | 1 | 3 | 1 |  |  |  |   |  | 8 | T0173 |
|   |                                   |               |                  | VKM 11130     | 1 |   |   |  |  |  |   |  |   |       |
|   |                                   |               |                  | VKM 21004     |   |   | 1 |  |  |  |   |  |   |       |
|   |                                   |               |                  | VKM 21130     |   |   | 1 |  |  |  |   |  |   |       |
|   |                                   |               |                  | VKM 21131     |   |   | 1 |  |  |  |   |  |   |       |
|  | 1Z, AFN, AHU                      | 08/96 → 06/99 | 2)               | VKPA 81401    |   |   |   |  |  |  | 1 |  |   |       |
|   |                                   |               |                  | VKPC 81401    |   |   |   |  |  |  | 1 |  |   |       |
|   | AGR, ALH, ASV                     | 06/99 → 10/02 |                  | VKPC 81623    |   |   |   |  |  |  | 1 |  |   |       |
|  | <b>B(Alt)</b> AGR, ALH, ASV       | 06/99 → 10/02 | <b>AC</b>        | VKMV 6PK906   |   |   | 1 |  |  |  |   |  |   |       |
|   |                                   |               |                  | VKM 31012     | 1 |   |   |  |  |  |   |  |   |       |
|   | <b>B(Alt)</b> AGR, ALH, ASV       | 06/99 → 10/02 | <b>AC</b>        | VKMA 31014    | 1 | 1 | 1 |  |  |  |   |  | 1 |       |
|   |                                   |               |                  | VKMV 6PK1660  |   |   | 1 |  |  |  |   |  |   |       |
|   |                                   |               |                  | VKM 31002     |   |   |   |  |  |  |   |  | 1 |       |
|   |                                   |               |                  | VKM 31012     | 1 |   |   |  |  |  |   |  |   |       |
|   | <b>B(Alt), B(PS)</b> 1Z, AFN, AHU | 08/96 → 06/99 | <b>A ⊙, AC</b>   | VKMA 31028    | 2 |   | 2 |  |  |  |   |  |   |       |
|   |                                   |               |                  | VKMV 10AVx730 |   |   | 1 |  |  |  |   |  |   |       |
|   |                                   |               |                  | VKMV 6PK1045  |   |   | 1 |  |  |  |   |  |   |       |
|   |                                   |               |                  | VKM 31004     | 1 |   |   |  |  |  |   |  |   |       |
|   |                                   |               |                  | VKM 31030     | 1 |   |   |  |  |  |   |  |   |       |
|   | <b>B(Alt), B(PS)</b> 1Z, AFN, AHU | 08/96 → 06/99 | <b>A ⊙, AC</b>   | VKMA 31030    | 2 |   | 2 |  |  |  |   |  |   |       |
|   |                                   |               |                  | VKMV 11.5x790 |   |   | 1 |  |  |  |   |  |   |       |
|   |                                   |               |                  | VKMV 6PK1145  |   |   | 1 |  |  |  |   |  |   |       |
|   |                                   |               |                  | VKM 31004     | 1 |   |   |  |  |  |   |  |   |       |
|   |                                   |               |                  | VKM 31030     | 1 |   |   |  |  |  |   |  |   |       |
|  | 1Z, AFN, AHU                      | 08/96 → 06/99 |                  | VKM_____      |   |   |   |  |  |  | 1 |  |   |       |
|   | AGR, ALH, ASV                     | 06/99 → 10/02 |                  | VKM_____      |   |   |   |  |  |  | 1 |  |   |       |

**SEAT**  **CORDOBA (6L2) 1.2**

|   |                        |               |                                |                |  |   |   |  |  |  |   |  |  |  |
|---|------------------------|---------------|--------------------------------|----------------|--|---|---|--|--|--|---|--|--|--|
|  | AZQ, BME               | 10/02 → 11/07 |                                | <b>OXOXOXO</b> |  |   |   |  |  |  |   |  |  |  |
|  | AZQ, BME               | 10/02 → 11/07 |                                | VKPC 81301     |  |   |   |  |  |  | 1 |  |  |  |
|  | <b>B(Alt)</b> AZQ, BME | 10/02 → 11/07 | <b>AC</b>                      | VKMV 6PK1453   |  |   | 1 |  |  |  |   |  |  |  |
|   | <b>B(Alt)</b> AZQ, BME | 10/02 → 11/07 | <b>AC, → ICH 6L-3-207 000</b>  | VKMV 6PK1880   |  |   | 1 |  |  |  |   |  |  |  |
|   |                        |               |                                | VKM_____       |  | 1 |   |  |  |  |   |  |  |  |
|   | <b>B(Alt)</b> AZQ, BME | 10/02 → 11/07 | <b>AC, CH 6L-3-207 001   →</b> | VKMV 6PK1873   |  |   | 1 |  |  |  |   |  |  |  |
|   |                        |               |                                | VKM_____       |  | 1 |   |  |  |  |   |  |  |  |

**SEAT**  **CORDOBA (6L2) 1.2 12V**





















|   |     |               |  |                |  |  |  |  |  |  |   |  |  |  |
|---|-----|---------------|--|----------------|--|--|--|--|--|--|---|--|--|--|
|  | BXV | 05/06 → 11/07 |  | <b>OXOXOXO</b> |  |  |  |  |  |  |   |  |  |  |
|  | BXV | 05/06 → 11/07 |  | VKPC 81301     |  |  |  |  |  |  | 1 |  |  |  |











































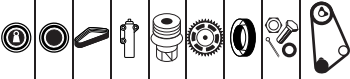

































|  | <b>B(Alt)</b> BXV                | 05/06 → 11/07 | VKMV 6PK1453   |              |   | 1 |   |   |  |   |  |  |  |  |  |  |  |       |       |
|--|----------------------------------|---------------|----------------|--------------|---|---|---|---|--|---|--|--|--|--|--|--|--|-------|-------|
| <b>SEAT</b> <b>CORDOBA (6L2) 1.4 16V</b> |                                  |               |                |              |   |   |   |   |  |   |  |  |  |  |  |  |  |       |       |
|  | BBY                              | 09/02 → 11/07 | VKMA 01121     | 2            | 2 | 2 |   |   |  |   |  |  |  |  |  |  |  | T0165 |       |
|  |                                  |               | VKM 11120      | 1            |   |   |   |   |  |   |  |  |  |  |  |  |  |       |       |
|  |                                  |               | VKM 11124      | 1            |   |   |   |   |  |   |  |  |  |  |  |  |  |       |       |
|  |                                  |               | VKM 21120      |              | 1 |   |   |   |  |   |  |  |  |  |  |  |  |       |       |
|  |                                  |               | VKM 21121      |              | 1 |   |   |   |  |   |  |  |  |  |  |  |  |       |       |
|  | BBZ, BKY                         | 10/02 → 12/05 | VKMA 01121     | 2            | 2 | 2 |   |   |  |   |  |  |  |  |  |  |  | T0165 |       |
|  |                                  |               | VKM 11120      | 1            |   |   |   |   |  |   |  |  |  |  |  |  |  |       |       |
|  |                                  |               | VKM 11124      | 1            |   |   |   |   |  |   |  |  |  |  |  |  |  |       |       |
|  |                                  |               | VKM 21120      |              | 1 |   |   |   |  |   |  |  |  |  |  |  |  |       |       |
|  |                                  |               | VKM 21121      |              | 1 |   |   |   |  |   |  |  |  |  |  |  |  |       |       |
|  | BBZ, BKY, BXW                    | 01/06 → 11/07 | —              | 2            | 2 | 2 |   |   |  |   |  |  |  |  |  |  |  | T0165 |       |
|  |                                  |               | VKM 11124      | 1            |   |   |   |   |  |   |  |  |  |  |  |  |  |       |       |
|  |                                  |               | VKM 11124      | 1            |   |   |   |   |  |   |  |  |  |  |  |  |  |       |       |
|  |                                  |               | VKM 21120      |              | 1 |   |   |   |  |   |  |  |  |  |  |  |  |       |       |
|  |                                  |               | VKM 21121      |              | 1 |   |   |   |  |   |  |  |  |  |  |  |  |       |       |
|  | BBY, BBZ, BKY, BXW               | 09/02 → 11/07 | VKPC 81407     |              |   |   |   |   |  | 1 |  |  |  |  |  |  |  |       |       |
|  | <b>B(Alt)</b> BBY, BBZ, BKY, BXW | 09/02 → 11/07 | <b>AC</b>      | VKMV 6PK736  |   |   |   | 1 |  |   |  |  |  |  |  |  |  |       |       |
|  | <b>B(Alt)</b> BBY, BBZ, BKY, BXW | 09/02 → 11/07 | <b>AC</b>      | VKMA 31216   | 1 |   | 1 |   |  |   |  |  |  |  |  |  |  |       |       |
|  |                                  |               |                | VKMV 6PK1076 |   |   | 1 |   |  |   |  |  |  |  |  |  |  |       |       |
|  |                                  |               |                | VKM 31015    | 1 |   |   |   |  |   |  |  |  |  |  |  |  |       |       |
| <b>SEAT</b> <b>CORDOBA (6L2) 1.6</b>     |                                  |               |                |              |   |   |   |   |  |   |  |  |  |  |  |  |  |       |       |
|  | BAH                              | 04/03 → 11/07 | VKMA 01107     | 1            |   | 1 |   |   |  |   |  |  |  |  |  |  |  | 2     | T0126 |
|  |                                  |               | VKM 11107      | 1            |   |   |   |   |  |   |  |  |  |  |  |  |  |       |       |
|  | BAH                              | 04/03 → 11/07 | VKPC 81210     |              |   |   |   |   |  | 1 |  |  |  |  |  |  |  |       |       |
|  | <b>B(Alt)</b> BAH                | 04/03 → 11/07 | <b>AC</b>      | VKMV 6PK751  |   |   | 1 |   |  |   |  |  |  |  |  |  |  |       |       |
|  | <b>B(Alt)</b> BAH                | 04/03 → 11/07 | <b>AC</b>      | VKMA 31216   | 1 |   | 1 |   |  |   |  |  |  |  |  |  |  |       |       |
|  |                                  |               |                | VKMV 6PK1076 |   |   | 1 |   |  |   |  |  |  |  |  |  |  |       |       |
|  |                                  |               |                | VKM 31015    | 1 |   |   |   |  |   |  |  |  |  |  |  |  |       |       |
| <b>SEAT</b> <b>CORDOBA (6L2) 1.6 16V</b> |                                  |               |                |              |   |   |   |   |  |   |  |  |  |  |  |  |  |       |       |
|  | BTS                              | 11/06 → 11/07 | <b>OXOXOXO</b> |              |   |   |   |   |  |   |  |  |  |  |  |  |  |       |       |
| <b>SEAT</b> <b>CORDOBA (6L2) 2.0</b>     |                                  |               |                |              |   |   |   |   |  |   |  |  |  |  |  |  |  |       |       |
|  | AZL, BBX                         | 09/02 → 11/07 | VKMA 01113     | 1            |   | 1 |   |   |  |   |  |  |  |  |  |  |  |       | T0149 |
|  |                                  |               | VKM 11113      | 1            |   |   |   |   |  |   |  |  |  |  |  |  |  |       |       |
|  | AZL, BBX                         | 09/02 → 11/07 | VKPC 81620     |              |   |   |   |   |  | 1 |  |  |  |  |  |  |  |       |       |
|  | <b>B(Alt)</b> AZL, BBX           | 09/02 → 11/07 | <b>AC</b>      | VKMV 6PK926  |   |   | 1 |   |  |   |  |  |  |  |  |  |  |       |       |
|  |                                  |               |                | VKM 31011    | 1 |   |   |   |  |   |  |  |  |  |  |  |  |       |       |
|  | <b>B(Alt)</b> AZL, BBX           | 09/02 → 11/07 | <b>AC</b>      | VKMV 6PK1032 |   |   | 1 |   |  |   |  |  |  |  |  |  |  |       |       |
|  |                                  |               |                | VKM 31011    | 1 |   |   |   |  |   |  |  |  |  |  |  |  |       |       |
| <b>SEAT</b> <b>CORDOBA (6L2) 1.4 TDI</b> |                                  |               |                |              |   |   |   |   |  |   |  |  |  |  |  |  |  |       |       |
|  | AMF, BMS, BNM, BNV               | 10/02 → 11/07 | VKMA 01250     | 1            | 1 | 1 |   |   |  |   |  |  |  |  |  |  |  |       | T0184 |
|  |                                  |               | VKM 11250      | 1            |   |   |   |   |  |   |  |  |  |  |  |  |  |       |       |
|  |                                  |               | VKM 21147      |              | 1 |   |   |   |  |   |  |  |  |  |  |  |  |       |       |
|  | AMF, BMS, BNM, BNV               | 10/02 → 11/07 | VKPC 81418     |              |   |   |   |   |  | 1 |  |  |  |  |  |  |  |       |       |
|  | <b>B(Alt)</b> AMF                | 10/02 → 11/07 | <b>AC</b>      | VKMV 6PK858  |   |   | 1 |   |  |   |  |  |  |  |  |  |  |       |       |
|  | <b>B(Alt)</b> AMF, BNM, BNV      | 10/02 → 11/07 | <b>AC</b>      | VKMV 6PK996  |   |   | 1 |   |  |   |  |  |  |  |  |  |  |       |       |
|  |                                  |               |                | VKM 31035    | 1 |   |   |   |  |   |  |  |  |  |  |  |  |       |       |
|  | <b>B(Alt)</b> BMS                | 06/05 → 11/07 | <b>AC</b>      | VKMV 6PK1180 |   |   | 1 |   |  |   |  |  |  |  |  |  |  |       |       |
|  |                                  |               |                | VKM 31058    | 1 |   |   |   |  |   |  |  |  |  |  |  |  |       |       |
| <b>SEAT</b> <b>CORDOBA (6L2) 1.9 SDI</b> |                                  |               |                |              |   |   |   |   |  |   |  |  |  |  |  |  |  |       |       |
|  | ASY                              | 09/02 → 11/07 | VKMA 01275     | 1            | 2 | 1 |   |   |  |   |  |  |  |  |  |  |  |       | T0173 |
|  |                                  |               | VKM 11130      | 1            |   |   |   |   |  |   |  |  |  |  |  |  |  |       |       |
|  |                                  |               | VKM 21004      |              | 1 |   |   |   |  |   |  |  |  |  |  |  |  |       |       |
|  |                                  |               | VKM 21130      |              | 1 |   |   |   |  |   |  |  |  |  |  |  |  |       |       |
|  | ASY                              | 09/02 → 11/07 | VKPC 81302     |              |   |   |   |   |  | 1 |  |  |  |  |  |  |  |       |       |
|  | <b>B(Alt)</b> ASY                | 09/02 → 11/07 | <b>AC</b>      | VKMV 6PK780  |   |   | 1 |   |  |   |  |  |  |  |  |  |  |       |       |
|  |                                  |               |                | VKM 31057    | 1 |   |   |   |  |   |  |  |  |  |  |  |  |       |       |
|  | <b>B(Alt)</b> ASY                | 09/02 → 11/07 | <b>AC</b>      | VKMV 6PK1095 |   |   | 1 |   |  |   |  |  |  |  |  |  |  |       |       |
|  |                                  |               |                | VKM 31058    | 1 |   |   |   |  |   |  |  |  |  |  |  |  |       |       |











































| <b>SEAT  CORDOBA (6L2) 1.9 TDI</b>       |               |                         |               |                  |  |                       |   |        |   |        |   |   |                 |
|--|---------------|-------------------------|---------------|------------------|--|-----------------------|---|--------|---|--------|---|---|-----------------|
|  |               | ASZ, ATD, AXR, BLT, BMT | 09/02 → 11/07 |                  | VKMA 01250<br>VKM 11250<br>VKM 21147                           | 1<br>1<br>1           | 1 |        |   |        |   |   | T0184           |
|  |               | ASZ, ATD, AXR, BLT, BMT | 09/02 → 11/07 |                  | VKPC 81418   |                       |   |        | 1 |        |   |   |                 |
|  | <b>B(Alt)</b> | ASZ, ATD, AXR, BLT      | 09/02 → 11/07 | <b>AC</b>        | VKMV 6PK780<br>VKM 31057                                       | 1                     |   | 1      |   |        |   |   |                 |
|  | <b>B(Alt)</b> | ASZ, ATD, AXR, BLT, BMT | 09/02 → 11/07 | <b>AC</b>        | VKMV 6PK1180<br>VKM 31058                                      | 1                     |   | 1      |   |        |   |   |                 |
|  |               | ASZ, ATD, AXR, BLT, BMT | 09/02 → 11/07 |                  | VKM_____   |                       |   |        |   | 1      |   |   |                 |
| <b>SEAT  CORDOBA Vario (6K5) 1.4</b>     |               |                         |               |                  |  |                       |   |        |   |        |   |   |                 |
|  |               | AKK                     | 06/99 → 03/06 | → IMot. 127 806  | VKMA 01106<br>VKM 11106  | 1<br>1                |   | 1      |   |        |   |   | T0126           |
|  |               | AKK                     | 06/99 → 03/06 | Mot. 127 807 I → | VKMC 01107<br>VKMA 01107<br>VKM 11107                          | 1<br>1<br>1           |   | 1      | 1 |        |   |   | 2<br>2<br>T0126 |
|  |               | ANW, AUD                | 06/99 → 03/06 |                  | VKMC 01107<br>VKMA 01107<br>VKM 11107                          | 1<br>1<br>1           |   | 1      | 1 |        |   |   | 2<br>2<br>T0126 |
|  |               | AEX, AKV, APQ           | 09/96 → 06/99 |                  | VKMA 01106<br>VKM 11106  | 1<br>1                |   | 1      |   |        |   |   | T0126           |
|  |               | AEX, AKV, APQ           | 09/96 → 06/07 |                  | VKPC 81210   |                       |   |        | 1 |        |   |   |                 |
|  |               | AKK                     | 06/99 → 05/05 |                  | VKPC 81215   |                       |   |        | 1 |        |   |   |                 |
|  | <b>B(Alt)</b> | AEX, AKK, ANW, APQ, AUD | 09/96 → 06/07 | <b>AC, ⊕</b>     | VKMA 31202<br>VKMV 6PK1068<br>VKM 31015                        | 1<br>1                |   | 1<br>1 |   |        |   |   |                 |
|  | <b>B(Alt)</b> | AEX, AKK, ANW, APQ, AUD | 09/96 → 06/07 | <b>AC, ⊕</b>     | VKMV 6PK1185<br>VKM 31023                                      | 1                     |   | 1      |   |        |   |   |                 |
| <b>SEAT  CORDOBA Vario (6K5) 1.4 16V</b> |               |                         |               |                  |  |                       |   |        |   |        |   |   |                 |
|  |               | APE, AQQ, AUA, AUB      | 06/99 → 03/06 |                  | VKMA 01121<br>VKM 11120<br>VKM 11124<br>VKM 21120<br>VKM 21121 | 2<br>1<br>1<br>1<br>1 | 2 | 2      |   |        |   |   | T0165           |
|  |               | APE, AQQ, AUA, AUB      | 06/99 → 06/07 |                  | VKPC 81407   |                       |   |        |   | 1      |   |   |                 |
|  | <b>B(Alt)</b> | APE, AQQ, AUA, AUB      | 06/99 → 06/07 | <b>AC, ⊕</b>     | VKMV 6PK751  |                       |   | 1      |   |        |   |   |                 |
|  | <b>B(Alt)</b> | APE, AQQ, AUA, AUB      | 06/99 → 06/07 | <b>AC, ⊕</b>     | VKMA 31202<br>VKMV 6PK1068<br>VKM 31015                        | 1<br>1                |   | 1<br>1 |   |        |   |   |                 |
|  | <b>B(Alt)</b> | APE, AQQ, AUA, AUB      | 06/99 → 06/07 | <b>AC, ⊕</b>     | VKMV 6PK1185<br>VKM 31023                                      | 1                     |   | 1      |   |        |   |   |                 |
| <b>SEAT  CORDOBA Vario (6K5) 1.6</b>     |               |                         |               |                  |  |                       |   |        |   |        |   |   |                 |
|  |               | 1F                      | 05/97 → 06/99 | 3)               | VKMS 01000<br>VKMA 01000<br>VKM 11000                          | 1<br>1<br>1           |   | 1      |   |        | 3 | 4 | T0005           |
|  |               | AEE, ALM                | 09/96 → 06/07 |                  | VKMA 01110<br>VKM 11106  | 1<br>1                |   | 1      |   |        |   |   | T0127           |
|  |               | AEH, AKL, APF, AUR      | 06/99 → 06/07 |                  | VKMA 01113<br>VKM 11113  | 1<br>1                |   | 1      |   |        |   |   | T0149           |
|  |               | AFT                     | 09/96 → 06/99 |                  | VKMA 01009<br>VKM 11000  | 1<br>1                |   | 1      |   |        |   | 3 | T0124           |
|  |               | 1F, AFT                 | 09/96 → 06/99 | 2)               | VKPA 81401<br>VKPC 81401                                       |                       |   |        |   | 1<br>1 |   |   |                 |
|  |               | AEE, ALM                | 09/96 → 06/07 |                  | VKPC 81210   |                       |   |        | 1 |        |   |   |                 |
|  |               | AEH, AKL, APF, AUR      | 06/99 → 05/05 |                  | VKPC 81408   |                       |   |        | 1 |        |   |   |                 |
|  | <b>B(Alt)</b> | 1F, AFT                 | 09/96 → 06/99 | <b>A ⊕, AC</b>   | VKMV 6PK894  |                       |   | 1      |   |        |   |   |                 |
|  | <b>B(Alt)</b> | 1F, AFT                 | 09/96 → 06/99 | <b>A ⊕, AC</b>   | VKMV 6PK1153<br>VKM 31004<br>VKM 31210                         | 1<br>1                |   | 1      |   |        |   |   |                 |































|   |  |  |  |  |  |  |  |  |  |  |  |  |  |
|---|---|---|---|--|---|---|---|---|---|---|---|---|---|
| <b>B(Alt)</b>   | AEH, AKL, APF, AUR  | 06/99 → 06/07   | <b>AC</b>   | VKMA 31203<br>VKMV 6PK1120<br>VKM 31011  | 1<br>1<br>1   | 1<br>1  |   |   |   |   |   |   |   |
| <b>B(Alt)</b>   | AEH, AKL, APF, AUR  | 06/99 → 06/07   | <b>AC</b>   | VKMA 31204<br>VKMV 6DK1195<br>VKM 31011  | 1<br>1<br>1   | 1<br>1  |   |   |   |   |   |   |   |
| <b>B(PS)</b>  | 1F, AFT   | 09/96 → 06/99   | <b>AC</b>   | VKMV 11.5x685  |   | 1   |   |   |   |   |   |   |   |
| <b>B(PS)</b>  | 1F, AFT   | 09/96 → 06/99   | <b>AC</b>   | VKMV 11.5x755  |   | 1   |   |   |   |   |   |   |   |
| <b>SEAT  CORDOBA Vario (6K5) 1.9 SDI</b>   |   |   |   |  |   |   |   |   |   |   |   |   |   |
|   | AEY   | 09/96 → 06/99   |   | VKMA 01019<br>VKM 11014<br>VKM 21012   | 1<br>1<br>1   | 1<br>1  | 1   |   |   |   |   | 5   | T0650   |
|   | AGP   | 06/99 → 06/07   | → <b>Mot.</b> 229 902   | VKMA 01130<br>VKM 11130<br>VKM 21004<br>VKM 21130                                  | 1<br>1<br>1<br>1  | 2<br>1  | 1   |   |   |   |   | 5   | T0173   |
|   | AGP   | 06/99 → 09/06   | <b>Mot.</b> 229 903   →,<br>→ <b>Mot.</b> 595 000                                 | VKMA 01131<br>VKM 11130<br>VKM 21004<br>VKM 21130<br>VKM 21131                     | 1<br>1<br>1<br>1<br>1   | 3<br>1<br>1<br>1  | 1   |   |   |   |   | 8   | T0173   |
|   | AGP   | 06/99 → 06/07   | <b>Mot.</b> 595 001   →   | VKMA 01251<br>VKM 11130<br>VKM 21004<br>VKM 21130<br>VKM 21131                     | 1<br>1<br>1<br>1<br>1   | 3<br>1<br>1<br>1  | 1   |   |   |   |   | 8   | T0173   |
|   | AQM   | 06/99 → 06/07   | → <b>Mot.</b> 004 131   | VKMA 01130<br>VKM 11130<br>VKM 21004<br>VKM 21130                                  | 1<br>1<br>1<br>1  | 2<br>1<br>1   | 1   |   |   |   |   | 5   | T0173   |
|   | AQM   | 06/99 → 09/06   | <b>Mot.</b> 004 132   →,<br>→ <b>Mot.</b> 045 000                                 | VKMA 01131<br>VKM 11130<br>VKM 21004<br>VKM 21130<br>VKM 21131                     | 1<br>1<br>1<br>1<br>1   | 3<br>1<br>1<br>1  | 1   |   |   |   |   | 8   | T0173   |
|   | AQM   | 06/99 → 06/07   | <b>Mot.</b> 045 001   →   | VKMA 01251<br>VKM 11130<br>VKM 21004<br>VKM 21130<br>VKM 21131                     | 1<br>1<br>1<br>1<br>1   | 3<br>1<br>1<br>1  | 1   |   |   |   |   | 8   | T0173   |
|   | AEY   | 09/96 → 06/99   | 2)  | VKPA 81401<br>VKPC 81401   |   |   |   | 1<br>1  |   |   |   |   |   |
|   | AGP, AQM  | 06/99 → 06/07   |   | VKPC 81623   |   |   |   | 1   |   |   |   |   |   |
|   | <b>B(Alt)</b>   | AGP, AQM  | 06/99 → 06/07   | <b>AC</b>  | VKMV 6PK906<br>VKM 31018  | 1   | 1   |   |   |   |   | 1   |   |
|   | <b>B(Alt)</b>   | AGP, AQM  | 06/99 → 06/07   | <b>AC</b>  | VKMA 31005<br>VKMV 6PK1660<br>VKM 31002<br>VKM 31018                                | 1<br>1<br>1<br>1  | 1<br>1  | 1   |   |   |   | 2<br>1<br>1   |   |
|   | <b>B(Alt), B(PS)</b>  | AEY   | 09/96 → 06/99   | <b>A</b> ⊙, <b>AC</b>  | VKMA 31028<br>VKMV 10AVx730<br>VKMV 6PK1045<br>VKM 31004<br>VKM 31030               | 2<br>1<br>1<br>1<br>1   | 2<br>1<br>1   |   |   |   |   |   |   |
|   | <b>B(Alt), B(PS)</b>  | AEY   | 09/96 → 06/99   | <b>A</b> ⊙, <b>AC</b>  | VKMA 31030<br>VKMV 11.5x790<br>VKMV 6PK1145<br>VKM 31004<br>VKM 31030               | 2<br>1<br>1<br>1<br>1   | 2<br>1<br>1   |   |   |   |   |   |   |
|   | AGP, AQM  | 06/99 → 09/06   |   | VKM _____  |   |   |   |   | 1   |   |   |   |   |
| <b>SEAT  CORDOBA Vario (6K5) 1.9 TDI</b> |   |   |   |  |   |   |   |   |   |   |   |   |   |
|   | 1Z, AFN, AHU  | 08/96 → 06/99   |   | VKMA 01014<br>VKM 11014<br>VKM 21012   | 1<br>1<br>1   | 1<br>1  | 1   |   |   |   |   | 5   | T0650   |

|  |  |  |  |  |  |  |  |  |  |  |  |  |  |
|--|---|---|---|--|---|---|---|---|---|---|---|---|---|
|  | AGR   | 06/99 → 09/06   | →   Mot. 565 000  | VKMA 01131<br>VKM 11130<br>VKM 21004<br>VKM 21130<br>VKM 21131                     | 1<br>1  | 3   | 1   |   |   |   |   |   | 8 T0173   |
|  | AGR   | 06/99 → 03/06   | Mot. 565 001   →  | VKMA 01251<br>VKM 11130<br>VKM 21004<br>VKM 21130<br>VKM 21131                     | 1<br>1  | 3   | 1   |   |   |   |   |   | 8 T0173   |
|  | ALH   | 06/99 → 09/06   | →   Mot. 500 000  | VKMA 01131<br>VKM 11130<br>VKM 21004<br>VKM 21130<br>VKM 21131                     | 1<br>1  | 3   | 1   |   |   |   |   |   | 8 T0173   |
|  | ALH   | 06/99 → 09/06   | Mot. 500 001   →  | VKMA 01251<br>VKM 11130<br>VKM 21004<br>VKM 21130<br>VKM 21131                     | 1<br>1  | 3   | 1   |   |   |   |   |   | 8 T0173   |
|  | ASV   | 06/99 → 09/06   | →   Mot. 150 000  | VKMA 01131<br>VKM 11130<br>VKM 21004<br>VKM 21130<br>VKM 21131                     | 1<br>1  | 3   | 1   |   |   |   |   |   | 8 T0173   |
|  | ASV   | 06/99 → 06/07   | Mot. 150 001   →  | VKMA 01251<br>VKM 11130<br>VKM 21004<br>VKM 21130<br>VKM 21131                     | 1<br>1  | 3   | 1   |   |   |   |   |   | 8 T0173   |
|                                 | 1Z, AFN, AHU, ASV   | 08/96 → 05/05   | 2)  | VKPA 81401<br>VKPC 81401   |   |   |   |   |   | 1<br>1  |   |   |   |
|  | AGR, ALH  | 06/99 → 06/07   |   | VKPC 81623   |   |   |   |   |   | 1   |   |   |   |
|                                 | <b>B(Alt)</b> AGR, ALH, ASV   | 06/99 → 06/07   | <b>AC</b>   | VKMA 6PK906<br>VKM 31012   | 1   |   | 1   |   |   |   |   |   |   |
|  | <b>B(Alt)</b> AGR, ALH, ASV   | 06/99 → 06/07   | <b>AC</b>   | VKMA 31014<br>VKMV 6PK1660<br>VKM 31002<br>VKM 31012                               | 1<br>1<br>1   | 1   | 1   |   |   |   |   | 1   |   |
|  | <b>B(Alt), B(PS)</b> 1Z, AFN, AHU   | 08/96 → 06/99   | <b>A ⊙, AC</b>  | VKMA 31028<br>VKMV 10AVx730<br>VKMV 6PK1045<br>VKM 31004<br>VKM 31030              | 2<br>1<br>1   | 2   | 1<br>1  |   |   |   |   |   |   |
|  | <b>B(Alt), B(PS)</b> 1Z, AFN, AHU   | 08/96 → 06/99   | <b>A ⊙, AC</b>  | VKMA 31030<br>VKMV 11.5x790<br>VKMV 6PK1145<br>VKM 31004<br>VKM 31030              | 2<br>1<br>1   | 2   | 1<br>1  |   |   |   |   |   |   |
|                                 | 1Z, AFN, AHU  | 08/96 → 06/99   |   | VKM _____  |   |   |   |   |   | 1   |   |   |   |
|  | AGR, ALH, ASV   | 06/99 → 09/06   |   | VKM _____  |   |   |   |   |   | 1   |   |   |   |
| <b>SEAT  FURA 0.9</b>           |   |   |   |  |   |   |   |   |   |   |   |   |   |
|                                 | 09 NCA, 100 GL 7000,<br>HB 90   | 01/82 → 12/86   |   | <b>OXOXOXO</b>   |   |   |   |   |   |   |   |   |   |
|                                 | 09 NCA, 100 GL 7000,<br>HB 90   | 01/82 → 12/86   | 2)  | VKPA 82202   |   |   |   |   |   | 1   |   |   |   |
|                                 | <b>B(Alt)</b> 09 NCA, 100 GL 7000,<br>HB 90                                       | 01/82 → 12/86   |   | VKMV 10AVx800  |   |   | 1   |   |   |   |   |   |   |
| <b>SEAT  FURA 1.4</b>           |   |   |   |  |   |   |   |   |   |   |   |   |   |
|                                 | 127 B.7000  | 01/82 → 06/86   | 2)  | VKPA 82202   |   |   |   |   |   | 1   |   |   |   |
|                                 | <b>B(Alt)</b> 127 B.7000  | 01/82 → 06/86   |   | VKMV 10AVx800  |   |   | 1   |   |   |   |   |   |   |
| <b>SEAT  IBIZA I (021A) 0.9</b> |   |   |   |  |   |   |   |   |   |   |   |   |   |
|                                 | 09 NCA, 146 A 000   | 08/86 → 05/93   |   | <b>OXOXOXO</b>   |   |   |   |   |   |   |   |   |   |
|                                 | 09 NCA, 146 A 000   | 08/86 → 05/93   | 2)  | VKPA 82202   |   |   |   |   |   | 1   |   |   |   |
|                                 | <b>B(Alt)</b> 09 NCA, 146 A 000   | 08/86 → 05/93   |   | VKMV 10AVx800  |   |   | 1   |   |   |   |   |   |   |

|  |               |   |    |  |  |   |  |   |  |   |  |  |  |  |  |  |       |  |  |  |  |  |  |  |
|--|---------------|---|---|--|---|---|---|---|--|---|---|--|--|--|--|--|-------|--|--|--|--|--|--|--|
| <b>SEAT  IBIZA I (021A) 1.2</b>       |               |   |   |  |   |   |   |   |  |   |   |  |  |  |  |  |       |  |  |  |  |  |  |  |
|                                        |               | 021 A 1000, 021 C.1000                            | 11/84 → 12/93   |  | VKMA 02700  | 1 |   | 1 |  |   |   |  |  |  |  |  | T0026 |  |  |  |  |  |  |  |
|  |               |   |   |  | VKM 12700   | 1 |   |   |  |   |   |  |  |  |  |  |       |  |  |  |  |  |  |  |
|                                        |               | 021 A 1000, 021 C.1000                            | 11/84 → 12/93   |  | VKPC 82419  |   |   |   |  |   | 1   |  |  |  |  |  |       |  |  |  |  |  |  |  |
|                                        | <b>B(Alt)</b> | 021 A 1000, 021 C.1000                            | 11/84 → 12/93   |  | VKMOV 10AVx750  |   |   | 1 |  |   |   |  |  |  |  |  |       |  |  |  |  |  |  |  |
| <b>SEAT  IBIZA I (021A) 1.5</b>       |               |   |   |  |   |   |   |   |  |   |   |  |  |  |  |  |       |  |  |  |  |  |  |  |
|                                        |               | 021 A 2000, 021 B.2000,<br>021 C.2000, 021 D.2000 | 11/84 → 05/93   |  | VKMA 02700  | 1 |   | 1 |  |   |   |  |  |  |  |  | T0026 |  |  |  |  |  |  |  |
|  |               |   |   |  | VKM 12700   | 1 |   |   |  |   |   |  |  |  |  |  |       |  |  |  |  |  |  |  |
|                                        |               | 021 A 2000, 021 B.2000,<br>021 C.2000, 021 D.2000 | 11/84 → 05/93   |  | VKPC 82419  |   |   |   |  |   | 1   |  |  |  |  |  |       |  |  |  |  |  |  |  |
|                                        | <b>B(Alt)</b> | 021 A 2000, 021 B.2000,<br>021 C.2000, 021 D.2000 | 11/84 → 05/93   |  | VKMOV 10AVx750  |   |   | 1 |  |   |   |  |  |  |  |  |       |  |  |  |  |  |  |  |
| <b>SEAT  IBIZA I (021A) 1.7</b>       |               |   |   |  |   |   |   |   |  |   |   |  |  |  |  |  |       |  |  |  |  |  |  |  |
|                                        |               | 021 A.3000, 021 B.3000                            | 01/91 → 05/93   |  | VKMA 02700  | 1 |   | 1 |  |   |   |  |  |  |  |  | T0026 |  |  |  |  |  |  |  |
|  |               |   |   |  | VKM 12700   | 1 |   |   |  |   |   |  |  |  |  |  |       |  |  |  |  |  |  |  |
|                                        | <b>B(Alt)</b> | 021 A.3000, 021 B.3000                            | 01/91 → 05/93   |  | VKMOV 10AVx750  |   |   | 1 |  |   |   |  |  |  |  |  |       |  |  |  |  |  |  |  |
| <b>SEAT  IBIZA I (021A) 1.7 D</b>     |               |   |   |  |   |   |   |   |  |   |   |  |  |  |  |  |       |  |  |  |  |  |  |  |
|                                        |               | 022 A.5000  | 06/84 → 05/93   |  | VKMA 02161  |   | 2   | 1 |  |   |   |  |  |  |  |  | T0648 |  |  |  |  |  |  |  |
|  |               |   |   |  | VKM 22160   |   | 1   |   |  |   |   |  |  |  |  |  |       |  |  |  |  |  |  |  |
|  |               |   |   |  | VKM 22160   |   | 1   |   |  |   |   |  |  |  |  |  |       |  |  |  |  |  |  |  |
|                                        |               | 022 A.5000  | 06/84 → 12/90   |  | VKPC 82410  |   |   |   |  |   | 1   |  |  |  |  |  |       |  |  |  |  |  |  |  |
|  |               | 022 A.5000  | 01/91 → 05/93 2)  |  | VKPA 82435  |   |   |   |  |   | 1   |  |  |  |  |  |       |  |  |  |  |  |  |  |
|                                        | <b>B(Alt)</b> | 022 A.5000  | 06/84 → 05/93   |  | VKMOV 10AVx838  |   |   | 1 |  |   |   |  |  |  |  |  |       |  |  |  |  |  |  |  |
| <b>SEAT  IBIZA II (6K1) 1.0</b>      |               |   |   |  |   |   |   |   |  |   |   |  |  |  |  |  |       |  |  |  |  |  |  |  |
|                                      |               | AAU   | 03/93 → 09/96    |  | VKMC 01103  |   |   | 1 | 1  |   |   |  |  |  |  |  | T0231 |  |  |  |  |  |  |  |
|  |               | AER   | 09/96 → 08/99   |  | VKMA 01106  | 1 |   | 1 |  |   |   |  |  |  |  |  | T0126 |  |  |  |  |  |  |  |
|  |               |   |   |  | VKM 11106   | 1 |   |   |  |   |   |  |  |  |  |  |       |  |  |  |  |  |  |  |
|                                      |               | AAU   | 03/93 → 09/96   |  | VKPC 81204  |   |   |   |  |   | 1   |  |  |  |  |  |       |  |  |  |  |  |  |  |
|  |               | AER   | 09/96 → 08/99   |  | VKPC 81215  |   |   |   |  |   | 1   |  |  |  |  |  |       |  |  |  |  |  |  |  |
|                                      | <b>B(Alt)</b> | AAU   | 03/93 → 09/96   |  | VKMOV 11.9x710  |   |   | 1 |  |   |   |  |  |  |  |  |       |  |  |  |  |  |  |  |
|  | <b>B(Alt)</b> | AER   | 09/96 → 08/99    |  | VKMOV 6PK751  |   |   | 1 |  |   |   |  |  |  |  |  |       |  |  |  |  |  |  |  |
|  | <b>B(Alt)</b> | AER   | 09/96 → 08/99    |  | VKMA 31202  | 1 |   | 1 |  |   |   |  |  |  |  |  |       |  |  |  |  |  |  |  |
|  |               |   |   |  | VKMOV 6PK1068   |   |   | 1 |  |   |   |  |  |  |  |  |       |  |  |  |  |  |  |  |
|  |               |   |   |  | VKM 31015   | 1 |   |   |  |   |   |  |  |  |  |  |       |  |  |  |  |  |  |  |
| <b>SEAT  IBIZA II (6K1) 1.3</b>     |               |   |   |  |   |   |   |   |  |   |   |  |  |  |  |  |       |  |  |  |  |  |  |  |
|                                      |               | 2G, AAV   | 03/93 → 08/99    |  | VKMC 01103  |   |   | 1 | 1  |   |   |  |  |  |  |  | T0231 |  |  |  |  |  |  |  |
|                                      |               | 2G, AAV   | 03/93 → 08/99   |  | VKPC 81204  |   |   |   |  |   | 1   |  |  |  |  |  |       |  |  |  |  |  |  |  |
|                                      | <b>B(Alt)</b> | 2G, AAV   | 03/93 → 08/99   |  | VKMOV 11.9x710  |   |   | 1 |  |   |   |  |  |  |  |  |       |  |  |  |  |  |  |  |
| <b>SEAT  IBIZA II (6K1) 1.4</b>     |               |   |   |  |   |   |   |   |  |   |   |  |  |  |  |  |       |  |  |  |  |  |  |  |
|                                      |               | ABD   | 09/93 → 08/99    |  | VKMC 01103  |   |   | 1 | 1  |   |   |  |  |  |  |  | T0231 |  |  |  |  |  |  |  |
|  |               | AEX, APQ  | 09/93 → 08/99   |  | VKMA 01106  | 1 |   | 1 |  |   |   |  |  |  |  |  | T0126 |  |  |  |  |  |  |  |
|  |               |   |   |  | VKM 11106   | 1 |   |   |  |   |   |  |  |  |  |  |       |  |  |  |  |  |  |  |
|                                      |               | ABD   | 09/93 → 08/99   |  | VKPC 81204  |   |   |   |  |   | 1   |  |  |  |  |  |       |  |  |  |  |  |  |  |
|  |               | AEX, AKV, APQ                                     | 09/93 → 08/99   |  | VKPC 81210  |   |   |   |  |   | 1   |  |  |  |  |  |       |  |  |  |  |  |  |  |
|                                      | <b>B(Alt)</b> | ABD   | 09/93 → 08/99    |  | VKMOV 6PK737  |   |   | 1 |  |   |   |  |  |  |  |  |       |  |  |  |  |  |  |  |
|  | <b>B(Alt)</b> | AEX, APQ  | 09/93 → 08/99    |  | VKMOV 6PK751  |   |   | 1 |  |   |   |  |  |  |  |  |       |  |  |  |  |  |  |  |
|  | <b>B(Alt)</b> | ABD, AEX, APQ                                     | 09/93 → 08/99   |  | VKMA 31202  | 1 |   | 1 |  |   |   |  |  |  |  |  |       |  |  |  |  |  |  |  |
|  |               |   |   |  | VKMOV 6PK1068   |   |   | 1 |  |   |   |  |  |  |  |  |       |  |  |  |  |  |  |  |
|  |               |   |   |  | VKM 31015   | 1 |   |   |  |   |   |  |  |  |  |  |       |  |  |  |  |  |  |  |
|  | <b>B(Alt)</b> | ABD, AEX, APQ                                     | 09/93 → 08/99   |  | VKMOV 6PK1185   |   |   | 1 |  |   |   |  |  |  |  |  |       |  |  |  |  |  |  |  |
|  |               |   |   |  | VKM 31023   | 1 |   |   |  |   |   |  |  |  |  |  |       |  |  |  |  |  |  |  |
| <b>SEAT  IBIZA II (6K1) 1.4 16V</b> |               |   |   |  |   |   |   |   |  |   |   |  |  |  |  |  |       |  |  |  |  |  |  |  |
|                                      |               | AFH   | 09/96 → 08/99    |  | VKMC 01114  | 1 | 1   | 1 |  | 1 |   |  |  |  |  |  | T0150 |  |  |  |  |  |  |  |
|  |               |   |   |  | VKMA 01114  | 1 | 1   | 1 |  |   |   |  |  |  |  |  |       |  |  |  |  |  |  |  |
|  |               |   |   |  | VKM 11114   | 1 |   |   |  |   |   |  |  |  |  |  |       |  |  |  |  |  |  |  |
|  |               |   |   |  | VKM 21122   |   | 1   |   |  |   |   |  |  |  |  |  |       |  |  |  |  |  |  |  |
|                                      |               | AFH   | 09/96 → 08/99   |  | VKPC 81411  |   |   |   |  |   | 1   |  |  |  |  |  |       |  |  |  |  |  |  |  |
|                                      | <b>B(Alt)</b> | AFH   | 09/96 → 08/99    |  | VKMA 31202  | 1 |   | 1 |  |   |   |  |  |  |  |  |       |  |  |  |  |  |  |  |
|  |               |   |   |  | VKMOV 6PK1068   |   |   | 1 |  |   |   |  |  |  |  |  |       |  |  |  |  |  |  |  |
|  |               |   |   |  | VKM 31015   | 1 |   |   |  |   |   |  |  |  |  |  |       |  |  |  |  |  |  |  |

|  |                        |  |   |  |  |  |  |  |  |  |  |  |
|--|------------------------|---|--|---|--|---|---|---|---|---|---|---|
|  | <b>B(Alt)</b> AFH      | 09/96 → 08/99   | AC   |   | VKMV 6PK1185<br>VKM 31023  | 1   |   | 1   |   |   |   |   |
| <b>SEAT  IBIZA II (6K1) 1.6</b>       |                        |   |  |   |  |   |   |   |   |   |   |   |
|                                       | ABU                    | 03/93 → 08/94   |   |   | VKMC 01104   |   |   | 1   | 1   |   |   | T0233   |
|  | 1F                     | 03/93 → 08/99   | 3)   |   | VKMS 01000   | 1   |   | 1   |   |   | 3   | 4   |
|  |                        |   |  |   | VKMA 01000   | 1   |   | 1   |   |   |   | 3   |
|  |                        |   |  |   | VKM 11000  | 1   |   |   |   |   |   |   |
|  | AEE, ALM               | 03/93 → 08/99   |  |   | VKMA 01110   | 1   |   | 1   |   |   |   | T0127   |
|  |                        |   |  |   | VKM 11106  | 1   |   |   |   |   |   |   |
|  | AFT                    | 04/96 → 08/99   |  |   | VKMA 01009   | 1   |   | 1   |   |   |   | 3   |
|  |                        |   |  |   | VKM 11000  | 1   |   |   |   |   |   | T0124   |
|                                       | 1F, AFT                | 03/93 → 08/99   | 2)   |   | VKPA 81401   |   |   |   |   | 1   |   |   |
|  |                        |   |  |   | VKPC 81401   |   |   |   |   | 1   |   |   |
|  | ABU                    | 03/93 → 08/99   |  |   | VKPC 81204   |   |   |   |   | 1   |   |   |
|  | AEE, ALM               | 03/93 → 08/99   |  |   | VKPC 81210   |   |   |   |   | 1   |   |   |
|                                       | <b>B(Alt)</b> 1F, AFT  | 09/94 → 08/99   |   |   | VKMV 6PK894  |   |   | 1   |   |   |   |   |
|  | <b>B(Alt)</b> 1F, AFT  | 09/94 → 08/99   | AC   |   | VKMV 6PK1153<br>VKM 31004<br>VKM 31210   | 1<br>1  |   | 1   |   |   |   |   |
|  | <b>B(Alt)</b> ABU      | 03/93 → 08/94   |          |   | VKMA 31202<br>VKMV 6PK1068<br>VKM 31015  | 1<br>1  |   | 1<br>1  |   |   |   |   |
|  | <b>B(Alt)</b> ABU      | 03/93 → 08/94   | AC    |   | VKMV 6PK1185<br>VKM 31023  | 1   |   | 1   |   |   |   |   |
|  | <b>B(Alt)</b> AEE, ALM | 05/97 → 08/99   |   |   | VKMA 31202<br>VKMV 6PK1068<br>VKM 31015  | 1<br>1  |   | 1<br>1  |   |   |   |   |
|  | <b>B(PS)</b> 1F, AFT   | 09/94 → 08/99   |   |   | VKMV 11.5x685  |   |   | 1   |   |   |   |   |
|  | <b>B(PS)</b> 1F, AFT   | 09/94 → 08/99   | AC   |   | VKMV 11.5x755  |   |   | 1   |   |   |   |   |
| <b>SEAT  IBIZA II (6K1) 1.8</b>     |                        |   |  |   |  |   |   |   |   |   |   |   |
|                                     | ABS, ADZ               | 03/93 → 08/99   | 3)   |   | VKMS 01000   | 1   |   | 1   |   |   | 3   | 4   |
|  |                        |   |  |   | VKMA 01000   | 1   |   | 1   |   |   |   | 3   |
|  |                        |   |  |   | VKM 11000  | 1   |   |   |   |   |   | 3   |
|                                     | ABS, ADZ               | 03/93 → 08/99   | 2)   |   | VKPA 81401   |   |   |   |   | 1   |   |   |
|  |                        |   |  |   | VKPC 81401   |   |   |   |   | 1   |   |   |
|                                     | <b>B(Alt)</b> ABS, ADZ | 03/93 → 08/99   |   |   | VKMV 6PK894  |   |   | 1   |   |   |   |   |
|  | <b>B(Alt)</b> ABS, ADZ | 03/93 → 08/99   |   AC |   | VKMV 6PK1153<br>VKM 31004<br>VKM 31210   | 1<br>1  |   | 1   |   |   |   |   |
|  | <b>B(PS)</b> ABS, ADZ  | 03/93 → 08/99   |   |   | VKMV 11.5x685  |   |   | 1   |   |   |   |   |
|  | <b>B(PS)</b> ABS, ADZ  | 03/93 → 08/99   | AC   |   | VKMV 11.5x755  |   |   | 1   |   |   |   |   |
| <b>SEAT  IBIZA II (6K1) 1.8 16V</b> |                        |   |  |   |  |   |   |   |   |   |   |   |
|                                     | ADL                    | 11/93 → 08/96   |  |   | VKMA 01023<br>VKM 11021  | 1<br>1  |   | 1   |   |   |   | T0057   |
|                                     | ADL                    | 11/93 → 08/96   | 2)   |   | VKPA 81401   |   |   |   |   | 1   |   |   |
|  |                        |   |  |   | VKPC 81401   |   |   |   |   | 1   |   |   |
|                                     | <b>B(Alt)</b> ADL      | 11/93 → 08/96   |   |   | VKMV 6PK1033<br>VKM 31004<br>VKM 31210   | 1<br>1  |   | 1   |   |   |   |   |
|  | <b>B(Alt)</b> ADL      | 11/93 → 08/96   | AC   |   | VKMV 6PK1153<br>VKM 31004<br>VKM 31210   | 1<br>1  |   | 1   |   |   |   |   |
|  | <b>B(PS)</b> ADL       | 11/93 → 08/96   |   |   | VKMV 11.5x685  |   |   | 1   |   |   |   |   |
|  | <b>B(PS)</b> ADL       | 11/93 → 08/96   | AC   |   | VKMV 11.5x755  |   |   | 1   |   |   |   |   |
| <b>SEAT  IBIZA II (6K1) 2.0</b>     |                        |   |  |   |  |   |   |   |   |   |   |   |
|                                     | 2E, AGG                | 03/93 → 08/99   |  |   | VKMA 01002<br>VKM 11000  | 1<br>1  |   | 1   |   |   |   | 3   |
|                                     | 2E, AGG                | 03/93 → 08/99   | 2)   |   | VKPA 81401   |   |   |   |   | 1   |   |   |
|  |                        |   |  |   | VKPC 81401   |   |   |   |   | 1   |   |   |
|                                     | <b>B(Alt)</b> 2E, AGG  | 03/93 → 08/99   |   |   | VKMV 6PK894  |   |   | 1   |   |   |   |   |
|  | <b>B(Alt)</b> 2E, AGG  | 03/93 → 08/99   |   AC |   | VKMV 6PK1153<br>VKM 31004<br>VKM 31210   | 1<br>1  |   | 1   |   |   |   |   |





























|  |  |  |  |  |  |  |  |  |  |  |  |
|--|---|---|---|--|---|---|---|---|---|---|---|
| B(PS)  | 2E, AGG   | 03/93 → 08/99   | AC  | VKMOV 11.5x685   |   |   | 1   |   |   |   |   |
| B(PS)  | 2E, AGG   | 03/93 → 08/99   | AC  | VKMOV 11.5x755   |   |   | 1   |   |   |   |   |
| <b>SEAT  IBIZA II (6K1) 2.0 16V</b>   |   |   |   |  |   |   |   |   |   |   |   |
|                                        | ABF   | 08/96 → 08/99   |   | VKMA 01024<br>VKM 11021  | 1<br>1  |   | 1   |   |   |   | T0114   |
|                                        | ABF   | 08/96 → 08/99   | 2)  | VKPA 81401<br>VKPC 81401   |   |   |   | 1<br>1  |   |   |   |
|                                        | B(Alt)  | ABF   | 08/96 → 08/99   | AC   | VKMOV 6PK894  |   |   | 1   |   |   |   |
|  | B(Alt)  | ABF   | 08/96 → 08/99   | AC, AC   | VKMOV 6PK1033<br>VKM 31004<br>VKM 31210   | 1<br>1  |   | 1   |   |   |   |
|  | B(Alt)  | ABF   | 08/96 → 08/99   | AC, AC   | VKMOV 6PK1153<br>VKM 31004<br>VKM 31210   | 1<br>1  |   | 1   |   |   |   |
|  | B(PS)   | ABF   | 08/96 → 08/99   | AC   | VKMOV 11.5x685  |   |   | 1   |   |   |   |
|  | B(PS)   | ABF   | 08/96 → 08/99   | AC   | VKMOV 11.5x755  |   |   | 1   |   |   |   |
| <b>SEAT  IBIZA II (6K1) 1.9 D</b>     |   |   |   |  |   |   |   |   |   |   |   |
|                                        | 1Y  | 04/93 → 08/96   | → Mot. 378 364  | VKMA 01011<br>VKM 11010  | 1<br>1  |   | 1   |   |   |   | 4 T0069   |
|  | 1Y  | 04/93 → 08/96   | Mot. 378 365 →  | VKMA 01013<br>VKM 11014  | 1<br>1  |   | 1   |   |   |   | 4 T0069   |
|                                        | 1Y  | 04/93 → 08/96   | 2)  | VKPA 81401<br>VKPC 81401   |   |   |   | 1<br>1  |   |   |   |
|                                        | B(Alt)  | 1Y  | 04/93 → 08/96   | AC   | VKMOV 6PK923  |   |   | 1   |   |   |   |
|  | B(Alt), B(PS)1Y   | 04/93 → 08/96   | AC, AC  | VKMA 31028<br>VKMV 10AVx730<br>VKMV 6PK1045<br>VKM 31004<br>VKM 31030              | 2<br>2<br>1<br>1  |   | 2<br>1<br>1   |   |   |   |   |
|  | B(Alt), B(PS)1Y   | 04/93 → 08/96   | AC, AC  | VKMA 31030<br>VKMV 11.5x790<br>VKMV 6PK1145<br>VKM 31004<br>VKM 31030              | 2<br>1<br>1<br>1<br>1   |   | 2<br>1<br>1   |   |   |   |   |
|                                      | 1Y  | 04/93 → 08/96   |   | VKM_____   |   |   |   |   | 1   |   |   |
| <b>SEAT  IBIZA II (6K1) 1.9 SDI</b> |   |   |   |  |   |   |   |   |   |   |   |
|                                      | AEY   | 08/96 → 08/99   |   | VKMA 01019<br>VKM 11014<br>VKM 21012   | 1<br>1<br>1   | 1   | 1   |   |   |   | 5 T0650   |
|                                      | AEY   | 08/96 → 08/99   | 2)  | VKPA 81401<br>VKPC 81401   |   |   |   | 1<br>1  |   |   |   |
|                                      | B(Alt)  | AEY   | 08/96 → 08/99   | AC   | VKMOV 6PK923  |   |   | 1   |   |   |   |
|  | B(Alt), B(PS)AEY  | 08/96 → 08/99   | AC, AC  | VKMA 31028<br>VKMV 10AVx730<br>VKMV 6PK1045<br>VKM 31004<br>VKM 31030              | 2<br>2<br>1<br>1  |   | 2<br>1<br>1   |   |   |   |   |
|  | B(Alt), B(PS)AEY  | 08/96 → 08/99   | AC, AC  | VKMA 31030<br>VKMV 11.5x790<br>VKMV 6PK1145<br>VKM 31004<br>VKM 31030              | 2<br>1<br>1<br>1<br>1   |   | 2<br>1<br>1   |   |   |   |   |
|                                      | AEY   | 08/96 → 08/99   |   | VKM_____   |   |   |   |   | 1   |   |   |
| <b>SEAT  IBIZA II (6K1) 1.9 TD</b>  |   |   |   |  |   |   |   |   |   |   |   |
|                                      | AAZ   | 03/93 → 08/96   | → Mot. 552 765  | VKMA 01011<br>VKM 11010  | 1<br>1  |   | 1   |   |   |   | 4 T0069   |
|  | AAZ   | 03/93 → 08/96   | Mot. 552 766 →  | VKMA 01013<br>VKM 11014  | 1<br>1  |   | 1   |   |   |   | 4 T0069   |
|                                      | AAZ   | 03/93 → 08/96   | 2)  | VKPA 81401<br>VKPC 81401   |   |   |   | 1<br>1  |   |   |   |
|                                      | B(Alt)  | AAZ   | 03/93 → 08/96   | AC   | VKMOV 6PK923  |   |   | 1   |   |   |   |
|  | B(Alt), B(PS)AAZ  | 03/93 → 08/96   | AC, AC  | VKMA 31028<br>VKMV 10AVx730<br>VKMV 6PK1045  | 2<br>2<br>1   |   | 2<br>1<br>1   |   |   |   |   |



|                                      |                                   |               |                         | VKM 31004     | 1 |   |   |  |   |  |  |  |         |
|--------------------------------------|-----------------------------------|---------------|-------------------------|---------------|---|---|---|--|---|--|--|--|---------|
|                                      |                                   |               |                         | VKM 31030     | 1 |   |   |  |   |  |  |  |         |
|                                      | <b>B(Alt), B(PS)</b> AAZ          | 03/93 → 08/96 | <b>A</b> ⊙, <b>AC</b>   | VKMA 31030    | 2 |   | 2 |  |   |  |  |  |         |
|                                      |                                   |               |                         | VKMV 11.5x790 |   |   | 1 |  |   |  |  |  |         |
|                                      |                                   |               |                         | VKMV 6PK1145  |   |   | 1 |  |   |  |  |  |         |
|                                      |                                   |               |                         | VKM 31004     | 1 |   |   |  |   |  |  |  |         |
|                                      |                                   |               |                         | VKM 31030     | 1 |   |   |  |   |  |  |  |         |
| ⊙                                    | AAZ                               | 03/93 → 08/96 |                         | VKM_____      |   |   |   |  | 1 |  |  |  |         |
| <b>SEAT  IBIZA II (6K1) 1.9 TDI</b>  |                                   |               |                         |               |   |   |   |  |   |  |  |  |         |
|                                      | 1Z, AFN, AHU                      | 08/96 → 08/99 |                         | VKMA 01014    | 1 | 1 | 1 |  |   |  |  |  | 5 T0650 |
|                                      |                                   |               |                         | VKM 11014     | 1 |   |   |  |   |  |  |  |         |
|                                      |                                   |               |                         | VKM 21012     |   | 1 |   |  |   |  |  |  |         |
|                                      | 1Z, AFN, AHU                      | 08/96 → 08/99 | 2)                      | VKPA 81401    |   |   |   |  | 1 |  |  |  |         |
|                                      |                                   |               |                         | VKPC 81401    |   |   |   |  | 1 |  |  |  |         |
|                                      | <b>B(Alt)</b> 1Z, AFN, AHU        | 08/96 → 08/99 | <b>A</b> ⊙              | VKMV 6PK923   |   |   | 1 |  |   |  |  |  |         |
|                                      | <b>B(Alt), B(PS)</b> 1Z, AFN, AHU | 08/96 → 08/99 | <b>A</b> ⊙, <b>AC</b>   | VKMA 31028    | 2 |   | 2 |  |   |  |  |  |         |
|                                      |                                   |               |                         | VKMV 10AVx730 |   |   | 1 |  |   |  |  |  |         |
|                                      |                                   |               |                         | VKMV 6PK1045  |   |   | 1 |  |   |  |  |  |         |
|                                      |                                   |               |                         | VKM 31004     | 1 |   |   |  |   |  |  |  |         |
|                                      |                                   |               |                         | VKM 31030     | 1 |   |   |  |   |  |  |  |         |
|                                      | <b>B(Alt), B(PS)</b> 1Z, AFN, AHU | 08/96 → 08/99 | <b>A</b> ⊙, <b>AC</b>   | VKMA 31030    | 2 |   | 2 |  |   |  |  |  |         |
|                                      |                                   |               |                         | VKMV 11.5x790 |   |   | 1 |  |   |  |  |  |         |
|                                      |                                   |               |                         | VKMV 6PK1145  |   |   | 1 |  |   |  |  |  |         |
|                                      |                                   |               |                         | VKM 31004     | 1 |   |   |  |   |  |  |  |         |
|                                      |                                   |               |                         | VKM 31030     | 1 |   |   |  |   |  |  |  |         |
| ⊙                                    | 1Z, AFN, AHU                      | 08/96 → 08/99 |                         | VKM_____      |   |   |   |  | 1 |  |  |  |         |
| <b>SEAT  IBIZA III (6K1) 1.0</b>     |                                   |               |                         |               |   |   |   |  |   |  |  |  |         |
|                                      | ALD                               | 08/99 → 02/02 | → <b>Mot.</b> 037 979   | VKMA 01106    | 1 |   | 1 |  |   |  |  |  | T0126   |
|                                      |                                   |               |                         | VKM 11106     | 1 |   |   |  |   |  |  |  |         |
|                                      | ALD                               | 08/99 → 02/02 | <b>Mot.</b> 037 980   → | VKMC 01107    | 1 |   | 1 |  | 1 |  |  |  | 2       |
|                                      |                                   |               |                         | VKMA 01107    | 1 |   | 1 |  |   |  |  |  | 2       |
|                                      |                                   |               |                         | VKM 11107     | 1 |   |   |  |   |  |  |  |         |
|                                      | AUC                               | 08/99 → 02/02 |                         | VKMC 01107    | 1 |   | 1 |  | 1 |  |  |  | 2       |
|                                      |                                   |               |                         | VKMA 01107    | 1 |   | 1 |  |   |  |  |  | 2       |
|                                      |                                   |               |                         | VKM 11107     | 1 |   |   |  |   |  |  |  |         |
|                                      | ANV                               | 08/99 → 02/02 |                         | VKMA 01106    | 1 |   | 1 |  |   |  |  |  | T0126   |
|                                      |                                   |               |                         | VKM 11106     | 1 |   |   |  |   |  |  |  |         |
|                                      | ALD, ANV, AUC                     | 08/99 → 02/02 |                         | VKPC 81215    |   |   |   |  | 1 |  |  |  |         |
|                                      | <b>B(Alt)</b> ALD, ANV, AUC       | 08/99 → 02/02 |                         | VKMV 6PK751   |   |   | 1 |  |   |  |  |  |         |
|                                      | <b>B(Alt)</b> ALD, ANV, AUC       | 08/99 → 02/02 | ⊙                       | VKMA 31202    | 1 |   | 1 |  |   |  |  |  |         |
|                                      |                                   |               |                         | VKMV 6PK1068  |   |   | 1 |  |   |  |  |  |         |
|                                      |                                   |               |                         | VKM 31015     | 1 |   |   |  |   |  |  |  |         |
| <b>SEAT  IBIZA III (6K1) 1.0 16V</b> |                                   |               |                         |               |   |   |   |  |   |  |  |  |         |
|                                      | AST, AVZ                          | 05/00 → 02/02 |                         | VKMC 01114    | 1 | 1 | 1 |  | 1 |  |  |  | T0150   |
|                                      |                                   |               |                         | VKMA 01114    | 1 | 1 | 1 |  |   |  |  |  |         |
|                                      |                                   |               |                         | VKM 11114     | 1 |   |   |  |   |  |  |  |         |
|                                      |                                   |               |                         | VKM 21122     |   | 1 |   |  |   |  |  |  |         |
|                                      | AST, AVZ                          | 05/00 → 02/02 |                         | VKPC 81411    |   |   |   |  | 1 |  |  |  |         |
|                                      | <b>B(Alt)</b> AST, AVZ            | 05/00 → 02/02 | <b>AC</b> , ⊙           | VKMA 31202    | 1 |   | 1 |  |   |  |  |  |         |
|                                      |                                   |               |                         | VKMV 6PK1068  |   |   | 1 |  |   |  |  |  |         |
|                                      |                                   |               |                         | VKM 31015     | 1 |   |   |  |   |  |  |  |         |
|                                      | <b>B(Alt)</b> AST, AVZ            | 05/00 → 02/02 | <b>AC</b> , ⊙           | VKMV 6PK1185  |   |   | 1 |  |   |  |  |  |         |
|                                      |                                   |               |                         | VKM 31023     | 1 |   |   |  |   |  |  |  |         |
| <b>SEAT  IBIZA III (6K1) 1.4</b>     |                                   |               |                         |               |   |   |   |  |   |  |  |  |         |
|                                      | AKK                               | 08/99 → 02/02 | → <b>Mot.</b> 127 806   | VKMA 01106    | 1 |   | 1 |  |   |  |  |  | T0126   |
|                                      |                                   |               |                         | VKM 11106     | 1 |   |   |  |   |  |  |  |         |
|                                      | AKK                               | 08/99 → 02/02 | <b>Mot.</b> 127 807   → | VKMC 01107    | 1 |   | 1 |  | 1 |  |  |  | 2       |
|                                      |                                   |               |                         | VKMA 01107    | 1 |   | 1 |  |   |  |  |  | 2       |
|                                      |                                   |               |                         | VKM 11107     | 1 |   |   |  |   |  |  |  |         |
|                                      | AUD                               | 08/99 → 02/02 |                         | VKMC 01107    | 1 |   | 1 |  | 1 |  |  |  | 2       |
|                                      |                                   |               |                         | VKMA 01107    | 1 |   | 1 |  |   |  |  |  | 2       |
|                                      |                                   |               |                         | VKM 11107     | 1 |   |   |  |   |  |  |  |         |
|                                      | AKK, ANW, AUD                     | 08/99 → 02/02 |                         | VKPC 81215    |   |   |   |  | 1 |  |  |  |         |
|                                      | <b>B(Alt)</b> AKK, ANW, AUD       | 08/99 → 02/02 | <b>AC</b> , ⊙           | VKMA 31202    | 1 |   | 1 |  |   |  |  |  |         |
|                                      |                                   |               |                         | VKMV 6PK1068  |   |   | 1 |  |   |  |  |  |         |
|                                      |                                   |               |                         | VKM 31015     | 1 |   |   |  |   |  |  |  |         |



|  | <b>B(Alt)</b> | AKK, ANW, AUD      | 08/99 → 02/02 | AC, ⊕                              | VKMOV 6PK1185<br>VKM 31023                                     | 1                     |   | 1      |   |  |  |  |         |
|--|---------------|--------------------|---------------|------------------------------------|--|-----------------------|---|--------|---|--|--|--|---------|
| <b>SEAT  IBIZA III (6K1) 1.4 16V</b>       |               |                    |               |                                    |  |                       |   |        |   |  |  |  |         |
|  |               | APE, AQQ, AUA, AUB | 08/99 → 02/02 |                                    | VKMA 01121<br>VKM 11120<br>VKM 11124<br>VKM 21120<br>VKM 21121 | 2<br>1<br>1<br>1<br>1 | 2 | 2      |   |  |  |  | T0165   |
|  |               | APE, AQQ, AUA, AUB | 08/99 → 02/02 |                                    | VKPC 81407   |                       |   |        | 1 |  |  |  |         |
|  | <b>B(Alt)</b> | APE, AQQ, AUA, AUB | 08/99 → 02/02 | AC, ⊕                              | VKMA 31202<br>VKMOV 6PK1068<br>VKM 31015                       | 1<br>1                |   | 1<br>1 |   |  |  |  |         |
|  | <b>B(Alt)</b> | APE, AQQ, AUA, AUB | 08/99 → 02/02 | AC, ⊕                              | VKMOV 6PK1185<br>VKM 31023                                     | 1                     |   | 1      |   |  |  |  |         |
| <b>SEAT  IBIZA III (6K1) 1.6</b>           |               |                    |               |                                    |  |                       |   |        |   |  |  |  |         |
|  |               | AEH, AKL, APF, AUR | 08/99 → 02/02 |                                    | VKMA 01113<br>VKM 11113  | 1<br>1                |   | 1      |   |  |  |  | T0149   |
|  |               | ALM                | 08/99 → 02/02 |                                    | VKMA 01110<br>VKM 11106  | 1<br>1                |   | 1      |   |  |  |  | T0127   |
|  |               | AEH, AKL, APF, AUR | 08/99 → 02/02 |                                    | VKPC 81408   |                       |   |        | 1 |  |  |  |         |
|  | <b>B(Alt)</b> | AEH, AKL, APF, AUR | 08/99 → 02/02 | AC                                 | VKMA 31203<br>VKMOV 6PK1120<br>VKM 31011                       | 1<br>1                |   | 1<br>1 |   |  |  |  |         |
|  | <b>B(Alt)</b> | AEH, AKL, APF, AUR | 08/99 → 02/02 | AC                                 | VKMA 31204<br>VKMOV 6DK1195<br>VKM 31011                       | 1<br>1                |   | 1<br>1 |   |  |  |  |         |
|  | <b>B(Alt)</b> | ALM                | 08/99 → 02/02 | AC, ⊕                              | VKMA 31202<br>VKMOV 6PK1068<br>VKM 31015                       | 1<br>1                |   | 1<br>1 |   |  |  |  |         |
|  | <b>B(Alt)</b> | ALM                | 08/99 → 02/02 | AC, ⊕                              | VKMOV 6PK1185<br>VKM 31023                                     | 1                     |   | 1      |   |  |  |  |         |
| <b>SEAT  IBIZA III (6K1) 1.8 Turbo 20V</b> |               |                    |               |                                    |  |                       |   |        |   |  |  |  |         |
|  |               | AQX, AYP           | 07/00 → 02/02 |                                    | VKMA 01116<br>VKM 11116<br>VKM 21115                           | 1<br>1                | 1 | 1      |   |  |  |  | T0151   |
|  |               | AQX, AYP           | 07/00 → 02/02 |                                    | VKPC 81620   |                       |   |        | 1 |  |  |  |         |
|  | <b>B(Alt)</b> | AQX, AYP           | 07/00 → 02/02 | AC                                 | VKMA 31203<br>VKMOV 6PK1120<br>VKM 31011                       | 1<br>1                |   | 1<br>1 |   |  |  |  |         |
|  | <b>B(Alt)</b> | AQX, AYP           | 07/00 → 02/02 | AC                                 | VKMA 31204<br>VKMOV 6DK1195<br>VKM 31011                       | 1<br>1                |   | 1<br>1 |   |  |  |  |         |
| <b>SEAT  IBIZA III (6K1) 1.9 SDI</b>       |               |                    |               |                                    |  |                       |   |        |   |  |  |  |         |
|  |               | AGP                | 08/99 → 02/02 | →IMot. 229 902                     | VKMA 01130<br>VKM 11130<br>VKM 21004<br>VKM 21130              | 1<br>1<br>1<br>1      | 2 | 1      |   |  |  |  | 5 T0173 |
|  |               | AGP                | 08/99 → 02/02 | Mot. 229 903 I→,<br>→IMot. 595 000 | VKMA 01131<br>VKM 11130<br>VKM 21004<br>VKM 21130<br>VKM 21131 | 1<br>1<br>1<br>1<br>1 | 3 | 1      |   |  |  |  | 8 T0173 |
|  |               | AGP                | 08/99 → 02/02 | Mot. 595 001 I→                    | VKMA 01251<br>VKM 11130<br>VKM 21004<br>VKM 21130<br>VKM 21131 | 1<br>1<br>1<br>1<br>1 | 3 | 1      |   |  |  |  | 8 T0173 |
|  |               | AQM                | 08/99 → 02/02 | →IMot. 004 131                     | VKMA 01130<br>VKM 11130<br>VKM 21004<br>VKM 21130              | 1<br>1<br>1<br>1      | 2 | 1      |   |  |  |  | 5 T0173 |

|   |  |  |  |  |  |  |  |  |  |  |  |  |  |
|---|---|---|---|--|---|---|---|---|---|---|---|---|---|
|   | AQM   | 08/99 → 02/02   | Mot. 004 132 I→,<br>→IMot. 045 000  | VKMA 01131<br>VKM 11130<br>VKM 21004<br>VKM 21130<br>VKM 21131                     | 1<br>1  | 3   | 1   |   |   |   |   | 8   | T0173   |
|   | AQM   | 08/99 → 02/02   | Mot. 045 001 I→   | VKMA 01251<br>VKM 11130<br>VKM 21004<br>VKM 21130<br>VKM 21131                     | 1<br>1  | 3   | 1   |   |   |   |   | 8   | T0173   |
|    | AGP, AQM  | 08/99 → 02/02   |   | VKPC 81623   |   |   |   |   | 1   |   |   |   |   |
|    | B(Alt) AGP, AQM   | 08/99 → 02/02   | AC  | VKMOV 6PK906<br>VKM 31018  | 1   |   | 1   |   |   |   |   | 1   |   |
|   | B(Alt) AGP, AQM   | 08/99 → 02/02   | AC  | VKMA 31005<br>VKMOV 6PK1660<br>VKM 31002<br>VKM 31018                              | 1<br>1  | 1   | 1   |   |   |   |   | 2   |   |
|    | AGP, AQM  | 08/99 → 02/02   |   | VKM_____   | 1   |   |   |   |   | 1   |   | 1   |   |
| <b>SEAT  IBIZA III (6K1) 1.9 TDI 90</b>    |   |   |   |  |   |   |   |   |   |   |   |   |   |
|    | AGR   | 08/99 → 02/02   | →IMot. 565 000  | VKMA 01131<br>VKM 11130<br>VKM 21004<br>VKM 21130<br>VKM 21131                     | 1<br>1  | 3   | 1   |   |   |   |   | 8   | T0173   |
|   | AGR   | 08/99 → 02/02   | Mot. 565 001 I→   | VKMA 01251<br>VKM 11130<br>VKM 21004<br>VKM 21130<br>VKM 21131                     | 1<br>1  | 3   | 1   |   |   |   |   | 8   | T0173   |
|   | ALH   | 08/99 → 02/02   | →IMot. 500 000  | VKMA 01131<br>VKM 11130<br>VKM 21004<br>VKM 21130<br>VKM 21131                     | 1<br>1  | 3   | 1   |   |   |   |   | 8   | T0173   |
|   | ALH   | 08/99 → 02/02   | Mot. 500 001 I→   | VKMA 01251<br>VKM 11130<br>VKM 21004<br>VKM 21130<br>VKM 21131                     | 1<br>1  | 3   | 1   |   |   |   |   | 8   | T0173   |
|    | AGR, ALH  | 08/99 → 02/02   |   | VKPC 81623   |   |   |   |   | 1   |   |   |   |   |
|    | B(Alt) AGR, ALH   | 08/99 → 02/02   | AC  | VKMOV 6PK906<br>VKM 31012  | 1   |   | 1   |   |   |   |   |   |   |
|   | B(Alt) AGR, ALH   | 08/99 → 02/02   | AC  | VKMA 31014<br>VKMOV 6PK1660<br>VKM 31002<br>VKM 31012                              | 1<br>1  | 1   | 1   |   |   |   |   | 1   |   |
|    | AGR, ALH  | 08/99 → 02/02   |   | VKM_____   | 1   |   |   |   |   | 1   |   |   |   |
| <b>SEAT  IBIZA III (6K1) 1.9 TDI 110</b> |   |   |   |  |   |   |   |   |   |   |   |   |   |
|    | ASV   | 08/99 → 02/02   | →IMot. 150 000  | VKMA 01131<br>VKM 11130<br>VKM 21004<br>VKM 21130<br>VKM 21131                     | 1<br>1  | 3   | 1   |   |   |   |   | 8   | T0173   |
|   | ASV   | 08/99 → 02/02   | Mot. 150 001 I→   | VKMA 01251<br>VKM 11130<br>VKM 21004<br>VKM 21130<br>VKM 21131                     | 1<br>1  | 3   | 1   |   |   |   |   | 8   | T0173   |
|    | ASV   | 08/99 → 02/02   |   | VKPC 81623   |   |   |   |   | 1   |   |   |   |   |
|    | B(Alt) ASV  | 08/99 → 02/02   | AC  | VKMOV 6PK906<br>VKM 31012  | 1   |   | 1   |   |   |   |   |   |   |
|   | B(Alt) ASV  | 08/99 → 02/02   | AC  | VKMA 31014<br>VKMOV 6PK1660<br>VKM 31002<br>VKM 31012                              | 1<br>1  | 1   | 1   |   |   |   |   | 1   |   |
|    | ASV   | 08/99 → 02/02   |   | VKM_____   | 1   |   |   |   |   | 1   |   |   |   |



SEAT

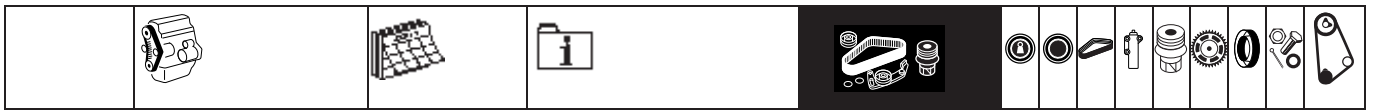

| SEAT  IBIZA IV (6L1) 1.2 |                 |               |                        |  |  |  |  |  |   |   |  |
|--------------------------|-----------------|---------------|------------------------|--|--|--|--|--|---|---|--|
|                          | AZQ, BME        | 02/02 → 11/07 |                        |  |  |  |  |  |   |   |  |
|                          | AZQ, BME        | 02/02 → 11/07 |                        |  |  |  |  |  |   | 1 |  |
|                          | B(Alt) AZQ, BME | 02/02 → 11/07 | AC                     |  |  |  |  |  | 1 |   |  |
|                          | B(Alt) AZQ, BME | 02/02 → 11/07 | AC, →ICH 6L-3-207 000  |  |  |  |  |  | 1 |   |  |
|                          | B(Alt) AZQ, BME | 02/02 → 11/07 | AC, CH 6L-3-207 001 I→ |  |  |  |  |  | 1 | 1 |  |

| SEAT  IBIZA IV (6L1) 1.2 12V |     |               |  |  |  |  |  |  |  |   |  |
|------------------------------|-----|---------------|--|--|--|--|--|--|--|---|--|
|                              | BXV | 05/06 → 11/07 |  |  |  |  |  |  |  |   |  |
|                              | BXV | 05/06 → 11/07 |  |  |  |  |  |  |  | 1 |  |

| SEAT  IBIZA IV (6L1) 1.4 16V |                         |               |                        |              |   |   |   |   |   |   |       |
|------------------------------|-------------------------|---------------|------------------------|--------------|---|---|---|---|---|---|-------|
|                              | AUB, BBY, BBZ, BKY, BXW | 02/02 → 11/07 |                        |              |   |   |   |   |   |   | T0165 |
|                              |                         |               |                        | VKMA 01121   | 2 | 2 | 2 |   |   |   |       |
|                              |                         |               |                        | VKM 11120    | 1 |   |   |   |   |   |       |
|                              |                         |               |                        | VKM 11124    | 1 |   |   |   |   |   |       |
|                              |                         |               |                        | VKM 21120    |   | 1 |   |   |   |   |       |
|                              |                         |               |                        | VKM 21121    |   | 1 |   |   |   |   |       |
|                              | AUB, BBY, BBZ, BKY, BXW | 02/02 → 11/07 |                        |              |   |   |   |   |   | 1 |       |
|                              | B(Alt) AUB, BBY         | 02/02 → 11/07 | AC, →ICH 6L-2-012 769  |              |   |   |   |   | 1 |   |       |
|                              | B(Alt) AUB, BBY         | 02/02 → 11/07 | AC, CH 6L-2-012 770 I→ |              |   |   |   |   | 1 |   |       |
|                              | B(Alt) AUB, BBY         | 02/02 → 11/07 | AC, →ICH 6L-2-012 769  |              | 1 |   |   | 1 |   |   |       |
|                              |                         |               |                        | VKMA 31215   |   |   |   |   |   | 1 |       |
|                              |                         |               |                        | VKMV 6PK1084 | 1 |   |   |   |   |   |       |
|                              |                         |               |                        | VKM 31015    | 1 |   |   |   |   |   |       |
|                              | B(Alt) AUB, BBY         | 02/02 → 11/07 | AC, CH 6L-2-012 770 I→ |              | 1 |   |   | 1 |   |   |       |
|                              |                         |               |                        | VKMA 31216   |   |   |   |   |   | 1 |       |
|                              |                         |               |                        | VKMV 6PK1076 | 1 |   |   |   |   |   |       |
|                              |                         |               |                        | VKM 31015    | 1 |   |   |   |   |   |       |
|                              | B(Alt) BBZ, BKY, BXW    | 02/02 → 11/07 | AC                     |              |   |   |   |   | 1 |   |       |
|                              | B(Alt) BBZ, BKY, BXW    | 02/02 → 11/07 | AC                     |              | 1 |   |   | 1 |   |   |       |
|                              |                         |               |                        | VKMA 31216   |   |   |   |   | 1 |   |       |
|                              |                         |               |                        | VKMV 6PK1076 | 1 |   |   |   | 1 |   |       |
|                              |                         |               |                        | VKM 31015    | 1 |   |   |   |   |   |       |

| SEAT  IBIZA IV (6L1) 1.6 |            |               |                        |              |   |  |  |   |   |   |         |
|--------------------------|------------|---------------|------------------------|--------------|---|--|--|---|---|---|---------|
|                          | BAH        | 02/03 → 11/07 |                        |              |   |  |  |   |   |   | 2 T0126 |
|                          |            |               |                        | VKMA 01107   | 1 |  |  | 1 |   |   |         |
|                          |            |               |                        | VKM 11107    | 1 |  |  |   |   |   |         |
|                          | BAH        | 02/03 → 11/07 |                        |              |   |  |  |   |   | 1 |         |
|                          | B(Alt) BAH | 02/03 → 11/07 | AC                     |              |   |  |  |   | 1 |   |         |
|                          | B(Alt) BAH | 02/03 → 11/07 | AC, →ICH 6L-2-012 769  |              | 1 |  |  | 1 |   |   |         |
|                          |            |               |                        | VKMA 31215   |   |  |  |   |   | 1 |         |
|                          |            |               |                        | VKMV 6PK1084 | 1 |  |  |   |   |   |         |
|                          |            |               |                        | VKM 31015    | 1 |  |  |   |   |   |         |
|                          | B(Alt) BAH | 02/03 → 11/07 | AC, CH 6L-2-012 770 I→ |              | 1 |  |  | 1 |   |   |         |
|                          |            |               |                        | VKMA 31216   |   |  |  |   |   | 1 |         |
|                          |            |               |                        | VKMV 6PK1076 | 1 |  |  |   |   |   |         |
|                          |            |               |                        | VKM 31015    | 1 |  |  |   |   |   |         |

































| SEAT  IBIZA IV (6L1) 1.6 16V |     |               |  |  |  |  |  |  |  |  |  |
|------------------------------|-----|---------------|--|--|--|--|--|--|--|--|--|
|                              | BTS | 11/06 → 11/07 |  |  |  |  |  |  |  |  |  |























| SEAT  IBIZA IV (6L1) 1.8 Turbo |                           |               |    |              |   |   |   |  |   |   |   |
|--------------------------------|---------------------------|---------------|----|--------------|---|---|---|--|---|---|---|
|                                | BBU, BLZ, BJX, BKV        | 12/03 → 11/07 |    |              |   |   |   |  |   |   | 3 |
|                                |                           |               |    | VKMA         | 1 | 1 | 1 |  |   |   |   |
|                                |                           |               |    | VKM          | 1 |   |   |  |   |   |   |
|                                |                           |               |    | —            |   | 1 |   |  |   |   |   |
|                                | BBU, BLZ, BJX, BKV        | 12/03 → 11/07 |    |              |   |   |   |  |   | 1 |   |
|                                | B(Alt) BBU, BLZ, BJX, BKV | 12/03 → 11/07 | AC |              |   |   |   |  | 1 |   |   |
|                                | B(Alt) BBU, BLZ, BJX, BKV | 12/03 → 11/07 | AC |              |   |   |   |  | 1 |   |   |
|                                |                           |               |    | VKMA 6PK926  |   |   |   |  |   |   |   |
|                                |                           |               |    | VKM 31011    | 1 |   |   |  |   |   |   |
|                                |                           |               |    | VKMA 6PK1032 |   |   |   |  |   |   |   |
|                                |                           |               |    | VKM 31011    | 1 |   |   |  |   |   |   |

| SEAT  IBIZA IV (6L1) 2.0 |          |               |  |            |   |  |  |   |  |   |       |
|--------------------------|----------|---------------|--|------------|---|--|--|---|--|---|-------|
|                          | AZL, BBX | 04/02 → 11/07 |  |            |   |  |  |   |  |   | T0149 |
|                          |          |               |  | VKMA 01113 | 1 |  |  | 1 |  |   |       |
|                          |          |               |  | VKM 11113  | 1 |  |  |   |  |   |       |
|                          | AZL, BBX | 04/02 → 11/07 |  |            |   |  |  |   |  | 1 |       |
|                          |          |               |  | VKPC 81620 |   |  |  |   |  |   |       |

|   | B(Alt) | AZL, BBX           | 04/02 → 11/07 | AC                  | VKMA 6PK926<br>VKM 31011                          | 1           |   | 1 |  |   |  |  |                 |
|---|--------|--------------------|---------------|---------------------|---|-------------|---|---|--|---|--|--|-----------------|
|   | B(Alt) | AZL, BBX           | 04/02 → 11/07 | AC                  | VKMA 6PK1032<br>VKM 31011                         | 1           |   | 1 |  |   |  |  |                 |
| <b>SEAT  IBIZA IV (6L1) 1.4 TDI</b>         |        |                    |               |                     |   |             |   |   |  |   |  |  |                 |
|   |        | AMF, BMS, BNM, BNV | 05/02 → 11/07 |                     | VKMA 01250<br>VKM 11250<br>VKM 21147              | 1<br>1      | 1 | 1 |  |   |  |  | T0184           |
|   |        | AMF, BMS, BNM, BNV | 05/02 → 11/07 |                     | VKPC 81418  |             |   |   |  | 1 |  |  |                 |
|   | B(Alt) | AMF                | 05/02 → 11/07 | AC                  | VKMA 6PK858                                       |             |   | 1 |  |   |  |  |                 |
|   | B(Alt) | AMF, BNM, BNV      | 05/02 → 11/07 | AC                  | VKMA 6PK996<br>VKM 31035                          | 1           |   | 1 |  |   |  |  |                 |
|   | B(Alt) | BMS                | 06/05 → 11/07 | AC                  | VKMA 6PK1180<br>VKM 31058                         | 1           |   | 1 |  |   |  |  |                 |
| <b>SEAT  IBIZA IV (6L1) 1.9 SDI</b>         |        |                    |               |                     |   |             |   |   |  |   |  |  |                 |
|   |        | ASY                | 02/02 → 11/07 |                     | VKMA 01275<br>VKM 11130<br>VKM 21004<br>VKM 21130 | 1<br>1      | 2 | 1 |  |   |  |  | T0173           |
|   |        | ASY                | 02/02 → 11/07 | → ICH 6L-3-000 000  | VKPC 81416  |             |   |   |  | 1 |  |  |                 |
|   |        | ASY                | 02/02 → 11/07 | CH 6L-3-000 001   → | VKPC 81302  |             |   |   |  | 1 |  |  |                 |
|   | B(Alt) | ASY                | 02/02 → 11/07 | AC                  | VKMA 6PK780<br>VKM 31057                          | 1           |   | 1 |  |   |  |  |                 |
|   | B(Alt) | ASY                | 02/02 → 11/07 | AC                  | VKMA 6PK1095<br>VKM 31058                         | 1           |   | 1 |  |   |  |  |                 |
| <b>SEAT  IBIZA IV (6L1) 1.9 TDI 100</b>     |        |                    |               |                     |   |             |   |   |  |   |  |  |                 |
|   |        | ATD                | 02/02 → 11/07 |                     | VKMA 01250<br>VKM 11250<br>VKM 21147              | 1<br>1      | 1 | 1 |  |   |  |  | T0184           |
|   |        | ATD                | 02/02 → 11/07 | → ICH 6L-3-000 000  | VKPC 81417  |             |   |   |  | 1 |  |  |                 |
|   |        | ATD                | 02/02 → 11/07 | CH 6L-3-000 001   → | VKPC 81418  |             |   |   |  | 1 |  |  |                 |
|   | B(Alt) | ATD                | 02/02 → 11/07 | AC                  | VKMA 6PK780<br>VKM 31057                          | 1           |   | 1 |  |   |  |  |                 |
|   | B(Alt) | ATD                | 02/02 → 11/07 | AC                  | VKMA 6PK1180<br>VKM 31058                         | 1           |   | 1 |  |   |  |  |                 |
|   |        | ATD                | 02/02 → 11/07 |                     | VKM_____  |             |   |   |  | 1 |  |  |                 |
| <b>SEAT  IBIZA IV (6L1) 1.9 TDI 130</b>     |        |                    |               |                     |   |             |   |   |  |   |  |  |                 |
|   |        | ASZ                | 02/02 → 11/07 |                     | VKMA 01250<br>VKM 11250<br>VKM 21147              | 1<br>1      | 1 | 1 |  |   |  |  | T0184           |
|   |        | ASZ                | 02/02 → 11/07 | → ICH 6L-3-000 000  | VKPC 81417  |             |   |   |  | 1 |  |  |                 |
|   |        | ASZ                | 02/02 → 11/07 | CH 6L-3-000 001   → | VKPC 81418  |             |   |   |  | 1 |  |  |                 |
|   | B(Alt) | ASZ                | 02/02 → 11/07 | AC                  | VKMA 6PK780<br>VKM 31057                          | 1           |   | 1 |  |   |  |  |                 |
|   | B(Alt) | ASZ                | 02/02 → 11/07 | AC                  | VKMA 6PK1180<br>VKM 31058                         | 1           |   | 1 |  |   |  |  |                 |
|   |        | ASZ                | 02/02 → 11/07 |                     | VKM_____  |             |   |   |  | 1 |  |  |                 |
| <b>SEAT  IBIZA IV (6L1) 1.9 TDI Cupra R</b> |        |                    |               |                     |   |             |   |   |  |   |  |  |                 |
|   |        | BPX, BUK           | 01/04 → 11/07 |                     | VKMA 01250<br>VKM 11250<br>VKM 21147              | 1<br>1      | 1 | 1 |  |   |  |  | T0184           |
|   |        | BPX, BUK           | 01/04 → 11/07 |                     | VKPC 81627  |             |   |   |  | 1 |  |  |                 |
|   | B(Alt) | BPX, BUK           | 01/04 → 11/07 | AC                  | VKMA 6PK780<br>VKM 31057                          | 1           |   | 1 |  |   |  |  |                 |
|   | B(Alt) | BPX, BUK           | 01/04 → 11/07 | AC                  | VKMA 6PK1180<br>VKM 31058                         | 1           |   | 1 |  |   |  |  |                 |
|   |        | BPX, BUK           | 01/04 → 11/07 |                     | VKM_____  |             |   |   |  | 1 |  |  |                 |
| <b>SEAT  INCA 1.4</b>                       |        |                    |               |                     |   |             |   |   |  |   |  |  |                 |
|   |        | AUD                | 09/00 → 11/07 |                     | VKMC 01107<br>VKMA 01107<br>VKM 11107             | 1<br>1<br>1 |   | 1 |  | 1 |  |  | 2<br>2<br>T0126 |
|   |        | AEX, AKV, APQ      | 11/95 → 09/00 |                     | VKMA 01106<br>VKM 11106                           | 1<br>1      |   | 1 |  |   |  |  | T0126           |



































|  |  |  |  |  |  |  |  |  |  |  |  |  |  |  |
|--|---|---|---|--|---|---|---|---|---|---|---|---|---|---|
|                            | AEX, AKV, APQ   | 11/95 → 09/00   |   | VKPC 81210   |   |   |   |   |   | 1   |   |   |   |   |
|  | AUD   | 09/00 → 11/07   |   | VKPC 81215   |   |   |   |   |   | 1   |   |   |   |   |
|                            | <b>B(Alt)</b> AEX, AKV, APQ, AUD  | 11/95 → 11/07   | <b>AC, ⊕</b>  | VKMA 6PK751  |   |   |   | 1   |   |   |   |   |   |   |
|  | <b>B(Alt)</b> AEX, AKV, APQ, AUD  | 11/95 → 11/07   | <b>AC, ⊕</b>  | VKMA 31202   | 1   |   |   | 1   |   |   |   |   |   |   |
|  |   |   |   | VKMA 6PK1068   |   |   |   | 1   |   |   |   |   |   |   |
|  |   |   |   | VKM 31015  | 1   |   |   |   |   |   |   |   |   |   |
|  | <b>B(Alt)</b> AEX, AKV, APQ, AUD  | 11/95 → 11/07   | <b>AC, ⊕</b>  | VKMA 6PK1185   |   |   |   | 1   |   |   |   |   |   |   |
|  |   |   |   | VKM 31023  | 1   |   |   |   |   |   |   |   |   |   |
| <b>SEAT  INCA 1.4 16V</b> |   |   |   |  |   |   |   |   |   |   |   |   |   |   |
|                            | AUA   | 04/00 → 11/07   |   | VKMA 01121   | 2   | 2   | 2   |   |   |   |   |   |   | T0165   |
|  |   |   |   | VKM 11120  | 1   |   |   |   |   |   |   |   |   |   |
|  |   |   |   | VKM 11124  | 1   |   |   |   |   |   |   |   |   |   |
|  |   |   |   | VKM 21120  |   |   | 1   |   |   |   |   |   |   |   |
|  |   |   |   | VKM 21121  |   |   | 1   |   |   |   |   |   |   |   |
|                            | AUA   | 04/00 → 11/07   |   | VKPC 81407   |   |   |   |   |   | 1   |   |   |   |   |
|                            | <b>B(Alt)</b> AUA   | 04/00 → 11/07   | <b>AC</b>   | VKMA 31202   | 1   |   |   | 1   |   |   |   |   |   |   |
|  |   |   |   | VKMA 6PK1068   |   |   |   | 1   |   |   |   |   |   |   |
|  |   |   |   | VKM 31015  | 1   |   |   |   |   |   |   |   |   |   |
|  | <b>B(Alt)</b> AUA   | 04/00 → 11/07   | <b>AC</b>   | VKMA 6PK1185   |   |   |   | 1   |   |   |   |   |   |   |
|  |   |   |   | VKM 31023  | 1   |   |   |   |   |   |   |   |   |   |
| <b>SEAT  INCA 1.6</b>     |   |   |   |  |   |   |   |   |   |   |   |   |   |   |
|                            | 1F  | 11/95 → 05/98   | 3)  | VKMA 01000   | 1   |   |   | 1   |   |   |   | 3   | 4   | T0005   |
|  |   |   |   | VKMA 01000   | 1   |   |   | 1   |   |   |   |   | 3   |   |
|  |   |   |   | VKM 11000  | 1   |   |   |   |   |   |   |   |   |   |
|  | AEE   | 11/95 → 05/98   |   | VKMA 01110   | 1   |   |   | 1   |   |   |   |   |   | T0127   |
|  |   |   |   | VKM 11106  | 1   |   |   |   |   |   |   |   |   |   |
|                          | 1F  | 11/95 → 05/98   | 2)  | VKPA 81401   |   |   |   |   |   | 1   |   |   |   |   |
|  |   |   |   | VKPC 81401   |   |   |   |   |   | 1   |   |   |   |   |
|  | AEE   | 11/95 → 05/98   |   | VKPC 81210   |   |   |   |   |   | 1   |   |   |   |   |
|                          | <b>B(Alt)</b> 1F  | 11/95 → 05/98   | <b>AC, AC</b>   | VKMA 6PK894  |   |   |   | 1   |   |   |   |   |   |   |
|  | <b>B(Alt)</b> 1F  | 11/95 → 05/98   | <b>AC, AC</b>   | VKMA 6PK1153   |   |   |   | 1   |   |   |   |   |   |   |
|  |   |   |   | VKM 31004  | 1   |   |   |   |   |   |   |   |   |   |
|  |   |   |   | VKM 31210  | 1   |   |   |   |   |   |   |   |   |   |
|  | <b>B(Alt)</b> AEE   | 11/95 → 05/98   | <b>AC, ⊕</b>  | VKMA 6PK751  |   |   |   | 1   |   |   |   |   |   |   |
|  | <b>B(Alt)</b> AEE   | 11/95 → 05/98   | <b>AC, ⊕</b>  | VKMA 31202   | 1   |   |   | 1   |   |   |   |   |   |   |
|  |   |   |   | VKMA 6PK1068   |   |   |   | 1   |   |   |   |   |   |   |
|  |   |   |   | VKM 31015  | 1   |   |   |   |   |   |   |   |   |   |
|  | <b>B(Alt)</b> AEE   | 11/95 → 05/98   | <b>AC, ⊕</b>  | VKMA 6PK1185   |   |   |   | 1   |   |   |   |   |   |   |
|  |   |   |   | VKM 31023  | 1   |   |   |   |   |   |   |   |   |   |
|  | <b>B(PS)</b> 1F   | 11/95 → 05/98   | <b>AC</b>   | VKMA 11.5x685  |   |   |   | 1   |   |   |   |   |   |   |
|  | <b>B(PS)</b> 1F   | 11/95 → 05/98   | <b>AC</b>   | VKMA 11.5x755  |   |   |   | 1   |   |   |   |   |   |   |
| <b>SEAT  INCA 1.7 D</b> |   |   |   |  |   |   |   |   |   |   |   |   |   |   |
|                          | AHB   | 09/96 → 11/07   |   | VKMA 01019   | 1   | 1   | 1   |   |   |   |   |   | 5   | T0650   |
|  |   |   |   | VKM 11014  | 1   |   |   |   |   |   |   |   |   |   |
|  |   |   |   | VKM 21012  |   |   | 1   |   |   |   |   |   |   |   |
|                          | AHB   | 09/96 → 11/07   | 2)  | VKPA 81401   |   |   |   |   |   | 1   |   |   |   |   |
|  |   |   |   | VKPC 81401   |   |   |   |   |   | 1   |   |   |   |   |
|                          | <b>B(Alt), B(PS)</b> AHB  | 09/96 → 11/07   | <b>AC</b>   | VKMA 31028   | 2   |   |   | 2   |   |   |   |   |   |   |
|  |   |   |   | VKMA 10AVx730  |   |   |   | 1   |   |   |   |   |   |   |
|  |   |   |   | VKMA 6PK1045   |   |   |   | 1   |   |   |   |   |   |   |
|  |   |   |   | VKM 31004  | 1   |   |   |   |   |   |   |   |   |   |
|  |   |   |   | VKM 31030  | 1   |   |   |   |   |   |   |   |   |   |
|  | <b>B(Alt), B(PS)</b> AHB  | 09/96 → 11/07   | <b>AC</b>   | VKMA 31030   | 2   |   |   | 2   |   |   |   |   |   |   |
|  |   |   |   | VKMA 11.5x790  |   |   |   | 1   |   |   |   |   |   |   |
|  |   |   |   | VKMA 6PK1145   |   |   |   | 1   |   |   |   |   |   |   |
|  |   |   |   | VKM 31004  | 1   |   |   |   |   |   |   |   |   |   |
|  |   |   |   | VKM 31030  | 1   |   |   |   |   |   |   |   |   |   |
|                          | AHB   | 09/96 → 11/07   |   | VKM_____   |   |   |   |   |   | 1   |   |   |   |   |
| <b>SEAT  INCA 1.9 D</b> |   |   |   |  |   |   |   |   |   |   |   |   |   |   |
|                          | 1Y  | 11/95 → 11/07   |   | VKMA 01013   | 1   |   |   | 1   |   |   |   |   | 4   | T0069   |
|  |   |   |   | VKM 11014  | 1   |   |   |   |   |   |   |   |   |   |
|                          | 1Y  | 11/95 → 11/07   | 2)  | VKPA 81401   |   |   |   |   |   | 1   |   |   |   |   |
|  |   |   |   | VKPC 81401   |   |   |   |   |   | 1   |   |   |   |   |

|  |  |  |  |  |  |  |  |  |  |  |  |  |
|--|---|---|---|--|---|---|---|---|---|---|---|---|
|                                     | B(Alt) 1Y   | 11/95 → 11/07   | AC  | VKMV 6PK923<br>VKM 31004<br>VKM 31030  | 1<br>1  |   | 1   |   |   |   |   |   |
|  | B(Alt), B(PS)1Y   | 11/95 → 11/07   | AC  | VKMA 31030<br>VKMV 11.5x790<br>VKMV 6PK1145<br>VKM 31004<br>VKM 31030              | 2<br>1<br>1<br>1<br>1   |   | 2<br>1<br>1   |   |   |   |   |   |
|  | B(PS) 1Y  | 11/95 → 11/07   | AC  | VKMV 10AVx730  |   |   | 1   |   |   |   |   |   |
|                                     | 1Y  | 11/95 → 11/07   |   | VKM _____  |   |   |   |   | 1   |   |   |   |
| <b>SEAT  INCA 1.9 SDI</b>           |   |   |   |  |   |   |   |   |   |   |   |   |
|                                     | AEY   | 11/95 → 09/00   |   | VKMA 01019<br>VKM 11014<br>VKM 21012   | 1<br>1<br>1   | 1   | 1   |   |   |   |   | 5 T0650   |
|  | AYQ   | 09/00 → 11/07   | → Mot. 005 517  | VKMA 01131<br>VKM 11130<br>VKM 21004<br>VKM 21130<br>VKM 21131                     | 1<br>1<br>1<br>1<br>1   | 3   | 1   |   |   |   |   | 8 T0173   |
|  | AYQ   | 09/00 → 11/07   | Mot. 005 518  →   | VKMA 01251<br>VKM 11130<br>VKM 21004<br>VKM 21130<br>VKM 21131                     | 1<br>1<br>1<br>1<br>1   | 3   | 1   |   |   |   |   | 8 T0173   |
|                                     | AEY   | 11/95 → 09/00   | 2)  | VKPA 81401<br>VKPC 81401   |   |   |   |   | 1<br>1  |   |   |   |
|  | AYQ   | 09/00 → 11/07   |   | VKPC 81623   |   |   |   |   | 1   |   |   |   |
|                                   | B(Alt) AYQ  | 09/00 → 11/07   | AC  | VKMV 6PK906<br>VKM 31018   | 1   |   | 1   |   |   |   |   | 1   |
|  | B(Alt) AYQ  | 09/00 → 11/07   | AC  | VKMA 31005<br>VKMV 6PK1660<br>VKM 31002<br>VKM 31018                               | 1<br>1<br>1<br>1  | 1   | 1<br>1  |   |   |   |   | 2<br>1<br>1   |
|  | B(Alt), B(PS)AEY  | 11/95 → 09/00   | A ⊙, AC   | VKMA 31028<br>VKMV 10AVx730<br>VKMV 6PK1045<br>VKM 31004<br>VKM 31030              | 2<br>1<br>1<br>1<br>1   |   | 2<br>1<br>1   |   |   |   |   |   |
|  | B(Alt), B(PS)AEY  | 11/95 → 09/00   | AC  | VKMA 31030<br>VKMV 11.5x790<br>VKMV 6PK1145<br>VKM 31004<br>VKM 31030              | 2<br>1<br>1<br>1<br>1   |   | 2<br>1<br>1   |   |   |   |   |   |
|                                   | AEY   | 11/95 → 09/00   |   | VKM _____  |   |   |   |   | 1   |   |   |   |
|  | AYQ   | 09/00 → 11/07   | → Mot. 074 037  | VKM _____  |   |   |   |   | 1   |   |   |   |
|  | AYQ   | 09/00 → 11/07   | Mot. 074 038  →   | VKM _____  |   |   |   |   | 1   |   |   |   |
| <b>SEAT  LEON I (1M1) 1.4 16V</b> |   |   |   |  |   |   |   |   |   |   |   |   |
|                                   | AHW   | 11/99 → 11/07   | → Mot. 160 000  | VKMA 01120<br>VKM 11120<br>VKM 11121<br>VKM 11120<br>VKM 21121                     | 2<br>1<br>1<br>1<br>1   | 2   | 2   | 2   |   |   |   | T0165   |
|  | AHW   | 11/99 → 11/07   | Mot. 160 001  →   | VKMA 01121<br>VKM 11120<br>VKM 11124<br>VKM 21120<br>VKM 21121                     | 2<br>1<br>1<br>1<br>1   | 2   | 2   | 2   |   |   |   | T0165   |
|  | APE, AXP, BCA   | 11/99 → 11/07   |   | VKMA 01121<br>VKM 11120<br>VKM 11124<br>VKM 21120<br>VKM 21121                     | 2<br>1<br>1<br>1<br>1   | 2   | 2   | 2   |   |   |   | T0165   |
|                                   | AHW, APE, AXP, BCA  | 11/99 → 11/07   |   | VKPC 81407   |   |   |   |   | 1   |   |   |   |
|                                   | B(Alt) AHW, APE, AXP, BCA   | 11/99 → 11/07   | AC  | VKMA 31206<br>VKMV 6PK1078<br>VKM 31015  | 1<br>1  |   | 1<br>1  |   |   |   |   |   |



SEAT

|  |  |  |  |   |  |  |  |  |  |  |  |  |
|--|---|---|---|---|---|---|---|---|---|---|---|---|
|  | <b>B(Alt)</b>   | AHW, APE, AXP, BCA  | 11/99 → 11/07   | AC  | VKMA 31207<br>VKMV 6PK1548<br>VKM 31016<br>VKM 31207                                | 1<br>1<br>1   | 1<br>1  |   |   |   |   |   |
| <b>SEAT  LEON I (1M1) 1.6</b>         |   |   |   |   |   |   |   |   |   |   |   |   |
|                                        |   | AEH, AKL  | 11/99 → 11/07   |   | VKMA 01113<br>VKM 11113   | 1<br>1  | 1   |   |   |   |   | T0149   |
|                                        |   | AEH, AKL  | 11/99 → 11/07   |   | VKPC 81408  |   |   |   | 1   |   |   |   |
|                                        | <b>B(Alt)</b>   | AEH, AKL  | 11/99 → 11/07   | AC  | VKMA 31203<br>VKMV 6PK1120<br>VKM 31011   | 1<br>1  | 1<br>1  |   |   |   |   |   |
|  | <b>B(Alt)</b>   | AEH, AKL  | 11/99 → 11/07   | AC  | VKMA 31204<br>VKMV 6DK1195<br>VKM 31011   | 1<br>1  | 1<br>1  |   |   |   |   |   |
| <b>SEAT  LEON I (1M1) 1.6 16V</b>     |   |   |   |   |   |   |   |   |   |   |   |   |
|                                        |   | AUS, AZD, BCB   | 09/00 → 11/07   |   | VKMA 01121<br>VKM 11120<br>VKM 11124<br>VKM 21120<br>VKM 21121                      | 2<br>1<br>1<br>1<br>1   | 2<br>1  | 2   |   |   |   | T0165   |
|                                        |   | AUS, AZD, BCB   | 09/00 → 11/07   |   | VKPC 81419  |   |   |   | 1   |   |   |   |
|                                        | <b>B(Alt)</b>   | AUS, AZD, BCB   | 09/00 → 11/07   | AC  | VKMA 31206<br>VKMV 6PK1078<br>VKM 31015   | 1<br>1  | 1<br>1  |   |   |   |   |   |
|  | <b>B(Alt)</b>   | AUS, AZD, BCB   | 09/00 → 11/07   | AC  | VKMA 31207<br>VKMV 6PK1548<br>VKM 31016<br>VKM 31207                                | 1<br>1<br>1   | 1<br>1  | 1   |   |   |   |   |
| <b>SEAT  LEON I (1M1) 1.8 20V</b>   |   |   |   |   |   |   |   |   |   |   |   |   |
|                                      |   | AGN, APG  | 11/99 → 11/07   | <br>→ ICH 1M-YB088 000,<br>1M-YR016 500  | VKMA 01115<br>VKM 11115<br>VKM 21115  | 1<br>1<br>1   | 1<br>1  | 1   |   |   |   | T0151   |
|  |   | AGN, APG  | 11/99 → 11/07   | <br>CH 1M-YB088 001,<br>1M-YR016 501   → | VKMA 01116<br>VKM 11116<br>VKM 21115  | 1<br>1<br>1   | 1<br>1  | 1   |   |   |   | T0151   |
|                                      |   | AGN, APG  | 11/99 → 11/07   |   | VKPC 81620  |   |   |   | 1   |   |   |   |
|                                      | <b>B(Alt)</b>   | AGN, APG  | 11/99 → 11/07   | AC  | VKMA 31203<br>VKMV 6PK1120<br>VKM 31011   | 1<br>1  | 1<br>1  |   |   |   |   |   |
|  | <b>B(Alt)</b>   | AGN, APG  | 11/99 → 11/07   | AC  | VKMA 31204<br>VKMV 6DK1195<br>VKM 31011   | 1<br>1  | 1<br>1  |   |   |   |   |   |
| <b>SEAT  LEON I (1M1) 1.8 Turbo</b> |   |   |   |   |   |   |   |   |   |   |   |   |
|                                      |   | AJQ, APP, ARY, AUQ  | 11/99 → 11/07   | <br>→ ICH 1M-YB088 000,<br>1M-YR016 500  | VKMA 01115<br>VKM 11115<br>VKM 21115  | 1<br>1<br>1   | 1<br>1  | 1   |   |   |   | T0151   |
|  |   | AJQ, APP, ARY, AUQ  | 11/99 → 11/07   | <br>CH 1M-YB088 001,<br>1M-YR016 501   → | VKMA 01116<br>VKM 11116<br>VKM 21115  | 1<br>1<br>1   | 1<br>1  | 1   |   |   |   | T0151   |
|  |   | AMK, BAM  | 02/02 → 11/07   |    | VKMA 01116<br>VKM 11116<br>VKM 21115  | 1<br>1<br>1   | 1<br>1  | 1   |   |   |   | T0151   |
|                                      |   | AJQ, AMK, APP, ARY,<br>AUQ, BAM   | 11/99 → 11/07   |   | VKPC 81620  |   |   |   | 1   |   |   |   |
|                                      | <b>B(Alt)</b>   | AJQ, AMK, APP, ARY,<br>AUQ, BAM   | 11/99 → 11/07   | AC  | VKMA 31203<br>VKMV 6PK1120<br>VKM 31011   | 1<br>1  | 1<br>1  |   |   |   |   |   |



|                                      | <b>B(Alt)</b> | AJQ, AMK, APP, ARY,<br>AUQ, BAM | 11/99 → 11/07 | AC                                 | VKMA 31204<br>VKMV 6DK1195<br>VKM 31011                        | 1<br>1                | 1<br>1 |        |  |   |  |             |
|--------------------------------------|---------------|---------------------------------|---------------|------------------------------------|--|-----------------------|--------|--------|--|---|--|-------------|
| <b>SEAT  LEON I (1M1) 2.8 V6</b>     |               |                                 |               |                                    |  |                       |        |        |  |   |  |             |
|                                      |               | AUE, BDE                        | 02/01 → 11/07 |                                    |  |                       |        |        |  |   |  |             |
|                                      |               | AUE, BDE                        | 02/01 → 11/07 | →IMot. 1M-2-050 000                | VKPC 81611   |                       |        |        |  | 1 |  |             |
|                                      |               | AUE, BDE                        | 02/01 → 11/07 | Mot. 1M-2-050 001  →               | —  |                       |        |        |  | 1 |  |             |
|                                      | <b>B(Alt)</b> | AUE, BDE                        | 02/01 → 11/07 | AC                                 | VKMV 6PK1264   |                       | 1      |        |  |   |  |             |
| <b>SEAT  LEON I (1M1) 1.9 SDI</b>    |               |                                 |               |                                    |  |                       |        |        |  |   |  |             |
|                                      |               | AQM                             | 11/99 → 11/07 | →IMot. 029 999                     | VKMA 01130<br>VKM 11130<br>VKM 21004<br>VKM 21130              | 1<br>1<br>1<br>1      | 2<br>1 | 1      |  |   |  | 5 T0173     |
|                                      |               | AQM                             | 11/99 → 11/07 | Mot. 030 000  →,<br>→IMot. 045 000 | VKMA 01131<br>VKM 11130<br>VKM 21004<br>VKM 21130<br>VKM 21131 | 1<br>1<br>1<br>1<br>1 | 3<br>1 | 1      |  |   |  | 8 T0173     |
|                                      |               | AQM                             | 11/99 → 11/07 | Mot. 045 001  →                    | VKMA 01251<br>VKM 11130<br>VKM 21004<br>VKM 21130<br>VKM 21131 | 1<br>1<br>1<br>1<br>1 | 3<br>1 | 1      |  |   |  | 8 T0173     |
|                                      |               | AQM                             | 11/99 → 11/07 |                                    | VKPC 81623   |                       |        |        |  | 1 |  |             |
|                                      | <b>B(Alt)</b> | AQM                             | 11/99 → 11/07 | AC                                 | VKMV 6PK906<br>VKM 31018                                       | 1                     |        | 1      |  |   |  | 1           |
|                                      | <b>B(Alt)</b> | AQM                             | 11/99 → 11/07 | AC                                 | VKMA 31005<br>VKMV 6PK1660<br>VKM 31002<br>VKM 31018           | 1<br>1<br>1           | 1<br>1 | 1<br>1 |  |   |  | 2<br>1<br>1 |
|                                      |               | AQM                             | 11/99 → 11/07 | →ICH 1M-3R099 130                  | VKM _____  |                       |        |        |  |   |  | 1           |
|                                      |               | AQM                             | 11/99 → 11/07 | CH 1M-3R099 131  →                 | VKM _____  |                       |        |        |  |   |  | 1           |
| <b>SEAT  LEON I (1M1) 1.9 TDI 90</b> |               |                                 |               |                                    |  |                       |        |        |  |   |  |             |
|                                      |               | AGR                             | 11/99 → 11/07 | →IMot. 565 000                     | VKMA 01131<br>VKM 11130<br>VKM 21004<br>VKM 21130<br>VKM 21131 | 1<br>1<br>1<br>1<br>1 | 3<br>1 | 1      |  |   |  | 8 T0173     |
|                                      |               | AGR                             | 11/99 → 11/07 | Mot. 565 001  →                    | VKMA 01251<br>VKM 11130<br>VKM 21004<br>VKM 21130<br>VKM 21131 | 1<br>1<br>1<br>1<br>1 | 3<br>1 | 1      |  |   |  | 8 T0173     |
|                                      |               | ALH                             | 11/99 → 11/07 | →IMot. 500 000                     | VKMA 01131<br>VKM 11130<br>VKM 21004<br>VKM 21130<br>VKM 21131 | 1<br>1<br>1<br>1<br>1 | 3<br>1 | 1      |  |   |  | 8 T0173     |
|                                      |               | ALH                             | 11/99 → 11/07 | Mot. 500 001  →                    | VKMA 01251<br>VKM 11130<br>VKM 21004<br>VKM 21130<br>VKM 21131 | 1<br>1<br>1<br>1<br>1 | 3<br>1 | 1      |  |   |  | 8 T0173     |
|                                      |               | AGR, ALH                        | 11/99 → 11/07 |                                    | VKPC 81623   |                       |        |        |  | 1 |  |             |
|                                      | <b>B(Alt)</b> | AGR, ALH                        | 11/99 → 11/07 | AC                                 | VKMV 6PK906<br>VKM 31002<br>VKM 31012                          | 1                     | 1      | 1      |  |   |  | 1           |
|                                      | <b>B(Alt)</b> | AGR, ALH                        | 11/99 → 11/07 | AC                                 | VKMA 31014<br>VKMV 6PK1660<br>VKM 31002<br>VKM 31012           | 1<br>1<br>1           | 1<br>1 | 1<br>1 |  |   |  | 1<br>1      |
|                                      |               | AGR, ALH                        | 11/99 → 11/07 | →ICH 1M-3R099 130                  | VKM _____  |                       |        |        |  |   |  | 1           |
|                                      |               | AGR, ALH                        | 11/99 → 11/07 | CH 1M-3R099 131  →                 | VKM _____  |                       |        |        |  |   |  | 1           |













































| SEAT  LEON I (1M1) 1.9 TDI 100 |                   |               |           |   |        |        |        |   |   |       |
|--------------------------------|-------------------|---------------|-----------|---|--------|--------|--------|---|---|-------|
|                                | AXR               | 10/05 → 11/07 |           | VKMA 01250<br>VKM 11250<br>VKM 21147    | 1<br>1 | 1<br>1 | 1      |   |   | T0184 |
|                                | AXR               | 10/05 → 11/07 |           | VKPC 81626                              |        |        |        | 1 |   |       |
|                                | <b>B(Alt)</b> AXR | 10/05 → 11/07 | <b>AC</b> | VKMV 6PK1120<br>VKM 31019               | 1      |        | 1      |   |   |       |
|                                | <b>B(Alt)</b> AXR | 10/05 → 11/07 | <b>AC</b> | VKMA 31001<br>VKMV 6DK1195<br>VKM 31019 | 1<br>1 |        | 1<br>1 |   |   |       |
|                                | AXR               | 10/05 → 11/07 |           | VKM_____                                |        |        |        |   | 1 |       |

| SEAT  LEON I (1M1) 1.9 TDI 110 |                        |               |                           |  |        |                  |        |   |   |         |
|--------------------------------|------------------------|---------------|---------------------------|--|--------|------------------|--------|---|---|---------|
|                                | AHF                    | 11/99 → 11/07 | → <b>IMot.</b> 595 000    | VKMA 01131<br>VKM 11130<br>VKM 21004<br>VKM 21130<br>VKM 21131 | 1<br>1 | 3<br>1<br>1<br>1 | 1      |   |   | 8 T0173 |
|                                | AHF                    | 11/99 → 11/07 | <b>Mot.</b> 595 001  →    | VKMA 01251<br>VKM 11130<br>VKM 21004<br>VKM 21130<br>VKM 21131 | 1<br>1 | 3<br>1<br>1<br>1 | 1      |   |   | 8 T0173 |
|                                | ASV                    | 11/99 → 11/07 | → <b>IMot.</b> 150 000    | VKMA 01131<br>VKM 11130<br>VKM 21004<br>VKM 21130<br>VKM 21131 | 1<br>1 | 3<br>1<br>1<br>1 | 1      |   |   | 8 T0173 |
|                                | ASV                    | 11/99 → 11/07 | <b>Mot.</b> 150 001  →    | VKMA 01251<br>VKM 11130<br>VKM 21004<br>VKM 21130<br>VKM 21131 | 1<br>1 | 3<br>1<br>1<br>1 | 1      |   |   | 8 T0173 |
|                                | AHF, ASV               | 11/99 → 11/07 |                           | VKPC 81623   |        |                  |        | 1 |   |         |
|                                | <b>B(Alt)</b> AHF, ASV | 11/99 → 11/07 | <b>AC</b>                 | VKMV 6PK906<br>VKM 31002<br>VKM 31012                          | 1      | 1                | 1      |   |   | 1       |
|                                | <b>B(Alt)</b> AHF, ASV | 11/99 → 11/07 | <b>AC</b>                 | VKMA 31014<br>VKMV 6PK1660<br>VKM 31002<br>VKM 31012           | 1<br>1 | 1<br>1           | 1<br>1 |   |   | 1<br>1  |
|                                | AHF, ASV               | 11/99 → 11/07 | → <b>ICH</b> 1M-3R099 130 | VKM_____   |        |                  |        |   | 1 |         |
|                                | AHF, ASV               | 11/99 → 11/07 | <b>CH</b> 1M-3R099 131  → | VKM_____   |        |                  |        |   | 1 |         |

| SEAT  LEON I (1M1) 1.9 TDI 130 |                   |               |                        |   |        |        |        |   |   |       |
|--------------------------------|-------------------|---------------|------------------------|---|--------|--------|--------|---|---|-------|
|                                | ASZ               | 05/03 → 11/07 |                        | VKMA 01250<br>VKM 11250<br>VKM 21147    | 1<br>1 | 1<br>1 | 1      |   |   | T0184 |
|                                | ASZ               | 05/03 → 11/07 |                        | VKPC 81626                              |        |        |        | 1 |   |       |
|                                | <b>B(Alt)</b> ASZ | 05/03 → 11/07 | <b>AC</b>              | VKMV 6PK1120<br>VKM 31019               | 1      |        | 1      |   |   |       |
|                                | <b>B(Alt)</b> ASZ | 05/03 → 11/07 | <b>AC</b>              | VKMA 31001<br>VKMV 6DK1195<br>VKM 31019 | 1<br>1 |        | 1<br>1 |   |   |       |
|                                | ASZ               | 05/03 → 11/07 | → <b>IMot.</b> 435 000 | VKM_____                                |        |        |        |   | 1 |       |
|                                | ASZ               | 05/03 → 11/07 | <b>Mot.</b> 435 001  → | VKM_____                                |        |        |        |   | 1 |       |

| SEAT  LEON I (1M1) 1.9 TDI 150 |     |               |                           |   |        |        |        |   |  |         |
|--------------------------------|-----|---------------|---------------------------|---|--------|--------|--------|---|--|---------|
|                                | ARL | 02/01 → 11/07 | → <b>ICH</b> 1M-2R120 000 | VKMA 01942<br>VKM 11142<br>VKM 11145<br>VKM 21142 | 1<br>1 | 1<br>1 | 1<br>1 | 1 |  | 3 T0184 |
|                                | ARL | 02/01 → 11/07 | → <b>ICH</b> 1M-2R120 000 | VKMA 01142<br>VKM 11142<br>VKM 21142              | 1<br>1 | 1<br>1 | 1      |   |  | 3 T0184 |
|                                | ARL | 02/01 → 11/07 | <b>CH</b> 1M-2R120 001  → | VKMA 01250<br>VKM 11250<br>VKM 21147              | 1<br>1 | 1<br>1 | 1      |   |  | T0184   |

























|   |  |  |  |  |  |  |  |  |  |  |  |  |  |  |  |  |
|---|---|---|---|--|---|---|---|---|---|---|---|---|---|---|---|--|
|    | ARL   | 02/01 → 11/07   |   | VKPC 81627   |   |   |   |   |   |   | 1   |   |   |   |   |  |
|    | <b>B(Alt)</b> ARL   | 02/01 → 11/07   | <i>AC</i>   | VKMOV 6PK1120<br>VKM 31019   | 1   |   | 1   |   |   |   |   |   |   |   |   |  |
|   | <b>B(Alt)</b> ARL   | 02/01 → 11/07   | <b>AC</b>   | VKMA 31001<br>VKMV 6DK1195<br>VKM 31019  | 1   |   | 1   |   | 1   |   |   |   |   |   |   |  |
|    | ARL   | 02/01 → 11/07   |   | VKM_____   |   |   |   |   |   |   | 1   |   |   |   |   |  |
| <b>SEAT  LEON II (1P1) 1.4 16V</b>       |   |   |   |  |   |   |   |   |   |   |   |   |   |   |   |  |
|    | BXW   | 09/05 → 11/07   |   | VKMA 01121<br>VKM 11120<br>VKM 11124<br>VKM 21120<br>VKM 21121                     | 2<br>1<br>1<br>1<br>1   | 2   | 2   |   |   |   |   |   |   |   | T0165   |  |
|    | BXW   | 09/05 → 11/07   |   | VKPC 81407   |   |   |   |   |   |   | 1   |   |   |   |   |  |
|    | <b>B(Alt)</b> BXW   | 09/05 → 11/07   | <i>AC</i>   | VKMOV 6PK736   |   |   | 1   |   |   |   |   |   |   |   |   |  |
|   | <b>B(Alt)</b> BXW   | 09/05 → 11/07   | <b>AC</b>   | VKMOV 6PK1100<br>VKM 31015   | 1   |   | 1   |   |   |   |   |   |   |   |   |  |
| <b>SEAT  LEON II (1P1) 1.6</b>           |   |   |   |  |   |   |   |   |   |   |   |   |   |   |   |  |
|    | BSE, BSF  | 09/05 → 11/07   |   | VKMA 01113<br>VKM 11113  | 1<br>1  |   | 1   |   |   |   |   |   |   |   | T0149   |  |
|    | BSE, BSF  | 09/05 → 11/07   |   | VKPC 81408   |   |   |   |   |   |   | 1   |   |   |   |   |  |
|    | <b>B(Alt)</b> BSE, BSF  | 09/05 → 11/07   | <i>AC</i>   | VKMOV 6PK900<br>VKM 31011  | 1   |   | 1   |   |   |   |   |   |   |   |   |  |
|   | <b>B(Alt)</b> BSE, BSF  | 09/05 → 11/07   | <b>AC</b>   | VKMOV 6PK1042<br>VKM 31011   | 1   |   | 1   |   |   |   |   |   |   |   |   |  |
| <b>SEAT  LEON II (1P1) 1.8 Turbo</b>    |   |   |   |  |   |   |   |   |   |   |   |   |   |   |   |  |
|                                        | BZB   | 09/05 → 11/07   |   | <del>XXXXXXXXXX</del>  |   |   |   |   |   |   |   |   |   |   |   |  |
| <b>SEAT  LEON II (1P1) 2.0 FSI</b>     |   |   |   |  |   |   |   |   |   |   |   |   |   |   |   |  |
|                                        | BLR, BLY, BVY, BVZ  | 09/05 → 11/07   |   | VKMA 01222<br>VKM 11222<br>VKM 21220<br>VKM_____                                   | 1<br>1<br>1<br>1  | 2   | 1   |   |   |   |   |   |   | 2   | T0247   |  |
|                                        | BLR, BLY, BVY, BVZ  | 09/05 → 11/07   |   | VKPC 81220   |   |   |   |   |   |   | 1   |   |   |   |   |  |
|                                        | <b>B(Alt)</b> BLR, BLY, BVY, BVZ  | 09/05 → 11/07   | <i>AC</i>   | VKMOV 6PK900<br>VKM 31011  | 1   |   | 1   |   |   |   |   |   |   |   |   |  |
|   | <b>B(Alt)</b> BLR, BLY, BVY, BVZ  | 09/05 → 11/07   | <b>AC</b>   | VKMOV 6PK1042<br>VKM 31011   | 1   |   | 1   |   |   |   |   |   |   |   |   |  |
| <b>SEAT  LEON II (1P1) 2.0 TFSI</b>    |   |   |   |  |   |   |   |   |   |   |   |   |   |   |   |  |
|                                        | BWA   | 09/05 → 11/07   |   | VKMA 01222<br>VKM 11222<br>VKM 21220<br>VKM_____                                   | 1<br>1<br>1<br>1  | 2   | 1   |   |   |   |   |   |   | 2   | T0247   |  |
|   | BWJ   | 11/06 → 11/07   |   | —<br>—<br>VKM 21220<br>VKM_____  | 1<br>1<br>1<br>1  | 2   | 1   |   |   |   |   |   |   |   | T0247   |  |
|                                        | BWA, BWJ  | 09/05 → 11/07   |   | —  |   |   |   |   |   |   | 1   |   |   |   |   |  |
|                                        | <b>B(Alt)</b> BWA, BWJ  | 09/05 → 11/07   | <i>AC</i>   | VKMOV 6PK953   |   |   | 1   |   |   |   |   |   |   |   |   |  |
|   | <b>B(Alt)</b> BWA, BWJ  | 09/05 → 11/07   | <b>AC</b>   | VKMOV 6PK1054  |   |   | 1   |   |   |   |   |   |   |   |   |  |
| <b>SEAT  LEON II (1P1) 1.9 TDI 105</b> |   |   |   |  |   |   |   |   |   |   |   |   |   |   |   |  |
|                                        | BKC, BLS  | 09/05 → 11/07   |   | VKMA 01250<br>VKM 11250<br>VKM 21147   | 1<br>1<br>1   | 1   | 1   |   |   |   |   |   |   |   | T0184   |  |
|                                        | BKC, BLS  | 09/05 → 11/07   |   | VKPC 81418   |   |   |   |   |   |   | 1   |   |   |   |   |  |
|                                        | <b>B(Alt)</b> BKC, BLS  | 09/05 → 11/07   | <i>AC</i>   | VKMOV 6PK950<br>VKM 31054  | 1   |   | 1   |   |   |   |   |   |   |   |   |  |
|   | <b>B(Alt)</b> BKC, BLS  | 09/05 → 11/07   | <b>AC</b>   | VKMOV 6PK1050<br>VKM 31054   | 1   |   | 1   |   |   |   |   |   |   |   |   |  |
| <b>SEAT  LEON II (1P1) 1.9 TDI 110</b> |   |   |   |  |   |   |   |   |   |   |   |   |   |   |   |  |
|                                        | BXE, BXF  | 09/05 → 11/07   |   | VKMA 01250<br>VKM 11250<br>VKM 21147   | 1<br>1<br>1   | 1   | 1   |   |   |   |   |   |   |   | T0184   |  |
|                                        | BXE, BXF  | 09/05 → 11/07   |   | VKPC 81418   |   |   |   |   |   |   | 1   |   |   |   |   |  |



















|  | <b>B(Alt)</b> | BXE, BXF  | 09/05 → 11/07 | <b>AC</b> | VKMOV 6PK950<br>VKM 31054                         | 1      | 1           |   |   |  |  |         |
|--|---------------|---|---------------|-----------|---|--------|-------------|---|---|--|--|---------|
|  | <b>B(Alt)</b> | BXE, BXF  | 09/05 → 11/07 | <b>AC</b> | VKMOV 6PK1050<br>VKM 31054                        | 1      | 1           |   |   |  |  |         |
| <b>SEAT  LEON II (1P1) 2.0 TDI 140</b> |               |   |               |           |   |        |             |   |   |  |  |         |
|  |               | AZV, BKD  | 09/05 → 11/07 |           | VKMA _____<br>VKM 11255<br>VKM 21147<br>VKM _____ | 1<br>1 | 2<br>1<br>1 | 1 |   |  |  | 5 T0184 |
|  |               | BMM   | 10/05 → 11/07 |           | VKMA 01250<br>VKM 11250<br>VKM 21147              | 1<br>1 | 1<br>1      | 1 |   |  |  | T0184   |
|  |               | AZV, BKD  | 09/05 → 11/07 |           | VKPC 81627  |        |             |   | 1 |  |  |         |
|  |               | BMM   | 10/05 → 11/07 |           | VKPC 81303  |        |             |   | 1 |  |  |         |
|  | <b>B(Alt)</b> | AZV, BKD  | 09/05 → 11/07 | <b>AC</b> | VKMOV 6PK950<br>VKM 31022                         | 1      |             | 1 |   |  |  |         |
|  | <b>B(Alt)</b> | AZV, BKD  | 09/05 → 11/07 | <b>AC</b> | VKMOV 6PK1050<br>VKM 31022                        | 1      |             | 1 |   |  |  |         |
|  | <b>B(Alt)</b> | BMM   | 10/05 → 11/07 | <b>AC</b> | VKMOV 6PK950<br>VKM 31054                         | 1      |             | 1 |   |  |  |         |
|  | <b>B(Alt)</b> | BMM   | 10/05 → 11/07 | <b>AC</b> | VKMOV 6PK1050<br>VKM 31054                        | 1      |             | 1 |   |  |  |         |
| <b>SEAT  LEON II (1P1) 2.0 TDI 170</b> |               |   |               |           |   |        |             |   |   |  |  |         |
|  |               | BMN   | 02/06 → 11/07 |           | VKMA _____<br>VKM 11255<br>VKM 21147<br>VKM _____ | 1<br>1 | 2<br>1<br>1 | 1 |   |  |  | 5 T0184 |
|  |               | BMN   | 02/06 → 11/07 |           | VKPC _____  |        |             |   | 1 |  |  |         |
|  | <b>B(Alt)</b> | BMN   | 02/06 → 11/07 | <b>AC</b> | VKMOV 6PK950<br>VKM 31022                         | 1      |             | 1 |   |  |  |         |
|  | <b>B(Alt)</b> | BMN   | 02/06 → 11/07 | <b>AC</b> | VKMOV 6PK1050<br>VKM 31022                        | 1      |             | 1 |   |  |  |         |
| <b>SEAT  MALAGA 1.2</b>                |               |   |               |           |   |        |             |   |   |  |  |         |
|  |               | 021 A 1000, 021 C.1000                            | 11/84 → 12/93 |           | VKMA 02700<br>VKM 12700                           | 1<br>1 |             | 1 |   |  |  | T0026   |
|  |               | 021 A 1000, 021 C.1000                            | 11/84 → 12/93 |           | VKPC 82419  |        |             |   | 1 |  |  |         |
|  | <b>B(Alt)</b> | 021 A 1000, 021 C.1000                            | 11/84 → 12/93 |           | VKMOV 10AVx750                                    |        |             | 1 |   |  |  |         |
| <b>SEAT  MALAGA 1.5</b>                |               |   |               |           |   |        |             |   |   |  |  |         |
|  |               | 021 A 2000, 021 B.2000,<br>021 C.2000, 021 D.2000 | 05/85 → 12/93 |           | VKMA 02700<br>VKM 12700                           | 1<br>1 |             | 1 |   |  |  | T0026   |
|  |               | 021 A 2000, 021 B.2000,<br>021 C.2000, 021 D.2000 | 05/85 → 12/93 |           | VKPC 82419  |        |             |   | 1 |  |  |         |
|  | <b>B(Alt)</b> | 021 A 2000, 021 B.2000,<br>021 C.2000, 021 D.2000 | 05/85 → 12/93 |           | VKMOV 10AVx750                                    |        |             | 1 |   |  |  |         |
| <b>SEAT  MALAGA 1.7 D</b>              |               |   |               |           |   |        |             |   |   |  |  |         |
|  |               | 022 A.5000  | 05/85 → 12/92 |           | VKMA 02161<br>VKM 22160<br>VKM 22160              |        | 2<br>1<br>1 | 1 |   |  |  | T0648   |
|  |               | 022 A.5000  | 05/85 → 04/90 | 2)        | —   |        |             |   | 1 |  |  |         |
|  |               | 022 A.5000  | 01/91 → 12/93 | 2)        | VKPC 82410<br>VKPA 82435                          |        |             |   | 1 |  |  |         |
|  | <b>B(Alt)</b> | 022 A.5000  | 05/85 → 12/93 |           | VKMOV 10AVx838                                    |        |             | 1 |   |  |  |         |
| <b>SEAT  MARBELLA 0.8</b>              |               |   |               |           |   |        |             |   |   |  |  |         |
|  |               | 08 NCA  | 08/86 → 12/93 |           | <b>OXOXOXO</b>                                    |        |             |   |   |  |  |         |
|  |               | 08 NCA  | 08/86 → 12/93 | 2)        | VKPA 82202  |        |             |   | 1 |  |  |         |
|  | <b>B(Alt)</b> | 08 NCA  | 08/86 → 12/93 |           | VKMOV 10AVx800                                    |        |             | 1 |   |  |  |         |
| <b>SEAT  MARBELLA 0.9</b>              |               |   |               |           |   |        |             |   |   |  |  |         |
|  |               | 08 NCB, 09 NCA,<br>09 NCB                         | 01/87 → 10/98 |           | <b>OXOXOXO</b>                                    |        |             |   |   |  |  |         |
|  |               | 08 NCB, 09 NCA,<br>09 NCB                         | 01/87 → 10/98 | 2)        | VKPA 82202  |        |             |   | 1 |  |  |         |

|                                | <b>B(Alt)</b> | 08 NCB, 09 NCA,<br>09 NCB | 01/87 → 10/98 |    | VKMV 10AVx800                         |             |             | 1 |  |        |  |  |  |   |   |  |  |  |  |       |
|--------------------------------|---------------|---------------------------|---------------|----|---------------------------------------|-------------|-------------|---|--|--------|--|--|--|---|---|--|--|--|--|-------|
| <b>SEAT  PANDA 0.9</b>         |               |                           |               |    |                                       |             |             |   |  |        |  |  |  |   |   |  |  |  |  |       |
|                                |               |                           | 10/80 → 12/86 |    |                                       |             |             |   |  |        |  |  |  |   |   |  |  |  |  |       |
|                                |               |                           | 10/80 → 12/86 | 2) | VKPA 82220                            |             |             |   |  | 1      |  |  |  |   |   |  |  |  |  |       |
|                                | <b>B(Alt)</b> |                           | 10/80 → 12/86 |    | VKMV 10AVx800                         |             |             | 1 |  |        |  |  |  |   |   |  |  |  |  |       |
| <b>SEAT  RITMO 1.4</b>         |               |                           |               |    |                                       |             |             |   |  |        |  |  |  |   |   |  |  |  |  |       |
|                                | <b>B(Alt)</b> |                           | 07/78 → 09/83 |    | VKMV 10AVx850                         |             |             | 1 |  |        |  |  |  |   |   |  |  |  |  |       |
| <b>SEAT  RITMO 1.7 D</b>       |               |                           |               |    |                                       |             |             |   |  |        |  |  |  |   |   |  |  |  |  |       |
|                                |               | 022 A.5000                | 10/79 → 09/83 |    | VKMA 02161<br>VKM 22160<br>VKM 22160  |             | 2<br>1<br>1 | 1 |  |        |  |  |  |   |   |  |  |  |  | T0648 |
|                                |               | 022 A.5000                | 10/79 → 09/83 |    | VKPC 82410                            |             |             |   |  | 1      |  |  |  |   |   |  |  |  |  |       |
|                                | <b>B(Alt)</b> | 022 A.5000                | 10/79 → 09/83 |    | VKMV 10AVx825                         |             |             | 1 |  |        |  |  |  |   |   |  |  |  |  |       |
| <b>SEAT  RONDA 1.2</b>         |               |                           |               |    |                                       |             |             |   |  |        |  |  |  |   |   |  |  |  |  |       |
|                                |               | 021 A 1000, 124 B6.000    | 08/83 → 12/86 |    | VKMA 02700<br>VKM 12700               | 1<br>1      |             | 1 |  |        |  |  |  |   |   |  |  |  |  | T0026 |
|                                |               | 021 A 1000, 124 B6.000    | 08/83 → 12/86 |    | VKPC 82419                            |             |             |   |  | 1      |  |  |  |   |   |  |  |  |  |       |
| <b>SEAT  RONDA 1.4</b>         |               |                           |               |    |                                       |             |             |   |  |        |  |  |  |   |   |  |  |  |  |       |
|                                |               | 021 A 1000                | 06/82 → 11/88 |    | VKPC 82419                            |             |             |   |  | 1      |  |  |  |   |   |  |  |  |  |       |
| <b>SEAT  RONDA 1.5</b>         |               |                           |               |    |                                       |             |             |   |  |        |  |  |  |   |   |  |  |  |  |       |
|                                |               | 021 A 2000                | 09/84 → 12/86 |    | VKMA 02700<br>VKM 12700               | 1<br>1      |             | 1 |  |        |  |  |  |   |   |  |  |  |  | T0026 |
|                                |               | 021 A 1000                | 09/84 → 12/86 |    | VKPC 82419                            |             |             |   |  | 1      |  |  |  |   |   |  |  |  |  |       |
| <b>SEAT  RONDA 1.6</b>         |               |                           |               |    |                                       |             |             |   |  |        |  |  |  |   |   |  |  |  |  |       |
|                                |               | 022 A 1000                | 08/83 → 09/85 |    | —<br>VKM 12001                        | 1<br>1      |             | 1 |  |        |  |  |  |   |   |  |  |  |  | T0220 |
|                                |               | 138 AR 6000               | 08/83 → 09/85 |    | —<br>VKM 12012                        | 1           |             |   |  |        |  |  |  |   |   |  |  |  |  |       |
| <b>SEAT  RONDA 1.7 D</b>       |               |                           |               |    |                                       |             |             |   |  |        |  |  |  |   |   |  |  |  |  |       |
|                                |               | 022 A.5000                | 06/82 → 12/86 |    | VKMA 02161<br>VKM 22160<br>VKM 22160  |             | 2<br>1<br>1 | 1 |  |        |  |  |  |   |   |  |  |  |  | T0648 |
|                                |               | 022 A.5000                | 01/84 → 12/86 |    | VKPC 82410                            |             |             |   |  | 1      |  |  |  |   |   |  |  |  |  |       |
| <b>SEAT  TERRA 0.9</b>         |               |                           |               |    |                                       |             |             |   |  |        |  |  |  |   |   |  |  |  |  |       |
|                                |               | 09 NCA, 09 NCB            | 01/87 → 12/96 |    |                                       |             |             |   |  |        |  |  |  |   |   |  |  |  |  |       |
|                                |               | 09 NCA, 09 NCB            | 01/87 → 12/96 | 2) | VKPA 82202                            |             |             |   |  | 1      |  |  |  |   |   |  |  |  |  |       |
|                                | <b>B(Alt)</b> | 09 NCA, 09 NCB            | 01/87 → 06/93 |    | VKMV 10AVx800                         |             |             | 1 |  |        |  |  |  |   |   |  |  |  |  |       |
| <b>SEAT  TERRA 1.3 D</b>       |               |                           |               |    |                                       |             |             |   |  |        |  |  |  |   |   |  |  |  |  |       |
|                                |               | MN                        | 03/90 → 12/94 |    | VKMC 01101                            |             |             | 1 |  | 1      |  |  |  |   |   |  |  |  |  | T0229 |
|                                |               | MN                        | 03/90 → 12/94 |    | VKPC 81206                            |             |             |   |  | 1      |  |  |  |   |   |  |  |  |  |       |
|                                | <b>B(Alt)</b> | MN                        | 03/90 → 06/93 |    | VKMV 10AVx675                         |             |             | 1 |  |        |  |  |  |   |   |  |  |  |  |       |
| <b>SEAT  TERRA 1.4 D</b>       |               |                           |               |    |                                       |             |             |   |  |        |  |  |  |   |   |  |  |  |  |       |
|                                |               | 1 W                       | 10/90 → 12/95 |    | VKMC 01101                            |             |             | 1 |  | 1      |  |  |  |   |   |  |  |  |  | T0229 |
|                                |               | 1 W                       | 10/90 → 12/95 |    | VKPC 81206                            |             |             |   |  | 1      |  |  |  |   |   |  |  |  |  |       |
| <b>SEAT  TOLEDO I (1L) 1.6</b> |               |                           |               |    |                                       |             |             |   |  |        |  |  |  |   |   |  |  |  |  |       |
|                                |               | 1F, ABN, EZ               | 05/91 → 03/99 | 3) | VKMS 01000<br>VKMA 01000<br>VKM 11000 | 1<br>1<br>1 |             | 1 |  |        |  |  |  | 3 | 4 |  |  |  |  | T0005 |
|                                |               | AFT                       | 11/96 → 03/99 |    | VKMA 01009<br>VKM 11000               | 1<br>1      |             | 1 |  |        |  |  |  |   | 3 |  |  |  |  | T0124 |
|                                |               | 1F, ABN, AFT, EZ          | 05/91 → 03/99 | 2) | VKPA 81401<br>VKPC 81401              |             |             |   |  | 1<br>1 |  |  |  |   |   |  |  |  |  |       |
|                                | <b>B(Alt)</b> | 1F                        | 05/91 → 03/99 |    | → ICH 1L-ZD304 850                    |             |             |   |  | 1      |  |  |  |   |   |  |  |  |  |       |
|                                | <b>B(Alt)</b> | 1F                        | 05/91 → 03/99 |    | → ICH 1L-ZD304 850                    |             |             |   |  | 1      |  |  |  |   |   |  |  |  |  |       |
|                                | <b>B(Alt)</b> | 1F                        | 05/91 → 03/99 |    | → ICH 1L-ZD304 850                    |             |             |   |  | 1      |  |  |  |   |   |  |  |  |  |       |



























|   |  |  |  |  |  |  |  |  |  |  |  |  |       |
|---|---|---|---|--|---|---|---|---|---|---|---|---|-------|
| B(Alt)  | 1F  | 05/91 → 03/99   | A⊙, AC,<br>CH1L-ZD 304 851 I→   | VKMOV 6PK894   |   |   | 1   |   |   |   |   |   |       |
| B(Alt)  | 1F  | 05/91 → 03/99   | A⊙, AC,<br>CH1L-ZD 304 851 I→   | VKMOV 6PK1153<br>VKM 31004<br>VKM 31210  | 1   |   | 1   |   |   |   |   |   |       |
| B(Alt)  | ABN, EZ   | 05/91 → 03/99   | ⊙   | VKMOV 10AVx950   |   |   | 1   |   |   |   |   |   |       |
| B(Alt)  | ABN, EZ   | 05/91 → 03/99   | ⊙   | VKMOV 10AVx865   |   |   | 1   |   |   |   |   |   |       |
| B(Alt)  | AFT   | 11/96 → 03/99   | A⊙, AC  | VKMOV 6PK894   |   |   | 1   |   |   |   |   |   |       |
| B(Alt)  | AFT   | 11/96 → 03/99   | A⊙, AC  | VKMOV 6PK1153<br>VKM 31004<br>VKM 31210  | 1   |   | 1   |   |   |   |   |   |       |
| B(PS)   | 1F  | 05/91 → 03/99   | →ICH1L-ZD304 850  | VKMOV 10AVx730   |   |   | 1   |   |   |   |   |   |       |
| B(PS)   | 1F  | 05/91 → 03/99   | AC,<br>CH1L-ZD304 851 I→  | VKMOV 11.5x685   |   |   | 1   |   |   |   |   |   |       |
| B(PS)   | 1F  | 05/91 → 03/99   | AC, CH1L-ZD304 851 I→   | VKMOV 11.5x755   |   |   | 1   |   |   |   |   |   |       |
| B(PS)   | ABN, EZ   | 05/91 → 03/99   |   | VKMOV 10AVx730   |   |   | 1   |   |   |   |   |   |       |
| B(PS)   | AFT   | 11/96 → 03/99   | AC  | VKMOV 11.5x685   |   |   | 1   |   |   |   |   |   |       |
| B(PS)   | AFT   | 11/96 → 03/99   | AC  | VKMOV 11.5x755   |   |   | 1   |   |   |   |   |   |       |
| B(AC)   | 1F  | 05/91 → 03/99   | →ICH1L-ZD304 850  | VKMOV 13AVx950   |   |   | 1   |   |   |   |   |   |       |
| <b>SEAT  TOLEDO I (1L) 1.8</b>       |   |   |   |  |   |   |   |   |   |   |   |   |       |
|                                       | ABS, ADZ, RP  | 05/91 → 12/96   | 3)  | VKMS 01000<br>VKMA 01000<br>VKM 11000  | 1<br>1<br>1   |   | 1   |   |   |   | 3   | 4<br>3  | T0005 |
|                                     | ABS, ADZ, RP  | 05/91 → 12/96   | 2)  | VKPA 81401<br>VKPC 81401   |   |   |   | 1<br>1  |   |   |   |   |       |
|                                     | B(Alt) ABS, ADZ   | 11/93 → 12/96   | A⊙  | VKMOV 6PK894   |   |   | 1   |   |   |   |   |   |       |
|   | B(Alt) ABS, ADZ   | 11/93 → 12/96   | A⊙, AC  | VKMOV 6PK1033<br>VKM 31004<br>VKM 31210  | 1<br>1  |   | 1   |   |   |   |   |   |       |
|   | B(Alt) ABS, ADZ   | 11/93 → 12/96   | A⊙, AC  | VKMOV 6PK1153<br>VKM 31004<br>VKM 31210  | 1<br>1  |   | 1   |   |   |   |   |   |       |
|   | B(Alt) RP   | 05/91 → 12/96   |   | VKMOV 10AVx865   |   |   | 1   |   |   |   |   |   |       |
|   | B(PS) ABS, ADZ  | 11/93 → 12/96   | AC  | VKMOV 11.5x685   |   |   | 1   |   |   |   |   |   |       |
|   | B(PS) ABS, ADZ  | 11/93 → 12/96   | AC  | VKMOV 11.5x755   |   |   | 1   |   |   |   |   |   |       |
|   | B(PS) RP  | 05/91 → 12/96   |   | VKMOV 10AVx730   |   |   | 1   |   |   |   |   |   |       |
|   | B(AC) RP  | 05/91 → 12/96   |   | VKMOV 10AVx730   |   |   | 1   |   |   |   |   |   |       |
| <b>SEAT  TOLEDO I (1L) 1.8 16V</b> |   |   |   |  |   |   |   |   |   |   |   |   |       |
|                                     | KR, PL  | 05/91 → 03/99   |   | VKMA 01020<br>VKM 11020  | 1<br>1  |   | 1   |   |   |   |   |   | T0057 |
|                                     | KR, PL  | 05/91 → 03/99   | 2)  | VKPA 81401<br>VKPC 81401   |   |   |   | 1<br>1  |   |   |   |   |       |
|                                     | B(Alt) KR, PL   | 05/91 → 03/99   |   | VKMOV 10AVx950   |   |   | 1   |   |   |   |   |   |       |
|   | B(PS) KR, PL  | 05/91 → 03/99   |   | VKMOV 10AVx630   |   |   | 1   |   |   |   |   |   |       |
|   | B(AC) KR, PL  | 05/91 → 03/99   |   | VKMOV 10AVx730   |   |   | 1   |   |   |   |   |   |       |
| <b>SEAT  TOLEDO I (1L) 2.0</b>     |   |   |   |  |   |   |   |   |   |   |   |   |       |
|                                     | 2E, AGG   | 05/91 → 03/99   |   | VKMA 01002<br>VKM 11000  | 1<br>1  |   | 1   |   |   |   |   | 3   | T0091 |
|                                     | 2E, AGG   | 05/91 → 03/99   | 2)  | VKPA 81401<br>VKPC 81401   |   |   |   | 1<br>1  |   |   |   |   |       |
|                                     | B(Alt) 2E, AGG  | 05/91 → 03/99   | A⊙,<br>CH1L-ZD304 851 I→  | VKMOV 6PK894   |   |   | 1   |   |   |   |   |   |       |
|   | B(Alt) 2E, AGG  | 05/91 → 03/99   | A⊙, AC,<br>CH1L-ZD 304 851 I→   | VKMOV 6PK1153<br>VKM 31004<br>VKM 31210  | 1<br>1  |   | 1   |   |   |   |   |   |       |
|   | B(PS) 2E, AGG   | 05/91 → 03/99   | AC,<br>CH1L-ZD304 851 I→  | VKMOV 11.5x685   |   |   | 1   |   |   |   |   |   |       |
|   | B(PS) 2E, AGG   | 05/91 → 03/99   | AC, CH1L-ZD304 851 I→   | VKMOV 11.5x755   |   |   | 1   |   |   |   |   |   |       |



| SEAT  TOLEDO I (1L) 2.0 16V   |                 |               |                                       |   |             |             |  |  |        |  |  |  |   |  |       |
|--|-----------------|---------------|---------------------------------------|---|-------------|-------------|--|--|--------|--|--|--|---|--|-------|
|                               | ABF             | 11/93 → 03/99 |                                       | VKMA 01024<br>VKM 11021   | 1<br>1      | 1           |  |  |        |  |  |  |   |  | T0114 |
|                               | ABF             | 11/93 → 03/99 | 2)                                    | VKPA 81401<br>VKPC 81401  |             |             |  |  | 1<br>1 |  |  |  |   |  |       |
|                               | B(Alt) ABF      | 11/93 → 03/99 | <i>AC</i>                             | VKMOV 6PK1033<br>VKM 31004<br>VKM 31210                                 | 1<br>1      | 1           |  |  |        |  |  |  |   |  |       |
|  | B(Alt) ABF      | 11/93 → 03/99 | <b>AC</b>                             | VKMOV 6PK1153<br>VKM 31004<br>VKM 31210                                 | 1<br>1      | 1           |  |  |        |  |  |  |   |  |       |
|  | B(PS) ABF       | 11/93 → 03/99 | <i>AC</i>                             | VKMOV 11.5x685  |             | 1           |  |  |        |  |  |  |   |  |       |
|  | B(PS) ABF       | 11/93 → 03/99 | <b>AC</b>                             | VKMOV 11.5x755  |             | 1           |  |  |        |  |  |  |   |  |       |
| SEAT  TOLEDO I (1L) 1.9 D     |                 |               |                                       |   |             |             |  |  |        |  |  |  |   |  |       |
|                               | 1Y              | 05/91 → 12/96 |                                       | VKMA 01011<br>VKM 11010   | 1<br>1      | 1           |  |  |        |  |  |  | 4 |  | T0069 |
|  | 1Y              | 01/97 → 03/99 | → Mot. 705 902                        | VKMA 01011<br>VKM 11010   | 1<br>1      | 1           |  |  |        |  |  |  | 4 |  | T0069 |
|  | 1Y              | 01/97 → 03/99 | Mot. 705 903  →                       | VKMA 01013<br>VKM 11014   | 1<br>1      | 1           |  |  |        |  |  |  | 4 |  | T0069 |
|                               | 1Y              | 05/91 → 03/99 | 2)                                    | VKPA 81401<br>VKPC 81401  |             |             |  |  | 1<br>1 |  |  |  |   |  |       |
|                               | B(Alt) 1Y       | 05/91 → 03/99 | <i>A⊙</i> ,<br>CH 1L-ZD304 851  →     | VKMOV 6PK923  |             | 1           |  |  |        |  |  |  |   |  |       |
|  | B(Alt), B(PS)1Y | 05/91 → 03/99 | <i>A⊙, AC</i> ,<br>CH 1L-ZD304 851  → | VKMA 31028<br>VKMOV 10AVx730<br>VKMOV 6PK1045<br>VKM 31004<br>VKM 31030 | 2<br>1<br>1 | 2<br>1<br>1 |  |  |        |  |  |  |   |  |       |
|  | B(Alt), B(PS)1Y | 05/91 → 03/99 | <i>A⊙, AC</i> ,<br>CH 1L-ZD304 851  → | VKMA 31030<br>VKMOV 11.5x790<br>VKMOV 6PK1145<br>VKM 31004<br>VKM 31030 | 2<br>1<br>1 | 2<br>1<br>1 |  |  |        |  |  |  |   |  |       |
|                             | 1Y              | 05/91 → 03/99 |                                       | VKM_____  |             |             |  |  | 1      |  |  |  |   |  |       |
| SEAT  TOLEDO I (1L) 1.9 SDI |                 |               |                                       |   |             |             |  |  |        |  |  |  |   |  |       |
|                             | 1Y              | 12/95 → 12/96 |                                       | VKMA 01011<br>VKM 11010   | 1<br>1      | 1           |  |  |        |  |  |  | 4 |  | T0069 |
|  | 1Y              | 01/97 → 03/99 | → Mot. 705 902                        | VKMA 01011<br>VKM 11010   | 1<br>1      | 1           |  |  |        |  |  |  | 4 |  | T0069 |
|  | 1Y              | 01/97 → 03/99 | Mot. 705 903  →                       | VKMA 01013<br>VKM 11014   | 1<br>1      | 1           |  |  |        |  |  |  | 4 |  | T0069 |
|                             | 1Y              | 12/95 → 03/99 | 2)                                    | VKPA 81401<br>VKPC 81401  |             |             |  |  | 1<br>1 |  |  |  |   |  |       |
|                             | B(Alt) 1Y       | 12/95 → 03/99 | <i>A⊙</i> ,<br>CH 1L-ZD304 851  →     | VKMOV 6PK923  |             | 1           |  |  |        |  |  |  |   |  |       |
|  | B(Alt), B(PS)1Y | 12/95 → 03/99 | <i>A⊙, AC</i>                         | VKMA 31028<br>VKMOV 10AVx730<br>VKMOV 6PK1045<br>VKM 31004<br>VKM 31030 | 2<br>1<br>1 | 2<br>1<br>1 |  |  |        |  |  |  |   |  |       |
|  | B(Alt), B(PS)1Y | 12/95 → 03/99 | <i>A⊙, AC</i>                         | VKMA 31030<br>VKMOV 11.5x790<br>VKMOV 6PK1145<br>VKM 31004<br>VKM 31030 | 2<br>1<br>1 | 2<br>1<br>1 |  |  |        |  |  |  |   |  |       |
|                             | 1Y              | 12/95 → 03/99 |                                       | VKM_____  |             |             |  |  | 1      |  |  |  |   |  |       |
| SEAT  TOLEDO I (1L) 1.9 TD  |                 |               |                                       |   |             |             |  |  |        |  |  |  |   |  |       |
|                             | AAZ             | 05/91 → 12/96 |                                       | VKMA 01011<br>VKM 11010   | 1<br>1      | 1           |  |  |        |  |  |  | 4 |  | T0069 |
|  | AAZ             | 01/97 → 03/99 | → Mot. 634 078                        | VKMA 01011<br>VKM 11010   | 1<br>1      | 1           |  |  |        |  |  |  | 4 |  | T0069 |



|   |  |  |  |  |  |  |  |  |  |  |  |  |
|---|---|---|---|--|---|---|---|---|---|---|---|---|
|   | AAZ   | 01/97 → 03/99   | Mot. 634 079 I→   | VKMA 01013<br>VKM 11014  | 1<br>1  | 1   |   |   |   |   |   | 4 T0069   |
|   | AAZ   | 05/91 → 03/99   | 2)  | VKPA 81401<br>VKPC 81401   |   |   |   | 1<br>1  |   |   |   |   |
|   | B(Alt) AAZ  | 05/91 → 03/99   | A⊙,<br>CH 1L-ZD304 851 I→   | VKMV 6PK923  |   | 1   |   |   |   |   |   |   |
|   | B(Alt), B(PS)AAZ  | 05/91 → 03/99   | A⊙, A⊙,<br>CH 1L-ZD304 851 I→   | VKMA 31028<br>VKMV 10AVx730<br>VKMV 6PK1045<br>VKM 31004<br>VKM 31030              | 2<br>1<br>1<br>1<br>1   | 2<br>1<br>1   |   |   |   |   |   |   |
|   | B(Alt), B(PS)AAZ  | 05/91 → 03/99   | A⊙, AC,<br>CH 1L-ZD304 851 I→   | VKMA 31030<br>VKMV 11.5x790<br>VKMV 6PK1145<br>VKM 31004<br>VKM 31030              | 2<br>1<br>1<br>1<br>1   | 2<br>1<br>1   |   |   |   |   |   |   |
|   | AAZ   | 05/91 → 03/99   |   | VKM _____  |   |   |   |   | 1   |   |   |   |
| <b>SEAT  TOLEDO I (1L) 1.9 TDI 90</b>    |   |   |   |  |   |   |   |   |   |   |   |   |
|   | 1Z, AHU   | 08/95 → 12/96   |   | VKMA 01012<br>VKM 11012<br>VKM 21012   | 1<br>1<br>1   | 1<br>1  | 1   |   |   |   |   | 5 T0650   |
|   | 1Z  | 01/97 → 03/99   | → I Mot. 289 575  | VKMA 01012<br>VKM 11012<br>VKM 21012   | 1<br>1<br>1   | 1<br>1  | 1   |   |   |   |   | 5 T0650   |
|   | 1Z  | 01/97 → 03/99   | Mot. 289 576 I→   | VKMA 01014<br>VKM 11014<br>VKM 21012   | 1<br>1<br>1   | 1<br>1  | 1   |   |   |   |   | 5 T0650   |
|   | AHU   | 01/97 → 03/99   | → I Mot. 136 385  | VKMA 01012<br>VKM 11012<br>VKM 21012   | 1<br>1<br>1   | 1<br>1  | 1   |   |   |   |   | 5 T0650   |
|   | AHU   | 01/97 → 03/99   | Mot. 136 386 I→   | VKMA 01014<br>VKM 11014<br>VKM 21012   | 1<br>1<br>1   | 1<br>1  | 1   |   |   |   |   | 5 T0650   |
|   | 1Z, AHU   | 08/95 → 03/99   | 2)  | VKPA 81401<br>VKPC 81401   |   |   |   | 1<br>1  |   |   |   |   |
|   | B(Alt) 1Z, AHU  | 08/95 → 03/99   | A⊙,<br>CH 1L-ZD304 851 I→   | VKMV 6PK923  |   | 1   |   |   |   |   |   |   |
|   | B(Alt), B(PS)1Z, AHU  | 08/95 → 03/99   | A⊙, A⊙  | VKMA 31028<br>VKMV 10AVx730<br>VKMV 6PK1045<br>VKM 31004<br>VKM 31030              | 2<br>1<br>1<br>1<br>1   | 2<br>1<br>1   |   |   |   |   |   |   |
|   | B(PS), B(AC)1Z, AHU   | 08/95 → 03/99   | A⊙, AC  | VKMA 31030<br>VKMV 11.5x790<br>VKMV 6PK1145<br>VKM 31004<br>VKM 31030              | 2<br>1<br>1<br>1<br>1   | 2<br>1<br>1   |   |   |   |   |   |   |
|   | 1Z, AHU   | 08/95 → 03/99   |   | VKM _____  |   |   |   |   | 1   |   |   |   |
| <b>SEAT  TOLEDO I (1L) 1.9 TDI 110</b> |   |   |   |  |   |   |   |   |   |   |   |   |
|   | AFN   | 11/96 → 03/99   | → I Mot. 136 733  | VKMA 01012<br>VKM 11012<br>VKM 21012   | 1<br>1<br>1   | 1<br>1  | 1   |   |   |   |   | 5 T0650   |
|   | AFN   | 11/96 → 03/99   | Mot. 136 734 I→   | VKMA 01014<br>VKM 11014<br>VKM 21012   | 1<br>1<br>1   | 1<br>1  | 1   |   |   |   |   | 5 T0650   |
|   | AFN   | 11/96 → 03/99   | 2)  | VKPA 81401<br>VKPC 81401   |   |   |   | 1<br>1  |   |   |   |   |
|   | B(Alt) AFN  | 11/96 → 03/99   | A⊙,<br>CH 1L-ZD304 851 I→   | VKMV 6PK923  |   | 1   |   |   |   |   |   |   |
|   | B(Alt), B(PS)AFN  | 11/96 → 03/99   | A⊙, A⊙  | VKMA 31028<br>VKMV 10AVx730<br>VKMV 6PK1045<br>VKM 31004<br>VKM 31030              | 2<br>1<br>1<br>1<br>1   | 2<br>1<br>1   |   |   |   |   |   |   |



|                                      | B(Alt), B(PS)AFN     | 11/96 → 03/99 | A ⊙ AC                               | VKMA 31030<br>VKMV 11.5x790<br>VKMV 6PK1145<br>VKM 31004<br>VKM 31030 | 2<br>1<br>1           | 2<br>1 |        |  |  |   |   |  |  |       |
|--------------------------------------|----------------------|---------------|--------------------------------------|---|-----------------------|--------|--------|--|--|---|---|--|--|-------|
| ⊙                                    | AFN                  | 11/96 → 03/99 |                                      | VKM _____   |                       |        |        |  |  |   | 1 |  |  |       |
| <b>SEAT  TOLEDO II (1M2) 1.4 16V</b> |                      |               |                                      |   |                       |        |        |  |  |   |   |  |  |       |
|                                      | AHW                  | 07/99 → 05/06 | →   Mot. 160 000                     | VKMA 01120<br>VKM 11120<br>VKM 11121<br>VKM 21120<br>VKM 21121        | 2<br>1<br>1<br>1<br>1 | 2<br>2 | 2      |  |  |   |   |  |  | T0165 |
|                                      | AHW                  | 07/99 → 05/06 | Mot. 160 001   →                     | VKMA 01121<br>VKM 11120<br>VKM 11124<br>VKM 21120<br>VKM 21121        | 2<br>1<br>1<br>1<br>1 | 2<br>2 | 2      |  |  |   |   |  |  | T0165 |
|                                      | APE, AXP             | 07/99 → 05/06 |                                      | VKMA 01121<br>VKM 11120<br>VKM 11124<br>VKM 21120<br>VKM 21121        | 2<br>1<br>1<br>1<br>1 | 2<br>2 | 2      |  |  |   |   |  |  | T0165 |
|                                      | AHW, APE, AWP        | 07/99 → 05/06 |                                      | VKPC 81407  |                       |        |        |  |  | 1 |   |  |  |       |
|                                      | B(Alt) AHW, APE, AXP | 07/99 → 05/06 | AC                                   | VKMA 31206<br>VKMV 6PK1078<br>VKM 31015                               | 1<br>1                |        | 1<br>1 |  |  |   |   |  |  |       |
|                                      | B(Alt) AHW, APE, AXP | 07/99 → 05/06 | AC                                   | VKMA 31207<br>VKMV 6PK1548<br>VKM 31016<br>VKM 31207                  | 1<br>1<br>1           | 1      | 1<br>1 |  |  |   |   |  |  |       |
| <b>SEAT  TOLEDO II (1M2) 1.6</b>     |                      |               |                                      |   |                       |        |        |  |  |   |   |  |  |       |
|                                      | AEH, AKL             | 04/99 → 09/00 |                                      | VKMA 01113<br>VKM 11113   | 1<br>1                |        | 1      |  |  |   |   |  |  | T0149 |
|                                      | AEH, AKL             | 04/99 → 09/00 |                                      | VKPC 81408  |                       |        |        |  |  | 1 |   |  |  |       |
|                                      | B(Alt) AEH, AKL      | 04/99 → 09/00 | AC                                   | VKMA 31203<br>VKMV 6PK1120<br>VKM 31011                               | 1<br>1                |        | 1<br>1 |  |  |   |   |  |  |       |
|                                      | B(Alt) AEH, AKL      | 04/99 → 09/00 | AC                                   | VKMA 31204<br>VKMV 6DK1195<br>VKM 31011                               | 1<br>1                |        | 1<br>1 |  |  |   |   |  |  |       |
| <b>SEAT  TOLEDO II (1M2) 1.6 16V</b> |                      |               |                                      |   |                       |        |        |  |  |   |   |  |  |       |
|                                      | AUS, AZD, BCB        | 09/00 → 05/06 |                                      | VKMA 01121<br>VKM 11120<br>VKM 11124<br>VKM 21120<br>VKM 21121        | 2<br>1<br>1<br>1<br>1 | 2<br>2 | 2      |  |  |   |   |  |  | T0165 |
|                                      | AUS, AZD, BCB        | 09/00 → 05/06 |                                      | VKPC 81419  |                       |        |        |  |  | 1 |   |  |  |       |
|                                      | B(Alt) AUS, AZD, BCB | 09/00 → 05/06 | AC                                   | VKMA 31206<br>VKMV 6PK1078<br>VKM 31015                               | 1<br>1                |        | 1<br>1 |  |  |   |   |  |  |       |
|                                      | B(Alt) AUS, AZD, BCB | 09/00 → 05/06 | AC                                   | VKMA 31207<br>VKMV 6PK1548<br>VKM 31016<br>VKM 31207                  | 1<br>1<br>1           | 1      | 1<br>1 |  |  |   |   |  |  |       |
| <b>SEAT  TOLEDO II (1M2) 1.8 20V</b> |                      |               |                                      |   |                       |        |        |  |  |   |   |  |  |       |
|                                      | AGN, APG             | 04/99 → 05/06 | → ICH 1M-YB088 000,<br>1M-YR016 500  | VKMA 01115<br>VKM 11115<br>VKM 21115                                  | 1<br>1<br>1           | 1      | 1<br>1 |  |  |   |   |  |  | T0151 |
|                                      | AGN, APG             | 04/99 → 05/06 | CH 1M-YB088 001,<br>1M-YR016 501   → | VKMA 01116<br>VKM 11116<br>VKM 21115                                  | 1<br>1<br>1           | 1      | 1<br>1 |  |  |   |   |  |  | T0151 |
|                                      | AGN, APG             | 04/99 → 05/06 |                                      | VKPC 81620  |                       |        |        |  |  | 1 |   |  |  |       |



























|   | <b>B(Alt)</b> | AGN, APG           | 04/99 → 05/06 | <b>AC</b>  | VKMA 31203<br>VKMV 6PK1120<br>VKM 31011                        | 1 | 1 |   |  |   |   |  |             |
|---|---------------|--------------------|---------------|--|--|---|---|---|--|---|---|--|-------------|
|   | <b>B(Alt)</b> | AGN, APG           | 04/99 → 05/06 | <b>AC</b>  | VKMA 31204<br>VKMV 6DK1195<br>VKM 31011                        | 1 | 1 |   |  |   |   |  |             |
| <b>SEAT  TOLEDO II (1M2) 1.8 Turbo</b>  |               |                    |               |  |  |   |   |   |  |   |   |  |             |
|   |               | AJQ, APP, ARY, AUQ | 05/01 → 05/06 | → <b>ICH</b> 1M-YB088 000,<br>1M-YR016 500         | VKMA 01115<br>VKM 11115<br>VKM 21115                           | 1 | 1 | 1 |  |   |   |  | T0151       |
|   |               | AJQ, APP, ARY, AUQ | 05/01 → 05/06 | <b>CH</b> 1M-YB088 001,<br>1M-YR016 501   →        | VKMA 01116<br>VKM 11116<br>VKM 21115                           | 1 | 1 | 1 |  |   |   |  | T0151       |
|   |               | AJQ, APP, ARY, AUQ | 05/01 → 05/06 |  | VKPC 81620   |   |   |   |  | 1 |   |  |             |
|   | <b>B(Alt)</b> | AJQ, APP, ARY, AUQ | 05/01 → 05/06 | <b>AC</b>  | VKMA 31203<br>VKMV 6PK1120<br>VKM 31011                        | 1 | 1 |   |  |   |   |  |             |
|   | <b>B(Alt)</b> | AJQ, APP, ARY, AUQ | 05/01 → 05/06 | <b>AC</b>  | VKMA 31204<br>VKMV 6DK1195<br>VKM 31011                        | 1 | 1 |   |  |   |   |  |             |
| <b>SEAT  TOLEDO II (1M2) 2.3 V5</b>     |               |                    |               |  |  |   |   |   |  |   |   |  |             |
|   |               | AGZ, AQN           | 04/99 → 05/06 |  | <del>XXXXXX</del>  |   |   |   |  |   |   |  |             |
|   |               | AGZ, AQN           | 04/99 → 05/06 |  | VKPC 81622   |   |   |   |  | 1 |   |  |             |
|   | <b>B(Alt)</b> | AGZ                | 04/99 → 05/01 | <b>AC</b>  | VKMV 6PK1285   |   |   | 1 |  |   |   |  |             |
|   | <b>B(Alt)</b> | AQN                | 05/01 → 05/06 | <b>AC</b>  | VKMV 6PK1264   |   |   | 1 |  |   |   |  |             |
| <b>SEAT  TOLEDO II (1M2) 1.9 SDI</b>    |               |                    |               |  |  |   |   |   |  |   |   |  |             |
|   |               | AQM                | 11/99 → 06/04 | → <b>IMot.</b> 029 999                             | VKMA 01130<br>VKM 11130<br>VKM 21004<br>VKM 21130              | 1 | 2 | 1 |  |   |   |  | 5 T0173     |
|   |               | AQM                | 11/99 → 06/04 | <b>Mot.</b> 030 000   →,<br>→ <b>IMot.</b> 045 000 | VKMA 01131<br>VKM 11130<br>VKM 21004<br>VKM 21130<br>VKM 21131 | 1 | 3 | 1 |  |   |   |  | 8 T0173     |
|   |               | AQM                | 11/99 → 06/04 | <b>Mot.</b> 045 001   →                            | VKMA 01251<br>VKM 11130<br>VKM 21004<br>VKM 21130<br>VKM 21131 | 1 | 3 | 1 |  |   |   |  | 8 T0173     |
|   |               | AQM                | 11/99 → 06/04 |  | VKPC 81623   |   |   |   |  | 1 |   |  |             |
|   | <b>B(Alt)</b> | AQM                | 11/99 → 06/04 | <b>AC</b>  | VKMV 6PK906<br>VKM 31018                                       | 1 |   | 1 |  |   |   |  | 1           |
|   | <b>B(Alt)</b> | AQM                | 11/99 → 06/04 | <b>AC</b>  | VKMA 31005<br>VKMV 6PK1660<br>VKM 31002<br>VKM 31018           | 1 | 1 | 1 |  |   |   |  | 2<br>1<br>1 |
|   |               | AQM                | 11/99 → 06/04 | → <b>ICH</b> 1M-3R099 130                          | VKM _____  |   |   |   |  |   | 1 |  |             |
|   |               | AQM                | 11/99 → 06/04 | <b>CH</b> 1M-3R099 131   →                         | VKM _____  |   |   |   |  |   | 1 |  |             |
| <b>SEAT  TOLEDO II (1M2) 1.9 TDI 90</b> |               |                    |               |  |  |   |   |   |  |   |   |  |             |
|   |               | AGR                | 04/99 → 05/06 | → <b>IMot.</b> 565 000                             | VKMA 01131<br>VKM 11130<br>VKM 21004<br>VKM 21130<br>VKM 21131 | 1 | 3 | 1 |  |   |   |  | 8 T0173     |
|   |               | AGR                | 04/99 → 05/06 | <b>Mot.</b> 565 001   →                            | VKMA 01251<br>VKM 11130<br>VKM 21004<br>VKM 21130<br>VKM 21131 | 1 | 3 | 1 |  |   |   |  | 8 T0173     |
|   |               | ALH                | 04/99 → 05/06 | → <b>IMot.</b> 500 000                             | VKMA 01131<br>VKM 11130  | 1 | 3 | 1 |  |   |   |  | 8 T0173     |

|  |                        |               |                    | VKM 21004    |   | 1 |   |   |   |   |  |   |       |
|--|------------------------|---------------|--------------------|--------------|---|---|---|---|---|---|--|---|-------|
|  |                        |               |                    | VKM 21130    |   | 1 |   |   |   |   |  |   |       |
|  |                        |               |                    | VKM 21131    |   | 1 |   |   |   |   |  |   |       |
|  | ALH                    | 04/99 → 05/06 | Mot. 500 001 I→    | VKMA 01251   | 1 | 3 | 1 |   |   |   |  | 8 | T0173 |
|  |                        |               |                    | VKM 11130    | 1 |   |   |   |   |   |  |   |       |
|  |                        |               |                    | VKM 21004    |   | 1 |   |   |   |   |  |   |       |
|  |                        |               |                    | VKM 21130    |   | 1 |   |   |   |   |  |   |       |
|  |                        |               |                    | VKM 21131    |   | 1 |   |   |   |   |  |   |       |
|  | AGR, ALH               | 04/99 → 05/06 |                    | VKPC 81623   |   |   |   |   | 1 |   |  |   |       |
|  | <b>B(Alt)</b> AGR, ALH | 04/99 → 05/06 | <b>AC</b>          | VKMV 6PK906  |   |   | 1 |   |   |   |  |   |       |
|  |                        |               |                    | VKM 31002    | 1 | 1 |   |   |   |   |  | 1 |       |
|  |                        |               |                    | VKM 31012    |   |   |   |   |   |   |  |   |       |
|  | <b>B(Alt)</b> AGR, ALH | 04/99 → 05/06 | <b>AC</b>          | VKMA 31014   | 1 | 1 | 1 |   |   |   |  | 1 |       |
|  |                        |               |                    | VKMV 6PK1660 |   |   | 1 |   |   |   |  |   |       |
|  |                        |               |                    | VKM 31002    |   | 1 |   |   |   |   |  | 1 |       |
|  |                        |               |                    | VKM 31012    | 1 |   |   |   |   |   |  |   |       |
|  | AGR, ALH               | 04/99 → 05/06 | → ICH 1M-3R099 130 | VKM _____    |   |   |   |   |   | 1 |  |   |       |
|  | AGR, ALH               | 04/99 → 05/06 | CH 1M-3R099 131 I→ | VKM _____    |   |   |   |   |   | 1 |  |   |       |
| <b>SEAT  TOLEDO II (1M2) 1.9 TDI 110</b> |                        |               |                    |              |   |   |   |   |   |   |  |   |       |
|  | AHF                    | 04/99 → 05/06 | → I Mot. 595 000   | VKMA 01131   | 1 | 3 | 1 |   |   |   |  | 8 | T0173 |
|  |                        |               |                    | VKM 11130    | 1 |   |   |   |   |   |  |   |       |
|  |                        |               |                    | VKM 21004    |   | 1 |   |   |   |   |  |   |       |
|  |                        |               |                    | VKM 21130    |   | 1 |   |   |   |   |  |   |       |
|  |                        |               |                    | VKM 21131    |   | 1 |   |   |   |   |  |   |       |
|  | AHF                    | 04/99 → 05/06 | Mot. 595 001 I→    | VKMA 01251   | 1 | 3 | 1 |   |   |   |  | 8 | T0173 |
|  |                        |               |                    | VKM 11130    | 1 |   |   |   |   |   |  |   |       |
|  |                        |               |                    | VKM 21004    |   | 1 |   |   |   |   |  |   |       |
|  |                        |               |                    | VKM 21130    |   | 1 |   |   |   |   |  |   |       |
|  |                        |               |                    | VKM 21131    |   | 1 |   |   |   |   |  |   |       |
|  | ASV                    | 04/99 → 05/06 | → I Mot. 150 000   | VKMA 01131   | 1 | 3 | 1 |   |   |   |  | 8 | T0173 |
|  |                        |               |                    | VKM 11130    | 1 |   |   |   |   |   |  |   |       |
|  |                        |               |                    | VKM 21004    |   | 1 |   |   |   |   |  |   |       |
|  |                        |               |                    | VKM 21130    |   | 1 |   |   |   |   |  |   |       |
|  |                        |               |                    | VKM 21131    |   | 1 |   |   |   |   |  |   |       |
|  | ASV                    | 04/99 → 05/06 | Mot. 150 001 I→    | VKMA 01251   | 1 | 3 | 1 |   |   |   |  | 8 | T0173 |
|  |                        |               |                    | VKM 11130    | 1 |   |   |   |   |   |  |   |       |
|  |                        |               |                    | VKM 21004    |   | 1 |   |   |   |   |  |   |       |
|  |                        |               |                    | VKM 21130    |   | 1 |   |   |   |   |  |   |       |
|  |                        |               |                    | VKM 21131    |   | 1 |   |   |   |   |  |   |       |
|  | AHF, ASV               | 04/99 → 05/06 |                    | VKPC 81623   |   |   |   |   | 1 |   |  |   |       |
|  | <b>B(Alt)</b> AHF, ASV | 04/99 → 05/06 | <b>AC</b>          | VKMV 6PK906  |   |   | 1 |   |   |   |  |   |       |
|  |                        |               |                    | VKM 31002    | 1 | 1 |   |   |   |   |  | 1 |       |
|  |                        |               |                    | VKM 31012    |   |   |   |   |   |   |  |   |       |
|  | <b>B(Alt)</b> AHF, ASV | 04/99 → 05/06 | <b>AC</b>          | VKMA 31014   | 1 | 1 | 1 |   |   |   |  | 1 |       |
|  |                        |               |                    | VKMV 6PK1660 |   |   | 1 |   |   |   |  |   |       |
|  |                        |               |                    | VKM 31002    |   | 1 |   |   |   |   |  | 1 |       |
|  |                        |               |                    | VKM 31012    | 1 |   |   |   |   |   |  |   |       |
|  | AHF, ASV               | 04/99 → 05/06 | → ICH 1M-3R099 130 | VKM _____    |   |   |   |   |   | 1 |  |   |       |
|  | AHF, ASV               | 04/99 → 05/06 | CH 1M-3R099 131 I→ | VKM _____    |   |   |   |   |   | 1 |  |   |       |
| <b>SEAT  TOLEDO II (1M2) 1.9 TDI 130</b> |                        |               |                    |              |   |   |   |   |   |   |  |   |       |
|  | ASZ                    | 05/03 → 05/06 |                    | VKMA 01250   | 1 | 1 | 1 |   |   |   |  |   | T0184 |
|  |                        |               |                    | VKM 11250    | 1 |   |   |   |   |   |  |   |       |
|  |                        |               |                    | VKM 21147    |   | 1 |   |   |   |   |  |   |       |
|  | ASZ                    | 05/03 → 05/06 |                    | VKPC 81626   |   |   |   |   | 1 |   |  |   |       |
|  | <b>B(Alt)</b> ASZ      | 05/03 → 05/06 | <b>AC</b>          | VKMV 6PK1120 |   |   | 1 |   |   |   |  |   |       |
|  |                        |               |                    | VKM 31019    | 1 |   |   |   |   |   |  |   |       |
|  | <b>B(Alt)</b> ASZ      | 05/03 → 05/06 | <b>AC</b>          | VKMA 31001   | 1 |   | 1 |   |   |   |  |   |       |
|  |                        |               |                    | VKMV 6DK1195 |   |   | 1 |   |   |   |  |   |       |
|  |                        |               |                    | VKM 31019    | 1 |   |   |   |   |   |  |   |       |
|  | ASZ                    | 05/03 → 05/06 | → I Mot. 435 000   | VKM _____    |   |   |   |   |   | 1 |  |   |       |
|  | ASZ                    | 05/03 → 05/06 | Mot. 435 001 I→    | VKM _____    |   |   |   |   |   | 1 |  |   |       |
| <b>SEAT  TOLEDO II (1M2) 1.9 TDI 150</b> |                        |               |                    |              |   |   |   |   |   |   |  |   |       |
|  | ARL                    | 10/00 → 05/06 | → ICH 1M-2R120 001 | VKMA 01942   | 1 | 1 | 1 | 1 |   |   |  | 3 | T0184 |
|  |                        |               |                    | VKM 11142    | 1 |   |   |   |   |   |  |   |       |
|  |                        |               |                    | VKM 11145    |   |   |   | 1 |   |   |  |   |       |
|  |                        |               |                    | VKM 21142    |   | 1 |   |   |   |   |  |   |       |



SEAT









































|   | ARL                       | 10/00 → 05/06 | → ICH 1M-2R120 001 | VKMA 01142<br>VKM 11142<br>VKM 21142              | 1<br>1<br>1      | 1<br>1      | 1<br>1 |  |  |   |  |   |  |  |  |  |  |  | 3 | T0184 |       |       |
|---|---------------------------|---------------|--------------------|---|------------------|-------------|--------|--|--|---|--|---|--|--|--|--|--|--|---|-------|-------|-------|
|   | ARL                       | 10/00 → 05/06 | CH 1M-2R120 001 I→ | VKMA 01250<br>VKM 11250<br>VKM 21147              | 1<br>1<br>1      | 1<br>1      | 1<br>1 |  |  |   |  |   |  |  |  |  |  |  |   | T0184 |       |       |
|   | ARL                       | 10/00 → 05/06 |                    | VKPC 81627  |                  |             |        |  |  | 1 |  |   |  |  |  |  |  |  |   |       |       |       |
|   | B(Alt) ARL                | 10/00 → 05/06 | AC                 | VKMV 6PK1120<br>VKM 31019                         | 1                |             | 1      |  |  |   |  |   |  |  |  |  |  |  |   |       |       |       |
|   | B(Alt) ARL                | 10/00 → 05/06 | AC                 | VKMA 31001<br>VKMV 6DK1195<br>VKM 31019           | 1<br>1<br>1      |             | 1<br>1 |  |  |   |  |   |  |  |  |  |  |  |   |       |       |       |
|   | ARL                       | 10/00 → 05/06 |                    | VKM_____  |                  |             |        |  |  |   |  | 1 |  |  |  |  |  |  |   |       |       |       |
| <b>SEAT  TOLEDO III (5P2) 1.6</b>         |                           |               |                    |   |                  |             |        |  |  |   |  |   |  |  |  |  |  |  |   |       |       |       |
|   | BGU, BSE, BSF             | 10/04 → 11/07 |                    | VKMA 01113<br>VKM 11113                           | 1<br>1           |             | 1      |  |  |   |  |   |  |  |  |  |  |  |   | T0149 |       |       |
|   | BGU, BSE, BSF             | 10/04 → 11/07 |                    | VKPC 81408  |                  |             |        |  |  | 1 |  |   |  |  |  |  |  |  |   |       |       |       |
|   | B(Alt) BGU, BSE, BSF      | 10/04 → 11/07 | AC                 | VKMV 6PK900<br>VKM 31011                          | 1                |             | 1      |  |  |   |  |   |  |  |  |  |  |  |   |       |       |       |
|   | B(Alt) BGU, BSE, BSF      | 10/04 → 11/07 | AC                 | VKMV 6PK1042<br>VKM 31011                         | 1                |             | 1      |  |  |   |  |   |  |  |  |  |  |  |   |       |       |       |
| <b>SEAT  TOLEDO III (5P2) 1.8 TFSI</b>    |                           |               |                    |   |                  |             |        |  |  |   |  |   |  |  |  |  |  |  |   |       |       |       |
|   | BYT, BZB                  | 01/07 → 11/07 |                    | <del>XXXXXXXXXX</del>                             |                  |             |        |  |  |   |  |   |  |  |  |  |  |  |   |       |       |       |
| <b>SEAT  TOLEDO III (5P2) 2.0 FSII</b>    |                           |               |                    |   |                  |             |        |  |  |   |  |   |  |  |  |  |  |  |   |       |       |       |
|   | BLR, BLY, BVY, BVZ        | 10/04 → 11/07 |                    | VKMA 01222<br>VKM 11222<br>VKM 21220<br>VKM_____  | 1<br>1<br>1<br>1 | 2<br>1      | 1<br>1 |  |  |   |  |   |  |  |  |  |  |  |   | 2     | T0247 |       |
|   | BLR, BLY, BVY, BVZ        | 10/04 → 11/07 |                    | VKPC 81220  |                  |             |        |  |  | 1 |  |   |  |  |  |  |  |  |   |       |       |       |
|   | B(Alt) BLR, BLY, BVY, BVZ | 10/04 → 11/07 | AC                 | VKMV 6PK900<br>VKM 31011                          | 1                |             | 1      |  |  |   |  |   |  |  |  |  |  |  |   |       |       |       |
|   | B(Alt) BLR, BLY, BVY, BVZ | 10/04 → 11/07 | AC                 | VKMV 6PK1042<br>VKM 31011                         | 1                |             | 1      |  |  |   |  |   |  |  |  |  |  |  |   |       |       |       |
| <b>SEAT  TOLEDO III (5P2) 1.9 TDI 105</b> |                           |               |                    |   |                  |             |        |  |  |   |  |   |  |  |  |  |  |  |   |       |       |       |
|   | BJB, BKC, BLS, BXE        | 10/04 → 11/07 |                    | VKMA 01250<br>VKM 11250<br>VKM 21147              | 1<br>1<br>1      | 1<br>1      | 1<br>1 |  |  |   |  |   |  |  |  |  |  |  |   |       | T0184 |       |
|   | BJB, BKC, BLS, BXE        | 10/04 → 11/07 |                    | VKPC 81418  |                  |             |        |  |  | 1 |  |   |  |  |  |  |  |  |   |       |       |       |
|   | B(Alt) BJB, BKC, BLS, BXE | 10/04 → 11/07 | AC                 | VKMV 6PK950<br>VKM 31054                          | 1                |             | 1      |  |  |   |  |   |  |  |  |  |  |  |   |       |       |       |
|   | B(Alt) BJB, BKC, BLS, BXE | 10/04 → 11/07 | AC                 | VKMV 6PK1050<br>VKM 31054                         | 1                |             | 1      |  |  |   |  |   |  |  |  |  |  |  |   |       |       |       |
| <b>SEAT  TOLEDO III (5P2) 2.0 TDI 140</b> |                           |               |                    |   |                  |             |        |  |  |   |  |   |  |  |  |  |  |  |   |       |       |       |
|   | AZV, BKD                  | 10/04 → 11/07 |                    | VKMA 01255<br>VKM 11255<br>VKM 21147<br>VKM 21256 | 1<br>1<br>1<br>1 | 2<br>1<br>1 | 1<br>1 |  |  |   |  |   |  |  |  |  |  |  |   |       | 5     | T0184 |
|   | BMM                       | 10/04 → 11/07 |                    | VKMA 01250<br>VKM 11250<br>VKM 21147              | 1<br>1<br>1      | 1<br>1      | 1<br>1 |  |  |   |  |   |  |  |  |  |  |  |   |       | T0184 |       |
|   | AZV, BKD                  | 10/04 → 11/07 |                    | VKPC 81627  |                  |             |        |  |  | 1 |  |   |  |  |  |  |  |  |   |       |       |       |
|   | BMM                       | 10/04 → 11/07 |                    | VKPC 81303  |                  |             |        |  |  | 1 |  |   |  |  |  |  |  |  |   |       |       |       |
|   | B(Alt) AZV, BKD           | 10/04 → 11/07 | AC                 | VKMV 6PK950<br>VKM 31022                          | 1                |             | 1      |  |  |   |  |   |  |  |  |  |  |  |   |       |       |       |
|   | B(Alt) AZV, BKD           | 10/04 → 11/07 | AC                 | VKMV 6PK1050<br>VKM 31022                         | 1                |             | 1      |  |  |   |  |   |  |  |  |  |  |  |   |       |       |       |
|   | B(Alt) BMM                | 10/04 → 11/07 | AC                 | VKMV 6PK950<br>VKM 31054                          | 1                |             | 1      |  |  |   |  |   |  |  |  |  |  |  |   |       |       |       |
|   | B(Alt) BMM                | 10/04 → 11/07 | AC                 | VKMV 6PK1050<br>VKM 31054                         | 1                |             | 1      |  |  |   |  |   |  |  |  |  |  |  |   |       |       |       |
| <b>SKODA  FABIA 1.0</b>                   |                           |               |                    |   |                  |             |        |  |  |   |  |   |  |  |  |  |  |  |   |       |       |       |
|   | AQV, ARV                  | 12/99 → 08/02 |                    | <del>XXXXXXXXXX</del>                             |                  |             |        |  |  |   |  |   |  |  |  |  |  |  |   |       |       |       |
|   | AQV, ARV                  | 12/99 → 08/02 |                    | —   |                  |             |        |  |  | 1 |  |   |  |  |  |  |  |  |   |       |       |       |

|  |  |  |  |  |  |  |  |  |  |  |  |
|--|---|---|---|--|---|---|---|---|---|---|---|
|                               | <b>B(Alt)</b> AQV, ARV  | 12/99 → 08/02   | <b>AC</b>   | VKMV 5PK1219<br>VKM 31025  | 1   |   | 1   |   |   |   |   |
|  | <b>B(Alt)</b> AQV, ARV  | 12/99 → 08/02   | <b>AC</b>   | VKMV 6PK1748<br>VKM 31025  | 1   |   | 1   |   |   |   |   |
| <b>SKODA  FABIA 1.2</b>       |   |   |   |  |   |   |   |   |   |   |   |
|                               | AWY, AZQ, BBM, BMD,<br>BME, BZG   | 07/01 → 11/07   |   | <b>OXOXOXO</b>   |   |   |   |   |   |   |   |
|                               | AWY, AZQ, BBM, BMD,<br>BME, BZG   | 07/01 → 11/07   |   | VKPC 81301   |   |   |   | 1   |   |   |   |
|                               | <b>B(Alt)</b> AWY, BMD  | 07/01 → 11/07   | <b>AC</b>   | VKMV 6PK1453<br>VKM _____  |   | 1   | 1   |   |   |   |   |
|  | <b>B(Alt)</b> AWY, BMD  | 07/01 → 11/07   | <b>AC, → ICH 6Y-3-893 311</b>   | VKMV 6PK1880<br>VKM _____  |   | 1   | 1   |   |   |   |   |
| <b>SKODA  FABIA 1.4</b>       |   |   |   |  |   |   |   |   |   |   |   |
|                               | AME, AQW, ATZ, AZE,<br>AZF  | 08/99 → 11/07   |   | <b>OXOXOXO</b>   |   |   |   |   |   |   |   |
|                               | AME, AQW, ATZ, AZE,<br>AZF  | 08/99 → 11/07   |   | —  |   |   |   | 1   |   |   |   |
|  | BXW   | 03/07 → 11/07   |   | VKPC 81407   |   |   |   | 1   |   |   |   |
|                               | <b>B(Alt)</b> AME, AQW, ATZ, AZE,<br>AZF  | 08/99 → 11/07   | <b>AC</b>   | VKMV 5PK1219   |   |   | 1   |   |   |   |   |
|  | <b>B(Alt)</b> AME, AQW, ATZ, AZE,<br>AZF  | 08/99 → 11/07   | <b>AC</b>   | VKMV 6PK1748   |   |   | 1   |   |   |   |   |
|  | <b>B(Alt)</b> BXW   | 03/07 → 11/07   | <b>AC</b>   | VKMV 6PK736  |   |   | 1   |   |   |   |   |
|  | <b>B(Alt)</b> BXW   | 03/07 → 11/07   | <b>AC</b>   | VKMA 31216<br>VKMV 6PK1076<br>VKM 31015  | 1<br>1  |   | 1<br>1  |   |   |   |   |
| <b>SKODA  FABIA 1.4 16V</b> |   |   |   |  |   |   |   |   |   |   |   |
|                             | AUA, AUB, BBY, BBZ,<br>BKY, BUD   | 10/99 → 11/07   |   | VKMA 01121<br>VKM 11120<br>VKM 11124<br>VKM 21120<br>VKM 21121                     | 2<br>1<br>1   | 2   | 2   |   |   |   | T0165   |
|                             | AUA, AUB, BBY, BBZ,<br>BKY, BUD   | 10/99 → 11/07   |   | VKPC 81407   |   |   |   | 1   |   |   |   |
|                             | <b>B(Alt)</b> AUA, AUB  | 10/99 → 11/07   | <b>AC</b> ,<br>→ ICH 6Y-2-389 395   | VKMV 6PK745  |   |   | 1   |   |   |   |   |
|  | <b>B(Alt)</b> AUA, AUB  | 10/99 → 11/07   | <b>AC</b> ,<br>CH 6Y-2-389 396 I →  | VKMV 6PK736  |   |   | 1   |   |   |   |   |
|  | <b>B(Alt)</b> AUA   | 10/99 → 11/07   | <b>AC, Man. GBX</b> ,<br>→ ICH 6Y-2-389 395                                       | VKMA 31215<br>VKMV 6PK1084<br>VKM 31015  | 1<br>1  |   | 1<br>1  |   |   |   |   |
|  | <b>B(Alt)</b> AUA   | 10/99 → 11/07   | <b>AC, Man. GBX</b> ,<br>CH 6Y-2-389 396 I →                                      | VKMA 31216<br>VKMV 6PK1076<br>VKM 31015  | 1<br>1  |   | 1<br>1  |   |   |   |   |
|  | <b>B(Alt)</b> AUA   | 10/99 → 11/07   | <b>AC, Auto. GBX</b>  | VKMA 31216<br>VKMV 6PK1076<br>VKM 31015  | 1<br>1  |   | 1<br>1  |   |   |   |   |
|  | <b>B(Alt)</b> AUB   | 12/99 → 11/07   | <b>AC, → ICH 6Y-2-389 395</b>   | VKMA 31215<br>VKMV 6PK1084<br>VKM 31015  | 1<br>1  |   | 1<br>1  |   |   |   |   |
|  | <b>B(Alt)</b> AUB   | 12/99 → 11/07   | <b>AC, CH 6Y-2-389 396 I →</b>  | VKMA 31216<br>VKMV 6PK1076<br>VKM 31015  | 1<br>1  |   | 1<br>1  |   |   |   |   |
|  | <b>B(Alt)</b> BBY, BBZ, BKY, BUD  | 10/99 → 11/07   | <b>AC</b>   | VKMV 6PK736  |   |   | 1   |   |   |   |   |
|  | <b>B(Alt)</b> BBY, BBZ, BKY, BUD  | 10/99 → 11/07   | <b>AC</b>   | VKMA 31216<br>VKMV 6PK1076<br>VKM 31015  | 1<br>1  |   | 1<br>1  |   |   |   |   |



SKODA



|   |  |  |        |    |  |  |  |  |  |  |
|---|---|---|---|--|---|---|---|---|---|---|
|  B(Alt)  | ASZ, ATD, BLS, BSW  | 01/00 → 11/07   | <i>AC</i>   | VKMV 6PK780<br>VKM 31057   | 1   | 1   |   |   |   |   |
| B(Alt)  | ASZ, ATD, BLS, BSW  | 01/00 → 11/07   | AC  | VKMV 6PK1180<br>VKM 31058  | 1   | 1   |   |   |   |   |
|    | ASZ, ATD  | 01/00 → 11/07   |   | VKM _____  |   |   |   | 1   |   |   |
| <b>SKODA  FAVORIT 1.3</b>                                    |   |   |   |  |   |   |   |   |   |   |
|    | 135B, 136 L, 136B,<br>781.135, 781.135E,<br>OHC                                   | 05/89 → 06/97   |   |    |   |   |   |   |   |   |
|    | 135B, 136 L, 781.135,<br>781.135E, OHC  | 05/89 → 06/97   | Carbu.  | VKPC 81405   |   |   |   | 1   |   |   |
|   | 135B, 136 L, 781.135,<br>781.135E, OHC  | 05/89 → 06/97   | Injec.  | VKPC 81409   |   |   |   | 1   |   |   |
|   | 136B  | 12/92 → 06/97   |   | VKPC 81406   |   |   |   | 1   |   |   |
|    | B(Alt) 135B, 136 L, 136B,<br>781.135, 781.135E,<br>OHC                            | 05/89 → 12/92   |   | VKMV 10AVx950  |   | 1   |   |   |   |   |
| B(Alt)  | 135B, 136 L, 136B,<br>781.135, 781.135E,<br>OHC                                   | 01/93 → 06/97   |   | VKMV 4PK950  |   | 1   |   |   |   |   |
| <b>SKODA  FELICIA I (6U1)/Estate (6U5)/Fun (797) 1.3</b>     |   |   |   |  |   |   |   |   |   |   |
|    | 135 L, 135B, 135M,<br>136B, 136M, AMG,<br>AMH, AMJ                                | 10/94 → 11/05   |   |    |   |   |   |   |   |   |
|    | 135 L, 135B, 135M,<br>136B, AMG, AMH, AMJ   | 10/94 → 07/07   | <i>AC</i>   | VKPC 81406   |   |   |   | 1   |   |   |
|   | 135 L, 135B, 135M,<br>136B, 136M, AMG,<br>AMH, AMJ                                | 10/94 → 07/07   | AC  | VKPC 81412   |   |   |   | 1   |   |   |
|    | B(Alt) 135 L, 135B, 135M,<br>136B, 136M, AMG,<br>AMH, AMJ                         | 10/94 → 07/07   | Carbu., <i>AC</i>   | VKMV 10AVx950  |   | 1   |   |   |   |   |
| B(Alt)  | 135 L, 135B, 135M,<br>136B, 136M, AMG,<br>AMH, AMJ                                | 10/94 → 07/07   | Injec., <i>AC</i>   | VKMV 4PK950  |   | 1   |   |   |   |   |
| <b>SKODA  FELICIA I (6U1)/Estate (6U5)/Fun (797) 1.6</b>   |   |   |   |  |   |   |   |   |   |   |
|    | AEE   | 08/95 → 07/07   |   | VKMA 01110<br>VKM 11106  | 1<br>1  | 1   |   |   |   | T0127   |
|    | AEE   | 08/95 → 07/07   |   | VKPC 81210   |   |   |   | 1   |   |   |
|    | B(Alt) AEE  | 08/95 → 07/07   | AC,  | VKMA 31206<br>VKMV 6PK1078<br>VKM 31015  | 1<br>1<br>1   | 1<br>1  |   |   |   |   |
| B(Alt)  | AEE   | 08/95 → 07/07   | AC,  | VKMA 31219<br>VKMV 6PK1123<br>VKM 31015  | 1<br>1<br>1   | 1<br>1  |   |   |   |   |
| <b>SKODA  FELICIA I (6U1)/Estate (6U5)/Fun (797) 1.9 D</b> |   |   |   |  |   |   |   |   |   |   |
|    | AEF   | 10/95 → 06/02   |   | VKMA 01015<br>VKM 11015  | 1<br>1  | 1   |   |   |   | T0183   |
|    | AEF   | 10/95 → 07/07   |   | VKPC 81615   |   |   |   | 1   |   |   |
|    | B(Alt) AEF  | 10/95 → 07/07   |   | VKMA 31017<br>VKMV 5PK1219<br>VKM 31025  | 1<br>1<br>1   | 1<br>1  |   |   |   |   |
| <b>SKODA  FELICIA II (6U1)/FELICIA II Estate (6U5) 1.3</b> |   |   |   |  |   |   |   |   |   |   |
|    | AMG, AMH, AMJ   | 01/98 → 06/01   |   |  |   |   |   |   |   |   |
|    | AMG, AMH, AMJ   | 01/98 → 06/01   | <i>AC</i>   | VKPC 81406   |   |   |   | 1   |   |   |
|    | B(Alt) AMG, AMH, AMJ  | 01/98 → 06/01   | Carbu., <i>AC</i>   | VKMV 10AVx950  |   | 1   |   |   |   |   |
| B(Alt)  | AMG, AMH, AMJ   | 01/98 → 06/01   | Injec., <i>AC</i>   | VKMV 4PK950  |   | 1   |   |   |   |   |
| <b>SKODA  FELICIA II (6U1)/FELICIA II Estate (6U5) 1.6</b> |   |   |   |  |   |   |   |   |   |   |
|    | AEE   | 01/98 → 06/01   |   | VKMA 01110<br>VKM 11106  | 1<br>1  | 1   |   |   |   | T0127   |
|    | AEE   | 01/98 → 06/01   |   | VKPC 81210   |   |   |   | 1   |   |   |



SKODA



















|  | B(Alt) | AEE                | 01/98 → 06/01 | AC,                 | VKMA 31206<br>VKMV 6PK1078<br>VKM 31015                        | 1<br>1<br>1           | 1<br>1 |        |   |  |  |  |  |  |  |       |
|--|--------|--------------------|---------------|---------------------|--|-----------------------|--------|--------|---|--|--|--|--|--|--|-------|
|  | B(Alt) | AEE                | 01/98 → 06/01 | AC,                 | VKMA 31219<br>VKMV 6PK1123<br>VKM 31015                        | 1<br>1<br>1           | 1<br>1 |        |   |  |  |  |  |  |  |       |
| <b>SKODA  FELICIA II (6U1)/FELICIA II Estate (6U5) 1.9 D</b> |        |                    |               |                     |  |                       |        |        |   |  |  |  |  |  |  |       |
|  |        | AEF                | 01/98 → 06/01 |                     | VKMA 01015<br>VKM 11015  | 1<br>1                | 1      |        |   |  |  |  |  |  |  | T0183 |
|  |        | AEF                | 01/98 → 06/01 |                     | VKPC 81615   |                       |        |        | 1 |  |  |  |  |  |  |       |
|  | B(Alt) | AEF                | 01/98 → 06/01 |                     | VKMA 31017<br>VKMV 5PK1219<br>VKM 31025                        | 1<br>1<br>1           | 1<br>1 |        |   |  |  |  |  |  |  |       |
| <b>SKODA  OCTAVIA I (1U2) / OCTAVIA Combi (1U5) 1.4</b>      |        |                    |               |                     |  |                       |        |        |   |  |  |  |  |  |  |       |
|  |        | AMD                | 04/99 → 11/07 |                     | <del>VKMA 31025</del>  |                       |        |        |   |  |  |  |  |  |  |       |
|  | B(Alt) | AMD                | 04/99 → 07/07 |                     | VKMV 6PK1520<br>VKM 31025                                      | 1                     | 1      |        |   |  |  |  |  |  |  |       |
| <b>SKODA  OCTAVIA I (1U2) / OCTAVIA Combi (1U5) 1.4 16V</b>  |        |                    |               |                     |  |                       |        |        |   |  |  |  |  |  |  |       |
|  |        | AXP, BCA           | 08/00 → 11/07 |                     | VKMA 01121<br>VKM 11120<br>VKM 11124<br>VKM 21120<br>VKM 21121 | 2<br>1<br>1<br>1<br>1 | 2<br>1 | 2      |   |  |  |  |  |  |  | T0165 |
|  |        | AXP, BCA           | 08/00 → 11/07 |                     | VKPC 81407   |                       |        |        | 1 |  |  |  |  |  |  |       |
|  | B(Alt) | AXP, BCA           | 08/00 → 11/07 | AC                  | VKMA 31206<br>VKMV 6PK1078<br>VKM 31015                        | 1<br>1<br>1           | 1<br>1 |        |   |  |  |  |  |  |  |       |
|  | B(Alt) | AXP, BCA           | 08/00 → 11/07 | AC                  | VKMA 31207<br>VKMV 6PK1548<br>VKM 31016<br>VKM 31207           | 1<br>1<br>1<br>1      | 1<br>1 | 1<br>1 |   |  |  |  |  |  |  |       |
| <b>SKODA  OCTAVIA I (1U2) / OCTAVIA Combi (1U5) 1.6</b>      |        |                    |               |                     |  |                       |        |        |   |  |  |  |  |  |  |       |
|  |        | AEE                | 09/96 → 11/07 |                     | VKMA 01110<br>VKM 11106  | 1<br>1                | 1      |        |   |  |  |  |  |  |  | T0127 |
|  |        | AEH, AKL, AVU, BFQ | 02/97 → 11/07 |                     | VKMA 01113<br>VKM 11113  | 1<br>1                | 1      |        |   |  |  |  |  |  |  | T0149 |
|  |        | AEE                | 09/96 → 11/07 |                     | VKPC 81210   |                       |        |        | 1 |  |  |  |  |  |  |       |
|  |        | AEH, AKL, AVU, BFQ | 02/97 → 11/07 |                     | VKPC 81408   |                       |        |        | 1 |  |  |  |  |  |  |       |
|  | B(Alt) | AEE                | 09/96 → 11/07 | AC                  | VKMA 31206<br>VKMV 6PK1078<br>VKM 31015                        | 1<br>1<br>1           | 1<br>1 |        |   |  |  |  |  |  |  |       |
|  | B(Alt) | AEE                | 09/96 → 11/07 | AC                  | VKMA 31207<br>VKMV 6PK1548<br>VKM 31016<br>VKM 31207           | 1<br>1<br>1<br>1      | 1<br>1 | 1<br>1 |   |  |  |  |  |  |  |       |
|  | B(Alt) | AEH, AKL, AVU, BFQ | 02/97 → 11/07 | AC                  | VKMA 31203<br>VKMV 6PK1120<br>VKM 31011                        | 1<br>1<br>1           | 1<br>1 |        |   |  |  |  |  |  |  |       |
|  | B(Alt) | AEH, AKL, AVU, BFQ | 02/97 → 11/07 | AC                  | VKMA 31204<br>VKMV 6DK1195<br>VKM 31011                        | 1<br>1<br>1           | 1<br>1 |        |   |  |  |  |  |  |  |       |
| <b>SKODA  OCTAVIA I (1U2) / OCTAVIA Combi (1U5) 1.8</b>      |        |                    |               |                     |  |                       |        |        |   |  |  |  |  |  |  |       |
|  |        | AGN                | 09/96 → 11/07 | → ICH 1U-Y-390 000  | VKMA 01115<br>VKM 11115<br>VKM 21115                           | 1<br>1<br>1           | 1<br>1 | 1      |   |  |  |  |  |  |  | T0151 |
|  |        | AGN                | 09/96 → 11/07 | CH 1U-Y-390 001 I → | VKMA 01116<br>VKM 11116<br>VKM 21115                           | 1<br>1<br>1           | 1<br>1 | 1      |   |  |  |  |  |  |  | T0151 |
|  |        | AGN                | 09/96 → 11/07 |                     | VKPC 81620   |                       |        |        | 1 |  |  |  |  |  |  |       |
|  | B(Alt) | AGN                | 09/96 → 11/07 | AC                  | VKMA 31203<br>VKMV 6PK1120<br>VKM 31011                        | 1<br>1<br>1           | 1<br>1 |        |   |  |  |  |  |  |  |       |





























| B(Alt)  | AGN                                 | 09/96 → 11/07 | AC                  | VKMA 31204<br>VKMV 6DK1195<br>VKM 31011                        | 1      |   | 1 |  |   |  |  |  |             |
|---|-------------------------------------|---------------|---------------------|--|--------|---|---|--|---|--|--|--|-------------|
| <b>SKODA  OCTAVIA I (1U2) / OCTAVIA Combi (1U5) 1.8 Turbo</b> |                                     |               |                     |  |        |   |   |  |   |  |  |  |             |
|   | AGU, ARZ                            | 08/97 → 11/07 | → ICH 1U-Y-390 000  | VKMA 01115<br>VKM 11115<br>VKM 21115                           | 1<br>1 | 1 | 1 |  |   |  |  |  | T0151       |
|   | AGU, ARZ                            | 08/97 → 11/07 | CH 1U-Y-390 001 I → | VKMA 01116<br>VKM 11116<br>VKM 21115                           | 1<br>1 | 1 | 1 |  |   |  |  |  | T0151       |
|   | ARX, AUM, AUQ                       | 08/00 → 11/07 |                     | VKMA 01116<br>VKM 11116<br>VKM 21115                           | 1<br>1 | 1 | 1 |  |   |  |  |  | T0151       |
|   | AGU, ARX, ARZ, AUM, AUQ             | 08/97 → 11/07 |                     | VKPC 81620   |        |   |   |  | 1 |  |  |  |             |
|   | B(Alt) AGU, ARX, ARZ, AUM, AUQ      | 08/97 → 11/07 | AC                  | VKMA 31203<br>VKMV 6PK1120<br>VKM 31011                        | 1<br>1 |   | 1 |  | 1 |  |  |  |             |
|   | B(Alt) AGU, ARX, ARZ, AUM, AUQ      | 08/97 → 11/07 | AC                  | VKMA 31204<br>VKMV 6DK1195<br>VKM 31011                        | 1<br>1 |   | 1 |  | 1 |  |  |  |             |
| <b>SKODA  OCTAVIA I (1U2) / OCTAVIA Combi (1U5) 2.0</b>       |                                     |               |                     |  |        |   |   |  |   |  |  |  |             |
|   | AEG, APK, AQY, AZH, AZJ             | 04/99 → 11/07 |                     | VKMA 01113<br>VKM 11113  | 1<br>1 |   | 1 |  |   |  |  |  | T0149       |
|   | AEG, APK, AQY, AZH, AZJ             | 04/99 → 11/07 |                     | VKPC 81620   |        |   |   |  | 1 |  |  |  |             |
|   | B(Alt) AEG, APK, AQY, ATF, AZH, AZJ | 04/99 → 11/07 | AC                  | VKMA 31203<br>VKMV 6PK1120<br>VKM 31011                        | 1<br>1 |   | 1 |  | 1 |  |  |  |             |
|   | B(Alt) AEG, APK, AQY, ATF, AZH, AZJ | 04/99 → 11/07 | AC                  | VKMA 31204<br>VKMV 6DK1195<br>VKM 31011                        | 1<br>1 |   | 1 |  | 1 |  |  |  |             |
| <b>SKODA  OCTAVIA I (1U2) / OCTAVIA Combi (1U5) 1.9 SDI</b>   |                                     |               |                     |  |        |   |   |  |   |  |  |  |             |
|   | AGP                                 | 06/97 → 12/00 | → I Mot. 399 999    | VKMA 01130<br>VKM 11130<br>VKM 21004<br>VKM 21130              | 1<br>1 | 2 | 1 |  |   |  |  |  | 5 T0173     |
|   | AGP                                 | 06/97 → 12/00 | Mot. 400 000 I →    | VKMA 01131<br>VKM 11130<br>VKM 21004<br>VKM 21130<br>VKM 21131 | 1<br>1 | 3 | 1 |  |   |  |  |  | 8 T0173     |
|   | AQM                                 | 08/00 → 11/07 | → I Mot. 045 000    | VKMA 01131<br>VKM 11130<br>VKM 21004<br>VKM 21130<br>VKM 21131 | 1<br>1 | 3 | 1 |  |   |  |  |  | 8 T0173     |
|   | AQM                                 | 08/00 → 11/07 | Mot. 045 001 I →    | VKMA 01251<br>VKM 11130<br>VKM 21004<br>VKM 21130<br>VKM 21131 | 1<br>1 | 3 | 1 |  |   |  |  |  | 8 T0173     |
|   | AGP, AQM                            | 06/97 → 11/07 |                     | VKPC 81623   |        |   |   |  | 1 |  |  |  |             |
|   | B(Alt) AGP, AQM                     | 06/97 → 11/07 | AC                  | VKMV 6PK906<br>VKM 31002<br>VKM 31018                          | 1<br>1 |   | 1 |  |   |  |  |  | 1<br>1      |
|   | B(Alt) AGP, AQM                     | 06/97 → 11/07 | AC                  | VKMA 31005<br>VKMV 6PK1660<br>VKM 31002<br>VKM 31018           | 1<br>1 | 1 | 1 |  | 1 |  |  |  | 2<br>1<br>1 |









































SKODA









































|  |  |  |  |  |  |  |  |  |  |  |  |  |  |
|--|---|---|---|--|---|---|---|---|---|---|---|---|---|
| ⊙  | AGP   | 06/97 → 11/07   |   | VKM_____   |   |   |   |   |   |   | 1   |   |   |
|  | AQM   | 06/97 → 11/07   | →ICH 1U-3-726 896,<br>1U-38684 072  | VKM_____   |   |   |   |   |   |   | 1   |   |   |
|  | AQM   | 06/97 → 11/07   | CH 1U-3-726 897,<br>1U-38684 073 I→   | VKM_____   |   |   |   |   |   |   | 1   |   |   |
| <b>SKODA  OCTAVIA I (1U2) / OCTAVIA Combi (1U5) 1.9 TDI 90</b>    |   |   |   |  |   |   |   |   |   |   |   |   |   |
|    | AGR   | 09/96 → 11/07   | →IMot. 044 441  | VKMA 01130<br>VKM 11130<br>VKM 21004<br>VKM 21130                                  | 1<br>1  | 2   | 1   |   |   |   |   |   | 5 T0173   |
|  | AGR   | 09/96 → 11/07   | Mot. 044 442 I→,<br>→IMot. 565 000  | VKMA 01131<br>VKM 11130<br>VKM 21004<br>VKM 21130<br>VKM 21131                     | 1<br>1  | 3   | 1   |   |   |   |   |   | 8 T0173   |
|  | AGR   | 09/96 → 11/07   | Mot. 565 001 I→   | VKMA 01251<br>VKM 11130<br>VKM 21004<br>VKM 21130<br>VKM 21131                     | 1<br>1  | 3   | 1   |   |   |   |   |   | 8 T0173   |
|  | ALH   | 08/00 → 11/07   | →IMot. 500 000  | VKMA 01131<br>VKM 11130<br>VKM 21004<br>VKM 21130<br>VKM 21131                     | 1<br>1  | 3   | 1   |   |   |   |   |   | 8 T0173   |
|  | ALH   | 08/00 → 11/07   | Mot. 500 001 I→   | VKMA 01251<br>VKM 11130<br>VKM 21004<br>VKM 21130<br>VKM 21131                     | 1<br>1  | 3   | 1   |   |   |   |   |   | 8 T0173   |
| ⊙  | AGR, ALH  | 09/96 → 11/07   |   | VKPC 81623   |   |   |   |   |   |   | 1   |   |   |
|    | <b>B(Alt)</b> AGR   | 09/96 → 11/07   | AC,<br>→ICH 1U-W-033 907  | VKMA 6PK906<br>VKM 31002<br>VKM 31018  | 1   | 1   | 1   |   |   |   |   |   | 1   |
|  | <b>B(Alt)</b> AGR   | 09/96 → 11/07   | AC,<br>CH 1U-W-033 908 I→   | VKMA 6PK906<br>VKM 31002<br>VKM 31012  | 1   | 1   | 1   |   |   |   |   |   | 1   |
|  | <b>B(Alt)</b> AGR   | 09/96 → 11/07   | AC,<br>→ICH 1U-W-033 907  | VKMA 31005<br>VKMA 6PK1660<br>VKM 31002<br>VKM 31018                               | 1<br>1  | 1   | 1   |   |   |   |   |   | 2<br>1<br>1   |
|  | <b>B(Alt)</b> AGR   | 09/96 → 11/07   | AC,<br>CH 1U-W-033 908 I→   | VKMA 31014<br>VKMA 6PK1660<br>VKM 31002<br>VKM 31012                               | 1<br>1  | 1   | 1   |   |   |   |   |   | 1<br>1  |
|  | <b>B(Alt)</b> ALH   | 09/96 → 11/07   | AC  | VKMA 6PK906<br>VKM 31002<br>VKM 31012  | 1   | 1   | 1   |   |   |   |   |   | 1   |
|  | <b>B(Alt)</b> ALH   | 09/96 → 11/07   | AC  | VKMA 31014<br>VKMA 6PK1660<br>VKM 31002<br>VKM 31012                               | 1<br>1  | 1   | 1   |   |   |   |   |   | 1<br>1  |
| ⊙  | AGR, ALH  | 09/96 → 11/07   | →ICH 1U-3-726 896,<br>1U-38684 072  | VKM_____   |   |   |   |   |   |   | 1   |   |   |
|  | AGR, ALH  | 09/96 → 11/07   | CH 1U-3-726 897,<br>1U-38684 073 I→   | VKM_____   |   |   |   |   |   |   | 1   |   |   |
| <b>SKODA  OCTAVIA I (1U2) / OCTAVIA Combi (1U5) 1.9 TDI 100</b> |   |   |   |  |   |   |   |   |   |   |   |   |   |
|    | ATD   | 08/00 → 11/07   | →IMot. 211 245  | VKMA 01942<br>VKM 11142<br>VKM 11145<br>VKM 21142                                  | 1<br>1  | 1   | 1   | 1   | 1   |   |   |   | 3 T0184   |

|  |  |  |  |  |  |  |  |  |  |  |  |  |
|--|---|---|---|--|---|---|---|---|---|---|---|---|
|  | ATD   | 08/00 → 11/07   | →IMot. 211 245  | VKMA 01142<br>VKM 11142<br>VKM 21142   | 1<br>1  | 1   | 1   |   |   |   |   | 3 T0184   |
|  | ATD   | 08/00 → 11/07   | Mot. 211 246 I→   | VKMA 01250<br>VKM 11250<br>VKM 21147   | 1<br>1  | 1   | 1   |   |   |   |   | T0184   |
|  | AXR   | 08/00 → 11/07   |   | VKMA 01250<br>VKM 11250<br>VKM 21147   | 1<br>1  | 1   | 1   |   |   |   |   | T0184   |
|   | ATD, AXR  | 08/00 → 11/07   |   | VKPC 81303   |   |   |   |   | 1   |   |   |   |
|   | B(Alt) ATD, AXR   | 08/00 → 11/07   | AC  | VKMA 31001<br>VKMV 6DK1195<br>VKM 31019  | 1   |   | 1   |   |   |   |   |   |
|  | B(Alt) ATD, AXR   | 08/00 → 11/07   | AC  | VKMA 31001<br>VKMV 6DK1195<br>VKM 31019  | 1   |   | 1   |   |   |   |   |   |
| <b>SKODA  OCTAVIA I (1U2) / OCTAVIA Combi (1U5) 1.9 TDI 110</b>   |   |   |   |  |   |   |   |   |   |   |   |   |
|   | AHF   | 08/97 → 11/07   | →IMot. 006 065  | VKMA 01130<br>VKM 11130<br>VKM 21004<br>VKM 21130                                  | 1<br>1  | 2   | 1   |   |   |   |   | 5 T0173   |
|  | AHF   | 08/97 → 11/07   | Mot. 006 066 I→,<br>→IMot. 595 000  | VKMA 01131<br>VKM 11130<br>VKM 21004<br>VKM 21130<br>VKM 21131                     | 1<br>1  | 3   | 1   |   |   |   |   | 8 T0173   |
|  | AHF   | 08/97 → 11/07   | Mot. 595 001 I→   | VKMA 01251<br>VKM 11130<br>VKM 21004<br>VKM 21130<br>VKM 21131                     | 1<br>1  | 3   | 1   |   |   |   |   | 8 T0173   |
|  | ASV   | 08/97 → 11/07   | →IMot. 150 000  | VKMA 01131<br>VKM 11130<br>VKM 21004<br>VKM 21130<br>VKM 21131                     | 1<br>1  | 3   | 1   |   |   |   |   | 8 T0173   |
|  | ASV   | 08/97 → 11/07   | Mot. 150 001 I→   | VKMA 01251<br>VKM 11130<br>VKM 21004<br>VKM 21130<br>VKM 21131                     | 1<br>1  | 3   | 1   |   |   |   |   | 8 T0173   |
|   | AHF, ASV  | 08/97 → 11/07   |   | VKPC 81623   |   |   |   |   | 1   |   |   |   |
|   | B(Alt) AHF, ASV   | 08/97 → 11/07   | AC  | VKMA 31014<br>VKMV 6PK906<br>VKM 31002<br>VKM 31012                                | 1   |   | 1   |   |   |   |   | 1   |
|  | B(Alt) AHF, ASV   | 08/97 → 11/07   | AC  | VKMA 31014<br>VKMV 6PK1660<br>VKM 31002<br>VKM 31012                               | 1   | 1   | 1   |   |   |   |   | 1   |
|   | AHF, ASV  | 08/97 → 11/07   | →ICH 1U-3-726 896,<br>1U-38684 072  | VKM_____   |   |   |   |   |   |   | 1   |   |
|  | AHF, ASV  | 08/97 → 11/07   | CH 1U-3-726 897,<br>1U-38684 073 I→   | VKM_____   |   |   |   |   |   |   | 1   |   |
| <b>SKODA  OCTAVIA I (1U2) / OCTAVIA Combi (1U5) 1.9 TDI 130</b> |   |   |   |  |   |   |   |   |   |   |   |   |
|   | ASZ   | 01/03 → 11/07   |   | VKMA 01250<br>VKM 11250<br>VKM 21147   | 1<br>1  | 1   | 1   |   |   |   |   | T0184   |
|   | ASZ   | 01/03 → 11/07   |   | VKPC 81303   |   |   |   |   | 1   |   |   |   |
|   | B(Alt) ASZ  | 01/03 → 11/07   | AC  | VKMA 31001<br>VKMV 6PK1120<br>VKM 31019  | 1   |   | 1   |   |   |   |   |   |
|  | B(Alt) ASZ  | 01/03 → 11/07   | AC  | VKMA 31001<br>VKMV 6DK1195<br>VKM 31019  | 1   |   | 1   |   |   |   |   |   |
|   | ASZ   | 01/03 → 11/07   |   | VKM_____   |   |   |   |   |   |   | 1   |   |
| <b>SKODA  OCTAVIA II (1Z3)/OCTAVIA II Combi (1Z5) 1.4</b>       |   |   |   |  |   |   |   |   |   |   |   |   |
|   | BCA, BUD  | 06/04 → 11/07   |   | VKMA 01121<br>VKM 11120  | 2<br>1  | 2   | 2   |   |   |   |   | T0165   |



SKODA

































|  |  |  |  |  |  |  |  |  |  |  |  |  |  |
|--|---|---|---|--|---|---|---|---|---|---|---|---|---|
|  |   |   |   | VKM 11124<br>VKM 21120<br>VKM 21121  | 1<br>1<br>1   |   |   |   |   |   |   |   |   |
|    | BCA, BUD  | 06/04 → 11/07   |   | VKPC 81407   |   |   |   | 1   |   |   |   |   |   |
|    | <b>B(Alt)</b> BCA, BUD  | 06/04 → 11/07   | <b>AC</b>   | VKMV 6PK736  |   |   |   | 1   |   |   |   |   |   |
|  | <b>B(Alt)</b> BCA, BUD  | 06/04 → 11/07   | <b>AC</b>   | VKMV 6PK1100<br>VKM 31015  | 1   |   |   | 1   |   |   |   |   |   |
| <b>SKODA  OCTAVIA II (1Z3)/OCTAVIA II Combi (1Z5) 1.6</b>       |   |   |   |  |   |   |   |   |   |   |   |   |   |
|    | BGU, BSE, BSF   | 06/04 → 11/07   |   | VKMA 01113<br>VKM 11113  | 1<br>1  |   |   | 1   |   |   |   |   | T0149   |
|    | BGU, BSE, BSF   | 06/04 → 11/07   |   | VKPC 81408   |   |   |   |   | 1   |   |   |   |   |
|    | <b>B(Alt)</b> BGU, BSE, BSF   | 06/04 → 11/07   | <b>AC</b>   | VKMV 6PK900<br>VKM 31011   | 1   |   |   | 1   |   |   |   |   |   |
|  | <b>B(Alt)</b> BGU, BSE, BSF   | 06/04 → 11/07   | <b>AC</b>   | VKMV 6PK1042<br>VKM 31011  | 1   |   |   | 1   |   |   |   |   |   |
| <b>SKODA  OCTAVIA II (1Z3)/OCTAVIA II Combi (1Z5) 1.6 FSI</b>   |   |   |   |  |   |   |   |   |   |   |   |   |   |
|    | BLF   | 06/04 → 11/07   |   | <b>XXXXXXXX</b>  |   |   |   |   |   |   |   |   |   |
|    | BLF   | 06/04 → 11/07   |   | VKPC 81501   |   |   |   |   | 1   |   |   |   |   |
|    | <b>B(Alt)</b> BLF   | 06/04 → 11/07   | <b>AC</b>   | VKMV 6PK1736<br>VKM 31044<br>VKM 31047   | 1   |   |   | 1   |   |   |   |   |   |
| <b>SKODA  OCTAVIA II (1Z3)/OCTAVIA II Combi (1Z5) 2.0 FSI</b>   |   |   |   |  |   |   |   |   |   |   |   |   |   |
|    | BLR, BLX, BLY, BVX  | 11/04 → 11/07   |   | VKMA 01222<br>VKM 11222<br>VKM 21220<br>VKM _____                                  | 1<br>1<br>1<br>1  | 2   |   | 1   |   |   |   |   | 2 T0247   |
|    | BLR, BLX, BLY, BVX  | 11/04 → 11/07   |   | VKPC 81220   |   |   |   |   | 1   |   |   |   |   |
|    | <b>B(Alt)</b> BLR, BLX, BLY, BVX  | 11/04 → 11/07   | <b>AC</b>   | VKMV 6PK900<br>VKM 31011   | 1   |   |   | 1   |   |   |   |   |   |
|  | <b>B(Alt)</b> BLR, BLX, BLY, BVX  | 11/04 → 11/07   | <b>AC</b>   | VKMV 6PK1042<br>VKM 31011  | 1   |   |   | 1   |   |   |   |   |   |
| <b>SKODA  OCTAVIA II (1Z3)/OCTAVIA II Combi (1Z5) 2.0 RS</b>  |   |   |   |  |   |   |   |   |   |   |   |   |   |
|    | BWA   | 01/06 → 11/07   |   | VKMA 01222<br>VKM 11222<br>VKM 21220<br>VKM _____                                  | 1<br>1<br>1<br>1  | 2   |   | 1   |   |   |   |   | 2 T0247   |
|    | BWA   | 01/06 → 11/07   |   | —  |   |   |   |   | 1   |   |   |   |   |
|    | <b>B(Alt)</b> BWA   | 01/06 → 11/07   | <b>AC</b>   | VKMV 6PK953  |   |   |   | 1   |   |   |   |   |   |
|  | <b>B(Alt)</b> BWA   | 01/06 → 11/07   | <b>AC</b>   | VKMV 6PK1054   |   |   |   | 1   |   |   |   |   |   |
| <b>SKODA  OCTAVIA II (1Z3)/OCTAVIA II Combi (1Z5) 1.9 TDI</b> |   |   |   |  |   |   |   |   |   |   |   |   |   |
|    | BJB, BKC, BLS, BXE  | 06/04 → 11/07   |   | VKMA 01250<br>VKM 11250<br>VKM 21147   | 1<br>1<br>1   | 1   |   | 1   |   |   |   |   | T0184   |
|    | BJB, BKC, BLS, BXE  | 06/04 → 11/07   |   | VKPC 81418   |   |   |   |   | 1   |   |   |   |   |
|    | <b>B(Alt)</b> BJB, BKC  | 06/04 → 11/07   | <b>AC. → ICH 1Z-5-121 646,<br/>1Z-58052 421</b>                                   | VKMV 6PK1050<br>VKM 31022  | 1   |   |   | 1   |   |   |   |   |   |
|  | <b>B(Alt)</b> BJB, BKC  | 06/04 → 11/07   | <b>AC, CH 1Z-6-121 647,<br/>1Z-68052 422   →</b>                                  | VKMV 6PK1050<br>VKM 31054  | 1   |   |   | 1   |   |   |   |   |   |
|  | <b>B(Alt)</b> BLS, BXE  | 11/04 → 11/07   | <b>AC</b>   | VKMV 6PK1050<br>VKM 31054  | 1   |   |   | 1   |   |   |   |   |   |
| <b>SKODA  OCTAVIA II (1Z3)/OCTAVIA II Combi (1Z5) 2.0 TDI</b> |   |   |   |  |   |   |   |   |   |   |   |   |   |
|    | BMM   | 11/05 → 11/07   |   | VKMA 01250<br>VKM 11250<br>VKM 21147   | 1<br>1<br>1   | 1   |   | 1   |   |   |   |   | T0184   |
|  | BKD   | 06/04 → 11/07   |   | VKMA 01255<br>VKM 11255<br>VKM 21147<br>VKM 21256                                  | 1<br>1<br>1<br>1  | 2   |   | 1   |   |   |   |   | 5 T0184   |
|    | BMM   | 11/05 → 11/07   |   | VKPC 81303   |   |   |   |   | 1   |   |   |   |   |
|  | BKD   | 06/04 → 11/07   |   | VKPC 81627   |   |   |   |   | 1   |   |   |   |   |

|   |  |  |    |  |  |  |  |  |  |  |  |  |
|---|---|---|---|--|---|---|---|---|---|---|---|---|
|                                      | B(Alt) BMM  | 11/05 → 11/07   | AC  | VKMV 6PK1050<br>VKM 31054  | 1   |   | 1   |   |   |   |   |   |
|   | B(Alt) BKD  | 06/04 → 11/07   | AC  | VKMV 6PK1050<br>VKM 31022  | 1   |   | 1   |   |   |   |   |   |
| <b>SKODA  ROOMSTER 1.2</b>           |   |   |   |  |   |   |   |   |   |   |   |   |
|                                      | BME, BZG  | 09/06 → 11/07   |   | <b>ΟΛΟΚΛΟΝΟ</b>  |   |   |   |   |   |   |   |   |
|                                      | BME   | 09/06 → 11/07   |   | VKPC 81301   |   |   |   | 1   |   |   |   |   |
|                                      | B(Alt) BME  | 09/06 → 11/07   | AC  | VKMV 6PK1453   |   |   | 1   |   |   |   |   |   |
|   | B(Alt) BME  | 09/06 → 11/07   | AC  | VKMV 6PK1873<br>VKM_____   |   | 1   | 1   |   |   |   |   |   |
| <b>SKODA  ROOMSTER 1.4</b>           |   |   |   |  |   |   |   |   |   |   |   |   |
|                                      | BXW   | 09/06 → 11/07   |   | —<br>VKM 11124<br>VKM 11124<br>VKM 21120<br>VKM 21121                              | 2<br>1<br>1   | 2<br>1  | 2<br>1  |   |   |   |   | T0165   |
|                                      | BXW   | 09/06 → 11/07   |   | VKPC 81407   |   |   |   |   | 1   |   |   |   |
|                                      | B(Alt) BXW  | 09/06 → 11/07   | AC  | VKMV 6PK736  |   |   | 1   |   |   |   |   |   |
|   | B(Alt) BXW  | 09/06 → 11/07   | AC  | VKMA 31216<br>VKMV 6PK1076<br>VKM 31015  | 1<br>1  |   | 1<br>1  |   |   |   |   |   |
| <b>SKODA  ROOMSTER 1.6</b>           |   |   |   |  |   |   |   |   |   |   |   |   |
|                                      | BTS   | 09/06 → 11/07   |   | <b>ΟΛΟΚΛΟΝΟ</b>  |   |   |   |   |   |   |   |   |
|                                      | B(Alt) BTS  | 09/06 → 11/07   | AC  | VKMV 6PK1736<br>VKM 31044<br>VKM 31047   | 1   |   | 1   |   |   |   |   |   |
| <b>SKODA  ROOMSTER 1.4 TDI</b>     |   |   |   |  |   |   |   |   |   |   |   |   |
|                                    | BMS, BNM, BNV   | 09/06 → 11/07   |   | VKMA 01250<br>VKM 11250<br>VKM 21147   | 1<br>1  | 1<br>1  | 1   |   |   |   |   | T0184   |
|                                    | BMS, BNM, BNV   | 09/06 → 11/07   |   | VKPC 81418   |   |   |   |   | 1   |   |   |   |
|                                    | B(Alt) BMS  | 09/06 → 11/07   | AC  | VKMV 6PK1180<br>VKM 31058  | 1   |   | 1   |   |   |   |   |   |
|   | B(Alt) BNM, BNV   | 09/06 → 11/07   | AC  | VKMV 6PK996<br>VKM 31035   | 1   |   | 1   |   |   |   |   |   |
| <b>SKODA  ROOMSTER 1.9 TDI</b>     |   |   |   |  |   |   |   |   |   |   |   |   |
|                                    | BLS, BSW  | 09/06 → 11/07   |   | VKMA 01250<br>VKM 11250<br>VKM 21147   | 1<br>1  | 1<br>1  | 1   |   |   |   |   | T0184   |
|                                    | BLS, BSW  | 09/06 → 11/07   |   | VKPC 81418   |   |   |   |   | 1   |   |   |   |
|                                    | B(Alt) BLS, BSW   | 09/06 → 11/07   | AC  | VKMV 6PK780<br>VKM 31057   | 1   |   | 1   |   |   |   |   |   |
|   | B(Alt) BLS, BSW   | 09/06 → 11/07   | AC  | VKMV 6PK1180<br>VKM 31058  | 1   |   | 1   |   |   |   |   |   |
| <b>SKODA  SUPERB 1.8 Turbo 20V</b> |   |   |   |  |   |   |   |   |   |   |   |   |
|                                    | AWT   | 02/02 → 11/07   |  | VKMA 01918<br>VKM 11018<br>VKM 11117   | 1<br>1  |   | 1<br>1  | 1<br>1  |   |   |   | 3 T0151   |
|   | AWT   | 02/02 → 11/07   |   | VKMA 01018<br>VKM 11018<br>VKM 21220   | 1<br>1  | 1<br>1  | 1   |   |   |   |   | 3 T0151   |
|                                    | AWT   | 02/02 → 11/07   |   | VKPC 81620   |   |   |   |   | 1   |   |   |   |
|                                    | B(Alt) AWT  | 02/02 → 11/07   | AC  | VKMV 5PK1300<br>VKM 31033  | 1   |   | 1   |   |   |   |   |   |
|   | B(Alt) AWT  | 02/02 → 11/07   | AC  | VKMV 4PK855<br>VKM 31033   | 1   |   | 1   |   |   |   |   |   |
| <b>SKODA  SUPERB 2.0</b>           |   |   |   |  |   |   |   |   |   |   |   |   |
|                                    | AZM   | 02/02 → 11/07   |   | VKMA 01113<br>VKM 11113  | 1<br>1  |   | 1   |   |   |   |   | T0149   |
|                                    | AZM   | 02/02 → 11/07   |   | VKPC 81620   |   |   |   |   | 1   |   |   |   |
|                                    | B(Alt) AZM  | 02/02 → 11/07   | AC  | VKMV 5PK1300<br>VKM 31033  | 1   |   | 1   |   |   |   |   |   |

































































SKODA

|                                  | <b>B(Alt)</b>        | AZM      | 02/02 → 11/07 | AC    | VKMV 4PK855<br>VKM 31033  | 1   |        | 1 |             |   |  |  |   |  |  |  |  |  |   |       |       |       |
|----------------------------------|----------------------|----------|---------------|-------|---|---|--------|---|-------------|---|--|--|---|--|--|--|--|--|---|-------|-------|-------|
| <b>SKODA  SUPERB 2.8 V6</b>      |                      |          |               |       |   |   |        |   |             |   |  |  |   |  |  |  |  |  |   |       |       |       |
|                                  |                      | AMX, BBG | 02/02 → 11/07 |       | VKMA 01903<br>VKM 11202<br>VKM 11209<br>VKM 21202                   | 1<br>1  | 1      | 1 | 1           |   |  |  |   |  |  |  |  |  | 1 | T0153 |       |       |
|                                  |                      | AMX, BBG | 02/02 → 11/07 |       | VKMA 01202<br>VKM 11202<br>VKM 21202                                | 1<br>1  | 1      | 1 | 1           |   |  |  |   |  |  |  |  |  |   | 1     | T0153 |       |
|                                  |                      | AMX, BBG | 02/02 → 11/07 |       | VKPC 81802  |   |        |   |             |   |  |  | 1 |  |  |  |  |  |   |       |       |       |
|                                  | <b>B(Alt)</b>        | AMX, BBG | 02/02 → 11/07 |       | VKMV 6PK1882<br>VKM 31061   | 1   |        |   | 1           |   |  |  |   |  |  |  |  |  |   |       |       |       |
| <b>SKODA  SUPERB 1.9 TDI 100</b> |                      |          |               |       |   |   |        |   |             |   |  |  |   |  |  |  |  |  |   |       |       |       |
|                                  |                      | AVB      | 08/02 → 11/07 |       | → ICH 3U-29015 228  | VKMA 01942<br>VKM 11142<br>VKM 11145<br>VKM 21142 | 1<br>1 | 1 | 1           | 1 |  |  |   |  |  |  |  |  |   | 3     | T0184 |       |
|                                  |                      | AVB      | 08/02 → 11/07 | → ICH | 3U-29015 228  | VKMA 01142<br>VKM 11142<br>VKM 21142              | 1<br>1 | 1 | 1           | 1 |  |  |   |  |  |  |  |  |   |       | 3     | T0184 |
|                                  |                      | AVB      | 08/02 → 11/07 | CH    | 3U-29015 229 I→   | VKMA 01250<br>VKM 11250<br>VKM 21147              | 1<br>1 | 1 | 1           | 1 |  |  |   |  |  |  |  |  |   |       |       | T0184 |
|                                  |                      | AVB      | 08/02 → 11/07 |       | VKPC 81303  |   |        |   |             |   |  |  | 1 |  |  |  |  |  |   |       |       |       |
|                                  | <b>B(Alt)</b>        | AVB      | 08/02 → 11/07 | AC    | VKMA 31000<br>VKMV 5PK1432<br>VKM 31013                             | 1<br>1  |        |   | 1           |   |  |  |   |  |  |  |  |  |   |       |       |       |
|                                  | <b>B(Alt), B(AC)</b> | AVB      | 08/02 → 11/07 | AC    | VKMA 31020<br>VKMV 4PK855<br>VKMV 5PK1432<br>VKM 31013<br>VKM 31059 | 2<br>1<br>1<br>1<br>1                             |        |   | 2<br>1<br>1 |   |  |  |   |  |  |  |  |  |   |       |       |       |
| <b>SKODA  SUPERB 1.9 TDI 105</b> |                      |          |               |       |   |   |        |   |             |   |  |  |   |  |  |  |  |  |   |       |       |       |
|                                  |                      | BSV      | 10/05 → 11/07 |       | VKMA 01250<br>VKM 11250<br>VKM 21147                                | 1<br>1  | 1      | 1 | 1           |   |  |  |   |  |  |  |  |  |   |       |       | T0184 |
|                                  |                      | BSV      | 10/05 → 11/07 |       | VKPC 81303  |   |        |   |             |   |  |  | 1 |  |  |  |  |  |   |       |       |       |
|                                  | <b>B(Alt)</b>        | BSV      | 10/05 → 11/07 | AC    | VKMA 31000<br>VKMV 5PK1432<br>VKM 31013                             | 1<br>1  |        |   | 1           |   |  |  |   |  |  |  |  |  |   |       |       |       |
|                                  | <b>B(Alt), B(AC)</b> | BSV      | 10/05 → 11/07 | AC    | VKMA 31020<br>VKMV 4PK855<br>VKMV 5PK1432<br>VKM 31013<br>VKM 31059 | 2<br>1<br>1<br>1<br>1                             |        |   | 2<br>1<br>1 |   |  |  |   |  |  |  |  |  |   |       |       |       |
| <b>SKODA  SUPERB 1.9 TDI 115</b> |                      |          |               |       |   |   |        |   |             |   |  |  |   |  |  |  |  |  |   |       |       |       |
|                                  |                      | BPZ      | 01/07 → 11/07 |       | VKMA 01250<br>VKM 11250<br>VKM 21147                                | 1<br>1  | 1      | 1 | 1           |   |  |  |   |  |  |  |  |  |   |       |       | T0184 |
|                                  |                      | BPZ      | 01/07 → 11/07 |       | VKPC 81303  |   |        |   |             |   |  |  | 1 |  |  |  |  |  |   |       |       |       |
|                                  | <b>B(Alt)</b>        | BPZ      | 01/07 → 11/07 | AC    | VKMA 31000<br>VKMV 5PK1432<br>VKM 31013                             | 1<br>1  |        |   | 1           |   |  |  |   |  |  |  |  |  |   |       |       |       |
|                                  | <b>B(Alt), B(AC)</b> | BPZ      | 01/07 → 11/07 | AC    | VKMA 31020<br>VKMV 4PK855<br>VKMV 5PK1432<br>VKM 31013<br>VKM 31059 | 2<br>1<br>1<br>1<br>1                             |        |   | 2<br>1<br>1 |   |  |  |   |  |  |  |  |  |   |       |       |       |
| <b>SKODA  SUPERB 1.9 TDI 130</b> |                      |          |               |       |   |   |        |   |             |   |  |  |   |  |  |  |  |  |   |       |       |       |
|                                  |                      | AVF, AWX | 02/02 → 11/07 |       | → ICH 3U-29015 228  | VKMA 01942<br>VKM 11142                           | 1<br>1 | 1 | 1           | 1 |  |  |   |  |  |  |  |  |   |       | 3     | T0184 |

|   |  |  |       |  |  |  |  |  |  |  |  |  |
|---|---|---|--|--|---|---|---|---|---|---|---|---|
|   |   |   |  | VKM 11145<br>VKM 21142   |   | 1   |   | 1   |   |   |   |   |
|   | AVF, AWX  | 02/02 → 11/07   | → ICH 3U-29015 228   | VKMA 01142<br>VKM 11142<br>VKM 21142   | 1<br>1  | 1<br>1  | 1   |   |   |   |   | 3 T0184   |
|   | AVF, AWX  | 02/02 → 11/07   | CH 3U-29015 229 I →  | VKMA 01250<br>VKM 11250<br>VKM 21147   | 1<br>1  | 1<br>1  | 1   |   |   |   |   | T0184   |
|                                | AVF, AWX  | 02/02 → 11/07   |  | VKPC 81303   |   |   |   | 1   |   |   |   |   |
|                                | B(Alt) AVF, AWX   | 02/02 → 11/07   | AC   | VKMA 31000<br>VKMV 5PK1432<br>VKM 31013  | 1<br>1  | 1<br>1  |   |   |   |   |   |   |
|   | B(Alt), B(AC) AVF, AWX  | 02/02 → 11/07   | AC   | VKMA 31020<br>VKMV 4PK855<br>VKMV 5PK1432<br>VKM 31013<br>VKM 31059                | 2<br>1<br>1<br>1  | 2<br>1<br>1   |   |   |   |   |   |   |
| <b>SKODA  SUPERB 2.0 TDI</b>   |   |   |  |  |   |   |   |   |   |   |   |   |
|                                | BSS   | 10/05 → 11/07   |  | VKMA 01250<br>VKM 11250<br>VKM 21147   | 1<br>1  | 1<br>1  | 1   |   |   |   |   | T0184   |
|                                | BSS   | 10/05 → 11/07   |  | VKPC 81303   |   |   |   | 1   |   |   |   |   |
|                                | B(Alt) BSS  | 10/05 → 11/07   | AC   | VKMA 31000<br>VKMV 5PK1432<br>VKM 31013  | 1<br>1  | 1<br>1  |   |   |   |   |   |   |
|   | B(Alt), B(AC) BSS   | 10/05 → 11/07   | AC   | VKMA 31020<br>VKMV 4PK855<br>VKMV 5PK1432<br>VKM 31013<br>VKM 31059                | 2<br>1<br>1<br>1  | 2<br>1<br>1   |   |   |   |   |   |   |
| <b>SKODA  SUPERB 2.5 TDI</b> |   |   |  |  |   |   |   |   |   |   |   |   |
|                              | AYM, BDG  | 02/02 → 11/07   |  4) | VKMA 01952<br>VKM 11150<br>VKM 11151<br>VKM 11154<br>VKM 21151                     | 2<br>1<br>1   | 1<br>1  | 2<br>1  | 1   |   |   |   | 3 T0170   |
|   | AYM, BDG  | 02/02 → 11/07   | 4)   | VKMA 01152<br>VKM 11150<br>VKM 11151<br>VKM 21151                                  | 2<br>1<br>1   | 1<br>1  | 2   |   |   |   |   | 2 T0170   |
|                              | AYM, BDG  | 02/02 → 11/07   |  | VKPC 81625   |   |   |   | 1   |   |   |   |   |
|                              | B(Alt) AYM, BDG   | 02/02 → 11/07   |  | VKMV 6PK2404<br>VKM 31038<br>VKM 31039<br>VKM 31041                                |   | 1<br>1<br>1   | 1   |   |   |   | 1   |   |
|   | B(AC) AYM, BDG  | 02/02 → 11/07   |  | VKMV 4PK1237<br>VKM 31040  | 1   |   | 1   |   |   |   |   |   |
| <b>SMART  CABRIO 0.6</b>     |   |   |  |  |   |   |   |   |   |   |   |   |
|                              | M 160 E6AL B03,<br>M 160 E6AL B05,<br>M 160 E6AL B09                              | 03/00 → 01/04   |  | ΟΧΘΙΧΘ   |   |   |   |   |   |   |   |   |
|                              | M 160 E6AL B03,<br>M 160 E6AL B05,<br>M 160 E6AL B09                              | 03/00 → 01/04   |  | VKPC 88848   |   |   |   | 1   |   |   |   |   |
| <b>SMART  CABRIO 0.7</b>     |   |   |  |  |   |   |   |   |   |   |   |   |
|                              | M 160 E6AL B07,<br>M 160 E6AL B09   | 01/03 → 01/04   |  | ΟΧΘΙΧΘ   |   |   |   |   |   |   |   |   |
|                              | M 160 E6AL B07,<br>M 160 E6AL B09   | 01/03 → 01/04   |  | VKPC 88848   |   |   |   | 1   |   |   |   |   |
| <b>SMART  CABRIO 0.8 CDI</b> |   |   |  |  |   |   |   |   |   |   |   |   |
|                              | OM 660  | 03/01 → 01/04   |  | ΟΧΘΙΧΘ   |   |   |   |   |   |   |   |   |
|                              | OM 660  | 03/01 → 01/04   |  | VKPC 88848   |   |   |   | 1   |   |   |   |   |



















SKODA

|  |    |  |  |  |  |  |  |  |  |  |  |  |  |  |
|--|---|---|---|--|---|---|---|---|---|---|---|---|---|---|
| <b>SMART</b>   |    | <b>CITY-COUPE 0.6</b>   |   |  |   |   |   |   |   |   |   |   |   |   |
|    |   | M 160 E6AL B03,<br>M 160 E6AL B04,<br>M 160 E6AL B05,<br>M 160 E6AL B09           | 07/98 → 01/04   | OKOKOKO  |   |   |   |   |   |   |   |   |   |   |
|    |   | M 160 E6AL B03,<br>M 160 E6AL B04,<br>M 160 E6AL B05,<br>M 160 E6AL B09           | 07/98 → 01/04   | VKPC 88848   |   |   |   |   |   |   | 1   |   |   |   |
| <b>SMART</b>   |    | <b>CITY-COUPE 0.7</b>   |   |  |   |   |   |   |   |   |   |   |   |   |
|    |   | M 160 E6AL B06,<br>M 160 E6AL B07,<br>M 160 E6AL B10                              | 01/03 → 01/04   | OKOKOKO  |   |   |   |   |   |   |   |   |   |   |
|    |   | M 160 E6AL B06,<br>M 160 E6AL B07,<br>M 160 E6AL B10                              | 01/03 → 01/04   | VKPC 88848   |   |   |   |   |   |   | 1   |   |   |   |
| <b>SMART</b>   |    | <b>CITY-COUPE 0.8 CDI</b>   |   |  |   |   |   |   |   |   |   |   |   |   |
|    |   | OM 660  | 11/99 → 01/04   | OKOKOKO  |   |   |   |   |   |   |   |   |   |   |
|    |   | OM 660  | 11/99 → 01/04   | VKPC 88848   |   |   |   |   |   |   | 1   |   |   |   |
| <b>SMART</b>   |    | <b>CROSSBLADE 0.6</b>   |   |  |   |   |   |   |   |   |   |   |   |   |
|    |   | M 160 E6AL B09  | 06/02 → 10/07   | OKOKOKO  |   |   |   |   |   |   |   |   |   |   |
|    |   | M 160 E6AL B09  | 06/02 → 10/07   | VKPC 88848   |   |   |   |   |   |   | 1   |   |   |   |
| <b>SMART</b>   |    | <b>FORFOUR 1.1</b>  |   |  |   |   |   |   |   |   |   |   |   |   |
|    |   | M 134.910   | 01/04 → 10/07   | OKOKOKO  |   |   |   |   |   |   |   |   |   |   |
|   |   | M 134.910   | 01/04 → 10/07   | —  |   |   |   |   |   |   | 1   |   |   |   |
| <b>SMART</b>   |  | <b>FORFOUR 1.3</b>  |   |  |   |   |   |   |   |   |   |   |   |   |
|  |   | M 150.930   | 01/04 → 10/07   | OKOKOKO  |   |   |   |   |   |   |   |   |   |   |
|  |   | M 135.930   | 01/04 → 10/07   | —  |   |   |   |   |   |   | 1   |   |   |   |
| <b>SMART</b>   |  | <b>FORFOUR 1.5</b>  |   |  |   |   |   |   |   |   |   |   |   |   |
|  |   | M 135.950   | 01/04 → 10/07   | OKOKOKO  |   |   |   |   |   |   |   |   |   |   |
|  |   | M 135.950   | 01/04 → 10/07   | —  |   |   |   |   |   |   | 1   |   |   |   |
| <b>SMART</b>   |  | <b>FORFOUR 1.5 CDI</b>  |   |  |   |   |   |   |   |   |   |   |   |   |
|  |   | OM 639.939  | 09/04 → 10/07   | OKOKOKO  |   |   |   |   |   |   |   |   |   |   |
|  |   | OM 639.939  | 09/04 → 10/07   | —  |   |   |   |   |   |   | 1   |   |   |   |
| <b>SMART</b>   |  | <b>FORTWO 0.7</b>   |   |  |   |   |   |   |   |   |   |   |   |   |
|  |   |   | 01/04 → 10/07   | OKOKOKO  |   |   |   |   |   |   |   |   |   |   |
|  |   |   | 01/04 → 10/07   | VKPC 88848   |   |   |   |   |   |   | 1   |   |   |   |
| <b>SMART</b>   |  | <b>FORTWO 1.0, 1.0 Turbo</b>  |   |  |   |   |   |   |   |   |   |   |   |   |
|  |   |   | 01/07 → 10/07   | OKOKOKO  |   |   |   |   |   |   |   |   |   |   |
| <b>SMART</b>   |  | <b>FORTWO 0.8 CDI</b>   |   |  |   |   |   |   |   |   |   |   |   |   |
|  |   | OM 660.950  | 01/04 → 10/07   | OKOKOKO  |   |   |   |   |   |   |   |   |   |   |
| <b>SMART</b>   |  | <b>ROADSTER 0.7</b>   |   |  |   |   |   |   |   |   |   |   |   |   |
|  |   |   | 04/03 → 10/07   | OKOKOKO  |   |   |   |   |   |   |   |   |   |   |
|  |   |   | 04/03 → 10/07   | VKPC 88848   |   |   |   |   |   |   | 1   |   |   |   |
| <b>SMART</b>   |  | <b>ROADSTER 0.7 Brabus</b>  |   |  |   |   |   |   |   |   |   |   |   |   |
|  |   |   | 12/03 → 10/07   | OKOKOKO  |   |   |   |   |   |   |   |   |   |   |
|  |   |   | 12/03 → 10/07   | VKPC 88848   |   |   |   |   |   |   | 1   |   |   |   |
| <b>SSANGYONG</b>   |  | <b>KORANDO</b>  |   |  |   |   |   |   |   |   |   |   |   |   |
|  |   | OM662LA   | 07/98 → 01/08   | OKOKOKO  |   |   |   |   |   |   |   |   |   |   |
| <b>SSANGYONG</b>   |  | <b>MUSSO SPORTS 2.9 D</b>   |   |  |   |   |   |   |   |   |   |   |   |   |
|  |   |   | 08/04 → 02/06   | OKOKOKO  |   |   |   |   |   |   |   |   |   |   |
| <b>SSANGYONG</b>   |  | <b>REXTON 2.3 RX230 4x4</b>   |   |  |   |   |   |   |   |   |   |   |   |   |
|  |   |   | 05/02 → 02/05   | OKOKOKO  |   |   |   |   |   |   |   |   |   |   |
| <b>SSANGYONG</b>   |  | <b>REXTON 2.8 RX280 4x4</b>   |   |  |   |   |   |   |   |   |   |   |   |   |
|  |   |   | 03/03 → 02/05   | OKOKOKO  |   |   |   |   |   |   |   |   |   |   |
| <b>SSANGYONG</b>   |  | <b>REXTON 3.2</b>   |   |  |   |   |   |   |   |   |   |   |   |   |
|  |   |   | 04/02 → 02/05   | OKOKOKO  |   |   |   |   |   |   |   |   |   |   |
| <b>SSANGYONG</b>   |  | <b>REXTON 2.9 TD</b>  |   |  |   |   |   |   |   |   |   |   |   |   |
|  |   |   | 04/02 → 02/05   | OKOKOKO  |   |   |   |   |   |   |   |   |   |   |







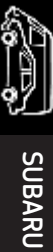













































| SUBARU  FORESTER 2.0         |   |
|---|---|
|                              | EJ201, EJ202 08/97 → 03/06 3), Mod. SF, SG, SOHC VKMS 98109 1 3 1 3 3<br>VKMA 98109 1 3 1<br>VKM 78005 1<br>VKM 88000 1<br>VKM 88001 1<br>VKM 88004 1 |
|   | EJ20J 08/97 → 09/02 3), Mod. SF, SOHC VKMS 98110 1 3 1 3 3<br>VKMA 98110 1 3 1<br>VKM 78005 1<br>VKM 88000 1<br>VKM 88000 1<br>VKM 88001 1            |
|                              | EJ201 09/02 → 03/06 Mod. SG, SOHC VKPC 1 1  |
|   | EJ202, EJ20J 08/97 → 09/02 Mod. SF, SOHC VKPC 99407 1 1   |
|                              | B(Alt) EJ201 09/02 → 03/06 Mod. SG, SOHC VKMV 5PK882 1 1  |
|   | B(Alt) EJ202, EJ20J 08/97 → 05/02 Mod. SF, SOHC VKMV 1 1  |
|   | B(AC) EJ201, EJ202, EJ20J 08/97 → 03/06 Mod. SF, SG, SOHC VKMA 1 1<br>VKMV 1<br>VKM 1   |
| SUBARU  FORESTER 2.0 S Turbo |   |
|                              | EJ205 06/98 → 09/02 Mod. SF, DOHC VKMA 1 4 1 4 4<br>VKM 78005 1<br>VKM 88000 1<br>VKM 88000 1<br>VKM 88001 1<br>VKM 1 1                               |
|   | EJ205 09/02 → 05/05 Mod. SG, DOHC VKMA 1 4 1 4 4<br>VKM 78005 1<br>VKM 88000 1<br>VKM 88000 1<br>VKM 88001 1<br>VKM 1 1                               |
|                            | EJ205 06/98 → 06/04 Mod. SF, SG, DOHC VKPC 1 1  |
|   | EJ205 04/04 → 05/05 Mod. SG, DOHC VKPC 1 1  |
|                            | B(Alt) EJ205 06/98 → 09/02 Mod. SF, DOHC VKMV 1 1   |
|   | B(Alt) EJ205 09/02 → 03/06 Mod. SG, DOHC VKMV 5PK882 1 1  |
|   | B(AC) EJ205 06/98 → 03/06 Mod. SF, SG, DOHC VKMA 1 1<br>VKMV 1<br>VKM 1   |
| SUBARU  FORESTER 2.0 X     |   |
|                            | EJ204 09/05 → 03/06 Mod. SG, DOHC VKMA 1 4 1 4 4<br>VKM 78005 1<br>VKM 88000 1<br>VKM 88000 1<br>VKM 88001 1<br>VKM 1 1                               |
|                            | EJ204 09/05 → 03/06 Mod. SG,  DOHC, Man. GBX VKPC 1 1              |
|   | EJ204 09/05 → 03/06 Mod. SG,  DOHC, Auto. GBX 4 VKPC 1 1           |
|   | EJ204 09/05 → 03/06 Mod. SG, DOHC, Man. GBX VKPC 1 1  |
|                            | B(Alt) EJ204 09/05 → 03/06 Mod. SG, DOHC VKMV 1 1   |
|   | B(AC) EJ204 09/05 → 03/06 Mod. SG, DOHC VKMA 1 1<br>VKMV 1<br>VKM 1   |
| SUBARU  FORESTER 2.5       |   |
|                            | EJ251, EJ253 01/99 → 06/04 3), Mod. SF, SG, SOHC VKMS 98109 1 3 1 3 3<br>VKMA 98109 1 3 1<br>VKM 78005 1<br>VKM 88000 1<br>VKM 88001 1<br>VKM 88004 1 |
|   | EJ255 12/03 → 10/05 Mod. SG, DOHC VKMA 1 4 1 4 4<br>VKM 78005 1<br>VKM 88000 1  |

































SUBARU































|   |  |  |  |  |  |  |  |  |  |  |  |  |
|---|---|---|---|--|---|---|---|---|---|---|---|---|
|   |   |   |   | VKM 88000  | 1   |   |   |   |   |   |   |   |
|   |   |   |   | VKM 88001  | 1   |   |   |   |   |   |   |   |
|   |   |   |   | VKM_____   | 1   |   |   |   |   |   |   |   |
|                               | EJ251   | 12/03 → 03/06   | Mod. SG, SOHC   | VKPC 99407   |   |   |   | 1   |   |   |   |   |
|   | EJ253   | 12/03 → 03/06   | Mod. SG, SOHC   | VKPC_____  |   |   |   | 1   |   |   |   |   |
|   | EJ255   | 12/03 → 03/06   | Mod. SG, DOHC   | VKPC_____  |   |   |   | 1   |   |   |   |   |
|                               | <b>B(Alt)</b> EJ251, EJ255  | 12/03 → 03/06   | Mod. SG   | VKMOV 5PK882   |   |   | 1   |   |   |   |   |   |
|   | <b>B(Alt)</b> EJ253   | 12/03 → 03/06   | Mod. SG, SOHC   | VKMOV_____   |   |   | 1   |   |   |   |   |   |
|   | <b>B(AC)</b> EJ251, EJ253, EJ255  | 12/03 → 03/06   | Mod. SG   | VKMA_____  | 1   |   | 1   |   |   |   |   |   |
|   |   |   |   | VKMOV_____   |   |   | 1   |   |   |   |   |   |
|   |   |   |   | VKM_____   | 1   |   |   |   |   |   |   |   |
| <b>SUBARU  IMPREZA 1.6</b>   |   |   |   |  |   |   |   |   |   |   |   |   |
|                               | EJ161   | 08/92 → 06/03   | 3), Mod. GC, GD, GF, GG, SOHC   | VKMS 98109   | 1   | 3   | 1   |   |   |   | 3   |   |
|   |   |   |   | VKMA 98109   | 1   | 3   | 1   |   |   |   |   | T0674   |
|   |   |   |   | VKM 78005  | 1   |   |   |   |   |   |   |   |
|   |   |   |   | VKM 88000  |   | 1   |   |   |   |   |   |   |
|   |   |   |   | VKM 88001  |   | 1   |   |   |   |   |   |   |
|   |   |   |   | VKM 88004  |   | 1   |   |   |   |   |   |   |
|   | EJ16E   | 08/92 → 12/00   | 3), Mod. GC, GF, SOHC   | VKMS 98000   | 1   | 3   | 1   |   |   |   | 3   |   |
|   |   |   |   | VKMA 98000   | 1   | 3   | 1   |   |   |   |   | T0674   |
|   |   |   |   | VKM 78000  | 1   |   |   |   |   |   |   |   |
|   |   |   |   | VKM 88000  |   | 1   |   |   |   |   |   |   |
|   |   |   |   | VKM 88000  |   | 1   |   |   |   |   |   |   |
|   |   |   |   | VKM 88001  |   | 1   |   |   |   |   |   |   |
|                               | EJ161, EJ16E  | 08/92 → 07/03   | Mod. GC, GD, GF, GG, SOHC   | VKPC 99407   |   |   |   |   | 1   |   |   |   |
|                             | <b>B(Alt)</b> EJ161   | 12/00 → 10/02   | Mod. GD, GG, SOHC   | VKMOV_____   |   |   | 1   |   |   |   |   |   |
|   | <b>B(Alt)</b> EJ161   | 11/02 → 07/05   | Mod. GD, GG, SOHC   | VKMOV_____   |   |   | 1   |   |   |   |   |   |
|   | <b>B(AC)</b> EJ161  | 12/00 → 06/05   | Mod. GD, GG, SOHC   | VKM_____   |   |   | 1   |   |   |   |   |   |
| <b>SUBARU  IMPREZA 1.8</b> |   |   |   |  |   |   |   |   |   |   |   |   |
|                             | EJ181   | 08/92 → 12/00   | 3), Mod. GC, GF, SOHC   | VKMS 98109   | 1   | 3   | 1   |   |   |   | 3   |   |
|   |   |   |   | VKMA 98109   | 1   | 3   | 1   |   |   |   |   | T0674   |
|   |   |   |   | VKM 78005  | 1   |   |   |   |   |   |   |   |
|   |   |   |   | VKM 88000  |   | 1   |   |   |   |   |   |   |
|   |   |   |   | VKM 88001  |   | 1   |   |   |   |   |   |   |
|   |   |   |   | VKM 88004  |   | 1   |   |   |   |   |   |   |
|   | EJ18E   | 08/92 → 12/95   | 3), Mod. GC, GF, GM, SOHC   | VKMS 98000   | 1   | 3   | 1   |   |   |   | 3   |   |
|   |   |   |   | VKMA 98000   | 1   | 3   | 1   |   |   |   |   | T0674   |
|   |   |   |   | VKM 78000  | 1   |   |   |   |   |   |   |   |
|   |   |   |   | VKM 88000  |   | 1   |   |   |   |   |   |   |
|   |   |   |   | VKM 88000  |   | 1   |   |   |   |   |   |   |
|   |   |   |   | VKM 88001  |   | 1   |   |   |   |   |   |   |
|                             | EJ181, EJ18E  | 08/92 → 12/00   | Mod. GC, GF, SOHC   | VKPC 99407   |   |   |   |   | 1   |   |   |   |
|                             | <b>B(Alt)</b> EJ181, EJ18E  | 08/92 → 12/00   | Mod. GC, GF, SOHC   | VKMOV_____   |   |   | 1   |   |   |   |   |   |
|   | <b>B(AC)</b> EJ181, EJ18E   | 08/92 → 12/00   | Mod. GC, GF, SOHC   | VKMA_____  |   |   | 1   | 1   |   |   |   |   |
|   |   |   |   | VKMOV_____   |   |   | 1   |   |   |   |   |   |
|   |   |   |   | VKM_____   |   |   | 1   |   |   |   |   |   |
| <b>SUBARU  IMPREZA 2.0</b> |   |   |   |  |   |   |   |   |   |   |   |   |
|                             | EJ201   | 10/95 → 06/03   | 3), Mod. GC, GD, GF, GG, SOHC   | VKMS 98109   | 1   | 3   | 1   |   |   |   | 3   |   |
|   |   |   |   | VKMA 98109   | 1   | 3   | 1   |   |   |   |   | T0674   |
|   |   |   |   | VKM 78005  | 1   |   |   |   |   |   |   |   |
|   |   |   |   | VKM 88000  |   | 1   |   |   |   |   |   |   |
|   |   |   |   | VKM 88001  |   | 1   |   |   |   |   |   |   |
|   |   |   |   | VKM 88004  |   | 1   |   |   |   |   |   |   |
|   | EJ20E   | 10/95 → 12/00   | 3), Mod. GC, GF, SOHC   | VKMS 98110   | 1   | 3   | 1   |   |   |   | 3   |   |
|   |   |   |   | VKMA 98110   | 1   | 3   | 1   |   |   |   |   | T0674   |
|   |   |   |   | VKM 78005  | 1   |   |   |   |   |   |   |   |
|   |   |   |   | VKM 88000  |   | 1   |   |   |   |   |   |   |
|   |   |   |   | VKM 88000  |   | 1   |   |   |   |   |   |   |
|   |   |   |   | VKM 88001  |   | 1   |   |   |   |   |   |   |
|   | EJ20G   | 06/98 → 12/00   | Mod. GF, DOHC   | VKMA 98112   | 1   | 3   | 1   |   |   |   |   | T0621   |
|   |   |   |   | VKM 78005  | 1   |   |   |   |   |   |   |   |
|   |   |   |   | VKM 88000  |   | 1   |   |   |   |   |   |   |

|   |  |  |  |  |  |  |  |  |  |  |  |
|---|---|---|---|--|---|---|---|---|---|---|---|
|   |   |   |   | VKM 88000  | 1   |   |   |   |   |   |   |
|   |   |   |   | VKM 88001  | 1   |   |   |   |   |   |   |
|                                    | EJ201, EJ20E  | 10/95 → 12/00   | Mod. GC, GF, SOHC   | VKPC 99407   |   |   |   | 1   |   |   |   |
|   | EJ201   | 12/00 → 03/06   | Mod. GD, GG, SOHC   | VKPC   |   |   |   | 1   |   |   |   |
|   | EJ20G   | 06/98 → 12/00   | Mod. GF, DOHC   | VKPC   |   |   |   | 1   |   |   |   |
|                                    | B(Alt) EJ201, EJ20E   | 10/95 → 10/02   | Mod. GC, GF, SOHC   | VKMV   |   |   | 1   |   |   |   |   |
|   | B(Alt) EJ201  | 11/02 → 07/05   | Mod. GD, GG, SOHC   | VKMV 5PK882  |   |   | 1   |   |   |   |   |
|   | B(Alt) EJ205, EJ20G   | 06/98 → 12/00   | Mod. GF, DOHC   | VKMV   |   |   | 1   |   |   |   |   |
|   | B(AC) EJ201, EJ20E  | 10/95 → 07/05   | Mod. GC, GF, SOHC   | VKMA   | 1   | 1   |   |   |   |   |   |
|   |   |   |   | VKMV   |   | 1   |   |   |   |   |   |
|   |   |   |   | VKM  | 1   |   |   |   |   |   |   |
|   | B(AC) EJ205   | 06/98 → 12/00   | Mod. GF, DOHC   | VKMA   | 1   | 1   |   |   |   |   |   |
|   |   |   |   | VKMV   |   | 1   |   |   |   |   |   |
|   |   |   |   | VKM  | 1   |   |   |   |   |   |   |
| <b>SUBARU  IMPREZA 2.0 R</b>       |   |   |   |  |   |   |   |   |   |   |   |
|                                    | EJ204   | 09/05 → 03/06   | Mod. GD, GG, DOHC   | VKMA   | 1   | 4   | 1   |   |   |   | T0675   |
|   |   |   |   | VKM 78005  | 1   |   |   |   |   |   |   |
|   |   |   |   | VKM 88000  |   | 1   |   |   |   |   |   |
|   |   |   |   | VKM 88000  |   | 1   |   |   |   |   |   |
|   |   |   |   | VKM 88001  |   | 1   |   |   |   |   |   |
|   |   |   |   | VKM  |   | 1   |   |   |   |   |   |
|                                    | EJ204   | 09/05 → 03/06   | Mod. GD, (EUR), GG, DOHC, Man. GBX 5  | VKPC   |   |   |   | 1   |   |   |   |
|   | EJ204   | 09/05 → 03/06   | Mod. GD, (EUR), GG, DOHC, Auto. GBX   | VKPC   |   |   |   | 1   |   |   |   |
|   | EJ204   | 09/05 → 03/06   | Mod. GD, GG, (AUS), DOHC, Auto. GBX   | VKPC   |   |   |   | 1   |   |   |   |
|                                  | B(Alt) EJ204  | 09/05 → 03/06   | Mod. GD, GG, DOHC   | VKMV   |   |   | 1   |   |   |   |   |
|   | B(AC) EJ204   | 09/05 → 03/06   | Mod. GD, GG, DOHC   | VKMA   | 1   | 1   |   |   |   |   |   |
|   |   |   |   | VKMV   |   | 1   |   |   |   |   |   |
|   |   |   |   | VKM  |   | 1   |   |   |   |   |   |
| <b>SUBARU  IMPREZA 2.0 Turbo</b> |   |   |   |  |   |   |   |   |   |   |   |
|                                  | EJ205   | 03/94 → 12/00   | Mod. GC, GF, DOHC   | VKMA   | 1   | 4   | 1   |   |   |   | T0675   |
|   |   |   |   | VKM 78005  | 1   |   |   |   |   |   |   |
|   |   |   |   | VKM 88000  |   | 1   |   |   |   |   |   |
|   |   |   |   | VKM 88000  |   | 1   |   |   |   |   |   |
|   |   |   |   | VKM 88001  |   | 1   |   |   |   |   |   |
|   |   |   |   | VKM  |   | 1   |   |   |   |   |   |
|   | EJ205   | 12/00 → 03/06   | Mod. GG, DOHC   | VKMA   | 1   | 4   | 1   |   |   |   | T0675   |
|   |   |   |   | VKM 78005  | 1   |   |   |   |   |   |   |
|   |   |   |   | VKM 88000  |   | 1   |   |   |   |   |   |
|   |   |   |   | VKM 88000  |   | 1   |   |   |   |   |   |
|   |   |   |   | VKM 88001  |   | 1   |   |   |   |   |   |
|   |   |   |   | VKM  |   | 1   |   |   |   |   |   |
|                                  | EJ205, EJ20G  | 03/94 → 08/03   | Mod. GC, GF, GG, DOHC   | VKPC   |   |   |   | 1   |   |   |   |
|   | EJ205   | 07/03 → 07/05   | Mod. GG, DOHC   | VKPC   |   |   |   | 1   |   |   |   |
|                                  | B(Alt) EJ205, EJ20G   | 03/94 → 10/02   | Mod. GC, GF, GG, DOHC   | VKMV   |   |   | 1   |   |   |   |   |
|   | B(Alt) EJ205  | 11/02 → 07/05   | Mod. GG, DOHC   | VKMV   |   |   | 1   |   |   |   |   |
|   | B(AC) EJ205   | 03/94 → 07/05   | Mod. GC, GF, GG, DOHC   | VKMA   | 1   | 1   |   |   |   |   |   |
|   |   |   |   | VKMV   |   | 1   |   |   |   |   |   |
|   |   |   |   | VKM  |   | 1   |   |   |   |   |   |
| <b>SUBARU  IMPREZA 2.0 WRX</b>   |   |   |   |  |   |   |   |   |   |   |   |
|                                  | EJ205   | 12/00 → 03/06   | Mod. GD, GG, DOHC   | VKMA   | 1   | 4   | 1   |   |   |   | T0675   |
|   |   |   |   | VKM 78005  | 1   |   |   |   |   |   |   |
|   |   |   |   | VKM 88000  |   | 1   |   |   |   |   |   |
|   |   |   |   | VKM 88000  |   | 1   |   |   |   |   |   |
|   |   |   |   | VKM 88001  |   | 1   |   |   |   |   |   |
|   |   |   |   | VKM  |   | 1   |   |   |   |   |   |
|                                  | EJ205   | 12/00 → 08/03   | Mod. GD, GG, DOHC   | VKPC   |   |   |   | 1   |   |   |   |
|   | EJ205   | 07/03 → 07/05   | Mod. GD, GG, DOHC   | VKPC   |   |   |   | 1   |   |   |   |
|                                  | B(Alt) EJ205  | 12/00 → 10/02   | Mod. GD, DOHC   | VKMV   |   |   | 1   |   |   |   |   |





































SUBARU









































|   |  |  |  |  |  |  |  |  |  |  |  |  |
|---|---|---|---|--|---|---|---|---|---|---|---|---|
| B(Alt)  | EJ205   | 11/02 → 07/05   | Mod. GD, GG, DOHC   | VKMV 5PK882  |   |   | 1   |   |   |   |   |   |
| B(AC)   | EJ205   | 12/00 → 07/05   | Mod. GD, GG, DOHC   | VKMA____<br>VKMV____<br>VKM____  | 1<br>1<br>1   | 1   |   |   |   |   |   |   |
| <b>SUBARU  IMPREZA 2.0 WRX STi</b>   |   |   |   |  |   |   |   |   |   |   |   |   |
|                                       | EJ207   | 11/01 → 03/06   | Mod. GD, DOHC   | VKMA____<br>VKM 78005<br>VKM 88000<br>VKM 88000<br>VKM 88001<br>VKM____            | 1<br>1<br>1<br>1<br>1   | 4   | 1   |   |   |   |   | T0675   |
|                                       | EJ207   | 11/01 → 08/03   | Mod. GD, DOHC   | VKPC____   |   |   |   | 1   |   |   |   |   |
|   | EJ207   | 02/04 → 07/05   | Mod. GD, DOHC   | VKPC____   |   |   |   | 1   |   |   |   |   |
|                                       | B(Alt)  | EJ207   | 11/01 → 10/02   | Mod. GD, DOHC  | VKMV____  |   | 1   |   |   |   |   |   |
|   | B(Alt)  | EJ207   | 11/02 → 07/05   | Mod. GD, DOHC  | VKMV 5PK882   |   | 1   |   |   |   |   |   |
|   | B(AC)   | EJ207   | 11/01 → 07/05   | Mod. GD, DOHC  | VKMA____<br>VKMV____<br>VKM____   | 1<br>1<br>1   | 1   |   |   |   |   |   |
| <b>SUBARU  IMPREZA 2.2</b>           |   |   |   |  |   |   |   |   |   |   |   |   |
|                                       | EJ22E   | 08/94 → 12/95   | 3), Mod. GC, GF, GM, SOHC   | VKMS 98000<br>VKMA 98000<br>VKM 78000<br>VKM 88000<br>VKM 88000<br>VKM 88001       | 1<br>1<br>1<br>1<br>1<br>1  | 3   | 1   |   |   | 3   |   | T0674   |
| <b>SUBARU  IMPREZA 2.5</b>         |   |   |   |  |   |   |   |   |   |   |   |   |
|                                     | EJ251   | 01/99 → 07/05   | 3), Mod. GD, GG, SOHC   | VKMS 98109<br>VKMA 98109<br>VKM 78005<br>VKM 88000<br>VKM 88001<br>VKM 88004       | 1<br>1<br>1<br>1<br>1<br>1  | 3   | 1   |   |   | 3   |   | T0674   |
|                                     | EJ251   | 04/00 → 07/05   | Mod. GD, GG, SOHC   | VKPC 99407   |   |   |   | 1   |   |   |   |   |
| <b>SUBARU  IMPREZA 2.5 WRX</b>     |   |   |   |  |   |   |   |   |   |   |   |   |
|                                     | EJ255   | 09/05 → 03/06   | Mod. GD, GG, DOHC   | VKMA____<br>VKM 78005<br>VKM 88000<br>VKM 88000<br>VKM 88001<br>VKM____            | 1<br>1<br>1<br>1<br>1   | 4   | 1   |   |   |   |   | T0675   |
|                                     | EJ255   | 09/05 → 03/06   | Mod. GD, GG, DOHC   | VKPC____   |   |   |   | 1   |   |   |   |   |
|                                     | B(Alt)  | EJ255   | 09/05 → 03/06   | Mod. GD, GG, DOHC  | VKMV 5PK882   |   | 1   |   |   |   |   |   |
|   | B(AC)   | EJ255   | 09/05 → 03/06   | Mod. GD, GG, DOHC  | VKMA____<br>VKMV____<br>VKM____   | 1<br>1<br>1   | 1   |   |   |   |   |   |
| <b>SUBARU  IMPREZA 2.5 WRX STi</b> |   |   |   |  |   |   |   |   |   |   |   |   |
|                                     | EJ257   | 09/05 → 03/06   | Mod. GD, DOHC   | VKMA____<br>VKM 78005<br>VKM 88000<br>VKM 88000<br>VKM 88001<br>VKM____            | 1<br>1<br>1<br>1<br>1   | 4   | 1   |   |   |   |   | T0675   |
|                                     | EJ257   | 09/05 → 03/06   | Mod. GD, DOHC   | VKPC____   |   |   |   | 1   |   |   |   |   |
|                                     | B(Alt)  | EJ257   | 09/05 → 03/06   | Mod. GD, DOHC  | VKMV 5PK882   |   | 1   |   |   |   |   |   |
|   | B(AC)   | EJ257   | 09/05 → 03/06   | Mod. GD, DOHC  | VKMA____<br>VKMV____<br>VKM____   | 1<br>1<br>1   | 1   |   |   |   |   |   |
| <b>SUBARU  JUSTY 1.0</b>           |   |   |   |  |   |   |   |   |   |   |   |   |
|                                     | EF10  | 01/87 → 12/91   | Mod. KA, KD   | —<br>VKM 78103   | 1<br>1  |   | 1   |   |   |   |   |   |

|   |                           |  |  |  |  |  |  |  |  |  |  |  |  |
|---|---------------------------|---|---|---|--|---|---|---|---|---|---|---|---|
| <b>SUBARU</b>  <b>JUSTY 1.2</b>            |                           |   |   |   |  |   |   |   |   |   |   |   |   |
|    | EF12                      | 01/87 → 12/91   | 3), Mod. KA, KD   | VKMS 98105<br>VKMA 98105<br>VKM 78105   | 1<br>1<br>1  |   | 1   |   |   |   |   | 3   | T0662   |
| <b>SUBARU</b>  <b>JUSTY 1.3</b>            |                           |   |   |   |  |   |   |   |   |   |   |   |   |
|    | EF13, G13B                | 10/95 → 11/03   |   | VKPC 96210  |  |   |   |   | 1   |   |   |   |   |
| <b>SUBARU</b>  <b>L SERIES 1.8</b>         |                           |   |   |   |  |   |   |   |   |   |   |   |   |
|    | EA82A, EA82E, EA82T       | 01/84 → 12/89   | Mod. AC, AG, AK, AN   | VKPC 99406  |  |   |   |   | 1   |   |   |   |   |
| <b>SUBARU</b>  <b>LEGACY 1.6</b>           |                           |   |   |   |  |   |   |   |   |   |   |   |   |
|    | EJ16A                     | 01/90 → 12/91   | 3), Mod. BC, BF, BJ, SOHC   | VKMS 98000<br>VKMA 98000<br>VKM 78000<br>VKM 88000<br>VKM 88001                   | 1<br>1<br>1<br>1<br>1  | 3<br>3  | 1<br>1  |   |   |   |   | 3   | T0674   |
|    | EJ16E                     | 01/90 → 12/94   | Mod. BC, BF, BJ, SOHC   | VKPC 99407  |  |   |   |   | 1   |   |   |   |   |
| <b>SUBARU</b>  <b>LEGACY 1.8</b>           |                           |   |   |   |  |   |   |   |   |   |   |   |   |
|    | EJ18E                     | 01/89 → 05/93   | 3), Mod. BC, BF, BJ, SOHC   | VKMS 98000<br>VKMA 98000<br>VKM 78000<br>VKM 88000<br>VKM 88001                   | 1<br>1<br>1<br>1<br>1  | 3<br>3  | 1<br>1  |   |   |   |   | 3   | T0674   |
|    | EJ18E                     | 01/89 → 07/94   | Mod. BC, BF, BJ, SOHC   | VKPC 99407  |  |   |   |   | 1   |   |   |   |   |
| <b>SUBARU</b>  <b>LEGACY 2.0</b>           |                           |   |   |   |  |   |   |   |   |   |   |   |   |
|    | EJ201, EJ202              | 12/98 → 03/06   | 3), Mod. BE, BH, BL, BP, SOHC   | VKMS 98109<br>VKMA 98109<br>VKM 78005<br>VKM 88000<br>VKM 88001<br>VKM 88004      | 1<br>1<br>1<br>1<br>1<br>1   | 3<br>3  | 1<br>1  |   |   |   |   | 3   | T0674   |
|   | EJ206, EJ208              | 12/98 → 08/03   | Mod. BE, BH, DOHC   | VKMA _____<br>VKM 78005<br>VKM 88000<br>VKM 88000<br>VKM 88001<br>VKM _____       | 1<br>1<br>1<br>1<br>1<br>1   | 4   | 1   |   |   |   |   |   | T0675   |
|    | EJ201, EJ20E              | 08/91 → 07/03   | Mod. BC, BE, BH, SOHC   | VKPC 99407  |  |   |   |   | 1   |   |   |   |   |
|   | EJ202                     | 09/03 → 06/05   | Mod. BL, BP, SOHC   | VKPC _____  |  |   |   |   | 1   |   |   |   |   |
|   | EJ206                     | 12/98 → 08/03   | Mod. BE, BH, DOHC   | —   |  |   |   |   | 1   |   |   |   |   |
|   | EJ208                     | 12/98 → 08/03   | Mod. BE, BH, DOHC   | VKPC _____  |  |   |   |   | 1   |   |   |   |   |
|    | B(Alt) EJ201              | 12/98 → 08/03   | Mod. BE, BH, SOHC   | VKMV _____  |  |   | 1   |   |   |   |   |   |   |
|   | B(Alt) EJ202              | 09/03 → 03/06   | Mod. BL, BP, SOHC   | VKMV _____  |  |   | 1   |   |   |   |   |   |   |
|   | B(Alt) EJ206, EJ208       | 10/01 → 08/03   | Mod. BE, BH, DOHC   | VKMV 5PK882   |  |   | 1   |   |   |   |   |   |   |
|   | B(Alt) EJ208              | 12/98 → 09/01   | Mod. BE, BH, DOHC   | VKMV _____  |  |   | 1   |   |   |   |   |   |   |
|   | B(AC) EJ201, EJ206, EJ208 | 12/98 → 08/03   | Mod. BE, BH   | VKMA _____<br>VKMV _____<br>VKM _____   | 1<br>1<br>1  |   | 1<br>1  |   |   |   |   |   |   |
|   | B(AC) EJ202               | 09/03 → 03/06   | Mod. BL, BP, SOHC   | VKMA _____<br>VKMV _____<br>VKM _____   | 1<br>1<br>1  |   | 1<br>1  |   |   |   |   |   |   |
| <b>SUBARU</b>  <b>LEGACY 2.0 Turbo R</b> |                           |   |   |   |  |   |   |   |   |   |   |   |   |
|    | EJ204                     | 06/05 → 03/06   | Mod. BP, DOHC   | VKMA _____<br>VKM 78005<br>VKM 88000<br>VKM 88000<br>VKM 88001<br>VKM _____       | 1<br>1<br>1<br>1<br>1<br>1   | 4   | 1   |   |   |   |   |   | T0675   |
|    | EJ204                     | 06/05 → 03/06   | Mod. BP, (EUR), DOHC, L.H.D, Man. GBX 5   | VKPC _____  |  |   |   |   | 1   |   |   |   |   |
|   | EJ204                     | 06/05 → 06/05   | Mod. BP, (EUR), DOHC, Auto. GBX 4   | VKPC _____  |  |   |   |   | 1   |   |   |   |   |
|   | EJ204                     | 06/05 → 03/06   | Mod. BP, (AUS), DOHC  | VKPC _____  |  |   |   |   | 1   |   |   |   |   |





































































SUBARU

|   |  |  |  |  |  |  |  |  |  |  |  |  |  |  |
|---|---|---|---|--|---|---|---|---|---|---|---|---|---|---|
|                                 | <b>B(Alt)</b> EJ204   | 06/05 → 03/06   | <b>Mod. BP, DOHC</b>  | VKMOV_____   |   |   | 1   |   |   |   |   |   |   |   |
|   | <b>B(AC)</b> EJ204  | 06/05 → 03/06   | <b>Mod. BP, DOHC</b>  | VKMA_____  |   | 1   | 1   |   |   |   |   |   |   |   |
|   |   |   |   | VKMOV_____   |   |   | 1   |   |   |   |   |   |   |   |
|   |   |   |   | VKM_____   |   | 1   |   |   |   |   |   |   |   |   |
| <b>SUBARU  LEGACY 2.2</b>      |   |   |   |  |   |   |   |   |   |   |   |   |   |   |
|                                 | EJ22E   | 01/90 → 12/95   | 3), <b>Mod. BC, BD, BF, BJ, BK, SOHC</b>  | VKMS 98000   | 1   | 3   | 1   |   |   |   | 3   |   |   | T0674   |
|   |   |   |   | VKMA 98000   | 1   | 3   | 1   |   |   |   |   |   |   |   |
|   |   |   |   | VKM 78000  | 1   |   |   |   |   |   |   |   |   |   |
|   |   |   |   | VKM 88000  |   | 1   |   |   |   |   |   |   |   |   |
|   |   |   |   | VKM 88000  |   | 1   |   |   |   |   |   |   |   |   |
|   |   |   |   | VKM 88001  |   | 1   |   |   |   |   |   |   |   |   |
|                                 | EJ22E   | 01/89 → 07/94   | <b>Mod. BC, SOHC</b>  | VKPC 99407   |   |   |   |   | 1   |   |   |   |   |   |
|                                 | <b>B(AC)</b> EJ22E  | 01/89 → 03/94   | <b>Mod. BC, SOHC</b>  | VKMA_____  |   | 1   | 1   |   |   |   |   |   |   |   |
|   |   |   |   | VKMOV_____   |   |   | 1   |   |   |   |   |   |   |   |
| <b>SUBARU  LEGACY 2.5</b>      |   |   |   |  |   |   |   |   |   |   |   |   |   |   |
|                                 | EJ251   | 10/98 → 03/06   | 3), <b>Mod. BE, BH, BL, BP, SOHC</b>  | VKMS 98109   | 1   | 3   | 1   |   |   |   | 3   |   |   | T0674   |
|   |   |   |   | VKMA 98109   | 1   | 3   | 1   |   |   |   |   |   |   |   |
|   |   |   |   | VKM 78005  | 1   |   |   |   |   |   |   |   |   |   |
|   |   |   |   | VKM 88000  |   | 1   |   |   |   |   |   |   |   |   |
|   |   |   |   | VKM 88001  |   | 1   |   |   |   |   |   |   |   |   |
|   |   |   |   | VKM 88004  |   | 1   |   |   |   |   |   |   |   |   |
|                                 | EJ251   | 10/98 → 06/03   | <b>Mod. BE, BH, SOHC</b>  | VKPC 99407   |   |   |   |   | 1   |   |   |   |   |   |
|   | EJ251   | 09/03 → 03/05   | <b>Mod. BL, BP, SOHC</b>  | VKPC_____  |   |   |   |   | 1   |   |   |   |   |   |
|                                | <b>B(Alt)</b> EJ25  | 09/03 → 03/06   | <b>Mod. BL, BP, SOHC</b>  | VKMOV_____   |   |   | 1   |   |   |   |   |   |   |   |
|   | <b>B(Alt)</b> EJ251   | 10/98 → 09/01   | <b>Mod. BE, BH, SOHC</b>  | VKMOV_____   |   |   | 1   |   |   |   |   |   |   |   |
|   | <b>B(Alt)</b> EJ251   | 10/01 → 08/03   | <b>Mod. BE, BH, SOHC</b>  | VKMOV 5PK882   |   |   | 1   |   |   |   |   |   |   |   |
|   | <b>B(AC)</b> EJ25   | 09/03 → 03/06   | <b>Mod. BL, BP, SOHC</b>  | VKMA_____  |   | 1   | 1   |   |   |   |   |   |   |   |
|   |   |   |   | VKMOV_____   |   |   | 1   |   |   |   |   |   |   |   |
|   |   |   |   | VKM_____   |   | 1   |   |   |   |   |   |   |   |   |
|   | <b>B(AC)</b> EJ251  | 10/98 → 08/03   | <b>Mod. BE, BH, SOHC</b>  | VKMA_____  |   | 1   | 1   |   |   |   |   |   |   |   |
|   |   |   |   | VKMOV_____   |   |   | 1   |   |   |   |   |   |   |   |
|   |   |   |   | VKM_____   |   | 1   |   |   |   |   |   |   |   |   |
| <b>SUBARU  LEGACY 3.0</b>    |   |   |   |  |   |   |   |   |   |   |   |   |   |   |
|                               | EZ30D   | 09/03 → 03/06   | <b>Mod. BL, BP</b>  | <del>OKOKOKO</del>   |   |   |   |   |   |   |   |   |   |   |
|                               | EZ30D   | 09/03 → 03/06   | <b>Mod. BL, BP, DOHC</b>  | VKPC_____  |   |   |   |   | 1   |   |   |   |   |   |
|                               | <b>B(Alt)</b> EZ30D   | 09/03 → 03/05   | <b>Mod. BL, BP, DOHC</b>  | VKMOV_____   |   |   |   |   |   |   |   |   |   |   |
|   |   |   |   | VKM_____   |   | 1   |   |   |   |   |   |   |   |   |
| <b>SUBARU  LEGACY 3.0 H6</b> |   |   |   |  |   |   |   |   |   |   |   |   |   |   |
|                               | EZ30D   | 08/00 → 08/03   | <b>Mod. BE, BH</b>  | <del>OKOKOKO</del>   |   |   |   |   |   |   |   |   |   |   |
|                               | EZ30D   | 08/00 → 08/03   | <b>Mod. BE, BH, DOHC</b>  | VKPC_____  |   |   |   |   | 1   |   |   |   |   |   |
|                               | <b>B(Alt)</b> EZ30D   | 08/00 → 08/03   | <b>Mod. BE, BH, DOHC</b>  | VKMA_____  | 1   | 2   | 1   |   |   |   |   |   |   |   |
|   |   |   |   | VKMOV 6PK1640  |   |   | 1   |   |   |   |   |   |   |   |
|   |   |   |   | VKM_____   | 1   |   |   |   |   |   |   |   |   |   |
| <b>SUBARU  LEONE 1.3</b>     |   |   |   |  |   |   |   |   |   |   |   |   |   |   |
|                               | EA65  | 01/86 → 12/89   | 3)  | VKMS 98001   | 2   | 1   | 2   |   |   |   | 3   |   |   | T0616   |
|   |   |   |   | VKMA 98001   | 2   | 1   | 2   |   |   |   |   |   |   |   |
|   |   |   |   | VKM 78001  | 1   |   |   |   |   |   |   |   |   |   |
|   |   |   |   | VKM 78002  | 1   |   |   |   |   |   |   |   |   |   |
|   |   |   |   | VKM 88002  |   | 1   |   |   |   |   |   |   |   |   |
| <b>SUBARU  LEONE 1.6</b>     |   |   |   |  |   |   |   |   |   |   |   |   |   |   |
|                               | EA71  | 01/86 → 12/89   | 3)  | VKMS 98001   | 2   | 1   | 2   |   |   |   | 3   |   |   | T0616   |
|   |   |   |   | VKMA 98001   | 2   | 1   | 2   |   |   |   |   |   |   |   |
|   |   |   |   | VKM 78001  | 1   |   |   |   |   |   |   |   |   |   |
|   |   |   |   | VKM 78002  | 1   |   |   |   |   |   |   |   |   |   |
|   |   |   |   | VKM 88002  |   | 1   |   |   |   |   |   |   |   |   |
| <b>SUBARU  LEONE 1.8</b>     |   |   |   |  |   |   |   |   |   |   |   |   |   |   |
|                               | EA82  | 01/86 → 07/91   | 3)  | VKMS 98001   | 2   | 1   | 2   |   |   |   | 3   |   |   | T0616   |
|   |   |   |   | VKMA 98001   | 2   | 1   | 2   |   |   |   |   |   |   |   |
|   |   |   |   | VKM 78001  | 1   |   |   |   |   |   |   |   |   |   |
|   |   |   |   | VKM 78002  | 1   |   |   |   |   |   |   |   |   |   |
|   |   |   |   | VKM 88002  |   | 1   |   |   |   |   |   |   |   |   |

|  |  |  |  |  |  |  |  |  |  |  |
|--|---|---|---|--|---|---|---|---|---|---|
|   | EA81  | 09/80 → 07/84   | Mod. AB-4, AB-5, AF-5,<br>AJ-5, AM-5  | VKPC 99404   |   |   |   |   | 1   |   |
|  | EA82  | 11/84 → 12/89   |   | VKPC 99406   |   |   |   |   | 1   |   |
| <b>SUBARU  LEONE 1.8 CAT, 1.8 Super CAT</b> |   |   |   |  |   |   |   |   |   |   |
|   |   | 07/86 → 07/91   | 3)  | VKMS 98001<br>VKMA 98001<br>VKM 78001<br>VKM 78002<br>VKM 88002                    | 2<br>2<br>1<br>1  | 1<br>1  | 2<br>2  |   |   | 3<br>T0616  |
| <b>SUBARU  OUTBACK 2.5</b>                  |   |   |   |  |   |   |   |   |   |   |
|   | EJ251   | 10/00 → 03/06   | 3), Mod. BH, BP, SOHC   | VKMS 98109<br>VKMA 98109<br>VKM 78005<br>VKM 88000<br>VKM 88001<br>VKM 88004       | 1<br>1<br>1   | 3<br>3  | 1<br>1  |   |   | 3<br>T0674  |
|   | EJ251   | 10/00 → 08/03   | Mod. BH, SOHC   | VKPC 99407   |   |   |   |   | 1   |   |
|  | EJ251   | 11/03 → 11/07   | Mod. BP, SOHC   | VKPC _____   |   |   |   |   | 1   |   |
|   | B(Alt)  | EJ25  | 11/03 → 11/05   | Mod. BP, SOHC  | VKMV _____  |   | 1   |   |   |   |
|  | B(Alt)  | EJ251   | 10/00 → 08/03   | Mod. BH, SOHC  | VKMV _____  |   | 1   |   |   |   |
|  | B(AC)   | EJ25  | 11/03 → 11/05   | Mod. BP, SOHC  | VKMA _____<br>VKMV _____<br>VKM _____   |   | 1<br>1<br>1   |   |   |   |
|  | B(AC)   | EJ251   | 10/00 → 08/03   | Mod. BH, SOHC  | VKMA _____<br>VKMV _____<br>VKM _____   |   | 1<br>1<br>1   |   |   |   |
| <b>SUBARU  OUTBACK 3.0</b>                 |   |   |   |  |   |   |   |   |   |   |
|   | EZ30D   | 11/03 → 03/06   | Mod. BP   | ОЛОХОЛО  |   |   |   |   |   |   |
|   | EZ30D   | 11/03 → 03/06   | Mod. BP, DOHC   | VKPC _____   |   |   |   |   | 1   |   |
|   | B(Alt)  | EZ30D   | 11/03 → 03/05   | Mod. BP, DOHC  | VKMV _____<br>VKM _____   | 1   |   |   |   |   |
| <b>SUBARU  OUTBACK 3.0 H6</b>             |   |   |   |  |   |   |   |   |   |   |
|   | EZ30D   | 10/00 → 08/03   | Mod. BH   | ОЛОХОЛО  |   |   |   |   |   |   |
|   | EZ30D   | 10/00 → 08/03   | Mod. BH, DOHC   | VKPC _____   |   |   |   |   | 1   |   |
|   | B(Alt)  | EZ30D   | 10/00 → 08/03   | Mod. BH, DOHC  | VKMA _____<br>VKMV 6PK1640<br>VKM _____   | 1   | 2<br>1  | 1<br>1  |   |   |
| <b>SUZUKI  ALTO 0.55</b>                  |   |   |   |  |   |   |   |   |   |   |
|   | F5A   | 02/82 → 12/85   |   | VKPC 96204   |   |   |   |   | 1   |   |
| <b>SUZUKI  ALTO 0.8</b>                   |   |   |   |  |   |   |   |   |   |   |
|   | F8B   | 01/85 → 12/87   |   | VKMA 96000<br>VKM 76103  | 1<br>1  |   | 1   |   |   | T0696   |
|   | F8B   | 06/82 → 07/83   |   | VKPC 96204   |   |   |   |   | 1   |   |
| <b>SUZUKI  ALTO 1.1</b>                   |   |   |   |  |   |   |   |   |   |   |
|   | F10B  | 04/03 → 06/05   | Carbu.  | VKMA 96218<br>VKM 76001  | 1<br>1  |   | 1   |   |   | T0697   |
|  | F10B  | 04/03 → 06/05   | Injec.  | VKMA 96214<br>VKM 76001  | 1<br>1  |   | 1   |   |   | T0697   |
|   | F10B  | 04/03 → 06/05   | Carbu.  | —  |   |   |   |   | 1   |   |
|  | F10B  | 04/03 → 06/05   | Injec.  | VKPC 96210   |   |   |   |   | 1   |   |
| <b>SUZUKI  BALENO 1.5</b>                 |   |   |   |  |   |   |   |   |   |   |
|   | G15A  | 01/95 → 12/97   | 3)  | VKMS 96002<br>VKMA 96002<br>VKM 76001  | 1<br>1<br>1   |   | 1<br>1  |   |   | 2<br>T0697  |
| <b>SUZUKI  BALENO 1.6</b>                 |   |   |   |  |   |   |   |   |   |   |
|   | G16B  | 07/95 → 12/99   | 3)  | VKMS 96002<br>VKMA 96002<br>VKM 76001  | 1<br>1<br>1   |   | 1<br>1  |   |   | 2<br>T0697  |
|   | G16B  | 07/95 → 12/99   |   | VKPC 96402   |   |   |   |   | 1   |   |
| <b>SUZUKI  CAPPUCINO 0.7</b>              |   |   |   |  |   |   |   |   |   |   |
|   | F6A   | 02/92 → 08/95   |   | VKMA 96206<br>VKM 76102  | 1<br>1  |   | 1   |   |   | T0697   |



SUBARU



































|   |   |  |                             |  |  |  |  |  |  |  |  |  |  |  |
|---|---|---|--|---|--|---|---|---|---|---|---|---|---|---|
|    |    | <b>CERVO 0.55</b>   |  |   |  |   |   |   |   |   |   |   |   |   |
|     | F5A   | 01/85 → 12/87   |  |   | —  | 1   | 1   |   |   |   |   |   |   |   |
|   |   |   |  |   | VKM 76103  | 1   |   |   |   |   |   |   |   |   |
|    |    | <b>CULTUS 1.0</b>   |  |   |  |   |   |   |   |   |   |   |   |   |
|     | G10   | 09/88 → 10/96   | 3)   |   | VKMS 96203   | 1   | 1   |   |   |   | 2   |   |   | T0697   |
|   |   |   |  |   | VKMA 96203   | 1   | 1   |   |   |   |   |   |   |   |
|   |   |   |  |   | VKM 76203  | 1   |   |   |   |   |   |   |   |   |
|   | G10   | 09/88 → 10/96   |  3), CH176379,<br>229457 I→ |   | VKMA 96213   | 1   | 1   |   |   |   |   |   |   | T0697   |
|   |   |   |  |   | VKM 76203  | 1   |   |   |   |   |   |   |   |   |
|   | G10   | 09/88 → 10/96   |  5), CH147247,<br>211923 I→ |   | VKMA 96213   | 1   | 1   |   |   |   |   |   |   | T0697   |
|   |   |   |  |   | VKM 76203  | 1   |   |   |   |   |   |   |   |   |
|    |    | <b>CULTUS 1.3</b>   |  |   |  |   |   |   |   |   |   |   |   |   |
|     | G10   | 02/92 → 12/93   | DOHC   |   | VKMA 96200   | 1   | 1   |   |   |   |   |   |   | T0694   |
|   |   |   |  |   | VKM 76200  | 1   |   |   |   |   |   |   |   |   |
|    |    | <b>CULTUS 1.5</b>   |  |   |  |   |   |   |   |   |   |   |   |   |
|     | G15A  | 03/99 → 07/03   |  |   | VKPC 96001   |   |   |   | 1   |   |   |   |   |   |
|    |    | <b>CULTUS 1.6</b>   |  |   |  |   |   |   |   |   |   |   |   |   |
|     | G16A  | 03/99 → 07/03   |  |   | VKPC 96001   |   |   |   | 1   |   |   |   |   |   |
|    |    | <b>ESCUDO 1.6</b>   |  |   |  |   |   |   |   |   |   |   |   |   |
|     |   | 03/96 → 12/01   | 3), Mod. D01W, TA01R,<br>TA01W   |   | VKMS 96002   | 1   | 1   |   |   |   | 2   |   |   | T0697   |
|   |   |   |  |   | VKMA 96002   | 1   | 1   |   |   |   |   |   |   |   |
|   |   |   |  |   | VKM 76001  | 1   |   |   |   |   |   |   |   |   |
|  |  | <b>ESCUDO 2.0 D</b>   |  |   |  |   |   |   |   |   |   |   |   |   |
|   | RF  | 11/97 → 12/02   | 3), Mod. TD32W   |   | VKMS 96010   | 1   | 1   |   |   |   | 2   |   |   | T0582   |
|   |   |   |  |   | VKMA 96010   | 1   | 1   |   |   |   |   |   |   |   |
|   |   |   |  |   | VKM 74004  | 1   |   |   |   |   |   |   |   |   |
|  |  | <b>FORSA 1.0</b>  |  |   |  |   |   |   |   |   |   |   |   |   |
|   | G10   | 01/85 → 12/88   |  |   | VKMA 96202   | 1   | 1   |   |   |   |   |   |   | T0697   |
|   |   |   |  |   | VKM 76202  | 1   |   |   |   |   |   |   |   |   |
|  |  | <b>FORSA 1.3</b>  |  |   |  |   |   |   |   |   |   |   |   |   |
|   | G13A/B  | 08/84 → 08/88   | SOHC   |   | VKMA 96202   | 1   | 1   |   |   |   |   |   |   | T0697   |
|   |   |   |  |   | VKM 76202  | 1   |   |   |   |   |   |   |   |   |
|   | G13B  | 06/85 → 08/88   | DOHC   |   | VKMA 96201   | 1   | 1   |   |   |   |   |   |   | T0694   |
|   |   |   |  |   | VKM 76203  | 1   |   |   |   |   |   |   |   |   |
|  |  | <b>FRONTE 0.55</b>  |  |   |  |   |   |   |   |   |   |   |   |   |
|   | F5A   | 09/84 → 08/88   |  |   | —  | 1   | 1   |   |   |   |   |   |   |   |
|   |   |   |  |   | VKM 76103  | 1   |   |   |   |   |   |   |   |   |
|  |  | <b>FRONTE 0.8</b>   |  |   |  |   |   |   |   |   |   |   |   |   |
|   | F8B   | 01/85 → 12/87   |  |   | VKMA 96000   | 1   | 1   |   |   |   |   |   |   | T0696   |
|   |   |   |  |   | VKM 76103  | 1   |   |   |   |   |   |   |   |   |
|  |  | <b>GRAND VITARA 1.6</b>   |  |   |  |   |   |   |   |   |   |   |   |   |
|   | G16B  | 03/98 → 03/04   |  |   | VKMA 96002   | 1   | 1   |   |   |   |   |   |   | T0697   |
|   |   |   |  |   | VKM 76001  | 1   |   |   |   |   |   |   |   |   |
|   | G16B  | 03/98 → 03/04   |  |   | VKPC 96001   |   |   |   | 1   |   |   |   |   |   |
|  |  | <b>GRAND VITARA 2.0</b>   |  |   |  |   |   |   |   |   |   |   |   |   |
|   | J20A  | 03/98 → 03/05   |  |   | <del>OKOKOK</del>  |   |   |   |   |   |   |   |   |   |
|   | J20A  | 03/98 → 03/05   | 2)   |   | VKPA _____   |   |   |   | 1   |   |   |   |   |   |
|  |  | <b>GRAND VITARA 2.5</b>   |  |   |  |   |   |   |   |   |   |   |   |   |
|   | H25A  | 04/98 → 03/05   |  |   | <del>OKOKOK</del>  |   |   |   |   |   |   |   |   |   |
|   | H25A  | 04/98 → 03/05   |  |   | VKPC 96403   |   |   |   | 1   |   |   |   |   |   |
|  |  | <b>GRAND VITARA 2.7</b>   |  |   |  |   |   |   |   |   |   |   |   |   |
|   | H27A  | 09/01 → 03/05   |  |   | <del>OKOKOK</del>  |   |   |   |   |   |   |   |   |   |
|   | H27A  | 09/01 → 03/05   |  |   | VKPC 96403   |   |   |   | 1   |   |   |   |   |   |
|  |  | <b>GRAND VITARA 2.0 HDi</b>   |  |   |  |   |   |   |   |   |   |   |   |   |
|   | RHW   | 06/03 → 03/05   |  |   | VKMA 03265   | 1   | 1   | 1   |   |   |   |   |   | T0196   |
|   |   |   |  |   | VKM 13264  | 1   |   |   |   |   |   |   |   |   |
|   |   |   |  |   | VKM 23264  |   | 1   |   |   |   |   |   |   |   |
|   | RHZ   | 07/01 → 10/03   |  |   | —  | 1   | 1   |   |   |   |   |   |   |   |



|  | RHW, RHZ    | 07/01 → 03/05               |    |                |   |   |   |  |  |  |  |  | 1 |  |   |  |   |  |  |  |  |       |
|--|-------------|-----------------------------|----|----------------|---|---|---|--|--|--|--|--|---|--|---|--|---|--|--|--|--|-------|
|  |             | <b>GRAND VITARA 2.0 TDi</b> |    |                |   |   |   |  |  |  |  |  |   |  |   |  |   |  |  |  |  |       |
|  | RF          | 03/98 → 05/03               | 3) | VKMS 96010     | 1 |   | 1 |  |  |  |  |  |   |  |   |  | 2 |  |  |  |  | T0582 |
|  |             |                             |    | VKMA 96010     | 1 |   | 1 |  |  |  |  |  |   |  |   |  |   |  |  |  |  |       |
|  |             |                             |    | VKM 74004      | 1 |   |   |  |  |  |  |  |   |  |   |  |   |  |  |  |  |       |
|  | RF          | 03/98 → 05/03               |    |                |   |   |   |  |  |  |  |  | 1 |  |   |  |   |  |  |  |  |       |
|  |             | <b>IGNIS 1.3</b>            |    |                |   |   |   |  |  |  |  |  |   |  |   |  |   |  |  |  |  |       |
|  | M13A        | 10/00 → 09/04               |    | <b>OKOKOKO</b> |   |   |   |  |  |  |  |  |   |  |   |  |   |  |  |  |  |       |
|  | M13A        | 10/00 → 09/04               |    | VKPC_____      |   |   |   |  |  |  |  |  | 1 |  |   |  |   |  |  |  |  |       |
|  |             | <b>IGNIS 1.5</b>            |    |                |   |   |   |  |  |  |  |  |   |  |   |  |   |  |  |  |  |       |
|  | M15A        | 09/03 → 09/04               |    | <b>OKOKOKO</b> |   |   |   |  |  |  |  |  |   |  |   |  |   |  |  |  |  |       |
|  | M15A        | 09/03 → 09/04               |    | VKPC_____      |   |   |   |  |  |  |  |  | 1 |  |   |  |   |  |  |  |  |       |
|  |             | <b>IGNIS 1.3 DDiS</b>       |    |                |   |   |   |  |  |  |  |  |   |  |   |  |   |  |  |  |  |       |
|  | Z13DT       | 09/03 → 09/04               |    | <b>OKOKOKO</b> |   |   |   |  |  |  |  |  |   |  |   |  |   |  |  |  |  |       |
|  | Z13DT       | 09/03 → 09/04               |    |                |   |   |   |  |  |  |  |  | 1 |  |   |  |   |  |  |  |  |       |
|  |             | <b>JIMNY 0.55</b>           |    |                |   |   |   |  |  |  |  |  |   |  |   |  |   |  |  |  |  |       |
|  | F5A         | 02/91 → 12/92               |    |                |   |   |   |  |  |  |  |  | 1 |  | 1 |  |   |  |  |  |  |       |
|  |             |                             |    | VKM 76103      | 1 |   |   |  |  |  |  |  |   |  |   |  |   |  |  |  |  |       |
|  | F5A         | 01/86 → 03/90               |    | VKPC 96204     |   |   |   |  |  |  |  |  |   |  |   |  | 1 |  |  |  |  |       |
|  |             | <b>JIMNY 1.3</b>            |    |                |   |   |   |  |  |  |  |  |   |  |   |  |   |  |  |  |  |       |
|  | M13A        | 09/00 → 04/04               |    | <b>OKOKOKO</b> |   |   |   |  |  |  |  |  |   |  |   |  |   |  |  |  |  |       |
|  | M13A        | 09/00 → 04/04               |    | VKPC_____      |   |   |   |  |  |  |  |  |   |  |   |  | 1 |  |  |  |  |       |
|  |             | <b>JUSTY 1.3</b>            |    |                |   |   |   |  |  |  |  |  |   |  |   |  |   |  |  |  |  |       |
|  | G13B        | 03/96 → 07/03               |    | VKPC 96210     |   |   |   |  |  |  |  |  |   |  |   |  | 1 |  |  |  |  |       |
|  |             | <b>MIGHTY - BOY 0.55</b>    |    |                |   |   |   |  |  |  |  |  |   |  |   |  |   |  |  |  |  |       |
|  | F5A         | 02/83 → 12/84               |    | VKPC 96204     |   |   |   |  |  |  |  |  |   |  |   |  | 1 |  |  |  |  |       |
|  |             | <b>SAMURAI 1.0</b>          |    |                |   |   |   |  |  |  |  |  |   |  |   |  |   |  |  |  |  |       |
|  | F10A        | 08/82 → 12/84               |    | VKPC 96204     |   |   |   |  |  |  |  |  |   |  |   |  | 1 |  |  |  |  |       |
|  |             | <b>SAMURAI 1.3</b>          |    |                |   |   |   |  |  |  |  |  |   |  |   |  |   |  |  |  |  |       |
|  | G13A, G13BA | 11/88 → 06/93               | 3) | VKMS 96202     | 1 |   | 1 |  |  |  |  |  |   |  |   |  | 2 |  |  |  |  | T0697 |
|  |             |                             |    | VKMA 96202     | 1 |   | 1 |  |  |  |  |  |   |  |   |  |   |  |  |  |  |       |
|  |             |                             |    | VKM 76202      | 1 |   |   |  |  |  |  |  |   |  |   |  |   |  |  |  |  |       |
|  | G13A, G13BA | 07/93 → 03/95               |    | VKMA 96208     | 1 |   | 1 |  |  |  |  |  |   |  |   |  |   |  |  |  |  | T0697 |
|  |             |                             |    | VKM 76202      | 1 |   |   |  |  |  |  |  |   |  |   |  |   |  |  |  |  |       |
|  | G13, G13A   | 07/83 → 08/88               |    | VKPC 96212     |   |   |   |  |  |  |  |  | 1 |  |   |  |   |  |  |  |  |       |
|  |             | <b>SAMURAI 1.9 TD</b>       |    |                |   |   |   |  |  |  |  |  |   |  |   |  |   |  |  |  |  |       |
|  | XUD9        | 11/98 → 12/99               | 3) | VKMS 03241     | 1 | 1 | 1 |  |  |  |  |  |   |  |   |  | 2 |  |  |  |  | T0017 |
|  |             |                             |    | VKMA 03241     | 1 | 1 | 1 |  |  |  |  |  |   |  |   |  |   |  |  |  |  |       |
|  |             |                             |    | VKM 13241      | 1 |   |   |  |  |  |  |  |   |  |   |  |   |  |  |  |  |       |
|  |             |                             |    | VKM 23241      |   | 1 |   |  |  |  |  |  |   |  |   |  |   |  |  |  |  |       |
|  |             | <b>SB308 0.8</b>            |    |                |   |   |   |  |  |  |  |  |   |  |   |  |   |  |  |  |  |       |
|  | F8B         | 01/85 → 12/87               |    | VKMA 96000     | 1 |   | 1 |  |  |  |  |  |   |  |   |  |   |  |  |  |  | T0696 |
|  |             |                             |    | VKM 76103      | 1 |   |   |  |  |  |  |  |   |  |   |  |   |  |  |  |  |       |
|  |             | <b>SE416 1.6</b>            |    |                |   |   |   |  |  |  |  |  |   |  |   |  |   |  |  |  |  |       |
|  | G16B        | 06/89 → 04/96               | 3) | VKMS 96002     | 1 |   | 1 |  |  |  |  |  |   |  |   |  | 2 |  |  |  |  | T0697 |
|  |             |                             |    | VKMA 96002     | 1 |   | 1 |  |  |  |  |  |   |  |   |  |   |  |  |  |  |       |
|  |             |                             |    | VKM 76001      | 1 |   |   |  |  |  |  |  |   |  |   |  |   |  |  |  |  |       |
|  | G16A        | 01/88 → 04/96               | 3) | VKMS 96204     | 1 |   | 1 |  |  |  |  |  |   |  |   |  | 2 |  |  |  |  | T0697 |
|  |             |                             |    | VKMA 96204     | 1 |   | 1 |  |  |  |  |  |   |  |   |  |   |  |  |  |  |       |
|  |             |                             |    | VKM 76202      | 1 |   |   |  |  |  |  |  |   |  |   |  |   |  |  |  |  |       |
|  |             | <b>SF310 1.0</b>            |    |                |   |   |   |  |  |  |  |  |   |  |   |  |   |  |  |  |  |       |
|  | G10         | 09/88 → 12/96               |    | VKMA 96213     | 1 |   | 1 |  |  |  |  |  |   |  |   |  |   |  |  |  |  | T0697 |
|  |             |                             |    | VKM 76203      | 1 |   |   |  |  |  |  |  |   |  |   |  |   |  |  |  |  |       |
|  |             | <b>SIDEKICK 1.6</b>         |    |                |   |   |   |  |  |  |  |  |   |  |   |  |   |  |  |  |  |       |
|  | G16         | 01/88 → 04/96               | 3) | VKMS 96204     | 1 |   | 1 |  |  |  |  |  |   |  |   |  | 2 |  |  |  |  | T0697 |
|  |             |                             |    | VKMA 96204     | 1 |   | 1 |  |  |  |  |  |   |  |   |  |   |  |  |  |  |       |
|  |             |                             |    | VKM 76202      | 1 |   |   |  |  |  |  |  |   |  |   |  |   |  |  |  |  |       |
|  |             | <b>SJ 410 1.0</b>           |    |                |   |   |   |  |  |  |  |  |   |  |   |  |   |  |  |  |  |       |
|  | F10A        | 08/85 → 12/88               |    | VKPC 96204     |   |   |   |  |  |  |  |  |   |  |   |  | 1 |  |  |  |  |       |
|  |             | <b>SJ 413 1.3</b>           |    |                |   |   |   |  |  |  |  |  |   |  |   |  |   |  |  |  |  |       |
|  | G13A        | 09/84 → 08/88               |    | VKPC 96212     |   |   |   |  |  |  |  |  |   |  |   |  | 1 |  |  |  |  |       |



SUZUKI

|   |  |  |                          |  |  |  |  |  |  |  |  |  |
|---|---|---|---|--|---|---|---|---|---|---|---|---|
| <b>SUZUKI</b>  <b>SPRINT 1.0</b>     |   |   |   |  |   |   |   |   |   |   |   |   |
|                                       | G10   | 01/86 → 12/88   |   | VKMA 96202<br>VKM 76202  | 1<br>1  | 1   |   |   |   |   |   | T0697   |
| <b>SUZUKI</b>  <b>SWIFT 1.0</b>      |   |   |   |  |   |   |   |   |   |   |   |   |
|                                       | G10A  | 03/89 → 10/96   | 3)  | VKMS 96203<br>VKMA 96203<br>VKM 76203  | 1<br>1<br>1   | 1   |   |   | 2   |   |   | T0697   |
|   | G10, G10A   | 01/85 → 08/88   |   | VKMA 96202<br>VKM 76202  | 1<br>1  | 1   |   |   |   |   |   | T0697   |
|   | G10   | 09/88 → 10/96   |  CH 176379,<br>229457 I→ | VKMA 96213<br>VKM 76203  | 1<br>1  | 1   |   |   |   |   |   | T0697   |
|   | G10   | 09/88 → 10/96   |  CH 147247,<br>211923 I→ | VKMA 96213<br>VKM 76203  | 1<br>1  | 1   |   |   |   |   |   | T0697   |
|   | G10A  | 11/96 → 05/01   |   | VKMA 96214<br>VKM 76001  | 1<br>1  | 1   |   |   |   |   |   | T0697   |
|                                       | G10, G10A   | 10/83 → 09/88   |   | VKPC 96212   |   |   |   |   | 1   |   |   |   |
|   | G10, G10A   | 10/88 → 12/94   |   | VKPC 96210   |   |   |   |   | 1   |   |   |   |
| <b>SUZUKI</b>  <b>SWIFT 1.3</b>      |   |   |   |  |   |   |   |   |   |   |   |   |
|                                       | G13A, G13B  | 10/84 → 03/96   | 3), SOHC  | VKMS 96202<br>VKMA 96202<br>VKM 76202  | 1<br>1<br>1   | 1   |   |   | 2   |   |   | T0697   |
|   | G13BA   | 03/89 → 10/96   | 3), SOHC, → ICH 253432,<br>339760   | VKMS 96202<br>VKMA 96202<br>VKM 76202  | 1<br>1<br>1   | 1   |   |   | 2   |   |   | T0697   |
|   | G13B  | 08/86 → 08/88   | DOHC  | VKMA 96201<br>VKM 76203  | 1<br>1  | 1   |   |   |   |   |   | T0694   |
|   | G13B  | 03/89 → 10/96   | DOHC  | VKMA 96200<br>VKM 76200  | 1<br>1  | 1   |   |   |   |   |   | T0694   |
|   | G13BA   | 03/89 → 10/96   | SOHC, CH 253433,<br>339761 I→   | VKMA 96208<br>VKM 76202  | 1<br>1  | 1   |   |   |   |   |   | T0697   |
|   | G13BA   | 11/96 → 05/01   | 8V  | VKMA 96218<br>VKM 76001  | 1<br>1  | 1   |   |   |   |   |   | T0697   |
|   | G13BB   | 11/96 → 05/01   | 16V   | VKMA 96214<br>VKM 76001  | 1<br>1  | 1   |   |   |   |   |   | T0697   |
|                                     | G13A  | 10/84 → 09/88   | Man. GBX  | VKPC 96212   |   |   |   |   | 1   |   |   |   |
|   | G13A  | 06/86 → 09/88   | Auto. GBX   | VKPC 96210   |   |   |   |   | 1   |   |   |   |
|   | G13B  | 08/86 → 05/01   |   | VKPC 96210   |   |   |   |   | 1   |   |   |   |
| <b>SUZUKI</b>  <b>SWIFT 1.5</b>    |   |   |   |  |   |   |   |   |   |   |   |   |
|                                     | G15A  | 07/90 → 12/95   |   | VKPC 96402   |   |   |   |   | 1   |   |   |   |
| <b>SUZUKI</b>  <b>SWIFT 1.6</b>    |   |   |   |  |   |   |   |   |   |   |   |   |
|                                     | G16B  | 11/89 → 05/95   | 3)  | VKMS 96002<br>VKMA 96002<br>VKM 76001  | 1<br>1<br>1   | 1   |   |   | 2   |   |   | T0697   |
|                                     | G16B  | 11/89 → 05/01   |   | VKPC 96402   |   |   |   |   | 1   |   |   |   |
| <b>SUZUKI</b>  <b>VERONA 2.0</b>   |   |   |   |  |   |   |   |   |   |   |   |   |
|                                     | X20SED  | 07/02 → 09/04   | DOHC  | VKMA 05222<br>VKM 15202<br>VKM 25212<br>VKM 25212                                  | 1<br>1<br>1<br>1  | 2   | 1   |   |   |   |   | T0116   |
| <b>SUZUKI</b>  <b>VITARA 1.6</b>   |   |   |   |  |   |   |   |   |   |   |   |   |
|                                     | G16A  | 07/88 → 04/96   | 3)  | VKMS 96204<br>VKMA 96204<br>VKM 76202  | 1<br>1<br>1   | 1   |   |   | 2   |   |   | T0697   |
|   | G16B  | 07/90 → 04/96   | 3)  | VKMS 96002<br>VKMA 96002<br>VKM 76001  | 1<br>1<br>1   | 1   |   |   | 2   |   |   | T0697   |
|                                     | G16A, G16B, G16M  | 07/88 → 03/99   |   | VKPC 96402   |   |   |   |   | 1   |   |   |   |
| <b>SUZUKI</b>  <b>VITARA 1.9 D</b> |   |   |   |  |   |   |   |   |   |   |   |   |
|                                     | XUD9A   | 08/96 → 03/99   | 3)  | VKMS 03241<br>VKMA 03241<br>VKM 13241<br>VKM 23241                                 | 1<br>1<br>1<br>1  | 1   | 1   |   |   | 2   |   | T0017   |

| <b>SUZUKI</b> <b>WAGON R+ 1.3</b>             |                           |               |              |  |                                      |             |   |   |        |  |  |  |         |
|---|---------------------------|---------------|--------------|--|--------------------------------------|-------------|---|---|--------|--|--|--|---------|
|   | G13BB                     | 05/00 → 09/02 |              |  | VKMA 96214<br>VKM 76001              | 1<br>1      | 1 |   |        |  |  |  | T0697   |
|   | G13BB                     | 05/00 → 09/02 |              |  | VKPC 96210                           |             |   |   | 1      |  |  |  |         |
| <b>SUZUKI</b> <b>X-90 1.6</b>                 |                           |               |              |  |                                      |             |   |   |        |  |  |  |         |
|   | G16B                      | 09/95 → 12/99 |              |  | VKMA 96002<br>VKM 76001              | 1<br>1      | 1 |   |        |  |  |  | T0697   |
|   | G16B                      | 09/95 → 09/96 |              |  | VKPC 96402                           |             |   |   | 1      |  |  |  |         |
| <b>SUZUKI</b> <b>CARRY 0.55</b>               |                           |               |              |  |                                      |             |   |   |        |  |  |  |         |
|   | F5A                       | 10/80 → 03/85 |              |  | —<br>VKM 76103                       | 1<br>1      | 1 |   |        |  |  |  |         |
| <b>SUZUKI</b> <b>CARRY 0.65</b>               |                           |               |              |  |                                      |             |   |   |        |  |  |  |         |
|   | F6A                       | 01/96 → 12/97 |              |  | VKMA 96207<br>VKM 76102              | 1<br>1      | 1 |   |        |  |  |  | T0697   |
|   | F6A                       | 01/96 → 12/97 | <b>Turbo</b> |  | VKMA 96206<br>VKM 76102              | 1<br>1      | 1 |   |        |  |  |  | T0697   |
| <b>SUZUKI</b> <b>CARRY 0.66</b>               |                           |               |              |  |                                      |             |   |   |        |  |  |  |         |
|   | F6A                       | 12/96 → 07/03 |              |  | VKPC 96000                           |             |   |   | 1      |  |  |  |         |
| <b>SUZUKI</b> <b>CARRY 1.3</b>                |                           |               |              |  |                                      |             |   |   |        |  |  |  |         |
|   | G13B, G13BB               | 03/99 → 08/02 |              |  | VKMA 96214<br>VKM 76001              | 1<br>1      | 1 |   |        |  |  |  | T0697   |
|   | G13B, G13BB               | 03/99 → 03/04 |              |  | VKPC 96210                           |             |   |   | 1      |  |  |  |         |
| <b>SUZUKI</b> <b>EVERY 0.65</b>               |                           |               |              |  |                                      |             |   |   |        |  |  |  |         |
|   | F6A                       | 01/96 → 12/97 |              |  | VKMA 96207<br>VKM 76102              | 1<br>1      | 1 |   |        |  |  |  | T0697   |
|   | F6A                       | 01/96 → 12/97 | <b>Turbo</b> |  | VKMA 96206<br>VKM 76102              | 1<br>1      | 1 |   |        |  |  |  | T0697   |
| <b>SUZUKI</b> <b>EVERY 0.66</b>               |                           |               |              |  |                                      |             |   |   |        |  |  |  |         |
|   | F6A                       | 12/96 → 07/03 |              |  | VKPC 96000                           |             |   |   | 1      |  |  |  |         |
| <b>SUZUKI</b> <b>SUPER CARRY 0.5</b>          |                           |               |              |  |                                      |             |   |   |        |  |  |  |         |
|   | F5A                       | 01/84 → 03/85 |              |  | VKPC 96204                           |             |   |   | 1      |  |  |  |         |
| <b>SUZUKI</b> <b>SUPER CARRY 1.0</b>          |                           |               |              |  |                                      |             |   |   |        |  |  |  |         |
|   | F10A, F10B                | 10/85 → 07/96 |              |  | VKPC 96204                           |             |   |   | 1      |  |  |  |         |
| <b>TALBOT</b> <b>1307-1510 Simca 1307 1.3</b> |                           |               |              |  |                                      |             |   |   |        |  |  |  |         |
|   | G1/G4                     | 01/78 → 12/79 |              |  | VKPC 83206                           |             |   |   | 1      |  |  |  |         |
| <b>TALBOT</b> <b>1307-1510 Simca 1308 1.4</b> |                           |               |              |  |                                      |             |   |   |        |  |  |  |         |
|   | Y2                        | 11/78 → 12/79 |              |  | VKPC 83206                           |             |   |   | 1      |  |  |  |         |
| <b>TALBOT</b> <b>1307-1510 1510 1.6</b>       |                           |               |              |  |                                      |             |   |   |        |  |  |  |         |
|   | J2/J2A                    | 07/81 → 06/82 |              |  | VKPC 83206                           |             |   |   | 1      |  |  |  |         |
| <b>TALBOT</b> <b>HORIZON 1.1/1.3/1.4/1.6</b>  |                           |               |              |  |                                      |             |   |   |        |  |  |  |         |
|   | E1, G1, Y, J2             | 02/78 → 06/86 |              |  | OXOXOXO                              |             |   |   |        |  |  |  |         |
|   | E1, G1, Y, J2             | 02/78 → 06/86 |              |  | VKPC 83206                           |             |   |   | 1      |  |  |  |         |
| <b>TALBOT</b> <b>HORIZON 1.9 D</b>            |                           |               |              |  |                                      |             |   |   |        |  |  |  |         |
|   | XUD9                      | 07/82 → 06/86 |              |  | VKMA 03240<br>VKM 13240<br>VKM 23240 | 1<br>1<br>1 | 1 | 1 |        |  |  |  | 2 T0017 |
|   | XUD9                      | 07/82 → 06/86 |              |  | VKPC 83401                           |             |   |   | 1      |  |  |  |         |
| <b>TALBOT</b> <b>RANCHO 1.4</b>               |                           |               |              |  |                                      |             |   |   |        |  |  |  |         |
|   | X3Y2                      | 01/77 → 07/84 |              |  | VKPC 83206                           |             |   |   | 1      |  |  |  |         |
| <b>TALBOT</b> <b>SAMBA 0.9</b>                |                           |               |              |  |                                      |             |   |   |        |  |  |  |         |
|   | XV                        | 01/81 → 12/85 |              |  | OXOXOXO                              |             |   |   |        |  |  |  |         |
|   | XV                        | 01/81 → 12/85 | 2)           |  | VKPA 83200<br>VKPC 83200             |             |   |   | 1<br>1 |  |  |  |         |
|   | B(Alt) 5C1(XV5), 5C1(XV8) | 01/81 → 12/85 |              |  | VKMMV 10AVx913                       |             |   | 1 |        |  |  |  |         |
| <b>TALBOT</b> <b>SAMBA 1.1</b>                |                           |               |              |  |                                      |             |   |   |        |  |  |  |         |
|   | XW                        | 01/81 → 06/86 |              |  | OXOXOXO                              |             |   |   |        |  |  |  |         |
|   | XW                        | 01/81 → 06/86 | 2)           |  | VKPA 83200<br>VKPC 83200             |             |   |   | 1<br>1 |  |  |  |         |
|   | B(Alt) XW7                | 01/81 → 06/86 |              |  | VKMMV 10AVx913                       |             |   | 1 |        |  |  |  |         |



SUZUKI





























| <b>TALBOT</b> <b>SAMBA 1.2</b>               |                               |               |                       |  |                |   |   |   |  |   |   |       |
|--|-------------------------------|---------------|-----------------------|--|----------------|---|---|---|--|---|---|-------|
|  | XZ                            | 01/83 → 10/86 |                       |  |                |   |   |   |  |   |   |       |
|  | XZ                            | 01/83 → 10/86 | 2)                    |  | VKPA 83200     |   |   |   |  | 1 |   |       |
|  |                               |               |                       |  | VKPC 83200     |   |   |   |  | 1 |   |       |
|  | <b>B(Alt)</b> 129 D           | 01/83 → 10/86 |                       |  | VKMV 10AVx913  |   |   | 1 |  |   |   |       |
| <b>TALBOT</b> <b>SAMBA 1.4</b>               |                               |               |                       |  |                |   |   |   |  |   |   |       |
|  | XY                            | 01/81 → 10/86 |                       |  |                |   |   |   |  |   |   |       |
|  | XY                            | 01/81 → 10/86 | 2)                    |  | VKPA 83200     |   |   |   |  | 1 |   |       |
|  |                               |               |                       |  | VKPC 83200     |   |   |   |  | 1 |   |       |
|  | <b>B(Alt)</b> 150 D, XY7, XY8 | 01/81 → 10/86 |                       |  | VKMV 10AVx913  |   |   | 1 |  |   |   |       |
| <b>TALBOT</b> <b>SOLARA 1.3</b>              |                               |               |                       |  |                |   |   |   |  |   |   |       |
|  | G1D                           | 02/80 → 07/86 |                       |  |                |   |   |   |  |   |   |       |
|  | G1D                           | 02/80 → 07/86 |                       |  | VKPC 83206     |   |   |   |  | 1 |   |       |
| <b>TALBOT</b> <b>SOLARA 1.6</b>              |                               |               |                       |  |                |   |   |   |  |   |   |       |
|  | Y1, Y2                        | 02/80 → 07/86 |                       |  |                |   |   |   |  |   |   |       |
|  | Y1, Y2                        | 02/80 → 07/86 |                       |  | VKPC 83206     |   |   |   |  | 1 |   |       |
| <b>TALBOT</b> <b>TAGORA 2.1</b>              |                               |               |                       |  |                |   |   |   |  |   |   |       |
|  | 5N2                           | 06/80 → 12/83 |                       |  |                |   |   |   |  |   |   |       |
|  | N2                            | 06/80 → 12/83 |                       |  | —              |   |   |   |  | 1 |   |       |
|  | <b>B(Alt)</b> 5N2             | 06/80 → 12/83 |                       |  | VKMV 10AVx913  |   |   | 1 |  |   |   |       |
| <b>TALBOT</b> <b>TAGORA 2.6</b>              |                               |               |                       |  |                |   |   |   |  |   |   |       |
|  | 9L6                           | 08/81 → 10/83 |                       |  |                |   |   |   |  |   |   |       |
|  | <b>B(Alt)</b> 9L6             | 08/81 → 10/83 |                       |  | VKMV 10AVx1100 |   |   | 1 |  |   |   |       |
|  | <b>B(WP)</b> 9L6              | 08/81 → 10/83 |                       |  | VKMV 10AVx1125 |   |   | 1 |  |   |   |       |
| <b>TALBOT</b> <b>TAGORA 2.3 Turbo Diesel</b> |                               |               |                       |  |                |   |   |   |  |   |   |       |
|  | XD2S                          | 08/81 → 12/87 |                       |  |                |   |   |   |  |   |   |       |
|  | XD2S                          | 08/81 → 12/87 |                       |  | —              |   |   |   |  | 1 |   |       |
|  | <b>B(Alt)</b> XD2S            | 08/81 → 12/87 |                       |  | VKMV 10AVx750  |   |   | 1 |  |   |   |       |
| <b>TOYOTA</b> <b>AVALON 3.0 V6</b>           |                               |               |                       |  |                |   |   |   |  |   |   |       |
|  | 1MZ-FE                        | 01/95 → 12/01 | Mod. MCX20            |  | VKMA 91011     | 1 | 1 | 1 |  |   |   | T0688 |
|  |                               |               |                       |  | VKM 71004      | 1 |   |   |  |   |   |       |
|  |                               |               |                       |  | VKM 81000      |   | 1 |   |  |   |   |       |
| <b>TOYOTA</b> <b>AVENSIS 1.6</b>             |                               |               |                       |  |                |   |   |   |  |   |   |       |
|  | 3ZZ-FE                        | 10/00 → 03/07 | Mod. ZZT25            |  |                |   |   |   |  |   |   |       |
|  | 4A-FE                         | 09/97 → 06/98 | 3), Mod. AT220        |  | VKMS 91005     | 1 | 1 |   |  |   | 2 |       |
|  |                               |               |                       |  | VKMA 91005     | 1 | 1 |   |  |   |   | T0697 |
|  |                               |               |                       |  | VKM 71007      | 1 |   |   |  |   |   |       |
|  | 3ZZ-FE                        | 10/00 → 03/07 | Mod. ZZT22, ZZT25     |  | VKPC 91808     |   |   |   |  | 1 |   |       |
|  | 4A-FE                         | 12/98 → 07/00 | Mod. AT220            |  | VKPC 91416     |   |   |   |  | 1 |   |       |
| <b>TOYOTA</b> <b>AVENSIS 1.8</b>             |                               |               |                       |  |                |   |   |   |  |   |   |       |
|  | 1ZZ-FE                        | 10/00 → 03/07 | Mod. ZZT251           |  |                |   |   |   |  |   |   |       |
|  | 7A-FE                         | 09/97 → 06/98 | 3), Mod. AT221        |  | VKMS 91006     | 1 | 1 |   |  |   | 2 |       |
|  |                               |               |                       |  | VKMA 91006     | 1 | 1 |   |  |   |   | T0697 |
|  |                               |               |                       |  | VKM 71007      | 1 |   |   |  |   |   |       |
|  | 1ZZ-FE                        | 10/00 → 03/07 | Mod. ZZT22, ZZT25     |  | VKPC 91808     |   |   |   |  | 1 |   |       |
|  | 7A-FE                         | 09/97 → 10/00 | 2), Mod. AT221        |  | VKPA 91441     |   |   |   |  | 1 |   |       |
| <b>TOYOTA</b> <b>AVENSIS 2.0</b>             |                               |               |                       |  |                |   |   |   |  |   |   |       |
|  | 1AZ-FSE                       | 01/03 → 03/07 | Mod. AZT25            |  |                |   |   |   |  |   |   |       |
|  | 3S-FE                         | 09/97 → 10/00 | 3), Mod. AT220, ST220 |  | VKMS 91003     | 1 | 1 | 1 |  |   | 3 |       |
|  |                               |               |                       |  | VKMA 91003     | 1 | 1 | 1 |  |   |   | T0663 |
|  |                               |               |                       |  | VKM 71003      | 1 |   |   |  |   |   |       |
|  |                               |               |                       |  | VKM 81004      |   | 1 |   |  |   |   |       |
|  | 1AZ-FSE                       | 10/00 → 01/03 | Mod. AZT220           |  | VKPC 91813     |   |   |   |  | 1 |   |       |
|  | 1AZ-FSE                       | 04/03 → 03/07 | Mod. AZT250           |  | VKPC 91813     |   |   |   |  | 1 |   |       |
|  | <b>B(Alt)</b> 1AZ-FSE         | 04/03 → 03/07 | Mod. AZT250, AC,      |  | VKMA _____     | 1 | 1 |   |  |   |   |       |
|  |                               |               |                       |  | VKMV _____     |   | 1 |   |  |   |   |       |
|  |                               |               |                       |  | VKM _____      | 1 |   |   |  |   |   |       |
| <b>TOYOTA</b> <b>AVENSIS 2.4</b>             |                               |               |                       |  |                |   |   |   |  |   |   |       |
|  | 2AZ-FSE                       | 09/03 → 03/07 |                       |  |                |   |   |   |  |   |   |       |
|  | 2AZ-FSE                       | 09/03 → 03/07 | Mod. AZT251           |  | VKPC 91813     |   |   |   |  | 1 |   |       |

|                                       | B(Alt)  | 2AZ-FSE          | 09/03 → 03/07 | Mod. AZT251, AC,           | VKMA _____<br>VKMV _____<br>VKM _____               | 1<br><br>1  | 1<br>1 |   |  |   |  |   |       |
|---------------------------------------|---------|------------------|---------------|----------------------------|---|-------------|--------|---|--|---|--|---|-------|
| <b>TOYOTA  AVENSIS 2.0 D-4D</b>       |         |                  |               |                            |   |             |        |   |  |   |  |   |       |
|                                       |         | 1CD-FTV          | 10/99 → 01/03 | 3), Mod. CDT220            | VKMS 91303<br>VKMA 91303<br>VKM 71303<br>VKM 81204  | 1<br>1<br>1 | 1<br>1 | 1 |  |   |  | 2 | T0687 |
|                                       |         | 1CD-FTV          | 04/03 → 03/07 | 3), Mod. CDT250, Turbo     | VKMS 91303<br>VKMA 91303<br>VKM 71303<br>VKM 81204  | 1<br>1<br>1 | 1<br>1 | 1 |  |   |  | 2 | T0687 |
|                                       |         | 1CD-FTV          | 04/03 → 04/06 | Mod. CDT250, Turbo         | VKPC _____  |             |        |   |  | 1 |  |   |       |
| <b>TOYOTA  AVENSIS 2.0 TD</b>         |         |                  |               |                            |   |             |        |   |  |   |  |   |       |
|                                       |         | 2C-TE            | 09/97 → 07/00 | 3), Mod. CT220             | VKMS 91100<br>VKMA 91100<br>VKM 71100<br>VKM 81100  | 1<br>1<br>1 | 1<br>1 | 1 |  |   |  | 2 | T0687 |
|                                       |         | 1CD-FTV          | 08/99 → 11/04 | Mod. CDT250, CDT220        | VKMA 91303<br>VKM 71303<br>VKM 81204                | 1<br>1      | 1<br>1 | 1 |  |   |  |   | T0687 |
|                                       |         | 2C-T             | 09/97 → 11/98 | Mod. CT220                 | VKPC 91405  |             |        |   |  | 1 |  |   |       |
| <b>TOYOTA  AVENSIS 2.2 D-4D</b>       |         |                  |               |                            |   |             |        |   |  |   |  |   |       |
|                                       |         | 2AD-FHV, 2AD-FTV | 07/05 → 03/07 |                            | <b>ΟΧΛΟΧΟ</b>                                       |             |        |   |  |   |  |   |       |
|                                       |         | 2AD-FHV, 2AD-FTV | 07/05 → 03/07 | Mod. ADT250, ADT251, Turbo | —   |             |        |   |  | 1 |  |   |       |
|                                       | B(Alt)  | 2AD-FHV, 2AD-FTV | 07/05 → 03/07 | Mod. ADT251, AC,           | VKMA _____<br>VKM 61016                             | 1<br>1      | 1<br>1 | 1 |  |   |  |   |       |
| <b>TOYOTA  AVENSIS VERSO 2.0</b>      |         |                  |               |                            |   |             |        |   |  |   |  |   |       |
|                                       |         | 1AZ-FE           | 08/01 → 03/07 |                            | <b>ΟΧΛΟΧΟ</b>                                       |             |        |   |  |   |  |   |       |
|                                       |         | 1AZ-FE           | 08/01 → 03/07 | Mod. ACM2                  | VKPC 91813  |             |        |   |  | 1 |  |   |       |
| <b>TOYOTA  AVENSIS VERSO 2.4</b>      |         |                  |               |                            |   |             |        |   |  |   |  |   |       |
|                                       |         | 2AZ-FE           | 10/03 → 03/07 |                            | <b>ΟΧΛΟΧΟ</b>                                       |             |        |   |  |   |  |   |       |
|                                       |         | 2AZ-FE           | 10/03 → 03/07 | Mod. ACM2                  | VKPC 91813  |             |        |   |  | 1 |  |   |       |
| <b>TOYOTA  AVENSIS VERSO 2.0 D-4D</b> |         |                  |               |                            |   |             |        |   |  |   |  |   |       |
|                                       |         | 1CD-FTV          | 08/01 → 07/05 | 3), Mod. CDT250, Turbo     | VKMS 91303<br>VKMA 91303<br>VKM 71303<br>VKM 81204  | 1<br>1<br>1 | 1<br>1 | 1 |  |   |  | 2 | T0687 |
|                                       |         | 1CD-FTV          | 08/01 → 07/05 | Mod. CLM20                 | VKPC 91814  |             |        |   |  | 1 |  |   |       |
|                                       | B(Comp) | 1CD-FTV          | 08/01 → 07/05 | Mod. CLM20, AC             | VKMV 5PK1240  |             |        | 1 |  |   |  |   |       |
| <b>TOYOTA  AYGO 1.0</b>               |         |                  |               |                            |   |             |        |   |  |   |  |   |       |
|                                       |         | 1KR-FE           | 07/05 → 03/07 |                            | <b>ΟΧΛΟΧΟ</b>                                       |             |        |   |  |   |  |   |       |
|                                       |         | 1KR-FE           | 02/05 → 05/05 | Mod. KGB10                 | —   |             |        |   |  | 1 |  |   |       |
|                                       |         | 1KR-FE           | 08/05 → 03/07 | Mod. KGB10                 | —   |             |        |   |  | 1 |  |   |       |
|                                       | B(Alt)  | 1KR-FE           | 07/05 → 08/07 | Mod. KGB10, <b>AC</b>      | VKMV 6PK850   |             |        | 1 |  |   |  |   |       |
|                                       | B(Alt)  | 1KR-FE           | 07/05 → 08/07 | Mod. KGB10, AC             | VKMV 6PK1210  |             |        | 1 |  |   |  |   |       |
| <b>TOYOTA  AYGO 1.4</b>               |         |                  |               |                            |   |             |        |   |  |   |  |   |       |
|                                       |         | 2WZ-TV           | 07/05 → 03/07 | 3), Mod. WNB10             | —<br>—<br>—<br>—                                    | 1<br>1      | 1<br>1 |   |  |   |  | 1 |       |
|                                       |         | 2WZ-TV           | 07/05 → 03/07 | Mod. WNB10                 | VKPC 83140  |             |        |   |  | 1 |  |   |       |
|                                       | B(Alt)  | 2WZ-TV           | 07/05 → 08/07 | Mod. WNB10, <b>AC</b>      | VKMA 33058<br>VKMV 6PK802<br>VKM 33043<br>VKM 33044 | 1<br>1      | 1<br>1 | 1 |  |   |  |   | 1     |
|                                       | B(Alt)  | 2WZ-TV           | 07/05 → 01/07 | Mod. WNB10, AC             | VKMV 6PK966<br>VKM 33043                            | 1           |        | 1 |  |   |  |   |       |
| <b>TOYOTA  BLIZZARD 2.4 D</b>         |         |                  |               |                            |   |             |        |   |  |   |  |   |       |
|                                       |         | 2L-T             | 05/84 → 02/90 |                            | VKPC 91606  |             |        |   |  | 1 |  |   |       |



TOYOTA



























| <b>TOYOTA  CAMRY 1.8</b>    |                     |               |                             |  |            |   |   |   |  |  |   |  |   |       |
|-----------------------------|---------------------|---------------|-----------------------------|--|------------|---|---|---|--|--|---|--|---|-------|
|                             | 15#, 15-L           | 10/82 → 08/88 | 3)                          |  | VKMS 91101 | 1 | 1 | 1 |  |  |   |  |   | 2     |
|                             |                     |               |                             |  | VKMA 91101 | 1 | 1 | 1 |  |  |   |  |   | T0663 |
|                             |                     |               |                             |  | VKM 71101  | 1 |   |   |  |  |   |  |   |       |
|                             |                     |               |                             |  | VKM 81004  |   | 1 |   |  |  |   |  |   |       |
|                             | 4S-FE               | 07/90 → 11/95 | 3)                          |  | VKMS 91003 | 1 | 1 | 1 |  |  |   |  | 3 | T0663 |
|                             |                     |               |                             |  | VKMA 91003 | 1 | 1 | 1 |  |  |   |  |   |       |
|                             |                     |               |                             |  | VKM 71003  | 1 |   |   |  |  |   |  |   |       |
|                             |                     |               |                             |  | VKM 81004  |   | 1 |   |  |  |   |  |   |       |
|                             | 1S                  | 03/82 → 08/88 |                             |  | VKPC 91404 |   |   |   |  |  | 1 |  |   |       |
|                             | 4S-F                | 08/88 → 08/94 |                             |  | VKPC 91613 |   |   |   |  |  | 1 |  |   |       |
| <b>TOYOTA  CAMRY 2.0</b>    |                     |               |                             |  |            |   |   |   |  |  |   |  |   |       |
|                             | 2S-E, 2S-EL, 2S-ELC | 03/83 → 07/86 | 3), Mod. SV11               |  | VKMS 91101 | 1 | 1 | 1 |  |  |   |  | 2 | T0663 |
|                             |                     |               |                             |  | VKMA 91101 | 1 | 1 | 1 |  |  |   |  |   |       |
|                             |                     |               |                             |  | VKM 71101  | 1 |   |   |  |  |   |  |   |       |
|                             |                     |               |                             |  | VKM 81004  |   | 1 |   |  |  |   |  |   |       |
|                             | 3S-FE               | 08/88 → 11/95 | 3)                          |  | VKMS 91003 | 1 | 1 | 1 |  |  |   |  | 3 | T0663 |
|                             |                     |               |                             |  | VKMA 91003 | 1 | 1 | 1 |  |  |   |  |   |       |
|                             |                     |               |                             |  | VKM 71003  | 1 |   |   |  |  |   |  |   |       |
|                             |                     |               |                             |  | VKM 81004  |   | 1 |   |  |  |   |  |   |       |
|                             | 2VZ-FE              | 08/88 → 06/91 | Mod. VZV21, VZV30, VZV31    |  | —          | 1 | 1 | 1 |  |  |   |  |   |       |
|                             |                     |               |                             |  | VKM 71004  | 1 |   |   |  |  |   |  |   |       |
|                             |                     |               |                             |  | VKM 81000  |   | 1 |   |  |  |   |  |   |       |
|                             | 3S-GE               | 07/90 → 01/91 | Mod. SV32, SV33             |  | VKMA 91302 | 1 | 1 | 1 |  |  |   |  |   | T0685 |
|                             |                     |               |                             |  | VKM 71302  | 1 |   |   |  |  |   |  |   |       |
|                             |                     |               |                             |  | VKM 81004  |   | 1 |   |  |  |   |  |   |       |
|                             | 1AZ-FE              | 08/01 → 06/06 | Mod. ACV3                   |  | VKPC 91813 |   |   |   |  |  | 1 |  |   |       |
|                             | 2S-E                | 03/82 → 07/86 | Mod. SV11                   |  | VKPC 91404 |   |   |   |  |  | 1 |  |   |       |
|                             | 3S-F                | 08/86 → 07/94 |                             |  | VKPC 91613 |   |   |   |  |  | 1 |  |   |       |
|                             | 3S-G, 3S-GE         | 06/84 → 07/94 | Mod. SV12, SV21, SV32, SV33 |  | VKPC 91604 |   |   |   |  |  | 1 |  |   |       |
| <b>TOYOTA  CAMRY 2.2</b>    |                     |               |                             |  |            |   |   |   |  |  |   |  |   |       |
|                             | 5S-FE               | 06/91 → 12/98 | 3), Mod. SXV10, SXV20       |  | VKMS 91003 | 1 | 1 | 1 |  |  |   |  | 3 | T0663 |
|                             |                     |               |                             |  | VKMA 91003 | 1 | 1 | 1 |  |  |   |  |   |       |
|                             |                     |               |                             |  | VKM 71003  | 1 |   |   |  |  |   |  |   |       |
|                             |                     |               |                             |  | VKM 81004  |   | 1 |   |  |  |   |  |   |       |
|                             | 5S-FE               | 06/91 → 07/01 | Mod. SXV10, SXV20           |  | VKPC 91613 |   |   |   |  |  | 1 |  |   |       |
| <b>TOYOTA  CAMRY 2.4</b>    |                     |               |                             |  |            |   |   |   |  |  |   |  |   |       |
|                             | 2AZ-FE              | 11/01 → 03/07 |                             |  | XXXXXXXX   |   |   |   |  |  |   |  |   |       |
|                             | 2AZ-FE              | 11/01 → 03/07 | Mod. ACV30, ACV40           |  | VKPC 91813 |   |   |   |  |  | 1 |  |   |       |
|                             | B(Alt) 2AZ-FE       | 11/01 → 01/06 | Mod. ACV3                   |  | VKMA _____ | 1 |   | 1 |  |  |   |  |   |       |
|                             |                     |               |                             |  | VKMA _____ |   |   | 1 |  |  |   |  |   |       |
|                             |                     |               |                             |  | VKM _____  | 1 |   |   |  |  |   |  |   |       |
| <b>TOYOTA  CAMRY 3.0</b>    |                     |               |                             |  |            |   |   |   |  |  |   |  |   |       |
|                             | 1MZ-FE              | 11/01 → 01/06 | 3), Mod. MCV30              |  | VKMS 91304 | 1 | 1 | 1 |  |  |   |  | 2 | T0688 |
|                             |                     |               |                             |  | VKMA 91304 | 1 | 1 | 1 |  |  |   |  |   |       |
|                             |                     |               |                             |  | VKM 71304  | 1 |   |   |  |  |   |  |   |       |
|                             |                     |               |                             |  | VKM 81000  |   | 1 |   |  |  |   |  |   |       |
|                             | 3VZ-FE              | 06/91 → 08/96 | 3), Mod. VCV10              |  | VKMS 91001 | 1 | 1 | 1 |  |  |   |  | 3 | T0688 |
|                             |                     |               |                             |  | VKMA 91001 | 1 | 1 | 1 |  |  |   |  |   |       |
|                             |                     |               |                             |  | VKM 71004  | 1 |   |   |  |  |   |  |   |       |
|                             |                     |               |                             |  | VKM 81000  |   | 1 |   |  |  |   |  |   |       |
|                             | 1MZ-FE              | 08/93 → 11/01 | Mod. MCV10, MCV20           |  | VKMA 91011 | 1 | 1 | 1 |  |  |   |  |   | T0688 |
|                             |                     |               |                             |  | VKM 71004  | 1 |   |   |  |  |   |  |   |       |
|                             |                     |               |                             |  | VKM 81000  |   | 1 |   |  |  |   |  |   |       |
|                             | 1MZ-FE              | 11/01 → 01/06 | Mod. MCV30                  |  | VKPC _____ |   |   |   |  |  | 1 |  |   |       |
| <b>TOYOTA  CAMRY 3.5</b>    |                     |               |                             |  |            |   |   |   |  |  |   |  |   |       |
|                             | 2GR-FE              | 01/06 → 03/07 | Mod. GSV40                  |  | XXXXXXXX   |   |   |   |  |  |   |  |   |       |
|                             | 2GR-FE              | 01/06 → 03/07 | Mod. GSV40                  |  | —          |   |   |   |  |  | 1 |  |   |       |
| <b>TOYOTA  CAMRY 1.8 D</b>  |                     |               |                             |  |            |   |   |   |  |  |   |  |   |       |
|                             | 1C-TL               | 08/83 → 10/86 | Mod. CV10                   |  | VKPC 91405 |   |   |   |  |  | 1 |  |   |       |
| <b>TOYOTA  CAMRY 1.8 TD</b> |                     |               |                             |  |            |   |   |   |  |  |   |  |   |       |
|                             | 1C-TL               | 11/83 → 03/86 | Mod. CV10                   |  | VKMA 91100 | 1 | 1 | 1 |  |  |   |  |   | T0687 |
|                             |                     |               |                             |  | VKM 71100  | 1 |   |   |  |  |   |  |   |       |
|                             |                     |               |                             |  | VKM 81100  |   | 1 |   |  |  |   |  |   |       |

|  |                          |  |  |  |  |  |  |  |  |  |  |
|--|--------------------------|---|---|---|--|---|---|---|---|---|---|
| <b>TOYOTA  CAMRY 2.0 D</b>  |                          |   |   |   |  |   |   |   |   |   |   |
|                             | 2C-T                     | 08/88 → 06/91   | Mod. CV30   | VKMA 91100<br>VKM 71100<br>VKM 81100  | 1<br>1<br>1  | 1   | 1   |   |   |   | T0687   |
|                             | 2C-T                     | 06/91 → 07/94   | Mod. CV30, CV20   | VKPC 91405  |  |   |   | 1   |   |   |   |
| <b>TOYOTA  CAMRY 2.0 TD</b> |                          |   |   |   |  |   |   |   |   |   |   |
|                             | 2C-T                     | 08/83 → 05/91   | Mod. CV11, CV20   | VKMA 91100<br>VKM 71100<br>VKM 81100  | 1<br>1<br>1  | 1   | 1   |   |   |   | T0687   |
|                             | 2C-T                     | 11/86 → 05/91   | Mod. CV20, CV30   | VKPC 91405  |  |   |   | 1   |   |   |   |
| <b>TOYOTA  CAMRY 2.2 D</b>  |                          |   |   |   |  |   |   |   |   |   |   |
|                             | 3C-T                     | 06/94 → 11/95   | 3), Mod. CV40, CV43   | VKMS 91100<br>VKMA 91100<br>VKM 71100<br>VKM 81100                                | 1<br>1<br>1<br>1   | 1   | 1   |   |   | 2   | T0687   |
| <b>TOYOTA  CARINA 1.5</b>   |                          |   |   |   |  |   |   |   |   |   |   |
|                             | 5A-FE                    | 08/92 → 02/95   | 3), Mod. AT192  | VKMS 91005<br>VKMA 91005<br>VKM 71007   | 1<br>1<br>1  |   | 1   |   |   | 2   | T0697   |
|  | 5E-FE                    | 11/92 → 08/95   | Mod. ET196  | VKMA 91015<br>VKM 71400<br>VKM 81400  | 1<br>1<br>1  | 1   | 1   |   |   |   | T0660   |
|                             | 3A-L                     | 05/84 → 04/88   | 2), Mod. AT150  | VKPA 91409<br>VKPC 91409  |  |   |   | 1<br>1  |   |   |   |
|  | 5A-F                     | 05/88 → 11/92   | Mod. AT170  | VKPC 91415  |  |   |   | 1   |   |   |   |
|  | 5E-FE                    | 11/92 → 11/94   | Mod. ET196V   | VKPC 91413  |  |   |   | 1   |   |   |   |
| <b>TOYOTA  CARINA 1.6</b> |                          |   |   |   |  |   |   |   |   |   |   |
|                           | 4A-F, 4A-FE              | 12/87 → 03/92   | 3), Mod. AT171  | VKMS 91702<br>VKMA 91702<br>VKM 71202   | 1<br>1<br>1  |   | 1   |   |   | 2   | T0696   |
|  | 4A-FE                    | 04/92 → 11/92   | 3), Mod. AT171  | VKMS 91002<br>VKMA 91002<br>VKM 71202   | 1<br>1<br>1  |   | 1   |   |   | 2   | T0696   |
|  | 4A-FE                    | 04/92 → 09/97   | 3), Mod. AT190  | VKMS 91005<br>VKMA 91005<br>VKM 71007   | 1<br>1<br>1  |   | 1   |   |   | 2   | T0697   |
|  | 4A-L, 4A-LC              | 10/83 → 11/87   | 3), Mod. AT151  | VKMS 91202<br>VKMA 91202<br>VKM 71202   | 1<br>1<br>1  |   | 1   |   |   | 2   | T0696   |
|                           | 4A-E                     | 05/84 → 11/87   | 2), Mod. AT151  | VKPA 91409<br>VKPC 91409  |  |   |   | 1<br>1  |   |   |   |
|  | 4A-FE                    | 05/88 → 03/92   | Mod. AT171, AT175   | VKPC 91415  |  |   |   | 1   |   |   |   |
|  | 4A-FE                    | 04/92 → 01/96   | 2), Mod. AT190  | VKPA 91416<br>VKPC 91416  |  |   |   | 1<br>1  |   |   |   |
|  | 4A-FE                    | 04/92 → 01/96   | Mod. AT190  | VKPC 91416  |  |   |   | 1   |   |   |   |
|  | 4A-G                     | 08/85 → 11/87   | Mod. AT160  | VKPC 91414  |  |   |   | 1   |   |   |   |
|  | 4A-GE                    | 05/88 → 03/92   | Mod. AT171  | VKPC 91414  |  |   |   | 1   |   |   |   |
|                           | <b>B(AC)</b> 4A-F, 4A-FE | 12/87 → 03/92   |   | VKM 61000   |  | 1   |   |   |   |   |   |
|  | <b>B(Comp)</b> 4A-FE     | 04/92 → 01/96   | Mod. AT190, AC  | VKMA ____<br>VKM 61000  |  | 1<br>1  | 1   |   |   |   |   |
| <b>TOYOTA  CARINA 1.8</b> |                          |   |   |   |  |   |   |   |   |   |   |
|                           | 1S, 1S-EL, 1S-L          | 09/81 → 11/87   | 3), Mod. SA60, ST150, ST151   | VKMS 91101<br>VKMA 91101<br>VKM 71101<br>VKM 81004                                | 1<br>1<br>1<br>1   | 1   | 1   |   |   | 2   | T0663   |
|  | 4S-FE                    | 08/92 → 08/95   | 3), Mod. ST190, ST200, ST201  | VKMS 91003<br>VKMA 91003<br>VKM 71003<br>VKM 81004                                | 1<br>1<br>1<br>1   | 1   | 1   |   |   | 3   | T0663   |
|  | 7A-FE                    | 01/95 → 09/97   | 3), Mod. AT191  | VKMS 91006<br>VKMA 91006<br>VKM 71007   | 1<br>1<br>1  |   | 1   |   |   | 2   | T0697   |
|                           | 1S, 1S-U                 | 09/81 → 11/87   | Mod. SA60, ST150, ST160   | VKPC 91404  |  |   |   | 1   |   |   |   |
|  | 4S-FE                    | 08/87 → 08/94   |   | VKPC 91613  |  |   |   | 1   |   |   |   |































TOYOTA



|   |  |  |  |  |  |  |  |  |  |  |  |
|---|---|---|---|--|---|---|---|---|---|---|---|
|   | 7A-FE   | 01/95 → 09/97   | 2), Mod. AT191  | VKPA 91441   |   |   |   |   |   | 1   |   |
| <b>TOYOTA  CARINA 2.0</b>    |   |   |   |  |   |   |   |   |   |   |   |
|                               | 2S-EL   | 08/85 → 11/87   | 3), Mod. ST151  | VKMS 91101<br>VKMA 91101<br>VKM 71101<br>VKM 81004                                 | 1<br>1<br>1<br>1  | 1<br>1<br>1<br>1  | 1<br>1<br>1<br>1  |   |   | 2   | T0663   |
|   | 3S-FE   | 12/87 → 09/97   | 3), Mod. ST171, ST195,<br>ST202, ST203  | VKMS 91003<br>VKMA 91003<br>VKM 71003<br>VKM 81004                                 | 1<br>1<br>1<br>1  | 1<br>1<br>1<br>1  | 1<br>1<br>1<br>1  |   |   | 3   | T0663   |
|   | 3S-GE   | 04/92 → 02/94   | 3), Mod. ST191  | VKMS 91013<br>VKMA 91013<br>VKM 71006<br>VKM 81004                                 | 1<br>1<br>1<br>1  | 1<br>1<br>1<br>1  | 1<br>1<br>1<br>1  |   |   | 2   | T0685   |
|   | 3S-FE, 3S-GE  | 01/93 → 01/96   | Mod. ST195, ST202,<br>ST205   | VKMA 91021<br>VKM 71013<br>VKM 81004   | 1<br>1<br>1   | 1<br>1<br>1   | 1<br>1<br>1   |   |   |   | T0685   |
|                               | 3S-FE   | 12/87 → 01/96   |   | VKPC 91613   |   |   |   |   |   | 1   |   |
|   | 3S-GE, 3S-GEL   | 08/85 → 09/93   | Mod. ST162, ST182,<br>ST183   | VKPC 91604   |   |   |   |   |   | 1   |   |
| <b>TOYOTA  CARINA 1.8 D</b>  |   |   |   |  |   |   |   |   |   |   |   |
|                               | 1C-TL   | 04/82 → 05/83   | Mod. CA16A  | VKMA 91100<br>VKM 71100<br>VKM 81100   | 1<br>1<br>1   | 1<br>1<br>1   | 1<br>1<br>1   |   |   |   | T0687   |
|                               | 1C  | 04/82 → 04/88   | Mod. CA60, CA67   | VKPC 91405   |   |   |   |   |   | 1   |   |
| <b>TOYOTA  CARINA 2.0 D</b> |   |   |   |  |   |   |   |   |   |   |   |
|                             | 2C, 2C-L  | 12/87 → 02/90   | 3), Mod. CT170  | VKMS 91100<br>VKMA 91100<br>VKM 71100<br>VKM 81100                                 | 1<br>1<br>1<br>1  | 1<br>1<br>1<br>1  | 1<br>1<br>1<br>1  |   |   | 2   | T0687   |
|   | 2C  | 04/92 → 09/97   | 3), Mod. CT190  | VKMS 91100<br>VKMA 91100<br>VKM 71100<br>VKM 81100                                 | 1<br>1<br>1<br>1  | 1<br>1<br>1<br>1  | 1<br>1<br>1<br>1  |   |   | 2   | T0687   |
|   | 2C  | 04/92 → 08/95   | Mod. CT195, CT196,<br>CT198   | VKMA 91100<br>VKM 71100<br>VKM 81100   | 1<br>1<br>1   | 1<br>1<br>1   | 1<br>1<br>1   |   |   |   | T0687   |
|                             | 2C  | 02/84 → 04/94   | Mod. CT190, CT190G,<br>CT195, CT196V, CT198V                                      | VKPC 91405   |   |   |   |   |   | 1   |   |
| <b>TOYOTA  CELICA 1.6</b>  |   |   |   |  |   |   |   |   |   |   |   |
|                             | 4A-FE   | 10/89 → 03/92   | 3), Mod. AT180  | VKMS 91702<br>VKMA 91702<br>VKM 71202  | 1<br>1<br>1   | 1<br>1<br>1   | 1<br>1<br>1   |   |   | 2   | T0696   |
|   | 4A-FE   | 04/92 → 11/93   | 3), Mod. AT180  | VKMS 91002<br>VKMA 91002<br>VKM 71202  | 1<br>1<br>1   | 1<br>1<br>1   | 1<br>1<br>1   |   |   | 2   | T0696   |
|   | 4A-GE, 4A-GEL   | 08/83 → 08/86   | 3), Mod. AA63, AT160  | VKMS 91401<br>VKMA 91401<br>VKM 71401  | 1<br>1<br>1   | 1<br>1<br>1   | 1<br>1<br>1   |   |   | 2   | T0694   |
|   | 4A-L  | 08/85 → 11/87   | 3), Mod. AT160  | VKMS 91202<br>VKMA 91202<br>VKM 71202  | 1<br>1<br>1   | 1<br>1<br>1   | 1<br>1<br>1   |   |   | 2   | T0696   |
|                             | 4A-FE   | 10/89 → 07/03   | Mod. AT180  | VKPC 91415   |   |   |   |   |   | 1   |   |
|   | 4A-GE   | 04/86 → 08/87   | Mod. AT160  | VKPC 91414   |   |   |   |   |   | 1   |   |
|   | 4A-L  | 08/87 → 08/89   | 2), Mod. AT160  | VKPA 91409<br>VKPC 91409   |   |   |   |   |   | 1<br>1  |   |
| <b>TOYOTA  CELICA 1.8</b>  |   |   |   |  |   |   |   |   |   |   |   |
|                             | 1ZZ-FE, 2ZZ-GE  | 11/99 → 07/06   |   | <del>OKOKOK</del>  |   |   |   |   |   |   |   |
|   | 7A-FE   | 11/93 → 12/97   | 3), Mod. AT200  | VKMS 91006<br>VKMA 91006<br>VKM 71007  | 1<br>1<br>1   | 1<br>1<br>1   | 1<br>1<br>1   |   |   | 2   | T0697   |
|                             | 1S  | 07/81 → 08/89   | Mod. SA60, ST160  | VKPC 91404   |   |   |   |   |   | 1   |   |
|   | 1ZZ-FE  | 11/99 → 09/05   | Mod. ZZT230   | VKPC 91808   |   |   |   |   |   | 1   |   |
|   | 2ZZ-GE  | 11/99 → 09/05   | Mod. ZZT231   | VKPC _____   |   |   |   |   |   | 1   |   |
|   | 4S-F  | 05/88 → 08/89   | Mod. ST162, ST163   | VKPC 91613   |   |   |   |   |   | 1   |   |































|  |  |  |  |  |  |  |  |  |  |  |  |
|--|---|---|---|--|---|---|---|---|---|---|---|
|  | 7A-FE   | 11/93 → 07/03   | 2), Mod. AT200  | VKPA 91441   |   |   |   |   | 1   |   |   |
|                                       | B(Alt) 1ZZ-FE   | 11/99 → 09/05   | Mod. ZZT230, AC, ⊕  | VKMA _____   | 1   | 1   |   |   |   |   |   |
|  | B(Alt) 1ZZ-FE   | 11/99 → 08/02   | Mod. ZZT230, AC, ⊕  | VKMA _____   | 1   | 1   |   |   |   |   |   |
|  | B(Alt) 1ZZ-FE   | 08/02 → 09/05   | Mod. ZZT230, AC, ⊕  | VKMA _____   | 1   | 1   |   |   |   |   |   |
| <b>TOYOTA  CELICA 2.0</b>             |   |   |   |  |   |   |   |   |   |   |   |
|                                       | 2S-C, 2S-ELC  | 08/83 → 08/86   | 3), Mod. SA63, ST161  | VKMS 91101<br>VKMA 91101<br>VKM 71101<br>VKM 81004                                 | 1<br>1<br>1   | 1<br>1  | 1   |   |   | 2   | T0663   |
|  | 3S-FE   | 10/86 → 12/88   | Mod. ST162  | VKMA 91003<br>VKM 71003<br>VKM 81004   | 1<br>1  | 1<br>1  | 1   |   |   |   | T0663   |
|  | 3S-GE   | 10/89 → 11/93   | Mod. ST182  | VKMA 91013<br>VKM 71006<br>VKM 81004   | 1<br>1  | 1<br>1  | 1   |   |   |   | T0685   |
|  | 3S-GE   | 11/93 → 12/95   | Mod. ST202  | VKMA 91021<br>VKM 71013<br>VKM 81004   | 1<br>1  | 1<br>1  | 1   |   |   |   | T0685   |
|  | 3S-GEL, 3S-GELC   | 08/85 → 12/88   | Mod. ST162  | VKMA 91302<br>VKM 71302<br>VKM 81004   | 1<br>1  | 1<br>1  | 1   |   |   |   | T0685   |
|                                       | 2SC   | 08/83 → 08/84   | Mod. SA63   | VKPC 91404   |   |   |   |   | 1   |   |   |
|  | 3S-FE   | 08/87 → 08/89   | Mod. ST162  | VKPC 91613   |   |   |   |   | 1   |   |   |
|  | 3S-FE   | 10/89 → 01/94   | Mod. ST182, ST183,<br>ST202, ST203  | VKPC 91613   |   |   |   |   | 1   |   |   |
|  | 3S-GE, 3S-GTE   | 08/85 → 08/89   | Mod. ST162, ST165   | VKPC 91604   |   |   |   |   | 1   |   |   |
|  | 3S-GE   | 10/89 → 09/93   | Mod. ST182, ST183   | VKPC 91604   |   |   |   |   | 1   |   |   |
|  | 3S-GE   | 04/96 → 11/99   |   | VKPC 91442   |   |   |   |   | 1   |   |   |
| <b>TOYOTA  CELICA 2.0 Turbo 4X4</b> |   |   |   |  |   |   |   |   |   |   |   |
|                                     | 3S-GTE  | 03/88 → 12/88   | Mod. ST165  | VKMA 91302<br>VKM 71302<br>VKM 81004   | 1<br>1  | 1<br>1  | 1   |   |   |   | T0685   |
|  | 3S-GTE  | 10/89 → 11/93   | Mod. ST185  | VKMA 91013<br>VKM 71006<br>VKM 81004   | 1<br>1  | 1<br>1  | 1   |   |   |   | T0685   |
|  | 3S-GTE  | 02/94 → 04/96   | Mod. ST205  | VKMA 91021<br>VKM 71013<br>VKM 81004   | 1<br>1  | 1<br>1  | 1   |   |   |   | T0685   |
| <b>TOYOTA  CELICA 2.2</b>           |   |   |   |  |   |   |   |   |   |   |   |
|                                     | 5S-FE   | 11/93 → 04/96   | 3), Mod. ST204, SOHC  | VKMS 91003<br>VKMA 91003<br>VKM 71003<br>VKM 81004                                 | 1<br>1<br>1   | 1<br>1  | 1   |   |   | 3   | T0663   |
|  | 5S-FE   | 09/89 → 05/91   | Mod. ST184  | VKMA 91003<br>VKM 71003<br>VKM 81004   | 1<br>1  | 1<br>1  | 1   |   |   |   | T0663   |
|  | 5S-FE   | 11/93 → 12/95   | Mod. ST204, DOHC  | VKMA 91701<br>VKM 71003<br>VKM 81004   | 1<br>1  | 1<br>1  | 1   |   |   |   | T0660   |
|                                     | 5S-FE   | 09/89 → 07/03   | Mod. ST184  | VKPC 91613   |   |   |   |   | 1   |   |   |
| <b>TOYOTA  CELICA SUPRA 2.8</b>     |   |   |   |  |   |   |   |   |   |   |   |
|                                     | 5M-GE   | 05/82 → 08/83   | Mod. MA61   | —<br>—   | 1<br>1  | 1   | 1   |   |   |   |   |
| <b>TOYOTA  CELSIOR 4.0</b>          |   |   |   |  |   |   |   |   |   |   |   |
|                                     | 1UZ-FE  | 12/89 → 10/94   | Mod. UCF10  | —<br>—<br>VKM 81005  | 1<br>1  | 1<br>1  | 1   |   |   |   |   |
| <b>TOYOTA  COASTER 4.2 D</b>        |   |   |   |  |   |   |   |   |   |   |   |
|                                     | 1HZ   | 01/93 → 06/94   | Mod. HZB4#, HZB5#,<br>HDB5#   | VKMA 91020<br>VKM 71012  | 1<br>1  | 1   | 1   |   |   |   | T0322   |
| <b>TOYOTA  COROLLA 1.3</b>          |   |   |   |  |   |   |   |   |   |   |   |
|                                     | 2A-L  | 05/83 → 07/88   | 3), Mod. AE80   | VKMS 91202<br>VKMA 91202<br>VKM 71202  | 1<br>1<br>1   | 1<br>1  |   |   |   | 2   | T0696   |



TOYOTA





























|                            | 2E-L, 2E-LC                | 10/84 → 04/86 | 3), Mod. EE80   | VKMS 91203<br>VKMA 91203<br>VKM 71200<br>VKM 81203 | 1<br>1<br>1<br>1 | 1<br>1<br>1 | 1      |  |  |  | 2      |  |  | T0676 |
|----------------------------|----------------------------|---------------|---|--|------------------|-------------|--------|--|--|--|--------|--|--|-------|
|                            | 4E-FE                      | 04/97 → 10/99 | 3), Mod. EE111  | VKMS 91400<br>VKMA 91400<br>VKM 71400<br>VKM 81400 | 1<br>1<br>1<br>1 | 1<br>1<br>1 | 1      |  |  |  | 2      |  |  | T0660 |
|                            | 2E                         | 08/87 → 09/01 | Mod. EE100  | VKMA 91201<br>VKM 71201<br>VKM 81201               | 1<br>1<br>1      | 1<br>1      | 1      |  |  |  |        |  |  | T0660 |
|                            | 4E-FE                      | 07/92 → 04/97 | Mod. EE101  | VKMA 91400<br>VKM 71400<br>VKM 81400               | 1<br>1<br>1      | 1<br>1      | 1      |  |  |  |        |  |  | T0660 |
|                            | 2A-LU                      | 06/83 → 04/87 | 2), Mod. AE80   | VKPA 91409<br>VKPC 91409                           |                  |             |        |  |  |  | 1<br>1 |  |  |       |
|                            | 2A-U                       | 05/82 → 04/86 | Mod. AL20   | VKPC 91431   |                  |             |        |  |  |  | 1      |  |  |       |
|                            | 2E, 2E/3E, 4E-FE           | 05/86 → 07/03 | Mod. EE90, EE96, EE97,<br>EL30, EL41                    | VKPC 91413   |                  |             |        |  |  |  | 1      |  |  |       |
|                            | 2E, 4E-FE                  | 07/92 → 07/03 | 2), Mod. EE100, EE101,<br>EE102, EE106, EE110,<br>EE111 | VKPA 91417<br>VKPC 91417                           |                  |             |        |  |  |  | 1<br>1 |  |  |       |
|                            | 2E-LU                      | 05/85 → 04/87 | Mod. EE80   | VKPC 91413   |                  |             |        |  |  |  | 1      |  |  |       |
|                            | B(PS) 2E, 4E-FE            | 07/92 → 02/94 | Mod. EE100, EE101, AC                                   | VKMA____<br>VKM 61009                              |                  | 1<br>1      | 1      |  |  |  |        |  |  |       |
|                            | B(AC) 2E, 4E-FE            | 07/92 → 02/94 | Mod. EE100, EE101,                                      | VKMA____<br>VKM 61009                              |                  | 1<br>1      | 1      |  |  |  |        |  |  |       |
|                            | B(AC) 2E, 4E-FE            | 05/93 → 02/94 | Mod. EE100, EE101,                                      | VKMA____<br>VKM 61009                              |                  | 1<br>1      | 1      |  |  |  |        |  |  |       |
| <b>TOYOTA  COROLLA 1.4</b> |                            |               |   |  |                  |             |        |  |  |  |        |  |  |       |
|                            | 4ZZ-FE                     | 02/00 → 03/07 | Mod. ZZE111, ZZE12                                      |  |                  |             |        |  |  |  |        |  |  |       |
|                            | 4ZZ-FE                     | 11/06 → 03/07 | Mod. ZZE150   |  |                  |             |        |  |  |  |        |  |  |       |
|                            | 4E-FE                      | 04/97 → 11/99 |   | VKMA 91400<br>VKM 71400<br>VKM 81400               | 1<br>1<br>1      | 1<br>1      | 1      |  |  |  |        |  |  | T0660 |
|                            | 4E-FE                      | 04/97 → 11/99 | 2)  | VKPA 91417<br>VKPC 91417                           |                  |             |        |  |  |  | 1<br>1 |  |  |       |
|                            | 4ZZ-FE                     | 02/00 → 03/07 | Mod. ZZE121   | VKPC 91808   |                  |             |        |  |  |  | 1      |  |  |       |
| <b>TOYOTA  COROLLA 1.5</b> |                            |               |   |  |                  |             |        |  |  |  |        |  |  |       |
|                            | 5A-FE                      | 06/91 → 12/95 | 3), Mod. AE100, AE110                                   | VKMS 91005<br>VKMA 91005<br>VKM 71007              | 1<br>1<br>1      |             | 1<br>1 |  |  |  | 2      |  |  | T0697 |
|                            | 3E                         | 08/87 → 05/92 | Mod. EE107, EE108,<br>EE98                              | —<br>VKM 71201<br>—                                | 1<br>1<br>1      | 1<br>1      | 1      |  |  |  |        |  |  |       |
|                            | 5A-F                       | 05/87 → 12/91 | Mod. AE91   | VKMA 91702<br>VKM 71202                            | 1<br>1           |             | 1      |  |  |  |        |  |  | T0696 |
|                            | 3A-LU                      | 05/83 → 04/87 | Mod. AE81   | VKPC 91409   |                  |             |        |  |  |  | 1      |  |  |       |
|                            | 3A-U/HU.SU, 3ETE,<br>5E-FE | 05/82 → 09/94 | Mod. AL21, AL25, EL31,<br>EL43, EL45                    | VKPC 91431   |                  |             |        |  |  |  | 1      |  |  |       |
|                            | 3E, 5E-FE                  | 08/87 → 07/03 | Mod. EE103, EE104,<br>EE107, EE108, EE80,<br>EE98       | VKPC 91413   |                  |             |        |  |  |  | 1      |  |  |       |
|                            | 5A-F/FE/FHE                | 05/87 → 05/92 | Mod. AE91   | VKPC 91415   |                  |             |        |  |  |  | 1      |  |  |       |
| <b>TOYOTA  COROLLA 1.6</b> |                            |               |   |  |                  |             |        |  |  |  |        |  |  |       |
|                            | 1ZR-FE                     | 11/06 → 03/07 | Mod. ZRE151   |  |                  |             |        |  |  |  |        |  |  |       |
|                            | 3ZZ-FE                     | 02/00 → 03/07 | Mod. ZZE112, ZZE12                                      |  |                  |             |        |  |  |  |        |  |  |       |
|                            | 4A-C, 4A-L, 4A-LC          | 08/82 → 07/88 | 3), Mod. AE71, AE82,<br>AE86                            | VKMS 91202<br>VKMA 91202<br>VKM 71202              | 1<br>1<br>1      |             | 1<br>1 |  |  |  | 2      |  |  | T0696 |
|                            | 4A-F, 4A-FE                | 08/87 → 04/92 | 3), Mod. AE92, AE95                                     | VKMS 91702<br>VKMA 91702<br>VKM 71202              | 1<br>1<br>1      |             | 1<br>1 |  |  |  | 2      |  |  | T0696 |





































|   |  |  |  |  |  |  |  |  |  |  |  |  |
|---|---|---|---|--|---|---|---|---|---|---|---|---|
|   | 4A-FE   | 06/91 → 03/93   | 3), Mod. AE101, AE104   | VKMS 91005<br>VKMA 91005<br>VKM 71007  | 1<br>1<br>1   | 1<br>1<br>1   |   |   |   | 2   |   | T0697   |
|   | 4A-FE   | 04/92 → 05/92   | 3), Mod. AE95   | VKMS 91002<br>VKMA 91002<br>VKM 71202  | 1<br>1<br>1   | 1<br>1<br>1   |   |   |   | 2   |   | T0696   |
|   | 4A-FE   | 09/93 → 12/00   | 3), Mod. AE111, AE92  | VKMS 91005<br>VKMA 91005<br>VKM 71007  | 1<br>1<br>1   | 1<br>1<br>1   |   |   |   | 2   |   | T0697   |
|   | 4A-GE, 4A-GEC, 4A-GEL   | 08/84 → 12/91   | 3), Mod. AE82, AE86, AE92   | VKMS 91401<br>VKMA 91401<br>VKM 71401  | 1<br>1<br>1   | 1<br>1<br>1   |   |   |   | 2   |   | T0694   |
|                                | 1ZR-FE  | 01/02 → 11/06   | Mod. ZRE151   | —  |   |   |   |   | 1   |   |   |   |
|   | 3ZZ-FE  | 02/00 → 03/07   | Mod. ZZE112, ZZE12#   | VKPC 91808   |   |   |   |   | 1   |   |   |   |
|   | 4A-ELU  | 06/83 → 08/87   | 2), Mod. AE82   | VKPA 91409<br>VKPC 91409   |   |   |   |   | 1<br>1  |   |   |   |
|   | 4A-F  | 07/87 → 06/93   | Mod. AE92, AE95   | VKPC 91415   |   |   |   |   | 1   |   |   |   |
|   | 4A-FE   | 07/92 → 01/96   | Mod. AE101  | VKPC 91416   |   |   |   |   | 1   |   |   |   |
|   | 4A-FE   | 04/97 → 11/99   | Mod. AE111  | VKPC 91416   |   |   |   |   | 1   |   |   |   |
|   | 4A-GE, 4A-GZE, 4G-GZE   | 10/84 → 06/94   | Mod. AE101, AE25, AE72, AE82, AE92  | VKPC 91414   |   |   |   |   | 1   |   |   |   |
|   | 4A-GEU  | 07/85 → 04/87   | 2), Mod. AE86   | —<br>—   |   |   |   |   | 1<br>1  |   |   |   |
|                                | B(AC) 4A-FE   | 07/92 → 04/97   | Mod. AE101  | VKMA _____<br>VKM 61000  |   | 1<br>1  | 1   |   |   |   |   |   |
|   | B(Comp) 4A-FE   | 04/98 → 08/98   | Mod. AE111, AC  | VKMA _____<br>VKM 61000  |   | 1<br>1  | 1   |   |   |   |   |   |
| <b>TOYOTA  COROLLA 1.8</b>   |   |   |   |  |   |   |   |   |   |   |   |   |
|                              | 2ZZ-GE  | 01/02 → 03/07   | Mod. ZZE12  | OKOKOKO  |   |   |   |   |   |   |   |   |
|   | 7A-FE   | 04/97 → 09/01   | 3), Mod. AE115  | VKMS 91006<br>VKMA 91006<br>VKM 71007  | 1<br>1<br>1   | 1<br>1<br>1   |   |   |   | 2   |   | T0697   |
|   | 7A-FE   | 11/92 → 04/97   | Mod. AE102, AE103   | VKMA 91006<br>VKM 71007  | 1<br>1  | 1<br>1  |   |   |   |   |   | T0697   |
|                              | 1ZZ-FE  | 09/01 → 12/03   | Mod. ZZE12#   | VKPC 91808   |   |   |   |   | 1   |   |   |   |
|   | 2ZZ-GE  | 01/02 → 11/05   | Mod. ZZE123   | VKPC _____   |   |   |   |   | 1   |   |   |   |
|   | 2ZZ-GE  | 12/05 → 03/07   | Mod. ZZE123   | —  |   |   |   |   | 1   |   |   |   |
|   | 7A-FE   | 11/92 → 07/03   | 2), Mod. AE102, AE103, AE115  | VKPA 91441   |   |   |   |   | 1   |   |   |   |
| <b>TOYOTA  COROLLA 1.4 D</b> |   |   |   |  |   |   |   |   |   |   |   |   |
|                              | 1ND-TV  | 07/04 → 03/07   | Mod. NDE120, ZZE12  | OKOKOKO  |   |   |   |   |   |   |   |   |
|   | 1ND-TV  | 11/06 → 03/07   | Mod. NDE150   | OKOKOKO  |   |   |   |   |   |   |   |   |
|                              | 1ND-TV  | 08/04 → 03/07   | Mod. NDE120   | VKPC 91806   |   |   |   |   | 1   |   |   |   |
| <b>TOYOTA  COROLLA 1.6 D</b> |   |   |   |  |   |   |   |   |   |   |   |   |
|                              | 1C  | 10/82 → 06/86   | Mod. CE70   | VKMA 91100<br>VKM 71100<br>VKM 81100   | 1<br>1<br>1   | 1<br>1<br>1   |   |   |   |   |   | T0687   |
| <b>TOYOTA  COROLLA 1.8 D</b> |   |   |   |  |   |   |   |   |   |   |   |   |
|                              | 1C, 1C-L  | 06/83 → 04/87   | Mod. CE80   | VKMA 91100<br>VKM 71100<br>VKM 81100   | 1<br>1<br>1   | 1<br>1<br>1   |   |   |   |   |   | T0687   |
|   | 1C  | 07/87 → 09/91   | Mod. CE90, CE96, CE97   | VKMA 91100<br>VKM 71100<br>VKM 81100   | 1<br>1<br>1   | 1<br>1<br>1   |   |   |   |   |   | T0687   |
|                              | 1C  | 07/87 → 08/91   | Mod. CE90, CE96, CE97   | VKPC 91405   |   |   |   |   | 1   |   |   |   |
|   | 1C-L  | 06/83 → 04/87   | Mod. CE80   | VKPC 91405   |   |   |   |   | 1   |   |   |   |
| <b>TOYOTA  COROLLA 2.0 D</b> |   |   |   |  |   |   |   |   |   |   |   |   |
|                              | 2C-E  | 04/97 → 10/99   | 3), Mod. CE110  | VKMS 91100<br>VKMA 91100<br>VKM 71100<br>VKM 81100                                 | 1<br>1<br>1<br>1  | 1<br>1<br>1<br>1  |   |   |   | 2   |   | T0687   |
|   | 2C  | 05/87 → 04/97   | Mod. CE100, CE95  | VKMA 91100<br>VKM 71100<br>VKM 81100   | 1<br>1<br>1   | 1<br>1<br>1   |   |   |   |   |   | T0687   |
|                              | 2C, 2C-E  | 01/89 → 11/98   | Mod. CE100, CE104, CE106, CE108, CE109, CE110, CE95                               | VKPC 91405   |   |   |   |   | 1   |   |   |   |





































TOYOTA

|                                       | B(PS) 2C                | 07/92 → 04/97 | Mod. CE100, AC         | VKMA____<br>VKM 61002<br>VKM 61003                 | 2<br>1<br>1      | 1      |        |  |  |  |   |        |  |       |
|---------------------------------------|-------------------------|---------------|------------------------|--|------------------|--------|--------|--|--|--|---|--------|--|-------|
|                                       | B(AC) 2C                | 07/92 → 04/97 | Mod. CE100,            | VKMA____<br>VKM 61002<br>VKM 61003                 | 2<br>1<br>1      | 1      |        |  |  |  |   |        |  |       |
| <b>TOYOTA  COROLLA 2.0 D-4D</b>       |                         |               |                        |  |                  |        |        |  |  |  |   |        |  |       |
|                                       | 1AD-FTV                 | 11/06 → 03/07 | Mod. ADE150            |  |                  |        |        |  |  |  |   |        |  |       |
|                                       | 1CD-FTV                 | 01/02 → 04/05 | 3), Mod. CDE120        | VKMS 91303<br>VKMA 91303<br>VKM 71303<br>VKM 81204 | 1<br>1<br>1<br>1 | 1<br>1 | 1      |  |  |  | 2 |        |  | T0687 |
|                                       | 1CD-FTV                 | 09/00 → 11/01 | Mod. CDE110, Turbo     | VKMA 91303<br>VKM 71303<br>VKM 81204               | 1<br>1<br>1      | 1<br>1 | 1      |  |  |  |   |        |  | T0687 |
|                                       | 1AD-FTV                 | 11/06 → 03/07 | Mod. ADE150            | —  |                  |        |        |  |  |  |   | 1      |  |       |
|                                       | 1CD-FTV                 | 01/02 → 04/04 | Mod. CDE120, , Turbo   | VKPC 91814   |                  |        |        |  |  |  |   | 1      |  |       |
|                                       | 1CD-FTV                 | 04/03 → 06/06 | Mod. CDE120, , Turbo   | VKPC____   |                  |        |        |  |  |  |   | 1      |  |       |
| <b>TOYOTA  COROLLA VERSO 1.4</b>      |                         |               |                        |  |                  |        |        |  |  |  |   |        |  |       |
|                                       | 4ZZ-FE                  | 01/02 → 05/04 |                        |  |                  |        |        |  |  |  |   |        |  |       |
| <b>TOYOTA  COROLLA VERSO 1.6</b>      |                         |               |                        |  |                  |        |        |  |  |  |   |        |  |       |
|                                       | 3ZZ-FE                  | 01/02 → 06/06 | Mod. ZZE12             |  |                  |        |        |  |  |  |   |        |  |       |
|                                       | 3ZZ-FE                  | 01/02 → 01/04 | Mod. ZZE12#            | VKPC 91808   |                  |        |        |  |  |  |   | 1      |  |       |
|                                       | 3ZZ-FE                  | 04/04 → 03/07 | Mod. ZNR1              | VKPC 91808   |                  |        |        |  |  |  |   | 1      |  |       |
|                                       | B(Alt) 3ZZ-FE           | 01/02 → 01/04 | Mod. ZZE12             | VKMA____   | 1                |        | 1      |  |  |  |   |        |  |       |
|                                       | B(Alt) 3ZZ-FE           | 04/04 → 09/07 | Mod. ZNR1#, AC         | VKMA____<br>VKMV 6PK1560                           | 1                |        | 1<br>1 |  |  |  |   |        |  |       |
| <b>TOYOTA  COROLLA VERSO 1.8</b>      |                         |               |                        |  |                  |        |        |  |  |  |   |        |  |       |
|                                       | 1ZZ-FE                  | 01/02 → 06/06 |                        |  |                  |        |        |  |  |  |   |        |  |       |
|                                       | 1ZZ-FE                  | 01/02 → 01/04 | Mod. ZZE12#            | VKPC 91808   |                  |        |        |  |  |  |   | 1      |  |       |
|                                       | 1ZZ-FE                  | 04/04 → 03/07 | Mod. ZNR1              | VKPC 91808   |                  |        |        |  |  |  |   | 1      |  |       |
|                                       | B(Alt) 1ZZ-FE           | 01/02 → 01/04 | Mod. ZZE12             | VKMA____   | 1                |        | 1      |  |  |  |   |        |  |       |
|                                       | B(Alt) 1ZZ-FE           | 04/04 → 09/07 | Mod. ZNR1#, AC         | VKMA____<br>VKMV 6PK1560                           | 1                |        | 1<br>1 |  |  |  |   |        |  |       |
| <b>TOYOTA  COROLLA VERSO 2.0 D-4D</b> |                         |               |                        |  |                  |        |        |  |  |  |   |        |  |       |
|                                       | 1CD-FTV                 | 01/02 → 01/04 | 3), Mod. CDE120, Turbo | VKMS 91303<br>VKMA 91303<br>VKM 71303<br>VKM 81204 | 1<br>1<br>1<br>1 | 1<br>1 | 1      |  |  |  | 2 |        |  | T0687 |
|                                       | 1CD-FTV                 | 04/04 → 08/05 | 3), Mod. CUR10         | VKMS 91303<br>VKMA 91303<br>VKM 71303<br>VKM 81204 | 1<br>1<br>1<br>1 | 1<br>1 | 1      |  |  |  | 2 |        |  | T0687 |
|                                       | 1CD-FTV                 | 01/02 → 06/06 | Mod. CDE120,           | VKPC 91814   |                  |        |        |  |  |  |   | 1      |  |       |
|                                       | 1CD-FTV                 | 02/04 → 08/05 | Mod. CUR10,            | VKPC____   |                  |        |        |  |  |  |   | 1      |  |       |
|                                       | B(Alt) 1CD-FTV          | 01/02 → 01/04 | Mod. CDE120            | VKMA____   |                  |        | 1      |  |  |  |   |        |  |       |
|                                       | B(Alt) 1CD-FTV          | 04/04 → 09/07 | Mod. CUR10             | VKMA____   |                  |        | 1      |  |  |  |   |        |  |       |
| <b>TOYOTA  COROLLA VERSO 2.2 D-4D</b> |                         |               |                        |  |                  |        |        |  |  |  |   |        |  |       |
|                                       | 2AD-FHV, 2AD-FTV        | 10/05 → 09/07 |                        |  |                  |        |        |  |  |  |   |        |  |       |
|                                       | 2AD-FHV, 2AD-FTV        | 10/05 → 03/07 | Mod. AUR10             | —  |                  |        |        |  |  |  |   | 1      |  |       |
|                                       | B(Alt) 2AD-FHV, 2AD-FTV | 10/05 → 09/07 | Mod. AUR10             | VKMA____<br>VKM 61016                              | 1<br>1           |        | 1<br>1 |  |  |  |   |        |  |       |
| <b>TOYOTA  CORONA 1.5</b>             |                         |               |                        |  |                  |        |        |  |  |  |   |        |  |       |
|                                       | 3E                      | 12/87 → 11/89 | Mod. ET176             | —<br>VKM 71201<br>—                                | 1<br>1<br>1      | 1<br>1 | 1      |  |  |  |   |        |  |       |
|                                       | 5A-F/FE                 | 12/87 → 11/89 | Mod. AT170             | VKMA 91702<br>VKM 71202                            | 1<br>1           |        | 1      |  |  |  |   |        |  | T0696 |
|                                       | 3A-LU                   | 10/83 → 11/87 | 2), Mod. AT150         | VKPA 91409<br>VKPC 91409                           |                  |        |        |  |  |  |   | 1<br>1 |  |       |
|                                       | 3E                      | 12/87 → 11/92 | Mod. ET176             | VKPC 91413   |                  |        |        |  |  |  |   | 1      |  |       |
|                                       | 5A-FE                   | 12/87 → 02/92 | Mod. AT170             | VKPC 91415   |                  |        |        |  |  |  |   | 1      |  |       |













































|  |  |  |  |  |  |  |  |  |  |  |       |
|--|---|---|---|--|---|---|---|---|---|---|-------|
| <b>TOYOTA  CORONA 1.6</b>     |   |   |   |  |   |   |   |   |   |   |       |
|                               | 4A-FE   | 12/87 → 10/89   | 3), Mod. AT175  | VKMS 91702<br>VKMA 91702<br>VKM 71202  | 1<br>1<br>1   | 1<br>1  |   |   |   | 2   | T0696 |
|  | 4A-FE   | 02/92 → 12/96   | Mod. AT190, AT210   | VKMA 91005<br>VKM 71007  | 1<br>1  | 1   |   |   |   |   | T0697 |
|  | 4A-L/LC   | 10/83 → 11/87   | Mod. AT151  | VKMA 91202<br>VKM 71202  | 1<br>1  | 1   |   |   |   |   | T0696 |
|                               | 3A-LU, 4A-ELU   | 12/87 → 09/97   | 2), Mod. AT150  | VKPA 91409<br>VKPC 91409   |   |   |   |   | 1<br>1  |   |       |
|  | 4A-FE   | 08/88 → 01/92   | Mod. AT175  | VKPC 91415   |   |   |   |   | 1   |   |       |
|  | 4A-G  | 10/83 → 10/85   | 2), Mod. AT141  | —  |   |   |   |   | 1   |   |       |
|  | 4A-G, 4A-GELU   | 12/87 → 10/89   | Mod. AT160  | VKPC 91414   |   |   |   |   | 1   |   |       |
| <b>TOYOTA  CORONA 1.8</b>     |   |   |   |  |   |   |   |   |   |   |       |
|                               | 1S-L  | 10/83 → 11/87   | 3), Mod. ST150  | VKMS 91101<br>VKMA 91101<br>VKM 71101<br>VKM 81004                                 | 1<br>1<br>1<br>1  | 1<br>1  | 1   |   |   | 2   | T0663 |
|  | 4S-FE/FI  | 12/87 → 11/89   | Mod. ST170  | VKMA 91003<br>VKM 71003<br>VKM 81004   | 1<br>1<br>1   | 1<br>1  | 1   |   |   |   | T0663 |
|                               | 1S-U/LU/ELU   | 01/82 → 08/89   | Mod. ST140, ST150,<br>ST160   | VKPC 91404   |   |   |   |   | 1   |   |       |
|  | 2Y-PU   | 02/89 → 02/94   | Mod. Y140   | VKPC 91428   |   |   |   |   | 1   |   |       |
|  | 4S-F, 4S-FE   | 12/87 → 02/94   |   | VKPC 91613   |   |   |   |   | 1   |   |       |
| <b>TOYOTA  CORONA 2.0</b>    |   |   |   |  |   |   |   |   |   |   |       |
|                             | 2S, 2S-C  | 08/83 → 02/90   | 3), Mod. ST141, ST151   | VKMS 91101<br>VKMA 91101<br>VKM 71101<br>VKM 81004                                 | 1<br>1<br>1<br>1  | 1<br>1  | 1   |   |   | 2   | T0663 |
|  | 3S-FE   | 12/87 → 12/96   | 3), Mod. ST171, ST210   | VKMS 91003<br>VKMA 91003<br>VKM 71003<br>VKM 81004                                 | 1<br>1<br>1<br>1  | 1<br>1  | 1   |   |   | 3   | T0663 |
|  | 3S-GE   | 12/87 → 11/89   | Mod. ST171  | VKMA 91302<br>VKM 71302<br>VKM 81004   | 1<br>1<br>1   | 1<br>1  | 1   |   |   |   | T0685 |
|  | 3S-GE   | 02/92 → 02/94   | Mod. ST191  | VKMA 91013<br>VKM 71006<br>VKM 81004   | 1<br>1<br>1   | 1   | 1   |   |   |   | T0685 |
|                             | 3S-FE   | 12/87 → 02/94   |   | VKPC 91613   |   |   |   |   | 1   |   |       |
|  | 3SG, 3S-GE  | 08/85 → 08/89   | Mod. ST162, ST171   | VKPC 91604   |   |   |   |   | 1   |   |       |
| <b>TOYOTA  CORONA 1.8 D</b> |   |   |   |  |   |   |   |   |   |   |       |
|                             | 1C  | 01/82 → 05/90   | Mod. CT140, CT147   | VKPC 91405   |   |   |   |   | 1   |   |       |
| <b>TOYOTA  CORONA 2.0 D</b> |   |   |   |  |   |   |   |   |   |   |       |
|                             | 2C, 2C-L  | 10/83 → 08/95   |   | VKMA 91100<br>VKM 71100<br>VKM 81100   | 1<br>1<br>1   | 1   | 1   |   |   |   | T0687 |
|                             | 2C  | 02/82 → 05/90   |   | VKPC 91405   |   |   |   |   | 1   |   |       |
| <b>TOYOTA  CRESSIDA 1.8</b> |   |   |   |  |   |   |   |   |   |   |       |
|                             | 1S-U  | 08/82 → 08/88   |   | VKPC 91404   |   |   |   |   | 1   |   |       |
|  | 2Y-PU.J.E   | 08/82 → 08/94   |   | VKPC 91428   |   |   |   |   | 1   |   |       |
|  | 4S-FI   | 06/88 → 06/94   |   | VKPC 91613   |   |   |   |   | 1   |   |       |
| <b>TOYOTA  CRESSIDA 2.0</b> |   |   |   |  |   |   |   |   |   |   |       |
|                             | 1G-E  | 11/82 → 07/84   | Mod. GX60   | —<br>VKM 71103<br>—  | 1<br>1<br>1   | 1   | 1   |   |   |   |       |
|  | 1G-E  | 08/84 → 12/84   | Mod. GX60   | —<br>VKM 71103<br>VKM 81004  | 1<br>1<br>1   | 1   | 1   |   |   |   |       |
|  | 1G-E  | 08/84 → 08/88   | Mod. GX71, SOHC   | —<br>VKM 71103<br>VKM 81004  | 1<br>1<br>1   | 1   | 1   |   |   |   |       |

|  |  |  |  |  |  |  |  |  |  |  |  |  |  |
|--|---|---|---|--|---|---|---|---|---|---|---|---|---|
|  | 1G-FE   | 08/88 → 08/89   | Mod. GS131, GX70, GX71, GX81  | —<br>—<br>—  | 1<br>1  | 1   |   |   |   |   |   |   |   |
|  | 1G-GE   | 08/84 → 08/86   | Mod. GX71, DOHC   | —<br>VKM 71103<br>—  | 1<br>1  | 1   |   |   |   |   |   |   |   |
|                                | 3Y-P  | 08/88 → 08/94   | Mod. YX80   | VKPC 91428   |   |   |   |   | 1   |   |   |   |   |
| <b>TOYOTA  CRESSIDA 2.8</b>   |   |   |   |  |   |   |   |   |   |   |   |   |   |
|                                | 5M-GE   | 04/83 → 08/88   | Mod. MX61, MX72, MX73   | —<br>—   | 1<br>1  | 1   |   |   |   |   |   |   |   |
| <b>TOYOTA  CRESSIDA 3.0</b>   |   |   |   |  |   |   |   |   |   |   |   |   |   |
|                                | 7M-GE   | 10/88 → 09/92   | 3), Mod. MX83   | VKMS 91700<br>VKMA 91700<br>VKM 71700  | 1<br>1<br>1   | 1   |   |   |   | 3   |   |   | T0342   |
| <b>TOYOTA  CRESSIDA 2.2 D</b> |   |   |   |  |   |   |   |   |   |   |   |   |   |
|                                | L   | 06/82 → 07/84   | 3), Mod. LX60   | VKMS 91122<br>VKMA 91122<br>VKM 71001<br>VKM 81001                                 | 1<br>1<br>1   | 1   | 1   |   |   |   | 2   |   | T0329   |
|  | L   | 09/80 → 05/82   | Mod. LX60   | —<br>VKM 71001   | 1<br>1  |   | 1   |   |   |   |   |   |   |
| <b>TOYOTA  CRESSIDA 2.4 D</b> |   |   |   |  |   |   |   |   |   |   |   |   |   |
|                                | 2L  | 08/88 → 08/89   | 3), Mod. LX80   | VKMS 91124<br>VKMA 91124<br>VKM 71002<br>VKM 81002                                 | 1<br>1<br>1   | 1   | 1   |   |   |   | 2   |   | T0330   |
|  | 2L/2L-T   | 08/84 → 08/88   | 3), Mod. LX70, LX71   | VKMS 91122<br>VKMA 91122<br>VKM 71001<br>VKM 81001                                 | 1<br>1<br>1   | 1   | 1   |   |   |   | 2   |   | T0329   |
|  | 2L  | 11/84 → 08/88   | Mod. LX76   | VKMA 91122<br>VKM 71001<br>VKM 81001   | 1<br>1  | 1   | 1   |   |   |   |   |   | T0329   |
|                              | 2L  | 08/82 → 08/88   | Mod. LX65, LX70, LX76   | VKPC 91606   |   |   |   |   | 1   |   |   |   |   |
|  | 2L  | 09/88 → 08/94   | Mod. LX76, LX80, LX90   | VKPC 91607   |   |   |   |   | 1   |   |   |   |   |
| <b>TOYOTA  CRESTA 2.5</b>   |   |   |   |  |   |   |   |   |   |   |   |   |   |
|                              | 1JZ-GTE   | 08/93 → 12/99   | 3), Mod. JZX90  | VKMS 91710<br>VKMA 91710<br>VKM 71705  | 1<br>1<br>1   | 1   | 1   |   |   |   | 3   |   | T0694   |
| <b>TOYOTA  CROWN 2.0</b>    |   |   |   |  |   |   |   |   |   |   |   |   |   |
|                              | 1G-FE   | 08/93 → 02/95   | Mod. GS141  | —<br>—<br>—  | 1<br>1  | 1   | 1   |   |   |   |   |   |   |
|                              | 3Y-PU/PE  | 08/83 → 08/94   | Mod. YS120, YS130   | VKPC 91428   |   |   |   |   | 1   |   |   |   |   |
| <b>TOYOTA  CROWN 2.2</b>    |   |   |   |  |   |   |   |   |   |   |   |   |   |
|                              | 4Y  | 08/89 → 07/03   | Mod. YS132  | VKPC 91428   |   |   |   |   | 1   |   |   |   |   |
| <b>TOYOTA  CROWN 2.5</b>    |   |   |   |  |   |   |   |   |   |   |   |   |   |
|                              | 1JZ-GE  | 10/91 → 02/95   | Mod. JZS141   | —<br>—   | 1<br>1  | 1   |   |   |   |   |   |   |   |
| <b>TOYOTA  CROWN 2.8</b>    |   |   |   |  |   |   |   |   |   |   |   |   |   |
|                              | 5M/5M-GE  | 08/83 → 08/87   | Mod. MS122, MS123   | —<br>—   | 1<br>1  | 1   |   |   |   |   |   |   |   |
| <b>TOYOTA  CROWN 3.0</b>    |   |   |   |  |   |   |   |   |   |   |   |   |   |
|                              | 7M-GE   | 08/87 → 10/89   | 3), Mod. MS135  | VKMS 91700<br>VKMA 91700<br>VKM 71700  | 1<br>1<br>1   | 1   |   |   |   | 3   |   |   | T0342   |
|  | 2JZ-GE  | 10/91 → 02/95   | Mod. JZS14#   | VKMA 91017<br>VKM 71010  | 1<br>1  | 1   |   |   |   |   |   |   | T0694   |
|  | 6M-GE   | 10/84 → 08/87   | Mod. MS125  | —<br>—   | 1<br>1  | 1   |   |   |   |   |   |   |   |
| <b>TOYOTA  CROWN 4.0</b>    |   |   |   |  |   |   |   |   |   |   |   |   |   |
|                              | 1UZ-FE  | 10/91 → 02/95   | Mod. UZS14#   | —<br>—<br>VKM 81005  | 1<br>1  | 1   | 1   |   |   |   |   |   |   |

|   |  |  |  |  |  |  |  |  |  |  |   |       |
|---|---|---|---|--|---|---|---|---|---|---|---|-------|
| <b>TOYOTA  CROWN 2.2 D</b>             |   |   |   |  |   |   |   |   |   |   |   |       |
|                                        |   | 06/82 → 03/83   | 3), Mod. LS110  | VKMS 91122<br>VKMA 91122<br>VKM 71001<br>VKM 81001                                 | 1<br>1<br>1   | 1<br>1<br>1   |   |   |   |   | 2 | T0329 |
|   |   | 04/80 → 05/82   | Mod. LS110  | —<br>VKM 71001   | 1<br>1  | 1   |   |   |   |   |   |       |
| <b>TOYOTA  CROWN 2.4 D</b>             |   |   |   |  |   |   |   |   |   |   |   |       |
|                                        | 2L  | 08/83 → 02/88   | 3), Mod. LS120, LS130   | VKMS 91122<br>VKMA 91122<br>VKM 71001<br>VKM 81001                                 | 1<br>1<br>1   | 1<br>1<br>1   |   |   |   |   | 2 | T0329 |
|   | 2L  | 08/89 → 02/95   | 3), Mod. LS141, LX130   | VKMS 91124<br>VKMA 91124<br>VKM 71002<br>VKM 81002                                 | 1<br>1<br>1   | 1<br>1<br>1   |   |   |   |   | 2 | T0330 |
|                                        | 2L-T(E/EH)  | 05/82 → 08/89   | Mod. LS111, LS120,<br>LS126, LS130, LS131,<br>LS136                               | VKPC 91606   |   |   |   |   |   |   | 1 |       |
| <b>TOYOTA  CROWN 2.4 TD</b>            |   |   |   |  |   |   |   |   |   |   |   |       |
|                                        | 2L-T(E/EH)  | 08/89 → 08/94   | Mod. LS130, LS131,<br>LS136, LS141  | VKPC 91607   |   |   |   |   |   |   | 1 |       |
| <b>TOYOTA  CROWN ESTATE 2.5</b>        |   |   |   |  |   |   |   |   |   |   |   |       |
|                                        | 1JZ-GTE   | 08/93 → 12/99   | 3), Mod. JZX100   | VKMS 91710<br>VKMA 91710<br>VKM 71705  | 1<br>1<br>1   | 1<br>1  |   |   |   |   | 3 | T0694 |
| <b>TOYOTA  DYNA 3.0 D-4D</b>         |   |   |   |  |   |   |   |   |   |   |   |       |
|                                      | 5L  | 08/01 → 09/06   | Mod. LY220, LY230,<br>LY235   | VKPC 91607   |   |   |   |   |   |   | 1 |       |
| <b>TOYOTA  LAND CRUISER 4.0</b>      |   |   |   |  |   |   |   |   |   |   |   |       |
|                                      | 1GR-FE  | 01/03 → 04/07   |   | <del>OKOKOKO</del>   |   |   |   |   |   |   |   |       |
|                                      | 1GR-FE  | 01/03 → 08/04   | Mod. GRJ12  | —  |   |   |   |   |   |   | 1 |       |
| <b>TOYOTA  LAND CRUISER 4.2</b>      |   |   |   |  |   |   |   |   |   |   |   |       |
|                                      | 1HD-FTE   | 01/98 → 12/98   | Mod. UZJ100   | VKMA 91707<br>—<br>VKM 81005   | 1<br>1  | 1<br>1  |   |   |   |   |   | T0347 |
| <b>TOYOTA  LAND CRUISER 2.4 D</b>    |   |   |   |  |   |   |   |   |   |   |   |       |
|                                      | 2L-T  | 03/91 → 01/95   | 3), Mod. LJ70, LJ73   | VKMS 91125<br>VKMA 91124<br>VKM 71002<br>VKM 81002                                 | 1<br>1<br>1   | 1<br>1<br>1   |   |   |   |   | 2 | T0330 |
|   | 2L-T  | 10/85 → 01/90   | Mod. LJ71   | VKMA 91122<br>VKM 71001<br>VKM 81001   | 1<br>1  | 1<br>1  |   |   |   |   |   | T0329 |
|   | 2L-T  | 04/90 → 05/93   | Mod. LJ71, LJ78   | VKMA 91124<br>VKM 71002<br>VKM 81002   | 1<br>1  | 1<br>1  |   |   |   |   |   | T0330 |
|                                      | 2L  | 11/84 → 01/90   | Mod. LJ70, LJ73, LJ91   | VKPC 91606   |   |   |   |   |   |   | 1 |       |
| <b>TOYOTA  LAND CRUISER 2.4 TD</b>   |   |   |   |  |   |   |   |   |   |   |   |       |
|                                      | 2L-T  | 01/90 → 02/91   | 3), Mod. LJ70, LJ73, LJ77   | VKMS 91124<br>VKMA 91124<br>VKM 71002<br>VKM 81002                                 | 1<br>1<br>1   | 1<br>1<br>1   |   |   |   |   | 2 | T0330 |
|   | 2L-T  | 03/91 → 06/95   | 3), Mod. LJ70, LJ73, LJ77   | VKMS 91125<br>VKMA 91124<br>VKM 71002<br>VKM 81002                                 | 1<br>1<br>1   | 1<br>1<br>1   |   |   |   |   | 2 | T0330 |
|                                      | 2L-T  | 01/90 → 01/95   | Mod. LJ70, LJ71, LJ73,<br>LJ77, LJ78  | VKPC 91607   |   |   |   |   |   |   | 1 |       |
| <b>TOYOTA  LAND CRUISER 3.0 D-4D</b> |   |   |   |  |   |   |   |   |   |   |   |       |
|                                      | 1KD-FTV   | 01/03 → 04/07   | Mod. KDJ12  | VKMA 91711<br>VKM 71014  | 1<br>1  | 1   |   |   |   |   |   | T0659 |
|                                      | 1KD-FTV   | 01/03 → 08/04   | Mod. KDJ12  | VKPC_____  |   |   |   |   |   |   | 1 |       |



TOYOTA







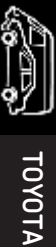

































|  |    |  |  |  |  |  |  |  |  |  |  |  |
|--|---|---|---|--|---|---|---|---|---|---|---|---|
| <b>TOYOTA</b>  |    | <b>LAND CRUISER 3.5 4X4</b>   |   |  |   |   |   |   |   |   |   |   |
|    | 1PZ   | 01/90 → 08/92   | Mod. PZJ70, PZJ73, PZJ75  | VKMA 91020<br>VKM 71012  | 1<br>1  | 1   |   |   |   |   |   | T0322   |
| <b>TOYOTA</b>  |    | <b>LAND CRUISER 4.2 TD</b>  |   |  |   |   |   |   |   |   |   |   |
|    | 1H-Z  | 01/90 → 04/95   | Mod. HZJ7#  | VKMA 91020<br>VKM 71012  | 1<br>1  | 1   |   |   |   |   |   | T0322   |
| <b>TOYOTA</b>  |    | <b>LAND CRUISER 100 4.7</b>   |   |  |   |   |   |   |   |   |   |   |
|    | 2UZ-FE  | 01/98 → 04/07   | Mod. UZJ100   | VKMA 91707<br>—<br>VKM 81005   | 1<br>1  | 1   | 1   |   |   |   |   | T0347   |
|    | 2UZ-FE  | 01/98 → 04/07   | Mod. UZJ100   | —  |   |   |   | 1   |   |   |   |   |
| <b>TOYOTA</b>  |    | <b>LAND CRUISER 100 4.2 TD</b>  |   |  |   |   |   |   |   |   |   |   |
|    | 1HD-FTE   | 01/98 → 04/07   | Mod. HDJ100   | VKMA 91708<br>VKM 71704  | 1<br>1  | 1   |   |   |   |   |   | T0659   |
|    | 1HD-FTE   | 01/98 → 04/07   |   | —  |   |   |   | 1   |   |   |   |   |
| <b>TOYOTA</b>  |    | <b>LAND CRUISER 90 3.4</b>  |   |  |   |   |   |   |   |   |   |   |
|    | 5VZ-FE  | 04/96 → 12/00   | 3), Mod. VZJ90, VZJ95   | VKMS 91704<br>VKMA 91704<br>VKM 71701<br>VKM 81401                                 | 1<br>1<br>1   | 1<br>1<br>1   | 1   |   |   | 1   |   | T0346   |
| <b>TOYOTA</b>  |    | <b>LAND CRUISER 90 3.0 D-4D</b>   |   |  |   |   |   |   |   |   |   |   |
|    | 1KD-FTV   | 10/00 → 09/02   | Mod. KDJ9, KZJ9   | VKMA 91711<br>VKM 71014  | 1<br>1  | 1   |   |   |   |   |   | T0659   |
| <b>TOYOTA</b>  |   | <b>LAND CRUISER 90 3.0 TD</b>   |   |  |   |   |   |   |   |   |   |   |
|  | 1KZ-TE  | 04/96 → 05/00   | Mod. KZJ9#  | VKMA 91713<br>VKM 71706  | 1<br>1  | 1   |   |   |   |   |   | T0659   |
|  | 1KZ-TE  | 06/00 → 09/02   | Mod. KZJ9#  | VKMA 91022<br>VKM 71014  | 1<br>1  | 1   |   |   |   |   |   | T0659   |
| <b>TOYOTA</b>  |  | <b>LEXUS 2.5</b>  |   |  |   |   |   |   |   |   |   |   |
|  | 4VZ-FE  | 08/93 → 12/94   | Mod. VCV11  | —<br>VKM 71004<br>VKM 81000  | 1<br>1  | 1   | 1   |   |   |   |   |   |
| <b>TOYOTA</b>  |  | <b>LEXUS 3.0</b>  |   |  |   |   |   |   |   |   |   |   |
|  | 3VZ-FE  | 07/91 → 12/94   | Mod. VCV10  | VKMA 91001<br>VKM 71004<br>VKM 81000   | 1<br>1  | 1   | 1   |   |   |   |   | T0688   |
| <b>TOYOTA</b>  |  | <b>LEXUS 4.0</b>  |   |  |   |   |   |   |   |   |   |   |
|  | 1UZ-FE  | 12/89 → 10/94   | Mod. UCF10  | —<br>—<br>VKM 81005  | 1<br>1  | 1   | 1   |   |   |   |   |   |
| <b>TOYOTA</b>  |  | <b>MARK II 1.8</b>  |   |  |   |   |   |   |   |   |   |   |
|  | 4S-FE   | 10/92 → 09/95   | 3), Mod. SX90   | VKMS 91003<br>VKMA 91003<br>VKM 71003<br>VKM 81004                                 | 1<br>1<br>1   | 1<br>1<br>1   | 1   |   |   | 3   |   | T0663   |
| <b>TOYOTA</b>  |  | <b>MARK II 2.0</b>  |   |  |   |   |   |   |   |   |   |   |
|  | 1G-FE   | 10/92 → 09/95   | Mod. GX90   | —<br>—<br>—  | 1<br>1  | 1   | 1   |   |   |   |   |   |
| <b>TOYOTA</b>  |  | <b>MARK II 2.5</b>  |   |  |   |   |   |   |   |   |   |   |
|  | 1JZ-GTE   | 08/93 → 12/99   | 3), Mod. JZX90  | VKMS 91710<br>VKMA 91710<br>VKM 71705  | 1<br>1<br>1   | 1   | 1   |   |   | 3   |   | T0694   |
|  | 1JZ-GE/GTE  | 10/92 → 09/95   | Mod. JZX90, JZX93   | —<br>—   | 1<br>1  | 1   |   |   |   |   |   |   |
| <b>TOYOTA</b>  |  | <b>MARK II 3.0</b>  |   |  |   |   |   |   |   |   |   |   |
|  | 2JZ-GE  | 10/92 → 09/95   | Mod. JZX91  | VKMA 91017<br>VKM 71010  | 1<br>1  | 1   |   |   |   |   |   | T0694   |
| <b>TOYOTA</b>  |  | <b>MARK II 2.4 D</b>  |   |  |   |   |   |   |   |   |   |   |
|  | 2L-TE   | 10/92 → 09/95   | Mod. LX90   | VKMA 91124<br>VKM 71002<br>VKM 81002   | 1<br>1  | 1   | 1   |   |   |   |   | T0330   |

































|  |  |  |  |  |  |  |  |  |  |  |  |
|--|---|---|---|--|---|---|---|---|---|---|---|
| <b>TOYOTA  MR 2 1.5</b>         |   |   |   |  |   |   |   |   |   |   |   |
|                                 | 3A-LU   | 06/84 → 10/89   | Mod. AW10   | VKPC 91409   |   |   |   |   |   | 1   |   |
| <b>TOYOTA  MR 2 1.6</b>         |   |   |   |  |   |   |   |   |   |   |   |
|                                 | 4A-GEL, 4A-GELC   | 11/84 → 01/89   | 3), Mod. AW11   | VKMS 91401<br>VKMA 91401<br>VKM 71401  | 1<br>1<br>1   |   | 1   |   |   |   | 2   |
|                                 | 4A-G  | 11/84 → 12/89   | Mod. AW11   | VKPC 91414   |   |   |   |   | 1   |   |   |
| <b>TOYOTA  MR 2 1.8</b>         |   |   |   |  |   |   |   |   |   |   |   |
|                                 | 1ZZ-FE  | 04/00 → 06/04   | Mod. ZZW30  | ΟΛΟΦΘΟ   |   |   |   |   |   |   |   |
|                                 | 1ZZ-FE  | 07/01 → 09/05   | Mod. ZZW30  | VKPC 91808   |   |   |   |   | 1   |   |   |
|                                 | B(Alt) 1ZZ-FE   | 04/00 → 06/04   | AC  | VKMW 6PK1400   |   |   | 1   |   |   |   |   |
|                                 | B(Alt) 1ZZ-FE   | 04/00 → 06/04   | AC  | VKMW 6PK1690   |   |   | 1   |   |   |   |   |
| <b>TOYOTA  MR 2 2.0</b>         |   |   |   |  |   |   |   |   |   |   |   |
|                                 | 3S-GE   | 01/90 → 10/93   | Mod. SW20   | VKMA 91013<br>VKM 71006<br>VKM 81004   | 1<br>1  | 1   | 1   |   |   |   |   |
|                                 | 3SF   | 12/89 → 11/93   | Mod. SW20   | VKPC 91613   |   |   |   |   | 1   |   |   |
|                                 | 3SG   | 12/89 → 11/93   | Mod. SW20   | VKPC 91604   |   |   |   |   | 1   |   |   |
| <b>TOYOTA  MR 2 2.2</b>         |   |   |   |  |   |   |   |   |   |   |   |
|                                 | 5S-FE   | 01/90 → 11/93   | Mod. SW21   | VKMA 91003<br>VKM 71003<br>VKM 81004   | 1<br>1  | 1   | 1   |   |   |   |   |
| <b>TOYOTA  PASEO 1.5</b>        |   |   |   |  |   |   |   |   |   |   |   |
|                                | 5E-FE   | 08/95 → 07/99   | Mod. EL44, EL54   | VKMA 91015<br>VKM 71400<br>VKM 81400   | 1<br>1  | 1   | 1   |   |   |   |   |
|                               | 5E-FE   | 08/95 → 07/99   | 2), Mod. EL54   | VKPA 91417<br>VKPC 91417   |   |   |   |   | 1<br>1  |   |   |
| <b>TOYOTA  PICNIC 2.0</b>     |   |   |   |  |   |   |   |   |   |   |   |
|                               | 3S-FE   | 06/01 → 12/01   |   | ΟΛΟΦΘΟ   |   |   |   |   |   |   |   |
|                               | 3S-FE   | 05/96 → 05/01   | 3), Mod. SXM10  | VKMS 91003<br>VKMA 91003<br>VKM 71003<br>VKM 81004                                 | 1<br>1<br>1   | 1   | 1   |   |   |   | 3   |
|                               | 3S-FE   | 05/96 → 04/01   | Mod. SXM10  | VKPC 91613   |   |   |   |   | 1   |   |   |
|                               | 1AZ-FE  | 05/01 → 12/06   | Mod. ACM20  | VKPC 91813   |   |   |   |   | 1   |   |   |
|                               | 3S-FE   | 05/96 → 04/01   | Mod. SXM10  | VKPC 91613   |   |   |   |   | 1   |   |   |
| <b>TOYOTA  PICNIC 2.4</b>     |   |   |   |  |   |   |   |   |   |   |   |
|                               | 2AZ-FE  | 05/01 → 12/06   | Mod. ACM20  | VKPC 91813   |   |   |   |   | 1   |   |   |
| <b>TOYOTA  PICNIC 2.0 TD</b>  |   |   |   |  |   |   |   |   |   |   |   |
|                               | 1CD-FTV   | 05/01 → 07/05   | 3), Mod. CLM20  | VKMS 91303<br>VKMA 91303<br>VKM 71303<br>VKM 81204                                 | 1<br>1<br>1   | 1   | 1   |   |   |   | 2   |
|                               | 1CD-FTV   | 05/01 → 07/05   | Mod. CLM20  | VKPC 91814   |   |   |   |   | 1   |   |   |
| <b>TOYOTA  PICNIC 2.2 D</b>   |   |   |   |  |   |   |   |   |   |   |   |
|                               | 3C-TE   | 08/97 → 05/01   | 3), Mod. CXM10  | VKMS 91100<br>VKMA 91100<br>VKM 71100<br>VKM 81100                                 | 1<br>1<br>1   | 1   | 1   |   |   |   | 2   |
|                               | 3C-TE   | 08/97 → 11/98   | Mod. CXM10  | VKPC 91405   |   |   |   |   | 1   |   |   |
| <b>TOYOTA  PREVIA 2.4</b>     |   |   |   |  |   |   |   |   |   |   |   |
|                               | 2AZ-FE, 2TZ-FE  | 05/90 → 06/04   | Mod. ACR30  | ΟΛΟΦΘΟ   |   |   |   |   |   |   |   |
|                               | 2AZ-FE  | 08/00 → 04/07   | Mod. ACR50  | ΟΛΟΦΘΟ   |   |   |   |   |   |   |   |
|                               | 2AZ-FE  | 08/00 → 02/06   | Mod. ACR30  | VKPC 91813   |   |   |   |   | 1   |   |   |
|                               | 2TZ-FE  | 05/90 → 08/00   | 2), Mod. TRC10, TRC11, TRC20, TRC21   | VKPA 91615   |   |   |   |   | 1   |   |   |
|                               | B(Alt) 2AZ-FE   | 08/00 → 12/05   | AC  | VKMA____<br>VKMV____<br>VKM____  | 1<br>1  |   | 1   |   |   |   |   |
|                               | B(Alt) 2AZ-FE   | 01/06 → 09/07   | Mod. ACR50, AC, R.H.D   | VKMA____   |   |   | 1   | 1   |   |   |   |
| <b>TOYOTA  PREVIA 2.4 4X4</b> |   |   |   |  |   |   |   |   |   |   |   |
|                               | 2TZ-FE  | 05/90 → 08/00   |   | ΟΛΟΦΘΟ   |   |   |   |   |   |   |   |



TOYOTA

|   |                |  |  |  |  |  |  |  |  |  |  |  |  |
|---|----------------|---|---|---|--|---|---|---|---|---|---|---|---|
| <b>TOYOTA</b>  <b>PREVIA 3.5</b>           |                |   |   |   |  |   |   |   |   |   |   |   |   |
|   | 2GR-FE         | 11/06 → 01/08   | Mod. GSR50  | —   |  |   |   |   |   |   |   | 1   |   |
| <b>TOYOTA</b>  <b>PREVIA 2.0 D-4D</b>      |                |   |   |   |  |   |   |   |   |   |   |   |   |
|   | 1CD-FTV        | 03/01 → 04/07   | 3), Mod. CLR30  | VKMS 91303<br>VKMA 91303<br>VKM 71303<br>VKM 81204                                | 1<br>1<br>1  | 1<br>1<br>1   |   |   |   |   |   | 2   | T0687   |
|   | 1CD-FTV        | 03/01 → 01/06   | Mod. CLR30  | VKPC 91814  |  |   |   |   |   | 1   |   |   |   |
|   | B(Alt) 1CD-FTV | 03/01 → 06/04   |   | VKMN _____  |  |   | 1   |   |   |   |   |   |   |
| <b>TOYOTA</b>  <b>PREVIA/TARAGO 2.4</b>    |                |   |   |   |  |   |   |   |   |   |   |   |   |
|   | 2AZ-FE         | 01/06 → 12/06   | Mod. ACR50  | VKPC 91813  |  |   |   |   |   | 1   |   |   |   |
| <b>TOYOTA</b>  <b>PRIUS 1.5</b>            |                |   |   |   |  |   |   |   |   |   |   |   |   |
|   | 1NZ-FXE        | 05/00 → 08/07   | Mod. NHW20  | <del>OKOKOKO</del>  |  |   |   |   |   |   |   |   |   |
|   | 1NZ-FXE        | 08/03 → 08/07   | Mod. NHW20  | VKPC 91806  |  |   |   |   |   | 1   |   |   |   |
| <b>TOYOTA</b>  <b>PRONARD 3.0 V6</b>       |                |   |   |   |  |   |   |   |   |   |   |   |   |
|   | 1MZ-FE         | 01/95 → 12/01   | Mod. MCX20  | VKMA 91011<br>VKM 71004<br>VKM 81000  | 1<br>1   | 1<br>1  |   |   |   |   |   |   | T0688   |
| <b>TOYOTA</b>  <b>PUBLICA 1.2</b>          |                |   |   |   |  |   |   |   |   |   |   |   |   |
|   | 4K-J           | 01/82 → 09/85   | Mod. KP39   | VKPC 91427  |  |   |   |   |   | 1   |   |   |   |
| <b>TOYOTA</b>  <b>RAV 4 1.8</b>            |                |   |   |   |  |   |   |   |   |   |   |   |   |
|   | 1ZZ-FE         | 02/01 → 11/05   | Mod. ZCA2#  | <del>OKOKOKO</del>  |  |   |   |   |   |   |   |   |   |
|   | 1ZZ-FE         | 07/01 → 11/05   | Mod. ZCA2#  | VKPC 91808  |  |   |   |   |   | 1   |   |   |   |
| <b>TOYOTA</b>  <b>RAV 4 2.0</b>           |                |   |   |   |  |   |   |   |   |   |   |   |   |
|   | 3S-FE          | 06/94 → 06/00   | Mod. SXA10, SXA11   | VKMA 91003<br>VKM 71003<br>VKM 81004  | 1<br>1   | 1<br>1  | 1   |   |   |   |   |   | T0663   |
|   | 3S-FE          | 06/94 → 06/00   | Mod. SXA10, SXA11   | VKPC 91613  |  |   |   |   |   | 1   |   |   |   |
| <b>TOYOTA</b>  <b>RAV 4 2.0 4X4</b>      |                |   |   |   |  |   |   |   |   |   |   |   |   |
|   | 1AZ-FE         | 06/00 → 06/07   | Mod. ACA2   | <del>OKOKOKO</del>  |  |   |   |   |   |   |   |   |   |
|   | 1AZ-FE         | 06/00 → 11/05   | Mod. ACA2#  | VKPC 91813  |  |   |   |   |   | 1   |   |   |   |
|   | 1AZ-FE         | 12/05 → 01/07   | Mod. ACA3#  | VKPC 91813  |  |   |   |   |   | 1   |   |   |   |
|   | B(Alt) 1AZ-FE  | 06/00 → 01/07   | AC  | VKMA _____<br>VKMN _____<br>VKM _____   | 1<br>1   |   | 1<br>1  |   |   |   |   |   |   |
| <b>TOYOTA</b>  <b>RAV 4 2.4 4X4</b>      |                |   |   |   |  |   |   |   |   |   |   |   |   |
|   | 2AZ-FE         | 08/03 → 10/05   | Mod. ACA2   | <del>OKOKOKO</del>  |  |   |   |   |   |   |   |   |   |
|   | 2AZ-FE         | 08/03 → 10/05   | Mod. ACA2#  | VKPC 91813  |  |   |   |   |   | 1   |   |   |   |
|   | 2AZ-FE         | 12/05 → 01/07   | Mod. ACA3#  | VKPC 91813  |  |   |   |   |   | 1   |   |   |   |
| <b>TOYOTA</b>  <b>RAV 4 2.0 D-4D 4X4</b> |                |   |   |   |  |   |   |   |   |   |   |   |   |
|   | 1CD-FTV        | 09/01 → 11/05   | 3), Mod. CLA2   | VKMS 91303<br>VKMA 91303<br>VKM 71303<br>VKM 81204                                | 1<br>1<br>1  | 1<br>1<br>1   |   |   |   |   |   | 2   | T0687   |
|   | 1CD-FTV        | 09/01 → 11/05   | Mod. CLA2   | VKPC 91814  |  |   |   |   |   | 1   |   |   |   |
| <b>TOYOTA</b>  <b>RAV 4 2.0 TD</b>       |                |   |   |   |  |   |   |   |   |   |   |   |   |
|   | 1CD-FTV        | 05/01 → 07/03   | 3), Mod. CLA2#  | VKMS 91303<br>VKMA 91303<br>VKM 71303<br>VKM 81204                                | 1<br>1<br>1  | 1<br>1<br>1   |   |   |   |   |   | 2   | T0687   |
| <b>TOYOTA</b>  <b>RAV 4 2.2 D</b>        |                |   |   |   |  |   |   |   |   |   |   |   |   |
|   | 2AD#           | 03/06 → 06/07   | Mod. ALA30  | —   |  |   |   |   |   | 1   |   |   |   |
| <b>TOYOTA</b>  <b>SC400 2.5</b>          |                |   |   |   |  |   |   |   |   |   |   |   |   |
|   | 1JZ-GTE        | 08/93 → 12/99   | 3), Mod. JZX100   | VKMS 91710<br>VKMA 91710<br>VKM 71705   | 1<br>1<br>1  |   | 1<br>1  |   |   |   |   | 3   | T0694   |
| <b>TOYOTA</b>  <b>SOARER 2.5</b>         |                |   |   |   |  |   |   |   |   |   |   |   |   |
|   | 1JZ-GTE        | 08/93 → 12/99   | 3), Mod. JZX100   | VKMS 91710<br>VKMA 91710<br>VKM 71705   | 1<br>1<br>1  |   | 1<br>1  |   |   |   |   | 3   | T0694   |









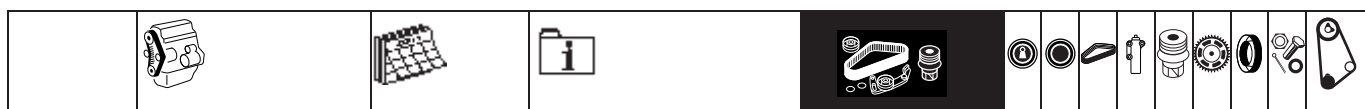

























|  |  |  |  |  |  |  |  |  |  |  |  |
|--|---|---|---|--|---|---|---|---|---|---|---|
| <b>TOYOTA  SPRINTER 1.3</b>     |   |   |   |  |   |   |   |   |   |   |   |
|                                 | 2E  | 05/87 → 06/90   | Mod. EE96   | VKMA 91201<br>VKM 71201<br>VKM 81201   | 1<br>1<br>1   | 1   | 1   |   |   |   | T0660   |
|  | 4E-FE   | 05/95 → 08/98   | Mod. EE111  | VKMA 91400<br>VKM 71400<br>VKM 81400   | 1<br>1<br>1   | 1   | 1   |   |   |   | T0660   |
| <b>TOYOTA  SPRINTER 1.5</b>     |   |   |   |  |   |   |   |   |   |   |   |
|                                 | 5A-FE   | 05/95 → 08/98   | 3), Mod. AE110  | VKMS 91005<br>VKMA 91005<br>VKM 71007  | 1<br>1<br>1   | 1   | 1   |   | 2   |   | T0697   |
|  | 5A  | 05/87 → 06/90   | Mod. AE91   | VKMA 91702<br>VKM 71202  | 1<br>1  | 1   | 1   |   |   |   | T0696   |
| <b>TOYOTA  SPRINTER 1.6</b>     |   |   |   |  |   |   |   |   |   |   |   |
|                                 | 4A-F/FE   | 05/87 → 06/90   | 3), Mod. AE95   | VKMS 91702<br>VKMA 91702<br>VKM 71202  | 1<br>1<br>1   | 1   | 1   |   | 2   |   | T0696   |
|  | 4A-FE   | 05/95 → 08/98   | 3), Mod. AE111  | VKMS 91005<br>VKMA 91005<br>VKM 71007  | 1<br>1<br>1   | 1   | 1   |   | 2   |   | T0697   |
|  | 4A-GE   | 05/87 → 06/90   | 3), Mod. AE92   | VKMS 91401<br>VKMA 91401<br>VKM 71401  | 1<br>1<br>1   | 1   | 1   |   | 2   |   | T0694   |
| <b>TOYOTA  SPRINTER 1.8 D</b>   |   |   |   |  |   |   |   |   |   |   |   |
|                                 | 1C  | 05/87 → 06/90   | Mod. CE90, CE96   | VKMA 91100<br>VKM 71100<br>VKM 81100   | 1<br>1<br>1   | 1   | 1   |   |   |   | T0687   |
| <b>TOYOTA  SPRINTER 2.0 D</b> |   |   |   |  |   |   |   |   |   |   |   |
|                               | 2C  | 05/87 → 08/98   | Mod. CE110, CE114,<br>CE95  | VKMA 91100<br>VKM 71100<br>VKM 81100   | 1<br>1<br>1   | 1   | 1   |   |   |   | T0687   |
| <b>TOYOTA  STARLET 1.0</b>    |   |   |   |  |   |   |   |   |   |   |   |
|                               | 1E, 1E-L  | 04/86 → 03/95   | Mod. EP80, EP70   | VKMA 91205<br>VKM 71201<br>VKM 81201   | 1<br>1<br>1   | 1   | 1   |   |   |   | T0676   |
|  | 1E-L  | 10/84 → 04/86   | Mod. EP70   | VKMA 91200<br>VKM 71200<br>VKM 81203   | 1<br>1<br>1   | 1   | 1   |   |   |   | T0676   |
|                               | 1E  | 10/84 → 12/92   | 2), Mod. EP70, EP80   | VKPA 91417<br>VKPC 91417   |   |   |   |   | 1<br>1  |   |   |
|  | 2K  | 02/78 → 09/84   | Mod. KP60, KP70   | VKPC 91402   |   |   |   |   | 1   |   |   |
|                               | B(AC) 1E  | 04/91 → 01/92   |   | VKMA _____<br>VKM 61000  |   | 1   | 1   |   |   |   |   |
| <b>TOYOTA  STARLET 1.2</b>    |   |   |   |  |   |   |   |   |   |   |   |
|                               | 3K-HJ   | 02/78 → 09/82   | Mod. KP62   | VKPC 91402   |   |   |   |   | 1   |   |   |
| <b>TOYOTA  STARLET 1.3</b>    |   |   |   |  |   |   |   |   |   |   |   |
|                               | 2E, 2E-E  | 12/89 → 05/95   | 3), Mod. EP81   | VKMS 91201<br>VKMA 91201<br>VKM 71201<br>VKM 81201                                 | 1<br>1<br>1<br>1  | 1   | 1   |   | 2   |   | T0660   |
|  | 2E-LC   | 10/84 → 03/86   | 3), Mod. EP71, EP76   | VKMS 91203<br>VKMA 91203<br>VKM 71200<br>VKM 81203                                 | 1<br>1<br>1<br>1  | 1   | 1   |   | 2   |   | T0676   |
|  | 4E-FE   | 04/96 → 03/99   | 3), Mod. EP91   | VKMS 91400<br>VKMA 91400<br>VKM 71400<br>VKM 81400                                 | 1<br>1<br>1<br>1  | 1   | 1   |   | 2   |   | T0660   |
|  | 2E  | 04/86 → 12/89   | Mod. EP76   | VKMA 91201<br>VKM 71201<br>VKM 81201   | 1<br>1<br>1   | 1   | 1   |   |   |   | T0660   |
|                               | 2E, 2E-ELU/LU/LJ  | 10/84 → 03/96   | 2), Mod. EP71, EP76,<br>EP81  | VKPA 91417<br>VKPC 91417   |   |   |   |   | 1<br>1  |   |   |
|  | 4E-F/FE/FTE   | 12/89 → 12/94   | Mod. EP82, EP85   | VKPC 91417   |   |   |   |   | 1   |   |   |





































TOYOTA







































|                                |        | 4E-FE                       | 04/96 → 03/99 | Mod. EP91                           | VKPC 91413                            |             |   |   |  |  |  |  |  |  |        |  |  |  |  |       |       |
|--------------------------------|--------|-----------------------------|---------------|-------------------------------------|---------------------------------------|-------------|---|---|--|--|--|--|--|--|--------|--|--|--|--|-------|-------|
|                                | B(PS)  | 4E-FE                       | 04/96 → 03/99 | AC                                  | VKM 61011                             | 1           |   |   |  |  |  |  |  |  |        |  |  |  |  |       |       |
|                                | B(AC)  | 2E, 2E-E                    | 12/89 → 01/92 |                                     | VKMA____<br>VKM 61000                 | 1<br>1      | 1 |   |  |  |  |  |  |  |        |  |  |  |  |       |       |
|                                | B(AC)  | 4E-FE                       | 04/96 → 03/99 | ⊗                                   | VKM 61011                             | 1           |   |   |  |  |  |  |  |  |        |  |  |  |  |       |       |
| <b>TOYOTA  STARLET 1.5 D</b>   |        |                             |               |                                     |                                       |             |   |   |  |  |  |  |  |  |        |  |  |  |  |       |       |
|                                |        | 1N                          | 12/86 → 01/87 | Mod. NP70                           | VKMA 91000<br>VKM 71000               | 1<br>1      | 1 |   |  |  |  |  |  |  |        |  |  |  |  | T0303 |       |
|                                |        | 1N                          | 12/89 → 12/90 | Mod. NP80                           | VKMA 91000<br>VKM 71000               | 1<br>1      | 1 |   |  |  |  |  |  |  |        |  |  |  |  |       | T0303 |
| <b>TOYOTA  SUPRA 3.0 Turbo</b> |        |                             |               |                                     |                                       |             |   |   |  |  |  |  |  |  |        |  |  |  |  |       |       |
|                                |        | 7M-GTE                      | 08/88 → 11/90 | 3), Mod. MA70                       | VKMS 91700<br>VKMA 91700<br>VKM 71700 | 1<br>1<br>1 | 1 |   |  |  |  |  |  |  | 3      |  |  |  |  |       | T0342 |
|                                |        | 2JZ-GTE                     | 05/93 → 06/96 | Mod. JZA80                          | VKMA 91017<br>VKM 71010               | 1<br>1      | 1 |   |  |  |  |  |  |  |        |  |  |  |  |       | T0694 |
| <b>TOYOTA  TERCEL 1.3</b>      |        |                             |               |                                     |                                       |             |   |   |  |  |  |  |  |  |        |  |  |  |  |       |       |
|                                |        | 2A                          | 05/82 → 08/84 | 3), Mod. AL11, AL20                 | VKMS 91202<br>VKMA 91202<br>VKM 71202 | 1<br>1<br>1 | 1 |   |  |  |  |  |  |  | 2      |  |  |  |  |       | T0696 |
|                                |        | 2E                          | 05/86 → 09/90 | Mod. EL30                           | VKMA 91201<br>VKM 71201<br>VKM 81201  | 1<br>1<br>1 | 1 | 1 |  |  |  |  |  |  |        |  |  |  |  |       | T0660 |
|                                |        | 2AU                         | 03/79 → 06/85 | Mod. AL11, AL20                     | VKPC 91431                            |             |   |   |  |  |  |  |  |  | 1      |  |  |  |  |       |       |
|                                |        | 2E, 4E-FE                   | 05/86 → 09/94 | Mod. EL41, EL43                     | VKPC 91413                            |             |   |   |  |  |  |  |  |  | 1      |  |  |  |  |       |       |
| <b>TOYOTA  TERCEL 1.5</b>      |        |                             |               |                                     |                                       |             |   |   |  |  |  |  |  |  |        |  |  |  |  |       |       |
|                                |        | 3A-C                        | 08/83 → 05/85 | 3), Mod. AL21, AL25                 | VKMS 91202<br>VKMA 91202<br>VKM 71202 | 1<br>1<br>1 | 1 |   |  |  |  |  |  |  | 2      |  |  |  |  |       | T0696 |
|                                |        | 3E                          | 08/88 → 10/92 | Mod. EL31, EL42                     | —<br>VKM 71201                        | 1<br>1      | 1 | 1 |  |  |  |  |  |  |        |  |  |  |  |       |       |
|                                |        | 5E-FE                       | 09/94 → 07/99 | Mod. EL53                           | VKMA 91015<br>VKM 71400<br>VKM 81400  | 1<br>1<br>1 | 1 | 1 |  |  |  |  |  |  |        |  |  |  |  |       | T0660 |
|                                |        | 2E, 3E/3E-TE, 3E-FE/<br>FHE | 05/86 → 09/94 | Mod. EL3, EL30, EL31,<br>EL43, EL45 | VKPC 91413                            |             |   |   |  |  |  |  |  |  | 1      |  |  |  |  |       |       |
|                                |        | 3EE                         | 09/90 → 08/92 | 2), Mod. EL42                       | VKPA 91417<br>VKPC 91417              |             |   |   |  |  |  |  |  |  | 1<br>1 |  |  |  |  |       |       |
| <b>TOYOTA  TERCEL 1.5 4X4</b>  |        |                             |               |                                     |                                       |             |   |   |  |  |  |  |  |  |        |  |  |  |  |       |       |
|                                |        | 3A, 3A-C                    | 10/82 → 01/88 | 3), Mod. AL21, AL25                 | VKMS 91202<br>VKMA 91202<br>VKM 71202 | 1<br>1<br>1 | 1 |   |  |  |  |  |  |  | 2      |  |  |  |  |       | T0696 |
|                                |        | 3A-U/HU.SU                  | 10/82 → 05/86 | Mod. AL21, AL25                     | VKPC 91431                            |             |   |   |  |  |  |  |  |  | 1      |  |  |  |  |       |       |
| <b>TOYOTA  WINDOW 3.0</b>      |        |                             |               |                                     |                                       |             |   |   |  |  |  |  |  |  |        |  |  |  |  |       |       |
|                                |        | 3VZ-FE                      | 07/91 → 12/94 | Mod. VCV10                          | VKMA 91001<br>VKM 71004<br>VKM 81000  | 1<br>1<br>1 | 1 | 1 |  |  |  |  |  |  |        |  |  |  |  |       | T0688 |
| <b>TOYOTA  YARIS 1.0</b>       |        |                             |               |                                     |                                       |             |   |   |  |  |  |  |  |  |        |  |  |  |  |       |       |
|                                |        | 1KR-FE, 1SZ-FE              | 08/05 → 03/07 | Mod. KSP90, SCP10                   | ⊗⊗⊗⊗⊗                                 |             |   |   |  |  |  |  |  |  |        |  |  |  |  |       |       |
|                                |        | 1SZ-FE                      | 04/99 → 12/02 | Mod. SCP10                          | ⊗⊗⊗⊗⊗                                 |             |   |   |  |  |  |  |  |  |        |  |  |  |  |       |       |
|                                |        | 1KR-FE                      | 08/05 → 06/06 | Mod. KSP90, (J)                     | VKPC____                              |             |   |   |  |  |  |  |  |  | 1      |  |  |  |  |       |       |
|                                |        | 1KR-FE                      | 11/05 → 03/07 | Mod. KSP90                          | —                                     |             |   |   |  |  |  |  |  |  | 1      |  |  |  |  |       |       |
|                                |        | 1SZ-FE                      | 04/99 → 12/02 | Mod. SCP10, (⊗)                     | VKPC 91805                            |             |   |   |  |  |  |  |  |  | 1      |  |  |  |  |       |       |
|                                |        | 1SZ-FE                      | 04/99 → 12/02 | Mod. SCP10, (⊗)                     | VKPC 91807                            |             |   |   |  |  |  |  |  |  | 1      |  |  |  |  |       |       |
| <b>TOYOTA  YARIS 1.3</b>       |        |                             |               |                                     |                                       |             |   |   |  |  |  |  |  |  |        |  |  |  |  |       |       |
|                                |        | 2NZ-FE                      | 11/99 → 12/02 | Mod. NCP10                          | ⊗⊗⊗⊗⊗                                 |             |   |   |  |  |  |  |  |  |        |  |  |  |  |       |       |
|                                |        | 2SZ-FE                      | 05/02 → 06/06 | Mod. SCP12                          | ⊗⊗⊗⊗⊗                                 |             |   |   |  |  |  |  |  |  |        |  |  |  |  |       |       |
|                                |        | 2SZ-FE                      | 11/05 → 06/06 | Mod. SCP12, SCP90                   | ⊗⊗⊗⊗⊗                                 |             |   |   |  |  |  |  |  |  |        |  |  |  |  |       |       |
|                                |        | 2NZ-FE                      | 08/99 → 12/02 | Mod. NLP10                          | VKPC 91806                            |             |   |   |  |  |  |  |  |  | 1      |  |  |  |  |       |       |
|                                |        | 2SZ-FE                      | 01/01 → 11/05 | Mod. SCP1#, (⊗)                     | VKPC 91807                            |             |   |   |  |  |  |  |  |  | 1      |  |  |  |  |       |       |
|                                |        | 2SZ-FE                      | 11/05 → 03/07 | Mod. SCP90, (⊗)                     | VKPC 91807                            |             |   |   |  |  |  |  |  |  | 1      |  |  |  |  |       |       |
|                                | B(Alt) | 2NZ-FE                      | 11/99 → 06/06 | (J), AC                             | VKMV____                              |             |   |   |  |  |  |  |  |  | 1      |  |  |  |  |       |       |



| TOYOTA  YARIS 1.5         |  |
|--|--|
|                           | 1NZ-FE 01/01 → 06/06 Mod. NCP13 <b>ΟΧΘΙΟΧΟ</b>   |
|                           | 1NZ-FE 08/99 → 08/05 Mod. NCP13 VKPC 91806   |
|                           | B(Alt) 1NZ-FE 04/01 → 06/06  , AC VKMV_____ 1                 |
| TOYOTA  YARIS 1.8         |  |
|                           | 2ZR-FE 01/07 → 03/07 Mod. ZSP90 <b>ΟΧΘΙΟΧΟ</b>   |
|                           | 2ZR-FE 11/06 → 03/07 Mod. ZSP90 — 1  |
| TOYOTA  YARIS 1.4 D-4D    |  |
|                           | 1ND-TV 12/01 → 06/06 Mod. NLP10 <b>ΟΧΘΙΟΧΟ</b>   |
|                           | 1ND-TV 11/05 → 06/06 Mod. NLP90 <b>ΟΧΘΙΟΧΟ</b>   |
|                           | 1ND-TV 08/99 → 01/03 Mod. NLP10 VKPC 91806 1   |
|                           | 1ND-TV 11/02 → 05/06 Mod. NLP2#, NLP90 VKPC 91806 1  |
|                           | 1ND-TV 02/03 → 11/05 Mod. NLP10 VKPC_____ 1  |
|                           | B(Alt) 1ND-TV 12/01 → 06/06  , 40), AC VKMV_____ 1            |
|                           | B(Alt) 1ND-TV 12/01 → 06/06  , 40), AC VKMV 5PK1190 1         |
| TOYOTA  4 RUNNER 2.7      |  |
|                           | 3RZ-FE 11/95 → 06/04 <b>ΟΧΘΙΟΧΟ</b>  |
| TOYOTA  4 RUNNER 3.0      |  |
|                           | 3VZ-E 08/92 → 11/95 Mod. VZN130 — 1 1 1  |
| TOYOTA  4 RUNNER 3.4      |  |
|                           | 5VZ-FE 11/95 → 12/00 3), Mod. VZN18# VKMS 91704 1 1 1 1<br>VKMA 91704 1 1 1<br>VKM 71701 1<br>VKM 81401 1                                      |
| TOYOTA  4 RUNNER 2.4 D  |  |
|                         | 2L 08/83 → 01/88 3), Mod. LN60, LN61 VKMS 91122 1 1 1 2<br>VKMA 91122 1 1 1<br>VKM 71001 1<br>VKM 81001 1                                      |
|  | 2L, 2L-T/TE 08/88 → 02/91 3), Mod. LN105, LN108, LN110, LN130, LN85, LN90 VKMS 91124 1 1 1 2<br>VKMA 91124 1 1 1<br>VKM 71002 1<br>VKM 81002 1 |
|  | 2L, 2L-T/TE 03/91 → 08/97 3), Mod. LN105, LN108, LN110, LN130, LN85 LN90 VKMS 91125 1 1 1 2<br>VKMA 91124 1 1 1<br>VKM 71002 1<br>VKM 81002 1  |
| TOYOTA  4 RUNNER 3.0 TD |  |
|                         | 1KZ-T 10/93 → 11/95 Mod. KZN130 VKMA 91022 1 1<br>VKM 71014 1  |
| TOYOTA  DYNA 1.8        |  |
|                         | 1Y, 2Y 09/84 → 07/03 Mod. YH81, YU81, YY50, YY81 VKPC 91428 1  |
| TOYOTA  DYNA 2.0        |  |
|                         | 3Y, 3Y-P 09/84 → 07/03 Mod. YU60, YU70, YU80, YY211, YY52, YY61 VKPC 91428 1   |
| TOYOTA  DYNA 2.4 D      |  |
|                         | 2L 08/83 → 08/88 3), Mod. LH80, LY21, LY31, LY50, LY60 VKMS 91122 1 1 1 2<br>VKMA 91122 1 1 1<br>VKM 71001 1<br>VKM 81001 1                    |
|  | 2L 01/89 → 02/91 3), Mod. LH80 VKMS 91124 1 1 1 2<br>VKMA 91124 1 1 1<br>VKM 71002 1<br>VKM 81002 1  |
|  | 2L 08/88 → 12/88 Mod. LY50 VKMA 91124 1 1 1<br>VKM 71002 1<br>VKM 81002 1  |
|                         | 2L 08/85 → 08/88 Mod. LY50, LY60, LY80 VKPC 91606 1  |















































|  |  |  |  |  |  |  |  |  |  |  |  |
|--|---|---|---|--|---|---|---|---|---|---|---|
|  | 2L  | 08/88 → 07/03   | Mod. LH80   | VKPC 91607   |   |   |   |   |   | 1   |   |
| <b>TOYOTA  DYNA 2.8 D</b>     |   |   |   |  |   |   |   |   |   |   |   |
|                                | 3L  | 08/88 → 02/91   | 3), Mod. LY51, LY61   | VKMS 91124<br>VKMA 91124<br>VKM 71002<br>VKM 81002                                 | 1<br>1<br>1<br>1  | 1<br>1<br>1   |   |   |   | 2   | T0330   |
|  | 3L  | 05/95 → 07/97   | 3), Mod. LY211  | VKMS 91125<br>VKMA 91124<br>VKM 71002<br>VKM 81002                                 | 1<br>1<br>1<br>1  | 1<br>1<br>1   |   |   |   | 2   | T0330   |
|                                | 3L  | 08/88 → 07/03   | Mod. LY211, LY61  | VKPC 91607   |   |   |   |   |   | 1   |   |
| <b>TOYOTA  HIACE 1.8</b>      |   |   |   |  |   |   |   |   |   |   |   |
|                                | 1Y-J  | 08/85 → 08/87   | Mod. YH80   | VKPC 91428   |   |   |   |   |   | 1   |   |
|  | 2Y  | 03/83 → 08/89   | Mod. YH50, YH60, YH81   | VKPC 91428   |   |   |   |   |   | 1   |   |
| <b>TOYOTA  HIACE 2.0</b>      |   |   |   |  |   |   |   |   |   |   |   |
|                                | 3Y-(P/J/U)  | 01/84 → 08/89   | Mod. YH51, YH52, YH57,<br>YH61, YH62, YH71  | VKPC 91428   |   |   |   |   |   | 1   |   |
| <b>TOYOTA  HIACE 2.4</b>      |   |   |   |  |   |   |   |   |   |   |   |
|                                | 2RZ-E   | 08/95 → 04/98   |   | <del>OKOKOKO</del>   |   |   |   |   |   |   |   |
|                                | 2RZ-E   | 08/95 → 11/03   | Mod. RCH12, RCH22   | —  |   |   |   |   |   | 1   |   |
| <b>TOYOTA  HIACE 2.7</b>      |   |   |   |  |   |   |   |   |   |   |   |
|                                | 3RZ-FE  | 04/98 → 04/04   |   | <del>OKOKOKO</del>   |   |   |   |   |   |   |   |
|                                | 3RZ-FE  | 04/98 → 05/06   | Mod. RCH13, RCH19,<br>RCH23, RCH29  | VKPC_____  |   |   |   |   |   | 1   |   |
| <b>TOYOTA  HIACE 2.8</b>     |   |   |   |  |   |   |   |   |   |   |   |
|                              | 3L  | 08/89 → 07/03   | Mod. LH102, LH108,<br>LH112, LH118, LH125   | VKPC 91607   |   |   |   |   |   | 1   |   |
| <b>TOYOTA  HIACE 2.2 D</b>  |   |   |   |  |   |   |   |   |   |   |   |
|                              | L   | 01/79 → 10/81   | Mod. LH20-30  | —<br>VKM 71001   | 1<br>1  |   | 1   |   |   |   |   |
|  | L   | 03/83 → 08/85   | Mod. LH50   | VKMA 91122<br>VKM 71001<br>VKM 81001   | 1<br>1<br>1   | 1<br>1  | 1   |   |   |   | T0329   |
|                              | L   | 11/82 → 07/85   | Mod. LH24   | VKPC 91606   |   |   |   |   |   | 1   |   |
|  | L   | 03/83 → 08/89   | Mod. LH50, LH60, LH70   | VKPC 91606   |   |   |   |   |   | 1   |   |
| <b>TOYOTA  HIACE 2.4 D</b>  |   |   |   |  |   |   |   |   |   |   |   |
|                              | 2L  | 01/84 → 08/89   | 3), Mod. LH61, LH71   | VKMS 91122<br>VKMA 91122<br>VKM 71001<br>VKM 81001                                 | 1<br>1<br>1<br>1  | 1<br>1<br>1   |   |   |   | 2   | T0329   |
|  | 2L, 2L/L/TE, 2L/T/TE  | 08/89 → 02/91   | 3), Mod. LH10#, LH11#,<br>LH12#, LH14#  | VKMS 91124<br>VKMA 91124<br>VKM 71002<br>VKM 81002                                 | 1<br>1<br>1<br>1  | 1<br>1<br>1   |   |   |   | 2   | T0330   |
|  | 2L#   | 03/91 → 08/01   | 3), Mod. LXH1#, LXH2#   | VKMS 91125<br>VKMA 91124<br>VKM 71002<br>VKM 81002                                 | 1<br>1<br>1<br>1  | 1<br>1<br>1   |   |   |   | 2   | T0330   |
|                              | 2L  | 12/82 → 08/89   | Mod. LH51, LH56, LH61,<br>LH66, LH71, LH80, LH85                                  | VKPC 91606   |   |   |   |   |   | 1   |   |
|  | 2L, 2L#   | 08/89 → 08/00   | Mod. LH80, LH85, LH90,<br>LH95, LXH1#, LXH2#                                      | VKPC 91607   |   |   |   |   |   | 1   |   |
| <b>TOYOTA  HIACE 2.4 TD</b> |   |   |   |  |   |   |   |   |   |   |   |
|                              | 2L-T  | 08/95 → 03/98   | 3), Mod. LXH18, LXH28   | VKMS 91125<br>VKMA 91124<br>VKM 71002<br>VKM 81002                                 | 1<br>1<br>1<br>1  | 1<br>1<br>1   |   |   |   | 2   | T0330   |
|  | 2L-T  | 08/95 → 08/04   | 3), Mod. LXH12, LXH22   | VKMS 91125<br>VKMA 91124<br>VKM 71002<br>VKM 81002                                 | 1<br>1<br>1<br>1  | 1<br>1<br>1   |   |   |   | 2   | T0330   |
|                              | 2L#   | 08/95 → 08/00   | Mod. LXH1#, LXH2#   | VKPC 91607   |   |   |   |   |   | 1   |   |



























































|   |  |  |  |  |  |  |  |  |  |  |
|---|---|---|---|--|---|---|---|---|---|---|
| <b>TOYOTA  HIACE 2.5 D-4D</b>    |   |   |   |  |   |   |   |   |   |   |
|                                  | 2KD-FTV   | 11/01 → 08/06   | 3)  | —  | 1   | 1   |   |   | 3   | T0659   |
|   |   |   |   | VKMA 91711   | 1   | 1   |   |   |   |   |
|   |   |   |   | VKM 71014  | 1   |   |   |   |   |   |
|                                  | 2KD-FTV   | 11/01 → 08/06   | 2), Mod. KLH1, KLH2   | VKPA_____  |   |   |   | 1   |   |   |
|   |   |   |   | VKPC_____  |   |   |   | 1   |   |   |
|                                  | B(Alt) 2KD-FTV  | 11/01 → 08/06   | AC  | VKMV_____  |   | 1   |   |   |   |   |
|   | B(Alt) 2KD-FTV  | 11/01 → 08/06   | AC  | VKMA_____  | 1   | 1   |   |   |   |   |
|   |   |   |   | VKMV_____  |   | 1   |   |   |   |   |
| <b>TOYOTA  HIACE 2.8 D</b>       |   |   |   |  |   |   |   |   |   |   |
|                                  | 3L  | 08/89 → 02/91   | 3), Mod. LH10#, LH11#, LH12#  | VKMS 91124   | 1   | 1   | 1   |   |   | 2   |
|   |   |   |   | VKMA 91124   | 1   | 1   | 1   |   |   |   |
|   |   |   |   | VKM 71002  | 1   |   |   |   |   |   |
|   |   |   |   | VKM 81002  |   | 1   |   |   |   |   |
|   | 3L  | 03/91 → 09/96   | 3), Mod. LH10#, LH11#, LH12#  | VKMS 91125   | 1   | 1   | 1   |   |   | 2   |
|   |   |   |   | VKMA 91124   | 1   | 1   | 1   |   |   |   |
|   |   |   |   | VKM 71002  | 1   |   |   |   |   |   |
|   |   |   |   | VKM 81002  |   | 1   |   |   |   |   |
|                                  | 3L  | 08/89 → 08/94   | Mod. LH1#   | VKPC 91607   |   |   |   | 1   |   |   |
| <b>TOYOTA  HIACE 3.0 D</b>       |   |   |   |  |   |   |   |   |   |   |
|                                  | 1KZ-TE  | 08/93 → 02/96   | Mod. KZH1#  | VKMA 91022   | 1   |   | 1   |   |   | T0659   |
|   |   |   |   | VKM 71014  | 1   |   |   |   |   |   |
| <b>TOYOTA  HILUX 1.8</b>         |   |   |   |  |   |   |   |   |   |   |
|                                 | 2Y  | 08/88 → 07/94   |   | ΟΧΘΙΟΧΟ  |   |   |   |   |   |   |
|                                | 1Y, 2Y  | 08/83 → 07/03   | Mod. YN50, YN51, YN55, YN56, YN80, YN85, YN90                                     | VKPC 91428   |   |   |   | 1   |   |   |
| <b>TOYOTA  HILUX 2.0</b>       |   |   |   |  |   |   |   |   |   |   |
|                                | 3Y  | 08/83 → 12/94   | Mod. YN100, YN105, YN107, YN136, YN52, YN56, YN57, YN60, YN61, YN65, YN81, YN86   | VKPC 91428   |   |   |   | 1   |   |   |
| <b>TOYOTA  HILUX 2.3</b>       |   |   |   |  |   |   |   |   |   |   |
|                                | 4Y  | 08/83 → 07/03   | Mod. YN58, YN62, YN63, YN67, YN106, YN110   | VKPC 91428   |   |   |   | 1   |   |   |
| <b>TOYOTA  HILUX 2.4 4X4</b>   |   |   |   |  |   |   |   |   |   |   |
|                                | 2RZ-FE  | 08/97 → 03/07   |   | ΟΧΘΙΟΧΟ  |   |   |   |   |   |   |
|                                | 2RZ-FE  | 08/97 → 08/01   |   | VKPC_____  |   |   |   | 1   |   |   |
| <b>TOYOTA  HILUX 3.0</b>       |   |   |   |  |   |   |   |   |   |   |
|                                | 3VZ-E   | 08/89 → 08/92   | Mod. VZN130   | VKPC 91804   |   |   |   | 1   |   |   |
| <b>TOYOTA  HILUX 2.2 D</b>     |   |   |   |  |   |   |   |   |   |   |
|                                | L   | 05/82 → 01/88   | 3), Mod. LN30, LN40, LN50, LN55   | VKMS 91122   | 1   | 1   | 1   |   |   | 2   |
|   |   |   |   | VKMA 91122   | 1   | 1   | 1   |   |   |   |
|   |   |   |   | VKM 71001  | 1   |   |   |   |   |   |
|   |   |   |   | VKM 81001  |   | 1   |   |   |   |   |
| <b>TOYOTA  HILUX 2.4 D</b>     |   |   |   |  |   |   |   |   |   |   |
|                                | 2L  | 08/88 → 02/91   | 3), Mod. LN#  | VKMS 91124   | 1   | 1   | 1   |   |   | 2   |
|   |   |   |   | VKMA 91124   | 1   | 1   | 1   |   |   |   |
|   |   |   |   | VKM 71002  | 1   |   |   |   |   |   |
|   |   |   |   | VKM 81002  |   | 1   |   |   |   |   |
|   | 2L  | 03/91 → 08/01   | 3), Mod. LN#  | VKMS 91125   | 1   | 1   | 1   |   |   | 2   |
|   |   |   |   | VKMA 91124   | 1   | 1   | 1   |   |   |   |
|   |   |   |   | VKM 71002  | 1   |   |   |   |   |   |
|   |   |   |   | VKM 81002  |   | 1   |   |   |   |   |
|                                | 2L  | 08/83 → 01/90   | Mod. LN51, LN56, LN60, LN61, LN65   | VKPC 91606   |   |   |   | 1   |   |   |
|   | 2L  | 08/97 → 08/00   | Mod. LN145, LN150, LN160, LN170, LN190  | VKPC 91607   |   |   |   | 1   |   |   |
| <b>TOYOTA  HILUX 2.4 D 4X4</b> |   |   |   |  |   |   |   |   |   |   |
|                                | 2L  | 08/88 → 02/91   | 3), Mod. LN#  | VKMS 91124   | 1   | 1   | 1   |   |   | 2   |
|   |   |   |   | VKMA 91124   | 1   | 1   | 1   |   |   |   |



TOYOTA

























































|  |  |  |  |  |  |  |  |  |  |  |  |  |  |  |
|--|---|---|---|--|---|---|---|---|---|---|---|---|---|---|
|  |   |   |   | VKM 71002<br>VKM 81002   | 1   |   |   |   |   |   |   |   |   |   |
|  | 2L  | 03/91 → 08/01   | 3), Mod. LN#  | VKMS 91125<br>VKMA 91124<br>VKM 71002<br>VKM 81002                                 | 1<br>1<br>1<br>1  | 1<br>1<br>1   |   |   |   |   |   | 2   |   | T0330   |
|                                    | 2L  | 08/97 → 08/00   | Mod. LN145  | VKPC 91607   |   |   |   |   | 1   |   |   |   |   |   |
| <b>TOYOTA  HILUX 2.4 TD 4X4</b>   |   |   |   |  |   |   |   |   |   |   |   |   |   |   |
|                                    | 2L-T  | 08/98 → 07/01   | 3), Mod. LN#  | VKMS 91125<br>VKMA 91124<br>VKM 71002<br>VKM 81002                                 | 1<br>1<br>1<br>1  | 1<br>1<br>1   |   |   |   |   |   | 2   |   | T0330   |
|                                    | 2L-T  | 08/98 → 08/00   | Mod. LN150, LN165,<br>LN170, LN190  | VKPC 91607   |   |   |   |   | 1   |   |   |   |   |   |
| <b>TOYOTA  HILUX 2.5 D-4D 4X4</b> |   |   |   |  |   |   |   |   |   |   |   |   |   |   |
|                                    | 2KD-FTV   | 11/01 → 04/07   | 3), Mod. KDN145,<br>KDN150, KDN165,<br>KDN170, KDN190,<br>KUN15, KUN25            | —<br>VKMA 91711<br>VKM 71014   | —<br>1<br>1   | —<br>1<br>1   |   |   |   |   |   | 3   |   | T0659   |
|                                    | 2KD-FTV   | 11/01 → 08/06   | 2), Mod. KLH12, KLH22   | VKPA ____<br>VKPC ____   |   |   |   |   | 1<br>1  |   |   |   |   |   |
|  | 2KD-FTV   | 07/05 → 08/06   | Mod. KUN15, KUN25   | —  |   |   |   |   | 1   |   |   |   |   |   |
|  | 2KD-FTV   | 09/06 → 03/07   | Mod. KUN15, KUN25   | —  |   |   |   |   | 1   |   |   |   |   |   |
|                                    | B(Alt) 2KD-FTV  | 11/01 → 08/05   | AC  | VKMV ____  |   |   |   | 1   |   |   |   |   |   |   |
|                                    | B(Alt) 2KD-FTV  | 11/01 → 08/05   | AC  | VKMA ____<br>VKMV ____   | 1   | 1   |   | 1   |   |   |   |   |   |   |
| <b>TOYOTA  HILUX 2.8 D</b>      |   |   |   |  |   |   |   |   |   |   |   |   |   |   |
|                                  | 3L  | 09/88 → 02/91   | 3), Mod. LN#  | VKMS 91124<br>VKMA 91124<br>VKM 71002<br>VKM 81002                                 | 1<br>1<br>1<br>1  | 1<br>1<br>1   |   |   |   |   |   | 2   |   | T0330   |
|  | 3L  | 03/91 → 02/95   | 3), Mod. LN#  | VKMS 91125<br>VKMA 91124<br>VKM 71002<br>VKM 81002                                 | 1<br>1<br>1<br>1  | 1<br>1<br>1   |   |   |   |   |   | 2   |   | T0330   |
|                                  | 3L  | 09/88 → 09/94   | Mod. LN81, LN86, LN100,<br>LN106  | VKPC 91607   |   |   |   |   | 1   |   |   |   |   |   |
| <b>TOYOTA  HILUX 3.0 D</b>      |   |   |   |  |   |   |   |   |   |   |   |   |   |   |
|                                  | 1KZ-TE  | 08/93 → 02/95   | Mod. KZN130   | VKMA 91022<br>VKM 71014  | 1<br>1  | 1   |   |   |   |   |   |   |   | T0659   |
| <b>TOYOTA  LITEACE 1.3</b>      |   |   |   |  |   |   |   |   |   |   |   |   |   |   |
|                                  | 4K-J  | 10/79 → 10/92   | Mod. KM11, KM20, KM21,<br>KM35, KM50  | VKPC 91427   |   |   |   |   |   |   |   | 1   |   |   |
| <b>TOYOTA  LITEACE 1.4</b>      |   |   |   |  |   |   |   |   |   |   |   |   |   |   |
|                                  | 4KU   | 09/85 → 07/03   | Mod. KM30, KM31, KM36,<br>KM51  | VKPC 91427   |   |   |   |   |   |   |   | 1   |   |   |
| <b>TOYOTA  LITEACE 1.5</b>      |   |   |   |  |   |   |   |   |   |   |   |   |   |   |
|                                  | 5K, 5K-J, 5K-J/U  | 05/86 → 01/95   | Mod. KM30, KM31, KM36,<br>KM51, KR21, KR27  | VKPC 91427   |   |   |   |   |   |   |   | 1   |   |   |
| <b>TOYOTA  LITEACE 1.6</b>      |   |   |   |  |   |   |   |   |   |   |   |   |   |   |
|                                  | 1Y-J  | 10/82 → 09/86   | Mod. YM20, YM25   | VKPC 91428   |   |   |   |   |   |   |   | 1   |   |   |
| <b>TOYOTA  LITEACE 1.8</b>      |   |   |   |  |   |   |   |   |   |   |   |   |   |   |
|                                  | 2Y-(U), 2Y-(U/J)  | 10/82 → 10/94   | Mod. YM21, YM30, YM31,<br>YM55, YM60  | VKPC 91428   |   |   |   |   |   |   |   | 1   |   |   |
| <b>TOYOTA  LITEACE 2.0</b>      |   |   |   |  |   |   |   |   |   |   |   |   |   |   |
|                                  | 3Y-U  | 09/85 → 01/92   | Mod. YM40   | VKPC 91428   |   |   |   |   |   |   |   | 1   |   |   |
| <b>TOYOTA  LITEACE 2.3</b>      |   |   |   |  |   |   |   |   |   |   |   |   |   |   |
|                                  | 4YE   | 01/92 → 07/03   | Mod. YR22, YR29   | VKPC 91428   |   |   |   |   |   |   |   | 1   |   |   |
| <b>TOYOTA  LITEACE 1.8 D</b>    |   |   |   |  |   |   |   |   |   |   |   |   |   |   |
|                                  | 1C  | 10/82 → 08/85   | Mod. CM20   | VKMA 91100<br>VKM 71100<br>VKM 81100   | 1<br>1<br>1   | 1<br>1  |   |   |   |   |   |   |   | T0687   |

































|   |  |  |  |  |  |  |  |  |  |  |  |
|---|---|---|---|--|---|---|---|---|---|---|---|
|                                      | 1C  | 10/85 → 08/88   | Mod. CM20, CM25, CM35   | VKPC 91405   |   |   |   |   | 1   |   |   |
|   | 1C  | 10/86 → 08/88   | Mod. CM50, CM60   | VKPC 91405   |   |   |   |   | 1   |   |   |
|   | 1Y-J  | 10/82 → 09/85   | Mod. YM20, YM25   | VKPC 91428   |   |   |   |   | 1   |   |   |
| <b>TOYOTA  LITEACE 2.0 D</b>         |   |   |   |  |   |   |   |   |   |   |   |
|                                      | 2C  | 01/92 → 05/92   | Mod. CR21, CR27, CR28, CR30, CR36, CR37   | VKMA 91100<br>VKM 71100<br>VKM 81100   | 1<br>1  | 1   | 1   |   |   |   | T0687   |
|                                      | 2C, 2C-T  | 08/85 → 10/94   |   | VKPC 91405   |   |   |   |   | 1   |   |   |
| <b>TOYOTA  MASTERACE 1.3</b>         |   |   |   |  |   |   |   |   |   |   |   |
|                                      | 4K-J  | 10/79 → 01/92   | Mod. KR12, KR26   | VKPC 91427   |   |   |   |   | 1   |   |   |
| <b>TOYOTA  MASTERACE 1.5</b>         |   |   |   |  |   |   |   |   |   |   |   |
|                                      | 5K-J  | 12/89 → 12/94   | Mod. KR27   | VKPC 91427   |   |   |   |   | 1   |   |   |
| <b>TOYOTA  MASTERACE 1.6</b>         |   |   |   |  |   |   |   |   |   |   |   |
|                                      | 1Y-J  | 11/82 → 08/88   | Mod. YM25, YR26V  | VKPC 91428   |   |   |   |   | 1   |   |   |
| <b>TOYOTA  MASTERACE 1.8</b>         |   |   |   |  |   |   |   |   |   |   |   |
|                                      | 1Y-J, 2Y-U/J  | 11/82 → 11/94   | Mod. YM25, YR20, YR25, YR26V, YR28  | VKPC 91428   |   |   |   |   | 1   |   |   |
| <b>TOYOTA  MASTERACE 2.0</b>         |   |   |   |  |   |   |   |   |   |   |   |
|                                      | 3Y-EU   | 05/83 → 05/94   | Mod. YR21, YR30, YR36   | VKPC 91428   |   |   |   |   | 1   |   |   |
| <b>TOYOTA  MASTERACE 1.8 D</b>       |   |   |   |  |   |   |   |   |   |   |   |
|                                      | 1C  | 11/82 → 08/88   | Mod. CM20, CM25, CR26   | VKPC 91405   |   |   |   |   | 1   |   |   |
| <b>TOYOTA  MASTERACE 2.0 D</b>       |   |   |   |  |   |   |   |   |   |   |   |
|                                      | 2C/T  | 08/88 → 05/92   | Mod. CR21, CR28, CR30, CR37   | VKMA 91100<br>VKM 71100<br>VKM 81100   | 1<br>1  | 1   | 1   |   |   |   | T0687   |
|                                    | 2C-T  | 04/83 → 01/94   | Mod. CR21, CR27, CR28, CR30, CR36, CR37   | VKPC 91405   |   |   |   |   | 1   |   |   |
| <b>TOYOTA  MODEL-F 1.8</b>         |   |   |   |  |   |   |   |   |   |   |   |
|                                    | 2Y  | 11/82 → 07/03   | Mod. YR20   | VKPC 91428   |   |   |   |   | 1   |   |   |
| <b>TOYOTA  MODEL-F 2.0</b>         |   |   |   |  |   |   |   |   |   |   |   |
|                                    | 3Y  | 11/82 → 07/03   | Mod. YR21   | VKPC 91428   |   |   |   |   | 1   |   |   |
| <b>TOYOTA  MODEL-F 2.3</b>         |   |   |   |  |   |   |   |   |   |   |   |
|                                    | 4YEC  | 11/82 → 07/03   | Mod. YR22, YR31   | VKPC 91428   |   |   |   |   | 1   |   |   |
| <b>TOYOTA  MODEL-F 2.0 D</b>       |   |   |   |  |   |   |   |   |   |   |   |
|                                    | 2C  | 05/83 → 07/03   | Mod. CR21   | VKPC 91405   |   |   |   |   | 1   |   |   |
| <b>TOYOTA  SPACE CRUISER 1.3</b>   |   |   |   |  |   |   |   |   |   |   |   |
|                                    | 4K-J  | 10/79 → 01/92   | Mod. KR12, KR26   | VKPC 91427   |   |   |   |   | 1   |   |   |
| <b>TOYOTA  SPACE CRUISER 1.5</b>   |   |   |   |  |   |   |   |   |   |   |   |
|                                    | 5K-J  | 12/89 → 12/94   | Mod. KR27   | VKPC 91427   |   |   |   |   | 1   |   |   |
| <b>TOYOTA  SPACE CRUISER 1.6</b>   |   |   |   |  |   |   |   |   |   |   |   |
|                                    | 1Y-J  | 11/82 → 08/88   | Mod. YM25, YR26V  | VKPC 91428   |   |   |   |   | 1   |   |   |
| <b>TOYOTA  SPACE CRUISER 1.8</b>   |   |   |   |  |   |   |   |   |   |   |   |
|                                    | 1Y-J, 2Y-U/J  | 11/82 → 11/94   | Mod. YM25, YR20, YR25, YR26V, YR28  | VKPC 91428   |   |   |   |   | 1   |   |   |
| <b>TOYOTA  SPACE CRUISER 2.0</b>   |   |   |   |  |   |   |   |   |   |   |   |
|                                    | 3Y-EU   | 05/83 → 05/94   | Mod. YR21, YR30, YR36   | VKPC 91428   |   |   |   |   | 1   |   |   |
| <b>TOYOTA  SPACE CRUISER 1.8 D</b> |   |   |   |  |   |   |   |   |   |   |   |
|                                    | 1C  | 11/82 → 08/88   | Mod. CM20, CM25, CR26   | VKPC 91405   |   |   |   |   | 1   |   |   |
| <b>TOYOTA  SPACE CRUISER 2.0 D</b> |   |   |   |  |   |   |   |   |   |   |   |
|                                    | 2C-T  | 04/83 → 01/94   | Mod. CR21, CR27, CR28, CR30, CR36, CR37   | VKPC 91405   |   |   |   |   | 1   |   |   |
| <b>TOYOTA  TOWNACE 1.3</b>         |   |   |   |  |   |   |   |   |   |   |   |
|                                    | 4K-J  | 10/79 → 01/92   | Mod. KR12, KR26   | VKPC 91427   |   |   |   |   | 1   |   |   |
| <b>TOYOTA  TOWNACE 1.5</b>         |   |   |   |  |   |   |   |   |   |   |   |
|                                    | 5K-J  | 12/89 → 12/94   | Mod. KR27   | VKPC 91427   |   |   |   |   | 1   |   |   |
| <b>TOYOTA  TOWNACE 1.6</b>         |   |   |   |  |   |   |   |   |   |   |   |
|                                    | 1Y-J  | 11/82 → 08/88   | Mod. YM25, YR26V  | VKPC 91428   |   |   |   |   | 1   |   |   |



TOYOTA































|  |  |  |    |  |  |  |  |  |  |  |  |  |
|--|---|---|---|--|---|---|---|---|---|---|---|---|
| <b>TOYOTA  TOWNACE 1.8</b>          |   |   |   |  |   |   |   |   |   |   |   |   |
|                                      | 1Y-J, 2Y-U/J  | 11/82 → 11/94   | Mod. YM25, YR20, YR25, YR26V, YR28  | VKPC 91428   |   |   |   |   |   | 1   |   |   |
| <b>TOYOTA  TOWNACE 2.0</b>          |   |   |   |  |   |   |   |   |   |   |   |   |
|                                      | 3Y-EU   | 05/83 → 05/94   | Mod. YR21, YR30, YR36   | VKPC 91428   |   |   |   |   |   | 1   |   |   |
| <b>TOYOTA  TOWNACE 1.8 D</b>        |   |   |   |  |   |   |   |   |   |   |   |   |
|                                      | 1C  | 11/82 → 08/88   | Mod. CM20, CM25, CR26   | VKPC 91405   |   |   |   |   |   | 1   |   |   |
| <b>TOYOTA  TOWNACE 2.0 D</b>        |   |   |   |  |   |   |   |   |   |   |   |   |
|                                      | 2C, 2C-T  | 08/88 → 05/92   | Mod. CR21, CR27, CR28, CR30, CR36, CR37   | VKMA 91100<br>VKM 71100<br>VKM 81100   | 1   | 1   | 1   |   |   |   |   | T0687   |
|                                      | 2C-T  | 04/83 → 01/94   | Mod. CR21, CR27, CR28, CR30, CR36, CR37   | VKPC 91405   |   |   |   |   |   | 1   |   |   |
| <b>TOYOTA  TOYOACE 1.6</b>          |   |   |   |  |   |   |   |   |   |   |   |   |
|                                      | 12R   | 03/79 → 07/85   | Mod. RY20, RY21   | —  |   |   |   |   |   | 1   |   |   |
| <b>TOYOTA  TOYOACE 1.8</b>          |   |   |   |  |   |   |   |   |   |   |   |   |
|                                      | 1Y, 2Y  | 08/85 → 09/93   | Mod. YY50, YY51, YY52   | VKPC 91428   |   |   |   |   |   | 1   |   |   |
| <b>TOYOTA  TOYOACE 2.0</b>          |   |   |   |  |   |   |   |   |   |   |   |   |
|                                      | 3Y-P  | 09/84 → 10/93   | Mod. YU60, YU61, YU70, YU80, YY52, YY61   | VKPC 91428   |   |   |   |   |   | 1   |   |   |
| <b>TOYOTA  TOYOACE 2.4 D</b>        |   |   |   |  |   |   |   |   |   |   |   |   |
|                                      | 2L  | 08/83 → 08/88   | Mod. LY21, LY31, LY50, LY60   | VKPC 91606   |   |   |   |   |   | 1   |   |   |
|  | 2L  | 08/88 → 08/94   | Mod. LY50   | VKPC 91607   |   |   |   |   |   | 1   |   |   |
| <b>TOYOTA  TOYOACE 2.8 D</b>      |   |   |   |  |   |   |   |   |   |   |   |   |
|                                    | 3L  | 08/88 → 08/94   | Mod. LY51, LY61   | VKPC 91607   |   |   |   |   |   | 1   |   |   |
| <b>VAUXHALL  AGILA 1.0 12V</b>    |   |   |   |  |   |   |   |   |   |   |   |   |
|                                    | Z 10 XE   | 09/00 → 10/07   |   | <del>OKOKOK</del>  |   |   |   |   |   |   |   |   |
|                                    | Z 10 XE   | 09/00 → 10/07   |   | VKPC 85220   |   |   |   |   |   | 1   |   |   |
|                                    | B(Alt) Z 10 XE  | 09/00 → 10/07   | AC  | VKMA 35113<br>VKMV 5PK1230<br>VKM 35013  | 1   | 1   | 1   |   |   |   |   |   |
|  | B(Alt) Z 10 XE  | 09/00 → 10/07   | AC  | VKMA 35013<br>VKMV 5PK1355<br>VKM 35013  | 1   | 1   | 1   |   |   |   |   |   |
|  |   |   |   |  | 1   |   |   |   |   |   |   |   |
| <b>VAUXHALL  AGILA 1.2 16V</b>    |   |   |   |  |   |   |   |   |   |   |   |   |
|                                    | Z 12 XE   | 09/00 → 10/07   |   | <del>OKOKOK</del>  |   |   |   |   |   |   |   |   |
|                                    | Z 12 XE   | 09/00 → 10/07   |   | VKPC 85220   |   |   |   |   |   | 1   |   |   |
|                                    | B(Alt) Z 12 XE  | 09/00 → 10/07   | AC  | VKMA 35113<br>VKMV 5PK1230<br>VKM 35013  | 1   | 1   | 1   |   |   |   |   |   |
|  | B(Alt) Z 12 XE  | 09/00 → 10/07   | AC  | VKMA 35013<br>VKMV 5PK1355<br>VKM 35013  | 1   | 1   | 1   |   |   |   |   |   |
|  |   |   |   |  | 1   |   |   |   |   |   |   |   |
| <b>VAUXHALL  ASTRA Mk I 1.2</b>   |   |   |   |  |   |   |   |   |   |   |   |   |
|                                    | 12 S  | 02/82 → 08/84   |  | VKMC 05100   |   |   | 1   | 1   |   |   |   | T0226   |
|                                    | 12 S  | 02/82 → 08/84   |   | VKPC 85201   |   |   |   | 1   |   |   |   |   |
| <b>VAUXHALL  ASTRA Mk I 1.3</b>   |   |   |   |  |   |   |   |   |   |   |   |   |
|                                    | 13 S  | 09/79 → 08/84   |  | VKMC 05103   |   |   | 1   | 1   |   |   |   | T0224   |
|                                    | 13 S  | 09/79 → 08/84   |   | VKPC 85202   |   |   |   | 1   |   |   |   |   |
| <b>VAUXHALL  ASTRA Mk I 1.6</b>   |   |   |   |  |   |   |   |   |   |   |   |   |
|                                    | 16 SH   | 09/81 → 08/86   |  | VKMC 05400   |   |   | 1   | 1   |   |   |   | T0225   |
|                                    | 16 SH   | 09/81 → 08/86   |   | VKPC 85400   |   |   |   | 1   |   |   |   |   |
| <b>VAUXHALL  ASTRA Mk I 1.8</b>   |   |   |   |  |   |   |   |   |   |   |   |   |
|                                    | 18 E  | 03/83 → 08/86   |  | VKMC 05400   |   |   | 1   | 1   |   |   |   | T0225   |
|                                    | 18 E  | 03/83 → 08/86   |   | VKPC 85400   |   |   |   | 1   |   |   |   |   |
| <b>VAUXHALL  ASTRA Mk I 1.6 D</b> |   |   |   |  |   |   |   |   |   |   |   |   |
|                                    | 16 D  | 02/82 → 08/86   |   | VKPC 85406   |   |   |   |   |   | 1   |   |   |



| VAUXHALL  ASTRA Mk II 1.2       |   |
|--|---|
|                                 | 12 SCOHV, 12 SOHV 09/84 → 08/91  VKMC 05100 1 1 T0226  |
|                                 | 12 SCOHV, 12 SOHV 09/84 → 08/91 VKPC 85201 1  |
|  | 12 SOHC, 12 STOHC 09/84 → 12/88 VKPC 85206 1  |
| VAUXHALL  ASTRA Mk II 1.3       |   |
|                                 | 13 S 09/84 → 08/91  VKMC 05103 1 1 T0224   |
|                                 | 13 S 09/84 → 08/91 VKPC 85202 1   |
| VAUXHALL  ASTRA Mk II 1.4       |   |
|                                 | 14 NV 01/89 → 08/91  VKMC 05121 1 1 1 1 T0092<br>VKMA 05121 1 1<br>VKM 15121 1 1   |
|  | C 14 NZ 01/90 → 12/91  →   Mot. 02 J22349, 19 311737 VKMC 05120 1 1 1 T0228  |
|  | C 14 NZ 01/90 → 12/91  Mot. 02 J22350, 19 311738   → VKMC 05121 1 1 1 T0092<br>VKMA 05121 1 1<br>VKM 15121 1 1                 |
|  | 14 NV 01/89 → 08/91 3) VKMS 05121 1 1 2 1 T0092<br>VKMA 05121 1 1<br>VKM 15121 1 1  |
|  | C 14 NZ 01/90 → 12/91 3), Mot. 02 J22350, 19 311738   → VKMS 05121 1 1 2 1 T0092<br>VKMA 05121 1 1<br>VKM 15121 1 1   |
|                                 | 14 NV 01/89 → 08/91 VKPC 85206 1  |
|  | C 14 NZ 01/90 → 12/91 →   Mot. 02 J22349, 19 311737 VKPC 85401 1  |
|  | C 14 NZ 01/90 → 12/91 Mot. 02 J22350, 19 311738   → VKPC 85206 1  |
| VAUXHALL  ASTRA Mk II 1.6     |   |
|                               | 16 S 09/84 → 12/91  VKMC 05400 1 1 T0225   |
|  | 16 SV, C 16 LZ, C 16 NZ, E 16 NZ 09/84 → 08/93  →   Mot. 02 J22349 VKMC 05120 1 1 T0228                                      |
|  | 16 SV, C 16 LZ, C 16 NZ, E 16 NZ 09/84 → 08/93  Mot. 02 J22350   → VKMC 05121 1 1 1 T0092<br>VKMA 05121 1 1<br>VKM 15121 1 1 |
|  | 16 SV, C 16 LZ, C 16 NZ, E 16 NZ 01/87 → 12/91 3), Mot. 02 J22350   → VKMS 05121 1 1 2 1 T0092<br>VKMA 05121 1 1<br>VKM 15121 1 1   |
|                               | 16 S 09/84 → 08/91 VKPC 85400 1   |
|  | 16 SV, C 16 NZ, E 16 NZ 09/84 → 08/93 →   Mot. 02 J22349 VKPC 85401 1   |
|  | 16 SV, C 16 NZ, E 16 NZ 09/84 → 08/93 Mot. 02 J22350   → VKPC 85206 1   |
|  | C 16 LZ 10/87 → 02/93 VKPC 85401 1  |
| VAUXHALL  ASTRA Mk II 1.8     |   |
|                               | 18 E, 18 SE 09/84 → 08/91  →   Mot. 14 056060 VKMC 05400 1 1 T0225   |
|  | 18 E, 18 SE 09/84 → 08/91 Mot. 14 056061   → VKMA 05402 1 1 T0105<br>VKM 15402 1  |
|                               | 18 E, 18 SE 09/84 → 08/91 →   Mot. 14 056060 VKPC 85400 1   |
|  | 18 E, 18 SE 09/84 → 08/91 Mot. 14 056061   →, →   Mot. 14 270600 VKPC 85407 1   |
|  | 18 E, 18 SE 09/84 → 08/91 Mot. 14 270601   → VKPC 85409 1   |
| VAUXHALL  ASTRA Mk II 2.0     |   |
|                               | 20 NE, 20 SEH, C 20 NE 09/86 → 08/93  →   Mot. 14 608700 VKMC 05401 1 1 T0225  |
|  | 20 NE, 20 SEH, C 20 NE 09/86 → 08/93 Mot. 14 608701   → VKMA 05402 1 1 T0105<br>VKM 15402 1   |
|                               | 20 NE, 20 SEH, C 20 NE 09/86 → 08/93 →   Mot. 14 608700 VKPC 85407 1  |
|  | 20 NE, 20 SEH, C 20 NE 09/86 → 08/93 Mot. 14 608701   → VKPC 85409 1  |
| VAUXHALL  ASTRA Mk II 2.0 16V |   |
|                               | 20 XE, C 20 XE 05/88 → 08/91 →   Mot. 14 142838 VKMA 05211 1 1 1 T0063<br>VKM 15211 1<br>VKM 25211 1  |
|  | 20 XE, C 20 XE 05/88 → 08/91 Mot. 14 142839   → VKMA 05220 1 2 1 T0106<br>VKM 15202 1   |



|                                       |  |               |                                  |  | VKM 25212    | 1 |   |   |   |  |   |       |
|---------------------------------------|--|---------------|----------------------------------|--|--------------|---|---|---|---|--|---|-------|
|                                       |  |               |                                  |  | VKM 25213    | 1 |   |   |   |  |   |       |
|                                       | 20 XE, C 20 XE                             | 05/88 → 08/91 | → I Mot. 14 142838               |  | VKPC 85610   |   |   |   | 1 |  |   |       |
|                                       | 20 XE, C 20 XE                             | 05/88 → 08/91 | Mot. 14 142839 I →               |  | VKPC 85611   |   |   |   | 1 |  |   |       |
| <b>VAUXHALL  ASTRA Mk II 1.5 DT</b>   |  |               |                                  |  |              |   |   |   |   |  |   |       |
|                                       | 15 TD (ISUZU)                              | 01/87 → 08/91 | 3)                               |  | VKMS 05208   | 1 | 1 | 1 |   |  | 3 | 1     |
|                                       |  |               |                                  |  | VKMA 05208   | 1 | 1 | 1 |   |  |   | 1     |
|                                       |  |               |                                  |  | VKM 15210    | 1 |   |   |   |  |   |       |
|                                       |  |               |                                  |  | VKM 25208    |   | 1 |   |   |  |   | 1     |
|                                       | 15 TD (ISUZU)                              | 01/87 → 08/91 | → I Mot. 817252                  |  | VKPC 85403   |   |   |   | 1 |  |   |       |
|                                       | 15 TD (ISUZU)                              | 01/87 → 08/91 | Mot. 817253 I →                  |  | VKPC 85410   |   |   |   | 1 |  |   |       |
| <b>VAUXHALL  ASTRA Mk II 1.6 D</b>    |  |               |                                  |  |              |   |   |   |   |  |   |       |
|                                       | 16 DA (GM)                                 | 09/84 → 08/91 | Man. GBX,<br>Mot. 14 498631 I →  |  | VKMC 05201   | 1 | 1 |   | 1 |  |   |       |
|                                       |  |               |                                  |  | VKMA 05201   | 1 | 1 |   |   |  |   | T0045 |
|                                       |  |               |                                  |  | VKM 25201    | 1 |   |   |   |  |   |       |
|                                       | 16 DA (GM)                                 | 09/84 → 08/91 | Auto. GBX,<br>Mot. 14 503757 I → |  | VKMC 05201   | 1 | 1 |   | 1 |  |   |       |
|                                       |  |               |                                  |  | VKMA 05201   | 1 | 1 |   |   |  |   | T0045 |
|                                       |  |               |                                  |  | VKM 25201    | 1 |   |   |   |  |   |       |
|                                       | 16 D (GM)                                  | 09/84 → 08/91 |                                  |  | VKMA 05200   | 1 | 1 |   |   |  |   | T0016 |
|                                       |  |               |                                  |  | VKM 25200    | 1 |   |   |   |  |   |       |
|                                       | 16 DA (GM)                                 | 09/84 → 08/91 | Man. GBX,<br>→ I Mot. 14 498630  |  | VKMA 05200   | 1 | 1 |   |   |  |   | T0016 |
|                                       |  |               |                                  |  | VKM 25200    | 1 |   |   |   |  |   |       |
|                                       | 16 DA (GM)                                 | 09/84 → 08/91 | Auto. GBX,<br>→ I Mot. 14 503756 |  | VKMA 05200   | 1 | 1 |   |   |  |   | T0016 |
|                                       |  |               |                                  |  | VKM 25200    | 1 |   |   |   |  |   |       |
|                                       | 16 DA (GM)                                 | 09/84 → 08/91 | Man. GBX,<br>→ I Mot. 14 498630  |  | VKPC 85406   |   |   |   | 1 |  |   |       |
|                                       | 16 DA (GM)                                 | 09/84 → 08/91 | Man. GBX,<br>Mot. 14 498631 I →  |  | VKPC 85408   |   |   |   | 1 |  |   |       |
|                                       | 16 DA (GM)                                 | 09/84 → 08/91 | Auto. GBX,<br>→ I Mot. 14 503756 |  | VKPC 85406   |   |   |   | 1 |  |   |       |
|                                       | 16 DA (GM)                                 | 09/84 → 08/91 | Auto. GBX,<br>Mot. 14 503757 I → |  | VKPC 85408   |   |   |   | 1 |  |   |       |
| <b>VAUXHALL  ASTRA Mk II 1.7 D</b>    |  |               |                                  |  |              |   |   |   |   |  |   |       |
|                                       | 17 D (GM)                                  | 01/89 → 12/91 | → I Mot. 14 363650               |  | VKMC 05201   | 1 | 1 |   | 1 |  |   |       |
|                                       |  |               |                                  |  | VKMA 05201   | 1 | 1 |   |   |  |   | T0045 |
|                                       |  |               |                                  |  | VKM 25201    | 1 |   |   |   |  |   |       |
|                                       | 17 D (GM)                                  | 01/89 → 12/91 | Mot. 14 363651 I →               |  | VKMA 05202   | 1 | 1 | 1 |   |  |   | T0654 |
|                                       |  |               |                                  |  | VKM 15202    | 1 |   |   |   |  |   |       |
|                                       |  |               |                                  |  | VKM 25202    |   | 1 |   |   |  |   |       |
|                                       | 17 D (GM)                                  | 01/89 → 12/91 | → I Mot. 14 363649               |  | VKPC 85408   |   |   |   | 1 |  |   |       |
|                                       | 17 D (GM)                                  | 01/89 → 12/91 | Mot. 14 363650 I →               |  | VKPC 85611   |   |   |   | 1 |  |   |       |
| <b>VAUXHALL  ASTRA Mk III 1.4</b>     |  |               |                                  |  |              |   |   |   |   |  |   |       |
|                                       | 14 NV, 14 SE, C 14 NZ,<br>C 14 SE, X 14 NZ | 01/91 → 03/01 |                                  |  | VKMC 05121   | 1 | 1 |   | 1 |  |   | 1     |
|                                       |  |               |                                  |  | VKMA 05121   | 1 | 1 |   |   |  |   | 1     |
|                                       |  |               |                                  |  | VKM 15121    | 1 |   |   |   |  |   | 1     |
|                                       | 14 NV, 14 SE, C 14 NZ,<br>C 14 SE, X 14 NZ | 01/91 → 03/01 |                                  |  | VKPC 85206   |   |   |   | 1 |  |   |       |
|                                       | B(Alt) 14 NV, C 14 NZ, C 14 SE             | 03/91 → 02/98 | AC, ⊗                            |  | VKMV 6PK1795 |   | 1 |   |   |  |   |       |
|                                       |  |               |                                  |  | VKM 35002    |   |   |   |   |  |   |       |
|                                       |  |               |                                  |  | VKM 35009    | 1 |   |   |   |  |   |       |
|                                       | B(Alt) 14 NV, 14 SE, C 14 NZ,<br>C 14 SE   | 03/91 → 03/01 | AC, ⊕                            |  | VKMA 35008   | 1 |   | 1 |   |  |   |       |
|                                       |  |               |                                  |  | VKMV 6PK1460 |   |   | 1 |   |  |   |       |
|                                       |  |               |                                  |  | VKM 35008    | 1 |   |   |   |  |   |       |
|                                       | B(Alt) C 14 SE                             | 03/91 → 03/01 | AC, ⊕                            |  | VKMA 35125   | 1 |   | 1 |   |  |   |       |
|                                       |  |               |                                  |  | VKMV 6PK1795 |   |   | 1 |   |  |   |       |
|                                       |  |               |                                  |  | VKM 35009    | 1 |   |   |   |  |   |       |
| <b>VAUXHALL  ASTRA Mk III 1.4 16V</b> |  |               |                                  |  |              |   |   |   |   |  |   |       |
|                                       | X 14 XE                                    | 01/96 → 03/01 | 3)                               |  | VKMS 05150   | 1 | 2 | 1 |   |  | 3 | 3     |
|                                       |  |               |                                  |  | VKMA 05150   | 1 | 2 | 1 |   |  |   | 3     |
|                                       |  |               |                                  |  | VKM 15216    | 1 |   |   |   |  |   | 1     |

|  |  |  |                            |  |  |  |  |  |  |  |  |
|--|---|---|---|--|---|---|---|---|---|---|---|
|  |   |   |   | VKM 25150  | 1   |   |   |   |   |   |   |
|  |   |   |   | VKM 25152  | 1   |   |   |   |   |   |   |
|   | X 14 XE   | 01/96 → 03/01   |   | VKPC 85212   |   |   | 1   |   |   |   |   |
|   | <b>B(Alt)</b> X 14 XE   | 01/96 → 03/01   | AC,                        | VKMA 35125<br>VKMV 6PK1795<br>VKM 35009  | 1<br>1<br>1   | 1<br>1  |   |   |   |   |   |
| <b>VAUXHALL  ASTRA Mk III 1.6</b>       |   |   |   |  |   |   |   |   |   |   |   |
|   | C 16 NZ, C 16 NZR,<br>C 16 SE, X 16 SZ,<br>X 16 SZR                               | 01/91 → 03/01   |                            | VKMC 05121<br>VKMA 05121<br>VKM 15121  | 1<br>1<br>1   | 1<br>1  | 1   |   |   | 1<br>1<br>1   | T0092   |
|   | 16 LZ2, 16 NZ2  | 01/91 → 08/98   |   | VKPC 85409   |   |   | 1   |   |   |   |   |
|   | C 16 NZ, C 16 SE,<br>X 16 SZ, X 16 SZR  | 03/91 → 03/01   |   | VKPC 85206   |   |   | 1   |   |   |   |   |
|   | <b>B(Alt)</b> C 16 NZ, C 16 SE,<br>X 16 SZ, X 16 SZR                              | 03/91 → 09/98   | AC,                        | VKMV 6PK1795<br>VKM 35002<br>VKM 35009   | 1   | 1   |   |   |   |   |   |
| <b>B(Alt)</b>  | C 16 NZ, C 16 SE,<br>X 16 SZ, X 16 SZR  | 03/91 → 03/01   | AC,                        | VKMA 35008<br>VKMV 6PK1460<br>VKM 35008  | 1<br>1  | 1<br>1  |   |   |   |   |   |
| <b>B(Alt)</b>  | C 16 NZ, C 16 SE,<br>X 16 SZ, X 16 SZR  | 03/91 → 03/01   | AC,                        | VKMA 35125<br>VKMV 6PK1795<br>VKM 35009  | 1<br>1  | 1<br>1  |   |   |   |   |   |
| <b>VAUXHALL  ASTRA Mk III 1.6 16V</b> |   |   |   |  |   |   |   |   |   |   |   |
|                                       | X 16 XEL  | 01/94 → 09/98   | 3)  | VKMS 05150<br>VKMA 05150<br>VKM 15216<br>VKM 25150<br>VKM 25152                    | 1<br>1<br>1<br>1<br>1   | 2<br>2  | 1<br>1  |   |   | 3<br>3<br>1   | T0107   |
|                                       | X 16 XEL  | 01/94 → 09/98   |   | VKPC 85212   |   |   | 1   |   |   |   |   |
|                                       | <b>B(Alt)</b> X 16 XEL  | 01/94 → 09/98   | AC,                      | VKMA 35125<br>VKMV 6PK1795<br>VKM 35009  | 1<br>1  | 1<br>1  |   |   |   |   |   |
| <b>VAUXHALL  ASTRA Mk III 1.8</b>     |   |   |   |  |   |   |   |   |   |   |   |
|                                       | C 18 NZ   | 09/91 → 09/98   |  → <b>Mot.</b> 14 254438 | VKMC 05401   |   |   | 1   | 1   |   |   | T0225   |
|  | C 18 NZ   | 09/91 → 09/98   | <b>Mot.</b> 14 254439   →   | VKMA 05402<br>VKM 15402  | 1<br>1  | 1   |   |   |   |   | T0105   |
|                                       | C 18 NZ   | 09/91 → 09/98   | → <b>Mot.</b> 14 254438   | VKPC 85407   |   |   | 1   |   |   |   |   |
|                                       | C 18 NZ   | 09/91 → 09/98   | <b>Mot.</b> 14 254439   →   | VKPC 85409   |   |   | 1   |   |   |   |   |
|                                       | <b>B(Alt)</b> C 18 NZ   | 09/91 → 09/98   | AC  | VKMA 35009<br>VKMV 6PK1725<br>VKM 35009  | 1<br>1  | 1<br>1  |   |   |   |   |   |
| <b>B(Alt)</b>  | C 18 NZ   | 09/91 → 09/98   | AC  | VKMA 35109<br>VKMV 6PK1900<br>VKM 35009  | 1<br>1  | 1<br>1  |   |   |   |   |   |
| <b>VAUXHALL  ASTRA Mk III 1.8 16V</b> |   |   |   |  |   |   |   |   |   |   |   |
|                                       | C 18 XE, C 18 XEL,<br>X 18 XE   | 06/93 → 03/01   | 3)  | VKMS 05222<br>VKMA 05222<br>VKM 15202<br>VKM 25212<br>VKM 25212                    | 1<br>1<br>1<br>1<br>1   | 2<br>2  | 1<br>1  |   |   | 3   | T0116   |
|                                       | C 18 XE, C 18 XEL,<br>X 18 XE   | 06/93 → 03/01   |   | VKPC 85611   |   |   | 1   |   |   |   |   |
|                                       | <b>B(Alt)</b> C 18 XE, C 18 XEL,<br>X 18 XE                                       | 06/93 → 03/01   | AC  | VKMA 35009<br>VKMV 6PK1725<br>VKM 35009  | 1<br>1  | 1<br>1  |   |   |   |   |   |
| <b>B(Alt)</b>  | C 18 XE, C 18 XEL,<br>X 18 XE   | 06/93 → 03/01   | AC  | VKMA 35109<br>VKMV 6PK1900<br>VKM 35009  | 1<br>1  | 1<br>1  |   |   |   |   |   |



VAUXHALL

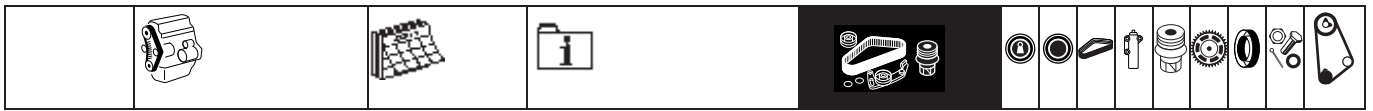

























| VAUXHALL  ASTRA Mk III 2.0 |                       |               |                    |              |   |  |  |   |   |   |       |
|----------------------------|-----------------------|---------------|--------------------|--------------|---|--|--|---|---|---|-------|
|                            | C 20 NE               | 09/91 → 09/98 | →   Mot. 14 608700 | VKMC 05401   |   |  |  |   | 1 | 1 | T0225 |
|                            | C 20 NE               | 09/91 → 09/98 | Mot. 14 608701   → | VKMA 05402   | 1 |  |  | 1 |   |   | T0105 |
|                            |                       |               |                    | VKM 15402    | 1 |  |  |   |   |   |       |
|                            | C 20 NE               | 09/91 → 02/98 | →   Mot. 14 608700 | VKPC 85407   |   |  |  |   | 1 |   |       |
|                            | C 20 NE               | 09/91 → 02/98 | Mot. 14 608701   → | VKPC 85409   |   |  |  |   | 1 |   |       |
|                            | <b>B(Alt)</b> C 20 NE | 09/91 → 09/98 | <b>AC</b>          | VKMA 35009   | 1 |  |  | 1 |   |   |       |
|                            |                       |               |                    | VKMV 6PK1725 |   |  |  | 1 |   |   |       |
|                            |                       |               |                    | VKM 35009    | 1 |  |  |   |   |   |       |
|                            | <b>B(Alt)</b> C 20 NE | 09/91 → 09/98 | <b>AC</b>          | VKMA 35109   | 1 |  |  | 1 |   |   |       |
|                            |                       |               |                    | VKMV 6PK1900 |   |  |  | 1 |   |   |       |
|                            |                       |               |                    | VKM 35009    | 1 |  |  |   |   |   |       |

| VAUXHALL  ASTRA Mk III 2.0 16V |                                 |               |                    |              |   |   |   |   |   |   |       |
|--------------------------------|---------------------------------|---------------|--------------------|--------------|---|---|---|---|---|---|-------|
|                                | X 20 XEV                        | 01/94 → 09/98 | 3)                 | VKMS 05222   | 1 | 2 | 1 |   |   | 3 |       |
|                                |                                 |               |                    | VKMA 05222   | 1 | 2 | 1 |   |   |   | T0116 |
|                                |                                 |               |                    | VKM 15202    | 1 |   |   |   |   |   |       |
|                                |                                 |               |                    | VKM 25212    |   | 1 |   |   |   |   |       |
|                                |                                 |               |                    | VKM 25212    |   | 1 |   |   |   |   |       |
|                                | C 20 XE                         | 09/91 → 09/98 | →   Mot. 14 142838 | VKMA 05211   | 1 | 1 | 1 |   |   |   | T0063 |
|                                |                                 |               |                    | VKM 15211    | 1 |   |   |   |   |   |       |
|                                |                                 |               |                    | VKM 25211    |   | 1 |   |   |   |   |       |
|                                | C 20 XE                         | 09/91 → 09/98 | Mot. 14 142839   → | VKMA 05220   | 1 | 2 | 1 |   |   |   | T0106 |
|                                |                                 |               |                    | VKM 15202    | 1 |   |   |   |   |   |       |
|                                |                                 |               |                    | VKM 25212    |   | 1 |   |   |   |   |       |
|                                |                                 |               |                    | VKM 25213    |   | 1 |   |   |   |   |       |
|                                | C 20 XE                         | 09/91 → 02/98 | →   Mot. 14 142839 | VKPC 85610   |   |   |   |   | 1 |   |       |
|                                | C 20 XE                         | 09/91 → 02/98 | Mot. 14 142840   → | VKPC 85611   |   |   |   |   | 1 |   |       |
|                                | X 20 XEV                        | 01/94 → 02/98 |                    | VKPC 85611   |   |   |   |   | 1 |   |       |
|                                | <b>B(Alt)</b> C 20 XE, X 20 XEV | 09/91 → 09/98 | <b>AC</b>          | VKMA 35009   | 1 |   |   | 1 |   |   |       |
|                                |                                 |               |                    | VKMV 6PK1725 |   |   |   | 1 |   |   |       |
|                                |                                 |               |                    | VKM 35009    | 1 |   |   |   |   |   |       |
|                                | <b>B(Alt)</b> C 20 XE, X 20 XEV | 01/94 → 09/98 | <b>AC</b>          | VKMA 35109   | 1 |   |   | 1 |   |   |       |
|                                |                                 |               |                    | VKMV 6PK1900 |   |   |   | 1 |   |   |       |
|                                |                                 |               |                    | VKM 35009    | 1 |   |   |   |   |   |       |

| VAUXHALL  ASTRA Mk III 1.7 D |                                     |               |                    |               |   |   |   |   |   |  |       |
|------------------------------|-------------------------------------|---------------|--------------------|---------------|---|---|---|---|---|--|-------|
|                              | 17 D (GM)                           | 12/91 → 02/98 | →   Mot. 14 363651 | VKMC 05201    |   | 1 | 1 |   | 1 |  |       |
|                              |                                     |               |                    | VKMA 05201    |   | 1 | 1 |   |   |  | T0045 |
|                              |                                     |               |                    | VKM 25201     |   | 1 |   |   |   |  |       |
|                              | 17 D (GM)                           | 12/91 → 02/98 | Mot. 14 363652   → | VKMA 05201    |   | 1 | 1 |   |   |  | T0045 |
|                              |                                     |               |                    | VKM 25201     |   | 1 |   |   |   |  |       |
|                              | 17 DR (GM)                          | 01/91 → 09/98 |                    | VKMA 05202    | 1 | 1 | 1 |   |   |  | T0654 |
|                              |                                     |               |                    | VKM 15202     | 1 |   |   |   |   |  |       |
|                              |                                     |               |                    | VKM 25202     |   | 1 |   |   |   |  |       |
|                              | 17 D (GM), 17 DR (GM)               | 01/91 → 09/98 | →   Mot. 14 363651 | VKPC 85408    |   |   |   |   | 1 |  |       |
|                              | 17 D (GM), 17 DR (GM)               | 01/91 → 09/98 | Mot. 14 363652   → | VKPC 85611    |   |   |   |   | 1 |  |       |
|                              | <b>B(Alt)</b> 17 D (GM), 17 DR (GM) | 03/91 → 09/98 |                    | VKMV 10AVx925 |   |   |   | 1 |   |  |       |

| VAUXHALL  ASTRA Mk III 1.7 TD |                             |               |                           |               |   |   |   |   |   |  |         |
|-------------------------------|-----------------------------|---------------|---------------------------|---------------|---|---|---|---|---|--|---------|
|                               | 17 TD (ISUZU)               | 12/91 → 12/94 |                           | VKMA 05213    | 1 | 1 | 1 |   |   |  | 1 T0062 |
|                               |                             |               |                           | VKM 15213     | 1 |   |   |   |   |  |         |
|                               |                             |               |                           | VKM 25208     |   | 1 |   |   |   |  | 1       |
|                               | 17 TD (ISUZU)               | 01/95 → 09/98 |                           | VKMA 05214    | 1 | 1 | 1 |   |   |  | 1 T0062 |
|                               |                             |               |                           | VKM 15215     | 1 |   |   |   |   |  |         |
|                               |                             |               |                           | VKM 25208     |   | 1 |   |   |   |  | 1       |
|                               | X 17 DTL (GM)               | 01/94 → 09/98 |                           | VKMA 05202    | 1 | 1 | 1 |   |   |  | T0654   |
|                               |                             |               |                           | VKM 15202     | 1 |   |   |   |   |  |         |
|                               |                             |               |                           | VKM 25202     |   | 1 |   |   |   |  |         |
|                               | 17 TD (ISUZU)               | 12/91 → 09/98 | →   CH V2087237, V8141367 | VKPC 85404    |   |   |   |   | 1 |  |         |
|                               | 17 TD (ISUZU)               | 12/91 → 09/98 | CH V2087238, V8141368   → | VKPC 85620    |   |   |   |   | 1 |  |         |
|                               | X 17 DTL (GM)               | 01/94 → 09/98 |                           | VKPC 85611    |   |   |   |   | 1 |  |         |
|                               | <b>B(Alt)</b> 17 TD (ISUZU) | 12/91 → 09/98 |                           | VKMV 13AVx915 |   |   |   | 1 |   |  |         |
|                               | <b>B(Alt)</b> X 17 DTL (GM) | 01/94 → 09/98 |                           | VKMV 10AVx925 |   |   |   | 1 |   |  |         |





















| VAUXHALL  ASTRA Mk IV 1.2 16V |                  |               |  |  |  |  |  |  |  |  |  |
|-------------------------------|------------------|---------------|--|--|--|--|--|--|--|--|--|
|                               | X 12 XE, Z 12 XE | 02/98 → 10/07 |  |  |  |  |  |  |  |  |  |

|  |  |  |    |  |  |  |  |  |  |  |  |
|--|---|---|---|--|---|---|---|---|---|---|---|
|   | X 12 XE, Z 12 XE  | 02/98 → 10/07   |   | VKPC 85220   |   |   |   | 1   |   |   |   |
|   | <b>B(Alt)</b> X 12 XE, Z 12 XE  | 02/98 → 10/07   | <b>AC</b>   | VKMA 35113<br>VKMV 5PK1230<br>VKM 35013  | 1   | 1   |   |   |   |   |   |
|  | <b>B(Alt)</b> X 12 XE, Z 12 XE  | 02/98 → 10/07   | <b>AC</b>   | VKMA 35013<br>VKMV 5PK1355<br>VKM 35013  | 1   | 1   |   |   |   |   |   |
| <b>VAUXHALL</b>  <b>ASTRA Mk IV 1.4 16V</b>   |   |   |   |  |   |   |   |   |   |   |   |
|   | X 14 XE, Z 14 XE  | 02/98 → 12/04   | 3), → <b>I</b> Mot. 02 HL5117,<br>20 041690   | VKMS 05152-1<br>VKMA 05152<br>VKM 15216<br>VKM 25150<br>VKM 25152                  | 1<br>1<br>1   | 2<br>2<br>1   | 1   |   |   | 3<br>3<br>1   | T0157   |
|  | X 14 XE, Z 14 XE  | 02/98 → 12/04   | 3), <b>Mot.</b> 02 HL5118,<br>20 041691  →,<br>→ <b>I</b> Mot. 20 EB2048  | VKMS 05154-1<br>VKMA 05154<br>VKM 15216<br>VKM 25152<br>VKM 25312                  | 1<br>1<br>1   | 2<br>2<br>1   | 1   |   |   | 3<br>2<br>1   | T0157   |
|  | X 14 XE, Z 14 XE  | 01/05 → 10/07   | <b>Mot.</b> 20 EB2049  →  | VKMA 05156<br>VKM 15216<br>VKM____<br>VKM 25158                                    | 1<br>1  | 2<br>1  | 1   |   |   | 1<br>1  | T0157   |
|   | X 14 XE, Z 14 XE  | 02/98 → 10/07   | → <b>I</b> Mot. 02 MV7224,<br>20 U75998   | VKPC 85212   |   |   |   | 1   |   |   |   |
|  | X 14 XE, Z 14 XE  | 02/98 → 10/07   | <b>Mot.</b> 02 MV7225,<br>20 U75999  →  | VKPC 85211   |   |   |   | 1   |   |   |   |
|   | <b>B(Alt)</b> X 14 XE, Z 14 XE  | 02/98 → 10/07   | <b>AC</b>   | VKMA 35012<br>VKMV 5PK938<br>VKM 35012   | 1   | 1   |   |   |   |   |   |
|  | <b>B(Alt)</b> X 14 XE, Z 14 XE  | 02/98 → 10/07   | <b>AC</b>   | VKMA 35022<br>VKMV 5PK1212<br>VKM 35012  | 1   | 1   |   |   |   |   |   |
| <b>VAUXHALL</b>  <b>ASTRA Mk IV 1.6</b>     |   |   |   |  |   |   |   |   |   |   |   |
|   | X 16 SZR  | 02/98 → 09/00   |  → <b>I</b> Mot. 02 MZ5253               | VKMC 05121<br>VKMA 05121<br>VKM 15121  | 1<br>1<br>1   | 1<br>1  | 1   |   |   | 1<br>1<br>1   | T0092   |
|  | Z 16 SE   | 09/00 → 10/07   |  → <b>I</b> Mot. 02 MZ5253,<br>20 U75998 | VKMC 05121<br>VKMA 05121<br>VKM 15121  | 1<br>1<br>1   | 1<br>1  | 1   |   |   | 1<br>1<br>1   | T0092   |
|  | X 16 SZR, Z 16 SE   | 02/98 → 10/07   | 3)  | VKMS 05121<br>VKMA 05121<br>VKM 15121  | 1<br>1<br>1   | 1<br>1  |   |   |   | 2<br>1<br>1   | T0092   |
|   | X 16 SZR  | 02/98 → 09/00   | → <b>I</b> Mot. 02 MZ5253   | VKPC 85206   |   |   |   | 1   |   |   |   |
|  | X 16 SZR  | 02/98 → 09/00   | <b>Mot.</b> 02 MZ5254  →  | VKPC 85460   |   |   |   | 1   |   |   |   |
|  | Z 16 SE   | 09/00 → 10/07   | → <b>I</b> Mot. 02 MZ5253,<br>20 U75998   | VKPC 85206   |   |   |   | 1   |   |   |   |
|  | Z 16 SE   | 09/00 → 10/07   | <b>Mot.</b> 02 MZ5254,<br>20 U75999  →  | VKPC 85460   |   |   |   | 1   |   |   |   |
|   | <b>B(Alt)</b> X 16 SZR, Z 16 SE   | 02/98 → 10/07   | <b>AC</b>   | VKMA 35012<br>VKMV 5PK938<br>VKM 35012   | 1   | 1   |   |   |   |   |   |
|  | <b>B(Alt)</b> X 16 SZR, Z 16 SE   | 02/98 → 10/07   | <b>AC</b>   | VKMA 35022<br>VKMV 5PK1212<br>VKM 35012  | 1   | 1   |   |   |   |   |   |
| <b>VAUXHALL</b>  <b>ASTRA Mk IV 1.6 16V</b> |   |   |   |  |   |   |   |   |   |   |   |
|   | X 16 XEL, Z 16 XE   | 02/98 → 12/04   | 3), → <b>I</b> Mot. 02 HL5117,<br>20 041690   | VKMS 05152-1<br>VKMA 05152<br>VKM 15216<br>VKM 25150<br>VKM 25152                  | 1<br>1<br>1   | 2<br>2<br>1   | 1   |   |   | 3<br>3<br>1   | T0157   |



































VAUXHALL



|   |  |  |  |  |  |  |  |  |  |  |  |  |       |
|---|---|---|---|--|---|---|---|---|---|---|---|---|-------|
|   | X 16 XEL, Z 16 XE   | 02/98 → 12/04   | 3), <b>Mot.</b> 02 HL5118,<br>20 041691 I→,<br>→I <b>Mot.</b> 20 EB2048           | VKMS 05154-1<br>VKMA 05154<br>VKM 15216<br>VKM 25152<br>VKM 25312                  | 1<br>1<br>1   | 2<br>2<br>1   | 1<br>1  |   |   |   | 3<br>3  | 3<br>2<br>1   | T0157 |
|   | X 16 XEL, Z 16 XE   | 01/05 → 10/07   | <b>Mot.</b> 20 EB2049 I→  | VKMA 05156<br>VKM 15216<br>VKM____<br>VKM 25158                                    | 1<br>1  | 2<br>1<br>1   | 1   |   |   |   |   | 1<br>1  | T0157 |
|   | X 16 XEL, Z 16 XE   | 02/98 → 10/07   | →I <b>Mot.</b> 02 MV7224,<br>20 U75998  | VKPC 85212   |   |   |   |   | 1   |   |   |   |       |
|   | X 16 XEL, Z 16 XE   | 02/98 → 10/07   | <b>Mot.</b> 02 MV7225,<br>20 U75999 I→  | VKPC 85211   |   |   |   |   | 1   |   |   |   |       |
|   | <b>B(Alt)</b> X 16 XEL, Z 16 XE   | 02/98 → 10/07   | <b>AC</b>   | VKMA 35012<br>VKMV 5PK938<br>VKM 35012   | 1<br>1  |   | 1<br>1  |   |   |   |   |   |       |
|   | <b>B(Alt)</b> X 16 XEL, Z 16 XE   | 02/98 → 10/07   | <b>AC</b>   | VKMA 35022<br>VKMV 5PK1212<br>VKM 35012  | 1<br>1  |   | 1<br>1  |   |   |   |   |   |       |
| <b>VAUXHALL</b>  <b>ASTRA Mk IV 1.6 16V Dualfuel</b> |   |   |   |  |   |   |   |   |   |   |   |   |       |
|   | Z 16 YNG  | 09/02 → 12/04   | 3), →I <b>Mot.</b> 20 EB2048  | VKMS 05154-1<br>VKMA 05154<br>VKM 15216<br>VKM 25152<br>VKM 25312                  | 1<br>1<br>1   | 2<br>2<br>1   | 1<br>1  |   |   |   | 3<br>3  | 3<br>2<br>1   | T0157 |
|   | Z 16 YNG  | 01/05 → 10/07   | <b>Mot.</b> 20 EB2049 I→  | VKMA 05156<br>VKM 15216<br>VKM____<br>VKM 25158                                    | 1<br>1  | 2<br>1<br>1   | 1   |   |   |   |   | 1<br>1  | T0157 |
|   | Z 16 YNG  | 09/02 → 10/07   |   | VKPC 85211   |   |   |   |   | 1   |   |   |   |       |
|   | <b>B(Alt)</b> Z 16 YNG  | 09/02 → 10/07   | <b>AC</b>   | VKMA 35012<br>VKMV 5PK938<br>VKM 35012   | 1<br>1  |   | 1<br>1  |   |   |   |   |   |       |
|   | <b>B(Alt)</b> Z 16 YNG  | 09/02 → 10/07   | <b>AC</b>   | VKMA 35022<br>VKMV 5PK1212<br>VKM 35012  | 1<br>1  |   | 1<br>1  |   |   |   |   |   |       |
| <b>VAUXHALL</b>  <b>ASTRA Mk IV 1.8 16V</b>        |   |   |   |  |   |   |   |   |   |   |   |   |       |
|   | X 18 XE1, Z 18 XE   | 02/98 → 12/02   | 3), →I <b>Mot.</b> 02 HL5117,<br>20 041690  | VKMS 05152-2<br>VKMA 05152<br>VKM 15216<br>VKM 25150<br>VKM 25152                  | 1<br>1<br>1   | 2<br>2<br>1   | 1<br>1  |   |   |   | 3<br>3  | 3<br>3<br>1   | T0157 |
|   | X 18 XE1  | 02/98 → 10/00   | 3), <b>Mot.</b> 02 HL5118,<br>20 041691 I→  | VKMS 05154-2<br>VKMA 05154<br>VKM 15216<br>VKM 25152<br>VKM 25312                  | 1<br>1<br>1   | 2<br>2<br>1   | 1<br>1  |   |   |   | 3<br>3  | 3<br>2<br>1   | T0157 |
|   | Z 18 XE   | 09/00 → 12/02   | 3), <b>Mot.</b> 02 HL5118,<br>20 041691 I→,<br>→I <b>Mot.</b> 20 EB2048           | VKMS 05154-2<br>VKMA 05154<br>VKM 15216<br>VKM 25152<br>VKM 25312                  | 1<br>1<br>1   | 2<br>2<br>1   | 1<br>1  |   |   |   | 3<br>3  | 3<br>2<br>1   | T0157 |
|   | Z 18 XE   | 01/03 → 12/04   | 3), →I <b>Mot.</b> 02 HL5117,<br>20 041690  | VKMS 05152-3<br>VKMA 05152<br>VKM 15216<br>VKM 25150<br>VKM 25152                  | 1<br>1<br>1   | 2<br>2<br>1   | 1<br>1  |   |   |   | 3<br>3  | 3<br>3<br>1   | T0157 |



|  |  |  |  |  |  |  |  |  |  |  |  |       |
|--|---|---|---|--|---|---|---|---|---|---|---|-------|
|  | Z 18 XE   | 01/03 → 12/04   | 3), Mot. 02 HL5118,<br>20 041691 I→,<br>→IMot. 20 EB2048                          | VKMS 05154-3<br>VKMA 05154<br>VKM 15216<br>VKM 25152<br>VKM 25312                  | 1<br>1<br>1   | 2<br>2<br>1   | 1<br>1<br>1   |   |   | 3<br>3<br>1   | T0157   |       |
|  | Z 18 XE   | 01/05 → 10/07   | Mot. 20 EB2049 I→   | VKMA 05156<br>VKM 15216<br>VKM____<br>VKM 25158                                    | 1<br>1  | 2<br>1<br>1   | 1<br>1<br>1   |   |   |   | 1<br>1  | T0157 |
|   | X 18 XE1, Z 18 XE   | 02/98 → 10/07   |   | VKPC 85624   |   |   |   | 1   |   |   |   |       |
|   | B(Alt) X 18 XE1, Z 18 XE  | 02/98 → 10/07   | AC  | VKMA 35012<br>VKMV 5PK938<br>VKM 35012   | 1   |   | 1<br>1  |   |   |   |   |       |
|  | B(Alt) X 18 XE1, Z 18 XE  | 02/98 → 10/07   | AC  | VKMA 35022<br>VKMV 5PK1212<br>VKM 35012  | 1<br>1  |   | 1<br>1  |   |   |   |   |       |
| <b>VAUXHALL  ASTRA Mk IV 1.8 16V Dualfuel</b> |   |   |   |  |   |   |   |   |   |   |   |       |
|   | Z 18 XEL  | 09/02 → 10/07   | Mot. 20 EB2049 I→   | VKMA 05156<br>VKM 15216<br>VKM____<br>VKM 25158                                    | 1<br>1  | 2<br>1<br>1   | 1<br>1<br>1   |   |   |   | 1<br>1  | T0157 |
|   | Z 18 XEL  | 09/02 → 10/07   |   | VKPC 85624   |   |   |   | 1   |   |   |   |       |
|   | B(Alt) Z 18 XEL   | 09/02 → 10/07   | AC  | VKMA 35012<br>VKMV 5PK938<br>VKM 35012   | 1   |   | 1<br>1  |   |   |   |   |       |
|  | B(Alt) Z 18 XEL   | 09/02 → 10/07   | AC  | VKMA 35022<br>VKMV 5PK1212<br>VKM 35012  | 1<br>1  |   | 1<br>1  |   |   |   |   |       |
| <b>VAUXHALL  ASTRA Mk IV 2.0 16V</b>        |   |   |   |  |   |   |   |   |   |   |   |       |
|   | X 20 XEV  | 02/98 → 10/07   |   | VKMA 05224<br>VKM 15202<br>VKM 25224<br>VKM 25224                                  | 1<br>1  | 2<br>1<br>1   | 1<br>1<br>1   |   |   |   |   | T0172 |
|   | X 20 XEV  | 02/98 → 10/07   |   | VKPC 85611   |   |   |   | 1   |   |   |   |       |
|   | B(Alt) X 20 XEV   | 02/98 → 10/07   | AC  | VKMA 35119<br>VKMV 5PK1680<br>VKM 35009  | 1<br>1  |   | 1<br>1  |   |   |   |   |       |
|  | B(Alt) X 20 XEV   | 09/98 → 10/07   | AC  | VKMV 5PK938  |   |   | 1   |   |   |   |   |       |
| <b>VAUXHALL  ASTRA Mk IV 2.0 16V Turbo</b>  |   |   |   |  |   |   |   |   |   |   |   |       |
|   | Z 20 LET  | 09/00 → 10/07   |   | VKMA 05140<br>VKM 15140<br>VKM 25224<br>VKM 25224                                  | 1<br>1  | 2<br>1<br>1   | 1<br>1<br>1   |   |   |   |   | T0172 |
|   | Z 20 LET  | 09/00 → 10/07   |   | VKPC 85611   |   |   |   | 1   |   |   |   |       |
|   | B(Alt) Z 20 LET   | 09/00 → 10/07   |   | VKMA 35119<br>VKMV 5PK1680<br>VKM 35009  | 1<br>1  |   | 1<br>1  |   |   |   |   |       |
| <b>VAUXHALL  ASTRA Mk IV 2.2 16V</b>        |   |   |   |  |   |   |   |   |   |   |   |       |
|   | Z 22 SE   | 03/00 → 10/07   |   | <del>XXXXXX</del><br>VKPC 85308  |   |   |   | 1   |   |   |   |       |
|   | Z 22 SE   | 03/00 → 10/07   |   |  |   |   |   |   |   |   |   |       |
|   | B(Alt) Z 22 SE  | 03/00 → 10/07   | AC  | VKMV 5PK880<br>VKM 34027   | 1   |   | 1   |   |   |   |   |       |
|  | B(Alt) Z 22 SE  | 03/00 → 10/07   | AC  | VKMA 34027<br>VKMV 5PK1028<br>VKM 34027  | 1<br>1  |   | 1<br>1  |   |   |   |   |       |
| <b>VAUXHALL  ASTRA Mk IV 1.7 TD</b>         |   |   |   |  |   |   |   |   |   |   |   |       |
|   | X 17 DTL (GM)   | 02/98 → 10/07   |   | VKMA 05202<br>VKM 15202<br>VKM 25202   | 1<br>1  | 1<br>1  | 1<br>1  |   |   |   |   | T0654 |
|   | X 17 DTL (GM)   | 02/98 → 10/07   |   | VKPC 85611   |   |   |   | 1   |   |   |   |       |
|   | B(AC) X 17 DTL (GM)   | 02/98 → 10/07   |   | VKMV 4PK882  |   |   | 1   |   |   |   |   |       |



VAUXHALL

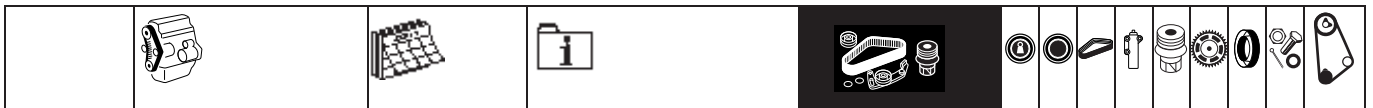





































| VAUXHALL  ASTRA Mk IV 1.7 DTI |                               |               |                |  |        |   |        |  |   |   |       |
|-------------------------------|-------------------------------|---------------|----------------|--|--------|---|--------|--|---|---|-------|
|                               | Y 17 DT (ISUZU)               | 02/00 → 10/07 | →IMot. 328704  | VKMA 05606<br>VKM 15215<br>VKM 25208                 | 1<br>1 | 1 | 1      |  |   | 1 | T0182 |
|                               | Y 17 DT (ISUZU)               | 02/00 → 10/07 | Mot. 328705 I→ | VKMA 05608<br>VKM 15218<br>VKM 25208                 | 1<br>1 | 1 | 1      |  |   | 3 | T0182 |
|                               | Y 17 DT (ISUZU)               | 02/00 → 10/07 | →IMot. 073532  | VKPC 85620   |        |   |        |  | 1 |   |       |
|                               | Y 17 DT (ISUZU)               | 02/00 → 10/07 | Mot. 073533 I→ | VKPC 85300   |        |   |        |  | 1 |   |       |
|                               | <b>B(Alt)</b> Y 17 DT (ISUZU) | 02/00 → 10/07 | <b>AC</b>      | VKMA 35215<br>VKMV 6PK1250<br>VKM 35015              | 1<br>1 |   | 1<br>1 |  |   |   |       |
|                               | <b>B(Alt)</b> Y 17 DT (ISUZU) | 02/00 → 10/07 | <b>AC</b>      | VKMA 35315<br>VKMV 6PK1590<br>VKM 35015<br>VKM 35025 | 1<br>1 | 1 | 1<br>1 |  |   |   |       |

| VAUXHALL  ASTRA Mk IV 1.7 CDTI |                                |               |           |   |        |   |        |  |   |  |   |       |
|--------------------------------|--------------------------------|---------------|-----------|---|--------|---|--------|--|---|--|---|-------|
|                                | Z 17 DTL (ISUZU)               | 04/03 → 10/07 |           | VKMA 05700<br>VKM 15218<br>VKM 25209    | 1<br>1 | 1 | 1      |  |   |  | 3 | T0201 |
|                                | Z 17 DTL (ISUZU)               | 04/03 → 10/07 |           | VKPC 85300                              |        |   |        |  | 1 |  |   |       |
|                                | <b>B(Alt)</b> Z 17 DTL (ISUZU) | 04/03 → 10/07 | <b>AC</b> | VKMA 35015<br>VKMV 6PK1275<br>VKM 35015 | 1<br>1 |   | 1<br>1 |  |   |  |   |       |
|                                | <b>B(Alt)</b> Z 17 DTL (ISUZU) | 04/03 → 10/07 | <b>AC</b> | VKMV 6PK1605<br>VKM 35015<br>VKM 35025  | 1<br>1 |   | 1      |  |   |  |   |       |



































| VAUXHALL  ASTRA Mk IV 2.0 DI |                                  |               |   |  |        |   |        |  |   |   |  |  |
|------------------------------|----------------------------------|---------------|---|--|--------|---|--------|--|---|---|--|--|
|                              | X 20 DTL, Y 20 DTL               | 02/98 → 10/07 |   | <b>OXOXOXO</b>                                       |        |   |        |  |   |   |  |  |
|                              | X 20 DTL, Y 20 DTL               | 02/98 → 10/07 |   | VKPC 85623   |        |   |        |  | 1 |   |  |  |
|                              | <b>B(Alt)</b> X 20 DTL, Y 20 DTL | 02/98 → 10/07 | <b>AC</b>   | VKMA 35006<br>VKMV 6PK1805<br>VKM 35007<br>VKM 35016 | 1<br>1 | 1 | 1<br>1 |  |   |   |  |  |
|                              | <b>B(Alt)</b> X 20 DTL, Y 20 DTL | 02/98 → 10/07 | <b>AC</b>   | VKMA 35030<br>VKMV 6PK1873<br>VKM 35007<br>VKM 35016 | 1<br>1 | 1 | 1<br>1 |  |   |   |  |  |
|                              | X 20 DTL, Y 20 DTL               | 02/98 → 01/07 | <b>AC. Man. GBX,</b><br>→ICH 22999999,<br>25999999, 26999999,<br>28999999, 2H999999 | VKM_____   |        |   |        |  |   | 1 |  |  |
|                              | X 20 DTL, Y 20 DTL               | 02/98 → 01/07 | <b>Auto. GBX,</b><br>→ICH 22999999,<br>25999999, 26999999,<br>28999999, 2H999999    | VKM_____   |        |   |        |  |   | 1 |  |  |
|                              | Y 20 DTL                         | 02/98 → 01/07 | <b>CH</b> 32000001, 35000001,<br>36000001, 38000001,<br>3H000001 I→                 | VKM_____   |        |   |        |  |   | 1 |  |  |

| VAUXHALL  ASTRA Mk IV 2.0 DTI |                        |               |  |  |        |   |        |  |   |   |  |  |
|-------------------------------|------------------------|---------------|--|--|--------|---|--------|--|---|---|--|--|
|                               | Y 20 DTH               | 08/99 → 10/07 |  | <b>OXOXOXO</b>                                       |        |   |        |  |   |   |  |  |
|                               | Y 20 DTH               | 08/99 → 10/07 |  | VKPC 85623   |        |   |        |  | 1 |   |  |  |
|                               | <b>B(Alt)</b> Y 20 DTH | 08/99 → 10/07 | <b>AC</b>  | VKMA 35006<br>VKMV 6PK1805<br>VKM 35007<br>VKM 35016 | 1<br>1 | 1 | 1<br>1 |  |   |   |  |  |
|                               | <b>B(Alt)</b> Y 20 DTH | 08/99 → 10/07 | <b>AC</b>  | VKMA 35030<br>VKMV 6PK1873<br>VKM 35007<br>VKM 35016 | 1<br>1 | 1 | 1<br>1 |  |   |   |  |  |
|                               | Y 20 DTH               | 08/99 → 01/07 | <b>AC. →ICH</b> 22999999,<br>25999999, 26999999,<br>28999999, 2H999999 | VKM_____   |        |   |        |  |   | 1 |  |  |



























































|  |  |  |  |    |  |  |  |  |  |  |  |  |
|--|---|---|---|--|---|---|---|---|---|---|---|---|
|  | Y 20 DTH  | 08/99 → 01/07   | CH 32000001, 35000001,<br>36000001, 38000001,<br>3H000001  →                      | VKM _____  |   |   |   |   |   | 1   |   |   |
| <b>VAUXHALL  ASTRA Mk V 1.4 16V</b>         |   |   |   |  |   |   |   |   |   |   |   |   |
|   | Z 14 XEL, Z 14 XEP  | 03/04 → 10/07   |   |    |   |   |   |   |   |   |   |   |
|   | Z 14 XEL, Z 14 XEP  | 03/04 → 10/07   |   | VKPC 85310   |   |   |   | 1   |   |   |   |   |
|   | <b>B(Alt)</b> Z 14 XEL, Z 14 XEP  | 03/04 → 10/07   | <b>AC</b>   | VKMA 35113<br>VKMV 5PK1230<br>VKM 35013  | 1   |   | 1   |   |   |   |   |   |
|  | <b>B(Alt)</b> Z 14 XEL, Z 14 XEP  | 03/04 → 10/07   | <b>AC</b>   | VKMA 35013<br>VKMV 5PK1355<br>VKM 35013  | 1   |   | 1   |   |   |   |   |   |
| <b>VAUXHALL  ASTRA Mk V 1.6 16V</b>         |   |   |   |  |   |   |   |   |   |   |   |   |
|   | Z 16 XEP  | 03/04 → 10/07   |   | VKMA _____<br>VKM 15260<br>VKM _____   | 1<br>1  | 1   | 1   |   |   |   | 2   | T0244   |
|   | Z 16 XEP  | 03/04 → 10/07   |   | VKPC _____   |   |   |   | 1   |   |   |   |   |
|   | <b>B(Alt)</b> Z 16 XEP  | 03/04 → 06/07   | <b>AC</b>   | VKMV 5PK1450<br>VKM 35260  | 1   |   | 1   |   |   |   |   |   |
|  | <b>B(Alt)</b> Z 16 XEP  | 03/04 → 06/07   | <b>AC</b>   | VKMV 5PK1546<br>VKM 35260  | 1   |   | 1   |   |   |   |   |   |
| <b>VAUXHALL  ASTRA Mk V 1.8 16V</b>         |   |   |   |  |   |   |   |   |   |   |   |   |
|   | Z 18 XE   | 03/04 → 10/07   | 3), → <b>Mot.</b> 20 EB2048   | VKMS 05154-3<br>VKMA 05154<br>VKM 15216<br>VKM 25152<br>VKM 25312                    | 1<br>1<br>1<br>1<br>1   | 2<br>2  | 1<br>1  |   |   | 3   | 3   | T0157   |
|  | Z 18 XE   | 03/04 → 10/07   | <b>Mot.</b> 20 EB2049  →  | VKMA 05156<br>VKM 15216<br>VKM _____<br>VKM 25158                                    | 1<br>1<br>1<br>1  | 2   | 1   |   |   |   | 1   | T0157   |
|   | Z 18 XE   | 03/04 → 10/07   |   | VKPC 85624   |   |   |   | 1   |   |   |   |   |
|    | <b>B(Alt)</b> Z 18 XE   | 03/04 → 10/07   | <b>AC</b>   | VKMA 35012<br>VKMV 5PK938<br>VKM 35012   | 1<br>1  |   | 1   |   |   |   |   |   |
|  | <b>B(Alt)</b> Z 18 XE   | 03/04 → 10/07   | <b>AC</b>   | VKMA 35022<br>VKMV 5PK1212<br>VKM 35012  | 1<br>1  |   | 1   |   |   |   |   |   |
| <b>VAUXHALL  ASTRA Mk V 2.0 16V Turbo</b> |   |   |   |  |   |   |   |   |   |   |   |   |
|   | Z 20 LEH, Z 20 LEL,<br>Z 20 LER   | 03/04 → 10/07   |   | VKMA _____<br>VKM 15140<br>VKM _____<br>VKM 25224                                    | 1<br>1  | 2   | 1   |   |   |   |   | T0172   |
|   | Z 20 LEH, Z 20 LEL,<br>Z 20 LER   | 03/04 → 10/07   |   | VKPC 85611   |   |   |   | 1   |   |   |   |   |
|   | <b>B(Alt)</b> Z 20 LEH, Z 20 LEL,<br>Z 20 LER                                     | 03/04 → 10/07   |   | VKMA 35119<br>VKMV 5PK1680<br>VKM 35009  | 1<br>1  |   | 1   |   |   |   |   |   |
| <b>VAUXHALL  ASTRA Mk V 1.3 CDTI</b>      |   |   |   |  |   |   |   |   |   |   |   |   |
|   | Z 13 DTH  | 08/05 → 10/07   |   |  |   |   |   |   |   |   |   |   |
|   | Z 13 DTH  | 08/05 → 10/07   |   | VKPC 85700   |   |   |   | 1   |   |   |   |   |
|   | <b>B(Alt)</b> Z 13 DTH  | 08/05 → 06/07   | <b>AC</b>   | VKMV 6PK1182<br>VKM 35023  | 1   |   | 1   |   |   |   |   |   |
|  | <b>B(Alt)</b> Z 13 DTH  | 08/05 → 06/07   | <b>AC</b>   | VKMV _____<br>VKM 35023  | 1   |   | 1   |   |   |   |   |   |
| <b>VAUXHALL  ASTRA Mk V 1.7 CDTI 80</b>   |   |   |   |  |   |   |   |   |   |   |   |   |
|   | Z 17 DTL  | 03/04 → 10/07   |   | VKMA 05700<br>VKM 15218<br>VKM 25209   | 1<br>1  | 1   | 1   |   |   |   | 3   | T0201   |
|   | Z 17 DTL  | 03/04 → 10/07   |   | VKPC 85300   |   |   |   | 1   |   |   | 1   |   |































VAUXHALL

|   |  |  |  |  |  |  |  |  |  |  |  |
|---|---|---|---|--|---|---|---|---|---|---|---|
|  B(Alt) Z 17 DTL                            |   |   | 03/04 → 06/07   | AC   | VKMA 35015  | 1   | 1   |   |   |   |   |
|   |   |   |   |  | VKMOV 6PK1275   | 1   | 1   |   |   |   |   |
|   |   |   |   |  | VKM 35015   | 1   |   |   |   |   |   |
| B(Alt) Z 17 DTL   |   |   | 03/04 → 06/07   | AC, →ICH 1306915   | VKMOV 6PK1620   |   | 1   |   |   |   |   |
|   |   |   |   |  | VKM 35025   | 1   |   |   |   |   |   |
|   |   |   |   |  | VKM_____  | 1   |   |   |   |   |   |
| B(Alt) Z 17 DTL   |   |   | 03/04 → 06/07   | AC, CH 1306916 I→  | VKMOV 6PK1620   | 1   | 1   |   |   |   |   |
|   |   |   |   |  | VKM_____  | 1   |   |   |   |   |   |
|   |   |   |   |  | VKM_____  | 1   | 1   |   |   |   |   |
| <b>VAUXHALL  ASTRA Mk V 1.7 CDTI 100</b>   |   |   |   |  |   |   |   |   |   |   |   |
|  Z 17 DTH                                   |   |   | 03/04 → 10/07   |  | VKMA 05700  | 1   | 1   | 1   |   |   | 3 T0201   |
|   |   |   |   |  | VKM 15218   | 1   |   |   |   |   |   |
|   |   |   |   |  | VKM 25209   |   | 1   |   |   |   | 1   |
|  Z 17 DTH                                   |   |   | 03/04 → 10/07   |  | VKPC 85300  |   |   | 1   |   |   |   |
|  B(Alt) Z 17 DTH                            |   |   | 03/04 → 06/07   | AC   | VKMOV 6PK1275   |   | 1   |   |   |   |   |
| B(Alt) Z 17 DTH   |   |   | 03/04 → 06/07   | AC, →ICH 1306915   | VKMOV 6PK1620   |   | 1   |   |   |   |   |
|   |   |   |   |  | VKM 35025   | 1   |   |   |   |   |   |
|   |   |   |   |  | VKM_____  | 1   |   |   |   |   |   |
| B(Alt) Z 17 DTH   |   |   | 03/04 → 06/07   | AC, CH 1306916 I→  | VKMOV 6PK1620   | 1   | 1   |   |   |   |   |
|   |   |   |   |  | VKM_____  | 1   |   |   |   |   |   |
|   |   |   |   |  | VKM_____  | 1   | 1   |   |   |   |   |
| <b>VAUXHALL  ASTRA Mk V 1.9 CDTI 120</b>   |   |   |   |  |   |   |   |   |   |   |   |
|  Z 19 DT                                    |   |   | 02/05 → 10/07   |  | VKMA 02192  | 1   | 1   | 1   |   |   | T0158   |
|   |   |   |   |  | VKM 12174   | 1   |   |   |   |   |   |
|   |   |   |   |  | VKM 22180   |   | 1   |   |   |   |   |
| Z 19 DTJ  |   |   | 04/04 → 10/07   | 16V  | VKMA 02193  | 1   | 1   | 1   |   |   | T0248   |
|   |   |   |   |  | VKM 12174   | 1   |   |   |   |   |   |
|   |   |   |   |  | VKM 22180   |   | 1   |   |   |   |   |
|  Z 19 DT                                  |   |   | 02/05 → 10/07   |  | VKPC 82665  |   |   | 1   |   |   |   |
| Z 19 DTJ  |   |   | 04/04 → 10/07   | 16V  | VKPC 82667  |   |   | 1   |   |   |   |
|  B(Alt) Z 19 DT, Z 19 DTJ                 |   |   | 04/04 → 12/07   | AC   | VKMOV 6PK1050   |   | 1   |   |   |   |   |
|   |   |   |   |  | VKM 32046   | 1   |   |   |   |   |   |
| B(Alt) Z 19 DT, Z 19 DTJ  |   |   | 04/04 → 06/07   | AC   | VKM 32046   | 1   |   |   |   |   |   |
| <b>VAUXHALL  ASTRA Mk V 1.9 CDTI 150</b> |   |   |   |  |   |   |   |   |   |   |   |
|  Z 19 DTH                                 |   |   | 06/04 → 10/07   |  | VKMA 02193  | 1   | 1   | 1   |   |   | T0248   |
|   |   |   |   |  | VKM 12174   | 1   |   |   |   |   |   |
|   |   |   |   |  | VKM 22180   |   | 1   |   |   |   |   |
|  Z 19 DTH                                 |   |   | 06/04 → 10/07   |  | VKPC 82667  |   |   | 1   |   |   |   |
|  B(Alt) Z 19 DTH                          |   |   | 06/04 → 12/07   | AC   | VKMOV 6PK1050   |   | 1   |   |   |   |   |
|   |   |   |   |  | VKM 32046   | 1   |   |   |   |   |   |
| B(Alt) Z 19 DTH   |   |   | 06/04 → 06/07   | AC   | VKM 32046   | 1   |   |   |   |   |   |
| <b>VAUXHALL  ASTRA TwinTop 1.6 16V</b>   |   |   |   |  |   |   |   |   |   |   |   |
|  Z 16 XEP                                 |   |   | 09/05 → 10/07   |  | VKMA_____   | 1   | 1   | 1   |   |   | 2 T0244   |
|   |   |   |   |  | VKM 15260   | 1   |   |   |   |   |   |
|   |   |   |   |  | VKM_____  |   | 1   |   |   |   |   |
|  Z 16 XEP                                 |   |   | 09/05 → 10/07   |  | VKPC_____   |   |   | 1   |   |   |   |
|  B(Alt) Z 16 XEP                          |   |   | 09/05 → 06/07   | AC   | VKMOV 5PK1450   |   | 1   |   |   |   |   |
|   |   |   |   |  | VKM 35260   | 1   |   |   |   |   |   |
| B(Alt) Z 16 XEP   |   |   | 09/05 → 06/07   | AC   | VKMOV 5PK1546   |   | 1   |   |   |   |   |
|   |   |   |   |  | VKM 35260   | 1   |   |   |   |   |   |
| <b>VAUXHALL  BRAVA 2.3</b>               |   |   |   |  |   |   |   |   |   |   |   |
|  Z 16 XEP                                 |   |   | 06/90 → 09/96   |  | VKMA 99001  | 1   | 1   |   |   |   | T0625   |
|   |   |   |   |  | VKM 79001   | 1   |   |   |   |   |   |
| <b>VAUXHALL  BRAVA 2.2 D</b>             |   |   |   |  |   |   |   |   |   |   |   |
|  Z 16 XEP                                 |   |   | 08/91 → 09/96   |  | —   | 1   | 1   |   |   |   |   |
|   |   |   |   |  | VKM 79003   | 1   |   |   |   |   |   |
| <b>VAUXHALL  BRAVA 2.5 D</b>             |   |   |   |  |   |   |   |   |   |   |   |
|  Z 16 XEP                                 |   |   | 06/90 → 06/94   |  | VKMA 99004  | 1   | 1   | 1   |   |   | T0628   |
|   |   |   |   |  | VKM 79002   | 1   |   |   |   |   |   |
|   |   |   |   |  | VKM 89003   |   | 1   |   |   |   |   |

| <b>VAUXHALL</b> <b>BRAVA 2.5 TD</b>      |                          |               |    |                  |              |   |   |   |  |   |  |  |   |       |
|--|--------------------------|---------------|----|------------------|--------------|---|---|---|--|---|--|--|---|-------|
|  |                          | 07/94 → 10/07 |    |                  | VKMA 99004   | 1 | 1 | 1 |  |   |  |  |   | T0628 |
|  |                          |               |    |                  | VKM 79002    | 1 |   |   |  |   |  |  |   |       |
|  |                          |               |    |                  | VKM 89003    |   | 1 |   |  |   |  |  |   |       |
| <b>VAUXHALL</b> <b>CALIBRA 2.0</b>       |                          |               |    |                  |              |   |   |   |  |   |  |  |   |       |
|  | C 20 NE                  | 06/90 → 07/97 |    | → Mot. 14 608701 | VKMC 05401   |   |   | 1 |  | 1 |  |  |   | T0225 |
|  | C 20 NE                  | 06/90 → 07/97 |    | Mot. 14 608702 → | VKMA 05402   | 1 |   | 1 |  |   |  |  |   | T0105 |
|  |                          |               |    |                  | VKM 15402    | 1 |   |   |  |   |  |  |   |       |
|  | C 20 NE                  | 06/90 → 07/97 |    | → Mot. 14 608701 | VKPC 85407   |   |   |   |  | 1 |  |  |   |       |
|  | C 20 NE                  | 06/90 → 07/97 |    | Mot. 14 608702 → | VKPC 85409   |   |   |   |  | 1 |  |  |   |       |
|  | B(Alt) C 20 NE           | 01/93 → 07/97 |    | AC               | VKMA 35009   | 1 |   | 1 |  |   |  |  |   |       |
|  |                          |               |    |                  | VKMV 6PK1725 |   |   | 1 |  |   |  |  |   |       |
|  |                          |               |    |                  | VKM 35009    | 1 |   |   |  |   |  |  |   |       |
|  | B(Alt) C 20 NE           | 01/93 → 07/97 |    | AC               | VKMA 35109   | 1 |   | 1 |  |   |  |  |   |       |
|  |                          |               |    |                  | VKMV 6PK1900 |   |   | 1 |  |   |  |  |   |       |
|  |                          |               |    |                  | VKM 35009    | 1 |   |   |  |   |  |  |   |       |
| <b>VAUXHALL</b> <b>CALIBRA 2.0 16V</b>   |                          |               |    |                  |              |   |   |   |  |   |  |  |   |       |
|  | X 20 XEV                 | 06/90 → 07/97 | 3) |                  | VKMS 05222   | 1 | 2 | 1 |  |   |  |  | 3 | T0116 |
|  |                          |               |    |                  | VKMA 05222   | 1 | 2 | 1 |  |   |  |  |   |       |
|  |                          |               |    |                  | VKM 15202    | 1 |   |   |  |   |  |  |   |       |
|  |                          |               |    |                  | VKM 25212    |   |   | 1 |  |   |  |  |   |       |
|  |                          |               |    |                  | VKM 25212    |   |   | 1 |  |   |  |  |   |       |
|  | C 20 XE                  | 06/90 → 02/94 |    | → Mot. 14 142838 | VKMA 05211   | 1 | 1 | 1 |  |   |  |  |   | T0063 |
|  |                          |               |    |                  | VKM 15211    | 1 |   |   |  |   |  |  |   |       |
|  |                          |               |    |                  | VKM 25211    |   |   | 1 |  |   |  |  |   |       |
|  | C 20 XE                  | 06/90 → 02/94 |    | Mot. 14 142839 → | VKMA 05220   | 1 | 2 | 1 |  |   |  |  |   | T0106 |
|  |                          |               |    |                  | VKM 15202    | 1 |   |   |  |   |  |  |   |       |
|  |                          |               |    |                  | VKM 25212    |   |   | 1 |  |   |  |  |   |       |
|  |                          |               |    |                  | VKM 25213    |   |   | 1 |  |   |  |  |   |       |
|  | C 20 XE                  | 06/90 → 02/94 |    | → Mot. 14 142838 | VKPC 85610   |   |   |   |  | 1 |  |  |   |       |
|  | C 20 XE                  | 06/90 → 02/94 |    | Mot. 14 142839 → | VKPC 85611   |   |   |   |  | 1 |  |  |   |       |
|  | X 20 XEV                 | 06/90 → 07/97 |    |                  | VKPC 85611   |   |   |   |  | 1 |  |  |   |       |
|  | B(Alt) C 20 XE, X 20 XEV | 01/93 → 07/97 |    | AC               | VKMA 35009   | 1 |   | 1 |  |   |  |  |   |       |
|  |                          |               |    |                  | VKMV 6PK1725 |   |   | 1 |  |   |  |  |   |       |
|  |                          |               |    |                  | VKM 35009    | 1 |   |   |  |   |  |  |   |       |
|  | B(Alt) C 20 XE, X 20 XEV | 01/93 → 07/97 |    | AC               | VKMA 35109   | 1 |   | 1 |  |   |  |  |   |       |
|  |                          |               |    |                  | VKMV 6PK1900 |   |   | 1 |  |   |  |  |   |       |
|  |                          |               |    |                  | VKM 35009    | 1 |   |   |  |   |  |  |   |       |
| <b>VAUXHALL</b> <b>CALIBRA 2.0 Turbo</b> |                          |               |    |                  |              |   |   |   |  |   |  |  |   |       |
|  | C 20 LET                 | 03/92 → 07/97 |    | → Mot. 14 002934 | VKMA 05211   | 1 | 1 | 1 |  |   |  |  |   | T0063 |
|  |                          |               |    |                  | VKM 15211    | 1 |   |   |  |   |  |  |   |       |
|  |                          |               |    |                  | VKM 25211    |   |   | 1 |  |   |  |  |   |       |
|  | C 20 LET                 | 03/92 → 07/97 |    | Mot. 14 002935 → | VKMA 05220   | 1 | 2 | 1 |  |   |  |  |   | T0106 |
|  |                          |               |    |                  | VKM 15202    | 1 |   |   |  |   |  |  |   |       |
|  |                          |               |    |                  | VKM 25212    |   |   | 1 |  |   |  |  |   |       |
|  |                          |               |    |                  | VKM 25213    |   |   | 1 |  |   |  |  |   |       |
|  | C 20 LET                 | 03/92 → 07/97 |    | → Mot. 14 002934 | VKPC 85610   |   |   |   |  | 1 |  |  |   |       |
|  | C 20 LET                 | 03/92 → 07/97 |    | Mot. 14 002935 → | VKPC 85611   |   |   |   |  | 1 |  |  |   |       |
|  | B(Alt) C 20 LET          | 01/93 → 07/97 |    | AC               | VKMA 35009   | 1 |   | 1 |  |   |  |  |   |       |
|  |                          |               |    |                  | VKMV 6PK1725 |   |   | 1 |  |   |  |  |   |       |
|  |                          |               |    |                  | VKM 35009    | 1 |   |   |  |   |  |  |   |       |
|  | B(Alt) C 20 LET          | 01/93 → 07/97 |    | AC               | VKMA 35109   | 1 |   | 1 |  |   |  |  |   |       |
|  |                          |               |    |                  | VKMV 6PK1900 |   |   | 1 |  |   |  |  |   |       |
|  |                          |               |    |                  | VKM 35009    | 1 |   |   |  |   |  |  |   |       |
| <b>VAUXHALL</b> <b>CALIBRA 2.5 V6</b>    |                          |               |    |                  |              |   |   |   |  |   |  |  |   |       |
|  | C 25 XE, X 25 XE         | 04/93 → 07/97 | 5) |                  | VKMA 05500   | 1 | 1 | 1 |  |   |  |  | 5 | T0135 |
|  | C 25 XE, X 25 XE         | 04/93 → 07/97 |    |                  | VKPC 85600   |   |   |   |  | 1 |  |  |   |       |
|  | B(Alt) C 25 XE, X 25 XE  | 04/93 → 07/97 |    | AC               | VKMV 6PK1900 |   |   | 1 |  |   |  |  |   |       |
|  |                          |               |    |                  | VKM 35500    | 1 |   |   |  |   |  |  |   |       |
|  | B(Alt) C 25 XE, X 25 XE  | 04/93 → 07/97 |    | AC               | VKMA 35500   | 1 |   | 1 |  |   |  |  |   |       |
|  |                          |               |    |                  | VKMV 6PK2020 |   |   | 1 |  |   |  |  |   |       |
|  |                          |               |    |                  | VKM 35500    | 1 |   |   |  |   |  |  |   |       |
| <b>VAUXHALL</b> <b>CARLTON Mk II 1.8</b> |                          |               |    |                  |              |   |   |   |  |   |  |  |   |       |
|  | 18 S                     | 11/82 → 08/86 |    |                  | VKMC 05400   |   |   | 1 |  | 1 |  |  |   | T0225 |

|  |  |  |                   |  |  |  |  |  |  |  |  |  |  |
|--|---|---|--|--|---|---|---|---|---|---|---|---|---|
|    | 18 S  | 11/82 → 08/86   |  | VKPC 85400   |   |   |   |   | 1   |   |   |   |   |
| <b>VAUXHALL  CARLTON Mk II 2.0</b>        |   |   |  |  |   |   |   |   |   |   |   |   |   |
|    | 20 E  | 01/83 → 12/84   | AC, →IMot.172888   | VKPC 85600   |   |   |   |   | 1   |   |   |   |   |
|  | 20 E  | 01/83 → 12/84   | 2), AC, Mot.172889  →  | VKPA 85608   |   |   |   |   | 1   |   |   |   |   |
|  | 20 E  | 01/83 → 12/84   | 2), AC, →IMot.172888   | —  |   |   |   |   | 1   |   |   |   |   |
|  | 20 E  | 01/83 → 12/84   | 2), AC, Mot.172889  →  | —  |   |   |   |   | 1   |   |   |   |   |
|  | 20 N  | 10/78 → 08/86   | AC, →IMot.197858   | VKPC 85600   |   |   |   |   | 1   |   |   |   |   |
|  | 20 N  | 10/78 → 08/86   | 2), AC, Mot.197859  →  | VKPA 85608   |   |   |   |   | 1   |   |   |   |   |
|  | 20 N  | 10/78 → 08/86   | 2), AC, →IMot.197858   | —  |   |   |   |   | 1   |   |   |   |   |
|  | 20 N  | 10/78 → 08/86   | 2), AC, Mot.197859  →  | —  |   |   |   |   | 1   |   |   |   |   |
| <b>VAUXHALL  CARLTON Mk II 2.2</b>        |   |   |  |  |   |   |   |   |   |   |   |   |   |
|    | 22 E  | 11/84 → 08/86   | 2)   | VKPA 85608   |   |   |   |   | 1   |   |   |   |   |
| <b>VAUXHALL  CARLTON Mk II 2.3 D</b>      |   |   |  |  |   |   |   |   |   |   |   |   |   |
|    | 23 D  | 05/83 → 08/86   | 2), →IMot.55082  | VKPA 85608   |   |   |   |   | 1   |   |   |   |   |
|  | 23 D  | 05/83 → 08/86   | Mot.0121527  →   | VKPC 85407   |   |   |   |   | 1   |   |   |   |   |
|  | 23 D  | 05/83 → 08/86   | Mot.55083  →,<br>→IMot.0121526   | VKPC 85600   |   |   |   |   | 1   |   |   |   |   |
| <b>VAUXHALL  CARLTON Mk III 1.8</b>       |   |   |  |  |   |   |   |   |   |   |   |   |   |
|    | 18 NV, 18 SEH, 18 SV,<br>E 18 NVR   | 09/86 → 03/94   |  →IMot.14 270600  | VKMC 05401   |   |   | 1   |   | 1   |   |   |   | T0225   |
|    | 18 NV, 18 SEH, 18 SV,<br>E 18 NVR   | 09/86 → 03/94   | →IMot.14 270600  | VKPC 85407   |   |   |   |   | 1   |   |   |   |   |
|  | 18 NV, 18 SEH, 18 SV,<br>E 18 NVR   | 09/86 → 03/94   | Mot.14 270601  →   | VKPC 85409   |   |   |   |   | 1   |   |   |   |   |
| <b>VAUXHALL  CARLTON Mk III 2.0</b>       |   |   |  |  |   |   |   |   |   |   |   |   |   |
|   | 20 SE, C 20 NE  | 09/86 → 03/94   |  →IMot.14 608700 | VKMC 05401   |   |   | 1   |   | 1   |   |   |   | T0225   |
|  | 20 SE, C 20 NE  | 09/86 → 03/94   | Mot.14 608701  →   | VKMA 05402<br>VKM 15402  | 1   |   | 1   |   |   |   |   |   | T0105   |
|    | 20 SE, C 20 NE  | 09/86 → 03/94   | →IMot.14 608700  | VKPC 85407   |   |   |   |   | 1   |   |   |   |   |
|  | 20 SE, C 20 NE  | 09/86 → 03/94   | Mot.14 608701  →   | VKPC 85409   |   |   |   |   | 1   |   |   |   |   |
| <b>VAUXHALL  CARLTON Mk III 2.4</b>     |   |   |  |  |   |   |   |   |   |   |   |   |   |
|    | C 24 NE   | 09/88 → 03/94   |  | <del>OKOKOK</del>  |   |   |   |   |   |   |   |   |   |
|    | C 24 NE   | 09/88 → 03/94   |  | VKPC 85603   |   |   |   |   | 1   |   |   |   |   |
| <b>VAUXHALL  CARLTON Mk III 2.6</b>     |   |   |  |  |   |   |   |   |   |   |   |   |   |
|    | C 26 NE   | 09/90 → 03/94   |  | <del>OKOKOK</del>  |   |   |   |   |   |   |   |   |   |
| <b>VAUXHALL  CARLTON Mk III 2.9</b>     |   |   |  |  |   |   |   |   |   |   |   |   |   |
|    | C 30 LE   | 03/87 → 12/87   |  | <del>OKOKOK</del>  |   |   |   |   |   |   |   |   |   |
|    | C 30 LE   | 03/87 → 12/87   |  | VKPC 85603   |   |   |   |   | 1   |   |   |   |   |
| <b>VAUXHALL  CARLTON Mk III 3.0 24V</b> |   |   |  |  |   |   |   |   |   |   |   |   |   |
|    | C 30 NE, C 30 SE,<br>C 30 SEJ   | 03/87 → 03/94   |  | <del>OKOKOK</del>  |   |   |   |   |   |   |   |   |   |
|    | C 30 NE   | 03/87 → 03/94   | →ICH L199999   | VKPC 85603   |   |   |   |   | 1   |   |   |   |   |
| <b>VAUXHALL  CARLTON Mk III 3.6 24V</b> |   |   |  |  |   |   |   |   |   |   |   |   |   |
|    | C 36 GET  | 08/90 → 09/92   |  | <del>OKOKOK</del>  |   |   |   |   |   |   |   |   |   |
| <b>VAUXHALL  CARLTON Mk III 2.2 TD</b>  |   |   |  |  |   |   |   |   |   |   |   |   |   |
|    | 23 YDT  | 09/86 → 08/88   |  | <del>OKOKOK</del>  |   |   |   |   |   |   |   |   |   |
|    | 23 YDT  | 09/86 → 08/88   |  | VKPC 85603   |   |   |   |   | 1   |   |   |   |   |
| <b>VAUXHALL  CARLTON Mk III 2.3 D</b>   |   |   |  |  |   |   |   |   |   |   |   |   |   |
|    | 23 YD   | 09/86 → 03/94   |  | <del>OKOKOK</del>  |   |   |   |   |   |   |   |   |   |
|    | 23 YD   | 09/86 → 03/94   |  | VKPC 85603   |   |   |   |   | 1   |   |   |   |   |
| <b>VAUXHALL  CARLTON Mk III 2.3 TD</b>  |   |   |  |  |   |   |   |   |   |   |   |   |   |
|    | 23 DTR  | 08/88 → 03/94   |  | <del>OKOKOK</del>  |   |   |   |   |   |   |   |   |   |
|    | 23 DTR  | 08/88 → 03/94   |  | VKPC 85603   |   |   |   |   | 1   |   |   |   |   |
| <b>VAUXHALL  CAVALIER Mk I 1.3</b>      |   |   |  |  |   |   |   |   |   |   |   |   |   |
|    | 13 N  | 08/77 → 08/81   |                 | VKMC 05103   |   |   | 1   |   | 1   |   |   |   | T0224   |
|    | 13 N, 13 S  | 08/77 → 08/81   |  | VKPC 85202   |   |   |   |   | 1   |   |   |   |   |
| <b>VAUXHALL  CAVALIER Mk I 1.6</b>      |   |   |  |  |   |   |   |   |   |   |   |   |   |
|    | 16 N, 16 S  | 03/75 → 08/81   |  | VKPC 85600   |   |   |   |   | 1   |   |   |   |   |
| <b>VAUXHALL  CAVALIER Mk I 1.9</b>      |   |   |  |  |   |   |   |   |   |   |   |   |   |
|    | 19 S  | 10/75 → 03/78   |  | VKPC 85600   |   |   |   |   | 1   |   |   |   |   |







































| VAUXHALL  CAVALIER Mk I 2.0    |   |               |   |               |  |  |  |   |   |  |       |
|---|---|---------------|---|---------------|--|--|--|---|---|--|-------|
|                                | 20 S  | 08/77 → 08/81 |   | VKPC 85600    |  |  |  | 1 |   |  |       |
| VAUXHALL  CAVALIER Mk II 1.3   |   |               |   |               |  |  |  |   |   |  |       |
|                                | 13 N, 13 S                                      | 09/81 → 08/88 |                                  | VKMC 05103    |  |  |  | 1 | 1 |  | T0224 |
|                                | 13 N, 13 S                                      | 09/81 → 08/88 |   | VKPC 85202    |  |  |  |   | 1 |  |       |
|                                | B(Alt) 13 N, 13 S                               | 09/81 → 08/88 |   | VKMC 10AVx875 |  |  |  | 1 |   |  |       |
|   | B(PS) 13 N, 13 S                                | 09/81 → 08/88 |   | VKMC 10AVx850 |  |  |  | 1 |   |  |       |
| VAUXHALL  CAVALIER Mk II 1.6   |   |               |   |               |  |  |  |   |   |  |       |
|                                | 16 N  | 09/81 → 08/88 |  Man. GBX,<br>→ IMot. 14 054370  | VKMC 05400    |  |  |  | 1 | 1 |  | T0225 |
|   | 16 N  | 09/81 → 08/88 |  Man. GBX,<br>Mot. 14 054371 I→  | VKMC 05401    |  |  |  | 1 | 1 |  | T0225 |
|   | 16 N  | 09/81 → 08/88 |  Auto. GBX,<br>→ IMot. 14 058556 | VKMC 05400    |  |  |  | 1 | 1 |  | T0225 |
|   | 16 N  | 09/81 → 08/88 |  Auto. GBX,<br>Mot. 14 058557 I→ | VKMC 05401    |  |  |  | 1 | 1 |  | T0225 |
|   | 16 SH   | 09/81 → 08/88 |  Man. GBX,<br>→ IMot. 14 391114  | VKMC 05400    |  |  |  | 1 | 1 |  | T0225 |
|   | 16 SH   | 09/81 → 08/88 |  Man. GBX,<br>Mot. 14 391115 I→  | VKMC 05401    |  |  |  | 1 | 1 |  | T0225 |
|   | 16 SH   | 09/81 → 08/88 |  Auto. GBX,<br>→ IMot. 12 387789 | VKMC 05400    |  |  |  | 1 | 1 |  | T0225 |
|   | 16 SH   | 09/81 → 08/88 |  Auto. GBX,<br>Mot. 12 387790 I→ | VKMC 05401    |  |  |  | 1 | 1 |  | T0225 |
|   | C 16 LZ, C 16 NZ,<br>E 16 NZ                    | 08/86 → 08/88 |                                  | VKMC 05120    |  |  |  | 1 | 1 |  | T0228 |
|                               | 16 N  | 09/81 → 08/88 | Man. GBX,<br>→ IMot. 14 054370  | VKPC 85400    |  |  |  |   | 1 |  |       |
|   | 16 N  | 09/81 → 08/88 | Man. GBX,<br>Mot. 14 054371 I→  | VKPC 85407    |  |  |  |   | 1 |  |       |
|   | 16 N  | 09/81 → 08/88 | Auto. GBX,<br>→ IMot. 14 058655   | VKPC 85400    |  |  |  |   | 1 |  |       |
|   | 16 N  | 09/81 → 08/88 | Auto. GBX,<br>Mot. 14 058656 I→   | VKPC 85407    |  |  |  |   | 1 |  |       |
|   | 16 SH   | 09/81 → 08/88 | Man. GBX,<br>→ IMot. 14 39114   | VKPC 85400    |  |  |  |   | 1 |  |       |
|   | 16 SH   | 09/81 → 08/88 | Man. GBX,<br>Mot. 14 39115 I→   | VKPC 85407    |  |  |  |   | 1 |  |       |
|   | 16 SH   | 09/81 → 08/88 | Auto. GBX,<br>→ IMot. 14 387789   | VKPC 85400    |  |  |  |   | 1 |  |       |
|   | 16 SH   | 09/81 → 08/88 | Auto. GBX,<br>Mot. 14 387790 I→   | VKPC 85407    |  |  |  |   | 1 |  |       |
|   | C 16 LZ, C 16 NZ,<br>E 16 NZ                    | 08/86 → 08/88 |   | VKPC 85401    |  |  |  |   | 1 |  |       |
|                              | B(Alt) 16 N                                     | 09/81 → 08/88 |                                | VKMC 10AVx925 |  |  |  | 1 |   |  |       |
|   | B(Alt) C 16 LZ, C 16 NZ,<br>E 16 NZ             | 08/86 → 08/88 |   | VKMC 10AVx913 |  |  |  | 1 |   |  |       |
|   | B(PS) 16 N, 16 SH, C 16 LZ,<br>C 16 NZ, E 16 NZ | 09/81 → 08/88 |   | VKMC 10AVx850 |  |  |  | 1 |   |  |       |
| VAUXHALL  CAVALIER Mk II 1.8 |   |               |   |               |  |  |  |   |   |  |       |
|                              | 18 E, C 18 NE                                   | 09/81 → 08/88 |                                | VKMC 05400    |  |  |  | 1 | 1 |  | T0225 |
|   | 18 SE   | 09/81 → 08/88 |  R.H.D.,<br>→ IMot. 14 056060  | VKMC 05400    |  |  |  | 1 | 1 |  | T0225 |
|   | 18 SE   | 09/81 → 08/88 |  R.H.D.,<br>Mot. 14 056061 I→  | VKMC 05401    |  |  |  | 1 | 1 |  | T0225 |
|   | E 18 NV   | 08/86 → 08/88 |                                | VKMC 05401    |  |  |  | 1 | 1 |  | T0225 |
|                              | 18 E, 18 SE                                     | 09/81 → 10/88 | L.H.D.,<br>→ IMot. 14 237769  | VKPC 85400    |  |  |  |   | 1 |  |       |
|   | 18 E, 18 SE                                     | 09/81 → 10/88 | L.H.D.,<br>Mot. 14 237770 I→  | VKPC 85407    |  |  |  |   | 1 |  |       |
|   | 18 E, 18 SE                                     | 09/81 → 10/88 | R.H.D.,<br>→ IMot. 14 056060  | VKPC 85400    |  |  |  |   | 1 |  |       |
|   | 18 E, 18 SE                                     | 09/81 → 10/88 | R.H.D.,<br>Mot. 14 056061 I→  | VKPC 85407    |  |  |  |   | 1 |  |       |







































VAUXHALL







































|   |  |  |                                 |  |  |  |  |  |  |  |  |  |
|---|---|---|--|--|---|---|---|---|---|---|---|---|
|   | 18 E  | 09/81 → 08/88   | R.H.D. Mot. 14 56061 I→  | VKPC 85407   |   |   |   |   |   | 1   |   |   |
|   | C 18 NE   | 01/85 → 08/86   |  | VKPC 85400   |   |   |   |   |   | 1   |   |   |
|   | E 18 NV, S 18 NV  | 08/86 → 08/88   |  | VKPC 85407   |   |   |   |   |   | 1   |   |   |
|   | <b>B(Alt)</b> 18 SE, E 18 NV  | 09/81 → 10/88   |  | VKMOV 10AVx925   |   |   | 1   |   |   |   |   |   |
|   | <b>B(PS)</b> 18 E, 18 SE, C 18 NE, E 18 NV  | 09/81 → 10/88   |  | VKMOV 10AVx850   |   |   | 1   |   |   |   |   |   |
| <b>VAUXHALL  CAVALIER Mk II 2.0</b>    |   |   |  |  |   |   |   |   |   |   |   |   |
|   | 20 NE, 20 SE, 20 SEH, C 20 NE   | 09/86 → 08/88   |                                 | VKMC 05401   |   |   | 1   | 1   |   |   |   | T0225   |
|   | 20 NE, 20 SE, 20 SEH, C 20 NE   | 09/86 → 08/88   |  | VKPC 85407   |   |   |   | 1   |   |   |   |   |
|   | <b>B(Alt)</b> 20 NE, 20 SE, 20 SEH, C 20 NE                                       | 09/86 → 08/88   |  | VKMOV 10AVx925   |   |   | 1   |   |   |   |   |   |
|   | <b>B(PS)</b> 20 NE, 20 SE, 20 SEH, C 20 NE  | 09/86 → 08/88   |  | VKMOV 10AVx850   |   |   | 1   |   |   |   |   |   |
| <b>VAUXHALL  CAVALIER Mk II 1.6 D</b>  |   |   |  |  |   |   |   |   |   |   |   |   |
|   | 16 D (GM), 16 DA (GM)   | 03/82 → 08/88   |  Man. GBX, Mot. 14 498631 I→    | VKMC 05201<br>VKMA 05201<br>VKM 25201  | 1<br>1<br>1   | 1<br>1<br>1   |   | 1   |   |   |   | T0045   |
|   | 16 D (GM), 16 DA (GM)   | 03/82 → 08/88   |  Auto. GBX, Mot. 14 503757 I→   | VKMC 05201<br>VKMA 05201<br>VKM 25201  | 1<br>1<br>1   | 1<br>1<br>1   |   | 1   |   |   |   | T0045   |
|   | 16 D (GM), 16 DA (GM)   | 03/82 → 08/88   | Man. GBX, →IMot. 14 498630   | VKMA 05200<br>VKM 25200  | 1<br>1  | 1   |   |   |   |   |   | T0016   |
|   | 16 D (GM), 16 DA (GM)   | 03/82 → 08/88   | Auto. GBX, →IMot. 14 503756  | VKMA 05200<br>VKM 25200  | 1<br>1  | 1   |   |   |   |   |   | T0016   |
|                                       | 16 D (GM), 16 DA (GM)   | 03/82 → 08/88   | Man. GBX, →IMot. 14 478630   | VKPC 85406   |   |   |   | 1   |   |   |   |   |
|   | 16 D (GM), 16 DA (GM)   | 03/82 → 08/88   | Man. GBX, Mot. 14 478631 I→  | VKPC 85408   |   |   |   | 1   |   |   |   |   |
|   | 16 D (GM), 16 DA (GM)   | 03/82 → 08/88   | Auto. GBX, →IMot. 14 503756  | VKPC 85406   |   |   |   | 1   |   |   |   |   |
|   | 16 D (GM), 16 DA (GM)   | 03/82 → 08/88   | Auto. GBX, Mot. 14 503757 I→   | VKPC 85408   |   |   |   | 1   |   |   |   |   |
|                                       | <b>B(Alt)</b> 16 D (GM), 16 DA (GM)   | 03/82 → 08/88   |  | VKMOV 10AVx913   |   |   | 1   |   |   |   |   |   |
|   | <b>B(PS)</b> 16 D (GM), 16 DA (GM)  | 03/82 → 08/88   |  | VKMOV 10AVx850   |   |   | 1   |   |   |   |   |   |
| <b>VAUXHALL  CAVALIER Mk III 1.4</b> |   |   |  |  |   |   |   |   |   |   |   |   |
|                                       | 14 NV   | 09/88 → 11/95   |  →IMot. 02 J22349, 19 307805  | VKMC 05120   |   |   | 1   | 1   |   |   |   | T0228   |
|   | 14 NV   | 09/88 → 11/95   |  Mot. 02 J22350, 19 307806 I→ | VKMC 05121<br>VKMA 05121<br>VKM 15121  | 1<br>1<br>1   | 1<br>1  |   | 1   |   |   | 1<br>1<br>1   | T0092   |
|                                       | 14 NV   | 09/88 → 11/95   | →IMot. 02 J22349, 19 307805  | VKPC 85401   |   |   |   | 1   |   |   |   |   |
|   | 14 NV   | 09/88 → 11/95   | Mot. 02 J22350, 19 307806 I→   | VKPC 85206   |   |   |   | 1   |   |   |   |   |
| <b>VAUXHALL  CAVALIER Mk III 1.6</b> |   |   |  |  |   |   |   |   |   |   |   |   |
|                                       | 16 SV, E 16 NZ, X 16 SZ   | 09/88 → 11/95   |  →IMot. 02 J22349, 19 307805  | VKMC 05120   |   |   | 1   | 1   |   |   |   | T0228   |
|   | 16 SV, E 16 NZ, X 16 SZ   | 09/88 → 11/95   |  Mot. 02 J22350, 19 307806 I→ | VKMC 05121<br>VKMA 05121<br>VKM 15121  | 1<br>1<br>1   | 1<br>1  |   | 1   |   |   | 1<br>1<br>1   | T0092   |
|                                       | 16 SV, E 16 NZ, X 16 SZ   | 09/88 → 11/95   | →IMot. 02 J22349, 19 307805  | VKPC 85401   |   |   |   | 1   |   |   |   |   |
|   | 16 SV, E 16 NZ, X 16 SZ   | 09/88 → 11/95   | Mot. 02 J22350, 19 307806 I→   | VKPC 85206   |   |   |   | 1   |   |   |   |   |
|                                       | <b>B(Alt)</b> E 16 NZ   | 01/93 → 11/95   |                               | VKMA 35009<br>VKMV 6PK1725<br>VKM 35009  | 1<br>1  | 1<br>1  |   |   |   |   |   |   |

































|   |  |  |                     |  |  |  |  |  |  |  |  |
|---|---|---|--|--|---|---|---|---|---|---|---|
| <b>B(Alt)</b>   | X 16 SZ   | 09/93 → 11/95   |                     | VKMA 35008<br>VKMV 6PK1460<br>VKM 35008  | 1<br>1<br>1   | 1<br>1  |   |   |   |   |   |
| <b>VAUXHALL  CAVALIER Mk III 1.8</b>         |   |   |  |  |   |   |   |   |   |   |   |
|    | 18 SV   | 09/88 → 10/90   |  →   Mot. 14 270600 | VKMC 05401   |   | 1   | 1   |   |   |   | T0225   |
|   | C 18 NZ   | 09/88 → 11/95   |  →   Mot. 14 254438 | VKMC 05401   |   | 1   | 1   |   |   |   | T0225   |
|   | 18 SV   | 09/88 → 10/92   | Mot. 14 270601   →   | VKMA 05402<br>VKM 15402  | 1<br>1  | 1   |   |   |   |   | T0105   |
|   | C 18 NZ   | 09/88 → 11/95   | Mot. 14 254439   →   | VKMA 05402<br>VKM 15402  | 1<br>1  | 1   |   |   |   |   | T0105   |
|   | E 18 NVR  | 09/88 → 10/92   |  | VKMA 05402<br>VKM 15402  | 1<br>1  | 1   |   |   |   |   | T0105   |
|    | 18 SV   | 09/88 → 10/90   | →   Mot. 14 270600   | VKPC 85407   |   |   | 1   |   |   |   |   |
|   | 18 SV   | 09/88 → 10/90   | Mot. 14 270601   →   | VKPC 85409   |   |   | 1   |   |   |   |   |
|   | C 18 NZ   | 09/88 → 11/95   | →   Mot. 14 254438   | VKPC 85407   |   |   | 1   |   |   |   |   |
|   | C 18 NZ   | 09/88 → 11/95   | Mot. 14 254439   →   | VKPC 85409   |   |   | 1   |   |   |   |   |
|    | <b>B(Alt)</b> C 18 NZ   | 01/93 → 11/95   |                     | VKMA 35009<br>VKMV 6PK1725<br>VKM 35009  | 1<br>1<br>1   | 1<br>1  |   |   |   |   |   |
| <b>VAUXHALL  CAVALIER Mk III 2.0</b>         |   |   |  |  |   |   |   |   |   |   |   |
|    | 20 NE, 20 SEH, C 20 NE  | 09/88 → 11/95   |  →   Mot. 14 608700 | VKMC 05401   |   | 1   | 1   |   |   |   | T0225   |
|   | 20 NE, 20 SEH, C 20 NE  | 09/88 → 11/95   | Mot. 14 608701   →   | VKMA 05402<br>VKM 15402  | 1<br>1  | 1   |   |   |   |   | T0105   |
|    | 20 NE, 20 SEH, C 20 NE  | 09/88 → 11/95   | →   Mot. 14 608700   | VKPC 85407   |   |   | 1   |   |   |   |   |
|   | 20 NE, 20 SEH, C 20 NE  | 09/88 → 11/95   | Mot. 14 608701   →   | VKPC 85409   |   |   | 1   |   |   |   |   |
|    | <b>B(Alt)</b> 20 NE, 20 SEH, C 20 NE  | 01/93 → 11/95   |                    | VKMA 35009<br>VKMV 6PK1725<br>VKM 35009  | 1<br>1<br>1   | 1<br>1  |   |   |   |   |   |
|   | <b>B(Alt)</b> 20 NE, 20 SEH, C 20 NE  | 01/93 → 11/95   |                   | VKMA 35109<br>VKMV 6PK1900<br>VKM 35009  | 1<br>1<br>1   | 1<br>1  |   |   |   |   |   |
| <b>VAUXHALL  CAVALIER Mk III 2.0 16V</b>   |   |   |  |  |   |   |   |   |   |   |   |
|    | X 20 XEV  | 09/93 → 11/95   | 3)   | VKMS 05222<br>VKMA 05222<br>VKM 15202<br>VKM 25212<br>VKM 25212                    | 1<br>1<br>1<br>1<br>1   | 2<br>2<br>1   | 1   |   |   | 3   | T0116   |
|   | C 20 XE   | 09/88 → 11/95   | →   Mot. 14 142838   | VKMA 05211<br>VKM 15211<br>VKM 25211   | 1<br>1<br>1   | 1<br>1  | 1   |   |   |   | T0063   |
|   | C 20 XE   | 09/88 → 11/95   | Mot. 14 142839   →   | VKMA 05220<br>VKM 15202<br>VKM 25212<br>VKM 25213                                  | 1<br>1<br>1<br>1  | 2<br>1<br>1   | 1   |   |   |   | T0106   |
|    | C 20 XE   | 09/88 → 11/95   | →   Mot. 14 142838   | VKPC 85610   |   |   | 1   |   |   |   |   |
|   | C 20 XE   | 09/88 → 11/95   | Mot. 14 142839   →   | VKPC 85611   |   |   | 1   |   |   |   |   |
|   | X 20 XEV  | 09/93 → 11/95   |  | VKPC 85611   |   |   | 1   |   |   |   |   |
|    | <b>B(Alt)</b> C 20 XE, X 20 XEV   | 01/93 → 11/95   |                   | VKMA 35009<br>VKMV 6PK1725<br>VKM 35009  | 1<br>1<br>1   | 1<br>1  |   |   |   |   |   |
|   | <b>B(Alt)</b> C 20 XE, X 20 XEV   | 01/93 → 11/95   |                   | VKMA 35109<br>VKMV 6PK1900<br>VKM 35009  | 1<br>1<br>1   | 1<br>1  |   |   |   |   |   |
| <b>VAUXHALL  CAVALIER Mk III 2.0 Turbo</b> |   |   |  |  |   |   |   |   |   |   |   |
|    | C 20 LET  | 06/92 → 11/94   | →   Mot. 14 002934   | VKMA 05211<br>VKM 15211<br>VKM 25211   | 1<br>1<br>1   | 1<br>1  | 1   |   |   |   | T0063   |
|   | C 20 LET  | 06/92 → 11/94   | Mot. 14 002935   →   | VKMA 05220<br>VKM 15202<br>VKM 25212<br>VKM 25213                                  | 1<br>1<br>1<br>1  | 2<br>1<br>1   | 1   |   |   |   | T0106   |
|    | C 20 LET  | 06/92 → 11/94   | →   Mot. 14 002934   | VKPC 85610   |   |   | 1   |   |   |   |   |
|   | C 20 LET  | 06/92 → 11/94   | Mot. 14 002935   →   | VKPC 85611   |   |   | 1   |   |   |   |   |
|    | <b>B(Alt)</b> C 20 LET  | 01/93 → 11/94   |                   | VKMA 35009<br>VKMV 6PK1725<br>VKM 35009  | 1<br>1<br>1   | 1<br>1  |   |   |   |   |   |































VAUXHALL































|   |  |  |    |  |  |  |  |  |  |  |  |  |
|---|---|---|---|--|---|---|---|---|---|---|---|---|
| <b>B(Alt)</b>   | C 20 LET  | 01/93 → 11/94   | AC, ⊕   | VKMA 35109<br>VKMV 6PK1900<br>VKM 35009  | 1<br>1<br>1   | 1<br>1  |   |   |   |   |   |   |
| <b>VAUXHALL</b>  <b>CAVALIER Mk III 2.5 V6</b> |   |   |   |  |   |   |   |   |   |   |   |   |
|   | C 25 XE   | 02/93 → 11/95   | 5)  | VKMA 05500   | 1   | 1   | 1   |   |   |   |   | 5 T0135   |
|   | C 25 XE   | 02/93 → 11/95   |   | VKPC 85613   |   |   |   | 1   |   |   |   |   |
|   | <b>B(Alt)</b> C 25 XE   | 02/93 → 11/95   | AC  | VKMV 6PK1900<br>VKM 35500  | 1   | 1   |   |   |   |   |   |   |
|   | <b>B(Alt)</b> C 25 XE   | 02/93 → 11/95   | AC  | VKMA 35500<br>VKMV 6PK2020<br>VKM 35500  | 1<br>1  | 1<br>1  |   |   |   |   |   |   |
| <b>VAUXHALL</b>  <b>CAVALIER Mk III 1.7 D</b>  |   |   |   |  |   |   |   |   |   |   |   |   |
|   | 17 D (GM)   | 09/88 → 09/92   |    | VKMC 05201<br>VKMA 05201<br>VKM 25201  |   | 1<br>1<br>1   | 1   | 1   |   |   |   | T0045   |
|   | 17 DR (GM)  | 07/92 → 11/95   |   | VKMA 05202<br>VKM 15202<br>VKM 25202   | 1<br>1  | 1<br>1  | 1   |   |   |   |   | T0654   |
|   | 17 D (GM), 17 DR (GM)   | 09/88 → 11/95   | →IMot. 14 363650  | VKPC 85408   |   |   |   | 1   |   |   |   |   |
|   | 17 D (GM), 17 DR (GM)   | 09/88 → 11/95   | Mot. 14 363651 I→   | VKPC 85611   |   |   |   | 1   |   |   |   |   |
| <b>VAUXHALL</b>  <b>CAVALIER Mk III 1.7 TD</b> |   |   |   |  |   |   |   |   |   |   |   |   |
|   | 17 TD (ISUZU)   | 09/88 → 11/95   | →IMot. 551390   | VKMA 05213<br>VKM 15213<br>VKM 25208   | 1<br>1  | 1<br>1  | 1   |   |   |   |   | 1 T0062   |
|   | 17 TD (ISUZU)   | 09/88 → 11/95   | Mot. 551391 I→  | VKMA 05214<br>VKM 15215<br>VKM 25208   | 1<br>1  | 1<br>1  | 1   |   |   |   |   | 1 T0062   |
|   | 17 TD (ISUZU)   | 09/88 → 11/95   |   | VKPC 85404   |   |   |   | 1   |   |   |   |   |
| <b>VAUXHALL</b>  <b>COMBO I 1.2</b>          |   |   |   |  |   |   |   |   |   |   |   |   |
|   | C 12 NZ, X 12 SZ  | 07/94 → 10/01   |  | VKMC 05121<br>VKMA 05121<br>VKM 15121  | 1<br>1<br>1   | 1<br>1  | 1   |   |   |   |   | 1 T0092   |
|   | C 12 NZ, X 12 SZ  | 07/94 → 10/01   |   | VKPC 85206   |   |   |   | 1   |   |   |   |   |
|   | <b>B(Alt)</b> C 12 NZ, X 12 SZ  | 07/94 → 10/01   | AC, ⊕   | VKMA 35008<br>VKMV 6PK1460<br>VKM 35008  | 1<br>1  | 1<br>1  |   |   |   |   |   |   |
|   | <b>B(Alt)</b> C 12 NZ, X 12 SZ  | 07/94 → 10/01   | AC, ⊕   | VKMA 35125<br>VKMV 6PK1795<br>VKM 35009  | 1<br>1  | 1<br>1  |   |   |   |   |   |   |
| <b>VAUXHALL</b>  <b>COMBO I 1.4</b>          |   |   |   |  |   |   |   |   |   |   |   |   |
|   | C 14 NZ, C 14 SE  | 07/94 → 10/01   |  | VKMC 05121<br>VKMA 05121<br>VKM 15121  | 1<br>1<br>1   | 1<br>1  | 1   |   |   |   |   | 1 T0092   |
|   | C 14 NZ, C 14 SE  | 07/94 → 10/01   |   | VKPC 85206   |   |   |   | 1   |   |   |   |   |
|   | <b>B(Alt)</b> C 14 NZ, C 14 SE  | 07/94 → 10/01   | AC, ⊕   | VKMA 35008<br>VKMV 6PK1460<br>VKM 35008  | 1<br>1  | 1<br>1  |   |   |   |   |   |   |
|   | <b>B(Alt)</b> C 14 NZ, C 14 SE  | 07/94 → 10/01   | AC, ⊕   | VKMA 35125<br>VKMV 6PK1795<br>VKM 35009  | 1<br>1  | 1<br>1  |   |   |   |   |   |   |
| <b>VAUXHALL</b>  <b>COMBO I 1.7 D</b>        |   |   |   |  |   |   |   |   |   |   |   |   |
|   | 17 D (ISUZU),<br>X 17 D (ISUZU)   | 07/94 → 12/94   |   | VKMA 05213<br>VKM 15213<br>VKM 25208   | 1<br>1  | 1<br>1  | 1   |   |   |   |   | 1 T0062   |
|   | 17 D (ISUZU),<br>X 17 D (ISUZU)   | 01/95 → 10/01   |   | VKMA 05214<br>VKM 15215<br>VKM 25208   | 1<br>1  | 1<br>1  | 1   |   |   |   |   | 1 T0062   |
|   | 17 D (ISUZU),<br>X 17 D (ISUZU)   | 07/94 → 10/01   | →IMot. 877697   | VKPC 85404   |   |   |   | 1   |   |   |   |   |
|   | 17 D (ISUZU),<br>X 17 D (ISUZU)   | 07/94 → 10/01   | Mot. 877698 I→  | VKPC 85620   |   |   |   | 1   |   |   |   |   |



| VAUXHALL  COMBO II 1.4         |  |
|---|--|
|                                | Z 14 XEP 01/04 → 10/07 <b>OXOXOXO</b>  |
|                                | Z 14 XEP 01/04 → 10/07 VKPC 85310 1  |
|                                | <b>B(Alt)</b> Z 14 XEP 01/04 → 10/07 <b>AC</b> VKMA 35113 1 1<br>VKMV 5PK1230 1<br>VKM 35013   |
|                                | <b>B(Alt)</b> Z 14 XEP 01/04 → 10/07 <b>AC</b> VKMV 5PK1368 1<br>VKM 35013   |
| VAUXHALL  COMBO II 1.6         |  |
|                                | Z 16 SE 10/01 → 10/07 3) VKMS 05121 1 1 2 1<br>VKMA 05121 1 1 T0092<br>VKM 15121 1 1   |
|                                | Z 16 SE 10/01 → 10/07 VKPC 85460 1   |
|                                | <b>B(Alt)</b> Z 16 SE 10/01 → 10/07 <b>AC</b> VKMA 35012 1 1<br>VKMV 5PK938 1<br>VKM 35012   |
|                                | <b>B(Alt)</b> Z 16 SE 10/01 → 10/07 <b>AC</b> VKMA 35022 1 1<br>VKMV 5PK1212 1<br>VKM 35012  |
| VAUXHALL  COMBO II 1.7 DI      |  |
|                                | Y 17 DTL (ISUZU) 09/01 → 10/07 →IMot. 328704 VKMA 05606 1 1 1 1 T0182<br>VKM 15215 1<br>VKM 25208 1  |
|                                | Y 17 DTL (ISUZU) 09/01 → 10/07 Mot. 328705 I→ VKMA 05608 1 1 1 3 T0182<br>VKM 15218 1<br>VKM 25208 1   |
|                              | Y 17 DTL (ISUZU) 09/01 → 10/07 VKPC 85300 1  |
|                              | <b>B(Alt)</b> Y 17 DTL (ISUZU) 09/01 → 10/07 <b>AC</b> VKMA 35215 1 1<br>VKMV 6PK1250 1<br>VKM 35015   |
|                              | <b>B(Alt)</b> Y 17 DTL (ISUZU) 09/01 → 10/07 <b>AC</b> VKMA 35315 1 1 1<br>VKMV 6PK1590 1<br>VKM 35015 1<br>VKM 35025  |
| VAUXHALL  COMBO II 1.7 DTI   |  |
|                              | Y 17 DT (ISUZU) 10/01 → 10/07 →IMot. 328704 VKMA 05606 1 1 1 1 T0182<br>VKM 15215 1<br>VKM 25208 1   |
|                              | Y 17 DT (ISUZU) 10/01 → 10/07 Mot. 328705 I→ VKMA 05608 1 1 1 3 T0182<br>VKM 15218 1<br>VKM 25208 1  |
|                              | Y 17 DT (ISUZU) 10/01 → 10/07 VKPC 85300 1   |
|                              | <b>B(Alt)</b> Y 17 DT (ISUZU) 10/01 → 10/07 <b>AC</b> VKMA 35215 1 1<br>VKMV 6PK1250 1<br>VKM 35015  |
|                              | <b>B(Alt)</b> Y 17 DT (ISUZU) 10/01 → 10/07 <b>AC</b> VKMA 35315 1 1 1<br>VKMV 6PK1590 1<br>VKM 35015 1<br>VKM 35025   |
| VAUXHALL  CORSA Mk I 1.0 12V |  |
|                              | X 10 XE 11/96 → 09/00 <b>OXOXOXO</b>   |
|                              | X 10 XE 11/96 → 09/00 VKPC 85220 1   |
|                              | <b>B(Alt)</b> X 10 XE 11/96 → 09/00 <b>AC</b> VKMA 35113 1 1<br>VKMV 5PK1230 1<br>VKM 35013  |
|                              | <b>B(Alt)</b> X 10 XE 11/96 → 09/00 <b>AC</b> VKMA 35013 1 1<br>VKMV 5PK1355 1<br>VKM 35013  |
| VAUXHALL  CORSA Mk I 1.2     |  |
|                              | C 12 NZ, X 12 SZ 03/93 → 09/00  VKMC 05121 1 1 1 1 T0092<br>VKMA 05121 1 1<br>VKM 15121 1 |
|                              | C 12 NZ, X 12 SZ 03/93 → 09/00 VKPC 85206 1  |





























|   |  |  |  |  |  |  |  |  |  |  |  |  |
|---|---|---|---|--|---|---|---|---|---|---|---|---|
|   | B(Alt)  | C 12 NZ, X 12 SZ  | 03/93 → 09/00   | AC, ⊕  | VKMA 35008<br>VKMV 6PK1460<br>VKM 35008   | 1<br>1<br>1   | 1<br>1  |   |   |   |   |   |
|   | B(Alt)  | C 12 NZ, X 12 SZ  | 03/93 → 09/00   | AC, ⊕  | VKMA 35125<br>VKMV 6PK1795<br>VKM 35009   | 1<br>1<br>1   | 1<br>1  |   |   |   |   |   |
| <b>VAUXHALL</b>  <b>CORSA Mk I 1.2 16V</b>   |   |   |   |  |   |   |   |   |   |   |   |   |
|   |   | X 12 XE   | 03/98 → 09/00   |  | <del>VKMA 35008</del><br>VKPC 85220   |   |   |   |   | 1   |   |   |
|   | B(Alt)  | X 12 XE   | 03/98 → 09/00   | AC   | VKMA 35113<br>VKMV 5PK1230<br>VKM 35013   | 1<br>1<br>1   | 1<br>1  |   |   |   |   |   |
|   | B(Alt)  | X 12 XE   | 03/98 → 09/00   | AC   | VKMA 35013<br>VKMV 5PK1355<br>VKM 35013   | 1<br>1<br>1   | 1<br>1  |   |   |   |   |   |
| <b>VAUXHALL</b>  <b>CORSA Mk I 1.4</b>       |   |   |   |  |   |   |   |   |   |   |   |   |
|   |   | C 14 NZ, C 14 SE,<br>X 14 SZ  | 03/93 → 09/00   |   | VKMC 05121<br>VKMA 05121<br>VKM 15121   | 1<br>1<br>1   | 1<br>1  | 1   |   |   | 1<br>1  | T0092   |
|   |   | C 14 NZ, C 14 SE,<br>X 14 SZ  | 03/93 → 09/00   |  | VKPC 85206  |   |   | 1   |   |   |   |   |
|   | B(Alt)  | C 14 NZ, C 14 SE,<br>X 14 SZ  | 03/93 → 09/00   | AC, ⊕  | VKMV 6PK1795<br>VKM 35002<br>VKM 35009  | 1<br>1<br>1   | 1   | 1   |   |   |   |   |
|   | B(Alt)  | C 14 NZ, C 14 SE,<br>X 14 SZ  | 03/93 → 09/00   | AC, ⊕  | VKMA 35008<br>VKMV 6PK1460<br>VKM 35008   | 1<br>1<br>1   | 1<br>1  |   |   |   |   |   |
|   | B(Alt)  | C 14 NZ, C 14 SE,<br>X 14 SZ  | 03/93 → 09/00   | AC, ⊕  | VKMA 35125<br>VKMV 6PK1795<br>VKM 35009   | 1<br>1<br>1   | 1<br>1  |   |   |   |   |   |
| <b>VAUXHALL</b>  <b>CORSA Mk I 1.4 16V</b> |   |   |   |  |   |   |   |   |   |   |   |   |
|   |   | X 14 XE   | 09/94 → 10/07   | 3)   | VKMS 05150<br>VKMA 05150<br>VKM 15216<br>VKM 25150<br>VKM 25152                     | 1<br>1<br>1<br>1<br>1   | 2<br>2<br>1<br>1<br>1   | 1<br>1  |   |   | 3<br>3<br>1   | T0107   |
|   |   | X 14 XE   | 09/94 → 09/00   |  | VKPC 85212  |   |   | 1   |   |   |   |   |
|   | B(Alt)  | X 14 XE   | 09/94 → 07/01   | AC, ⊕  | VKMV 6PK1795<br>VKM 35002<br>VKM 35009  | 1<br>1<br>1   | 1   | 1   |   |   |   |   |
|   | B(Alt)  | X 14 XE   | 09/94 → 10/07   | AC, ⊕  | VKMA 35025<br>VKMV 6PK1530<br>VKM 35009   | 1<br>1<br>1   | 1<br>1  |   |   |   |   |   |
|   | B(Alt)  | X 14 XE   | 09/94 → 09/00   | AC, ⊕  | VKMA 35125<br>VKMV 6PK1795<br>VKM 35009   | 1<br>1<br>1   | 1<br>1  |   |   |   |   |   |
| <b>VAUXHALL</b>  <b>CORSA Mk I 1.6 16V</b> |   |   |   |  |   |   |   |   |   |   |   |   |
|   |   | C 16 XE, X 16 XE  | 03/93 → 09/00   | 3)   | VKMS 05150<br>VKMA 05150<br>VKM 15216<br>VKM 25150<br>VKM 25152                     | 1<br>1<br>1<br>1<br>1   | 2<br>2<br>1<br>1<br>1   | 1<br>1  |   |   | 3<br>3<br>1   | T0107   |
|   |   | C 16 XE, X 16 XE  | 03/93 → 09/00   |  | VKPC 85212  |   |   | 1   |   |   |   |   |
|   | B(Alt)  | C 16 XE, X 16 XE  | 03/93 → 09/00   | AC, ⊕  | VKMV 6PK1795<br>VKM 35002<br>VKM 35009  | 1<br>1<br>1   | 1   | 1   |   |   |   |   |
|   | B(Alt)  | C 16 XE, X 16 XE  | 03/93 → 09/00   | AC, ⊕  | VKMA 35025<br>VKMV 6PK1530<br>VKM 35009   | 1<br>1<br>1   | 1<br>1  |   |   |   |   |   |

|   |  |  |  |  |  |  |  |  |  |  |  |  |
|---|---|---|---|--|---|---|---|---|---|---|---|---|
| <b>B(Alt)</b>   | C 16 XE, X 16 XE  | 03/93 → 09/00   | AC  | VKMA 35125<br>VKMV 6PK1795<br>VKM 35009  | 1   | 1   | 1   |   |   |   |   |   |
| <b>VAUXHALL  CORSA Mk I 1.5 D</b>      |   |   |   |  |   |   |   |   |   |   |   |   |
|                                        | 15 D (ISUZU),<br>X 15 D (ISUZU)   | 03/93 → 09/00   | 3)  | VKMS 05208<br>VKMA 05208<br>VKM 15210<br>VKM 25208                                 | 1<br>1<br>1   | 1<br>1<br>1   | 1<br>1<br>1   |   |   | 3   | 1<br>1  | T0062   |
|                                        | 15 D (ISUZU),<br>X 15 D (ISUZU)   | 03/93 → 09/00   | →IMot. 877697   | VKPC 85410   |   |   |   |   | 1   |   |   |   |
|   | 15 D (ISUZU),<br>X 15 D (ISUZU)   | 03/93 → 09/00   | Mot. 877698 I→  | VKPC 85621   |   |   |   |   | 1   |   |   |   |
| <b>VAUXHALL  CORSA Mk I 1.5 TD</b>     |   |   |   |  |   |   |   |   |   |   |   |   |
|                                        | 15 TD (ISUZU),<br>X 15 TD (ISUZU)   | 03/93 → 10/96   | 3)  | VKMS 05208<br>VKMA 05208<br>VKM 15210<br>VKM 25208                                 | 1<br>1<br>1   | 1<br>1<br>1   | 1<br>1<br>1   |   |   | 3   | 1<br>1  | T0062   |
|                                        | 15 TD (ISUZU),<br>X 15 TD (ISUZU)   | 03/93 → 10/96   | →IMot. 877697   | VKPC 85410   |   |   |   |   | 1   |   |   |   |
|   | 15 TD (ISUZU),<br>X 15 TD (ISUZU)   | 03/93 → 10/96   | Mot. 877698 I→,<br>→IMot. 076350  | VKPC 85621   |   |   |   |   | 1   |   |   |   |
|   | 15 TD (ISUZU),<br>X 15 TD (ISUZU)   | 03/93 → 10/96   | Mot. 076351 I→  | VKPC 85622   |   |   |   |   | 1   |   |   |   |
| <b>VAUXHALL  CORSA Mk I 1.7 D</b>     |   |   |   |  |   |   |   |   |   |   |   |   |
|                                      | 17 D (ISUZU),<br>X 17 D (ISUZU)   | 01/94 → 12/94   |   | VKMA 05213<br>VKM 15213<br>VKM 25208   | 1<br>1  | 1<br>1  | 1<br>1  |   |   |   | 1<br>1  | T0062   |
|   | 17 D (ISUZU),<br>X 17 D (ISUZU)   | 01/95 → 09/00   |   | VKMA 05214<br>VKM 15215<br>VKM 25208   | 1<br>1  | 1<br>1  | 1<br>1  |   |   |   | 1<br>1  | T0062   |
|                                      | 17 D (ISUZU),<br>X 17 D (ISUZU)   | 01/94 → 09/00   | →IMot. 877697   | VKPC 85404   |   |   |   |   | 1   |   |   |   |
|   | 17 D (ISUZU),<br>X 17 D (ISUZU)   | 01/94 → 09/00   | Mot. 877698 I→  | VKPC 85620   |   |   |   |   | 1   |   |   |   |
| <b>VAUXHALL  CORSA Mk II 1.0 12V</b> |   |   |   |  |   |   |   |   |   |   |   |   |
|                                      | Z 10 XE   | 09/00 → 10/07   |   | <del>OKOKOK</del>  |   |   |   |   |   |   |   |   |
|                                      | Z 10 XE   | 09/00 → 10/07   |   | VKPC 85220   |   |   |   |   | 1   |   |   |   |
|                                      | <b>B(Alt)</b> Z 10 XE   | 09/00 → 10/07   | AC  | VKMA 35113<br>VKMV 5PK1230<br>VKM 35013  | 1   | 1   | 1   |   |   |   |   |   |
|   | <b>B(Alt)</b> Z 10 XE   | 09/00 → 10/07   | AC  | VKMA 35013<br>VKMV 5PK1355<br>VKM 35013  | 1   | 1   | 1   |   |   |   |   |   |
| <b>VAUXHALL  CORSA Mk II 1.2 16V</b> |   |   |   |  |   |   |   |   |   |   |   |   |
|                                      | Z 12 XE, Z 12 XEP   | 09/00 → 12/07   |   | <del>OKOKOK</del>  |   |   |   |   |   |   |   |   |
|                                      | Z 12 XE, Z 12 XEP   | 09/00 → 12/07   |   | VKPC 85220   |   |   |   |   | 1   |   |   |   |
|                                      | <b>B(Alt)</b> Z 12 XE, Z 12 XEP   | 09/00 → 12/07   | AC  | VKMA 35113<br>VKMV 5PK1230<br>VKM 35013  | 1   | 1   | 1   |   |   |   |   |   |
|   | <b>B(Alt)</b> Z 12 XE, Z 12 XEP   | 09/00 → 12/07   | AC, →ICH 36 152608,<br>44 001048  | VKMA 35013<br>VKMV 5PK1355<br>VKM 35013  | 1   | 1   | 1   |   |   |   |   |   |
|   | <b>B(Alt)</b> Z 12 XE, Z 12 XEP   | 09/00 → 03/07   | AC, CH 36 152609,<br>44 001049 I→   | VKMV 5PK1368<br>VKM 35013  | 1   | 1   | 1   |   |   |   |   |   |
| <b>VAUXHALL  CORSA Mk II 1.4 16V</b> |   |   |   |  |   |   |   |   |   |   |   |   |
|                                      | Z 14 XE   | 09/00 → 12/02   | 3), →IMot. 20 EB2049  | VKMS 05154-1<br>VKMA 05154<br>VKM 15216  | 1<br>1<br>1   | 2<br>2<br>1   | 1<br>1<br>1   |   |   | 3   | 3<br>2<br>1   | T0157   |













































VAUXHALL

|   |  |  |  |  |  |  |  |  |  |  |  |  |
|---|---|---|---|--|---|---|---|---|---|---|---|---|
|   |   |   |   | VKM 25152<br>VKM 25312   | 1<br>1  |   |   |   |   |   |   |   |
|   | Z 14 XE   | 01/03 → 10/07   | 3), → <b>I</b> Mot. 20 EB2049   | VKMS 05154-2<br>VKMA 05154<br>VKM 15216<br>VKM 25152<br>VKM 25312                  | 1<br>1<br>1   | 2<br>2<br>1   | 1   |   |   | 3   | 3<br>2<br>1   | T0157   |
|   | Z 14 XE   | 01/03 → 10/07   | <b>Mot.</b> 20 EB2050 <b>I</b> →  | VKMA 05156<br>VKM 15216<br>VKM____<br>VKM 25158                                    | 1<br>1  | 2<br>1  | 1   |   |   |   | 1<br>1  | T0157   |
|   | Z 14 XE   | 09/00 → 10/07   | → <b>I</b> Mot. 02 MZ5253,<br>20 U75998   | VKPC 85212   |   |   |   |   | 1   |   |   |   |
|   | Z 14 XE   | 09/00 → 10/07   | <b>Mot.</b> 02 MZ5254,<br>20 U75999 <b>I</b> →                                    | VKPC 85211   |   |   |   |   | 1   |   |   |   |
|   | <b>B(Alt)</b> Z 14 XE   | 09/00 → 10/07   | <b>AC</b>   | VKMA 35012<br>VKMV 5PK938<br>VKM 35012   | 1   |   | 1<br>1  |   |   |   |   |   |
|   | <b>B(Alt)</b> Z 14 XE   | 09/00 → 10/07   | <b>AC</b>   | VKMA 35022<br>VKMV 5PK1212<br>VKM 35012  | 1   |   | 1<br>1  |   |   |   |   |   |
| <b>VAUXHALL</b>  <b>CORSA Mk II 1.8 16V</b>    |   |   |   |  |   |   |   |   |   |   |   |   |
|   | Z 18 XE   | 09/00 → 12/02   | 3), → <b>I</b> Mot. 20 EB2049   | VKMS 05154-1<br>VKMA 05154<br>VKM 15216<br>VKM 25152<br>VKM 25312                  | 1<br>1<br>1   | 2<br>2<br>1   | 1   |   |   | 3   | 3<br>2<br>1   | T0157   |
|   | Z 18 XE   | 01/03 → 10/07   | 3), → <b>I</b> Mot. 20 EB2049   | VKMS 05154-2<br>VKMA 05154<br>VKM 15216<br>VKM 25152<br>VKM 25312                  | 1<br>1<br>1   | 2<br>2<br>1   | 1   |   |   | 3   | 3<br>2<br>1   | T0157   |
|   | Z 18 XE   | 01/03 → 10/07   | <b>Mot.</b> 20 EB2050 <b>I</b> →  | VKMA 05156<br>VKM 15216<br>VKM____<br>VKM 25158                                    | 1<br>1  | 2<br>1  | 1   |   |   |   | 1<br>1  | T0157   |
|   | Z 18 XE   | 09/00 → 10/07   |   | VKPC 85624   |   |   |   |   | 1   |   |   |   |
|   | <b>B(Alt)</b> Z 18 XE   | 09/00 → 10/07   | <b>AC</b>   | VKMA 35012<br>VKMV 5PK938<br>VKM 35012   | 1   |   | 1<br>1  |   |   |   |   |   |
|   | <b>B(Alt)</b> Z 18 XE   | 09/00 → 10/07   | <b>AC</b>   | VKMA 35022<br>VKMV 5PK1212<br>VKM 35012  | 1   |   | 1<br>1  |   |   |   |   |   |
| <b>VAUXHALL</b>  <b>CORSA Mk II 1.3 CDTI</b> |   |   |   |  |   |   |   |   |   |   |   |   |
|   | Y 13 DT, Z 13 DT  | 04/04 → 10/07   |   | <del>OKOKOK</del>  |   |   |   |   |   |   |   |   |
|   | Y 13 DT, Z 13 DT  | 04/04 → 10/07   |   | VKPC 85700   |   |   |   |   | 1   |   |   |   |
|   | <b>B(Alt)</b> Z 13 DT   | 04/04 → 10/07   | <b>AC</b>   | VKMA 35012<br>VKMV 6PK1182<br>VKM 35023  | 1   |   | 1   |   |   |   |   |   |
|   | <b>B(Alt)</b> Z 13 DT   | 04/04 → 10/07   | <b>AC</b>   | VKMA 35012<br>VKMV 6PK1182<br>VKM 35023  | 1   |   | 1   |   |   |   |   |   |
| <b>VAUXHALL</b>  <b>CORSA Mk II 1.7 DI</b>   |   |   |   |  |   |   |   |   |   |   |   |   |
|   | Y 17 DTL (ISUZU)  | 09/00 → 10/07   | → <b>I</b> Mot. 328704  | VKMA 05606<br>VKM 15215<br>VKM 25208   | 1<br>1  | 1<br>1  | 1   |   |   |   | 1   | T0182   |
|   | Y 17 DTL (ISUZU)  | 09/00 → 10/07   | <b>Mot.</b> 328705 <b>I</b> →   | VKMA 05608<br>VKM 15218<br>VKM 25208   | 1<br>1  | 1<br>1  | 1   |   |   |   | 3<br>1  | T0182   |
|   | Y 17 DTL (ISUZU)  | 09/00 → 10/07   |   | VKPC 85300   |   |   |   |   | 1   |   |   |   |
|   | <b>B(Alt)</b> Y 17 DTL (ISUZU)  | 09/00 → 10/07   | <b>AC</b>   | VKMA 35215<br>VKMV 6PK1250<br>VKM 35015  | 1   |   | 1<br>1  |   |   |   |   |   |
|   | <b>B(Alt)</b> Y 17 DTL (ISUZU)  | 09/00 → 10/07   | <b>AC</b>   | VKMA 35315<br>VKMV 6PK1590<br>VKM 35015<br>VKM 35025                               | 1<br>1  | 1<br>1  | 1<br>1  |   |   |   |   |   |









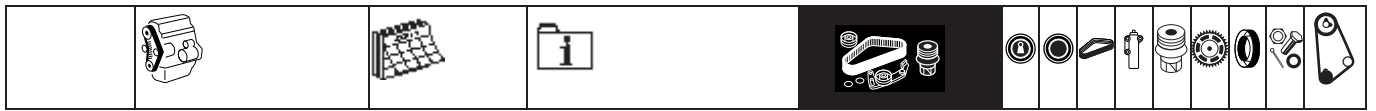















| <b>VAUXHALL</b> <b>CORSA Mk II 1.7 DTI</b>        |                         |               |                |                |   |   |   |  |   |  |  |   |       |
|---|-------------------------|---------------|----------------|----------------|---|---|---|--|---|--|--|---|-------|
|   | Y 17 DT (ISUZU)         | 09/00 → 10/07 | → IMot. 328704 | VKMA 05606     | 1 | 1 | 1 |  |   |  |  | 1 | T0182 |
|   |                         |               |                | VKM 15215      | 1 |   |   |  |   |  |  |   |       |
|   |                         |               |                | VKM 25208      |   | 1 |   |  |   |  |  | 1 |       |
|   | Y 17 DT (ISUZU)         | 09/00 → 10/07 | Mot. 328705 I→ | VKMA 05608     | 1 | 1 | 1 |  |   |  |  | 3 | T0182 |
|   |                         |               |                | VKM 15218      | 1 |   |   |  |   |  |  |   |       |
|   |                         |               |                | VKM 25208      |   | 1 |   |  |   |  |  | 1 |       |
|   | Y 17 DT (ISUZU)         | 09/00 → 10/07 |                | VKPC 85300     |   |   |   |  | 1 |  |  |   |       |
|   | B(Alt) Y 17 DT (ISUZU)  | 09/00 → 10/07 | AC             | VKMA 35215     | 1 |   | 1 |  |   |  |  |   |       |
|   |                         |               |                | VKMMV 6PK1250  |   |   | 1 |  |   |  |  |   |       |
|   |                         |               |                | VKM 35015      | 1 |   |   |  |   |  |  |   |       |
|   | B(Alt) Y 17 DT (ISUZU)  | 09/00 → 10/07 | AC             | VKMA 35315     | 1 | 1 | 1 |  |   |  |  |   |       |
|   |                         |               |                | VKMMV 6PK1590  |   |   | 1 |  |   |  |  |   |       |
|   |                         |               |                | VKM 35015      | 1 |   |   |  |   |  |  |   |       |
|   |                         |               |                | VKM 35025      |   | 1 |   |  |   |  |  |   |       |
| <b>VAUXHALL</b> <b>CORSA Mk II 1.7 CDTI</b>       |                         |               |                |                |   |   |   |  |   |  |  |   |       |
|   | Z 17 DTH (ISUZU)        | 04/04 → 10/07 |                | VKMA 05608     | 1 | 1 | 1 |  |   |  |  | 3 | T0182 |
|   |                         |               |                | VKM 15218      | 1 |   |   |  |   |  |  |   |       |
|   |                         |               |                | VKM 25208      |   | 1 |   |  |   |  |  | 1 |       |
|   | Z 17 DTH (ISUZU)        | 04/04 → 10/07 |                | VKPC 85300     |   |   |   |  | 1 |  |  |   |       |
|   | B(Alt) Z 17 DTH (ISUZU) | 04/04 → 10/07 | AC             | VKMA 35015     | 1 |   | 1 |  |   |  |  |   |       |
|   |                         |               |                | VKMMV 6PK1275  |   |   | 1 |  |   |  |  |   |       |
|   |                         |               |                | VKM 35015      | 1 |   |   |  |   |  |  |   |       |
|   | B(Alt) Z 17 DTH (ISUZU) | 04/04 → 10/07 | AC             | VKMMV 6PK1600  |   |   | 1 |  |   |  |  |   |       |
|   |                         |               |                | VKM 35015      | 1 |   |   |  |   |  |  |   |       |
|   |                         |               |                | VKM 35025      |   | 1 |   |  |   |  |  |   |       |
| <b>VAUXHALL</b> <b>CORSA Mk III 1.0 16V</b>       |                         |               |                |                |   |   |   |  |   |  |  |   |       |
|   | Z 10 XEP                | 07/06 → 12/07 |                | <b>ΟΧΘΙΟΧΟ</b> |   |   |   |  |   |  |  |   |       |
|   | Z 10 XEP                | 07/06 → 12/07 |                | VKPC 85310     |   |   |   |  | 1 |  |  |   |       |
|   | B(Alt) Z 10 XEP         | 07/06 → 12/07 | AC             | VKMA 35113     | 1 |   | 1 |  |   |  |  |   |       |
|   |                         |               |                | VKMMV 5PK1230  |   |   | 1 |  |   |  |  |   |       |
|   |                         |               |                | VKM 35013      | 1 |   |   |  |   |  |  |   |       |
|   | B(Alt) Z 10 XEP         | 07/06 → 12/07 | AC             | VKMA 35013     | 1 |   | 1 |  |   |  |  |   |       |
|   |                         |               |                | VKMMV 5PK1355  |   |   | 1 |  |   |  |  |   |       |
|   |                         |               |                | VKM 35013      | 1 |   |   |  |   |  |  |   |       |
| <b>VAUXHALL</b> <b>CORSA Mk III 1.2 16V</b>       |                         |               |                |                |   |   |   |  |   |  |  |   |       |
|   | Z 12 XEP                | 07/06 → 12/07 |                | <b>ΟΧΘΙΟΧΟ</b> |   |   |   |  |   |  |  |   |       |
|   | Z 12 XEP                | 07/06 → 12/07 |                | VKPC 85310     |   |   |   |  | 1 |  |  |   |       |
|   | B(Alt) Z 12 XEP         | 07/06 → 12/07 | AC             | VKMA 35113     | 1 |   | 1 |  |   |  |  |   |       |
|   |                         |               |                | VKMMV 5PK1230  |   |   | 1 |  |   |  |  |   |       |
|   |                         |               |                | VKM 35013      | 1 |   |   |  |   |  |  |   |       |
|   | B(Alt) Z 12 XEP         | 07/06 → 12/07 | AC             | VKMA 35013     | 1 |   | 1 |  |   |  |  |   |       |
|   |                         |               |                | VKMMV 5PK1355  |   |   | 1 |  |   |  |  |   |       |
|   |                         |               |                | VKM 35013      | 1 |   |   |  |   |  |  |   |       |
| <b>VAUXHALL</b> <b>CORSA Mk III 1.4 16V</b>       |                         |               |                |                |   |   |   |  |   |  |  |   |       |
|   | Z 14 XEP                | 07/06 → 12/07 |                | <b>ΟΧΘΙΟΧΟ</b> |   |   |   |  |   |  |  |   |       |
|   | Z 14 XEP                | 07/06 → 12/07 |                | VKPC 85310     |   |   |   |  | 1 |  |  |   |       |
|   | B(Alt) Z 14 XEP         | 07/06 → 12/07 | AC             | VKMA 35113     | 1 |   | 1 |  |   |  |  |   |       |
|   |                         |               |                | VKMMV 5PK1230  |   |   | 1 |  |   |  |  |   |       |
|   |                         |               |                | VKM 35013      | 1 |   |   |  |   |  |  |   |       |
|   | B(Alt) Z 14 XEP         | 07/06 → 12/07 | AC             | VKMA 35013     | 1 |   | 1 |  |   |  |  |   |       |
|   |                         |               |                | VKMMV 5PK1355  |   |   | 1 |  |   |  |  |   |       |
|   |                         |               |                | VKM 35013      | 1 |   |   |  |   |  |  |   |       |
| <b>VAUXHALL</b> <b>CORSA Mk III 1.6 16V Turbo</b> |                         |               |                |                |   |   |   |  |   |  |  |   |       |
|   | Z 16 LER                | 02/07 → 12/07 |                | VKMA ____      | 1 | 1 | 1 |  |   |  |  | 2 | T0244 |
|   |                         |               |                | VKM 15260      | 1 |   |   |  |   |  |  |   |       |
|   |                         |               |                | VKM ____       |   | 1 |   |  |   |  |  |   |       |
|   | Z 16 LER                | 02/07 → 12/07 |                | VKPC ____      |   |   |   |  | 1 |  |  |   |       |
|   | B(Alt) Z 16 LER         | 02/07 → 12/07 | AC             | VKMMV 5PK1450  |   |   | 1 |  |   |  |  |   |       |
|   |                         |               |                | VKM 35260      | 1 |   |   |  |   |  |  |   |       |
|   | B(Alt) Z 16 LER         | 02/07 → 12/07 | AC             | VKMMV 5PK1546  |   |   | 1 |  |   |  |  |   |       |
|   |                         |               |                | VKM 35260      | 1 |   |   |  |   |  |  |   |       |









































|   |  |  |                        |   |  |  |  |  |  |  |  |  |
|---|---|---|---|---|---|---|---|---|---|---|---|---|
| <b>VAUXHALL  CORSA Mk III 1.3 CDTI</b>   |   |   |   |   |   |   |   |   |   |   |   |   |
|   | A 13 DTH, A 13 DTJ,<br>Z 13 DTH, Z 13 DTJ   | 07/06 → 12/07   |   |    |   |   |   |   |   |   |   |   |
|   | A 13 DTH, A 13 DTJ,<br>Z 13 DTH, Z 13 DTJ   | 07/06 → 12/07   |   | VKPC 85700  |   |   |   | 1   |   |   |   |   |
|   | <b>B(Alt)</b> A 13 DTH, A 13 DTJ,<br>Z 13 DTH, Z 13 DTJ                           | 07/06 → 12/07   | <i>AC</i>   | VKMV 6PK1182<br>VKM 35023   | 1   |   |   | 1   |   |   |   |   |
|   | <b>B(Alt)</b> A 13 DTH, A 13 DTJ,<br>Z 13 DTH, Z 13 DTJ                           | 07/06 → 12/07   | <b>AC</b>   | VKMV____<br>VKM 35023   | 1   |   |   | 1   |   |   |   |   |
| <b>VAUXHALL  CORSA Mk III 1.7 CDTI</b>   |   |   |   |   |   |   |   |   |   |   |   |   |
|   | A 17 DTR, Z 17 DTR  | 07/06 → 09/07   |   | —<br>VKM 15218<br>—   | 1<br>1  | 1   | 1   |   |   |   |   | 3 T0182   |
|   | A 17 DTR, Z 17 DTR  | 07/06 → 03/07   |   | VKPC 85300  |   |   |   | 1   |   |   |   |   |
|   | <b>B(Alt)</b> A 17 DTR, Z 17 DTR  | 07/06 → 09/07   | <i>AC</i>   | VKMV 6PK1250<br>VKM____   | 1   |   |   | 1   |   |   |   |   |
|   | <b>B(Alt)</b> A 17 DTR, Z 17 DTR  | 07/06 → 09/07   | <b>AC</b>   | VKMV 6PK1615<br>VKM____<br>VKM____  | 1   | 1   |   | 1   |   |   |   |   |
| <b>VAUXHALL  FRONTERA Mk I 2.0</b>       |   |   |   |   |   |   |   |   |   |   |   |   |
|   | C 20 NE   | 03/92 → 10/98   |  <b>Mot.</b> 14 608700 | VKMC 05401  |   |   | 1   | 1   |   |   |   | T0225   |
|   | C 20 NE   | 03/92 → 10/98   | <b>Mot.</b> 14 608701 I→  | VKMA 05402<br>VKM 15402   | 1<br>1  |   | 1   |   |   |   |   | T0105   |
|   | X 20 SE   | 03/92 → 10/98   |   | VKMA 05402<br>VKM 15402   | 1<br>1  | 1   |   |   |   |   |   | T0105   |
|   | C 20 NE   | 03/92 → 10/98   | → <b>Mot.</b> 14 608700   | VKPC 85407  |   |   |   | 1   |   |   |   |   |
|   | C 20 NE   | 03/92 → 10/98   | <b>Mot.</b> 14 608701 I→  | VKPC 85409  |   |   |   | 1   |   |   |   |   |
|   | X 20 SE   | 03/92 → 10/98   |   | VKPC 85409  |   |   |   | 1   |   |   |   |   |
|   | <b>B(Alt)</b> X 20 SE   | 03/92 → 10/98   | <i>AC</i>   | VKMA 35009<br>VKMV 6PK1725<br>VKM 35009   | 1<br>1  |   | 1   | 1   |   |   |   |   |
|   | <b>B(Alt)</b> X 20 SE   | 03/92 → 10/98   | <b>AC</b>   | VKMV 6PK2050<br>VKM 35009   | 1   |   | 1   |   |   |   |   |   |
| <b>VAUXHALL  FRONTERA Mk I 2.2 16V</b> |   |   |   |   |   |   |   |   |   |   |   |   |
|   | X 22 XE   | 03/95 → 12/96   | → <b>ICH</b> TV 899999  | VKMA 05223<br>VKM 15202<br>VKM 25212<br>VKM 25212                                   | 1<br>1  | 2   | 1   |   |   |   |   | T0139   |
|   | X 22 XE   | 01/97 → 10/98   | <b>CH</b> VV 600001 I→  | VKMA 05228<br>VKM 15230<br>VKM 25212<br>VKM 25212                                   | 1<br>1  | 2   | 1   |   |   |   |   | T0139   |
|   | X 22 XE   | 03/95 → 10/98   |   | VKPC 85611  |   |   |   | 1   |   |   |   |   |
|   | <b>B(Alt)</b> X 22 XE   | 03/95 → 10/98   | <i>AC</i>   | VKMA 35009<br>VKMV 6PK1725<br>VKM 35009   | 1<br>1  |   | 1   | 1   |   |   |   |   |
|   | <b>B(Alt)</b> X 22 XE   | 03/95 → 10/98   | <b>AC</b>   | VKMV 6PK2050<br>VKM 35009   | 1   |   | 1   |   |   |   |   |   |
| <b>VAUXHALL  FRONTERA Mk I 2.4</b>     |   |   |   |   |   |   |   |   |   |   |   |   |
|   | C 24 NE   | 03/92 → 10/98   |   |  |   |   |   |   |   |   |   |   |
|   | C 24 NE   | 03/92 → 10/98   |   | VKPC 85603  |   |   |   | 1   |   |   |   |   |
| <b>VAUXHALL  FRONTERA Mk I 2.3 TD</b>  |   |   |   |   |   |   |   |   |   |   |   |   |
|   | 23 TD   | 03/92 → 10/98   |   |  |   |   |   |   |   |   |   |   |
|   | 23 TD   | 03/92 → 10/98   |   | VKPC 85603  |   |   |   | 1   |   |   |   |   |
| <b>VAUXHALL  FRONTERA Mk I 2.5 TD</b>  |   |   |   |   |   |   |   |   |   |   |   |   |
|   | 25 TD, 25TDS  | 09/96 → 10/98   |   | VKPC 82810  |   |   |   | 1   |   |   |   |   |
| <b>VAUXHALL  FRONTERA Mk I 2.8 TD</b>  |   |   |   |   |   |   |   |   |   |   |   |   |
|   | 28 TD, 28 TDI   | 03/95 → 10/98   |   | VKMA 99004<br>VKM 79002<br>VKM 89003  | 1<br>1  | 1   | 1   |   |   |   |   | T0628   |









| VAUXHALL  FRONTERA Mk II 2.2 16V    |                                  |               |                            |                |   |   |   |  |  |   |  |  |   |   |  |  |  |       |
|--|----------------------------------|---------------|----------------------------|----------------|---|---|---|--|--|---|--|--|---|---|--|--|--|-------|
|                                     | X 22 SE, Y 22 SE                 | 10/98 → 01/07 |                            | VKMA 05228     | 1 | 2 | 1 |  |  |   |  |  |   |   |  |  |  | T0139 |
|  |                                  |               |                            | VKM 15230      | 1 |   |   |  |  |   |  |  |   |   |  |  |  |       |
|  |                                  |               |                            | VKM 25212      |   |   | 1 |  |  |   |  |  |   |   |  |  |  |       |
|  |                                  |               |                            | VKM 25212      |   |   | 1 |  |  |   |  |  |   |   |  |  |  |       |
|                                     | X 22 SE, Y 22 SE                 | 10/98 → 10/07 |                            | VKPC 85611     |   |   |   |  |  | 1 |  |  |   |   |  |  |  |       |
|                                     | <b>B(Alt)</b> X 22 SE, Y 22 SE   | 10/98 → 01/07 | <b>AC</b>                  | VKMA 35009     | 1 |   | 1 |  |  |   |  |  |   |   |  |  |  |       |
|  |                                  |               |                            | VKMV 6PK1725   |   |   | 1 |  |  |   |  |  |   |   |  |  |  |       |
|  |                                  |               |                            | VKM 35009      | 1 |   |   |  |  |   |  |  |   |   |  |  |  |       |
|  | <b>B(Alt)</b> X 22 SE, Y 22 SE   | 10/98 → 01/07 | <b>AC</b>                  | VKMV 6PK1850   |   |   | 1 |  |  |   |  |  |   |   |  |  |  |       |
|  |                                  |               |                            | VKM 35009      | 1 |   |   |  |  |   |  |  |   |   |  |  |  |       |
| VAUXHALL  FRONTERA Mk II 3.2        |                                  |               |                            |                |   |   |   |  |  |   |  |  |   |   |  |  |  |       |
|                                     | 6 VD1, Y 32 NE                   | 10/98 → 01/07 |                            | —              | 1 | 1 | 1 |  |  |   |  |  |   |   |  |  |  |       |
|  |                                  |               |                            | —              | 1 |   |   |  |  |   |  |  |   |   |  |  |  |       |
|  |                                  |               |                            | VKM_____       |   |   | 1 |  |  |   |  |  |   |   |  |  |  |       |
|                                     | 6 VD1, Y 32 NE                   | 10/98 → 10/07 | 2)                         | —              |   |   |   |  |  | 1 |  |  |   |   |  |  |  |       |
|  |                                  |               |                            | —              |   |   |   |  |  | 1 |  |  |   |   |  |  |  |       |
| VAUXHALL  FRONTERA Mk II 2.2 DTI    |                                  |               |                            |                |   |   |   |  |  |   |  |  |   |   |  |  |  |       |
|                                     | X 22 DTH, Y 22 DTH               | 10/98 → 01/07 |                            | <b>OKOKOKO</b> |   |   |   |  |  |   |  |  |   |   |  |  |  |       |
|                                     | X 22 DTH, Y 22 DTH               | 10/98 → 10/07 |                            | VKPC 85623     |   |   |   |  |  | 1 |  |  |   |   |  |  |  |       |
|                                     | <b>B(Alt)</b> X 22 DTH, Y 22 DTH | 10/98 → 01/07 | <b>AC</b>                  | VKMA 35007     | 1 |   | 1 |  |  |   |  |  |   |   |  |  |  |       |
|  |                                  |               |                            | VKMV 6PK1805   |   |   | 1 |  |  |   |  |  |   |   |  |  |  |       |
|  |                                  |               |                            | VKM 35007      | 1 |   |   |  |  |   |  |  |   |   |  |  |  |       |
|  | <b>B(Alt)</b> X 22 DTH, Y 22 DTH | 10/98 → 01/07 | <b>AC</b>                  | VKMA 35107     | 1 |   | 1 |  |  |   |  |  |   |   |  |  |  |       |
|  |                                  |               |                            | VKMV 6PK1902   |   |   | 1 |  |  |   |  |  |   |   |  |  |  |       |
|  |                                  |               |                            | VKM 35007      | 1 |   |   |  |  |   |  |  |   |   |  |  |  |       |
|                                   | X 22 DTH, Y 22 DTH               | 10/98 → 01/07 |                            | VKM_____       |   |   |   |  |  | 1 |  |  |   |   |  |  |  |       |
| VAUXHALL  MERIVA 1.4 16V Twinport |                                  |               |                            |                |   |   |   |  |  |   |  |  |   |   |  |  |  |       |
|                                   | Z 14 XEP                         | 07/04 → 03/07 |                            | <b>OKOKOKO</b> |   |   |   |  |  |   |  |  |   |   |  |  |  |       |
|                                   | Z 14 XEP                         | 07/04 → 10/07 |                            | VKPC 85310     |   |   |   |  |  | 1 |  |  |   |   |  |  |  |       |
|                                   | <b>B(Alt)</b> Z 14 XEP           | 07/04 → 03/07 | <b>AC</b>                  | VKMA 35113     | 1 |   | 1 |  |  |   |  |  |   |   |  |  |  |       |
|  |                                  |               |                            | VKMV 5PK1230   |   |   | 1 |  |  |   |  |  |   |   |  |  |  |       |
|  |                                  |               |                            | VKM 35013      | 1 |   |   |  |  |   |  |  |   |   |  |  |  |       |
|  | <b>B(Alt)</b> Z 14 XEP           | 07/04 → 03/07 | <b>AC, →ICH 44 001048</b>  | VKMA 35013     | 1 |   | 1 |  |  |   |  |  |   |   |  |  |  |       |
|  |                                  |               |                            | VKMV 5PK1355   |   |   | 1 |  |  |   |  |  |   |   |  |  |  |       |
|  |                                  |               |                            | VKM 35013      | 1 |   |   |  |  |   |  |  |   |   |  |  |  |       |
|  | <b>B(Alt)</b> Z 14 XEP           | 07/04 → 03/07 | <b>AC, CH 44 001049 I→</b> | VKMV 5PK1368   |   |   | 1 |  |  |   |  |  |   |   |  |  |  |       |
|  |                                  |               |                            | VKM 35013      | 1 |   |   |  |  |   |  |  |   |   |  |  |  |       |
| VAUXHALL  MERIVA 1.6              |                                  |               |                            |                |   |   |   |  |  |   |  |  |   |   |  |  |  |       |
|                                   | Z 16 SE                          | 05/03 → 10/07 | 3)                         | VKMS 05121     | 1 |   | 1 |  |  |   |  |  | 2 | 1 |  |  |  | T0092 |
|  |                                  |               |                            | VKMA 05121     | 1 |   | 1 |  |  |   |  |  |   | 1 |  |  |  |       |
|  |                                  |               |                            | VKM 15121      | 1 |   |   |  |  |   |  |  |   | 1 |  |  |  |       |
|                                   | Z 16 SE                          | 05/03 → 10/07 |                            | VKPC 85460     |   |   |   |  |  | 1 |  |  |   |   |  |  |  |       |
|                                   | <b>B(Alt)</b> Z 16 SE            | 05/03 → 10/07 | <b>AC</b>                  | VKMA 35012     | 1 |   | 1 |  |  |   |  |  |   |   |  |  |  |       |
|  |                                  |               |                            | VKMV 5PK938    |   |   | 1 |  |  |   |  |  |   |   |  |  |  |       |
|  |                                  |               |                            | VKM 35012      | 1 |   |   |  |  |   |  |  |   |   |  |  |  |       |
|  | <b>B(Alt)</b> Z 16 SE            | 05/03 → 10/07 | <b>AC</b>                  | VKMA 35022     | 1 |   | 1 |  |  |   |  |  |   |   |  |  |  |       |
|  |                                  |               |                            | VKMV 5PK1212   |   |   | 1 |  |  |   |  |  |   |   |  |  |  |       |
|  |                                  |               |                            | VKM 35012      | 1 |   |   |  |  |   |  |  |   |   |  |  |  |       |
| VAUXHALL  MERIVA 1.6 16V          |                                  |               |                            |                |   |   |   |  |  |   |  |  |   |   |  |  |  |       |
|                                   | Z 16 XE                          | 05/03 → 10/07 | 3), →IMot. 20 EB2049       | VKMS 05154-1   | 1 | 2 | 1 |  |  |   |  |  | 3 | 3 |  |  |  | T0157 |
|  |                                  |               |                            | VKMA 05154     | 1 | 2 | 1 |  |  |   |  |  |   | 2 |  |  |  |       |
|  |                                  |               |                            | VKM 15216      | 1 |   |   |  |  |   |  |  |   | 1 |  |  |  |       |
|  |                                  |               |                            | VKM 25152      |   |   | 1 |  |  |   |  |  |   |   |  |  |  |       |
|  |                                  |               |                            | VKM 25312      |   |   | 1 |  |  |   |  |  |   |   |  |  |  |       |
|  | Z 16 XE                          | 05/03 → 10/07 | <b>Mot. 20 EB2050 I→</b>   | VKMA 05156     | 1 | 2 | 1 |  |  |   |  |  |   | 1 |  |  |  | T0157 |
|  |                                  |               |                            | VKM 15216      | 1 |   |   |  |  |   |  |  |   | 1 |  |  |  |       |
|  |                                  |               |                            | VKM_____       |   |   | 1 |  |  |   |  |  |   |   |  |  |  |       |
|  |                                  |               |                            | VKM 25158      |   |   | 1 |  |  |   |  |  |   |   |  |  |  |       |
|                                   | Z 16 XE                          | 05/03 → 10/07 |                            | VKPC 85211     |   |   |   |  |  | 1 |  |  |   |   |  |  |  |       |
|                                   | <b>B(Alt)</b> Z 16 XE            | 05/03 → 10/07 | <b>AC</b>                  | VKMA 35012     | 1 |   | 1 |  |  |   |  |  |   |   |  |  |  |       |
|  |                                  |               |                            | VKMV 5PK938    |   |   | 1 |  |  |   |  |  |   |   |  |  |  |       |
|  |                                  |               |                            | VKM 35012      | 1 |   |   |  |  |   |  |  |   |   |  |  |  |       |













































































|  |  |  |  |   |  |  |  |  |  |  |  |  |  |
|--|---|---|---|---|---|---|---|---|---|---|---|---|---|
|  | <b>B(Alt)</b>   | Z 16 XE   | 05/03 → 10/07   | <b>AC</b>   | VKMA 35022<br>VKMV 5PK1212<br>VKM 35012   | 1<br>1<br>1   | 1<br>1  |   |   |   |   |   |   |
| <b>VAUXHALL</b>  <b>MERIVA 1.6 16V Turbo</b>    |   |   |   |   |   |   |   |   |   |   |   |   |   |
|    |   | Z 16 LET  | 05/06 → 03/07   |   | VKMA____<br>VKM 15260<br>VKM____  | 1<br>1<br>1   | 1<br>1  | 1   |   |   |   | 2   | T0244   |
|    |   | Z 16 LET  | 05/06 → 10/07   |   | VKPC____  |   |   |   | 1   |   |   |   |   |
|    | <b>B(Alt)</b>   | Z 16 LET  | 05/06 → 06/07   | <b>AC</b>   | VKMV 5PK1450<br>VKM 35260   | 1   | 1   |   |   |   |   |   |   |
|  | <b>B(Alt)</b>   | Z 16 LET  | 05/06 → 06/07   | <b>AC</b>   | VKMV 5PK1546<br>VKM 35260   | 1   | 1   |   |   |   |   |   |   |
| <b>VAUXHALL</b>  <b>MERIVA 1.6 16V Twinport</b> |   |   |   |   |   |   |   |   |   |   |   |   |   |
|    |   | Z 16 XEP  | 01/06 → 03/07   |   | VKMA____<br>VKM 15260<br>VKM____  | 1<br>1<br>1   | 1<br>1  | 1   |   |   |   | 2   | T0244   |
|    |   | Z 16 XEP  | 01/06 → 10/07   |   | VKPC____  |   |   |   | 1   |   |   |   |   |
|    | <b>B(Alt)</b>   | Z 16 XEP  | 01/06 → 06/07   | <b>AC</b>   | VKMV 5PK1450<br>VKM 35260   | 1   | 1   |   |   |   |   |   |   |
|  | <b>B(Alt)</b>   | Z 16 XEP  | 01/06 → 06/07   | <b>AC</b>   | VKMV 5PK1546<br>VKM 35260   | 1   | 1   |   |   |   |   |   |   |
| <b>VAUXHALL</b>  <b>MERIVA 1.8 16V</b>          |   |   |   |   |   |   |   |   |   |   |   |   |   |
|    |   | Z 18 XE   | 05/03 → 10/07   | 3), → <b>Mot.</b> 20 EB2049   | VKMS 05154-3<br>VKMA 05154<br>VKM 15216<br>VKM 25152<br>VKM 25312                   | 1<br>1<br>1<br>1<br>1   | 2<br>2<br>1<br>1  | 1   |   |   | 3   | 3<br>2<br>1   | T0157   |
|  |   | Z 18 XE   | 05/03 → 10/07   | <b>Mot.</b> 20 EB2050  →  | VKMA 05156<br>VKM 15216<br>VKM____<br>VKM 25158                                     | 1<br>1<br>1<br>1  | 2<br>1<br>1   | 1   |   |   |   | 1<br>1  | T0157   |
|    |   | Z 18 XE   | 05/03 → 10/07   |   | VKPC 85624  |   |   |   | 1   |   |   |   |   |
|    | <b>B(Alt)</b>   | Z 18 XE   | 05/03 → 10/07   | <b>AC</b>   | VKMA 35012<br>VKMV 5PK938<br>VKM 35012  | 1<br>1<br>1   | 1<br>1  |   |   |   |   |   |   |
|  | <b>B(Alt)</b>   | Z 18 XE   | 05/03 → 10/07   | <b>AC</b>   | VKMA 35022<br>VKMV 5PK1212<br>VKM 35012   | 1<br>1<br>1   | 1<br>1  |   |   |   |   |   |   |
| <b>VAUXHALL</b>  <b>MERIVA 1.7 CDTI</b>       |   |   |   |   |   |   |   |   |   |   |   |   |   |
|    |   | Z 17 DTH  | 04/04 → 10/07   |   | VKMA 05608<br>VKM 15218<br>VKM 25208  | 1<br>1<br>1   | 1<br>1  | 1   |   |   |   | 3<br>1  | T0182   |
|    |   | Z 17 DTH  | 04/04 → 10/07   |   | VKPC 85300  |   |   |   | 1   |   |   |   |   |
|    | <b>B(Alt)</b>   | Z 17 DTH  | 04/04 → 10/07   | <b>AC</b>   | VKMA 35015<br>VKMV 6PK1275<br>VKM 35015   | 1<br>1<br>1   | 1<br>1  |   |   |   |   |   |   |
|  | <b>B(Alt)</b>   | Z 17 DTH  | 04/04 → 10/07   | <b>AC</b>   | VKMV 6PK1600<br>VKM 35015<br>VKM 35025  | 1<br>1<br>1   | 1<br>1  |   |   |   |   |   |   |
| <b>VAUXHALL</b>  <b>MONTEREY 3.1 TD</b>       |   |   |   |   |   |   |   |   |   |   |   |   |   |
|    |   | 4 JG2TC   | 09/91 → 07/98   |   | VKMA 99004<br>VKM 79002<br>VKM 89003  | 1<br>1<br>1   | 1<br>1  | 1   |   |   |   |   | T0628   |
| <b>VAUXHALL</b>  <b>NOVA 1.0</b>              |   |   |   |   |   |   |   |   |   |   |   |   |   |
|    |   | 10 S  | 09/82 → 03/93   |   | <b>OXOXOXO</b>  |   |   |   |   |   |   |   |   |
|    |   | 10 S  | 09/82 → 03/93   |   | VKPC 85201  |   |   |   | 1   |   |   |   |   |
| <b>VAUXHALL</b>  <b>NOVA 1.2</b>              |   |   |   |   |   |   |   |   |   |   |   |   |   |
|    |   | 12 NC, E 12 GV  | 01/85 → 10/89   |   | <b>OXOXOXO</b>  |   |   |   |   |   |   |   |   |
|  |   | 12 NV, 12 S, 12 ST  | 09/82 → 03/93   |  | VKMC 05100  |   |   | 1   | 1   |   |   |   | T0226   |
|  |   | 12 NZ, C 12 NZ, X 12 SZ   | 09/89 → 03/93   |  | VKMC 05121<br>VKMA 05121<br>VKM 15121   | 1<br>1<br>1   | 1<br>1  | 1   |   |   |   | 1<br>1<br>1   | T0092   |
|    |   | 12 N, 12 NC, E 12 GV  | 01/85 → 02/90   |   | VKPC 85201  |   |   |   | 1   |   |   |   |   |

|   |  |  |    |  |  |  |  |  |  |  |  |       |
|---|---|---|---|--|---|---|---|---|---|---|---|-------|
|   | 12 NV, 12 S, 12 ST,<br>C 12 NZ  | 05/83 → 03/93   |   |  |   |   |   |   |   |   |   |       |
|   | 12 ST   | 09/82 → 10/87   |   |  |   |   |   |   |   |   |   |       |
|   | 12 ST   | 09/82 → 10/87   |   |  |   |   |   |   |   |   |   |       |
| <b>VAUXHALL  NOVA 1.3</b>      |   |   |   |  |   |   |   |   |   |   |   |       |
|                                | 13 NB, 13 S, 13 SB,<br>13NB, 13S, 13SB,<br>C 13 N, C13N                           | 09/82 → 03/93   |    |  |   |   |   |   |   |   |   | T0224 |
|                                | 13 NB, 13 S, 13 SB,<br>C 13 N   | 09/82 → 03/93   |   |  |   |   |   |   |   |   |   |       |
| <b>VAUXHALL  NOVA 1.4</b>      |   |   |   |  |   |   |   |   |   |   |   |       |
|                                | 14 NV   | 01/90 → 03/93   |  → <b>Mot.</b> 02 J22349,<br>19 307805   |  |   |   |   |   |   |   |   | T0228 |
|   | 14 NV   | 01/90 → 03/93   |  <b>Mot.</b> 02 J22350,<br>19 307806   →   |  |   |   |   |   |   |   |   |       |
|   | C 14 NZ   | 01/90 → 03/93   |  → <b>Mot.</b> 02 J22349,<br>19 311737   |  |   |   |   |   |   |   |   | T0228 |
|   | C 14 NZ   | 01/90 → 03/93   |  <b>Mot.</b> 02 J22350,<br>19 311738   →   |  |   |   |   |   |   |   |   |       |
|   | C 14 SE   | 09/91 → 03/93   |    |  |   |   |   |   |   |   |   |       |
|                                | 14 NV   | 01/90 → 03/93   | → <b>Mot.</b> 02 J22349,<br>19 307805   |  |   |   |   |   |   |   |   |       |
|   | 14 NV   | 01/90 → 03/93   | <b>Mot.</b> 02 J22350,<br>19 307806   →   |  |   |   |   |   |   |   |   |       |
|   | C 14 NZ   | 01/90 → 03/93   | → <b>Mot.</b> 02 J22349,<br>19 311737   |  |   |   |   |   |   |   |   |       |
|   | C 14 NZ   | 01/90 → 03/93   | <b>Mot.</b> 02 J22350,<br>19 311738   →   |  |   |   |   |   |   |   |   |       |
|   | C 14 SE   | 09/91 → 03/93   |   |  |   |   |   |   |   |   |   |       |
|                              | 14 NV   | 01/90 → 03/93   | → <b>Mot.</b> 02 J22349,<br>19 307805   |  |   |   |   |   |   |   |   |       |
|   | 14 NV   | 01/90 → 03/93   | <b>Mot.</b> 02 J22350,<br>19 307806   →   |  |   |   |   |   |   |   |   |       |
|   | C 14 NZ   | 01/90 → 03/93   | → <b>Mot.</b> 02 J22349,<br>19 311737   |  |   |   |   |   |   |   |   |       |
|   | C 14 NZ   | 01/90 → 03/93   | <b>Mot.</b> 02 J22350,<br>19 311738   →   |  |   |   |   |   |   |   |   |       |
|   | C 14 SE   | 09/91 → 03/93   |   |  |   |   |   |   |   |   |   |       |
| <b>VAUXHALL  NOVA 1.6</b>    |   |   |   |  |   |   |   |   |   |   |   |       |
|                              | C 16 SE, E 16 SE  | 05/88 → 03/93   |  → <b>Mot.</b> 02 J22349   |  |   |   |   |   |   |   |   | T0228 |
|   | C 16 SE, E 16 SE  | 05/88 → 03/93   |  <b>Mot.</b> 02 J22350   →   |  |   |   |   |   |   |   |   |       |
|                              | C 16 SE, C 16 SEI,<br>E 16 SE   | 05/88 → 03/93   | → <b>Mot.</b> 02 J22349   |  |   |   |   |   |   |   |   |       |
|   | C 16 SE, C 16 SEI,<br>E 16 SE   | 05/88 → 03/93   | <b>Mot.</b> 02 J22350   →   |  |   |   |   |   |   |   |   |       |
| <b>VAUXHALL  NOVA 1.5 D</b>  |   |   |   |  |   |   |   |   |   |   |   |       |
|                              | 15 D (ISUZU)  | 09/87 → 03/93   | 3)  |  |   |   |   |   |   |   |   |       |
|   |   |   |   |  |   |   |   |   |   |   |   |       |
|                              | 15 D (ISUZU)  | 09/87 → 03/93   | → <b>Mot.</b> 804794  |  |   |   |   |   |   |   |   |       |
|   | 15 D (ISUZU)  | 09/87 → 03/93   | <b>Mot.</b> 804795   →,<br>→ <b>Mot.</b> 909999   |  |   |   |   |   |   |   |   |       |
|   | 15 D (ISUZU)  | 09/87 → 03/93   | <b>Mot.</b> 910000   →  |  |   |   |   |   |   |   |   |       |
| <b>VAUXHALL  NOVA 1.5 TD</b> |   |   |   |  |   |   |   |   |   |   |   |       |
|                              | 15 TD (ISUZU)   | 01/90 → 03/93   | 3)  |  |   |   |   |   |   |   |   |       |
|   |   |   |   |  |   |   |   |   |   |   |   |       |
|                              | 15 TD (ISUZU)   | 01/90 → 03/93   | → <b>Mot.</b> 804794  |  |   |   |   |   |   |   |   |       |
|   | 15 TD (ISUZU)   | 01/90 → 03/93   | <b>Mot.</b> 804795   →,<br>→ <b>Mot.</b> 909999   |  |   |   |   |   |   |   |   |       |
|   | 15 TD (ISUZU)   | 01/90 → 03/93   | <b>Mot.</b> 910000   →  |  |   |   |   |   |   |   |   |       |
| <b>VAUXHALL  NOVAVAN 1.2</b> |   |   |   |  |   |   |   |   |   |   |   |       |
|                              | 12 NV, 12 S, 12 ST  | 01/90 → 10/94   |    |  |   |   |   |   |   |   |   | T0226 |
|                              | 12 NV   | 01/90 → 10/94   |   |  |   |   |   |   |   |   |   |       |



























































VAUXHALL

























|   |  |  |  |  |  |  |  |  |  |  |  |  |
|---|---|---|---|--|---|---|---|---|---|---|---|---|
| <b>VAUXHALL  NOVAVAN 1.5 D</b>   |   |   |   |  |   |   |   |   |   |   |   |   |
|                                   | 15 D (ISUZU)  | 01/91 → 10/94   | 3)  | VKMS 05208   | 1   | 1   | 1   |   |   | 3   | 1   | T0062   |
|   |   |   |   | VKMA 05208   | 1   | 1   | 1   |   |   |   |   |   |
|   |   |   |   | VKM 15210  | 1   |   |   |   |   |   | 1   |   |
|   |   |   |   | VKM 25208  |   | 1   |   |   |   |   |   |   |
|                                   | 15 D (ISUZU)  | 01/91 → 10/94   | → Mot. 804794   | VKPC 85403   |   |   |   | 1   |   |   |   |   |
|   | 15 D (ISUZU)  | 01/91 → 10/94   | Mot. 804795  →,   |  |   |   |   |   |   |   |   |   |
|   |   |   | → Mot. 909999   | VKPC 85404   |   |   |   | 1   |   |   |   |   |
|   | 15 D (ISUZU)  | 01/91 → 10/94   | Mot. 910000  →  | VKPC 85410   |   |   |   | 1   |   |   |   |   |
| <b>VAUXHALL  OMEGA 2.0</b>       |   |   |   |  |   |   |   |   |   |   |   |   |
|                                   | 20 SE, X 20 SE  | 03/94 → 12/00   |   | VKMA 05402   | 1   |   | 1   |   |   |   |   | T0105   |
|   |   |   |   | VKM 15402  | 1   |   |   |   |   |   |   |   |
|                                   | 20 SE, X 20 SE  | 03/94 → 12/00   |   | VKPC 85409   |   |   |   | 1   |   |   |   |   |
|                                   | B(Alt) 20 SE, X 20 SE   | 03/94 → 12/00   | AC  | VKMA 35009   | 1   |   | 1   |   |   |   |   |   |
|   |   |   |   | VKMV 6PK1725   |   |   | 1   |   |   |   |   |   |
|   |   |   |   | VKM 35009  | 1   |   |   |   |   |   |   |   |
|   | B(Alt) 20 SE, X 20 SE   | 03/94 → 12/00   | AC  | VKMA 35109   | 1   |   | 1   |   |   |   |   |   |
|   |   |   |   | VKMV 6PK1900   |   |   | 1   |   |   |   |   |   |
|   |   |   |   | VKM 35009  | 1   |   |   |   |   |   |   |   |
| <b>VAUXHALL  OMEGA 2.0 16V</b>   |   |   |   |  |   |   |   |   |   |   |   |   |
|                                   | X 20 XEV  | 03/94 → 09/99   | 3)  | VKMS 05222   | 1   | 2   | 1   |   |   | 3   |   | T0116   |
|   |   |   |   | VKMA 05222   | 1   | 2   | 1   |   |   |   |   |   |
|   |   |   |   | VKM 15202  | 1   |   |   |   |   |   |   |   |
|   |   |   |   | VKM 25212  |   | 1   |   |   |   |   |   |   |
|   |   |   |   | VKM 25212  |   | 1   |   |   |   |   |   |   |
|                                  | X 20 XEV  | 03/94 → 09/99   |   | VKPC 85611   |   |   |   | 1   |   |   |   |   |
|                                 | B(Alt) X 20 XEV   | 03/94 → 09/99   | AC  | VKMA 35009   | 1   |   | 1   |   |   |   |   |   |
|   |   |   |   | VKMV 6PK1725   |   |   | 1   |   |   |   |   |   |
|   |   |   |   | VKM 35009  | 1   |   |   |   |   |   |   |   |
|   | B(Alt) X 20 XEV   | 03/94 → 09/99   | AC  | VKMA 35109   | 1   |   | 1   |   |   |   |   |   |
|   |   |   |   | VKMV 6PK1900   |   |   | 1   |   |   |   |   |   |
|   |   |   |   | VKM 35009  | 1   |   |   |   |   |   |   |   |
| <b>VAUXHALL  OMEGA 2.2 16V</b> |   |   |   |  |   |   |   |   |   |   |   |   |
|                                 | Y 22 XE, Z 22 XE  | 09/99 → 10/07   |   | VKMA 05228   | 1   | 2   | 1   |   |   |   |   | T0139   |
|   |   |   |   | VKM 15230  | 1   |   |   |   |   |   |   |   |
|   |   |   |   | VKM 25212  |   | 1   |   |   |   |   |   |   |
|   |   |   |   | VKM 25212  |   | 1   |   |   |   |   |   |   |
|                                 | Y 22 XE, Z 22 XE  | 09/99 → 10/07   |   | VKPC 85611   |   |   |   | 1   |   |   |   |   |
|                                 | B(Alt) Y 22 XE, Z 22 XE   | 09/99 → 10/07   | AC  | VKMA 35009   | 1   |   | 1   |   |   |   |   |   |
|   |   |   |   | VKMV 6PK1725   |   |   | 1   |   |   |   |   |   |
|   |   |   |   | VKM 35009  | 1   |   |   |   |   |   |   |   |
|   | B(Alt) Y 22 XE, Z 22 XE   | 09/99 → 10/07   | AC  | VKMA 35109   | 1   |   | 1   |   |   |   |   |   |
|   |   |   |   | VKMV 6PK1900   |   |   | 1   |   |   |   |   |   |
|   |   |   |   | VKM 35009  | 1   |   |   |   |   |   |   |   |
| <b>VAUXHALL  OMEGA 2.5 V6</b>  |   |   |   |  |   |   |   |   |   |   |   |   |
|                                 | X 25 XE   | 03/94 → 09/00   | 5), → Mot. 08 300418  | VKMA 05500   | 1   | 1   | 1   |   |   |   | 5   | T0135   |
|   | X 25 XE   | 03/94 → 09/00   | 5), Mot. 08 300419  →,  |  |   |   |   |   |   |   |   |   |
|   |   |   | → Mot. 08 578511  | VKMA 05501   | 1   | 1   | 1   |   |   |   | 5   | T0135   |
|   | X 25 XE   | 03/94 → 09/00   | 5), Mot. 08 578512  →   | VKMA 05502   | 1   | 1   | 1   |   |   |   | 5   | T0135   |
|                                 | X 25 XE   | 03/94 → 09/00   |   | VKPC 85613   |   |   |   | 1   |   |   |   |   |
|                                 | B(Alt) X 25 XE  | 03/94 → 09/00   | AC  | VKMV 6PK1900   |   |   | 1   |   |   |   |   |   |
|   |   |   |   | VKM 35500  | 1   |   |   |   |   |   |   |   |
|   | B(Alt) X 25 XE  | 03/94 → 09/00   | AC  | VKMA 35500   | 1   |   | 1   |   |   |   |   |   |
|   |   |   |   | VKMV 6PK2020   |   |   | 1   |   |   |   |   |   |
|   |   |   |   | VKM 35500  | 1   |   |   |   |   |   |   |   |
| <b>VAUXHALL  OMEGA 2.6 V6</b>  |   |   |   |  |   |   |   |   |   |   |   |   |
|                                 | Y 26 SE   | 09/00 → 01/07   | 5), → Mot. 08 578511  | VKMA 05501   | 1   | 1   | 1   |   |   |   | 5   | T0135   |
|   | Y 26 SE   | 09/00 → 01/07   | 5), Mot. 08 578512  →   | VKMA 05502   | 1   | 1   | 1   |   |   |   | 5   | T0135   |
|                                 | Y 26 SE   | 09/00 → 10/07   |   | VKPC 85613   |   |   |   | 1   |   |   |   |   |
|                                 | B(Alt) Y 26 SE  | 09/00 → 10/07   | AC  | VKMV 6PK1900   |   |   | 1   |   |   |   |   |   |
|   |   |   |   | VKM 35500  | 1   |   |   |   |   |   |   |   |
|   | B(Alt) Y 26 SE  | 09/00 → 10/07   | AC  | VKMA 35500   | 1   |   | 1   |   |   |   |   |   |
|   |   |   |   | VKMV 6PK2020   |   |   | 1   |   |   |   |   |   |
|   |   |   |   | VKM 35500  | 1   |   |   |   |   |   |   |   |

| <b>VAUXHALL</b>  <b>OMEGA 3.0 V6</b>       |                  |               |       |                    |   |   |   |   |  |  |   |  |  |  |  |  |  |   |       |  |  |   |  |  |  |  |
|---|------------------|---------------|-------|--------------------|---|---|---|---|--|--|---|--|--|--|--|--|--|---|-------|--|--|---|--|--|--|--|
|    | X 30 XE          | 04/94 → 01/07 | 5), → | Mot. 08 300418     | VKMA 05500                              | 1 | 1 | 1 |  |  |   |  |  |  |  |  |  | 5 | T0135 |  |  |   |  |  |  |  |
|   | X 30 XE          | 04/94 → 01/07 | 5),   | Mot. 08 300419   → | VKMA 05501                              | 1 | 1 | 1 |  |  |   |  |  |  |  |  |  | 5 | T0135 |  |  |   |  |  |  |  |
|    | X 30 XE          | 04/94 → 10/07 |       |                    | VKPC 85613                              |   |   |   |  |  | 1 |  |  |  |  |  |  |   |       |  |  |   |  |  |  |  |
|    | B(Alt) X 30 XE   | 04/94 → 10/07 | AC    |                    | VKMV 6PK1900<br>VKM 35500               | 1 |   | 1 |  |  |   |  |  |  |  |  |  |   |       |  |  |   |  |  |  |  |
|   | B(Alt) X 30 XE   | 04/94 → 10/07 | AC    |                    | VKMA 35500<br>VKMV 6PK2020<br>VKM 35500 | 1 |   | 1 |  |  | 1 |  |  |  |  |  |  |   |       |  |  |   |  |  |  |  |
| <b>VAUXHALL</b>  <b>OMEGA 3.2 V6</b>       |                  |               |       |                    |   |   |   |   |  |  |   |  |  |  |  |  |  |   |       |  |  |   |  |  |  |  |
|    | Y 32 SE          | 02/01 → 01/07 | 5), → | Mot. 08 578511     | VKMA 05501                              | 1 | 1 | 1 |  |  |   |  |  |  |  |  |  | 5 | T0135 |  |  |   |  |  |  |  |
|   | Y 32 SE          | 02/01 → 01/07 | 5),   | Mot. 08 578512   → | VKMA 05502                              | 1 | 1 | 1 |  |  |   |  |  |  |  |  |  | 5 | T0135 |  |  |   |  |  |  |  |
|    | Y 32 SE          | 02/01 → 10/07 |       |                    | VKPC 85613                              |   |   |   |  |  | 1 |  |  |  |  |  |  |   |       |  |  |   |  |  |  |  |
|    | B(Alt) Y 32 SE   | 02/01 → 10/07 | AC    |                    | VKMV 6PK1900<br>VKM 35500               | 1 |   | 1 |  |  |   |  |  |  |  |  |  |   |       |  |  |   |  |  |  |  |
|   | B(Alt) Y 32 SE   | 02/01 → 10/07 | AC    |                    | VKMA 35500<br>VKMV 6PK2020<br>VKM 35500 | 1 |   | 1 |  |  | 1 |  |  |  |  |  |  |   |       |  |  |   |  |  |  |  |
| <b>VAUXHALL</b>  <b>OMEGA 2.0 DTI</b>      |                  |               |       |                    |   |   |   |   |  |  |   |  |  |  |  |  |  |   |       |  |  |   |  |  |  |  |
|    | X 20 DTH         | 10/98 → 09/00 |       |                    | <b>ΟΛΟΚΛΟΝΟ</b>                         |   |   |   |  |  |   |  |  |  |  |  |  |   |       |  |  |   |  |  |  |  |
|    | X 20 DTH         | 10/98 → 09/00 |       |                    | VKPC 85623                              |   |   |   |  |  | 1 |  |  |  |  |  |  |   |       |  |  |   |  |  |  |  |
|    | B(Alt) X 20 DTH  | 10/98 → 09/00 | AC    |                    | VKMA 35007<br>VKMV 6PK1805<br>VKM 35007 | 1 |   | 1 |  |  | 1 |  |  |  |  |  |  |   |       |  |  |   |  |  |  |  |
|   | B(Alt) X 20 DTH  | 10/98 → 09/00 | AC    |                    | VKMA 35107<br>VKMV 6PK1902<br>VKM 35007 | 1 |   | 1 |  |  | 1 |  |  |  |  |  |  |   |       |  |  |   |  |  |  |  |
|    | X 20 DTH         | 10/98 → 09/00 |       |                    | VKM_____                                |   |   |   |  |  |   |  |  |  |  |  |  |   |       |  |  | 1 |  |  |  |  |
| <b>VAUXHALL</b>  <b>OMEGA 2.2 DTI</b>    |                  |               |       |                    |   |   |   |   |  |  |   |  |  |  |  |  |  |   |       |  |  |   |  |  |  |  |
|    | Y 22 DTH         | 09/00 → 10/07 |       |                    | <b>ΟΛΟΚΛΟΝΟ</b>                         |   |   |   |  |  |   |  |  |  |  |  |  |   |       |  |  |   |  |  |  |  |
|    | Y 22 DTH         | 09/00 → 10/07 |       |                    | VKPC 85623                              |   |   |   |  |  | 1 |  |  |  |  |  |  |   |       |  |  |   |  |  |  |  |
|    | B(Alt) Y 22 DTH  | 09/00 → 10/07 |       |                    | VKMA 35107<br>VKMV 6PK1902<br>VKM 35007 | 1 |   | 1 |  |  | 1 |  |  |  |  |  |  |   |       |  |  |   |  |  |  |  |
|    | Y 22 DTH         | 09/00 → 01/07 |       |                    | VKM_____                                |   |   |   |  |  |   |  |  |  |  |  |  |   |       |  |  | 1 |  |  |  |  |
| <b>VAUXHALL</b>  <b>OMEGA 2.5 TD</b>     |                  |               |       |                    |   |   |   |   |  |  |   |  |  |  |  |  |  |   |       |  |  |   |  |  |  |  |
|    | U 25 TD, X 25 TD | 04/94 → 02/01 |       |                    | <b>ΟΛΟΚΛΟΝΟ</b>                         |   |   |   |  |  |   |  |  |  |  |  |  |   |       |  |  |   |  |  |  |  |
|    | U 25 TD, X 25 TD | 04/94 → 02/01 |       |                    | VKPC 88826                              |   |   |   |  |  | 1 |  |  |  |  |  |  |   |       |  |  |   |  |  |  |  |
| <b>VAUXHALL</b>  <b>OMEGA 2.5 DTI</b>    |                  |               |       |                    |   |   |   |   |  |  |   |  |  |  |  |  |  |   |       |  |  |   |  |  |  |  |
|    | Y 25 DT          | 09/01 → 10/07 |       |                    | <b>ΟΛΟΚΛΟΝΟ</b>                         |   |   |   |  |  |   |  |  |  |  |  |  |   |       |  |  |   |  |  |  |  |
|    | Y 25 DT          | 09/01 → 10/07 |       |                    | VKPC 88430                              |   |   |   |  |  | 1 |  |  |  |  |  |  |   |       |  |  |   |  |  |  |  |
| <b>VAUXHALL</b>  <b>ROYALE 2.0</b>       |                  |               |       |                    |   |   |   |   |  |  |   |  |  |  |  |  |  |   |       |  |  |   |  |  |  |  |
|    | 20 E             | 03/83 → 10/84 | 2),   | AC                 | VKPA 85608                              |   |   |   |  |  | 1 |  |  |  |  |  |  |   |       |  |  |   |  |  |  |  |
|   | 20 E             | 03/83 → 10/84 | 2),   | AC                 | —                                       |   |   |   |  |  | 1 |  |  |  |  |  |  |   |       |  |  |   |  |  |  |  |
| <b>VAUXHALL</b>  <b>ROYALE 2.2</b>       |                  |               |       |                    |   |   |   |   |  |  |   |  |  |  |  |  |  |   |       |  |  |   |  |  |  |  |
|    | 22 E             | 11/84 → 08/87 | 2),   | AC                 | VKPA 85608                              |   |   |   |  |  | 1 |  |  |  |  |  |  |   |       |  |  |   |  |  |  |  |
|   | 22 E             | 11/84 → 08/87 | 2),   | AC                 | —                                       |   |   |   |  |  | 1 |  |  |  |  |  |  |   |       |  |  |   |  |  |  |  |
| <b>VAUXHALL</b>  <b>ROYALE 2.5</b>       |                  |               |       |                    |   |   |   |   |  |  |   |  |  |  |  |  |  |   |       |  |  |   |  |  |  |  |
|    | 25 E             | 05/78 → 08/87 |       |                    | VKPC 85600                              |   |   |   |  |  | 1 |  |  |  |  |  |  |   |       |  |  |   |  |  |  |  |
| <b>VAUXHALL</b>  <b>ROYALE 2.8</b>       |                  |               |       |                    |   |   |   |   |  |  |   |  |  |  |  |  |  |   |       |  |  |   |  |  |  |  |
|    | 28 H             | 02/78 → 10/82 |       |                    | VKPC 85600                              |   |   |   |  |  | 1 |  |  |  |  |  |  |   |       |  |  |   |  |  |  |  |
| <b>VAUXHALL</b>  <b>ROYALE 2.9</b>       |                  |               |       |                    |   |   |   |   |  |  |   |  |  |  |  |  |  |   |       |  |  |   |  |  |  |  |
|    | 30, C 30 NE      | 02/78 → 08/87 |       |                    | VKPC 85600                              |   |   |   |  |  | 1 |  |  |  |  |  |  |   |       |  |  |   |  |  |  |  |
| <b>VAUXHALL</b>  <b>ROYALE 3.0</b>       |                  |               |       |                    |   |   |   |   |  |  |   |  |  |  |  |  |  |   |       |  |  |   |  |  |  |  |
|    | 30, C 30 NE      | 10/79 → 10/82 |       |                    | VKPC 85600                              |   |   |   |  |  | 1 |  |  |  |  |  |  |   |       |  |  |   |  |  |  |  |
| <b>VAUXHALL</b>  <b>ROYALE 2.2 TD</b>    |                  |               |       |                    |   |   |   |   |  |  |   |  |  |  |  |  |  |   |       |  |  |   |  |  |  |  |
|    | 23 TD            | 11/84 → 08/87 | 2),   | 32)                | —                                       |   |   |   |  |  | 1 |  |  |  |  |  |  |   |       |  |  |   |  |  |  |  |
|   |                  |               |       |                    | —                                       |   |   |   |  |  | 1 |  |  |  |  |  |  |   |       |  |  |   |  |  |  |  |
| <b>VAUXHALL</b>  <b>SENATOR Mk I 2.5</b> |                  |               |       |                    |   |   |   |   |  |  |   |  |  |  |  |  |  |   |       |  |  |   |  |  |  |  |
|    | 25 E             | 09/84 → 08/87 |       |                    | <b>ΟΛΟΚΛΟΝΟ</b>                         |   |   |   |  |  |   |  |  |  |  |  |  |   |       |  |  |   |  |  |  |  |



|   |  |  |  |  |  |  |  |  |  |  |  |  |
|---|---|---|---|--|---|---|---|---|---|---|---|---|
|   | 25 E  | 09/84 → 08/87   |   | VKPC 85600   |   |   |   |   |   | 1   |   |   |
| <b>VAUXHALL  SENATOR Mk I 3.0</b>      |   |   |   |  |   |   |   |   |   |   |   |   |
|   | C 30 NE   | 09/84 → 12/86   |   | OKOKOKO  |   |   |   |   |   |   |   |   |
|   | C 30 NE   | 09/84 → 12/86   |   | VKPC 85600   |   |   |   |   |   | 1   |   |   |
| <b>VAUXHALL  SENATOR Mk II 2.5</b>     |   |   |   |  |   |   |   |   |   |   |   |   |
|   | 25 NE   | 09/87 → 10/90   |   | OKOKOKO  |   |   |   |   |   |   |   |   |
|   | 25 NE   | 09/87 → 10/90   |   | VKPC 85603   |   |   |   |   |   | 1   |   |   |
| <b>VAUXHALL  SENATOR Mk II 2.6</b>     |   |   |   |  |   |   |   |   |   |   |   |   |
|   | C 26 NE   | 09/90 → 09/93   |   | OKOKOKO  |   |   |   |   |   |   |   |   |
| <b>VAUXHALL  SENATOR Mk II 3.0</b>     |   |   |   |  |   |   |   |   |   |   |   |   |
|   | 30 NE, C 30 LE, C 30 NE   | 09/87 → 09/93   |   | OKOKOKO  |   |   |   |   |   |   |   |   |
|   | 30 NE, C 30 NE  | 01/88 → 09/93   | → ICH L1999999  | VKPC 85603   |   |   |   |   |   | 1   |   |   |
|   | 30 NE, C 30 NE  | 01/88 → 09/93   | CH M1000001 I→  | —  |   |   |   |   |   | 1   |   |   |
|   | C 30 LE   | 09/87 → 09/93   |   | VKPC 85603   |   |   |   |   |   | 1   |   |   |
| <b>VAUXHALL  SENATOR Mk II 3.0 24V</b> |   |   |   |  |   |   |   |   |   |   |   |   |
|   | C 30 SE   | 09/89 → 09/93   |   | OKOKOKO  |   |   |   |   |   |   |   |   |
|   | C 30 SE   | 09/89 → 09/93   |   | —  |   |   |   |   |   | 1   |   |   |
| <b>VAUXHALL  SIGNUM 2.0 Turbo</b>      |   |   |   |  |   |   |   |   |   |   |   |   |
|   | Z 20 NET  | 05/03 → 10/07   |   | OKOKOKO  |   |   |   |   |   |   |   |   |
|   | Z 20 NET  | 05/03 → 10/07   |   | VKPC 85308   |   |   |   |   |   | 1   |   |   |
|   | B(Alt) Z 20 NET   | 05/03 → 10/07   | AC  | VKMOV 5PK880<br>VKM 34027  | 1   |   | 1   |   |   |   |   |   |
|   | B(Alt) Z 20 NET   | 05/03 → 10/07   | AC  | VKMA 34027<br>VKMOV 5PK1028<br>VKM 34027   | 1   |   | 1   | 1   |   |   |   |   |
| <b>VAUXHALL  SIGNUM 2.2</b>          |   |   |   |  |   |   |   |   |   |   |   |   |
|                                       | Z 22 YH   | 05/03 → 10/07   |   | OKOKOKO  |   |   |   |   |   |   |   |   |
|                                       | Z 22 YH   | 05/03 → 10/07   |   | VKPC 85308   |   |   |   |   |   | 1   |   |   |
|                                       | B(Alt) Z 22 YH  | 05/03 → 10/07   | AC  | VKMOV 5PK880<br>VKM 34027  | 1   |   | 1   |   |   |   |   |   |
|                                       | B(Alt) Z 22 YH  | 05/03 → 10/07   | AC  | VKMA 34027<br>VKMOV 5PK1028<br>VKM 34027   | 1   |   | 1   | 1   |   |   |   |   |
| <b>VAUXHALL  SIGNUM 2.8 V6 Turbo</b> |   |   |   |  |   |   |   |   |   |   |   |   |
|                                       | Z 28 NEL, Z 28 NET  | 08/05 → 10/07   |   | OKOKOKO  |   |   |   |   |   |   |   |   |
| <b>VAUXHALL  SIGNUM 3.2 V6</b>       |   |   |   |  |   |   |   |   |   |   |   |   |
|                                       | Z 32 SE   | 05/03 → 10/07   | 5)  | VKMA 05502   | 1   | 1   | 1   |   |   |   |   | 5 T0135   |
|                                       | Z 32 SE   | 05/03 → 10/07   |   | VKPC 85613   |   |   |   |   |   | 1   |   |   |
|                                       | B(Alt) Z 32 SE  | 05/03 → 10/07   | AC  | VKMOV 6PK1992<br>VKM 35016<br>VKM 35500  | 1   |   | 1   |   |   |   |   |   |
| <b>VAUXHALL  SIGNUM 1.9 CDTI 120</b> |   |   |   |  |   |   |   |   |   |   |   |   |
|                                       | Z 19 DT   | 04/04 → 10/07   |   | VKMA 02192<br>VKM 12174<br>VKM 22180   | 1   | 1   | 1   |   |   |   |   | T0158   |
|                                       | Z 19 DT   | 04/04 → 10/07   |   | VKPC 82665   |   |   |   |   |   | 1   |   |   |
|                                       | B(Alt) Z 19 DT  | 04/04 → 12/07   | AC, →IMot. 71 111927  | VKMOV 6PK1050<br>VKM 32046   | 1   |   | 1   |   |   |   |   |   |
|                                       | B(Alt) Z 19 DT  | 04/04 → 12/07   | AC, Mot. 71 111928 I→   | VKMOV 6PK1050  |   |   | 1   |   |   |   |   |   |
|                                       | B(Alt) Z 19 DT  | 04/04 → 03/07   | AC  | VKM 32046  | 1   |   |   |   |   |   |   |   |
| <b>VAUXHALL  SIGNUM 1.9 CDTI 150</b> |   |   |   |  |   |   |   |   |   |   |   |   |
|                                       | Z 19 DTH  | 04/04 → 10/07   |   | VKMA 02193<br>VKM 12174<br>VKM 22180   | 1   | 1   | 1   |   |   |   |   | T0248   |
|                                       | Z 19 DTH  | 04/04 → 10/07   |   | VKPC 82667   |   |   |   |   |   | 1   |   |   |
|                                       | B(Alt) Z 19 DTH   | 04/04 → 12/07   | AC, →IMot. 71 111927  | VKMOV 6PK1050<br>VKM 32046   | 1   |   | 1   |   |   |   |   |   |
|                                       | B(Alt) Z 19 DTH   | 04/04 → 12/07   | AC, Mot. 71 111928 I→   | VKMOV 6PK1050  |   |   | 1   |   |   |   |   |   |
|                                       | B(Alt) Z 19 DTH   | 04/04 → 03/07   | AC  | VKM 32046  | 1   |   |   |   |   |   |   |   |



































| VAUXHALL  SIGNUM 2.0 DTI      |                 |               |    |  |   |   |   |   |   |         |
|--|-----------------|---------------|----|--|---|---|---|---|---|---------|
|                               | Y 20 DTH        | 05/03 → 10/07 |    | <b>ΟΧΘΙΧΘΟ</b>   |   |   |   |   |   |         |
|                               | Y 20 DTH        | 05/03 → 10/07 |    | VKPC 85623   |   |   |   |   | 1 |         |
|                               | B(Alt) Y 20 DTH | 05/03 → 10/07 | AC | VKMA 35006<br>VKMV 6PK1805<br>VKM 35007<br>VKM 35016                     | 1 | 1 | 1 | 1 |   |         |
|  | B(Alt) Y 20 DTH | 05/03 → 10/07 | AC | VKMA 35016<br>VKMV 6PK1880<br>VKM 35007<br>VKM 35016                     | 1 | 1 | 1 | 1 |   |         |
|                               | Y 20 DTH        | 05/03 → 01/07 |    | VKM_____   |   |   |   |   | 1 |         |
| VAUXHALL  SIGNUM 2.2 DTI      |                 |               |    |  |   |   |   |   |   |         |
|                               | Y 22 DTR        | 05/03 → 10/07 |    | <b>ΟΧΘΙΧΘΟ</b>   |   |   |   |   |   |         |
|                               | Y 22 DTR        | 05/03 → 10/07 |    | VKPC 85623   |   |   |   |   | 1 |         |
|                               | B(Alt) Y 22 DTR | 05/03 → 10/07 | AC | VKMA 35006<br>VKMV 6PK1805<br>VKM 35007<br>VKM 35016                     | 1 | 1 | 1 | 1 |   |         |
|  | B(Alt) Y 22 DTR | 05/03 → 10/07 | AC | VKMA 35016<br>VKMV 6PK1880<br>VKM 35007<br>VKM 35016                     | 1 | 1 | 1 | 1 |   |         |
|                               | Y 22 DTR        | 05/03 → 01/07 |    | VKM_____   |   |   |   |   | 1 |         |
| VAUXHALL  SIGNUM 3.0 V6 CDTI |                 |               |    |  |   |   |   |   |   |         |
|                             | Y 30 DT         | 05/03 → 10/07 |    | VKMA 05230<br>VKM 15220<br>VKM 25222<br>VKM 25226                        | 1 | 2 | 1 |   |   | T0200   |
|  | Z 30 DT         | 09/05 → 03/07 |    | —<br>—<br>VKM 25222<br>VKM 25226   | 1 | 2 | 1 |   |   | T0200   |
|                             | Y 30 DT         | 05/03 → 10/07 |    | VKPC_____  |   |   |   |   | 1 |         |
|                             | B(Alt) Y 30 DT  | 05/03 → 03/07 |    | VKMV_____<br>VKM_____<br>VKM_____<br>VKM 35212<br>VKM 35214<br>VKM 35216 |   |   |   | 1 |   |         |
|  | B(Alt) Z 30 DT  | 09/05 → 03/07 |    | VKMV_____<br>VKM_____<br>VKM_____<br>VKM 35212<br>VKM 35214              |   |   |   | 1 |   |         |
| VAUXHALL  SINTRA 2.2 16V    |                 |               |    |  |   |   |   |   |   |         |
|                             | X 22 XE         | 11/96 → 04/99 |    | VKMA 05228<br>VKM 15230<br>VKM 25212<br>VKM 25212                        | 1 | 2 | 1 |   |   | T0139   |
|                             | X 22 XE         | 11/96 → 04/99 |    | VKPC 85611   |   |   |   |   | 1 |         |
|                             | B(Alt) X 22 XE  | 11/96 → 04/99 | AC | VKMA 35109<br>VKMV 6PK1900<br>VKM 35009                                  | 1 |   | 1 | 1 |   |         |
| VAUXHALL  SINTRA 3.0 24V    |                 |               |    |  |   |   |   |   |   |         |
|                             | X 30 XE         | 11/96 → 04/99 | 5) | VKMA 05500   | 1 | 1 | 1 |   |   | 5 T0135 |
|                             | X 30 XE         | 11/96 → 04/99 |    | VKPC 85613   |   |   |   |   | 1 |         |
|                             | B(Alt) X 30 XE  | 11/96 → 04/99 |    | VKMA 35500<br>VKMV 6PK2020<br>VKM 35500                                  | 1 |   | 1 | 1 |   |         |
| VAUXHALL  SINTRA 2.2 DTI    |                 |               |    |  |   |   |   |   |   |         |
|                             | X 22 DTH        | 07/97 → 04/99 |    | <b>ΟΧΘΙΧΘΟ</b>   |   |   |   |   |   |         |
|                             | X 22 DTH        | 07/97 → 04/99 |    | VKPC 85623   |   |   |   |   | 1 |         |





























VAUXHALL















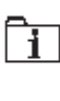



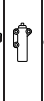















|   |  |  |  |  |  |  |  |  |  |  |  |  |
|---|---|---|---|--|---|---|---|---|---|---|---|---|
|   | B(Alt)  | X 22 DTH  | 07/97 → 04/99   | AC   | VKMA 35007  | 1   | 1   |   |   |   |   |   |
|   |   |   |   |  | VKMA 35007  | 1   | 1   |   |   |   |   |   |
|   | B(Alt)  | X 22 DTH  | 07/97 → 04/99   | AC   | VKMA 35107  | 1   | 1   |   |   |   |   |   |
|   |   |   |   |  | VKMA 35107  | 1   | 1   |   |   |   |   |   |
|   |   | X 22 DTH  | 07/97 → 04/99   |  | VKM_____  |   |   |   | 1   |   |   |   |
| <b>VAUXHALL</b>  <b>TIGRA Mk I 1.4 16V</b>     |   |   |   |  |   |   |   |   |   |   |   |   |
|   |   | X 14 XE   | 07/94 → 10/07   | 3)   | VKMS 05150  | 1   | 2   | 1   |   |   | 3   | 3   |
|   |   |   |   |  | VKMA 05150  | 1   | 2   | 1   |   |   | 3   | 3   |
|   |   |   |   |  | VKM 15216   | 1   |   |   |   |   | 1   | 1   |
|   |   |   |   |  | VKM 25150   |   | 1   |   |   |   |   |   |
|   |   |   |   |  | VKM 25152   |   | 1   |   |   |   |   |   |
|   |   | X 14 XE   | 07/94 → 10/07   |  | VKPC 85212  |   |   |   | 1   |   |   |   |
|   | B(Alt)  | X 14 XE   | 07/94 → 10/07   | AC, ⊕  | VKMA 35025  | 1   |   | 1   |   |   |   |   |
|   |   |   |   |  | VKMA 35025  | 1   |   | 1   |   |   |   |   |
|   |   |   |   |  | VKMV 6PK1530  |   |   | 1   |   |   |   |   |
|   |   |   |   |  | VKM 35009   | 1   |   |   |   |   |   |   |
|   | B(Alt)  | X 14 XE   | 07/94 → 10/07   | AC, ⊕  | VKMA 35125  | 1   |   | 1   |   |   |   |   |
|   |   |   |   |  | VKMA 35125  | 1   |   | 1   |   |   |   |   |
|   |   |   |   |  | VKMV 6PK1795  |   |   | 1   |   |   |   |   |
|   |   |   |   |  | VKM 35009   | 1   |   |   |   |   |   |   |
| <b>VAUXHALL</b>  <b>TIGRA Mk I 1.6 16V</b>     |   |   |   |  |   |   |   |   |   |   |   |   |
|   |   | X 16 XE   | 07/94 → 10/07   | 3)   | VKMS 05150  | 1   | 2   | 1   |   |   | 3   | 3   |
|   |   |   |   |  | VKMA 05150  | 1   | 2   | 1   |   |   | 3   | 3   |
|   |   |   |   |  | VKM 15216   | 1   |   |   |   |   | 1   | 1   |
|   |   |   |   |  | VKM 25150   |   | 1   |   |   |   |   |   |
|   |   |   |   |  | VKM 25152   |   | 1   |   |   |   |   |   |
|    |   | X 16 XE   | 07/94 → 10/07   |  | VKPC 85212  |   |   |   | 1   |   |   |   |
|   | B(Alt)  | X 16 XE   | 07/94 → 10/07   | AC, ⊕  | VKMA 35025  | 1   |   | 1   |   |   |   |   |
|   |   |   |   |  | VKMA 35025  | 1   |   | 1   |   |   |   |   |
|   |   |   |   |  | VKMV 6PK1530  |   |   | 1   |   |   |   |   |
|   |   |   |   |  | VKM 35009   | 1   |   |   |   |   |   |   |
|   | B(Alt)  | X 16 XE   | 07/94 → 10/07   | AC, ⊕  | VKMA 35125  | 1   |   | 1   |   |   |   |   |
|   |   |   |   |  | VKMA 35125  | 1   |   | 1   |   |   |   |   |
|   |   |   |   |  | VKMV 6PK1795  |   |   | 1   |   |   |   |   |
|   |   |   |   |  | VKM 35009   | 1   |   |   |   |   |   |   |
| <b>VAUXHALL</b>  <b>TIGRA Mk II 1.4 16V</b>  |   |   |   |  |   |   |   |   |   |   |   |   |
|   |   | Z 14 XEP  | 06/04 → 06/07   |  | <del>VKMS 05150</del>   |   |   |   |   |   |   |   |
|   |   | Z 14 XEP  | 06/04 → 10/07   |  | VKPC 85310  |   |   |   | 1   |   |   |   |
|   | B(Alt)  | Z 14 XEP  | 06/04 → 10/07   | AC   | VKMA 35113  | 1   |   | 1   |   |   |   |   |
|   |   |   |   |  | VKMA 35113  | 1   |   | 1   |   |   |   |   |
|   |   |   |   |  | VKMV 5PK1230  |   |   | 1   |   |   |   |   |
|   |   |   |   |  | VKM 35013   | 1   |   |   |   |   |   |   |
|   | B(Alt)  | Z 14 XEP  | 06/04 → 10/07   | AC   | VKMV 5PK1368  |   |   | 1   |   |   |   |   |
|   |   |   |   |  | VKMV 5PK1368  | 1   |   | 1   |   |   |   |   |
|   |   |   |   |  | VKM 35013   | 1   |   |   |   |   |   |   |
| <b>VAUXHALL</b>  <b>TIGRA Mk II 1.8 16V</b>  |   |   |   |  |   |   |   |   |   |   |   |   |
|   |   | Z 18 XE   | 06/04 → 12/04   | 3), → ICH 4E 999999  | VKMS 05154-3  | 1   | 2   | 1   |   |   | 3   | 3   |
|   |   |   |   |  | VKMA 05154  | 1   | 2   | 1   |   |   | 2   | 2   |
|   |   |   |   |  | VKM 15216   | 1   |   |   |   |   | 1   | 1   |
|   |   |   |   |  | VKM 25152   |   | 1   |   |   |   |   |   |
|   |   |   |   |  | VKM 25312   |   | 1   |   |   |   |   |   |
|   |   | Z 18 XE   | 01/05 → 06/07   | CH 5E 000001 I →   | VKMA 05156  | 1   | 2   | 1   |   |   | 1   | 1   |
|   |   |   |   |  | VKMA 05156  | 1   | 2   | 1   |   |   | 1   | 1   |
|   |   |   |   |  | VKM_____  |   | 1   |   |   |   |   |   |
|   |   |   |   |  | VKM 25158   |   | 1   |   |   |   |   |   |
|   |   | Z 18 XE   | 06/04 → 10/07   |  | VKPC 85624  |   |   |   | 1   |   |   |   |
|   | B(Alt)  | Z 18 XE   | 06/04 → 06/07   | AC   | VKMA 35012  | 1   |   | 1   |   |   |   |   |
|   |   |   |   |  | VKMA 35012  | 1   |   | 1   |   |   |   |   |
|   |   |   |   |  | VKMV 5PK938   |   |   | 1   |   |   |   |   |
|   |   |   |   |  | VKM 35012   | 1   |   |   |   |   |   |   |
|   | B(Alt)  | Z 18 XE   | 06/04 → 06/07   | AC   | VKMA 35022  | 1   |   | 1   |   |   |   |   |
|   |   |   |   |  | VKMA 35022  | 1   |   | 1   |   |   |   |   |
|   |   |   |   |  | VKMV 5PK1212  |   |   | 1   |   |   |   |   |
|   |   |   |   |  | VKM 35012   | 1   |   |   |   |   |   |   |
| <b>VAUXHALL</b>  <b>TIGRA Mk II 1.3 CDTI</b> |   |   |   |  |   |   |   |   |   |   |   |   |
|   |   | Z 13 DT   | 06/04 → 10/07   |  | <del>VKMS 05150</del>   |   |   |   |   |   |   |   |
|   |   | Z 13 DT   | 06/04 → 10/07   |  | VKPC 85700  |   |   |   | 1   |   |   |   |
|   | B(Alt)  | Z 13 DT   | 06/04 → 06/07   | AC   | VKMV 6PK1182  |   |   | 1   |   |   |   |   |
|   |   |   |   |  | VKMV 6PK1182  | 1   |   | 1   |   |   |   |   |
|   |   |   |   |  | VKM 35023   | 1   |   |   |   |   |   |   |











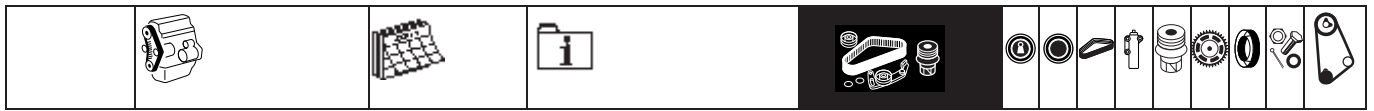







|   |  |  |  |  |  |  |  |  |  |  |  |
|---|---|---|---|--|---|---|---|---|---|---|---|
|   | <b>B(Alt)</b> Z 13 DT   | 06/04 → 06/07   | <b>AC</b>   | VKMV<br>VKM 35023  | 1   | 1   |   |   |   |   |   |
| <b>VAUXHALL  VECTRA Mk I 1.6</b>       |   |   |   |  |   |   |   |   |   |   |   |
|                                        | X 16 SZR  | 10/95 → 01/03   |  | VKMC 05121<br>VKMA 05121<br>VKM 15121  | 1<br>1<br>1   | 1   | 1   |   |   | 1<br>1  | T0092   |
|                                        | X 16 SZR  | 10/95 → 01/03   |   | VKPC 85206   |   |   | 1   |   |   |   |   |
|                                        | <b>B(Alt)</b> X 16 SZR  | 10/95 → 10/07   | <b>AC</b>   | VKMA 35008<br>VKMV 6PK1460<br>VKM 35008  | 1<br>1  | 1   |   |   |   |   |   |
|   | <b>B(Alt)</b> X 16 SZR  | 10/95 → 10/07   | <b>AC</b>   | VKMA 35125<br>VKMV 6PK1795<br>VKM 35009  | 1<br>1  | 1   |   |   |   |   |   |
| <b>VAUXHALL  VECTRA Mk I 1.6 16V</b>   |   |   |   |  |   |   |   |   |   |   |   |
|                                        | X 16 XEL, Y 16 XE,<br>Z 16 XE   | 10/95 → 10/07   |   | VKMA 05150<br>VKM 15216<br>VKM 25150<br>VKM 25152                                  | 1<br>1  | 2   | 1   |   |   |   | 3<br>1 T0107  |
|                                        | X 16 XEL, Y 16 XE,<br>Z 16 XE   | 10/95 → 10/07   | → <b>Mot.</b> 02 MZ5253,<br>20 U75998   | VKPC 85212   |   |   |   | 1   |   |   |   |
|   | X 16 XEL, Y 16 XE,<br>Z 16 XE   | 10/95 → 10/07   | <b>Mot.</b> 02 MZ5254,<br>20 U75999  →  | VKPC 85211   |   |   |   | 1   |   |   |   |
|                                       | <b>B(Alt)</b> X 16 XEL, Y 16 XE,<br>Z 16 XE                                       | 10/95 → 10/07   | <b>AC</b>   | VKMA 35025<br>VKMV 6PK1530<br>VKM 35009  | 1<br>1  | 1   |   |   |   |   |   |
|   | <b>B(Alt)</b> X 16 XEL, Y 16 XE,<br>Z 16 XE                                       | 10/95 → 10/07   | <b>AC</b>   | VKMA 35125<br>VKMV 6PK1795<br>VKM 35009  | 1<br>1  | 1   |   |   |   |   |   |
| <b>VAUXHALL  VECTRA Mk I 1.8 16V</b> |   |   |   |  |   |   |   |   |   |   |   |
|                                      | X 18 XE1, Z 18 XE,<br>Z 18 XEL  | 10/95 → 06/07   |   | VKMC 05150<br>VKMA 05150<br>VKM 15216<br>VKM 25150<br>VKM 25152                    | 1<br>1<br>1   | 2   | 1   | 1   |   |   | 3<br>3<br>1 T0107   |
|   | X 18 XE   | 10/95 → 09/00   | 3)  | VKMS 05222<br>VKMA 05222<br>VKM 15202<br>VKM 25212<br>VKM 25212                    | 1<br>1<br>1   | 2   | 1   |   |   | 3   | T0116   |
|                                      | X 18 XE<br>X 18 XE1, Z 18 XE,<br>Z 18 XEL   | 10/95 → 09/00<br>10/95 → 10/07  |   | VKPC 85611<br>VKPC 85624   |   |   |   | 1<br>1  |   |   |   |
|                                      | <b>B(Alt)</b> X 18 XE   | 10/95 → 09/00   | <b>AC</b>   | VKMA 35009<br>VKMV 6PK1725<br>VKM 35009  | 1<br>1  | 1   |   |   |   |   |   |
|   | <b>B(Alt)</b> X 18 XE   | 10/95 → 09/00   | <b>AC</b>   | VKMA 35109<br>VKMV 6PK1900<br>VKM 35009  | 1<br>1  | 1   |   |   |   |   |   |
|   | <b>B(Alt)</b> X 18 XE1, Z 18 XE,<br>Z 18 XEL                                      | 10/95 → 10/07   | <b>AC</b>   | VKMA 35025<br>VKMV 6PK1530<br>VKM 35009  | 1<br>1  | 1   |   |   |   |   |   |
|   | <b>B(Alt)</b> X 18 XE1, Z 18 XE,<br>Z 18 XEL                                      | 10/95 → 10/07   | <b>AC</b>   | VKMA 35125<br>VKMV 6PK1795<br>VKM 35009  | 1<br>1  | 1   |   |   |   |   |   |
| <b>VAUXHALL  VECTRA Mk I 2.0 16V</b> |   |   |   |  |   |   |   |   |   |   |   |
|                                      | X 20 XEV  | 10/95 → 09/00   | 3)  | VKMS 05222<br>VKMA 05222<br>VKM 15202  | 1<br>1<br>1   | 2   | 1   |   |   | 3   | T0116   |



































VAUXHALL



































|   |  |  |  |  |  |  |  |  |  |  |  |
|---|---|---|---|--|---|---|---|---|---|---|---|
|   |   |   |   | VKM 25212<br>VKM 25212   | 1<br>1  |   |   |   |   |   |   |
|   | X 20 XEV  | 10/95 → 09/00   |   | VKPC 85611   |   |   | 1   |   |   |   |   |
|   | <b>B(Alt)</b> X 20 XEV  | 10/95 → 09/00   | <b>AC</b>   | VKMA 35009<br>VKMV 6PK1725<br>VKM 35009  | 1<br>1  | 1<br>1  |   |   |   |   |   |
|   | <b>B(Alt)</b> X 20 XEV  | 10/95 → 09/00   | <b>AC</b>   | VKMA 35109<br>VKMV 6PK1900<br>VKM 35009  | 1<br>1  | 1<br>1  |   |   |   |   |   |
| <b>VAUXHALL</b>  <b>VECTRA Mk I 2.2 16V</b>  |   |   |   |  |   |   |   |   |   |   |   |
|   | Z 22 SE   | 09/00 → 10/07   |   | <b>OXOXOXO</b>   |   |   |   |   |   |   |   |
|   | C 22 SEL  | 09/00 → 10/07   |   | VKMA 05228<br>VKM 15230<br>VKM 25212<br>VKM 25212                                  | 1<br>1  | 2<br>1  | 1   |   |   |   | T0139   |
|   | C 22 SEL, Z 22 SE   | 09/00 → 10/07   |   | VKPC 85308   |   |   | 1   |   |   |   |   |
|   | <b>B(Alt)</b> C 22 SEL  | 09/00 → 10/07   | <b>AC</b>   | VKMA 35009<br>VKMV 6PK1725<br>VKM 35009  | 1<br>1  | 1<br>1  |   |   |   |   |   |
|   | <b>B(Alt)</b> C 22 SEL  | 09/00 → 10/07   | <b>AC</b>   | VKMA 35109<br>VKMV 6PK1900<br>VKM 35009  | 1<br>1  | 1<br>1  |   |   |   |   |   |
|   | <b>B(Alt)</b> Z 22 SE   | 09/00 → 03/07   | <b>AC</b>   | VKMV 5PK880<br>VKM 34027   | 1   | 1   |   |   |   |   |   |
|   | <b>B(Alt)</b> Z 22 SE   | 09/00 → 10/07   | <b>AC</b>   | VKMA 34027<br>VKMV 5PK1028<br>VKM 34027  | 1<br>1  | 1<br>1  |   |   |   |   |   |
| <b>VAUXHALL</b>  <b>VECTRA Mk I 2.5 V6</b> |   |   |   |  |   |   |   |   |   |   |   |
|   | X 25 XE   | 10/95 → 12/98   | 5), → CH W1 285446,<br>W5 276825, W7 154528                                       | VKMA 05500   | 1   | 1   | 1   |   |   |   | 5 T0135   |
|   | X 25 XE   | 01/98 → 09/00   | 5), CH W1 285447,<br>W7 154259  →   | VKMA 05501   | 1   | 1   | 1   |   |   |   | 5 T0135   |
|   | X 25 XE   | 10/95 → 09/00   |   | VKPC 85613   |   |   | 1   |   |   |   |   |
|   | <b>B(Alt)</b> X 25 XE   | 10/95 → 09/00   | <b>AC</b>   | VKMV 6PK1900<br>VKM 35500  | 1   | 1   |   |   |   |   |   |
|   | <b>B(Alt)</b> X 25 XE   | 10/95 → 09/00   | <b>AC</b>   | VKMA 35500<br>VKMV 6PK2020<br>VKM 35500  | 1<br>1  | 1<br>1  |   |   |   |   |   |
| <b>VAUXHALL</b>  <b>VECTRA Mk I 2.6 V6</b> |   |   |   |  |   |   |   |   |   |   |   |
|   | Y 26 SE   | 09/00 → 10/07   | 5), → Mot. 11 162841,<br>17 080724  | VKMA 05501   | 1   | 1   | 1   |   |   |   | 5 T0135   |
|   | Y 26 SE   | 09/00 → 10/07   | 5), Mot. 11 162842,<br>17 080725  →   | VKMA 05502   | 1   | 1   | 1   |   |   |   | 5 T0135   |
|   | Y 26 SE   | 09/00 → 10/07   |   | VKPC 85613   |   |   | 1   |   |   |   |   |
|   | <b>B(Alt)</b> Y 26 SE   | 09/00 → 06/07   | <b>AC</b>   | VKMV 6PK1900<br>VKM 35500  | 1   | 1   |   |   |   |   |   |
|   | <b>B(Alt)</b> Y 26 SE   | 09/00 → 10/07   | <b>AC</b>   | VKMA 35500<br>VKMV 6PK2020<br>VKM 35500  | 1<br>1  | 1<br>1  |   |   |   |   |   |
| <b>VAUXHALL</b>  <b>VECTRA Mk I 1.7 TD</b> |   |   |   |  |   |   |   |   |   |   |   |
|   | X 17 TD (ISUZU)   | 10/95 → 11/96   |   | VKMA 05214<br>VKM 15215<br>VKM 25208   | 1<br>1  | 1<br>1  |   |   |   |   | 1 T0062   |
|   | X 17 TD (ISUZU)   | 10/95 → 11/96   |   | VKPC 85620   |   |   | 1   |   |   |   |   |
| <b>VAUXHALL</b>  <b>VECTRA Mk I 2.0 DI</b> |   |   |   |  |   |   |   |   |   |   |   |
|   | X 20 DTL  | 11/96 → 10/07   |   | <b>OXOXOXO</b>   |   |   |   |   |   |   |   |
|   | X 20 DTL  | 11/96 → 10/07   |   | VKPC 85623   |   |   | 1   |   |   |   |   |
|   | <b>B(Alt)</b> X 20 DTL  | 11/96 → 10/07   | <b>AC</b>   | VKMA 35007<br>VKMV 6PK1805<br>VKM 35007  | 1<br>1  | 1<br>1  |   |   |   |   |   |
|   | <b>B(Alt)</b> X 20 DTL  | 11/96 → 10/07   | <b>AC</b>   | VKMA 35107<br>VKMV 6PK1902<br>VKM 35007  | 1<br>1  | 1<br>1  |   |   |   |   |   |
|   | X 20 DTL  | 11/96 → 06/07   | <b>AC</b>   | VKM_____   |   |   |   | 1   |   |   |   |



| VAUXHALL  VECTRA Mk I 2.0 DTI    |                                  |               |                                       |   |   |   |   |   |   |                 |
|---|----------------------------------|---------------|---------------------------------------|---|---|---|---|---|---|-----------------|
|                                  | X 20 DTH, Y 20 DTH               | 06/97 → 10/07 |                                       | <b>OKOKOKO</b>  |   |   |   |   |   |                 |
|                                  | X 20 DTH, Y 20 DTH               | 06/97 → 10/07 |                                       | VKPC 85623  |   |   |   |   | 1 |                 |
|                                  | <b>B(Alt)</b> X 20 DTH, Y 20 DTH | 06/97 → 10/07 | <b>AC</b>                             | VKMA 35007<br>VKMV 6PK1805<br>VKM 35007                           | 1 |   | 1 | 1 |   |                 |
|   | <b>B(Alt)</b> X 20 DTH, Y 20 DTH | 06/97 → 10/07 | <b>AC</b>                             | VKMA 35107<br>VKMV 6PK1902<br>VKM 35007                           | 1 |   | 1 | 1 |   |                 |
|                                  | X 20 DTH, Y 20 DTH               | 06/97 → 06/07 | <b>AC</b>                             | VKM _____   |   |   |   |   | 1 |                 |
| VAUXHALL  VECTRA Mk I 2.2 DTI    |                                  |               |                                       |   |   |   |   |   |   |                 |
|                                  | Y 22 DTR                         | 09/00 → 10/07 |                                       | <b>OKOKOKO</b>  |   |   |   |   |   |                 |
|                                  | Y 22 DTR                         | 09/00 → 10/07 |                                       | VKPC 85623  |   |   |   |   | 1 |                 |
|                                  | <b>B(Alt)</b> Y 22 DTR           | 09/00 → 10/07 | <b>AC</b>                             | VKMA 35007<br>VKMV 6PK1805<br>VKM 35007                           | 1 |   | 1 | 1 |   |                 |
|   | <b>B(Alt)</b> Y 22 DTR           | 09/00 → 06/07 | <b>AC</b>                             | VKMA 35107<br>VKMV 6PK1902<br>VKM 35007                           | 1 |   | 1 | 1 |   |                 |
|                                  | Y 22 DTR                         | 09/00 → 06/07 |                                       | VKM _____   |   |   |   |   | 1 |                 |
| VAUXHALL  VECTRA Mk II 1.6 16V   |                                  |               |                                       |   |   |   |   |   |   |                 |
|                                  | Z 16 XE                          | 06/04 → 12/07 | 3), → <b>IMot.</b> 20 EB2048          | VKMS 05154-1<br>VKMA 05154<br>VKM 15216<br>VKM 25152<br>VKM 25312 | 1 | 2 | 1 |   |   | 3 3<br>2 1<br>1 |
|   | Z 16 XE                          | 06/04 → 12/07 | <b>Mot.</b> 20 EB2049 <b>I→</b>       | VKMA 05156<br>VKM 15216<br>VKM _____<br>VKM 25158                 | 1 | 2 | 1 |   |   | 1 1<br>1        |
|   | Z 16 XEP                         | 01/06 → 12/07 |                                       | VKMA _____<br>VKM 15260<br>VKM _____                              | 1 | 1 | 1 |   |   | 2 T0244         |
|                                | Z 16 XE                          | 06/04 → 12/07 |                                       | VKPC 85211  |   |   |   |   | 1 |                 |
|   | Z 16 XEP                         | 01/06 → 12/07 |                                       | VKPC _____  |   |   |   |   | 1 |                 |
|                                | <b>B(Alt)</b> Z 16 XE            | 06/04 → 12/07 | <b>AC</b>                             | VKMA 35012<br>VKMV 5PK938<br>VKM 35012                            | 1 |   | 1 | 1 |   |                 |
|   | <b>B(Alt)</b> Z 16 XE            | 06/04 → 12/07 | <b>AC, →ICH</b> 51 058884             | VKMA 35112<br>VKMV 5PK1240<br>VKM 35012                           | 1 |   | 1 | 1 |   |                 |
|   | <b>B(Alt)</b> Z 16 XE            | 06/04 → 12/07 | <b>AC, CH</b> 51 058885 <b>I→</b>     | VKMV 5PK1255<br>VKM 35012   | 1 |   | 1 |   |   |                 |
|   | <b>B(Alt)</b> Z 16 XEP           | 01/06 → 12/07 | <b>AC</b>                             | VKMV 5PK1450<br>VKM 35260   | 1 |   | 1 |   |   |                 |
|   | <b>B(Alt)</b> Z 16 XEP           | 01/06 → 12/07 | <b>AC, →ICH</b> 51999999,<br>58999999 | VKMV 5PK1546<br>VKM 35260   | 1 |   | 1 |   |   |                 |
|   | <b>B(Alt)</b> Z 16 XEP           | 01/06 → 12/07 | <b>AC, CH</b> 61000001 <b>I→</b>      | VKMV 5PK1570<br>VKM 35260   | 1 |   | 1 |   |   |                 |
| VAUXHALL  VECTRA Mk II 1.8 16V |                                  |               |                                       |   |   |   |   |   |   |                 |
|                                | Z 18 XE, Z 18 XEL                | 04/02 → 12/02 | 3), → <b>IMot.</b> 20 EB2048          | VKMS 05154-2<br>VKMA 05154<br>VKM 15216<br>VKM 25152<br>VKM 25312 | 1 | 2 | 1 |   |   | 3 3<br>2 1<br>1 |
|   | Z 18 XE, Z 18 XEL                | 01/03 → 12/07 | 3), → <b>IMot.</b> 20 EB2048          | VKMS 05154-3<br>VKMA 05154<br>VKM 15216<br>VKM 25152<br>VKM 25312 | 1 | 2 | 1 |   |   | 3 3<br>2 1<br>1 |
|   | Z 18 XE, Z 18 XEL                | 01/03 → 12/07 | <b>Mot.</b> 20 EB2049 <b>I→</b>       | VKMA 05156<br>VKM 15216<br>VKM _____<br>VKM 25158                 | 1 | 2 | 1 |   |   | 1 1<br>1        |





























|  |  |  |  |  |  |  |  |  |  |  |  |  |  |
|--|---|---|---|--|---|---|---|---|---|---|---|---|---|
|  | Z 18 XER  | 01/06 → 12/07   |   | —  | 1   | 1   | 1   |   |   |   |   |   |   |
|  |   |   |   | VKM  | 1   | 1   |   |   |   |   |   |   |   |
|    | Z 18 XE, Z 18 XEL   | 04/02 → 12/07   |   | VKPC 85624   |   |   |   |   | 1   |   |   |   |   |
|  | Z 18 XER  | 01/06 → 12/07   |   | VKPC   |   |   |   |   | 1   |   |   |   |   |
|    | <b>B(Alt)</b> Z 18 XE   | 04/02 → 12/07   | <b>AC</b>   | VKMA 35012<br>VKMV 5PK938<br>VKM 35012   | 1   |   | 1   |   |   |   |   |   |   |
|  | <b>B(Alt)</b> Z 18 XE   | 04/02 → 12/04   | <b>AC</b>   | VKMA 35112<br>VKMV 5PK1240<br>VKM 35012  | 1   |   | 1   |   |   |   |   |   |   |
|  | <b>B(Alt)</b> Z 18 XE   | 01/05 → 12/07   | <b>AC, →ICH 51 058884</b>   | VKMA 35112<br>VKMV 5PK1240<br>VKM 35012  | 1   |   | 1   |   |   |   |   |   |   |
|  | <b>B(Alt)</b> Z 18 XE   | 01/05 → 12/07   | <b>AC, CH 51 058885 I→</b>  | VKMV 5PK1255<br>VKM 35012  | 1   |   | 1   |   |   |   |   |   |   |
|  | <b>B(Alt)</b> Z 18 XEL  | 04/02 → 12/07   | <b>AC</b>   | VKMA 35012<br>VKMV 5PK938<br>VKM 35012   | 1   |   | 1   |   |   |   |   |   |   |
|  | <b>B(Alt)</b> Z 18 XEL  | 04/02 → 12/07   | <b>AC, →ICH 51 058884</b>   | VKMA 35112<br>VKMV 5PK1240<br>VKM 35012  | 1   |   | 1   |   |   |   |   |   |   |
|  | <b>B(Alt)</b> Z 18 XEL  | 04/02 → 12/07   | <b>AC, CH 51 058885 I→</b>  | VKMV 5PK1255<br>VKM 35012  | 1   |   | 1   |   |   |   |   |   |   |
|  | <b>B(Alt)</b> Z 18 XER  | 01/06 → 12/07   | <b>AC</b>   | VKMV 5PK1450<br>VKM 35260  | 1   |   | 1   |   |   |   |   |   |   |
|  | <b>B(Alt)</b> Z 18 XER  | 01/06 → 12/07   | <b>AC, →ICH 51999999, 58999999</b>  | VKMV 5PK1546<br>VKM 35260  | 1   |   | 1   |   |   |   |   |   |   |
|  | <b>B(Alt)</b> Z 18 XER  | 01/06 → 12/07   | <b>AC, CH 61000001 I→</b>   | VKMV 5PK1570<br>VKM 35260  | 1   |   | 1   |   |   |   |   |   |   |
| <b>VAUXHALL  VECTRA Mk II 2.0 16V Turbo</b> |   |   |   |  |   |   |   |   |   |   |   |   |   |
|    | Z 20 NET  | 03/03 → 12/07   |   | <b>OXOXOXO</b>   |   |   |   |   |   |   |   |   |   |
|    | Z 20 NET  | 03/03 → 12/07   |   | VKPC 85308   |   |   |   |   | 1   |   |   |   |   |
|    | <b>B(Alt)</b> Z 20 NET  | 03/03 → 12/07   | <b>AC</b>   | VKMV 5PK880<br>VKM 34027   | 1   |   | 1   |   |   |   |   |   |   |
|  | <b>B(Alt)</b> Z 20 NET  | 03/03 → 12/07   | <b>AC</b>   | VKMA 34027<br>VKMV 5PK1028<br>VKM 34027  | 1   |   | 1   |   |   |   |   |   |   |
| <b>VAUXHALL  VECTRA Mk II 2.2 16V</b>       |   |   |   |  |   |   |   |   |   |   |   |   |   |
|    | Z 22 SE, Z 22 YH  | 04/02 → 12/07   |   | <b>OXOXOXO</b>   |   |   |   |   |   |   |   |   |   |
|    | Z 22 SE, Z 22 YH  | 04/02 → 12/07   |   | VKPC 85308   |   |   |   |   | 1   |   |   |   |   |
|    | <b>B(Alt)</b> Z 22 SE, Z 22 YH  | 04/02 → 12/07   | <b>AC</b>   | VKMV 5PK880<br>VKM 34027   | 1   |   | 1   |   |   |   |   |   |   |
|  | <b>B(Alt)</b> Z 22 SE, Z 22 YH  | 04/02 → 12/07   | <b>AC</b>   | VKMA 34027<br>VKMV 5PK1028<br>VKM 34027  | 1   |   | 1   |   |   |   |   |   |   |
| <b>VAUXHALL  VECTRA Mk II 2.8 V6 Turbo</b>  |   |   |   |  |   |   |   |   |   |   |   |   |   |
|    | Z 28 NET  | 08/05 → 12/07   |   | <b>OXOXOXO</b>   |   |   |   |   |   |   |   |   |   |
| <b>VAUXHALL  VECTRA Mk II 3.2 V6</b>        |   |   |   |  |   |   |   |   |   |   |   |   |   |
|    | Z 32 SE   | 08/02 → 12/07   | 5)  | VKMA 05502   | 1   | 1   | 1   |   |   |   |   |   | 5 T0135   |
|    | Z 32 SE   | 08/02 → 12/07   |   | VKPC 85613   |   |   |   |   | 1   |   |   |   |   |
|    | <b>B(Alt)</b> Z 32 SE   | 08/02 → 12/07   | <b>AC</b>   | VKMV 6PK1992<br>VKM 35016<br>VKM 35500   | 1   |   | 1   |   |   |   |   |   |   |
| <b>VAUXHALL  VECTRA Mk II 1.9 CDTI 100</b>  |   |   |   |  |   |   |   |   |   |   |   |   |   |
|    | Z 19 DTL  | 10/05 → 12/07   |   | VKMA 02192<br>VKM 12174<br>VKM 22180   | 1   | 1   | 1   |   |   |   |   |   | T0158   |
|    | Z 19 DTL  | 10/05 → 12/07   |   | VKPC 82665   |   |   |   |   | 1   |   |   |   |   |
|    | <b>B(Alt)</b> Z 19 DTL  | 10/05 → 12/07   | <b>AC, →IMot. 71 111927</b>   | VKMV 6PK1050<br>VKM 32046  | 1   |   | 1   |   |   |   |   |   |   |

|  |  |  |  |  |  |  |  |  |  |  |  |  |
|--|---|---|---|--|---|---|---|---|---|---|---|---|
| B(Alt)   | Z 19 DTL  | 10/05 → 12/07   | AC, Mot. 71 111928 I→   | VKMV 6PK1050   |   |   | 1   |   |   |   |   |   |
| B(Alt)   | Z 19 DTL  | 10/05 → 12/07   | AC  | VKM 32046  | 1   |   |   |   |   |   |   |   |
| <b>VAUXHALL  VECTRA Mk II 1.9 CDTI 120</b>  |   |   |   |  |   |   |   |   |   |   |   |   |
|   | Z 19 DT   | 04/04 → 12/07   |   | VKMA 02192<br>VKM 12174<br>VKM 22180   | 1<br>1  | 1   | 1   |   |   |   |   | T0158   |
|   | Z 19 DT   | 04/04 → 12/07   |   | VKPC 82665   |   |   |   | 1   |   |   |   |   |
|   | B(Alt)  | Z 19 DT   | 04/04 → 12/07   | AC, →IMot. 71 111927   | VKMV 6PK1050<br>VKM 32046   |   |   | 1   |   |   |   |   |
|  | B(Alt)  | Z 19 DT   | 04/04 → 12/07   | AC, Mot. 71 111928 I→  | VKMV 6PK1050  |   |   | 1   |   |   |   |   |
|  | B(Alt)  | Z 19 DT   | 04/04 → 12/07   | AC   | VKM 32046   | 1   |   |   |   |   |   |   |
| <b>VAUXHALL  VECTRA Mk II 1.9 CDTI 150</b>  |   |   |   |  |   |   |   |   |   |   |   |   |
|   | Z 19 DTH  | 04/04 → 12/07   |   | VKMA 02193<br>VKM 12174<br>VKM 22180   | 1<br>1  | 1   | 1   |   |   |   |   | T0248   |
|   | Z 19 DTH  | 04/04 → 12/07   |   | VKPC 82667   |   |   |   | 1   |   |   |   |   |
|   | B(Alt)  | Z 19 DTH  | 04/04 → 12/07   | AC, →IMot. 71 111927   | VKMV 6PK1050<br>VKM 32046   |   |   | 1   |   |   |   |   |
|  | B(Alt)  | Z 19 DTH  | 04/04 → 12/07   | AC, Mot. 71 111928 I→  | VKMV 6PK1050  |   |   | 1   |   |   |   |   |
|  | B(Alt)  | Z 19 DTH  | 04/04 → 12/07   | AC   | VKM 32046   | 1   |   |   |   |   |   |   |
| <b>VAUXHALL  VECTRA Mk II 2.0 DTI</b>       |   |   |   |  |   |   |   |   |   |   |   |   |
|   | Y 20 DTH  | 04/02 → 12/07   |   | OXOXOXO  |   |   |   |   |   |   |   |   |
|   | Y 20 DTH  | 04/02 → 12/07   |   | VKPC 85623   |   |   |   | 1   |   |   |   |   |
|    | B(Alt)  | Y 20 DTH  | 04/02 → 12/07   | AC   | VKMA 35006<br>VKMV 6PK1805<br>VKM 35007<br>VKM 35016                                | 1<br>1  | 1   | 1   |   |   |   |   |
|  | B(Alt)  | Y 20 DTH  | 04/02 → 12/07   | AC   | VKMA 35016<br>VKMV 6PK1880<br>VKM 35007<br>VKM 35016                                | 1<br>1  | 1   | 1   |   |   |   |   |
|   | Y 20 DTH  | 04/02 → 12/07   |   | VKM_____   |   |   |   |   | 1   |   |   |   |
| <b>VAUXHALL  VECTRA Mk II 2.2 DTI</b>     |   |   |   |  |   |   |   |   |   |   |   |   |
|   | Y 22 DTR  | 04/02 → 12/07   |   | OXOXOXO  |   |   |   |   |   |   |   |   |
|   | Y 22 DTR  | 04/02 → 12/07   |   | VKPC 85623   |   |   |   | 1   |   |   |   |   |
|   | B(Alt)  | Y 22 DTR  | 04/02 → 12/07   | AC   | VKMA 35006<br>VKMV 6PK1805<br>VKM 35007<br>VKM 35016                                | 1<br>1  | 1   | 1   |   |   |   |   |
|  | B(Alt)  | Y 22 DTR  | 04/02 → 12/07   | AC   | VKMA 35016<br>VKMV 6PK1880<br>VKM 35007<br>VKM 35016                                | 1<br>1  | 1   | 1   |   |   |   |   |
|   | Y 22 DTR  | 04/02 → 12/07   |   | VKM_____   |   |   |   |   | 1   |   |   |   |
| <b>VAUXHALL  VECTRA Mk II 3.0 V6 CDTI</b> |   |   |   |  |   |   |   |   |   |   |   |   |
|   | Z 30 DT   | 08/05 → 12/07   |   | —<br>—<br>VKM 25222<br>VKM 25226   | 1<br>1  | 2   | 1   |   |   |   |   | T0200   |
|  | Y 30 DT   | 06/03 → 12/07   |   | VKMA 05230<br>VKM 15220<br>VKM 25222<br>VKM 25226                                  | 1<br>1  | 2   | 1   |   |   |   |   | T0200   |
|   | Z 30 DT   | 08/05 → 12/07   |   | VKPC_____  |   |   |   | 1   |   |   |   |   |
|  | Y 30 DT   | 06/03 → 12/07   |   | VKPC_____  |   |   |   | 1   |   |   |   |   |
|   | B(Alt)  | Z 30 DT   | 08/05 → 12/07   | VKMV_____<br>VKM_____<br>VKM_____<br>VKM 35212<br>VKM 35214                        |   |   |   | 1   |   |   |   |   |
|  | B(Alt)  | Y 30 DT   | 06/03 → 12/07   | VKMV_____<br>VKM_____<br>VKM_____  |   |   |   | 1   |   |   |   |   |



















VAUXHALL

|  |                        |               |  | VKM 35212          | 1 |   |   |  |  |   |   |   |  |       |
|--|------------------------|---------------|--|--------------------|---|---|---|--|--|---|---|---|--|-------|
|  |                        |               |  | VKM 35214          | 1 |   |   |  |  |   |   |   |  |       |
|  |                        |               |  | VKM 35216          | 1 |   |   |  |  |   |   |   |  |       |
| <b>VAUXHALL</b> <b>VICEROY 2.5</b>         |                        |               |  |                    |   |   |   |  |  |   |   |   |  |       |
|  | 25 S                   | 01/80 → 10/82 |  | VKPC 85600         |   |   |   |  |  | 1 |   |   |  |       |
| <b>VAUXHALL</b> <b>VX 220 2.0 Turbo</b>    |                        |               |  |                    |   |   |   |  |  |   |   |   |  |       |
|  | Z 20 LET               | 04/03 → 12/03 |  | VKMA 05140         | 1 | 2 | 1 |  |  |   |   |   |  | T0172 |
|  |                        |               |  | VKM 15140          | 1 |   |   |  |  |   |   |   |  |       |
|  |                        |               |  | VKM 25224          |   | 1 |   |  |  |   |   |   |  |       |
|  |                        |               |  | VKM 25224          |   | 1 |   |  |  |   |   |   |  |       |
|  | Z 20 LET               | 01/04 → 10/07 |  | VKMA _____         | 1 | 2 | 1 |  |  |   |   |   |  | T0172 |
|  |                        |               |  | VKM 15140          | 1 |   |   |  |  |   |   |   |  |       |
|  |                        |               |  | VKM _____          |   | 1 |   |  |  |   |   |   |  |       |
|  |                        |               |  | VKM 25224          |   | 1 |   |  |  |   |   |   |  |       |
|  | Z 20 LET               | 04/03 → 10/07 |  | VKPC 85611         |   |   |   |  |  | 1 |   |   |  |       |
|  | <b>B(Alt)</b> Z 20 LET | 04/03 → 10/07 |  | VKMOV 5PK1680      | 1 |   | 1 |  |  |   |   |   |  |       |
|  |                        |               |  | VKM 35009          |   |   |   |  |  |   |   |   |  |       |
|  |                        |               |  | VKM 35016          |   | 1 |   |  |  |   |   |   |  |       |
| <b>VAUXHALL</b> <b>VX 220 2.2</b>          |                        |               |  |                    |   |   |   |  |  |   |   |   |  |       |
|  | Z 22 SE                | 09/00 → 10/07 |  | <del>OKOKOKO</del> |   |   |   |  |  |   |   |   |  |       |
|  | Z 22 SE                | 09/00 → 10/07 |  | VKPC 85308         |   |   |   |  |  | 1 |   |   |  |       |
|  | <b>B(Alt)</b> Z 22 SE  | 09/00 → 10/07 |  | VKMOV 5PK880       |   |   | 1 |  |  |   |   |   |  |       |
|  |                        |               |  | VKM 34027          | 1 |   |   |  |  |   |   |   |  |       |
| <b>VAUXHALL</b> <b>ZAFIRA Mk I 1.6 16V</b> |                        |               |  |                    |   |   |   |  |  |   |   |   |  |       |
|  | X 16 XEL               | 04/99 → 12/04 | 3), → <b>Mot.</b> 02 HL5117,<br>20 041690          | VKMS 05152-1       | 1 | 2 | 1 |  |  |   | 3 | 3 |  | T0157 |
|  |                        |               |  | VKMA 05152         | 1 | 2 | 1 |  |  |   |   | 3 |  |       |
|  |                        |               |  | VKM 15216          | 1 |   |   |  |  |   |   | 1 |  |       |
|  |                        |               |  | VKM 25150          |   | 1 |   |  |  |   |   |   |  |       |
|  |                        |               |  | VKM 25152          |   | 1 |   |  |  |   |   |   |  |       |
|  | X 16 XEL               | 04/99 → 12/04 | 3), <b>Mot.</b> 02 HL5118,<br>20 041691 <b>↳</b> , | VKMS 05154-1       | 1 | 2 | 1 |  |  |   | 3 | 3 |  | T0157 |
|  |                        |               | <b>↳</b> <b>Mot.</b> 20 EB2048                     | VKMA 05154         | 1 | 2 | 1 |  |  |   |   | 2 |  |       |
|  |                        |               |  | VKM 15216          | 1 |   |   |  |  |   |   | 1 |  |       |
|  |                        |               |  | VKM 25152          |   | 1 |   |  |  |   |   |   |  |       |
|  |                        |               |  | VKM 25312          |   | 1 |   |  |  |   |   |   |  |       |
|  | X 16 XEL               | 01/05 → 10/07 | <b>Mot.</b> 20 EB2049 <b>↳</b>                     | VKMA 05156         | 1 | 2 | 1 |  |  |   |   | 1 |  | T0157 |
|  |                        |               |  | VKM 15216          | 1 |   |   |  |  |   |   | 1 |  |       |
|  |                        |               |  | VKM _____          |   | 1 |   |  |  |   |   |   |  |       |
|  |                        |               |  | VKM 25158          |   | 1 |   |  |  |   |   |   |  |       |
|  | X 16 XEL               | 04/99 → 10/07 | <b>↳</b> <b>Mot.</b> 02 MV7224,<br>20 U75998       | VKPC 85212         |   |   |   |  |  | 1 |   |   |  |       |
|  | X 16 XEL               | 04/99 → 10/07 | <b>Mot.</b> 02 MV7225,<br>20 U75999 <b>↳</b>       | VKPC 85211         |   |   |   |  |  | 1 |   |   |  |       |
|  | <b>B(Alt)</b> X 16 XEL | 04/99 → 10/07 | <b>AC</b>  | VKMA 35012         | 1 |   | 1 |  |  |   |   |   |  |       |
|  |                        |               |  | VKMOV 5PK938       |   |   | 1 |  |  |   |   |   |  |       |
|  |                        |               |  | VKM 35012          | 1 |   |   |  |  |   |   |   |  |       |
|  | <b>B(Alt)</b> X 16 XEL | 04/99 → 12/01 | <b>AC</b>  | VKMOV 5PK1255      |   |   | 1 |  |  |   |   |   |  |       |
|  |                        |               |  | VKM 35012          | 1 |   |   |  |  |   |   |   |  |       |
|  | <b>B(Alt)</b> X 16 XEL | 01/02 → 10/07 | <b>AC</b>  | VKMA 35022         | 1 |   | 1 |  |  |   |   |   |  |       |
|  |                        |               |  | VKMOV 5PK1212      |   |   | 1 |  |  |   |   |   |  |       |
|  |                        |               |  | VKM 35012          | 1 |   |   |  |  |   |   |   |  |       |
| <b>VAUXHALL</b> <b>ZAFIRA Mk I 1.8 16V</b> |                        |               |  |                    |   |   |   |  |  |   |   |   |  |       |
|  | X 18 XE1, Z 18 XE      | 04/99 → 12/02 | 3), → <b>Mot.</b> 02 HL5117,<br>20 041690          | VKMS 05152-2       | 1 | 2 | 1 |  |  |   | 3 | 3 |  | T0157 |
|  |                        |               |  | VKMA 05152         | 1 | 2 | 1 |  |  |   |   | 3 |  |       |
|  |                        |               |  | VKM 15216          | 1 |   |   |  |  |   |   | 1 |  |       |
|  |                        |               |  | VKM 25150          |   | 1 |   |  |  |   |   |   |  |       |
|  |                        |               |  | VKM 25152          |   | 1 |   |  |  |   |   |   |  |       |
|  | X 18 XE1               | 04/99 → 09/00 | 3), <b>Mot.</b> 02 HL5118,<br>20 041691 <b>↳</b>   | VKMS 05154-2       | 1 | 2 | 1 |  |  |   | 3 | 3 |  | T0157 |
|  |                        |               |  | VKMA 05154         | 1 | 2 | 1 |  |  |   |   | 2 |  |       |
|  |                        |               |  | VKM 15216          | 1 |   |   |  |  |   |   | 1 |  |       |
|  |                        |               |  | VKM 25152          |   | 1 |   |  |  |   |   |   |  |       |
|  |                        |               |  | VKM 25312          |   | 1 |   |  |  |   |   |   |  |       |





































|  |  |  |  |  |  |  |  |  |  |  |  |  |  |       |
|--|---|---|---|--|---|---|---|---|---|---|---|---|---|-------|
|  | Z 18 XE   | 09/00 → 12/02   | 3), <b>Mot.</b> 02 HL5118,<br>20 041691 I→,<br>→I <b>Mot.</b> 20 EB2048           | VKMS 05154-2<br>VKMA 05154<br>VKM 15216<br>VKM 25152<br>VKM 25312                  | 1<br>1<br>1   | 2<br>2<br>1   | 1<br>1  |   |   |   |   | 3<br>2<br>1   | 3<br>1  | T0157 |
|  | Z 18 XE   | 01/03 → 12/04   | 3), →I <b>Mot.</b> 02 HL5117,<br>20 041690  | VKMS 05152-3<br>VKMA 05152<br>VKM 15216<br>VKM 25150<br>VKM 25152                  | 1<br>1<br>1   | 2<br>2<br>1   | 1<br>1  |   |   |   |   | 3<br>3<br>1   | 3<br>1  | T0157 |
|  | Z 18 XE   | 01/03 → 12/04   | 3), <b>Mot.</b> 02 HL5118,<br>20 041691 I→,<br>→I <b>Mot.</b> 20 EB2048           | VKMS 05154-3<br>VKMA 05154<br>VKM 15216<br>VKM 25152<br>VKM 25312                  | 1<br>1<br>1   | 2<br>2<br>1   | 1<br>1  |   |   |   |   | 3<br>2<br>1   | 3<br>1  | T0157 |
|  | Z 18 XE   | 01/05 → 10/07   | <b>Mot.</b> 20 EB2049 I→  | VKMA 05156<br>VKM 15216<br>VKM _____<br>VKM 25158                                  | 1<br>1  | 2<br>1  | 1<br>1  |   |   |   |   |   | 1<br>1  | T0157 |
|   | X 18 XE1, Z 18 XE   | 04/99 → 10/07   |   | VKPC 85624   |   |   |   |   |   | 1   |   |   |   |       |
|   | <b>B(Alt)</b> X 18 XE1, Z 18 XE   | 04/99 → 10/07   | <b>AC</b>   | VKMA 35012<br>VKMV 5PK938<br>VKM 35012   | 1   |   | 1<br>1  |   |   |   |   |   |   |       |
|  | <b>B(Alt)</b> X 18 XE1, Z 18 XE   | 04/99 → 12/01   | <b>AC</b>   | VKMV 5PK1255<br>VKM 35012  | 1   |   | 1   |   |   |   |   |   |   |       |
|  | <b>B(Alt)</b> Z 18 XE   | 01/02 → 10/07   | <b>AC</b>   | VKMA 35022<br>VKMV 5PK1212<br>VKM 35012  | 1   |   | 1<br>1  |   |   |   |   |   |   |       |
| <b>VAUXHALL</b>  <b>ZAFIRA Mk I 2.0 Turbo</b> |   |   |   |  |   |   |   |   |   |   |   |   |   |       |
|   | Z 20 LET  | 09/01 → 12/03   |   | VKMA 05140<br>VKM 15140<br>VKM 25224<br>VKM 25224                                  | 1<br>1  | 2<br>1<br>1   | 1   |   |   |   |   |   |   | T0172 |
|  | Z 20 LET  | 01/04 → 10/07   |   | VKMA _____<br>VKM 15140<br>VKM _____<br>VKM 25224                                  | 1<br>1  | 2<br>1<br>1   | 1   |   |   |   |   |   |   | T0172 |
|   | Z 20 LET  | 09/01 → 10/07   |   | VKPC 85611   |   |   |   |   |   | 1   |   |   |   |       |
|   | <b>B(Alt)</b> Z 20 LET  | 09/01 → 10/07   |   | VKMA 35119<br>VKMV 5PK1680<br>VKM 35009  | 1   |   | 1<br>1  |   |   |   |   |   |   |       |
| <b>VAUXHALL</b>  <b>ZAFIRA Mk I 2.2 16V</b>   |   |   |   |  |   |   |   |   |   |   |   |   |   |       |
|   | Z 22 SE   | 09/00 → 10/07   |   | <b>OXOXOXO</b>   |   |   |   |   |   |   |   |   |   |       |
|   | Z 22 SE   | 09/00 → 10/07   |   | VKPC 85308   |   |   |   |   |   | 1   |   |   |   |       |
|   | <b>B(Alt)</b> Z 22 SE   | 09/00 → 10/07   | <b>AC</b>   | VKMV 5PK880<br>VKM 34027   | 1   |   | 1   |   |   |   |   |   |   |       |
|  | <b>B(Alt)</b> Z 22 SE   | 09/00 → 10/07   | <b>AC</b>   | VKMA 34027<br>VKMV 5PK1028<br>VKM 34027  | 1   |   | 1<br>1  |   |   |   |   |   |   |       |
| <b>VAUXHALL</b>  <b>ZAFIRA Mk I 2.0 DI</b>    |   |   |   |  |   |   |   |   |   |   |   |   |   |       |
|   | X 20 DTL, Y 20 DTL  | 10/99 → 10/07   |   | <b>OXOXOXO</b>   |   |   |   |   |   |   |   |   |   |       |
|   | X 20 DTL, Y 20 DTL  | 10/99 → 10/07   |   | VKPC 85623   |   |   |   |   |   | 1   |   |   |   |       |
|   | <b>B(Alt)</b> X 20 DTL, Y 20 DTL  | 10/99 → 10/07   | <b>AC</b>   | VKMA 35006<br>VKMV 6PK1805<br>VKM 35007<br>VKM 35016                               | 1   | 1   | 1<br>1  |   |   |   |   |   |   |       |
|  | <b>B(Alt)</b> X 20 DTL, Y 20 DTL  | 10/99 → 10/07   | <b>AC</b>   | VKMA 35010<br>VKMV 6PK1863<br>VKM 35007<br>VKM 35016                               | 1   | 1   | 1<br>1  |   |   |   |   |   |   |       |



VAUXHALL







































|  |  |  |  |  |  |  |  |  |  |  |  |  |
|--|---|---|---|--|---|---|---|---|---|---|---|---|
| ⊙  | X 20 DTL  | 10/99 → 01/07   | AC. Man. GBX.<br>→ ICH 22999999,<br>25999999, 26999999,<br>28999999, 2H999999     | VKM_____   |   |   |   |   |   |   |   |   |
|  | X 20 DTL  | 10/99 → 01/07   | Auto. GBX.<br>→ ICH 22999999,<br>25999999, 26999999,<br>28999999, 2H999999        | VKM_____   |   |   |   |   |   |   |   | 1   |
|  | Y 20 DTL  | 10/99 → 01/07   | CH 32000001, 35000001,<br>36000001, 38000001,<br>3H000001 I→                      | VKM_____   |   |   |   |   |   |   |   | 1   |
| <b>VAUXHALL  ZAFIRA Mk I 2.0 DTI</b>    |   |   |   |  |   |   |   |   |   |   |   |   |
|  | Y 20 DTH  | 04/99 → 10/07   |   | <b>OXOXOXO</b>   |   |   |   |   |   |   |   |   |
|  | Y 20 DTH  | 04/99 → 10/07   |   | VKPC 85623   |   |   |   |   |   |   |   | 1   |
|  | <b>B(Alt)</b> Y 20 DTH  | 04/99 → 10/07   | AC  | VKMA 35006<br>VKMV 6PK1805<br>VKM 35007<br>VKM 35016                               | 1   | 1   | 1   |   |   |   |   |   |
|  | <b>B(Alt)</b> Y 20 DTH  | 04/99 → 12/01   | AC  | VKMA 35010<br>VKMV 6PK1863<br>VKM 35007<br>VKM 35016                               | 1   | 1   | 1   |   |   |   |   |   |
|  | <b>B(Alt)</b> Y 20 DTH  | 01/02 → 10/07   | AC. → ICH 22 109974,<br>2H 019030   | VKMA 35010<br>VKMV 6PK1863<br>VKM 35007<br>VKM 35016                               | 1   | 1   | 1   |   |   |   |   |   |
|  | <b>B(Alt)</b> Y 20 DTH  | 01/02 → 10/07   | AC. CH 22 109975,<br>2H 019031 I→   | VKMA 35030<br>VKMV 6PK1873<br>VKM 35007<br>VKM 35016                               | 1   | 1   | 1   |   |   |   |   |   |
| ⊙  | Y 20 DTH  | 04/99 → 01/07   | AC. → ICH 22999999,<br>25999999, 26999999,<br>28999999, 2H999999                  | VKM_____   |   |   |   |   |   |   |   | 1   |
|  | Y 20 DTH  | 04/99 → 01/07   | CH 32000001, 35000001,<br>36000001, 38000001,<br>3H000001 I→                      | VKM_____   |   |   |   |   |   |   |   | 1   |
| <b>VAUXHALL  ZAFIRA Mk II 1.6 16V</b> |   |   |   |  |   |   |   |   |   |   |   |   |
|  | Z 16 XE1, Z 16 XEP,<br>Z 16 XER   | 07/05 → 10/07   |   | VKMA_____  | 1   | 1   | 1   |   |   |   |   | 2 T0244   |
|  | Z 16 XE1, Z 16 XEP,<br>Z 16 XER   | 07/05 → 10/07   |   | VKMA_____  | 1   |   |   |   |   |   |   |   |
|  | Z 16 XE1, Z 16 XEP,<br>Z 16 XER   | 07/05 → 10/07   |   | VKM 15260<br>VKM_____  |   | 1   |   |   |   |   |   |   |
|  | <b>B(Alt)</b> Z 16 XE1, Z 16 XEP,<br>Z 16 XER                                     | 07/05 → 03/07   | AC  | VKPC_____  |   |   |   |   |   |   |   | 1   |
|  | <b>B(Alt)</b> Z 16 XE1, Z 16 XEP,<br>Z 16 XER                                     | 07/05 → 03/07   | AC  | VKMA 35006<br>VKMV 5PK1546<br>VKM 35260  | 1   |   | 1   |   |   |   |   |   |
|  | <b>B(AC)</b> Z 16 XE1, Z 16 XEP,<br>Z 16 XER                                      | 07/05 → 03/07   | AC  | VKMA 35010<br>VKMV 5PK1450<br>VKM 35260  | 1   |   | 1   |   |   |   |   |   |
| <b>VAUXHALL  ZAFIRA Mk II 1.8 16V</b> |   |   |   |  |   |   |   |   |   |   |   |   |
|  | Z 18 XER  | 07/05 → 01/07   |   | —  | 1   | 1   | 1   |   |   |   |   |   |
|  | Z 18 XER  | 07/05 → 10/07   |   | VKM_____   | 1   |   |   |   |   |   |   |   |
|  | Z 18 XER  | 07/05 → 10/07   |   | VKPC_____  |   |   |   |   |   |   |   | 1   |
|  | <b>B(Alt)</b> Z 18 XER  | 07/05 → 03/07   | AC  | VKMA 35030<br>VKMV 5PK1873<br>VKM 35007<br>VKM 35016                               | 1   |   | 1   |   |   |   |   |   |
|  | <b>B(AC)</b> Z 18 XER   | 07/05 → 03/07   | AC  | VKMA 35030<br>VKMV 5PK1873<br>VKM 35007<br>VKM 35016                               | 1   |   | 1   |   |   |   |   |   |
| <b>VAUXHALL  ZAFIRA Mk II 2.2</b>     |   |   |   |  |   |   |   |   |   |   |   |   |
|  | Z 22 YH   | 07/05 → 01/07   |   | <b>OXOXOXO</b>   |   |   |   |   |   |   |   |   |
|  | Z 22 YH   | 07/05 → 10/07   |   | —  |   |   |   |   |   |   |   | 1   |
|  | <b>B(Alt)</b> Z 22 YH   | 07/05 → 03/07   | AC  | VKMA 35030<br>VKMV 5PK1873<br>VKM 35007<br>VKM 35016                               | 1   |   | 1   |   |   |   |   |   |
|  | Z 22 YH   | 07/05 → 03/07   | AC  | VKMA 35030<br>VKMV 5PK1873<br>VKM 35007<br>VKM 35016                               | 1   |   | 1   |   |   |   |   |   |



















































|   |  |  |    |  |  |  |  |  |  |  |  |
|---|---|---|---|--|---|---|---|---|---|---|---|
|   | B(Alt) Z 22 YH  | 07/05 → 03/07   | AC  | VKMA 34027<br>VKMV 5PK1028<br>VKM 34027  | 1<br>1<br>1   | 1<br>1  |   |   |   |   |   |
| <b>VAUXHALL  ZAFIRA Mk II 1.9 CDTI 120</b> |   |   |   |  |   |   |   |   |   |   |   |
|    | Z 19 DT   | 07/05 → 01/07   |   | VKMA 02192<br>VKM 12174<br>VKM 22180   | 1<br>1<br>1   | 1<br>1  | 1   |   |   |   | T0158   |
|    | Z 19 DT   | 07/05 → 10/07   |   | VKPC 82665   |   |   |   | 1   |   |   |   |
|    | B(Alt) Z 19 DT  | 07/05 → 03/07   | AC  | VKMV 6PK1050<br>VKM 32046  | 1   | 1   |   |   |   |   |   |
|   | B(Alt) Z 19 DT  | 07/05 → 03/07   | AC  | VKM 32046  | 1   |   |   |   |   |   |   |
| <b>VAUXHALL  ARENA 1.9 D</b>               |   |   |   |  |   |   |   |   |   |   |   |
|    | F8Q 600, F8Q 606  | 03/98 → 08/01   | 3)  | VKMS 06114-2<br>VKMA 06114<br>VKM 16101<br>VKM 26101                               | 1<br>1<br>1<br>1  | 1<br>1<br>1   |   |   |   | 2   | T0147   |
|    | F8Q 600, F8Q 606  | 03/98 → 08/01   |   | VKPC 86413   |   |   |   | 1   |   |   |   |
| <b>VAUXHALL  ARENA 2.5 D</b>               |   |   |   |  |   |   |   |   |   |   |   |
|    | S8U 758, S8U 780,<br>S8U 782  | 03/98 → 08/01   |    | VKMA 02983<br>—<br>VKM 22380<br>VKM 22385  | —<br>—<br>1<br>1  | 2<br>1<br>1   | 1<br>1  |   |   |   | T0096   |
|   | S8U 758, S8U 780,<br>S8U 782  | 03/98 → 08/01   |   | VKMA 02383<br>VKM 22380<br>VKM 22385   | —<br>—<br>1<br>1  | 2<br>1<br>1   | 1   |   |   |   | T0652   |
|    | S8U 758, S8U 780,<br>S8U 782  | 03/98 → 08/01   |   | VKPC 82630   |   |   |   | 1   |   |   |   |
| <b>VAUXHALL  MOVANO 1.9 DTI</b>          |   |   |   |  |   |   |   |   |   |   |   |
|    | F9Q 772, F9Q 774  | 10/01 → 10/07   |  | VKMC 06127<br>VKMA 06127<br>VKM 16113  | 1<br>1<br>1   | 1<br>1  | 1   | 1   |   |   | T0647   |
|   | F9Q 770   | 09/00 → 10/01   | c   | VKMA 06117<br>VKM 16551<br>VKM 26117<br>VKM 26128                                  | 1<br>1<br>1<br>1  | 1<br>1<br>1   | 1   |   | 1   |   | T0181   |
|    | F9Q 770   | 09/00 → 10/01   |   | VKPC 86413   |   |   |   | 1   |   |   |   |
|   | F9Q 772, F9Q 774  | 10/01 → 10/07   |   | VKPC 85304   |   |   |   | 1   |   |   |   |
| <b>VAUXHALL  MOVANO 2.2 DTI</b>          |   |   |   |  |   |   |   |   |   |   |   |
|    | G9T 720, G9T 722,<br>G9T 750  | 09/00 → 10/07   |   | VKMA 06503<br>VKM 16503<br>VKM 26503   | 1<br>1<br>1   | 1<br>1  | 1   |   |   |   | 1 T0187   |
|    | G9T 720, G9T 722,<br>G9T 750  | 09/00 → 10/07   |   | VKPC 86305   |   |   |   | 1   |   |   |   |
| <b>VAUXHALL  MOVANO 2.5 CDTI</b>         |   |   |   |  |   |   |   |   |   |   |   |
|    | G9U 632, G9U 650  | 04/04 → 10/07   |   | VKMA 06503<br>VKM 16503<br>VKM 26503   | 1<br>1<br>1   | 1<br>1  | 1   |   |   |   | 1 T0187   |
|    | G9U 632, G9U 650  | 04/04 → 10/07   |   | VKPC 86305   |   |   |   | 1   |   |   |   |
| <b>VAUXHALL  MOVANO 2.5 D</b>            |   |   |   |  |   |   |   |   |   |   |   |
|    | S8U 772   | 10/98 → 09/00   |  | VKMA 02983<br>—<br>VKM 22380<br>VKM 22385  | —<br>—<br>1<br>1  | 2<br>1<br>1   | 1<br>1  |   |   |   | T0096   |
|   | S8U 772   | 10/98 → 09/00   |   | VKMA 02383<br>VKM 22380<br>VKM 22385   | —<br>—<br>1<br>1  | 2<br>1<br>1   | 1   |   |   |   | T0652   |
|    | S8U 772   | 10/98 → 09/00   |   | VKPC 85302   |   |   |   | 1   |   |   |   |
|    | B(Alt) S8U 772  | 10/98 → 09/00   | → Mot. 3053818  | VKMA 36017<br>VKMV 6PK860<br>VKM 36017   | 1<br>1<br>1   | 1<br>1  |   |   |   |   |   |

































VAUXHALL

|  |  |  |    |  |  |  |  |  |  |  |  |  |
|--|---|---|---|--|---|---|---|---|---|---|---|---|
| <b>VAUXHALL  MOVANO 2.5 DTI</b>   |   |   |   |  |   |   |   |   |   |   |   |   |
|                                    | G9U 720, G9U 724,<br>G9U 750, G9U 754   | 10/01 → 10/07   |   | VKMA 06503<br>VKM 16503<br>VKM 26503   | 1<br>1  | 1<br>1  |   |   |   |   |   | 1 T0187   |
|                                    | G9U 720, G9U 724,<br>G9U 750, G9U 754   | 10/01 → 10/07   |   | VKPC 86305   |   |   |   | 1   |   |   |   |   |
| <b>VAUXHALL  MOVANO 2.8 DTI</b>   |   |   |   |  |   |   |   |   |   |   |   |   |
|                                    | S9W 700, S9W 702  | 10/98 → 10/01   |    | VKMA 02986<br>—<br>VKM 22385<br>VKM 22385  |   | 2<br>1<br>1   | 1<br>1  |   |   |   |   | T0155   |
|  | S9W 700, S9W 702  | 10/98 → 10/01   |   | VKMA 02386<br>VKM 22385<br>VKM 22385   |   | 2<br>1<br>1   | 1   |   |   |   |   | T0155   |
|                                    | S9W 700, S9W 702  | 10/98 → 10/01   |   | VKPC 85303   |   |   |   | 1   |   |   |   |   |
|                                    | <b>B(Alt)</b> S9W 700, S9W 702  | 10/98 → 10/01   | → IMot. 3053818   | VKMA 36117<br>VKMV 6PK841<br>VKM 36017   |   | 1<br>1<br>1   | 1<br>1  |   |   |   |   |   |
| <b>VAUXHALL  MOVANO 3.0 DTI</b>   |   |   |   |  |   |   |   |   |   |   |   |   |
|                                    | ZD3 200, ZD3 202  | 10/03 → 10/07   |   |   |   |   |   |   |   |   |   |   |
|                                    | <b>B(Alt)</b> ZD3 200, ZD3 202  | 10/03 → 10/07   | <b>AC</b>   | VKMV 7PK1922   |   |   | 1   |   |   |   |   |   |
| <b>VAUXHALL  VIVARO 2.0 16V</b>   |   |   |   |  |   |   |   |   |   |   |   |   |
|                                    | F4R 720   | 08/01 → 10/07   |   | —<br>—<br>VKM 26105  | 1<br>1  | 1<br>1  |   |   |   |   |   | T0177   |
|                                  | F4R 720   | 08/01 → 10/07   |   | VKPC 85304   |   |   |   | 1   |   |   |   |   |
|                                  | <b>B(Alt)</b> F4R 720   | 08/01 → 10/07   | <b>AC</b>   | VKMV 5PK1125   |   |   | 1   |   |   |   |   |   |
|  | <b>B(Alt)</b> F4R 720   | 08/01 → 02/02   | <b>AC</b>   | VKMA 36033<br>VKMV 6PK1792<br>VKM 36030<br>VKM 36031                               | 1<br>1  | 1<br>1  | 1<br>1  |   |   |   |   |   |
|  | <b>B(Alt)</b> F4R 720   | 02/02 → 05/06   | <b>AC</b>   | VKMA 36038<br>VKMV 6PK1792<br>VKM 36030<br>VKM 36038                               | 1<br>1  | 1<br>1  | 1<br>1  |   |   |   |   |   |
| <b>VAUXHALL  VIVARO 1.9 DI</b>  |   |   |   |  |   |   |   |   |   |   |   |   |
|                                  | F9Q 762   | 08/01 → 10/07   |  | VKMC 06127<br>VKMA 06127<br>VKM 16113  | 1<br>1<br>1   |   | 1<br>1  | 1   |   |   |   | T0647   |
|                                  | F9Q 762   | 08/01 → 10/07   |   | VKPC 85304   |   |   |   | 1   |   |   |   |   |
|                                  | <b>B(Alt)</b> F9Q 762   | 08/01 → 10/07   | <b>AC</b>   | VKMV 5PK1125   |   |   | 1   |   |   |   |   |   |
|  | <b>B(Alt)</b> F9Q 762   | 08/01 → 03/02   | <b>AC</b>   | VKMA 36033<br>VKMV 6PK1792<br>VKM 36030<br>VKM 36031                               | 1<br>1  | 1<br>1  | 1<br>1  |   |   |   |   |   |
|  | <b>B(Alt)</b> F9Q 762   | 03/02 → 11/05   | <b>AC</b>   | VKMA 36038<br>VKMV 6PK1792<br>VKM 36030<br>VKM 36038                               | 1<br>1  | 1<br>1  | 1<br>1  |   |   |   |   |   |
| <b>VAUXHALL  VIVARO 1.9 DTI</b> |   |   |   |  |   |   |   |   |   |   |   |   |
|                                  | F9Q 760   | 08/01 → 10/07   |  | VKMC 06127<br>VKMA 06127<br>VKM 16113  | 1<br>1<br>1   |   | 1<br>1  | 1   |   |   |   | T0647   |
|                                  | F9Q 760   | 08/01 → 10/07   |   | VKPC 85304   |   |   |   | 1   |   |   |   |   |
|                                  | <b>B(Alt)</b> F9Q 760   | 08/01 → 10/07   | <b>AC</b>   | VKMV 5PK1125   |   |   | 1   |   |   |   |   |   |
|  | <b>B(Alt)</b> F9Q 760   | 08/01 → 03/02   | <b>AC</b>   | VKMA 36033<br>VKMV 6PK1792<br>VKM 36030<br>VKM 36031                               | 1<br>1  | 1<br>1  | 1<br>1  |   |   |   |   |   |
|  | <b>B(Alt)</b> F9Q 760   | 03/02 → 11/05   | <b>AC</b>   | VKMA 36038<br>VKMV 6PK1792   | 1<br>1  | 1<br>1  | 1<br>1  |   |   |   |   |   |































|  |  |  |  |  |  |  |  |  |  |  |  |  |  |  |  |  |  |  |  |  |  |  |  |  |  |  |  |  |  |  |  |  |  |  |  |  |  |  |  |  |  |  |  |  |  |  |  |  |  |  |  |  |  |  |  |  |  |  |  |  |  |  |  |  |  |  |  |  |  |  |  |  |  |  |  |  |  |  |  |  |  |  |  |  |  |  |  |  |  |  |  |  |  |  |  |  |  |  |  |  |  |  |  |  |  |  |  |  |  |  |  |  |  |  |  |  |  |  |  |  |  |  |  |  |  |  |  |  |  |  |  |  |  |  |  |  |  |  |  |  |  |  |  |  |  |  |  |  |  |  |  |  |  |  |  |  |  |  |  |  |  |  |  |  |  |  |  |  |  |  |  |  |  |  |  |  |  |  |  |  |  |  |  |  |  |  |  |  |  |  |  |  |  |  |  |  |  |  |  |  |  |  |  |  |  |  |  |  |  |  |  |  |  |  |  |  |  |  |  |  |  |  |  |  |  |  |  |  |  |  |  |  |  |  |  |  |  |  |  |  |  |  |  |  |  |  |  |  |  |  |  |  |  |  |  |  |  |  |  |  |  |  |  |  |  |  |  |  |  |  |  |  |  |  |  |  |  |  |  |  |  |  |  |  |  |  |  |  |  |  |  |  |  |  |  |  |  |  |  |  |  |  |  |  |  |  |  |  |  |  |  |  |  |  |  |  |  |  |  |  |  |  |  |  |  |  |  |  |  |  |  |  |  |  |  |  |  |  |  |  |  |  |  |  |  |  |  |  |  |  |  |  |  |  |  |  |  |  |  |  |  |  |  |  |  |  |  |  |  |  |  |  |  |  |  |  |  |  |  |
|--|--|--|--|---|---|---|---|---|---|---|---|---|---|---|---|---|---|---|---|---|---|---|---|---|---|---|---|---|---|---|---|---|---|---|---|---|---|---|---|---|---|---|---|---|---|---|---|---|---|---|---|---|---|---|---|---|---|---|---|---|---|---|---|---|---|---|---|---|---|---|---|---|---|---|---|---|---|---|---|---|---|---|---|---|---|---|---|---|---|---|---|---|---|---|---|---|---|---|---|---|---|---|---|---|---|---|---|---|---|---|---|---|---|---|---|---|---|---|---|---|---|---|---|---|---|---|---|---|---|---|---|---|---|---|---|---|---|---|---|---|---|---|--|--|--|--|--|--|--|--|--|--|--|--|--|--|--|--|--|--|--|--|--|--|--|--|--|--|--|--|--|--|--|--|--|--|--|--|--|--|--|--|--|--|--|--|--|--|--|--|--|--|--|--|--|--|--|--|--|--|--|--|--|--|--|--|--|--|--|--|--|--|--|--|--|--|--|--|--|--|--|--|--|--|--|--|--|--|--|--|--|--|--|--|--|--|--|--|--|--|--|--|--|--|--|--|--|--|--|--|--|--|--|--|--|--|--|--|--|--|--|--|--|--|--|--|--|--|--|--|--|--|--|--|--|--|--|--|--|--|--|--|--|--|--|--|--|--|--|--|--|--|--|--|--|--|--|--|--|--|--|--|--|--|--|--|--|--|--|--|--|--|--|--|--|--|--|--|--|--|--|--|--|--|--|--|--|--|--|--|--|--|--|--|--|--|--|--|--|--|--|--|--|--|--|--|--|--|--|--|--|--|--|--|--|--|--|--|--|--|--|--|--|--|--|--|--|--|--|--|--|--|--|--|--|--|--|--|--|
|--|--|--|--|---|---|---|---|---|---|---|---|---|---|---|---|---|---|---|---|---|---|---|---|---|---|---|---|---|---|---|---|---|---|---|---|---|---|---|---|---|---|---|---|---|---|---|---|---|---|---|---|---|---|---|---|---|---|---|---|---|---|---|---|---|---|---|---|---|---|---|---|---|---|---|---|---|---|---|---|---|---|---|---|---|---|---|---|---|---|---|---|---|---|---|---|---|---|---|---|---|---|---|---|---|---|---|---|---|---|---|---|---|---|---|---|---|---|---|---|---|---|---|---|---|---|---|---|---|---|---|---|---|---|---|---|---|---|---|---|---|---|---|--|--|--|--|--|--|--|--|--|--|--|--|--|--|--|--|--|--|--|--|--|--|--|--|--|--|--|--|--|--|--|--|--|--|--|--|--|--|--|--|--|--|--|--|--|--|--|--|--|--|--|--|--|--|--|--|--|--|--|--|--|--|--|--|--|--|--|--|--|--|--|--|--|--|--|--|--|--|--|--|--|--|--|--|--|--|--|--|--|--|--|--|--|--|--|--|--|--|--|--|--|--|--|--|--|--|--|--|--|--|--|--|--|--|--|--|--|--|--|--|--|--|--|--|--|--|--|--|--|--|--|--|--|--|--|--|--|--|--|--|--|--|--|--|--|--|--|--|--|--|--|--|--|--|--|--|--|--|--|--|--|--|--|--|--|--|--|--|--|--|--|--|--|--|--|--|--|--|--|--|--|--|--|--|--|--|--|--|--|--|--|--|--|--|--|--|--|--|--|--|--|--|--|--|--|--|--|--|--|--|--|--|--|--|--|--|--|--|--|--|--|--|--|--|--|--|--|--|--|--|--|--|--|--|--|--|--|

|  |  |  |  |  |  |  |  |  |  |  |  |  |  |
|--|--|---|---|---|--|---|---|---|---|---|---|---|---|
|  | B 200 E, B 200 F,<br>B 200 K   | 08/84 → 07/90   |   |   | VKPC 86614   |   |   |   |   | 1   |   |   |   |
| <b>VOLVO</b>   |  <b>340-360 1.6 D</b>     |   |   |   |  |   |   |   |   |   |   |   |   |
|    | D 16   | 08/84 → 07/91   | 3), Mot. 32768  →   |   | VKMS 06111-2<br>VKMA 06111<br>VKM 16101<br>VKM 26101                               | 1<br>1<br>1   | 1<br>1  | 1   |   |   | 3   |   | T0066   |
|  | D 16   | 08/84 → 07/91   | → Mot. 32767  |   | VKMA 06110<br>VKM 16110<br>VKM 26100   | 1<br>1  | 1<br>1  | 1   |   |   |   |   | T0019   |
|    | D 16   | 08/84 → 07/91   |   |   | VKPC 86413   |   |   |   |   | 1   |   |   |   |
| <b>VOLVO</b>   |  <b>440-460 1.6</b>       |   |   |   |  |   |   |   |   |   |   |   |   |
|    | B 16 F   | 09/88 → 12/96   |   |   | VKMA 06101<br>VKM 16101<br>VKM 26101   | 1<br>1  | 1<br>1  | 1   |   |   |   |   | T0046   |
|    | B 16 F   | 09/88 → 12/96   |   |   | VKPC 86413   |   |   |   |   | 1   |   |   |   |
| <b>VOLVO</b>   |  <b>440-460 1.7</b>       |   |   |   |  |   |   |   |   |   |   |   |   |
|    | B 18 EP, B 18 F,<br>B 18 FP, B 18 KP   | 08/88 → 12/96   |   |   | VKMA 06101<br>VKM 16101<br>VKM 26101   | 1<br>1  | 1<br>1  | 1   |   |   |   |   | T0046   |
|    | B 18 EP, B 18 F,<br>B 18 FP, B 18 KP   | 08/88 → 12/96   |   |   | VKPC 86413   |   |   |   |   | 1   |   |   |   |
| <b>VOLVO</b>   |  <b>440-460 1.7 Turbo</b> |   |   |   |  |   |   |   |   |   |   |   |   |
|    | B 18 FT  | 08/88 → 12/96   |   |   | VKMA 06101<br>VKM 16101<br>VKM 26101   | 1<br>1  | 1<br>1  | 1   |   |   |   |   | T0046   |
|  | B 18 FT  | 08/88 → 12/96   |   |   | VKPC 86413   |   |   |   |   | 1   |   |   |   |
| <b>VOLVO</b>   |  <b>440-460 1.8</b>     |   |   |   |  |   |   |   |   |   |   |   |   |
|  | B 18 KPD, B 18 U   | 08/91 → 12/96   |   |   | VKMA 06101<br>VKM 16101<br>VKM 26101   | 1<br>1  | 1<br>1  | 1   |   |   |   |   | T0046   |
|  | B 18 KPD, B 18 U   | 08/91 → 12/96   |   |   | VKPC 86413   |   |   |   |   | 1   |   |   |   |
| <b>VOLVO</b>   |  <b>440-460 2.0</b>     |   |   |   |  |   |   |   |   |   |   |   |   |
|  | B 20 F   | 08/92 → 07/96   |   |   | VKMA 06103<br>VKM 16101<br>VKM 26101   | 1<br>1  | 1<br>1  | 1   |   |   |   |   | T0108   |
|  | B 20 F   | 08/92 → 07/96   |   |   | VKPC 86413   |   |   |   |   | 1   |   |   |   |
| <b>VOLVO</b>   |  <b>440-460 1.9 TD</b>  |   |   |   |  |   |   |   |   |   |   |   |   |
|  | D 19 T   | 07/94 → 12/96   | 3)  |   | VKMS 06111-2<br>VKMA 06111<br>VKM 16101<br>VKM 26101                               | 1<br>1<br>1   | 1<br>1  | 1   |   |   | 3   |   | T0066   |
|  | D 19 T   | 07/94 → 12/96   |   |   | VKPC 86413   |   |   |   |   | 1   |   |   |   |
| <b>VOLVO</b>   |  <b>480 1.7</b>         |   |   |   |  |   |   |   |   |   |   |   |   |
|  | B 18 E, B 18 EP  | 04/86 → 07/96   | → Mot. 16529  |   | VKMA 06100<br>VKM 16100<br>VKM 26100   | 1<br>1  | 1<br>1  | 1   |   |   |   |   | T0023   |
|  | B 18 E, B 18 EP  | 04/86 → 07/96   | Mot. 16530  →   |   | VKMA 06101<br>VKM 16101<br>VKM 26101   | 1<br>1  | 1<br>1  | 1   |   |   |   |   | T0046   |
|  | B 18 F   | 08/87 → 07/89   | → Mot. 1725   |   | VKMA 06100<br>VKM 16100<br>VKM 26100   | 1<br>1  | 1<br>1  | 1   |   |   |   |   | T0023   |
|  | B 18 F   | 08/87 → 07/89   | Mot. 1726  →  |   | VKMA 06101<br>VKM 16101<br>VKM 26101   | 1<br>1  | 1<br>1  | 1   |   |   |   |   | T0046   |
|  | B 18 E, B 18 EP, B 18 F  | 04/86 → 07/96   |   |   | VKPC 86413   |   |   |   |   | 1   |   |   |   |
| <b>VOLVO</b>   |  <b>480 1.7 Turbo</b>   |   |   |   |  |   |   |   |   |   |   |   |   |
|  | B 18 FT  | 08/87 → 07/96   | → Mot. 1455   |   | VKMA 06100<br>VKM 16100<br>VKM 26100   | 1<br>1  | 1<br>1  | 1   |   |   |   |   | T0023   |
|  | B 18 FT  | 08/87 → 07/96   | Mot. 1456  →  |   | VKMA 06101<br>VKM 16101<br>VKM 26101   | 1<br>1  | 1<br>1  | 1   |   |   |   |   | T0046   |
|  | B 18 FT  | 08/87 → 07/96   |   |   | VKPC 86413   |   |   |   |   | 1   |   |   |   |

|  |  |  |       |  |  |  |  |  |  |  |  |  |
|--|--|---|--|---|--|---|---|---|---|---|---|---|
| <b>VOLVO  480 2.0</b>         |  |   |  |   |  |   |   |   |   |   |   |   |
|                               | B 20 F   | 08/92 → 09/95   |  | VKMA 06103<br>VKM 16101<br>VKM 26101  | 1<br>1   | 1   | 1   |   |   |   |   | T0108   |
|                               | B 20 F   | 08/92 → 09/95   |  | VKPC 86413  |  |   |   | 1   |   |   |   |   |
| <b>VOLVO  66 1.1</b>          |  |   |  |   |  |   |   |   |   |   |   |   |
|                               | B 11   | 08/75 → 11/79   |  | VKPC 86403  |  |   |   | 1   |   |   |   |   |
| <b>VOLVO  66 1.3</b>          |  |   |  |   |  |   |   |   |   |   |   |   |
|                               | B 130  | 08/75 → 11/79   |  | VKPC 86403  |  |   |   | 1   |   |   |   |   |
| <b>VOLVO  740 2.0</b>         |  |   |  |   |  |   |   |   |   |   |   |   |
|                               | B 19 E, B 19 ET,<br>B 200 E, B 200 ET,<br>B 200 F, B 200 K                       | 01/85 → 07/91   |  | VKMA 06300<br>VKM 16300   | 1<br>1   |   | 1   |   |   |   |   | T0007   |
|  | B 204 E, B 204 FT,<br>B 204 GT   | 08/85 → 07/92   | 1), M⊙   | VKMA 06406<br>VKM 16400<br>VKM 16410<br>VKM 26400<br>VKM 26400                    | 2<br>1<br>1<br>1<br>1  | 2   | 2   |   |   |   |   | T0074   |
|  | B 204 E, B 204 FT,<br>B 204 GT   | 08/85 → 07/92   | 1), A⊙   | VKMA 06408<br>VKM 16402<br>VKM 16410<br>VKM 26400<br>VKM 26402                    | 2<br>1<br>1<br>1<br>1  | 2   | 2   |   |   |   |   | T0232   |
|                              | B 19 E, B 19 ET,<br>B 200 E, B 200 ET,<br>B 200 F, B 200 K                       | 01/85 → 07/91   |  | VKPC 86609  |  |   |   | 1   |   |   |   |   |
|  | B 204 E, B 204 FT,<br>B 204 GT   | 08/85 → 07/92   |  | VKPC 86610  |  |   |   | 1   |   |   |   |   |
| <b>VOLVO  740 2.3</b>       |  |   |  |   |  |   |   |   |   |   |   |   |
|                             | B 23 E, B 230 A,<br>B 230 E, B 230 F,<br>B 230 FB, B 230 FT,<br>B 230 G, B 230 K | 08/83 → 07/92   |  | VKMA 06300<br>VKM 16300   | 1<br>1   |   | 1   |   |   |   |   | T0007   |
|  | B 234 F  | 08/87 → 08/92   | 1), M⊙   | VKMA 06406<br>VKM 16400<br>VKM 16410<br>VKM 26400<br>VKM 26400                    | 2<br>1<br>1<br>1<br>1  | 2   | 2   |   |   |   |   | T0074   |
|  | B 234 F  | 08/87 → 08/92   | 1), A⊙   | VKMA 06408<br>VKM 16402<br>VKM 16410<br>VKM 26400<br>VKM 26402                    | 2<br>1<br>1<br>1<br>1  | 2   | 2   |   |   |   |   | T0232   |
|                             | B 23 E   | 08/83 → 07/90   |  | VKPC 86610  |  |   |   | 1   |   |   |   |   |
|  | B 230 A, B 230 E,<br>B 230 F, B 230 FB,<br>B 230 G, B 230 K,<br>B 234 F          | 08/84 → 08/92   |  | VKPC 86609  |  |   |   | 1   |   |   |   |   |
| <b>VOLVO  740 2.3 Turbo</b> |  |   |  |   |  |   |   |   |   |   |   |   |
|                             | B 230 ET, B 230 FT,<br>B 230 GT  | 08/85 → 07/90   |  | VKMA 06300<br>VKM 16300   | 1<br>1   |   | 1   |   |   |   |   | T0007   |
|                             | B 230 ET, B 230 FT,<br>B 230 GT  | 08/85 → 07/90   |  | VKPC 86609  |  |   |   | 1   |   |   |   |   |
| <b>VOLVO  740 2.4 D</b>     |  |   |  |   |  |   |   |   |   |   |   |   |
|                             | D 24   | 08/84 → 07/92   |  4) | VKMC 01040<br>VKMA 01040<br>VKM 21031   | 1<br>1<br>1  | 2   | 2   |   | 1   |   |   | T0012   |
|                             | D 24   | 08/84 → 07/92   |  | VKPC 81602  |  |   |   | 1   |   |   |   |   |





































|  |  |  |                  |  |  |  |  |  |  |  |  |       |       |
|--|---|---|---|--|---|---|---|---|---|---|---|-------|-------|
|  | B 5204 FT, B 5204 T,<br>B 5204 T2   | 02/93 → 12/96   | Mot. 131035 I→  | VKMA 06602<br>VKM 16602<br>VKM 26602   | 1<br>1  | 1<br>1  | 1   |   |   |   | 1   | T0163 |       |
|                             | B 5204 FT, B 5204 T,<br>B 5204 T2   | 02/93 → 12/96   |   | VKPC 86618   |   |   |   | 1   |   |   |   |       |       |
|                             | B(Alt) B 5204 FT, B 5204 T,<br>B 5204 T2  | 01/95 → 12/96   | AC, Mot. 565357 I→  | VKMV 6PK1743<br>VKM 36003<br>VKM 36120   | 1   | 1   | 1   |   |   |   |   |       |       |
| <b>VOLVO  850 2.3 Turbo</b> |   |   |   |  |   |   |   |   |   |   |   |       |       |
|                             | B 5234 FS, B 5234 FT,<br>B 5234 T4, B 5234 T5                                     | 02/93 → 12/96   | →IMot. 131034   | VKMA 06600<br>VKM 16600<br>VKM 26600   | 1<br>1  | 1<br>1  | 1   |   |   |   |   | 1     | T0099 |
|  | B 5234 FS, B 5234 FT,<br>B 5234 T4, B 5234 T5                                     | 02/93 → 12/96   | Mot. 131035 I→  | VKMA 06602<br>VKM 16602<br>VKM 26602   | 1<br>1  | 1<br>1  | 1   |   |   |   |   | 1     | T0163 |
|                             | B 5234 FS, B 5234 FT,<br>B 5234 T2, B 5234 T4,<br>B 5234 T5                       | 02/93 → 12/96   |   | VKPC 86618   |   |   |   | 1   |   |   |   |       |       |
|                             | B(Alt) B 5234 FT, B 5234 T2,<br>B 5234 T5   | 01/95 → 12/96   | AC, Mot. 565357 I→  | VKMV 6PK1743<br>VKM 36003<br>VKM 36120   | 1   | 1   | 1   |   |   |   |   |       |       |
|  | B(Alt) B 5234 T4  | 08/95 → 12/96   | AC, Mot. 121321 I→  | VKM 36003  |   | 1   |   |   |   |   |   |       |       |
| <b>VOLVO  850 2.5 10V</b> |   |   |   |  |   |   |   |   |   |   |   |       |       |
|                           | B 5252 FS   | 06/91 → 12/96   |  →IMot. 131034 | —<br>VKMA 06601<br>VKM 16600<br>VKM 26600  | 1<br>1<br>1   | 1<br>1<br>1   | 1   |   | 1   |   |   | 1     | T0112 |
|  | B 5252 FS   | 08/94 → 12/96   |                | —<br>VKMA 06601<br>VKM 16600<br>VKM 26600  | 1<br>1<br>1   | 1<br>1<br>1   | 1   |   | 1   |   |   | 1     | T0112 |
|  | B 5252 FS   | 06/91 → 12/96   | →IMot. 131034   | VKMA 06601<br>VKM 16600<br>VKM 26600   | 1<br>1  | 1<br>1  | 1   |   |   |   |   | 1     | T0112 |
|  | B 5252 FS   | 06/91 → 12/96   | Mot. 131035 I→  | VKMA 06603<br>VKM 16602<br>VKM 26602   | 1<br>1  | 1<br>1  | 1   |   |   |   |   | 1     | T0113 |
|                           | B 5252 FS   | 06/91 → 12/96   |   | VKPC 86618   |   |   |   | 1   |   |   |   |       |       |
|                           | B(Alt) B 5252 FS  | 06/91 → 12/96   | AC, Mot. 121321 I→  | VKM 36003  |   | 1   |   |   |   |   |   |       |       |
| <b>VOLVO  850 2.5 20V</b> |   |   |   |  |   |   |   |   |   |   |   |       |       |
|                           | B 5254 FS   | 08/91 → 12/96   | →IMot. 131034   | VKMA 06600<br>VKM 16600<br>VKM 26600   | 1<br>1  | 1<br>1  | 1   |   |   |   |   | 1     | T0099 |
|  | B 5254 FS   | 08/91 → 12/96   | Mot. 131035 I→  | VKMA 06602<br>VKM 16602<br>VKM 26602   | 1<br>1  | 1<br>1  | 1   |   |   |   |   | 1     | T0163 |
|                           | B 5254 FS   | 08/91 → 12/96   |   | VKPC 86618   |   |   |   | 1   |   |   |   |       |       |
|                           | B(Alt) B 5254 FS  | 08/91 → 12/96   | AC, Mot. 121321 I→  | VKM 36003  |   | 1   |   |   |   |   |   |       |       |
| <b>VOLVO  850 2.5 TDI</b> |   |   |   |  |   |   |   |   |   |   |   |       |       |
|                           | D 5252 T  | 08/95 → 12/96   | 4)  | VKMA 01258<br>VKM 11073<br>VKM 11257<br>VKM 11258                                  | 3<br>1<br>1<br>1  |   | 2   |   |   |   |   | 6     | T0095 |
|                           | D 5252 T  | 08/95 → 12/96   |   | VKPC 86620   |   |   |   | 1   |   |   |   |       |       |
|                           | B(Alt) D 5252 T   | 08/95 → 12/96   | AC  | VKMA 36520<br>VKMV 6PK1432<br>VKM____<br>VKM 36530                                 | 1<br>1<br>1   | 1<br>1  | 1<br>1  |   |   |   |   |       |       |
|  | B(Alt) D 5252 T   | 08/95 → 12/96   | AC  | VKMA____<br>VKMV 6PK1683   | 1<br>1  | 1<br>1  | 1<br>1  |   |   |   |   |       |       |



VOLVO





















|  |  |  |                     |                   |  |  |  |  |  |  |  |  |
|--|--|---|--|--|--|---|---|---|---|---|---|---|
|  |  |   |  |  | VKM _____<br>VKM 36530   | 1   | 1   |   |   |   |   |   |
| <b>VOLVO  940 2.0</b>         |  |   |  |  |  |   |   |   |   |   |   |   |
|                                |  | B 200 E, B 200 F,<br>B 200 G  | 01/92 → 12/92  |  | VKMA 06300<br>VKM 16300  | 1<br>1  |   | 1   |   |   |   | T0007   |
|  |  | B 200 E, B 200 F,<br>B 200 G  | 01/93 → 07/94  |  | VKMA 06301<br>VKM 16300  | 1<br>1  |   | 1   |   |   |   | T0109   |
|  |  | B 204 E   | 01/92 → 07/94 1)   |  | VKMA 06408<br>VKM 16402<br>VKM 16410<br>VKM 26400<br>VKM 26402                     | 2<br>1<br>1<br>1  | 2   | 2   | 2   |   |   | T0232   |
|                                |  | B 200 F   | 01/92 → 07/94  |  | VKPC 86609   |   |   |   |   | 1   |   |   |
| <b>VOLVO  940 2.0 Turbo</b>   |  |   |  |  |  |   |   |   |   |   |   |   |
|                                |  | B 200 FT, B 200 GT  | 01/91 → 12/92  |  | VKMA 06300<br>VKM 16300  | 1<br>1  |   | 1   |   |   |   | T0007   |
|  |  | B 200 FT, B 200 GT  | 01/93 → 10/98  |  | VKMA 06301<br>VKM 16300  | 1<br>1  |   | 1   |   |   |   | T0109   |
|                                |  | B 200 FT  | 01/91 → 10/98  |  | VKPC 86609   |   |   |   |   | 1   |   |   |
| <b>VOLVO  940 2.3</b>         |  |   |  |  |  |   |   |   |   |   |   |   |
|                                |  | B 230 E, B 230 F,<br>B 230 FB, B 230 FD,<br>B 230 G                               | 08/90 → 12/92  |  | VKMA 06300<br>VKM 16300  | 1<br>1  |   | 1   |   |   |   | T0007   |
|  |  | B 230 E, B 230 F,<br>B 230 FB, B 230 FD,<br>B 230 G                               | 01/93 → 10/98  |  | VKMA 06301<br>VKM 16300  | 1<br>1  |   | 1   |   |   |   | T0109   |
|  |  | B 234 F, B 234 G  | 08/90 → 07/91 1)   |  | VKMA 06408<br>VKM 16402<br>VKM 16410<br>VKM 26400<br>VKM 26402                     | 2<br>1<br>1<br>1  | 2   | 2   | 2   |   |   | T0232   |
|                              |  | B 230 E, B 230 FB,<br>B 230 G, B 234 F,<br>B 234 G                                | 08/90 → 10/98  |  | VKPC 86609   |   |   |   |   | 1   |   |   |
| <b>VOLVO  940 2.3 Turbo</b> |  |   |  |  |  |   |   |   |   |   |   |   |
|                              |  | B 230 FT, B 230 GT  | 08/90 → 12/92  |  | VKMA 06300<br>VKM 16300  | 1<br>1  |   | 1   |   |   |   | T0007   |
|  |  | B 230 FK, B 230 FT,<br>B 230 GT   | 01/93 → 10/98  |  | VKMA 06301<br>VKM 16300  | 1<br>1  |   | 1   |   |   |   | T0109   |
|                              |  | B 230 FB, B 230 FT,<br>B 230 GT, B 234 F,<br>B 234 G                              | 08/90 → 10/98  |  | VKPC 86609   |   |   |   |   | 1   |   |   |
| <b>VOLVO  940 2.4 D</b>     |  |   |  |  |  |   |   |   |   |   |   |   |
|                              |  | D 24  | 08/90 → 07/95  4) |  | VKMC 01040<br>VKMA 01040<br>VKM 21031  |   | 1<br>1<br>1   | 2<br>2  |   | 1   |   | T0012   |
|                              |  | D 24  | 08/90 → 07/95  |  | VKPC 81602   |   |   |   |   | 1   |   |   |
| <b>VOLVO  940 2.4 TD</b>    |  |   |  |  |  |   |   |   |   |   |   |   |
|                              |  | D 24 T  | 08/90 → 12/94  4) |  | VKMC 01040<br>VKMA 01040<br>VKM 21031  |   | 1<br>1<br>1   | 2<br>2  |   | 1   |   | T0012   |
|  |  | D 24 TIC  | 08/90 → 10/98 4)   |  | VKMA 01046<br>VKM 11045<br>VKM 21045   | 1<br>1  | 1   | 2   |   |   |   | T0013   |
|                              |  | D 24 T  | 08/90 → 12/94  |  | VKPC 81602   |   |   |   |   | 1   |   |   |
|  |  | D 24 TIC  | 08/90 → 12/94  | → ICH 112962   | VKPC 81602   |   |   |   |   | 1   |   |   |
|  |  | D 24 TIC  | 08/90 → 12/94  | → ICH 112963 I →   | VKPC 86620   |   |   |   |   | 1   |   |   |
|  |  | D 24 TIC  | 08/90 → 08/94  |  → ICH 65355    | VKPC 81602   |   |   |   |   | 1   |   |   |
|  |  | D 24 TIC  | 08/90 → 08/94  |  → CH 65356 I → | VKPC 86620   |   |   |   |   | 1   |   |   |
|  |  | D 24 TIC  | 08/94 → 10/98  |  | VKPC 86620   |   |   |   |   | 1   |   |   |



























| VOLVO |                                | 960 2.0             |                  |              |   |   |   |  |  |   |  |  |   |       |       |
|-------|--------------------------------|---------------------|------------------|--------------|---|---|---|--|--|---|--|--|---|-------|-------|
|       | B 204 FT                       | 08/90 → 09/93       | 1)               | VKMA 06408   | 2 | 2 | 2 |  |  |   |  |  |   |       | T0232 |
|       |                                |                     |                  | VKM 16402    | 1 |   |   |  |  |   |  |  |   |       |       |
|       |                                |                     |                  | VKM 16410    | 1 |   |   |  |  |   |  |  |   |       |       |
|       |                                |                     |                  | VKM 26400    |   | 1 |   |  |  |   |  |  |   |       |       |
|       |                                |                     |                  | VKM 26402    |   | 1 |   |  |  |   |  |  |   |       |       |
| VOLVO |                                | 960 2.5             |                  |              |   |   |   |  |  |   |  |  |   |       |       |
|       | B 6254 FS, B 6254 GS           | 07/94 → 12/96       |                  | VKMA 06610   | 1 | 1 | 1 |  |  |   |  |  |   |       | T0138 |
|       |                                |                     |                  | VKM 16612    | 1 |   |   |  |  |   |  |  |   |       |       |
|       |                                |                     |                  | VKM 26612    |   | 1 |   |  |  |   |  |  |   |       |       |
| VOLVO |                                | 960 2.9             |                  |              |   |   |   |  |  |   |  |  |   |       |       |
|       | B 6304 FS, B 6304 GS           | 08/90 → 07/94       | →   Mot. 131034  | VKMA 06600   | 1 | 1 | 1 |  |  |   |  |  | 1 | T0099 |       |
|       |                                |                     |                  | VKM 16600    | 1 |   |   |  |  |   |  |  |   |       |       |
|       |                                |                     |                  | VKM 26600    |   | 1 |   |  |  |   |  |  |   |       |       |
|       | B 6304 FS, B 6304 GS           | 08/90 → 07/94       | Mot. 131035   →  | VKMA 06608   | 1 | 1 | 1 |  |  |   |  |  |   | T0163 |       |
|       |                                |                     |                  | VKM 16602    | 1 |   |   |  |  |   |  |  |   |       |       |
|       |                                |                     |                  | VKM 26610    |   | 1 |   |  |  |   |  |  |   |       |       |
|       | B 6304 FS, B 6304 GS           | 07/94 → 12/96       |                  | VKMA 06610   | 1 | 1 | 1 |  |  |   |  |  |   | T0138 |       |
|       |                                |                     |                  | VKM 16612    | 1 |   |   |  |  |   |  |  |   |       |       |
|       |                                |                     |                  | VKM 26612    |   | 1 |   |  |  |   |  |  |   |       |       |
|       | B 6304 FS, B 6304 GS           | 08/90 → 07/94       |                  | VKPC 86618   |   |   |   |  |  | 1 |  |  |   |       |       |
|       | B(Alt) B 6304 FS, B 6304 GS    | 01/94 → 07/94       | AC               | VKMV 6PK1623 |   |   | 1 |  |  |   |  |  |   |       |       |
|       |                                |                     |                  | VKM 36003    |   | 1 |   |  |  |   |  |  |   |       |       |
|       |                                |                     |                  | VKM 36120    | 1 |   |   |  |  |   |  |  |   |       |       |
| VOLVO |                                | 960 2.4 TD          |                  |              |   |   |   |  |  |   |  |  |   |       |       |
|       | D 24 TIC                       | 09/91 → 07/94       | 4)               | VKMA 01046   | 1 | 1 | 2 |  |  |   |  |  |   | T0013 |       |
|       |                                |                     |                  | VKM 11045    | 1 |   |   |  |  |   |  |  |   |       |       |
|       |                                |                     |                  | VKM 21045    |   | 1 |   |  |  |   |  |  |   |       |       |
|       | D 24 TIC                       | 09/91 → 07/94       | →   CH 30003     | VKPC 81602   |   |   |   |  |  | 1 |  |  |   |       |       |
|       | D 24 TIC                       | 09/91 → 07/94       | →   CH 30004   → | VKPC 86620   |   |   |   |  |  | 1 |  |  |   |       |       |
|       | D 24 TIC                       | 09/91 → 07/94       | →   CH 11622     | VKPC 81602   |   |   |   |  |  | 1 |  |  |   |       |       |
|       | D 24 TIC                       | 09/91 → 07/94       | →   CH 11623   → | VKPC 86620   |   |   |   |  |  | 1 |  |  |   |       |       |
| VOLVO |                                | C30 2.4 D5          |                  |              |   |   |   |  |  |   |  |  |   |       |       |
|       | D 5244 T8, D 5244 T9           | 10/06 → 04/07       |                  | VKMA 06220   | 1 | 1 | 1 |  |  |   |  |  |   | T0192 |       |
|       |                                |                     |                  | VKM 16220    | 1 |   |   |  |  |   |  |  |   |       |       |
|       |                                |                     |                  | VKM 26220    |   | 1 |   |  |  |   |  |  |   |       |       |
|       | D 5244 T8, D 5244 T9           | 10/06 → 04/07       |                  | —            |   |   |   |  |  | 1 |  |  |   |       |       |
|       | B(Alt) D 5244 T8, D 5244 T9    | 10/06 → 04/07       |                  | VKMV 5PK891  |   |   | 1 |  |  |   |  |  |   |       |       |
|       |                                |                     |                  | VKM 36236    | 1 |   |   |  |  |   |  |  |   |       |       |
|       | B(AC) D 5244 T8, D 5244 T9     | 10/06 → 04/07       |                  | VKMA _____   | 1 |   | 1 |  |  |   |  |  |   |       |       |
|       |                                |                     |                  | VKMV 5PK847  |   |   | 1 |  |  |   |  |  |   |       |       |
|       |                                |                     |                  | VKM 36238    | 1 |   |   |  |  |   |  |  |   |       |       |
| VOLVO |                                | C70 - S70 2.0 10V   |                  |              |   |   |   |  |  |   |  |  |   |       |       |
|       | B 5202 FS, B 5204 F            | 01/97 → 11/00       | →   Mot. 1266127 | VKMA 06603   | 1 | 1 | 1 |  |  |   |  |  | 1 | T0113 |       |
|       |                                |                     |                  | VKM 16602    | 1 |   |   |  |  |   |  |  |   |       |       |
|       |                                |                     |                  | VKM 26602    |   | 1 |   |  |  |   |  |  |   |       |       |
|       | B 5202 FS, B 5204 F            | 01/97 → 11/00       | Mot. 1266128   → | VKMA 06605   | 1 | 1 | 1 |  |  |   |  |  |   | T0240 |       |
|       |                                |                     |                  | VKM 16604    | 1 |   |   |  |  |   |  |  |   |       |       |
|       |                                |                     |                  | VKM 26602    |   | 1 |   |  |  |   |  |  |   |       |       |
|       | B 5202 FS, B 5204 F            | 01/97 → 11/00       |                  | VKPC 86618   |   |   |   |  |  | 1 |  |  |   |       |       |
|       | B(Alt) B 5202 FS, B 5204 F     | 01/97 → 12/98       | AC, Man. GBX     | VKMV 6PK1267 |   |   | 1 |  |  |   |  |  |   |       |       |
|       |                                |                     |                  | VKM 36003    |   | 1 |   |  |  |   |  |  |   |       |       |
|       |                                |                     |                  | VKM 36120    | 1 |   |   |  |  |   |  |  |   |       |       |
|       | B(Alt) B 5202 FS, B 5204 F     | 01/97 → 12/98       | AC               | VKMV 6PK1743 |   |   | 1 |  |  |   |  |  |   |       |       |
|       |                                |                     |                  | VKM 36003    |   | 1 |   |  |  |   |  |  |   |       |       |
|       |                                |                     |                  | VKM 36120    | 1 |   |   |  |  |   |  |  |   |       |       |
|       | B(Alt) B 5202 FS, B 5204 F     | 01/99 → 12/99       | AC               | VKMV 6DK1836 |   |   | 1 |  |  |   |  |  |   |       |       |
|       |                                |                     |                  | VKM 36240    | 1 |   |   |  |  |   |  |  |   |       |       |
| VOLVO |                                | C70 - S70 2.0 Turbo |                  |              |   |   |   |  |  |   |  |  |   |       |       |
|       | B 5204 T, B 5204 T2, B 5204 T3 | 01/97 → 09/02       | →   Mot. 1266127 | VKMA 06602   | 1 | 1 | 1 |  |  |   |  |  | 1 | T0163 |       |
|       |                                |                     |                  | VKM 16602    | 1 |   |   |  |  |   |  |  |   |       |       |
|       |                                |                     |                  | VKM 26602    |   | 1 |   |  |  |   |  |  |   |       |       |



|  |  |  |  |  |  |  |  |  |  |  |  |  |  |  |
|--|---|---|---|--|---|---|---|---|---|---|---|---|---|---|
|  | B 5204 T, B 5204 T2,<br>B 5204 T3   | 01/97 → 09/02   | Mot. 1266128 I→   | VKMA 06604<br>VKM 16604<br>VKM 26602   | 1<br>1  | 1   | 1   |   |   |   |   |   |   | T0163   |
|  | B 5204 T4   | 03/00 → 10/05   |   | VKMA 06604<br>VKM 16604<br>VKM 26602   | 1<br>1  | 1   | 1   |   |   |   |   |   |   | T0163   |
|                                      | B 5204 T, B 5204 T2,<br>B 5204 T3, B 5204 T4                                      | 01/97 → 10/05   |   | VKPC 86618   |   |   |   |   | 1   |   |   |   |   |   |
|                                      | <b>B(Alt)</b> B 5204 T, B 5204 T2,<br>B 5204 T3                                   | 01/97 → 12/98   | AC, Man. GBX  | VKMOV 6PK1267<br>VKM 36003<br>VKM 36120  | 1   | 1   | 1   |   |   |   |   |   |   |   |
|  | <b>B(Alt)</b> B 5204 T2, B 5204 T3  | 03/98 → 12/98   | AC, Auto. GBX   | VKMOV 6PK1253<br>VKM 36003<br>VKM 36120  | 1   | 1   | 1   |   |   |   |   |   |   |   |
|  | <b>B(Alt)</b> B 5204 T3   | 01/99 → 12/99   | AC  | VKMOV 6DK1825<br>VKM 36240<br>VKM 36250  | 1   | 1   | 1   |   |   |   |   |   |   |   |
|  | <b>B(Alt)</b> B 5204 T3, B 5204 T4  | 01/00 → 10/05   | AC  | VKMA 36230<br>VKMOV 6DK1841<br>VKM 36240<br>VKM 36250                              | 1<br>1  | 1   | 1   |   |   |   |   |   |   |   |
|  | <b>B(Alt)</b> B 5204 T, B 5204 T2,<br>B 5204 T3                                   | 01/97 → 12/98   | AC  | VKMOV 6PK1743<br>VKM 36003<br>VKM 36120  | 1   | 1   | 1   |   |   |   |   |   |   |   |
|  | <b>B(Alt)</b> B 5204 T, B 5204 T2,<br>B 5204 T3                                   | 01/99 → 12/99   | AC  | VKMOV 6DK1836<br>VKM 36240   | 1   | 1   | 1   |   |   |   |   |   |   |   |
|  | <b>B(Alt)</b> B 5204 T3, B 5204 T4  | 01/00 → 10/05   | AC  | VKMOV 6DK1853<br>VKM 36240   | 1   | 1   | 1   |   |   |   |   |   |   |   |
| <b>VOLVO  C70 - S70 2.3 Turbo</b> |   |   |   |  |   |   |   |   |   |   |   |   |   |   |
|                                    | B 5234 FS, B 5234 T2,<br>B 5234 T3, B 5234 T7                                     | 01/97 → 10/05   | →IMot. 1266127  | VKMA 06602<br>VKM 16602<br>VKM 26602   | 1<br>1  | 1   | 1   |   |   |   |   |   | 1   | T0163   |
|  | B 5234 FS, B 5234 T2,<br>B 5234 T3, B 5234 T7                                     | 01/97 → 10/05   | Mot. 1266128 I→   | VKMA 06604<br>VKM 16604<br>VKM 26602   | 1<br>1  | 1   | 1   |   |   |   |   |   |   | T0163   |
|  | B 5234 T9   | 07/02 → 10/05   |   | VKMA 06604<br>VKM 16604<br>VKM 26602   | 1<br>1  | 1   | 1   |   |   |   |   |   |   | T0163   |
|                                    | B 5234 FS, B 5234 T2,<br>B 5234 T3, B 5234 T7,<br>B 5234 T9                       | 01/97 → 10/05   |   | VKPC 86618   |   |   |   |   | 1   |   |   |   |   |   |
|                                    | <b>B(Alt)</b> B 5234 FS, B 5234 T2,<br>B 5234 T3, B 5234 T7                       | 01/97 → 12/98   | AC, Man. GBX  | VKMOV 6PK1267<br>VKM 36003<br>VKM 36120  | 1   | 1   | 1   |   |   |   |   |   |   |   |
|  | <b>B(Alt)</b> B 5234 T3   | 03/98 → 12/98   | AC, Auto. GBX   | VKMOV 6PK1253<br>VKM 36003<br>VKM 36120  | 1   | 1   | 1   |   |   |   |   |   |   |   |
|  | <b>B(Alt)</b> B 5234 T3   | 01/99 → 12/99   | AC  | VKMOV 6DK1825<br>VKM 36240<br>VKM 36250  | 1   | 1   | 1   |   |   |   |   |   |   |   |
|  | <b>B(Alt)</b> B 5234 T3, B 5234 T9  | 01/00 → 10/05   | AC  | VKMA 36230<br>VKMOV 6DK1841<br>VKM 36240<br>VKM 36250                              | 1<br>1  | 1   | 1   |   |   |   |   |   |   |   |
|  | <b>B(Alt)</b> B 5234 FS, B 5234 T2,<br>B 5234 T3, B 5234 T7                       | 01/97 → 12/98   | AC  | VKMOV 6PK1743<br>VKM 36003<br>VKM 36120  | 1   | 1   | 1   |   |   |   |   |   |   |   |

|  |  |  |  |  |  |  |  |  |  |  |  |  |
|--|---|---|---|--|---|---|---|---|---|---|---|---|
| B(Alt)   | B 5234 FS, B 5234 T2,<br>B 5234 T3, B 5234 T7                                     | 01/99 → 12/99   | AC  | VKMV 6DK1836<br>VKM 36240  | 1   |   | 1   |   |   |   |   |   |
| B(Alt)   | B 5234 T3, B 5234 T9  | 01/00 → 10/05   | AC  | VKMV 6DK1853<br>VKM 36240  | 1   |   | 1   |   |   |   |   |   |
| <b>VOLVO  C70 - S70 2.4 20V</b>     |   |   |   |  |   |   |   |   |   |   |   |   |
|                                     | B 5244 FS, B 5244 S   | 01/97 → 11/00   | →IMot. 1266127  | VKMA 06602<br>VKM 16602<br>VKM 26602   | 1<br>1  | 1   | 1   |   |   |   |   | 1 T0163   |
|  | B 5244 FS, B 5244 S   | 01/97 → 11/00   | Mot. 1266128  →   | VKMA 06604<br>VKM 16604<br>VKM 26602   | 1<br>1  | 1   | 1   |   |   |   |   | T0163   |
|  | B 5244 S2   | 08/99 → 11/00   |   | VKMA 06604<br>VKM 16604<br>VKM 26602   | 1<br>1  | 1   | 1   |   |   |   |   | T0163   |
|                                     | B 5244 FS, B 5244 S,<br>B 5244 S2   | 01/97 → 11/00   |   | VKPC 86618   |   |   |   | 1   |   |   |   |   |
|                                     | B(Alt) B 5244 FS, B 5244 S  | 01/97 → 12/98   | AC, Man. GBX  | VKMV 6PK1267<br>VKM 36003<br>VKM 36120   | 1   | 1   | 1   |   |   |   |   |   |
| B(Alt)   | B 5244 FS, B 5244 S   | 01/97 → 12/98   | AC  | VKMV 6PK1743<br>VKM 36003<br>VKM 36120   | 1   | 1   | 1   |   |   |   |   |   |
| B(Alt)   | B 5244 FS, B 5244 S,<br>B 5244 S2   | 01/99 → 12/99   | AC  | VKMV 6DK1836<br>VKM 36240  | 1   |   | 1   |   |   |   |   |   |
| B(Alt)   | B 5244 S2   | 08/99 → 12/99   | AC  | VKMV 6DK1825<br>VKM 36240<br>VKM 36250   | 1   |   | 1   |   |   |   |   |   |
| B(Alt)   | B 5244 S2   | 01/00 → 11/00   | AC  | VKMA 36230<br>VKMV 6DK1841<br>VKM 36240<br>VKM 36250                               | 1<br>1  | 1   | 1   |   |   |   |   |   |
| B(Alt)   | B 5244 S2   | 01/00 → 11/00   | AC  | VKMV 6DK1853<br>VKM 36240  | 1   |   | 1   |   |   |   |   |   |
| <b>VOLVO  C70 - S70 2.4 Turbo</b> |   |   |   |  |   |   |   |   |   |   |   |   |
|                                   | B 5244 T  | 01/97 → 11/00   | →IMot. 1266127  | VKMA 06602<br>VKM 16602<br>VKM 26602   | 1<br>1  | 1   | 1   |   |   |   |   | 1 T0163   |
|  | B 5244 T  | 01/97 → 11/00   | Mot. 1266128  →   | VKMA 06604<br>VKM 16604<br>VKM 26602   | 1<br>1  | 1   | 1   |   |   |   |   | T0163   |
|  | B 5244 T7   | 07/02 → 10/05   |   | VKMA 06604<br>VKM 16604<br>VKM 26602   | 1<br>1  | 1   | 1   |   |   |   |   | T0163   |
|                                   | B 5244 T, B 5244 T7   | 01/97 → 10/05   |   | VKPC 86618   |   |   |   | 1   |   |   |   |   |
|                                   | B(Alt) B 5244 T   | 01/97 → 12/98   | AC, Man. GBX  | VKMV 6PK1267<br>VKM 36003<br>VKM 36120   | 1   | 1   | 1   |   |   |   |   |   |
| B(Alt)   | B 5244 T  | 01/97 → 12/98   | AC  | VKMV 6PK1743<br>VKM 36003<br>VKM 36120   | 1   | 1   | 1   |   |   |   |   |   |
| B(Alt)   | B 5244 T  | 01/99 → 12/99   | AC  | VKMV 6DK1836<br>VKM 36240  | 1   |   | 1   |   |   |   |   |   |
| B(Alt)   | B 5244 T7   | 07/02 → 10/05   | AC  | VKMA 36230<br>VKMV 6DK1841<br>VKM 36240<br>VKM 36250                               | 1<br>1  | 1   | 1   |   |   |   |   |   |
| B(Alt)   | B 5244 T7   | 07/02 → 10/05   | AC  | VKMV 6DK1853<br>VKM 36240  | 1   |   | 1   |   |   |   |   |   |
| <b>VOLVO  C70 - S70 2.4 20V</b>   |   |   |   |  |   |   |   |   |   |   |   |   |
|                                   | B 5254 S  | 06/98 → 10/05   |   | VKMA 06604<br>VKM 16604<br>VKM 26602   | 1<br>1  | 1   | 1   |   |   |   |   | T0163   |
|                                   | B 5254 S  | 06/98 → 10/05   |   | VKPC 86618   |   |   |   | 1   |   |   |   |   |





















VOLVO





















| <b>VOLVO  C70 - S70 2.4 20V Bifuel</b> |                             |               |               |  |              |   |   |   |  |   |  |  |  |   |       |
|--|-----------------------------|---------------|---------------|--|--------------|---|---|---|--|---|--|--|--|---|-------|
|  | B 5244 SG, B 5244 SG2       | 07/99 → 11/00 |               |  | VKMA 06604   | 1 | 1 | 1 |  |   |  |  |  |   | T0163 |
|  |                             |               |               |  | VKM 16604    | 1 |   |   |  |   |  |  |  |   |       |
|  |                             |               |               |  | VKM 26602    |   | 1 |   |  |   |  |  |  |   |       |
|  | B 5244 SG, B 5244 SG2       | 07/99 → 11/00 |               |  | VKPC 86618   |   |   |   |  | 1 |  |  |  |   |       |
| <b>VOLVO  C70 - S70 2.5</b>            |                             |               |               |  |              |   |   |   |  |   |  |  |  |   |       |
|  | B 5254 S                    | 03/99 → 09/02 |               |  | VKMA 06604   | 1 | 1 | 1 |  |   |  |  |  |   | T0163 |
|  |                             |               |               |  | VKM 16604    | 1 |   |   |  |   |  |  |  |   |       |
|  |                             |               |               |  | VKM 26602    |   | 1 |   |  |   |  |  |  |   |       |
|  | B 5254 S                    | 03/99 → 09/02 |               |  | VKPC 86618   |   |   |   |  | 1 |  |  |  |   |       |
| <b>VOLVO  C70 - S70 2.5 10V</b>        |                             |               |               |  |              |   |   |   |  |   |  |  |  |   |       |
|  | B 5252 FS, B 5254 FS        | 01/97 → 11/00 | → Mot.1266127 |  | VKMA 06603   | 1 | 1 | 1 |  |   |  |  |  | 1 | T0113 |
|  |                             |               |               |  | VKM 16602    | 1 |   |   |  |   |  |  |  |   |       |
|  |                             |               |               |  | VKM 26602    |   | 1 |   |  |   |  |  |  |   |       |
|  | B 5252 FS, B 5254 FS        | 01/97 → 11/00 | Mot.1266128 → |  | VKMA 06605   | 1 | 1 | 1 |  |   |  |  |  |   | T0240 |
|  |                             |               |               |  | VKM 16604    | 1 |   |   |  |   |  |  |  |   |       |
|  |                             |               |               |  | VKM 26602    |   | 1 |   |  |   |  |  |  |   |       |
|  | B 5252 FS, B 5254 FS        | 01/97 → 11/00 |               |  | VKPC 86618   |   |   |   |  | 1 |  |  |  |   |       |
|  | B(Alt) B 5252 FS, B 5254 FS | 01/97 → 12/98 | AC, Man. GBX  |  | VKMV 6PK1267 |   |   | 1 |  |   |  |  |  |   |       |
|  |                             |               |               |  | VKM 36003    |   | 1 |   |  |   |  |  |  |   |       |
|  |                             |               |               |  | VKM 36120    | 1 |   |   |  |   |  |  |  |   |       |
|  | B(Alt) B 5252 FS, B 5254 FS | 01/97 → 12/98 | AC            |  | VKMV 6PK1743 |   |   | 1 |  |   |  |  |  |   |       |
|  |                             |               |               |  | VKM 36003    |   | 1 |   |  |   |  |  |  |   |       |
|  |                             |               |               |  | VKM 36120    | 1 |   |   |  |   |  |  |  |   |       |
|  | B(Alt) B 5252 FS, B 5254 FS | 01/99 → 12/99 | AC            |  | VKMV 6DK1836 |   |   | 1 |  |   |  |  |  |   |       |
|  |                             |               |               |  | VKM 36240    | 1 |   |   |  |   |  |  |  |   |       |
| <b>VOLVO  C70 - S70 2.5 10V Bifuel</b> |                             |               |               |  |              |   |   |   |  |   |  |  |  |   |       |
|  | GB 5252 S                   | 10/98 → 11/00 | → Mot.1266127 |  | VKMA 06603   | 1 | 1 | 1 |  |   |  |  |  | 1 | T0113 |
|  |                             |               |               |  | VKM 16602    | 1 |   |   |  |   |  |  |  |   |       |
|  |                             |               |               |  | VKM 26602    |   | 1 |   |  |   |  |  |  |   |       |
|  | GB 5252 S                   | 10/98 → 11/00 | Mot.1266128 → |  | VKMA 06605   | 1 | 1 | 1 |  |   |  |  |  |   | T0240 |
|  |                             |               |               |  | VKM 16604    | 1 |   |   |  |   |  |  |  |   |       |
|  |                             |               |               |  | VKM 26602    |   | 1 |   |  |   |  |  |  |   |       |
|  | GB 5252 S                   | 10/98 → 11/00 |               |  | VKPC 86618   |   |   |   |  | 1 |  |  |  |   |       |
| <b>VOLVO  C70 - S70 2.5 Turbo</b>      |                             |               |               |  |              |   |   |   |  |   |  |  |  |   |       |
|  | B 5254 T                    | 03/97 → 10/05 | → Mot.1266127 |  | VKMA 06602   | 1 | 1 | 1 |  |   |  |  |  | 1 | T0163 |
|  |                             |               |               |  | VKM 16602    | 1 |   |   |  |   |  |  |  |   |       |
|  |                             |               |               |  | VKM 26602    |   | 1 |   |  |   |  |  |  |   |       |
|  | B 5254 T                    | 03/97 → 10/05 | Mot.1266128 → |  | VKMA 06604   | 1 | 1 | 1 |  |   |  |  |  |   | T0163 |
|  |                             |               |               |  | VKM 16604    | 1 |   |   |  |   |  |  |  |   |       |
|  |                             |               |               |  | VKM 26602    |   | 1 |   |  |   |  |  |  |   |       |
|  | B 5254 T                    | 03/97 → 08/04 |               |  | VKPC 86618   |   |   |   |  | 1 |  |  |  |   |       |
|  | B(Alt) B 5254 T             | 03/98 → 12/98 | AC, Man. GBX  |  | VKMV 6PK1267 |   |   | 1 |  |   |  |  |  |   |       |
|  |                             |               |               |  | VKM 36003    |   | 1 |   |  |   |  |  |  |   |       |
|  |                             |               |               |  | VKM 36120    | 1 |   |   |  |   |  |  |  |   |       |
|  | B(Alt) B 5254 T             | 03/98 → 12/98 | AC, Auto. GBX |  | VKMV 6PK1253 |   |   | 1 |  |   |  |  |  |   |       |
|  |                             |               |               |  | VKM 36003    |   | 1 |   |  |   |  |  |  |   |       |
|  |                             |               |               |  | VKM 36120    | 1 |   |   |  |   |  |  |  |   |       |
|  | B(Alt) B 5254 T             | 01/99 → 12/99 | AC            |  | VKMV 6DK1825 |   |   | 1 |  |   |  |  |  |   |       |
|  |                             |               |               |  | VKM 36240    | 1 |   |   |  |   |  |  |  |   |       |
|  |                             |               |               |  | VKM 36250    |   | 1 |   |  |   |  |  |  |   |       |
|  | B(Alt) B 5254 T             | 01/00 → 10/05 | AC            |  | VKMA 36230   | 1 | 1 | 1 |  |   |  |  |  |   |       |
|  |                             |               |               |  | VKMV 6DK1841 |   |   | 1 |  |   |  |  |  |   |       |
|  |                             |               |               |  | VKM 36240    | 1 |   |   |  |   |  |  |  |   |       |
|  |                             |               |               |  | VKM 36250    |   | 1 |   |  |   |  |  |  |   |       |
|  | B(Alt) B 5254 T             | 03/98 → 12/98 | AC            |  | VKMV 6PK1743 |   |   | 1 |  |   |  |  |  |   |       |
|  |                             |               |               |  | VKM 36003    |   | 1 |   |  |   |  |  |  |   |       |
|  |                             |               |               |  | VKM 36120    | 1 |   |   |  |   |  |  |  |   |       |
|  | B(Alt) B 5254 T             | 01/99 → 12/99 | AC            |  | VKMV 6DK1836 |   |   | 1 |  |   |  |  |  |   |       |
|  |                             |               |               |  | VKM 36240    | 1 |   |   |  |   |  |  |  |   |       |
|  | B(Alt) B 5254 T             | 01/00 → 10/05 | AC            |  | VKMV 6DK1853 |   |   | 1 |  |   |  |  |  |   |       |
|  |                             |               |               |  | VKM 36240    | 1 |   |   |  |   |  |  |  |   |       |



| VOLVO  C70 - S70 2.4 D5   |        |                      |               |                     |  |   |   |   |   |  |   |  |  |  |   |  |  |  |       |       |
|---------------------------|--------|----------------------|---------------|---------------------|--|---|---|---|---|--|---|--|--|--|---|--|--|--|-------|-------|
|                           | B(Alt) | D 5244 T8, D 5244 T9 | 03/06 → 04/07 |                     | VKMV 5PK891<br>VKM 36236                             | 1 |   | 1 |   |  |   |  |  |  |   |  |  |  |       |       |
|                           | B(AC)  | D 5244 T8, D 5244 T9 | 03/06 → 04/07 |                     | VKMA _____<br>VKMV 5PK847<br>VKM 36238               | 1 |   | 1 | 1 |  |   |  |  |  |   |  |  |  |       |       |
| VOLVO  C70 - S70 2.5 TDI  |        |                      |               |                     |  |   |   |   |   |  |   |  |  |  |   |  |  |  |       |       |
|                           |        | D 5252 T             | 01/97 → 11/00 | 4)                  | VKMA 01258<br>VKM 11073<br>VKM 11257<br>VKM 11258    | 3 |   | 2 |   |  |   |  |  |  | 6 |  |  |  | T0095 |       |
|                           |        | D 5252 T             | 01/97 → 11/00 |                     | VKPC 86620   |   |   |   |   |  | 1 |  |  |  |   |  |  |  |       |       |
|                           | B(Alt) | D 5252 T             | 01/97 → 11/00 | AC                  | VKMA 36520<br>VKMV 6PK1432<br>VKM _____<br>VKM 36530 | 1 | 1 | 1 | 1 |  |   |  |  |  |   |  |  |  |       |       |
|                           | B(Alt) | D 5252 T             | 01/97 → 11/00 | AC                  | VKMA _____<br>VKMV 6PK1683<br>VKM _____<br>VKM 36530 | 1 | 1 | 1 | 1 |  |   |  |  |  |   |  |  |  |       |       |
| VOLVO  P 121 1.8          |        |                      |               |                     |  |   |   |   |   |  |   |  |  |  |   |  |  |  |       |       |
|                           |        | B 18                 | 02/67 → 05/71 |                     | VKPC 86607   |   |   |   |   |  | 1 |  |  |  |   |  |  |  |       |       |
| VOLVO  P 121 2.0          |        |                      |               |                     |  |   |   |   |   |  |   |  |  |  |   |  |  |  |       |       |
|                           |        | B 20 A               | 11/68 → 05/71 |                     | VKPC 86607   |   |   |   |   |  | 1 |  |  |  |   |  |  |  |       |       |
| VOLVO  P 122 S AMAZON 1.8 |        |                      |               |                     |  |   |   |   |   |  |   |  |  |  |   |  |  |  |       |       |
|                           |        | B 18, B 18 D         | 01/61 → 05/71 |                     | VKPC 86607   |   |   |   |   |  | 1 |  |  |  |   |  |  |  |       |       |
| VOLVO  P 122 S AMAZON 2.0 |        |                      |               |                     |  |   |   |   |   |  |   |  |  |  |   |  |  |  |       |       |
|                           |        | B 20 B               | 11/68 → 05/71 |                     | VKPC 86607   |   |   |   |   |  | 1 |  |  |  |   |  |  |  |       |       |
| VOLVO  S40 I - V40 1.6    |        |                      |               |                     |  |   |   |   |   |  |   |  |  |  |   |  |  |  |       |       |
|                           |        | B 4164 S             | 09/95 → 08/99 | →IMot. 1266195      | VKMA 06602<br>VKM 16602<br>VKM 26602                 | 1 | 1 | 1 |   |  |   |  |  |  | 1 |  |  |  | T0163 |       |
|                           |        | B 4164 S             | 09/95 → 08/99 | Mot. 1266196 I→     | VKMA 06604<br>VKM 16604<br>VKM 26602                 | 1 | 1 | 1 |   |  |   |  |  |  |   |  |  |  |       | T0163 |
|                           |        | B 4164 S2            | 03/99 → 06/04 |                     | VKMA 06604<br>VKM 16604<br>VKM 26602                 | 1 | 1 | 1 |   |  |   |  |  |  |   |  |  |  |       | T0163 |
|                           |        | B 4164 S, B 4164 S2  | 09/95 → 03/04 |                     | VKPC 86618   |   |   |   |   |  | 1 |  |  |  |   |  |  |  |       |       |
|                           | B(Alt) | B 4164 S             | 09/95 → 08/99 | AC, →IMot. 1440994  | VKMA 36121<br>VKMV 6PK1613<br>VKM 36122<br>VKM 36124 | 1 | 1 | 1 | 1 |  |   |  |  |  |   |  |  |  |       |       |
|                           | B(Alt) | B 4164 S             | 09/95 → 08/99 | AC, Mot. 1440995 I→ | VKMA 36122<br>VKMV 6PK1621<br>VKM 36122<br>VKM 36124 | 1 | 1 | 1 | 1 |  |   |  |  |  |   |  |  |  |       |       |
|                           | B(Alt) | B 4164 S2            | 03/99 → 06/04 | AC                  | VKMA 36230<br>VKMV 6DK1841<br>VKM 36240<br>VKM 36250 | 1 | 1 | 1 | 1 |  |   |  |  |  |   |  |  |  |       |       |
|                           | B(Alt) | B 4164 S             | 09/95 → 08/99 | AC, →IMot. 1440994  | VKMA 36123<br>VKMV 6PK1752<br>VKM 36122<br>VKM 36124 | 1 | 1 | 1 | 1 |  |   |  |  |  |   |  |  |  |       |       |
|                           | B(Alt) | B 4164 S             | 09/95 → 08/99 | AC, Mot. 1440995 I→ | VKMA 36124<br>VKMV 6PK1762<br>VKM 36122<br>VKM 36124 | 1 | 1 | 1 | 1 |  |   |  |  |  |   |  |  |  |       |       |
| VOLVO  S40 I - V40 1.8    |        |                      |               |                     |  |   |   |   |   |  |   |  |  |  |   |  |  |  |       |       |
|                           |        | B 4184 S             | 07/95 → 08/99 | →IMot. 1266195      | VKMA 06602<br>VKM 16602<br>VKM 26602                 | 1 | 1 | 1 |   |  |   |  |  |  | 1 |  |  |  | T0163 |       |





























|  |  |  |  |  |  |  |  |  |  |  |  |  |  |
|--|---|---|---|--|---|---|---|---|---|---|---|---|---|
|  | B 4184 S  | 07/95 → 08/99   | Mot. 1266196 I→   | VKMA 06604<br>VKM 16604<br>VKM 26602   | 1<br>1  | 1<br>1  | 1   |   |   |   |   |   | T0163   |
|  | B 4184 S10, B 4184 S2,<br>B 4184 S3, B 4184 S9                                    | 03/99 → 12/03   |   | VKMA 06604<br>VKM 16604<br>VKM 26602   | 1<br>1  | 1<br>1  | 1   |   |   |   |   |   | T0163   |
|  | B 4184 SJ, B 4184 SM  | 03/98 → 06/04   |   | VKMA 95624<br>VKM 75009<br>VKM 85000   | 1<br>1  | 1<br>1  | 1   |   |   |   |   |   | T0693   |
|                                        | B 4184 S, B 4184 S10,<br>B 4184 S2, B 4184 S3,<br>B 4184 S9                       | 07/95 → 03/04   |   | VKPC 86618   |   |   |   |   | 1   |   |   |   |   |
|  | B 4184 SJ, B 4184 SM  | 03/98 → 03/04   |   | VKPC 86500   |   |   |   |   | 1   |   |   |   |   |
|                                        | <b>B(Alt)</b> B 4184 S  | 07/95 → 08/99   | <b>AC</b> , →IMot. 1440994  | VKMA 36121<br>VKMV 6PK1613<br>VKM 36122<br>VKM 36124                               | 1<br>1  | 1<br>1  | 1   |   |   |   |   |   |   |
|  | <b>B(Alt)</b> B 4184 S  | 07/95 → 08/99   | <b>AC</b> , Mot. 1440995 I→   | VKMA 36122<br>VKMV 6PK1621<br>VKM 36122<br>VKM 36124                               | 1<br>1  | 1<br>1  | 1   |   |   |   |   |   |   |
|  | <b>B(Alt)</b> B 4184 S  | 07/95 → 08/99   | <b>AC</b> , →IMot. 1440994  | VKMA 36123<br>VKMV 6PK1752<br>VKM 36122<br>VKM 36124                               | 1<br>1  | 1<br>1  | 1   |   |   |   |   |   |   |
|  | <b>B(Alt)</b> B 4184 S  | 07/95 → 08/99   | <b>AC</b> , Mot. 1440995 I→   | VKMA 36124<br>VKMV 6PK1762<br>VKM 36122<br>VKM 36124                               | 1<br>1  | 1<br>1  | 1   |   |   |   |   |   |   |
|  | <b>B(Alt)</b> B 4184 S10, B 4184 S2,<br>B 4184 S3, B 4184 S9                      | 01/00 → 06/04   | <b>AC</b>   | VKMA 36230<br>VKMV 6DK1841<br>VKM 36240<br>VKM 36250                               | 1<br>1  | 1<br>1  | 1   |   |   |   |   |   |   |
|  | <b>B(Alt)</b> B 4184 SJ, B 4184 SM  | 03/98 → 06/04   |   | VKMV 4PK780  |   |   | 1   |   |   |   |   |   |   |
|  | <b>B(PS)</b> B 4184 SJ, B 4184 SM   | 03/98 → 06/04   | <b>AC</b>   | VKMV 5PK1090   |   |   | 1   |   |   |   |   |   |   |
| <b>VOLVO  S40 I - V40 1.9 Turbo</b> |   |   |   |  |   |   |   |   |   |   |   |   |   |
|                                      | B 4194 T  | 05/97 → 07/00   | →IMot. 1219753  | VKMA 06602<br>VKM 16602<br>VKM 26602   | 1<br>1  | 1<br>1  | 1   |   |   |   |   |   | 1 T0163   |
|  | B 4194 T  | 05/97 → 07/00   | Mot. 1219754 I→   | VKMA 06604<br>VKM 16604<br>VKM 26602   | 1<br>1  | 1<br>1  | 1   |   |   |   |   |   | T0163   |
|  | B 4194 T2   | 05/97 → 07/00   |   | VKMA 06604<br>VKM 16604<br>VKM 26602   | 1<br>1  | 1<br>1  | 1   |   |   |   |   |   | T0163   |
|                                      | B 4194 T, B 4194 T2   | 05/97 → 07/00   |   | VKPC 86618   |   |   |   |   | 1   |   |   |   |   |
|                                      | <b>B(Alt)</b> B 4194 T  | 05/97 → 12/99   | <b>AC</b> , →IMot. 1440994  | VKMA 36121<br>VKMV 6PK1613<br>VKM 36122<br>VKM 36124                               | 1<br>1  | 1<br>1  | 1   |   |   |   |   |   |   |
|  | <b>B(Alt)</b> B 4194 T  | 05/97 → 12/99   | <b>AC</b> , Mot. 1440995 I→   | VKMA 36122<br>VKMV 6PK1621<br>VKM 36122<br>VKM 36124                               | 1<br>1  | 1<br>1  | 1   |   |   |   |   |   |   |
|  | <b>B(Alt)</b> B 4194 T  | 05/97 → 12/99   | <b>AC</b> , →IMot. 1440994  | VKMA 36123<br>VKMV 6PK1752<br>VKM 36122<br>VKM 36124                               | 1<br>1  | 1<br>1  | 1   |   |   |   |   |   |   |
|  | <b>B(Alt)</b> B 4194 T  | 05/97 → 12/99   | <b>AC</b> , Mot. 1440995 I→   | VKMA 36124<br>VKMV 6PK1762<br>VKM 36122<br>VKM 36124                               | 1<br>1  | 1<br>1  | 1   |   |   |   |   |   |   |
|  | <b>B(Alt)</b> B 4194 T2   | 01/00 → 07/00   | <b>AC</b>   | VKMA 36230<br>VKMV 6DK1841   | 1<br>1  | 1<br>1  | 1   |   |   |   |   |   |   |

































|  |  |  |  |  |  |  |  |  |  |  |  |  |
|--|---|---|---|--|---|---|---|---|---|---|---|---|
|  |   |   |   | VKM 36240<br>VKM 36250   | 1   | 1   |   |   |   |   |   |   |
| <b>VOLVO  S40 I - V40 2.0</b>         |   |   |   |  |   |   |   |   |   |   |   |   |
|                                       | B 4204 S  | 07/95 → 06/04   | → Mot. 1266195  | VKMA 06602<br>VKM 16602<br>VKM 26602   | 1<br>1  | 1   | 1   |   |   |   |   | 1 T0163   |
|  | B 4204 S  | 07/95 → 06/04   | Mot. 1266196  →   | VKMA 06604<br>VKM 16604<br>VKM 26602   | 1<br>1  | 1   | 1   |   |   |   |   | T0163   |
|  | B 4204 S2   | 07/95 → 12/03   |   | VKMA 06604<br>VKM 16604<br>VKM 26602   | 1<br>1  | 1   | 1   |   |   |   |   | T0163   |
|                                       | B 4204 S, B 4204 S2   | 07/95 → 03/04   |   | VKPC 86618   |   |   |   |   | 1   |   |   |   |
|                                       | <b>B(Alt)</b> B 4204 S  | 07/95 → 12/99   | AC, → Mot. 1440994  | VKMA 36121<br>VKMV 6PK1613<br>VKM 36122<br>VKM 36124                               | 1<br>1  | 1   | 1   |   |   |   |   |   |
|  | <b>B(Alt)</b> B 4204 S  | 07/95 → 12/99   | AC, Mot. 1440995  →   | VKMA 36122<br>VKMV 6PK1621<br>VKM 36122<br>VKM 36124                               | 1<br>1  | 1   | 1   |   |   |   |   |   |
|  | <b>B(Alt)</b> B 4204 S  | 07/95 → 12/99   | AC, → Mot. 1440994  | VKMA 36123<br>VKMV 6PK1752<br>VKM 36122<br>VKM 36124                               | 1<br>1  | 1   | 1   |   |   |   |   |   |
|  | <b>B(Alt)</b> B 4204 S  | 07/95 → 12/99   | AC, Mot. 1440995  →   | VKMA 36124<br>VKMV 6PK1762<br>VKM 36122<br>VKM 36124                               | 1<br>1  | 1   | 1   |   |   |   |   |   |
|  | <b>B(Alt)</b> B 4204 S2   | 01/00 → 06/04   | AC  | VKMA 36230<br>VKMV 6DK1841<br>VKM 36240<br>VKM 36250                               | 1<br>1  | 1   | 1   |   |   |   |   |   |
|  | <b>B(Alt)</b> B 4204 S2   | 01/00 → 12/03   | AC  | VKMA 36230<br>VKMV 6DK1841<br>VKM 36240<br>VKM 36250                               | 1<br>1  | 1   | 1   |   |   |   |   |   |
| <b>VOLVO  S40 I - V40 2.0 Turbo</b> |   |   |   |  |   |   |   |   |   |   |   |   |
|                                     | B 4204 T  | 10/97 → 07/00   | M⊙, Mot. 1219754  →   | VKMA 06604<br>VKM 16604<br>VKM 26602   | 1<br>1  | 1   | 1   |   |   |   |   | T0163   |
|  | B 4204 T  | 10/97 → 07/00   | A⊙, → Mot. 1219753  | VKMA 06602<br>VKM 16602<br>VKM 26602   | 1<br>1  | 1   | 1   |   |   |   |   | 1 T0163   |
|  | B 4204 T2, B 4204 T3,<br>B 4204 T5  | 10/97 → 06/04   |   | VKMA 06604<br>VKM 16604<br>VKM 26602   | 1<br>1  | 1   | 1   |   |   |   |   | T0163   |
|                                     | B 4204 T, B 4204 T2,<br>B 4204 T3, B 4204 T5                                      | 10/97 → 03/04   |   | VKPC 86618   |   |   |   |   | 1   |   |   |   |
|                                     | <b>B(Alt)</b> B 4204 T  | 10/97 → 12/99   | AC, → Mot. 1440994  | VKMA 36121<br>VKMV 6PK1613<br>VKM 36122<br>VKM 36124                               | 1<br>1  | 1   | 1   |   |   |   |   |   |
|  | <b>B(Alt)</b> B 4204 T  | 10/97 → 12/99   | AC, Mot. 1440995  →   | VKMA 36122<br>VKMV 6PK1621<br>VKM 36122<br>VKM 36124                               | 1<br>1  | 1   | 1   |   |   |   |   |   |
|  | <b>B(Alt)</b> B 4204 T  | 10/97 → 12/99   | AC, → Mot. 1440994  | VKMA 36123<br>VKMV 6PK1752<br>VKM 36122<br>VKM 36124                               | 1<br>1  | 1   | 1   |   |   |   |   |   |
|  | <b>B(Alt)</b> B 4204 T  | 10/97 → 12/99   | AC, Mot. 1440995  →   | VKMA 36124<br>VKMV 6PK1762<br>VKM 36122<br>VKM 36124                               | 1<br>1  | 1   | 1   |   |   |   |   |   |



VOLVO





































|   |   |  |  |  |  |  |  |  |  |  |  |  |  |
|---|---|---|---|---|--|---|---|---|---|---|---|---|---|
| <b>B(Alt)</b>   | B 4204 T2, B 4204 T3,<br>B 4204 T5              |   | 01/00 → 06/04   | AC  | VKMA 36230<br>VKMV 6DK1841<br>VKM 36240<br>VKM 36250                               | 1<br>1<br>1   | 1<br>1  |   |   |   |   |   |   |
| <b>VOLVO  S40 I - V40 1.9 TD</b>       |   |   |   |   |  |   |   |   |   |   |   |   |   |
|   | D 4192 T3, D 4192 T4                            |   | 07/00 → 06/04   |  | VKMC 06127<br>VKMA 06127<br>VKM 16113  | 1<br>1<br>1   |   | 1   |   |   |   |   | T0647   |
|   | D 4192 T  |   | 07/95 → 08/99   | 3), → <b>Mot.</b> 3534  | VKMS 06111-2<br>VKMA 06111<br>VKM 16101<br>VKM 26101                               | 1<br>1<br>1<br>1  | 1<br>1  | 1   |   |   | 3   |   | T0066   |
|   | D 4192 T  |   | 07/95 → 08/99   | <b>Mot.</b> 3535 <b>→</b>   | VKMA 06114<br>VKM 16101<br>VKM 26101   | 1<br>1<br>1   | 1   | 1   |   |   |   |   | T0147   |
|   | D 4192 T2                                       |   | 03/99 → 07/00   |   | VKMA 06115<br>VKM 16101<br>VKM 26115   | 1<br>1<br>1   | 1   | 1   |   |   |   |   | T0148   |
|   | D 4192 T, D 4192 T2                             |   | 07/95 → 07/00   |   | VKPC 86413   |   |   |   |   | 1   |   |   |   |
|   | D 4192 T3, D 4192 T4                            |   | 07/00 → 03/04   |   | VKPC 85304   |   |   |   |   | 1   |   |   |   |
|   | <b>B(Alt)</b> D 4192 T                          |   | 07/95 → 08/99   | <b>AC</b> , → <b>Mot.</b> 7794  | VKMA 36016<br>VKMV 6PK1640<br>VKM 36016<br>VKM 36018                               | 1<br>1<br>1<br>1  | 1   | 1   |   |   |   |   | 1   |
| <b>B(Alt)</b>   | D 4192 T  |   | 07/95 → 08/99   | <b>AC</b> , <b>Mot.</b> 7795 <b>→</b>   | VKMA 36032<br>VKMV 6PK1640<br>VKM 36016<br>VKM 36032                               | 1<br>1<br>1<br>1  | 1   | 1   |   |   |   |   | 1   |
| <b>B(Alt)</b>   | D 4192 T2                                       |   | 03/99 → 07/00   | <b>AC</b>   | VKMA 36032<br>VKMV 6PK1640<br>VKM 36016<br>VKM 36032                               | 1<br>1<br>1<br>1  | 1   | 1   |   |   |   |   | 1   |
| <b>B(Alt)</b>   | D 4192 T3                                       |   | 07/00 → 06/04   | <b>AC</b> , → <b>Mot.</b> 14515   | VKMA 36033<br>VKMV 6PK1792<br>VKM 36030<br>VKM 36031                               | 1<br>1<br>1<br>1  | 1   | 1   |   |   |   |   |   |
| <b>B(Alt)</b>   | D 4192 T4                                       |   | 07/00 → 06/04   | <b>AC</b> , → <b>Mot.</b> 17963   | VKMA 36033<br>VKMV 6PK1792<br>VKM 36030<br>VKM 36031                               | 1<br>1<br>1<br>1  | 1   | 1   |   |   |   |   |   |
| <b>VOLVO  S40 II - V50 1.8</b>       |   |   |   |   |  |   |   |   |   |   |   |   |   |
|                                       | B 4184 S11, B 4184 S8                           |   | 04/04 → 04/07   |   | <del>OKOKOK</del>  |   |   |   |   |   |   |   |   |
|                                       | <b>B(Alt)</b> B 4184 S11, B 4184 S8             |   | 04/04 → 04/07   |   | VKMV 6PK1306<br>VKM 34014  |   | 1   |   |   | 1   |   |   |   |
| <b>VOLVO  S40 II - V50 2.4</b>       |   |   |   |   |  |   |   |   |   |   |   |   |   |
|                                       | B 5244 S, B 5244 S4,<br>B 5244 S5               |   | 01/04 → 04/07   |   | VKMA 06040<br>VKM 16040<br>VKM 26602   | 1<br>1<br>1   | 1   | 1   |   |   |   |   | T0163   |
|                                       | B 5244 S, B 5244 S4,<br>B 5244 S5               |   | 01/04 → 04/07   |   | VKPC 86618   |   |   |   |   | 1   |   |   |   |
|                                       | <b>B(Alt)</b> B 5244 S, B 5244 S4,<br>B 5244 S5 |   | 01/04 → 04/07   |   | VKMV 5PK891<br>VKM 36236   |   | 1   |   |   | 1   |   |   |   |
| <b>B(AC)</b>  | B 5244 S, B 5244 S4,<br>B 5244 S5               |   | 01/04 → 04/07   |   | VKMA____<br>VKMV 5PK847<br>VKM 36238   | 1<br>1<br>1   |   | 1   |   | 1   |   |   |   |
| <b>VOLVO  S40 II - V50 2.5 Turbo</b> |   |   |   |   |  |   |   |   |   |   |   |   |   |
|                                       | B 5254 T3                                       |   | 01/04 → 04/07   |   | VKMA 06040<br>VKM 16040<br>VKM 26602   | 1<br>1<br>1   | 1   | 1   |   |   |   |   | T0163   |
|                                       | B 5254 T3                                       |   | 01/04 → 04/07   |   | VKPC 86618   |   |   |   |   | 1   |   |   |   |

























|   |  |  |  |  |  |  |  |  |  |  |  |
|---|---|---|---|--|---|---|---|---|---|---|---|
|    | <b>B(Alt)</b> B 5254 T3   | 01/04 → 04/07   |   | VKMV 5PK891<br>VKM 36236   | 1   |   | 1   |   |   |   |   |
|   | <b>B(AC)</b> B 5254 T3  | 01/04 → 04/07   |   | VKMA____<br>VKMV 5PK847<br>VKM 36238   | 1   |   | 1   |   |   |   |   |
| <b>VOLVO</b>  <b>S40 II - V50 1.6 D</b>    |   |   |   |  |   |   |   |   |   |   |   |
|    | D 4164 T  | 01/05 → 04/07   |   | VKMA 03259<br>VKM 13140<br>VKM 23140   | 1<br>1  | 1   | 1   |   |   |   | T0195   |
|    | D 4164 T  | 01/05 → 04/07   |   | VKPC 83259   |   |   |   | 1   |   |   |   |
|    | <b>B(Alt)</b> D 4164 T  | 01/05 → 04/07   | <b>AC</b>   | VKMA 33058<br>VKMV 6PK802<br>VKM 33043<br>VKM 33044                                | 1<br>1  | 1   | 1   |   |   |   | 1   |
|   | <b>B(Alt)</b> D 4164 T  | 01/05 → 04/07   | <b>AC</b>   | VKMA 33043<br>VKMV 6PK976<br>VKM 33043   | 1<br>1  |   | 1   |   |   |   |   |
| <b>VOLVO</b>  <b>S40 II - V50 2.0 D</b>    |   |   |   |  |   |   |   |   |   |   |   |
|    | D 4204 T  | 01/04 → 04/07   |   | VKMA 03257<br>VKM 13257<br>VKM 23257   | 1<br>1  | 1   | 1   |   |   |   | T0205   |
|    | D 4204 T  | 01/04 → 04/07   | → <b>ICH</b> 193808   | VKPC 83643   |   |   |   | 1   |   |   |   |
|   | D 4204 T  | 01/04 → 04/07   | <b>CH</b> 193809 →  | —  |   |   |   | 1   |   |   |   |
|   | D 4204 T  | 04/04 → 04/07   | → <b>ICH</b> 199424   | VKPC 83643   |   |   |   | 1   |   |   |   |
|   | D 4204 T  | 04/04 → 04/07   | <b>CH</b> 199425 →  | —  |   |   |   | 1   |   |   |   |
|   | <b>B(Alt)</b> D 4204 T  | 01/04 → 04/07   |   | VKMA 33320<br>VKMV 6PK1217<br>VKM 33320  | 1<br>1  |   | 1   |   |   |   |   |
| <b>VOLVO</b>  <b>S40 II - V50 2.4 D5</b> |   |   |   |  |   |   |   |   |   |   |   |
|    | <b>B(Alt)</b> D 5244 T8, D 5244 T9  | 03/06 → 04/07   |   | VKMV 5PK891<br>VKM 36236   | 1   |   | 1   |   |   |   |   |
|   | <b>B(AC)</b> D 5244 T8, D 5244 T9   | 03/06 → 04/07   |   | VKMA____<br>VKMV 5PK847<br>VKM 36238   | 1   |   | 1   |   |   |   |   |
| <b>VOLVO</b>  <b>S60 2.0 Turbo</b>       |   |   |   |  |   |   |   |   |   |   |   |
|    | B 5204 T5   | 09/01 → 12/04   | → <b>IMot.</b> 3188688  | VKMA 06604<br>VKM 16604<br>VKM 26602   | 1<br>1  | 1   | 1   |   |   |   | T0163   |
|   | B 5204 T5   | 01/05 → 04/07   | <b>Mot.</b> 3188689 →   | VKMA 06040<br>VKM 16040<br>VKM 26602   | 1<br>1  | 1   | 1   |   |   |   | T0163   |
|    | B 5204 T5   | 09/01 → 04/07   |   | VKPC 86618   |   |   |   | 1   |   |   |   |
|    | <b>B(Alt)</b> B 5204 T5   | 09/01 → 04/07   | → <b>IMot.</b> 3655531  | VKMA 36230<br>VKMV 6DK1841<br>VKM 36240<br>VKM 36250                               | 1<br>1  | 1   | 1   |   |   |   |   |
| <b>VOLVO</b>  <b>S60 2.3 Turbo</b>       |   |   |   |  |   |   |   |   |   |   |   |
|    | B 5234 T3, B 5234 T7  | 11/00 → 12/04   | → <b>IMot.</b> 3188688  | VKMA 06604<br>VKM 16604<br>VKM 26602   | 1<br>1  | 1   | 1   |   |   |   | T0163   |
|    | B 5234 T3, B 5234 T7  | 11/00 → 04/07   |   | VKPC 86618   |   |   |   | 1   |   |   |   |
|    | <b>B(Alt)</b> B 5234 T3, B 5234 T7  | 11/00 → 04/07   | → <b>IMot.</b> 3655531  | VKMA 36230<br>VKMV 6DK1841<br>VKM 36240<br>VKM 36250                               | 1<br>1  | 1   | 1   |   |   |   |   |
| <b>VOLVO</b>  <b>S60 2.4</b>             |   |   |   |  |   |   |   |   |   |   |   |
|    | B 5244 S, B 5244 S2   | 11/00 → 12/04   | → <b>IMot.</b> 3188688  | VKMA 06604<br>VKM 16604<br>VKM 26602   | 1<br>1  | 1   | 1   |   |   |   | T0163   |
|   | B 5244 S, B 5244 S2   | 01/05 → 04/07   | <b>Mot.</b> 3188689 →   | VKMA 06040<br>VKM 16040<br>VKM 26602   | 1<br>1  | 1   | 1   |   |   |   | T0163   |
|    | B 5244 S, B 5244 S2   | 11/00 → 04/07   |   | VKPC 86618   |   |   |   | 1   |   |   |   |































VOLVO

|  |  |  |  |  |  |  |  |  |  |  |  |  |  |
|--|---|---|---|--|---|---|---|---|---|---|---|---|---|
|  <b>B(Alt)</b>                 | B 5244 S, B 5244 S2   | 11/00 → 04/07   | →IMot. 3655531  | VKMA 36230<br>VKMV 6DK1841<br>VKM 36240<br>VKM 36250                               | 1<br>1<br>1   | 1<br>1  | 1<br>1  |   |   |   |   |   |   |
| <b>VOLVO  S60 2.4 Bifuel</b>  |   |   |   |  |   |   |   |   |   |   |   |   |   |
|                                | B 5244 SG, B 5244 SG2   | 06/02 → 12/04   | →IMot. 3188688  | VKMA 06604<br>VKM 16604<br>VKM 26602   | 1<br>1<br>1   | 1<br>1  | 1<br>1  |   |   |   |   |   | T0163   |
|  | B 5244 SG, B 5244 SG2   | 01/05 → 04/07   | Mot. 3188689  →   | VKMA 06040<br>VKM 16040<br>VKM 26602   | 1<br>1<br>1   | 1<br>1  | 1<br>1  |   |   |   |   |   | T0163   |
|                                | B 5244 SG, B 5244 SG2   | 06/02 → 04/07   |   | VKPC 86618   |   |   |   | 1   |   |   |   |   |   |
|  <b>B(Alt)</b>                 | B 5244 SG, B 5244 SG2   | 06/02 → 04/07   | →IMot. 3655531  | VKMA 36230<br>VKMV 6DK1841<br>VKM 36240<br>VKM 36250                               | 1<br>1<br>1   | 1<br>1  | 1<br>1  |   |   |   |   |   |   |
| <b>VOLVO  S60 2.4 Turbo</b>   |   |   |   |  |   |   |   |   |   |   |   |   |   |
|                                | B 5244 T3, B 5244 T5  | 11/00 → 12/04   | →IMot. 3188688  | VKMA 06604<br>VKM 16604<br>VKM 26602   | 1<br>1<br>1   | 1<br>1  | 1<br>1  |   |   |   |   |   | T0163   |
|  | B 5244 T3, B 5244 T5  | 01/05 → 04/07   | Mot. 3188689  →   | VKMA 06040<br>VKM 16040<br>VKM 26602   | 1<br>1<br>1   | 1<br>1  | 1<br>1  |   |   |   |   |   | T0163   |
|                                | B 5244 T3, B 5244 T5  | 11/00 → 04/07   |   | VKPC 86618   |   |   |   | 1   |   |   |   |   |   |
|  <b>B(Alt)</b>                 | B 5244 T3, B 5244 T5  | 11/00 → 04/07   | →IMot. 3655531  | VKMA 36230<br>VKMV 6DK1841<br>VKM 36240<br>VKM 36250                               | 1<br>1<br>1   | 1<br>1  | 1<br>1  |   |   |   |   |   |   |
| <b>VOLVO  S60 2.5 Turbo</b> |   |   |   |  |   |   |   |   |   |   |   |   |   |
|                              | B 5254 T2   | 02/04 → 12/04   | →IMot. 3188688  | VKMA 06604<br>VKM 16604<br>VKM 26602   | 1<br>1<br>1   | 1<br>1  | 1<br>1  |   |   |   |   |   | T0163   |
|  | B 5254 T2   | 01/05 → 04/07   | Mot. 3188689  →   | VKMA 06040<br>VKM 16040<br>VKM 26602   | 1<br>1<br>1   | 1<br>1  | 1<br>1  |   |   |   |   |   | T0163   |
|  | B 5254 T4   | 03/03 → 12/04   |   | —<br>VKM 26602   | 1<br>1  | 1<br>1  | 1<br>1  |   |   |   |   |   | T0163   |
|                              | B 5254 T2, B 5254 T4  | 03/03 → 04/07   |   | VKPC 86618   |   |   |   | 1   |   |   |   |   |   |
|  <b>B(Alt)</b>               | B 5254 T2   | 02/04 → 04/07   | →IMot. 3655531  | VKMA 36230<br>VKMV 6DK1841<br>VKM 36240<br>VKM 36250                               | 1<br>1<br>1   | 1<br>1  | 1<br>1  |   |   |   |   |   |   |
| <b>VOLVO  S60 2.4 D</b>     |   |   |   |  |   |   |   |   |   |   |   |   |   |
|                              | D 5244 T2   | 12/01 → 12/05   |   | VKMA 06220<br>VKM 16220<br>VKM 26220   | 1<br>1<br>1   | 1<br>1  | 1<br>1  |   |   |   |   |   | T0192   |
|                              | D 5244 T2   | 12/01 → 04/07   |   | VKPC 86635   |   |   |   | 1   |   |   |   |   |   |
|  <b>B(Alt)</b>               | D 5244 T2   | 12/01 → 04/07   | AC. →IMot. 349808   | VKMA 36220<br>VKMV 6DK1841<br>VKM 36220<br>VKM 36230                               | 1<br>1<br>1   | 1<br>1  | 1<br>1  |   |   |   |   |   |   |
| <b>VOLVO  S60 2.4 D5</b>    |   |   |   |  |   |   |   |   |   |   |   |   |   |
|                              | D 5244 T  | 07/01 → 12/05   |   | VKMA 06220<br>VKM 16220<br>VKM 26220   | 1<br>1<br>1   | 1<br>1  | 1<br>1  |   |   |   |   |   | T0192   |
|                              | D 5244 T  | 07/01 → 04/07   |   | VKPC 86635   |   |   |   | 1   |   |   |   |   |   |
|  <b>B(Alt)</b>               | D 5244 T  | 07/01 → 04/07   | AC. →IMot. 349808   | VKMA 36220<br>VKMV 6DK1841<br>VKM 36220<br>VKM 36230                               | 1<br>1<br>1   | 1<br>1  | 1<br>1  |   |   |   |   |   |   |
| <b>VOLVO  S80 2.0 Turbo</b> |   |   |   |  |   |   |   |   |   |   |   |   |   |
|                              | B 5204 T3, B 5204 T4,<br>B 5204 T5  | 06/98 → 12/04   | →IMot. 3188688  | VKMA 06604<br>VKM 16604<br>VKM 26602   | 1<br>1<br>1   | 1<br>1  | 1<br>1  |   |   |   |   |   | T0163   |

|   |  |  |  |  |  |  |  |  |  |  |  |
|---|---|---|---|--|---|---|---|---|---|---|---|
|   | B 5204 T3, B 5204 T4,<br>B 5204 T5  | 01/05 → 07/06   | Mot. 3188689 I→   | VKMA 06040<br>VKM 16040<br>VKM 26602   | 1<br>1  | 1<br>1  |   |   |   |   | T0163   |
|                                | B 5204 T3, B 5204 T4,<br>B 5204 T5  | 06/98 → 07/06   |   | VKPC 86618   |   |   |   | 1   |   |   |   |
|                                | <b>B(Alt)</b> B 5204 T3, B 5204 T4,<br>B 5204 T5                                  | 06/98 → 07/06   | AC, → ICH 44276   | VKMOV 6DK1825<br>VKM 36240<br>VKM 36250  | 1   |   | 1   |   |   |   |   |
|   | <b>B(Alt)</b> B 5204 T3, B 5204 T4,<br>B 5204 T5                                  | 06/98 → 07/06   | AC, CH 44277 I→   | VKMA 36230<br>VKMOV 6DK1841<br>VKM 36240<br>VKM 36250                              | 1<br>1  | 1<br>1  | 1<br>1  |   |   |   |   |
|   | <b>B(Alt)</b> B 5204 T3, B 5204 T4,<br>B 5204 T5                                  | 06/98 → 07/06   | AC, → ICH 44276   | VKMOV 6DK1825<br>VKM 36240   | 1   |   | 1   |   |   |   |   |
|   | <b>B(Alt)</b> B 5204 T3, B 5204 T4,<br>B 5204 T5                                  | 06/98 → 07/06   | AC, CH 44277 I→   | VKMOV 6DK1841<br>VKM 36240   | 1   |   | 1   |   |   |   |   |
| <b>VOLVO  S80 2.4 20V</b>      |   |   |   |  |   |   |   |   |   |   |   |
|                                | B 5244 S, B 5244 S2   | 01/99 → 12/04   | → I Mot. 3188688  | VKMA 06604<br>VKM 16604<br>VKM 26602   | 1<br>1  | 1<br>1  | 1   |   |   |   | T0163   |
|   | B 5244 S, B 5244 S2   | 01/05 → 07/06   | Mot. 3188689 I→   | VKMA 06040<br>VKM 16040<br>VKM 26602   | 1<br>1  | 1<br>1  |   |   |   |   | T0163   |
|                              | B 5244 S, B 5244 S2   | 01/99 → 07/06   |   | VKPC 86618   |   |   |   | 1   |   |   |   |
|                              | <b>B(Alt)</b> B 5244 S, B 5244 S2   | 01/99 → 07/06   | AC, → ICH 44276   | VKMOV 6DK1825<br>VKM 36240<br>VKM 36250  | 1   |   | 1   |   |   |   |   |
|   | <b>B(Alt)</b> B 5244 S, B 5244 S2   | 01/99 → 07/06   | AC, CH 44277 I→   | VKMA 36230<br>VKMOV 6DK1841<br>VKM 36240<br>VKM 36250                              | 1<br>1  | 1<br>1  | 1<br>1  |   |   |   |   |
|   | <b>B(Alt)</b> B 5244 S, B 5244 S2   | 01/99 → 07/06   | AC, → ICH 44276   | VKMOV 6DK1825<br>VKM 36240   | 1   |   | 1   |   |   |   |   |
|   | <b>B(Alt)</b> B 5244 S, B 5244 S2   | 01/99 → 07/06   | AC, CH 44277 I→   | VKMOV 6DK1841<br>VKM 36240   | 1   |   | 1   |   |   |   |   |
| <b>VOLVO  S80 2.4 Bifuel</b> |   |   |   |  |   |   |   |   |   |   |   |
|                              | B 5244 SG, B 5244 SG2   | 09/01 → 12/04   | → I Mot. 3188688  | VKMA 06604<br>VKM 16604<br>VKM 26602   | 1<br>1  | 1<br>1  | 1   |   |   |   | T0163   |
|   | B 5244 SG, B 5244 SG2   | 01/05 → 07/06   | Mot. 3188689 I→   | VKMA 06040<br>VKM 16040<br>VKM 26602   | 1<br>1  | 1<br>1  |   |   |   |   | T0163   |
|                              | B 5244 SG, B 5244 SG2   | 09/01 → 07/06   |   | VKPC 86618   |   |   |   | 1   |   |   |   |
|                              | <b>B(Alt)</b> B 5244 SG, B 5244 SG2   | 09/01 → 07/06   | AC, → ICH 44276   | VKMOV 6DK1825<br>VKM 36240<br>VKM 36250  | 1   |   | 1   |   |   |   |   |
|   | <b>B(Alt)</b> B 5244 SG, B 5244 SG2   | 09/01 → 07/06   | AC, CH 44277 I→   | VKMA 36230<br>VKMOV 6DK1841<br>VKM 36240<br>VKM 36250                              | 1<br>1  | 1<br>1  | 1<br>1  |   |   |   |   |
|   | <b>B(Alt)</b> B 5244 SG, B 5244 SG2   | 09/01 → 07/06   | AC, → ICH 44276   | VKMOV 6DK1825<br>VKM 36240   | 1   |   | 1   |   |   |   |   |
|   | <b>B(Alt)</b> B 5244 SG, B 5244 SG2   | 09/01 → 07/06   | AC, CH 44277 I→   | VKMOV 6DK1841<br>VKM 36240   | 1   |   | 1   |   |   |   |   |
| <b>VOLVO  S80 2.4 Turbo</b>  |   |   |   |  |   |   |   |   |   |   |   |
|                              | B 5244 T3   | 06/00 → 12/04   | → I Mot. 3188688  | VKMA 06604<br>VKM 16604<br>VKM 26602   | 1<br>1  | 1<br>1  | 1   |   |   |   | T0163   |























































VOLVO

|   |  |  |  |  |  |  |  |  |  |  |  |  |  |  |
|---|---|---|---|--|---|---|---|---|---|---|---|---|---|---|
|   | B 5244 T3   | 01/05 → 07/06   | Mot. 3188689 I→   | VKMA 06040<br>VKM 16040<br>VKM 26602   | 1<br>1  | 1<br>1  | 1   |   |   |   |   |   |   | T0163   |
|                               | B 5244 T3   | 06/00 → 07/06   |   | VKPC 86618   |   |   |   |   | 1   |   |   |   |   |   |
|                               | B(Alt) B 5244 T3  | 06/00 → 07/06   | AC, → ICH 44276   | VKMOV 6DK1825<br>VKM 36240<br>VKM 36250  | 1   |   | 1   |   |   |   |   |   |   |   |
|   | B(Alt) B 5244 T3  | 06/00 → 07/06   | AC, CH 44277 I→   | VKMA 36230<br>VKMOV 6DK1841<br>VKM 36240<br>VKM 36250                              | 1<br>1  | 1<br>1  |   |   |   |   |   |   |   |   |
|   | B(Alt) B 5244 T3  | 06/00 → 07/06   | AC, → ICH 44276   | VKMOV 6DK1825<br>VKM 36240   | 1   |   | 1   |   |   |   |   |   |   |   |
|   | B(Alt) B 5244 T3  | 06/00 → 07/06   | AC, CH 44277 I→   | VKMOV 6DK1841<br>VKM 36240   | 1   |   | 1   |   |   |   |   |   |   |   |
| <b>VOLVO  S80 2.5 Turbo</b>  |   |   |   |  |   |   |   |   |   |   |   |   |   |   |
|                               | B 5254 T2   | 03/03 → 12/04   | → I Mot. 3188688  | VKMA 06604<br>VKM 16604<br>VKM 26602   | 1<br>1  | 1<br>1  | 1   |   |   |   |   |   |   | T0163   |
|   | B 5254 T2   | 01/05 → 07/06   | Mot. 3188689 I→   | VKMA 06040<br>VKM 16040<br>VKM 26602   | 1<br>1  | 1<br>1  | 1   |   |   |   |   |   |   | T0163   |
|                               | B 5254 T2   | 07/03 → 07/06   |   | VKPC 86618   |   |   |   |   | 1   |   |   |   |   |   |
|                               | B(Alt) B 5254 T6  | 03/06 → 04/07   |   | VKMOV 5PK1094  |   |   | 1   |   |   |   |   |   |   |   |
|   | B(AC) B 5254 T6   | 03/06 → 04/07   |   | VKMOV 5PK628   |   |   | 1   |   |   |   |   |   |   |   |
| <b>VOLVO  S80 2.8 Turbo</b> |   |   |   |  |   |   |   |   |   |   |   |   |   |   |
|                             | B 6284 T  | 05/98 → 12/99   |   | VKMA 06560<br>VKM 16560<br>VKM 26220   | 1<br>1  | 1<br>1  | 1   |   |   |   |   |   |   | T0138   |
|   | B 6284 T  | 01/00 → 07/06   |   | VKMA 06800<br>VKM 16800<br>VKM 26220   | 1<br>1  | 1<br>1  | 1   |   |   |   |   |   |   | T0178   |
|                             | B 6284 T  | 05/98 → 12/02   |   | VKPC 86520   |   |   |   |   | 1   |   |   |   |   |   |
|                             | B(Alt) B 6284 T   | 05/98 → 07/06   | AC, → ICH 44276   | VKMOV 6DK1825<br>VKM 36240<br>VKM 36250  | 1   |   | 1   |   |   |   |   |   |   |   |
|   | B(Alt) B 6284 T   | 05/98 → 07/06   | AC, CH 44277 I→   | VKMA 36230<br>VKMOV 6DK1841<br>VKM 36240<br>VKM 36250                              | 1<br>1  | 1<br>1  |   |   |   |   |   |   |   |   |
|   | B(Alt) B 6284 T   | 05/98 → 07/06   | AC, → ICH 44276   | VKMOV 6DK1825<br>VKM 36240   | 1   |   | 1   |   |   |   |   |   |   |   |
|   | B(Alt) B 6284 T   | 05/98 → 07/06   | AC, CH 44277 I→   | VKMOV 6DK1841<br>VKM 36240   | 1   |   | 1   |   |   |   |   |   |   |   |
| <b>VOLVO  S80 2.9 24V</b>  |   |   |   |  |   |   |   |   |   |   |   |   |   |   |
|                             | B 6294 S  | 05/98 → 12/99   |   | VKMA 06560<br>VKM 16560<br>VKM 26220   | 1<br>1  | 1<br>1  | 1   |   |   |   |   |   |   | T0138   |
|   | B 6294 S  | 01/00 → 07/06   |   | VKMA 06800<br>VKM 16800<br>VKM 26220   | 1<br>1  | 1<br>1  | 1   |   |   |   |   |   |   | T0178   |
|                             | B 6294 S  | 05/98 → 12/02   |   | VKPC 86520   |   |   |   |   | 1   |   |   |   |   |   |
|                             | B(Alt) B 6294 S   | 05/98 → 07/06   | AC, → ICH 44276   | VKMOV 6DK1825<br>VKM 36240<br>VKM 36250  | 1   |   | 1   |   |   |   |   |   |   |   |
|   | B(Alt) B 6294 S   | 05/98 → 07/06   | AC, CH 44277 I→   | VKMA 36230<br>VKMOV 6DK1841<br>VKM 36240<br>VKM 36250                              | 1<br>1  | 1<br>1  |   |   |   |   |   |   |   |   |
|   | B(Alt) B 6294 S   | 05/98 → 07/06   | AC, → ICH 44276   | VKMOV 6DK1825<br>VKM 36240   | 1   |   | 1   |   |   |   |   |   |   |   |
|   | B(Alt) B 6294 S   | 05/98 → 07/06   | AC, CH 44277 I→   | VKMOV 6DK1841<br>VKM 36240   | 1   |   | 1   |   |   |   |   |   |   |   |

| <b>VOLVO  S80 3.0 24V</b>   |                  |               |                    |  |              |   |   |   |   |  |  |   |  |  |  |  |  |  |   |       |
|-----------------------------|------------------|---------------|--------------------|--|--------------|---|---|---|---|--|--|---|--|--|--|--|--|--|---|-------|
|                             | B 6294 S2        | 06/01 → 07/06 |                    |  | VKMA 06800   | 1 | 1 | 1 |   |  |  |   |  |  |  |  |  |  |   | T0178 |
|                             |                  |               |                    |  | VKM 16800    | 1 |   |   |   |  |  |   |  |  |  |  |  |  |   |       |
|                             |                  |               |                    |  | VKM 26220    |   |   | 1 |   |  |  |   |  |  |  |  |  |  |   |       |
|                             | B 6294 S2        | 06/01 → 12/02 |                    |  | VKPC 86520   |   |   |   |   |  |  | 1 |  |  |  |  |  |  |   |       |
|                             | B(Alt) B 6294 S2 | 06/01 → 07/06 | AC, → ICH 44276    |  | VKMV 6DK1825 | 1 |   |   | 1 |  |  |   |  |  |  |  |  |  |   |       |
|                             |                  |               |                    |  | VKM 36240    |   |   |   |   |  |  |   |  |  |  |  |  |  |   |       |
|                             |                  |               |                    |  | VKM 36250    |   |   | 1 |   |  |  |   |  |  |  |  |  |  |   |       |
|                             | B(Alt) B 6294 S2 | 06/01 → 07/06 | AC, CH 44277 I→    |  | VKMA 36230   | 1 | 1 | 1 |   |  |  |   |  |  |  |  |  |  |   |       |
|                             |                  |               |                    |  | VKMV 6DK1841 |   |   |   | 1 |  |  |   |  |  |  |  |  |  |   |       |
|                             |                  |               |                    |  | VKM 36240    | 1 |   |   |   |  |  |   |  |  |  |  |  |  |   |       |
|                             |                  |               |                    |  | VKM 36250    |   |   | 1 |   |  |  |   |  |  |  |  |  |  |   |       |
|                             | B(Alt) B 6294 S2 | 06/01 → 07/06 | AC, → ICH 44276    |  | VKMV 6DK1825 | 1 |   |   | 1 |  |  |   |  |  |  |  |  |  |   |       |
|                             |                  |               |                    |  | VKM 36240    |   |   |   |   |  |  |   |  |  |  |  |  |  |   |       |
|                             | B(Alt) B 6294 S2 | 06/01 → 07/06 | AC, CH 44277 I→    |  | VKMV 6DK1841 | 1 |   |   | 1 |  |  |   |  |  |  |  |  |  |   |       |
|                             |                  |               |                    |  | VKM 36240    |   |   |   |   |  |  |   |  |  |  |  |  |  |   |       |
| <b>VOLVO  S80 3.0 Turbo</b> |                  |               |                    |  |              |   |   |   |   |  |  |   |  |  |  |  |  |  |   |       |
|                             | B 6294 T         | 06/01 → 07/06 |                    |  | VKMA 06800   | 1 | 1 | 1 |   |  |  |   |  |  |  |  |  |  |   | T0178 |
|                             |                  |               |                    |  | VKM 16800    | 1 |   |   |   |  |  |   |  |  |  |  |  |  |   |       |
|                             |                  |               |                    |  | VKM 26220    |   |   | 1 |   |  |  |   |  |  |  |  |  |  |   |       |
|                             | B 6294 T         | 06/01 → 12/02 |                    |  | VKPC 86520   |   |   |   |   |  |  | 1 |  |  |  |  |  |  |   |       |
|                             | B(Alt) B 6294 T  | 06/01 → 07/06 | AC, → ICH 44276    |  | VKMV 6DK1825 | 1 |   |   | 1 |  |  |   |  |  |  |  |  |  |   |       |
|                             |                  |               |                    |  | VKM 36240    |   |   |   |   |  |  |   |  |  |  |  |  |  |   |       |
|                             |                  |               |                    |  | VKM 36250    |   |   | 1 |   |  |  |   |  |  |  |  |  |  |   |       |
|                             | B(Alt) B 6294 T  | 06/01 → 07/06 | AC, CH 44277 I→    |  | VKMA 36230   | 1 | 1 | 1 |   |  |  |   |  |  |  |  |  |  |   |       |
|                             |                  |               |                    |  | VKMV 6DK1841 |   |   |   | 1 |  |  |   |  |  |  |  |  |  |   |       |
|                             |                  |               |                    |  | VKM 36240    | 1 |   |   |   |  |  |   |  |  |  |  |  |  |   |       |
|                             |                  |               |                    |  | VKM 36250    |   |   | 1 |   |  |  |   |  |  |  |  |  |  |   |       |
|                             | B(Alt) B 6294 T  | 06/01 → 07/06 | AC, → ICH 44276    |  | VKMV 6DK1825 | 1 |   |   | 1 |  |  |   |  |  |  |  |  |  |   |       |
|                             |                  |               |                    |  | VKM 36240    |   |   |   |   |  |  |   |  |  |  |  |  |  |   |       |
|                             | B(Alt) B 6294 T  | 06/01 → 07/06 | AC, CH 44277 I→    |  | VKMV 6DK1841 | 1 |   |   | 1 |  |  |   |  |  |  |  |  |  |   |       |
|                             |                  |               |                    |  | VKM 36240    |   |   |   |   |  |  |   |  |  |  |  |  |  |   |       |
| <b>VOLVO  S80 2.4 D</b>     |                  |               |                    |  |              |   |   |   |   |  |  |   |  |  |  |  |  |  |   |       |
|                             | D 5244 T2        | 10/01 → 12/05 |                    |  | VKMA 06220   | 1 | 1 | 1 |   |  |  |   |  |  |  |  |  |  |   | T0192 |
|                             |                  |               |                    |  | VKM 16220    | 1 |   |   |   |  |  |   |  |  |  |  |  |  |   |       |
|                             |                  |               |                    |  | VKM 26220    |   |   | 1 |   |  |  |   |  |  |  |  |  |  |   |       |
|                             | D 5244 T2        | 10/01 → 07/06 |                    |  | VKPC 86635   |   |   |   |   |  |  | 1 |  |  |  |  |  |  |   |       |
|                             | B(Alt) D 5244 T2 | 10/01 → 07/06 | AC, → IMot. 349808 |  | VKMA 36220   | 1 | 1 | 1 |   |  |  |   |  |  |  |  |  |  |   |       |
|                             |                  |               |                    |  | VKMV 6DK1841 |   |   |   |   |  |  |   |  |  |  |  |  |  |   |       |
|                             |                  |               |                    |  | VKM 36220    | 1 |   |   |   |  |  |   |  |  |  |  |  |  |   |       |
|                             |                  |               |                    |  | VKM 36230    |   |   | 1 |   |  |  |   |  |  |  |  |  |  |   |       |
|                             | B(AC) D 5244 T4  | 03/06 → 04/07 |                    |  | VKMV 5PK628  |   |   |   | 1 |  |  |   |  |  |  |  |  |  |   |       |
| <b>VOLVO  S80 2.4 D5</b>    |                  |               |                    |  |              |   |   |   |   |  |  |   |  |  |  |  |  |  |   |       |
|                             | D 5244 T         | 08/01 → 07/06 |                    |  | VKMA 06220   | 1 | 1 | 1 |   |  |  |   |  |  |  |  |  |  |   | T0192 |
|                             |                  |               |                    |  | VKM 16220    | 1 |   |   |   |  |  |   |  |  |  |  |  |  |   |       |
|                             |                  |               |                    |  | VKM 26220    |   |   | 1 |   |  |  |   |  |  |  |  |  |  |   |       |
|                             | D 5244 T         | 08/01 → 07/06 |                    |  | VKPC 86635   |   |   |   |   |  |  | 1 |  |  |  |  |  |  |   |       |
|                             | B(Alt) D 5244 T  | 08/01 → 07/06 | AC, → IMot. 349808 |  | VKMA 36220   | 1 | 1 | 1 |   |  |  |   |  |  |  |  |  |  |   |       |
|                             |                  |               |                    |  | VKMV 6DK1841 |   |   |   |   |  |  |   |  |  |  |  |  |  |   |       |
|                             |                  |               |                    |  | VKM 36220    | 1 |   |   |   |  |  |   |  |  |  |  |  |  |   |       |
|                             |                  |               |                    |  | VKM 36230    |   |   | 1 |   |  |  |   |  |  |  |  |  |  |   |       |
|                             | B(AC) D 5244 T5  | 03/06 → 04/07 |                    |  | VKMV 5PK628  |   |   |   | 1 |  |  |   |  |  |  |  |  |  |   |       |
| <b>VOLVO  S80 2.5 TDI</b>   |                  |               |                    |  |              |   |   |   |   |  |  |   |  |  |  |  |  |  |   |       |
|                             | D 5252 T         | 01/99 → 07/06 | 4)                 |  | VKMA 01258   | 3 |   | 2 |   |  |  |   |  |  |  |  |  |  | 6 | T0095 |
|                             |                  |               |                    |  | VKM 11073    | 1 |   |   |   |  |  |   |  |  |  |  |  |  |   |       |
|                             |                  |               |                    |  | VKM 11257    | 1 |   |   |   |  |  |   |  |  |  |  |  |  |   |       |
|                             |                  |               |                    |  | VKM 11258    | 1 |   |   |   |  |  |   |  |  |  |  |  |  |   |       |
|                             | D 5252 T         | 01/99 → 07/06 |                    |  | VKPC 86620   |   |   |   |   |  |  | 1 |  |  |  |  |  |  |   |       |
|                             | B(Alt) D 5252 T  | 01/99 → 07/06 | AC, → ICH 116810   |  | VKMA 36520   | 1 | 1 | 1 |   |  |  |   |  |  |  |  |  |  |   |       |
|                             |                  |               |                    |  | VKMV 6PK1432 |   |   |   |   |  |  |   |  |  |  |  |  |  |   |       |
|                             |                  |               |                    |  | VKM _____    |   |   | 1 |   |  |  |   |  |  |  |  |  |  |   |       |
|                             |                  |               |                    |  | VKM 36530    | 1 |   |   |   |  |  |   |  |  |  |  |  |  |   |       |



|  |  |  |  |  |  |  |  |  |  |  |  |  |  |  |
|--|---|---|---|--|---|---|---|---|---|---|---|---|---|---|
| B(Alt)   | D 5252 T  | 01/99 → 07/06   | AC, →ICH 116810   | VKMA _____<br>VKMV 6PK1683<br>VKM _____<br>VKM 36530                               | 1   | 1   | 1   |   |   |   |   |   |   |   |
| <b>VOLVO  S90 - V90 3.0</b>     |   |   |   |  |   |   |   |   |   |   |   |   |   |   |
|                                  | B 6304 FS, B 6304 FS2,<br>B 6304 GS   | 01/97 → 12/98   |   | VKMA 06610<br>VKM 16612<br>VKM 26612   | 1   | 1   | 1   |   |   |   |   |   |   | T0138   |
|                                  | B(Alt) B 6304 FS, B 6304 FS2,<br>B 6304 GS  | 01/97 → 12/98   | AC  | VKMV 6PK1752   |   |   | 1   |   |   |   |   |   |   |   |
|  | B(Alt) B 6304 G, B 6304 S2  | 01/97 → 12/98   | AC, Man. GBX  | VKMV 6PK1267   |   |   | 1   |   |   |   |   |   |   |   |
|  | B(Alt) B 6304 G, B 6304 S2  | 01/97 → 12/98   | AC, Auto. GBX   | VKMV 6PK1253   |   |   | 1   |   |   |   |   |   |   |   |
| <b>VOLVO  V70 I 2.0 10V</b>     |   |   |   |  |   |   |   |   |   |   |   |   |   |   |
|                                  | B 5202 FS   | 01/97 → 03/00   | →IMot. 1266127  | VKMA 06603<br>VKM 16602<br>VKM 26602   | 1   | 1   | 1   |   |   |   |   |   | 1   | T0113   |
|  | B 5202 FS   | 01/97 → 03/00   | Mot. 1266128 I→   | VKMA 06605<br>VKM 16604<br>VKM 26602   | 1   | 1   | 1   |   |   |   |   |   |   | T0240   |
|                                  | B 5202 FS   | 01/97 → 03/00   |   | VKPC 86618   |   |   |   |   | 1   |   |   |   |   |   |
|                                  | B(Alt) B 5202 FS  | 01/97 → 12/98   | AC, Man. GBX  | VKMV 6PK1267<br>VKM 36003<br>VKM 36120   |   |   | 1   |   |   |   |   |   |   |   |
|  | B(Alt) B 5202 FS  | 01/97 → 12/98   | AC, Auto. GBX   | VKMV 6PK1253<br>VKM 36003<br>VKM 36120   |   |   | 1   |   |   |   |   |   |   |   |
|  | B(Alt) B 5202 FS  | 01/99 → 12/99   | AC  | VKMV 6DK1825<br>VKM 36240<br>VKM 36250   |   |   | 1   |   |   |   |   |   |   |   |
|  | B(Alt) B 5202 FS  | 01/00 → 03/00   | AC  | VKMA 36230<br>VKMV 6DK1841<br>VKM 36240<br>VKM 36250                               |   |   | 1   | 1   | 1   |   |   |   |   |   |
|  | B(Alt) B 5202 FS  | 01/97 → 12/98   | AC  | VKMV 6PK1743<br>VKM 36003<br>VKM 36120   |   |   | 1   |   | 1   |   |   |   |   |   |
|  | B(Alt) B 5202 FS  | 01/99 → 12/99   | AC  | VKMV 6DK1836<br>VKM 36240  |   |   | 1   |   | 1   |   |   |   |   |   |
|  | B(Alt) B 5202 FS  | 01/00 → 03/00   | AC  | VKMV 6DK1853<br>VKM 36240  |   |   | 1   |   | 1   |   |   |   |   |   |
| <b>VOLVO  V70 I 2.0 Turbo</b> |   |   |   |  |   |   |   |   |   |   |   |   |   |   |
|                                | B 5204 T, B 5204 T2,<br>B 5204 T3   | 01/97 → 03/00   | →IMot. 1266127  | VKMA 06602<br>VKM 16602<br>VKM 26602   | 1   | 1   | 1   |   |   |   |   |   | 1   | T0163   |
|  | B 5204 T, B 5204 T2,<br>B 5204 T3   | 01/97 → 03/00   | Mot. 1266128 I→   | VKMA 06604<br>VKM 16604<br>VKM 26602   | 1   | 1   | 1   |   |   |   |   |   |   | T0163   |
|                                | B 5204 T, B 5204 T2,<br>B 5204 T3   | 01/97 → 03/00   |   | VKPC 86618   |   |   |   |   | 1   |   |   |   |   |   |
|                                | B(Alt) B 5204 T, B 5204 T3  | 01/97 → 12/99   | AC  | VKMV 6DK1825<br>VKM 36240<br>VKM 36250   |   |   | 1   |   |   |   |   |   |   |   |
|  | B(Alt) B 5204 T, B 5204 T3  | 01/00 → 03/00   | AC  | VKMA 36230<br>VKMV 6DK1841<br>VKM 36240<br>VKM 36250                               |   |   | 1   | 1   | 1   |   |   |   |   |   |
|  | B(Alt) B 5204 T, B 5204 T3  | 01/97 → 12/99   | AC  | VKMV 6DK1836<br>VKM 36240  |   |   | 1   |   | 1   |   |   |   |   |   |
|  | B(Alt) B 5204 T, B 5204 T3  | 01/00 → 03/00   | AC  | VKMV 6DK1853<br>VKM 36240  |   |   | 1   |   | 1   |   |   |   |   |   |































|   |                                     |  |  |  |  |  |  |  |  |  |  |  |
|---|-------------------------------------|---|---|---|--|---|---|---|---|---|---|---|
| <b>VOLVO  V70   2.3 Turbo</b>    |                                     |   |   |   |  |   |   |   |   |   |   |   |
|                                  | B 5234 FT+, B 5234 T3,<br>B 5234 T7 | 01/97 → 03/00   | →IMot. 1266127  | VKMA 06602<br>VKM 16602<br>VKM 26602  | 1<br>1   | 1   | 1   |   |   |   |   | 1 T0163   |
|   | B 5234 FT+, B 5234 T3,<br>B 5234 T7 | 01/97 → 03/00   | Mot. 1266128 I→   | VKMA 06604<br>VKM 16604<br>VKM 26602  | 1<br>1   | 1   | 1   |   |   |   |   | T0163   |
|                                  | B 5234 FT+, B 5254 T3,<br>B 5254 T7 | 01/97 → 03/00   |   | VKPC 86618  |  |   |   |   | 1   |   |   |   |
| <b>VOLVO  V70   2.4 20V</b>      |                                     |   |   |   |  |   |   |   |   |   |   |   |
|                                  | B 5244 S, B 5244 S2                 | 01/97 → 05/00   |   | VKMA 06604<br>VKM 16604<br>VKM 26602  | 1<br>1   | 1   | 1   |   |   |   |   | T0163   |
|                                  | B 5244 S, B 5244 S2                 | 01/97 → 05/00   |   | VKPC 86618  |  |   |   |   | 1   |   |   |   |
|                                  | <b>B(Alt)</b> B 5244 S              | 01/97 → 12/98   | <i>AC</i> , Man. GBX  | VKMW 6PK1267<br>VKM 36003<br>VKM 36120  | 1  |   | 1   |   |   |   |   |   |
|   | <b>B(Alt)</b> B 5244 S              | 01/97 → 12/98   | <b>AC</b>   | VKMW 6PK1743<br>VKM 36003<br>VKM 36120  | 1  |   | 1   |   |   |   |   |   |
|   | <b>B(Alt)</b> B 5244 S, B 5244 S2   | 01/99 → 12/99   | <b>AC</b>   | VKMW 6DK1836<br>VKM 36240   | 1  |   | 1   |   |   |   |   |   |
|   | <b>B(Alt)</b> B 5244 S2             | 08/99 → 12/99   | <i>AC</i>   | VKMW 6DK1825<br>VKM 36240<br>VKM 36250  | 1  |   | 1   |   |   |   |   |   |
|   | <b>B(Alt)</b> B 5244 S2             | 01/00 → 05/00   | <i>AC</i>   | VKMA 36230<br>VKMW 6DK1841<br>VKM 36240<br>VKM 36250                              | 1<br>1   | 1   | 1   |   |   |   |   |   |
|   | <b>B(Alt)</b> B 5244 S2             | 01/00 → 05/00   | <b>AC</b>   | VKMW 6DK1853<br>VKM 36240   | 1  |   | 1   |   |   |   |   |   |
| <b>VOLVO  V70   2.4 Bifuel</b> |                                     |   |   |   |  |   |   |   |   |   |   |   |
|                                | B 5244 SG, B 5244 SG2               | 08/99 → 03/00   |   | VKMA 06604<br>VKM 16604<br>VKM 26602  | 1<br>1   | 1   | 1   |   |   |   |   | T0163   |
|                                | B 5244 SG, B 5244 SG2               | 08/99 → 03/00   |   | VKPC 86618  |  |   |   |   | 1   |   |   |   |
| <b>VOLVO  V70   2.4 Turbo</b>  |                                     |   |   |   |  |   |   |   |   |   |   |   |
|                                | B 5244 T                            | 01/97 → 03/00   |   | VKMA 06604<br>VKM 16604<br>VKM 26602  | 1<br>1   | 1   | 1   |   |   |   |   | T0163   |
|                                | B 5244 T                            | 01/97 → 03/00   |   | VKPC 86618  |  |   |   |   | 1   |   |   |   |
|                                | <b>B(Alt)</b> B 5244 T              | 01/97 → 12/99   | <i>AC</i>   | VKMW 6DK1825<br>VKM 36240<br>VKM 36250  | 1  |   | 1   |   |   |   |   |   |
|   | <b>B(Alt)</b> B 5244 T              | 01/00 → 03/00   | <i>AC</i>   | VKMA 36230<br>VKMW 6DK1841<br>VKM 36240<br>VKM 36250                              | 1  | 1   | 1   |   |   |   |   |   |
|   | <b>B(Alt)</b> B 5244 T              | 01/97 → 12/99   | <b>AC</b>   | VKMW 6DK1836<br>VKM 36240   | 1  |   | 1   |   |   |   |   |   |
|   | <b>B(Alt)</b> B 5244 T              | 01/00 → 03/00   | <b>AC</b>   | VKMW 6DK1853<br>VKM 36240   | 1  |   | 1   |   |   |   |   |   |
| <b>VOLVO  V70   2.5 10V</b>    |                                     |   |   |   |  |   |   |   |   |   |   |   |
|                                | B 5252 FS, B 5252 S                 | 01/97 → 03/00   | →IMot. 1266127  | VKMA 06603<br>VKM 16602<br>VKM 26602  | 1<br>1   | 1   | 1   |   |   |   |   | 1 T0113   |
|   | B 5252 FS, B 5252 S                 | 01/97 → 03/00   | Mot. 1266128 I→   | VKMA 06605<br>VKM 16604<br>VKM 26602  | 1<br>1   | 1   | 1   |   |   |   |   | T0240   |
|                                | B 5252 FS, B 5252 S                 | 01/97 → 03/00   |   | VKPC 86618  |  |   |   |   | 1   |   |   |   |



VOLVO





























|                                      | <b>B(Alt)</b> | B 5252 FS, B 5252 S   | 01/97 → 12/98 | <b>AC</b> , Man. GBX    | VKMOV 6PK1267<br>VKM 36003<br>VKM 36120               | 1                | 1 | 1 |   |   |  |   |  |  |  |  |  |   |       |       |
|--------------------------------------|---------------|-----------------------|---------------|-------------------------|---|------------------|---|---|---|---|--|---|--|--|--|--|--|---|-------|-------|
|                                      | <b>B(Alt)</b> | B 5252 FS, B 5252 S   | 01/97 → 12/98 | <b>AC</b>               | VKMOV 6PK1743<br>VKM 36003<br>VKM 36120               | 1                | 1 | 1 |   |   |  |   |  |  |  |  |  |   |       |       |
|                                      | <b>B(Alt)</b> | B 5252 FS, B 5252 S   | 01/99 → 12/99 | <b>AC</b>               | VKMOV 6DK1836<br>VKM 36240                            | 1                |   | 1 |   |   |  |   |  |  |  |  |  |   |       |       |
| <b>VOLVO</b> <b>V70   2.5 20V</b>    |               |                       |               |                         |   |                  |   |   |   |   |  |   |  |  |  |  |  |   |       |       |
|                                      |               | B 5254 S              | 03/99 → 03/00 | → <b>I</b> Mot. 1266127 | VKMA 06602<br>VKM 16602<br>VKM 26602                  | 1<br>1           | 1 | 1 |   |   |  |   |  |  |  |  |  | 1 | T0163 |       |
|                                      |               | B 5254 S              | 03/99 → 03/00 | <b>Mot.</b> 1266128  →  | VKMA 06604<br>VKM 16604<br>VKM 26602                  | 1<br>1           | 1 | 1 |   |   |  |   |  |  |  |  |  |   |       | T0163 |
|                                      |               | B 5254 S              | 03/99 → 03/00 |                         | VKPC 86618  |                  |   |   |   |   |  | 1 |  |  |  |  |  |   |       |       |
| <b>VOLVO</b> <b>V70   2.5 Bifuel</b> |               |                       |               |                         |   |                  |   |   |   |   |  |   |  |  |  |  |  |   |       |       |
|                                      |               | GB 5252 S, GB 5252 S2 | 10/98 → 08/99 | → <b>I</b> Mot. 1266127 | VKMA 06603<br>VKM 16602<br>VKM 26602                  | 1<br>1           | 1 | 1 |   |   |  |   |  |  |  |  |  |   | 1     | T0113 |
|                                      |               | GB 5252 S, GB 5252 S2 | 10/98 → 08/99 | <b>Mot.</b> 1266128  →  | VKMA 06605<br>VKM 16604<br>VKM 26602                  | 1<br>1           | 1 | 1 |   |   |  |   |  |  |  |  |  |   |       | T0240 |
|                                      |               | GB 5252 S, GB 5252 S2 | 10/98 → 08/99 |                         | VKPC 86618  |                  |   |   |   |   |  | 1 |  |  |  |  |  |   |       |       |
|                                      | <b>B(Alt)</b> | GB 5252 S, GB 5252 S2 | 10/98 → 08/99 | <b>AC</b>               | VKMOV 6DK1825<br>VKM 36240<br>VKM 36250               | 1                |   |   | 1 |   |  |   |  |  |  |  |  |   |       |       |
|                                      | <b>B(Alt)</b> | GB 5252 S, GB 5252 S2 | 10/98 → 08/99 | <b>AC</b>               | VKMOV 6DK1836<br>VKM 36240                            | 1                |   |   | 1 |   |  |   |  |  |  |  |  |   |       |       |
| <b>VOLVO</b> <b>V70   2.5 Turbo</b>  |               |                       |               |                         |   |                  |   |   |   |   |  |   |  |  |  |  |  |   |       |       |
|                                      |               | B 5254 T              | 01/97 → 05/00 | → <b>I</b> Mot. 1266127 | VKMA 06602<br>VKM 16602<br>VKM 26602                  | 1<br>1           | 1 | 1 |   |   |  |   |  |  |  |  |  |   | 1     | T0163 |
|                                      |               | B 5254 T              | 01/97 → 05/00 | <b>Mot.</b> 1266128  →  | VKMA 06604<br>VKM 16604<br>VKM 26602                  | 1<br>1           | 1 | 1 |   |   |  |   |  |  |  |  |  |   |       | T0163 |
|                                      |               | B 5254 T              | 01/97 → 05/00 |                         | VKPC 86618  |                  |   |   |   |   |  | 1 |  |  |  |  |  |   |       |       |
|                                      | <b>B(Alt)</b> | B 5254 T              | 01/97 → 12/99 | <b>AC</b>               | VKMOV 6DK1825<br>VKM 36240<br>VKM 36250               | 1                |   |   | 1 |   |  |   |  |  |  |  |  |   |       |       |
|                                      | <b>B(Alt)</b> | B 5254 T              | 01/97 → 12/99 | <b>AC</b>               | VKMOV 6DK1836<br>VKM 36240                            | 1                |   |   | 1 |   |  |   |  |  |  |  |  |   |       |       |
|                                      | <b>B(Alt)</b> | B 5254 T              | 01/00 → 05/00 | <b>AC</b>               | VKMA 36230<br>VKMOV 6DK1841<br>VKM 36240<br>VKM 36250 | 1<br>1           | 1 | 1 |   |   |  |   |  |  |  |  |  |   |       |       |
|                                      | <b>B(Alt)</b> | B 5254 T              | 01/00 → 05/00 | <b>AC</b>               | VKMOV 6DK1853<br>VKM 36240                            | 1                |   |   | 1 |   |  |   |  |  |  |  |  |   |       |       |
| <b>VOLVO</b> <b>V70   2.5 TDI</b>    |               |                       |               |                         |   |                  |   |   |   |   |  |   |  |  |  |  |  |   |       |       |
|                                      |               | D 5252 T              | 01/97 → 05/00 | 4)                      | VKMA 01258<br>VKM 11073<br>VKM 11257<br>VKM 11258     | 3<br>1<br>1<br>1 |   | 2 |   |   |  |   |  |  |  |  |  |   | 6     | T0095 |
|                                      |               | D 5252 T              | 01/97 → 05/00 |                         | VKPC 86620  |                  |   |   |   |   |  | 1 |  |  |  |  |  |   |       |       |
|                                      | <b>B(Alt)</b> | D 5252 T              | 01/97 → 05/00 | <b>AC</b>               | VKMA 36520<br>VKMOV 6PK1432<br>VKM____<br>VKM 36530   | 1<br>1<br>1      | 1 | 1 |   | 1 |  |   |  |  |  |  |  |   |       |       |
|                                      | <b>B(Alt)</b> | D 5252 T              | 01/97 → 05/00 | <b>AC</b>               | VKMA____<br>VKMOV 6PK1683<br>VKM____<br>VKM 36530     | 1<br>1<br>1      | 1 | 1 |   | 1 |  |   |  |  |  |  |  |   |       |       |



|  |  |  |  |  |  |  |  |  |  |  |  |  |
|--|--|---|---|---|--|---|---|---|---|---|---|---|
| <b>VOLVO  V70 II 2.0 Turbo</b>    |  |   |   |   |  |   |   |   |   |   |   |   |
|                                   | B 5204 T5  | 07/01 → 12/04   | → Mot. 3188688  | VKMA 06604<br>VKM 16604<br>VKM 26602  | 1<br>1   | 1   | 1   |   |   |   |   | T0163   |
|  | B 5204 T5  | 01/05 → 04/07   | Mot. 3188689  →   | VKMA 06040<br>VKM 16040<br>VKM 26602  | 1<br>1   | 1   | 1   |   |   |   |   | T0163   |
|                                   | B 5204 T5  | 07/01 → 04/07   |   | VKPC 86618  |  |   |   |   | 1   |   |   |   |
|                                   | <b>B(Alt)</b> B 5204 T5                          | 07/01 → 04/07   |   | VKMA 36230<br>VKMV 6DK1841<br>VKM 36240<br>VKM 36250                              | 1<br>1   | 1   | 1   |   |   |   |   |   |
| <b>VOLVO  V70 II 2.3 Turbo</b>    |  |   |   |   |  |   |   |   |   |   |   |   |
|                                   | B 5234 T3, B 5234 T7                             | 03/00 → 12/04   | → Mot. 3188688  | VKMA 06604<br>VKM 16604<br>VKM 26602  | 1<br>1   | 1   | 1   |   |   |   |   | T0163   |
|  | B 5234 T3, B 5234 T7                             | 01/05 → 04/07   | Mot. 3188689  →   | VKMA 06040<br>VKM 16040<br>VKM 26602  | 1<br>1   | 1   | 1   |   |   |   |   | T0163   |
|                                   | B 5234 T3, B 5234 T7                             | 03/00 → 04/07   |   | VKPC 86618  |  |   |   |   | 1   |   |   |   |
|                                   | <b>B(Alt)</b> B 5234 T3, B 5234 T7               | 03/00 → 04/07   |   | VKMA 36230<br>VKMV 6DK1841<br>VKM 36240<br>VKM 36250                              | 1<br>1   | 1   | 1   |   |   |   |   |   |
| <b>VOLVO  V70 II 2.4</b>          |  |   |   |   |  |   |   |   |   |   |   |   |
|                                  | B 5244 S, B 5244 S2                              | 03/00 → 12/04   | → Mot. 3188688  | VKMA 06604<br>VKM 16604<br>VKM 26602  | 1<br>1   | 1   | 1   |   |   |   |   | T0163   |
|  | B 5244 S, B 5244 S2                              | 01/05 → 04/07   | Mot. 3188689  →   | VKMA 06040<br>VKM 16040<br>VKM 26602  | 1<br>1   | 1   | 1   |   |   |   |   | T0163   |
|                                 | B 5244 S, B 5244 S2                              | 03/00 → 04/07   |   | VKPC 86618  |  |   |   |   | 1   |   |   |   |
|                                 | <b>B(Alt)</b> B 5244 S, B 5244 S2                | 03/00 → 04/07   |   | VKMA 36230<br>VKMV 6DK1841<br>VKM 36240<br>VKM 36250                              | 1<br>1   | 1   | 1   |   |   |   |   |   |
| <b>VOLVO  V70 II 2.4 Bifuel</b> |  |   |   |   |  |   |   |   |   |   |   |   |
|                                 | B 5244 SG, B 5244 SG2                            | 09/01 → 12/04   | → Mot. 3188688  | VKMA 06604<br>VKM 16604<br>VKM 26602  | 1<br>1   | 1   | 1   |   |   |   |   | T0163   |
|  | B 5244 SG, B 5244 SG2                            | 01/05 → 04/07   | Mot. 3188689  →   | VKMA 06040<br>VKM 16040<br>VKM 26602  | 1<br>1   | 1   | 1   |   |   |   |   | T0163   |
|                                 | B 5244 SG, B 5244 SG2                            | 09/01 → 04/07   |   | VKPC 86618  |  |   |   |   | 1   |   |   |   |
|                                 | <b>B(Alt)</b> B 5244 SG, B 5244 SG2              | 09/01 → 04/07   |   | VKMA 36230<br>VKMV 6DK1841<br>VKM 36240<br>VKM 36250                              | 1<br>1   | 1   | 1   |   |   |   |   |   |
| <b>VOLVO  V70 II 2.4 Turbo</b>  |  |   |   |   |  |   |   |   |   |   |   |   |
|                                 | B 5244 T3, B 5244 T4,<br>B 5244 T5               | 03/00 → 04/07   | → Mot. 3188688  | VKMA 06604<br>VKM 16604<br>VKM 26602  | 1<br>1   | 1   | 1   |   |   |   |   | T0163   |
|  | B 5244 T3, B 5244 T4,<br>B 5244 T5               | 01/05 → 04/07   | Mot. 3188689  →   | VKMA 06040<br>VKM 16040<br>VKM 26602  | 1<br>1   | 1   | 1   |   |   |   |   | T0163   |
|                                 | B 5244 T3, B 5244 T4,<br>B 5244 T5               | 03/00 → 04/07   |   | VKPC 86618  |  |   |   |   | 1   |   |   |   |
|                                 | <b>B(Alt)</b> B 5244 T3, B 5244 T4,<br>B 5244 T5 | 03/00 → 04/07   |   | VKMA 36230<br>VKMV 6DK1841<br>VKM 36240<br>VKM 36250                              | 1<br>1   | 1   | 1   |   |   |   |   |   |



































| <b>VOLVO  V70 II 2.5 Turbo</b> |                                    |               |                  |  |                  |   |   |  |   |  |  |  |         |
|--------------------------------|------------------------------------|---------------|------------------|--|------------------|---|---|--|---|--|--|--|---------|
|                                | B 5254 T2                          | 09/02 → 12/04 | →   Mot. 3188688 | VKMA 06604<br>VKM 16604<br>VKM 26602                 | 1<br>1           | 1 | 1 |  |   |  |  |  | T0163   |
|                                | B 5254 T2                          | 01/05 → 04/07 | Mot. 3188689   → | VKMA 06040<br>VKM 16040<br>VKM 26602                 | 1<br>1           | 1 | 1 |  |   |  |  |  | T0163   |
|                                | B 5254 T4                          | 03/03 → 12/04 |                  | —<br>—<br>VKM 26602                                  | 1<br>1           | 1 | 1 |  |   |  |  |  | T0163   |
|                                | B 5254 T2, B 5254 T4               | 09/02 → 04/07 |                  | VKPC 86618   |                  |   |   |  | 1 |  |  |  |         |
|                                | <b>B(Alt)</b> B 5254 T2, B 5254 T4 | 09/02 → 04/07 |                  | VKMA 36230<br>VKMV 6DK1841<br>VKM 36240<br>VKM 36250 | 1<br>1           | 1 | 1 |  |   |  |  |  |         |
| <b>VOLVO  V70 II 2.4 D</b>     |                                    |               |                  |  |                  |   |   |  |   |  |  |  |         |
|                                | D 5244 T2, D 5244 T3               | 12/01 → 12/05 |                  | VKMA 06220<br>VKM 16220<br>VKM 26220                 | 1<br>1           | 1 | 1 |  |   |  |  |  | T0192   |
|                                | D 5244 T2, D 5244 T3               | 12/01 → 04/07 |                  | VKPC 86635   |                  |   |   |  | 1 |  |  |  |         |
|                                | <b>B(Alt)</b> D 5244 T2, D 5244 T3 | 12/01 → 04/07 | <b>AC</b>        | VKMA 36220<br>VKMV 6DK1841<br>VKM 36220<br>VKM 36230 | 1<br>1           | 1 | 1 |  |   |  |  |  |         |
| <b>VOLVO  V70 II 2.4 D5</b>    |                                    |               |                  |  |                  |   |   |  |   |  |  |  |         |
|                                | D 5244 T                           | 08/01 → 12/05 |                  | VKMA 06220<br>VKM 16220<br>VKM 26220                 | 1<br>1           | 1 | 1 |  |   |  |  |  | T0192   |
|                                | D 5244 T                           | 08/01 → 04/07 |                  | VKPC 86635   |                  |   |   |  | 1 |  |  |  |         |
|                                | <b>B(Alt)</b> D 5244 T             | 08/01 → 04/07 | <b>AC</b>        | VKMA 36220<br>VKMV 6DK1841<br>VKM 36220<br>VKM 36230 | 1<br>1           | 1 | 1 |  |   |  |  |  |         |
| <b>VOLVO  V70 II 2.5 TDI</b>   |                                    |               |                  |  |                  |   |   |  |   |  |  |  |         |
|                                | D 5252 T                           | 03/00 → 04/07 | 4)               | VKMA 01258<br>VKM 11073<br>VKM 11257<br>VKM 11258    | 3<br>1<br>1<br>1 |   | 2 |  |   |  |  |  | 6 T0095 |
|                                | D 5252 T                           | 03/00 → 04/07 |                  | VKPC 86620   |                  |   |   |  | 1 |  |  |  |         |
|                                | <b>B(Alt)</b> D 5252 T             | 03/00 → 04/07 | <b>AC</b>        | VKMA 36520<br>VKMV 6PK1432<br>VKM____<br>VKM 36530   | 1<br>1           | 1 | 1 |  |   |  |  |  |         |
|                                | <b>B(Alt)</b> D 5252 T             | 03/00 → 04/07 | <b>AC</b>        | VKMA____<br>VKMV 6PK1683<br>VKM____<br>VKM 36530     | 1<br>1           | 1 | 1 |  |   |  |  |  |         |
| <b>VOLVO  XC70 I 2.4 Turbo</b> |                                    |               |                  |  |                  |   |   |  |   |  |  |  |         |
|                                | B 5244 T3                          | 03/00 → 09/02 |                  | VKMA 06604<br>VKM 16604<br>VKM 26602                 | 1<br>1           | 1 | 1 |  |   |  |  |  | T0163   |
|                                | B 5244 T3                          | 03/00 → 09/02 |                  | VKPC 86618   |                  |   |   |  | 1 |  |  |  |         |
|                                | <b>B(Alt)</b> B 5244 T3            | 03/00 → 09/02 |                  | VKMA 36230<br>VKMV 6DK1841<br>VKM 36240<br>VKM 36250 | 1<br>1           | 1 | 1 |  |   |  |  |  |         |
| <b>VOLVO  XC70 I 2.5 Turbo</b> |                                    |               |                  |  |                  |   |   |  |   |  |  |  |         |
|                                | B 5254 T2                          | 09/02 → 12/04 | →   Mot. 3188688 | VKMA 06604<br>VKM 16604<br>VKM 26602                 | 1<br>1           | 1 | 1 |  |   |  |  |  | T0163   |
|                                | B 5254 T2                          | 01/05 → 04/07 | Mot. 3188688   → | VKMA 06040<br>VKM 16040<br>VKM 26602                 | 1<br>1           | 1 | 1 |  |   |  |  |  | T0163   |
|                                | B 5254 T2                          | 09/02 → 04/07 |                  | VKPC 86618   |                  |   |   |  | 1 |  |  |  |         |

|  |  |  |  |  |  |  |  |  |  |  |  |
|--|---|---|---|--|---|---|---|---|---|---|---|
|   | <b>B(Alt)</b> B 5254 T2   | 09/02 → 04/07   |   | VKMA 36230<br>VKMV 6DK1841<br>VKM 36240<br>VKM 36250                               | 1<br>1<br>1<br>1  | 1<br>1  | 1<br>1  |   |   |   |   |
| <b>VOLVO  XC70 I 2.4 D5</b>                         |   |   |   |  |   |   |   |   |   |   |   |
|   | D 5244 T  | 09/02 → 12/05   |   | VKMA 06220<br>VKM 16220<br>VKM 26220   | 1<br>1<br>1   | 1<br>1  | 1   |   |   |   | T0192   |
|   | D 5244 T  | 09/02 → 04/07   |   | VKPC 86635   |   |   |   | 1   |   |   |   |
|   | <b>B(Alt)</b> D 5244 T  | 09/02 → 04/07   | <b>AC</b>   | VKMV 6DK1841<br>VKM 36220<br>VKM 36230<br>VKM 36250                                | 1<br>1<br>1   | 1   | 1   |   |   |   |   |
|  | <b>B(Alt)</b> D 5244 T  | 09/02 → 04/07   | <b>AC</b>   | VKMA 36220<br>VKMV 6DK1841<br>VKM 36220<br>VKM 36230                               | 1<br>1<br>1<br>1  | 1<br>1  | 1   |   |   |   |   |
| <b>VOLVO  XC90 2.5 Turbo</b>                        |   |   |   |  |   |   |   |   |   |   |   |
|   | B 5254 T2   | 10/02 → 12/04   | → <b>IMot.</b> 3188688  | VKMA 06604<br>VKM 16604<br>VKM 26602   | 1<br>1<br>1   | 1<br>1  | 1   |   |   |   | T0163   |
|  | B 5254 T2   | 01/05 → 04/07   | <b>Mot.</b> 3188689  →  | VKMA 06040<br>VKM 16040<br>VKM 26602   | 1<br>1<br>1   | 1<br>1  | 1   |   |   |   | T0163   |
|   | B 5254 T2   | 10/02 → 04/07   |   | VKPC 86618   |   |   |   | 1   |   |   |   |
| <b>VOLVO  XC90 3.0 Turbo</b>                       |   |   |   |  |   |   |   |   |   |   |   |
|   | B 6294 T  | 10/02 → 04/07   |   | VKMA 06800<br>VKM 16800<br>VKM 26220   | 1<br>1<br>1   | 1<br>1  | 1   |   |   |   | T0178   |
| <b>VOLVO  XC90 4.4 V8</b>                         |   |   |   |  |   |   |   |   |   |   |   |
|   | B 8444 S  | 01/05 → 04/07   |   | <b>0x0x0x0</b>   |   |   |   |   |   |   |   |
| <b>VOLVO  XC90 2.4 D5</b>                         |   |   |   |  |   |   |   |   |   |   |   |
|   | D 5244 T  | 10/02 → 12/05   |   | VKMA 06220<br>VKM 16220<br>VKM 26220   | 1<br>1<br>1   | 1<br>1  | 1   |   |   |   | T0192   |
|   | D 5244 T  | 10/02 → 04/07   |   | VKPC 86635   |   |   |   | 1   |   |   |   |
|   | <b>B(Alt)</b> D 5244 T  | 10/02 → 04/07   | <b>AC</b>   | VKMV 6DK1825<br>VKM 36220<br>VKM 36230   | 1<br>1<br>1   | 1   | 1   |   |   |   |   |
| <b>VW  BORA (1J2) / BORA Estate (1J6) 1.4 16V</b> |   |   |   |  |   |   |   |   |   |   |   |
|   | AHW   | 03/00 → 05/05   | → <b>IMot.</b> 160 000  | VKMA 01120<br>VKM 11120<br>VKM 11121<br>VKM 21120<br>VKM 21121                     | 2<br>1<br>1<br>1<br>1   | 2<br>1  | 2   |   |   |   | T0165   |
|  | AHW   | 03/00 → 05/05   | <b>Mot.</b> 160 001  →  | VKMA 01121<br>VKM 11120<br>VKM 11124<br>VKM 21120<br>VKM 21121                     | 2<br>1<br>1<br>1<br>1   | 2<br>1  | 2   |   |   |   | T0165   |
|  | AKQ   | 03/00 → 05/05   | → <b>IMot.</b> 242 000  | VKMA 01120<br>VKM 11120<br>VKM 11121<br>VKM 21120<br>VKM 21121                     | 2<br>1<br>1<br>1<br>1   | 2<br>1  | 2   |   |   |   | T0165   |
|  | AKQ   | 03/00 → 05/05   | <b>Mot.</b> 242 001  →  | VKMA 01121<br>VKM 11120<br>VKM 11124<br>VKM 21120<br>VKM 21121                     | 2<br>1<br>1<br>1<br>1   | 2<br>1  | 2   |   |   |   | T0165   |
|  | APE, AXP, BCA   | 03/00 → 05/05   |   | VKMA 01121<br>VKM 11120<br>VKM 11124<br>VKM 21120<br>VKM 21121                     | 2<br>1<br>1<br>1<br>1   | 2<br>1  | 2   |   |   |   | T0165   |



VOLVO

|   | AHW, AKQ, APE, AXP, BCA               | 03/00 → 05/05 |                  |              |   |   |   |  |  |  |  | 1     |
|---|---------------------------------------|---------------|------------------|--------------|---|---|---|--|--|--|--|-------|
|   | <b>B(Alt)</b> AHW, AKQ, APE, AXP, BCA | 03/00 → 05/05 | AC               |              |   |   |   |  |  |  |  |       |
|   |                                       |               |                  | VKPC 81407   |   |   |   |  |  |  |  |       |
|   |                                       |               |                  | VKMA 31206   | 1 |   |   |  |  |  |  | 1     |
|   |                                       |               |                  | VKMA 31207   | 1 |   |   |  |  |  |  | 1     |
|   |                                       |               |                  | VKMV 6PK1078 |   |   |   |  |  |  |  | 1     |
|   |                                       |               |                  | VKM 31015    |   |   |   |  |  |  |  | 1     |
|   |                                       |               |                  | VKMA 31207   | 1 | 1 |   |  |  |  |  | 1     |
|   |                                       |               |                  | VKMA 31207   | 1 |   |   |  |  |  |  | 1     |
|   |                                       |               |                  | VKMV 6PK1548 |   |   |   |  |  |  |  | 1     |
|   |                                       |               |                  | VKM 31016    |   |   |   |  |  |  |  | 1     |
|   |                                       |               |                  | VKM 31207    |   |   |   |  |  |  |  | 1     |
| <b>VW  BORA (1J2) / BORA Estate (1J6) 1.6</b>     |                                       |               |                  |              |   |   |   |  |  |  |  |       |
|   | AEH, APF, AVU, BFQ, BJH               | 10/98 → 05/05 |                  |              |   |   |   |  |  |  |  | T0149 |
|   |                                       |               |                  | VKMA 01113   | 1 |   |   |  |  |  |  | 1     |
|   |                                       |               |                  | VKMA 01113   | 1 |   |   |  |  |  |  | 1     |
|   | AEH, APF, AVU, BFQ, BJH               | 10/98 → 05/05 |                  |              |   |   |   |  |  |  |  | 1     |
|   | <b>B(Alt)</b> AEH, APF, AVU, BFQ, BJH | 10/98 → 05/05 | AC               |              |   |   |   |  |  |  |  |       |
|   |                                       |               |                  | VKPC 81408   |   |   |   |  |  |  |  | 1     |
|   |                                       |               |                  | VKMA 31203   | 1 |   |   |  |  |  |  | 1     |
|   |                                       |               |                  | VKMA 31203   | 1 |   |   |  |  |  |  | 1     |
|   |                                       |               |                  | VKMV 6PK1120 |   |   |   |  |  |  |  | 1     |
|   |                                       |               |                  | VKM 31011    |   |   |   |  |  |  |  | 1     |
|   |                                       |               |                  | VKMA 31204   | 1 |   |   |  |  |  |  | 1     |
|   |                                       |               |                  | VKMA 31204   | 1 |   |   |  |  |  |  | 1     |
|   |                                       |               |                  | VKMV 6DK1195 |   |   |   |  |  |  |  | 1     |
|   |                                       |               |                  | VKM 31011    |   |   |   |  |  |  |  | 1     |
| <b>VW  BORA (1J2) / BORA Estate (1J6) 1.6 16V</b> |                                       |               |                  |              |   |   |   |  |  |  |  |       |
|   | ATN, AUS, AZD, BCB                    | 02/00 → 05/05 |                  |              |   |   |   |  |  |  |  | T0165 |
|   |                                       |               |                  | VKMA 01121   | 2 | 2 | 2 |  |  |  |  | 1     |
|   |                                       |               |                  | VKMA 01121   | 1 |   |   |  |  |  |  | 1     |
|   |                                       |               |                  | VKM 11120    |   |   |   |  |  |  |  | 1     |
|   |                                       |               |                  | VKM 11124    |   |   |   |  |  |  |  | 1     |
|   |                                       |               |                  | VKM 21120    |   |   |   |  |  |  |  | 1     |
|   |                                       |               |                  | VKM 21121    |   |   |   |  |  |  |  | 1     |
|   | ATN, AUS, AZD, BCB                    | 02/00 → 05/05 |                  |              |   |   |   |  |  |  |  | 1     |
|   | <b>B(Alt)</b> ATN, AUS, AZD, BCB      | 02/00 → 05/05 | AC               |              |   |   |   |  |  |  |  |       |
|   |                                       |               |                  | VKPC 81419   |   |   |   |  |  |  |  | 1     |
|   |                                       |               |                  | VKMA 31206   | 1 |   |   |  |  |  |  | 1     |
|   |                                       |               |                  | VKMA 31206   | 1 |   |   |  |  |  |  | 1     |
|   |                                       |               |                  | VKMV 6PK1078 |   |   |   |  |  |  |  | 1     |
|   |                                       |               |                  | VKM 31015    |   |   |   |  |  |  |  | 1     |
|   |                                       |               |                  | VKMA 31207   | 1 | 1 |   |  |  |  |  | 1     |
|   |                                       |               |                  | VKMA 31207   | 1 |   |   |  |  |  |  | 1     |
|   |                                       |               |                  | VKMV 6PK1548 |   |   |   |  |  |  |  | 1     |
|   |                                       |               |                  | VKM 31016    |   |   |   |  |  |  |  | 1     |
|   |                                       |               |                  | VKM 31207    |   |   |   |  |  |  |  | 1     |
| <b>VW  BORA (1J2) / BORA Estate (1J6) 1.6 FSI</b> |                                       |               |                  |              |   |   |   |  |  |  |  |       |
|   | BAD                                   | 01/02 → 05/05 |                  |              |   |   |   |  |  |  |  | T0165 |
|   |                                       |               |                  | VKMA 01121   | 2 | 2 | 2 |  |  |  |  | 1     |
|   |                                       |               |                  | VKMA 01121   | 1 |   |   |  |  |  |  | 1     |
|   |                                       |               |                  | VKM 11120    |   |   |   |  |  |  |  | 1     |
|   |                                       |               |                  | VKM 11124    |   |   |   |  |  |  |  | 1     |
|   |                                       |               |                  | VKM 21120    |   |   |   |  |  |  |  | 1     |
|   |                                       |               |                  | VKM 21121    |   |   |   |  |  |  |  | 1     |
|   | BAD                                   | 01/02 → 05/05 |                  |              |   |   |   |  |  |  |  | 1     |
|   | <b>B(Alt)</b> BAD                     | 01/02 → 05/05 | AC               |              |   |   |   |  |  |  |  |       |
|   |                                       |               |                  | VKPC 81419   |   |   |   |  |  |  |  | 1     |
|   |                                       |               |                  | VKMA 31206   | 1 |   |   |  |  |  |  | 1     |
|   |                                       |               |                  | VKMA 31206   | 1 |   |   |  |  |  |  | 1     |
|   |                                       |               |                  | VKMV 6PK1078 |   |   |   |  |  |  |  | 1     |
|   |                                       |               |                  | VKM 31015    |   |   |   |  |  |  |  | 1     |
|   |                                       |               |                  | VKMA 31208   | 1 | 1 |   |  |  |  |  | 1     |
|   |                                       |               |                  | VKMA 31208   | 1 |   |   |  |  |  |  | 1     |
|   |                                       |               |                  | VKMV 6PK1540 |   |   |   |  |  |  |  | 1     |
|   |                                       |               |                  | VKM 31016    |   |   |   |  |  |  |  | 1     |
|   |                                       |               |                  | VKM 31207    |   |   |   |  |  |  |  | 1     |
| <b>VW  BORA (1J2) / BORA Estate (1J6) 1.8</b>     |                                       |               |                  |              |   |   |   |  |  |  |  |       |
|   | AGN, BAF                              | 10/98 → 05/05 | ICH 1J-Y-850 000 |              |   |   |   |  |  |  |  | T0151 |
|   |                                       |               |                  | VKMA 01115   | 1 | 1 | 1 |  |  |  |  | 1     |
|   |                                       |               |                  | VKMA 01115   | 1 |   |   |  |  |  |  | 1     |
|   |                                       |               |                  | VKM 11115    |   |   |   |  |  |  |  | 1     |
|   |                                       |               |                  | VKMA 01116   | 1 | 1 | 1 |  |  |  |  | 1     |
|   |                                       |               |                  | VKMA 01116   | 1 |   |   |  |  |  |  | 1     |
|   |                                       |               |                  | VKM 11116    |   |   |   |  |  |  |  | 1     |
|   |                                       |               |                  | VKM 21115    |   |   |   |  |  |  |  | 1     |
|   | AGN, BAF                              | 10/98 → 05/05 |                  |              |   |   |   |  |  |  |  | 1     |
|   | <b>B(Alt)</b> AGN, BAF                | 10/98 → 05/05 | AC               |              |   |   |   |  |  |  |  |       |
|   |                                       |               |                  | VKPC 81620   |   |   |   |  |  |  |  | 1     |
|   |                                       |               |                  | VKMA 31203   | 1 |   |   |  |  |  |  | 1     |
|   |                                       |               |                  | VKMA 31203   | 1 |   |   |  |  |  |  | 1     |
|   |                                       |               |                  | VKMV 6PK1120 |   |   |   |  |  |  |  | 1     |
|   |                                       |               |                  | VKM 31011    |   |   |   |  |  |  |  | 1     |

|  |  |  |                      |  |  |  |  |  |  |  |  |  |
|--|---|---|---|--|---|---|---|---|---|---|---|---|
|  | <b>B(Alt)</b> AGN, BAF  | 10/98 → 05/05   | <b>AC</b>   | VKMA 31204<br>VKMV 6DK1195<br>VKM 31011  | 1<br>1<br>1   | 1<br>1  |   |   |   |   |   |   |
| <b>VW  BORA (1J2) / BORA Estate (1J6) 1.8 Turbo</b> |   |   |   |  |   |   |   |   |   |   |   |   |
|   | AGU, AUM, BAE   | 05/00 → 05/05   |  ICH 1J-Y-850 000    | VKMA 01115<br>VKM 11115<br>VKM 21115   | 1<br>1<br>1   | 1<br>1  | 1   |   |   |   |   | T0151   |
|  | AGU, AUM, BAE   | 05/00 → 05/05   |  CH 1J-Y-850 001 I → | VKMA 01116<br>VKM 11116<br>VKM 21115   | 1<br>1<br>1   | 1<br>1  | 1   |   |   |   |   | T0151   |
|  | AUQ   | 03/02 → 05/05   |                      | VKMA 01116<br>VKM 11116<br>VKM 21115   | 1<br>1<br>1   | 1<br>1  | 1   |   |   |   |   | T0151   |
|   | AGU, AUM, AUQ, BAE  | 05/00 → 05/05   |   | VKPC 81620   |   |   |   | 1   |   |   |   |   |
|   | <b>B(Alt)</b> AGU, AUM, AUQ, BAE  | 05/00 → 05/05   | <b>AC</b>   | VKMA 31203<br>VKMV 6PK1120<br>VKM 31011  | 1<br>1<br>1   | 1<br>1  |   |   |   |   |   |   |
|  | <b>B(Alt)</b> AGU, AUM, AUQ, BAE  | 05/00 → 05/05   | <b>AC</b>   | VKMA 31204<br>VKMV 6DK1195<br>VKM 31011  | 1<br>1<br>1   | 1<br>1  |   |   |   |   |   |   |
| <b>VW  BORA (1J2) / BORA Estate (1J6) 2.0</b>       |   |   |   |  |   |   |   |   |   |   |   |   |
|   | APK, AQY, AZG, AZH,<br>AZJ  | 10/98 → 05/05   |   | VKMA 01113<br>VKM 11113  | 1<br>1  | 1   |   |   |   |   |   | T0149   |
|   | APK, AQY, AZG, AZH,<br>AZJ  | 10/98 → 05/05   |   | VKPC 81620   |   |   |   | 1   |   |   |   |   |
|    | <b>B(Alt)</b> APK, AQY, AZG, AZH,<br>AZJ  | 10/98 → 05/05   | <b>AC</b>   | VKMA 31203<br>VKMV 6PK1120<br>VKM 31011  | 1<br>1<br>1   | 1<br>1  |   |   |   |   |   |   |
|  | <b>B(Alt)</b> APK, AQY, AZG, AZH,<br>AZJ  | 10/98 → 05/05   | <b>AC</b>   | VKMA 31204<br>VKMV 6DK1195<br>VKM 31011  | 1<br>1<br>1   | 1<br>1  |   |   |   |   |   |   |
| <b>VW  BORA (1J2) / BORA Estate (1J6) 2.3 V5</b>  |   |   |   |  |   |   |   |   |   |   |   |   |
|   | AGZ, AQN  | 10/98 → 05/05   |   | XXXXXXXX   |   |   |   |   |   |   |   |   |
|   | AGZ, AQN  | 10/98 → 05/05   |   | VKPC 81622   |   |   |   | 1   |   |   |   |   |
|   | <b>B(Alt)</b> AGZ   | 10/98 → 10/00   | <b>AC</b>   | VKMV 6PK1285   |   |   | 1   |   |   |   |   |   |
|  | <b>B(Alt)</b> AQN   | 10/00 → 05/05   | <b>AC</b>   | VKMV 6PK1264   |   |   | 1   |   |   |   |   |   |
| <b>VW  BORA (1J2) / BORA Estate (1J6) 2.8 V6</b>  |   |   |   |  |   |   |   |   |   |   |   |   |
|   | AQP, AUE, BDE   | 03/99 → 05/05   |   | XXXXXXXX   |   |   |   |   |   |   |   |   |
|   | AQP, AUE  | 03/99 → 05/05   |   | VKPC 81611   |   |   |   | 1   |   |   |   |   |
|  | BDE   | 03/99 → 05/05   |   | —  |   |   |   | 1   |   |   |   |   |
|   | <b>B(Alt)</b> AQP, AUE, BDE   | 03/99 → 05/05   | <b>AC</b>   | VKMV 6PK1264   |   |   | 1   |   |   |   |   |   |
| <b>VW  BORA (1J2) / BORA Estate (1J6) 1.9 SDI</b> |   |   |   |  |   |   |   |   |   |   |   |   |
|   | AGP   | 10/98 → 05/05   | → Mot. 400 000  | VKMA 01131<br>VKM 11130<br>VKM 21004<br>VKM 21130<br>VKM 21131                     | 1<br>1<br>1<br>1<br>1   | 3<br>1<br>1<br>1  | 1   |   |   |   |   | 8 T0173   |
|  | AGP   | 10/98 → 05/05   | Mot. 400 001 I →  | VKMA 01251<br>VKM 11130<br>VKM 21004<br>VKM 21130<br>VKM 21131                     | 1<br>1<br>1<br>1<br>1   | 3<br>1<br>1<br>1  | 1   |   |   |   |   | 8 T0173   |
|  | AQM   | 10/98 → 05/05   | → Mot. 045 000  | VKMA 01131<br>VKM 11130<br>VKM 21004<br>VKM 21130<br>VKM 21131                     | 1<br>1<br>1<br>1<br>1   | 3<br>1<br>1<br>1  | 1   |   |   |   |   | 8 T0173   |
|  | AQM   | 10/98 → 05/05   | Mot. 045 001 I →  | VKMA 01251<br>VKM 11130<br>VKM 21004<br>VKM 21130<br>VKM 21131                     | 1<br>1<br>1<br>1<br>1   | 3<br>1<br>1<br>1  | 1   |   |   |   |   | 8 T0173   |



VW











































|   | AGP, AQM               | 10/98 → 05/05 |  | VKPC 81623   |   |   |   |   |  |  |  |  | 1 |  |   |       |
|---|------------------------|---------------|--|--|---|---|---|---|--|--|--|--|---|--|---|-------|
|   | <b>B(Alt)</b> AGP, AQM | 10/98 → 05/05 | <b>AC</b>  | VKMA 01131<br>VKM 11130<br>VKM 21004<br>VKM 21130<br>VKM 21131 | 1 | 3 | 1 |   |  |  |  |  |   |  | 8 | T0173 |
|   | <b>B(Alt)</b> AGP, AQM | 10/98 → 05/05 | <b>AC</b>  | VKMA 01251<br>VKM 11130<br>VKM 21004<br>VKM 21130<br>VKM 21131 | 1 | 3 | 1 |   |  |  |  |  |   |  | 8 | T0173 |
|   | <b>B(Alt)</b> AGP, AQM | 10/98 → 05/05 | <b>AC</b>  | VKMA 31005<br>VKMV 6PK1660<br>VKM 31002<br>VKM 31018           | 1 | 1 | 1 |   |  |  |  |  |   |  | 2 |       |
|   | <b>B(Alt)</b> AGP, AQM | 10/98 → 05/05 | <b>AC</b>  | VKMA 31002<br>VKM 31018  | 1 | 1 |   |   |  |  |  |  |   |  | 1 |       |
|   | <b>B(Alt)</b> AGP, AQM | 10/98 → 05/05 | <b>AC</b>  | VKMA 31018   | 1 |   |   |   |  |  |  |  |   |  | 1 |       |
|   | AGP, AQM               | 10/98 → 05/05 |  | VKM_____   |   |   |   |   |  |  |  |  | 1 |  |   |       |
| <b>VW  BORA (1J2) / BORA Estate (1J6) 1.9 TDI 90</b>  |                        |               |  |  |   |   |   |   |  |  |  |  |   |  |   |       |
|   | AGR                    | 10/98 → 06/01 | → <b>I</b> Mot. 565 000                            | VKMA 01131<br>VKM 11130<br>VKM 21004<br>VKM 21130<br>VKM 21131 | 1 | 3 | 1 |   |  |  |  |  |   |  | 8 | T0173 |
|   | AGR                    | 10/98 → 06/01 | <b>Mot.</b> 565 001 <b>I</b> →                     | VKMA 01251<br>VKM 11130<br>VKM 21004<br>VKM 21130<br>VKM 21131 | 1 | 3 | 1 |   |  |  |  |  |   |  | 8 | T0173 |
|   | ALH                    | 10/98 → 06/01 | → <b>I</b> Mot. 500 000                            | VKMA 01131<br>VKM 11130<br>VKM 21004<br>VKM 21130<br>VKM 21131 | 1 | 3 | 1 |   |  |  |  |  |   |  | 8 | T0173 |
|   | ALH                    | 10/98 → 06/01 | <b>Mot.</b> 500 001 <b>I</b> →                     | VKMA 01251<br>VKM 11130<br>VKM 21004<br>VKM 21130<br>VKM 21131 | 1 | 3 | 1 |   |  |  |  |  |   |  | 8 | T0173 |
|   | AGR, ALH               | 10/98 → 06/01 |  | VKPC 81623   |   |   |   |   |  |  |  |  | 1 |  |   |       |
|   | <b>B(Alt)</b> AGR, ALH | 10/98 → 06/01 | <b>AC</b>  | VKMA 01131<br>VKM 11130<br>VKM 21004<br>VKM 21130<br>VKM 21131 | 1 | 3 | 1 |   |  |  |  |  |   |  | 8 | T0173 |
|   | <b>B(Alt)</b> AGR, ALH | 10/98 → 06/01 | <b>AC</b>  | VKMA 31014<br>VKMV 6PK1660<br>VKM 31002<br>VKM 31012           | 1 | 1 | 1 |   |  |  |  |  |   |  | 1 |       |
|   | <b>B(Alt)</b> AGR, ALH | 10/98 → 06/01 | <b>AC</b>  | VKMA 31012   | 1 |   |   |   |  |  |  |  |   |  | 1 |       |
|   | <b>B(Alt)</b> AGR, ALH | 10/98 → 06/01 | <b>AC</b>  | VKMA 31012   | 1 |   |   |   |  |  |  |  |   |  | 1 |       |
|   | <b>B(Alt)</b> AGR, ALH | 10/98 → 06/01 | <b>AC</b>  | VKM_____   |   |   |   |   |  |  |  |  | 1 |  |   |       |
| <b>VW  BORA (1J2) / BORA Estate (1J6) 1.9 TDI 100</b> |                        |               |  |  |   |   |   |   |  |  |  |  |   |  |   |       |
|   | ATD                    | 09/00 → 12/02 | → <b>I</b> CH 1J-2-525 000,<br>1J-2D352 773        | VKMA 01942<br>VKM 11142<br>VKM 11145<br>VKM 21142              | 1 | 1 | 1 | 1 |  |  |  |  |   |  | 3 | T0184 |
|   | ATD                    | 09/00 → 12/02 | → <b>I</b> CH 1J-2-525 000,<br>1J-2D352 773        | VKMA 01142<br>VKM 11142<br>VKM 21142                           | 1 | 1 | 1 |   |  |  |  |  |   |  | 3 | T0184 |
|   | ATD                    | 01/02 → 05/05 | <b>CH</b> 1J-2-525 001,<br>1J-2D352 774 <b>I</b> → | VKMA 01250<br>VKM 11250<br>VKM 21147                           | 1 | 1 | 1 |   |  |  |  |  |   |  |   | T0184 |
|   | AXR                    | 09/00 → 12/02 | → <b>I</b> Mot. 010 000                            | VKMA 01942<br>VKM 11142<br>VKM 11145<br>VKM 21142              | 1 | 1 | 1 | 1 |  |  |  |  |   |  | 3 | T0184 |
|   | AXR                    | 09/00 → 12/02 | → <b>I</b> Mot. 010 000                            | VKMA 01142<br>VKM 11142<br>VKM 21142                           | 1 | 1 | 1 |   |  |  |  |  |   |  | 3 | T0184 |
|   | AXR                    | 01/02 → 05/05 | <b>Mot.</b> 010 001 <b>I</b> →                     | VKMA 01250<br>VKM 11250<br>VKM 21147                           | 1 | 1 | 1 |   |  |  |  |  |   |  |   | T0184 |
|   | ATD, AXR               | 09/00 → 12/02 |  | VKPC 81626   |   |   |   |   |  |  |  |  | 1 |  |   |       |
|   | ATD, AXR               | 01/03 → 05/05 |  | VKPC 81303   |   |   |   |   |  |  |  |  | 1 |  |   |       |
|   | <b>B(Alt)</b> ATD, AXR | 09/00 → 05/05 | <b>AC</b>  | VKMA 01131<br>VKM 11130<br>VKM 21004<br>VKM 21130<br>VKM 21131 | 1 | 3 | 1 |   |  |  |  |  |   |  | 8 | T0173 |
|   | <b>B(Alt)</b> ATD, AXR | 09/00 → 05/05 | <b>AC</b>  | VKMA 01251<br>VKM 11130<br>VKM 21004<br>VKM 21130<br>VKM 21131 | 1 | 3 | 1 |   |  |  |  |  |   |  | 8 | T0173 |
|   | <b>B(Alt)</b> ATD, AXR | 09/00 → 05/05 | <b>AC</b>  | VKMA 31014<br>VKMV 6PK1660<br>VKM 31002<br>VKM 31012           | 1 | 1 | 1 |   |  |  |  |  |   |  | 1 |       |
|   | <b>B(Alt)</b> ATD, AXR | 09/00 → 05/05 | <b>AC</b>  | VKMA 31012   | 1 |   |   |   |  |  |  |  |   |  | 1 |       |
|   | <b>B(Alt)</b> ATD, AXR | 09/00 → 05/05 | <b>AC</b>  | VKMA 31012   | 1 |   |   |   |  |  |  |  |   |  | 1 |       |
|   | <b>B(Alt)</b> ATD, AXR | 09/00 → 05/05 | <b>AC</b>  | VKM_____   |   |   |   |   |  |  |  |  | 1 |  |   |       |

|   | B(Alt)   | ATD, AXR | 09/00 → 05/05 | AC                 | VKMA 31001   | 1 |   | 1 |   |  |   |  |         |
|---|----------|----------|---------------|--------------------|--------------|---|---|---|---|--|---|--|---------|
|   |          |          |               |                    | VKMV 6DK1195 |   |   | 1 |   |  |   |  |         |
|   |          |          |               |                    | VKM 31019    | 1 |   |   |   |  |   |  |         |
| ⊙   |          | ATD, AXR | 09/00 → 05/05 |                    | VKM _____    |   |   |   |   |  | 1 |  |         |
| <b>VW  BORA (1J2) / BORA Estate (1J6) 1.9 TDI 110</b> |          |          |               |                    |              |   |   |   |   |  |   |  |         |
|   |          | AHF      | 10/98 → 06/01 | → Mot. 595 000     | VKMA 01131   | 1 | 3 | 1 |   |  |   |  | 8 T0173 |
|   |          |          |               |                    | VKM 11130    | 1 |   |   |   |  |   |  |         |
|   |          |          |               |                    | VKM 21004    |   |   | 1 |   |  |   |  |         |
|   |          |          |               |                    | VKM 21130    |   |   | 1 |   |  |   |  |         |
|   |          |          |               |                    | VKM 21131    |   |   | 1 |   |  |   |  |         |
|   | AHF      |          | 10/98 → 06/01 | Mot. 595 001  →    | VKMA 01251   | 1 | 3 | 1 |   |  |   |  | 8 T0173 |
|   |          |          |               |                    | VKM 11130    | 1 |   |   |   |  |   |  |         |
|   |          |          |               |                    | VKM 21004    |   |   | 1 |   |  |   |  |         |
|   |          |          |               |                    | VKM 21130    |   |   | 1 |   |  |   |  |         |
|   |          |          |               |                    | VKM 21131    |   |   | 1 |   |  |   |  |         |
|   | ASV      |          | 10/98 → 06/01 | → Mot. 150 000     | VKMA 01131   | 1 | 3 | 1 |   |  |   |  | 8 T0173 |
|   |          |          |               |                    | VKM 11130    | 1 |   |   |   |  |   |  |         |
|   |          |          |               |                    | VKM 21004    |   |   | 1 |   |  |   |  |         |
|   |          |          |               |                    | VKM 21130    |   |   | 1 |   |  |   |  |         |
|   |          |          |               |                    | VKM 21131    |   |   | 1 |   |  |   |  |         |
|   | ASV      |          | 10/98 → 06/01 | Mot. 150 001  →    | VKMA 01251   | 1 | 3 | 1 |   |  |   |  | 8 T0173 |
|   |          |          |               |                    | VKM 11130    | 1 |   |   |   |  |   |  |         |
|   |          |          |               |                    | VKM 21004    |   |   | 1 |   |  |   |  |         |
|   |          |          |               |                    | VKM 21130    |   |   | 1 |   |  |   |  |         |
|   |          |          |               |                    | VKM 21131    |   |   | 1 |   |  |   |  |         |
|   | AHF, ASV |          | 10/98 → 06/01 |                    | VKPC 81623   |   |   |   |   |  | 1 |  |         |
|   | B(Alt)   | AHF      | 10/98 → 06/01 | AC                 | VKMV 6PK906  |   |   | 1 |   |  |   |  |         |
|   |          |          |               |                    | VKM 31002    |   |   | 1 |   |  |   |  | 1       |
|   |          |          |               |                    | VKM 31012    | 1 |   |   |   |  |   |  |         |
|   | B(Alt)   | AHF      | 10/98 → 06/01 | AC                 | VKMA 31014   | 1 | 1 | 1 |   |  |   |  | 1       |
|   |          |          |               |                    | VKMV 6PK1660 |   |   | 1 |   |  |   |  |         |
|   |          |          |               |                    | VKM 31002    |   |   | 1 |   |  |   |  | 1       |
|   |          |          |               |                    | VKM 31012    | 1 |   |   |   |  |   |  |         |
|   | B(Alt)   | ASV      | 10/98 → 06/01 | AC                 | VKMV 6PK906  |   |   | 1 |   |  |   |  |         |
|   |          |          |               |                    | VKM 31002    |   |   | 1 |   |  |   |  | 1       |
|   |          |          |               |                    | VKM 31018    | 1 |   |   |   |  |   |  | 1       |
|   | B(Alt)   | ASV      | 10/98 → 06/01 | AC                 | VKMA 31005   | 1 | 1 | 1 |   |  |   |  | 2       |
|   |          |          |               |                    | VKMV 6PK1660 |   |   | 1 |   |  |   |  |         |
|   |          |          |               |                    | VKM 31002    |   |   | 1 |   |  |   |  | 1       |
|   |          |          |               |                    | VKM 31018    | 1 |   |   |   |  |   |  | 1       |
| ⊙   |          | AHF, ASV | 10/98 → 06/01 |                    | VKM _____    |   |   |   |   |  | 1 |  |         |
| <b>VW  BORA (1J2) / BORA Estate (1J6) 1.9 TDI 115</b> |          |          |               |                    |              |   |   |   |   |  |   |  |         |
|   |          | AJM      | 12/98 → 06/01 | ↔, → Mot. 185 670  | VKMA 01941   | 1 | 1 | 1 | 1 |  |   |  | 2 T0184 |
|   |          |          |               |                    | VKM 11141    | 1 |   |   |   |  |   |  |         |
|   |          |          |               |                    | VKM 11144    |   |   |   | 1 |  |   |  |         |
|   |          |          |               |                    | VKM 21142    |   |   | 1 |   |  |   |  |         |
|   | AJM      |          | 12/98 → 06/01 | → Mot. 185 670     | VKMA 01141   | 1 | 1 | 1 |   |  |   |  | 1 T0184 |
|   |          |          |               |                    | VKM 11141    | 1 |   |   |   |  |   |  |         |
|   |          |          |               |                    | VKM 21142    |   |   | 1 |   |  |   |  |         |
|   | AJM      |          | 12/98 → 06/01 | ↔, Mot. 185 671  → | VKMA 01942   | 1 | 1 | 1 | 1 |  |   |  | 3 T0184 |
|   |          |          |               |                    | VKM 11142    | 1 |   |   |   |  |   |  |         |
|   |          |          |               |                    | VKM 11145    |   |   |   | 1 |  |   |  |         |
|   |          |          |               |                    | VKM 21142    |   |   | 1 |   |  |   |  |         |
|   | AJM      |          | 12/98 → 06/01 | Mot. 185 671  →    | VKMA 01142   | 1 | 1 | 1 |   |  |   |  | 3 T0184 |
|   |          |          |               |                    | VKM 11142    | 1 |   |   |   |  |   |  |         |
|   |          |          |               |                    | VKM 21142    |   |   | 1 |   |  |   |  |         |
|   | AUY      |          | 12/98 → 06/01 | ↔                  | VKMA 01942   | 1 | 1 | 1 | 1 |  |   |  | 3 T0184 |
|   |          |          |               |                    | VKM 11142    | 1 |   |   |   |  |   |  |         |
|   |          |          |               |                    | VKM 11145    |   |   |   | 1 |  |   |  |         |
|   |          |          |               |                    | VKM 21142    |   |   | 1 |   |  |   |  |         |
|   | AUY      |          | 12/98 → 06/01 |                    | VKMA 01142   | 1 | 1 | 1 |   |  |   |  | 3 T0184 |
|   |          |          |               |                    | VKM 11142    | 1 |   |   |   |  |   |  |         |
|   |          |          |               |                    | VKM 21142    |   |   | 1 |   |  |   |  |         |
|   | AJM, AUY |          | 12/98 → 06/01 |                    | VKPC 81626   |   |   |   |   |  | 1 |  |         |
|   | B(Alt)   | AJM, AUY | 12/98 → 06/01 | AC                 | VKMV 6PK1120 |   |   | 1 |   |  |   |  |         |
|   |          |          |               |                    | VKM 31019    | 1 |   |   |   |  |   |  |         |



|   | B(Alt) | AJM, AUJ | 12/98 → 06/01 | AC                                  | VKMA 31001<br>VKMV 6DK1195<br>VKM 31019           | 1<br>1      | 1<br>1 |        |        |        |        |              |
|---|--------|----------|---------------|-------------------------------------|---|-------------|--------|--------|--------|--------|--------|--------------|
| ⊙   |        | AJM, AUJ | 12/98 → 06/01 |                                     | VKM_____  |             |        |        |        | 1      |        |              |
| <b>VW  BORA (1J2) / BORA Estate (1J6) 1.9 TDI 130</b> |        |          |               |                                     |   |             |        |        |        |        |        |              |
|   |        | ASZ      | 11/00 → 12/02 | → ICH 1J-2-525 000,<br>1J-2D352 773 | VKMA 01942<br>VKM 11142<br>VKM 11145<br>VKM 21142 | 1<br>1      | 1<br>1 | 1<br>1 | 1<br>1 |        |        | 3 T0184      |
|   |        | ASZ      | 11/00 → 12/02 | → ICH 1J-2-525 000,<br>1J-2D352 773 | VKMA 01142<br>VKM 11142<br>VKM 21142              | 1<br>1      | 1<br>1 | 1      |        |        |        | 3 T0184      |
|   |        | ASZ      | 01/02 → 05/05 | CH 1J-2-525 001,<br>1J-2D352 774 I→ | VKMA 01250<br>VKM 11250<br>VKM 21147              | 1<br>1      | 1<br>1 | 1      |        |        |        | T0184        |
| ⊙   |        | ASZ      | 11/00 → 12/02 |                                     | VKPC 81626  |             |        |        |        | 1      |        |              |
|   |        | ASZ      | 01/03 → 05/05 |                                     | VKPC 81303  |             |        |        |        | 1      |        |              |
|   | B(Alt) | ASZ      | 11/00 → 05/05 | AC                                  | VKMV 6PK1120<br>VKM 31019                         | 1           |        | 1      |        |        |        |              |
|   | B(Alt) | ASZ      | 11/00 → 05/05 | AC                                  | VKMA 31001<br>VKMV 6DK1195<br>VKM 31019           | 1<br>1      |        | 1<br>1 |        |        |        |              |
| ⊙   |        | ASZ      | 11/00 → 05/05 |                                     | VKM_____  |             |        |        |        | 1      |        |              |
| <b>VW  BORA (1J2) / BORA Estate (1J6) 1.9 TDI 150</b> |        |          |               |                                     |   |             |        |        |        |        |        |              |
|   |        | ARL      | 05/00 → 12/02 | → ICH 1J-2-525 000,<br>1J-2D352 773 | VKMA 01942<br>VKM 11142<br>VKM 11145<br>VKM 21142 | 1<br>1      | 1<br>1 | 1<br>1 | 1<br>1 |        |        | 3 T0184      |
|   |        | ARL      | 05/00 → 12/02 | → ICH 1J-2-525 000,<br>1J-2D352 773 | VKMA 01142<br>VKM 11142<br>VKM 21142              | 1<br>1      | 1<br>1 | 1      |        |        |        | 3 T0184      |
|   |        | ARL      | 01/02 → 05/05 | CH 1J-2-525 001,<br>1J-2D352 774 I→ | VKMA 01250<br>VKM 11250<br>VKM 21147              | 1<br>1      | 1<br>1 | 1      |        |        |        | T0184        |
| ⊙   |        | ARL      | 05/00 → 05/05 |                                     | VKPC 81627  |             |        |        |        | 1      |        |              |
|   | B(Alt) | ARL      | 05/00 → 05/05 | AC                                  | VKMV 6PK1120<br>VKM 31019                         | 1           |        | 1      |        |        |        |              |
|   | B(Alt) | ARL      | 05/00 → 05/05 | AC                                  | VKMA 31001<br>VKMV 6DK1195<br>VKM 31019           | 1<br>1      |        | 1<br>1 |        |        |        |              |
| ⊙   |        | ARL      | 05/00 → 05/05 |                                     | VKM_____  |             |        |        |        | 1      |        |              |
| <b>VW  CADDY I (14) 1.5</b>                           |        |          |               |                                     |   |             |        |        |        |        |        |              |
|   |        | JB       | 08/82 → 07/83 | 3)                                  | VKMS 01000<br>VKMA 01000<br>VKM 11000             | 1<br>1<br>1 |        | 1<br>1 |        |        | 3<br>4 | 4<br>3 T0005 |
| ⊙   |        | JB       | 08/82 → 07/83 | 2)                                  | VKPA 81401<br>VKPC 81401                          |             |        |        |        | 1<br>1 |        |              |
|   | B(Alt) | JB       | 08/82 → 07/83 |                                     | VKMV 10AVx950                                     |             |        | 1      |        |        |        |              |
| <b>VW  CADDY I (14) 1.6</b>                           |        |          |               |                                     |   |             |        |        |        |        |        |              |
|   |        | EM, EW   | 10/82 → 07/92 | 3)                                  | VKMS 01000<br>VKMA 01000<br>VKM 11000             | 1<br>1<br>1 |        | 1<br>1 |        |        | 3<br>4 | 4<br>3 T0005 |
| ⊙   |        | EM, EW   | 10/82 → 07/92 | 2)                                  | VKPA 81401<br>VKPC 81401                          |             |        |        |        | 1<br>1 |        |              |
|   | B(Alt) | EM, EW   | 10/82 → 07/92 |                                     | VKMV 10AVx950                                     |             |        | 1      |        |        |        |              |



|   |  |  |    |  |  |  |  |  |  |  |       |
|---|---|---|---|--|---|---|---|---|---|---|-------|
| <b>VW  CADDY I (14) 1.8</b>                                  |   |   |   |  |   |   |   |   |   |   |       |
|    | JH  | 08/85 → 07/92   | 3)  | VKMS 01000<br>VKMA 01000<br>VKM 11000  | 1<br>1<br>1   | 1   |   |   |   | 3<br>4<br>3   | T0005 |
|    | JH  | 08/85 → 07/92   | 2)  | VKPA 81401<br>VKPC 81401   |   |   | 1<br>1  |   |   |   |       |
|    | <b>B(Alt)</b> JH  | 08/85 → 07/92   |   | VKMM 10AVx950  |   | 1   |   |   |   |   |       |
| <b>VW  CADDY I (14) 1.6 D</b>                                |   |   |   |  |   |   |   |   |   |   |       |
|    | JK, ME  | 08/82 → 07/92   | 3)  | VKMS 01010<br>VKMA 01010<br>VKM 11010  | 1<br>1<br>1   | 1   |   |   |   | 3<br>2<br>1   | T0051 |
|    | JK, ME  | 08/82 → 07/92   | 2)  | VKPA 81401<br>VKPC 81401   |   |   | 1<br>1  |   |   |   |       |
|    | <b>B(Alt)</b> JK, ME  | 08/82 → 07/92   |   | VKMM 10AVx875  |   | 1   |   |   |   |   |       |
| <b>VW  CADDY II(9K9A)/Estate(9K9B)/Pickup(9U7) 1.4</b>       |   |   |   |  |   |   |   |   |   |   |       |
|    | AUD   | 11/95 → 01/04   |    | VKMC 01107<br>VKMA 01107<br>VKM 11107  | 1<br>1<br>1   | 1   | 1   |   |   | 2<br>2  | T0126 |
|   | AEX, AKV, APQ   | 11/95 → 01/04   |   | VKMA 01106<br>VKM 11106  | 1<br>1  | 1   |   |   |   |   | T0126 |
|    | AUD   | 11/95 → 01/04   |   | VKPC 81215   |   |   | 1   |   |   |   |       |
|   | AEX, AKV, APQ   | 11/95 → 01/04   |   | VKPC 81210   |   |   | 1   |   |   |   |       |
|    | <b>B(Alt)</b> AEX, AKV, APQ, AUD  | 11/95 → 01/04   |    | VKMM 6PK751  |   | 1   |   |   |   |   |       |
|   | <b>B(Alt)</b> AEX, AKV, APQ, AUD  | 11/95 → 01/04   |    | VKMA 31202<br>VKMM 6PK1068<br>VKM 31015  | 1<br>1  | 1   |   |   |   |   |       |
|   | <b>B(Alt)</b> AEX, AKV, APQ, AUD  | 11/95 → 01/04   |  | VKMM 6PK1185<br>VKM 31023  | 1   | 1   |   |   |   |   |       |
| <b>VW  CADDY II(9K9A)/Estate(9K9B)/Pickup(9U7) 1.4 16V</b> |   |   |   |  |   |   |   |   |   |   |       |
|    | AUA   | 08/00 → 01/04   |   | VKMA 01121<br>VKM 11120<br>VKM 11124<br>VKM 21120<br>VKM 21121                     | 2<br>1<br>1<br>1<br>1   | 2   | 2   |   |   |   | T0165 |
|    | AUA   | 08/00 → 01/04   |   | VKPC 81407   |   |   | 1   |   |   |   |       |
|    | <b>B(Alt)</b> AUA   | 08/00 → 01/04   |  | VKMA 31202<br>VKMM 6PK1068<br>VKM 31015  | 1<br>1  | 1   | 1   |   |   |   |       |
|   | <b>B(Alt)</b> AUA   | 08/00 → 01/04   |  | VKMM 6PK1185<br>VKM 31023  | 1   | 1   |   |   |   |   |       |
| <b>VW  CADDY II(9K9A)/Estate(9K9B)/Pickup(9U7) 1.6</b>     |   |   |   |  |   |   |   |   |   |   |       |
|    | 1F  | 11/95 → 05/97   | 3)  | VKMS 01000<br>VKMA 01000<br>VKM 11000  | 1<br>1<br>1   | 1   |   |   |   | 3<br>4<br>3   | T0005 |
|   | AEE   | 11/95 → 12/00   |   | VKMA 01110<br>VKM 11106  | 1<br>1  | 1   |   |   |   |   | T0127 |
|    | 1F  | 11/95 → 05/97   | 2)  | VKPA 81401<br>VKPC 81401   |   |   | 1<br>1  |   |   |   |       |
|   | AEE   | 11/95 → 12/00   |   | VKPC 81210   |   |   | 1   |   |   |   |       |
|    | <b>B(Alt)</b> 1F  | 11/95 → 05/97   |  | VKMM 6PK894  |   | 1   |   |   |   |   |       |
|   | <b>B(Alt)</b> 1F  | 11/95 → 05/97   |  | VKMM 6PK1153<br>VKM 31004<br>VKM 31210   | 1<br>1  | 1   |   |   |   |   |       |
|   | <b>B(Alt)</b> AEE   | 11/95 → 12/00   |  | VKMM 6PK751  |   | 1   |   |   |   |   |       |
|   | <b>B(Alt)</b> AEE   | 11/95 → 12/00   |  | VKMA 31202<br>VKMM 6PK1068<br>VKM 31015  | 1<br>1  | 1   |   |   |   |   |       |
|   | <b>B(Alt)</b> AEE   | 11/95 → 12/00   |  | VKMM 6PK1185<br>VKM 31023  | 1   | 1   |   |   |   |   |       |
|   | <b>B(PS)</b> 1F   | 11/95 → 05/97   |  | VKMM 11.5x685  |   | 1   |   |   |   |   |       |
|   | <b>B(PS)</b> 1F   | 11/95 → 05/97   |  | VKMM 11.5x755  |   | 1   |   |   |   |   |       |



VW







































|  |                      |                      |   | VKM 31004        | 1             |              |   |   |   |  |  |  |   |  |  |  |   |       |
|--|----------------------|----------------------|---|------------------|---------------|--------------|---|---|---|--|--|--|---|--|--|--|---|-------|
|  |                      |                      |   | VKM 31030        | 1             |              |   |   |   |  |  |  |   |  |  |  |   |       |
|  | <b>B(Alt), B(PS)</b> | AEY                  | 11/95 → 01/04   | <b>A ⊙, AC</b>   | VKMA 31030    | 2            |   | 2 |   |  |  |  |   |  |  |  |   |       |
|  |                      |                      |   |                  | VKMA 31030    | 2            |   | 2 |   |  |  |  |   |  |  |  |   |       |
|  |                      |                      |   |                  | VKMV 11.5x790 |              |   | 1 |   |  |  |  |   |  |  |  |   |       |
|  |                      |                      |   |                  | VKMV 6PK1145  |              |   | 1 |   |  |  |  |   |  |  |  |   |       |
|  |                      |                      |   |                  | VKM 31004     | 1            |   |   |   |  |  |  |   |  |  |  |   |       |
|  |                      |                      |   |                  | VKM 31030     | 1            |   |   |   |  |  |  |   |  |  |  |   |       |
|  |                      | AEY                  | 11/95 → 01/04   |                  | VKM_____      |              |   |   |   |  |  |  | 1 |  |  |  |   |       |
|  | <b>VW</b>            |                      | <b>CADDY II(9K9A)/Estate(9K9B)/Pickup(9U7) 1.9 TDI</b>  |                  |               |              |   |   |   |  |  |  |   |  |  |  |   |       |
|  |                      | 1Z, AHU, ALE         | 09/96 → 01/04   |                  | VKMA 01014    | 1            | 1 | 1 |   |  |  |  |   |  |  |  | 5 | T0650 |
|  |                      |                      |   |                  | VKM 11014     | 1            |   |   |   |  |  |  |   |  |  |  |   |       |
|  |                      |                      |   |                  | VKM 21012     |              |   | 1 |   |  |  |  |   |  |  |  |   |       |
|  |                      | ALH                  | 09/96 → 01/04   | →   Mot. 500 000 | VKMA 01131    | 1            | 3 | 1 |   |  |  |  |   |  |  |  | 8 | T0173 |
|  |                      |                      |   |                  | VKM 11130     | 1            |   |   |   |  |  |  |   |  |  |  |   |       |
|  |                      |                      |   |                  | VKM 21004     |              |   | 1 |   |  |  |  |   |  |  |  |   |       |
|  |                      |                      |   |                  | VKM 21130     |              |   | 1 |   |  |  |  |   |  |  |  |   |       |
|  |                      |                      |   |                  | VKM 21131     |              |   | 1 |   |  |  |  |   |  |  |  |   |       |
|  |                      | ALH                  | 09/96 → 01/04   | Mot. 500 001   → | VKMA 01251    | 1            | 3 | 1 |   |  |  |  |   |  |  |  | 8 | T0173 |
|  |                      |                      |   |                  | VKM 11130     | 1            |   |   |   |  |  |  |   |  |  |  |   |       |
|  |                      |                      |   |                  | VKM 21004     |              |   | 1 |   |  |  |  |   |  |  |  |   |       |
|  |                      |                      |   |                  | VKM 21130     |              |   | 1 |   |  |  |  |   |  |  |  |   |       |
|  |                      |                      |   |                  | VKM 21131     |              |   | 1 |   |  |  |  |   |  |  |  |   |       |
|  |                      | 1Z, AHU, ALE         | 09/96 → 01/04   | 2)               | VKPA 81401    |              |   |   |   |  |  |  | 1 |  |  |  |   |       |
|  |                      |                      |   |                  | VKPC 81401    |              |   |   |   |  |  |  | 1 |  |  |  |   |       |
|  |                      | ALH                  | 09/96 → 01/04   |                  | VKPC 81623    |              |   |   |   |  |  |  | 1 |  |  |  |   |       |
|  |                      | <b>B(Alt)</b>        | ALH   | 09/96 → 01/04    | <b>AC</b>     | VKMV 6PK906  |   |   | 1 |  |  |  |   |  |  |  |   |       |
|  |                      |                      |   |                  | VKM 31002     |              |   | 1 |   |  |  |  |   |  |  |  |   | 1     |
|  |                      |                      |   |                  | VKM 31012     | 1            |   |   |   |  |  |  |   |  |  |  |   |       |
|  |                      | <b>B(Alt)</b>        | ALH   | 09/96 → 01/04    | <b>AC</b>     | VKMA 31014   | 1 | 1 | 1 |  |  |  |   |  |  |  |   | 1     |
|  |                      |                      |   |                  | VKMV 6PK1660  |              |   | 1 |   |  |  |  |   |  |  |  |   |       |
|  |                      |                      |   |                  | VKM 31002     |              |   | 1 |   |  |  |  |   |  |  |  |   | 1     |
|  |                      |                      |   |                  | VKM 31012     | 1            |   |   |   |  |  |  |   |  |  |  |   |       |
|  |                      | <b>B(Alt), B(PS)</b> | 1Z, AHU, ALE  | 09/96 → 01/04    | <b>AC</b>     | VKMA 31028   | 2 |   | 2 |  |  |  |   |  |  |  |   |       |
|  |                      |                      |   |                  | VKMV 10AVx730 |              |   | 1 |   |  |  |  |   |  |  |  |   |       |
|  |                      |                      |   |                  | VKMV 6PK1045  |              |   | 1 |   |  |  |  |   |  |  |  |   |       |
|  |                      |                      |   |                  | VKM 31004     | 1            |   |   |   |  |  |  |   |  |  |  |   |       |
|  |                      |                      |   |                  | VKM 31030     | 1            |   |   |   |  |  |  |   |  |  |  |   |       |
|  |                      | <b>B(Alt), B(PS)</b> | 1Z, AHU, ALE  | 09/96 → 01/04    | <b>AC</b>     | VKMA 31030   | 2 |   | 2 |  |  |  |   |  |  |  |   |       |
|  |                      |                      |   |                  | VKMV 11.5x790 |              |   | 1 |   |  |  |  |   |  |  |  |   |       |
|  |                      |                      |   |                  | VKMV 6PK1145  |              |   | 1 |   |  |  |  |   |  |  |  |   |       |
|  |                      |                      |   |                  | VKM 31004     | 1            |   |   |   |  |  |  |   |  |  |  |   |       |
|  |                      |                      |   |                  | VKM 31030     | 1            |   |   |   |  |  |  |   |  |  |  |   |       |
|  |                      | 1Z, AHU, ALE         | 09/96 → 01/04   |                  | VKM_____      |              |   |   |   |  |  |  | 1 |  |  |  |   |       |
|  | <b>VW</b>            |                      | <b>CADDY III (2KA) / CADDY III Estate (2KB) 1.4</b>     |                  |               |              |   |   |   |  |  |  |   |  |  |  |   |       |
|  |                      | BCA                  | 03/04 → 10/07   |                  | VKMA 01121    | 2            | 2 | 2 |   |  |  |  |   |  |  |  |   | T0165 |
|  |                      |                      |   |                  | VKM 11120     | 1            |   |   |   |  |  |  |   |  |  |  |   |       |
|  |                      |                      |   |                  | VKM 11124     | 1            |   |   |   |  |  |  |   |  |  |  |   |       |
|  |                      |                      |   |                  | VKM 21120     |              |   | 1 |   |  |  |  |   |  |  |  |   |       |
|  |                      |                      |   |                  | VKM 21121     |              |   | 1 |   |  |  |  |   |  |  |  |   |       |
|  |                      | BCA                  | 03/04 → 10/07   |                  | VKPC 81407    |              |   |   |   |  |  |  | 1 |  |  |  |   |       |
|  |                      | <b>B(Alt)</b>        | BCA   | 03/04 → 10/07    | <b>AC</b>     | VKMV 6PK736  |   |   | 1 |  |  |  |   |  |  |  |   |       |
|  |                      | <b>B(Alt)</b>        | BCA   | 03/04 → 10/07    | <b>AC</b>     | VKMV 6PK1100 |   |   | 1 |  |  |  |   |  |  |  |   |       |
|  |                      |                      |   |                  | VKM 31015     | 1            |   |   |   |  |  |  |   |  |  |  |   |       |
|  | <b>VW</b>            |                      | <b>CADDY III (2KA) / CADDY III Estate (2KB) 1.4 16V</b> |                  |               |              |   |   |   |  |  |  |   |  |  |  |   |       |
|  |                      | BUD                  | 05/06 → 10/07   |                  | VKMA 01121    | 2            | 2 | 2 |   |  |  |  |   |  |  |  |   | T0165 |
|  |                      |                      |   |                  | VKM 11120     | 1            |   |   |   |  |  |  |   |  |  |  |   |       |
|  |                      |                      |   |                  | VKM 11124     | 1            |   |   |   |  |  |  |   |  |  |  |   |       |
|  |                      |                      |   |                  | VKM 21120     |              |   | 1 |   |  |  |  |   |  |  |  |   |       |
|  |                      |                      |   |                  | VKM 21121     |              |   | 1 |   |  |  |  |   |  |  |  |   |       |
|  |                      | <b>B(Alt)</b>        | BUD   | 05/06 → 10/07    | <b>AC, ⊙</b>  | VKMV 6PK736  |   |   | 1 |  |  |  |   |  |  |  |   |       |
|  |                      | <b>B(Alt)</b>        | BUD   | 05/06 → 10/07    | <b>AC, ⊙</b>  | VKMA 31202   | 1 |   | 1 |  |  |  |   |  |  |  |   |       |
|  |                      |                      |   |                  | VKMV 6PK1068  |              |   | 1 |   |  |  |  |   |  |  |  |   |       |
|  |                      |                      |   |                  | VKM 31015     | 1            |   |   |   |  |  |  |   |  |  |  |   |       |
|  |                      | <b>B(Alt)</b>        | BUD   | 05/06 → 10/07    | <b>AC</b>     | VKMV 6PK1100 |   |   | 1 |  |  |  |   |  |  |  |   |       |
|  |                      |                      |   |                  | VKM 31015     | 1            |   |   |   |  |  |  |   |  |  |  |   |       |



VW

| <b>VW  CADDY III (2KA) / CADDY III Estate (2KB) 1.6</b>         |                             |               |                                   |              |   |   |   |   |  |  |  |  |       |
|---|-----------------------------|---------------|-----------------------------------|--------------|---|---|---|---|--|--|--|--|-------|
|   | BGU, BSE, BSF               | 04/04 → 10/07 |                                   | VKMA 01113   | 1 | 1 |   |   |  |  |  |  | T0149 |
|   |                             |               |                                   | VKM 11113    | 1 |   |   |   |  |  |  |  |       |
|   | BGU, BSE, BSF               | 04/04 → 10/07 |                                   | VKPC 81408   |   |   |   | 1 |  |  |  |  |       |
|   | <b>B(Alt)</b> BGU, BSE, BSF | 04/04 → 10/07 | <b>AC</b>                         | VKMV 6PK900  |   | 1 |   |   |  |  |  |  |       |
|   |                             |               |                                   | VKM 31011    | 1 |   |   |   |  |  |  |  |       |
|   | <b>B(Alt)</b> BGU, BSE, BSF | 04/04 → 10/07 | <b>AC</b>                         | VKMV 6PK1042 |   | 1 |   |   |  |  |  |  |       |
|   |                             |               |                                   | VKM 31011    | 1 |   |   |   |  |  |  |  |       |
| <b>VW  CADDY III (2KA) / CADDY III Estate (2KB) 2.0</b>         |                             |               |                                   |              |   |   |   |   |  |  |  |  |       |
|   | BSX                         | 04/06 → 10/07 |                                   | VKMA 01113   | 1 | 1 |   |   |  |  |  |  | T0149 |
|   |                             |               |                                   | VKM 11113    | 1 |   |   |   |  |  |  |  |       |
|   | <b>B(Alt)</b> BSX           | 04/06 → 10/07 | <b>AC</b>                         | VKMV 6PK900  |   | 1 |   |   |  |  |  |  |       |
|   |                             |               |                                   | VKM 31011    | 1 |   |   |   |  |  |  |  |       |
|   | <b>B(Alt)</b> BSX           | 04/06 → 10/07 | <b>AC</b>                         | VKMV 6PK1042 |   | 1 |   |   |  |  |  |  |       |
|   |                             |               |                                   | VKM 31011    | 1 |   |   |   |  |  |  |  |       |
| <b>VW  CADDY III (2KA) / CADDY III Estate (2KB) 1.9 TDI 75</b>  |                             |               |                                   |              |   |   |   |   |  |  |  |  |       |
|   | BSU                         | 09/05 → 10/07 |                                   | VKMA 01250   | 1 | 1 | 1 |   |  |  |  |  | T0184 |
|   |                             |               |                                   | VKM 11250    | 1 |   |   |   |  |  |  |  |       |
|   |                             |               |                                   | VKM 21147    |   | 1 |   |   |  |  |  |  |       |
|   | BSU                         | 09/05 → 10/07 |                                   | VKPC 81418   |   |   |   | 1 |  |  |  |  |       |
|   | <b>B(Alt)</b> BLS           | 09/05 → 10/07 | <b>AC</b>                         | VKMV 6PK950  |   |   | 1 |   |  |  |  |  |       |
|   |                             |               |                                   | VKM 31054    | 1 |   |   |   |  |  |  |  |       |
|   | <b>B(Alt)</b> BLS           | 09/05 → 10/07 | <b>AC</b>                         | VKMV 6PK1050 |   |   | 1 |   |  |  |  |  |       |
|   |                             |               |                                   | VKM 31054    | 1 |   |   |   |  |  |  |  |       |
|   | <b>B(Alt)</b> BSU           | 09/05 → 10/07 |                                   | VKMV 6PK1050 |   |   | 1 |   |  |  |  |  |       |
|   |                             |               |                                   | VKM 31054    | 1 |   |   |   |  |  |  |  |       |
| <b>VW  CADDY III (2KA) / CADDY III Estate (2KB) 1.9 TDI 105</b> |                             |               |                                   |              |   |   |   |   |  |  |  |  |       |
|   | BJB, BLS                    | 04/04 → 10/07 |                                   | VKMA 01250   | 1 | 1 | 1 |   |  |  |  |  | T0184 |
|   |                             |               |                                   | VKM 11250    | 1 |   |   |   |  |  |  |  |       |
|   |                             |               |                                   | VKM 21147    |   | 1 |   |   |  |  |  |  |       |
|   | BJB, BLS                    | 04/04 → 10/07 |                                   | VKPC 81418   |   |   |   | 1 |  |  |  |  |       |
|   | <b>B(Alt)</b> BJB           | 04/04 → 10/07 | <b>AC</b> ,<br>→ ICH 2K-6-048 669 | VKMV 6PK950  |   |   | 1 |   |  |  |  |  |       |
|   |                             |               |                                   | VKM 31022    | 1 |   |   |   |  |  |  |  |       |
|   | <b>B(Alt)</b> BJB           | 04/04 → 10/07 | <b>AC</b> ,<br>CH 6K-2-048 670 I→ | VKMV 6PK1135 |   |   | 1 |   |  |  |  |  |       |
|   |                             |               |                                   | VKM 31054    | 1 |   |   |   |  |  |  |  |       |
|   | <b>B(Alt)</b> BJB           | 04/04 → 10/07 | <b>AC</b> , → ICH 2K-6-048 669    | VKMV 6PK1050 |   |   | 1 |   |  |  |  |  |       |
|   |                             |               |                                   | VKM 31022    | 1 |   |   |   |  |  |  |  |       |
|   | <b>B(Alt)</b> BJB           | 04/04 → 10/07 | <b>AC</b> , CH 2K-6-048 670 I→    | VKMV 6PK1050 |   |   | 1 |   |  |  |  |  |       |
|   |                             |               |                                   | VKM 31054    | 1 |   |   |   |  |  |  |  |       |
| <b>VW  CADDY III (2KA) / CADDY III Estate (2KB) 2.0 SDI</b>     |                             |               |                                   |              |   |   |   |   |  |  |  |  |       |
|   | BDJ, BST                    | 03/04 → 10/07 |                                   | VKMA 01250   | 1 | 1 | 1 |   |  |  |  |  | T0184 |
|   |                             |               |                                   | VKM 11250    | 1 |   |   |   |  |  |  |  |       |
|   |                             |               |                                   | VKM 21147    |   | 1 |   |   |  |  |  |  |       |
|   | BDJ, BST                    | 03/04 → 10/07 |                                   | VKPC 81418   |   |   |   | 1 |  |  |  |  |       |
|   | <b>B(Alt)</b> BDJ, BST      | 03/04 → 10/07 | <b>AC</b> ,<br>→ ICH 2K-6-048 669 | VKMV 6PK950  |   |   | 1 |   |  |  |  |  |       |
|   |                             |               |                                   | VKM 31022    | 1 |   |   |   |  |  |  |  |       |
|   | <b>B(Alt)</b> BDJ, BST      | 03/04 → 10/07 | <b>AC</b> ,<br>CH 6K-2-048 670 I→ | VKMV 6PK1135 |   |   | 1 |   |  |  |  |  |       |
|   |                             |               |                                   | VKM 31054    | 1 |   |   |   |  |  |  |  |       |
|   | <b>B(Alt)</b> BDJ, BST      | 03/04 → 10/07 | <b>AC</b> , → ICH 2K-6-048 669    | VKMV 6PK1050 |   |   | 1 |   |  |  |  |  |       |
|   |                             |               |                                   | VKM 31022    | 1 |   |   |   |  |  |  |  |       |
|   | <b>B(Alt)</b> BDJ, BST      | 03/04 → 10/07 | <b>AC</b> , CH 2K-6-048 670 I→    | VKMV 6PK1050 |   |   | 1 |   |  |  |  |  |       |
|   |                             |               |                                   | VKM 31054    | 1 |   |   |   |  |  |  |  |       |
| <b>VW  CORRADO (53I) 1.8 16V</b>                                |                             |               |                                   |              |   |   |   |   |  |  |  |  |       |
|   | KR                          | 04/89 → 07/92 |                                   | VKMA 01020   | 1 |   | 1 |   |  |  |  |  | T0057 |
|   |                             |               |                                   | VKM 11020    | 1 |   |   |   |  |  |  |  |       |
|   | KR                          | 04/89 → 07/92 | 2)                                | VKPA 81401   |   |   |   | 1 |  |  |  |  |       |
|   |                             |               |                                   | VKPC 81401   |   |   |   | 1 |  |  |  |  |       |

|   |  |  |    |  |  |  |  |  |  |  |
|---|---|---|---|--|---|---|---|---|---|---|
|                                    | B(Alt) KR   | 04/89 → 07/92   | AC  | VKMV 10AVx950  |   |   | 1   |   |   |   |
|   | B(Alt) KR   | 04/89 → 07/92   | AC  | VKMV 10AVx630  |   |   | 1   |   |   |   |
|   | B(PS) KR  | 04/89 → 07/92   | → ICH 50-M-005 059  | VKMV 10AVx730  |   |   | 1   |   |   |   |
|   | B(PS) KR  | 04/89 → 07/92   | CH 50-M-005 060 I→  | VKMV 10AVx630  |   |   | 1   |   |   |   |
|   | B(AC) KR  | 04/89 → 07/92   |   | VKMV 13AVx950  |   |   | 1   |   |   |   |
| <b>VW  CORRADO (53I) 1.8 G60</b>   |   |   |   |  |   |   |   |   |   |   |
|                                    | PG  | 09/88 → 09/93   | 3)  | VKMS 01000<br>VKMA 01000<br>VKM 11000  | 1<br>1<br>1   |   | 1   |   | 3   | 4<br>3<br>T0005   |
|                                    | PG  | 09/88 → 09/93   | 2)  | VKPA 81401<br>VKPC 81401   |   |   |   | 1<br>1  |   |   |
|                                    | B(Alt) PG   | 09/88 → 09/93   | AC  | VKMV 6PK1660<br>VKM 31007<br>VKM 31007   |   | 1<br>1  |   | 1   |   |   |
|   | B(Alt) PG   | 09/88 → 09/93   | AC  | VKMV 6PK1760<br>VKM 31007<br>VKM 31007   |   | 1<br>1  |   | 1   |   |   |
|   | B(PS) PG  | 09/88 → 09/93   | AC  | VKMV 10AVx660  |   |   | 1   |   |   |   |
|   | B(PS) PG  | 09/88 → 09/93   | AC  | VKMV 10AVx735  |   |   | 1   |   |   |   |
| <b>VW  CORRADO (53I) 2.0</b>       |   |   |   |  |   |   |   |   |   |   |
|                                    | 2E, ADY   | 04/93 → 12/95   |   | VKMA 01002<br>VKM 11000  | 1<br>1  |   | 1   |   |   | 3<br>T0091  |
|                                    | 2E, ADY   | 04/93 → 12/95   | 2)  | VKPA 81401<br>VKPC 81401   |   |   |   | 1<br>1  |   |   |
|                                   | B(Alt) 2E, ADY  | 04/93 → 12/95   | A⊙  | VKMV 6PK894  |   |   | 1   |   |   |   |
|   | B(Alt) 2E, ADY  | 04/93 → 12/95   | A⊙, AC  | VKMV 6PK976<br>VKM 31004<br>VKM 31210  |   | 1<br>1  |   | 1   |   |   |
|   | B(Alt) 2E, ADY  | 04/93 → 12/95   | A⊙, AC  | VKMV 6PK1153<br>VKM 31004<br>VKM 31210   |   | 1<br>1  |   | 1   |   |   |
|   | B(PS) 2E, ADY   | 04/93 → 12/95   | AC  | VKMV 11.5x685  |   |   | 1   |   |   |   |
|   | B(PS) 2E, ADY   | 04/93 → 12/95   | AC  | VKMV 11.5x755  |   |   | 1   |   |   |   |
| <b>VW  CORRADO (53I) 2.0 16V</b> |   |   |   |  |   |   |   |   |   |   |
|                                  | 9A  | 08/91 → 12/95   | → IMot. 131 261   | VKMA 01020<br>VKM 11020  | 1<br>1  |   | 1   |   |   | T0057   |
|   | 9A  | 08/91 → 12/95   | Mot. 131 262 I→   | VKMA 01023<br>VKM 11021  | 1<br>1  |   | 1   |   |   | T0057   |
|                                  | 9A  | 08/91 → 12/95   | 2)  | VKPA 81401<br>VKPC 81401   |   |   |   | 1<br>1  |   |   |
|                                  | B(Alt) 9A   | 08/91 → 12/95   | AC  | VKMV 10AVx950  |   |   | 1   |   |   |   |
|   | B(Alt) 9A   | 08/91 → 12/95   | AC  | VKMV 10AVx630  |   |   | 1   |   |   |   |
|   | B(PS) 9A  | 08/91 → 12/95   |   | VKMV 10AVx630  |   |   | 1   |   |   |   |
|   | B(AC) 9A  | 08/91 → 12/95   |   | VKMV 13AVx950  |   |   | 1   |   |   |   |
| <b>VW  CORRADO (53I) 2.9 VR6</b> |   |   |   |  |   |   |   |   |   |   |
|                                  | ABV   | 08/91 → 12/95   |   | <del>0101010</del><br>VKPC 81611   |   |   |   | 1   |   |   |
|                                  | ABV   | 08/91 → 12/95   |   |  |   |   |   |   |   |   |
|                                  | B(Alt) ABV  | 08/91 → 12/95   | AC  | VKMV 7PK1290<br>VKM 31060  |   | 1   |   | 1   |   |   |
|   | B(Alt) ABV  | 08/91 → 12/95   | AC  | VKMA 31060<br>VKMV 7DK1360<br>VKM 31060  |   | 1<br>1<br>1   |   | 1   |   |   |
| <b>VW  DERBY (86) 0.9</b>        |   |   |   |  |   |   |   |   |   |   |
|                                  | HA  | 02/77 → 09/81   |  | VKMC 01100   |   |   | 1   | 1   |   | T0222   |
|                                  | HA  | 02/77 → 09/81   |   | VKPC 81200   |   |   |   | 1   |   |   |
|                                  | B(Alt) HA   | 02/77 → 09/81   | → ICH 86A 0087 520  | VKMV 10AVx695  |   |   | 1   |   |   |   |
|   | B(Alt) HA   | 02/77 → 09/81   | CH 86A 0087 521 I→  | VKMV 10AVx675  |   |   | 1   |   |   |   |
| <b>VW  DERBY (86) 1.1</b>        |   |   |   |  |   |   |   |   |   |   |
|                                  | HB  | 02/77 → 09/81   |  | VKMC 01100   |   |   | 1   | 1   |   | T0222   |
|                                  | HB  | 02/77 → 09/81   |   | VKPC 81200   |   |   |   | 1   |   |   |



|                                | B(Alt) HB             | 02/77 → 09/81 | → ICH 86A 0087 520 | VKMOV 10AVx695                                    |                  |   |   |  |   |  |   |   |  |         |
|--------------------------------|-----------------------|---------------|--------------------|---|------------------|---|---|--|---|--|---|---|--|---------|
|                                | B(Alt) HB             | 02/77 → 09/81 | CH 86A 0087 521 I→ | VKMOV 10AVx675                                    |                  |   |   |  |   |  |   |   |  |         |
| <b>VW  DERBY (86) 1.3</b>      |                       |               |                    |   |                  |   |   |  |   |  |   |   |  |         |
|                                | HH, HJ                | 02/77 → 09/81 |                    | VKMC 01100  |                  |   |   |  | 1 |  | 1 |   |  | T0222   |
|                                | HH, HJ                | 02/77 → 09/81 |                    | VKPC 81200  |                  |   |   |  |   |  | 1 |   |  |         |
|                                | B(Alt) HH, HJ         | 02/77 → 09/81 | → ICH 86A 0087 520 | VKMOV 10AVx695                                    |                  |   |   |  |   |  |   | 1 |  |         |
|                                | B(Alt) HH, HJ         | 02/77 → 09/81 | CH 86A 0087 521 I→ | VKMOV 10AVx675                                    |                  |   |   |  |   |  |   | 1 |  |         |
| <b>VW  DERBY (86C, 80) 1.0</b> |                       |               |                    |   |                  |   |   |  |   |  |   |   |  |         |
|                                | GL, HZ                | 08/81 → 12/84 |                    | VKMC 01100  |                  |   |   |  | 1 |  | 1 |   |  | T0222   |
|                                | GL, HZ                | 08/81 → 12/84 |                    | VKPC 81200  |                  |   |   |  |   |  | 1 |   |  |         |
|                                | B(Alt) GL, HZ         | 08/81 → 12/84 | → ICH 86-D-200 001 | VKMOV 10AVx695                                    |                  |   |   |  |   |  |   | 1 |  |         |
|                                | B(Alt) GL, HZ         | 08/81 → 12/84 | CH 86-E-000 001 I→ | VKMOV 10AVx675                                    |                  |   |   |  |   |  |   | 1 |  |         |
| <b>VW  DERBY (86C, 80) 1.1</b> |                       |               |                    |   |                  |   |   |  |   |  |   |   |  |         |
|                                | HB                    | 10/81 → 07/83 |                    | VKMC 01100  |                  |   |   |  | 1 |  | 1 |   |  | T0222   |
|                                | HB                    | 10/81 → 07/83 |                    | VKPC 81200  |                  |   |   |  |   |  | 1 |   |  |         |
|                                | B(Alt) HB             | 10/81 → 07/83 | → ICH 86-D-200 001 | VKMOV 10AVx695                                    |                  |   |   |  |   |  |   | 1 |  |         |
|                                | B(Alt) HB             | 10/81 → 07/83 | CH 86-E-000 001 I→ | VKMOV 10AVx675                                    |                  |   |   |  |   |  |   | 1 |  |         |
| <b>VW  DERBY (86C, 80) 1.3</b> |                       |               |                    |   |                  |   |   |  |   |  |   |   |  |         |
|                                | GK, HH, HK, HW        | 08/81 → 12/84 |                    | VKMC 01100  |                  |   |   |  | 1 |  | 1 |   |  | T0222   |
|                                | GK, HH, HK, HW        | 08/81 → 12/84 |                    | VKPC 81200  |                  |   |   |  |   |  | 1 |   |  |         |
|                                | B(Alt) GK, HH, HK, HW | 08/81 → 12/84 | → ICH 86-D-200 001 | VKMOV 10AVx695                                    |                  |   |   |  |   |  |   | 1 |  |         |
|                                | B(Alt) GK, HH, HK, HW | 08/81 → 12/84 | CH 86-E-000 001 I→ | VKMOV 10AVx675                                    |                  |   |   |  |   |  |   | 1 |  |         |
| <b>VW  EOS 1.6 FSI</b>         |                       |               |                    |   |                  |   |   |  |   |  |   |   |  |         |
|                                | BLF                   | 06/06 → 10/07 |                    | <del>OXOXOXO</del>                                |                  |   |   |  |   |  |   |   |  |         |
|                                | BLF                   | 06/06 → 10/07 |                    | VKPC 81501  |                  |   |   |  |   |  | 1 |   |  |         |
|                                | B(Alt) BLF            | 06/06 → 10/07 | AC                 | VKMOV 6PK1087                                     |                  |   |   |  |   |  |   | 1 |  |         |
|                                | B(Alt) BLF            | 06/06 → 10/07 | AC                 | VKMOV 6PK1736<br>VKM 31044<br>VKM 31047           |                  |   |   |  |   |  | 1 | 1 |  |         |
| <b>VW  EOS 2.0 FSI</b>         |                       |               |                    |   |                  |   |   |  |   |  |   |   |  |         |
|                                | BVY                   | 03/06 → 10/07 |                    | VKMA 01222<br>VKM 11222<br>VKM 21220<br>VKM _____ | 1<br>1<br>1<br>1 | 2 | 1 |  |   |  |   |   |  | 2 T0247 |
|                                | BVY                   | 03/06 → 10/07 |                    | VKPC 81220  |                  |   |   |  |   |  | 1 |   |  |         |
|                                | B(Alt) BVY            | 03/06 → 10/07 | AC                 | VKMOV 6PK900<br>VKM 31011                         | 1                |   |   |  |   |  | 1 |   |  |         |
|                                | B(Alt) BVY            | 03/06 → 10/07 | AC                 | VKMOV 6PK1042<br>VKM 31011                        | 1                |   |   |  |   |  | 1 |   |  |         |
| <b>VW  EOS 2.0 TFSI</b>        |                       |               |                    |   |                  |   |   |  |   |  |   |   |  |         |
|                                | BWA                   | 03/06 → 10/07 |                    | VKMA 01222<br>VKM 11222<br>VKM 21220<br>VKM _____ | 1<br>1<br>1<br>1 | 2 | 1 |  |   |  |   |   |  | 2 T0247 |
|                                | BWA                   | 03/06 → 10/07 |                    | —   |                  |   |   |  |   |  | 1 |   |  |         |
|                                | B(Alt) BWA            | 03/06 → 10/07 |                    | VKMOV 6PK1054                                     |                  |   |   |  |   |  | 1 |   |  |         |
| <b>VW  EOS 3.2 V6</b>          |                       |               |                    |   |                  |   |   |  |   |  |   |   |  |         |
|                                | BUB                   | 06/06 → 10/07 |                    | <del>OXOXOXO</del>                                |                  |   |   |  |   |  |   |   |  |         |
|                                | BUB                   | 06/06 → 10/07 |                    | —   |                  |   |   |  |   |  | 1 |   |  |         |
|                                | B(Alt) BUB            | 06/06 → 10/07 | → ICH 1F-7-022 289 | VKMOV 6PK1620                                     |                  |   |   |  |   |  |   | 1 |  |         |
| <b>VW  EOS 2.0 TDI</b>         |                       |               |                    |   |                  |   |   |  |   |  |   |   |  |         |
|                                | BMM                   | 06/06 → 10/07 |                    | VKMA 01250<br>VKM 11250<br>VKM 21147              | 1<br>1<br>1      | 1 | 1 |  |   |  |   |   |  | T0184   |
|                                | BMM                   | 06/06 → 10/07 |                    | VKPC 81626  |                  |   |   |  |   |  | 1 |   |  |         |
|                                | B(Alt) BMM            | 06/06 → 10/07 |                    | VKMOV 6PK1050<br>VKM 31054                        | 1                |   |   |  |   |  | 1 |   |  |         |



























































| <b>VW  FOX (5Z1) 1.0</b>     |                              |               |                                     |   |             |   |        |        |  |  |   |   |         |
|------------------------------|------------------------------|---------------|-------------------------------------|---|-------------|---|--------|--------|--|--|---|---|---------|
|                              | AQZ, BJE, BNX                | 10/03 → 10/07 |                                     | VKMA 01107<br>VKM 11107                 | 1<br>1      |   | 1      |        |  |  |   |   | 2 T0126 |
|                              | AQZ, BJE, BNX                | 10/03 → 10/07 |                                     | VKPC 81210                              |             |   |        | 1      |  |  |   |   |         |
| <b>VW  FOX (5Z1) 1.2</b>     |                              |               |                                     |   |             |   |        |        |  |  |   |   |         |
|                              | BMD                          | 04/05 → 10/07 |                                     | <b>0x0x0x0</b>                          |             |   |        |        |  |  |   |   |         |
|                              | BMD                          | 04/05 → 10/07 |                                     | VKPC 81301                              |             |   |        | 1      |  |  |   |   |         |
|                              | <b>B(Alt)</b> BMD            | 04/05 → 10/07 | <b>AC</b>                           | VKMV 6PK1453                            |             |   | 1      |        |  |  |   |   |         |
|                              | <b>B(Alt)</b> BMD            | 04/05 → 10/07 | <b>AC</b>                           | VKMV 6PK1873<br>VKM_____                |             | 1 | 1      |        |  |  |   |   |         |
| <b>VW  FOX (5Z1) 1.4</b>     |                              |               |                                     |   |             |   |        |        |  |  |   |   |         |
|                              | BKR                          | 04/05 → 10/07 |                                     | VKMA 01107<br>VKM 11107                 | 1<br>1      |   | 1      |        |  |  |   |   | 2 T0126 |
|                              | BKR                          | 04/05 → 10/07 | → ICH 5Z-70035 000,<br>5Z-74153 000 | VKPC 81210                              |             |   |        | 1      |  |  |   |   |         |
|                              | <b>B(Alt)</b> BKR            | 04/05 → 10/07 | <b>AC</b>                           | VKMA 31216<br>VKMV 6PK1076<br>VKM 31015 | 1<br>1      |   | 1<br>1 |        |  |  |   |   |         |
| <b>VW  FOX (5Z1) 1.6</b>     |                              |               |                                     |   |             |   |        |        |  |  |   |   |         |
|                              | BAH, BJA, BLH, BPA           | 10/03 → 10/07 |                                     | VKMA 01107<br>VKM 11107                 | 1<br>1      |   | 1      |        |  |  |   |   | 2 T0126 |
|                              | BAH, BJA, BLH, BPA           | 10/03 → 10/07 |                                     | VKPC 81210                              |             |   |        | 1      |  |  |   |   |         |
| <b>VW  FOX (5Z1) 1.4 TDI</b> |                              |               |                                     |   |             |   |        |        |  |  |   |   |         |
|                              | BNM                          | 04/05 → 10/07 |                                     | VKMA 01250<br>VKM 11250<br>VKM 21147    | 1<br>1<br>1 | 1 | 1      |        |  |  |   |   | T0184   |
|                              | BNM                          | 04/05 → 10/07 |                                     | VKPC 81418                              |             |   |        | 1      |  |  |   |   |         |
|                              | <b>B(Alt)</b> BNM            | 04/05 → 10/07 | <b>AC</b>                           | VKMV 6PK858<br>VKM 31035                | 1           |   | 1      |        |  |  |   |   |         |
|                              | <b>B(Alt)</b> BNM            | 04/05 → 10/07 | <b>AC</b>                           | VKMV 6PK996<br>VKM 31035                | 1           |   | 1      |        |  |  |   |   |         |
| <b>VW  GOLF I (17) 1.1</b>   |                              |               |                                     |   |             |   |        |        |  |  |   |   |         |
|                              | FA, FJ, GG                   | 04/74 → 07/83 |                                     | VKMC 01100                              |             |   | 1      | 1      |  |  |   |   | T0222   |
|                              | FA, FJ, GG                   | 04/74 → 07/83 |                                     | VKPC 81200                              |             |   |        | 1      |  |  |   |   |         |
|                              | <b>B(Alt)</b> FA, FJ, GG     | 04/74 → 07/83 |                                     | VKMV 10AVx695                           |             |   | 1      |        |  |  |   |   |         |
|                              | <b>B(PS)</b> FA, FJ, GG      | 04/74 → 07/83 |                                     | VKMV 10AVx850                           |             |   | 1      |        |  |  |   |   |         |
| <b>VW  GOLF I (17) 1.3</b>   |                              |               |                                     |   |             |   |        |        |  |  |   |   |         |
|                              | GF, GS                       | 08/79 → 12/83 |                                     | VKMC 01100                              |             |   | 1      | 1      |  |  |   |   | T0222   |
|                              | GF, GS                       | 08/79 → 12/83 |                                     | VKPC 81200                              |             |   |        | 1      |  |  |   |   |         |
|                              | <b>B(Alt)</b> GF, GS         | 08/79 → 12/83 |                                     | VKMV 10AVx695                           |             |   | 1      |        |  |  |   |   |         |
|                              | <b>B(PS)</b> GF, GS          | 08/79 → 12/83 |                                     | VKMV 10AVx850                           |             |   | 1      |        |  |  |   |   |         |
| <b>VW  GOLF I (17) 1.5</b>   |                              |               |                                     |   |             |   |        |        |  |  |   |   |         |
|                              | FH, JB                       | 04/74 → 07/83 | 3)                                  | VKMS 01000<br>VKMA 01000<br>VKM 11000   | 1<br>1<br>1 |   | 1<br>1 |        |  |  | 3 | 4 | T0005   |
|                              | FH, JB                       | 04/74 → 07/83 | 2)                                  | VKPA 81400<br>VKPC 81400                |             |   |        | 1<br>1 |  |  |   |   |         |
|                              | <b>B(Alt)</b> FH, JB         | 04/74 → 07/83 |                                     | VKMV 10AVx950                           |             |   | 1      |        |  |  |   |   |         |
|                              | <b>B(PS)</b> FH, JB          | 04/74 → 07/83 |                                     | VKMV 10AVx850                           |             |   | 1      |        |  |  |   |   |         |
| <b>VW  GOLF I (17) 1.6</b>   |                              |               |                                     |   |             |   |        |        |  |  |   |   |         |
|                              | EG, EW, FP, FT               | 08/75 → 02/84 | 3)                                  | VKMS 01000<br>VKMA 01000<br>VKM 11000   | 1<br>1<br>1 |   | 1<br>1 |        |  |  | 3 | 4 | T0005   |
|                              | EG, FP, FT                   | 08/75 → 02/84 | 2)                                  | VKPA 81400<br>VKPC 81400                |             |   |        | 1<br>1 |  |  |   |   |         |
|                              | EW                           | 01/83 → 02/84 | 2)                                  | VKPA 81401<br>VKPC 81401                |             |   |        | 1<br>1 |  |  |   |   |         |
|                              | <b>B(Alt)</b> EG, EW, FP, FT | 08/75 → 02/84 |                                     | VKMV 10AVx950                           |             |   | 1      |        |  |  |   |   |         |
|                              | <b>B(PS)</b> EG, EW, FP, FT  | 08/75 → 02/84 |                                     | VKMV 10AVx850                           |             |   | 1      |        |  |  |   |   |         |









































| <b>VW  GOLF I (17) 1.8</b>            |                        |               |       |               |   |   |  |   |  |   |   |       |
|---------------------------------------|------------------------|---------------|-------|---------------|---|---|--|---|--|---|---|-------|
|                                       | DX                     | 08/82 → 12/83 | 3)    | VKMS 01000    | 1 | 1 |  |   |  | 3 | 4 | T0005 |
|                                       |                        |               |       | VKMA 01000    | 1 | 1 |  |   |  |   | 3 |       |
|                                       |                        |               |       | VKM 11000     | 1 |   |  |   |  |   |   |       |
|                                       | DX                     | 08/82 → 12/83 |       | VKPC 81400    |   |   |  | 1 |  |   |   |       |
|                                       | B(Alt) DX              | 08/82 → 12/83 |       | VKMV 10AVx950 |   | 1 |  |   |  |   |   |       |
|                                       | B(PS) DX               | 08/82 → 12/83 |       | VKMV 10AVx850 |   | 1 |  |   |  |   |   |       |
| <b>VW  GOLF I (17) 1.5 D</b>          |                        |               |       |               |   |   |  |   |  |   |   |       |
|                                       | CK                     | 08/76 → 07/80 |       | VKMA 01010    | 1 | 1 |  |   |  |   | 1 | T0051 |
|                                       |                        |               |       | VKM 11010     | 1 |   |  |   |  |   |   |       |
|                                       | CK                     | 08/76 → 07/80 | 2)    | VKPA 81400    |   |   |  | 1 |  |   |   |       |
|                                       |                        |               |       | VKPC 81400    |   |   |  | 1 |  |   |   |       |
|                                       | B(Alt) CK              | 08/76 → 07/80 |       | VKMV 10AVx875 |   | 1 |  |   |  |   |   |       |
|                                       | B(PS) CK               | 08/76 → 07/80 |       | VKMV 10AVx850 |   | 1 |  |   |  |   |   |       |
| <b>VW  GOLF I (17) 1.6 D</b>          |                        |               |       |               |   |   |  |   |  |   |   |       |
|                                       | CR, JK                 | 08/80 → 07/83 |       | VKMA 01010    | 1 | 1 |  |   |  |   | 1 | T0051 |
|                                       |                        |               |       | VKM 11010     | 1 |   |  |   |  |   |   |       |
|                                       | CR                     | 08/80 → 07/83 | 2)    | VKPA 81400    |   |   |  | 1 |  |   |   |       |
|                                       |                        |               |       | VKPC 81400    |   |   |  | 1 |  |   |   |       |
|                                       | JK                     | 08/80 → 07/83 |       | VKPC 81401    |   |   |  | 1 |  |   |   |       |
|                                       | B(Alt) CR, JK          | 08/80 → 07/83 | AC    | VKMV 10AVx875 |   | 1 |  |   |  |   |   |       |
|                                       | B(Alt) CR, JK          | 08/80 → 07/83 | AC    | VKMV 10AVx650 |   | 1 |  |   |  |   |   |       |
|                                       | B(PS) CR, JK           | 08/80 → 07/83 |       | VKMV 10AVx850 |   | 1 |  |   |  |   |   |       |
|                                       | B(AC) CR, JK           | 08/80 → 07/83 |       | VKMV 13AVx950 |   | 1 |  |   |  |   |   |       |
| <b>VW  GOLF I (17) 1.6 TD</b>         |                        |               |       |               |   |   |  |   |  |   |   |       |
|                                       | CY                     | 03/82 → 07/85 |       | VKMA 01010    | 1 | 1 |  |   |  |   | 1 | T0051 |
|                                       |                        |               |       | VKM 11010     | 1 |   |  |   |  |   |   |       |
|                                       | CY                     | 03/82 → 07/85 |       | VKPC 81400    |   |   |  | 1 |  |   |   |       |
|                                       | B(Alt) CY              | 03/82 → 07/85 | AC    | VKMV 10AVx875 |   | 1 |  |   |  |   |   |       |
|                                       | B(Alt) CY              | 03/82 → 07/85 | AC    | VKMV 10AVx650 |   | 1 |  |   |  |   |   |       |
|                                       | B(PS) CY               | 03/82 → 07/85 |       | VKMV 10AVx850 |   | 1 |  |   |  |   |   |       |
|                                       | B(AC) CY               | 03/82 → 07/85 |       | VKMV 13AVx950 |   | 1 |  |   |  |   |   |       |
| <b>VW  GOLF I Cabriolet (155) 1.5</b> |                        |               |       |               |   |   |  |   |  |   |   |       |
|                                       | JB                     | 01/79 → 11/83 | 3)    | VKMS 01000    | 1 | 1 |  |   |  | 3 | 4 | T0005 |
|                                       |                        |               |       | VKMA 01000    | 1 | 1 |  |   |  |   | 3 |       |
|                                       |                        |               |       | VKM 11000     | 1 |   |  |   |  |   |   |       |
|                                       | JB                     | 01/79 → 11/83 | 2)    | VKPA 81400    |   |   |  | 1 |  |   |   |       |
|                                       |                        |               |       | VKPC 81400    |   |   |  | 1 |  |   |   |       |
|                                       | B(Alt) JB              | 01/79 → 11/83 |       | VKMV 10AVx950 |   | 1 |  |   |  |   |   |       |
| <b>VW  GOLF I Cabriolet (155) 1.6</b> |                        |               |       |               |   |   |  |   |  |   |   |       |
|                                       | EG, EW, RE             | 08/79 → 04/92 | 3)    | VKMS 01000    | 1 | 1 |  |   |  | 3 | 4 | T0005 |
|                                       |                        |               |       | VKMA 01000    | 1 | 1 |  |   |  |   | 3 |       |
|                                       |                        |               |       | VKM 11000     | 1 |   |  |   |  |   |   |       |
|                                       | EG                     | 08/79 → 07/82 | 2)    | VKPA 81400    |   |   |  | 1 |  |   |   |       |
|                                       |                        |               |       | VKPC 81400    |   |   |  | 1 |  |   |   |       |
|                                       | EW                     | 08/83 → 04/92 |       | VKPC 81400    |   |   |  | 1 |  |   |   |       |
|                                       | RE                     | 04/86 → 02/90 | 2)    | VKPA 81401    |   |   |  | 1 |  |   |   |       |
|                                       |                        |               |       | VKPC 81401    |   |   |  | 1 |  |   |   |       |
|                                       | B(Alt) EG              | 08/79 → 07/82 |       | VKMV 10AVx950 |   | 1 |  |   |  |   |   |       |
|                                       | B(Alt) EW, RE          | 08/83 → 04/92 | ⊗     | VKMV 10AVx950 |   | 1 |  |   |  |   |   |       |
|                                       | B(Alt) EW              | 08/83 → 04/92 | AC, ⊗ | VKMV 10AVx865 |   | 1 |  |   |  |   |   |       |
|                                       | B(Alt) EW              | 08/83 → 04/92 | AC, ⊗ | VKMV 10AVx630 |   | 1 |  |   |  |   |   |       |
|                                       | B(Alt) RE              | 04/86 → 02/90 | ⊗     | VKMV 10AVx865 |   | 1 |  |   |  |   |   |       |
|                                       | B(PS) EW               | 08/83 → 04/92 | AC    | VKMV 10AVx730 |   | 1 |  |   |  |   |   |       |
|                                       | B(PS) RE               | 04/86 → 02/90 |       | VKMV 10AVx730 |   | 1 |  |   |  |   |   |       |
| <b>VW  GOLF I Cabriolet (155) 1.8</b> |                        |               |       |               |   |   |  |   |  |   |   |       |
|                                       | 2H, DX, EV, EX, JH, PB | 08/82 → 04/93 | 3)    | VKMS 01000    | 1 | 1 |  |   |  | 3 | 4 | T0005 |
|                                       |                        |               |       | VKMA 01000    | 1 | 1 |  |   |  |   | 3 |       |
|                                       |                        |               |       | VKM 11000     | 1 |   |  |   |  |   |   |       |



|  |  |  |    |  |  |  |  |  |  |  |  |
|--|---|---|---|--|---|---|---|---|---|---|---|
|                                     | 2H, DX, EV, EX, JH, PB  | 08/82 → 04/93   | 2)  | VKPA 81401<br>VKPC 81401   |   |   |   |   | 1<br>1  |   |   |
|                                     | <b>B(Alt)</b> 2H, DX, EV, EX, JH, PB  | 08/82 → 04/93   |    | VKMV 10AVx950  |   | 1   |   |   |   |   |   |
|  | <b>B(Alt)</b> 2H, DX, EV, EX, JH, PB  | 08/82 → 04/93   |       | VKMV 10AVx865  |   | 1   |   |   |   |   |   |
|  | <b>B(Alt)</b> 2H, DX, EV, EX, JH, PB  | 08/82 → 04/93   |       | VKMV 10AVx630  |   | 1   |   |   |   |   |   |
|  | <b>B(PS)</b> 2H, DX, EX, JH   | 08/82 → 04/93   |    | VKMV 10AVx730  |   | 1   |   |   |   |   |   |
| <b>VW  GOLF II (19E, 1G1) 1.0</b>   |   |   |   |  |   |   |   |   |   |   |   |
|                                     | GN  | 11/83 → 08/85   |    | VKMC 01100   |   | 1   | 1   |   |   |   | T0222   |
|  | HZ  | 08/85 → 10/91   |  → <b>I</b> Mot. 786 022   | VKMC 01100   |   | 1   | 1   |   |   |   | T0222   |
|  | HZ  | 08/85 → 10/91   |  <b>Mot.</b> 786 023 <b>I</b> →  | VKMC 01103   |   | 1   | 1   |   |   |   | T0231   |
|                                     | GN  | 11/83 → 08/85   |   | VKPC 81200   |   |   | 1   |   |   |   |   |
|  | HZ  | 08/85 → 10/91   | → <b>I</b> Mot. 786 022   | VKPC 81200   |   |   | 1   |   |   |   |   |
|  | HZ  | 08/85 → 10/91   | <b>Mot.</b> 786 023 <b>I</b> →  | VKPC 81204   |   |   | 1   |   |   |   |   |
|                                     | <b>B(Alt)</b> GN  | 11/83 → 08/85   |   | VKMV 10AVx675  |   | 1   |   |   |   |   |   |
|  | <b>B(Alt)</b> HZ  | 08/85 → 10/91   | → <b>I</b> CH 1G-M-368 060  | VKMV 10AVx675  |   | 1   |   |   |   |   |   |
|  | <b>B(Alt)</b> HZ  | 08/85 → 10/91   | <b>CH</b> 1G-M-368 061 <b>I</b> →   | VKMV 11.9x710  |   | 1   |   |   |   |   |   |
|  | <b>B(PS)</b> GN, HZ   | 11/83 → 10/91   |   | VKMV 10AVx730  |   | 1   |   |   |   |   |   |
| <b>VW  GOLF II (19E, 1G1) 1.3</b>   |   |   |   |  |   |   |   |   |   |   |   |
|                                     | 2G  | 06/86 → 12/92   |  → <b>I</b> Mot. 262 739   | VKMC 01100   |   | 1   | 1   |   |   |   | T0222   |
|  | 2G  | 06/86 → 12/92   |  <b>Mot.</b> 262 740 <b>I</b> →  | VKMC 01103   |   | 1   | 1   |   |   |   | T0231   |
|  | GT, HK, MH, NU  | 08/83 → 12/92   |    | VKMC 01100   |   | 1   | 1   |   |   |   | T0222   |
|  | NZ  | 06/86 → 12/92   |  → <b>I</b> Mot. 200 000   | VKMC 01100   |   | 1   | 1   |   |   |   | T0222   |
|  | NZ  | 06/86 → 12/92   |  <b>Mot.</b> 200 001 <b>I</b> →  | VKMC 01103   |   | 1   | 1   |   |   |   | T0231   |
|                                     | 2G  | 06/86 → 12/92   | → <b>I</b> Mot. 262 739   | VKPC 81200   |   |   | 1   |   |   |   |   |
|  | 2G  | 06/86 → 12/92   | <b>Mot.</b> 262 740 <b>I</b> →  | VKPC 81204   |   |   | 1   |   |   |   |   |
|  | GT, HK, MH, NU  | 08/83 → 12/92   |   | VKPC 81200   |   |   | 1   |   |   |   |   |
|  | NZ  | 06/86 → 12/92   | → <b>I</b> Mot. 200 000   | VKPC 81200   |   |   | 1   |   |   |   |   |
|  | NZ  | 06/86 → 12/92   | <b>Mot.</b> 200 001 <b>I</b> →  | VKPC 81204   |   |   | 1   |   |   |   |   |
|                                   | <b>B(Alt)</b> 2G, MH, NZ  | 06/86 → 12/92   | → <b>I</b> CH 1G-M-368 060  | VKMV 10AVx675  |   | 1   |   |   |   |   |   |
|  | <b>B(Alt)</b> 2G, MH, NZ  | 06/86 → 12/92   | <b>CH</b> 1G-M-368 061 <b>I</b> →   | VKMV 11.9x710  |   | 1   |   |   |   |   |   |
|  | <b>B(Alt)</b> GT, HK, MH, NU  | 08/83 → 12/87   |   | VKMV 10AVx675  |   | 1   |   |   |   |   |   |
|  | <b>B(PS)</b> GT, HK, MH, NU   | 08/83 → 12/87   |   | VKMV 10AVx730  |   | 1   |   |   |   |   |   |
| <b>VW  GOLF II (19E, 1G1) 1.6</b> |   |   |   |  |   |   |   |   |   |   |   |
|                                   | ABN, EZ, PN, RF   | 08/83 → 12/92   | 3)  | VKMS 01000<br>VKMA 01000<br>VKM 11000  | 1<br>1<br>1   | 1   |   |   |   | 3<br>3<br>3   | 4<br>3<br>T0005   |
|                                   | ABN, EZ, PN, RF   | 08/83 → 12/92   | 2)  | VKPA 81401<br>VKPC 81401   |   |   |   | 1<br>1  |   |   |   |
|                                   | <b>B(Alt)</b> ABN, EZ, PN, RF   | 08/83 → 12/92   |   | VKMV 10AVx950  |   | 1   |   |   |   |   |   |
|  | <b>B(Alt)</b> ABN, EZ, PN, RF   | 08/83 → 12/92   |   | VKMV 10AVx865  |   | 1   |   |   |   |   |   |
|  | <b>B(Alt)</b> ABN, EZ, PN, RF   | 08/83 → 12/92   |    | VKMV 10AVx630  |   | 1   |   |   |   |   |   |
|  | <b>B(PS)</b> ABN, EZ, PN, RF  | 08/83 → 12/92   |   | VKMV 10AVx730  |   | 1   |   |   |   |   |   |
|  | <b>B(AC)</b> ABN, EZ, PN, RF  | 08/83 → 12/92   |   | VKMV 13AVx950  |   | 1   |   |   |   |   |   |
| <b>VW  GOLF II (19E, 1G1) 1.8</b> |   |   |   |  |   |   |   |   |   |   |   |
|                                   | 1P, GU, GX, RH, RP  | 08/84 → 10/91   | 3)  | VKMS 01000<br>VKMA 01000<br>VKM 11000  | 1<br>1<br>1   | 1   |   |   |   | 3<br>3<br>3   | 4<br>3<br>T0005   |
|                                   | 1P, GU, GX, RH, RP  | 08/84 → 10/91   | 2)  | VKPA 81401<br>VKPC 81401   |   |   |   | 1<br>1  |   |   |   |
|                                   | <b>B(Alt)</b> 1P, GU, GX, RH, RP  | 08/84 → 10/91   |    | VKMV 10AVx630  |   | 1   |   |   |   |   |   |
|  | <b>B(Alt)</b> 1P, GU, GX  | 02/86 → 07/91   |   | VKMV 10AVx850  |   | 1   |   |   |   |   |   |
|  | <b>B(Alt)</b> GU, GX, RH, RP  | 08/84 → 10/91   |   | VKMV 10AVx865  |   | 1   |   |   |   |   |   |
|  | <b>B(Alt)</b> RH  | 08/86 → 01/90   |   | VKMV 10AVx950  |   | 1   |   |   |   |   |   |
|  | <b>B(PS)</b> 1P, GU, GX   | 02/86 → 07/91   |    | VKMV 10AVx730  |   | 1   |   |   |   |   |   |
|  | <b>B(PS)</b> 1P, GU   | 02/86 → 07/91   |  → <b>I</b> CH -M-240 000  | VKMV 10AVx730  |   | 1   |   |   |   |   |   |
|  | <b>B(PS)</b> 1P, GU   | 02/86 → 07/91   |  <b>CH</b> -M-240 001 <b>I</b> →   | VKMV 10AVx630  |   | 1   |   |   |   |   |   |
|  | <b>B(PS)</b> GU, GX, RH, RP   | 08/84 → 10/91   |   | VKMV 10AVx730  |   | 1   |   |   |   |   |   |



|  |               |  |  |                |  |  |  |  |  |  |  |  |
|--|---------------|---|---|---|--|---|---|---|---|---|---|---|
| <b>VW  GOLF II (19E, 1G1) 1.8 GTI</b>     |               |   |   |   |  |   |   |   |   |   |   |   |
|    |               | DX, EV, HT, PB, PF, RD  | 08/83 → 10/91   | 3)  | VKMS 01000   | 1   | 1   |   |   | 3   | 4   | T0055   |
|  |               |   |   |   | VKMA 01000   | 1   | 1   |   |   |   | 3   |   |
|  |               |   |   |   | VKM 11000  | 1   |   |   |   |   |   |   |
|    |               | DX, EV, HT, PB, PF, RD  | 08/83 → 10/91   | 2)  | VKPA 81401   |   |   |   | 1   |   |   |   |
|  |               |   |   |   | VKPC 81401   |   |   |   | 1   |   |   |   |
|    | <b>B(Alt)</b> | DX, EV, PB  | 08/83 → 10/91   | <b>AC</b> ,    | VKMV 10AVx950  |   | 1   |   |   |   |   |   |
|  | <b>B(Alt)</b> | DX, EV, HT, PB, PF, RD  | 08/83 → 10/91   | <b>AC</b> ,    | VKMV 10AVx865  |   | 1   |   |   |   |   |   |
|  | <b>B(Alt)</b> | DX, EV, PB, PF  | 08/83 → 10/91   | <b>AC</b>   | VKMV 10AVx630  |   | 1   |   |   |   |   |   |
|  | <b>B(PS)</b>  | DX, EV, HT, PB, PF, RD  | 08/83 → 10/91   |   | VKMV 10AVx730  |   | 1   |   |   |   |   |   |
|  | <b>B(AC)</b>  | DX, EV, PB, PF, RD  | 08/83 → 10/91   |   | VKMV 13AVx950  |   | 1   |   |   |   |   |   |
| <b>VW  GOLF II (19E, 1G1) 1.8 GTI 16V</b> |               |   |   |   |  |   |   |   |   |   |   |   |
|    |               | KR, PL  | 02/86 → 10/91   |   | VKMA 01020   | 1   | 1   |   |   |   |   | T0057   |
|  |               |   |   |   | VKM 11020  | 1   |   |   |   |   |   |   |
|    |               | KR, PL  | 02/86 → 10/91   | 2)  | VKPA 81401   |   |   |   | 1   |   |   |   |
|  |               |   |   |   | VKPC 81401   |   |   |   | 1   |   |   |   |
|    | <b>B(Alt)</b> | KR, PL  | 02/86 → 10/91   | <b>AC</b>   | VKMV 10AVx950  |   | 1   |   |   |   |   |   |
|  | <b>B(Alt)</b> | KR, PL  | 02/86 → 10/91   | <b>AC</b>   | VKMV 10AVx630  |   | 1   |   |   |   |   |   |
|  | <b>B(PS)</b>  | KR, PL  | 02/86 → 10/91   | → <b>ICH</b> 1G-MB-075 000,<br>1G-MW240 000   | VKMV 10AVx730  |   | 1   |   |   |   |   |   |
|  | <b>B(PS)</b>  | KR, PL  | 02/86 → 10/91   | <b>CH</b> 1G-MB075 001,<br>1G-MW240 001  →  | VKMV 10AVx630  |   | 1   |   |   |   |   |   |
|  | <b>B(AC)</b>  | KR, PL  | 02/86 → 10/91   |   | VKMV 13AVx950  |   | 1   |   |   |   |   |   |
| <b>VW  GOLF II (19E, 1G1) 1.8 G60</b>    |               |   |   |   |  |   |   |   |   |   |   |   |
|    |               | 1H, PG  | 08/88 → 07/91   | 3)  | VKMS 01000   | 1   | 1   |   |   | 3   | 4   | T0055   |
|  |               |   |   |   | VKMA 01000   | 1   | 1   |   |   |   | 3   |   |
|  |               |   |   |   | VKM 11000  | 1   |   |   |   |   |   |   |
|    |               | 1H, PG  | 08/88 → 07/91   | 2)  | VKPA 81401   |   |   |   | 1   |   |   |   |
|  |               |   |   |   | VKPC 81401   |   |   |   | 1   |   |   |   |
|    | <b>B(Alt)</b> | 1H, PG  | 08/88 → 07/91   | <b>AC</b>   | VKMV 6PK1660   |   | 1   |   |   |   |   |   |
|  |               |   |   |   | VKM 31007  | 1   |   |   |   |   |   |   |
|  |               |   |   |   | VKM 31007  | 1   |   |   |   |   |   |   |
|  | <b>B(Alt)</b> | 1H, PG  | 08/88 → 07/91   | <b>AC</b>   | VKMV 6PK1760   |   | 1   |   |   |   |   |   |
|  |               |   |   |   | VKM 31007  | 1   |   |   |   |   |   |   |
|  |               |   |   |   | VKM 31007  | 1   |   |   |   |   |   |   |
|  | <b>B(PS)</b>  | 1H, PG  | 08/88 → 07/91   |   | VKMV 10AVx660  |   | 1   |   |   |   |   |   |
| <b>VW  GOLF II (19E, 1G1) 1.6 D</b>     |               |   |   |   |  |   |   |   |   |   |   |   |
|    |               | JP, ME  | 08/83 → 10/91   | 3)  | VKMS 01010   | 1   | 1   |   |   | 3   | 2   | T0051   |
|  |               |   |   |   | VKMA 01010   | 1   | 1   |   |   |   | 1   |   |
|  |               |   |   |   | VKM 11010  | 1   |   |   |   |   |   |   |
|    |               | JP, ME  | 08/83 → 10/91   | 2)  | VKPA 81401   |   |   |   | 1   |   |   |   |
|  |               |   |   |   | VKPC 81401   |   |   |   | 1   |   |   |   |
|    | <b>B(Alt)</b> | JP, ME  | 08/83 → 10/91   | <b>AC</b> ,  | VKMV 10AVx965  |   | 1   |   |   |   |   |   |
|  | <b>B(Alt)</b> | JP, ME  | 08/83 → 10/91   | <b>AC</b> ,  | VKMV 10AVx865  |   | 1   |   |   |   |   |   |
|  | <b>B(PS)</b>  | JP, ME  | 08/83 → 10/91   |   | VKMV 10AVx740  |   | 1   |   |   |   |   |   |
|  | <b>B(AC)</b>  | JP, ME  | 08/83 → 10/91   |   | VKMV 13AVx950  |   | 1   |   |   |   |   |   |
|  |               |   |   |   | VKM 31009  |   | 1   |   |   |   |   |   |
| <b>VW  GOLF II (19E, 1G1) 1.6 TD</b>    |               |   |   |   |  |   |   |   |   |   |   |   |
|    |               | 1V, JR, RA, SB  | 08/83 → 10/91   | 3)  | VKMS 01010   | 1   | 1   |   |   | 3   | 2   | T0051   |
|  |               |   |   |   | VKMA 01010   | 1   | 1   |   |   |   | 1   |   |
|  |               |   |   |   | VKM 11010  | 1   |   |   |   |   |   |   |
|    |               | 1V, JR, RA, SB  | 08/83 → 10/91   | 2)  | VKPA 81401   |   |   |   | 1   |   |   |   |
|  |               |   |   |   | VKPC 81401   |   |   |   | 1   |   |   |   |
|    | <b>B(Alt)</b> | 1V, JR, RA, SB  | 08/83 → 10/91   | <b>AC</b> ,  | VKMV 10AVx965  |   | 1   |   |   |   |   |   |
|  | <b>B(Alt)</b> | 1V, JR, RA, SB  | 08/83 → 10/91   | <b>AC</b> ,  | VKMV 10AVx865  |   | 1   |   |   |   |   |   |
|  | <b>B(PS)</b>  | 1V, JR, SB  | 08/83 → 10/91   | → <b>ICH</b> 1G-MB125 000,<br>1G-MW400 000  | VKMV 10AVx740  |   | 1   |   |   |   |   |   |
|  | <b>B(PS)</b>  | 1V, JR, SB  | 08/83 → 10/91   | <b>CH</b> 1G-MB125 001,<br>1G-MW400 001  →  | VKMV 11.9x650  |   | 1   |   |   |   |   |   |
|  | <b>B(PS)</b>  | RA  | 04/89 → 10/91   |   | VKMV 10AVx740  |   | 1   |   |   |   |   |   |





































|  |  |  |  |  |  |  |  |  |  |  |  |  |  |  |  |  |  |  |  |  |  |  |  |  |  |  |  |  |  |  |  |  |  |  |  |  |  |  |  |  |  |  |  |  |  |  |  |  |  |  |  |  |  |  |  |  |  |  |  |  |  |  |  |  |  |  |  |  |  |  |  |  |  |  |  |  |  |  |  |  |  |  |  |  |  |  |  |  |  |  |  |  |  |  |  |  |  |  |  |  |  |  |  |  |  |  |  |  |  |  |  |  |  |  |  |  |  |  |  |  |  |  |  |  |  |  |  |  |  |  |  |  |  |  |  |  |  |  |  |  |  |  |  |  |  |  |  |  |  |  |  |  |  |  |  |  |  |  |  |  |  |  |  |  |  |  |  |  |  |  |  |  |  |  |  |  |  |  |  |  |  |  |  |  |  |  |  |  |  |  |  |  |  |  |  |  |  |  |  |  |  |  |  |  |  |  |  |  |  |  |  |  |  |  |  |  |  |  |  |  |  |  |  |  |  |  |  |  |  |  |  |  |  |  |  |  |  |  |  |  |  |  |  |  |  |  |  |  |  |  |  |  |  |  |  |  |  |  |  |  |  |  |  |  |  |  |  |  |  |  |  |  |  |  |  |  |  |  |  |  |  |  |  |  |  |  |  |  |  |  |  |  |  |  |  |  |  |  |  |  |  |  |  |  |  |  |  |  |  |  |  |  |  |  |  |  |  |  |  |  |  |  |  |  |  |  |  |  |  |  |  |  |  |  |  |  |  |  |  |  |  |  |  |  |  |  |  |  |  |  |  |  |  |  |  |  |  |  |  |  |  |  |  |  |  |  |  |  |  |  |  |  |  |  |  |  |  |  |  |  |  |  |  |  |  |  |  |  |  |  |  |  |  |  |  |  |  |  |  |  |  |  |  |  |  |  |  |  |  |  |  |  |  |  |  |  |  |  |  |  |  |  |  |  |  |  |  |  |  |  |  |  |  |  |  |  |  |  |  |  |  |  |  |  |  |  |  |  |  |  |  |  |  |  |  |  |  |  |  |  |  |  |  |  |  |  |  |  |  |  |  |  |  |  |  |  |  |  |  |  |  |  |  |  |  |  |  |  |  |  |  |  |  |  |  |  |  |  |  |  |  |  |  |  |  |  |  |  |  |  |  |  |  |  |  |  |  |  |  |  |  |  |  |  |  |  |  |  |  |  |  |  |  |  |  |  |  |  |  |  |  |  |  |  |  |  |  |  |  |  |  |  |  |  |  |  |  |  |  |  |  |  |  |  |  |  |  |  |  |  |  |  |  |  |  |  |  |  |  |  |  |  |  |  |  |  |  |  |  |  |  |  |  |  |  |  |  |  |  |  |  |  |  |  |  |  |  |  |  |  |  |  |  |  |  |  |  |  |  |  |  |  |  |  |  |  |  |  |  |  |  |  |  |  |  |  |  |  |  |  |  |  |  |  |  |  |  |  |  |  |  |  |  |  |  |  |  |  |  |  |  |  |  |  |  |  |  |  |  |  |  |  |  |  |  |  |  |  |  |  |  |  |  |  |  |  |  |  |  |  |  |  |  |  |  |  |  |  |  |  |  |  |  |  |  |  |  |  |  |  |  |  |  |  |  |  |  |  |  |  |  |  |  |  |  |  |  |  |  |  |  |  |  |  |  |  |  |  |  |  |  |  |  |  |  |  |  |  |  |  |  |  |  |  |  |  |  |  |  |  |  |  |  |  |  |  |  |  |  |  |  |  |  |  |  |  |  |  |  |  |  |  |  |  |  |  |  |  |  |  |  |  |  |  |  |  |  |  |  |  |  |  |  |  |  |  |  |  |  |  |  |  |  |  |  |  |  |  |  |  |  |  |  |  |  |  |  |  |  |  |  |  |  |  |  |  |  |  |  |  |  |  |  |  |  |  |  |  |  |  |  |  |  |  |  |  |  |  |  |  |  |  |  |  |  |  |  |  |  |  |  |  |  |  |  |  |  |  |  |  |  |  |  |  |  |  |  |  |  |  |  |  |  |  |  |  |  |  |  |  |  |  |  |  |  |  |  |  |  |  |  |  |  |  |  |  |  |  |  |  |  |  |  |  |  |  |  |  |  |  |  |  |  |  |  |  |  |  | </ |
|--|--|--|--|--|--|--|--|--|--|--|--|--|--|--|--|--|--|--|--|--|--|--|--|--|--|--|--|--|--|--|--|--|--|--|--|--|--|--|--|--|--|--|--|--|--|--|--|--|--|--|--|--|--|--|--|--|--|--|--|--|--|--|--|--|--|--|--|--|--|--|--|--|--|--|--|--|--|--|--|--|--|--|--|--|--|--|--|--|--|--|--|--|--|--|--|--|--|--|--|--|--|--|--|--|--|--|--|--|--|--|--|--|--|--|--|--|--|--|--|--|--|--|--|--|--|--|--|--|--|--|--|--|--|--|--|--|--|--|--|--|--|--|--|--|--|--|--|--|--|--|--|--|--|--|--|--|--|--|--|--|--|--|--|--|--|--|--|--|--|--|--|--|--|--|--|--|--|--|--|--|--|--|--|--|--|--|--|--|--|--|--|--|--|--|--|--|--|--|--|--|--|--|--|--|--|--|--|--|--|--|--|--|--|--|--|--|--|--|--|--|--|--|--|--|--|--|--|--|--|--|--|--|--|--|--|--|--|--|--|--|--|--|--|--|--|--|--|--|--|--|--|--|--|--|--|--|--|--|--|--|--|--|--|--|--|--|--|--|--|--|--|--|--|--|--|--|--|--|--|--|--|--|--|--|--|--|--|--|--|--|--|--|--|--|--|--|--|--|--|--|--|--|--|--|--|--|--|--|--|--|--|--|--|--|--|--|--|--|--|--|--|--|--|--|--|--|--|--|--|--|--|--|--|--|--|--|--|--|--|--|--|--|--|--|--|--|--|--|--|--|--|--|--|--|--|--|--|--|--|--|--|--|--|--|--|--|--|--|--|--|--|--|--|--|--|--|--|--|--|--|--|--|--|--|--|--|--|--|--|--|--|--|--|--|--|--|--|--|--|--|--|--|--|--|--|--|--|--|--|--|--|--|--|--|--|--|--|--|--|--|--|--|--|--|--|--|--|--|--|--|--|--|--|--|--|--|--|--|--|--|--|--|--|--|--|--|--|--|--|--|--|--|--|--|--|--|--|--|--|--|--|--|--|--|--|--|--|--|--|--|--|--|--|--|--|--|--|--|--|--|--|--|--|--|--|--|--|--|--|--|--|--|--|--|--|--|--|--|--|--|--|--|--|--|--|--|--|--|--|--|--|--|--|--|--|--|--|--|--|--|--|--|--|--|--|--|--|--|--|--|--|--|--|--|--|--|--|--|--|--|--|--|--|--|--|--|--|--|--|--|--|--|--|--|--|--|--|--|--|--|--|--|--|--|--|--|--|--|--|--|--|--|--|--|--|--|--|--|--|--|--|--|--|--|--|--|--|--|--|--|--|--|--|--|--|--|--|--|--|--|--|--|--|--|--|--|--|--|--|--|--|--|--|--|--|--|--|--|--|--|--|--|--|--|--|--|--|--|--|--|--|--|--|--|--|--|--|--|--|--|--|--|--|--|--|--|--|--|--|--|--|--|--|--|--|--|--|--|--|--|--|--|--|--|--|--|--|--|--|--|--|--|--|--|--|--|--|--|--|--|--|--|--|--|--|--|--|--|--|--|--|--|--|--|--|--|--|--|--|--|--|--|--|--|--|--|--|--|--|--|--|--|--|--|--|--|--|--|--|--|--|--|--|--|--|--|--|--|--|--|--|--|--|--|--|--|--|--|--|--|--|--|--|--|--|--|--|--|--|--|--|--|--|--|--|--|--|--|--|--|--|--|--|--|--|--|--|--|--|--|--|--|--|--|--|--|--|--|--|--|--|--|--|--|--|--|--|--|--|--|--|--|--|--|--|--|--|--|--|--|--|--|--|--|--|--|--|--|--|--|--|--|--|--|--|--|--|--|--|--|--|--|--|--|--|--|--|--|--|--|--|--|--|--|--|--|--|--|--|--|--|--|--|--|--|--|--|--|--|--|--|--|--|--|--|--|--|--|--|--|--|--|--|--|--|--|--|--|--|--|--|--|--|--|--|--|--|--|--|--|--|--|--|--|--|--|--|--|--|--|--|--|--|--|--|--|--|--|--|--|--|--|--|--|--|--|--|--|--|--|--|--|--|--|--|--|--|--|--|--|--|--|--|--|--|--|--|--|--|--|--|--|--|--|--|--|--|--|----|
|--|--|--|--|--|--|--|--|--|--|--|--|--|--|--|--|--|--|--|--|--|--|--|--|--|--|--|--|--|--|--|--|--|--|--|--|--|--|--|--|--|--|--|--|--|--|--|--|--|--|--|--|--|--|--|--|--|--|--|--|--|--|--|--|--|--|--|--|--|--|--|--|--|--|--|--|--|--|--|--|--|--|--|--|--|--|--|--|--|--|--|--|--|--|--|--|--|--|--|--|--|--|--|--|--|--|--|--|--|--|--|--|--|--|--|--|--|--|--|--|--|--|--|--|--|--|--|--|--|--|--|--|--|--|--|--|--|--|--|--|--|--|--|--|--|--|--|--|--|--|--|--|--|--|--|--|--|--|--|--|--|--|--|--|--|--|--|--|--|--|--|--|--|--|--|--|--|--|--|--|--|--|--|--|--|--|--|--|--|--|--|--|--|--|--|--|--|--|--|--|--|--|--|--|--|--|--|--|--|--|--|--|--|--|--|--|--|--|--|--|--|--|--|--|--|--|--|--|--|--|--|--|--|--|--|--|--|--|--|--|--|--|--|--|--|--|--|--|--|--|--|--|--|--|--|--|--|--|--|--|--|--|--|--|--|--|--|--|--|--|--|--|--|--|--|--|--|--|--|--|--|--|--|--|--|--|--|--|--|--|--|--|--|--|--|--|--|--|--|--|--|--|--|--|--|--|--|--|--|--|--|--|--|--|--|--|--|--|--|--|--|--|--|--|--|--|--|--|--|--|--|--|--|--|--|--|--|--|--|--|--|--|--|--|--|--|--|--|--|--|--|--|--|--|--|--|--|--|--|--|--|--|--|--|--|--|--|--|--|--|--|--|--|--|--|--|--|--|--|--|--|--|--|--|--|--|--|--|--|--|--|--|--|--|--|--|--|--|--|--|--|--|--|--|--|--|--|--|--|--|--|--|--|--|--|--|--|--|--|--|--|--|--|--|--|--|--|--|--|--|--|--|--|--|--|--|--|--|--|--|--|--|--|--|--|--|--|--|--|--|--|--|--|--|--|--|--|--|--|--|--|--|--|--|--|--|--|--|--|--|--|--|--|--|--|--|--|--|--|--|--|--|--|--|--|--|--|--|--|--|--|--|--|--|--|--|--|--|--|--|--|--|--|--|--|--|--|--|--|--|--|--|--|--|--|--|--|--|--|--|--|--|--|--|--|--|--|--|--|--|--|--|--|--|--|--|--|--|--|--|--|--|--|--|--|--|--|--|--|--|--|--|--|--|--|--|--|--|--|--|--|--|--|--|--|--|--|--|--|--|--|--|--|--|--|--|--|--|--|--|--|--|--|--|--|--|--|--|--|--|--|--|--|--|--|--|--|--|--|--|--|--|--|--|--|--|--|--|--|--|--|--|--|--|--|--|--|--|--|--|--|--|--|--|--|--|--|--|--|--|--|--|--|--|--|--|--|--|--|--|--|--|--|--|--|--|--|--|--|--|--|--|--|--|--|--|--|--|--|--|--|--|--|--|--|--|--|--|--|--|--|--|--|--|--|--|--|--|--|--|--|--|--|--|--|--|--|--|--|--|--|--|--|--|--|--|--|--|--|--|--|--|--|--|--|--|--|--|--|--|--|--|--|--|--|--|--|--|--|--|--|--|--|--|--|--|--|--|--|--|--|--|--|--|--|--|--|--|--|--|--|--|--|--|--|--|--|--|--|--|--|--|--|--|--|--|--|--|--|--|--|--|--|--|--|--|--|--|--|--|--|--|--|--|--|--|--|--|--|--|--|--|--|--|--|--|--|--|--|--|--|--|--|--|--|--|--|--|--|--|--|--|--|--|--|--|--|--|--|--|--|--|--|--|--|--|--|--|--|--|--|--|--|--|--|--|--|--|--|--|--|--|--|--|--|--|--|--|--|--|--|--|--|--|--|--|--|--|--|--|--|--|--|--|--|--|--|--|--|--|--|--|--|--|--|--|--|--|--|--|--|--|--|--|--|--|--|--|--|--|--|--|--|--|--|--|--|--|--|--|--|--|--|--|--|--|--|--|--|--|--|--|--|--|--|--|--|--|--|--|--|--|--|--|--|--|--|--|--|--|--|--|--|--|--|--|--|--|--|--|--|--|--|--|--|--|--|--|--|----|

| B(Alt)   | AAA              |  | 01/92 → 09/97 | AC              | VKMA 31060<br>VKMV 7DK1360<br>VKM 31060                               | 1 |   | 1 |  |   |  |   |  |  |   |       |  |
|--|------------------|--|---------------|-----------------|---|---|---|---|--|---|--|---|--|--|---|-------|--|
| <b>VW  GOLF III (1H1) / GOLF III Variant (1H5) 2.9 VR6</b> |                  |  |               |                 |   |   |   |   |  |   |  |   |  |  |   |       |  |
|  | ABV              |  | 10/94 → 04/99 |                 | <b>OXOXOXO</b>  |   |   |   |  |   |  |   |  |  |   |       |  |
|  | ABV              |  | 10/94 → 04/99 |                 | VKPC 81611  |   |   |   |  | 1 |  |   |  |  |   |       |  |
|  | B(Alt) ABV       |  | 10/94 → 04/99 | <b>AC</b>       | VKMV 7PK1290<br>VKM 31060   | 1 |   | 1 |  |   |  |   |  |  |   |       |  |
|  | B(Alt) ABV       |  | 10/94 → 04/99 | AC              | VKMA 31060<br>VKMV 7DK1360<br>VKM 31060                               | 1 |   | 1 |  | 1 |  |   |  |  |   |       |  |
| <b>VW  GOLF III (1H1) / GOLF III Variant (1H5) 1.9 D</b>   |                  |  |               |                 |   |   |   |   |  |   |  |   |  |  |   |       |  |
|  | 1Y               |  | 11/91 → 04/99 | →IMot. 378 364  | VKMA 01011<br>VKM 11010   | 1 |   | 1 |  |   |  |   |  |  | 4 | T0069 |  |
|  | 1Y               |  | 11/91 → 04/99 | Mot. 378 365  → | VKMA 01013<br>VKM 11014   | 1 |   | 1 |  |   |  |   |  |  | 4 | T0069 |  |
|  | 1Y               |  | 11/91 → 04/99 | 2)              | VKPA 81401<br>VKPC 81401  |   |   |   |  | 1 |  |   |  |  |   |       |  |
|  | B(Alt) 1Y        |  | 11/91 → 04/99 | <b>AC</b>       | VKMA 31028<br>VKMV 10AVx730<br>VKMV 6PK1045<br>VKM 31004<br>VKM 31030 | 2 |   | 2 |  | 1 |  |   |  |  |   |       |  |
|  | B(Alt), B(PS)1Y  |  | 11/91 → 04/99 | <b>AC</b>       | VKMA 31028<br>VKMV 10AVx730<br>VKMV 6PK1045<br>VKM 31004<br>VKM 31030 | 1 |   | 1 |  | 1 |  |   |  |  |   |       |  |
|  | 1Y               |  | 11/91 → 04/99 |                 | VKM _____   |   |   |   |  |   |  | 1 |  |  |   |       |  |
| <b>VW  GOLF III (1H1) / GOLF III Variant (1H5) 1.9 SDI</b> |                  |  |               |                 |   |   |   |   |  |   |  |   |  |  |   |       |  |
|  | AEY              |  | 04/97 → 04/99 |                 | VKMA 01014<br>VKM 11014<br>VKM 21012                                  | 1 | 1 | 1 |  |   |  |   |  |  | 5 | T0650 |  |
|  | AEY              |  | 04/97 → 04/99 | 2)              | VKPA 81401<br>VKPC 81401  |   |   |   |  | 1 |  |   |  |  |   |       |  |
|  | B(Alt), B(PS)AEY |  | 04/97 → 04/99 | <b>AC</b>       | VKMA 31028<br>VKMV 10AVx730<br>VKMV 6PK1045<br>VKM 31004<br>VKM 31030 | 2 |   | 2 |  | 1 |  |   |  |  |   |       |  |
|  | B(Alt), B(PS)AEY |  | 04/97 → 04/99 | AC              | VKMA 31030<br>VKMV 11.5x790<br>VKMV 6PK1145<br>VKM 31004<br>VKM 31030 | 1 |   | 1 |  | 1 |  |   |  |  |   |       |  |
|  | AEY              |  | 04/97 → 04/99 |                 | VKM _____   |   |   |   |  |   |  | 1 |  |  |   |       |  |
| <b>VW  GOLF III (1H1) / GOLF III Variant (1H5) 1.9 TD</b>  |                  |  |               |                 |   |   |   |   |  |   |  |   |  |  |   |       |  |
|  | AAZ              |  | 11/91 → 04/99 | →IMot. 552 765  | VKMA 01011<br>VKM 11010   | 1 |   | 1 |  |   |  |   |  |  | 4 | T0069 |  |
|  | AAZ              |  | 11/91 → 04/99 | Mot. 552 766  → | VKMA 01013<br>VKM 11014   | 1 |   | 1 |  |   |  |   |  |  | 4 | T0069 |  |
|  | AAZ              |  | 11/91 → 04/99 | 2)              | VKPA 81401<br>VKPC 81401  |   |   |   |  | 1 |  |   |  |  |   |       |  |
|  | B(Alt) AAZ       |  | 11/91 → 04/99 | <b>AC</b>       | VKMA 31028<br>VKMV 10AVx730<br>VKMV 6PK1045<br>VKM 31004<br>VKM 31030 | 2 |   | 2 |  | 1 |  |   |  |  |   |       |  |
|  | B(Alt), B(PS)AAZ |  | 11/91 → 04/99 | <b>AC</b>       | VKMA 31028<br>VKMV 10AVx730<br>VKMV 6PK1045<br>VKM 31004<br>VKM 31030 | 1 |   | 1 |  | 1 |  |   |  |  |   |       |  |
|  | B(Alt), B(PS)AAZ |  | 11/91 → 04/99 | <b>AC</b>       | VKMA 31030<br>VKMV 11.5x790<br>VKMV 6PK1145<br>VKM 31004<br>VKM 31030 | 2 |   | 2 |  | 1 |  |   |  |  |   |       |  |
|  | AAZ              |  | 11/91 → 04/99 |                 | VKM _____   |   |   |   |  |   |  | 1 |  |  |   |       |  |
| <b>VW  GOLF III (1H1) / GOLF III Variant (1H5) 1.9 TDI</b> |                  |  |               |                 |   |   |   |   |  |   |  |   |  |  |   |       |  |
|  | 1Z               |  | 09/93 → 04/99 | →IMot. 289 575  | VKMA 01012<br>VKM 11012<br>VKM 21012                                  | 1 | 1 | 1 |  |   |  |   |  |  | 5 | T0650 |  |



































| 1Z                                      |  | 09/93 → 04/99 | Mot. 289 576 I→                       | VKMA 01014<br>VKM 11014<br>VKM 21012                                  | 1<br>1<br>1      | 1<br>1      | 1 |  |        |  |  |  |   |   |  |  |  |  | 5 | T0650 |  |
|---|--|---------------|---------------------------------------|---|------------------|-------------|---|--|--------|--|--|--|---|---|--|--|--|--|---|-------|--|
|   | AFN, AHU, ALE                          | 09/93 → 04/99 |                                       | VKMA 01014<br>VKM 11014<br>VKM 21012                                  | 1<br>1<br>1      | 1<br>1      | 1 |  |        |  |  |  |   |   |  |  |  |  | 5 | T0650 |  |
|   | 1Z, AFN, AHU, ALE                      | 09/93 → 04/99 | 2)                                    | VKPA 81401<br>VKPC 81401  |                  |             |   |  | 1<br>1 |  |  |  |   |   |  |  |  |  |   |       |  |
|   | <b>B(Alt), B(PS)</b> 1Z, AFN, AHU, ALE | 09/93 → 04/99 | <b>AC</b>                             | VKMA 31028<br>VKMV 10AVx730<br>VKMV 6PK1045<br>VKM 31004<br>VKM 31030 | 2<br>1<br>1<br>1 | 2<br>1<br>1 |   |  |        |  |  |  |   |   |  |  |  |  |   |       |  |
|   | <b>B(Alt), B(PS)</b> 1Z, AFN, AHU, ALE | 09/93 → 04/99 | <b>AC</b>                             | VKMA 31030<br>VKMV 11.5x790<br>VKMV 6PK1145<br>VKM 31004<br>VKM 31030 | 2<br>1<br>1      | 2<br>1<br>1 |   |  |        |  |  |  |   |   |  |  |  |  |   |       |  |
|   | 1Z, AFN, AHU, ALE                      | 09/93 → 04/99 |                                       | VKM_____  |                  |             |   |  |        |  |  |  | 1 |   |  |  |  |  |   |       |  |
| <b>VW  GOLF III Cabriolet (1E7) 1.6</b> |  |               |                                       |   |                  |             |   |  |        |  |  |  |   |   |  |  |  |  |   |       |  |
|   | AEK, AFT, AKS                          | 10/94 → 05/98 |                                       | VKMA 01009<br>VKM 11000   | 1<br>1           | 1           |   |  |        |  |  |  |   |   |  |  |  |  | 3 | T0124 |  |
|   | AEK, AFT, AKS                          | 10/94 → 05/98 | 2)                                    | VKPA 81401<br>VKPC 81401  |                  |             |   |  | 1<br>1 |  |  |  |   |   |  |  |  |  |   |       |  |
|   | <b>B(Alt)</b> AEK, AFT, AKS            | 10/94 → 05/98 | <b>AC</b> ,<br>→ ICH 1E-T-012 000     | VKMV 6PK976<br>VKM 31004<br>VKM 31210                                 | 1<br>1           | 1           |   |  |        |  |  |  |   |   |  |  |  |  |   |       |  |
|   | <b>B(Alt)</b> AEK, AFT, AKS            | 10/94 → 05/98 | <b>AC</b> ,<br>CH 1E-T-012 001 I→     | VKMV 6PK1033<br>VKM 31004<br>VKM 31210                                | 1<br>1           | 1           |   |  |        |  |  |  |   |   |  |  |  |  |   |       |  |
|   | <b>B(Alt)</b> AEK, AFT, AKS            | 10/94 → 05/98 | <b>AC</b>                             | VKMV 6PK1153<br>VKM 31004<br>VKM 31210                                | 1<br>1           | 1           |   |  |        |  |  |  |   |   |  |  |  |  |   |       |  |
|   | <b>B(PS)</b> AEK, AFT, AKS             | 10/94 → 05/98 | <b>AC</b>                             | VKMV 11.5x685   |                  | 1           |   |  |        |  |  |  |   |   |  |  |  |  |   |       |  |
|   | <b>B(PS)</b> AEK, AFT, AKS             | 10/94 → 05/98 | <b>AC</b>                             | VKMV 11.5x755   |                  | 1           |   |  |        |  |  |  |   |   |  |  |  |  |   |       |  |
| <b>VW  GOLF III Cabriolet (1E7) 1.8</b> |  |               |                                       |   |                  |             |   |  |        |  |  |  |   |   |  |  |  |  |   |       |  |
|   | ABS                                    | 07/93 → 05/98 | 3)                                    | VKMS 01000<br>VKMA 01000<br>VKM 11000                                 | 1<br>1<br>1      | 1<br>1      |   |  |        |  |  |  | 3 | 4 |  |  |  |  | 3 | T0005 |  |
|   | AAM                                    | 07/93 → 12/94 |                                       | VKMA 01000<br>VKM 11000   | 1<br>1           | 1           |   |  |        |  |  |  |   |   |  |  |  |  | 3 | T0005 |  |
|   | AAM                                    | 01/95 → 05/98 |                                       | VKMA 01009<br>VKM 11000   | 1<br>1           | 1           |   |  |        |  |  |  |   |   |  |  |  |  | 3 | T0124 |  |
|   | ADZ                                    | 07/93 → 05/98 |                                       | VKMA 01009<br>VKM 11000   | 1<br>1           | 1           |   |  |        |  |  |  |   |   |  |  |  |  | 3 | T0124 |  |
|   | AAM, ABS, ADZ                          | 07/93 → 05/98 | 2)                                    | VKPA 81401<br>VKPC 81401  |                  |             |   |  | 1<br>1 |  |  |  |   |   |  |  |  |  |   |       |  |
|   | <b>B(Alt)</b> AAM, ABS, ADZ            | 07/93 → 05/98 | <b>A⊙</b>                             | VKMV 6PK894   |                  | 1           |   |  |        |  |  |  |   |   |  |  |  |  |   |       |  |
|   | <b>B(Alt)</b> AAM, ABS, ADZ            | 07/93 → 05/98 | <b>A⊙, AC</b> ,<br>→ ICH 1E-T-012 000 | VKMV 6PK976<br>VKM 31004<br>VKM 31210                                 | 1<br>1           | 1           |   |  |        |  |  |  |   |   |  |  |  |  |   |       |  |
|   | <b>B(Alt)</b> AAM, ABS, ADZ            | 07/93 → 05/98 | <b>A⊙, AC</b> ,<br>CH 1E-T-012 001 I→ | VKMV 6PK1033<br>VKM 31004<br>VKM 31210                                | 1<br>1           | 1           |   |  |        |  |  |  |   |   |  |  |  |  |   |       |  |
|   | <b>B(Alt)</b> AAM, ABS, ADZ            | 07/93 → 05/98 | <b>A⊙, AC</b>                         | VKMV 6PK1153<br>VKM 31004<br>VKM 31210                                | 1<br>1           | 1           |   |  |        |  |  |  |   |   |  |  |  |  |   |       |  |
|   | <b>B(PS)</b> AAM, ABS, ADZ             | 07/93 → 05/98 | <b>AC</b>                             | VKMV 11.5x685   |                  | 1           |   |  |        |  |  |  |   |   |  |  |  |  |   |       |  |
|   | <b>B(PS)</b> AAM, ABS, ADZ             | 07/93 → 05/98 | <b>AC</b>                             | VKMV 11.5x755   |                  | 1           |   |  |        |  |  |  |   |   |  |  |  |  |   |       |  |

|   |                            |               |            |   |                  |             |   |        |   |         |
|---|----------------------------|---------------|--|---|------------------|-------------|---|--------|---|---------|
| <b>VW  GOLF III Cabriolet (1E7) 2.0</b>                    |                            |               |  |   |                  |             |   |        |   |         |
|    | 2E, ADY, AGG, AKR          | 07/93 → 05/98 |  | VKMA 01002<br>VKM 11000   | 1<br>1           | 1           |   |        | 3 | T0091   |
|    | 2E, ADY, AGG, AKR          | 07/93 → 05/98 | 2)   | VKPA 81401<br>VKPC 81401  |                  |             |   | 1<br>1 |   |         |
|    | B(Alt) 2E, ADY, AGG, AKR   | 07/93 → 05/98 |   | VKMOV 6PK894  |                  | 1           |   |        |   |         |
|   | B(Alt) 2E, ADY, AGG, AKR   | 07/93 → 05/98 |  <br>→ ICH 1E-T-012 000  | VKMOV 6PK976<br>VKM 31004<br>VKM 31210                                  | 1<br>1           | 1           |   |        |   |         |
|   | B(Alt) 2E, ADY, AGG, AKR   | 07/93 → 05/98 |  <br>CH 1E-T-012 001 I→  | VKMOV 6PK1033<br>VKM 31004<br>VKM 31210                                 | 1<br>1           | 1           |   |        |   |         |
|   | B(Alt) 2E, ADY, AGG, AKR   | 07/93 → 05/98 |    | VKMOV 6PK1153<br>VKM 31004<br>VKM 31210                                 | 1<br>1           | 1           |   |        |   |         |
|   | B(PS) 2E, ADY, AGG, AKR    | 07/93 → 05/98 |   | VKMOV 11.5x685  |                  | 1           |   |        |   |         |
|   | B(PS) 2E, ADY, AGG, AKR    | 07/93 → 05/98 |   | VKMOV 11.5x755  |                  | 1           |   |        |   |         |
| <b>VW  GOLF III Cabriolet (1E7) 1.9 TDI</b>                |                            |               |  |   |                  |             |   |        |   |         |
|    | 1Z, AFN, AHU               | 08/95 → 05/98 |  | VKMA 01014<br>VKM 11014<br>VKM 21012                                    | 1<br>1           | 1<br>1      |   |        |   | 5 T0650 |
|    | 1Z, AFN, AHU               | 08/95 → 05/98 | 2)   | VKPA 81401<br>VKPC 81401  |                  |             |   | 1<br>1 |   |         |
|   | B(Alt), B(PS) 1Z, AFN, AHU | 08/95 → 05/98 |    | VKMA 31028<br>VKMOV 10AVx730<br>VKMOV 6PK1045<br>VKM 31004<br>VKM 31030 | 2<br>1<br>1<br>1 | 2<br>1<br>1 |   |        |   |         |
|   | B(Alt), B(PS) 1Z, AFN, AHU | 08/95 → 05/98 |   | VKMA 31030<br>VKMOV 11.5x790<br>VKMOV 6PK1145<br>VKM 31004<br>VKM 31030 | 2<br>1<br>1<br>1 | 2<br>1<br>1 |   |        |   |         |
|    | 1Z, AFN, AHU               | 08/95 → 05/98 |  | VKM _____   |                  |             |   | 1      |   |         |
| <b>VW  GOLF IV (1J1) / GOLF IV Variant (1J5) 1.4 16V</b> |                            |               |  |   |                  |             |   |        |   |         |
|    | AHW                        | 08/97 → 06/07 | → Mot. 160 000   | VKMA 01120<br>VKM 11120<br>VKM 11121<br>VKM 21120<br>VKM 21121          | 2<br>1<br>1      | 2<br>1<br>1 | 2 |        |   | T0165   |
|   | AHW                        | 08/97 → 06/07 | Mot. 160 001 I→  | VKMA 01121<br>VKM 11120<br>VKM 11124<br>VKM 21120<br>VKM 21121          | 2<br>1<br>1      | 2<br>1<br>1 | 2 |        |   | T0165   |
|   | AKQ                        | 08/97 → 06/07 | → Mot. 242 000   | VKMA 01120<br>VKM 11120<br>VKM 11121<br>VKM 21120<br>VKM 21121          | 2<br>1<br>1      | 2<br>1<br>1 | 2 |        |   | T0165   |
|   | AKQ                        | 08/97 → 06/07 | Mot. 242 001 I→  | VKMA 01121<br>VKM 11120<br>VKM 11124<br>VKM 21120<br>VKM 21121          | 2<br>1<br>1      | 2<br>1<br>1 | 2 |        |   | T0165   |
|   | APE, AXP, BCA              | 08/97 → 06/07 |  | VKMA 01121<br>VKM 11120<br>VKM 11124<br>VKM 21120<br>VKM 21121          | 2<br>1<br>1      | 2<br>1<br>1 | 2 |        |   | T0165   |
|    | AHW, AKQ, APE, AXP,<br>BCA | 08/97 → 06/07 |  | VKPC 81407  |                  |             |   | 1      |   |         |











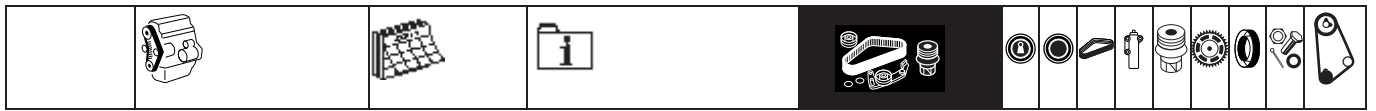















VW























|   |  |  |                       |  |  |  |  |  |  |  |  |  |  |
|---|---|---|--|--|---|---|---|---|---|---|---|---|---|
|  <b>B(Alt)</b>  | AHW, AKQ, APE, AXP,<br>BCA  | 08/97 → 06/07   | <i>AC</i>  | VKMA 31206<br>VKMV 6PK1078<br>VKM 31015  | 1<br>1  | 1<br>1  |   |   |   |   |   |   |   |
| <b>B(Alt)</b>   | AHW, AKQ, APE, AXP,<br>BCA  | 08/97 → 06/07   | <b>AC</b>  | VKMA 31207<br>VKMV 6PK1548<br>VKM 31016<br>VKM 31207                               | 1<br>1  | 1<br>1  | 1<br>1  |   |   |   |   |   |   |
| <b>VW  GOLF IV (1J1) / GOLF IV Variant (1J5) 1.6</b>       |   |   |  |  |   |   |   |   |   |   |   |   |   |
|  <b>B(Alt)</b>  | AEH, AKL, APF, AVU,<br>BFQ, BJH   | 08/97 → 06/07   |  | VKMA 01113<br>VKM 11113  | 1<br>1  | 1   |   |   |   |   |   |   | T0149   |
|  <b>B(Alt)</b>  | AEH, AKL, APF, AVU,<br>BFQ, BJH   | 08/97 → 06/07   |  | VKPC 81408   |   |   |   | 1   |   |   |   |   |   |
|  <b>B(Alt)</b>  | AEH, AKL, APF, AVU,<br>BFQ, BJH   | 08/97 → 06/07   | <i>AC</i>  | VKMA 31203<br>VKMV 6PK1120<br>VKM 31011  | 1<br>1  | 1<br>1  |   |   |   |   |   |   |   |
| <b>B(Alt)</b>   | AEH, AKL, APF, AVU,<br>BFQ, BJH   | 08/97 → 06/07   | <b>AC</b>  | VKMA 31204<br>VKMV 6DK1195<br>VKM 31011  | 1<br>1  | 1<br>1  |   |   |   |   |   |   |   |
| <b>VW  GOLF IV (1J1) / GOLF IV Variant (1J5) 1.6 16V</b>   |   |   |  |  |   |   |   |   |   |   |   |   |   |
|  <b>B(Alt)</b>  | ATN, AUS, AZD, BCB  | 02/00 → 06/07   |  | VKMA 01121<br>VKM 11120<br>VKM 11124<br>VKM 21120<br>VKM 21121                     | 2<br>1<br>1<br>1<br>1   | 2<br>1  | 2   |   |   |   |   |   | T0165   |
|  <b>B(Alt)</b>  | ATN, AUS, AZD, BCB  | 02/00 → 06/07   |  | VKPC 81419   |   |   |   | 1   |   |   |   |   |   |
|  <b>B(Alt)</b>  | ATN, AUS, AZD, BCB  | 02/00 → 06/07   | <i>AC</i>  | VKMA 31206<br>VKMV 6PK1078<br>VKM 31015  | 1<br>1  | 1<br>1  |   |   |   |   |   |   |   |
| <b>B(Alt)</b>   | ATN, AUS, AZD, BCB  | 02/00 → 06/07   | <b>AC</b>  | VKMA 31207<br>VKMV 6PK1548<br>VKM 31016<br>VKM 31207                               | 1<br>1  | 1<br>1  | 1<br>1  |   |   |   |   |   |   |
| <b>VW  GOLF IV (1J1) / GOLF IV Variant (1J5) 1.6 FSI</b> |   |   |  |  |   |   |   |   |   |   |   |   |   |
|  <b>B(Alt)</b>  | BAD   | 01/02 → 06/07   |  | VKMA 01121<br>VKM 11120<br>VKM 11124<br>VKM 21120<br>VKM 21121                     | 2<br>1<br>1<br>1<br>1   | 2<br>1  | 2   |   |   |   |   |   | T0165   |
|  <b>B(Alt)</b>  | BAD   | 01/02 → 06/07   |  | VKPC 81419   |   |   |   | 1   |   |   |   |   |   |
|  <b>B(Alt)</b>  | BAD   | 01/02 → 06/07   | <i>AC</i>  | VKMA 31206<br>VKMV 6PK1078<br>VKM 31015  | 1<br>1  | 1<br>1  |   |   |   |   |   |   |   |
| <b>B(Alt)</b>   | BAD   | 01/02 → 06/07   | <b>AC</b>  | VKMA 31208<br>VKMV 6PK1540<br>VKM 31016<br>VKM 31207                               | 1<br>1  | 1<br>1  | 1<br>1  |   |   |   |   |   |   |
| <b>VW  GOLF IV (1J1) / GOLF IV Variant (1J5) 1.8</b>     |   |   |  |  |   |   |   |   |   |   |   |   |   |
|  <b>B(Alt)</b>  | AGN   | 08/97 → 06/07   |  → ICH 1J-Y-850 000 | VKMA 01115<br>VKM 11115<br>VKM 21115   | 1<br>1<br>1   | 1<br>1  | 1   |   |   |   |   |   | T0151   |
| <b>B(Alt)</b>   | AGN   | 08/97 → 06/07   |  CH 1J-Y-850 001 →  | VKMA 01116<br>VKM 11116<br>VKM 21115   | 1<br>1<br>1   | 1<br>1  | 1   |   |   |   |   |   | T0151   |
|  <b>B(Alt)</b>  | AGN   | 08/97 → 06/07   |  | VKPC 81620   |   |   |   | 1   |   |   |   |   |   |
|  <b>B(Alt)</b>  | AGN   | 08/97 → 06/07   | <i>AC</i>  | VKMA 31203<br>VKMV 6PK1120<br>VKM 31011  | 1<br>1  | 1<br>1  |   |   |   |   |   |   |   |
| <b>B(Alt)</b>   | AGN   | 08/97 → 06/07   | <b>AC</b>  | VKMA 31204<br>VKMV 6DK1195<br>VKM 31011  | 1<br>1  | 1<br>1  |   |   |   |   |   |   |   |





| VW  GOLF IV (1J1) / GOLF IV Variant (1J5) 1.8 Turbo |   |               |   |  |                       |                       |   |   |         |
|--|---|---------------|---|--|-----------------------|-----------------------|---|---|---------|
|   | AGU, ARZ, AUM, AUQ                            | 08/97 → 06/07 |  ICH1J-Y-850 000   | VKMA 01115<br>VKM 11115<br>VKM 21115                           | 1<br>1<br>1           | 1<br>1<br>1           |   |   | T0151   |
|  | AGU, ARZ, AUM, AUQ                            | 08/97 → 06/07 |  CH1J-Y-850 001 I→ | VKMA 01116<br>VKM 11116<br>VKM 21115                           | 1<br>1<br>1           | 1<br>1<br>1           |   |   | T0151   |
|   | AGU, ARZ, AUM, AUQ                            | 08/97 → 06/07 |   | VKPC 81620   |                       |                       |   | 1 |         |
|   | <b>B(Alt)</b> AGU, ARZ, AUM, AUQ              | 08/97 → 06/07 | <i>AC</i>   | VKMA 31203<br>VKMV 6PK1120<br>VKM 31011                        | 1<br>1<br>1           | 1<br>1                |   |   |         |
|  | <b>B(Alt)</b> AGU, ARZ, AUM, AUQ              | 08/97 → 06/07 | <b>AC</b>   | VKMA 31204<br>VKMV 6DK1195<br>VKM 31011                        | 1<br>1<br>1           | 1<br>1                |   |   |         |
| VW  GOLF IV (1J1) / GOLF IV Variant (1J5) 2.0       |   |               |   |  |                       |                       |   |   |         |
|   | APK, AQY, AZG, AZH,<br>AZJ, BEH               | 07/98 → 06/07 |   | VKMA 01113<br>VKM 11113  | 1<br>1                | 1                     |   |   | T0149   |
|   | APK, AQY, AZG, AZH,<br>AZJ, BEH               | 07/98 → 06/07 |   | VKPC 81620   |                       |                       |   | 1 |         |
|   | <b>B(Alt)</b> APK, AQY, AZG, AZH,<br>AZJ, BEH | 07/98 → 06/07 | <i>AC</i>   | VKMA 31203<br>VKMV 6PK1120<br>VKM 31011                        | 1<br>1<br>1           | 1<br>1                |   |   |         |
|  | <b>B(Alt)</b> APK, AQY, AZG, AZH,<br>AZJ, BEH | 07/98 → 06/07 | <b>AC</b>   | VKMA 31204<br>VKMV 6DK1195<br>VKM 31011                        | 1<br>1<br>1           | 1<br>1                |   |   |         |
| VW  GOLF IV (1J1) / GOLF IV Variant (1J5) 2.3 V5  |   |               |   |  |                       |                       |   |   |         |
|   | AGZ, AQN                                      | 08/97 → 06/07 |   | <b>ΟΧΘΙΟΧΟ</b>   |                       |                       |   |   |         |
|   | AGZ, AQN                                      | 08/97 → 06/07 |   | VKPC 81622   |                       |                       |   | 1 |         |
|   | <b>B(Alt)</b> AGZ                             | 08/97 → 06/07 | <i>AC</i>   | VKMV 6PK1285   |                       | 1                     |   |   |         |
|  | <b>B(Alt)</b> AQN                             | 10/00 → 06/07 | <i>AC</i>   | VKMV 6PK1264   |                       | 1                     |   |   |         |
| VW  GOLF IV (1J1) / GOLF IV Variant (1J5) 2.8 V6  |   |               |   |  |                       |                       |   |   |         |
|   | AQP, AUE, BDE                                 | 03/99 → 06/07 |   | <b>ΟΧΘΙΟΧΟ</b>   |                       |                       |   |   |         |
|   | AQP, AUE, BDE                                 | 03/99 → 06/07 |   | VKPC 81611   |                       |                       |   | 1 |         |
|   | <b>B(Alt)</b> AQP, AUE, BDE                   | 03/99 → 06/07 | <i>AC</i>   | VKMV 6PK1264   |                       | 1                     |   |   |         |
| VW  GOLF IV (1J1) / GOLF IV Variant (1J5) 3.2 R32 |   |               |   |  |                       |                       |   |   |         |
|   | BFH, BML                                      | 09/02 → 06/05 |   | <b>ΟΧΘΙΟΧΟ</b>   |                       |                       |   |   |         |
|   | BFH, BML                                      | 09/02 → 06/05 |   | —  |                       |                       |   | 1 |         |
|   | <b>B(Alt)</b> BFH, BML                        | 09/02 → 06/05 | <i>AC</i>   | VKMV 6PK1264   |                       | 1                     |   |   |         |
| VW  GOLF IV (1J1) / GOLF IV Variant (1J5) 1.9 SDI |   |               |   |  |                       |                       |   |   |         |
|   | AGP   | 08/97 → 06/07 | →IMot. 400 000  | VKMA 01130<br>VKM 11130<br>VKM 21004<br>VKM 21130              | 1<br>1<br>1<br>1      | 2<br>1<br>1<br>1      | 1 |   | 5 T0173 |
|  | AGP   | 08/97 → 06/07 | Mot. 400 001 I→   | VKMA 01251<br>VKM 11130<br>VKM 21004<br>VKM 21130<br>VKM 21131 | 1<br>1<br>1<br>1<br>1 | 3<br>1<br>1<br>1<br>1 | 1 |   | 8 T0173 |
|  | AQM   | 08/97 → 06/07 | →IMot. 029 999  | VKMA 01130<br>VKM 11130<br>VKM 21004<br>VKM 21130              | 1<br>1<br>1<br>1      | 2<br>1<br>1<br>1      | 1 |   | 5 T0173 |
|  | AQM   | 08/97 → 06/07 | Mot. 030 000 I→,<br>→IMot. 045 000  | VKMA 01131<br>VKM 11130<br>VKM 21004<br>VKM 21130<br>VKM 21131 | 1<br>1<br>1<br>1<br>1 | 3<br>1<br>1<br>1<br>1 | 1 |   | 8 T0173 |
|  | AQM   | 08/97 → 06/07 | Mot. 045 001 I→   | VKMA 01251<br>VKM 11130<br>VKM 21004                           | 1<br>1<br>1           | 3<br>1<br>1           | 1 |   | 8 T0173 |



|   |  |  |              |  |  |  |  |  |  |  |  |
|---|---|---|---|--|---|---|---|---|---|---|---|
|   |   |   |   | VKM 21130<br>VKM 21131   | 1<br>1  |   |   |   |   |   |   |
|   | AGP, AQM  | 08/97 → 06/07   |   | VKPC 81623   |   |   | 1   |   |   |   |   |
|   | <b>B(Alt)</b> AGP, AQM  | 08/97 → 06/07   | <b>AC</b>   | VKMA 31005<br>VKMV 6PK1660<br>VKM 31002<br>VKM 31018                               | 1<br>1<br>1<br>1  | 1   |   |   |   | 1<br>1  |   |
|   | <b>B(Alt)</b> AGP, AQM  | 08/97 → 06/07   | <b>AC</b>   | VKMA 31005<br>VKMV 6PK1660<br>VKM 31002<br>VKM 31018                               | 1<br>1<br>1<br>1  | 1<br>1  | 1<br>1  |   |   | 2<br>1<br>1   |   |
|   | AGP<br>AQM  | 08/97 → 06/07<br>08/97 → 06/07  |   | VKM____  |   |   |   |   | 1   |   |   |
|   |   |   | → <b>ICH</b> 1J-3B075 000,<br>1J-3D016 000,<br>1J-3P066 000,<br>1J-3U205 000,<br>1J-3W350 000 | VKM____  |   |   |   |   | 1   |   |   |
|   | AQM   | 08/97 → 06/07   | <b>CH</b> 1J-3B075 001,<br>1J-3D016 001,<br>1J-3P066 001,<br>1J-3U205 001,<br>1J-3W350 001  → | VKM____  |   |   |   |   | 1   |   |   |
| <b>VW  GOLF IV (1J1) / GOLF IV Variant (1J5) 1.9 TDI 90</b>    |   |   |   |  |   |   |   |   |   |   |   |
|   | AGR   | 10/97 → 05/06   | → <b>IMot.</b> 565 000  | VKMA 01131<br>VKM 11130<br>VKM 21004<br>VKM 21130<br>VKM 21131                     | 1<br>1<br>1<br>1<br>1   | 3<br>1<br>1<br>1<br>1   | 1   |   |   |   | 8 T0173   |
|   | AGR   | 10/97 → 05/06   | <b>Mot.</b> 565 001  →  | VKMA 01251<br>VKM 11130<br>VKM 21004<br>VKM 21130<br>VKM 21131                     | 1<br>1<br>1<br>1<br>1   | 3<br>1<br>1<br>1<br>1   | 1   |   |   |   | 8 T0173   |
|   | ALH   | 10/97 → 05/06   | → <b>IMot.</b> 500 000  | VKMA 01131<br>VKM 11130<br>VKM 21004<br>VKM 21130<br>VKM 21131                     | 1<br>1<br>1<br>1<br>1   | 3<br>1<br>1<br>1<br>1   | 1   |   |   |   | 8 T0173   |
|   | ALH   | 10/97 → 05/06   | <b>Mot.</b> 500 001  →  | VKMA 01251<br>VKM 11130<br>VKM 21004<br>VKM 21130<br>VKM 21131                     | 1<br>1<br>1<br>1<br>1   | 3<br>1<br>1<br>1<br>1   | 1   |   |   |   | 8 T0173   |
|   | AGR, ALH  | 10/97 → 05/06   |   | VKPC 81623   |   |   | 1   |   |   |   |   |
|   | <b>B(Alt)</b> AGR, ALH  | 10/97 → 05/06   | <b>AC</b>   | VKMA 31014<br>VKMV 6PK1660<br>VKM 31002<br>VKM 31012                               | 1<br>1<br>1<br>1  | 1<br>1  | 1<br>1  |   |   | 1<br>1  |   |
|   | <b>B(Alt)</b> AGR, ALH  | 10/97 → 05/06   | <b>AC</b>   | VKMA 31014<br>VKMV 6PK1660<br>VKM 31002<br>VKM 31012                               | 1<br>1<br>1<br>1  | 1<br>1  | 1<br>1  |   |   | 1<br>1  |   |
|   | AGR, ALH  | 10/97 → 05/06   | → <b>ICH</b> 1J-3B075 000,<br>1J-3D016 000,<br>1J-3P066 000,<br>1J-3U205 000,<br>1J-3W350 000 | VKM____  |   |   |   |   | 1   |   |   |
|   | AGR, ALH  | 10/97 → 05/06   | <b>CH</b> 1J-3B075 001,<br>1J-3D016 001,<br>1J-3P066 001,<br>1J-3U205 001,<br>1J-3W350 001  → | VKM____  |   |   |   |   | 1   |   |   |
| <b>VW  GOLF IV (1J1) / GOLF IV Variant (1J5) 1.9 TDI 100</b> |   |   |   |  |   |   |   |   |   |   |   |
|   | ATD   | 09/00 → 12/02   | → <b>ICH</b> 1J-2B123 078,<br>1J-2P394 000,<br>1J-2U352 773,<br>1J-2U403 276,<br>1J-2W592 782 | VKMA 01942<br>VKM 11142  | 1<br>1  | 1<br>1  | 1<br>1  | 1<br>1  |   |   | 3 T0184   |

|  |                 |               |  | VKM 11145<br>VKM 21142   |        | 1      |   | 1      |  |  |   |  |   |  |  |  |   |       |
|--|-----------------|---------------|--|--|--------|--------|---|--------|--|--|---|--|---|--|--|--|---|-------|
|  | ATD             | 09/00 → 12/02 | → ICH 1J-2B123 078,<br>1J-2P394 000,<br>1J-2U352 773,<br>1J-2U403 276,<br>1J-2W592 782 | VKMA 01142<br>VKM 11142<br>VKM 21142                           | 1<br>1 | 1<br>1 | 1 |        |  |  |   |  |   |  |  |  | 3 | T0184 |
|  | ATD             | 01/02 → 06/07 | CH 1J-2B123 079,<br>1J-2D352 774,<br>1J-2U403 277,<br>1J-2W592 783  →                  | VKMA 01250<br>VKM 11250<br>VKM 21147                           | 1<br>1 | 1<br>1 | 1 |        |  |  |   |  |   |  |  |  |   | T0184 |
|  | AXR             | 09/00 → 06/07 | ↔, → Mot. 010 000  | VKMA 01942<br>VKM 11142<br>VKM 11145<br>VKM 21142              | 1<br>1 | 1<br>1 | 1 | 1      |  |  | 1 |  |   |  |  |  | 3 | T0184 |
|  | AXR             | 09/00 → 06/07 | → Mot. 010 000   | VKMA 01142<br>VKM 11142<br>VKM 21142                           | 1<br>1 | 1<br>1 | 1 |        |  |  |   |  |   |  |  |  | 3 | T0184 |
|  | AXR             | 09/00 → 06/07 | Mot. 010 001  →  | VKMA 01250<br>VKM 11250<br>VKM 21147                           | 1<br>1 | 1<br>1 | 1 |        |  |  |   |  |   |  |  |  |   | T0184 |
|  | ATD, AXR        | 09/00 → 12/02 |  | VKPC 81626   |        |        |   |        |  |  | 1 |  |   |  |  |  |   |       |
|  | ATD, AXR        | 01/03 → 06/07 |  | VKPC 81303   |        |        |   |        |  |  | 1 |  |   |  |  |  |   |       |
|  | B(Alt) ATD, AXR | 09/00 → 06/07 | AC   | VKMA 6PK1120<br>VKM 31019                                      | 1      |        |   | 1      |  |  |   |  |   |  |  |  |   |       |
|  | B(Alt) ATD, AXR | 09/00 → 06/07 | AC   | VKMA 31001<br>VKMV 6DK1195<br>VKM 31019                        | 1<br>1 |        |   | 1<br>1 |  |  |   |  |   |  |  |  |   |       |
|  | ATD, AXR        | 09/00 → 06/07 | → ICH 1J-6-005 000   | VKM_____   |        |        |   |        |  |  |   |  | 1 |  |  |  |   |       |
|  | ATD, AXR        | 09/00 → 06/07 | CH 1J-6-005 001  →   | VKM_____   |        |        |   |        |  |  |   |  | 1 |  |  |  |   |       |
| <b>VW  GOLF IV (1J1) / GOLF IV Variant (1J5) 1.9 TDI 110</b> |                 |               |  |  |        |        |   |        |  |  |   |  |   |  |  |  |   |       |
|  | AHF             | 08/97 → 05/04 | → Mot. 595 000   | VKMA 01131<br>VKM 11130<br>VKM 21004<br>VKM 21130<br>VKM 21131 | 1<br>1 | 3<br>1 | 1 |        |  |  |   |  |   |  |  |  | 8 | T0173 |
|  | AHF             | 08/97 → 05/04 | Mot. 595 001  →  | VKMA 01251<br>VKM 11130<br>VKM 21004<br>VKM 21130<br>VKM 21131 | 1<br>1 | 3<br>1 | 1 |        |  |  |   |  |   |  |  |  | 8 | T0173 |
|  | ASV             | 08/97 → 05/04 | → Mot. 150 000   | VKMA 01131<br>VKM 11130<br>VKM 21004<br>VKM 21130<br>VKM 21131 | 1<br>1 | 3<br>1 | 1 |        |  |  |   |  |   |  |  |  | 8 | T0173 |
|  | ASV             | 08/97 → 05/04 | Mot. 150 001  →  | VKMA 01251<br>VKM 11130<br>VKM 21004<br>VKM 21130<br>VKM 21131 | 1<br>1 | 3<br>1 | 1 |        |  |  |   |  |   |  |  |  | 8 | T0173 |
|  | AHF, ASV        | 08/97 → 05/04 |  | VKPC 81623   |        |        |   |        |  |  | 1 |  |   |  |  |  |   |       |
|  | B(Alt) AHF, ASV | 08/97 → 05/04 | AC   | VKMA 6PK906<br>VKM 31002<br>VKM 31012                          | 1      |        |   | 1      |  |  |   |  |   |  |  |  | 1 |       |
|  | B(Alt) AHF, ASV | 08/97 → 05/04 | AC   | VKMA 31014<br>VKMV 6PK1660<br>VKM 31002<br>VKM 31012           | 1<br>1 | 1<br>1 | 1 | 1      |  |  |   |  |   |  |  |  | 1 | 1     |
|  | AHF, ASV        | 08/97 → 05/04 | → ICH 1J-3B075 000,<br>1J-3D016 000,<br>1J-3P066 000,<br>1J-3U205 000,<br>1J-3W350 000 | VKM_____   |        |        |   |        |  |  |   |  | 1 |  |  |  |   |       |



|  | AHF, ASV               | 08/97 → 05/04 | CH 1J-3B075 001,<br>1J-3D016 001,<br>1J-3P066 001,<br>1J-3U205 001,<br>1J-3W350 001  →    | VKM____   |        |   |   |        |  |  |  |  |  |  |  |  |  | 1       |
|--|------------------------|---------------|---|---|--------|---|---|--------|--|--|--|--|--|--|--|--|--|---------|
| <b>VW  GOLF IV (1J1) / GOLF IV Variant (1J5) 1.9 TDI 115</b> |                        |               |   |   |        |   |   |        |  |  |  |  |  |  |  |  |  |         |
|  | AJM                    | 12/98 → 06/01 | →   Mot. 185 670  | VKMA 01941<br>VKM 11141<br>VKM 11144<br>VKM 21142 | 1<br>1 | 1 | 1 | 1      |  |  |  |  |  |  |  |  |  | 2 T0184 |
|  | AJM                    | 12/98 → 06/01 | →   Mot. 185 670  | VKMA 01141<br>VKM 11141<br>VKM 21142              | 1<br>1 | 1 | 1 |        |  |  |  |  |  |  |  |  |  | 1 T0184 |
|  | AJM                    | 12/98 → 06/01 | Mot. 185 671  →   | VKMA 01942<br>VKM 11142<br>VKM 11145<br>VKM 21142 | 1<br>1 | 1 | 1 | 1      |  |  |  |  |  |  |  |  |  | 3 T0184 |
|  | AJM                    | 12/98 → 06/01 | Mot. 185 671  →   | VKMA 01142<br>VKM 11142<br>VKM 21142              | 1<br>1 | 1 | 1 |        |  |  |  |  |  |  |  |  |  | 3 T0184 |
|  | AUY                    | 12/98 → 06/01 |   | VKMA 01942<br>VKM 11142<br>VKM 11145<br>VKM 21142 | 1<br>1 | 1 | 1 | 1      |  |  |  |  |  |  |  |  |  | 3 T0184 |
|  | AUY                    | 12/98 → 06/01 |   | VKMA 01142<br>VKM 11142<br>VKM 21142              | 1<br>1 | 1 | 1 |        |  |  |  |  |  |  |  |  |  | 3 T0184 |
|  | AJM, AUY               | 12/98 → 06/01 |   | VKPC 81626  |        |   |   |        |  |  |  |  |  |  |  |  |  | 1       |
|  | <b>B(Alt)</b> AJM, AUY | 12/98 → 06/01 | <b>AC</b>   | VKMA 6PK1120<br>VKM 31019                         | 1      |   |   | 1      |  |  |  |  |  |  |  |  |  |         |
|  | <b>B(Alt)</b> AJM, AUY | 12/98 → 06/01 | <b>AC</b>   | VKMA 31001<br>VKMA 6DK1195<br>VKM 31019           | 1<br>1 |   |   | 1<br>1 |  |  |  |  |  |  |  |  |  |         |
|  | AJM, AUY               | 12/98 → 06/01 |   | VKM____   |        |   |   |        |  |  |  |  |  |  |  |  |  | 1       |
| <b>VW  GOLF IV (1J1) / GOLF IV Variant (1J5) 1.9 TDI 130</b> |                        |               |   |   |        |   |   |        |  |  |  |  |  |  |  |  |  |         |
|  | ASZ                    | 11/00 → 12/02 | →<br>ICH 1J-2B123 078,<br>1J-2P394 000,<br>1J-2U352 773,<br>1J-2U403 276,<br>1J-2W592 782 | VKMA 01942<br>VKM 11142<br>VKM 11145<br>VKM 21142 | 1<br>1 | 1 | 1 | 1      |  |  |  |  |  |  |  |  |  | 3 T0184 |
|  | ASZ                    | 11/00 → 12/02 | →   ICH 1J-2B123 078,<br>1J-2P394 000,<br>1J-2U352 773,<br>1J-2U403 276,<br>1J-2W592 782  | VKMA 01142<br>VKM 11142<br>VKM 21142              | 1<br>1 | 1 | 1 |        |  |  |  |  |  |  |  |  |  | 3 T0184 |
|  | ASZ                    | 01/02 → 06/07 | CH 1J-2B123 079,<br>1J-2D352 774,<br>1J-2U403 277,<br>1J-2W592 783  →                     | VKMA 01250<br>VKM 11250<br>VKM 21147              | 1<br>1 | 1 | 1 | 1      |  |  |  |  |  |  |  |  |  | T0184   |
|  | ASZ                    | 11/00 → 12/02 |   | VKPC 81626  |        |   |   |        |  |  |  |  |  |  |  |  |  | 1       |
|  | ASZ                    | 01/03 → 06/07 |   | VKPC 81303  |        |   |   |        |  |  |  |  |  |  |  |  |  | 1       |
|  | <b>B(Alt)</b> ASZ      | 11/00 → 06/07 | <b>AC</b>   | VKMA 6PK1120<br>VKM 31019                         | 1      |   |   | 1      |  |  |  |  |  |  |  |  |  |         |
|  | <b>B(Alt)</b> ASZ      | 11/00 → 06/07 | <b>AC</b>   | VKMA 31001<br>VKMA 6DK1195<br>VKM 31019           | 1<br>1 |   |   | 1<br>1 |  |  |  |  |  |  |  |  |  |         |
|  | ASZ                    | 11/00 → 06/07 | →   ICH 1J-4D008 311,<br>1J-4U001 138,<br>1J-4W040 231                                    | VKM____   |        |   |   |        |  |  |  |  |  |  |  |  |  | 1       |

|  | ASZ                       | 11/00 → 06/07 | CH 1J-4D008 312,<br>1J-4U001 139,<br>1J-4W040 232 I →                                  | VKM _____   |             |   |   |   |   |        |  |  |  |  |  |   | 1            |
|--|---------------------------|---------------|--|---|-------------|---|---|---|---|--------|--|--|--|--|--|---|--------------|
| <b>VW  GOLF IV (1J1) / GOLF IV Variant (1J5) 1.9 TDI 150</b> |                           |               |  |   |             |   |   |   |   |        |  |  |  |  |  |   |              |
|  | ARL                       | 02/00 → 12/02 | → ICH 1J-2B123 078,<br>1J-2P394 000,<br>1J-2U352 773,<br>1J-2U403 276,<br>1J-2W592 782 | VKMA 01942<br>VKM 11142<br>VKM 11145<br>VKM 21142 | 1<br>1      | 1 | 1 | 1 | 1 |        |  |  |  |  |  |   | 3 T0184      |
|  | ARL                       | 02/00 → 12/02 | → ICH 1J-2B123 078,<br>1J-2P394 000,<br>1J-2U352 773,<br>1J-2U403 276,<br>1J-2W592 782 | VKMA 01142<br>VKM 11142<br>VKM 21142              | 1<br>1      | 1 | 1 | 1 |   |        |  |  |  |  |  |   | 3 T0184      |
|  | ARL                       | 01/02 → 06/07 | CH 1J-2B123 079,<br>1J-2D352 774,<br>1J-2U403 277,<br>1J-2W592 783 I →                 | VKMA 01250<br>VKM 11250<br>VKM 21147              | 1<br>1      | 1 | 1 | 1 |   |        |  |  |  |  |  |   | T0184        |
|  | ARL                       | 02/00 → 06/07 |  | VKPC 81627  |             |   |   |   |   | 1      |  |  |  |  |  |   |              |
|  | B(Alt) ARL                | 02/00 → 06/07 |  | VKMV 6PK1120<br>VKM 31019                         | 1           |   |   | 1 |   |        |  |  |  |  |  |   |              |
|  | B(Alt) ARL                | 02/00 → 06/07 | AC   | VKMA 31001<br>VKMV 6DK1195<br>VKM 31019           | 1<br>1      |   |   | 1 | 1 |        |  |  |  |  |  |   |              |
|  | ARL                       | 02/00 → 06/07 |  | VKM _____   |             |   |   |   |   |        |  |  |  |  |  |   | 1            |
| <b>VW  GOLF IV Cabriolet (1E7) 1.6</b>                       |                           |               |  |   |             |   |   |   |   |        |  |  |  |  |  |   |              |
|  | AFT, AKS                  | 06/98 → 06/02 | 3)   | VKMS 01000<br>VKMA 01000<br>VKM 11000             | 1<br>1<br>1 |   | 1 |   |   |        |  |  |  |  |  | 3 | 4<br>3 T0005 |
|  | AFT, AKS                  | 06/98 → 06/02 | 2)   | VKPA 81401<br>VKPC 81401                          |             |   |   |   |   | 1<br>1 |  |  |  |  |  |   |              |
|  | B(Alt) AFT, AKS           | 06/98 → 06/02 |  | VKMV 6PK894                                       |             |   |   | 1 |   |        |  |  |  |  |  |   |              |
|  | B(Alt) AFT, AKS           | 06/98 → 06/02 |  | VKMV 6PK1033<br>VKM 31004<br>VKM 31210            | 1<br>1      |   |   | 1 |   |        |  |  |  |  |  |   |              |
|  | B(Alt) AFT, AKS           | 06/98 → 06/02 |  | VKMV 6PK1153<br>VKM 31004<br>VKM 31210            | 1<br>1      |   |   | 1 |   |        |  |  |  |  |  |   |              |
|  | B(PS) AFT, AKS            | 06/98 → 06/02 |  | VKMV 11.5x685                                     |             |   |   | 1 |   |        |  |  |  |  |  |   |              |
|  | B(PS) AFT, AKS            | 06/98 → 06/02 | AC   | VKMV 11.5x755                                     |             |   |   | 1 |   |        |  |  |  |  |  |   |              |
| <b>VW  GOLF IV Cabriolet (1E7) 1.8</b>                       |                           |               |  |   |             |   |   |   |   |        |  |  |  |  |  |   |              |
|  | AAM, ADZ, ANN, ANP        | 06/98 → 06/02 | 3)   | VKMS 01000<br>VKMA 01000<br>VKM 11000             | 1<br>1<br>1 |   | 1 |   |   |        |  |  |  |  |  | 3 | 4<br>3 T0005 |
|  | AAM, ADZ, ANN, ANP        | 06/98 → 06/02 | 2)   | VKPA 81401<br>VKPC 81401                          |             |   |   |   |   | 1<br>1 |  |  |  |  |  |   |              |
|  | B(Alt) AAM, ADZ, ANN, ANP | 06/98 → 06/02 |  | VKMV 6PK894                                       |             |   |   | 1 |   |        |  |  |  |  |  |   |              |
|  | B(Alt) AAM, ADZ, ANN, ANP | 06/98 → 06/02 |  | VKMV 6PK1153<br>VKM 31004<br>VKM 31210            | 1<br>1      |   |   | 1 |   |        |  |  |  |  |  |   |              |
|  | B(PS) AAM, ADZ, ANN, ANP  | 06/98 → 06/02 |  | VKMV 11.5x685                                     |             |   |   | 1 |   |        |  |  |  |  |  |   |              |
|  | B(PS) AAM, ADZ, ANN, ANP  | 06/98 → 06/02 | AC   | VKMV 11.5x755                                     |             |   |   | 1 |   |        |  |  |  |  |  |   |              |
| <b>VW  GOLF IV Cabriolet (1E7) 2.0</b>                       |                           |               |  |   |             |   |   |   |   |        |  |  |  |  |  |   |              |
|  | AGG, AKR                  | 06/98 → 06/02 |  | VKMA 01002<br>VKM 11000                           | 1<br>1      |   | 1 |   |   |        |  |  |  |  |  |   | 3 T0091      |
|  | ATU, AWF, AWG             | 06/98 → 06/02 |  | VKMA 01003<br>VKM 11003                           | 1<br>1      |   | 1 |   |   |        |  |  |  |  |  |   | T0091        |







|  | AGG, AKR, ATU, AWF, AWG                 | 06/98 → 06/02 | 2)            | VKPA 81401<br>VKPC 81401  |   |   |   |   | 1 |  |  |  |         |
|--|---|---------------|---------------|---|---|---|---|---|---|--|--|--|---------|
|  | <b>B(Alt)</b> AGG, AKR, ATU, AWF, AWG   | 06/98 → 06/02 | <i>AC, AC</i> | VKMOV 6PK894  |   |   | 1 |   |   |  |  |  |         |
|  | <b>B(Alt)</b> AGG, AKR, ATU, AWF, AWG   | 06/98 → 06/02 | <b>A</b>      | VKMOV 6PK1153<br>VKM 31004<br>VKM 31210                               | 1 |   | 1 |   |   |  |  |  |         |
|  | <b>B(PS)</b> AGG, AKR, ATU, AWF, AWG    | 06/98 → 06/02 | <i>AC</i>     | VKMOV 11.5x685  |   |   | 1 |   |   |  |  |  |         |
|  | <b>B(PS)</b> AGG, AKR, ATU, AWF, AWG    | 06/98 → 06/02 | <b>AC</b>     | VKMOV 11.5x755  |   |   | 1 |   |   |  |  |  |         |
| <b>VW  GOLF IV Cabriolet (1E7) 1.9 TDI</b>             |   |               |               |   |   |   |   |   |   |  |  |  |         |
|  | AFN, AHU, ALE, AVG                      | 06/98 → 06/02 |               | VKMA 01014<br>VKM 11014<br>VKM 21012                                  | 1 | 1 | 1 |   |   |  |  |  | 5 T0650 |
|  | AFN, AHU, ALE, AVG                      | 06/98 → 06/02 | 2)            | VKPA 81401<br>VKPC 81401  |   |   |   |   | 1 |  |  |  |         |
|  | <b>B(Alt), B(PS)</b> AFN, AHU, ALE, AVG | 06/98 → 06/02 | <i>AC</i>     | VKMA 31028<br>VKMV 10AVx730<br>VKMV 6PK1045<br>VKM 31004<br>VKM 31030 | 2 |   | 2 | 1 |   |  |  |  |         |
|  | <b>B(Alt), B(PS)</b> AFN, AHU, ALE, AVG | 06/98 → 06/02 | <b>AC</b>     | VKMA 31030<br>VKMV 11.5x790<br>VKMV 6PK1145<br>VKM 31004<br>VKM 31030 | 2 |   | 2 | 1 | 1 |  |  |  |         |
| <b>VW  GOLF V (1K1) / GOLF V VARIANT (1K1) 1.4 16V</b> |   |               |               |   |   |   |   |   |   |  |  |  |         |
|  | BCA, BUD                                | 10/03 → 11/07 |               | VKMA 01121<br>VKM 11120<br>VKM 11124<br>VKM 21120<br>VKM 21121        | 2 | 2 | 2 |   |   |  |  |  | T0165   |
|  | BCA, BUD                                | 10/03 → 11/07 |               | VKPC 81407  |   |   |   |   | 1 |  |  |  |         |
|  | <b>B(Alt)</b> BCA                       | 10/03 → 11/07 | <i>AC</i>     | VKMOV 6PK736<br>VKM 31015   | 1 |   | 1 |   |   |  |  |  |         |
|  | <b>B(Alt)</b> BUD                       | 05/06 → 11/07 | <i>AC</i>     | VKMOV 6PK736  |   |   | 1 |   |   |  |  |  |         |
|  | <b>B(Alt)</b> BCA, BUD                  | 10/03 → 11/07 | <b>AC</b>     | VKMOV 6PK1100<br>VKM 31015  | 1 |   | 1 |   |   |  |  |  |         |
| <b>VW  GOLF V (1K1) / GOLF V VARIANT (1K1) 1.4 FSI</b> |   |               |               |   |   |   |   |   |   |  |  |  |         |
|  | BKG, BLN                                | 10/03 → 11/07 |               | <del>XXXXXX</del>   |   |   |   |   |   |  |  |  |         |
|  | BKG, BLN                                | 10/03 → 11/07 |               | —   |   |   |   |   | 1 |  |  |  |         |
|  | <b>B(Alt)</b> BKG, BLN                  | 10/03 → 11/07 | <i>AC</i>     | VKMOV 6PK1087   |   |   | 1 |   |   |  |  |  |         |
|  | <b>B(Alt)</b> BKG, BLN                  | 10/03 → 11/07 | <b>AC</b>     | VKMOV 6PK1736<br>VKM 31044<br>VKM 31047                               | 1 |   | 1 |   |   |  |  |  |         |
| <b>VW  GOLF V (1K1) / GOLF V VARIANT (1K1) 1.4 TSI</b> |   |               |               |   |   |   |   |   |   |  |  |  |         |
|  | BLG, BMY                                | 11/05 → 11/07 |               | <del>XXXXXX</del>   |   |   |   |   |   |  |  |  |         |
|  | BLG, BMY                                | 11/05 → 11/07 |               | —   |   |   |   |   | 1 |  |  |  |         |
| <b>VW  GOLF V (1K1) / GOLF V VARIANT (1K1) 1.6</b>     |   |               |               |   |   |   |   |   |   |  |  |  |         |
|  | BGU, BSE, BSF                           | 01/04 → 11/07 |               | VKMA 01113<br>VKM 11113   | 1 |   | 1 |   |   |  |  |  | T0149   |
|  | BGU, BSE, BSF                           | 01/04 → 11/07 |               | VKPC 81408  |   |   |   |   | 1 |  |  |  |         |
|  | <b>B(Alt)</b> BGU, BSE, BSF             | 01/04 → 11/07 | <i>AC</i>     | VKMOV 6PK900<br>VKM 31011   | 1 |   | 1 |   |   |  |  |  |         |
|  | <b>B(Alt)</b> BGU, BSE, BSF             | 01/04 → 11/07 | <b>AC</b>     | VKMOV 6PK1042<br>VKM 31011  | 1 |   | 1 |   |   |  |  |  |         |
| <b>VW  GOLF V (1K1) / GOLF V VARIANT (1K1) 1.6 FSI</b> |   |               |               |   |   |   |   |   |   |  |  |  |         |
|  | BAG, BLF, BLP                           | 10/03 → 11/07 |               | <del>XXXXXX</del>   |   |   |   |   |   |  |  |  |         |
|  | BAG, BLF, BLP                           | 10/03 → 11/07 |               | VKPC 81501  |   |   |   |   | 1 |  |  |  |         |
|  | <b>B(Alt)</b> BAG, BLF, BLP             | 10/03 → 11/07 | <i>AC</i>     | VKMOV 6PK1087   |   |   | 1 |   |   |  |  |  |         |

|   | <b>B(Alt)</b> BAG, BLF, BLP                        | 10/03 → 11/07 | <b>AC</b>   | VKMV 6PK1736<br>VKM 31044<br>VKM 31047           | 1      | 1           |   |  |  |  |   |  |  |  |  |   |       |
|---|--|---------------|---|--|--------|-------------|---|--|--|--|---|--|--|--|--|---|-------|
| <b>VW  GOLF V (1K1) / GOLF V VARIANT (1K1) 2.0 FSI</b>    |  |               |   |  |        |             |   |  |  |  |   |  |  |  |  |   |       |
|   | AXW, BLR, BLX, BLY,<br>BVX, BVY, BVZ               | 01/04 → 11/07 |   | VKMA 01220<br>VKM 11220<br>VKM 21220<br>VKM_____ | 1<br>1 | 2<br>1<br>1 | 1 |  |  |  |   |  |  |  |  | 2 | T0247 |
|   | AXW, BLR, BLX, BLY,<br>BVX, BVY, BVZ               | 01/04 → 11/07 |   | VKPC 81220                                       |        |             |   |  |  |  | 1 |  |  |  |  |   |       |
|   | <b>B(Alt)</b> AXW, BLR, BLX, BLY,<br>BVX, BVY, BVZ | 01/04 → 11/07 | <b>AC</b>   | VKMV 6PK900<br>VKM 31011                         | 1      |             |   |  |  |  | 1 |  |  |  |  |   |       |
|   | <b>B(Alt)</b> AXW, BLR, BLX, BLY,<br>BVX, BVY, BVZ | 01/04 → 11/07 | <b>AC</b>   | VKMV 6PK1042<br>VKM 31011                        | 1      |             |   |  |  |  | 1 |  |  |  |  |   |       |
| <b>VW  GOLF V (1K1) / GOLF V VARIANT (1K1) 2.0 GTI</b>    |  |               |   |  |        |             |   |  |  |  |   |  |  |  |  |   |       |
|   | AXX, BWA   | 10/04 → 11/07 |   | VKMA 01222<br>VKM 11222<br>VKM 21220<br>VKM_____ | 1<br>1 | 2<br>1<br>1 | 1 |  |  |  |   |  |  |  |  | 2 | T0247 |
|   | BYD  | 09/06 → 11/07 |   | —<br>—<br>VKM 21220<br>VKM_____                  | 1<br>1 | 2<br>1      | 1 |  |  |  |   |  |  |  |  |   | T0247 |
|   | AXX, BWA, BYD                                      | 10/04 → 11/07 |   | —  |        |             |   |  |  |  | 1 |  |  |  |  |   |       |
|   | <b>B(Alt)</b> AXX, BWA, BYD                        | 10/04 → 11/07 | <b>AC</b>   | VKMV 6PK953                                      |        |             |   |  |  |  | 1 |  |  |  |  |   |       |
|   | <b>B(Alt)</b> AXX, BWA, BYD                        | 10/04 → 11/07 | <b>AC</b>   | VKMV 6PK1054                                     |        |             |   |  |  |  | 1 |  |  |  |  |   |       |
| <b>VW  GOLF V (1K1) / GOLF V VARIANT (1K1) 3.2 R32</b>    |  |               |   |  |        |             |   |  |  |  |   |  |  |  |  |   |       |
|   | BUB, CBR   | 11/05 → 11/07 |   | <b>OXOXOXO</b>                                   |        |             |   |  |  |  |   |  |  |  |  |   |       |
|   | BUB, CBR   | 11/05 → 11/07 |   | —  |        |             |   |  |  |  | 1 |  |  |  |  |   |       |
|   | <b>B(Alt)</b> BUB, CBR                             | 11/05 → 11/07 | <b>AC</b> ,<br>→ <b>ICH</b> 1K-7B083 209,<br>1K-7P015 319,<br>1K-7U015 405,<br>1K-7W102 690 | VKMV 6PK1240                                     |        |             |   |  |  |  | 1 |  |  |  |  |   |       |
|   | <b>B(Alt)</b> BUB, CBR                             | 11/05 → 11/07 | <b>AC</b> ,<br>→ <b>ICH</b> 1K-7B083 209,<br>1K-7P015 319,<br>1K-7U015 405,<br>1K-7W102 690 | VKMV 6PK1620                                     |        |             |   |  |  |  | 1 |  |  |  |  |   |       |
| <b>VW  GOLF V (1K1) / GOLF V VARIANT (1K1) 1.9 TDI 90</b> |  |               |   |  |        |             |   |  |  |  |   |  |  |  |  |   |       |
|   | BRU, BXF   | 05/04 → 11/07 |   | VKMA 01250<br>VKM 11250<br>VKM 21147             | 1<br>1 | 1<br>1      | 1 |  |  |  |   |  |  |  |  |   | T0184 |
|   | BRU, BXF   | 05/04 → 11/07 |   | VKPC 81418                                       |        |             |   |  |  |  | 1 |  |  |  |  |   |       |
|   | <b>B(Alt)</b> BRU                                  | 05/04 → 11/07 | <b>AC</b> ,<br>→ <b>ICH</b> 1K-5-600 000  | VKMV 6PK950<br>VKM 31022                         | 1      |             |   |  |  |  | 1 |  |  |  |  |   |       |
|   | <b>B(Alt)</b> BRU                                  | 05/04 → 11/07 | <b>AC</b> ,<br>CH 1K-6-500 000 I→   | VKMV 6PK950<br>VKM 31054                         | 1      |             |   |  |  |  | 1 |  |  |  |  |   |       |
|   | <b>B(Alt)</b> BRU                                  | 05/04 → 11/07 | <b>AC</b> , → <b>ICH</b> 1K-5-600 000   | VKMV 6PK1050<br>VKM 31022                        | 1      |             |   |  |  |  | 1 |  |  |  |  |   |       |
|   | <b>B(Alt)</b> BRU                                  | 05/04 → 11/07 | <b>AC</b> , CH 1K-6-500 000 I→  | VKMV 6PK1050<br>VKM 31054                        | 1      |             |   |  |  |  | 1 |  |  |  |  |   |       |
|   | <b>B(Alt)</b> BXF                                  | 05/04 → 11/07 | <b>AC</b>   | VKMV 6PK950<br>VKM 31054                         | 1      |             |   |  |  |  | 1 |  |  |  |  |   |       |
|   | <b>B(Alt)</b> BXF                                  | 05/04 → 11/07 | <b>AC</b>   | VKMV 6PK1050<br>VKM 31054                        | 1      |             |   |  |  |  | 1 |  |  |  |  |   |       |











**VW  GOLF V (1K1) / GOLF V VARIANT (1K1) 1.9 TDI 105**

|  |                      |               |  |                                      |        |        |   |  |  |   |  |   |  |  |  |  |  |       |
|--|----------------------|---------------|--|--------------------------------------|--------|--------|---|--|--|---|--|---|--|--|--|--|--|-------|
|  | BKC, BLS, BXE        | 10/03 → 11/07 |  | VKMA 01250<br>VKM 11250<br>VKM 21147 | 1<br>1 | 1<br>1 | 1 |  |  |   |  |   |  |  |  |  |  | T0184 |
|  | BKC, BLS, BXE        | 10/03 → 11/07 |  | VKPC 81418                           |        |        |   |  |  | 1 |  |   |  |  |  |  |  |       |
|  | B(Alt) BKC           | 10/03 → 11/07 | AC,<br>→ICH 1K-5-600 000   | VKMV 6PK950<br>VKM 31022             | 1      |        |   |  |  |   |  | 1 |  |  |  |  |  |       |
|  | B(Alt) BKC           | 10/03 → 11/07 | AC,<br>CH 1K-6-500 000 I→  | VKMV 6PK950<br>VKM 31054             | 1      |        |   |  |  |   |  | 1 |  |  |  |  |  |       |
|  | B(Alt) BKC           | 10/03 → 11/07 | AC, →ICH 1K-5-600 000  | VKMV 6PK1050<br>VKM 31022            | 1      |        |   |  |  |   |  | 1 |  |  |  |  |  |       |
|  | B(Alt) BKC           | 10/03 → 11/07 | AC, CH 1K-6-500 000 I→   | VKMV 6PK1050<br>VKM 31054            | 1      |        |   |  |  |   |  | 1 |  |  |  |  |  |       |
|  | B(Alt) BKC, BLS, BXE | 06/07 → 11/07 |  AC | VKMV 6PK950<br>VKM 31054             | 1      |        |   |  |  |   |  | 1 |  |  |  |  |  |       |
|  | B(Alt) BKC, BLS, BXE | 06/07 → 11/07 |  AC | VKMV 6PK1050<br>VKM 31054            | 1      |        |   |  |  |   |  | 1 |  |  |  |  |  |       |
|  | B(Alt) BLS, BXE      | 10/03 → 11/07 | AC   | VKMV 6PK950<br>VKM 31054             | 1      |        |   |  |  |   |  | 1 |  |  |  |  |  |       |
|  | B(Alt) BLS, BXE      | 10/03 → 11/07 | AC   | VKMV 6PK1050<br>VKM 31054            | 1      |        |   |  |  |   |  | 1 |  |  |  |  |  |       |



**VW  GOLF V (1K1) / GOLF V VARIANT (1K1) 2.0 SDI**

|  |            |               |    |                                      |        |        |   |  |  |   |  |   |  |  |  |  |  |       |
|--|------------|---------------|----|--------------------------------------|--------|--------|---|--|--|---|--|---|--|--|--|--|--|-------|
|  | BDK        | 01/04 → 11/07 |    | VKMA 01250<br>VKM 11250<br>VKM 21147 | 1<br>1 | 1<br>1 | 1 |  |  |   |  |   |  |  |  |  |  | T0184 |
|  | BDK        | 01/04 → 11/07 |    | VKPC 81418                           |        |        |   |  |  | 1 |  |   |  |  |  |  |  |       |
|  | B(Alt) BDK | 01/04 → 11/07 | AC | VKMV 6PK950<br>VKM 31054             | 1      |        |   |  |  |   |  | 1 |  |  |  |  |  |       |
|  | B(Alt) BDK | 01/04 → 11/07 | AC | VKMV 6PK1050<br>VKM 31054            | 1      |        |   |  |  |   |  | 1 |  |  |  |  |  |       |







































**VW  GOLF V (1K1) / GOLF V VARIANT (1K1) 2.0 TDI 136**

|  |            |               |                    |   |        |             |   |  |  |   |  |   |  |  |  |  |  |         |
|--|------------|---------------|--------------------|---|--------|-------------|---|--|--|---|--|---|--|--|--|--|--|---------|
|  | AZV        | 10/03 → 12/06 | →ICH 1K-6-250 000  | VKMA 01255<br>VKM 11255<br>VKM 21147<br>VKM 21256 | 1<br>1 | 2<br>1<br>1 | 1 |  |  |   |  |   |  |  |  |  |  | 5 T0184 |
|  | AZV        | 01/07 → 11/07 | CH 1K-7-000 001 I→ | VKMA____<br>VKM 11255<br>VKM 21147<br>VKM____     | 1<br>1 | 2<br>1<br>1 | 1 |  |  |   |  |   |  |  |  |  |  | 5 T0184 |
|  | AZV        | 10/03 → 11/07 |                    | VKPC 81627  |        |             |   |  |  | 1 |  |   |  |  |  |  |  |         |
|  | B(Alt) AZV | 10/03 → 11/07 | AC                 | VKMV 6PK950<br>VKM 31022                          | 1      |             |   |  |  |   |  | 1 |  |  |  |  |  |         |
|  | B(Alt) AZV | 10/03 → 11/07 | AC                 | VKMV 6PK1050<br>VKM 31022                         | 1      |             |   |  |  |   |  | 1 |  |  |  |  |  |         |

**VW  GOLF V (1K1) / GOLF V VARIANT (1K1) 2.0 TDI 140**

|  |            |               |                    |   |        |             |   |  |  |   |  |   |  |  |  |  |  |         |
|--|------------|---------------|--------------------|---|--------|-------------|---|--|--|---|--|---|--|--|--|--|--|---------|
|  | BKD        | 10/03 → 12/06 | →ICH 1K-6-250 000  | VKMA 01255<br>VKM 11255<br>VKM 21147<br>VKM 21256 | 1<br>1 | 2<br>1<br>1 | 1 |  |  |   |  |   |  |  |  |  |  | 5 T0184 |
|  | BKD        | 01/07 → 11/07 | CH 1K-7-000 001 I→ | VKMA____<br>VKM 11255<br>VKM 21147<br>VKM____     | 1<br>1 | 2<br>1<br>1 | 1 |  |  |   |  |   |  |  |  |  |  | 5 T0184 |
|  | BMM        | 08/04 → 11/07 |                    | VKMA 01250<br>VKM 11250<br>VKM 21147              | 1<br>1 | 1<br>1      | 1 |  |  |   |  |   |  |  |  |  |  | T0184   |
|  | BKD        | 10/03 → 11/07 |                    | VKPC 81627  |        |             |   |  |  | 1 |  |   |  |  |  |  |  |         |
|  | BMM        | 08/04 → 11/07 |                    | VKPC 81303  |        |             |   |  |  | 1 |  |   |  |  |  |  |  |         |
|  | B(Alt) BKD | 10/03 → 11/07 | AC                 | VKMV 6PK950<br>VKM 31022                          | 1      |             |   |  |  |   |  | 1 |  |  |  |  |  |         |































































|   |  |  |  |  |  |  |  |  |  |  |  |  |
|---|---|---|---|--|---|---|---|---|---|---|---|---|
| B(Alt)  | BKD   | 10/03 → 11/07   | AC  | VKMA 6PK1050<br>VKM 31022  | 1   |   | 1   |   |   |   |   |   |
| B(Alt)  | BMM   | 08/04 → 11/07   | AC  | VKMA 6PK950<br>VKM 31054   | 1   |   | 1   |   |   |   |   |   |
| B(Alt)  | BMM   | 08/04 → 11/07   | AC  | VKMA 6PK1050<br>VKM 31054  | 1   |   | 1   |   |   |   |   |   |
| <b>VW  GOLF V (1K1) / GOLF V VARIANT (1K1) 2.0 TDI 170</b> |   |   |   |  |   |   |   |   |   |   |   |   |
|    | BMN   | 11/05 → 11/07   |   | VKMA _____<br>VKM 11255<br>VKM 21147<br>VKM _____                                  | 1<br>1<br>1<br>1  | 2   | 1   |   |   |   | 5   | T0184   |
|    | BMN   | 11/05 → 11/07   |   | VKPC _____   |   |   |   | 1   |   |   |   |   |
|    | B(Alt)  | BMN   | 11/05 → 11/07   | AC   | VKMA 6PK950<br>VKM 31022  | 1   |   | 1   |   |   |   |   |
|   | B(Alt)  | BMN   | 11/05 → 11/07   | AC   | VKMA 6PK1050<br>VKM 31022   | 1   |   | 1   |   |   |   |   |
| <b>VW  GOLF V PLUS (5M1) 1.4 16V</b>                       |   |   |   |  |   |   |   |   |   |   |   |   |
|    | BCA, BUD  | 01/05 → 11/07   |   | VKMA 01121<br>VKM 11120<br>VKM 11124<br>VKM 21120<br>VKM 21121                     | 2<br>1<br>1<br>1<br>1   | 2   | 2   |   |   |   |   | T0165   |
|    | BCA   | 01/05 → 11/07   |   | VKPC 81407   |   |   |   | 1   |   |   |   |   |
|    | B(Alt)  | BCA   | 01/05 → 11/07   | AC   | VKMA 6PK736<br>VKM 31015  | 1   |   | 1   |   |   |   |   |
|   | B(Alt)  | BUD   | 01/05 → 11/07   | AC   | VKMA 6PK736   |   |   | 1   |   |   |   |   |
|   | B(Alt)  | BCA, BUD  | 01/05 → 11/07   | AC   | VKMA 6PK1100<br>VKM 31015   | 1   |   | 1   |   |   |   |   |
| <b>VW  GOLF V PLUS (5M1) 1.4 FSI</b>                     |   |   |   |  |   |   |   |   |   |   |   |   |
|    | BLN   | 07/05 → 05/06   |   | ΟΛΟΧΩΟ   |   |   |   |   |   |   |   |   |
|    | BLN   | 07/05 → 05/06   |   | —  |   |   |   | 1   |   |   |   |   |
| <b>VW  GOLF V PLUS (5M1) 1.4 TSI</b>                     |   |   |   |  |   |   |   |   |   |   |   |   |
|    | BLG, BMY  | 05/06 → 11/07   |   | ΟΛΟΧΩΟ   |   |   |   |   |   |   |   |   |
|    | BLG, BMY  | 05/06 → 11/07   |   | —  |   |   |   | 1   |   |   |   |   |
| <b>VW  GOLF V PLUS (5M1) 1.6</b>                         |   |   |   |  |   |   |   |   |   |   |   |   |
|    | BSE, BSF  | 05/05 → 11/07   |   | VKMA 01113<br>VKM 11113  | 1<br>1  |   | 1   |   |   |   |   | T0149   |
|    | BSE, BSF  | 05/05 → 11/07   |   | VKPC 81408   |   |   |   | 1   |   |   |   |   |
|    | B(Alt)  | BSE, BSF  | 05/05 → 11/07   | AC   | VKMA 6PK900<br>VKM 31011  | 1   |   | 1   |   |   |   |   |
|   | B(Alt)  | BSE, BSF  | 05/05 → 11/07   | AC   | VKMA 6PK1042<br>VKM 31011   | 1   |   | 1   |   |   |   |   |
| <b>VW  GOLF V PLUS (5M1) 1.6 FSI</b>                     |   |   |   |  |   |   |   |   |   |   |   |   |
|    | BLF   | 01/05 → 11/07   |   | ΟΛΟΧΩΟ   |   |   |   |   |   |   |   |   |
|    | BLF   | 01/05 → 11/07   |   | VKPC 81501   |   |   |   | 1   |   |   |   |   |
|    | B(Alt)  | BLF   | 01/05 → 11/07   | AC   | VKMA 6PK1087  |   |   | 1   |   |   |   |   |
|   | B(Alt)  | BLF   | 01/05 → 11/07   | AC   | VKMA 6PK1736<br>VKM 31044<br>VKM 31047  | 1   | 1   | 1   |   |   |   |   |
| <b>VW  GOLF V PLUS (5M1) 2.0 FSI</b>                     |   |   |   |  |   |   |   |   |   |   |   |   |
|    | BLR, BLY, BVY, BVZ  | 05/05 → 11/07   |   | VKMA 01222<br>VKM 11222<br>VKM 21220<br>VKM _____                                  | 1<br>1<br>1<br>1  | 2   | 1   |   |   |   | 2   | T0247   |
|    | BLR, BLY, BVY, BVZ  | 05/05 → 11/07   |   | VKPC 81220   |   |   |   | 1   |   |   |   |   |
|    | B(Alt)  | BLR, BLY, BVY, BVZ  | 05/05 → 11/07   | AC   | VKMA 6PK900<br>VKM 31011  | 1   |   | 1   |   |   |   |   |
|   | B(Alt)  | BLR, BLY, BVY, BVZ  | 05/05 → 11/07   | AC   | VKMA 6PK1042<br>VKM 31011   | 1   |   | 1   |   |   |   |   |



VW



| VW  GOLF V PLUS (5M1) 1.9 TDI 90    |                        |               |                                   |   |        |             |   |   |  |         |
|--|------------------------|---------------|-----------------------------------|---|--------|-------------|---|---|--|---------|
|                                      | BRU, BXF               | 05/05 → 11/07 |                                   | VKMA 01250<br>VKM 11250<br>VKM 21147              | 1<br>1 | 1<br>1      | 1 |   |  | T0184   |
|                                      | BRU, BXF               | 05/05 → 10/07 |                                   | VKPC 81418  |        |             |   | 1 |  |         |
|                                      | <b>B(Alt)</b> BRU      | 05/05 → 11/07 | <b>AC</b> ,<br>→ICH 1K-5-600 000  | VKMV 6PK950<br>VKM 31022                          | 1      |             | 1 |   |  |         |
|  | <b>B(Alt)</b> BRU      | 05/05 → 11/07 | <b>AC</b> ,<br>CH 1K-6-500 000 I→ | VKMV 6PK950<br>VKM 31054                          | 1      |             | 1 |   |  |         |
|  | <b>B(Alt)</b> BRU      | 05/05 → 11/07 | <b>AC</b> , →ICH 1K-5-600 000     | VKMV 6PK1050<br>VKM 31022                         | 1      |             | 1 |   |  |         |
|  | <b>B(Alt)</b> BRU      | 05/05 → 11/07 | <b>AC</b> , CH 1K-6-500 000 I→    | VKMV 6PK1050<br>VKM 31054                         | 1      |             | 1 |   |  |         |
|  | <b>B(Alt)</b> BXF      | 05/05 → 11/07 | <b>AC</b>                         | VKMV 6PK950<br>VKM 31054                          | 1      |             | 1 |   |  |         |
|  | <b>B(Alt)</b> BXF      | 05/05 → 11/07 | <b>AC</b>                         | VKMV 6PK1050<br>VKM 31054                         | 1      |             | 1 |   |  |         |
| VW  GOLF V PLUS (5M1) 1.9 TDI 105   |                        |               |                                   |   |        |             |   |   |  |         |
|                                      | BKC, BLS, BXE          | 01/05 → 11/07 |                                   | VKMA 01250<br>VKM 11250<br>VKM 21147              | 1<br>1 | 1<br>1      | 1 |   |  | T0184   |
|                                      | BKC, BLS, BXE          | 01/05 → 10/07 |                                   | VKPC 81418  |        |             |   | 1 |  |         |
|                                     | <b>B(Alt)</b> BKC      | 01/05 → 11/07 | <b>AC</b> ,<br>→ICH 1K-5-600 000  | VKMV 6PK950<br>VKM 31022                          | 1      |             | 1 |   |  |         |
|  | <b>B(Alt)</b> BKC      | 01/05 → 11/07 | <b>AC</b> ,<br>CH 1K-6-500 000 I→ | VKMV 6PK950<br>VKM 31054                          | 1      |             | 1 |   |  |         |
|  | <b>B(Alt)</b> BKC      | 01/05 → 11/07 | <b>AC</b> , →ICH 1K-5-600 000     | VKMV 6PK1050<br>VKM 31022                         | 1      |             | 1 |   |  |         |
|  | <b>B(Alt)</b> BKC      | 01/05 → 11/07 | <b>AC</b> , CH 1K-6-500 000 I→    | VKMV 6PK1050<br>VKM 31054                         | 1      |             | 1 |   |  |         |
|  | <b>B(Alt)</b> BLS, BXE | 01/05 → 11/07 | <b>AC</b>                         | VKMV 6PK950<br>VKM 31054                          | 1      |             | 1 |   |  |         |
|  | <b>B(Alt)</b> BLS, BXE | 01/05 → 11/07 | <b>AC</b>                         | VKMV 6PK1050<br>VKM 31054                         | 1      |             | 1 |   |  |         |
| VW  GOLF V PLUS (5M1) 2.0 TDI 136 |                        |               |                                   |   |        |             |   |   |  |         |
|                                    | AZV                    | 05/05 → 11/07 | →ICH 1K-6-650 000                 | VKMA 01255<br>VKM 11255<br>VKM 21147<br>VKM 21256 | 1<br>1 | 2<br>1<br>1 | 1 |   |  | 5 T0184 |
|  | AZV                    | 05/05 → 11/07 | CH 1K-7-500 001 I→                | VKMA ____<br>VKM 11255<br>VKM 21147<br>VKM ____   | 1<br>1 | 2<br>1<br>1 | 1 |   |  | 5 T0184 |
|                                    | AZV                    | 05/05 → 11/07 |                                   | VKPC 81627  |        |             |   | 1 |  |         |
|                                    | <b>B(Alt)</b> AZV      | 05/05 → 11/07 | <b>AC</b>                         | VKMV 6PK950<br>VKM 31022                          | 1      |             | 1 |   |  |         |
|  | <b>B(Alt)</b> AZV      | 05/05 → 11/07 | <b>AC</b>                         | VKMV 6PK1050<br>VKM 31022                         | 1      |             | 1 |   |  |         |
| VW  GOLF V PLUS (5M1) 2.0 TDI 140 |                        |               |                                   |   |        |             |   |   |  |         |
|                                    | BKD                    | 01/05 → 11/07 | →ICH 1K-6-650 000                 | VKMA 01255<br>VKM 11255<br>VKM 21147<br>VKM 21256 | 1<br>1 | 2<br>1<br>1 | 1 |   |  | 5 T0184 |
|  | BKD                    | 01/05 → 11/07 | CH 1K-7-500 001 I→                | VKMA ____<br>VKM 11255<br>VKM 21147<br>VKM ____   | 1<br>1 | 2<br>1<br>1 | 1 |   |  | 5 T0184 |

|  |  |  |    |  |  |  |  |  |  |  |  |  |
|--|---|---|---|--|---|---|---|---|---|---|---|---|
|  | BMM   | 12/05 → 11/07   |   | VKMA 01250<br>VKM 11250<br>VKM 21147   | 1<br>1  | 1<br>1  |   |   |   |   |   | T0184   |
|                                 | BKD   | 01/05 → 11/07   |   | VKPC 81627   |   |   |   | 1   |   |   |   |   |
|  | BMM   | 12/05 → 11/07   |   | VKPC 81303   |   |   |   | 1   |   |   |   |   |
|                                 | <b>B(Alt)</b> BKD   | 01/05 → 11/07   | <b>AC</b>   | VKMW 6PK950<br>VKM 31022   | 1   |   | 1   |   |   |   |   |   |
|  | <b>B(Alt)</b> BKD   | 01/05 → 11/07   | <b>AC</b>   | VKMW 6PK1050<br>VKM 31022  | 1   |   | 1   |   |   |   |   |   |
|  | <b>B(Alt)</b> BMM   | 12/05 → 11/07   | <b>AC</b>   | VKMW 6PK950<br>VKM 31054   | 1   |   | 1   |   |   |   |   |   |
|  | <b>B(Alt)</b> BMM   | 12/05 → 11/07   | <b>AC</b>   | VKMW 6PK1050<br>VKM 31054  | 1   |   | 1   |   |   |   |   |   |
| <b>VW  ILTIS (183) 1.7</b>      |   |   |   |  |   |   |   |   |   |   |   |   |
|                                 | WL, YX  | 03/79 → 12/88   | 3)  | VKMS 01000<br>VKMA 01000<br>VKM 11000  | 1<br>1<br>1   |   | 1   |   |   | 3   | 4   | T0005   |
|                                 | WL, YX  | 03/79 → 12/88   | → ICH 18-C-000 887  | VKPC 81400   |   |   |   | 1   |   |   |   |   |
|  | WL, YX  | 03/79 → 12/88   | CH 18-G-000 001 I→  | VKPC 81401   |   |   |   | 1   |   |   |   |   |
|                                 | <b>B(Alt)</b> WL, YX  | 03/79 → 12/88   |   | VKMW 10AVx950  |   |   | 1   |   |   |   |   |   |
| <b>VW  ILTIS (183) 1.6 TD</b>   |   |   |   |  |   |   |   |   |   |   |   |   |
|                                 | 1C  | 08/87 → 12/88   | 3)  | VKMS 01010<br>VKMA 01010<br>VKM 11010  | 1<br>1<br>1   |   | 1   |   |   | 3   | 2   | T0051   |
|                                 | 1C  | 08/87 → 12/88   |   | VKPC 81401   |   |   |   | 1   |   |   |   |   |
|                                | <b>B(Alt)</b> 1C  | 08/87 → 12/88   |   | VKMW 10AVx965  |   |   | 1   |   |   |   |   |   |
| <b>VW  JETTA I (16) 1.1</b>   |   |   |   |  |   |   |   |   |   |   |   |   |
|                               | FA, GG  | 08/78 → 02/84   |  | VKMC 01100   |   |   | 1   | 1   |   |   |   | T0222   |
|                               | FA, GG  | 08/78 → 02/84   |   | VKPC 81200   |   |   |   | 1   |   |   |   |   |
|                               | <b>B(Alt)</b> FA  | 08/78 → 02/84   |   | VKMW 10AVx695  |   |   | 1   |   |   |   |   |   |
|  | <b>B(Alt)</b> GG  | 08/78 → 02/84   | → ICH 16A 0326 545  | VKMW 10AVx695  |   |   | 1   |   |   |   |   |   |
|  | <b>B(Alt)</b> GG  | 08/78 → 02/84   | CH 16A 0326 546 I→  | VKMW 10AVx675  |   |   | 1   |   |   |   |   |   |
| <b>VW  JETTA I (16) 1.3</b>   |   |   |   |  |   |   |   |   |   |   |   |   |
|                               | GF, GS  | 08/79 → 02/84   |  | VKMC 01100   |   |   | 1   | 1   |   |   |   | T0222   |
|                               | GF, GS  | 08/79 → 02/84   |   | VKPC 81200   |   |   |   | 1   |   |   |   |   |
|                               | <b>B(Alt)</b> GF  | 08/79 → 02/84   | → ICH 16A 0326 545  | VKMW 10AVx695  |   |   | 1   |   |   |   |   |   |
|  | <b>B(Alt)</b> GF  | 08/79 → 02/84   | CH 16A 0326 546 I→  | VKMW 10AVx675  |   |   | 1   |   |   |   |   |   |
| <b>VW  JETTA I (16) 1.5</b>   |   |   |   |  |   |   |   |   |   |   |   |   |
|                               | JB  | 08/78 → 02/84   | 3)  | VKMS 01000<br>VKMA 01000<br>VKM 11000  | 1<br>1<br>1   |   | 1   |   |   | 3   | 4   | T0005   |
|                               | JB  | 08/78 → 02/84   |   | VKPC 81400   |   |   |   | 1   |   |   |   |   |
|                               | <b>B(Alt)</b> JB  | 08/78 → 02/84   |   | VKMW 10AVx950  |   |   | 1   |   |   |   |   |   |
| <b>VW  JETTA I (16) 1.6</b>   |   |   |   |  |   |   |   |   |   |   |   |   |
|                               | EG, EM, FR  | 08/78 → 02/84   | 3)  | VKMS 01000<br>VKMA 01000<br>VKM 11000  | 1<br>1<br>1   |   | 1   |   |   | 3   | 4   | T0005   |
|                               | EG, EM, FR  | 08/78 → 02/84   | 2)  | VKPA 81401<br>VKPC 81401   |   |   |   | 1<br>1  |   |   |   |   |
|                               | <b>B(Alt)</b> EG, EM, FR  | 08/78 → 02/84   |   | VKMW 10AVx950  |   |   | 1   |   |   |   |   |   |
| <b>VW  JETTA I (16) 1.8</b>   |   |   |   |  |   |   |   |   |   |   |   |   |
|                               | DX  | 08/82 → 02/84   | 3)  | VKMS 01000<br>VKMA 01000<br>VKM 11000  | 1<br>1<br>1   |   | 1   |   |   | 3   | 4   | T0005   |
|                               | DX  | 08/82 → 02/84   | 2)  | VKPA 81401<br>VKPC 81401   |   |   |   | 1<br>1  |   |   |   |   |
|                               | <b>B(Alt)</b> DX  | 08/82 → 02/84   |   | VKMW 10AVx950  |   |   | 1   |   |   |   |   |   |
| <b>VW  JETTA I (16) 1.5 D</b> |   |   |   |  |   |   |   |   |   |   |   |   |
|                               | CK  | 08/78 → 07/80   |   | VKMA 01010<br>VKM 11010  | 1<br>1  |   | 1   |   |   |   | 1   | T0051   |































































VW























| <b>VW</b> | <b>JETTA I (16) 1.6 D</b>          |               |                                  |                |            |   |   |   |   |       |
|-----------|------------------------------------|---------------|----------------------------------|----------------|------------|---|---|---|---|-------|
|           | CR, JK                             | 08/80 → 02/84 | 3)                               | VKMS 01010     | VKMA 01010 | 1 | 1 |   | 3 | 2     |
|           |                                    |               |                                  | VKMA 01010     | VKM 11010  | 1 | 1 |   |   | 1     |
|           | CR, JK                             | 08/80 → 02/84 | 2)                               | VKPA 81400     | VKPC 81400 |   |   | 1 |   |       |
|           |                                    |               |                                  | VKPC 81400     |            |   |   | 1 |   |       |
| <b>VW</b> | <b>JETTA I (16) 1.6 TD</b>         |               |                                  |                |            |   |   |   |   |       |
|           | CY                                 | 03/82 → 02/84 | 3)                               | VKMS 01010     | VKMA 01010 | 1 | 1 |   | 3 | 2     |
|           |                                    |               |                                  | VKMA 01010     | VKM 11010  | 1 | 1 |   |   | 1     |
|           | CY                                 | 03/82 → 02/84 | 2)                               | VKPA 81401     | VKPC 81401 |   |   | 1 |   |       |
|           |                                    |               |                                  | VKPC 81401     |            |   |   | 1 |   |       |
| <b>VW</b> | <b>JETTA II (19E, 1G2) 1.3</b>     |               |                                  |                |            |   |   |   |   |       |
|           | 2G                                 | 06/87 → 12/91 | → IMot. 262 739                  | VKMC 01100     |            |   | 1 | 1 |   | T0222 |
|           | 2G                                 | 06/87 → 12/91 | Mot. 262 740 I→                  | VKMC 01103     |            |   | 1 | 1 |   | T0231 |
|           | GT, HK, MH                         | 01/84 → 12/91 |                                  | VKMC 01100     |            |   | 1 | 1 |   | T0222 |
|           | NZ                                 | 06/87 → 12/91 | → IMot. 200 000                  | VKMC 01100     |            |   | 1 | 1 |   | T0222 |
|           | NZ                                 | 06/87 → 12/91 | Mot. 200 001 I→                  | VKMC 01103     |            |   | 1 | 1 |   | T0231 |
|           | 2G                                 | 06/87 → 12/91 | → IMot. 262 739                  | VKPC 81200     |            |   |   | 1 |   |       |
|           | 2G                                 | 06/87 → 12/91 | Mot. 262 740 I→                  | VKPC 81204     |            |   |   | 1 |   |       |
|           | GT, HK, MH                         | 01/84 → 12/91 |                                  | VKPC 81200     |            |   |   | 1 |   |       |
|           | NZ                                 | 06/87 → 12/91 | → IMot. 200 000                  | VKPC 81200     |            |   |   | 1 |   |       |
|           | NZ                                 | 06/87 → 12/91 | Mot. 200 001 I→                  | VKPC 81204     |            |   |   | 1 |   |       |
|           | B(Alt) 2G, NZ                      | 06/87 → 12/91 | → ICH 1G-M-368 060               | VKMOV 10AVx675 |            |   | 1 |   |   |       |
|           | B(Alt) 2G, NZ                      | 06/87 → 12/91 | CH 1G-M-368 061 I→               | VKMOV 11.9x710 |            |   | 1 |   |   |       |
|           | B(Alt) GT, HK, MH                  | 01/84 → 12/91 |                                  | VKMOV 10AVx675 |            |   | 1 |   |   |       |
| <b>VW</b> | <b>JETTA II (19E, 1G2) 1.6</b>     |               |                                  |                |            |   |   |   |   |       |
|           | ABN, EZ, PN, RF                    | 01/84 → 07/92 | 3)                               | VKMS 01000     | VKMA 01000 | 1 | 1 |   | 3 | 4     |
|           |                                    |               |                                  | VKMA 01000     | VKM 11000  | 1 | 1 |   |   | 3     |
|           | ABN, EZ, PN, RF                    | 01/84 → 07/92 | 2)                               | VKPA 81401     | VKPC 81401 |   |   | 1 |   |       |
|           |                                    |               |                                  | VKPC 81401     |            |   |   | 1 |   |       |
| <b>VW</b> | <b>JETTA II (19E, 1G2) 1.8</b>     |               |                                  |                |            |   |   |   |   |       |
|           | 1P, EV, GU, GX, PB, PF, RD, RH, RP | 01/84 → 10/91 | 3)                               | VKMS 01000     | VKMA 01000 | 1 | 1 |   | 3 | 4     |
|           |                                    |               |                                  | VKMA 01000     | VKM 11000  | 1 | 1 |   |   | 3     |
|           | 1P, EV, GU, GX, PB, PF, RD, RH, RP | 01/84 → 10/91 | 2)                               | VKPA 81401     | VKPC 81401 |   |   | 1 |   |       |
|           |                                    |               |                                  | VKPC 81401     |            |   |   | 1 |   |       |
| <b>VW</b> | <b>JETTA II (19E, 1G2) 1.8 16V</b> |               |                                  |                |            |   |   |   |   |       |
|           | KR, PL                             | 08/86 → 10/91 |                                  | VKMA 01020     | VKM 11020  | 1 | 1 |   |   | T0057 |
|           |                                    |               |                                  | VKM 11020      |            | 1 |   |   |   |       |
|           | KR, PL                             | 08/86 → 10/91 | 2)                               | VKPA 81401     | VKPC 81401 |   |   | 1 |   |       |
|           |                                    |               |                                  | VKPC 81401     |            |   |   | 1 |   |       |
|           | B(Alt) KR, PL                      | 08/86 → 10/91 | AC                               | VKMOV 10AVx950 |            |   | 1 |   |   |       |
|           | B(Alt) KR, PL                      | 08/86 → 10/91 | AC                               | VKMOV 10AVx630 |            |   | 1 |   |   |       |
|           | B(PS) KR, PL                       | 08/86 → 10/91 | → ICH 1G-MB075 000, 1G-MW240 000 | VKMOV 10AVx730 |            |   | 1 |   |   |       |
|           | B(PS) KR, PL                       | 08/86 → 10/91 | CH 1G-MB075 001, 1G-MW240 001 I→ | VKMOV 10AVx630 |            |   | 1 |   |   |       |
|           | B(AC) KR, PL                       | 08/86 → 10/91 |                                  | VKMOV 13AVx950 |            |   | 1 |   |   |       |
| <b>VW</b> | <b>JETTA II (19E, 1G2) 1.6 D</b>   |               |                                  |                |            |   |   |   |   |       |
|           | JP                                 | 01/84 → 10/91 | 3)                               | VKMS 01010     | VKMA 01010 | 1 | 1 |   | 3 | 2     |
|           |                                    |               |                                  | VKMA 01010     | VKM 11010  | 1 | 1 |   |   | 1     |
|           | JP                                 | 01/84 → 10/91 | 2)                               | VKPA 81401     | VKPC 81401 |   |   | 1 |   |       |
|           |                                    |               |                                  | VKPC 81401     |            |   |   | 1 |   |       |
|           | B(Alt) JP                          | 01/84 → 10/91 | AC                               | VKMOV 10AVx965 |            |   | 1 |   |   |       |
|           | B(Alt) JP                          | 01/84 → 10/91 | AC, → ICH...-F-350 000           | VKMOV 10AVx675 |            |   | 1 |   |   |       |
|           | B(Alt) JP                          | 01/84 → 10/91 | AC, CH...-F-350 001 I→           | VKMOV 10AVx695 |            |   | 1 |   |   |       |

| B(PS)                                  | JP                 | 01/84 → 10/91      |               | VKMV 10AVx740                                     |  |   | 1 |  |        |  |   |              |
|--|--------------------|--------------------|---------------|---|--|---|---|--|--------|--|---|--------------|
| B(AC)                                  | JP                 | 01/84 → 10/91      |               | VKMA 13AVx950<br>VKM 31009                        |  |   | 1 |  |        |  |   |              |
| <b>VW  JETTA II (19E, 1G2) 1.6 TD</b>  |                    |                    |               |   |  |   |   |  |        |  |   |              |
|  | 1V, JR, RA, SB     | 01/84 → 10/91      | 3)            | VKMS 01010<br>VKMA 01010<br>VKM 11010             | 1<br>1<br>1                            |   | 1 |  |        |  | 3 | 2<br>1 T0051 |
|  | 1V, JR, RA, SB     | 01/84 → 10/91      | 2)            | VKPA 81401<br>VKPC 81401                          |  |   |   |  | 1<br>1 |  |   |              |
|  | B(Alt)             | JR                 | 01/84 → 10/91 | AC, → ICH..-F-350 000                             | VKMA 10AVx675                          |   |   |  | 1      |  |   |              |
|  | B(AC)              | 1V, RA, SB         | 04/89 → 10/91 |   | VKMA 13AVx950<br>VKM 31009             |   |   |  | 1      |  |   |              |
| <b>VW  JETTA III (1KM) 1.4 TSI</b>     |                    |                    |               |   |  |   |   |  |        |  |   |              |
|  | BLG, BMY           | 07/06 → 10/07      |               | OKOKOKO   |  |   |   |  |        |  |   |              |
|  | BLG, BMY           | 07/06 → 10/07      |               | —   |  |   |   |  | 1      |  |   |              |
| <b>VW  JETTA III (1KM) 1.6</b>         |                    |                    |               |   |  |   |   |  |        |  |   |              |
|  | BSE, BSF           | 10/05 → 10/07      |               | VKMA 01113<br>VKM 11113                           | 1<br>1                                 |   | 1 |  |        |  |   | T0149        |
|  | BSE, BSF           | 10/05 → 10/07      |               | VKPC 81408  |  |   |   |  | 1      |  |   |              |
|  | B(Alt)             | BSE, BSF           | 10/05 → 10/07 |   | VKMA 6PK1042<br>VKM 31011              |   |   |  | 1      |  |   |              |
| <b>VW  JETTA III (1KM) 1.6 FSI</b>     |                    |                    |               |   |  |   |   |  |        |  |   |              |
|  | BLF                | 09/05 → 10/07      |               | OKOKOKO   |  |   |   |  |        |  |   |              |
|  | BLF                | 09/05 → 10/07      |               | VKPC 81501  |  |   |   |  | 1      |  |   |              |
|  | B(Alt)             | BLF                | 09/05 → 10/07 |   | VKMA 6PK1736<br>VKM 31044<br>VKM 31047 |   |   |  | 1      |  |   |              |
| <b>VW  JETTA III (1KM) 2.0 FSI</b>     |                    |                    |               |   |  |   |   |  |        |  |   |              |
|  | BLR, BLY, BVY, BVZ | 08/05 → 10/07      |               | VKMA 01222<br>VKM 11222<br>VKM 21220<br>VKM _____ | 1<br>1<br>1<br>1                       | 2 | 1 |  |        |  |   | 2 T0247      |
|  | BLR, BLY, BVY, BVZ | 08/05 → 10/07      |               | VKPC 81220  |  |   |   |  | 1      |  |   |              |
|  | B(Alt)             | BLR, BLY, BVY, BVZ | 08/05 → 10/07 |   | VKMA 6PK1042<br>VKM 31011              |   |   |  | 1      |  |   |              |
| <b>VW  JETTA III (1KM) 2.0 TFSI</b>    |                    |                    |               |   |  |   |   |  |        |  |   |              |
|  | BPY, BWA           | 10/05 → 10/07      |               | VKMA 01222<br>VKM 11222<br>VKM 21220<br>VKM _____ | 1<br>1<br>1<br>1                       | 2 | 1 |  |        |  |   | 2 T0247      |
|  | BPY, BWA           | 10/05 → 10/07      |               | —   |  |   |   |  | 1      |  |   |              |
|  | B(Alt)             | BPY, BWA           | 10/05 → 10/07 |   | VKMA 6PK1054                           |   |   |  | 1      |  |   |              |
| <b>VW  JETTA III (1KM) 1.9 TDI</b>     |                    |                    |               |   |  |   |   |  |        |  |   |              |
|  | BKC, BLS           | 09/05 → 10/07      |               | VKMA 01250<br>VKM 11250<br>VKM 21147              | 1<br>1<br>1                            | 1 | 1 |  |        |  |   | T0184        |
|  | BKC, BLS           | 09/05 → 10/07      |               | VKPC 81418  |  |   |   |  | 1      |  |   |              |
|  | B(Alt)             | BKC, BLS           | 09/05 → 10/07 |   | VKMA 6PK1050<br>VKM 31054              |   |   |  | 1      |  |   |              |
| <b>VW  JETTA III (1KM) 2.0 TDI 136</b> |                    |                    |               |   |  |   |   |  |        |  |   |              |
|  | AZV                | 09/05 → 10/07      |               | VKMA 01255<br>VKM 11255<br>VKM 21147<br>VKM 21256 | 1<br>1<br>1<br>1                       | 2 | 1 |  |        |  |   | 5 T0184      |
|  | AZV                | 09/05 → 10/07      |               | VKPC 81627  |  |   |   |  | 1      |  |   |              |
|  | B(Alt)             | AZV                | 09/05 → 10/07 |   | VKMA 6PK1050<br>VKM 31022              |   |   |  | 1      |  |   |              |
| <b>VW  JETTA III (1KM) 2.0 TDI 140</b> |                    |                    |               |   |  |   |   |  |        |  |   |              |
|  | BMM                | 10/05 → 10/07      |               | VKMA 01250<br>VKM 11250<br>VKM 21147              | 1<br>1<br>1                            | 1 | 1 |  |        |  |   | T0184        |



























|  |  |  |  |   |  |  |  |  |  |  |  |  |
|--|---|---|---|---|---|---|---|---|---|---|---|---|
|  | BKD   | 08/05 → 10/07   |   | VKMA 01255<br>VKM 11255<br>VKM 21147<br>VKM 21256                                   | 1<br>1  | 2<br>1  | 1   |   |   |   |   | 5 T0184   |
|    | BMM   | 10/05 → 10/07   |   | VKPC 81303  |   |   |   | 1   |   |   |   |   |
|  | BKD   | 08/05 → 10/07   |   | VKPC 81627  |   |   |   | 1   |   |   |   |   |
|    | B(Alt) BMM  | 10/05 → 10/07   |   | VKMV 6PK1050<br>VKM 31054   | 1   |   | 1   |   |   |   |   |   |
|  | B(Alt) BKD  | 08/05 → 10/07   |   | VKMV 6PK1050<br>VKM 31022   | 1   |   | 1   |   |   |   |   |   |
| <b>VW  JETTA III (1KM) 2.0 TDI 170</b>                |   |   |   |   |   |   |   |   |   |   |   |   |
|    | BMN   | 10/06 → 10/07   |   | VKMA 01255<br>VKM 11255<br>VKM 21147<br>VKM 21256                                   | 1<br>1  | 2<br>1  | 1   |   |   |   |   | 5 T0184   |
|    | BMN   | 10/06 → 10/07   |   | VKPC  |   |   |   | 1   |   |   |   |   |
|    | B(Alt) BMN  | 10/06 → 10/07   |   | VKMV 6PK1050<br>VKM 31022   | 1   |   | 1   |   |   |   |   |   |
| <b>VW  181 1.5</b>                                    |   |   |   |   |   |   |   |   |   |   |   |   |
|    | H   | 09/69 → 07/70   |   |    |   |   |   |   |   |   |   |   |
|    | H   | 09/69 → 07/70   |   | —   |   |   |   |   |   |   |   |   |
|    | B(Alt) H  | 09/69 → 07/70   |   | VKMV 11.3x912   |   |   | 1   |   |   |   |   |   |
|  | B(Gen) H  | 09/69 → 07/70   | → ICH 184 2219 788  | VKMV 10AVx905   |   |   | 1   |   |   |   |   |   |
|  | B(Gen) H  | 09/69 → 07/70   | CH 184 2219 789 I→  | VKMV 11.3x912   |   |   | 1   |   |   |   |   |   |
| <b>VW  181 1.6</b>                                   |   |   |   |   |   |   |   |   |   |   |   |   |
|    | AG, AL, AM  | 08/70 → 02/79   |   |  |   |   |   |   |   |   |   |   |
|    | AG, AL, AM  | 08/70 → 02/79   |   | —   |   |   |   |   |   |   |   |   |
|    | B(Gen) AG, AL, AM   | 08/70 → 02/79   | → ICH 184 2219 788  | VKMV 10AVx905   |   |   | 1   |   |   |   |   |   |
|  | B(Gen) AG, AL, AM   | 08/70 → 02/79   | CH 184 2219 789 I→  | VKMV 11.3x912   |   |   | 1   |   |   |   |   |   |
|  | B(Alt) AG, AL, AM   | 08/70 → 02/79   |   | VKMV 11.3x912   |   |   | 1   |   |   |   |   |   |
| <b>VW  411,412 1.7</b>                              |   |   |   |   |   |   |   |   |   |   |   |   |
|    | V, W, Z   | 07/68 → 08/73   |   |  |   |   |   |   |   |   |   |   |
|    | V, W, Z   | 07/68 → 08/73   |   | —   |   |   |   |   |   |   |   |   |
|    | B(Alt) V, W, Z  | 07/68 → 08/73   |   | VKMV 10AVx965   |   |   | 1   |   |   |   |   |   |
| <b>VW  411,412 1.8</b>                              |   |   |   |   |   |   |   |   |   |   |   |   |
|    | AN, AT  | 07/73 → 03/75   |   |  |   |   |   |   |   |   |   |   |
|    | AN, AT  | 07/73 → 03/75   |   | —   |   |   |   |   |   |   |   |   |
|    | B(Alt) AN, AT   | 07/73 → 03/75   |   | VKMV 10AVx965   |   |   | 1   |   |   |   |   |   |
| <b>VW  K 70 (48) 1.6</b>                            |   |   |   |   |   |   |   |   |   |   |   |   |
|    | DA, DB  | 08/70 → 10/74   |   |  |   |   |   |   |   |   |   |   |
|    | B(Alt) DA, DB   | 08/70 → 10/74   |   | VKMV 10AVx925   |   |   | 1   |   |   |   |   |   |
| <b>VW  K 70 (48) 1.8</b>                            |   |   |   |   |   |   |   |   |   |   |   |   |
|    | DC  | 08/73 → 10/74   |   |  |   |   |   |   |   |   |   |   |
|    | B(Alt) DC   | 08/73 → 10/74   |   | VKMV 10AVx925   |   |   | 1   |   |   |   |   |   |
| <b>VW  KAEFER / BEETLE / COCCINELLE / FUSCA 1.1</b> |   |   |   |   |   |   |   |   |   |   |   |   |
|    |   | 04/49 → 12/53   |   |  |   |   |   |   |   |   |   |   |
|    |   | 04/49 → 12/53   |   | —   |   |   |   |   |   |   |   |   |
|    | B(Gen)  | 04/49 → 12/53   |   | VKMV 10AVx905   |   |   | 1   |   |   |   |   |   |
| <b>VW  KAEFER / BEETLE / COCCINELLE / FUSCA 1.2</b> |   |   |   |   |   |   |   |   |   |   |   |   |
|    | D   | 01/54 → 12/85   |   |  |   |   |   |   |   |   |   |   |
|    | D   | 01/54 → 12/85   |   | —   |   |   |   |   |   |   |   |   |
|    | B(Gen) D  | 01/54 → 12/85   |   | VKMV 10AVx905   |   |   | 1   |   |   |   |   |   |
|  | B(Alt) D  | 01/54 → 12/85   |   | VKMV 11.3x912   |   |   | 1   |   |   |   |   |   |
| <b>VW  KAEFER / BEETLE / COCCINELLE / FUSCA 1.3</b> |   |   |   |   |   |   |   |   |   |   |   |   |
|    | AB, AC, AR, E, F  | 07/64 → 03/81   |   |  |   |   |   |   |   |   |   |   |
|    | AB, AC, AR, E, F  | 07/64 → 03/81   |   | —   |   |   |   |   |   |   |   |   |
|    | B(Gen) AB, AC, AR, E, F   | 07/64 → 03/81   |   | VKMV 10AVx905   |   |   | 1   |   |   |   |   |   |
|  | B(Alt) AB, AC, AR, E, F   | 07/64 → 03/81   |   | VKMV 11.3x912   |   |   | 1   |   |   |   |   |   |



|   |  |  |  |  |  |  |  |  |  |  |  |
|---|---|---|---|--|---|---|---|---|---|---|---|
| <b>B(Alt)</b>   | AUD   | 10/00 → 07/05   | AC, ⊕   | VKMA 31202<br>VKMV 6PK1068<br>VKM 31015  | 1   | 1   |   |   |   |   |   |
| <b>B(Alt)</b>   | AUD   | 10/00 → 07/05   | AC, ⊕   | VKMA 31219<br>VKMV 6PK1123<br>VKM 31015  | 1   | 1   |   |   |   |   |   |
| <b>VW  Lupo (6X1, 6E1) 1.4 16V</b>   |   |   |   |  |   |   |   |   |   |   |   |
|                                       | AFK, ANM, APE, AQQ,<br>AUA, AUB, BBY  | 09/98 → 07/05   |   | VKMA 01121<br>VKM 11120<br>VKM 11124<br>VKM 21120<br>VKM 21121                     | 2<br>1<br>1<br>1<br>1   | 2   | 2   |   |   |   | T0165   |
|   | AHW   | 09/98 → 07/05   | →   Mot. 160 000  | VKMA 01120<br>VKM 11120<br>VKM 11121<br>VKM 21120<br>VKM 21121                     | 2<br>1<br>1<br>1<br>1   | 2   | 2   |   |   |   | T0165   |
|   | AHW   | 09/98 → 07/05   | Mot. 160 001   →  | VKMA 01121<br>VKM 11120<br>VKM 11124<br>VKM 21120<br>VKM 21121                     | 2<br>1<br>1<br>1<br>1   | 2   | 2   |   |   |   | T0165   |
|   | AKQ   | 09/98 → 07/05   | →   Mot. 242 000  | VKMA 01120<br>VKM 11120<br>VKM 11121<br>VKM 21120<br>VKM 21121                     | 2<br>1<br>1<br>1<br>1   | 2   | 2   |   |   |   | T0165   |
|   | AKQ   | 09/98 → 07/05   | Mot. 242 001   →  | VKMA 01121<br>VKM 11120<br>VKM 11124<br>VKM 21120<br>VKM 21121                     | 2<br>1<br>1<br>1<br>1   | 2   | 2   |   |   |   | T0165   |
|                                     | AFK, AHW, AKQ, ANM,<br>APE, AQQ, AUA, AUB,<br>BBY                                 | 09/98 → 07/05   |   | VKPC 81407   |   |   |   | 1   |   |   |   |
|                                     | <b>B(Alt)</b> AFK, AHW, AKQ, ANM,<br>APE, AQQ, AUA, AUB,<br>BBY                   | 09/98 → 07/05   | AC  | VKMA 31202<br>VKMV 6PK1068<br>VKM 31015  | 1<br>1  |   | 1   | 1   |   |   |   |
|   | <b>B(Alt)</b> AFK, AHW, AKQ, ANM,<br>APE, AQQ, AUA, AUB,<br>BBY                   | 09/98 → 07/05   | AC  | VKMA 31219<br>VKMV 6PK1123<br>VKM 31015  | 1<br>1  |   | 1   | 1   |   |   |   |
| <b>VW  Lupo (6X1, 6E1) 1.4 FSI</b> |   |   |   |  |   |   |   |   |   |   |   |
|                                     | ARR   | 02/01 → 07/05   |   | VKMA 01121<br>VKM 11120<br>VKM 11124<br>VKM 21120<br>VKM 21121                     | 2<br>1<br>1<br>1<br>1   | 2   | 2   |   |   |   | T0165   |
|                                     | ARR   | 02/01 → 07/05   |   | VKPC 81407   |   |   |   | 1   |   |   |   |
|                                     | <b>B(Alt)</b> ARR   | 02/01 → 07/05   | AC  | VKMV 6PK745  |   |   | 1   |   |   |   |   |
|   | <b>B(Alt)</b> ARR   | 02/01 → 07/05   | AC  | VKMA 31215<br>VKMV 6PK1084<br>VKM 31015  | 1<br>1  |   | 1   | 1   |   |   |   |
| <b>VW  Lupo (6X1, 6E1) 1.6</b>     |   |   |   |  |   |   |   |   |   |   |   |
|                                     | AVY   | 09/00 → 07/05   |   | VKMA 01121<br>VKM 11120<br>VKM 11124<br>VKM 21120<br>VKM 21121                     | 2<br>1<br>1<br>1<br>1   | 2   | 2   |   |   |   | T0165   |
|                                     | AVY   | 09/00 → 07/05   |   | VKPC 81419   |   |   |   | 1   |   |   |   |
|                                     | <b>B(Alt)</b> AVY   | 09/00 → 07/05   |   | VKMA 31202<br>VKMV 6PK1068<br>VKM 31015  | 1<br>1  |   | 1   | 1   |   |   |   |















































| VW  LUPU (6X1, 6E1) 1.2 TDI   |                 |               |   |   |        |   |   |   |   |  |  |   |   |  |  |  |         |
|--|-----------------|---------------|---|---|--------|---|---|---|---|--|--|---|---|--|--|--|---------|
|                               | ANY, AYZ        | 07/99 → 07/05 |    | VKMA 01940<br>VKM 11142<br>VKM____<br>VKM 21142   | 1<br>1 | 1 | 1 | 1 | 1 |  |  |   |   |  |  |  | T0243   |
|  | ANY, AYZ        | 07/99 → 07/05 |   | VKMA 01140<br>VKM 11142<br>VKM 21142              | 1<br>1 | 1 | 1 | 1 |   |  |  |   |   |  |  |  | T0243   |
|                               | ANY, AYZ        | 07/99 → 07/05 | → ICH 6E-2-010 000  | VKPC 81417  |        |   |   |   |   |  |  | 1 |   |  |  |  |         |
|  | ANY, AYZ        | 07/99 → 07/05 | CH 6E-2-010 001 I→  | VKPC 81418  |        |   |   |   |   |  |  | 1 |   |  |  |  |         |
|                               | B(Alt) ANY, AYZ | 07/99 → 07/05 |    | VKMA 6PK858<br>VKM 31035                          | 1      |   |   | 1 |   |  |  |   |   |  |  |  |         |
|  | B(Alt) ANY, AYZ | 07/99 → 07/05 | AC  | VKMA 6PK996<br>VKM 31035                          | 1      |   |   | 1 |   |  |  |   |   |  |  |  |         |
| VW  LUPU (6X1, 6E1) 1.4 TDI   |                 |               |   |   |        |   |   |   |   |  |  |   |   |  |  |  |         |
|                               | AMF             | 01/99 → 07/05 |  → I Mot. 011 494,<br>→ ICH 6X-2-015 000 | VKMA 01941<br>VKM 11141<br>VKM 11144<br>VKM 21142 | 1<br>1 | 1 | 1 | 1 | 1 |  |  |   |   |  |  |  | 2 T0184 |
|  | AMF             | 01/99 → 07/05 | → I Mot. 011 494,<br>→ ICH 6X-2-015 000   | VKMA 01141<br>VKM 11141<br>VKM 21142              | 1<br>1 | 1 | 1 | 1 |   |  |  |   |   |  |  |  | 1 T0184 |
|  | AMF             | 01/99 → 07/05 |  Mot. 011 495 I→,<br>→ ICH 6X-2-015 000  | VKMA 01942<br>VKM 11142<br>VKM 11145<br>VKM 21142 | 1<br>1 | 1 | 1 | 1 | 1 |  |  |   | 1 |  |  |  | 3 T0184 |
|  | AMF             | 01/99 → 07/05 | → I Mot. 011 495,<br>CH 6X-2-015 001 I→   | VKMA 01142<br>VKM 11142<br>VKM 21142              | 1<br>1 | 1 | 1 | 1 |   |  |  |   |   |  |  |  | 3 T0184 |
|  | AMF             | 01/99 → 07/05 | CH 6X-2-015 001 I→  | VKMA 01250<br>VKM 11250<br>VKM 21147              | 1<br>1 | 1 | 1 | 1 |   |  |  |   |   |  |  |  | T0184   |
|                             | AMF             | 01/99 → 07/05 | → ICH 6X-2-100 000  | VKPC 81417  |        |   |   |   |   |  |  | 1 |   |  |  |  |         |
|  | AMF             | 01/99 → 07/05 | CH 6X-2-100 001 I→  | VKPC 81418  |        |   |   |   |   |  |  | 1 |   |  |  |  |         |
|                             | B(Alt) AMF      | 01/99 → 07/05 |                                        | VKMA 31203<br>VKMA 6PK1120<br>VKM 31011           | 1<br>1 |   |   | 1 | 1 |  |  |   |   |  |  |  |         |
|  | B(Alt) AMF      | 01/99 → 07/05 | AC  | VKMA 6DK1188<br>VKM 31011                         | 1      |   |   | 1 |   |  |  |   |   |  |  |  |         |
| VW  LUPU (6X1, 6E1) 1.7 SDI |                 |               |   |   |        |   |   |   |   |  |  |   |   |  |  |  |         |
|                             | AKU             | 09/98 → 07/05 |   | VKMA 01016<br>VKM 11015<br>VKM 21012              | 1<br>1 | 1 | 1 | 1 |   |  |  |   |   |  |  |  | 4 T0183 |
|                             | AKU             | 09/98 → 07/05 |   | VKPC 81615  |        |   |   |   |   |  |  | 1 |   |  |  |  |         |
|                             | B(Alt) AKU      | 09/98 → 07/05 |   | VKMA 31017<br>VKMA 5PK1219<br>VKM 31025           | 1<br>1 |   |   | 1 | 1 |  |  |   |   |  |  |  |         |
| VW  MULTIVAN V (7HM) 2.0    |                 |               |   |   |        |   |   |   |   |  |  |   |   |  |  |  |         |
|                             | AXA             | 04/03 → 10/07 |   | VKMA 01113<br>VKM 11113                           | 1<br>1 |   |   | 1 |   |  |  |   |   |  |  |  | T0149   |
|                             | AXA             | 04/03 → 10/07 |   | VKPC 81620  |        |   |   |   |   |  |  | 1 |   |  |  |  |         |
|                             | B(Alt) AXA      | 04/03 → 03/06 |                                        | VKMA 31203<br>VKMA 6PK1120<br>VKM 31011           | 1<br>1 |   |   | 1 | 1 |  |  |   |   |  |  |  |         |
|  | B(Alt) AXA      | 04/03 → 03/06 | AC  | VKMA 31204<br>VKMA 6DK1195<br>VKM 31011           | 1<br>1 |   |   | 1 | 1 |  |  |   |   |  |  |  |         |
| VW  MULTIVAN V (7HM) 3.2 V6 |                 |               |   |   |        |   |   |   |   |  |  |   |   |  |  |  |         |
|                             | BDL, BKK        | 04/03 → 06/06 |   | 0X0X0X0   |        |   |   |   |   |  |  |   |   |  |  |  |         |
|                             | BDL, BKK        | 04/03 → 10/07 |   | —   |        |   |   |   |   |  |  | 1 |   |  |  |  |         |











































|  | <b>B(Alt)</b> BDL, BKK           | 04/03 → 03/06 | <b>AC</b> ,<br>→ ICH 7H-4-120 000 | VKMV 6PK1264   |                       |   |   |   |        |  |  |  |  |  |  |  |  |  |       |
|--|----------------------------------|---------------|-----------------------------------|--|-----------------------|---|---|---|--------|--|--|--|--|--|--|--|--|--|-------|
| <b>VW  MULTIVAN V (7HM) 1.9 TDI</b>                          |                                  |               |                                   |  |                       |   |   |   |        |  |  |  |  |  |  |  |  |  |       |
|  | AXB, BRS                         | 04/03 → 10/07 |                                   | VKMA 01250<br>VKM 11250<br>VKM 21147                           | 1<br>1                | 1 | 1 |   |        |  |  |  |  |  |  |  |  |  | T0184 |
|  | AXB, BRS                         | 04/03 → 10/07 |                                   | VKPC 81418   |                       |   |   |   | 1      |  |  |  |  |  |  |  |  |  |       |
|  | <b>B(Alt)</b> AXB, BRS           | 04/03 → 01/08 | <b>AC</b>                         | VKMV 6PK1120<br>VKM 31019                                      | 1                     |   |   |   | 1      |  |  |  |  |  |  |  |  |  |       |
|  | <b>B(Alt)</b> AXB, BRS           | 04/03 → 01/08 | <b>AC</b>                         | VKMA 31001<br>VKMV 6DK1195<br>VKM 31019                        | 1<br>1                |   |   |   | 1<br>1 |  |  |  |  |  |  |  |  |  |       |
| <b>VW  MULTIVAN V (7HM) 2.5 TDI</b>                          |                                  |               |                                   |  |                       |   |   |   |        |  |  |  |  |  |  |  |  |  |       |
|  | AXD, AXE                         | 04/03 → 10/07 |                                   |  |                       |   |   |   |        |  |  |  |  |  |  |  |  |  |       |
|  | AXD, AXE                         | 04/03 → 10/07 |                                   | VKPC _____   |                       |   |   |   | 1      |  |  |  |  |  |  |  |  |  |       |
| <b>VW  NEW BEETLE (9C1, 1C1)/Convertible (1Y7) 1.4</b>       |                                  |               |                                   |  |                       |   |   |   |        |  |  |  |  |  |  |  |  |  |       |
|  | BCA                              | 11/01 → 12/07 |                                   | VKMA 01121<br>VKM 11120<br>VKM 11124<br>VKM 21120<br>VKM 21121 | 2<br>1<br>1<br>1<br>1 | 2 | 2 |   |        |  |  |  |  |  |  |  |  |  | T0165 |
|  | BCA                              | 11/01 → 12/07 |                                   | VKPC 81407   |                       |   |   |   | 1      |  |  |  |  |  |  |  |  |  |       |
|  | <b>B(Alt)</b> BCA                | 11/01 → 12/07 | <b>AC</b>                         | VKMA 31206<br>VKMV 6PK1078<br>VKM 31015                        | 1<br>1                |   |   |   | 1<br>1 |  |  |  |  |  |  |  |  |  |       |
|  | <b>B(Alt)</b> BCA                | 11/01 → 12/02 | <b>AC</b> , → ICH 9C-2-610 157    | VKMV 6PK1548<br>VKM 31015                                      | 1                     |   |   |   | 1      |  |  |  |  |  |  |  |  |  |       |
| <b>VW  NEW BEETLE (9C1, 1C1)/Convertible (1Y7) 1.6</b>       |                                  |               |                                   |  |                       |   |   |   |        |  |  |  |  |  |  |  |  |  |       |
|  | AWH, AYD, BFS                    | 10/99 → 12/07 |                                   | VKMA 01113<br>VKM 11113  | 1<br>1                |   | 1 |   |        |  |  |  |  |  |  |  |  |  | T0149 |
|  | AWH, AYD, BFS                    | 10/99 → 12/07 |                                   | VKPC 81408   |                       |   |   |   | 1      |  |  |  |  |  |  |  |  |  |       |
|  | <b>B(Alt)</b> AWH, AYD, BFS      | 10/99 → 12/07 | <b>AC</b>                         | VKMA 31203<br>VKMV 6PK1120<br>VKM 31011                        | 1<br>1                |   |   |   | 1<br>1 |  |  |  |  |  |  |  |  |  |       |
|  | <b>B(Alt)</b> AWH, AYD, BFS      | 10/99 → 12/07 | <b>AC</b>                         | VKMA 31204<br>VKMV 6DK1195<br>VKM 31011                        | 1<br>1                |   |   |   | 1<br>1 |  |  |  |  |  |  |  |  |  |       |
| <b>VW  NEW BEETLE (9C1, 1C1)/Convertible (1Y7) 1.8 Turbo</b> |                                  |               |                                   |  |                       |   |   |   |        |  |  |  |  |  |  |  |  |  |       |
|  | APH                              | 10/99 → 12/07 | → I Mot. 028 500                  | VKMA 01115<br>VKM 11115<br>VKM 21115                           | 1<br>1<br>1           | 1 | 1 |   |        |  |  |  |  |  |  |  |  |  | T0151 |
|  | APH                              | 10/99 → 12/07 | Mot. 028 501 I →                  | VKMA 01116<br>VKM 11116<br>VKM 21115                           | 1<br>1<br>1           | 1 | 1 | 1 |        |  |  |  |  |  |  |  |  |  | T0151 |
|  | AVC                              | 10/99 → 12/07 | → I Mot. 003 000                  | VKMA 01115<br>VKM 11115<br>VKM 21115                           | 1<br>1<br>1           | 1 | 1 | 1 |        |  |  |  |  |  |  |  |  |  | T0151 |
|  | AVC                              | 10/99 → 12/07 | Mot. 003 001 I →                  | VKMA 01116<br>VKM 11116<br>VKM 21115                           | 1<br>1<br>1           | 1 | 1 | 1 |        |  |  |  |  |  |  |  |  |  | T0151 |
|  | AWU, AWV                         | 10/99 → 12/07 |                                   | VKMA 01116<br>VKM 11116<br>VKM 21115                           | 1<br>1<br>1           | 1 | 1 | 1 |        |  |  |  |  |  |  |  |  |  | T0151 |
|  | APH, AVC, AWU, AWV               | 10/99 → 12/07 |                                   | VKPC 81620   |                       |   |   |   | 1      |  |  |  |  |  |  |  |  |  |       |
|  | <b>B(Alt)</b> APH, AVC, AWU, AWV | 10/99 → 12/07 | <b>AC</b>                         | VKMA 31203<br>VKMV 6PK1120<br>VKM 31011                        | 1<br>1                |   |   |   | 1<br>1 |  |  |  |  |  |  |  |  |  |       |
|  | <b>B(Alt)</b> APH, AVC, AWU, AWV | 10/99 → 12/07 | <b>AC</b>                         | VKMA 31204<br>VKMV 6DK1195<br>VKM 31011                        | 1<br>1                |   |   |   | 1<br>1 |  |  |  |  |  |  |  |  |  |       |
| <b>VW  NEW BEETLE (9C1, 1C1)/Convertible (1Y7) 2.0</b>       |                                  |               |                                   |  |                       |   |   |   |        |  |  |  |  |  |  |  |  |  |       |
|  | AEG, AQY, AZJ                    | 01/98 → 12/07 |                                   | VKMA 01113<br>VKM 11113  | 1<br>1                |   | 1 |   |        |  |  |  |  |  |  |  |  |  | T0149 |
|  | AEG, AQY, AZJ                    | 01/98 → 12/07 |                                   | VKPC 81620   |                       |   |   |   | 1      |  |  |  |  |  |  |  |  |  |       |

|  | <b>B(Alt)</b> | AEG, AQY, AZJ | 01/98 → 12/07 | <b>AC</b>             | VKMA 31203<br>VKMV 6PK1120<br>VKM 31011                        | 1      |   | 1 |   |  |  |  |   |  |  |  |  |  |   |       |       |       |
|--|---------------|---------------|---------------|-----------------------|--|--------|---|---|---|--|--|--|---|--|--|--|--|--|---|-------|-------|-------|
|  | <b>B(Alt)</b> | AEG, AQY, AZJ | 01/98 → 12/07 | <b>AC</b>             | VKMA 31204<br>VKMV 6DK1195<br>VKM 31011                        | 1      |   | 1 |   |  |  |  |   |  |  |  |  |  |   |       |       |       |
| <b>VW  NEW BEETLE (9C1, 1C1)/Convertible (1Y7) 2.3 V5</b>      |               |               |               |                       |  |        |   |   |   |  |  |  |   |  |  |  |  |  |   |       |       |       |
|  |               | AQN           | 10/00 → 12/07 |                       | <b>OXOXOXO</b>   |        |   |   |   |  |  |  |   |  |  |  |  |  |   |       |       |       |
|  |               | AQN           | 10/00 → 12/07 |                       | VKPC 81622   |        |   |   |   |  |  |  | 1 |  |  |  |  |  |   |       |       |       |
|  | <b>B(Alt)</b> | AQN           | 10/00 → 12/07 | <b>AC</b>             | VKMV 6PK1264   |        |   | 1 |   |  |  |  |   |  |  |  |  |  |   |       |       |       |
| <b>VW  NEW BEETLE (9C1, 1C1)/Convertible (1Y7) 3.2 RSI</b>     |               |               |               |                       |  |        |   |   |   |  |  |  |   |  |  |  |  |  |   |       |       |       |
|  |               | AXJ           | 04/00 → 12/07 |                       | <b>OXOXOXO</b>   |        |   |   |   |  |  |  |   |  |  |  |  |  |   |       |       |       |
|  |               | AXJ           | 04/00 → 12/07 |                       | —  |        |   |   |   |  |  |  | 1 |  |  |  |  |  |   |       |       |       |
| <b>VW  NEW BEETLE (9C1, 1C1)/Convertible (1Y7) 1.9 TDI 90</b>  |               |               |               |                       |  |        |   |   |   |  |  |  |   |  |  |  |  |  |   |       |       |       |
|  |               | ALH           | 01/98 → 02/01 | →IMot. 500 000        | VKMA 01131<br>VKM 11130<br>VKM 21004<br>VKM 21130<br>VKM 21131 | 1<br>1 | 3 | 1 |   |  |  |  |   |  |  |  |  |  | 8 | T0173 |       |       |
|  |               | ALH           | 01/98 → 02/01 | Mot. 500 001 I→       | VKMA 01251<br>VKM 11130<br>VKM 21004<br>VKM 21130<br>VKM 21131 | 1<br>1 | 3 | 1 |   |  |  |  |   |  |  |  |  |  | 8 | T0173 |       |       |
|  |               | ALH           | 01/98 → 02/01 |                       | VKPC 81623   |        |   |   |   |  |  |  | 1 |  |  |  |  |  |   |       |       |       |
|  | <b>B(Alt)</b> | ALH           | 01/98 → 02/01 | <b>AC</b>             | VKMV 6PK906<br>VKM 31002<br>VKM 31012                          | 1      |   | 1 |   |  |  |  |   |  |  |  |  |  |   |       | 1     |       |
|  | <b>B(Alt)</b> | ALH           | 01/98 → 02/01 | <b>AC</b>             | VKMA 31014<br>VKMV 6PK1660<br>VKM 31002<br>VKM 31012           | 1<br>1 | 1 | 1 | 1 |  |  |  |   |  |  |  |  |  |   | 1     |       |       |
|  |               | ALH           | 01/98 → 02/01 |                       |  | 1      |   | 1 |   |  |  |  |   |  |  |  |  |  |   | 1     |       |       |
| <b>VW  NEW BEETLE (9C1, 1C1)/Convertible (1Y7) 1.9 TDI 100</b> |               |               |               |                       |  |        |   |   |   |  |  |  |   |  |  |  |  |  |   |       |       |       |
|  |               | ATD           | 02/01 → 12/07 | <br>→ICH 9C-2-613 920 | VKMA 01942<br>VKM 11142<br>VKM 11145<br>VKM 21142              | 1<br>1 | 1 | 1 | 1 |  |  |  | 1 |  |  |  |  |  |   | 3     | T0184 |       |
|  |               | ATD           | 02/01 → 12/07 | →ICH 9C-2-613 920     | VKMA 01142<br>VKM 11142<br>VKM 21142                           | 1<br>1 | 1 | 1 | 1 |  |  |  |   |  |  |  |  |  |   |       | 3     | T0184 |
|  |               | ATD           | 02/01 → 12/07 | CH 9C-2-613 921 I→    | VKMA 01250<br>VKM 11250<br>VKM 21147                           | 1<br>1 | 1 | 1 | 1 |  |  |  |   |  |  |  |  |  |   |       |       | T0184 |
|  |               | AXR           | 03/03 → 12/07 |                       | VKMA 01250<br>VKM 11250<br>VKM 21147                           | 1<br>1 | 1 | 1 | 1 |  |  |  |   |  |  |  |  |  |   |       |       | T0184 |
|  |               | ATD           | 02/01 → 12/07 |                       | VKPC 81626   |        |   |   |   |  |  |  | 1 |  |  |  |  |  |   |       |       |       |
|  |               | AXR           | 03/03 → 12/07 |                       | VKPC 81303   |        |   |   |   |  |  |  | 1 |  |  |  |  |  |   |       |       |       |
|  | <b>B(Alt)</b> | ATD, AXR      | 02/01 → 12/07 | <b>AC</b>             | VKMV 6PK1120<br>VKM 31019                                      | 1      |   | 1 |   |  |  |  |   |  |  |  |  |  |   |       |       |       |
|  | <b>B(Alt)</b> | ATD, AXR      | 02/01 → 12/07 | <b>AC</b>             | VKMA 31001<br>VKMV 6DK1195<br>VKM 31019                        | 1<br>1 |   | 1 |   |  |  |  |   |  |  |  |  |  |   |       |       |       |
|  |               | ATD, AXR      | 02/01 → 12/07 |                       |  | 1      |   | 1 |   |  |  |  |   |  |  |  |  |  |   |       |       |       |
| <b>VW  NEW BEETLE (9C1, 1C1)/Convertible (1Y7) 1.9 TDI 105</b> |               |               |               |                       |  |        |   |   |   |  |  |  |   |  |  |  |  |  |   |       |       |       |
|  |               | BEW, BSW      | 07/05 → 12/07 |                       | VKMA 01250<br>VKM 11250<br>VKM 21147                           | 1<br>1 | 1 | 1 | 1 |  |  |  |   |  |  |  |  |  |   |       |       | T0184 |
|  |               | BEW, BSW      | 07/05 → 12/07 |                       | VKPC 81303   |        |   |   |   |  |  |  | 1 |  |  |  |  |  |   |       |       |       |
|  | <b>B(Alt)</b> | BEW, BSW      | 07/05 → 12/07 | <b>AC</b>             | VKMV 6PK1120<br>VKM 31019                                      | 1      |   | 1 |   |  |  |  |   |  |  |  |  |  |   |       |       |       |
|  | <b>B(Alt)</b> | BEW, BSW      | 07/05 → 12/07 | <b>AC</b>             | VKMA 31001<br>VKMV 6DK1195<br>VKM 31019                        | 1<br>1 |   | 1 |   |  |  |  |   |  |  |  |  |  |   |       |       |       |











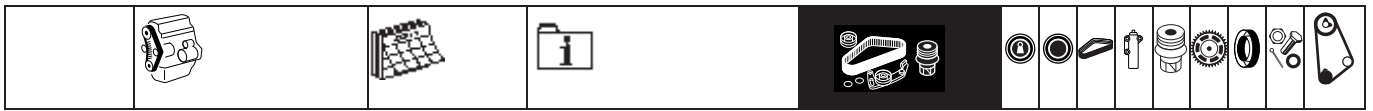



|  |                               |  |  |    |  |  |  |  |  |  |  |  |  |  |  |
|--|-------------------------------|---|---|---|--|---|---|---|---|---|---|---|---|---|---|
| <b>VW  PARATI 1.9 D</b>                       |                               |   |   |   |  |   |   |   |   |   |   |   |   |   |   |
|    | 1Y                            |   | 08/02 → 10/07   |   | VKMA 01013   | 1   |   | 1   |   |   |   |   |   | 4   | T0069   |
|  |                               |   |   |   | VKM 11014  | 1   |   |   |   |   |   |   |   |   |   |
| <b>VW  PASSAT (32) / Variant (33) 1.3</b>     |                               |   |   |   |  |   |   |   |   |   |   |   |   |   |   |
|    | FY                            |   | 05/73 → 07/80   |    | VKMC 01100   |   |   | 1   |   | 1   |   |   |   |   | T0222   |
|  | ZA, ZF                        |   | 05/73 → 01/78   | 3)  | VKMS 01000   | 1   |   | 1   |   |   |   |   | 3   | 4   |   |
|  |                               |   |   |   | VKMA 01000   | 1   |   | 1   |   |   |   |   |   | 3   | T0005   |
|  |                               |   |   |   | VKM 11000  | 1   |   |   |   |   |   |   |   |   |   |
|    | FY                            |   | 05/73 → 07/80   |   | VKPC 81200   |   |   |   |   | 1   |   |   |   |   |   |
|  | ZA, ZF                        |   | 05/73 → 07/80   | 2)  | VKPA 81400   |   |   |   |   | 1   |   |   |   |   |   |
|  |                               |   |   |   | VKPC 81400   |   |   |   |   | 1   |   |   |   |   |   |
|    | B(Alt) FY                     |   | 05/73 → 07/80   | → ICH 32A 0089 525  | VKMOV 10AVx695   |   |   | 1   |   |   |   |   |   |   |   |
|  | B(Alt) FY                     |   | 05/73 → 07/80   | CH 32A 0089 526 I→  | VKMOV 10AVx675   |   |   | 1   |   |   |   |   |   |   |   |
|  | B(Alt) ZA, ZF                 |   | 05/73 → 01/78   |   | VKMOV 10AVx950   |   |   | 1   |   |   |   |   |   |   |   |
| <b>VW  PASSAT (32) / Variant (33) 1.5</b>     |                               |   |   |   |  |   |   |   |   |   |   |   |   |   |   |
|    | YJ, ZB, ZC                    |   | 05/73 → 12/75   | 3)  | VKMS 01000   | 1   |   | 1   |   |   |   |   | 3   | 4   |   |
|  |                               |   |   |   | VKMA 01000   | 1   |   | 1   |   |   |   |   |   | 3   | T0005   |
|  |                               |   |   |   | VKM 11000  | 1   |   |   |   |   |   |   |   |   |   |
|    | YJ, ZB, ZC                    |   | 05/73 → 12/75   | 2)  | VKPA 81400   |   |   |   |   | 1   |   |   |   |   |   |
|  |                               |   |   |   | VKPC 81400   |   |   |   |   | 1   |   |   |   |   |   |
|    | B(Alt) YJ, ZB, ZC             |   | 05/73 → 12/75   |   | VKMOV 10AVx950   |   |   | 1   |   |   |   |   |   |   |   |
| <b>VW  PASSAT (32) / Variant (33) 1.6</b>     |                               |   |   |   |  |   |   |   |   |   |   |   |   |   |   |
|    | FS, YN, YP, YS                |   | 08/75 → 07/80   | 3)  | VKMS 01000   | 1   |   | 1   |   |   |   |   | 3   | 4   |   |
|  |                               |   |   |   | VKMA 01000   | 1   |   | 1   |   |   |   |   |   | 3   | T0005   |
|  |                               |   |   |   | VKM 11000  | 1   |   |   |   |   |   |   |   |   |   |
|    | FS, YS                        |   | 08/75 → 07/80   | 2)  | VKPA 81400   |   |   |   |   | 1   |   |   |   |   |   |
|  |                               |   |   |   | VKPC 81400   |   |   |   |   | 1   |   |   |   |   |   |
|  | YN, YP                        |   | 08/75 → 07/80   | 2), → ICH 32-B-100 000  | VKPA 81400   |   |   |   |   | 1   |   |   |   |   |   |
|  |                               |   |   |   | VKPC 81400   |   |   |   |   | 1   |   |   |   |   |   |
|  | YN, YP                        |   | 08/75 → 07/80   | 2), CH 32-B-100 001 I→  | VKPA 81401   |   |   |   |   | 1   |   |   |   |   |   |
|  |                               |   |   |   | VKPC 81401   |   |   |   |   | 1   |   |   |   |   |   |
|    | B(Alt) FS, YN, YP, YS         |   | 08/75 → 07/80   |   | VKMOV 10AVx950   |   |   | 1   |   |   |   |   |   |   |   |
| <b>VW  PASSAT (32) / Variant (33) 1.5 D</b> |                               |   |   |   |  |   |   |   |   |   |   |   |   |   |   |
|    | CK                            |   | 02/77 → 07/80   | 3)  | VKMS 01010   | 1   |   | 1   |   |   |   |   | 3   | 2   |   |
|  |                               |   |   |   | VKMA 01010   | 1   |   | 1   |   |   |   |   |   | 1   | T0051   |
|  |                               |   |   |   | VKM 11010  | 1   |   |   |   |   |   |   |   |   |   |
|    | CK                            |   | 02/77 → 07/80   | 2)  | VKPA 81400   |   |   |   |   | 1   |   |   |   |   |   |
|  |                               |   |   |   | VKPC 81400   |   |   |   |   | 1   |   |   |   |   |   |
| <b>VW  PASSAT (32) / Variant (33) 1.6 D</b> |                               |   |   |   |  |   |   |   |   |   |   |   |   |   |   |
|    | CR                            |   | 02/79 → 07/80   | 3)  | VKMS 01010   | 1   |   | 1   |   |   |   |   | 3   | 2   |   |
|  |                               |   |   |   | VKMA 01010   | 1   |   | 1   |   |   |   |   |   | 1   | T0051   |
|  |                               |   |   |   | VKM 11010  | 1   |   |   |   |   |   |   |   |   |   |
|    | CR                            |   | 02/79 → 07/80   | 2)  | VKPA 81401   |   |   |   |   | 1   |   |   |   |   |   |
|  |                               |   |   |   | VKPC 81401   |   |   |   |   | 1   |   |   |   |   |   |
| <b>VW  PASSAT (32B) 1.3</b>                 |                               |   |   |   |  |   |   |   |   |   |   |   |   |   |   |
|    | FY, FZ                        |   | 08/80 → 07/86   |  | VKMC 01100   |   |   | 1   |   | 1   |   |   |   |   | T0222   |
|  | EP                            |   | 08/80 → 07/86   | 3)  | VKMS 01000   | 1   |   | 1   |   |   |   |   | 3   | 4   |   |
|  |                               |   |   |   | VKMA 01000   | 1   |   | 1   |   |   |   |   |   | 3   | T0005   |
|  |                               |   |   |   | VKM 11000  | 1   |   |   |   |   |   |   |   |   |   |
|    | EP                            |   | 08/80 → 07/86   | 2)  | VKPA 81401   |   |   |   |   | 1   |   |   |   |   |   |
|  |                               |   |   |   | VKPC 81401   |   |   |   |   | 1   |   |   |   |   |   |
|  | FY, FZ                        |   | 08/80 → 07/86   |   | VKPC 81200   |   |   |   |   | 1   |   |   |   |   |   |
|    | B(Alt) EP                     |   | 08/80 → 07/86   |   | VKMOV 10AVx950   |   |   | 1   |   |   |   |   |   |   |   |
|  | B(Alt) FY, FZ                 |   | 08/80 → 12/81   |   | VKMOV 10AVx675   |   |   | 1   |   |   |   |   |   |   |   |
|  | B(Alt) FY, FZ                 |   | 01/82 → 07/86   |   | VKMOV 10AVx695   |   |   | 1   |   |   |   |   |   |   |   |
| <b>VW  PASSAT (32B) 1.6</b>                 |                               |   |   |   |  |   |   |   |   |   |   |   |   |   |   |
|    | DT, PP, RF, RL, WV,<br>YN, YP |   | 08/80 → 03/88   | 3)  | VKMS 01000   | 1   |   | 1   |   |   |   |   | 3   | 4   |   |
|  |                               |   |   |   | VKMA 01000   | 1   |   | 1   |   |   |   |   |   | 3   | T0005   |
|  |                               |   |   |   | VKM 11000  | 1   |   |   |   |   |   |   |   |   |   |
|    | DT, PP, RF, RL, WV            |   | 08/80 → 03/88   | 2)  | VKPA 81401   |   |   |   |   | 1   |   |   |   |   |   |
|  |                               |   |   |   | VKPC 81401   |   |   |   |   | 1   |   |   |   |   |   |























|  |  |  |    |  |  |  |  |  |  |  |  |  |
|--|---|---|---|--|---|---|---|---|---|---|---|---|
|  | YN, YP  | 08/80 → 03/88   | 2), → ICH 32-B-100 000  | VKPA 81400<br>VKPC 81400   |   |   |   |   | 1   |   |   |   |
|  | WV, YN, YP  | 08/80 → 03/88   | 2), CH 32-B-100 001 I→  | VKPA 81401<br>VKPC 81401   |   |   |   |   | 1   |   |   |   |
|                                 | B(Alt) DT, PP, RF, RL, WV,<br>YN, YP  | 08/80 → 03/88   |   | VKMV 10AVx950  |   |   |   | 1   |   |   |   |   |
|  | B(PS) DT  | 08/80 → 03/88   |   | VKMV 10AVx763  |   |   |   | 1   |   |   |   |   |
| <b>VW  PASSAT (32B) 1.8</b>     |   |   |   |  |   |   |   |   |   |   |   |   |
|                                 | DS, DZ, JN, RM  | 01/83 → 03/88   | 3)  | VKMS 01000<br>VKMA 01000<br>VKM 11000  | 1<br>1<br>1   |   | 1   |   |   |   | 3<br>4  | T0005   |
|                                 | DS, DZ, JN, RM  | 01/83 → 03/88   | 2)  | VKPA 81401<br>VKPC 81401   |   |   |   | 1<br>1  |   |   |   |   |
|                                 | B(Alt) DS, DZ, JN, RM   | 01/83 → 03/88   |   | VKMV 10AVx950  |   |   |   | 1   |   |   |   |   |
|  | B(PS) DS, DZ, JN  | 01/83 → 03/88   | → ICH 32-E-220 000  | VKMV 11.5x790  |   |   |   | 1   |   |   |   |   |
|  | B(PS) DS, DZ, JN  | 01/83 → 03/88   | CH 32-E-220 001 I→  | VKMV 10AVx763  |   |   |   | 1   |   |   |   |   |
|  | B(PS) RM  | 05/86 → 03/88   |   | VKMV 10AVx763  |   |   |   | 1   |   |   |   |   |
| <b>VW  PASSAT (32B) 1.9</b>     |   |   |   |  |   |   |   |   |   |   |   |   |
|                                 | WN  | 01/81 → 07/83   |    | —  |   |   |   | 1   | 1   |   |   |   |
|                                 | WN  | 01/81 → 07/83   |   | VKPC 81605   |   |   |   | 1   |   |   |   |   |
|                                 | B(Alt) WN   | 01/81 → 07/83   |   | VKMV 11.5x790  |   |   |   | 1   |   |   |   |   |
|  | B(PS) WN  | 01/81 → 07/83   |   | VKMV 13AVx990  |   |   |   | 1   |   |   |   |   |
| <b>VW  PASSAT (32B) 2.0</b>     |   |   |   |  |   |   |   |   |   |   |   |   |
|                                 | JS  | 08/83 → 03/88   |    | VKMC 01031<br>VKMA 01031<br>VKM 21031  | 1<br>1<br>1   | 1   |   | 1   |   |   |   | T0020   |
|                               | JS  | 08/83 → 03/88   |   | VKPC 81605   |   |   |   | 1   |   |   |   |   |
|                               | B(Alt) JS   | 08/83 → 03/88   | AC,<br>→ ICH 32-F-299 999   | VKMV 11.5x790  |   |   |   | 1   |   |   |   |   |
|  | B(Alt) JS   | 08/83 → 03/88   | AC,<br>CH 32-F-300 001 I→   | VKMV 11.2x820  |   |   |   | 1   |   |   |   |   |
|  | B(PS) JS  | 08/83 → 03/88   |   | VKMV 13AVx990  |   |   |   | 1   |   |   |   |   |
| <b>VW  PASSAT (32B) 2.1</b>   |   |   |   |  |   |   |   |   |   |   |   |   |
|                               | WE  | 01/81 → 07/83   |  | —  |   |   |   | 1   | 1   |   |   |   |
|                               | WE  | 01/81 → 07/83   |   | VKPC 81605   |   |   |   | 1   |   |   |   |   |
|                               | B(Alt) WE   | 01/81 → 07/83   |   | VKMV 11.5x790  |   |   |   | 1   |   |   |   |   |
|  | B(PS) WE  | 01/81 → 07/83   |   | VKMV 13AVx990  |   |   |   | 1   |   |   |   |   |
| <b>VW  PASSAT (32B) 2.2</b>   |   |   |   |  |   |   |   |   |   |   |   |   |
|                               | JT, KV, KX  | 01/85 → 03/88   |  | VKMC 01031<br>VKMA 01031<br>VKM 21031  | 1<br>1<br>1   | 1   |   | 1   |   |   |   | T0020   |
|                               | JT, KV, KX  | 01/85 → 03/88   |   | VKPC 81605   |   |   |   | 1   |   |   |   |   |
|                               | B(Alt) KV   | 01/85 → 03/88   | AC,<br>→ ICH 32-F-299 999   | VKMV 11.5x790  |   |   |   | 1   |   |   |   |   |
|  | B(Alt) KV   | 01/85 → 03/88   | AC,<br>CH 32-F-300 001 I→   | VKMV 11.2x820  |   |   |   | 1   |   |   |   |   |
|  | B(Alt) KX   | 01/85 → 03/88   | AC  | VKMV 11.2x820  |   |   |   | 1   |   |   |   |   |
|  | B(Alt) KV, KX   | 01/85 → 03/88   | AC  | VKMV 10AVx850  |   |   |   | 1   |   |   |   |   |
|  | B(PS) KV, KX  | 01/85 → 03/88   |   | VKMV 13AVx990  |   |   |   | 1   |   |   |   |   |
| <b>VW  PASSAT (32B) 1.6 D</b> |   |   |   |  |   |   |   |   |   |   |   |   |
|                               | CR, JK  | 08/80 → 03/88   | 3)  | VKMS 01010<br>VKMA 01010<br>VKM 11010  | 1<br>1<br>1   |   | 1   |   |   |   | 3<br>2  | T0051   |
|                               | CR, JK  | 08/80 → 03/88   | 2)  | VKPA 81401<br>VKPC 81401   |   |   |   | 1<br>1  |   |   |   |   |
|                               | B(Alt) CR, JK   | 08/80 → 03/88   | AC  | VKMV 10AVx735  |   |   |   | 1   |   |   |   |   |
|  | B(Alt) CR, JK   | 08/80 → 03/88   | AC  | VKMV 10AVx763  |   |   |   | 1   |   |   |   |   |
|  | B(PS) CR, JK  | 08/80 → 03/88   |   | VKMV 11.5x790  |   |   |   | 1   |   |   |   |   |
|  | B(AC) CR, JK  | 08/80 → 03/88   |   | VKMV 13AVx825  |   |   |   | 1   |   |   |   |   |



VW



| VW  PASSAT (32B) 1.6 TD                          |                              |               |  |                |   |   |   |   |   |   |       |
|---|------------------------------|---------------|--|----------------|---|---|---|---|---|---|-------|
|   | CY, RA                       | 04/82 → 03/88 | 3)   | VKMS 01010     | 1 | 1 |   |   | 3 | 2 |       |
|   |                              |               |  | VKMA 01010     | 1 | 1 |   |   |   | 1 | T0051 |
|   |                              |               |  | VKM 11010      | 1 |   |   |   |   |   |       |
|   | CY, RA                       | 04/82 → 03/88 | 2)   | VKPA 81401     |   |   |   | 1 |   |   |       |
|   |                              |               |  | VKPC 81401     |   |   |   | 1 |   |   |       |
|   | B(Alt) CY, RA                | 04/82 → 03/88 | AC   | VKMOV 10AVx735 |   | 1 |   |   |   |   |       |
|   | B(Alt) CY                    | 04/82 → 12/85 | AC   | VKMOV 10AVx763 |   | 1 |   |   |   |   |       |
|   | B(Alt) CY, RA                | 01/86 → 03/88 | AC   | VKMOV 10AVx775 |   | 1 |   |   |   |   |       |
|   | B(PS) CY, RA                 | 04/82 → 03/88 |  | VKMOV 11.5x790 |   | 1 |   |   |   |   |       |
|   | B(AC) CY, RA                 | 04/82 → 03/88 |  | VKMOV 13AVx825 |   | 1 |   |   |   |   |       |
| VW  PASSAT (3A2, 35I) / Variant (3A5, 35I) 1.6   |                              |               |  |                |   |   |   |   |   |   |       |
|   | 1F, AEK, AFT, EZ             | 02/88 → 08/96 | 3)   | VKMS 01000     | 1 | 1 |   |   | 3 | 4 |       |
|   |                              |               |  | VKMA 01000     | 1 | 1 |   |   |   | 3 | T0005 |
|   |                              |               |  | VKM 11000      | 1 |   |   |   |   |   |       |
|   | 1F, AEK, AFT, EZ             | 02/88 → 08/96 | 2)   | VKPA 81401     |   |   |   | 1 |   |   |       |
|   |                              |               |  | VKPC 81401     |   |   |   | 1 |   |   |       |
|   | B(Alt) 1F, EZ                | 02/88 → 09/91 | AC, ⊗  | VKMOV 10AVx950 |   | 1 |   |   |   |   |       |
|   | B(Alt) 1F, EZ                | 02/88 → 09/91 | AC, ⊗  | VKMOV 10AVx865 |   | 1 |   |   |   |   |       |
|   | B(Alt) 1F, EZ                | 02/88 → 09/91 | AC, ⊗  | VKMOV 10AVx630 |   | 1 |   |   |   |   |       |
|   | B(Alt) AEK, AFT              | 07/94 → 08/96 | A⊗   | VKMOV 6PK894   |   | 1 |   |   |   |   |       |
|   | B(Alt) AEK, AFT              | 07/94 → 08/96 | A⊗, AC,<br>→ ICH 3A-T-011 389                        | VKMOV 6PK976   |   |   | 1 |   |   |   |       |
|   |                              |               |  | VKM 31004      | 1 |   |   |   |   |   |       |
|   |                              |               |  | VKM 31210      | 1 |   |   |   |   |   |       |
|   | B(Alt) AEK, AFT              | 07/94 → 08/96 | A⊗, AC,<br>CH 3A-T-011 390 I→                        | VKMOV 6PK1033  |   |   | 1 |   |   |   |       |
|   |                              |               |  | VKM 31004      | 1 |   |   |   |   |   |       |
|   |                              |               |  | VKM 31210      | 1 |   |   |   |   |   |       |
|   | B(Alt) AEK, AFT              | 07/94 → 08/96 | A⊗, AC   | VKMOV 6PK1153  |   |   | 1 |   |   |   |       |
|   |                              |               |  | VKM 31004      | 1 |   |   |   |   |   |       |
|   |                              |               |  | VKM 31210      | 1 |   |   |   |   |   |       |
|   | B(PS) 1F, EZ                 | 02/88 → 09/91 |  | VKMOV 10AVx730 |   | 1 |   |   |   |   |       |
|   | B(PS) AEK, AFT               | 07/94 → 08/96 | AC   | VKMOV 11.5x685 |   | 1 |   |   |   |   |       |
|   | B(PS) AEK, AFT               | 07/94 → 08/96 | AC   | VKMOV 11.5x755 |   | 1 |   |   |   |   |       |
|   | B(AC) 1F, EZ                 | 02/88 → 09/91 |  | VKMOV 13AVx950 |   | 1 |   |   |   |   |       |
| VW  PASSAT (3A2, 35I) / Variant (3A5, 35I) 1.8 |                              |               |  |                |   |   |   |   |   |   |       |
|   | AAM, ABS, ADZ, PB, PF,<br>RP | 02/88 → 05/97 | 3)   | VKMS 01000     | 1 | 1 |   |   | 3 | 4 |       |
|   |                              |               |  | VKMA 01000     | 1 | 1 |   |   |   | 3 | T0005 |
|   |                              |               |  | VKM 11000      | 1 |   |   |   |   |   |       |
|   | AAM, ABS, ADZ, PB, PF,<br>RP | 02/88 → 05/97 | 2)   | VKPA 81401     |   |   |   | 1 |   |   |       |
|   |                              |               |  | VKPC 81401     |   |   |   | 1 |   |   |       |
|   | B(Alt) AAM                   | 08/90 → 08/96 | A⊗,<br>CH 31-P-200 001 I→                            | VKMOV 6PK894   |   | 1 |   |   |   |   |       |
|   | B(Alt) AAM                   | 08/90 → 08/96 | A⊗, AC,<br>CH 3A-T-011 390 I→                        | VKMOV 6PK1033  |   |   | 1 |   |   |   |       |
|   |                              |               |  | VKM 31004      | 1 |   |   |   |   |   |       |
|   |                              |               |  | VKM 31210      | 1 |   |   |   |   |   |       |
|   | B(Alt) AAM                   | 08/90 → 08/96 | A⊗, AC,<br>CH 31-P-200 001 I→                        | VKMOV 6PK1153  |   |   | 1 |   |   |   |       |
|   |                              |               |  | VKM 31004      | 1 |   |   |   |   |   |       |
|   |                              |               |  | VKM 31210      | 1 |   |   |   |   |   |       |
|   | B(Alt) AAM                   | 08/90 → 08/96 | A⊗, AC,<br>CH 31-P-200 001 I→,<br>→ ICH 3A-T-011 389 | VKMOV 6PK976   |   |   | 1 |   |   |   |       |
|   |                              |               |  | VKM 31004      | 1 |   |   |   |   |   |       |
|   |                              |               |  | VKM 31210      | 1 |   |   |   |   |   |       |
|   | B(Alt) PB, PF                | 04/88 → 07/93 | ⊗  | VKMOV 10AVx950 |   | 1 |   |   |   |   |       |
|   | B(Alt) PB, PF                | 04/88 → 07/93 | ⊗  | VKMOV 10AVx865 |   | 1 |   |   |   |   |       |

|  |  |  |  |  |  |  |  |  |  |  |  |
|--|---|---|---|--|---|---|---|---|---|---|---|
| B(Alt)   | RP  | 02/88 → 05/97   | AC, Ø   | VKMV 10AVx950  |   |   | 1   |   |   |   |   |
| B(Alt)   | RP  | 02/88 → 05/97   | AC, Ø   | VKMV 10AVx865  |   |   | 1   |   |   |   |   |
| B(Alt)   | RP  | 02/88 → 05/97   | AC, Ø   | VKMV 10AVx630  |   |   | 1   |   |   |   |   |
| B(PS)  | AAM   | 08/90 → 08/96   | AC,   |  |   |   |   |   |   |   |   |
|  |   |   | CH 31-P-200 001 I→  | VKMV 11.5x685  |   |   | 1   |   |   |   |   |
| B(PS)  | AAM   | 08/90 → 08/96   | AC, CH 31-P-200 001 I→  | VKMV 11.5x755  |   |   | 1   |   |   |   |   |
| B(PS)  | PB, PF  | 04/88 → 07/93   |   | VKMV 10AVx730  |   |   | 1   |   |   |   |   |
| B(PS)  | RP  | 02/88 → 05/97   | AC  | VKMV 10AVx730  |   |   | 1   |   |   |   |   |
| B(PS)  | RP  | 02/88 → 05/97   | AC,   |  |   |   |   |   |   |   |   |
|  |   |   | → ICH 31-M-120 000  | VKMV 10AVx730  |   |   | 1   |   |   |   |   |
| B(PS)  | RP  | 02/88 → 05/97   | AC,   |  |   |   |   |   |   |   |   |
|  |   |   | CH 31-M-120 001 I→  | VKMV 10AVx630  |   |   | 1   |   |   |   |   |
| <b>VW  PASSAT (3A2, 35I) / Variant (3A5, 35I) 1.8 16V</b> |   |   |   |  |   |   |   |   |   |   |   |
|   | KR  | 04/88 → 09/93   |   | VKMA 01020<br>VKM 11020  | 1<br>1  |   | 1   |   |   |   | T0057   |
|   | KR  | 04/88 → 09/93   | 2)  | VKPA 81401<br>VKPC 81401   |   |   |   | 1<br>1  |   |   |   |
| <b>VW  PASSAT (3A2, 35I) / Variant (3A5, 35I) 1.8 G60</b> |   |   |   |  |   |   |   |   |   |   |   |
|   | PG  | 08/88 → 05/97   | 3)  | VKMS 01000<br>VKMA 01000<br>VKM 11000  | 1<br>1<br>1   |   | 1   |   |   | 3<br>4  | T0005   |
|   | PG  | 08/88 → 05/97   | 2)  | VKPA 81401<br>VKPC 81401   |   |   |   | 1<br>1  |   |   |   |
|   | B(Alt)  | PG  | 08/88 → 05/97   | AC   | VKMV 6PK1660<br>VKM 31007<br>VKM 31007  |   | 1<br>1  |   |   |   |   |
|  | B(Alt)  | PG  | 08/88 → 05/97   | AC   | VKMV 6PK1760<br>VKM 31007<br>VKM 31007  |   | 1<br>1  |   |   |   |   |
| <b>VW  PASSAT (3A2, 35I) / Variant (3A5, 35I) 2.0</b>   |   |   |   |  |   |   |   |   |   |   |   |
|   | 2E, ADY, AEP, AGG   | 09/89 → 05/97   |   | VKMA 01002<br>VKM 11000  | 1<br>1  |   | 1   |   |   | 3   | T0091   |
|   | 2E, ADY, AEP, AGG   | 09/89 → 05/97   | 2)  | VKPA 81401<br>VKPC 81401   |   |   |   | 1<br>1  |   |   |   |
|   | B(Alt)  | 2E  | 02/90 → 08/96   | AC, Ø,<br>→ ICH 31-N-500 000   | VKMV 10AVx950   |   |   | 1   |   |   |   |
|  | B(Alt)  | 2E  | 02/90 → 08/96   | AC, Ø,<br>→ ICH 31-N-500 000   | VKMV 10AVx865   |   |   | 1   |   |   |   |
|  | B(Alt)  | 2E  | 02/90 → 08/96   | AC, Ø,<br>→ ICH 31-N-500 000   | VKMV 10AVx630   |   |   | 1   |   |   |   |
|  | B(Alt)  | 2E  | 02/90 → 08/96   | AØ,<br>CH 31-P-000 001 I→  | VKMV 6PK894   |   |   | 1   |   |   |   |
|  | B(Alt)  | 2E  | 02/90 → 08/96   | AØ, AC,<br>CH 3A-T-011 390 I→  | VKMV 6PK1033<br>VKM 31004<br>VKM 31210  | 1<br>1  |   | 1   |   |   |   |
|  | B(Alt)  | 2E  | 02/90 → 08/96   | AØ, AC,<br>CH 31-P-000 001 I→  | VKMV 6PK1153<br>VKM 31004<br>VKM 31210  | 1<br>1  |   | 1   |   |   |   |
|  | B(Alt)  | 2E  | 02/90 → 08/96   | AØ, AC,<br>CH 31-P-000 001 I→,<br>→ ICH 3A-T-011 389                               | VKMV 6PK976<br>VKM 31004<br>VKM 31210   | 1<br>1  |   | 1   |   |   |   |
|  | B(PS)   | 2E  | 02/90 → 08/96   | AC,<br>CH 31-P-000 001 I→  | VKMV 11.5x685   |   |   | 1   |   |   |   |
|  | B(PS)   | 2E  | 02/90 → 08/96   | AC, CH 31-P-000 001 I→   | VKMV 11.5x755   |   |   | 1   |   |   |   |
|  | B(PS)   | 2E  | 02/90 → 08/96   | → ICH 31-N-500 000   | VKMV 10AVx730   |   |   | 1   |   |   |   |
|  | B(AC)   | 2E  | 02/90 → 08/96   | → ICH 31-N-500 000   | VKMV 13AVx950   |   |   | 1   |   |   |   |



VW





**VW PASSAT (3A2, 35I) / Variant (3A5, 35I) 2.0 16V**

|  |            |               |                               |   |        |   |  |  |  |  |        |   |  |  |  |  |  |  |       |
|--|------------|---------------|-------------------------------|---|--------|---|--|--|--|--|--------|---|--|--|--|--|--|--|-------|
|  | 9A         | 08/88 → 09/93 |                               | VKMA 01020<br>VKM 11020                 | 1<br>1 | 1 |  |  |  |  |        |   |  |  |  |  |  |  | T0057 |
|  | ABF        | 01/94 → 05/97 | →IMot. 020 922                | VKMA 01021<br>VKM 11020                 | 1<br>1 | 1 |  |  |  |  |        |   |  |  |  |  |  |  | T0114 |
|  | ABF        | 01/94 → 05/97 | Mot. 020 923 I→               | VKMA 01024<br>VKM 11021                 | 1<br>1 | 1 |  |  |  |  |        |   |  |  |  |  |  |  | T0114 |
|  | 9A, ABF    | 08/88 → 05/97 | 2)                            | VKPA 81401<br>VKPC 81401                |        |   |  |  |  |  | 1<br>1 |   |  |  |  |  |  |  |       |
|  | B(Alt) ABF | 01/94 → 05/97 | A⊙                            | VKMOV 6PK894                            |        |   |  |  |  |  | 1      |   |  |  |  |  |  |  |       |
|  | B(Alt) ABF | 01/94 → 05/97 | A⊙, AC,<br>→ICH 3A-T-011 389  | VKMOV 6PK976<br>VKM 31004<br>VKM 31210  |        |   |  |  |  |  | 1<br>1 | 1 |  |  |  |  |  |  |       |
|  | B(Alt) ABF | 01/94 → 05/97 | A⊙, AC,<br>CH 3A-T-011 390 I→ | VKMOV 6PK1033<br>VKM 31004<br>VKM 31210 |        |   |  |  |  |  | 1<br>1 | 1 |  |  |  |  |  |  |       |
|  | B(Alt) ABF | 01/94 → 05/97 | A⊙, AC                        | VKMOV 6PK1153<br>VKM 31004<br>VKM 31210 |        |   |  |  |  |  | 1<br>1 | 1 |  |  |  |  |  |  |       |
|  | B(PS) ABF  | 01/94 → 05/97 | AC                            | VKMOV 11.5x685                          |        |   |  |  |  |  |        | 1 |  |  |  |  |  |  |       |
|  | B(PS) ABF  | 01/94 → 05/97 | AC                            | VKMOV 11.5x755                          |        |   |  |  |  |  |        | 1 |  |  |  |  |  |  |       |

**VW PASSAT (3A2, 35I) / Variant (3A5, 35I) 2.8 VR6**

|  |            |               |    |   |  |  |  |  |  |  |             |        |  |  |  |  |  |  |  |
|--|------------|---------------|----|---|--|--|--|--|--|--|-------------|--------|--|--|--|--|--|--|--|
|  | AAA        | 06/91 → 05/97 |    | OXOXOXO                                 |  |  |  |  |  |  |             |        |  |  |  |  |  |  |  |
|  | AAA        | 06/91 → 05/97 |    | VKPC 81611                              |  |  |  |  |  |  |             | 1      |  |  |  |  |  |  |  |
|  | B(Alt) AAA | 06/91 → 05/97 | AC | VKMOV 7PK1290<br>VKM 31060              |  |  |  |  |  |  | 1           | 1      |  |  |  |  |  |  |  |
|  | B(Alt) AAA | 06/91 → 05/97 | AC | VKMA 31060<br>VKMV 7DK1360<br>VKM 31060 |  |  |  |  |  |  | 1<br>1<br>1 | 1<br>1 |  |  |  |  |  |  |  |

**VW PASSAT (3A2, 35I) / Variant (3A5, 35I) 2.9 VR6**

|  |            |               |    |   |  |  |  |  |  |  |             |        |  |  |  |  |  |  |  |
|--|------------|---------------|----|---|--|--|--|--|--|--|-------------|--------|--|--|--|--|--|--|--|
|  | ABV        | 01/94 → 05/97 |    | OXOXOXO                                 |  |  |  |  |  |  |             |        |  |  |  |  |  |  |  |
|  | ABV        | 01/94 → 05/97 |    | VKPC 81611                              |  |  |  |  |  |  |             | 1      |  |  |  |  |  |  |  |
|  | B(Alt) ABV | 01/94 → 05/97 | AC | VKMOV 7PK1290<br>VKM 31060              |  |  |  |  |  |  | 1           | 1      |  |  |  |  |  |  |  |
|  | B(Alt) ABV | 01/94 → 05/97 | AC | VKMA 31060<br>VKMV 7DK1360<br>VKM 31060 |  |  |  |  |  |  | 1<br>1<br>1 | 1<br>1 |  |  |  |  |  |  |  |

**VW PASSAT (3A2, 35I) / Variant (3A5, 35I) 1.6 TD**

|  |               |               |                   |                                       |             |        |  |  |  |  |   |        |  |   |   |  |  |  |       |
|--|---------------|---------------|-------------------|---------------------------------------|-------------|--------|--|--|--|--|---|--------|--|---|---|--|--|--|-------|
|  | RA, SB        | 08/88 → 09/93 | 3)                | VKMS 01010<br>VKMA 01010<br>VKM 11010 | 1<br>1<br>1 | 1<br>1 |  |  |  |  |   |        |  | 3 | 2 |  |  |  | T0051 |
|  | RA, SB        | 08/88 → 09/93 | 2)                | VKPA 81401<br>VKPC 81401              |             |        |  |  |  |  |   | 1<br>1 |  |   |   |  |  |  |       |
|  | B(Alt) RA, SB | 08/88 → 09/93 | AC, ⊙             | VKMOV 11.9x950                        |             |        |  |  |  |  | 1 |        |  |   |   |  |  |  |       |
|  | B(Alt) RA, SB | 08/88 → 09/93 | AC, ⊙             | VKMOV 10AVx865                        |             |        |  |  |  |  | 1 |        |  |   |   |  |  |  |       |
|  | B(Alt) RA, SB | 08/88 → 09/93 | AC, ⊙             | VKMOV 10AVx695                        |             |        |  |  |  |  | 1 |        |  |   |   |  |  |  |       |
|  | B(PS) RA, SB  | 08/88 → 09/93 | →ICH 31-M-200 000 | VKMOV 10AVx740                        |             |        |  |  |  |  | 1 |        |  |   |   |  |  |  |       |
|  | B(PS) RA, SB  | 08/88 → 09/93 | CH 31M-200 001 I→ | VKMOV 11.9x650                        |             |        |  |  |  |  | 1 |        |  |   |   |  |  |  |       |





























**VW PASSAT (3A2, 35I) / Variant (3A5, 35I) 1.9 D**

|  |           |               |       |                          |        |   |  |  |  |  |   |        |  |  |  |  |  |  |   |       |
|--|-----------|---------------|-------|--------------------------|--------|---|--|--|--|--|---|--------|--|--|--|--|--|--|---|-------|
|  | 1Y        | 05/89 → 10/93 |       | VKMA 01011<br>VKM 11010  | 1<br>1 | 1 |  |  |  |  |   |        |  |  |  |  |  |  | 4 | T0069 |
|  | 1Y        | 05/89 → 10/93 | 2)    | VKPA 81401<br>VKPC 81401 |        |   |  |  |  |  |   | 1<br>1 |  |  |  |  |  |  |   |       |
|  | B(Alt) 1Y | 05/89 → 10/93 | AC, ⊙ | VKMOV 11.9x950           |        |   |  |  |  |  | 1 |        |  |  |  |  |  |  |   |       |
|  | B(Alt) 1Y | 05/89 → 10/93 | AC, ⊙ | VKMOV 10AVx865           |        |   |  |  |  |  | 1 |        |  |  |  |  |  |  |   |       |
|  | B(Alt) 1Y | 05/89 → 10/93 | AC, ⊙ | VKMOV 10AVx695           |        |   |  |  |  |  | 1 |        |  |  |  |  |  |  |   |       |

**VW PASSAT (3A2, 35I) / Variant (3A5, 35I) 1.9 TD**



























|  |     |               |                |                         |        |   |  |  |  |  |  |  |  |  |  |  |  |  |   |       |
|--|-----|---------------|----------------|-------------------------|--------|---|--|--|--|--|--|--|--|--|--|--|--|--|---|-------|
|  | AAZ | 03/91 → 05/97 | →IMot. 552 765 | VKMA 01011<br>VKM 11010 | 1<br>1 | 1 |  |  |  |  |  |  |  |  |  |  |  |  | 4 | T0069 |
|--|-----|---------------|----------------|-------------------------|--------|---|--|--|--|--|--|--|--|--|--|--|--|--|---|-------|







































|  |  |  |    |  |  |  |  |  |  |  |  |  |
|--|---|---|---|--|---|---|---|---|---|---|---|---|
|  | AAZ   | 03/91 → 05/97   | Mot. 552 766 I→   | VKMA 01013<br>VKM 11014  | 1<br>1  |   | 1   |   |   |   |   | 4 T0069   |
|   | AAZ   | 03/91 → 05/97   | 2)  | VKPA 81401<br>VKPC 81401   |   |   |   |   | 1<br>1  |   |   |   |
|   | B(Alt), B(PS)AAZ  | 03/91 → 05/97   | A⊙, AC  | VKMA 31028<br>VKMV 10AVx730<br>VKMV 6PK1045<br>VKM 31004<br>VKM 31030              | 2<br>1<br>1<br>1<br>1   |   | 2<br>1<br>1   |   |   |   |   |   |
|  | B(Alt), B(PS)AAZ  | 03/91 → 05/97   | A⊙, AC  | VKMA 31030<br>VKMV 11.5x790<br>VKMV 6PK1145<br>VKM 31004<br>VKM 31030              | 2<br>1<br>1<br>1<br>1   |   | 2<br>1<br>1   |   |   |   |   |   |
|   | AAZ   | 03/91 → 05/97   |   | VKM_____   |   |   |   |   | 1   |   |   |   |
| <b>VW  PASSAT (3A2, 35i) / Variant (3A5, 35i) 1.9 TDI</b> |   |   |   |  |   |   |   |   |   |   |   |   |
|   | 1Z  | 10/93 → 05/97   | →IMot. 289 575  | VKMA 01012<br>VKM 11012<br>VKM 21012   | 1<br>1<br>1   | 1   | 1   |   |   |   |   | 5 T0650   |
|  | 1Z  | 10/93 → 05/97   | Mot. 289 576 I→   | VKMA 01014<br>VKM 11014<br>VKM 21012   | 1<br>1<br>1   | 1   | 1   |   |   |   |   | 5 T0650   |
|  | AFN, AHU  | 10/93 → 05/97   |   | VKMA 01014<br>VKM 11014<br>VKM 21012   | 1<br>1<br>1   | 1   | 1   |   |   |   |   | 5 T0650   |
|   | 1Z  | 10/93 → 05/97   | 2)  | VKPA 81401<br>VKPC 81401   |   |   |   |   | 1<br>1  |   |   |   |
|  | AFN   | 03/96 → 05/97   | 2), →ICH3A-V-300 000  | VKPA 81401<br>VKPC 81401   |   |   |   |   | 1<br>1  |   |   |   |
|  | AFN   | 03/96 → 05/97   | CH3B-V-300 001 I→   | VKPC 81615   |   |   |   |   | 1   |   |   |   |
|  | AHU   | 10/93 → 05/97   |   | VKPC 81615   |   |   |   |   | 1   |   |   |   |
|   | B(Alt), B(PS)1Z, AFN, AHU   | 10/93 → 05/97   | A⊙, AC  | VKMA 31028<br>VKMV 10AVx730<br>VKMV 6PK1045<br>VKM 31004<br>VKM 31030              | 2<br>1<br>1<br>1<br>1   |   | 2<br>1<br>1   |   |   |   |   |   |
|  | B(Alt), B(PS)1Z, AFN, AHU   | 10/93 → 05/97   | A⊙, AC  | VKMA 31030<br>VKMV 11.5x790<br>VKMV 6PK1145<br>VKM 31004<br>VKM 31030              | 2<br>1<br>1<br>1<br>1   |   | 2<br>1<br>1   |   |   |   |   |   |
|   | 1Z, AFN, AHU  | 10/93 → 05/97   |   | VKM_____   |   |   |   |   | 1   |   |   |   |
| <b>VW  PASSAT (3B2) / Variant (3B5) 1.6</b>             |   |   |   |  |   |   |   |   |   |   |   |   |
|   | AHL, ANA, ARM   | 10/96 → 11/00   |   | VKMA 01113<br>VKM 11113  | 1<br>1  |   | 1   |   |   |   |   | T0149   |
|   | AHL, ANA, ARM   | 10/96 → 11/00   |   | VKPC 81408   |   |   |   |   | 1   |   |   |   |
|   | B(Alt) AHL, ANA, ARM  | 10/96 → 11/00   |   | VKMV 5PK1300<br>VKM 31033  | 1<br>1  |   | 1   |   |   |   |   |   |
|  | B(AC) AHL, ANA, ARM   | 10/96 → 11/00   |   | VKMV 4PK855<br>VKM 31059   | 1<br>1  |   | 1   |   |   |   |   |   |
| <b>VW  PASSAT (3B2) / Variant (3B5) 1.8</b>             |   |   |   |  |   |   |   |   |   |   |   |   |
|   | ADR, AFY, APT, ARG  | 10/96 → 11/00   |  | VKMA 01908<br>VKM 11008<br>VKM 11009<br>VKM 21004                                  | 1<br>1<br>1<br>1  | 1   | 1   | 1   | 1   |   |   | 1 T0152   |
|  | ADR, AFY, APT, ARG  | 10/96 → 11/00   |   | VKMA 01008<br>VKM 11008<br>VKM 21004   | 1<br>1<br>1   | 1   | 1   | 1   |   |   |   | 1 T0152   |
|   | ADR, AFY, APT, ARG  | 10/96 → 11/00   | 2)  | VKPA 81402<br>VKPC 81402   |   |   |   |   | 1<br>1  |   |   |   |
|   | B(Alt) ADR, AFY, APT, ARG   | 10/96 → 11/00   |   | VKMV 5PK1300<br>VKM 31033  | 1<br>1  |   | 1   |   |   |   |   |   |
|  | B(AC) ADR, AFY, APT, ARG  | 10/96 → 11/00   |   | VKMV 4PK855<br>VKM 31059   | 1<br>1  |   | 1   |   |   |   |   |   |



VW

| <b>VW  PASSAT (3B2) / Variant (3B5) 1.8 Turbo</b>     |  |               |  |                    |   |   |   |   |  |  |  |   |  |  |  |  |  |  |   |       |  |
|--|--|---------------|--|--------------------|---|---|---|---|--|--|--|---|--|--|--|--|--|--|---|-------|--|
|    | AEB, ANB, APU                                      | 10/96 → 11/00 |  5)   | VKMA 01908         | 1 | 1 | 1 | 1 |  |  |  |   |  |  |  |  |  |  | 1 | T0152 |  |
|  |  |               |  | VKM 11008          | 1 |   |   |   |  |  |  |   |  |  |  |  |  |  |   |       |  |
|  |  |               |  | VKM 11009          |   |   |   | 1 |  |  |  |   |  |  |  |  |  |  |   |       |  |
|  |  |               |  | VKM 21004          |   | 1 |   |   |  |  |  |   |  |  |  |  |  |  |   |       |  |
|  | AEB, ANB, APU                                      | 10/96 → 11/00 | 5)   | VKMA 01008         | 1 | 1 | 1 |   |  |  |  |   |  |  |  |  |  |  | 1 | T0152 |  |
|  |  |               |  | VKM 11008          | 1 |   |   |   |  |  |  |   |  |  |  |  |  |  |   |       |  |
|  |  |               |  | VKM 21004          |   | 1 |   |   |  |  |  |   |  |  |  |  |  |  |   |       |  |
|    | AEB, ANB, APU                                      | 10/96 → 11/00 | 2)   | VKPA 81402         |   |   |   |   |  |  |  | 1 |  |  |  |  |  |  |   |       |  |
|  |  |               |  | VKPC 81402         |   |   |   |   |  |  |  | 1 |  |  |  |  |  |  |   |       |  |
|    | <b>B(Alt)</b> AEB, ANB, APU                        | 10/96 → 11/00 |  | VKMA 5PK1300       |   |   |   | 1 |  |  |  |   |  |  |  |  |  |  |   |       |  |
|  |  |               |  | VKM 31033          | 1 |   |   |   |  |  |  |   |  |  |  |  |  |  |   |       |  |
|  | <b>B(AC)</b> AEB, ANB, APU                         | 10/96 → 11/00 |  | VKMA 4PK855        |   |   |   | 1 |  |  |  |   |  |  |  |  |  |  |   |       |  |
|  |  |               |  | VKM 31059          | 1 |   |   |   |  |  |  |   |  |  |  |  |  |  |   |       |  |
| <b>VW  PASSAT (3B2) / Variant (3B5) 2.0</b>           |  |               |  |                    |   |   |   |   |  |  |  |   |  |  |  |  |  |  |   |       |  |
|    | AZM  | 04/00 → 11/00 |  | VKMA 01113         | 1 |   | 1 |   |  |  |  |   |  |  |  |  |  |  |   | T0149 |  |
|  |  |               |  | VKM 11113          | 1 |   |   |   |  |  |  |   |  |  |  |  |  |  |   |       |  |
|    | AZM  | 04/00 → 11/00 |  | VKPC 81620         |   |   |   |   |  |  |  | 1 |  |  |  |  |  |  |   |       |  |
|    | <b>B(Alt)</b> ASU, AUZ, AZM                        | 04/00 → 11/00 |  | VKMA 5PK1300       |   |   |   | 1 |  |  |  |   |  |  |  |  |  |  |   |       |  |
|  |  |               |  | VKM 31033          | 1 |   |   |   |  |  |  |   |  |  |  |  |  |  |   |       |  |
|  | <b>B(AC)</b> ASU, AUZ, AZM                         | 04/00 → 11/00 |  | VKMA 4PK855        |   |   |   | 1 |  |  |  |   |  |  |  |  |  |  |   |       |  |
|  |  |               |  | VKM 31059          | 1 |   |   |   |  |  |  |   |  |  |  |  |  |  |   |       |  |
| <b>VW  PASSAT (3B2) / Variant (3B5) 2.3 VR5</b>       |  |               |  |                    |   |   |   |   |  |  |  |   |  |  |  |  |  |  |   |       |  |
|    | AGZ  | 10/96 → 11/00 |  | <del>OKOKOKO</del> |   |   |   |   |  |  |  |   |  |  |  |  |  |  |   |       |  |
|   | AGZ  | 10/96 → 11/00 |  | VKPC 81622         |   |   |   |   |  |  |  | 1 |  |  |  |  |  |  |   |       |  |
|    | <b>B(Alt)</b> AGZ                                  | 10/96 → 11/00 | <b>AC</b>  | VKMA 6PK1660       |   |   |   | 1 |  |  |  |   |  |  |  |  |  |  |   |       |  |
|  | <b>B(Alt)</b> AGZ                                  | 10/96 → 11/00 | <b>AC</b>  | VKMA 6PK2373       |   |   |   | 1 |  |  |  |   |  |  |  |  |  |  |   |       |  |
| <b>VW  PASSAT (3B2) / Variant (3B5) 2.8 V6</b>      |  |               |  |                    |   |   |   |   |  |  |  |   |  |  |  |  |  |  |   |       |  |
|    | ACK, AGE, ALG, APR,<br>AQD, ATX, BBG               | 08/96 → 11/00 |  5) | VKMA 01903         | 1 | 1 | 1 | 1 |  |  |  |   |  |  |  |  |  |  | 1 | T0153 |  |
|  |  |               |  | VKM 11202          | 1 |   |   |   |  |  |  |   |  |  |  |  |  |  |   |       |  |
|  |  |               |  | VKM 11209          |   |   |   | 1 |  |  |  |   |  |  |  |  |  |  |   |       |  |
|  |  |               |  | VKM 21202          |   | 1 |   |   |  |  |  |   |  |  |  |  |  |  |   |       |  |
|  | ACK, AGE, ALG, APR,<br>AQD, ATX, BBG               | 08/96 → 11/00 |  | VKMA 01202         | 1 | 1 | 1 |   |  |  |  |   |  |  |  |  |  |  | 1 | T0153 |  |
|  |  |               |  | VKM 11202          | 1 |   |   |   |  |  |  |   |  |  |  |  |  |  |   |       |  |
|  |  |               |  | VKM 21202          |   | 1 |   |   |  |  |  |   |  |  |  |  |  |  |   |       |  |
|    | ACK, AGE, ALG, APR,<br>AQD, ATX, BBG               | 08/96 → 11/00 |  | VKPC 81802         |   |   |   |   |  |  |  | 1 |  |  |  |  |  |  |   |       |  |
|    | <b>B(Alt)</b> ACK, AGE, ALG, APR,<br>AQD, ATX, BBG | 08/96 → 11/00 | <b>AC</b>  | VKMA 6PK1760       |   |   |   | 1 |  |  |  |   |  |  |  |  |  |  |   |       |  |
|  |  |               |  | VKM 31061          | 1 |   |   |   |  |  |  |   |  |  |  |  |  |  |   |       |  |
|  | <b>B(Alt)</b> ACK, AGE, ALG, APR,<br>AQD, ATX, BBG | 08/96 → 11/00 | <b>AC</b>  | VKMA 6PK1882       |   |   |   | 1 |  |  |  |   |  |  |  |  |  |  |   |       |  |
|  |  |               |  | VKM 31061          | 1 |   |   |   |  |  |  |   |  |  |  |  |  |  |   |       |  |
| <b>VW  PASSAT (3B2) / Variant (3B5) 1.9 TDI 90</b>  |  |               |  |                    |   |   |   |   |  |  |  |   |  |  |  |  |  |  |   |       |  |
|    | AHH  | 10/96 → 11/00 |  | VKMA 01256         | 1 | 1 | 1 |   |  |  |  |   |  |  |  |  |  |  | 5 | T0650 |  |
|  |  |               |  | VKM 11256          | 1 |   |   |   |  |  |  |   |  |  |  |  |  |  |   |       |  |
|  |  |               |  | VKM 21012          |   | 1 |   |   |  |  |  |   |  |  |  |  |  |  |   |       |  |
|  | AHU  | 10/96 → 11/00 |  | VKMA 01014         | 1 | 1 | 1 |   |  |  |  |   |  |  |  |  |  |  | 5 | T0650 |  |
|  |  |               |  | VKM 11014          | 1 |   |   |   |  |  |  |   |  |  |  |  |  |  |   |       |  |
|  |  |               |  | VKM 21012          |   | 1 |   |   |  |  |  |   |  |  |  |  |  |  |   |       |  |
|    | AHH, AHU   | 10/96 → 11/00 |  | VKPC 81615         |   |   |   |   |  |  |  | 1 |  |  |  |  |  |  |   |       |  |
|    | <b>B(Alt)</b> AHH, AHU                             | 10/96 → 11/00 |  | VKMA 5PK1592       |   |   |   | 1 |  |  |  |   |  |  |  |  |  |  |   |       |  |
|  |  |               |  | VKM 31034          | 1 |   |   |   |  |  |  |   |  |  |  |  |  |  |   |       |  |
|  | <b>B(AC)</b> AHH, AHU                              | 10/96 → 11/00 |  | VKMA 4PK855        |   |   |   | 1 |  |  |  |   |  |  |  |  |  |  |   |       |  |
|  |  |               |  | VKM 31059          | 1 |   |   |   |  |  |  |   |  |  |  |  |  |  |   |       |  |
|    | AHH, AHU   | 10/96 → 11/00 |  | VKM_____           |   |   |   |   |  |  |  | 1 |  |  |  |  |  |  |   |       |  |
| <b>VW  PASSAT (3B2) / Variant (3B5) 1.9 TDI 100</b> |  |               |  |                    |   |   |   |   |  |  |  |   |  |  |  |  |  |  |   |       |  |
|    | AVB  | 02/00 → 11/00 |  5) | VKMA 01942         | 1 | 1 | 1 | 1 |  |  |  |   |  |  |  |  |  |  | 3 | T0184 |  |
|  |  |               |  | VKM 11142          | 1 |   |   |   |  |  |  |   |  |  |  |  |  |  |   |       |  |
|  |  |               |  | VKM 11145          |   |   |   | 1 |  |  |  |   |  |  |  |  |  |  |   |       |  |
|  |  |               |  | VKM 21142          |   | 1 |   |   |  |  |  |   |  |  |  |  |  |  |   |       |  |



































































|  |  |  |    |  |  |  |  |  |  |  |  |
|--|---|---|---|--|---|---|---|---|---|---|---|
|  |   |   |   | VKM 11151<br>VKM 21151   | 1   | 1   |   |   |   |   | 1   |
|    | AFB, AKN  | 07/98 → 11/00   |   | VKPC 81625   |   |   |   | 1   |   |   |   |
|    | <b>B(Alt)</b> AFB, AKN  | 07/98 → 11/00   |   | VKMV 6PK2404<br>VKM 31038<br>VKM 31039<br>VKM 31041                                |   | 1   |   |   |   | 1   |   |
|  | <b>B(AC)</b> AFB, AKN   | 07/98 → 11/00   |   | VKMV 4PK1237<br>VKM 31040  | 1   | 1   |   |   |   |   |   |
| <b>VW  PASSAT (3B3) / Variant (3B6) 1.6</b>       |   |   |   |  |   |   |   |   |   |   |   |
|    | ALZ   | 11/00 → 05/05   |   | VKMA 01113<br>VKM 11113  | 1<br>1  | 1   |   |   |   |   | T0149   |
|    | ALZ   | 11/00 → 05/05   |   | VKPC 81408   |   |   |   | 1   |   |   |   |
|    | <b>B(Alt)</b> ALZ   | 11/00 → 05/05   |   | VKMV 5PK1300<br>VKM 31033  | 1   | 1   |   |   |   |   |   |
|  | <b>B(AC)</b> ALZ  | 11/00 → 05/05   |   | VKMV 4PK855<br>VKM 31059   | 1   | 1   |   |   |   |   |   |
| <b>VW  PASSAT (3B3) / Variant (3B6) 1.8 Turbo</b> |   |   |   |  |   |   |   |   |   |   |   |
|    | AWM, AWT  | 11/00 → 08/05   |    | VKMA 01918<br>VKM 11018<br>VKM 11117   | 1<br>1  | 1   | 1   |   |   |   | 3 T0151   |
|  | AWM, AWT  | 11/00 → 08/05   |   | VKMA 01018<br>VKM 11018<br>VKM 21220   | 1<br>1  | 1   | 1   |   |   |   | 3 T0151   |
|    | AWM, AWT  | 11/00 → 05/05   |   | VKPC 81620   |   |   |   | 1   |   |   |   |
|    | <b>B(Alt)</b> AWM, AWT  | 11/00 → 08/05   |   | VKMV 5PK1300<br>VKM 31033  | 1   | 1   |   |   |   |   |   |
|  | <b>B(AC)</b> AWM, AWT   | 11/00 → 08/05   |   | VKMV 4PK855<br>VKM 31059   | 1   | 1   |   |   |   |   |   |
| <b>VW  PASSAT (3B3) / Variant (3B6) 2.0</b>     |   |   |   |  |   |   |   |   |   |   |   |
|    | ALT   | 11/01 → 05/05   |  | VKMA 01918<br>VKM 11018<br>VKM 11117   | 1<br>1  | 1   | 1   |   |   |   | 3 T0151   |
|  | ALT   | 11/01 → 05/05   |   | VKMA 01018<br>VKM 11018<br>VKM 21220   | 1<br>1  | 1   | 1   |   |   |   | 3 T0151   |
|  | AZM   | 11/00 → 05/05   |   | VKMA 01113<br>VKM 11113  | 1<br>1  | 1   |   |   |   |   | T0149   |
|    | ALT   | 11/01 → 05/05   |   | VKPC 81408   |   |   |   | 1   |   |   |   |
|  | AZM   | 11/00 → 05/05   |   | VKPC 81620   |   |   |   | 1   |   |   |   |
|    | <b>B(Alt)</b> ALT, AZM  | 11/00 → 05/05   |   | VKMV 5PK1300<br>VKM 31033  | 1   | 1   |   |   |   |   |   |
|  | <b>B(AC)</b> ALT, AZM   | 11/00 → 05/05   |   | VKMV 4PK855<br>VKM 31059   | 1   | 1   |   |   |   |   |   |
| <b>VW  PASSAT (3B3) / Variant (3B6) 2.3 VR5</b> |   |   |   |  |   |   |   |   |   |   |   |
|    | AZX   | 11/00 → 05/05   |   | <del>VKMA 01918</del><br><del>VKM 11018</del><br><del>VKM 11117</del>              |   |   |   |   |   |   |   |
|    | AZX   | 11/00 → 05/05   |   | VKPC 81622   |   |   |   | 1   |   |   |   |
|    | <b>B(Alt)</b> AZX   | 11/00 → 05/05   | <b>AC</b>   | VKMV 6PK1660   |   | 1   |   |   |   |   |   |
|  | <b>B(Alt)</b> AZX   | 11/00 → 05/05   | <b>AC</b>   | VKMV 6PK2373   |   | 1   |   |   |   |   |   |
| <b>VW  PASSAT (3B3) / Variant (3B6) 2.8 V6</b>  |   |   |   |  |   |   |   |   |   |   |   |
|    | AMX, ATQ  | 11/00 → 05/05   |  | VKMA 01903<br>VKM 11202<br>VKM 11209<br>VKM 21202                                  | 1<br>1  | 1   | 1   | 1   |   |   | 1 T0153   |
|  | AMX, ATQ  | 11/00 → 05/05   |   | VKMA 01202<br>VKM 11202<br>VKM 21202   | 1<br>1  | 1   | 1   |   |   |   | 1 T0153   |
|    | AMX, ATQ  | 11/00 → 05/05   |   | VKPC 81802   |   |   |   | 1   |   |   |   |
|    | <b>B(Alt)</b> AMX, ATQ  | 11/00 → 05/05   | <b>AC</b>   | VKMV 6PK1760<br>VKM 31061  | 1   | 1   |   |   |   |   |   |
|  | <b>B(Alt)</b> AMX, ATQ  | 11/00 → 05/05   | <b>AC</b>   | VKMV 6PK1882<br>VKM 31061  | 1   | 1   |   |   |   |   |   |



| VW  PASSAT (3B3) / Variant (3B6) 4.0 W8  |  |               |                                     |              |   |   |   |   |   |   |  |   |   |       |
|--|--|---------------|-------------------------------------|--------------|---|---|---|---|---|---|--|---|---|-------|
|  | BDN                                      | 09/01 → 05/05 | OXOXOXO                             |              |   |   |   |   |   |   |  |   |   |       |
|  | <b>B(Alt)</b> BDN                        | 09/01 → 05/05 | VKMV 7DK2569                        |              |   | 1 |   |   |   |   |  |   |   |       |
| VW  PASSAT (3B3) / Variant (3B6) 1.9 TDI |  |               |                                     |              |   |   |   |   |   |   |  |   |   |       |
|  | AVB, AVF, AWX                            | 11/00 → 12/02 |                                     | VKMA 01942   | 1 | 1 | 1 | 1 |   |   |  |   | 3 | T0184 |
|  |  |               |                                     | VKM 11142    | 1 |   |   |   |   |   |  |   |   |       |
|  |  |               |                                     | VKM 11145    |   |   |   | 1 |   |   |  |   |   |       |
|  |  |               |                                     | VKM 21142    |   | 1 |   |   |   |   |  |   |   |       |
|  | AVB, AVF, AWX                            | 11/00 → 12/02 |                                     | VKMA 01142   | 1 | 1 | 1 |   |   |   |  |   | 3 | T0184 |
|  |  |               |                                     | VKM 11142    | 1 |   |   |   |   |   |  |   |   |       |
|  |  |               |                                     | VKM 21142    |   | 1 |   |   |   |   |  |   |   |       |
|  | AVB, AVF, AWX                            | 01/03 → 05/05 |                                     | VKMA 01250   | 1 | 1 | 1 |   |   |   |  |   |   | T0184 |
|  |  |               |                                     | VKM 11250    | 1 |   |   |   |   |   |  |   |   |       |
|  |  |               |                                     | VKM 21147    |   | 1 |   |   |   |   |  |   |   |       |
|  | AVB, AVF, AWX                            | 11/00 → 12/02 |                                     | VKPC 81626   |   |   |   |   | 1 |   |  |   |   |       |
|  | AVB, AVF, AWX                            | 01/03 → 05/05 |                                     | VKPC 81303   |   |   |   |   | 1 |   |  |   |   |       |
|  | <b>B(Alt)</b> AVB, AVF, AWX              | 11/00 → 05/05 |                                     | VKMA 31000   | 1 |   | 1 |   |   |   |  |   |   |       |
|  |  |               |                                     | VKMV 5PK1432 |   |   | 1 |   |   |   |  |   |   |       |
|  |  |               |                                     | VKM 31013    | 1 |   |   |   |   |   |  |   |   |       |
|  | <b>B(Alt), B(AC)</b> AVB, AVF, AWX       | 11/00 → 05/05 |                                     | VKMA 31020   | 2 |   | 2 |   |   |   |  |   |   |       |
|  |  |               |                                     | VKMV 4PK855  |   |   | 1 |   |   |   |  |   |   |       |
|  |  |               |                                     | VKMV 5PK1432 |   |   | 1 |   |   |   |  |   |   |       |
|  |  |               |                                     | VKM 31013    | 1 |   |   |   |   |   |  |   |   |       |
|  |  |               |                                     | VKM 31059    | 1 |   |   |   |   |   |  |   |   |       |
|  | AVB, AVF, AWX                            | 11/00 → 05/05 | → ICH 3B-5-100 000,<br>3B-5E170 000 | VKM_____     |   |   |   |   |   | 1 |  |   |   |       |
| VW  PASSAT (3B3) / Variant (3B6) 2.0 TDI |  |               |                                     |              |   |   |   |   |   |   |  |   |   |       |
|  | BGW                                      | 12/03 → 05/05 |                                     | VKMA 01250   | 1 | 1 | 1 |   |   |   |  |   |   | T0184 |
|  |  |               |                                     | VKM 11250    | 1 |   |   |   |   |   |  |   |   |       |
|  |  |               |                                     | VKM 21147    |   | 1 |   |   |   |   |  |   |   |       |
|  | BGW                                      | 12/03 → 05/05 |                                     | VKPC 81627   |   |   |   |   | 1 |   |  |   |   |       |
|  | <b>B(Alt), B(AC)</b> BGW                 | 12/03 → 05/05 |                                     | VKMA 31020   | 2 |   | 2 |   |   |   |  |   |   |       |
|  |  |               |                                     | VKMV 4PK855  |   |   | 1 |   |   |   |  |   |   |       |
|  |  |               |                                     | VKMV 5PK1432 |   |   | 1 |   |   |   |  |   |   |       |
|  |  |               |                                     | VKM 31013    | 1 |   |   |   |   |   |  |   |   |       |
|  |  |               |                                     | VKM 31059    | 1 |   |   |   |   |   |  |   |   |       |
| VW  PASSAT (3B3) / Variant (3B6) 2.5 TDI |  |               |                                     |              |   |   |   |   |   |   |  |   |   |       |
|  | AFB, AKN                                 | 11/00 → 05/05 |                                     | VKMA 01951   | 2 | 1 | 2 | 1 |   |   |  |   | 3 | T0166 |
|  |  |               |                                     | VKM 11150    | 1 |   |   |   |   |   |  |   |   |       |
|  |  |               |                                     | VKM 11151    | 1 |   |   |   |   |   |  |   |   |       |
|  |  |               |                                     | VKM 11154    |   |   |   | 1 |   |   |  |   |   |       |
|  |  |               |                                     | VKM 21151    |   | 1 |   |   |   |   |  |   | 1 |       |
|  | AFB, AKN                                 | 11/00 → 05/05 | 4)                                  | VKMA 01151   | 2 | 1 | 2 |   |   |   |  |   | 2 | T0166 |
|  |  |               |                                     | VKM 11150    | 1 |   |   |   |   |   |  |   |   |       |
|  |  |               |                                     | VKM 11151    | 1 |   |   |   |   |   |  |   |   |       |
|  |  |               |                                     | VKM 21151    |   | 1 |   |   |   |   |  |   | 1 |       |
|  | BAU, BDG, BDH                            | 01/03 → 05/05 |                                     | VKMA 01952   | 2 | 1 | 2 | 1 |   |   |  |   | 3 | T0170 |
|  |  |               |                                     | VKM 11150    | 1 |   |   |   |   |   |  |   |   |       |
|  |  |               |                                     | VKM 11151    | 1 |   |   |   |   |   |  |   |   |       |
|  |  |               |                                     | VKM 11154    |   |   |   | 1 |   |   |  |   |   |       |
|  |  |               |                                     | VKM 21151    |   | 1 |   |   |   |   |  |   | 1 |       |
|  | BAU, BDG, BDH                            | 01/03 → 05/05 | 4)                                  | VKMA 01152   | 2 | 1 | 2 |   |   |   |  |   | 2 | T0170 |
|  |  |               |                                     | VKM 11150    | 1 |   |   |   |   |   |  |   |   |       |
|  |  |               |                                     | VKM 11151    | 1 |   |   |   |   |   |  |   |   |       |
|  |  |               |                                     | VKM 21151    |   | 1 |   |   |   |   |  |   | 1 |       |
|  | AFB, AKN, BAU, BDG,<br>BDH               | 11/00 → 05/05 |                                     | VKPC 81625   |   |   |   |   | 1 |   |  |   |   |       |
|  | <b>B(Alt)</b> AFB, AKN, BAU, BDG,<br>BDH | 11/00 → 05/05 |                                     | VKMV 6PK2404 |   |   | 1 |   |   |   |  |   |   |       |
|  |  |               |                                     | VKM 31038    |   | 1 |   |   |   |   |  |   |   |       |
|  |  |               |                                     | VKM 31039    |   | 1 |   |   |   |   |  | 1 |   |       |
|  |  |               |                                     | VKM 31041    |   | 1 |   |   |   |   |  |   |   |       |
|  | <b>B(AC)</b> AFB, AKN, BAU, BDG,<br>BDH  | 11/00 → 05/05 |                                     | VKMV 4PK1237 |   |   | 1 |   |   |   |  |   |   |       |
|  |  |               |                                     | VKM 31040    | 1 |   |   |   |   |   |  |   |   |       |



| <b>VW  PASSAT (3C2) / Variant (3C5) 1.6</b>         |                        |               |                    |  |                    |   |   |   |  |   |  |  |  |         |
|---|------------------------|---------------|--------------------|--|--------------------|---|---|---|--|---|--|--|--|---------|
|   | BSE, BSF               | 05/05 → 12/07 |                    |  | VKMA 01113         | 1 |   | 1 |  |   |  |  |  | T0149   |
|   |                        |               |                    |  | VKM 11113          | 1 |   |   |  |   |  |  |  |         |
|   | BSE, BSF               | 05/05 → 12/07 |                    |  | VKPC 81408         |   |   |   |  | 1 |  |  |  |         |
|   | <b>B(Alt)</b> BSE, BSF | 05/05 → 12/07 | <b>AC</b>          |  | VKMMV 6PK1042      | 1 |   | 1 |  |   |  |  |  |         |
|   |                        |               |                    |  | VKM 31011          |   |   |   |  |   |  |  |  |         |
| <b>VW  PASSAT (3C2) / Variant (3C5) 1.6 FSI</b>     |                        |               |                    |  |                    |   |   |   |  |   |  |  |  |         |
|   | BLF                    | 03/05 → 03/06 |                    |  | <del>OXOXOXO</del> |   |   |   |  |   |  |  |  |         |
|   | BLF                    | 03/05 → 12/07 |                    |  | VKPC 81501         |   |   |   |  | 1 |  |  |  |         |
|   | <b>B(Alt)</b> BLF      | 03/05 → 12/07 | <b>AC</b>          |  | VKMMV 6PK1736      | 1 |   | 1 |  |   |  |  |  |         |
|   |                        |               |                    |  | VKM 31044          |   | 1 |   |  |   |  |  |  |         |
|   |                        |               |                    |  | VKM 31047          |   |   |   |  |   |  |  |  |         |
| <b>VW  PASSAT (3C2) / Variant (3C5) 2.0 FSI</b>     |                        |               |                    |  |                    |   |   |   |  |   |  |  |  |         |
|   | BLR, BLX, BLY, BVX     | 03/05 → 12/07 |                    |  | VKMA 01222         | 1 | 2 | 1 |  |   |  |  |  | 2 T0247 |
|   |                        |               |                    |  | VKM 11222          | 1 |   |   |  |   |  |  |  |         |
|   |                        |               |                    |  | VKM 21220          |   | 1 |   |  |   |  |  |  |         |
|   |                        |               |                    |  | VKM _____          |   | 1 |   |  |   |  |  |  |         |
|   | BLR, BLX, BLY, BVX     | 03/05 → 12/07 |                    |  | VKPC 81220         |   |   |   |  | 1 |  |  |  |         |
|   | <b>B(Alt)</b> BLR, BLY | 03/05 → 12/07 |                    |  | VKMMV 6PK1042      | 1 |   | 1 |  |   |  |  |  |         |
|   |                        |               |                    |  | VKM 31011          |   |   |   |  |   |  |  |  |         |
| <b>VW  PASSAT (3C2) / Variant (3C5) 2.0 TFSI</b>    |                        |               |                    |  |                    |   |   |   |  |   |  |  |  |         |
|   | AXX, BPY, BWA          | 07/05 → 12/07 |                    |  | VKMA 01222         | 1 | 2 | 1 |  |   |  |  |  | 2 T0247 |
|   |                        |               |                    |  | VKM 11222          | 1 |   |   |  |   |  |  |  |         |
|   |                        |               |                    |  | VKM 21220          |   | 1 |   |  |   |  |  |  |         |
|   |                        |               |                    |  | VKM _____          |   | 1 |   |  |   |  |  |  |         |
|   | AXX, BPY, BWA          | 07/05 → 12/07 |                    |  | —                  |   |   |   |  | 1 |  |  |  |         |
| <b>VW  PASSAT (3C2) / Variant (3C5) 3.2 FSI</b>     |                        |               |                    |  |                    |   |   |   |  |   |  |  |  |         |
|   | AXZ                    | 11/05 → 12/07 |                    |  | <del>OXOXOXO</del> |   |   |   |  |   |  |  |  |         |
|   | <b>B(Alt)</b> AXZ      | 11/05 → 12/07 |                    |  | VKMMV 6PK1620      |   |   | 1 |  |   |  |  |  |         |
| <b>VW  PASSAT (3C2) / Variant (3C5) 3.6 R36</b>     |                        |               |                    |  |                    |   |   |   |  |   |  |  |  |         |
|   | BWS                    | 04/07 → 12/07 |                    |  | <del>OXOXOXO</del> |   |   |   |  |   |  |  |  |         |
| <b>VW  PASSAT (3C2) / Variant (3C5) 1.9 TDI 105</b> |                        |               |                    |  |                    |   |   |   |  |   |  |  |  |         |
|   | BKC, BLS               | 03/05 → 12/07 |                    |  | VKMA 01250         | 1 | 1 | 1 |  |   |  |  |  | T0184   |
|   |                        |               |                    |  | VKM 11250          | 1 |   |   |  |   |  |  |  |         |
|   |                        |               |                    |  | VKM 21147          |   | 1 |   |  |   |  |  |  |         |
|   | BKC, BLS               | 03/05 → 12/07 |                    |  | VKPC 81418         |   |   |   |  | 1 |  |  |  |         |
|   | <b>B(Alt)</b> BKC, BLS | 03/05 → 03/06 |                    |  | VKMMV 6PK1042      | 1 |   | 1 |  |   |  |  |  |         |
|   |                        |               |                    |  | VKM 31011          |   |   |   |  |   |  |  |  |         |
| <b>VW  PASSAT (3C2) / Variant (3C5) 2.0 TDI 122</b> |                        |               |                    |  |                    |   |   |   |  |   |  |  |  |         |
|   | BVD, BVE               | 08/05 → 12/07 |                    |  | VKMA 01255         | 1 | 2 | 1 |  |   |  |  |  | 5 T0184 |
|   |                        |               |                    |  | VKM 11255          | 1 |   |   |  |   |  |  |  |         |
|   |                        |               |                    |  | VKM 21147          |   | 1 |   |  |   |  |  |  |         |
|   |                        |               |                    |  | VKM 21256          |   | 1 |   |  |   |  |  |  |         |
|   | BVD                    | 08/05 → 12/07 |                    |  | VKPC 81303         |   |   |   |  | 1 |  |  |  |         |
|   | BVE                    | 08/05 → 12/07 |                    |  | VKPC 81627         |   |   |   |  | 1 |  |  |  |         |
|   | <b>B(Alt)</b> BVD, BVE | 08/05 → 12/07 |                    |  | VKMMV 6PK1050      | 1 |   | 1 |  |   |  |  |  |         |
|   |                        |               |                    |  | VKM 31022          |   |   |   |  |   |  |  |  |         |
| <b>VW  PASSAT (3C2) / Variant (3C5) 2.0 TDI 136</b> |                        |               |                    |  |                    |   |   |   |  |   |  |  |  |         |
|   | BMA                    | 08/05 → 12/07 |                    |  | VKMA 01255         | 1 | 2 | 1 |  |   |  |  |  | 5 T0184 |
|   |                        |               |                    |  | VKM 11255          | 1 |   |   |  |   |  |  |  |         |
|   |                        |               |                    |  | VKM 21147          |   | 1 |   |  |   |  |  |  |         |
|   |                        |               |                    |  | VKM 21256          |   | 1 |   |  |   |  |  |  |         |
|   | BMA                    | 08/05 → 12/07 |                    |  | VKPC 81627         |   |   |   |  | 1 |  |  |  |         |
|   | <b>B(Alt)</b> BMA      | 08/05 → 12/07 |                    |  | VKMMV 6PK1050      | 1 |   | 1 |  |   |  |  |  |         |
|   |                        |               |                    |  | VKM 31022          |   |   |   |  |   |  |  |  |         |
| <b>VW  PASSAT (3C2) / Variant (3C5) 2.0 TDI 140</b> |                        |               |                    |  |                    |   |   |   |  |   |  |  |  |         |
|   | BKP                    | 03/05 → 12/07 | → ICH 3C-6-300 000 |  | VKMA 01255         | 1 | 2 | 1 |  |   |  |  |  | 5 T0184 |
|   |                        |               |                    |  | VKM 11255          | 1 |   |   |  |   |  |  |  |         |
|   |                        |               |                    |  | VKM 21147          |   | 1 |   |  |   |  |  |  |         |
|   |                        |               |                    |  | VKM 21256          |   | 1 |   |  |   |  |  |  |         |
|   |                        |               |                    |  | VKMA _____         | 1 | 2 | 1 |  |   |  |  |  | 5 T0184 |
|   |                        |               |                    |  | VKM 11255          | 1 |   |   |  |   |  |  |  |         |

































|  |  |  |                     |   |  |  |  |  |  |  |  |  |
|--|---|---|--|---|---|---|---|---|---|---|---|---|
|  |   |   |  | VKM 21147   |   | 1   |   |   |   |   |   |   |
|  |   |   |  | VKM   |   | 1   |   |   |   |   |   |   |
|  | BMP   | 03/05 → 12/07   |  | VKMA 01250  |   | 1   | 1   | 1   |   |   |   | T0184   |
|  |   |   |  | VKM 11250   |   | 1   |   |   |   |   |   |   |
|  |   |   |  | VKM 21147   |   |   | 1   |   |   |   |   |   |
|   | BKP   | 03/05 → 12/07   |  | VKPC 81627  |   |   |   |   | 1   |   |   |   |
|   | B(Alt) BKP  | 03/05 → 12/07   |  | VKMV 6PK1050  |   |   | 1   |   |   |   |   |   |
|  |   |   |  | VKM 31022   |   | 1   |   |   |   |   |   |   |
| <b>VW  PASSAT (3C2) / Variant (3C5) 2.0 TDI 170</b> |   |   |  |   |   |   |   |   |   |   |   |   |
|   | BMR, BUZ  | 08/05 → 12/07   |  | VKMA 01255  |   | 1   | 2   | 1   |   |   |   | 5 T0184   |
|  |   |   |  | VKM 11255   |   | 1   |   |   |   |   |   |   |
|  |   |   |  | VKM 21147   |   |   | 1   |   |   |   |   |   |
|  |   |   |  | VKM 21256   |   |   | 1   |   |   |   |   |   |
|   | BMR, BUZ  | 08/05 → 12/07   |  | VKPC  |   |   |   |   | 1   |   |   |   |
|   | B(Alt) BMR, BUZ   | 08/05 → 12/07   |  | VKMV 6PK1050  |   |   | 1   |   |   |   |   |   |
|  |   |   |  | VKM 31022   |   | 1   |   |   |   |   |   |   |
| <b>VW  PHAETON (3D2) 3.2 V6</b>                     |   |   |  |   |   |   |   |   |   |   |   |   |
|   | AYT, BKL, BRK   | 04/02 → 03/06   |  | OXOXOXO   |   |   |   |   |   |   |   |   |
|   | AYT, BKL, BRK   | 04/02 → 06/07   |  | —   |   |   |   |   | 1   |   |   |   |
| <b>VW  PHAETON (3D2) 4.2 V8</b>                     |   |   |  |   |   |   |   |   |   |   |   |   |
|   | BGH, BGJ  | 05/03 → 06/07   |  ICH 3D-6-010 000   | VKMA 01927  |   | 1   | 2   | 1   | 1   |   |   | T0153   |
|  |   |   |  | VKM 11204   |   | 1   |   |   |   |   |   |   |
|  |   |   |  | —   |   |   |   |   |   |   |   |   |
|  |   |   |  | VKM 21203   |   |   |   |   | 1   |   |   |   |
|  |   |   |  | VKM 21204   |   |   | 1   |   |   |   |   |   |
| <b>VW  PHAETON (3D2) 6.0 W12</b>                  |   |   |  |   |   |   |   |   |   |   |   |   |
|   | BAN, BRN, BTT   | 04/02 → 06/07   |  | OXOXOXO   |   |   |   |   |   |   |   |   |
| <b>VW  PHAETON (3D2) 3.0 TDI</b>                  |   |   |  |   |   |   |   |   |   |   |   |   |
|   | BMK   | 09/04 → 06/07   |  | VKMA 01332  |   | 1   |   | 1   |   |   |   | 1 T0246   |
|  |   |   |  | VKM 11332   |   | 1   |   |   |   |   |   |   |
|   | B(Alt) BMK  | 09/04 → 06/07   |  | VKMV 6PK2480  |   |   |   | 1   |   |   |   |   |
| <b>VW  PHAETON (3D2) 5.0 V10 TDI</b>              |   |   |  |   |   |   |   |   |   |   |   |   |
|   | AJS   | 11/02 → 03/06   |  |  |   |   |   |   |   |   |   |   |
| <b>VW  POLO (86) 0.8</b>                          |   |   |  |   |   |   |   |   |   |   |   |   |
|   | HE  | 09/75 → 09/81   |                   | VKMC 01100  |   |   |   | 1   | 1   |   |   | T0222   |
|   | HE  | 09/75 → 09/81   |  | VKPC 81200  |   |   |   |   | 1   |   |   |   |
|   | B(Alt) HE   | 09/75 → 09/81   |  ICH 86A 0087 520 | VKMV 10AVx695   |   |   |   | 1   |   |   |   |   |
|   | B(Alt) HE   | 09/75 → 09/81   | CH 86A 0087 521 I→   | VKMV 10AVx675   |   |   |   | 1   |   |   |   |   |
| <b>VW  POLO (86) 0.9</b>                          |   |   |  |   |   |   |   |   |   |   |   |   |
|   | HA  | 09/75 → 09/81   |                   | VKMC 01100  |   |   |   | 1   | 1   |   |   | T0222   |
|   | HA  | 09/75 → 09/81   |  | VKPC 81200  |   |   |   |   | 1   |   |   |   |
|   | B(Alt) HA   | 09/75 → 09/81   |  ICH 86A 0087 520 | VKMV 10AVx695   |   |   |   | 1   |   |   |   |   |
|   | B(Alt) HA   | 09/75 → 09/81   | CH 86A 0087 521 I→   | VKMV 10AVx675   |   |   |   | 1   |   |   |   |   |
| <b>VW  POLO (86) 1.1</b>                          |   |   |  |   |   |   |   |   |   |   |   |   |
|   | HB, HC  | 03/75 → 09/81   |                   | VKMC 01100  |   |   |   | 1   | 1   |   |   | T0222   |
|   | HB, HC  | 03/75 → 09/81   |  | VKPC 81200  |   |   |   |   | 1   |   |   |   |
|   | B(Alt) HB, HC   | 03/75 → 09/81   |  ICH 86A 0087 520 | VKMV 10AVx695   |   |   |   | 1   |   |   |   |   |
|   | B(Alt) HB, HC   | 03/75 → 09/81   | CH 86A 0087 521 I→   | VKMV 10AVx675   |   |   |   | 1   |   |   |   |   |
| <b>VW  POLO (86) 1.3</b>                          |   |   |  |   |   |   |   |   |   |   |   |   |
|   | HH  | 12/76 → 09/81   |                   | VKMC 01100  |   |   |   | 1   | 1   |   |   | T0222   |
|   | HH  | 12/76 → 09/81   |  | VKPC 81200  |   |   |   |   | 1   |   |   |   |
|   | B(Alt) HH   | 12/76 → 09/81   |  ICH 86A 0087 520 | VKMV 10AVx695   |   |   |   | 1   |   |   |   |   |
|   | B(Alt) HH   | 12/76 → 09/81   | CH 86A 0087 521 I→   | VKMV 10AVx675   |   |   |   | 1   |   |   |   |   |
| <b>VW  POLO (86C, 80) / POLO Box (86CF) 0.9</b>   |   |   |  |   |   |   |   |   |   |   |   |   |
|   | HA  | 10/81 → 12/81   |                   | VKMC 01100  |   |   |   | 1   | 1   |   |   | T0222   |
|   | HA  | 10/81 → 12/81   |  | VKPC 81200  |   |   |   |   | 1   |   |   |   |
|   | B(Alt) HA   | 10/81 → 12/81   |  | VKMV 10AVx675   |   |   |   | 1   |   |   |   |   |



































VW











































| VW  POLO (86C, 80) / POLO Box (86CF) 1.0     |                                      |               |   |            |  |  |   |   |       |
|---|--------------------------------------|---------------|---|------------|--|--|---|---|-------|
|   | AAK, GL                              | 10/81 → 09/94 |                    | VKMC 01100 |  |  | 1 | 1 | T0222 |
|   | AAU                                  | 08/89 → 09/94 |  → IMot. 015 867   | VKMC 01100 |  |  | 1 | 1 | T0222 |
|   | AAU                                  | 08/89 → 09/94 |  Mot. 015 868 I→   | VKMC 01103 |  |  | 1 | 1 | T0231 |
|   | ACM                                  | 08/89 → 09/94 |                    | VKMC 01103 |  |  | 1 | 1 | T0231 |
|   | HZ                                   | 08/85 → 01/92 |  → IMot. 786 022   | VKMC 01100 |  |  | 1 | 1 | T0222 |
|   | HZ                                   | 08/85 → 01/92 |  Mot. 786 023 I→   | VKMC 01103 |  |  | 1 | 1 | T0231 |
|   | AAK, GL                              | 10/81 → 09/94 |   | VKPC 81200 |  |  |   | 1 |       |
|   | AAU                                  | 01/85 → 09/94 | → IMot. 015 867   | VKPC 81200 |  |  |   | 1 |       |
|   | AAU                                  | 01/85 → 09/94 | Mot. 015 868 I→   | VKPC 81204 |  |  |   | 1 |       |
|   | ACM                                  | 08/89 → 09/94 |   | VKPC 81204 |  |  |   | 1 |       |
|   | HZ                                   | 01/85 → 09/94 | → IMot. 786 022   | VKPC 81200 |  |  |   | 1 |       |
|   | HZ                                   | 01/85 → 09/94 | Mot. 786 023 I→   | VKPC 81204 |  |  |   | 1 |       |
|   | <b>B(Alt)</b> AAK, AAU, ACM, HZ      | 08/85 → 09/94 | → ICH 80-MP120 202, 80-MW162 419  | VKMC 01100 |  |  |   | 1 |       |
|   | <b>B(Alt)</b> AAK, AAU, ACM, HZ      | 08/85 → 09/94 | CH 80-MP120 202, 80-MW162 420 I→  | VKMC 01103 |  |  |   | 1 |       |
|   | <b>B(Alt)</b> AAU                    | 08/92 → 07/94 |   | VKMC 01103 |  |  |   | 1 |       |
|   | <b>B(Alt)</b> GL                     | 10/81 → 10/86 | → ICH 86-D-200 001  | VKMC 01103 |  |  |   | 1 |       |
|   | <b>B(Alt)</b> GL                     | 10/81 → 10/86 | CH 86-E-000 001 I→  | VKMC 01103 |  |  |   | 1 |       |
|   |                                      |               |   | VKMC 01103 |  |  |   | 1 |       |
| VW  POLO (86C, 80) / POLO Box (86CF) 1.1     |                                      |               |   |            |  |  |   |   |       |
|   | HB                                   | 10/81 → 09/89 |                    | VKMC 01100 |  |  | 1 | 1 | T0222 |
|   | HB                                   | 10/81 → 09/89 |   | VKPC 81200 |  |  |   | 1 |       |
|   | <b>B(Alt)</b> HB                     | 10/81 → 09/89 | → ICH 86-D-200 001  | VKMC 01103 |  |  |   | 1 |       |
|   | <b>B(Alt)</b> HB                     | 10/81 → 09/89 | CH 86-E-000 001 I→  | VKMC 01103 |  |  |   | 1 |       |
| VW  POLO (86C, 80) / POLO Box (86CF) 1.3   |                                      |               |   |            |  |  |   |   |       |
|   | 2G                                   | 07/87 → 09/94 |  → IMot. 262 739 | VKMC 01100 |  |  | 1 | 1 | T0222 |
|   | 2G                                   | 07/87 → 09/94 |  Mot. 262 740 I→ | VKMC 01103 |  |  | 1 | 1 | T0231 |
|   | 3F                                   | 10/89 → 09/94 |  → IMot. 008 526 | VKMC 01100 |  |  | 1 | 1 | T0222 |
|   | 3F                                   | 10/89 → 09/94 |  Mot. 008 527 I→ | VKMC 01103 |  |  | 1 | 1 | T0231 |
|   | AAV                                  | 07/87 → 09/94 |                  | VKMC 01103 |  |  | 1 | 1 | T0231 |
|   | GK, HH, HJ, HK, HW, MH, NZ           | 10/81 → 09/94 |                  | VKMC 01100 |  |  | 1 | 1 | T0222 |
|   | NZ                                   | 07/87 → 08/94 |  → IMot. 200 000 | VKMC 01100 |  |  | 1 | 1 | T0222 |
|   | NZ                                   | 07/87 → 09/94 |  Mot. 200 001 I→ | VKMC 01103 |  |  | 1 | 1 | T0231 |
|   | PY                                   | 01/87 → 09/94 |  → IMot. 002 177 | VKMC 01100 |  |  | 1 | 1 | T0222 |
|   | PY                                   | 01/87 → 09/94 |  Mot. 002 178 I→ | VKMC 01103 |  |  | 1 | 1 | T0231 |
|   | 2G                                   | 07/87 → 09/94 | → IMot. 262 739   | VKPC 81200 |  |  |   | 1 |       |
|   | 2G                                   | 07/87 → 09/94 | Mot. 262 740 I→   | VKPC 81204 |  |  |   | 1 |       |
|   | 3F                                   | 10/89 → 09/94 | → IMot. 008 526   | VKPC 81200 |  |  |   | 1 |       |
|   | 3F                                   | 10/89 → 09/94 | Mot. 008 527 I→   | VKPC 81204 |  |  |   | 1 |       |
|   | AAV                                  | 07/87 → 09/94 |   | VKPC 81204 |  |  |   | 1 |       |
|   | GK, HH, HJ, HK, HW, MH, PY           | 10/81 → 09/94 |   | VKPC 81200 |  |  |   | 1 |       |
|   | NZ                                   | 07/87 → 09/94 | → IMot. 200 000   | VKPC 81200 |  |  |   | 1 |       |
|   | NZ                                   | 07/87 → 09/94 | Mot. 200 001 I→   | VKPC 81204 |  |  |   | 1 |       |
|   | PY                                   | 08/90 → 09/94 | → IMot. 002 177   | VKPC 81200 |  |  |   | 1 |       |
|   | PY                                   | 08/90 → 09/94 | Mot. 002 178 I→   | VKPC 81204 |  |  |   | 1 |       |
|   | <b>B(Alt)</b> 2G, 3F, AAV, MH, NZ    | 07/87 → 09/94 | → ICH 80-MP120 202, 80-MW162 419  | VKMC 01100 |  |  |   | 1 |       |
|   | <b>B(Alt)</b> 2G, 3F, AAV, MH, NZ    | 07/87 → 09/94 | CH 80-MP120 202, 80-MW162 420 I→  | VKMC 01103 |  |  |   | 1 |       |
|   | <b>B(Alt)</b> AAV                    | 08/92 → 07/94 |   | VKMC 01103 |  |  |   | 1 |       |
|   | <b>B(Alt)</b> GK, HH, HJ, HK, HW, MH | 10/81 → 09/89 | → ICH 86-D-200 001  | VKMC 01103 |  |  |   | 1 |       |
|   | <b>B(Alt)</b> GK, HH, HJ, HK, HW, MH | 10/81 → 09/89 | CH 86-E-000 001 I→  | VKMC 01103 |  |  |   | 1 |       |
| VW  POLO (86C, 80) / POLO Box (86CF) 1.3 D |                                      |               |   |            |  |  |   |   |       |
|   | MN                                   | 08/86 → 08/90 |                  | VKMC 01101 |  |  | 1 | 1 | T0229 |
|   | MN                                   | 08/86 → 08/90 |   | VKPC 81206 |  |  |   | 1 |       |
|   | <b>B(Alt)</b> MN                     | 08/86 → 08/90 |   | VKMC 01101 |  |  |   | 1 |       |
| VW  POLO (86C, 80) / POLO Box (86CF) 1.4 D |                                      |               |   |            |  |  |   |   |       |
|   | 1W                                   | 08/90 → 09/94 |                  | VKMC 01101 |  |  | 1 | 1 | T0229 |









































|   |  |  |    |  |  |  |  |  |  |  |
|---|---|---|---|--|---|---|---|---|---|---|
|    | 1W  | 08/90 → 09/94   |   | VKPC 81206   |   |   |   | 1   |   |   |
|    | B(Alt) 1W   | 08/90 → 09/94   | → ICH 80-MP120 201,<br>80-MW162 419   | VKMC 10AVx675  |   | 1   |   |   |   |   |
|   | B(Alt) 1W   | 08/90 → 09/94   | CH 80-MP120 202,<br>80-MW162 420 I→   | VKMC 11.9x710  |   | 1   |   |   |   |   |
|   | B(Alt) 1W   | 08/92 → 07/94   |   | VKMC 11.9x710  |   | 1   |   |   |   |   |
| <b>VW  POLO (6N1) / POLO Box (6NF) 1.0</b>       |   |   |   |  |   |   |   |   |   |   |
|    | AEV   | 10/94 → 12/99   |    | VKMC 01105<br>VKMA 01105<br>VKM 11105  | 1<br>1<br>1   | 1   | 1   |   |   | T0125   |
|   | AER, ALL  | 09/96 → 10/99   |   | VKMA 01106<br>VKM 11106  | 1<br>1  | 1   |   |   |   | T0126   |
|    | AAU   | 10/94 → 12/99   | → IMot. 015 867   | VKPC 81200   |   |   |   | 1   |   |   |
|   | AAU   | 10/94 → 12/99   | Mot. 015 868 I→   | VKPC 81204   |   |   |   | 1   |   |   |
|   | AER, ALL  | 09/96 → 10/99   |   | VKPC 81215   |   |   |   | 1   |   |   |
|   | AEV   | 10/94 → 09/96   |   | VKPC 81210   |   |   |   | 1   |   |   |
|    | B(Alt) AAU, AER, AEV, ALL   | 10/94 → 12/99   | ∅   | VKMC 6PK751  |   |   | 1   |   |   |   |
|   | B(Alt) AAU  | 10/94 → 12/99   | AC, ⊕   | VKMA 31202<br>VKMC 6PK1068<br>VKM 31015  | 1<br>1<br>1   | 1   | 1   |   |   |   |
|   | B(Alt) AAU  | 10/94 → 12/99   | AC, ⊕   | VKMA 31219<br>VKMC 6PK1123<br>VKM 31015  | 1<br>1<br>1   | 1   | 1   |   |   |   |
|   | B(Alt) AER, AEV, ALL  | 10/94 → 10/99   | ⊕   | VKMA 31202<br>VKMC 6PK1068<br>VKM 31015  | 1<br>1<br>1   | 1   | 1   |   |   |   |
| <b>VW  POLO (6N1) / POLO Box (6NF) 1.3</b>     |   |   |   |  |   |   |   |   |   |   |
|    | ADX   | 10/94 → 07/95   |   | VKMA 01106<br>VKM 11106  | 1<br>1  | 1   |   |   |   | T0126   |
|    | ADX   | 10/94 → 07/95   |   | VKPC 81210   |   |   |   | 1   |   |   |
|    | B(Alt) ADX  | 10/94 → 07/95   | ∅   | VKMC 6PK751  |   |   | 1   |   |   |   |
|   | B(Alt) ADX  | 10/94 → 07/95   | ⊕   | VKMA 31202<br>VKMC 6PK1068<br>VKM 31015  | 1<br>1<br>1   | 1   | 1   |   |   |   |
| <b>VW  POLO (6N1) / POLO Box (6NF) 1.4</b>     |   |   |   |  |   |   |   |   |   |   |
|    | AEX, AKV, APQ   | 07/95 → 12/99   |   | VKMA 01106<br>VKM 11106  | 1<br>1  | 1   |   |   |   | T0126   |
|    | AEX, AKV, APQ   | 07/95 → 12/99   |   | VKPC 81210   |   |   |   | 1   |   |   |
|    | B(Alt) AEX, AKV, APQ  | 07/95 → 10/99   | ∅   | VKMC 6PK751  |   |   | 1   |   |   |   |
|   | B(Alt) AEX, AKV, APQ  | 07/95 → 12/99   | AC, ⊕   | VKMA 31202<br>VKMC 6PK1068<br>VKM 31015  | 1<br>1<br>1   | 1   | 1   |   |   |   |
|   | B(Alt) AEX, AKV, APQ  | 07/95 → 12/99   | AC, ⊕   | VKMA 31219<br>VKMC 6PK1123<br>VKM 31015  | 1<br>1<br>1   | 1   | 1   |   |   |   |
| <b>VW  POLO (6N1) / POLO Box (6NF) 1.4 16V</b> |   |   |   |  |   |   |   |   |   |   |
|    | AFH   | 04/96 → 10/99   |  | VKMC 01114<br>VKMA 01114<br>VKM 11114<br>VKM 21122                                 | 1<br>1<br>1<br>1  | 1   | 1   | 1   |   | T0150   |
|    | AFH   | 04/96 → 10/99   |   | VKPC 81411   |   |   |   | 1   |   |   |
|    | B(Alt) AFH  | 04/96 → 10/99   | AC  | VKMA 31202<br>VKMC 6PK1068<br>VKM 31015  | 1<br>1<br>1   | 1   | 1   |   |   |   |
|   | B(Alt) AFH  | 04/96 → 10/99   | AC  | VKMA 31219<br>VKMC 6PK1123<br>VKM 31015  | 1<br>1<br>1   | 1   | 1   |   |   |   |
| <b>VW  POLO (6N1) / POLO Box (6NF) 1.6</b>     |   |   |   |  |   |   |   |   |   |   |
|    | AEA, AEE  | 10/94 → 10/99   |   | VKMA 01110<br>VKM 11106  | 1<br>1  | 1   |   |   |   | T0127   |
|    | AEA, AEE  | 10/94 → 10/99   |   | VKPC 81210   |   |   |   | 1   |   |   |



VW

|   |  |  |                                      |  |  |  |  |  |  |  |  |  |
|---|---|---|---|--|---|---|---|---|---|---|---|---|
|   | <b>B(Alt)</b> AEA, AEE  | 10/94 → 10/99   | <b>AC</b>   | VKMA 31202<br>VKMV 6PK1068<br>VKM 31015  | 1   |   | 1   |   |   |   |   |   |
|   | <b>B(Alt)</b> AEA, AEE  | 10/94 → 10/99   | <b>AC</b>   | VKMA 31219<br>VKMV 6PK1123<br>VKM 31015  | 1   |   | 1   |   |   |   |   |   |
| <b>VW  POLO (6N1) / POLO Box (6NF) 1.6 16V</b>   |   |   |   |  |   |   |   |   |   |   |   |   |
|   | AJV   | 09/98 → 10/99   | → <b>I</b> Mot. 005 000   | VKMA 01120<br>VKM 11120<br>VKM 11121<br>VKM 21120<br>VKM 21121                     | 2<br>1<br>1   | 2   | 2   |   |   |   |   | T0165   |
|   | AJV   | 09/98 → 10/99   | <b>Mot.</b> 005 001 <b>I</b> →  | VKMA 01121<br>VKM 11120<br>VKM 11124<br>VKM 21120<br>VKM 21121                     | 2<br>1<br>1   | 2   | 2   |   |   |   |   | T0165   |
|   | AJV   | 09/98 → 10/99   |   | VKPC 81419   |   |   |   |   | 1   |   |   |   |
|   | <b>B(Alt)</b> AJV   | 09/98 → 10/99   | <b>AC</b>   | VKMA 31202<br>VKMV 6PK1068<br>VKM 31015  | 1   |   | 1   |   |   |   |   |   |
|   | <b>B(Alt)</b> AJV   | 09/98 → 10/99   | <b>AC</b>   | VKMA 31219<br>VKMV 6PK1123<br>VKM 31015  | 1   |   | 1   |   |   |   |   |   |
| <b>VW  POLO (6N1) / POLO Box (6NF) 1.7 SDI</b>   |   |   |   |  |   |   |   |   |   |   |   |   |
|    | AHG, AKU  | 04/97 → 12/99   |   | VKMA 01016<br>VKM 11015<br>VKM 21012   | 1<br>1  | 1   | 1   |   |   |   |   | 4 T0183   |
|   | AHG, AKU  | 04/97 → 12/99   |   | VKPC 81615   |   |   |   |   | 1   |   |   |   |
|   | <b>B(Alt)</b> AHG, AKU  | 04/97 → 12/99   |   | VKMA 31017<br>VKMV 5PK1219<br>VKM 31025  | 1   |   | 1   |   |   |   |   |   |
| <b>VW  POLO (6N1) / POLO Box (6NF) 1.9 D</b>   |   |   |   |  |   |   |   |   |   |   |   |   |
|   | AEF   | 10/94 → 12/99   |   | VKMA 01015<br>VKM 11015  | 1<br>1  |   | 1   |   |   |   |   | T0183   |
|   | AEF   | 10/94 → 12/99   |   | VKPC 81615   |   |   |   |   | 1   |   |   |   |
|   | <b>B(Alt)</b> AEF   | 10/94 → 12/99   |   | VKMA 31017<br>VKMV 5PK1219<br>VKM 31025  | 1   |   | 1   |   |   |   |   |   |
| <b>VW  POLO (6N1) / POLO Box (6NF) 1.9 SDI</b> |   |   |   |  |   |   |   |   |   |   |   |   |
|   | AGD   | 07/96 → 12/99   |   | VKMA 01016<br>VKM 11015<br>VKM 21012   | 1<br>1  | 1   | 1   |   |   |   |   | 4 T0183   |
|   | AGD   | 07/96 → 12/99   |   | VKPC 81615   |   |   |   |   | 1   |   |   |   |
|   | <b>B(Alt)</b> AGD   | 07/96 → 12/99   |   | VKMA 31017<br>VKMV 5PK1219<br>VKM 31025  | 1   |   | 1   |   |   |   |   |   |
| <b>VW  POLO (6N2) 1.0</b>                      |   |   |   |  |   |   |   |   |   |   |   |   |
|   | ALD, AUC  | 10/99 → 09/01   | → <b>I</b> CH 6N-Y-600 000  | VKMA 01106<br>VKM 11106  | 1<br>1  |   | 1   |   |   |   |   | T0126   |
|   | ALD, AUC  | 10/99 → 09/01   |  <b>CH</b> 6N-Y-600 001 <b>I</b> → | VKMC 01107<br>VKMA 01107<br>VKM 11107  | 1<br>1<br>1   |   | 1   |   | 1   |   |   | 2<br>2 T0126  |
|   | ALD, AUC  | 10/99 → 09/01   |   | VKPC 81215   |   |   |   |   | 1   |   |   |   |
|   | <b>B(Alt)</b> ALD, AUC  | 10/99 → 09/01   |                                    | VKMV 6PK751  |   |   | 1   |   |   |   |   |   |
|   | <b>B(Alt)</b> ALD, AUC  | 10/99 → 09/01   | <b>AC</b> ,                        | VKMA 31202<br>VKMV 6PK1068<br>VKM 31015  | 1<br>1  |   | 1   |   |   |   |   |   |
|   | <b>B(Alt)</b> ALD, AUC  | 10/99 → 09/01   | <b>AC</b> ,                        | VKMA 31219<br>VKMV 6PK1123<br>VKM 31015  | 1<br>1  |   | 1   |   |   |   |   |   |
| <b>VW  POLO (6N2) 1.4</b>                      |   |   |   |  |   |   |   |   |   |   |   |   |
|   | AKK, AKP, AUD   | 10/99 → 09/01   | → <b>I</b> CH 6N-Y-600 000  | VKMA 01106<br>VKM 11106  | 1<br>1  |   | 1   |   |   |   |   | T0126   |







































|  |  |  |                      |  |  |  |  |  |  |  |  |  |  |
|--|---|---|---|--|---|---|---|---|---|---|---|---|---|
|  | AKK, AKP, AUD   | 10/99 → 09/01   |  CH 6N-Y-600 001   → | VKMC 01107<br>VKMA 01107<br>VKM 11107  | 1<br>1<br>1   |   | 1   | 1   |   |   |   | 2<br>2  | T0126   |
|                                 | AKK, AKP, AUD   | 10/99 → 09/01   |   | VKPC 81215   |   |   |   | 1   |   |   |   |   |   |
|                                 | <b>B(Alt)</b> AKK, AKP, AUD   | 10/99 → 09/01   |                      | VKMOV 6PK751   |   |   | 1   |   |   |   |   |   |   |
|  | <b>B(Alt)</b> AKK, AKP, AUD   | 10/99 → 09/01   |                      | VKMA 31202<br>VKMV 6PK1068<br>VKM 31015  | 1<br>1<br>1   |   | 1   | 1   |   |   |   |   |   |
|  | <b>B(Alt)</b> AKK, AKP, AUD   | 10/99 → 09/01   |                      | VKMA 31219<br>VKMV 6PK1123<br>VKM 31015  | 1<br>1<br>1   |   | 1   | 1   |   |   |   |   |   |
| <b>VW  POLO (6N2) 1.4 16V</b>   |   |   |   |  |   |   |   |   |   |   |   |   |   |
|                                 | AFK, AHW, APE, AQQ,<br>AUA, AUB   | 10/99 → 09/01   |   | VKMA 01121<br>VKM 11120<br>VKM 11124<br>VKM 21120<br>VKM 21121                     | 2<br>1<br>1<br>1<br>1   | 2   | 2   | 2   |   |   |   |   | T0165   |
|                                 | AFK, AHW, APE, AQQ,<br>AUA, AUB   | 10/99 → 09/01   |   | VKPC 81407   |   |   |   |   | 1   |   |   |   |   |
|                                 | <b>B(Alt)</b> AFK, AQQ, AUB   | 10/99 → 09/01   |   | VKMA 31219<br>VKMV 6PK1123<br>VKM 31015  | 1<br>1<br>1   |   | 1   | 1   |   |   |   |   |   |
|  | <b>B(Alt)</b> AHW, APE, AUA   | 10/99 → 09/01   |                      | VKMA 31202<br>VKMV 6PK1068<br>VKM 31015  | 1<br>1<br>1   |   | 1   | 1   |   |   |   |   |   |
|  | <b>B(Alt)</b> AHW, APE, AUA   | 10/99 → 09/01   |                    | VKMA 31219<br>VKMV 6PK1123<br>VKM 31015  | 1<br>1<br>1   |   | 1   | 1   |   |   |   |   |   |
| <b>VW  POLO (6N2) 1.6 16V</b> |   |   |   |  |   |   |   |   |   |   |   |   |   |
|                               | ARC, AVY  | 10/99 → 09/01   |   | VKMA 01121<br>VKM 11120<br>VKM 11124<br>VKM 21120<br>VKM 21121                     | 2<br>1<br>1<br>1<br>1   | 2   | 2   | 2   |   |   |   |   | T0165   |
|                               | ARC, AVY  | 10/99 → 09/01   |   | VKPC 81419   |   |   |   |   | 1   |   |   |   |   |
|                               | <b>B(Alt)</b> ARC   | 10/99 → 09/01   |   | VKMA 31219<br>VKMV 6PK1123<br>VKM 31015  | 1<br>1<br>1   |   | 1   | 1   |   |   |   |   |   |
|  | <b>B(Alt)</b> AVY   | 10/99 → 09/01   |                    | VKMA 31202<br>VKMV 6PK1068<br>VKM 31015  | 1<br>1<br>1   |   | 1   | 1   |   |   |   |   |   |
|  | <b>B(Alt)</b> AVY   | 10/99 → 09/01   |                    | VKMA 31219<br>VKMV 6PK1123<br>VKM 31015  | 1<br>1<br>1   |   | 1   | 1   |   |   |   |   |   |
| <b>VW  POLO (6N2) 1.4 TDI</b> |   |   |   |  |   |   |   |   |   |   |   |   |   |
|                               | AMF   | 10/99 → 09/01   |  Mot. 011 494      | VKMA 01941<br>VKM 11141<br>VKM 11144<br>VKM 21142                                  | 1<br>1<br>1<br>1  | 1   | 1   | 1   | 1   |   |   |   | 2 T0184   |
|  | AMF   | 10/99 → 09/01   | → Mot. 011 494  | VKMA 01141<br>VKM 11141<br>VKM 21142   | 1<br>1<br>1   | 1   | 1   | 1   |   |   |   |   | 1 T0184   |
|  | AMF   | 10/99 → 09/01   |  Mot. 011 495   →  | VKMA 01942<br>VKM 11142<br>VKM 11145<br>VKM 21142                                  | 1<br>1<br>1<br>1  | 1   | 1   | 1   | 1   |   | 1   |   | 3 T0184   |
|  | AMF   | 10/99 → 09/01   | → Mot. 011 495  | VKMA 01142<br>VKM 11142<br>VKM 21142   | 1<br>1<br>1   | 1   | 1   | 1   |   |   |   |   | 3 T0184   |
|                               | AMF   | 10/99 → 09/01   |   | VKPC 81417   |   |   |   |   | 1   |   |   |   |   |
|                               | <b>B(Alt)</b> AMF   | 10/99 → 09/01   |                    | VKMA 31203<br>VKMV 6PK1120<br>VKM 31011  | 1<br>1<br>1   |   | 1   | 1   |   |   |   |   |   |
|  | <b>B(Alt)</b> AMF   | 10/99 → 09/01   |                    | VKMOV 6DK1188<br>VKM 31011   | 1<br>1  |   | 1   |   |   |   |   |   |   |









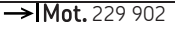
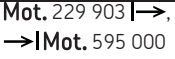
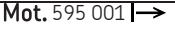















|   | AKP, AUD   | 12/95 → 09/01 |        | VKMC 01107    | 1 | 1 | 1 |   |   |   |   |   |   |  |  |  | 2 | T0126 |
|---|--|---------------|--------|---------------|---|---|---|---|---|---|---|---|---|--|--|--|---|-------|
|   |  |               |        | VKMA 01107    | 1 | 1 |   |   |   |   |   |   |   |  |  |  | 2 |       |
|   |  |               |        | VKM 11107     | 1 |   |   |   |   |   |   |   |   |  |  |  |   |       |
|   | AEX, AKV, ANX, APQ                                   | 12/95 → 09/01 |        | VKMA 01106    | 1 | 1 |   |   |   |   |   |   |   |  |  |  |   | T0126 |
|   |  |               |        | VKM 11106     | 1 |   |   |   |   |   |   |   |   |  |  |  |   |       |
|   | AEX, AKV, APQ  | 12/95 → 09/01 |        | VKPC 81210    |   |   |   | 1 |   |   |   |   |   |  |  |  |   |       |
|   | AKK, AKP, ANW, AUD                                   | 12/95 → 09/01 |        | VKPC 81215    |   |   |   | 1 |   |   |   |   |   |  |  |  |   |       |
|   | <b>B(Alt)</b> AEX, AKK, AKV, ANW, ANX, APQ, AUD      | 12/95 → 09/01 | AC, Ø  | VKMV 6PK751   |   |   |   |   |   | 1 |   |   |   |  |  |  |   |       |
|   | <b>B(Alt)</b> AEX, AKK, AKP, AKV, ANW, ANX, APQ, AUD | 12/95 → 09/01 | AC, Ø  | VKMA 31202    | 1 |   |   |   |   |   |   | 1 |   |  |  |  |   |       |
|   |  |               |        | VKMV 6PK1068  |   |   |   |   |   |   | 1 |   |   |  |  |  |   |       |
|   |  |               |        | VKM 31015     | 1 |   |   |   |   |   |   |   |   |  |  |  |   |       |
|   | <b>B(Alt)</b> AEX, AKK, AKP, AKV, ANW, ANX, APQ, AUD | 12/95 → 09/01 | AC, Ø  | VKMV 6PK1185  |   |   |   |   |   | 1 |   |   |   |  |  |  |   |       |
|   |  |               |        | VKM 31023     | 1 |   |   |   |   |   |   |   |   |  |  |  |   |       |
| <b>VW  POLO CLASSIC (6KV2) / Variant (6KV5) 1.4 16V</b> |  |               |        |               |   |   |   |   |   |   |   |   |   |  |  |  |   |       |
|   | APE, AUA   | 10/99 → 09/01 |        | VKMA 01121    | 2 | 2 | 2 |   |   |   |   |   |   |  |  |  |   | T0165 |
|   |  |               |        | VKM 11120     | 1 |   |   |   |   |   |   |   |   |  |  |  |   |       |
|   |  |               |        | VKM 11124     | 1 |   |   |   |   |   |   |   |   |  |  |  |   |       |
|   |  |               |        | VKM 21120     |   | 1 |   |   |   |   |   |   |   |  |  |  |   |       |
|   |  |               |        | VKM 21121     |   | 1 |   |   |   |   |   |   |   |  |  |  |   |       |
|   | APE, AUA   | 10/99 → 09/01 |        | VKPC 81407    |   |   |   |   | 1 |   |   |   |   |  |  |  |   |       |
|   | <b>B(Alt)</b> APE, AUA                               | 10/99 → 09/01 | AC     | VKMA 31202    | 1 |   |   |   |   | 1 |   |   |   |  |  |  |   |       |
|   |  |               |        | VKMV 6PK1068  |   |   |   |   |   | 1 |   |   |   |  |  |  |   |       |
|   |  |               |        | VKM 31015     | 1 |   |   |   |   |   |   |   |   |  |  |  |   |       |
|   | <b>B(Alt)</b> APE, AUA                               | 10/99 → 09/01 | AC     | VKMV 6PK1185  |   |   |   |   |   | 1 |   |   |   |  |  |  |   |       |
|   |  |               |        | VKM 31023     | 1 |   |   |   |   |   |   |   |   |  |  |  |   |       |
| <b>VW  POLO CLASSIC (6KV2) / Variant (6KV5) 1.6</b>     |  |               |        |               |   |   |   |   |   |   |   |   |   |  |  |  |   |       |
|   | 1F   | 11/95 → 09/97 | 3)     | VKMS 01000    | 1 | 1 |   |   |   |   |   | 3 | 4 |  |  |  |   | T0005 |
|   |  |               |        | VKMA 01000    | 1 | 1 |   |   |   |   |   |   |   |  |  |  |   |       |
|   |  |               |        | VKM 11000     | 1 |   |   |   |   |   |   |   |   |  |  |  |   |       |
|   | AEE, ALM   | 11/95 → 09/01 |        | VKMA 01110    | 1 |   |   |   |   | 1 |   |   |   |  |  |  |   | T0127 |
|   |  |               |        | VKM 11106     | 1 |   |   |   |   |   |   |   |   |  |  |  |   |       |
|   | AEH, AKL, APF, AUR                                   | 12/95 → 09/01 |        | VKMA 01113    | 1 |   |   |   |   | 1 |   |   |   |  |  |  |   | T0149 |
|   |  |               |        | VKM 11113     | 1 |   |   |   |   |   |   |   |   |  |  |  |   |       |
|   | AFT  | 12/95 → 09/01 |        | VKMA 01009    | 1 |   |   |   |   | 1 |   |   |   |  |  |  | 3 | T0124 |
|   |  |               |        | VKM 11000     | 1 |   |   |   |   |   |   |   |   |  |  |  |   |       |
|   | 1F, AFT  | 11/95 → 09/01 |        | VKPC 81401    |   |   |   |   |   |   |   | 1 |   |  |  |  |   |       |
|   | AEE, ALM   | 11/95 → 09/01 |        | VKPC 81210    |   |   |   |   |   |   |   | 1 |   |  |  |  |   |       |
|   | AEH, AKL, APF, AUR                                   | 12/95 → 09/01 |        | VKPC 81408    |   |   |   |   |   |   |   | 1 |   |  |  |  |   |       |
|   | <b>B(Alt)</b> 1F, AFT                                | 11/95 → 09/01 | AØ     | VKMV 6PK894   |   |   |   |   |   | 1 |   |   |   |  |  |  |   |       |
|   | <b>B(Alt)</b> 1F, AFT                                | 11/95 → 09/01 | AØ, AC | VKMV 6PK1153  |   |   |   |   |   | 1 |   |   |   |  |  |  |   |       |
|   |  |               |        | VKM 31004     | 1 |   |   |   |   |   |   |   |   |  |  |  |   |       |
|   |  |               |        | VKM 31210     | 1 |   |   |   |   |   |   |   |   |  |  |  |   |       |
|   | <b>B(Alt)</b> AEE, ALM                               | 11/95 → 09/01 | AC     | VKMA 31202    | 1 |   |   |   |   | 1 |   |   |   |  |  |  |   |       |
|   |  |               |        | VKMV 6PK1068  |   |   |   |   |   | 1 |   |   |   |  |  |  |   |       |
|   |  |               |        | VKM 31015     | 1 |   |   |   |   |   |   |   |   |  |  |  |   |       |
|   | <b>B(Alt)</b> AEE, ALM                               | 11/95 → 09/01 | AC     | VKMV 6PK1185  |   |   |   |   |   | 1 |   |   |   |  |  |  |   |       |
|   |  |               |        | VKM 31023     | 1 |   |   |   |   |   |   |   |   |  |  |  |   |       |
|   | <b>B(Alt)</b> AEH, AKL, APF, AUR                     | 12/95 → 09/01 | AC     | VKMA 31203    | 1 |   |   |   |   | 1 |   |   |   |  |  |  |   |       |
|   |  |               |        | VKMV 6PK1120  |   |   |   |   |   | 1 |   |   |   |  |  |  |   |       |
|   |  |               |        | VKM 31011     | 1 |   |   |   |   |   |   |   |   |  |  |  |   |       |
|   | <b>B(Alt)</b> AEH, AKL, APF, AUR                     | 12/95 → 09/01 | AC     | VKMA 31204    | 1 |   |   |   |   | 1 |   |   |   |  |  |  |   |       |
|   |  |               |        | VKMV 6DK1195  |   |   |   |   |   | 1 |   |   |   |  |  |  |   |       |
|   |  |               |        | VKM 31011     | 1 |   |   |   |   |   |   |   |   |  |  |  |   |       |
|   | <b>B(PS)</b> 1F, AFT                                 | 11/95 → 09/01 | AC     | VKMV 11.5x685 |   |   |   |   |   | 1 |   |   |   |  |  |  |   |       |
|   | <b>B(PS)</b> 1F, AFT                                 | 11/95 → 09/01 | AC     | VKMV 11.5x755 |   |   |   |   |   | 1 |   |   |   |  |  |  |   |       |
| <b>VW  POLO CLASSIC (6KV2) / Variant (6KV5) 1.8</b>     |  |               |        |               |   |   |   |   |   |   |   |   |   |  |  |  |   |       |
|   | ADD, ADZ   | 01/97 → 09/01 |        | VKMA 01009    | 1 |   |   |   |   | 1 |   |   |   |  |  |  | 3 | T0124 |
|   |  |               |        | VKM 11000     | 1 |   |   |   |   |   |   |   |   |  |  |  |   |       |
|   | ADD, ADZ   | 01/97 → 09/01 | 2)     | VKPA 81401    |   |   |   |   |   |   |   | 1 |   |  |  |  |   |       |
|   |  |               |        | VKPC 81401    |   |   |   |   |   |   |   | 1 |   |  |  |  |   |       |





























|  |                  |  |  |    |  |  |  |  |  |  |  |  |
|--|------------------|---|---|---|--|---|---|---|---|---|---|---|
| <b>VW  POLO CLASSIC (6KV2) / Variant (6KV5) 2.0</b>       |                  |   |   |   |  |   |   |   |   |   |   |   |
|   | ADC              | 08/99 → 09/01   |   |   | VKMA 01002<br>VKM 11000  | 1<br>1  | 1   |   |   |   |   | 3 T0091   |
|   | ADC              | 08/99 → 09/01   | 2)  |   | VKPA 81401<br>VKPC 81401   |   |   |   | 1<br>1  |   |   |   |
|   | B(Alt) ADC       | 08/99 → 09/01   |   |    | VKMV 6PK894  |   | 1   |   |   |   |   |   |
|  | B(Alt) ADC       | 08/99 → 09/01   |   |    | VKMV 6PK1153<br>VKM 31004<br>VKM 31210   | 1<br>1  | 1   |   |   |   |   |   |
|  | B(PS) ADC        | 08/99 → 09/01   |   |    | VKMV 11.5x685  |   | 1   |   |   |   |   |   |
|  | B(PS) ADC        | 08/99 → 09/01   |   |    | VKMV 11.5x755  |   | 1   |   |   |   |   |   |
| <b>VW  POLO CLASSIC (6KV2) / Variant (6KV5) 1.7 SDI</b>   |                  |   |   |   |  |   |   |   |   |   |   |   |
|   | AKW              | 07/97 → 09/01   |   |   | VKMA 01019<br>VKM 11014<br>VKM 21012   | 1<br>1<br>1   | 1   | 1   |   |   |   | 5 T0650   |
|   | AKW              | 07/97 → 09/01   | 2)  |   | VKPA 81401<br>VKPC 81401   |   |   |   | 1<br>1  |   |   |   |
|   | B(Alt) AKW       | 07/97 → 09/01   |   |    | VKMV 6PK923  |   | 1   |   |   |   |   |   |
|  | B(Alt), B(PS)AKW | 07/97 → 09/01   |   |    | VKMA 31028<br>VKMV 10AVx730<br>VKMV 6PK1045<br>VKM 31004<br>VKM 31030              | 2<br>1<br>1   | 2<br>1<br>1   |   |   |   |   |   |
|  | B(Alt), B(PS)AKW | 07/97 → 09/01   |   |    | VKMA 31030<br>VKMV 11.5x790<br>VKMV 6PK1145<br>VKM 31004<br>VKM 31030              | 2<br>1<br>1   | 2<br>1<br>1   |   |   |   |   |   |
|   | AKW              | 07/97 → 09/01   |   |  | VKM _____  |   |   |   | 1   |   |   |   |
| <b>VW  POLO CLASSIC (6KV2) / Variant (6KV5) 1.9 D</b>   |                  |   |   |   |  |   |   |   |   |   |   |   |
|   | 1Y               | 01/96 → 10/96   |   |   | VKMA 01013<br>VKM 11014  | 1<br>1  | 1   |   |   |   |   | 4 T0069   |
|   | 1Y               | 01/96 → 10/96   | 2)  |   | VKPA 81401<br>VKPC 81401   |   |   |   | 1<br>1  |   |   |   |
|   | B(Alt) 1Y        | 01/96 → 10/96   |   |  | VKMV 6PK923  |   | 1   |   |   |   |   |   |
|  | B(Alt), B(PS)1Y  | 01/96 → 10/96   |   |  | VKMA 31028<br>VKMV 10AVx730<br>VKMV 6PK1045<br>VKM 31004<br>VKM 31030              | 2<br>1<br>1   | 2<br>1<br>1   |   |   |   |   |   |
|  | B(Alt), B(PS)1Y  | 01/96 → 10/96   |   |  | VKMA 31030<br>VKMV 11.5x790<br>VKMV 6PK1145<br>VKM 31004<br>VKM 31030              | 2<br>1<br>1   | 2<br>1<br>1   |   |   |   |   |   |
|   | 1Y               | 01/96 → 10/96   |   |   | VKM _____  |   |   |   | 1   |   |   |   |
| <b>VW  POLO CLASSIC (6KV2) / Variant (6KV5) 1.9 SDI</b> |                  |   |   |   |  |   |   |   |   |   |   |   |
|   | 1Y               | 12/95 → 08/99   |   |   | VKMA 01013<br>VKM 11014  | 1<br>1  | 1   |   |   |   |   | 4 T0069   |
|  | AEY              | 12/95 → 09/01   |   |   | VKMA 01019<br>VKM 11014<br>VKM 21012   | 1<br>1  | 1   | 1   |   |   |   | 5 T0650   |
|  | AGP              | 08/99 → 09/01   |   |  | VKMA 01130<br>VKM 11130<br>VKM 21004<br>VKM 21130                                  | 1<br>1  | 2   | 1   |   |   |   | 5 T0173   |
|  | AGP              | 08/99 → 09/01   |   |  | VKMA 01131<br>VKM 11130<br>VKM 21004<br>VKM 21130<br>VKM 21131                     | 1<br>1  | 3   | 1   |   |   |   | 8 T0173   |
|  | AGP              | 08/99 → 09/01   |   |  | VKMA 01251<br>VKM 11130<br>VKM 21004   | 1<br>1  | 3   | 1   |   |   |   | 8 T0173   |



VW

|  |  |  |  |  |  |  |  |  |  |  |  |  |  |  |
|--|---|---|---|--|---|---|---|---|---|---|---|---|---|---|
|  |   |   |   | VKM 21130<br>VKM 21131   | 1<br>1  |   |   |   |   |   |   |   |   |   |
|  | AQM   | 08/99 → 09/01   | →   Mot. 004 131  | VKMA 01130<br>VKM 11130<br>VKM 21004<br>VKM 21130                                  | 1<br>1  | 2   | 1   |   |   |   |   |   | 5   | T0173   |
|  | AQM   | 08/99 → 09/01   | Mot. 004 132   →,<br>→   Mot. 045 000   | VKMA 01131<br>VKM 11130<br>VKM 21004<br>VKM 21130                                  | 1<br>1  | 3   | 1   |   |   |   |   |   | 8   | T0173   |
|  | AQM   | 08/99 → 09/01   | Mot. 045 001   →  | VKMA 01251<br>VKM 11130<br>VKM 21004<br>VKM 21130<br>VKM 21131                     | 1<br>1  | 3   | 1   |   |   |   |   |   | 8   | T0173   |
|    | 1Y, AEY   | 12/95 → 09/01   | 2)  | VKPA 81401<br>VKPC 81401   |   |   |   |   | 1<br>1  |   |   |   |   |   |
|  | AGP, AQM  | 08/99 → 09/01   |   | VKPC 81623   |   |   |   |   | 1   |   |   |   |   |   |
|    | B(Alt) 1Y, AEY  | 12/95 → 09/01   | A⊙  | VKMV 6PK923  |   |   | 1   |   |   |   |   |   |   |   |
|  | B(Alt) AGP, AQM   | 08/99 → 09/01   | AC  | VKMV 6PK906<br>VKM 31002<br>VKM 31018  | 1   | 1   | 1   |   |   |   |   |   | 1<br>1  |   |
|  | B(Alt) AGP, AQM   | 08/99 → 09/01   | AC  | VKMA 31005<br>VKMV 6PK1660<br>VKM 31002<br>VKM 31018                               | 1<br>1  | 1   | 1<br>1  |   |   |   |   |   | 2<br>1<br>1   |   |
|  | B(Alt), B(PS) 1Y, AEY   | 12/95 → 09/01   | A⊙, AC  | VKMA 31028<br>VKMV 10AVx730<br>VKMV 6PK1045<br>VKM 31004<br>VKM 31030              | 2<br>1<br>1   |   | 2<br>1<br>1   |   |   |   |   |   |   |   |
|  | B(Alt), B(PS) 1Y, AEY   | 12/95 → 09/01   | A⊙, AC  | VKMA 31030<br>VKMV 11.5x790<br>VKMV 6PK1145<br>VKM 31004<br>VKM 31030              | 2<br>1<br>1   |   | 2<br>1<br>1   |   |   |   |   |   |   |   |
|    | 1Y, AEY   | 12/95 → 08/99   |   | VKM _____  |   |   |   |   |   |   |   | 1   |   |   |
|  | AEY   | 06/97 → 09/01   | →   CH 69K-Y-502 794  | VKM _____  |   |   |   |   |   |   |   | 1   |   |   |
|  | AGP, AQM  | 08/99 → 09/01   | CH 6K-Y-502 795   →   | VKM _____  |   |   |   |   |   |   |   | 1   |   |   |
| <b>VW  POLO CLASSIC (6KV2) / Variant (6KV5) 1.9 TDI</b> |   |   |   |  |   |   |   |   |   |   |   |   |   |   |
|    | AFN, AHU, ALE   | 09/96 → 09/01   |   | VKMA 01014<br>VKM 11014<br>VKM 21012   | 1<br>1  | 1   | 1   |   |   |   |   |   | 5   | T0650   |
|  | AGR   | 09/96 → 09/01   | →   Mot. 565 000  | VKMA 01131<br>VKM 11130<br>VKM 21004<br>VKM 21130<br>VKM 21131                     | 1<br>1  | 3   | 1   |   |   |   |   |   | 8   | T0173   |
|  | AGR   | 09/96 → 09/01   | Mot. 565 001   →  | VKMA 01251<br>VKM 11130<br>VKM 21004<br>VKM 21130<br>VKM 21131                     | 1<br>1  | 3   | 1   |   |   |   |   |   | 8   | T0173   |
|  | ALH   | 09/96 → 09/01   | →   Mot. 500 000  | VKMA 01131<br>VKM 11130<br>VKM 21004<br>VKM 21130<br>VKM 21131                     | 1<br>1  | 3   | 1   |   |   |   |   |   | 8   | T0173   |
|  | ALH   | 09/96 → 09/01   | Mot. 500 001   →  | VKMA 01251<br>VKM 11130<br>VKM 21004<br>VKM 21130<br>VKM 21131                     | 1<br>1  | 3   | 1   |   |   |   |   |   | 8   | T0173   |
|  | ASV   | 06/98 → 09/01   | →   Mot. 150 000  | VKMA 01131<br>VKM 11130<br>VKM 21004   | 1<br>1  | 3   | 1   |   |   |   |   |   | 8   | T0173   |

















































|   |  |  |  |  |  |  |  |  |  |  |  |
|---|---|---|---|--|---|---|---|---|---|---|---|
|   |   |   |   | VKM 21130  |   | 1   |   |   |   |   |   |
|   |   |   |   | VKM 21131  |   | 1   |   |   |   |   |   |
|   | ASV   | 06/98 → 09/01   | Mot. 150 001 I→   | VKMA 01251   | 1   | 3   | 1   |   |   |   | 8 T0173   |
|   |   |   |   | VKM 11130  | 1   |   |   |   |   |   |   |
|   |   |   |   | VKM 21004  |   | 1   |   |   |   |   |   |
|   |   |   |   | VKM 21130  |   | 1   |   |   |   |   |   |
|   |   |   |   | VKM 21131  |   | 1   |   |   |   |   |   |
|                                  | AFN, AHU, ALE   | 09/96 → 09/01   | 2)  | VKPA 81401   |   |   |   | 1   |   |   |   |
|   |   |   |   | VKPC 81401   |   |   |   | 1   |   |   |   |
|   | AGR, ALH, ASV   | 09/96 → 09/01   |   | VKPC 81623   |   |   |   | 1   |   |   |   |
|                                  | <b>B(Alt)</b> AGR, ALH, ASV   | 09/96 → 09/01   | AC  | VKMMV 6PK906   |   |   | 1   |   |   |   |   |
|   |   |   |   | VKM 31002  |   | 1   |   |   |   |   | 1   |
|   |   |   |   | VKM 31012  | 1   |   |   |   |   |   |   |
|   | <b>B(Alt)</b> AGR, ALH, ASV   | 09/96 → 09/01   | AC  | VKMA 31014   | 1   | 1   | 1   |   |   |   | 1   |
|   |   |   |   | VKMMV 6PK1660  |   |   | 1   |   |   |   |   |
|   |   |   |   | VKM 31002  |   | 1   |   |   |   |   | 1   |
|   |   |   |   | VKM 31012  | 1   |   |   |   |   |   |   |
|   | <b>B(Alt), B(PS)</b> AFN, AHU, ALE  | 09/96 → 09/01   | A ⊙, AC   | VKMA 31028   | 2   |   | 2   |   |   |   |   |
|   |   |   |   | VKMMV 10AVx730   |   |   | 1   |   |   |   |   |
|   |   |   |   | VKMMV 6PK1045  |   |   | 1   |   |   |   |   |
|   |   |   |   | VKM 31004  | 1   |   |   |   |   |   |   |
|   |   |   |   | VKM 31030  | 1   |   |   |   |   |   |   |
|   | <b>B(Alt), B(PS)</b> AFN, AHU, ALE  | 09/96 → 09/01   | A ⊙, AC   | VKMA 31030   | 2   |   | 2   |   |   |   |   |
|   |   |   |   | VKMMV 11.5x790   |   |   | 1   |   |   |   |   |
|   |   |   |   | VKMMV 6PK1145  |   |   | 1   |   |   |   |   |
|   |   |   |   | VKM 31004  | 1   |   |   |   |   |   |   |
|   |   |   |   | VKM 31030  | 1   |   |   |   |   |   |   |
|                                 | AFN, AHU, ALE   | 09/96 → 09/01   | → ICH 6K-Y-502 794  | VKM _____  |   |   |   |   |   | 1   |   |
|   | AGR, ALH, ASV   | 09/96 → 09/01   | CH 6K-Y-502 795 I→  | VKM _____  |   |   |   |   |   | 1   |   |
| <b>VW  POLO Saloon 1.4 16V</b> |   |   |   |  |   |   |   |   |   |   |   |
|                                | BBY, BBZ  | 07/03 → 03/06   |   | VKMA 01121   | 2   | 2   | 2   |   |   |   | T0165   |
|   |   |   |   | VKM 11120  | 1   |   |   |   |   |   |   |
|   |   |   |   | VKM 11124  | 1   |   |   |   |   |   |   |
|   |   |   |   | VKM 21120  |   |   | 1   |   |   |   |   |
|   |   |   |   | VKM 21121  |   |   | 1   |   |   |   |   |
|                                | BBY, BBZ  | 07/03 → 06/07   |   | VKPC 81407   |   |   |   | 1   |   |   |   |
|                                | <b>B(Alt)</b> BBY, BBZ  | 07/03 → 06/07   | AC  | VKMMV 6PK736   |   |   | 1   |   |   |   |   |
|   | <b>B(Alt)</b> BBY, BBZ  | 07/03 → 06/07   | AC  | VKMA 31216   | 1   |   | 1   |   |   |   |   |
|   |   |   |   | VKMMV 6PK1076  |   |   | 1   |   |   |   |   |
|   |   |   |   | VKM 31015  | 1   |   |   |   |   |   |   |
| <b>VW  POLO Saloon 1.4 TDI</b> |   |   |   |  |   |   |   |   |   |   |   |
|                                | BAY   | 07/03 → 06/07   |   | VKMA 01250   | 1   | 1   | 1   |   |   |   | T0184   |
|   |   |   |   | VKM 11250  | 1   |   |   |   |   |   |   |
|   |   |   |   | VKM 21147  |   |   | 1   |   |   |   |   |
|                                | BAY   | 07/03 → 06/07   | → ICH 9N-2-100 000  | VKPC 81417   |   |   |   | 1   |   |   |   |
|   | BAY   | 07/03 → 06/07   | CH 9N-2-100 001 I→  | VKPC 81418   |   |   |   | 1   |   |   |   |
|                                | <b>B(Alt)</b> BAY   | 07/03 → 03/06   | AC  | VKMMV 6PK858   |   |   | 1   |   |   |   |   |
|   |   |   |   | VKM 31035  | 1   |   |   |   |   |   |   |
|   | <b>B(Alt)</b> BAY   | 07/03 → 06/07   | AC  | VKMMV 6PK996   |   |   | 1   |   |   |   |   |
|   |   |   |   | VKM 31035  | 1   |   |   |   |   |   |   |
| <b>VW  POLO Saloon 1.9 SDI</b> |   |   |   |  |   |   |   |   |   |   |   |
|                                | ASY   | 11/03 → 06/07   |   | VKMA 01275   | 1   | 2   | 1   |   |   |   | T0173   |
|   |   |   |   | VKM 11130  | 1   |   |   |   |   |   |   |
|   |   |   |   | VKM 21004  |   |   | 1   |   |   |   |   |
|   |   |   |   | VKM 21130  |   |   | 1   |   |   |   |   |
|                                | ASY   | 11/03 → 06/07   | → ICH 9N-2-100 000  | VKPC 81416   |   |   |   | 1   |   |   |   |
|   | ASY   | 11/03 → 06/07   | CH 9N-2-100 001 I→  | VKPC 81302   |   |   |   | 1   |   |   |   |
|                                | <b>B(Alt)</b> ASY   | 11/03 → 06/07   | AC  | VKMMV 6PK780   |   |   | 1   |   |   |   |   |
|   |   |   |   | VKM 31057  | 1   |   |   |   |   |   |   |
|   | <b>B(Alt)</b> ASY   | 11/03 → 06/07   | AC  | VKMMV 6PK1095  |   |   | 1   |   |   |   |   |
|   |   |   |   | VKM 31058  | 1   |   |   |   |   |   |   |
| <b>VW  SANTANA 1.8</b>         |   |   |   |  |   |   |   |   |   |   |   |
|                                | AAM, ABS, ADZ   | 01/95 → 03/06   | 3)  | VKMS 01000   | 1   |   | 1   |   |   | 3   | 4 T0005   |
|   |   |   |   | VKMA 01000   | 1   |   | 1   |   |   |   | 3   |
|   |   |   |   | VKM 11000  | 1   |   |   |   |   |   |   |



VW





| VW  SANTANA (32B) 1.6 D  |   |
|---|---|
|                          | CR, JK 08/81 → 12/84 VKMA 01010 1 1 1 T0051<br>VKM 11010 1  |
|                          | CR, JK 08/81 → 12/84 2) VKPA 81401 1<br>VKPC 81401 1  |
|                          | B(Alt) CR, JK 08/81 → 12/84 AC VKMV 10AVx735 1  |
|                          | B(Alt) CR, JK 08/81 → 12/84 AC VKMV 10AVx763 1  |
|                          | B(PS) CR, JK 08/81 → 12/84 VKMV 11.5x790 1  |
|                          | B(AC) CR, JK 08/81 → 12/84 VKMV 13AVx825 1  |
| VW  SANTANA (32B) 1.6 TD |   |
|                          | CY 12/81 → 12/84 VKMA 01010 1 1 1 T0051<br>VKM 11010 1  |
|                          | CY 12/81 → 12/84 2) VKPA 81401 1<br>VKPC 81401 1  |
|                          | B(Alt) CY 12/81 → 12/84 AC VKMV 10AVx735 1  |
|                          | B(Alt) CY 12/81 → 12/84 AC VKMV 10AVx763 1  |
|                          | B(PS) CY 12/81 → 12/84 VKMV 11.5x790 1  |
|                          | B(AC) CY 12/81 → 12/84 VKMV 13AVx825 1  |
| VW  SCIROCCO (53) 1.1    |   |
|                          | FA 04/74 → 07/79  VKMC 01100 1 1 T0222   |
|                          | FA 04/74 → 07/79 VKPC 81200 1   |
|                          | B(Alt) FA 04/74 → 07/79 VKMV 10AVx695 1   |
| VW  SCIROCCO (53) 1.3   |   |
|                        | GF 08/79 → 07/80  VKMC 01100 1 1 T0222 |
|                        | GF 08/79 → 07/80 VKPC 81200 1   |
|                        | B(Alt) GF 08/79 → 07/80 → ICH 53A 0034 226 VKMV 10AVx695 1  |
|                        | B(Alt) GF 08/79 → 07/80 CH 53A 0034 227 I→ VKMV 10AVx675 1  |
| VW  SCIROCCO (53) 1.5  |   |
|                        | FH, FR, JB, YJ, ZB 02/74 → 07/80 3) VKMS 01000 1 1 3 4<br>VKMA 01000 1 1 3 T0005<br>VKM 11000 1                           |
|                        | FH, FR, YJ, ZB 02/74 → 12/77 2) VKPA 81400 1<br>VKPC 81400 1  |
|                        | JB 08/77 → 07/80 2), AC VKPA 81400 1<br>VKPC 81400 1  |
|                        | JB 08/77 → 07/80 2), AC VKPA 81401 1<br>VKPC 81401 1  |
|                        | B(Alt) FH, JB 02/74 → 07/80 VKMV 10AVx950 1   |
| VW  SCIROCCO (53) 1.6  |   |
|                        | EG, FP, FR, FT 08/75 → 07/80 3) VKMS 01000 1 1 3 4<br>VKMA 01000 1 1 3 T0005<br>VKM 11000 1                               |
|                        | EG, FP, FR, FT 08/75 → 07/80 2) VKPA 81400 1<br>VKPC 81400 1  |
|                        | B(Alt) EG, FP, FR, FT 08/75 → 07/80 VKMV 10AVx950 1   |
| VW  SCIROCCO (53B) 1.3 |   |
|                        | GF 08/80 → 12/83  VKMC 01100 1 1 T0222 |
|                        | GF 08/80 → 12/83 VKPC 81200 1   |
|                        | B(Alt) GF 08/80 → 07/81 VKMV 10AVx675 1   |
|                        | B(Alt) GF 08/81 → 12/83 VKMV 10AVx695 1   |
| VW  SCIROCCO (53B) 1.5 |   |
|                        | JB 08/80 → 12/83 3) VKMS 01000 1 1 3 4<br>VKMA 01000 1 1 3 T0005<br>VKM 11000 1   |
|                        | JB 08/80 → 12/83 2), AC VKPA 81400 1<br>VKPC 81400 1  |
|                        | JB 08/80 → 12/83 2), AC VKPA 81401 1<br>VKPC 81401 1  |
|                        | B(Alt) JB 08/80 → 12/83 AC VKMV 10AVx950 1  |
|                        | B(Alt) JB 08/80 → 12/83 AC VKMV 10AVx850 1  |



| <b>VW  SCIROCCO (53B) 1.6</b>               |                     |               |                               |  |               |   |   |   |  |  |  |  |   |  |  |  |  |   |   |   |       |
|---|---------------------|---------------|-------------------------------|--|---------------|---|---|---|--|--|--|--|---|--|--|--|--|---|---|---|-------|
|   | EG, EW, EWA, FR, RE | 08/80 → 07/90 | 3)                            |  | VKMS 01000    | 1 |   | 1 |  |  |  |  |   |  |  |  |  | 3 | 4 |   |       |
|   |                     |               |                               |  | VKMA 01000    | 1 |   | 1 |  |  |  |  |   |  |  |  |  |   | 3 | 3 | T0005 |
|   |                     |               |                               |  | VKM 11000     | 1 |   |   |  |  |  |  |   |  |  |  |  |   |   |   |       |
|   | EG, FR              | 08/80 → 04/84 | 2), AC                        |  | VKPA 81400    |   |   |   |  |  |  |  | 1 |  |  |  |  |   |   |   |       |
|   |                     |               |                               |  | VKPC 81400    |   |   |   |  |  |  |  | 1 |  |  |  |  |   |   |   |       |
|   | EG, FR              | 08/80 → 04/84 | 2), AC                        |  | VKPA 81401    |   |   |   |  |  |  |  | 1 |  |  |  |  |   |   |   |       |
|   |                     |               |                               |  | VKPC 81401    |   |   |   |  |  |  |  | 1 |  |  |  |  |   |   |   |       |
|   | EW, EWA, RE         | 01/83 → 07/90 | 2)                            |  | VKPA 81401    |   |   |   |  |  |  |  | 1 |  |  |  |  |   |   |   |       |
|   |                     |               |                               |  | VKPC 81401    |   |   |   |  |  |  |  | 1 |  |  |  |  |   |   |   |       |
| <b>VW  SCIROCCO (53B) 1.8</b>               |                     |               |                               |  |               |   |   |   |  |  |  |  |   |  |  |  |  |   |   |   |       |
|   | DX, EV, EX, JH, PB  | 08/82 → 12/88 | 3)                            |  | VKMS 01000    | 1 |   | 1 |  |  |  |  |   |  |  |  |  | 3 | 4 |   |       |
|   |                     |               |                               |  | VKMA 01000    | 1 |   | 1 |  |  |  |  |   |  |  |  |  |   | 3 | 3 | T0005 |
|   |                     |               |                               |  | VKM 11000     | 1 |   |   |  |  |  |  |   |  |  |  |  |   |   |   |       |
|   | DX, EX, JH          | 08/82 → 07/92 | 2)                            |  | VKPA 81401    |   |   |   |  |  |  |  | 1 |  |  |  |  |   |   |   |       |
|   |                     |               |                               |  | VKPC 81401    |   |   |   |  |  |  |  | 1 |  |  |  |  |   |   |   |       |
| <b>VW  SCIROCCO (53B) 1.8 16V</b>           |                     |               |                               |  |               |   |   |   |  |  |  |  |   |  |  |  |  |   |   |   |       |
|   | KR, PL              | 10/85 → 07/92 |                               |  | VKMA 01020    | 1 |   | 1 |  |  |  |  |   |  |  |  |  |   |   |   | T0057 |
|   |                     |               |                               |  | VKM 11020     | 1 |   |   |  |  |  |  |   |  |  |  |  |   |   |   |       |
|   | KR, PL              | 10/85 → 07/92 | 2)                            |  | VKPA 81401    |   |   |   |  |  |  |  | 1 |  |  |  |  |   |   |   |       |
|   |                     |               |                               |  | VKPC 81401    |   |   |   |  |  |  |  | 1 |  |  |  |  |   |   |   |       |
| <b>VW  SHARAN (7M8, 7M9, 7M6) 1.8 Turbo</b> |                     |               |                               |  |               |   |   |   |  |  |  |  |   |  |  |  |  |   |   |   |       |
|   | AJH                 | 09/97 → 02/00 |                               |  | VKMA 01115    | 1 | 1 | 1 |  |  |  |  |   |  |  |  |  |   |   |   | T0151 |
|   |                     |               |                               |  | VKM 11115     | 1 |   |   |  |  |  |  |   |  |  |  |  |   |   |   |       |
|   |                     |               |                               |  | VKM 21115     |   | 1 |   |  |  |  |  |   |  |  |  |  |   |   |   |       |
|   | AWC                 | 04/00 → 06/07 |                               |  | VKMA 01116    | 1 | 1 | 1 |  |  |  |  |   |  |  |  |  |   |   |   | T0151 |
|   |                     |               |                               |  | VKM 11116     | 1 |   |   |  |  |  |  |   |  |  |  |  |   |   |   |       |
|   |                     |               |                               |  | VKM 21115     |   | 1 |   |  |  |  |  |   |  |  |  |  |   |   |   |       |
|   | AJH, AWC            | 09/97 → 06/07 |                               |  | VKPC 81620    |   |   |   |  |  |  |  | 1 |  |  |  |  |   |   |   |       |
|   | B(Alt) AJH          | 09/97 → 02/00 | AC                            |  | VKMA 31203    | 1 |   | 1 |  |  |  |  |   |  |  |  |  |   |   |   |       |
|   |                     |               |                               |  | VKMV 6PK1120  |   |   | 1 |  |  |  |  |   |  |  |  |  |   |   |   |       |
|   |                     |               |                               |  | VKM 31011     | 1 |   |   |  |  |  |  |   |  |  |  |  |   |   |   |       |
|   | B(Alt) AJH          | 09/97 → 02/00 | AC                            |  | VKMA 31204    | 1 |   | 1 |  |  |  |  |   |  |  |  |  |   |   |   |       |
|   |                     |               |                               |  | VKMV 6DK1195  |   |   | 1 |  |  |  |  |   |  |  |  |  |   |   |   |       |
|   |                     |               |                               |  | VKM 31011     | 1 |   |   |  |  |  |  |   |  |  |  |  |   |   |   |       |
|   | B(Alt) AWC          | 04/00 → 06/07 |                               |  | VKMA 31204    | 1 |   | 1 |  |  |  |  |   |  |  |  |  |   |   |   |       |
|   |                     |               |                               |  | VKMV 6DK1195  |   |   | 1 |  |  |  |  |   |  |  |  |  |   |   |   |       |
|   |                     |               |                               |  | VKM 31011     | 1 |   |   |  |  |  |  |   |  |  |  |  |   |   |   |       |
| <b>VW  SHARAN (7M8, 7M9, 7M6) 2.0</b>       |                     |               |                               |  |               |   |   |   |  |  |  |  |   |  |  |  |  |   |   |   |       |
|   | ADY                 | 09/95 → 02/00 |                               |  | VKMA 01002    | 1 |   | 1 |  |  |  |  |   |  |  |  |  |   | 3 |   | T0091 |
|   |                     |               |                               |  | VKM 11000     | 1 |   |   |  |  |  |  |   |  |  |  |  |   |   |   |       |
|   | ATM                 | 04/00 → 06/07 |                               |  | VKMA 01113    | 1 |   | 1 |  |  |  |  |   |  |  |  |  |   |   |   | T0149 |
|   |                     |               |                               |  | VKM 11113     | 1 |   |   |  |  |  |  |   |  |  |  |  |   |   |   |       |
|   | ADY                 | 09/95 → 02/00 | 2)                            |  | VKPA 81401    |   |   |   |  |  |  |  | 1 |  |  |  |  |   |   |   |       |
|   |                     |               |                               |  | VKPC 81401    |   |   |   |  |  |  |  | 1 |  |  |  |  |   |   |   |       |
|   | ATM                 | 04/00 → 05/05 |                               |  | VKPC 81620    |   |   |   |  |  |  |  | 1 |  |  |  |  |   |   |   |       |
|   | B(Alt) ADY          | 09/95 → 02/00 | A⊙                            |  | VKMV 6PK894   |   |   | 1 |  |  |  |  |   |  |  |  |  |   |   |   |       |
|   | B(Alt) ADY          | 09/95 → 02/00 | A⊙, AC,<br>→ ICH 7M-T-027 000 |  | VKMV 6PK976   |   |   | 1 |  |  |  |  |   |  |  |  |  |   |   |   |       |
|   |                     |               |                               |  | VKM 31004     | 1 |   |   |  |  |  |  |   |  |  |  |  |   |   |   |       |
|   |                     |               |                               |  | VKM 31210     | 1 |   |   |  |  |  |  |   |  |  |  |  |   |   |   |       |
|   | B(Alt) ADY          | 09/95 → 02/00 | A⊙, AC,<br>CH 7M-T-027 001 I→ |  | VKMV 6PK1033  |   |   | 1 |  |  |  |  |   |  |  |  |  |   |   |   |       |
|   |                     |               |                               |  | VKM 31004     | 1 |   |   |  |  |  |  |   |  |  |  |  |   |   |   |       |
|   |                     |               |                               |  | VKM 31210     | 1 |   |   |  |  |  |  |   |  |  |  |  |   |   |   |       |
|   | B(Alt) ADY          | 09/95 → 02/00 | A⊙, AC                        |  | VKMV 6PK1153  |   |   | 1 |  |  |  |  |   |  |  |  |  |   |   |   |       |
|   |                     |               |                               |  | VKM 31004     | 1 |   |   |  |  |  |  |   |  |  |  |  |   |   |   |       |
|   |                     |               |                               |  | VKM 31210     | 1 |   |   |  |  |  |  |   |  |  |  |  |   |   |   |       |
|   | B(Alt) ATM          | 04/00 → 06/07 |                               |  | VKMA 31204    | 1 |   | 1 |  |  |  |  |   |  |  |  |  |   |   |   |       |
|   |                     |               |                               |  | VKMV 6DK1195  |   |   | 1 |  |  |  |  |   |  |  |  |  |   |   |   |       |
|   |                     |               |                               |  | VKM 31011     | 1 |   |   |  |  |  |  |   |  |  |  |  |   |   |   |       |
|   | B(PS) ADY           | 09/95 → 02/00 | AC                            |  | VKMV 11.5x685 |   |   | 1 |  |  |  |  |   |  |  |  |  |   |   |   |       |
|   | B(PS) ADY           | 09/95 → 02/00 | AC                            |  | VKMV 11.5x745 |   |   | 1 |  |  |  |  |   |  |  |  |  |   |   |   |       |

































| VW SHARAN (7M8, 7M9, 7M6) 2.8 VR6     |                        |               |                     |   |             |   |   |        |        |   |         |
|---------------------------------------|------------------------|---------------|---------------------|---|-------------|---|---|--------|--------|---|---------|
|                                       | AAA, AMY               | 09/95 → 04/00 |                     | 0x0x0x0   |             |   |   |        |        |   |         |
|                                       | AAA, AMY               | 09/95 → 04/00 |                     | VKPC 81611  |             |   |   | 1      |        |   |         |
|                                       | B(Alt) AAA, AMY        | 09/95 → 04/00 | AC                  | VKMV 7PK1290<br>VKM 31060   | 1           |   | 1 |        |        |   |         |
|                                       | B(Alt) AAA, AMY        | 09/95 → 04/00 | AC                  | VKMA 31060<br>VKMV 7DK1360<br>VKM 31060                               | 1           |   | 1 | 1      |        |   |         |
|                                       |                        |               |                     |   | 1           |   |   |        |        |   |         |
| VW SHARAN (7M8, 7M9, 7M6) 2.8 V6      |                        |               |                     |   |             |   |   |        |        |   |         |
|                                       | AYL                    | 04/00 → 06/07 |                     | 0x0x0x0   |             |   |   |        |        |   |         |
|                                       | AYL                    | 04/00 → 06/07 | → ICH 7M-2-035 000  | VKPC 81611  |             |   |   | 1      |        |   |         |
|                                       | AYL                    | 04/00 → 06/07 | CH 7M-2-035 001 I→  | —   |             |   |   | 1      |        |   |         |
| VW SHARAN (7M8, 7M9, 7M6) 1.9 TDI 90  |                        |               |                     |   |             |   |   |        |        |   |         |
|                                       | 1Z, AHU                | 09/95 → 06/07 |                     | VKMA 01019<br>VKM 11014<br>VKM 21012                                  | 1<br>1      | 1 | 1 |        |        |   | 5 T0650 |
|                                       | ANU                    | 09/95 → 12/02 | ↔, →   Mot. 005 000 | VKMA 01943<br>VKM 11143<br>VKM 11144<br>VKM 21142                     | 1<br>1      | 1 | 1 | 1      |        | 1 | 2 T0184 |
|                                       | ANU                    | 09/95 → 12/02 | →   Mot. 005 000    | VKMA 01143<br>VKM 11143<br>VKM 21142                                  | 1<br>1      | 1 | 1 |        |        |   | T0184   |
|                                       | ANU                    | 09/95 → 12/02 | ↔, Mot. 005 001 I→  | VKMA 01942<br>VKM 11142<br>VKM 11145<br>VKM 21142                     | 1<br>1      | 1 | 1 | 1      |        | 1 | 3 T0184 |
|                                       | ANU                    | 09/95 → 12/02 | Mot. 005 001 I→     | VKMA 01142<br>VKM 11142<br>VKM 21142                                  | 1<br>1      | 1 | 1 |        |        |   | 3 T0184 |
|                                       | ANU                    | 01/03 → 06/07 |                     | VKMA 01250<br>VKM 11250<br>VKM 21147                                  | 1<br>1      | 1 | 1 | 1      |        |   | T0184   |
|                                       | 1Z, AHU                | 09/95 → 06/07 | 2)                  | VKPA 81401<br>VKPC 81401  |             |   |   |        | 1<br>1 |   |         |
|                                       | ANU                    | 09/95 → 12/02 |                     | VKPC 81626  |             |   |   |        | 1      |   |         |
|                                       | ANU                    | 01/03 → 06/07 |                     | VKPC 81303  |             |   |   |        | 1      |   |         |
|                                       | B(Alt) 1Z, AHU         | 09/95 → 12/00 | A⊙, ⊗ 90A, AC       | VKMV 6PK923<br>VKM 31004<br>VKM 31030                                 | 1<br>1      |   | 1 |        |        |   |         |
|                                       | B(Alt) ANU             | 04/00 → 06/07 |                     | VKMA 31001<br>VKMV 6DK1195<br>VKM 31019                               | 1<br>1      |   | 1 | 1      |        |   |         |
|                                       | B(Alt), B(PS) 1Z, AHU  | 09/95 → 12/00 | A⊙, ⊗ 120A, AC      | VKMA 31028<br>VKMV 10AVx730<br>VKMV 6PK1045<br>VKM 31004<br>VKM 31030 | 2<br>1<br>1 |   | 2 | 1<br>1 |        |   |         |
|                                       | B(Alt), B(PS) 1Z, AHU  | 09/95 → 12/00 | A⊙, AC              | VKMA 31030<br>VKMV 11.5x790<br>VKMV 6PK1145<br>VKM 31004<br>VKM 31030 | 2<br>1<br>1 |   | 2 | 1<br>1 |        |   |         |
| VW SHARAN (7M8, 7M9, 7M6) 1.9 TDI 110 |                        |               |                     |   |             |   |   |        |        |   |         |
|                                       | AFN, AVG               | 09/96 → 04/00 |                     | VKMA 01019<br>VKM 11014<br>VKM 21012                                  | 1<br>1      | 1 | 1 |        |        |   | 5 T0650 |
|                                       | AFN, AVG               | 09/96 → 04/00 | 2)                  | VKPA 81401<br>VKPC 81401  |             |   |   |        | 1<br>1 |   |         |
|                                       | B(Alt) AFN, AVG        | 09/96 → 04/00 | A⊙, ⊗ 90A, AC       | VKMV 6PK923<br>VKM 31004<br>VKM 31030                                 | 1<br>1      |   | 1 |        |        |   |         |
|                                       | B(Alt), B(PS) AFN, AVG | 09/96 → 04/00 | A⊙, ⊗ 120A, AC      | VKMA 31028<br>VKMV 10AVx730<br>VKMV 6PK1045                           | 2           |   | 2 | 1<br>1 |        |   |         |









































|   |               |          |  | VKM 31004     | 1                 |   |   |   |   |   |  |  |  |  |   |       |
|---|---------------|----------|--|---------------|-------------------|---|---|---|---|---|--|--|--|--|---|-------|
|   |               |          |  | VKM 31030     | 1                 |   |   |   |   |   |  |  |  |  |   |       |
| <b>B(Alt), B(PS)AFN, AVG</b>                  |               |          |  | 09/96 → 04/00 | <b>A ⊙, AC</b>    |   |   |   |   |   |  |  |  |  |   |       |
|   |               |          |  | VKMA 31030    | 2                 |   | 2 |   |   |   |  |  |  |  |   |       |
|   |               |          |  | VKMV 11.5x790 |                   |   | 1 |   |   |   |  |  |  |  |   |       |
|   |               |          |  | VKMV 6PK1145  |                   |   | 1 |   |   |   |  |  |  |  |   |       |
|   |               |          |  | VKM 31004     | 1                 |   |   |   |   |   |  |  |  |  |   |       |
|   |               |          |  | VKM 31030     | 1                 |   |   |   |   |   |  |  |  |  |   |       |
| <b>VW  SHARAN (7M8, 7M9, 7M6) 1.9 TDI 115</b> |               |          |  |               |                   |   |   |   |   |   |  |  |  |  |   |       |
|   | AUY           |          |  | 04/00 → 12/02 |                   |   |   |   |   |   |  |  |  |  |   |       |
|   |               |          |  |               | VKMA 01942        | 1 | 1 | 1 | 1 |   |  |  |  |  | 3 | T0184 |
|   |               |          |  |               | VKM 11142         | 1 |   |   |   |   |  |  |  |  |   |       |
|   |               |          |  |               | VKM 11145         |   |   |   | 1 |   |  |  |  |  |   |       |
|   |               |          |  |               | VKM 21142         |   | 1 |   |   |   |  |  |  |  |   |       |
|   | AUY           |          |  | 04/00 → 12/02 | VKMA 01142        | 1 | 1 | 1 |   |   |  |  |  |  | 3 | T0184 |
|   |               |          |  |               | VKM 11142         | 1 |   |   |   |   |  |  |  |  |   |       |
|   |               |          |  |               | VKM 21142         |   | 1 |   |   |   |  |  |  |  |   |       |
|   | AUY           |          |  | 01/03 → 06/07 | VKMA 01250        | 1 | 1 | 1 |   |   |  |  |  |  |   | T0184 |
|   |               |          |  |               | VKM 11250         | 1 |   |   |   |   |  |  |  |  |   |       |
|   |               |          |  |               | VKM 21147         |   | 1 |   |   |   |  |  |  |  |   |       |
|   | AUY           |          |  | 04/00 → 12/02 | VKPC 81626        |   |   |   |   | 1 |  |  |  |  |   |       |
|   | AUY           |          |  | 01/03 → 06/07 | VKPC 81303        |   |   |   |   | 1 |  |  |  |  |   |       |
|   | <b>B(Alt)</b> | AUY      |  | 04/00 → 06/07 | VKMA 31001        | 1 |   | 1 |   |   |  |  |  |  |   |       |
|   |               |          |  |               | VKMV 6DK1195      |   |   | 1 |   |   |  |  |  |  |   |       |
|   |               |          |  |               | VKM 31019         | 1 |   |   |   |   |  |  |  |  |   |       |
| <b>VW  SHARAN (7M8, 7M9, 7M6) 1.9 TDI 130</b> |               |          |  |               |                   |   |   |   |   |   |  |  |  |  |   |       |
|   | ASZ           |          |  | 11/02 → 06/07 | VKMA 01250        | 1 | 1 | 1 |   |   |  |  |  |  |   | T0184 |
|   |               |          |  |               | VKM 11250         | 1 |   |   |   |   |  |  |  |  |   |       |
|   |               |          |  |               | VKM 21147         |   | 1 |   |   |   |  |  |  |  |   |       |
|   | ASZ           |          |  | 11/02 → 06/07 | VKPC 81418        |   |   |   |   | 1 |  |  |  |  |   |       |
|   | <b>B(Alt)</b> | ASZ      |  | 11/02 → 06/07 | VKMA 31001        | 1 |   | 1 |   |   |  |  |  |  |   |       |
|   |               |          |  |               | VKMV 6DK1195      |   |   | 1 |   |   |  |  |  |  |   |       |
|   |               |          |  |               | VKM 31019         | 1 |   |   |   |   |  |  |  |  |   |       |
| <b>VW  SHARAN (7M8, 7M9, 7M6) 1.9 TDI 150</b> |               |          |  |               |                   |   |   |   |   |   |  |  |  |  |   |       |
|   | BTB           |          |  | 06/05 → 06/07 | VKMA 01250        | 1 | 1 | 1 |   |   |  |  |  |  |   | T0184 |
|   |               |          |  |               | VKM 11250         | 1 |   |   |   |   |  |  |  |  |   |       |
|   |               |          |  |               | VKM 21147         |   | 1 |   |   |   |  |  |  |  |   |       |
|   | BTB           |          |  | 06/05 → 06/07 | VKPC 81418        |   |   |   |   | 1 |  |  |  |  |   |       |
|   | <b>B(Alt)</b> | BTB      |  | 06/05 → 06/07 | VKMA 31001        | 1 |   | 1 |   |   |  |  |  |  |   |       |
|   |               |          |  |               | VKMV 6DK1195      |   |   | 1 |   |   |  |  |  |  |   |       |
|   |               |          |  |               | VKM 31019         | 1 |   |   |   |   |  |  |  |  |   |       |
| <b>VW  SHARAN (7M8, 7M9, 7M6) 2.0 TDI</b>     |               |          |  |               |                   |   |   |   |   |   |  |  |  |  |   |       |
|   | BRT, BVH      |          |  | 11/05 → 06/07 | VKMA 01250        | 1 | 1 | 1 |   |   |  |  |  |  |   | T0184 |
|   |               |          |  |               | VKM 11250         | 1 |   |   |   |   |  |  |  |  |   |       |
|   |               |          |  |               | VKM 21147         |   | 1 |   |   |   |  |  |  |  |   |       |
|   | BRT           |          |  | 11/05 → 11/07 | VKPC 81303        |   |   |   |   | 1 |  |  |  |  |   |       |
|   | <b>B(Alt)</b> | BRT, BVH |  | 11/05 → 06/07 | VKMV 6DK1215      |   |   | 1 |   |   |  |  |  |  |   |       |
|   |               |          |  |               | VKM 31054         | 1 |   |   |   |   |  |  |  |  |   |       |
| <b>VW  TIGUAN (5N) 1.4 TSI</b>                |               |          |  |               |                   |   |   |   |   |   |  |  |  |  |   |       |
|   | BWK           |          |  | 09/07 → 11/07 | <del>OKOKOK</del> |   |   |   |   |   |  |  |  |  |   |       |
|   | BWK           |          |  | 09/07 → 11/07 | —                 |   |   |   |   | 1 |  |  |  |  |   |       |
| <b>VW  TIGUAN (5N) 2.0 TFSI</b>               |               |          |  |               |                   |   |   |   |   |   |  |  |  |  |   |       |
|   | CAW           |          |  | 09/07 → 11/07 | <del>OKOKOK</del> |   |   |   |   |   |  |  |  |  |   |       |
| <b>VW  TIGUAN (5N) 2.0 TDI</b>                |               |          |  |               |                   |   |   |   |   |   |  |  |  |  |   |       |
|   | CBA, CBB      |          |  | 09/07 → 11/07 | —                 | 1 | 3 | 1 |   |   |  |  |  |  |   |       |
|   |               |          |  |               | —                 | 1 |   |   |   |   |  |  |  |  |   |       |
|   |               |          |  |               | VKM 21142         |   | 1 |   |   |   |  |  |  |  |   |       |
|   |               |          |  |               | VKM 21147         |   | 1 |   |   |   |  |  |  |  |   |       |
|   |               |          |  |               | VKM 21256         |   | 1 |   |   |   |  |  |  |  |   |       |
|   | <b>B(Alt)</b> | CBA, CBB |  | 09/07 → 11/07 | VKM 31058         | 1 |   |   |   |   |  |  |  |  |   |       |
| <b>VW  TOUAREG (7LA) 3.2 V6</b>               |               |          |  |               |                   |   |   |   |   |   |  |  |  |  |   |       |
|   | BMX           |          |  | 11/04 → 10/07 | <del>OKOKOK</del> |   |   |   |   |   |  |  |  |  |   |       |
|   | AZZ, BKJ      |          |  | 10/02 → 10/07 | <del>OKOKOK</del> |   |   |   |   |   |  |  |  |  |   |       |
|   | AZZ, BKJ      |          |  | 10/02 → 06/07 | —                 |   |   |   |   | 1 |  |  |  |  |   |       |
| <b>VW  TOUAREG (7LA) 3.6 V6 FSI</b>           |               |          |  |               |                   |   |   |   |   |   |  |  |  |  |   |       |
|   | BHK, BHL      |          |  | 03/06 → 10/07 | <del>OKOKOK</del> |   |   |   |   |   |  |  |  |  |   |       |













































| VW  <b>TOUAREG (7LA) 4.2 V8</b>      |  |                    |  |  |  |        |        |   |   |  |  |   |  |  |  |  |   |       |       |
|---|--|--------------------|--|--|--|--------|--------|---|---|--|--|---|--|--|--|--|---|-------|-------|
|                                      | AXQ                                    | 12/02 → 12/06      |  → ICH 7L-6-080 000 | VKMA 01927<br>VKM 11204  | 1<br>1   | 2      | 1      | 1 |   |  |  |   |  |  |  |  |   | T0153 |       |
|   |  |                    |  | VKM 21203<br>VKM 21204   |  |        | 1<br>1 |   | 1 |  |  |   |  |  |  |  |   |       |       |
| VW  <b>TOUAREG (7LA) 6.0 W12</b>     |  | BJN                | 03/05 → 10/07  |    |  |        |        |   |   |  |  |   |  |  |  |  |   |       |       |
| VW  <b>TOUAREG (7LA) 2.5 R5 TDI</b>  |  | BAC                | 01/03 → 10/07  |    |  |        |        |   |   |  |  |   |  |  |  |  |   |       |       |
|                                      | BAC, BLK                               | 01/03 → 06/07      |  | VKPC _____   |  |        |        |   |   |  |  | 1 |  |  |  |  |   |       |       |
| VW  <b>TOUAREG (7LA) 3.0 TDI</b>     |  | BKS                | 11/04 → 10/07  | B(Cam)   |  |        |        |   |   |  |  |   |  |  |  |  |   |       |       |
|                                      | BKS                                    | 11/04 → 10/07      | B(inj)   | VKMA 01332<br>VKM 11332  | 1<br>1   |        | 1      |   |   |  |  |   |  |  |  |  | 1 | T0246 |       |
| VW  <b>TOUAREG (7LA) 5.0 V10 TDI</b> |  | AYH                | 10/02 → 10/07  |    |  |        |        |   |   |  |  |   |  |  |  |  |   |       |       |
| VW  <b>TOURAN 1.4 TSI</b>            |  | BMV                | 02/06 → 03/06  |    |  |        |        |   |   |  |  |   |  |  |  |  |   |       |       |
|                                      | BMV                                    | 02/06 → 06/07      |  | —  |  |        |        |   |   |  |  | 1 |  |  |  |  |   |       |       |
| VW  <b>TOURAN 1.6</b>                |  | BGU, BSE, BSF      | 07/03 → 06/07  |  | VKMA 01113<br>VKM 11113  | 1<br>1 |        | 1 |   |  |  |   |  |  |  |  |   | T0149 |       |
|                                     | BGU, BSE, BSF                          | 07/03 → 05/05      |  | VKPC 81408   |  |        |        |   |   |  |  | 1 |  |  |  |  |   |       |       |
|                                    | B(Alt) BGU, BSE, BSF                   | 07/03 → 06/07      | AC   | VKMV 6PK900<br>VKM 31011   | 1  |        | 1      |   |   |  |  |   |  |  |  |  |   |       |       |
|   | B(Alt) BGU, BSE, BSF                   | 07/03 → 06/07      | AC   | VKMV 6PK1042<br>VKM 31011  | 1  |        | 1      |   |   |  |  |   |  |  |  |  |   |       |       |
| VW  <b>TOURAN 1.6 FSI</b>          |  | BAG, BLF, BLP      | 02/03 → 03/06  |  |  |        |        |   |   |  |  |   |  |  |  |  |   |       |       |
|                                    | BAG, BLF, BLP                          | 02/03 → 06/07      |  | VKPC 81501   |  |        |        |   |   |  |  | 1 |  |  |  |  |   |       |       |
|                                    | B(Alt) BAG, BLF, BLP                   | 02/03 → 06/07      | AC   | VKMV 6PK1736<br>VKM 31044<br>VKM 31047   | 1  |        | 1      |   |   |  |  |   |  |  |  |  |   |       |       |
| VW  <b>TOURAN 2.0</b>              |  | BSX                | 02/06 → 06/07  |  | VKMA 01113<br>VKM 11113  | 1<br>1 |        | 1 |   |  |  |   |  |  |  |  |   | T0149 |       |
|                                    | B(Alt) BSX                             | 02/06 → 06/07      | AC   | VKMV 6PK900<br>VKM 31011   | 1  |        | 1      |   |   |  |  |   |  |  |  |  |   |       |       |
|   | B(Alt) BSX                             | 02/06 → 06/07      | AC   | VKMV 6PK1042<br>VKM 31011  | 1  |        | 1      |   |   |  |  |   |  |  |  |  |   |       |       |
| VW  <b>TOURAN 2.0 FSI</b>          |  | AXW, BLR, BLX, BLY | 10/03 → 03/06  |  | VKMA 01220<br>VKM 11220<br>VKM 21220<br>VKM _____                                  | 1<br>1 | 2      | 1 |   |  |  |   |  |  |  |  |   | 2     | T0247 |
|                                    | AXW, BLR, BLX, BLY                     | 10/03 → 06/07      |  | VKPC 81220   |  |        |        |   |   |  |  | 1 |  |  |  |  |   |       |       |
|                                    | B(Alt) AXW, BLR, BLX, BLY,<br>BVY, BVZ | 10/03 → 06/07      | AC   | VKMV 6PK900<br>VKM 31011   | 1  |        | 1      |   |   |  |  |   |  |  |  |  |   |       |       |
|   | B(Alt) AXW, BLR, BLX, BLY,<br>BVY, BVZ | 10/03 → 06/07      | AC   | VKMV 6PK1042<br>VKM 31011  | 1  |        | 1      |   |   |  |  |   |  |  |  |  |   |       |       |
| VW  <b>TOURAN 1.9 TDI 90</b>       |  | BRU                | 11/04 → 06/07  |  | VKMA 01250<br>VKM 11250<br>VKM 21147   | 1<br>1 | 1      | 1 |   |  |  |   |  |  |  |  |   | T0184 |       |
|                                    | BRU                                    | 11/04 → 06/07      |  | VKPC 81418   |  |        |        |   |   |  |  | 1 |  |  |  |  |   |       |       |
|                                    | B(Alt) BRU                             | 11/04 → 06/07      | AC   | VKMV 6PK950<br>VKM 31022   | 1  |        | 1      |   |   |  |  |   |  |  |  |  |   |       |       |





























|  |  |  |  |                      |  |  |  |  |  |  |  |
|--|---|---|---|--|---|---|---|---|---|---|---|
|  | B(Alt)  | BRU   | 11/04 → 06/07   | AC   | VKMOV 6PK1050<br>VKM 31022  | 1   | 1   |   |   |   |   |
| <b>VW  TOURAN 1.9 TDI 100</b>   |   |   |   |  |   |   |   |   |   |   |   |
|                                  | AVQ   |   | 02/03 → 06/07   |  | VKMA 01250<br>VKM 11250<br>VKM 21147  | 1<br>1  | 1<br>1  |   |   |   | T0184   |
|                                  | AVQ   |   | 02/03 → 05/05   |  | VKPC 81418  |   |   | 1   |   |   |   |
|                                  | B(Alt)  | AVQ   | 02/03 → 06/07   | AC   | VKMOV 6PK950<br>VKM 31022   | 1   | 1   |   |   |   |   |
|  | B(Alt)  | AVQ   | 02/03 → 06/07   | AC   | VKMOV 6PK1050<br>VKM 31022  | 1   | 1   |   |   |   |   |
| <b>VW  TOURAN 1.9 TDI 105</b>   |   |   |   |  |   |   |   |   |   |   |   |
|                                  | BKC   |   | 08/03 → 06/07   |  | VKMA 01250<br>VKM 11250<br>VKM 21147  | 1<br>1  | 1<br>1  |   |   |   | T0184   |
|                                  | BKC   |   | 08/03 → 05/05   |  | VKPC 81418  |   |   | 1   |   |   |   |
|                                  | B(Alt)  | BKC   | 08/03 → 06/07   | AC   | VKMOV 6PK950<br>VKM 31022   | 1   | 1   |   |   |   |   |
|  | B(Alt)  | BKC   | 08/03 → 06/07   | AC   | VKMOV 6PK1050<br>VKM 31022  | 1   | 1   |   |   |   |   |
| <b>VW  TOURAN 2.0 TDI 136</b>   |   |   |   |  |   |   |   |   |   |   |   |
|                                  | AZV   |   | 02/03 → 06/07   |  | VKMA 01255<br>VKM 11255<br>VKM 21147<br>VKM 21256                                   | 1<br>1  | 2<br>1<br>1   | 1   |   |   | 5 T0184   |
|                                 | AZV   |   | 02/03 → 05/05   |  | VKPC 81627  |   |   | 1   |   |   |   |
|                                | B(Alt)  | AZV   | 02/03 → 06/07   | AC   | VKMOV 6PK950<br>VKM 31022   | 1   | 1   |   |   |   |   |
|  | B(Alt)  | AZV   | 02/03 → 06/07   | AC   | VKMOV 6PK1050<br>VKM 31022  | 1   | 1   |   |   |   |   |
| <b>VW  TOURAN 2.0 TDI 140</b> |   |   |   |  |   |   |   |   |   |   |   |
|                                | BMM   |   | 12/05 → 06/07   |  | VKMA 01250<br>VKM 11250<br>VKM 21147  | 1<br>1  | 1<br>1  | 1   |   |   | T0184   |
|  | BKD   |   | 08/03 → 06/07   |  | VKMA 01255<br>VKM 11255<br>VKM 21147<br>VKM 21256                                   | 1<br>1  | 2<br>1<br>1   | 1   |   |   | 5 T0184   |
|                                | BKD   |   | 08/03 → 05/05   |  | VKPC 81627  |   |   | 1   |   |   |   |
|                                | B(Alt)  | BKD   | 08/03 → 06/07   | AC   | VKMOV 6PK950<br>VKM 31022   | 1   | 1   |   |   |   |   |
|  | B(Alt)  | BKD   | 08/03 → 06/07   | AC   | VKMOV 6PK1050<br>VKM 31022  | 1   | 1   |   |   |   |   |
| <b>VW  TOURAN 2.0 TDI 170</b> |   |   |   |  |   |   |   |   |   |   |   |
|                                | BMN   |   | 12/05 → 06/07   |  | VKMA____<br>VKM 11255<br>VKM 21147<br>VKM____                                       | 1<br>1  | 2<br>1<br>1   | 1   |   |   | 5 T0184   |
|                                | BMN   |   | 12/05 → 06/07   |  | VKPC____  |   |   | 1   |   |   |   |
|                                | B(Alt)  | BMN   | 12/05 → 06/07   | AC   | VKMOV 6PK950<br>VKM 31022   | 1   | 1   |   |   |   |   |
|  | B(Alt)  | BMN   | 12/05 → 06/07   | AC   | VKMOV 6PK1050<br>VKM 31022  | 1   | 1   |   |   |   |   |
| <b>VW  VENTO (1H2) 1.4</b>    |   |   |   |  |   |   |   |   |   |   |   |
|                                | ABD   |   | 11/91 → 07/95   |                     | VKMC 01103  |   |   | 1   | 1   |   | T0231   |
|  | AEX   |   | 07/95 → 09/98   |  | VKMA 01106<br>VKM 11106   | 1<br>1  | 1   |   |   |   | T0126   |
|                                | ABD   |   | 11/91 → 07/95   |  | VKPC 81204  |   |   | 1   |   |   |   |
|  | AEX   |   | 07/95 → 09/98   |  | VKPC 81210  |   |   | 1   |   |   |   |
|                                | B(Alt)  | ABD   | 11/91 → 07/95   |                     | VKMOV 6PK737  |   |   | 1   |   |   |   |
|  | B(Alt)  | ABD   | 11/91 → 07/95   |  → ICH 1H-S-120 000 | VKMOV 6PK1100<br>VKM 31023  | 1   |   | 1   |   |   |   |























|   |  |  |                     |                         |  |  |  |  |  |  |  |  |  |  |
|---|---|---|--|---|---|---|---|---|---|---|---|---|---|---|
| B(Alt)  | ABD   | 11/91 → 07/95   |  CH 1H-S-120 001 I→ | VKMA 31202<br>VKMV 6PK1068<br>VKM 31015   | 1   |   | 1   |   |   |   |   |   |   |   |
| B(Alt)  | AEX   | 07/95 → 09/98   |                     | VKMV 6PK751   |   |   | 1   |   |   |   |   |   |   |   |
| B(Alt)  | AEX   | 07/95 → 09/98   |                     | VKMV 6PK1100<br>VKM 31023   | 1   |   | 1   |   |   |   |   |   |   |   |
| <b>VW  VENTO (1H2) 1.6</b>   |   |   |  |   |   |   |   |   |   |   |   |   |   |   |
|                              | ABU   | 09/92 → 09/94   |                     | VKMC 01104  |   |   | 1   |   | 1   |   |   |   |   | T0233   |
|   | AEA, AEE  | 10/94 → 09/98   |  | VKMA 01110<br>VKM 11106   | 1   |   | 1   |   |   |   |   |   |   | T0127   |
|   | AEK, AFT  | 10/94 → 09/98   |  | VKMA 01009<br>VKM 11000   | 1   |   | 1   |   |   |   |   | 3   |   | T0124   |
|                              | ABU   | 09/92 → 09/94   |  | VKPC 81204  |   |   |   |   | 1   |   |   |   |   |   |
|   | AEA, AEE  | 10/94 → 09/98   |  | VKPC 81210  |   |   |   |   | 1   |   |   |   |   |   |
|   | AEK, AFT  | 10/94 → 09/98   | 2)   | VKPA 81401<br>VKPC 81401  |   |   |   |   | 1   |   |   |   |   |   |
|                              | B(Alt)  | ABU   | 09/92 → 09/94  |                          | VKMV 6PK737   |   |   |   | 1   |   |   |   |   |   |
|   | B(Alt)  | ABU   | 09/92 → 09/94  |  → ICH 1H-S-120 000      | VKMV 6PK1100<br>VKM 31023   | 1   |   |   | 1   |   |   |   |   |   |
|   | B(Alt)  | ABU   | 09/92 → 09/94  |  CH 1H-S-120 001 I→      | VKMA 31202<br>VKMV 6PK1068<br>VKM 31015   | 1   |   |   | 1   |   |   |   |   |   |
|   | B(Alt)  | AEA, AEE  | 10/94 → 09/98  |                          | VKMA 31202<br>VKMV 6PK1068<br>VKM 31015   | 1   |   |   | 1   |   |   |   |   |   |
|   | B(Alt)  | AEK, AFT  | 10/94 → 09/98  |                          | VKMV 6PK894   |   |   |   | 1   |   |   |   |   |   |
|   | B(Alt)  | AEK, AFT  | 10/94 → 09/98  |  → ICH 1H-T-240 000      | VKMV 6PK976<br>VKM 31004<br>VKM 31210   | 1   |   |   | 1   |   |   |   |   |   |
|   | B(Alt)  | AEK, AFT  | 10/94 → 09/98  |  → ICH 1H-T-240 001 I→  | VKMV 6PK1033<br>VKM 31004<br>VKM 31210  | 1   |   |   | 1   |   |   |   |   |   |
|   | B(Alt)  | AEK, AFT  | 10/94 → 09/98  |                        | VKMV 6PK1153<br>VKM 31004<br>VKM 31210  | 1   |   |   | 1   |   |   |   |   |   |
|   | B(PS)   | AEK, AFT  | 10/94 → 09/98  |                        | VKMV 11.5x685   |   |   |   | 1   |   |   |   |   |   |
|   | B(PS)   | AEK, AFT  | 10/94 → 09/98  |                        | VKMV 11.5x755   |   |   |   | 1   |   |   |   |   |   |
| <b>VW  VENTO (1H2) 1.8</b> |   |   |  |   |   |   |   |   |   |   |   |   |   |   |
|                            | ABS, ADZ  | 11/91 → 09/98   | 3)   | VKMS 01000<br>VKMA 01000<br>VKM 11000   | 1   |   | 1   |   |   |   |   | 3   | 4   | T0005   |
|   | AAM   | 11/91 → 09/98   |  | VKMA 01009<br>VKM 11000   | 1   |   | 1   |   |   |   |   | 3   |   | T0124   |
|                            | AAM, ABS, ADZ   | 11/91 → 09/98   | 2)   | VKPA 81401<br>VKPC 81401  |   |   |   |   | 1   |   |   |   |   |   |
|                            | B(Alt)  | AAM, ABS, ADZ   | 11/91 → 09/98  |                        | VKMV 6PK894   |   |   |   | 1   |   |   |   |   |   |
|   | B(Alt)  | AAM, ABS, ADZ   | 11/91 → 09/98  |  → ICH 1H-T-240 000    | VKMV 6PK976<br>VKM 31004<br>VKM 31210   | 1   |   |   | 1   |   |   |   |   |   |
|   | B(Alt)  | AAM, ABS, ADZ   | 11/91 → 09/98  |  → ICH 1H-T-240 001 I→ | VKMV 6PK1033<br>VKM 31004<br>VKM 31210  | 1   |   |   | 1   |   |   |   |   |   |
|   | B(Alt)  | AAM, ABS, ADZ   | 11/91 → 09/98  |                        | VKMV 6PK1153<br>VKM 31004<br>VKM 31210  | 1   |   |   | 1   |   |   |   |   |   |
|   | B(PS)   | AAM, ABS, ADZ   | 11/91 → 09/98  |                        | VKMV 11.5x685   |   |   |   | 1   |   |   |   |   |   |
|   | B(PS)   | AAM, ABS, ADZ   | 11/91 → 09/98  |                        | VKMV 11.5x755   |   |   |   | 1   |   |   |   |   |   |



VW



















































|   |  |  |  |  |  |  |  |  |  |  |  |  |
|---|---|---|---|--|---|---|---|---|---|---|---|--|
| <b>VW  VENTO (1H2) 2.0</b>       |   |   |   |  |   |   |   |   |   |   |   |  |
|                                   | 2E, ADY, AGG, AKR   | 11/91 → 09/98   |   | VKMA 01002<br>VKM 11000  | 1<br>1  | 1   |   |   |   |   | 3 T0091   |  |
|                                   | 2E, ADY, AGG, AKR   | 11/91 → 09/98   | 2)  | VKPA 81401<br>VKPC 81401   |   |   |   | 1<br>1  |   |   |   |  |
|                                   | <b>B(Alt)</b> 2E, ADY, AGG, AKR   | 11/91 → 09/98   | <b>A</b>  | VKMOV 6PK894   |   | 1   |   |   |   |   |   |  |
|   | <b>B(Alt)</b> 2E, ADY, AGG, AKR   | 11/91 → 09/98   | <b>A</b> , <b>A</b> ,<br>→ ICH 1H-T-240 000                                       | VKMOV 6PK976<br>VKM 31004<br>VKM 31210   | 1<br>1  | 1   |   |   |   |   |   |  |
|   | <b>B(Alt)</b> 2E, ADY, AGG, AKR   | 11/91 → 09/98   | <b>A</b> , <b>A</b> ,<br>CH 1H-T-240 001 I→                                       | VKMOV 6PK1033<br>VKM 31004<br>VKM 31210  | 1<br>1  | 1   |   |   |   |   |   |  |
|   | <b>B(Alt)</b> 2E, ADY, AGG, AKR   | 11/91 → 09/98   | <b>A</b> , <b>A</b>   | VKMOV 6PK1153<br>VKM 31004<br>VKM 31210  | 1<br>1  | 1   |   |   |   |   |   |  |
|   | <b>B(PS)</b> 2E, ADY, AGG, AKR  | 11/91 → 09/98   | <b>A</b>  | VKMOV 11.5x685   |   | 1   |   |   |   |   |   |  |
|   | <b>B(PS)</b> 2E, ADY, AGG, AKR  | 11/91 → 09/98   | <b>A</b>  | VKMOV 11.5x755   |   | 1   |   |   |   |   |   |  |
| <b>VW  VENTO (1H2) 2.8 VR6</b>   |   |   |   |  |   |   |   |   |   |   |   |  |
|                                   | AAA   | 01/92 → 09/98   |   | <b>OXOXOXO</b>   |   |   |   |   |   |   |   |  |
|                                   | AAA   | 01/92 → 09/98   |   | VKPC 81611   |   |   |   | 1   |   |   |   |  |
|                                   | <b>B(Alt)</b> AAA   | 01/92 → 09/98   | <b>A</b>  | VKMOV 7PK1290<br>VKM 31060   | 1   | 1   |   |   |   |   |   |  |
|   | <b>B(Alt)</b> AAA   | 01/92 → 09/98   | <b>A</b>  | VKMA 31060<br>VKMOV 7DK1360<br>VKM 31060   | 1<br>1  | 1<br>1  |   |   |   |   |   |  |
| <b>VW  VENTO (1H2) 1.9 D</b>   |   |   |   |  |   |   |   |   |   |   |   |  |
|                                 | 1Y  | 11/91 → 09/98   | → I Mot. 378 364  | VKMA 01011<br>VKM 11010  | 1<br>1  | 1   |   |   |   |   | 4 T0069   |  |
|   | 1Y  | 11/91 → 09/98   | Mot. 378 365 I→   | VKMA 01013<br>VKM 11014  | 1<br>1  | 1   |   |   |   |   | 4 T0069   |  |
|                                 | 1Y  | 11/91 → 09/98   | 2)  | VKPA 81401<br>VKPC 81401   |   |   |   | 1<br>1  |   |   |   |  |
|                                 | <b>B(Alt)</b> 1Y  | 11/91 → 09/98   | <b>A</b>  | VKMOV 6PK923   |   | 1   |   |   |   |   |   |  |
|   | <b>B(Alt), B(PS)</b> 1Y   | 11/91 → 09/98   | <b>A</b> , <b>A</b>   | VKMA 31028<br>VKMOV 10AVx730<br>VKMOV 6PK1045<br>VKM 31004<br>VKM 31030            | 2<br>1<br>1<br>1<br>1   | 2<br>1<br>1   |   |   |   |   |   |  |
|   | <b>B(Alt), B(PS)</b> 1Y   | 11/91 → 09/98   | <b>A</b> , <b>A</b>   | VKMA 31030<br>VKMOV 11.5x790<br>VKMOV 6PK1145<br>VKM 31004<br>VKM 31030            | 2<br>1<br>1<br>1<br>1   | 2<br>1<br>1   |   |   |   |   |   |  |
| <b>VW  VENTO (1H2) 1.9 SDI</b> |   |   |   |  |   |   |   |   |   |   |   |  |
|                                 | AEY   | 04/97 → 09/98   |   | VKMA 01014<br>VKM 11014<br>VKM 21012   | 1<br>1<br>1   | 1<br>1  |   |   |   |   | 5 T0650   |  |
|                                 | AEY   | 04/97 → 09/98   | 2)  | VKPA 81401<br>VKPC 81401   |   |   |   | 1<br>1  |   |   |   |  |
|                                 | <b>B(Alt), B(PS)</b> AEY  | 04/97 → 09/98   | <b>A</b>  | VKMA 31028<br>VKMOV 10AVx730<br>VKMOV 6PK1045<br>VKM 31004<br>VKM 31030            | 2<br>1<br>1<br>1<br>1   | 2<br>1<br>1   |   |   |   |   |   |  |
|   | <b>B(Alt), B(PS)</b> AEY  | 04/97 → 09/98   | <b>A</b>  | VKMA 31030<br>VKMOV 11.5x790<br>VKMOV 6PK1145<br>VKM 31004<br>VKM 31030            | 2<br>1<br>1<br>1<br>1   | 2<br>1<br>1   |   |   |   |   |   |  |



| VW  VENTO (1H2) 1.9 TD                   |                                |               |   |   |                  |        |   |  |  |             |        |   |  |  |  |  |   |       |
|---|--------------------------------|---------------|---|---|------------------|--------|---|--|--|-------------|--------|---|--|--|--|--|---|-------|
|    | AAZ                            | 11/91 → 09/98 | →   Mot. 552 765  | VKMA 01011<br>VKM 11010   | 1<br>1           | 1      |   |  |  |             |        |   |  |  |  |  | 4 | T0069 |
|   | AAZ                            | 11/91 → 09/98 | Mot. 552 766   →  | VKMA 01013<br>VKM 11014   | 1<br>1           | 1      |   |  |  |             |        |   |  |  |  |  | 4 | T0069 |
|    | AAZ                            | 11/91 → 09/98 | 2)  | VKPA 81401<br>VKPC 81401  |                  |        |   |  |  |             | 1<br>1 |   |  |  |  |  |   |       |
|    | B(Alt) AAZ                     | 11/91 → 09/98 | A ⊙   | VKMA 6PK923   |                  |        |   |  |  | 1           |        |   |  |  |  |  |   |       |
|   | B(Alt), B(PS)AAZ               | 11/91 → 09/98 | A ⊙, A ⊙  | VKMA 31028<br>VKMV 10AVx730<br>VKMV 6PK1045<br>VKM 31004<br>VKM 31030 | 2<br>1<br>1<br>1 | 2      |   |  |  | 2<br>1<br>1 |        |   |  |  |  |  |   |       |
|   | B(Alt), B(PS)AAZ               | 11/91 → 09/98 | A ⊙, AC   | VKMA 31030<br>VKMV 11.5x790<br>VKMV 6PK1145<br>VKM 31004<br>VKM 31030 | 2<br>1<br>1      | 2      |   |  |  | 2<br>1<br>1 |        |   |  |  |  |  |   |       |
| VW  VENTO (1H2) 1.9 TDI                  |                                |               |   |   |                  |        |   |  |  |             |        |   |  |  |  |  |   |       |
|    | 1Z                             | 09/93 → 09/98 | →   Mot. 289 575  | VKMA 01012<br>VKM 11012<br>VKM 21012                                  | 1<br>1           | 1      | 1 |  |  |             |        |   |  |  |  |  | 5 | T0650 |
|   | 1Z                             | 09/93 → 09/98 | Mot. 289 576   →  | VKMA 01014<br>VKM 11014<br>VKM 21012                                  | 1<br>1           | 1      | 1 |  |  |             | 1      |   |  |  |  |  | 5 | T0650 |
|   | AFN, AHU, ALE                  | 09/93 → 09/98 |   | VKMA 01014<br>VKM 11014<br>VKM 21012                                  | 1<br>1           | 1      | 1 |  |  |             |        |   |  |  |  |  | 5 | T0650 |
|                                        | 1Z, AFN, AHU, ALE              | 09/93 → 09/98 | 2)  | VKPA 81401<br>VKPC 81401  |                  |        |   |  |  |             | 1<br>1 |   |  |  |  |  |   |       |
|                                        | B(Alt), B(PS)1Z, AFN, AHU, ALE | 09/93 → 09/98 | A ⊙   | VKMA 31028<br>VKMV 10AVx730<br>VKMV 6PK1045<br>VKM 31004<br>VKM 31030 | 2<br>1<br>1      | 2      |   |  |  | 2<br>1<br>1 |        |   |  |  |  |  |   |       |
|   | B(Alt), B(PS)1Z, AFN, AHU, ALE | 09/93 → 09/98 | AC  | VKMA 31030<br>VKMV 11.5x790<br>VKMV 6PK1145<br>VKM 31004<br>VKM 31030 | 2<br>1<br>1      | 2      |   |  |  | 2<br>1<br>1 |        |   |  |  |  |  |   |       |
| VW  CRAFTER 30-35 / 30-50 (2E) 2.5 TDI |                                |               |   |   |                  |        |   |  |  |             |        |   |  |  |  |  |   |       |
|                                        | BJJ, BJK, BJL, BJM             | 04/06 → 10/07 |   | —<br>VKM 11257<br>VKM 21004<br>VKM 21130                              | 1<br>1           | 2      | 1 |  |  |             |        |   |  |  |  |  |   | T0173 |
|                                        | B(Alt) BJJ, BJK, BJL, BJM      | 04/06 → 10/07 | A ⊙   | VKMA 6PK2000  |                  |        |   |  |  | 1           |        |   |  |  |  |  |   |       |
|                                        | BJJ, BJK, BJL, BJM             | 04/06 → 10/07 | A ⊙   | VKM _____   |                  |        |   |  |  |             |        | 1 |  |  |  |  |   |       |
| VW  LT   2.0                           |                                |               |   |   |                  |        |   |  |  |             |        |   |  |  |  |  |   |       |
|                                        | CH                             | 04/75 → 09/83 |   | VKMA 01000<br>VKM 11000   | 1<br>1           | 1      |   |  |  | 1           |        |   |  |  |  |  | 3 | T0005 |
|                                        | CH                             | 04/75 → 09/83 |   | VKPC 81601  |                  |        |   |  |  |             | 1      |   |  |  |  |  |   |       |
| VW  LT   2.4                           |                                |               |   |   |                  |        |   |  |  |             |        |   |  |  |  |  |   |       |
|                                        | 1E, DL                         | 01/85 → 06/96 |  | —<br>VKM 21031  |                  | 1<br>1 | 1 |  |  | 1           |        |   |  |  |  |  |   | T0001 |
|   | DL                             | 12/82 → 12/84 |  | —   |                  |        |   |  |  | 1           |        | 1 |  |  |  |  |   |       |
|                                        | 1E, DL                         | 12/82 → 06/96 |   | —   |                  |        |   |  |  |             |        | 1 |  |  |  |  |   |       |
|                                        | B(Alt) 1E, DL                  | 12/82 → 06/96 | →   ICH 28-G-016 821  | VKMA 10AVx813   |                  |        |   |  |  | 1           |        |   |  |  |  |  |   |       |
|   | B(Alt) 1E, DL                  | 12/82 → 06/96 | CH 28-G-016 822   →   | VKMA 11.5x790   |                  |        |   |  |  | 1           |        |   |  |  |  |  |   |       |
|   | B(PS) 1E, DL                   | 12/82 → 06/96 |   | VKMA 13AVx800   |                  |        |   |  |  | 1           |        |   |  |  |  |  |   |       |
|   | B(AC) 1E, DL                   | 12/82 → 06/96 |   | VKMA 13AVx865   |                  |        |   |  |  | 1           |        |   |  |  |  |  |   |       |





























































|  |  |  |          |   |  |  |  |  |  |  |  |  |
|--|---|---|---|---|---|---|---|---|---|---|---|---|
|  | B(Alt) AGX  | 07/96 → 12/03   | AC,<br>CH 2D-Y-009 087 I→   | VKMV 6PK1715<br>VKM 31007<br>VKM 31063<br>VKM_____                                  | 1   | 1   |   |   | 1   |   |   | 1   |
|                                 | AGX   | 07/96 → 11/07   |   | VKM_____  |   |   |   |   | 1   |   |   |   |
| <b>VW  LT II 2.5 TDI</b>        |   |   |   |   |   |   |   |   |   |   |   |   |
|                                 | AHD, ANJ, APA, AVR,<br>BBE, BBF   | 05/96 → 11/07   | 4)  | VKMA 01270<br>VKM 11072<br>VKM 11073<br>VKM 11258                                   | 3<br>1<br>1<br>1  | 2   |   |   |   |   |   | 6 T0644   |
|                                 | AHD, ANJ, APA, AVR,<br>BBE, BBF   | 05/96 → 11/07   |   | VKPC 86619  |   |   |   | 1   |   |   |   |   |
|                                 | B(Alt) AHD, ANJ, APA, AVR,<br>BBE, BBF  | 05/96 → 12/03   | AC,<br>→ ICH 2D-Y-009 086   | VKMV 6PK1751<br>VKM 31007<br>VKM 31063<br>VKM_____                                  | 1   | 1   |   |   | 1   |   |   | 1   |
|  | B(Alt) AHD, ANJ, APA, AVR,<br>BBE, BBF  | 05/96 → 12/03   | AC,<br>CH 2D-Y-009 087 I→   | VKMV 6PK1715<br>VKM 31007<br>VKM 31063<br>VKM_____                                  | 1   | 1   |   |   | 1   |   |   | 1   |
|                                | AHD, ANJ, APA, AVR,<br>BBE, BBF   | 05/96 → 11/07   |   | VKM_____  |   |   |   | 1   |   |   |   |   |
| <b>VW  LT II 2.8 TDI</b>      |   |   |   |   |   |   |   |   |   |   |   |   |
|                               | AGK, ATA, AUH   | 06/97 → 03/06   |   | ΟΡΘΟΓΩΝΟ  |   |   |   |   |   |   |   |   |
|                               | AGK, ATA  | 06/97 → 11/07   |   | —   |   |   |   | 1   |   |   |   |   |
|                               | AUH   | 04/02 → 11/07   |   | —   |   |   |   | 1   |   |   |   |   |
|                               | B(Alt) AGK, ATA   | 06/97 → 11/07   | 2x  HP | VKMV 6PK2000<br>VKM 38001   | 1   | 1   |   |   |   |   |   |   |
|  | B(Alt) AGK, ATA   | 06/97 → 11/07   | AC  | VKMV 6PK1642<br>VKM 38001   | 1   | 1   |   |   |   |   |   |   |
|  | B(Alt) AGK, ATA   | 06/97 → 11/07   | AC  | VKMV_____<br>VKM 38001<br>VKM 38001   | 1<br>1  | 1   |   |   |   |   |   |   |
|  | B(Alt) AUH  | 04/02 → 11/07   | AC  | VKMV 6PK1683  |   | 1   |   |   |   |   |   |   |
|  | B(Alt) AUH  | 04/02 → 11/07   | AC  | VKMV 6PK2155  |   | 1   |   |   |   |   |   |   |
| <b>VW  TRANSPORTER I 1.1</b>  |   |   |   |   |   |   |   |   |   |   |   |   |
|                               |   | 01/50 → 12/62   |   |  |   |   |   |   |   |   |   |   |
|                               |   | 01/50 → 12/62   |   | —   |   |   |   |   |   |   |   |   |
| <b>VW  TRANSPORTER I 1.2</b>  |   |   |   |   |   |   |   |   |   |   |   |   |
|                               |   | 01/50 → 07/67   |   |  |   |   |   |   |   |   |   |   |
|                               |   | 01/50 → 07/67   |   | —   |   |   |   |   |   |   |   |   |
| <b>VW  TRANSPORTER I 1.5</b>  |   |   |   |   |   |   |   |   |   |   |   |   |
|                               |   | 02/62 → 10/70   |   |  |   |   |   |   |   |   |   |   |
|                               |   | 02/62 → 10/70   |   | —   |   |   |   |   |   |   |   |   |
| <b>VW  TRANSPORTER I 1.6</b>  |   |   |   |   |   |   |   |   |   |   |   |   |
|                               |   | 08/64 → 12/68   |   |  |   |   |   |   |   |   |   |   |
|                               |   | 08/64 → 12/68   |   | —   |   |   |   |   |   |   |   |   |
| <b>VW  TRANSPORTER II 1.6</b> |   |   |   |   |   |   |   |   |   |   |   |   |
|                               | AD, AE, AF, AH, AS  | 08/67 → 07/79   |   |  |   |   |   |   |   |   |   |   |
|                               | AD, AE, AF, AH, AS  | 08/67 → 07/79   |   | —   |   |   |   |   |   |   |   |   |
|                               | B(Gen) AD, AE, AF, AH, AS   | 08/67 → 07/79   |   | VKMV 10AVx905   |   | 1   |   |   |   |   |   |   |
|  | B(Alt) AD, AE, AF, AH, AS   | 08/67 → 07/79   |   | VKMV 11.3x912   |   | 1   |   |   |   |   |   |   |
| <b>VW  TRANSPORTER II 1.7</b> |   |   |   |   |   |   |   |   |   |   |   |   |
|                               | CA, CB  | 08/71 → 12/73   |   |  |   |   |   |   |   |   |   |   |
|                               | CA, CB  | 08/71 → 12/73   |   | —   |   |   |   |   |   |   |   |   |
|                               | B(Gen) CA, CB   | 08/71 → 12/73   |   | VKMV 10AVx905   |   | 1   |   |   |   |   |   |   |



























|   |  |  |  |  |  |  |  |  |  |  |  |
|---|---|---|---|--|---|---|---|---|---|---|---|
| B(Alt)  | JX  | 08/84 → 07/92   | 90A,<br>→ ICH 24-K-033 108  | VKMV 10AVx625  |   | 1   |   |   |   |   |   |
| B(Alt)  | JX  | 08/84 → 07/92   | 90A,<br>CH 24-K-033 109 I→  | VKMV 10AVx910  |   | 1   |   |   |   |   |   |
| B(PS)   | JX  | 08/84 → 07/92   |   | VKMV 10AVx763  |   | 1   |   |   |   |   |   |
| B(AC)   | JX  | 08/84 → 07/92   |   | VKMV 13AVx1250   |   | 1   |   |   |   |   |   |
| B(WP)   | JX  | 08/84 → 07/92   | AC, ⊗   | VKMV 10AVx650  |   | 1   |   |   |   |   |   |
| B(WP)   | JX  | 08/84 → 07/92   | AC, ⊗   | VKMV 10AVx630  |   | 1   |   |   |   |   |   |
| B(WP)   | JX  | 08/84 → 07/92   | AC, ⊗   | VKMV 10AVx910  |   | 1   |   |   |   |   |   |
| B(WP)   | JX  | 08/84 → 07/92   | AC, ⊗   | VKMV 10AVx838  |   | 1   |   |   |   |   |   |
| <b>VW  TRANSPORTER III 1.7 D</b> |   |   |   |  |   |   |   |   |   |   |   |
|                                  | KY  | 08/85 → 07/92   | 3)  | VKMS 01010<br>VKMA 01010<br>VKM 11010  | 1<br>1<br>1   | 1   |   |   | 3   | 2   | T0051   |
|                                  | KY  | 08/85 → 07/92   | 2)  | VKPA 81401<br>VKPC 81401   |   |   |   | 1<br>1  |   |   |   |
|                                  | B(Alt)  | KY  | 08/85 → 07/92   | 65A,<br>→ ICH 24-K-033 108   | VKMV 10AVx600   |   | 1   |   |   |   |   |
|   | B(Alt)  | KY  | 08/85 → 07/92   | 65A,<br>CH 24-K-033 109 I→   | VKMV 10AVx875   |   | 1   |   |   |   |   |
|   | B(Alt)  | KY  | 08/85 → 07/92   | 90A,<br>→ ICH 24-K-033 108   | VKMV 10AVx625   |   | 1   |   |   |   |   |
|   | B(Alt)  | KY  | 08/85 → 07/92   | 90A,<br>CH 24-K-033 109 I→   | VKMV 10AVx910   |   | 1   |   |   |   |   |
|   | B(PS)   | KY  | 08/85 → 07/92   |  | VKMV 10AVx763   |   | 1   |   |   |   |   |
|   | B(AC)   | KY  | 08/85 → 07/92   |  | VKMV 13AVx1250  |   | 1   |   |   |   |   |
|   | B(WP)   | KY  | 08/85 → 07/92   | AC, ⊗  | VKMV 10AVx650   |   | 1   |   |   |   |   |
|   | B(WP)   | KY  | 08/85 → 07/92   | AC, ⊗  | VKMV 10AVx630   |   | 1   |   |   |   |   |
|   | B(WP)   | KY  | 08/85 → 07/92   | AC, ⊗  | VKMV 10AVx910   |   | 1   |   |   |   |   |
|   | B(WP)   | KY  | 08/85 → 07/92   | AC, ⊗  | VKMV 10AVx838   |   | 1   |   |   |   |   |
| <b>VW  TRANSPORTER IV 1.8</b>  |   |   |   |  |   |   |   |   |   |   |   |
|                                | PD  | 12/90 → 07/92   |   | VKMA 01000<br>VKM 11000  | 1<br>1  | 1   |   |   |   | 3   | T0005   |
|                                | PD  | 12/90 → 07/92   | 2)  | VKPA 81401<br>VKPC 81401   |   |   |   | 1<br>1  |   |   |   |
|                                | B(Alt)  | PD  | 12/90 → 07/92   |  | VKMV 11.9x950   |   | 1   |   |   |   |   |
| <b>VW  TRANSPORTER IV 2.0</b>  |   |   |   |  |   |   |   |   |   |   |   |
|                                | AAC   | 07/90 → 04/03   |   | VKMA 01002<br>VKM 11000  | 1<br>1  | 1   |   |   |   | 3   | T0091   |
|                                | AAC   | 07/90 → 04/03   | 2)  | VKPA 81401<br>VKPC 81401   |   |   |   | 1<br>1  |   |   |   |
|                                | B(Alt)  | AAC   | 07/90 → 04/03   | AC,<br>→ ICH 70-T-199 000  | VKMV 10AVx965   |   | 1   |   |   |   |   |
|   | B(Alt)  | AAC   | 07/90 → 04/03   | AC, → ICH 70-T-199 000   | VKMV 6PK1590<br>VKM 31007<br>VKM 31007<br>VKM 31007                                 |   | 1<br>1<br>1   |   |   |   |   |
|   | B(Alt)  | AAC   | 07/90 → 04/03   | 2x ⊗, 29),<br>CH 70-T-200 001 I→   | VKMV 6PK1870<br>VKM 31007<br>VKM 31007<br>VKM 31043                                 |   | 1<br>1<br>1   |   | 1   |   |   |
|   | B(Alt)  | AAC   | 07/90 → 04/03   | 29), AC,<br>CH 70-T-200 001 I→   | VKMV 6PK1905<br>VKM 31007<br>VKM 31007<br>VKM 31043                                 |   | 1<br>1  |   | 1   |   |   |
|   | B(Alt)  | AAC   | 07/90 → 04/03   | 28), CH 70-T-200 001 I→  | VKMV 6PK1068<br>VKM 31004<br>VKM 31210  |   | 1<br>1  |   | 1   |   |   |



|   |  |  |                        |  |  |  |  |  |  |  |  |  |  |
|---|---|---|---|--|---|---|---|---|---|---|---|---|---|
| B(Alt)  | AAC   | 07/90 → 04/03   | AØ,<br>CH 70-T-200 001 I→   | VKMA 6PK923  |   |   |   | 1   |   |   |   |   |   |
| B(PS)   | AAC   | 07/90 → 04/03   |   | VKMA 10AVx650  |   |   |   | 1   |   |   |   |   |   |
| <b>VW  TRANSPORTER IV 2.5</b>      |   |   |   |  |   |   |   |   |   |   |   |   |   |
|                                     | AAF   | 11/90 → 12/93   | → ICH 70-N-014 000  | VKMA 01042<br>VKM 21031  | 1   | 1   |   |   |   |   |   |   | T0095   |
|   | AAF   | 11/90 → 12/93   | CH 70-N-014 001 I→  | VKMA 01262<br>VKM 11251<br>VKM 21031   | 1   | 1   | 1   |   |   |   |   |   | 2 T0101   |
|   | ACU   | 01/94 → 04/03   | → I Mot. 019 149  | VKMA 01262<br>VKM 11251<br>VKM 21031   | 1   | 1   | 1   |   |   |   |   |   | 2 T0101   |
|   | ACU   | 01/94 → 04/03   | Mot. 019 150 I→   | VKMA 01253<br>VKM 11054  | 1   |   | 1   |   |   |   |   |   | 1 T0095   |
|   | AEN, AET, AEU, APL,<br>AVT  | 01/95 → 04/03   |   | VKMA 01253<br>VKM 11054  | 1   |   | 1   |   |   |   |   |   | 1 T0095   |
|                                     | AAF   | 11/90 → 12/93   | → ICH 70-N-014 000  | VKPC 81803   |   |   |   |   |   | 1   |   |   |   |
|   | AAF   | 11/90 → 12/93   | CH 70-N-014 001 I→  | VKPC 86619   |   |   |   |   |   | 1   |   |   |   |
|   | ACU, AEN, AET, AEU,<br>APL, AVT   | 11/90 → 04/03   |   | VKPC 86619   |   |   |   |   |   | 1   |   |   |   |
|   | ACU, AEN, AEU   | 11/90 → 04/03   |   | VKPC 81810   |   |   |   |   |   | 1   |   |   |   |
|                                     | B(Alt)  | AET, APL, AVT   | 08/96 → 04/03 2x  (29) | VKMA _____<br>VKM 31007<br>VKM 31007<br>VKM 31043                                  |   |   |   | 1   |   |   |   |   |   |
| <b>VW  TRANSPORTER IV 2.8 V6</b>  |   |   |   |  |   |   |   |   |   |   |   |   |   |
|                                   | AES, AMV  | 11/95 → 04/03   |   | <del>OKOKOK</del>  |   |   |   |   |   |   |   |   |   |
|                                   | AES   | 11/95 → 05/00   |   | VKPC 81611   |   |   |   |   |   | 1   |   |   |   |
|   | AMV   | 04/00 → 04/03   | → ICH 70-2-097 000  | VKPC 81611   |   |   |   |   |   | 1   |   |   |   |
|   | AMV   | 04/00 → 04/03   | CH 70-2-097 001 I→  | —  |   |   |   |   |   | 1   |   |   |   |
| <b>VW  TRANSPORTER IV 1.9 D</b>  |   |   |   |  |   |   |   |   |   |   |   |   |   |
|                                   | 1X  | 07/90 → 04/03   | → I Mot. 120 077  | VKMA 01011<br>VKM 11010  | 1   | 1   |   |   |   |   |   |   | 4 T0069   |
|   | 1X  | 07/90 → 04/03   | Mot. 120 078 I→   | VKMA 01013<br>VKM 11014  | 1   | 1   |   |   |   |   |   |   | 4 T0069   |
|                                   | 1X  | 07/90 → 04/03   | 2)  | VKPA 81401<br>VKPC 81401   |   |   |   |   |   | 1   |   |   |   |
|                                   | B(Alt)  | 1X  | 07/90 → 04/03 AØ,<br>CH 70-P-000 001 I→   | VKMA 6PK923  |   |   |   |   |   | 1   |   |   |   |
|   | B(Alt)  | 1X  | 07/90 → 04/03 AØ,<br>CH 70-P-000 001 I→   | VKMA 6PK1045<br>VKM 31004<br>VKM 31030   | 1   |   |   |   |   | 1   |   |   |   |
|   | B(PS)   | 1X  | 07/90 → 04/03   | VKMA 10AVx650  |   |   |   |   |   | 1   |   |   |   |
| <b>VW  TRANSPORTER IV 1.9 TD</b> |   |   |   |  |   |   |   |   |   |   |   |   |   |
|                                   | ABL   | 10/92 → 04/03   | → I Mot. 029 319  | VKMA 01011<br>VKM 11010  | 1   | 1   |   |   |   |   |   |   | 4 T0069   |
|   | ABL   | 10/92 → 04/03   | Mot. 029 320 I→   | VKMA 01013<br>VKM 11014  | 1   | 1   |   |   |   |   |   |   | 4 T0069   |
|                                   | ABL   | 10/92 → 04/03   | 2)  | VKPA 81401<br>VKPC 81401   |   |   |   |   |   | 1   |   |   |   |
|                                   | B(Alt)  | ABL   | 10/92 → 04/03  120A  | VKMA 6PK923<br>VKM 31004<br>VKM 31030  | 1   |   |   |   |   | 1   |   |   |   |
|   | B(Alt)  | ABL   | 10/92 → 04/03  120A  | VKMA 6PK1045<br>VKM 31004<br>VKM 31030   | 1   |   |   |   |   | 1   |   |   |   |
|   | B(PS)   | ABL   | 10/92 → 04/03   | VKMA 10AVx650  |   |   |   |   |   | 1   |   |   |   |
| <b>VW  TRANSPORTER IV 2.4 D</b>  |   |   |   |  |   |   |   |   |   |   |   |   |   |
|                                   | AAB   | 07/90 → 04/03   | 4), → I Mot. 320 126  | VKMA 01266<br>VKM 21031  |   |   |   | 1   | 2   |   |   |   | T0643   |
|   | AAB   | 07/90 → 04/03   | 4), Mot. 320 127 I→   | VKMA 01271<br>VKM 11072  | 1   |   |   |   | 2   |   |   |   | 1 T0078   |



|   |  |  |           |  |  |  |  |  |  |  |  |  |  |
|---|---|---|--|--|---|---|---|---|---|---|---|---|---|
|   | AJA   | 08/97 → 04/03   | 4)   | VKMA 01271<br>VKM 11072  | 1<br>1  |   | 2   |   |   |   |   |   | 1 T0078   |
|                                      | AAB   | 07/90 → 04/03   | → IMot. 320 127  | VKPC 81803   |   |   |   |   |   | 1   |   |   |   |
|   | AAB   | 07/90 → 04/03   | Mot. 320 128 I→  | VKPC 86619   |   |   |   |   |   | 1   |   |   |   |
|   | AJA   | 08/97 → 04/03   |  | VKPC 86619   |   |   |   |   |   | 1   |   |   |   |
|                                      | B(Alt) AAB  | 07/90 → 04/03   | 2x  , 29) | VKMMV 6PK2060<br>VKM 31007<br>VKM 31007<br>VKM 31043                               |   | 1<br>1  |   | 1   |   |   |   |   |   |
|   | B(Alt) AAB  | 07/90 → 04/03   | CH 70-S-071 872 I→,<br>→ ICH 70-T-199 000  | VKMMV 6PK1343<br>VKM 31004<br>VKM 31030  | 1<br>1  |   |   | 1   |   |   |   |   |   |
|   | B(Alt) AAB  | 07/90 → 04/98   | 28), CH 70-T-200 001 I→  | VKMMV 6PK1355<br>VKM 31004<br>VKM 31030  | 1<br>1  |   |   | 1   |   |   |   |   |   |
|   | B(Alt) AJA  | 08/97 → 04/98   | 28), AC  | VKMMV 6PK1355<br>VKM 31004<br>VKM 31030  | 1<br>1  |   |   | 1   |   |   |   |   |   |
|   | B(Alt) AJA  | 08/97 → 04/98   | 29), AC  | VKMMV _____<br>VKM 31007<br>VKM 31007<br>VKM 31043                                 |   | 1<br>1  |   | 1   |   |   |   |   |   |
|                                      | AAB, AJA  | 07/90 → 04/03   | Mot. 320 127 I→  | VKM _____  | 1   |   |   |   |   |   | 1   |   |   |
| <b>VW  TRANSPORTER IV 2.5 TDI 90</b> |   |   |  |  |   |   |   |   |   |   |   |   |   |
|                                      | AJT, AYY  | 05/98 → 04/03   | 4)   | VKMA 01258<br>VKM 11073<br>VKM 11257<br>VKM 11258                                  | 3<br>1<br>1<br>1  |   | 2   |   |   |   |   |   | 6 T0095   |
|                                    | AJT, AYY  | 05/98 → 04/03   |  | VKPC 86619   |   |   |   |   |   | 1   |   |   |   |
|                                    | B(Alt) AJT  | 05/98 → 04/03   | 28), AC, Man. GBX,<br>→ ICH 70-XH132 969,<br>70-XX133 656                                  | VKMMV 6PK1767<br>VKM 31007<br>VKM 31043  |   | 1   |   | 1   |   |   |   |   |   |
|   | B(Alt) AJT  | 05/98 → 04/03   | 28), AC, Man. GBX,<br>CH 70-XH132 970,<br>70-XX133 657 I→                                  | VKMMV 6PK1751<br>VKM 31007<br>VKM 31043  | 1   |   |   | 1   |   |   |   |   |   |
|   | B(Alt) AJT  | 05/98 → 04/03   | 28), AC, Auto. GBX   | VKMMV 6PK1751<br>VKM 31007<br>VKM 31043  | 1   |   |   | 1   |   |   |   |   |   |
|   | B(Alt) AJT  | 05/98 → 04/03   | 28), AC, Man. GBX,<br>→ ICH 70-XH132 969,<br>70-XX133 656                                  | VKMMV 6PK2236<br>VKM 31007<br>VKM 31043  | 1   |   |   | 1   |   |   |   |   |   |
|   | B(Alt) AJT  | 05/98 → 04/03   | 28), AC, Man. GBX,<br>CH 70-XH132 970,<br>70-XX133 657 I→                                  | VKM 31007<br>VKM 31043   | 1   |   |   | 1   |   |   |   |   |   |
|   | B(Alt) AJT  | 05/98 → 04/03   | 28), AC, Auto. GBX   | VKM 31007<br>VKM 31043   | 1   |   |   | 1   |   |   |   |   |   |
|   | B(Alt) AJT  | 05/98 → 04/03   | 29),<br>→ ICH 70-XH132 969,<br>70-XX133 656  | VKMMV 6PK2130<br>VKM 31007<br>VKM 31043  |   | 1   |   | 1   |   |   |   |   |   |
|   | B(Alt) AJT  | 05/98 → 04/03   | 29), CH 70-XH132 970,<br>70-XX133 657 I→   | VKM 31007<br>VKM 31043   | 1   |   |   | 1   |   |   |   |   |   |
|                                    | AJT, AYY  | 05/98 → 04/03   |  | VKM _____  |   |   |   |   |   |   | 1   |   |   |



VW

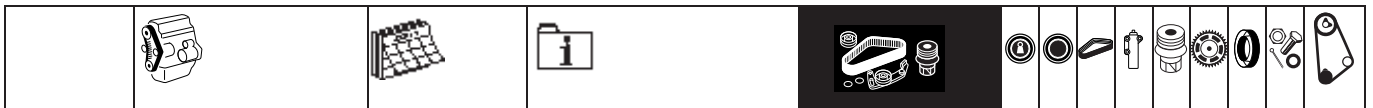

**VW TRANSPORTER IV 2.5 TDI 100**

|  |                        |               |   |   |                  |   |  |  |   |  |   |  |  |   |       |
|--|------------------------|---------------|---|---|------------------|---|--|--|---|--|---|--|--|---|-------|
|  | ACV, AUF, AXL, AYC     | 09/95 → 04/03 | 4)  | VKMA 01270<br>VKM 11072<br>VKM 11073<br>VKM 11258 | 3<br>1<br>1<br>1 | 2 |  |  |   |  |   |  |  | 6 | T0644 |
|  | ACV, AUF, AXL, AYC     | 09/95 → 04/03 |   | VKPC 86619  |                  |   |  |  | 1 |  |   |  |  |   |       |
|  | <b>B(Alt)</b> ACV      | 09/95 → 04/96 | 28), <i>AC</i>                              | VKMV 6PK1767<br>VKM 31007<br>VKM 31030            | 1                | 1 |  |  |   |  |   |  |  |   |       |
|  | <b>B(Alt)</b> ACV, AYC | 09/95 → 04/03 | 29),<br>→ ICH 70-XH132 969,<br>70-XX133 656 | VKMV 6PK2130<br>VKM 31007<br>VKM 31043            | 1                | 1 |  |  |   |  |   |  |  |   |       |
|  | <b>B(Alt)</b> ACV, AYC | 09/95 → 04/03 | 29), CH 70-XH132 970,<br>70-XX133 657 I→    | VKM 31007<br>VKM 31043                            | 1                | 1 |  |  |   |  |   |  |  |   |       |
|  | <b>B(Alt)</b> ACV      | 05/96 → 04/03 | 28), <i>AC</i>                              | VKMV 6PK1767<br>VKM 31007<br>VKM 31043            | 1                | 1 |  |  |   |  |   |  |  |   |       |
|  | <b>B(Alt)</b> AXL      | 09/95 → 04/03 | <i>AC</i>                                   | VKMV 6PK1694<br>VKM 31007                         |                  | 1 |  |  |   |  |   |  |  |   |       |
|  | <b>B(Alt)</b> AYC      | 09/95 → 04/03 | 28), <i>AC</i>                              | VKMV 6PK1751<br>VKM 31007<br>VKM 31043            | 1                | 1 |  |  |   |  |   |  |  |   |       |
|  | <b>B(Alt)</b> AYC      | 09/95 → 04/03 | 28), <b>AC</b>                              | VKM 31007<br>VKM 31043                            | 1                | 1 |  |  |   |  |   |  |  |   |       |
|  | ACV, AUF, AXL, AYC     | 09/95 → 04/03 |   | VKM_____  |                  |   |  |  |   |  | 1 |  |  |   |       |

**VW TRANSPORTER IV 2.5 TDI 150**

|  |                        |               |           |   |                  |   |  |  |   |  |   |  |   |   |       |
|--|------------------------|---------------|-----------|---|------------------|---|--|--|---|--|---|--|---|---|-------|
|  | AHY, AXG               | 05/98 → 04/03 | 4)        | VKMA 01258<br>VKM 11073<br>VKM 11257<br>VKM 11258   | 3<br>1<br>1<br>1 | 2 |  |  |   |  |   |  |   | 6 | T0095 |
|  | AHY, AXG               | 05/98 → 04/03 |           | VKPC 86619  |                  |   |  |  | 1 |  |   |  |   |   |       |
|  | <b>B(Alt)</b> AHY, AXG | 05/98 → 04/03 | <i>AC</i> | VKMV 6PK1694<br>VKM 31007<br>VKM 31043<br>VKM 31063 | 1                | 1 |  |  |   |  |   |  | 1 |   |       |
|  | <b>B(Alt)</b> AHY, AXG | 05/98 → 04/03 | <b>AC</b> | VKMV_____<br>VKM 31007<br>VKM 31043<br>VKM 31063    | 1                | 1 |  |  |   |  |   |  | 1 |   |       |
|  | AHY, AXG               | 05/98 → 04/03 |           | VKM_____  |                  |   |  |  |   |  | 1 |  |   |   |       |

**VW TRANSPORTER V 2.0**



































|  |                   |               |           |   |        |   |  |  |   |  |  |  |  |  |       |
|--|-------------------|---------------|-----------|---|--------|---|--|--|---|--|--|--|--|--|-------|
|  | AXA               | 04/03 → 10/07 |           | VKMA 01113<br>VKM 11113                 | 1<br>1 | 1 |  |  |   |  |  |  |  |  | T0149 |
|  | AXA               | 04/03 → 10/07 |           | VKPC 81620                              |        |   |  |  | 1 |  |  |  |  |  |       |
|  | <b>B(Alt)</b> AXA | 04/03 → 10/07 | <i>AC</i> | VKMA 31203<br>VKMV 6PK1120<br>VKM 31011 | 1<br>1 | 1 |  |  |   |  |  |  |  |  |       |
|  | <b>B(Alt)</b> AXA | 04/03 → 10/07 | <b>AC</b> | VKMA 31204<br>VKMV 6DK1195<br>VKM 31011 | 1<br>1 | 1 |  |  |   |  |  |  |  |  |       |

**VW TRANSPORTER V 3.2 V6**

|  |          |               |  |                   |  |  |  |  |   |  |  |  |  |  |  |
|--|----------|---------------|--|-------------------|--|--|--|--|---|--|--|--|--|--|--|
|  | BDL, BKK | 04/03 → 10/07 |  | <del>XXXXXX</del> |  |  |  |  |   |  |  |  |  |  |  |
|  | BDL, BKK | 04/03 → 10/07 |  | —                 |  |  |  |  | 1 |  |  |  |  |  |  |

**VW TRANSPORTER V 1.9 TDI**

|  |                        |               |           |                                      |        |   |   |  |  |  |   |  |  |  |       |
|--|------------------------|---------------|-----------|--------------------------------------|--------|---|---|--|--|--|---|--|--|--|-------|
|  | AXB, AXC, BRS          | 04/03 → 10/07 |           | VKMA 01250<br>VKM 11250<br>VKM 21147 | 1<br>1 | 1 | 1 |  |  |  |   |  |  |  | T0184 |
|  | AXB, AXC, BRS          | 04/03 → 10/07 |           | VKPC 81418                           |        |   |   |  |  |  | 1 |  |  |  |       |
|  | <b>B(Alt)</b> AXB, AXC | 04/03 → 10/07 | <i>AC</i> | VKMV 6PK1120<br>VKM 31019            | 1      |   |   |  |  |  | 1 |  |  |  |       |

|   |  |  |  |  |  |  |  |  |  |  |  |  |  |
|---|---|---|---|--|---|---|---|---|---|---|---|---|---|
| <b>B(Alt)</b>   | AXB, AXC  | 04/03 → 10/07   | AC  | VKMA 31001<br>VKMV 6DK1195<br>VKM 31019  | 1   |   | 1   |   |   |   |   |   |   |
| <b>B(Alt)</b>   | BRS   | 06/06 → 10/07   | AC  | VKMV 6DK1215<br>VKM 31054  | 1   |   | 1   |   |   |   |   |   |   |
| <b>VW  TRANSPORTER V 2.5 TDI</b> |   |   |   |  |   |   |   |   |   |   |   |   |   |
|                                  | AXD, AXE  | 04/03 → 10/07   |   |   |   |   |   |   |   |   |   |   |   |
|                                  | AXD, AXE  | 04/03 → 01/08   |   | VKPC _____   |   |   |   | 1   |   |   |   |   |   |
| <b>VW  TARO 1.8</b>              |   |   |   |  |   |   |   |   |   |   |   |   |   |
|                                  | 2Y  | 04/89 → 09/94   |   |   |   |   |   |   |   |   |   |   |   |
|                                  | 2Y  | 04/89 → 09/94   |   | VKPC 91428   |   |   |   | 1   |   |   |   |   |   |
|                                  | <b>B(AC)</b> 2Y   | 04/89 → 09/94   |   | VKMV 13AVx865  |   |   | 1   |   |   |   |   |   |   |
| <b>VW  TARO 2.2</b>              |   |   |   |  |   |   |   |   |   |   |   |   |   |
|                                  | 4Y  | 06/89 → 07/94   |   |   |   |   |   |   |   |   |   |   |   |
|                                  | 4Y  | 06/89 → 07/94   |   | VKPC 91428   |   |   |   | 1   |   |   |   |   |   |
| <b>VW  TARO 2.4</b>              |   |   |   |  |   |   |   |   |   |   |   |   |   |
|                                  | 22R   | 06/89 → 03/97   |   |   |   |   |   |   |   |   |   |   |   |
|                                  | 22R   | 06/89 → 03/97   |   | —  |   |   |   | 1   |   |   |   |   |   |
| <b>VW  TARO 2.4 D</b>            |   |   |   |  |   |   |   |   |   |   |   |   |   |
|                                  | 2L  | 04/89 → 03/97   | 3)  | VKMS 91125<br>VKMA 91124<br>VKM 71002<br>VKM 81002                                 | 1<br>1<br>1   | 1<br>1<br>1   | 1<br>1<br>1   |   |   |   | 2   |   | T0330   |
|                                  | 2L  | 04/89 → 03/97   |   | VKPC 91607   |   |   |   | 1   |   |   |   |   |   |
|                                 | <b>B(PS)</b> 2L   | 04/89 → 03/97   |   | VKMV 13AVx865  |   |   | 1   |   |   |   |   |   |   |
|   | <b>B(AC)</b> 2L   | 04/89 → 03/97   |   | VKMV 13AVx825  |   |   | 1   |   |   |   |   |   |   |



VW



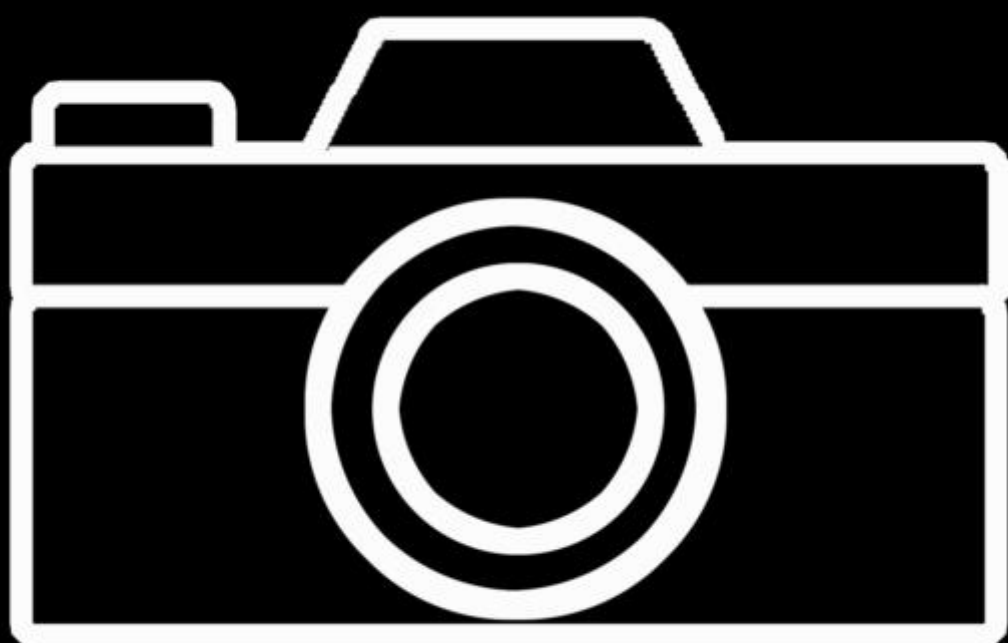

**VKM 11000**

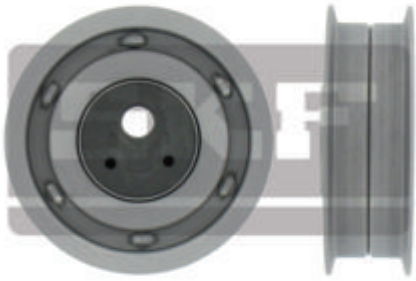

M⊙ D=72 W=20

**VKM 11001**



M⊙ D=72 W=19

**VKM 11003**

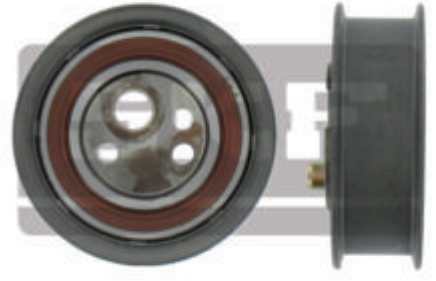

M⊙ D=66 W=17

**VKM 11007**

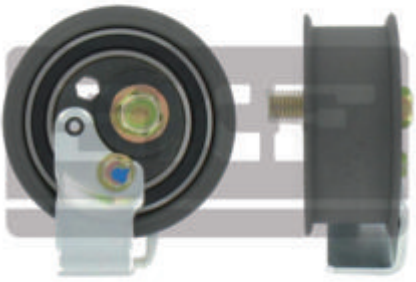

HT D=72,05 W=26,55

**VKM 11008**

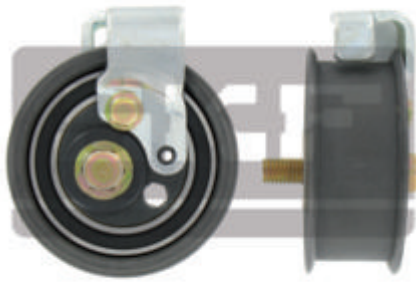

HT D=72 W=27

**VKM 11009**

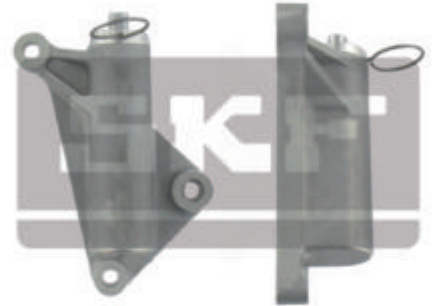

HT

**VKM 11010**

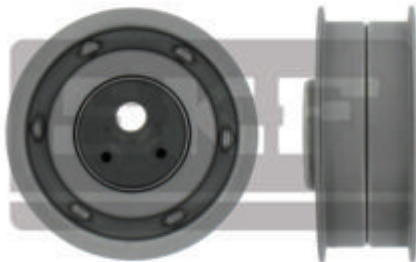

M⊙ D=72 W=26

**VKM 11012**



A⊙ D=67 W=26

**VKM 11014**



A⊙ D=67 W=26

**VKM 11015**



A⊙ D=67 W=24

**VKM 11018**

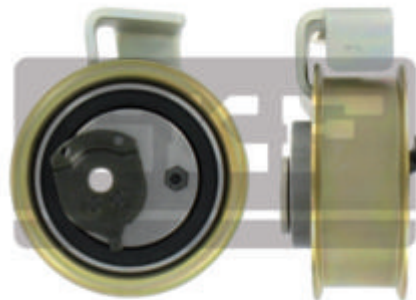

HT D=72 W=25

**VKM 11020**

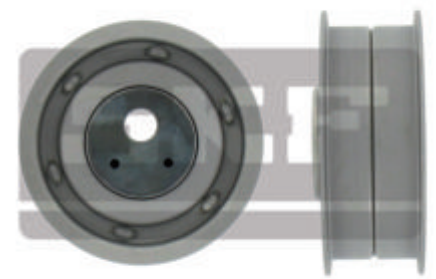

M⊙ D=72 W=26



**VKM 11021**

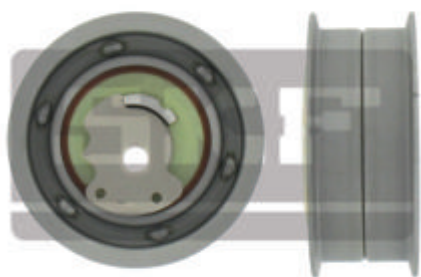

A⊙ D=72 W=26

**VKM 11043**

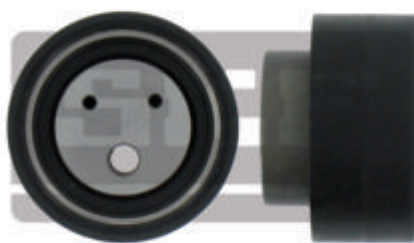

M⊙ D=63 W=28

**VKM 11045**



A⊙ D=63 W=27

**VKM 11050**

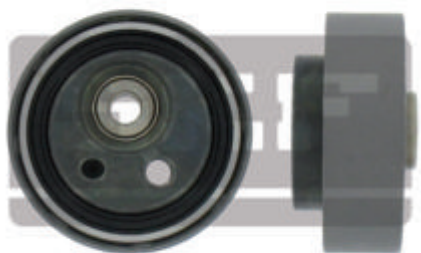

HT D=66 W=21

**VKM 11054**

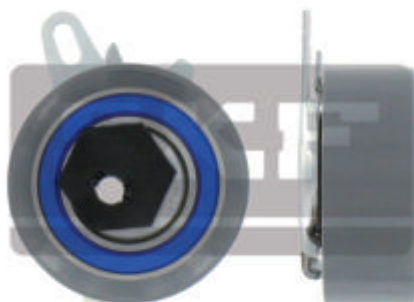

A⊙ D=73 W=27

**VKM 11060**

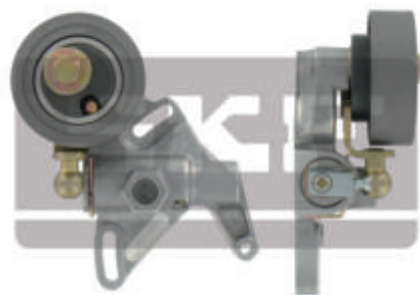

HT D=66 W=21

**VKM 11072**

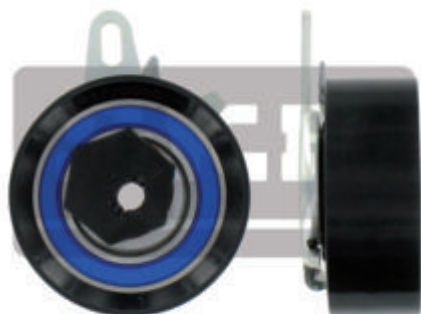

A⊙ D=73 W=27

**VKM 11073**

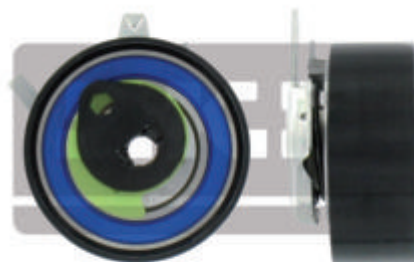

A⊙ D=66 W=24

**VKM 11105**



A⊙ D=59 W=22

**VKM 11106**



A⊙ D=62 W=22

**VKM 11107**



A⊙ D=61 W=22

**VKM 11113**

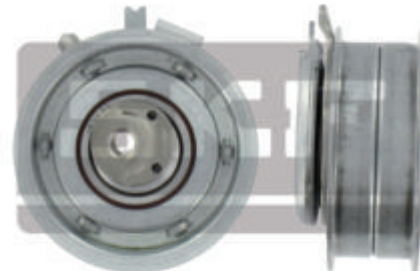

A⊙ D=72 W=25



**VKM 11114**

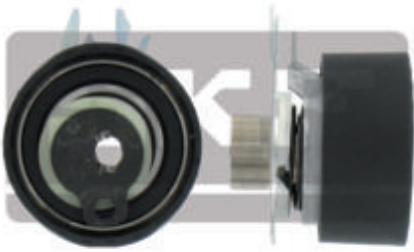

A⊙ D=60 W=27

**VKM 11115**

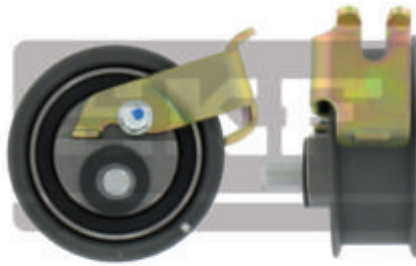

HT D=72 W=25

**VKM 11116**

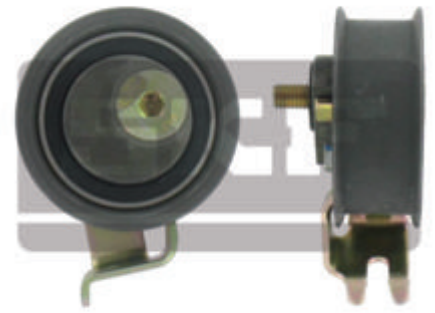

HT D=72 W=25

**VKM 11117**

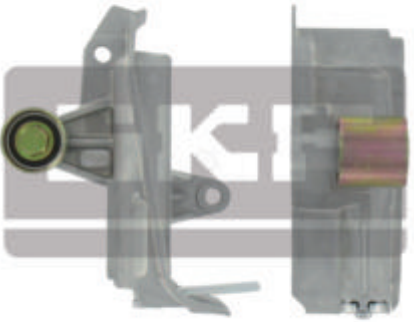

HT

**VKM 11120**

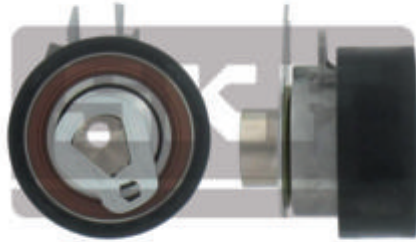

A⊙ D=60 W=25

**VKM 11121**

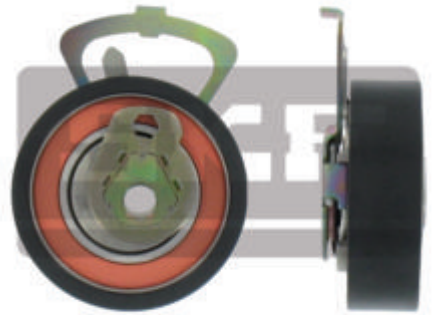

A⊙ D=60 W=18

**VKM 11124**



A⊙ D=60 W=19

**VKM 11130**



A⊙ D=68 W=26

**VKM 11141**

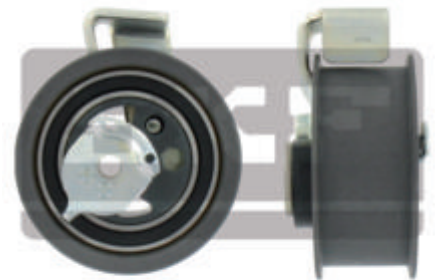

HT D=72 W=31

**VKM 11142**

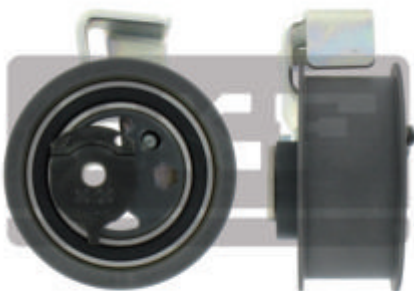

HT D=72 W=31

**VKM 11143**

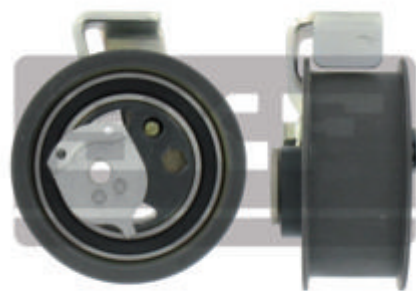

HT D=72 W=31

**VKM 11144**

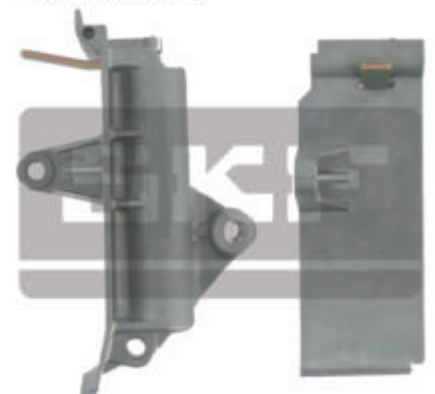

HT



**VKM 11145**

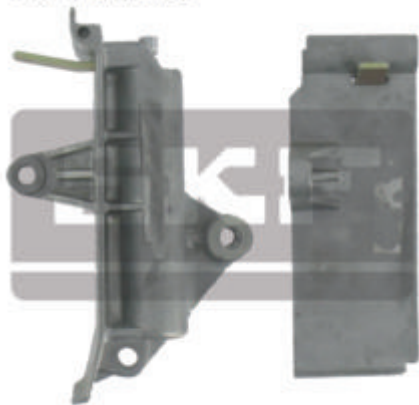

A⊙

**VKM 11150**

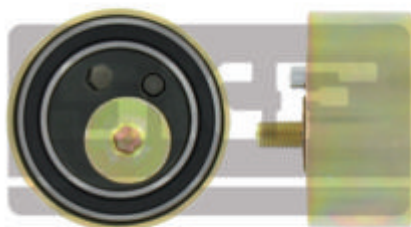

HT D=72 W=34

**VKM 11151**



A⊙ D=73 W=27

**VKM 11154**



HT

**VKM 11200**

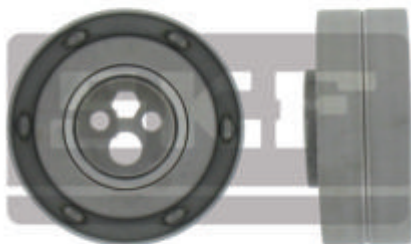

M⊙ D=72 W=27

**VKM 11201**

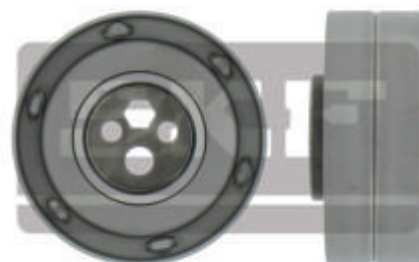

M⊙ D=72 W=27

**VKM 11202**



HT D=72 W=32

**VKM 11204**

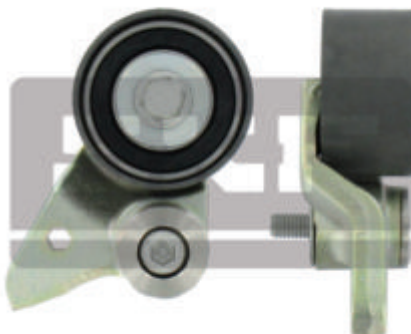

HT D=62 W=34

**VKM 11207**

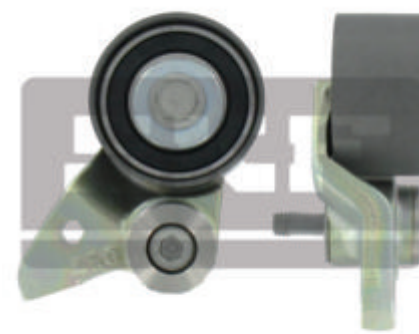

HT D=62 W=34

**VKM 11208**



HT

**VKM 11209**



HT

**VKM 11220**



A⊙ D=67,1 W=24,4



**VKM 11222**



A⊙ D=67 W=30

**VKM 11250**



A⊙ D=67 W=31

**VKM 11251**

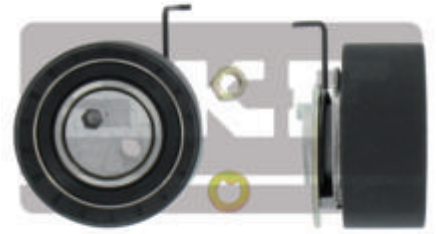

A⊙ D=47 W=30

**VKM 11255**

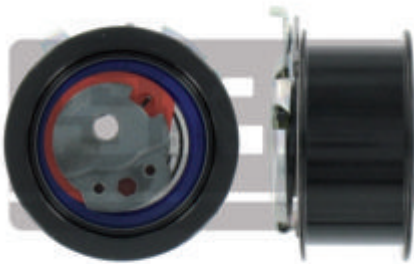

A⊙ D=68 W=31

**VKM 11256**

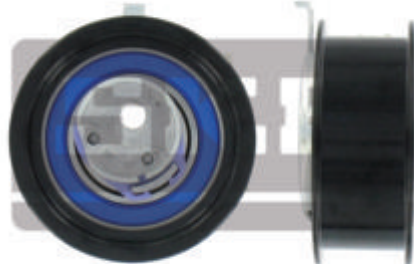

A⊙ D=67 W=25

**VKM 11257**

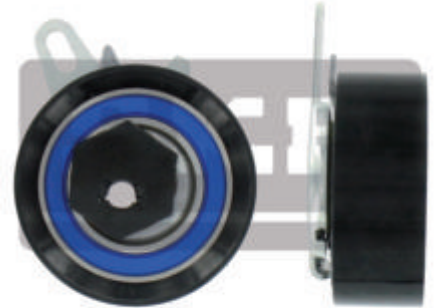

A⊙ D=73 W=27

**VKM 11258**

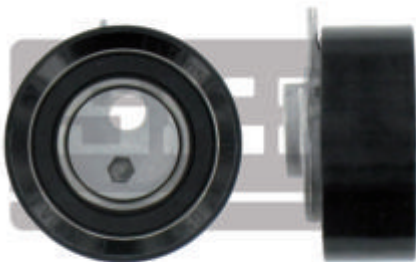

A⊙ D=63 W=24

**VKM 11265**

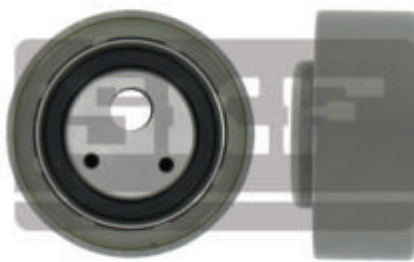

M⊙ D=60 W=24

**VKM 11266**

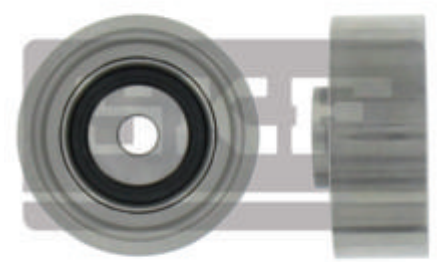

M⊙ D=64 W=24

**VKM 11300**

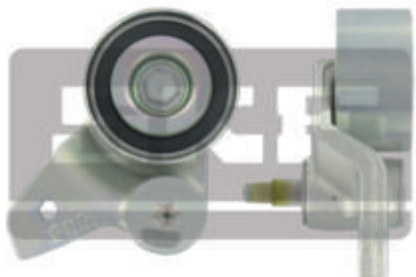

HT D=65 W=32,9

**VKM 11330**

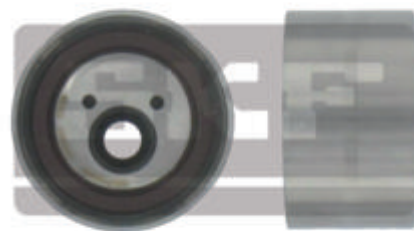

M⊙ D=58,75 W=34

**VKM 11331**

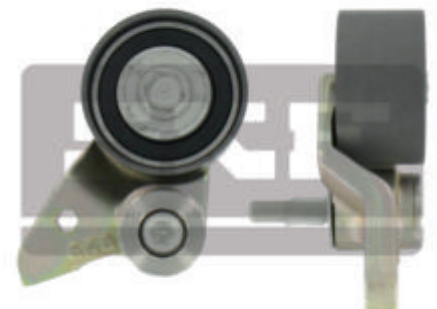

HT D=62 W=33,9



**VKM 11332**

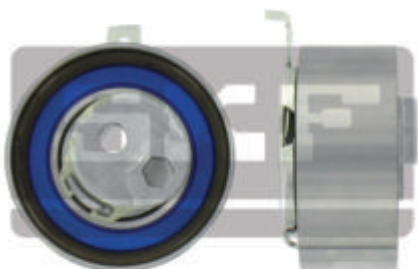

A⊙ D=67 W=32

**VKM 12001**



M⊙ D=67 W=28

**VKM 12003**

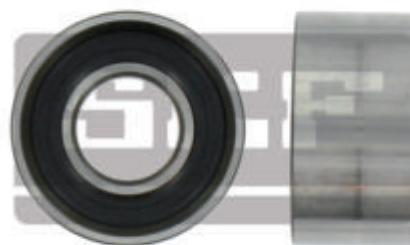

M⊙ D=65 W=29

**VKM 12004**



M⊙ D=67 W=26

**VKM 12005**

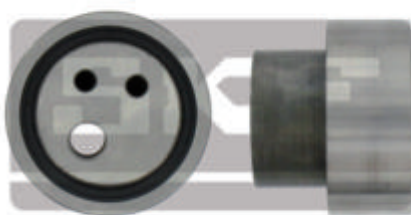

M⊙ D=60 W=25

**VKM 12012**

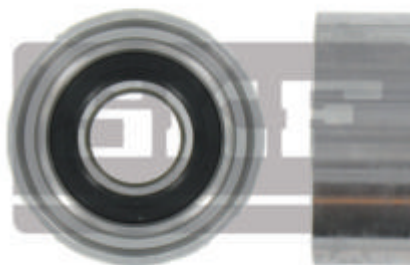

M⊙ D=71 W=28

**VKM 12100**



M⊙ D=60 W=29

**VKM 12101**

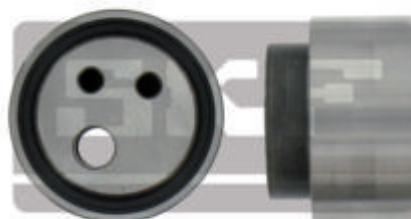

M⊙ D=65 W=27

**VKM 12150**

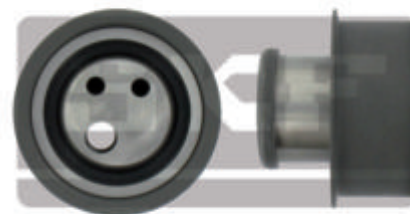

M⊙ D=61 W=27

**VKM 12151**

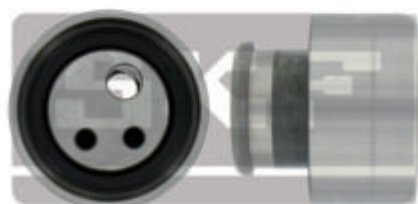

M⊙ D=61 W=30

**VKM 12153**



M⊙ D=61 W=30

**VKM 12160**



M⊙ D=65 W=33



**VKM 12172**

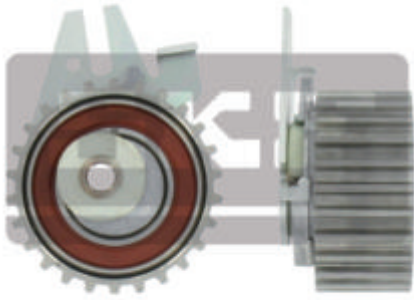

A⊙ D=65 W=30

**VKM 12173**

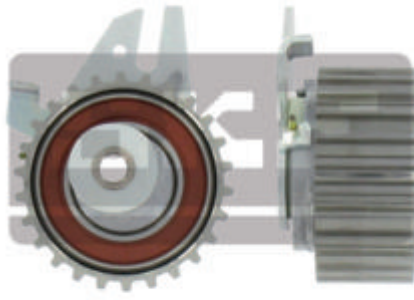

A⊙ D=65 W=29

**VKM 12174**

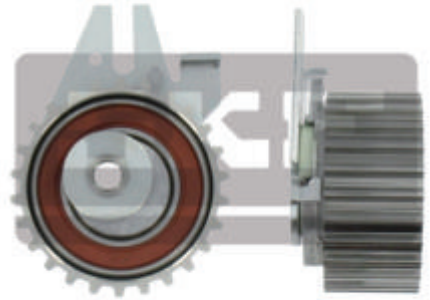

A⊙ D=65 W=30

**VKM 12182**

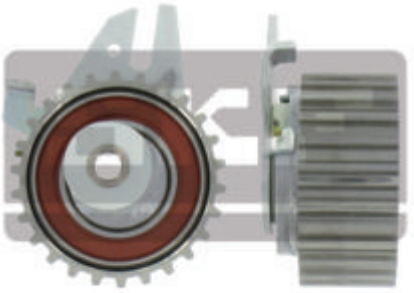

A⊙ D=65 W=29

**VKM 12200**



M⊙ D=57 W=24

**VKM 12201**

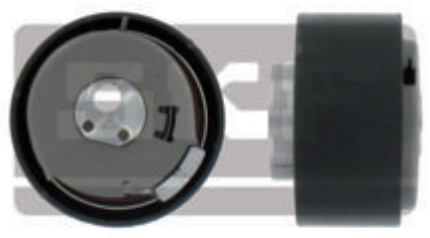

A⊙ D=60 W=29

**VKM 12206**

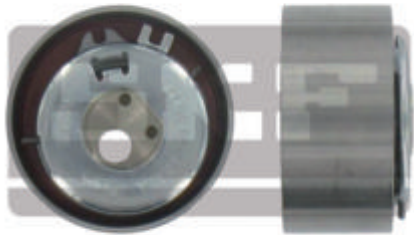

A⊙ D=55,5 W=26

**VKM 12215**

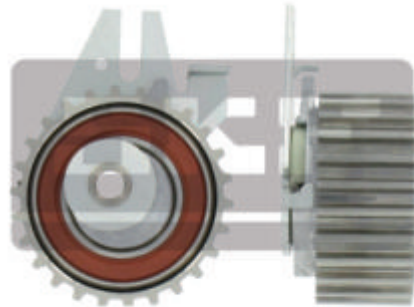

A⊙ D=65 W=29

**VKM 12227**

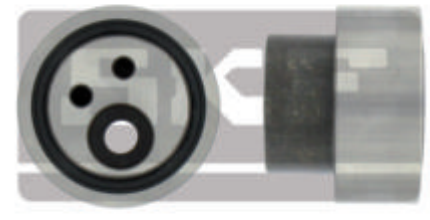

M⊙ D=60 W=25

**VKM 12242**

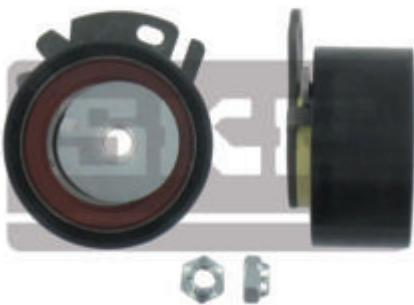

A⊙ D=60 W=29

**VKM 12277**



A⊙ D=59 W=16

**VKM 12390**



A⊙ D=69 W=34



**VKM 12400**

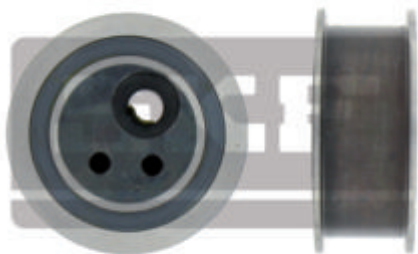

M⊙ D=60 W=22

**VKM 12500**

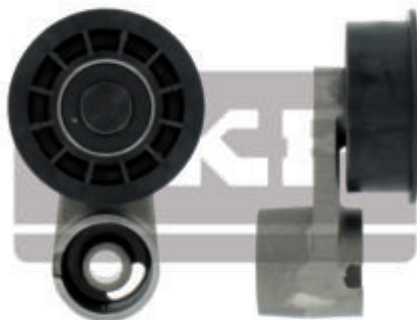

M⊙ D=68 W=25

**VKM 12501**

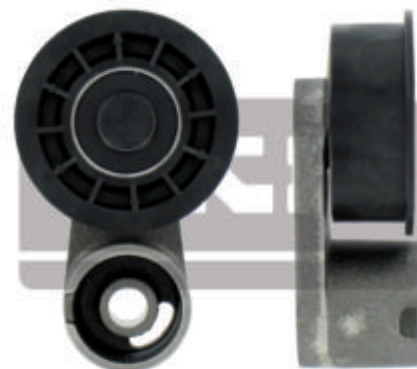

M⊙ D=60 W=25

**VKM 12630**

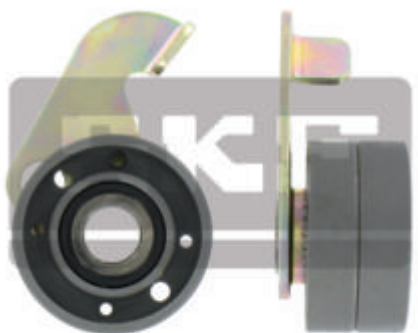

M⊙ D=60 W=31

**VKM 12700**



M⊙ D=59 W=23

**VKM 13050**



M⊙ D=68 W=36

**VKM 13100**



M⊙ D=59 W=22

**VKM 13120**

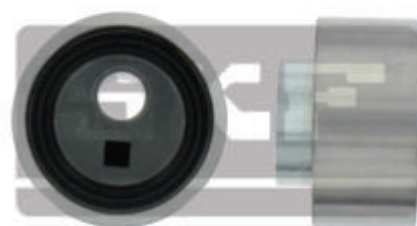

M⊙ D=59 W=29

**VKM 13130**

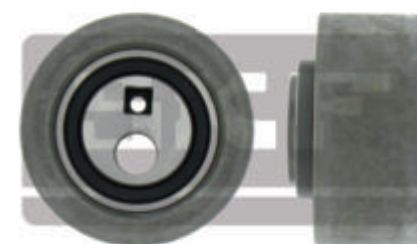

M⊙ D=70 W=32

**VKM 13132**

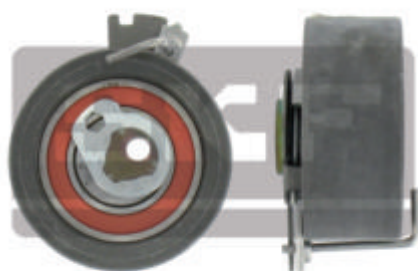

A⊙ D=73 W=31

**VKM 13140**

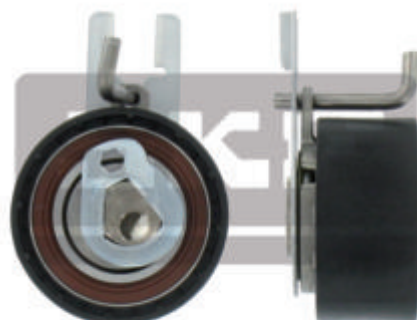

A⊙ D=60 W=29

**VKM 13200**



M⊙ D=57 W=24



**VKM 13202**

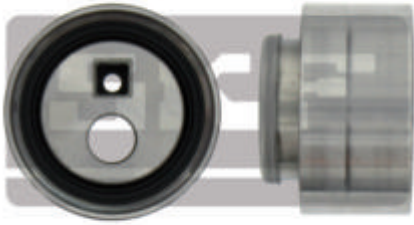

M ⊙ D=57 W=29

**VKM 13210**



M ⊙ D=57 W=31

**VKM 13211**

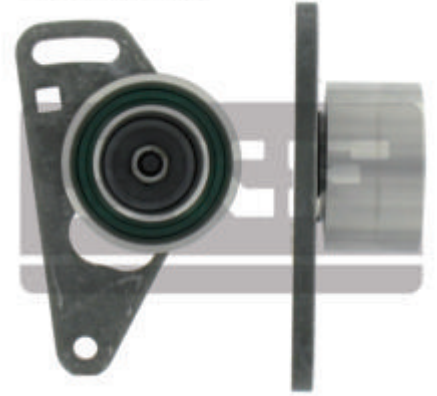

M ⊙ D=57 W=31

**VKM 13214**

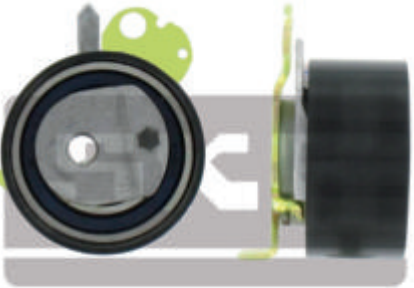

A ⊙ D=60 W=29

**VKM 13216**

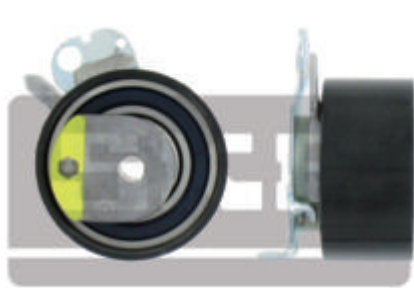

A ⊙ D=60 W=29

**VKM 13218**

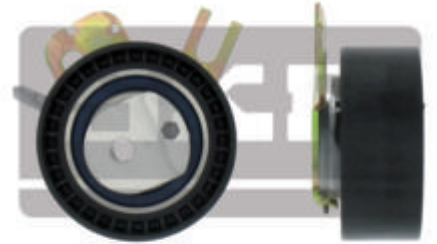

A ⊙ D=74 W=29

**VKM 13220**

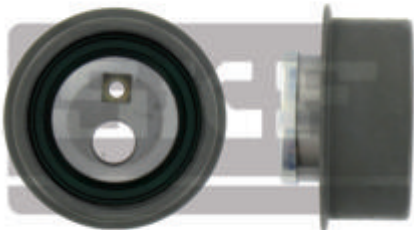

M ⊙ D=59 W=26

**VKM 13231**



A ⊙ D=60 W=29

**VKM 13234**



A ⊙ D=62 W=29

**VKM 13240**



M D=60 W=34

**VKM 13241**

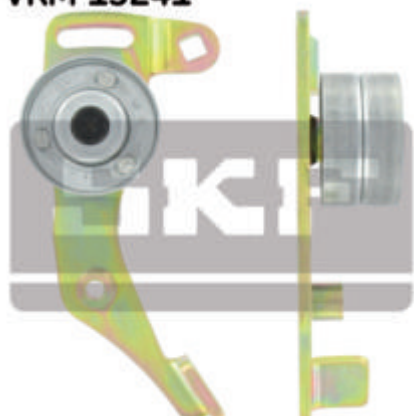

M ⊙ D=60 W=34

**VKM 13244**

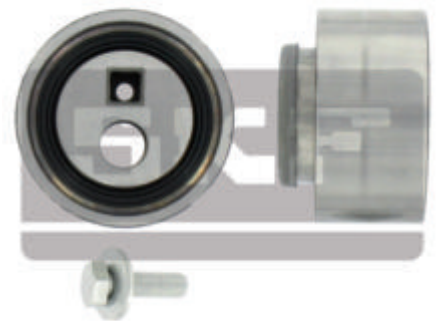

M ⊙ D=60 W=34



VKM 13246

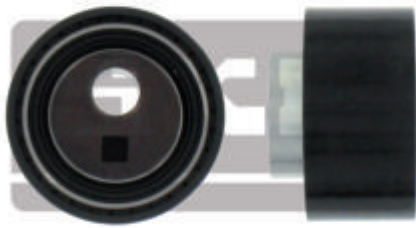

M⊙ D=60 W=30

VKM 13250

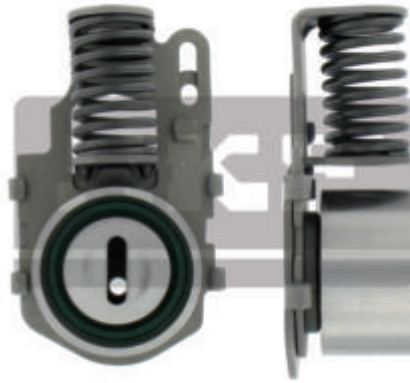

A⊙ D=57 W=31

VKM 13253

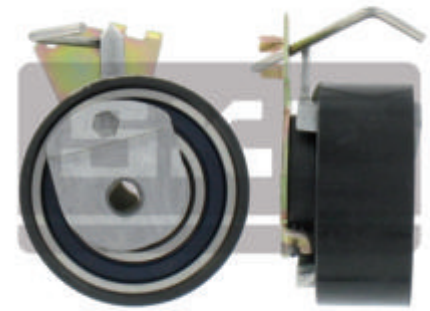

A⊙ D=60 W=25

VKM 13256

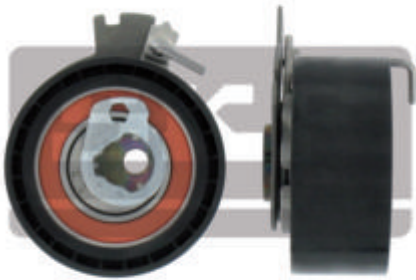

A⊙ D=70 W=30

VKM 13257

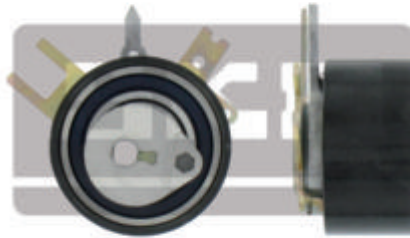

A⊙ D=60 W=29

VKM 13258

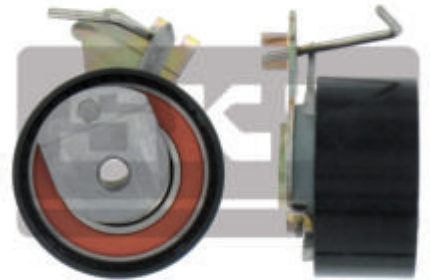

A⊙ D=60 W=29

VKM 13262



A⊙ D=69 W=34,3

VKM 13263

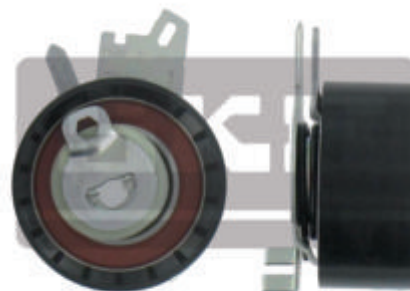

A⊙ D=62 W=29

VKM 13264

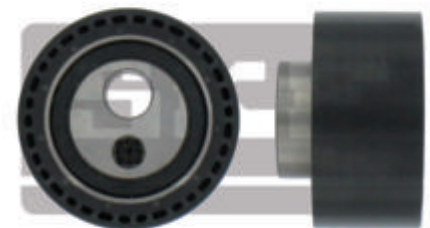

M⊙ D=62 W=30,1

VKM 13300

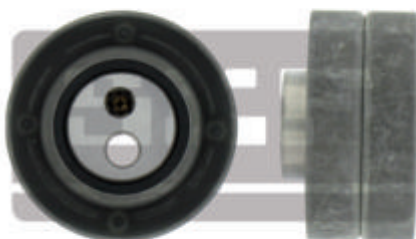

M⊙ D=71 W=32

VKM 13301

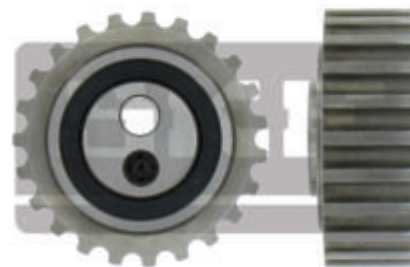

M⊙ D=68 W=23

VKM 13304

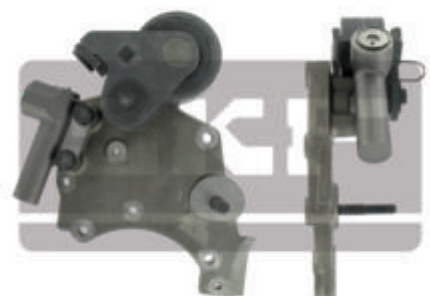

HT D=70 W=38



**VKM 13902**



A⊙ D=70 W=32

**VKM 14000**

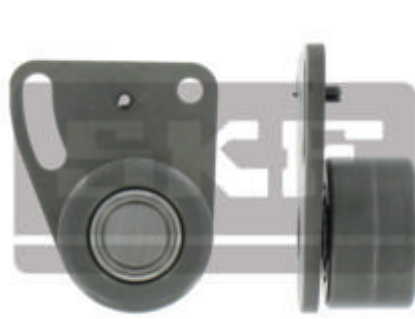

M⊙ D=47 W=26

**VKM 14100**

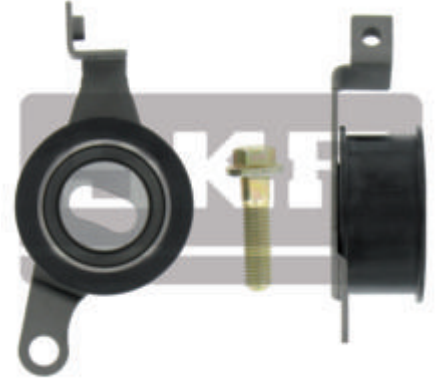

M⊙ D=52 W=22

**VKM 14101**

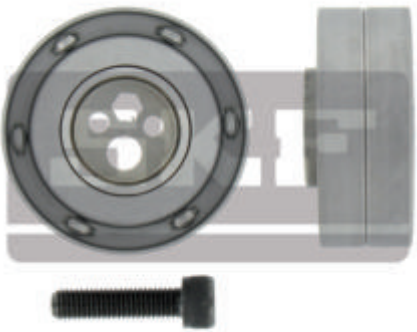

M⊙ D=73 W=28

**VKM 14103**

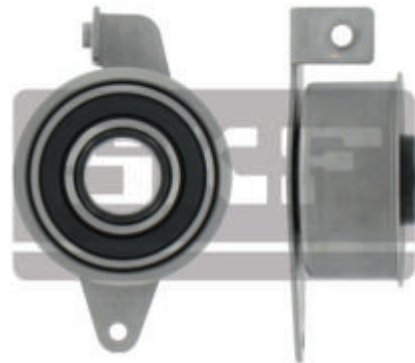

M⊙ D=60 W=26

**VKM 14105**



M⊙ D=52 W=26

**VKM 14107**

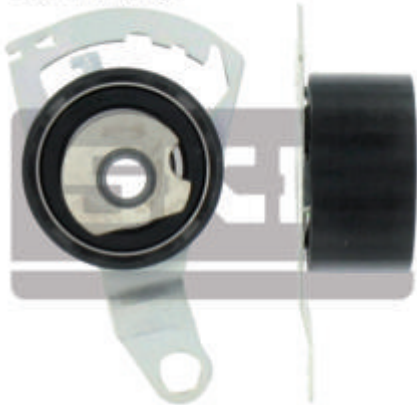

A⊙ D=50 W=25

**VKM 14108**

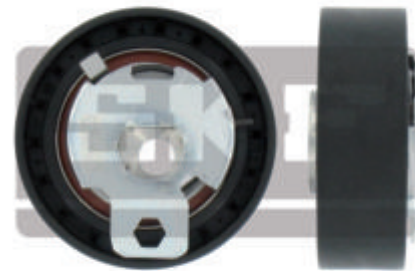

A⊙ D=74 W=24

**VKM 14200**



M⊙ D=47 W=39

**VKM 14201**



M⊙ D=57 W=30

**VKM 14204**

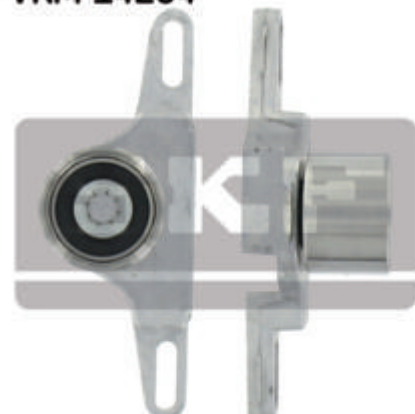

M⊙ D=47 W=32

**VKM 14210**

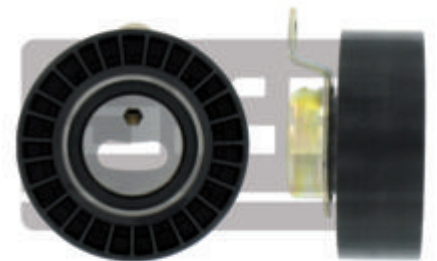

M⊙ D=86 W=30



VKM 14211

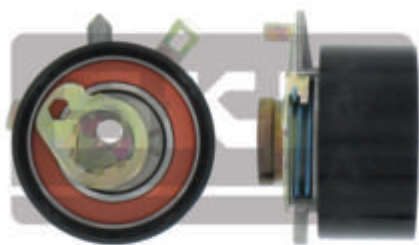

A⊙ D=60 W=29

VKM 14216



A⊙ D=60 W=29

VKM 14220

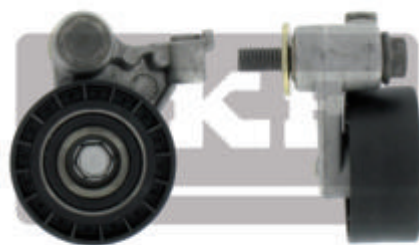

HT D=62 W=27

VKM 14222

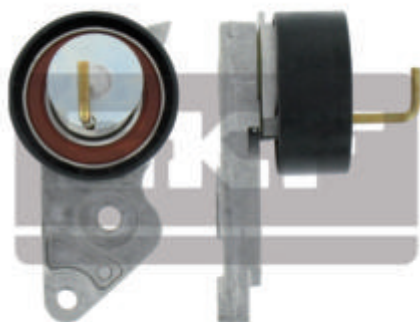

A⊙ D=62 W=26

VKM 14224

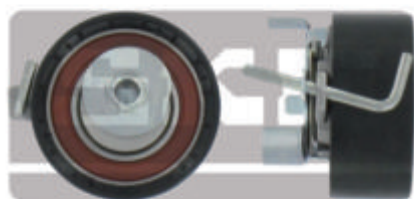

A⊙ D=62,1 W=26,5

VKM 14300



M⊙ D=63 W=30

VKM 14301



M⊙ D=60 W=32

VKM 15121

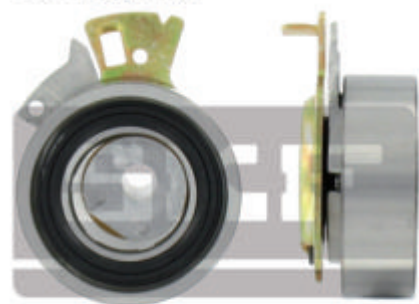

A⊙ D=59 W=19

VKM 15140

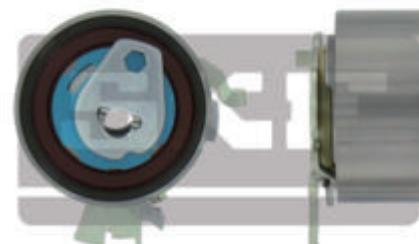

A⊙ D=59 W=26

VKM 15202

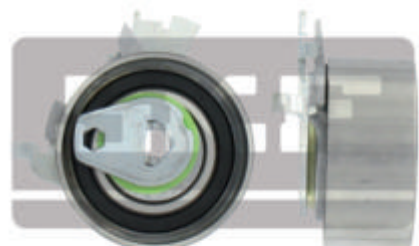

A⊙ D=59 W=26

VKM 15210

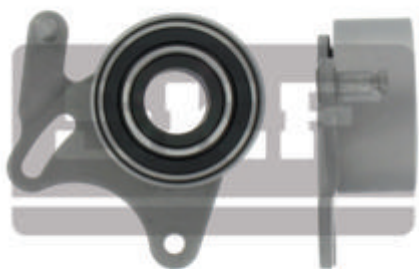

M⊙ D=65 W=28

VKM 15211

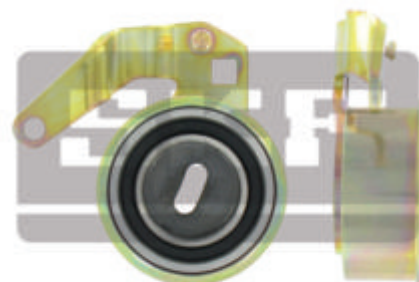

M⊙ D=67 W=27



**VKM 15213**



M D=65 W=29

**VKM 15215**

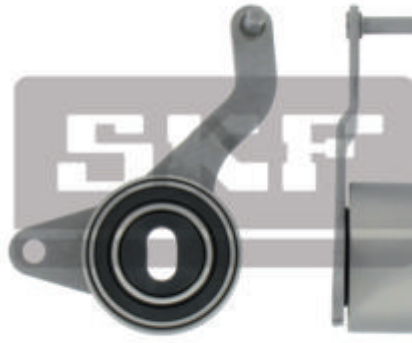

M⊙ D=65 W=28

**VKM 15216**

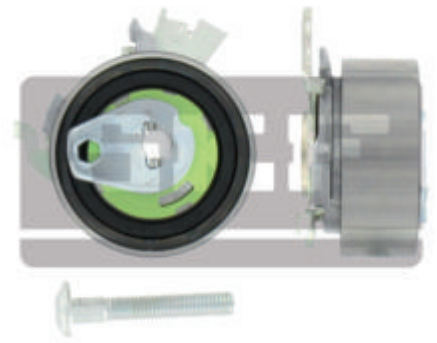

A⊙ D=60 W=22

**VKM 15218**

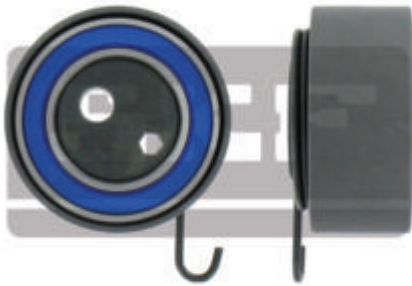

M⊙ D=65 W=28

**VKM 15220**



HT D=72 W=28

**VKM 15230**

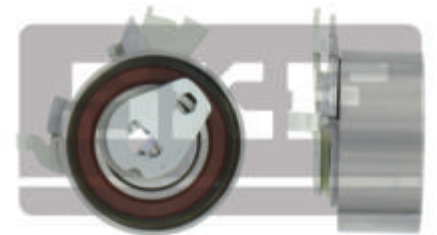

A⊙ D=59 W=26

**VKM 15260**

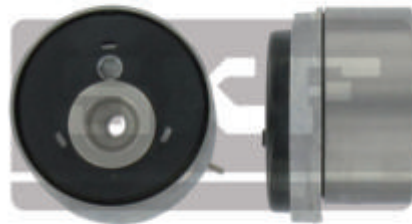

A⊙ D=66 W=29

**VKM 15402**



A⊙ D=59 W=22

**VKM 16000**

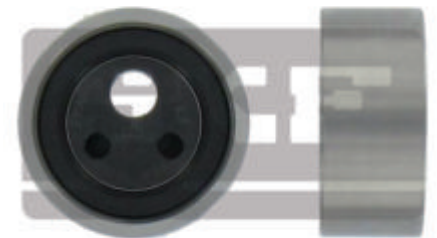

M⊙ D=50 W=22

**VKM 16001**

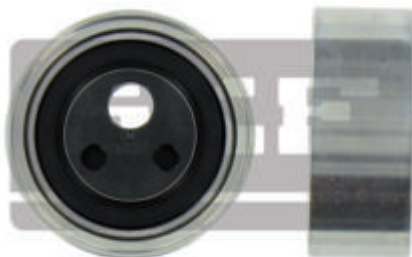

M⊙ D=55 W=22

**VKM 16002**

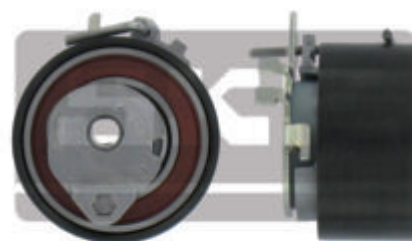

A⊙ D=59 W=28

**VKM 16003**

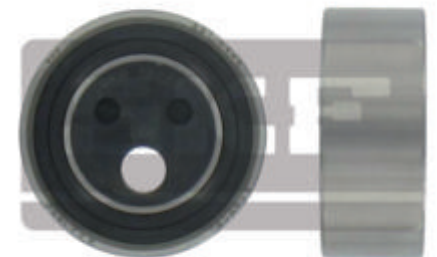

M⊙ D=55 W=22



VKM 16020

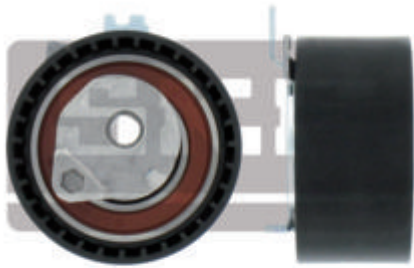

A⊙ D=65 W=32

VKM 16021

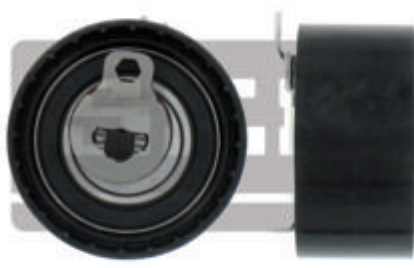

A⊙ D=66 W=32

VKM 16040

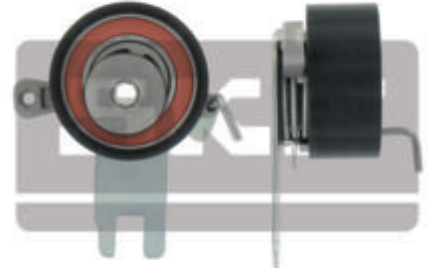

A⊙ D=60 W=26,65

VKM 16100

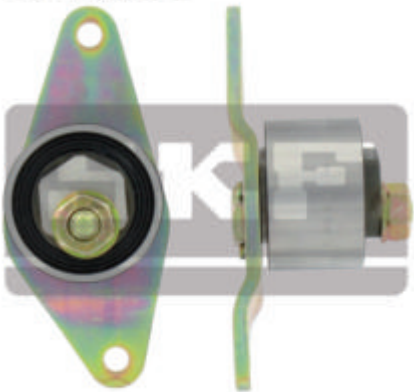

M⊙ D=50 W=31

VKM 16101



M⊙ D=50 W=31

VKM 16102



A⊙ D=60 W=32

VKM 16110



M⊙ D=50 W=31

VKM 16112



M⊙ D=50 W=31

VKM 16113

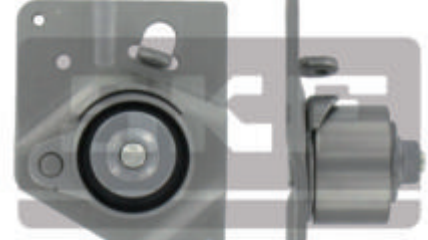

M⊙ D=50 W=30

VKM 16129

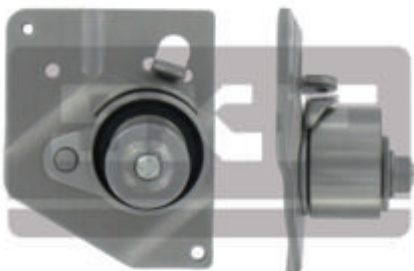

M⊙ D=50 W=31

VKM 16200

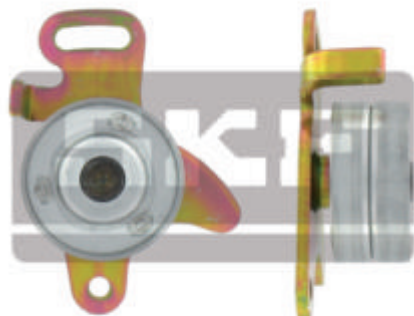

M⊙ D=60 W=28

VKM 16204

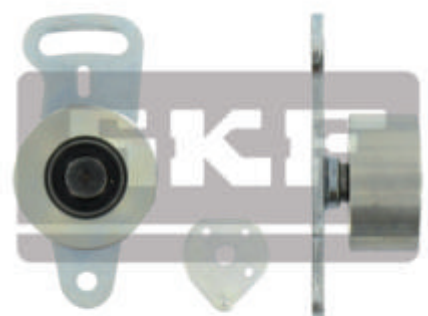

M⊙ D=55 W=26



**VKM 16212**

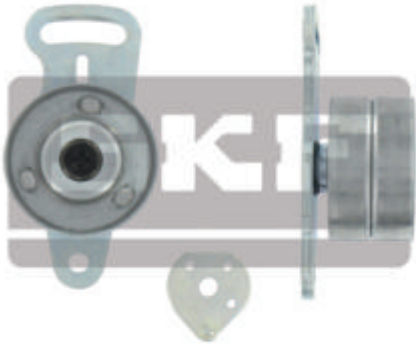

M⊙ D=60 W=33

**VKM 16220**

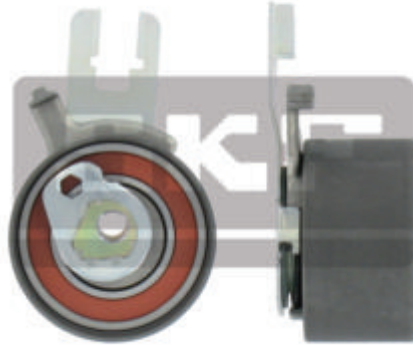

A⊙ D=59 W=32

**VKM 16300**



HT D=47 W=31

**VKM 16400**

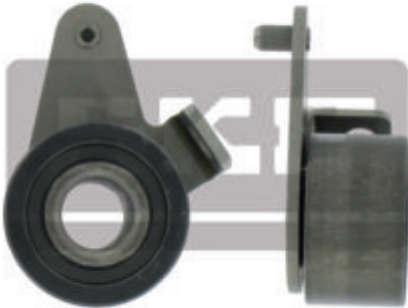

HT D=85 W=31

**VKM 16402**

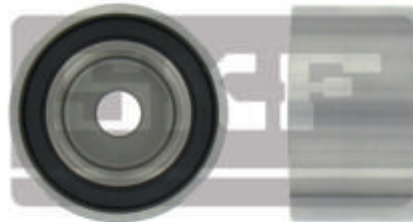

HT D=53 W=30

**VKM 16410**

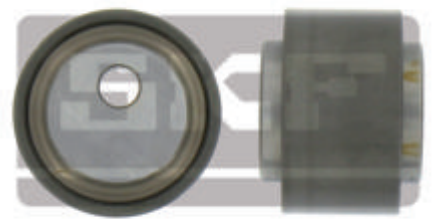

M⊙ D=36 W=21

**VKM 16501**

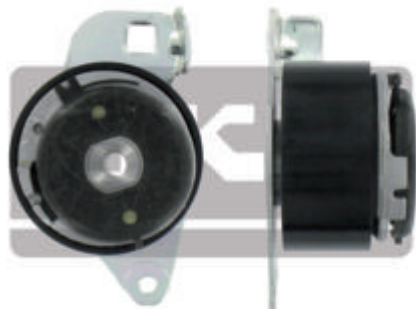

A⊙ D=66 W=30

**VKM 16503**



A⊙ D=70 W=32

**VKM 16550**

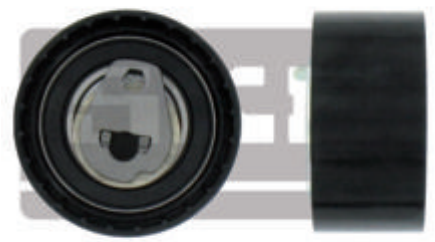

A⊙ D=66 W=32

**VKM 16551**



A⊙ D=65 W=30

**VKM 16560**



HT D=53 W=32

**VKM 16600**



HT D=47 W=27



**VKM 16602**



HT D=53 W=27

**VKM 16604**

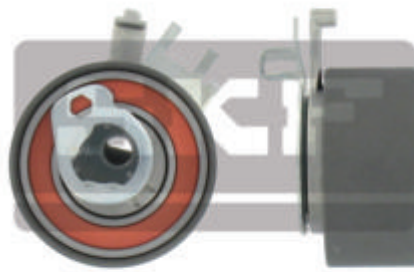

A⊙ D=59 W=27

**VKM 16612**

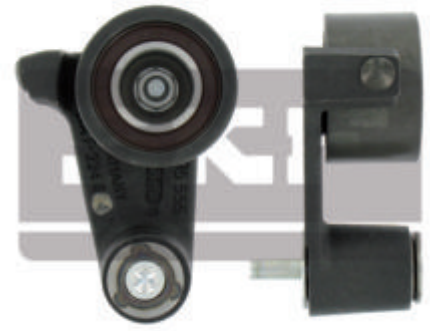

HT D=53 W=32

**VKM 16800**

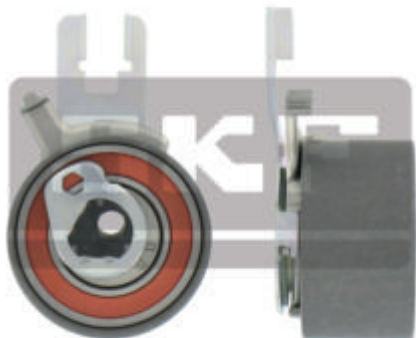

A⊙ D=59 W=32

**VKM 17000**

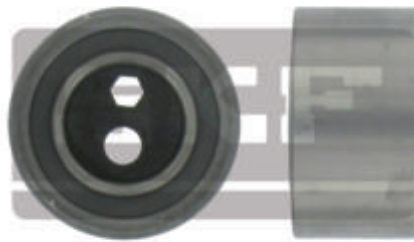

M⊙ D=60 W=31,9

**VKM 17110**

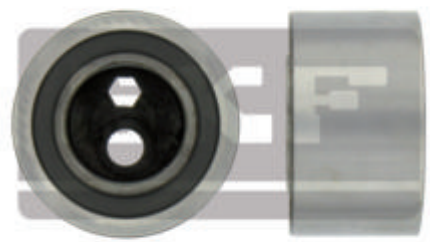

M⊙ D=60 W=34

**VKM 17200**



M⊙ D=47 W=27

**VKM 17300**

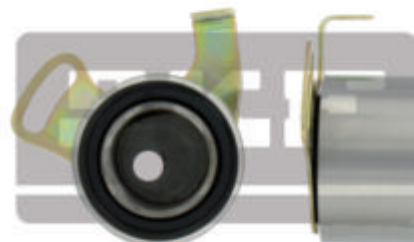

M⊙ D=55 W=32

**VKM 17301**



A⊙ D=59 W=28

**VKM 17302**



M⊙ D=60 W=32

**VKM 17303**



M⊙ D=60 W=34

**VKM 17304**

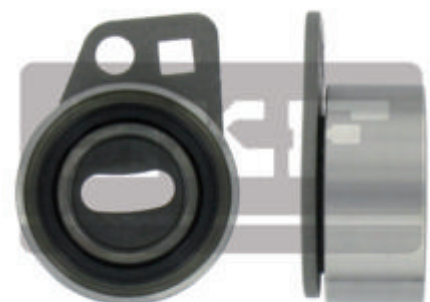

M⊙ D=60 W=26



**VKM 17305**

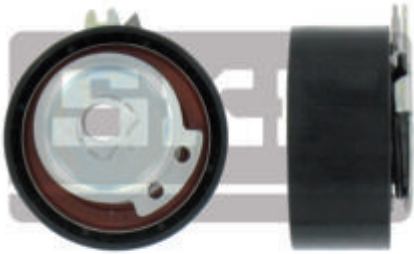

A⊙ D=60 W=26

**VKM 17310**

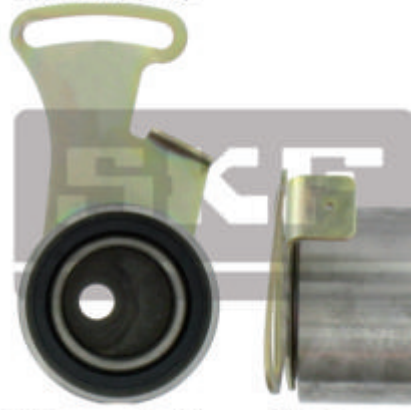

M⊙ D=55 W=32

**VKM 17400**

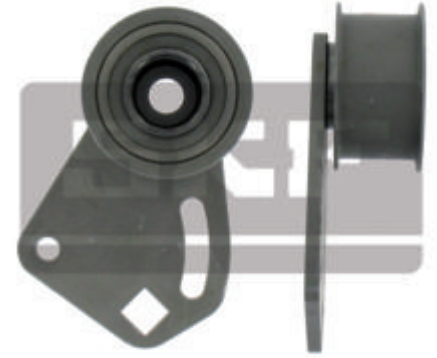

M⊙ D=50 W=26

**VKM 18000**

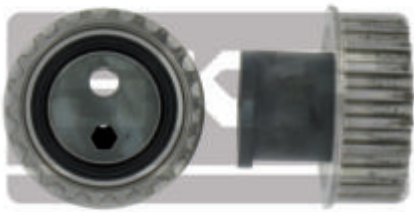

M⊙ D=65 W=25

**VKM 18001**

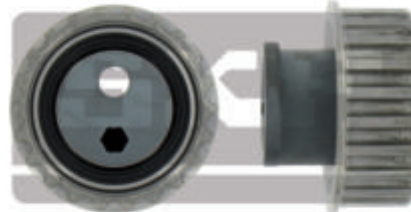

M⊙ D=71 W=23

**VKM 18100**

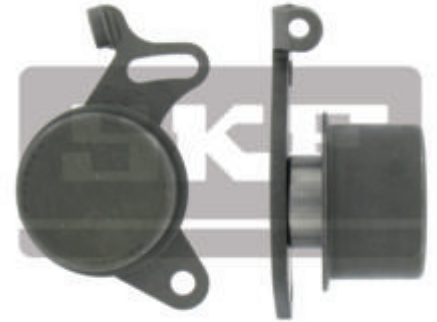

M⊙ D=50 W=30

**VKM 18120**



M⊙ D=67 W=33

**VKM 18200**



M⊙ D=62 W=22

**VKM 21004**



D=29 W=29

**VKM 21012**



D=29 W=29

**VKM 21031**

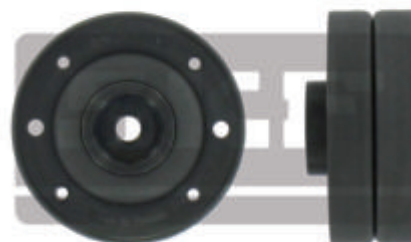

D=75 W=28

**VKM 21032**

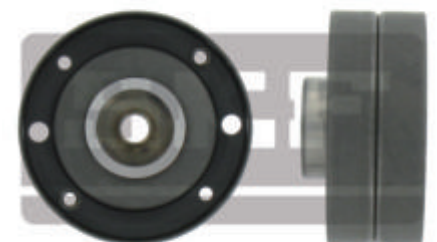

D=69 W=27



**VKM 21041**

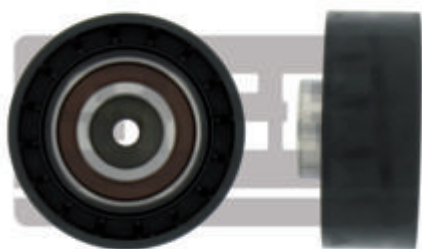

D=71 W=28

**VKM 21045**

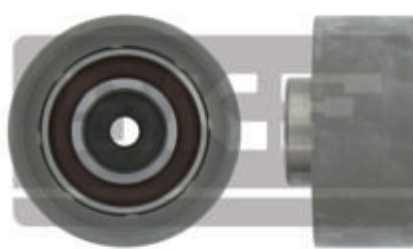

D=64 W=28

**VKM 21052**

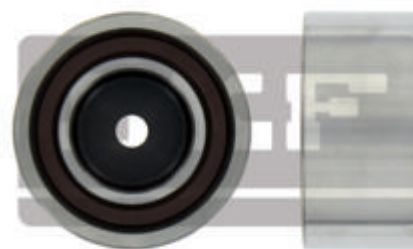

D=59 W=29

**VKM 21115**

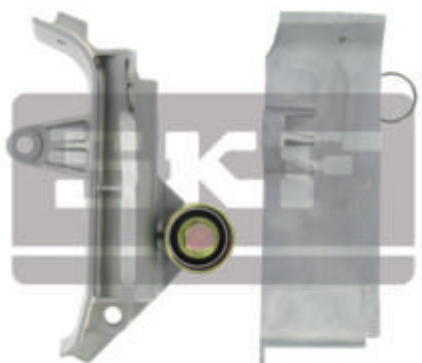

D=29 W=27

**VKM 21120**



D=56 W=22

**VKM 21121**



D=29 W=29

**VKM 21122**

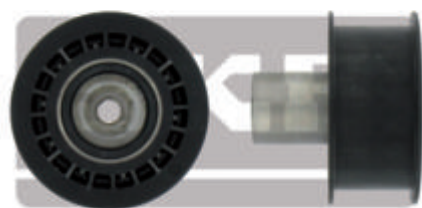

D=56 W=26

**VKM 21130**

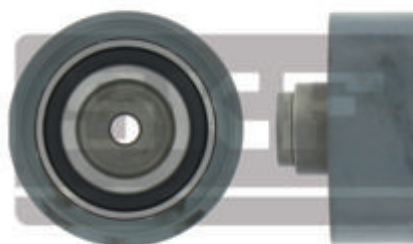

D=80 W=29

**VKM 21131**



D=29 W=29

**VKM 21142**



D=28 W=34

**VKM 21147**



D=40 W=36

**VKM 21150**

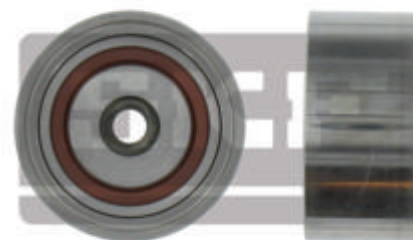

D=70 W=34





**VKM 21151**

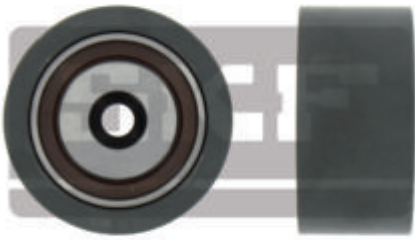

D=70 W=34

**VKM 21201**

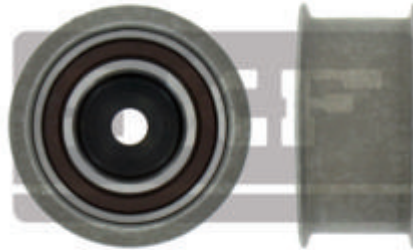

D=59 W=26

**VKM 21202**

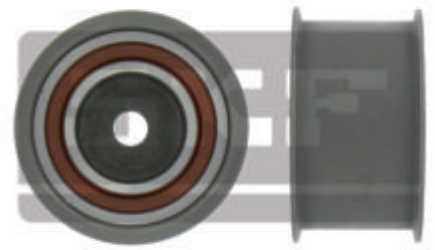

D=59 W=31

**VKM 21203**



D=28 W=34

**VKM 21204**

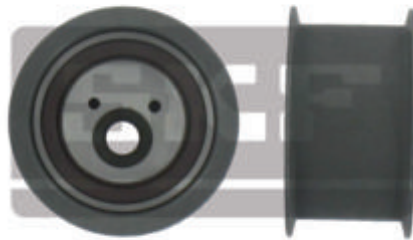

D=57,9 W=31

**VKM 21220**

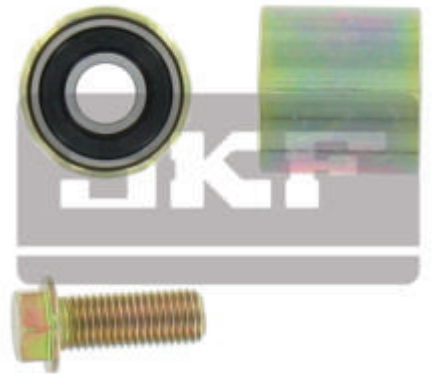

D=29 W=27

**VKM 21256**

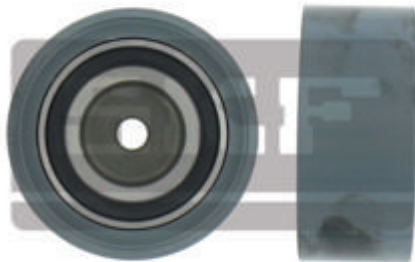

D=80 W=34

**VKM 21302**

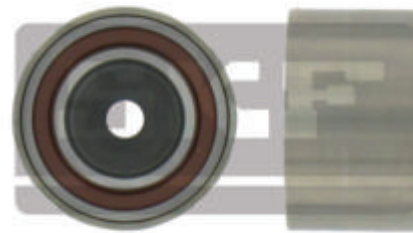

D=59 W=34

**VKM 21330**

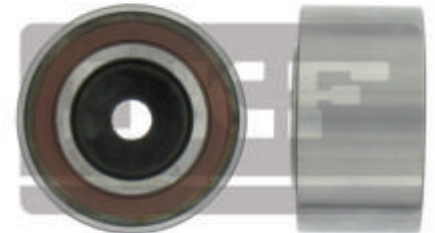

D=65 W=34

**VKM 22150**

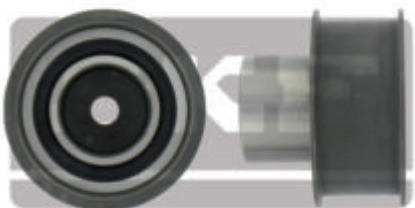

D=69 W=27

**VKM 22151**

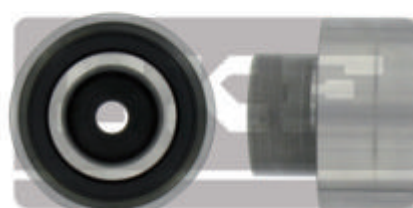

D=61 W=30

**VKM 22153**

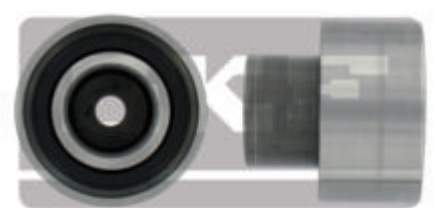

D=61 W=33

VKM 22155

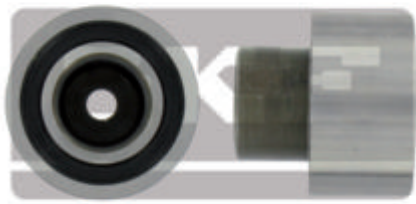

D=62 W=33

VKM 22160



D=71 W=33

VKM 22174

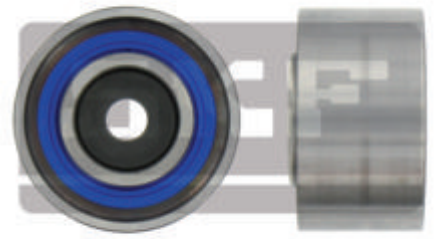

D=53 W=29

VKM 22177



D=57 W=29

VKM 22179

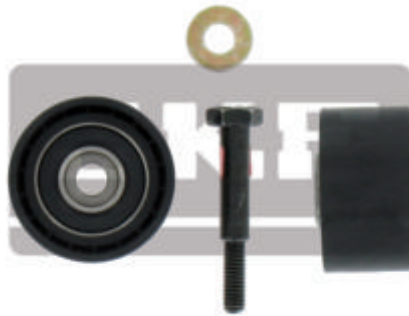

D=53 W=29

VKM 22180

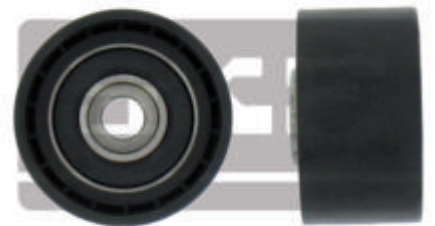

D=53 W=29

VKM 22242



D=65 W=30

VKM 22380



D=64 W=34

VKM 22385



D=67 W=34

VKM 22390



D=71 W=34

VKM 22510



D=60 W=22

VKM 22540

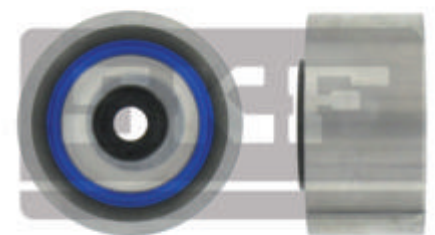

D=68 W=34





VKM 22541

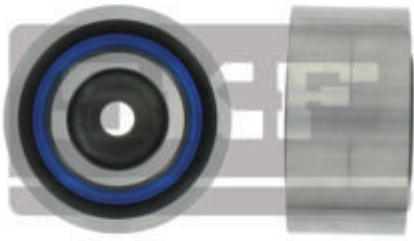

D=68 W=34

VKM 22630

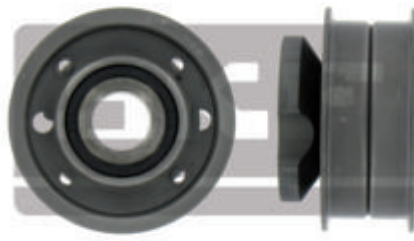

D=57 W=26

VKM 23120

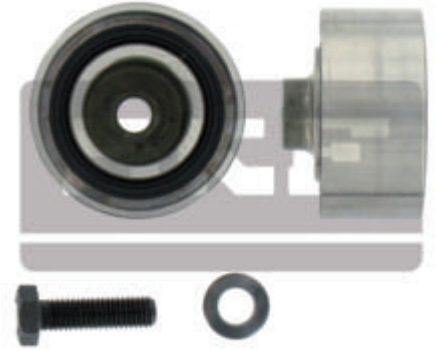

D=60 W=29

VKM 23122

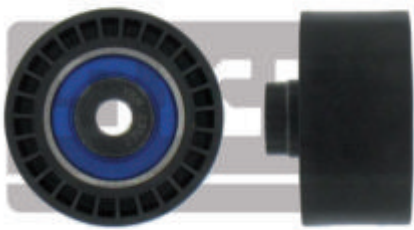

D=60 W=30

VKM 23130

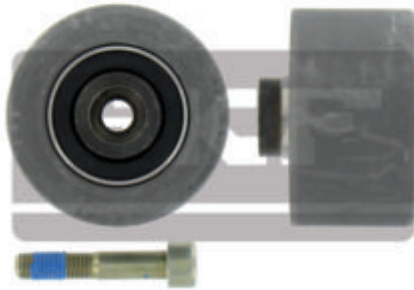

D=57 W=32

VKM 23140

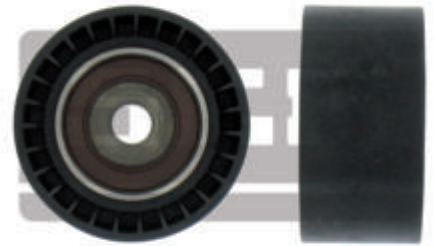

D=60 W=30

VKM 23213

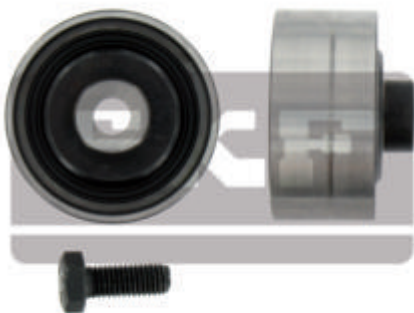

D=60 W=29

VKM 23214

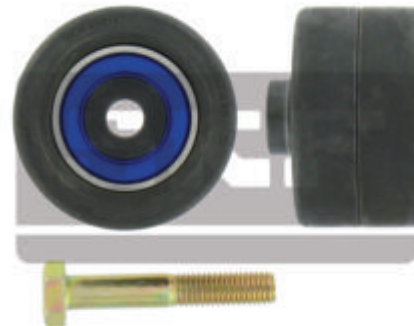

D=60 W=34

VKM 23218

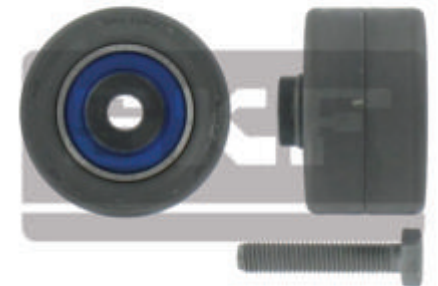

D=60 W=34

VKM 23230

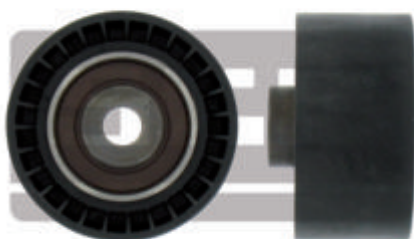

D=60 W=31

VKM 23240

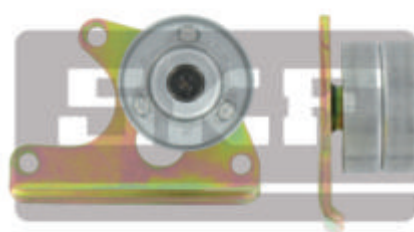

D=60 W=34

VKM 23241



D=60 W=33

VKM 23246

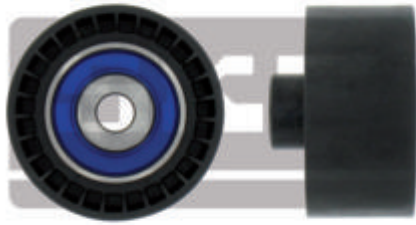

D=60 W=30

VKM 23256

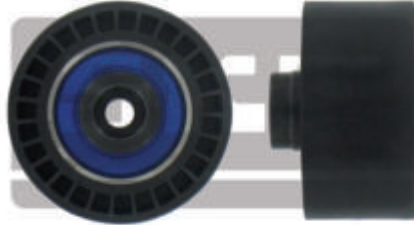

D=60 W=30

VKM 23257

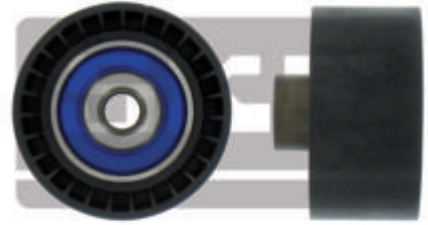

D=60 W=30

VKM 23258

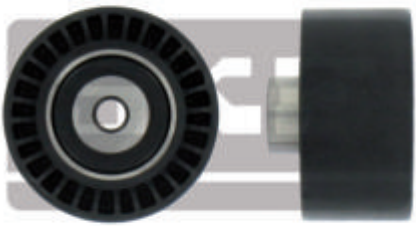

D=60 W=30

VKM 23261

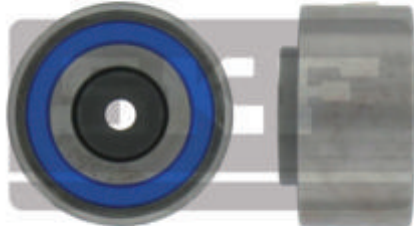

D=69 W=34

VKM 23264

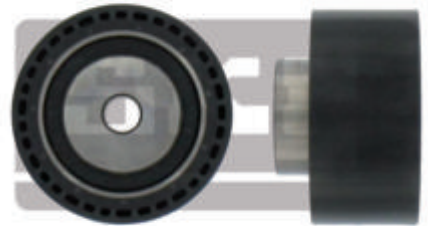

D=62 W=30,1

VKM 23300

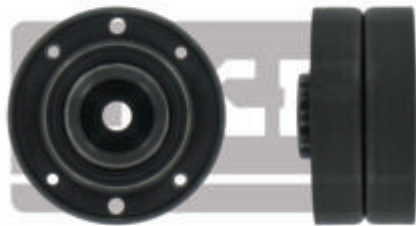

D=71 W=32

VKM 23304

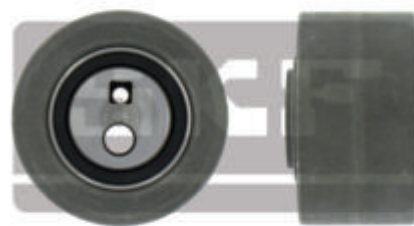

D=71 W=38

VKM 23900

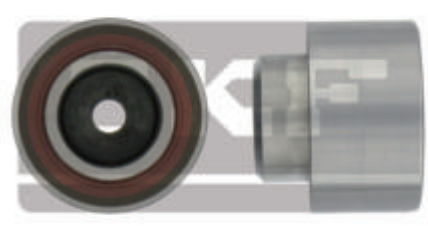

D=65 W=36

VKM 23901

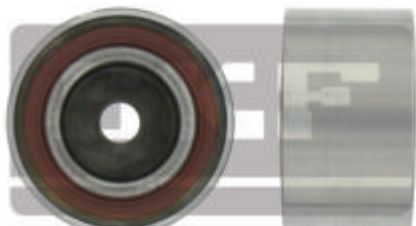

D=65 W=36

VKM 24100



D=24 W=19

VKM 24104

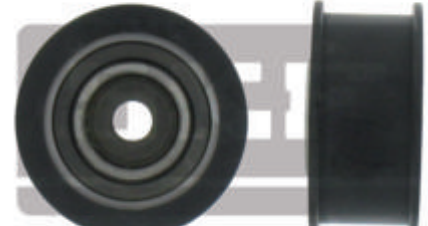

D=52 W=22





**VKM 24107**

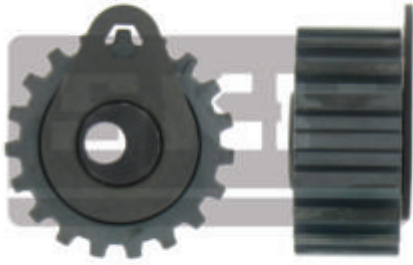

D=58 W=25

**VKM 24210**

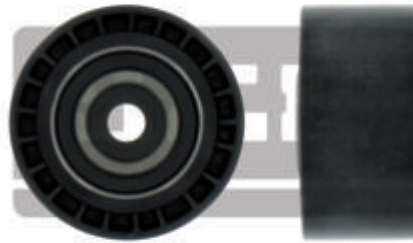

D=60 W=29

**VKM 24211**

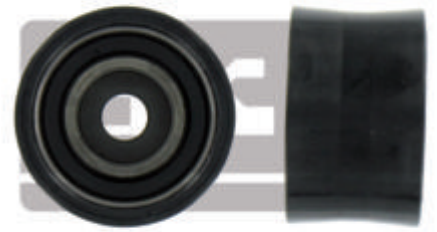

D=46 W=29

**VKM 24212**

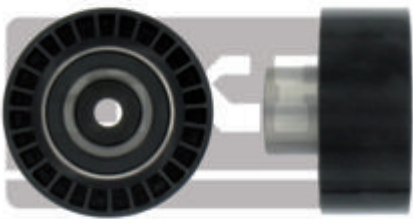

D=70 W=29

**VKM 24213**

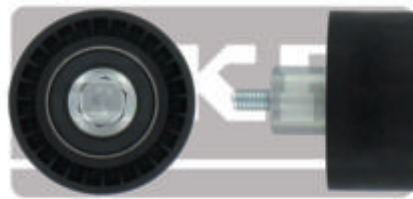

D=60 W=29

**VKM 24214**



D=47 W=29

**VKM 25150**

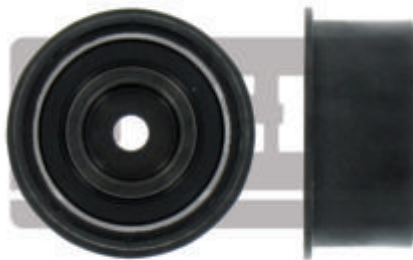

D=52 W=23

**VKM 25152**

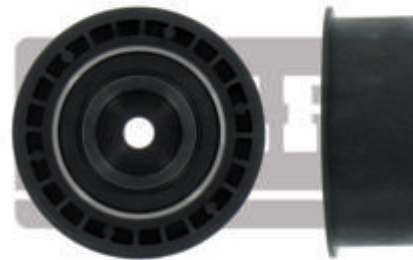

D=63 W=23

**VKM 25158**

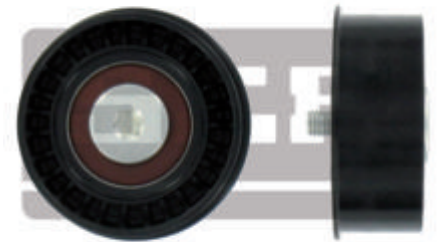

D=63 W=23

**VKM 25200**

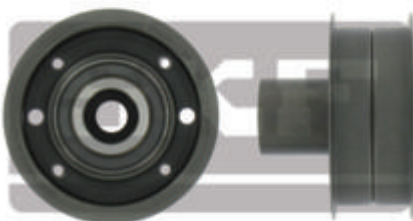

D=79 W=27

**VKM 25201**

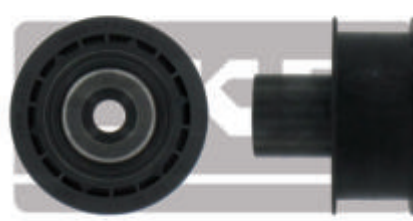

D=58 W=27

**VKM 25202**

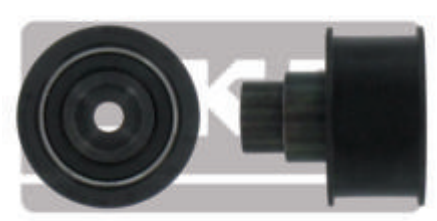

D=53 W=27

VKM 25208

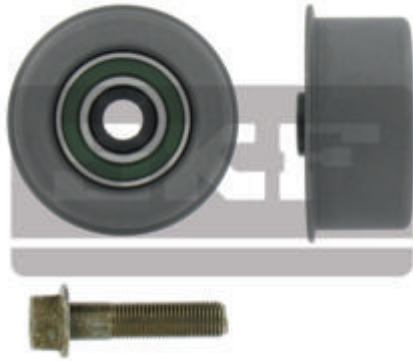

D=65 W=27

VKM 25209

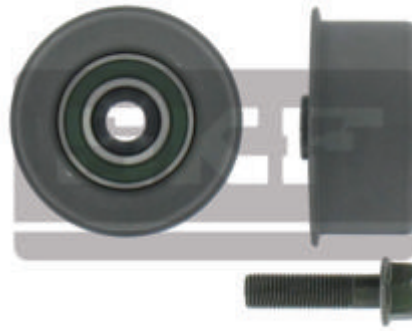

D=65.1 W=31,4

VKM 25211

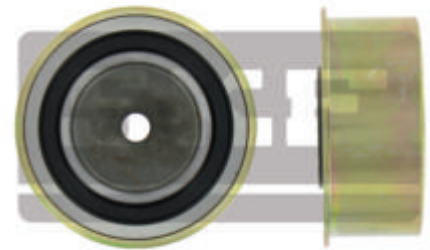

D=67 W=29

VKM 25212

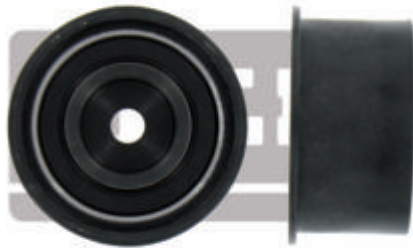

D=52 W=27

VKM 25213

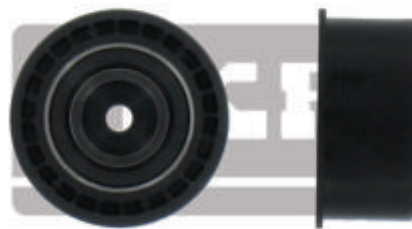

D=63 W=27

VKM 25222

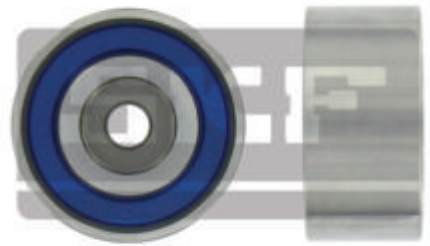

D=58 W=28

VKM 25224

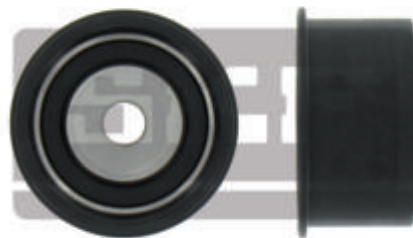

D=54 W=27

VKM 25226

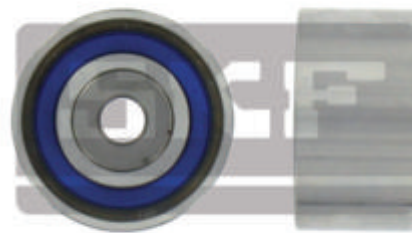

D=52 W=28

VKM 25312

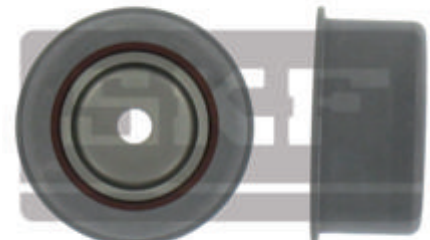

D=53 W=22

VKM 26020

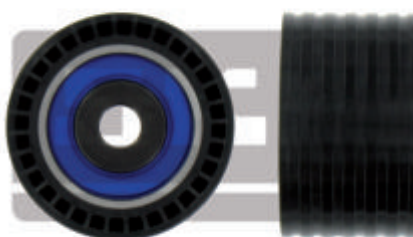

D=54 W=32

VKM 26100

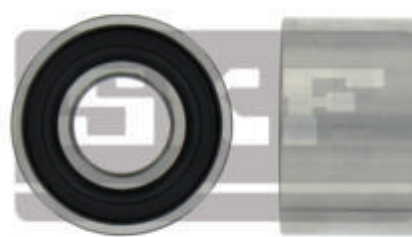

D=50 W=31

VKM 26101



D=50 W=31





**VKM 26102**



D=50 W=31

**VKM 26105**

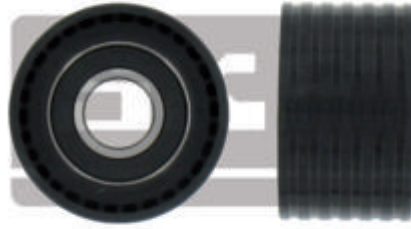

D=54 W=32

**VKM 26115**



D=65 W=31

**VKM 26117**

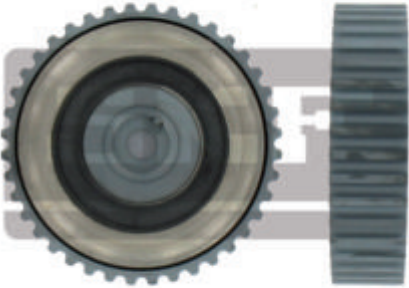

D=120 W=30

**VKM 26123**

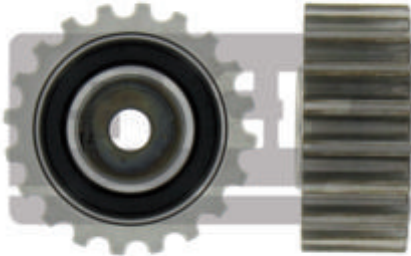

D=61 W=25

**VKM 26125**

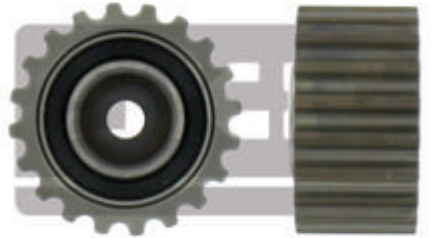

D=60 W=31

**VKM 26128**



D=65 W=31

**VKM 26211**

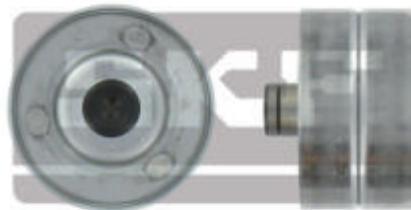

D=60 W=33

**VKM 26212**

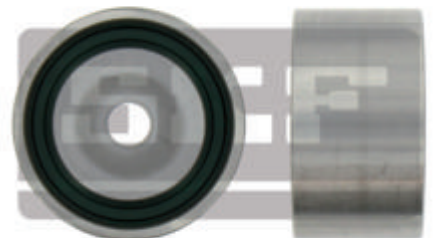

D=57 W=31

**VKM 26220**

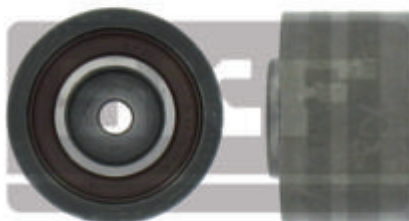

D=53 W=32

**VKM 26310**

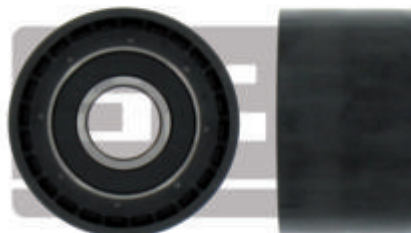

D=54 W=32

**VKM 26400**

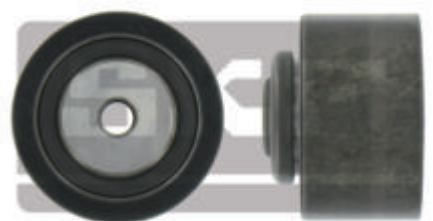

D=53 W=30



**VKM 26402**

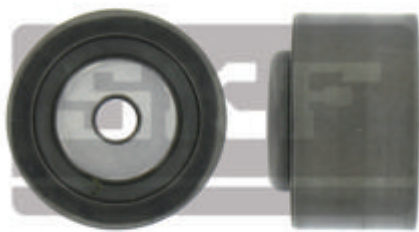

D=53 W=30

**VKM 26500**

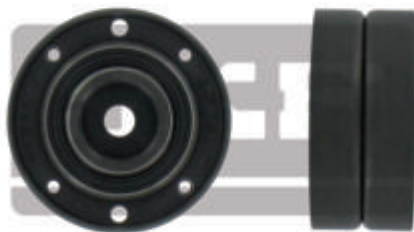

D=71 W=32

**VKM 26501**

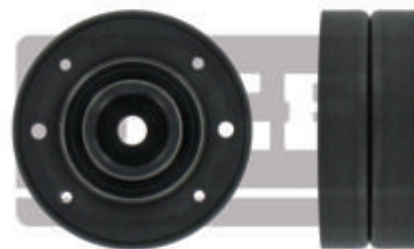

D=80 W=32

**VKM 26502**

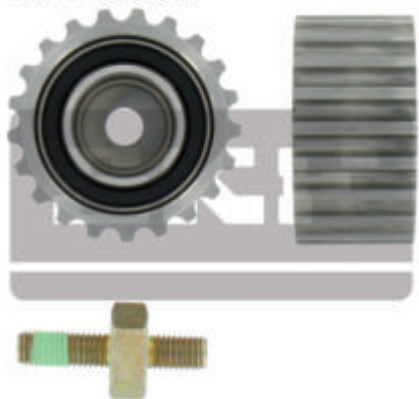

D=62 W=32

**VKM 26503**

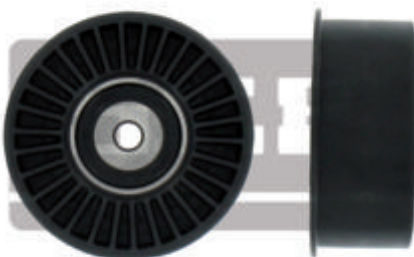

D=76 W=30

**VKM 26600**

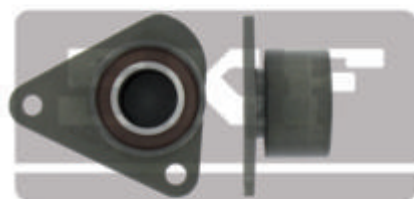

D=47 W=27

**VKM 26602**

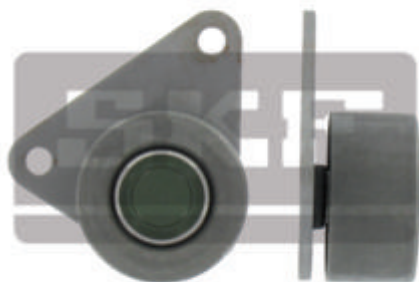

D=53 W=27

**VKM 26610**

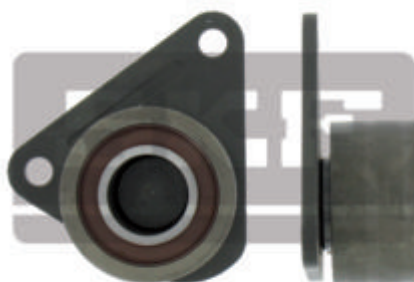

D=53 W=27

**VKM 26612**



D=53 W=32

**VKM 27110**

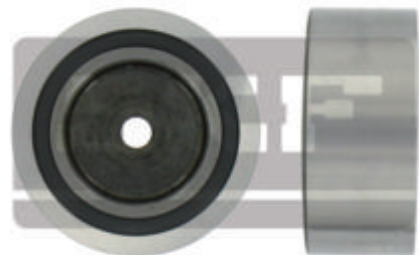

D=80 W=34

**VKM 27302**

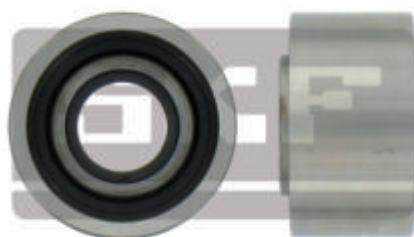

D=60 W=32

**VKM 27303**

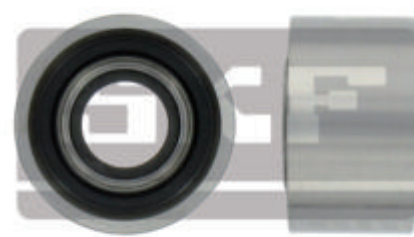

D=60 W=34



VKM 27307

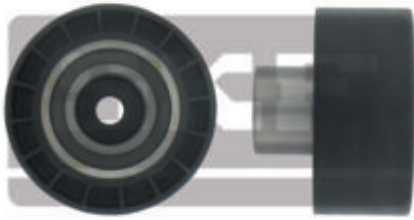

D=69,9 W=32

VKM 27404

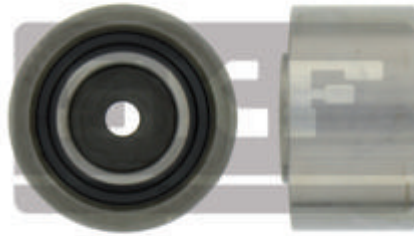

D=65 W=35

VKM 28000

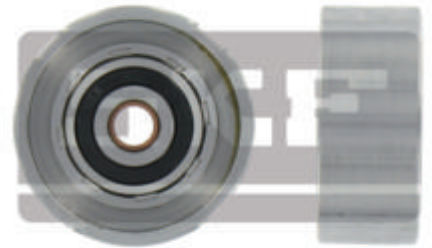

D=50 W=21

VKM 28001

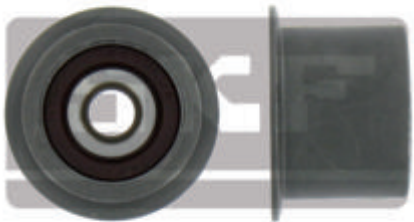

D=32 W=23

VKM 31002



D=65 W=25

VKM 31004

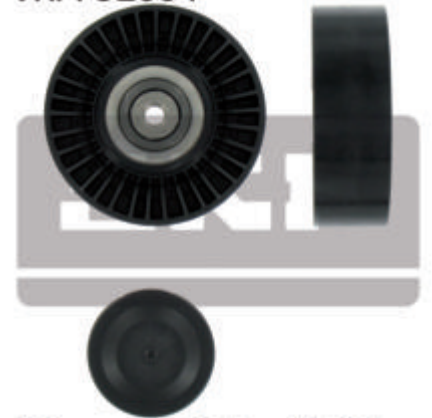

A⊙ D=78,15 W=25,3

VKM 31006



A⊙ D=76,1 W=27,9

VKM 31007



D=90 W=25

VKM 31009

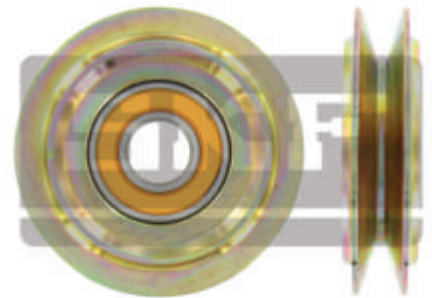

D=70 W=10

VKM 31010

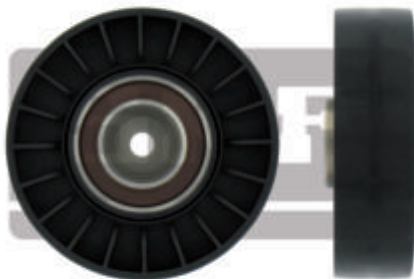

D=90 W=25

VKM 31011

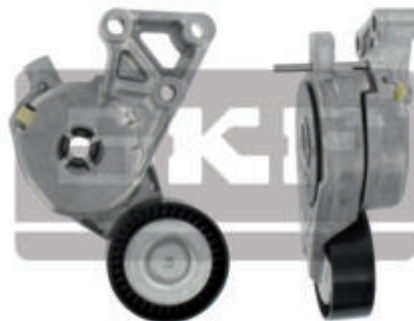

A⊙ D=70 W=24

VKM 31012



HT D=70 W=24



VKM 31013



HT D=75 W=19

VKM 31015

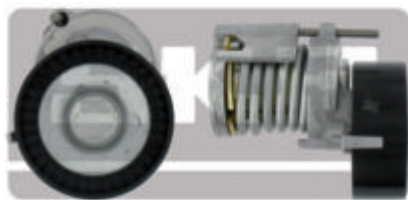

A⊙ D=70 W=26

VKM 31016

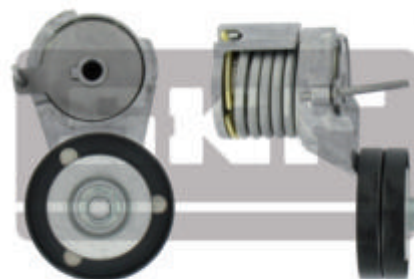

A⊙ D=70 W=24

VKM 31018

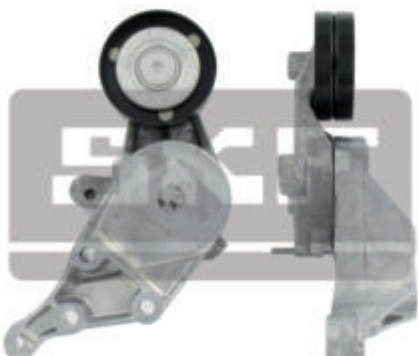

A⊙ D=70 W=24

VKM 31019

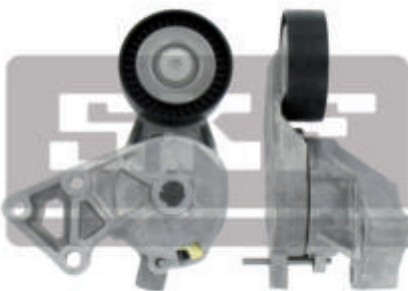

A⊙ D=70 W=24

VKM 31022

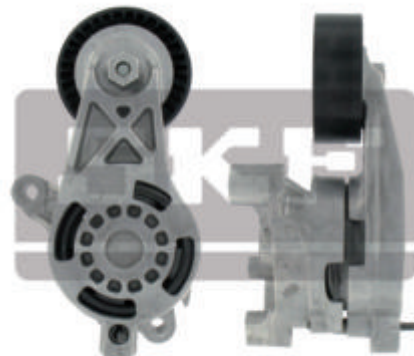

A⊙ D=70,15 W=24,8

VKM 31023

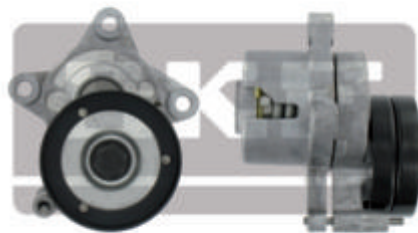

A⊙ D=70 W=26

VKM 31025

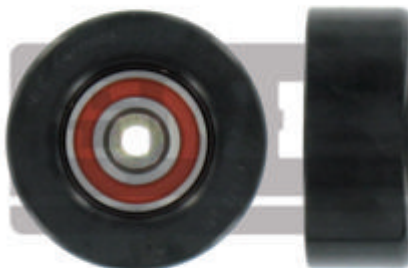

M⊙ D=70 W=28

VKM 31030



A⊙

VKM 31033



A⊙ D=76 W=21

VKM 31034



A⊙ D=77 W=20

VKM 31035



A⊙ D=70,3 W=28,6



VKM 31038

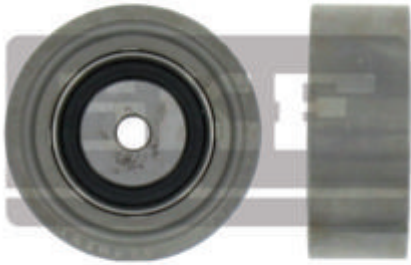

D=64 W=24

VKM 31039



D=76 W=25

VKM 31040

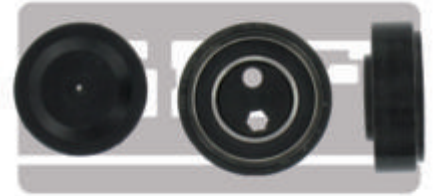

A⊙ D=63 W=17

VKM 31041

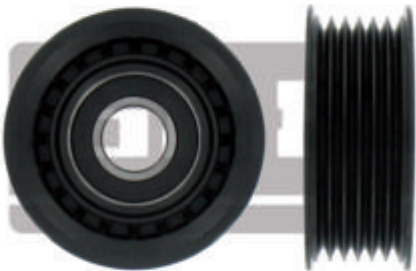

D=64 W=23

VKM 31043



D=76 W=23

VKM 31044



D=76,1 W=25,9

VKM 31047



A⊙ D=65 W=24

VKM 31054

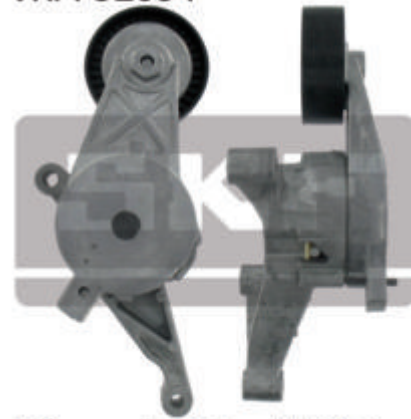

A⊙ D=70,1 W=23,9

VKM 31057



A⊙ D=70,2 W=24,1

VKM 31058

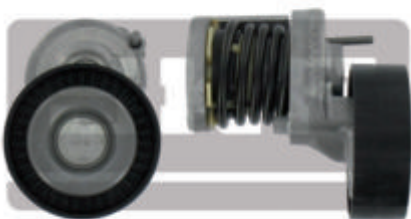

A⊙ D=70 W=24

VKM 31059



M⊙ D=60 W=16

VKM 31060

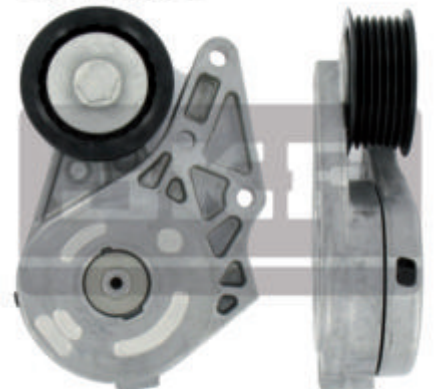

A⊙ D=62 W=26



VKM 31061

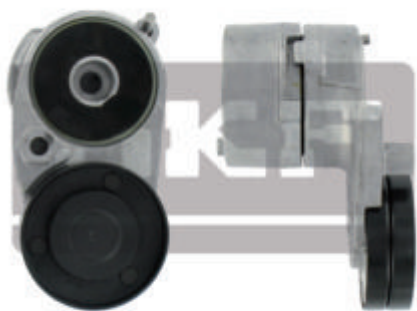

A⊙ D=76 W=25

VKM 31063



HT

VKM 31207

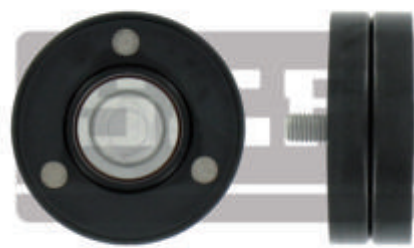

D=76 W=26

VKM 31210

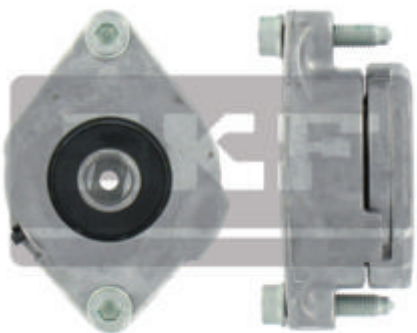

A⊙ D=71 W=30

VKM 32001

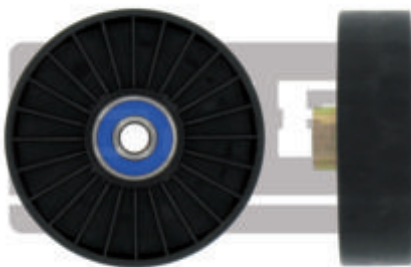

D=90 W=25

VKM 32002

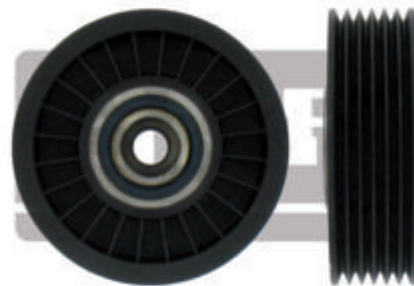

D=80 W=25

VKM 32004

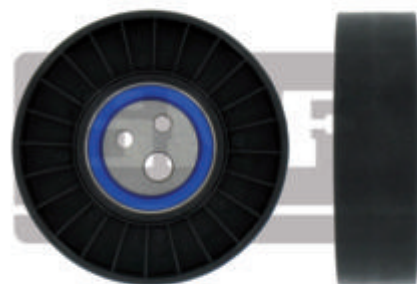

D=100 W=28

VKM 32005

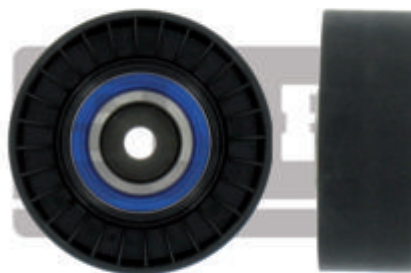

D=80 W=29

VKM 32006

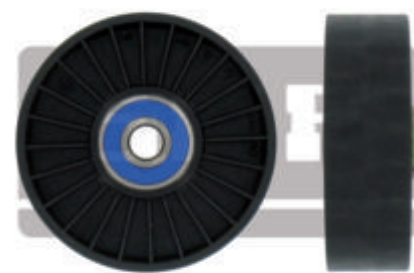

D=80 W=25

VKM 32007

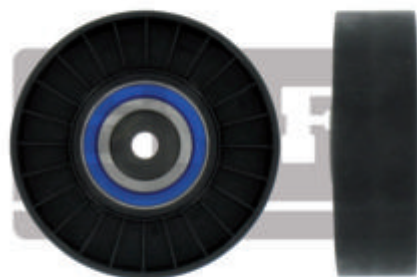

D=100 W=29

VKM 32008

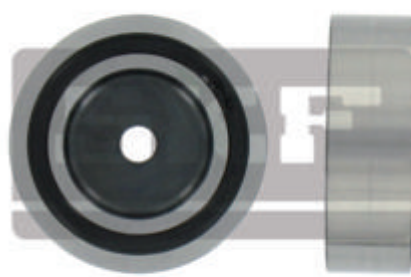

D=74 W=24

VKM 32009

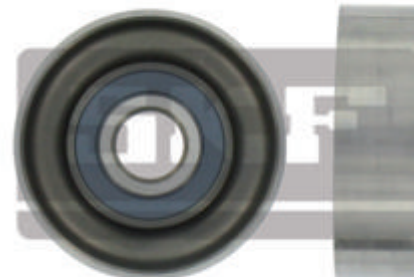

D=80 W=23



VKM 32009

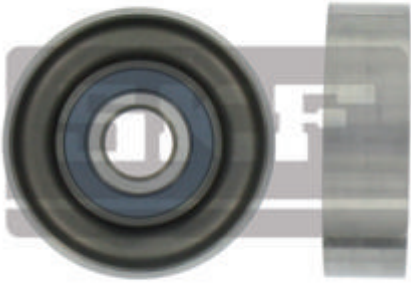

D=80 W=23

VKM 32010

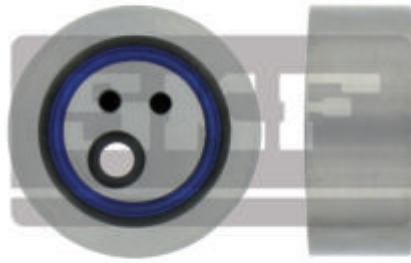

M⊙ D=75 W=30

VKM 32011

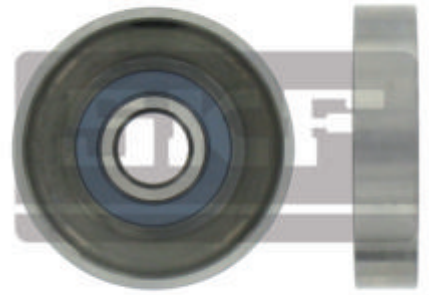

D=80 W=17

VKM 32012

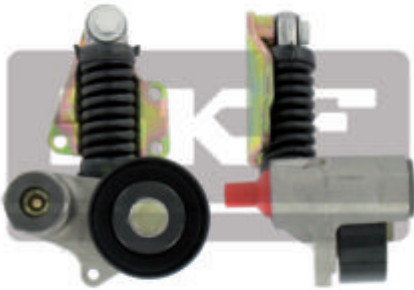

HT D=65 W=27

VKM 32015



M⊙ D=65 W=27

VKM 32016

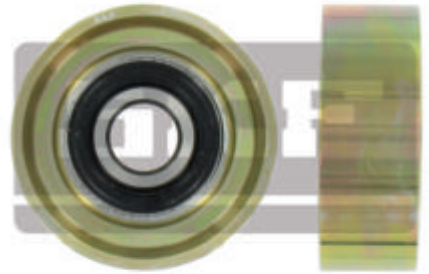

D=78 W=28

VKM 32017

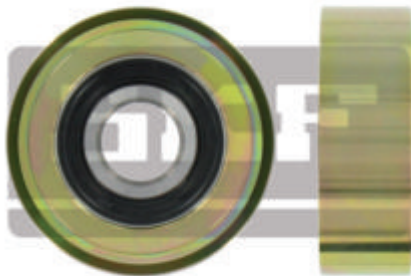

D=85 W=28

VKM 32018

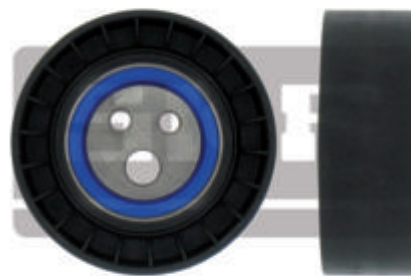

D=80 W=28

VKM 32022

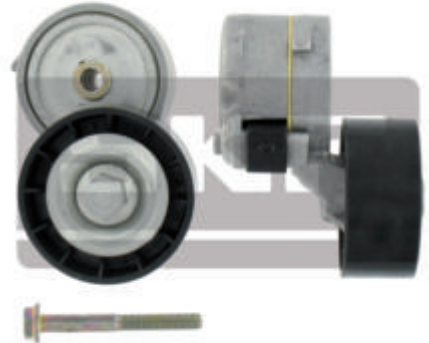

A⊙ D=65 W=29

VKM 32023



A⊙ D=65 W=23

VKM 32024



D=91 W=25

VKM 32025

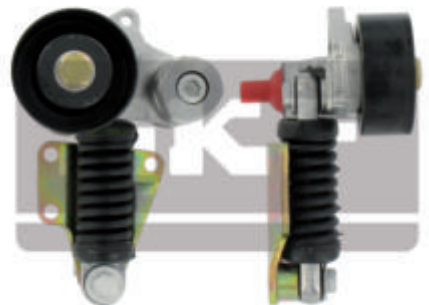

HT D=65 W=27



VKM 32026

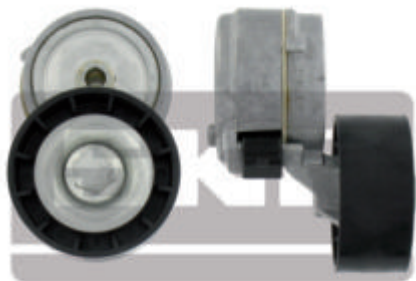

A⊙ D=66 W=29

VKM 32027

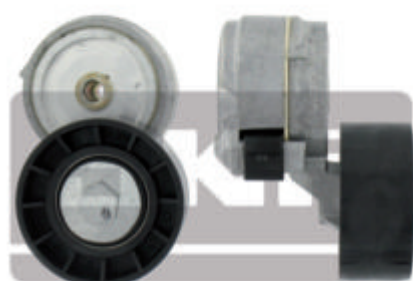

A⊙ D=66 W=29

VKM 32030

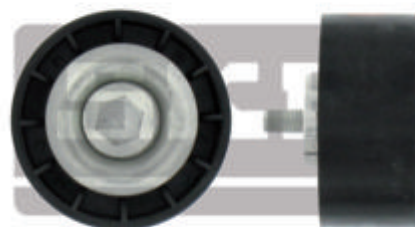

D=65 W=29

VKM 32031



D=65 W=23

VKM 32033



A⊙ D=65 W=23

VKM 32034

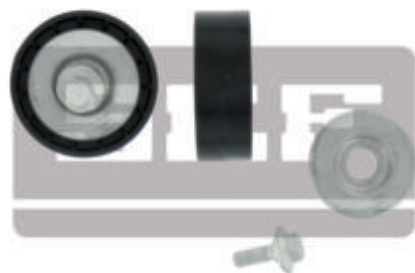

D=65 W=23

VKM 32035

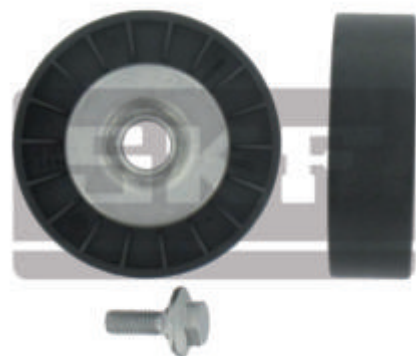

D=80,4 W=24,2

VKM 32036



D=80,3 W=26,1

VKM 32046

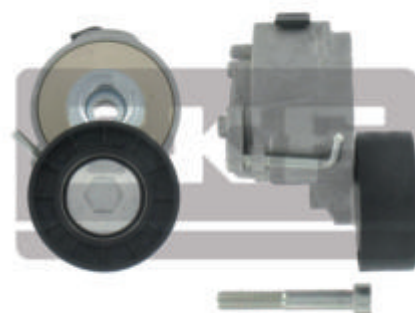

A⊙ D=65,1 W=25,5

VKM 32080



A⊙ D=65 W=25,2

VKM 32082

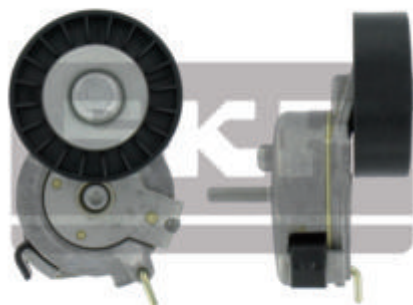

A⊙ D=80,25 W=26

VKM 32083



D=80,25 W=26,1





VKM 32154

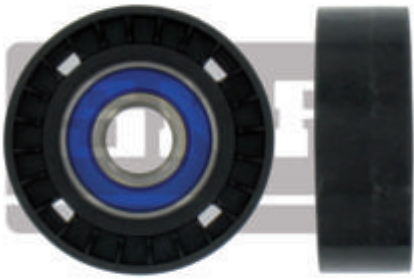

D=81 W=27

VKM 32184

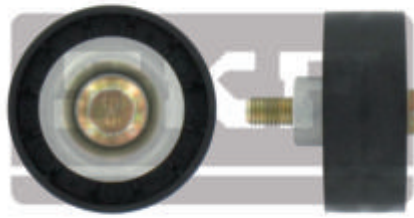

D=65,1 W=25,4

VKM 32242

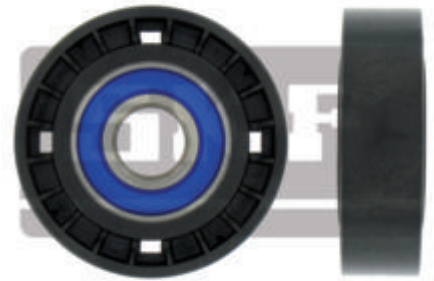

D=80 W=23

VKM 32243

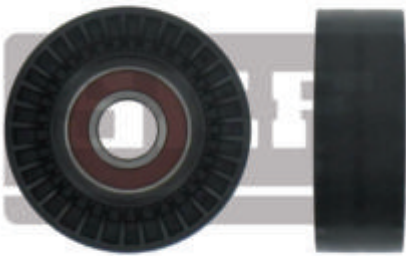

D=70 W=24,6

VKM 33001

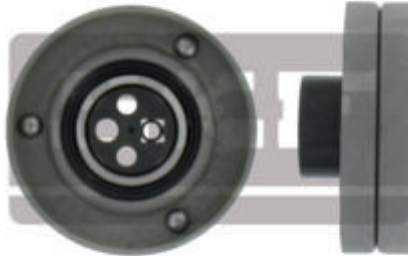

M⊙ D=85 W=23

VKM 33002



M⊙ D=85 W=26

VKM 33003



M⊙ D=90 W=25

VKM 33004



M⊙ D=85 W=26

VKM 33006

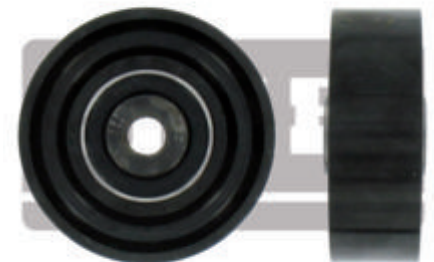

D=70 W=24

VKM 33007

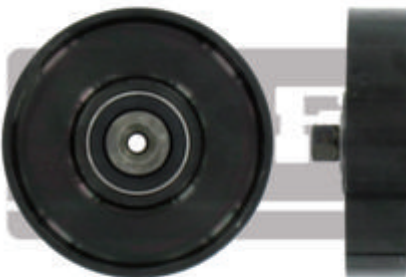

D=95 W=21

VKM 33008



D=60 W=28

VKM 33009



M⊙ D=69 W=25

VKM 33010

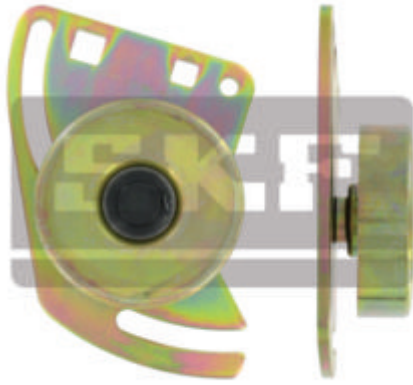

M⊙ D=85 W=23

VKM 33012



M⊙ D=65 W=27

VKM 33013

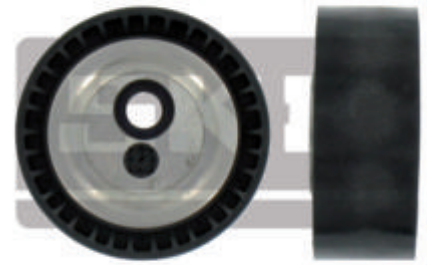

M⊙ D=70 W=27

VKM 33014



D=94 W=26

VKM 33015



D=94 W=26

VKM 33016



M⊙ D=80 W=26

VKM 33017

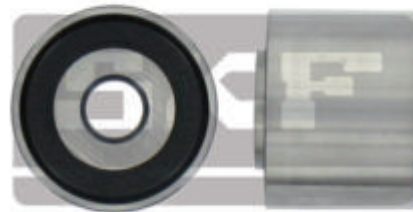

D=37 W=27

VKM 33018



D=70 W=27

VKM 33019

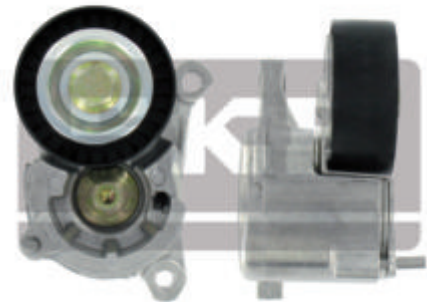

A⊙ D=65 W=23

VKM 33020

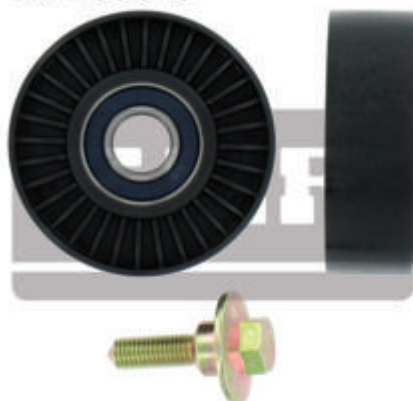

D=78 W=25

VKM 33021



M⊙ D=90 W=25

VKM 33022



M⊙ D=70 W=25





VKM 33023

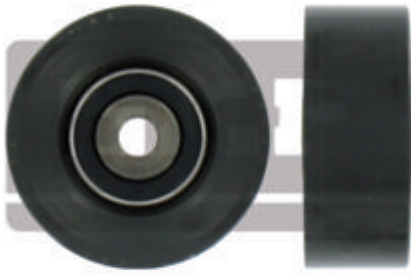

D=70 W=27

VKM 33024

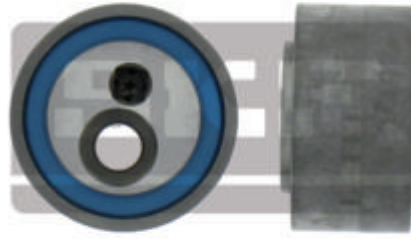

M⊙ D=50 W=26

VKM 33025



D=70 W=25

VKM 33026

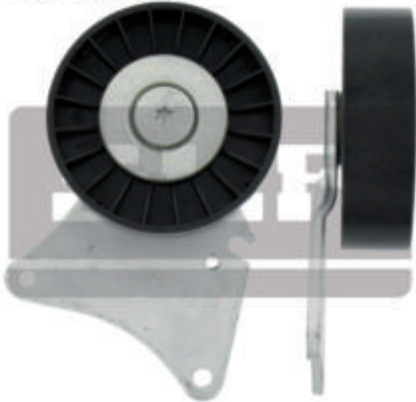

D=91 W=25

VKM 33027

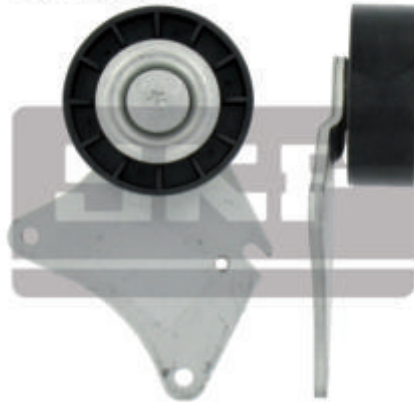

D=70 W=25

VKM 33028



A⊙ D=91 W=25

VKM 33029

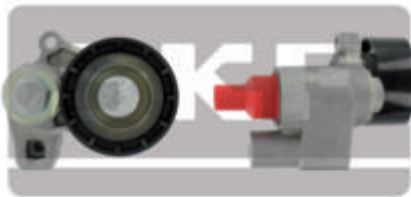

A⊙ D=60 W=26

VKM 33031



D=60 W=25

VKM 33032

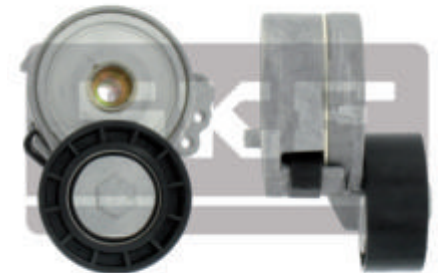

A⊙ D=60 W=25

VKM 33033

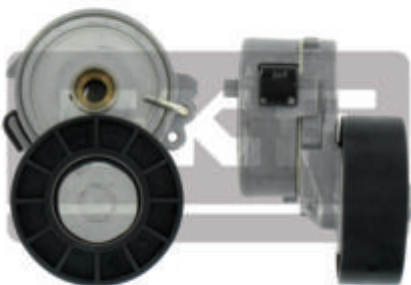

A⊙ D=70 W=25

VKM 33034

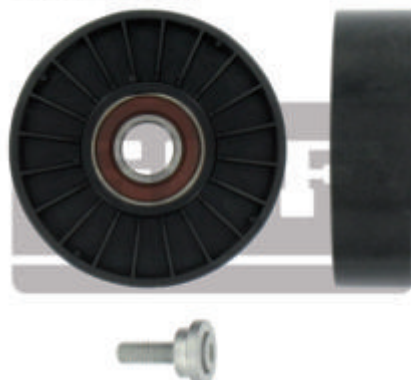

D=90 W=25

VKM 33035

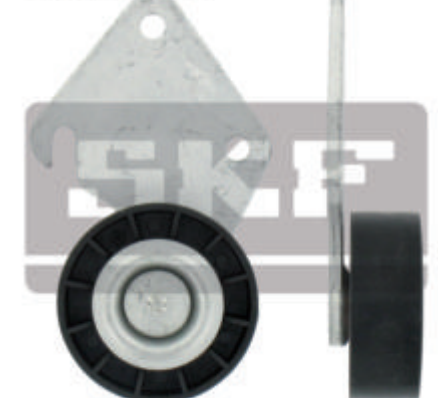

D=70 W=25

VKM 33037



HT D=65 W=27

VKM 33038



M⊙ D=69 W=24

VKM 33039



M⊙ D=69 W=24

VKM 33040



A⊙ D=60 W=28

VKM 33041



M⊙ D=94 W=26

VKM 33042

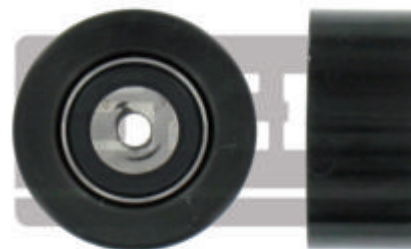

D=60 W=27

VKM 33043



A⊙ D=65 W=25

VKM 33044



D=60 W=30

VKM 33045



D=70 W=25

VKM 33060



D=51 W=26

VKM 33061

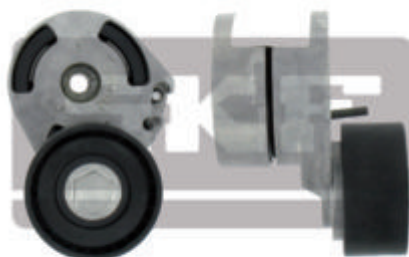

A⊙ D=55 W=25

VKM 33063

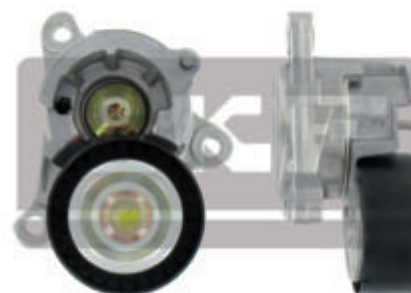

A⊙ D=65 W=25





VKM 33064



D=125,2 W=22,5

VKM 33065



D=126 W=22

VKM 33069

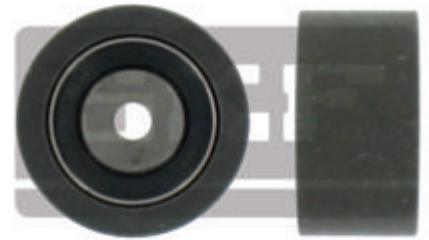

D=50 W=26

VKM 33073



M⊙ D=70 W=27

VKM 33074

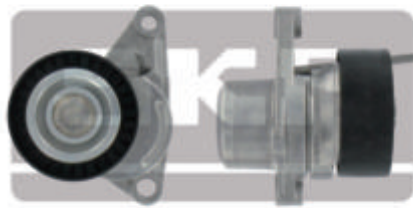

A⊙ D=65,1 W=25,1

VKM 33075

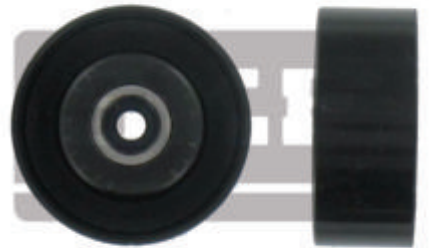

D=65 W=26,6

VKM 33082



M⊙ D=66 W=26

VKM 33083

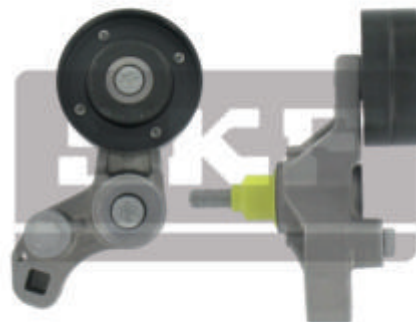

A⊙ D=65,1 W=26

VKM 33086

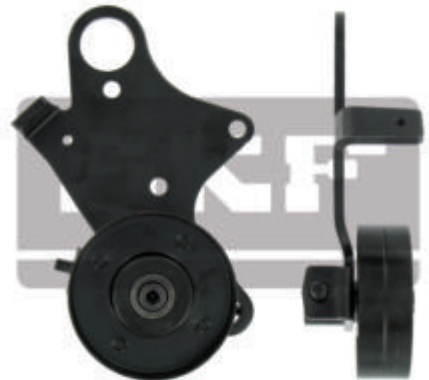

M⊙ D=80 W=21

VKM 33090

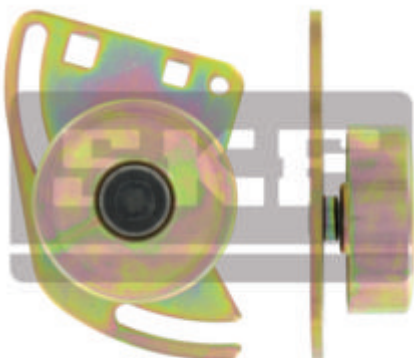

M⊙ D=85 W=27

VKM 33091

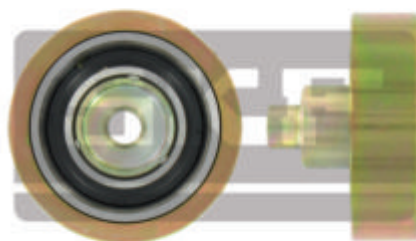

D=70 W=21

VKM 33100



D=60 W=30,3

VKM 33101

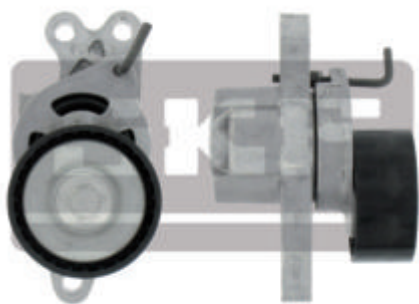

A⊙ D=60 W=26

VKM 33125

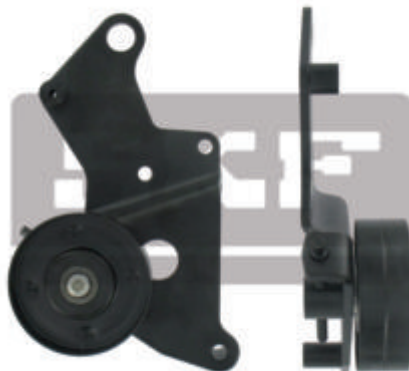

M⊙ D=80 W=26

VKM 33311



HT

VKM 33314

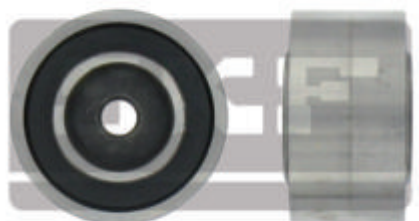

D=50 W=26

VKM 33320



A⊙ D=70 W=25

VKM 34002



M⊙ D=76 W=16

VKM 34003

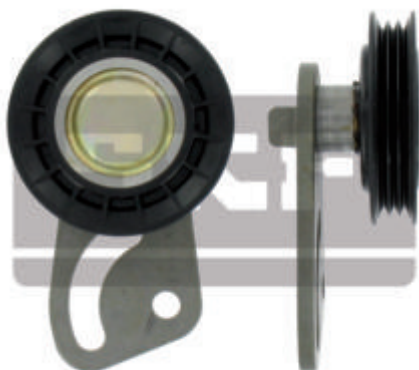

M⊙ D=76 W=16

VKM 34004



M⊙ D=60 W=22

VKM 34005

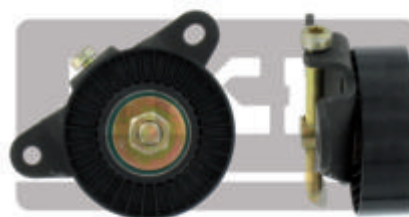

M⊙ D=73 W=22

VKM 34007



A⊙ D=98 W=23

VKM 34008



A⊙ D=98 W=23

VKM 34009



A⊙ D=98 W=22





**VKM 34010**

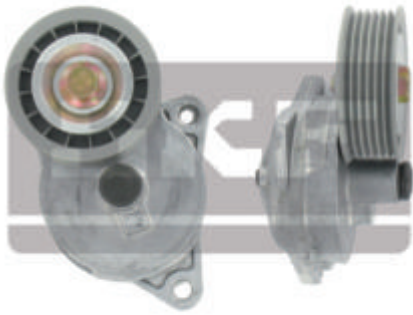

A⊙ D=69 W=21

**VKM 34012**



A⊙ D=70,1 W=26,2

**VKM 34013**



D=76 W=26

**VKM 34014**

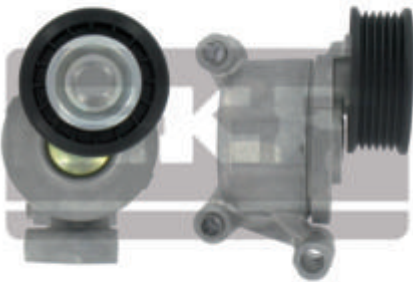

A⊙ D=69,2 W=12,1

**VKM 34018**



A⊙ D=69,1 W=21

**VKM 34023**



D=62 W=22

**VKM 34025**



A⊙ D=52,2 W=12,1

**VKM 34027**



A⊙ D=82 W=22

**VKM 34030**

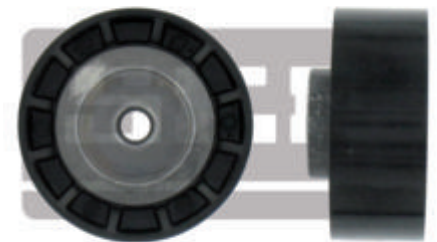

D=65 W=25

**VKM 34031**

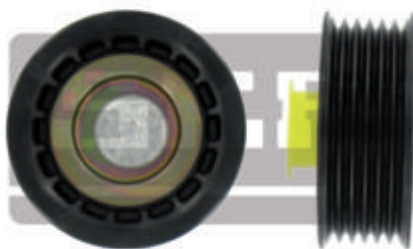

D=65 W=23

**VKM 34032**



HT D=65 W=25

**VKM 34033**



A⊙ D=70,1 W=26,1



VKM 34034



D=70 W=25

VKM 34040



A⊙ D=76 W=26

VKM 34042



A⊙ D=72 W=18

VKM 34043



M⊙ D=72 W=18

VKM 34046



A⊙ D=76,2 W=26

VKM 34047

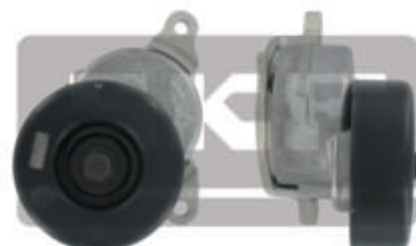

A⊙ D=90 W=30,5

VKM 34048



D=90 W=30,4

VKM 34051



D=76 W=30,1

VKM 34052

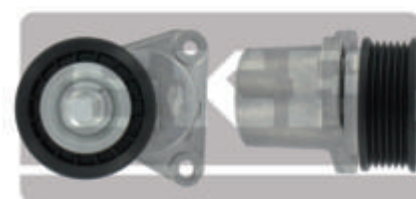

A⊙ D=69,2 W=22

VKM 34056

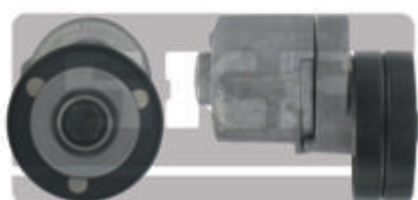

A⊙ D=70 W=26

VKM 34061

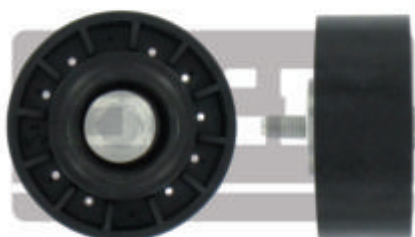

D=70 W=28,5

VKM 34071



A⊙ D=76,4 W=37



VKM 34072



D=76,3 W=37

VKM 34102

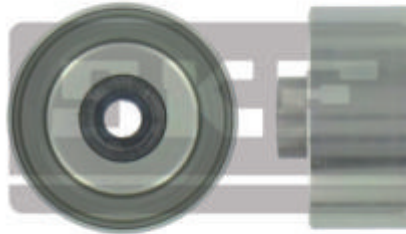

D=60 W=26,6

VKM 34107



D=90 W=29

VKM 34108



A⊙ D=70 W=26

VKM 34110

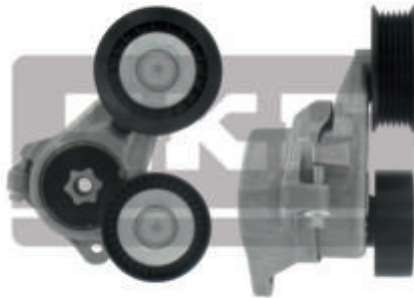

A⊙ D1=70/D2=76,65 W1=19/W2=23,1

VKM 34111



D=76 W=29

VKM 34500

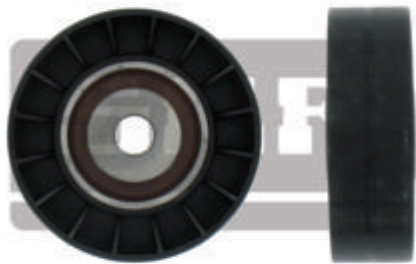

D=80 W=25

VKM 34501

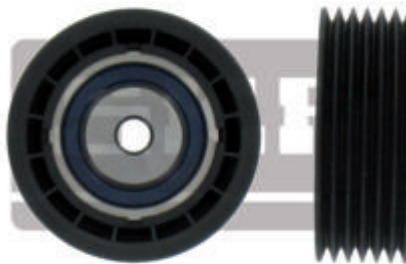

D=65 W=23

VKM 34502

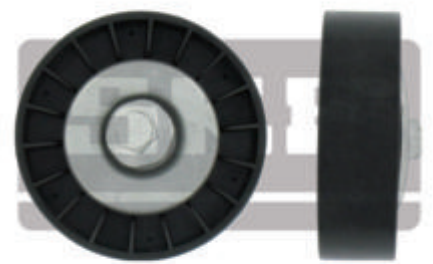

D=80 W=24

VKM 34510

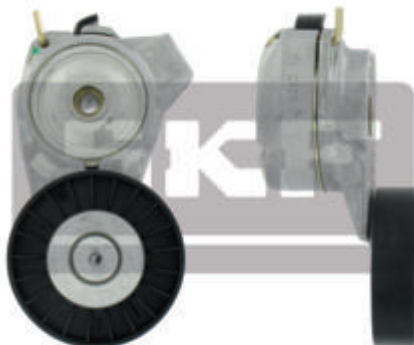

A⊙ D=90 W=23

VKM 35002

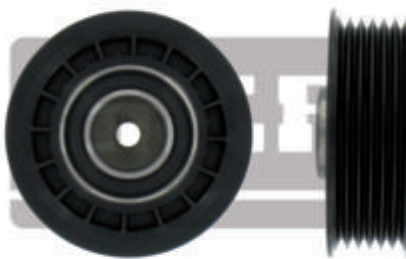

D=80 W=30

VKM 35007



HT D=90 W=24



VKM 35008

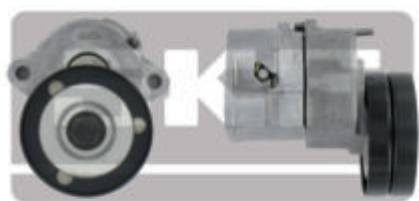

A⊙ D=70 W=26

VKM 35009

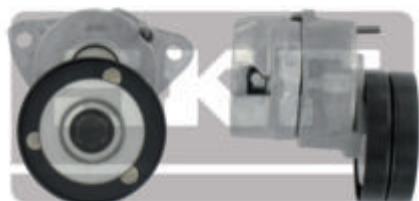

A⊙ D=70 W=26

VKM 35011

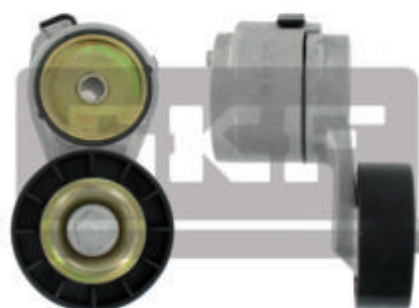

A⊙ D=70 W=25

VKM 35012



A⊙ D=76 W=22

VKM 35013

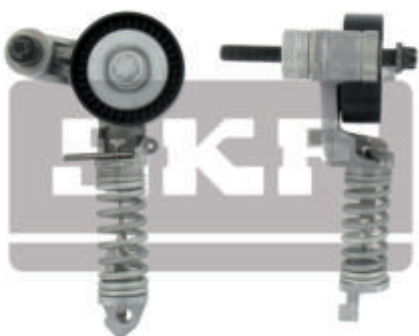

HT D=70 W=24

VKM 35015

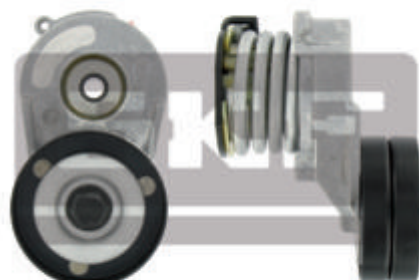

A⊙ D=70 W=25,5

VKM 35016



D=108 W=23

VKM 35023

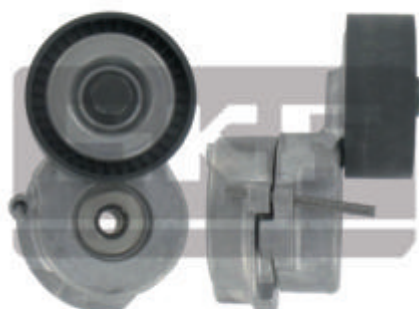

A⊙ D=65,1 W=26,2

VKM 35025



D=76 W=26

VKM 35212

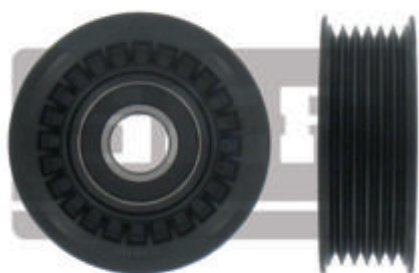

D=69,5 W=22,7

VKM 35214



D=118,5 W=22,5

VKM 35216



A⊙ D=69,9 W=26,25



VKM 35260

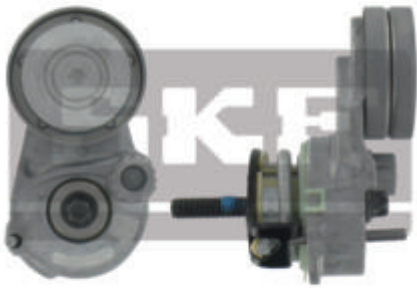

A⊙ D=63 W=21,85

VKM 35500

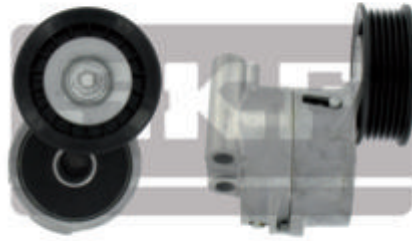

A⊙ D=77 W=23

VKM 36001

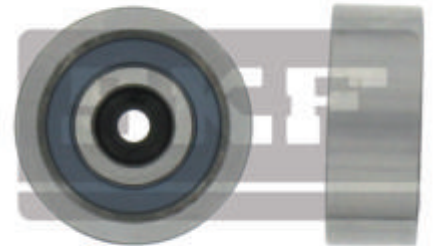

D=60 W=22

VKM 36002

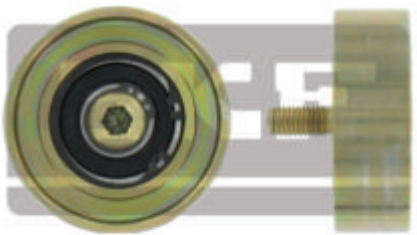

D=68 W=23

VKM 36003



D=88 W=24

VKM 36004



M⊙ D=57 W=16

VKM 36005



M⊙ D=70 W=21

VKM 36006

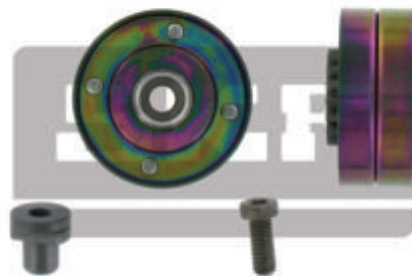

D=70 W=28

VKM 36007

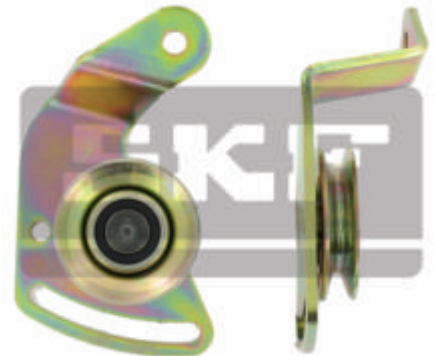

M⊙ D=69 W=10

VKM 36008

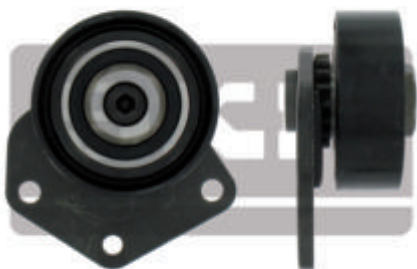

D=72 W=25

VKM 36009

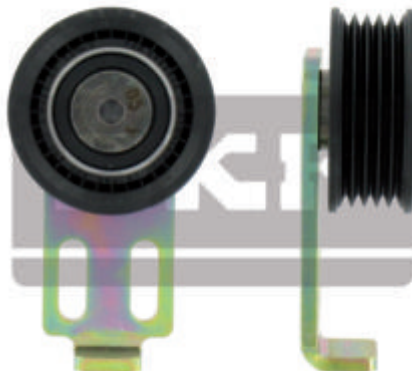

M⊙ D=60 W=24

VKM 36010



M⊙ D=70 W=26



VKM 36011

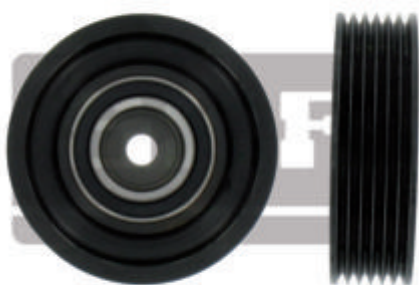

D=87 W=25

VKM 36012

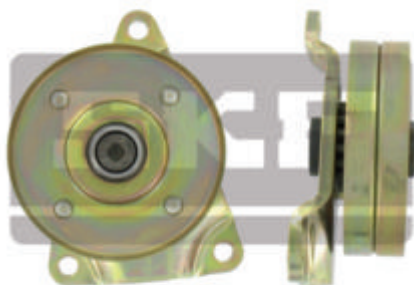

D=90 W=24

VKM 36013

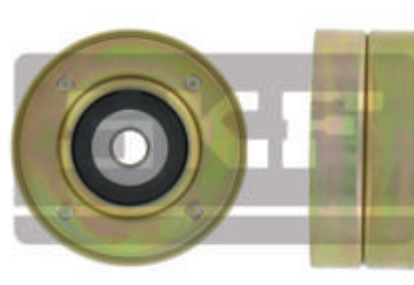

D=70 W=30

VKM 36014

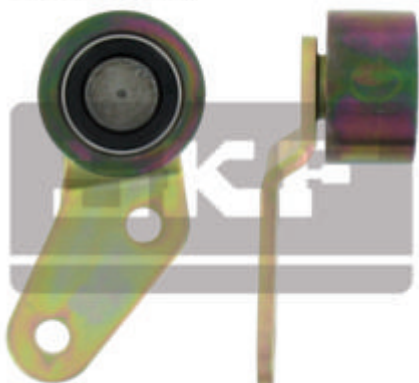

D=50 W=28

VKM 36016



D=50 W=26

VKM 36017

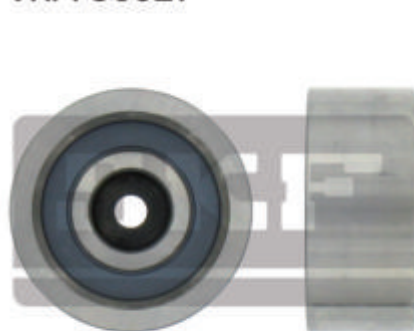

D=60 W=26

VKM 36018

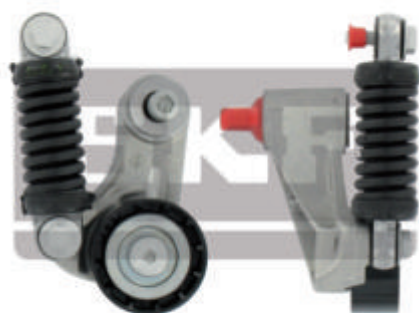

HT D=60 W=25

VKM 36019



D=72 W=22

VKM 36022

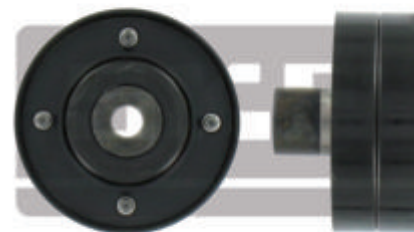

M⊙ D=70 W=27

VKM 36023

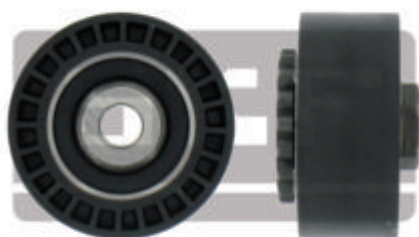

D=56 W=24

VKM 36024



M⊙ D=72 W=25

VKM 36025

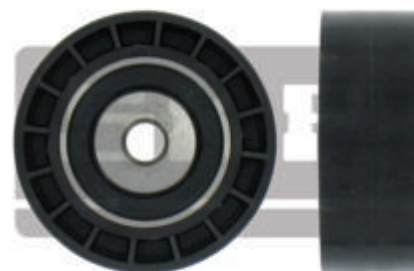

D=56 W=21



VKM 36026



HT D=65 W=27

VKM 36030

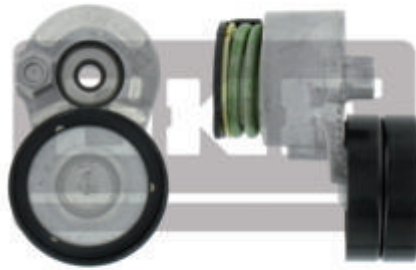

A⊙ D=65 W=30

VKM 36031

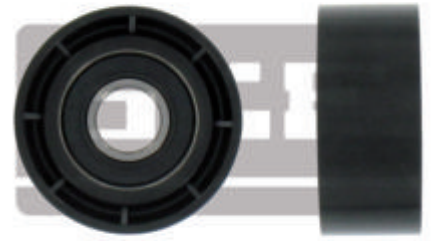

D=60 W=25

VKM 36032



HT D=60 W=25

VKM 36035



HT D=60 W=25

VKM 36038

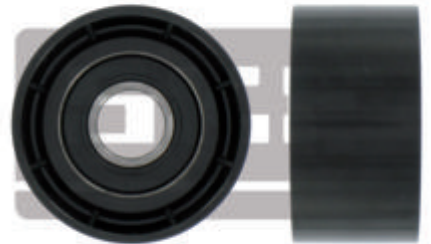

D=60 W=30,9

VKM 36040

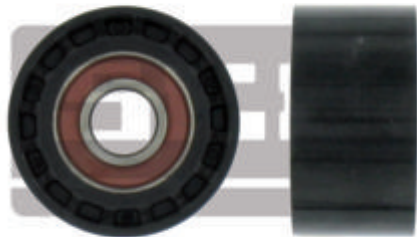

D=60 W=31

VKM 36050

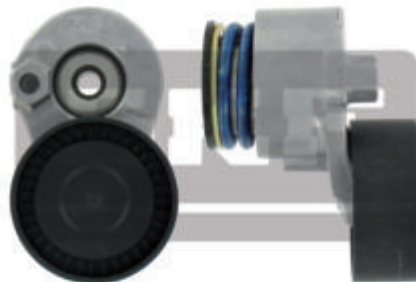

A⊙ D=65 W=26

VKM 36052



M⊙ D=65 W=26

VKM 36053



D=127 W=22

VKM 36064



M⊙ D=63,7 W=17,5

VKM 36070



HT D=65 W=26



VKM 36072

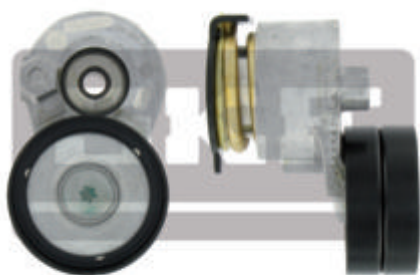

A⊙ D=65 W=30

VKM 36075



A⊙ D=65,1 W=25,5

VKM 36080



D=70 W=15

VKM 36081



M⊙ D=70 W=18

VKM 36082



A⊙ D=76,3 W=18

VKM 36091

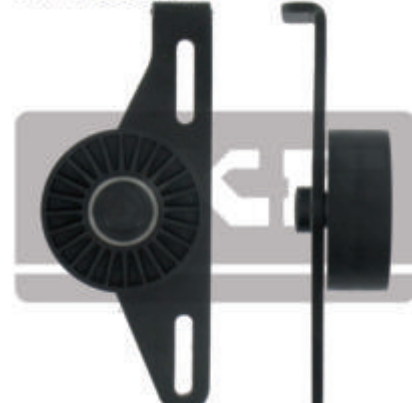

M⊙ D=70,1 W=25,7

VKM 36120



A⊙ D=76 W=26

VKM 36122



D=76 W=26

VKM 36124



A⊙ D=76 W=26

VKM 36220

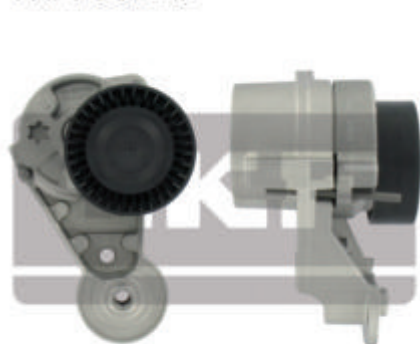

A⊙ D=70 W=24,1

VKM 36230

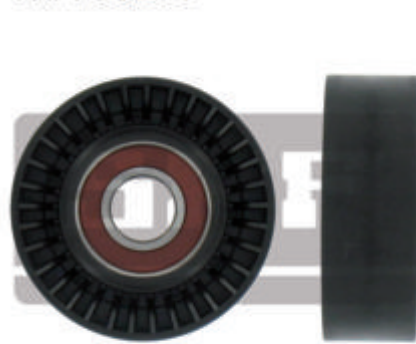

D=70 W=24

VKM 36236

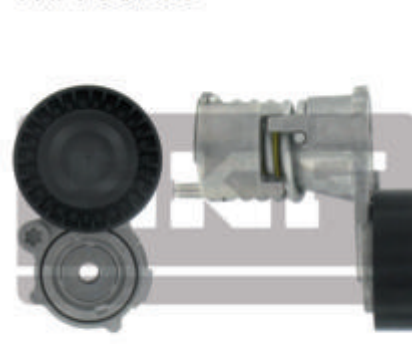

A⊙ D=70 W=20,5





VKM 36238

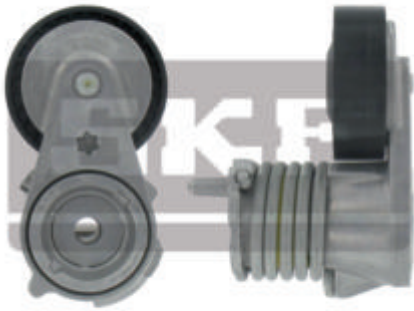

A⊙ D=65,2 W=21,1

VKM 36240

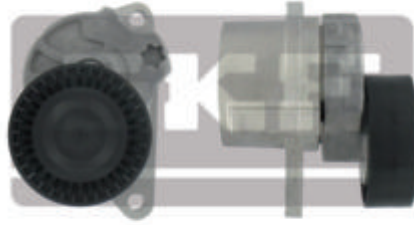

A⊙ D=70 W=24,15

VKM 36250



D=124 W=23

VKM 36530

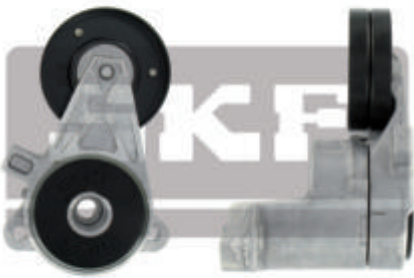

A⊙ D=76 W=24

VKM 37002

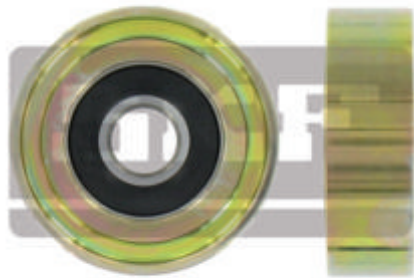

D=70 W=22

VKM 37005

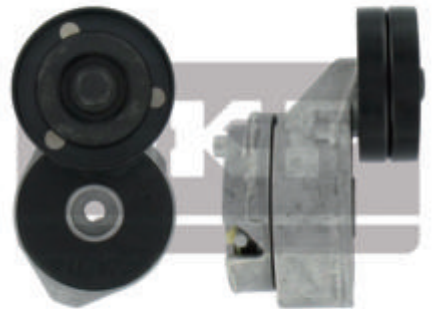

A⊙ D=70,1 W=26

VKM 37010

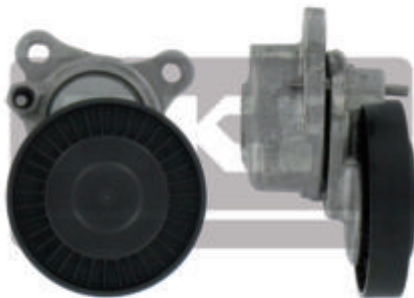

A⊙ D=76,2 W=14,5

VKM 37011

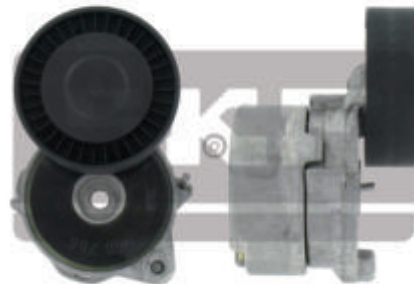

A⊙ D=70 W=22

VKM 37014

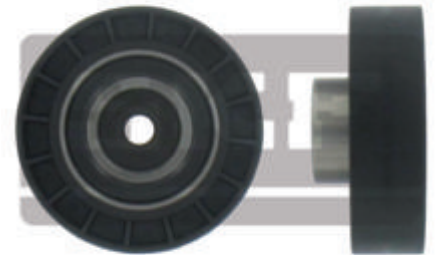

M⊙ D=70 W=20,15

VKM 37015

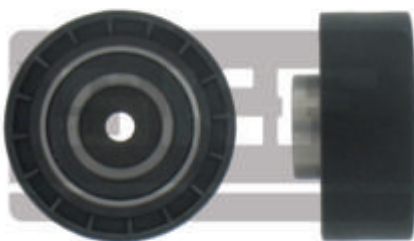

M⊙ D=65,2 W=25,6

VKM 38001

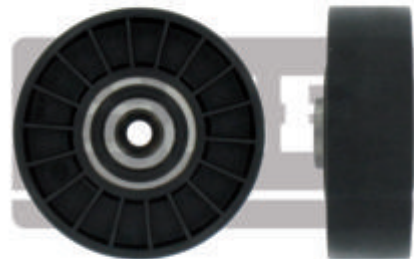

M⊙ D=80 W=25

VKM 38002

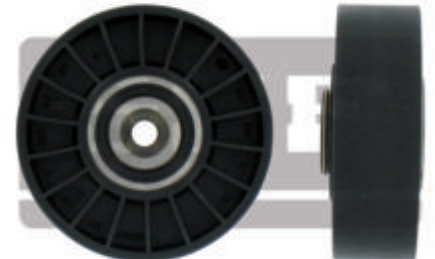

M⊙ D=80 W=25

VKM 38003



M⊙ D=80 W=25

VKM 38004

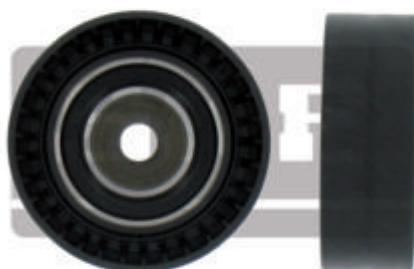

D=70 W=25

VKM 38007



HT

VKM 38008



HT

VKM 38009

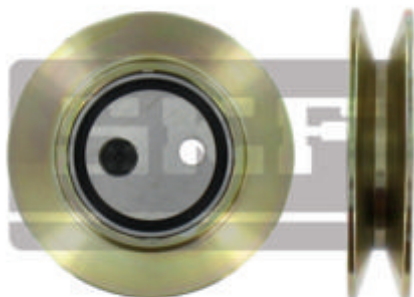

M⊙ D=89 W=13

VKM 38011



HT

VKM 38012

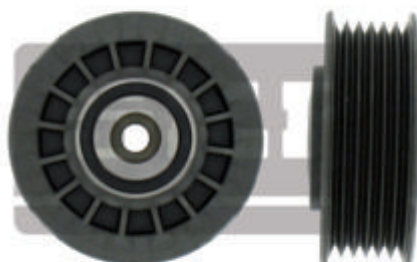

D=70 W=26

VKM 38020

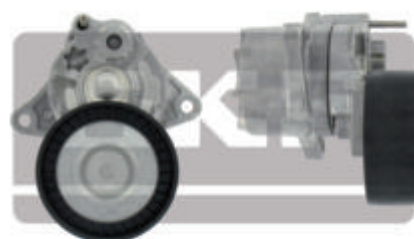

A⊙ D=70 W=26

VKM 38022

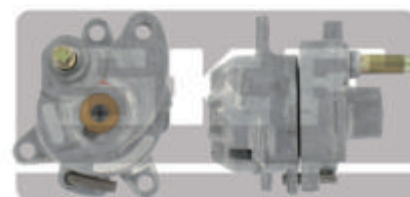

A⊙

VKM 38023



HT D=65 W=30

VKM 38026

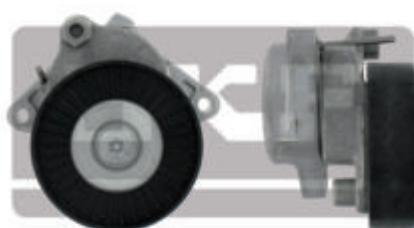

A⊙ D=95 W=26

VKM 38027



D=110 W=28





VKM 38100

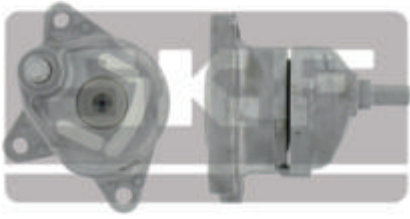

A⊙

VKM 38202

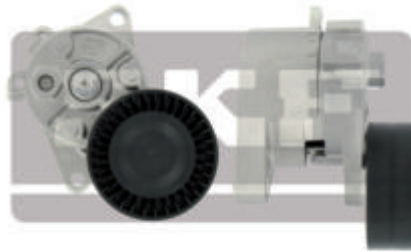

A⊙ D=70 W=26

VKM 38220



D=70 W=23

VKM 38221

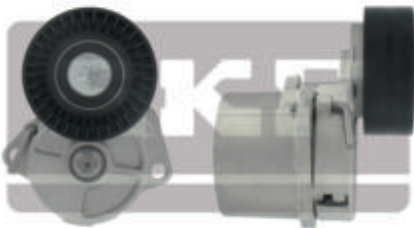

A⊙ D=69,9 W=26,15

VKM 38225



D=80 W=24

VKM 38226



D=70 W=26

VKM 38230



M⊙ D=80 W=21

VKM 38231



A⊙ D=90 W=26

VKM 38240



D=70,1 W=23

VKM 38700



A⊙ D=70,1 W=24,2

VKM 61000

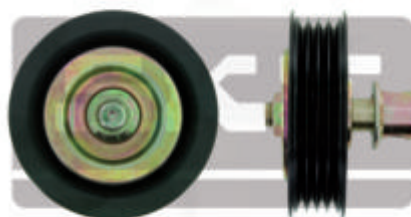

D=75 W=19.5

VKM 61002

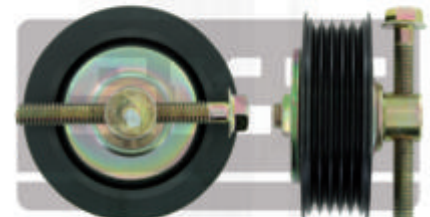

D=75 W=23

VKM 61003

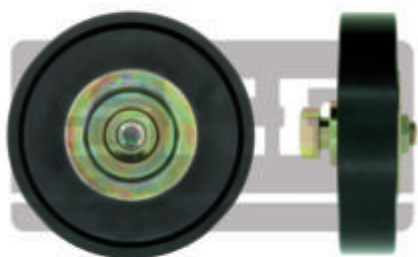

D=90 W=20

VKM 61009

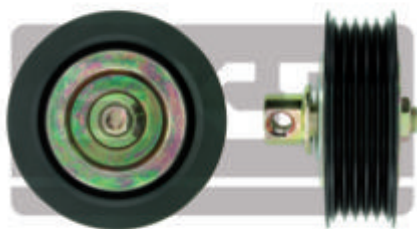

D=75 W=23

VKM 61011

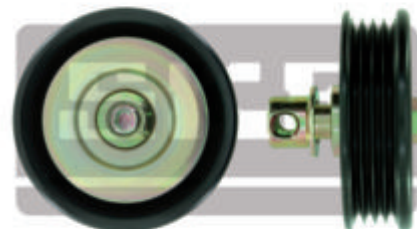

D=75 W=22

VKM 61016

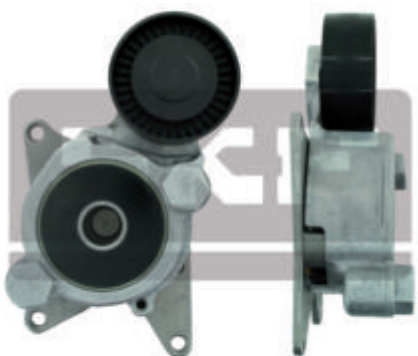

A⊙ D=70 W=28

VKM 63000



D=76 W=13

VKM 63001

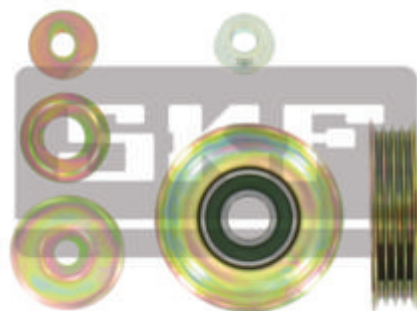

D=76 W=14

VKM 63004



A⊙ D=76 W=33

VKM 64000



D=75 W=21

VKM 65004



D=90 W=25

VKM 65005

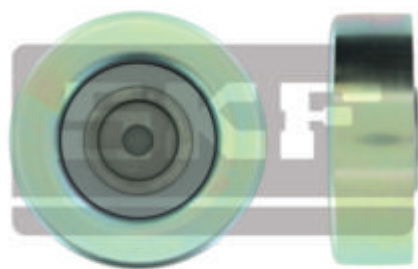

D=90 W=30,5

VKM 67000



D=88 W=20

VKM 70000

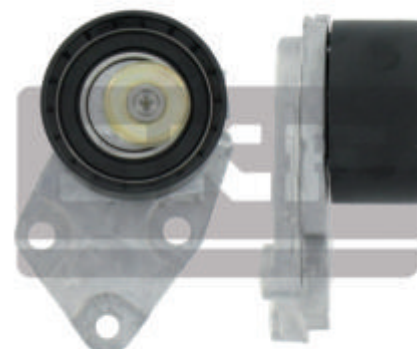

A⊙ D=60 W=29





**VKM 70001**



A⊙ D=72 W=22

**VKM 70004**

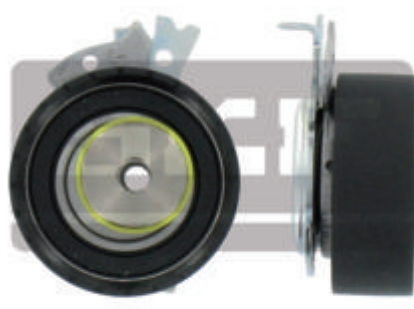

A⊙ D=60 W=21

**VKM 71000**

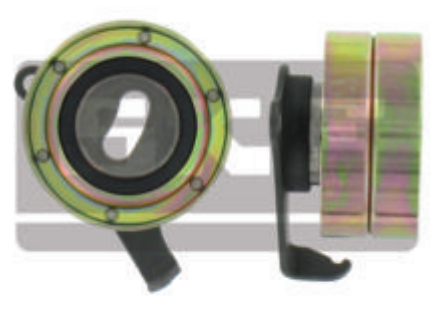

M⊙ D=62 W=29

**VKM 71001**

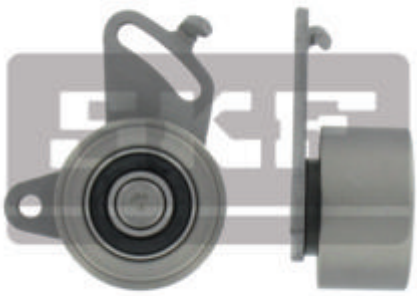

M⊙ D=60 W=33

**VKM 71002**



M⊙ D=62 W=35

**VKM 71003**

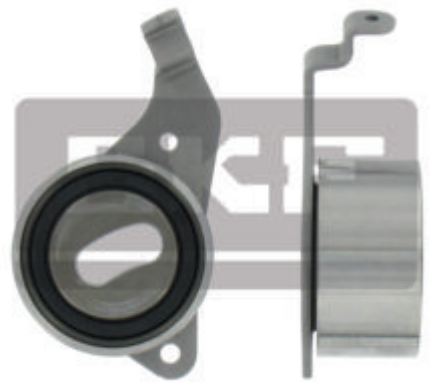

M⊙ D=58 W=29

**VKM 71004**

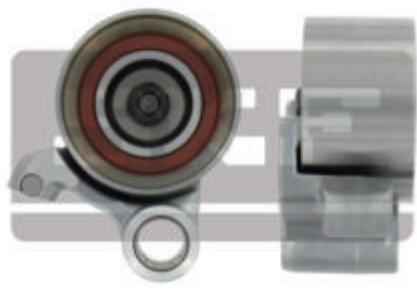

HT D=62 W=37

**VKM 71006**

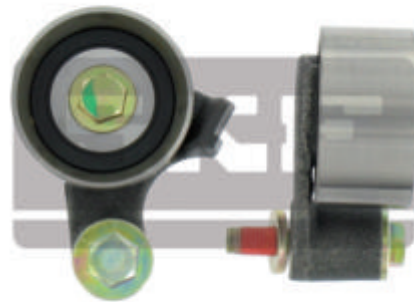

HT D=58 W=30

**VKM 71007**

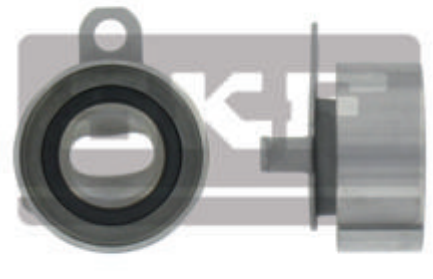

M⊙ D=57 W=25

**VKM 71010**

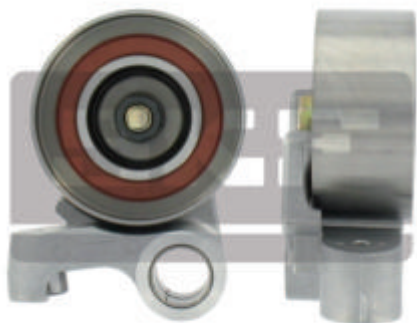

HT D=62 W=29

**VKM 71012**



M⊙ D=61 W=30

**VKM 71013**

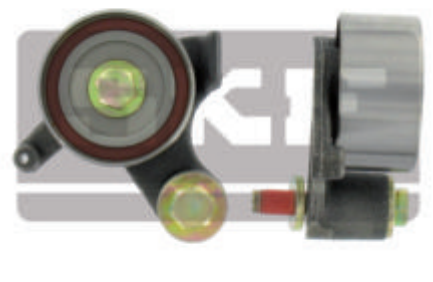

HT D=58 W=29

**VKM 71014**

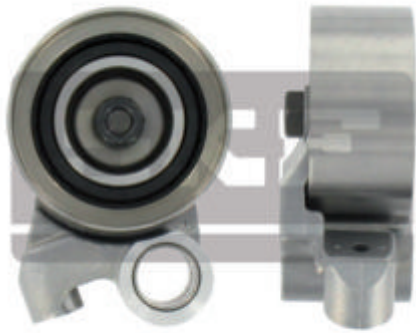

HT D=62 W=29

**VKM 71100**



M⊙ D=62 W=26

**VKM 71101**

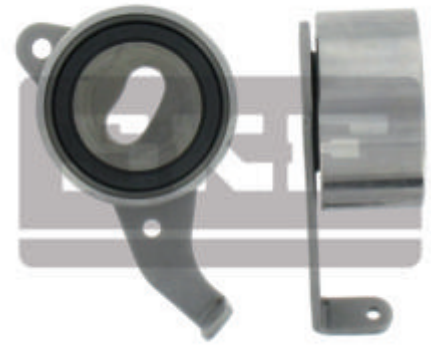

M⊙ D=58 W=29

**VKM 71200**

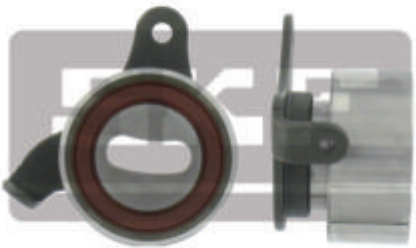

M⊙ D=50 W=23

**VKM 71201**

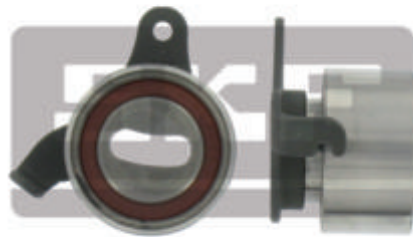

M⊙ D=50 W=27

**VKM 71202**

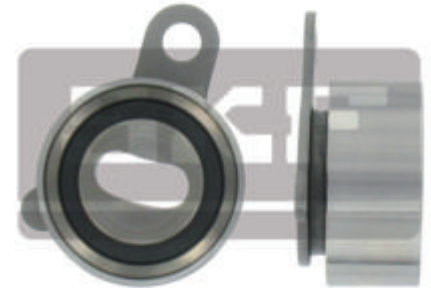

M⊙ D=52 W=23

**VKM 71302**

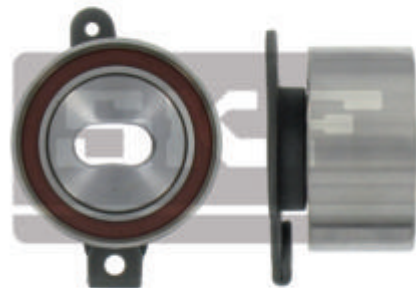

M⊙ D=58 W=29

**VKM 71303**

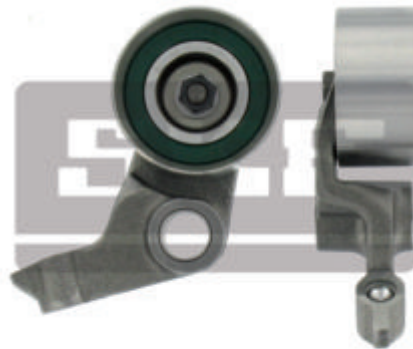

HT D=62 W=31

**VKM 71304**

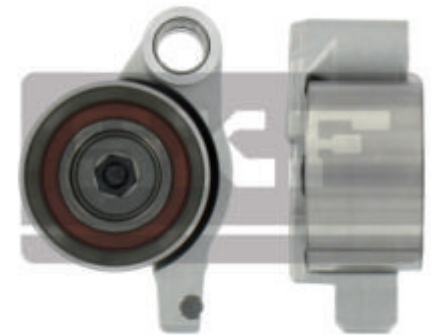

HT D=62 W=36

**VKM 71400**



M⊙ D=56 W=29

**VKM 71401**

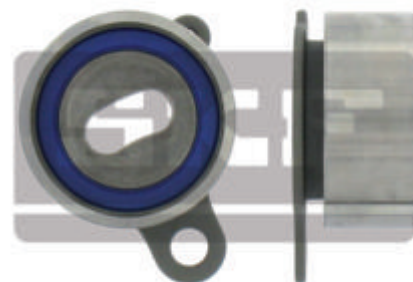

M⊙ D=55 W=23

**VKM 71700**

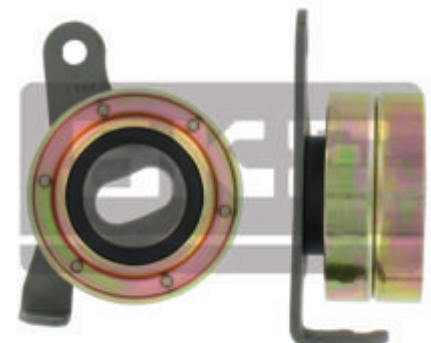

M⊙ D=64 W=29





**VKM 71701**

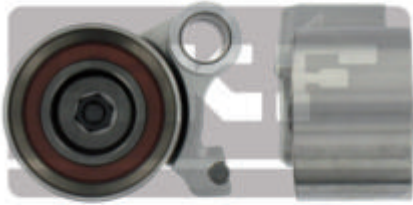

HT D=62 W=41

**VKM 71704**

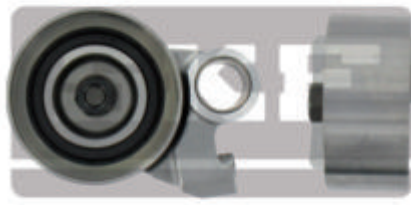

HT D=62 W=28

**VKM 71705**

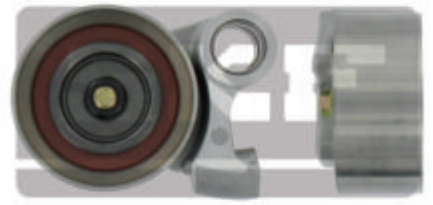

HT D=62 W=29

**VKM 71706**

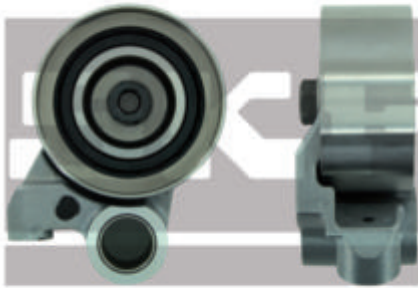

HT D=62 W=28

**VKM 72000**

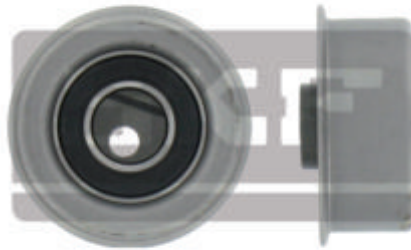

M⊙ D=60 W=22

**VKM 72004**



M⊙ D=60 W=31

**VKM 72100**

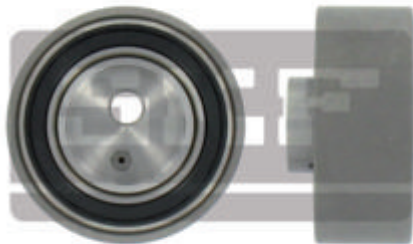

M⊙ D=60 W=24

**VKM 72200**

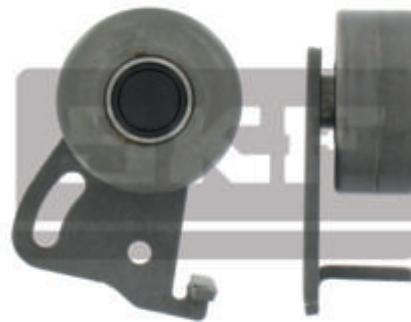

M⊙ D=60 W=27

**VKM 72300**

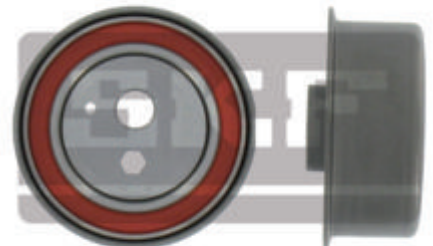

M⊙ D=65 W=29

**VKM 72303**

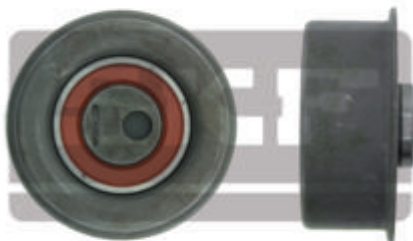

M⊙ D=60 W=23

**VKM 72310**

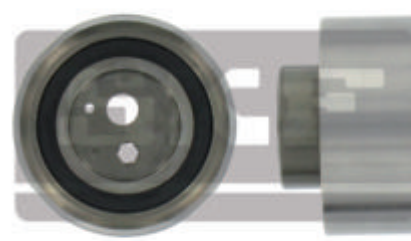

M⊙ D=70 W=30

**VKM 72320**

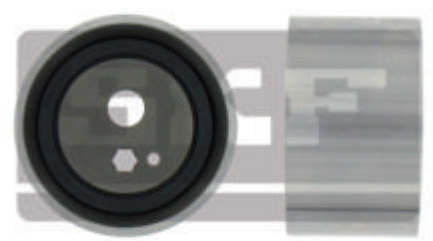

M⊙ D=60 W=35



VKM 72400

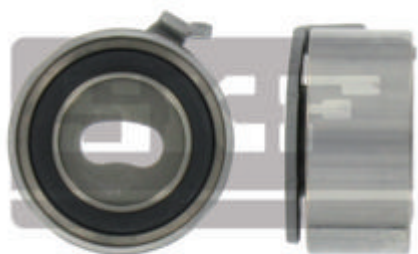

M⊙ D=50 W=22

VKM 72500

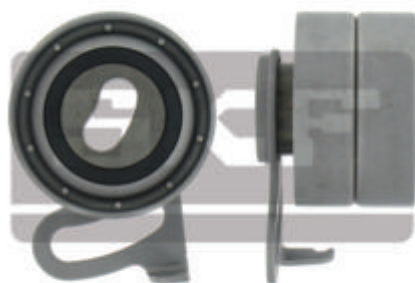

M⊙ D=60 W=37

VKM 72501

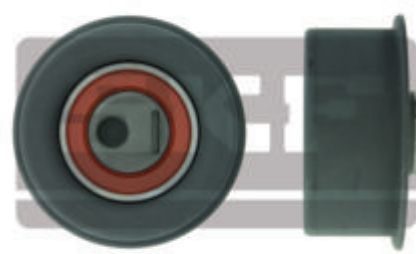

M⊙ D=60 W=28

VKM 73000

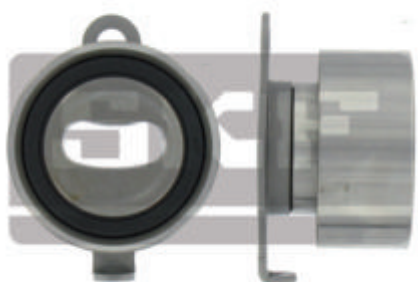

M⊙ D=57 W=26

VKM 73001

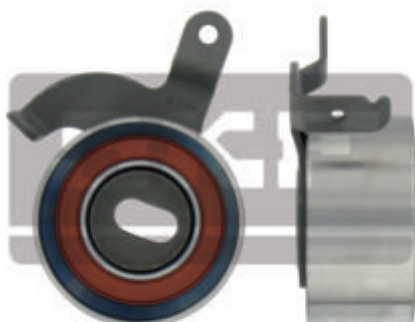

M⊙ D=65 W=32

VKM 73002

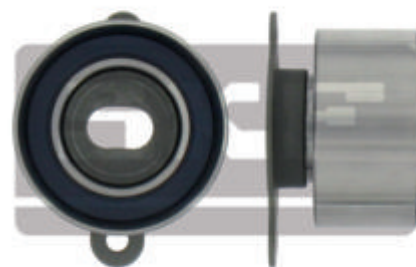

M⊙ D=55 W=28

VKM 73003

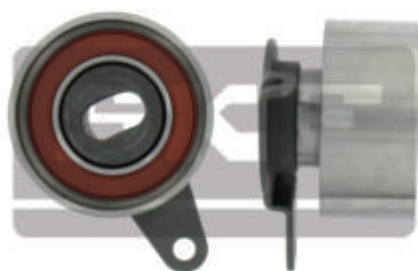

M⊙ D=60 W=28

VKM 73004



M⊙ D=55 W=32

VKM 73005

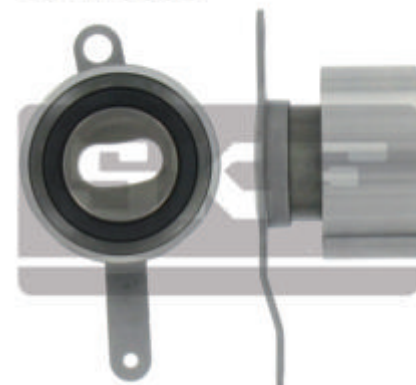

M⊙ D=53 W=26

VKM 73006



HT D=55 W=27

VKM 73007

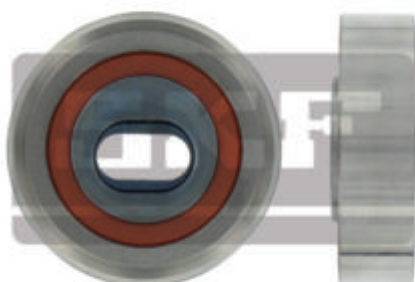

M⊙ D=70 W=19

VKM 73011

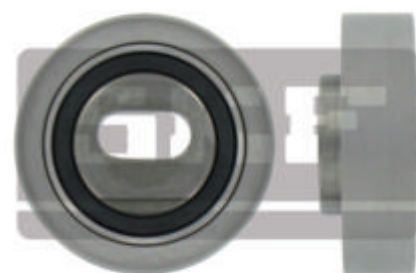

M⊙ D=70 W=19



**VKM 73101**

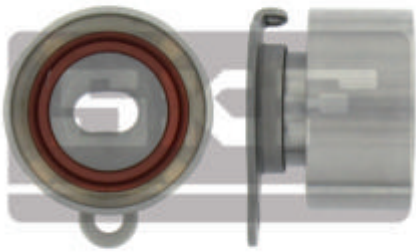

M⊙ D=55 W=28

**VKM 73200**

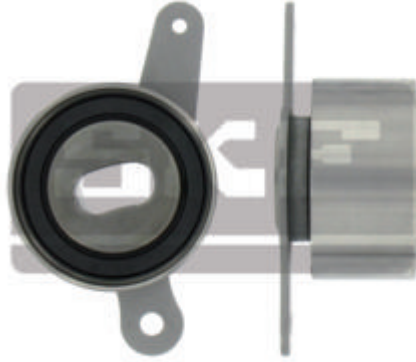

M⊙ D=55 W=28

**VKM 73201**

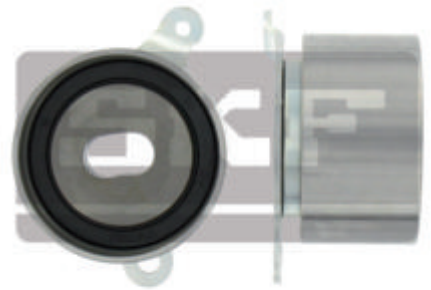

M⊙ D=50 W=30

**VKM 73600**

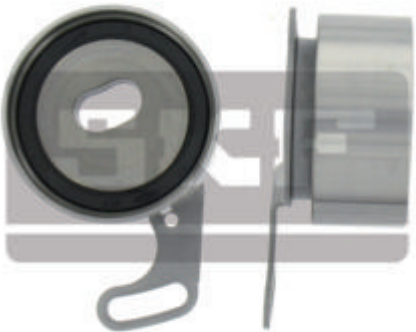

M⊙ D=62 W=27

**VKM 73605**



HT D=55 W=30

**VKM 73607**

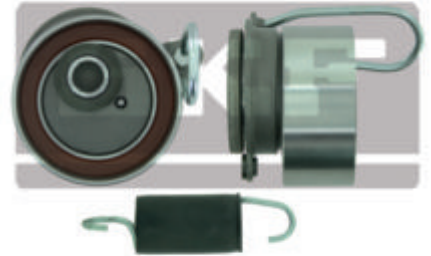

A⊙ D=55 W=24

**VKM 74000**

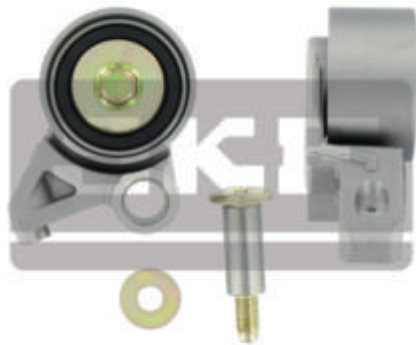

HT D=60 W=33

**VKM 74001**

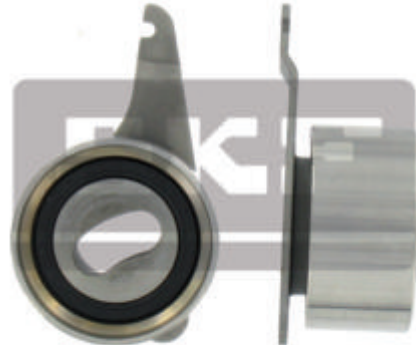

M⊙ D=52 W=26

**VKM 74002**

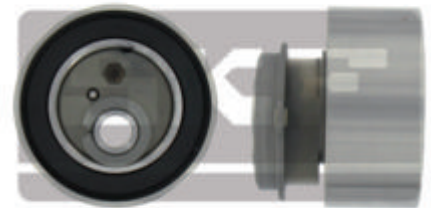

A⊙ D=62 W=29

**VKM 74004**

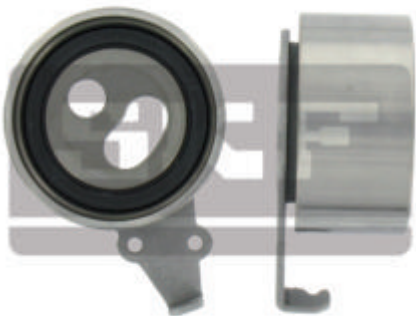

M⊙ D=58 W=31

**VKM 74006**



HT D=62 W=28,5

**VKM 74007**

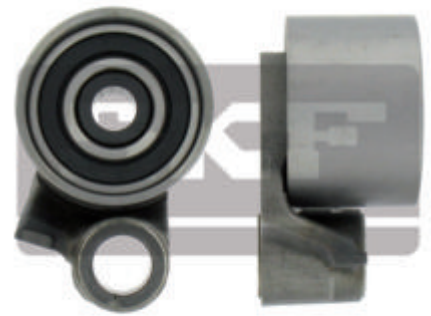

HT D=52 W=35



**VKM 74008**

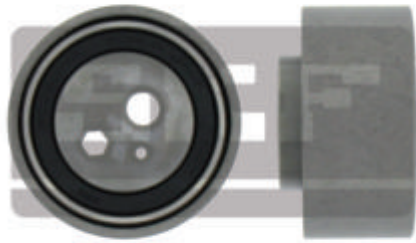

M⊙ D=60 W=28

**VKM 74200**

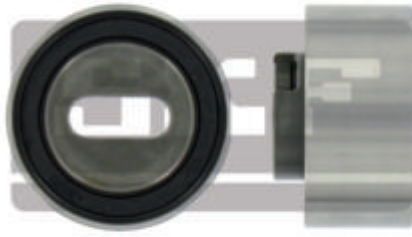

M⊙ D=52 W=25

**VKM 74201**

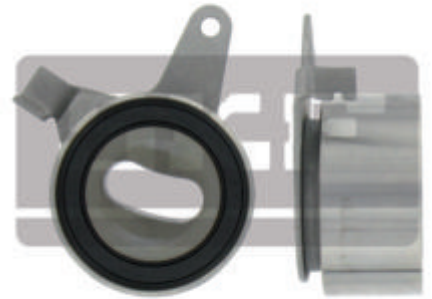

M⊙ D=52 W=25

**VKM 74300**

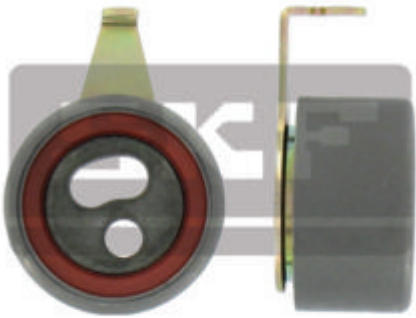

M⊙ D=58 W=31

**VKM 74310**

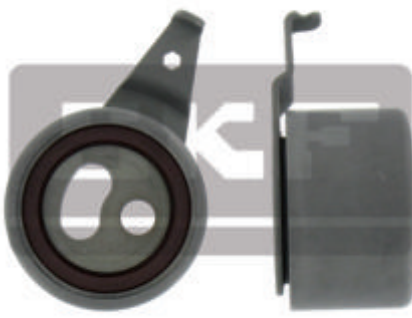

M⊙ D=58 W=35

**VKM 74501**

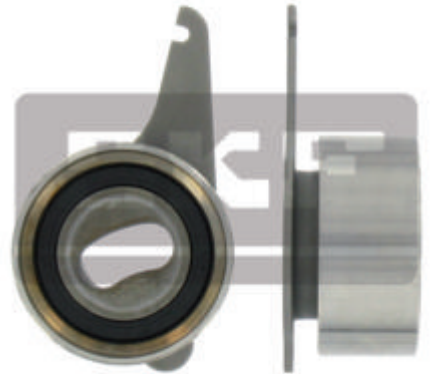

M⊙ D=52 W=23

**VKM 74502**

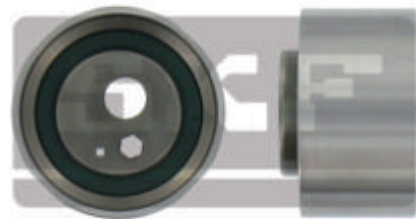

M⊙ D=52 W=25

**VKM 74503**



M⊙ D=60 W=26

**VKM 74504**

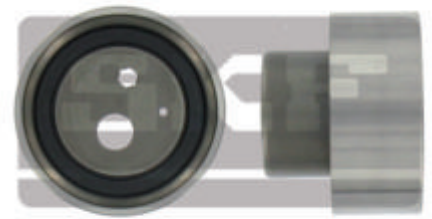

M⊙ D=60 W=26

**VKM 74506**



HT D=60 W=32

**VKM 74600**

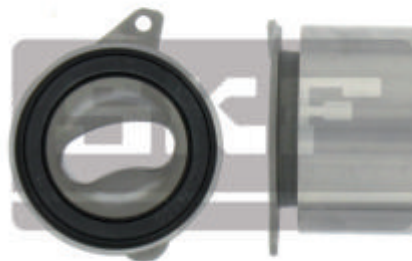

M⊙ D=52 W=29

**VKM 74601**

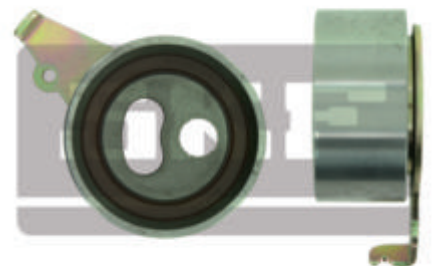

M⊙ D=58 W=27



**VKM 74602**

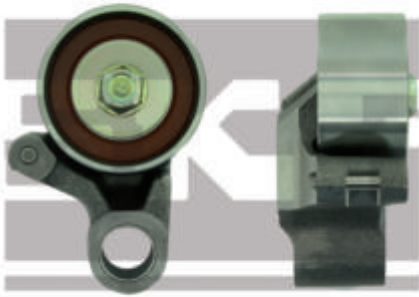

HT D=58 W=30

**VKM 74604**

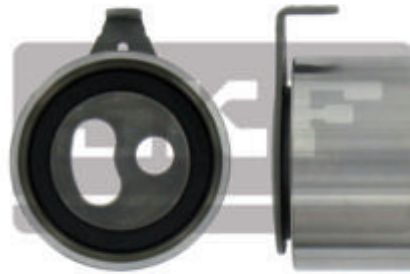

M⊙ D=58 W=32

**VKM 74606**

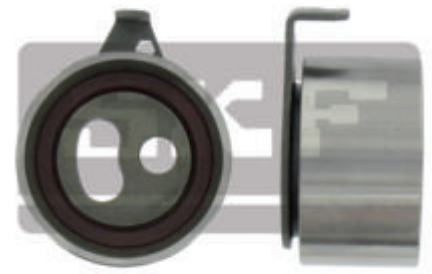

M⊙ D=58 W=32

**VKM 74607**

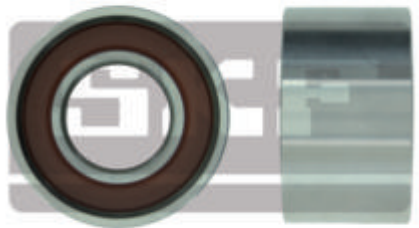

M⊙ D=58 W=33

**VKM 74608**

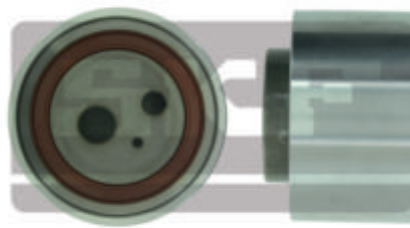

M⊙ D=60 W=34

**VKM 74609**

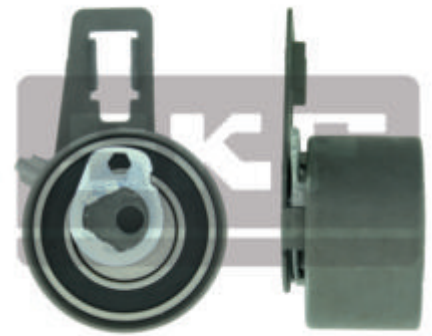

A⊙ D=59 W=34

**VKM 75000**

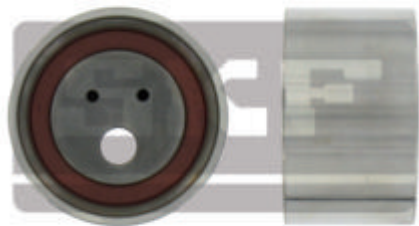

M⊙ D=60 W=35

**VKM 75001**



M⊙ D=60 W=25

**VKM 75002**



M⊙ D=58 W=30

**VKM 75004**

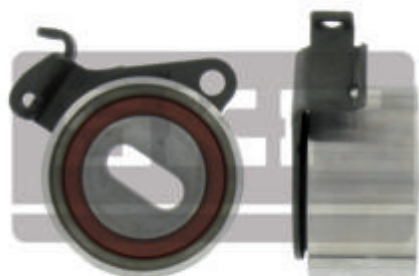

M⊙ D=60 W=32

**VKM 75006**



M⊙ D=60 W=26

**VKM 75008**

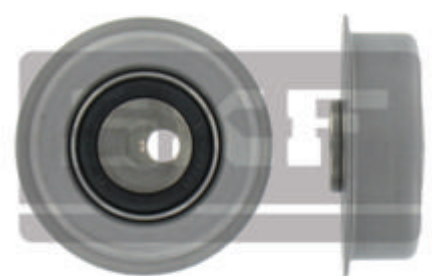

M⊙ D=60 W=16



**VKM 75009**

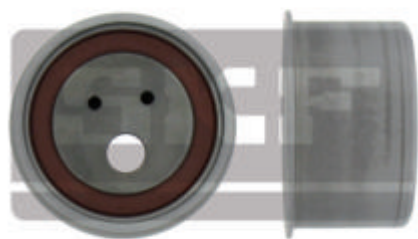

M⊙ D=58 W=30

**VKM 75033**

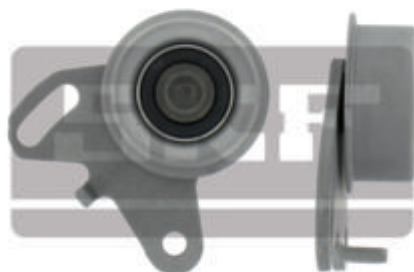

M⊙ D=60 W=22

**VKM 75044**

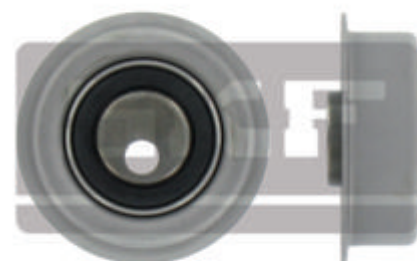

M⊙ D=55 W=16

**VKM 75054**

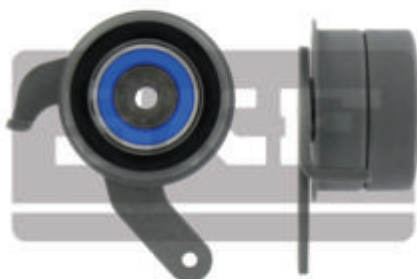

HT D=60 W=34

**VKM 75064**

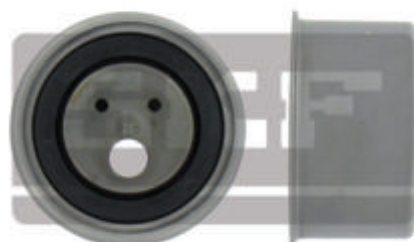

M⊙ D=60 W=31

**VKM 75100**



M⊙ D=60 W=21

**VKM 75101**

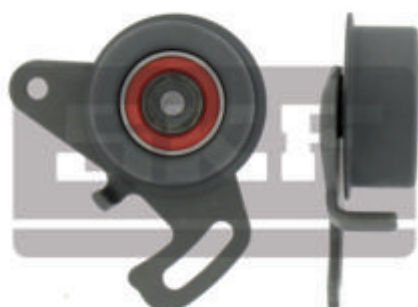

M⊙ D=60 W=22

**VKM 75108**

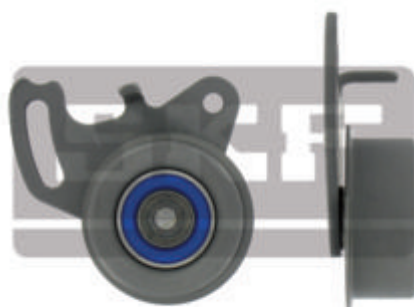

M⊙ D=60 W=22

**VKM 75113**



M⊙ D=60 W=16

**VKM 75119**



M⊙ D=60 W=15

**VKM 75130**

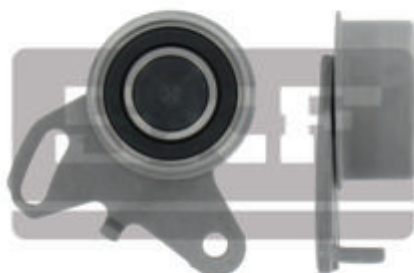

M⊙ D=60 W=26

**VKM 75140**

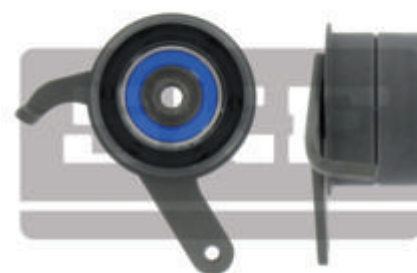

HT D=60 W=34



**VKM 75144**

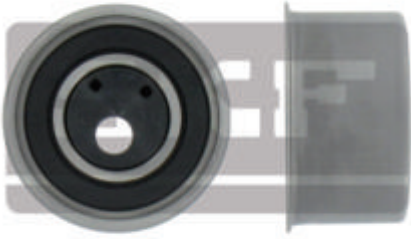

M⊙ D=60 W=31

**VKM 75601**



M⊙ D=60 W=29

**VKM 75612**



M⊙ D=58 W=21

**VKM 75613**

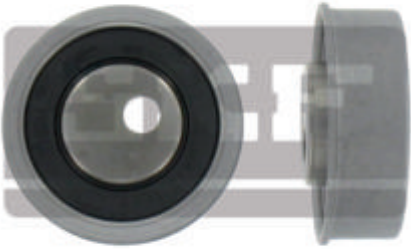

M⊙ D=55 W=18

**VKM 75614**

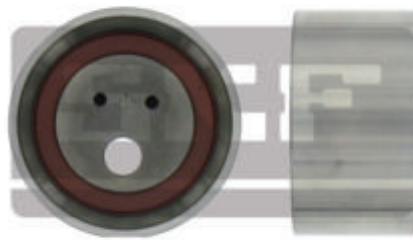

M⊙ D=62 W=33

**VKM 75615**

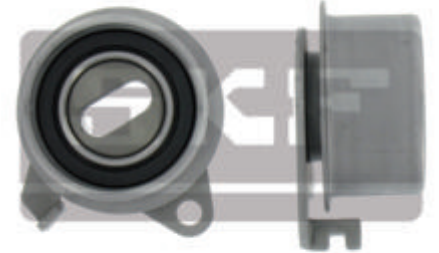

M⊙ D=57 W=28

**VKM 75616**



M⊙ D=58 W=29

**VKM 75621**

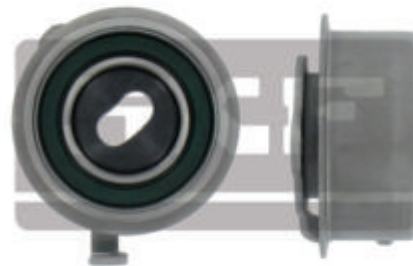

M⊙ D=57 W=22

**VKM 75624**



M⊙ D=60 W=34

**VKM 75625**



M⊙ D=57 W=31

**VKM 75628**

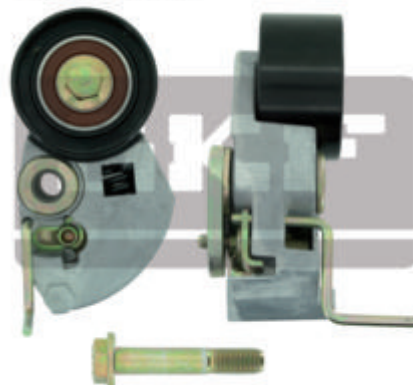

A⊙ D=58 W=32

**VKM 75629**

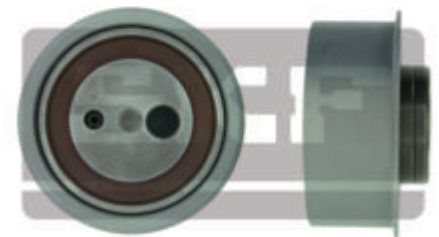

M⊙ D=70 W=30



VKM 75630

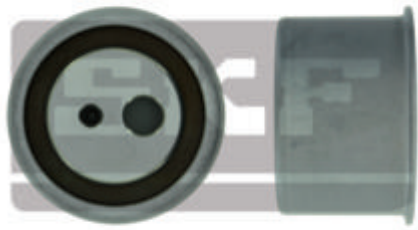

M $\odot$  D=58 W=38,5

VKM 75633

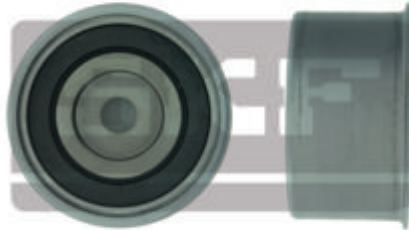

M $\odot$  D=60 W=32

VKM 75634

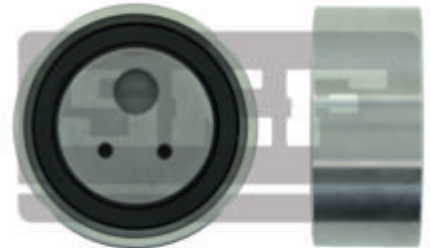

M $\odot$  D=57,5 W=25

VKM 76001

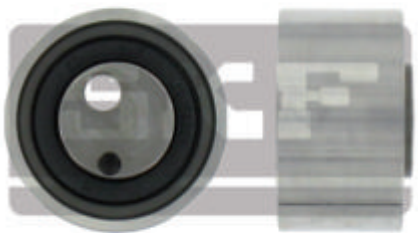

M $\odot$  D=51 W=28

VKM 76102

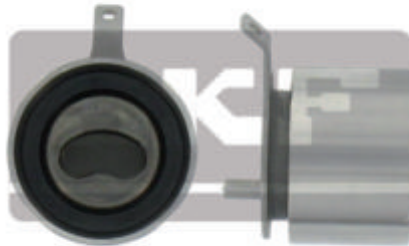

M $\odot$  D=42 W=28

VKM 76103



M $\odot$  D=52 W=22

VKM 76200



M $\odot$  D=42 W=30

VKM 76202



M $\odot$  D=58 W=24

VKM 76203



M $\odot$  D=42 W=24

VKM 77100

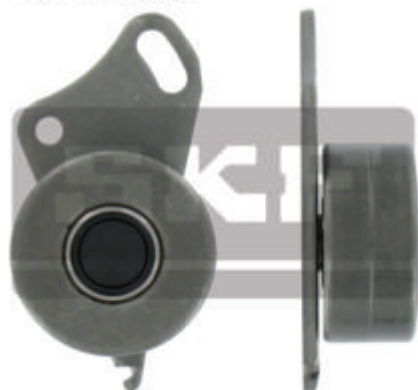

M $\odot$  D=60 W=27

VKM 77300

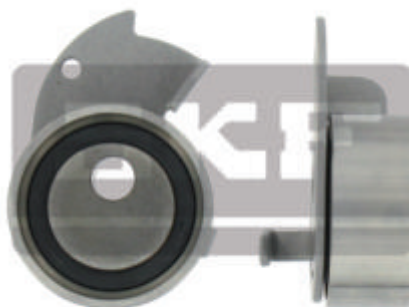

M $\odot$  D=50 W=21

VKM 77401

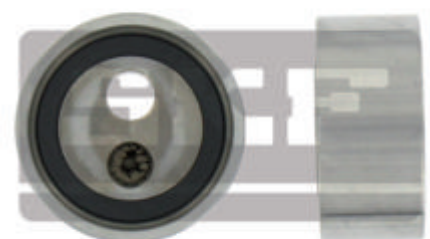

M $\odot$  D=50 W=23





**VKM 77500**

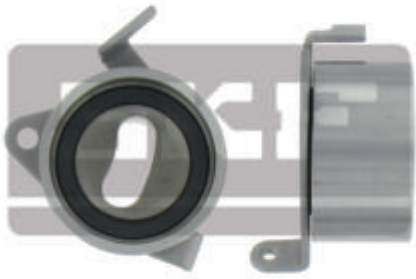

M⊙ D=50 W=27

**VKM 77501**

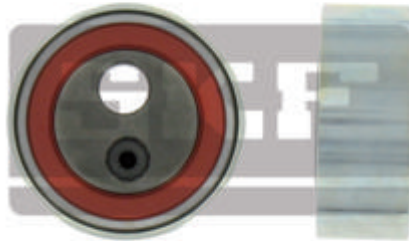

HT D=50 W=20

**VKM 77503**

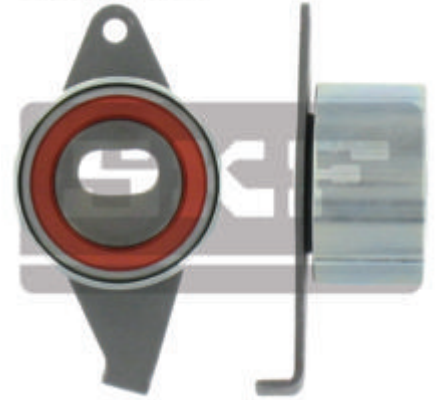

M⊙ D=50 W=27

**VKM 78000**



HT D=70 W=34

**VKM 78001**

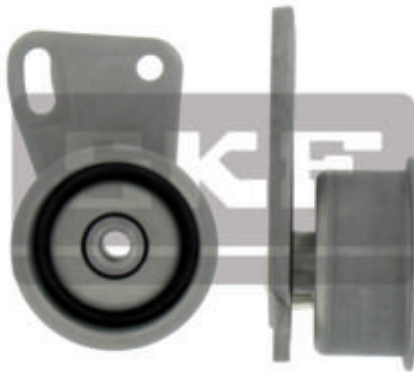

M⊙ D=52 W=21

**VKM 78002**

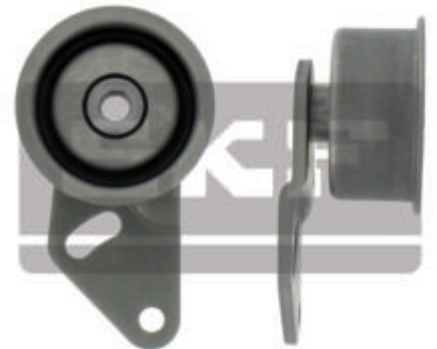

M⊙ D=52 W=22

**VKM 78005**

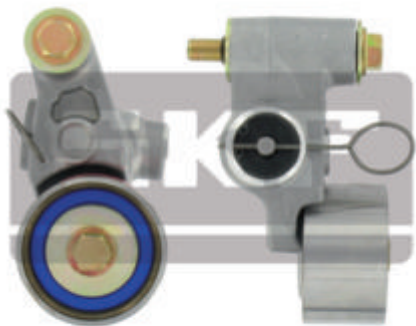

HT D=60 W=34

**VKM 78103**



M⊙ D=52 W=27

**VKM 78105**

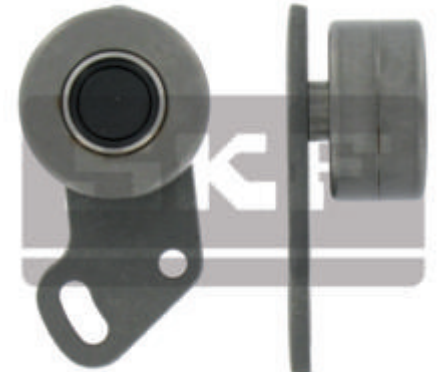

M⊙ D=52 W=27

**VKM 79000**

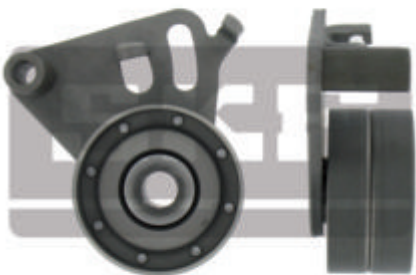

M⊙ D=60 W=30

**VKM 79001**

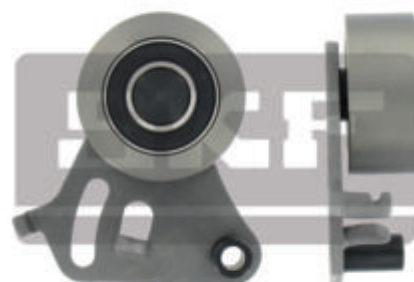

M⊙ D=60 W=26

**VKM 79002**



M⊙ D=67 W=39

VKM 79003



M<sup>⊙</sup> D=62 W=38

VKM 80000

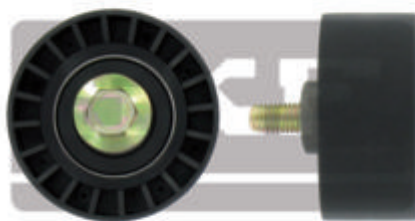

D=64 W=30

VKM 80002

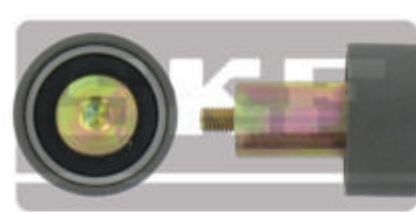

D=45 W=21

VKM 81000

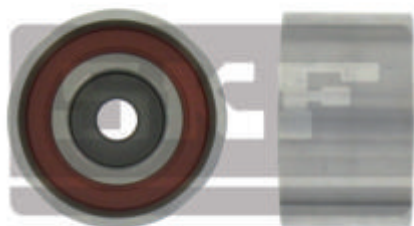

D=62 W=37

VKM 81001

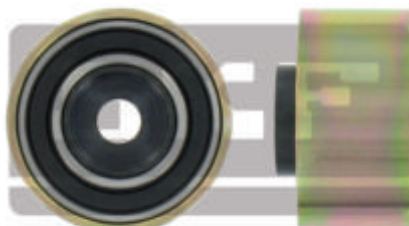

D=60 W=30

VKM 81002

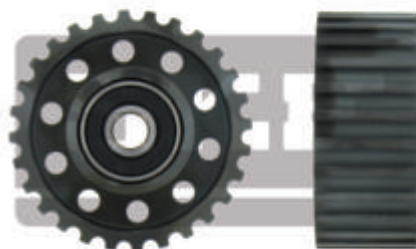

D=83 W=36

VKM 81004

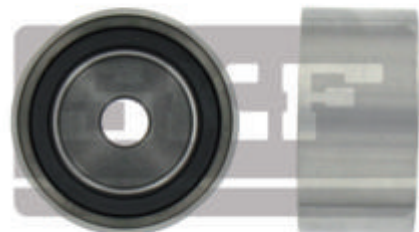

D=58 W=29

VKM 81005

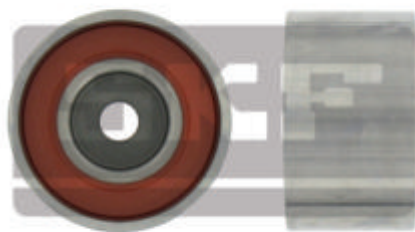

D=66 W=38

VKM 81100

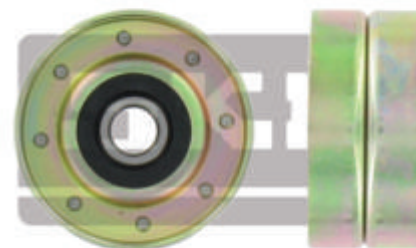

D=62 W=29

VKM 81201

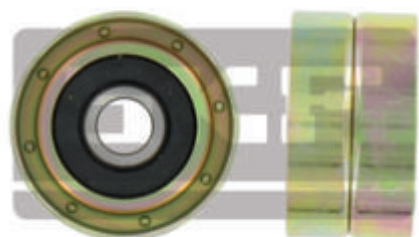

D=50 W=27

VKM 81203

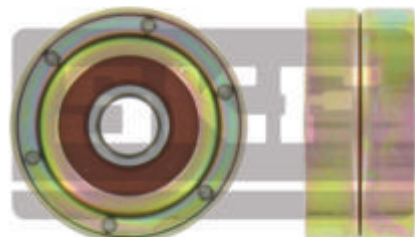

D=50 W=23

VKM 81204

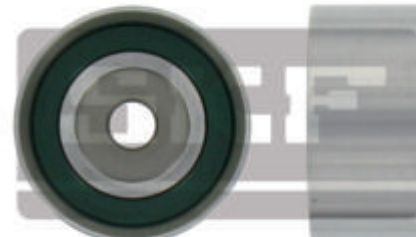

D=62 W=28





**VKM 81400**

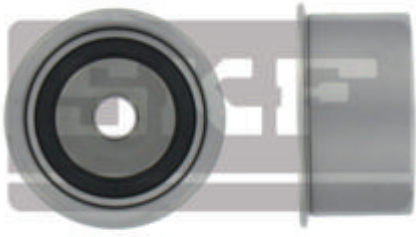

D=54 W=27

**VKM 81401**

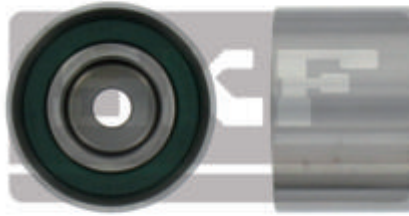

D=62 W=41

**VKM 82000**



D=60 W=36

**VKM 82101**

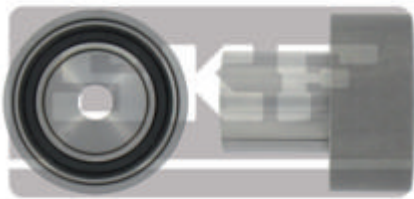

D=52 W=24

**VKM 82300**

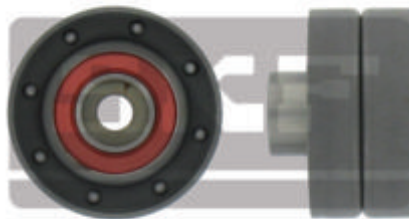

D=60 W=29

**VKM 82302**



D=60 W=29

**VKM 82320**

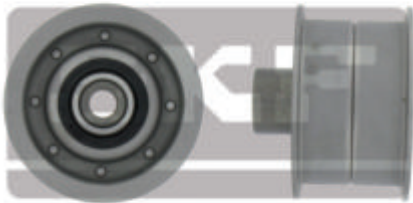

D=60 W=35

**VKM 82500**



D=60 W=36

**VKM 82502**

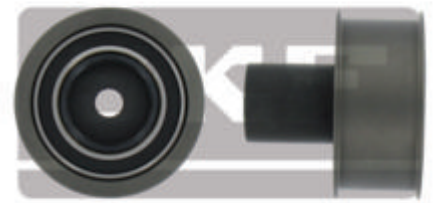

D=60 W=26

**VKM 82503**



D=60 W=26,4

**VKM 83003**



D=55 W=30

**VKM 84000**

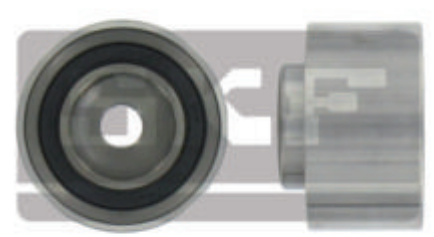

D=52 W=29

**VKM 84001**

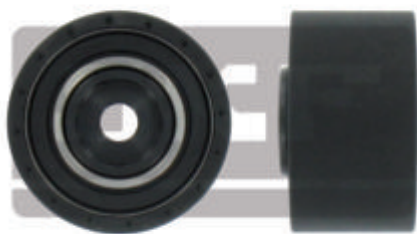

D=60 W=33

**VKM 84002**

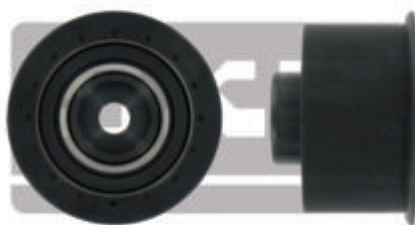

D=60 W=32

**VKM 84007**



D=52 W=31

**VKM 84201**

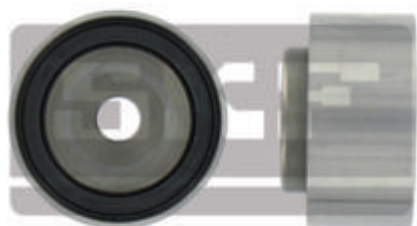

D=52 W=25

**VKM 84310**

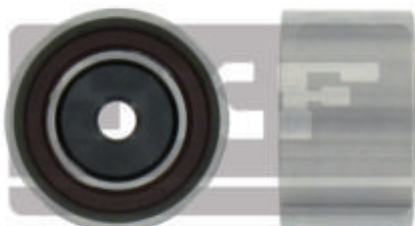

D=58 W=34

**VKM 84502**

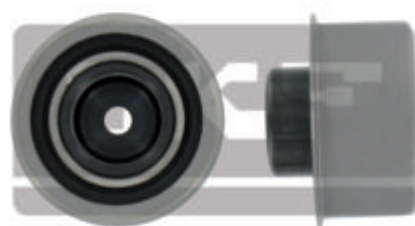

D=71 W=32

**VKM 84503**



D=55 W=34

**VKM 84504**

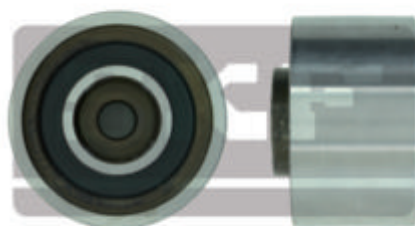

D=60 W=34

**VKM 84506**



D=28,3 W=36,5

**VKM 84600**

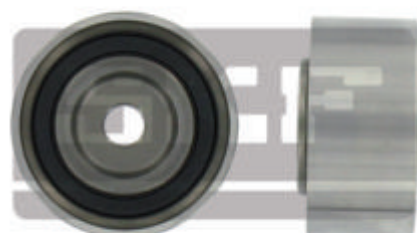

D=60 W=29

**VKM 84601**

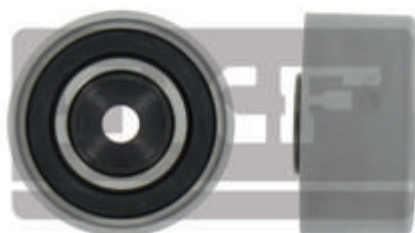

D=60 W=30

**VKM 84602**

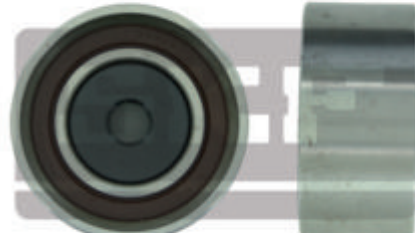

D=58 W=27



**VKM 84603**

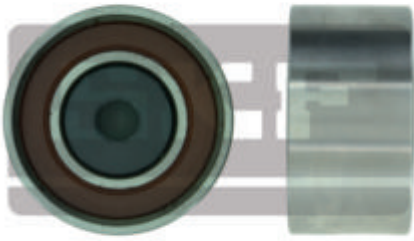

D=58 W=30

**VKM 84604**

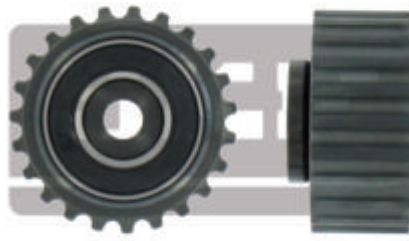

D=57 W=25

**VKM 84608**

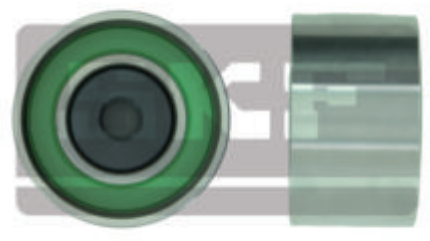

D=58 W=33

**VKM 85000**

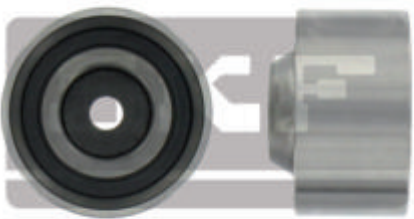

D=60 W=32

**VKM 85002**

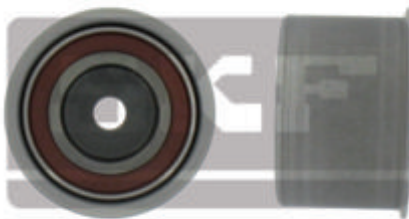

D=58 W=35

**VKM 85140**

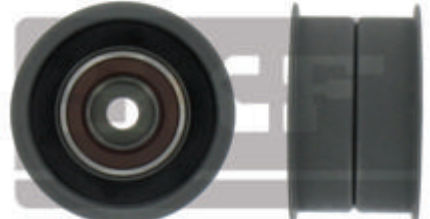

D=60 W=35

**VKM 85141**

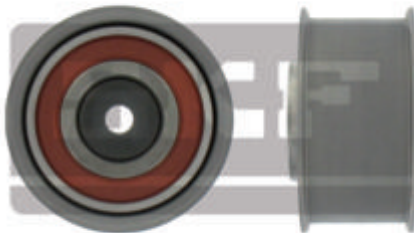

D=70 W=32

**VKM 85145**

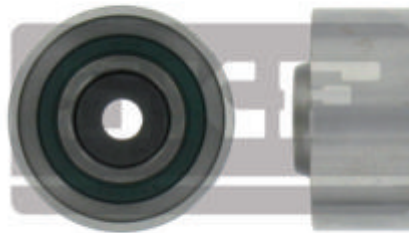

D=55 W=25

**VKM 85146**

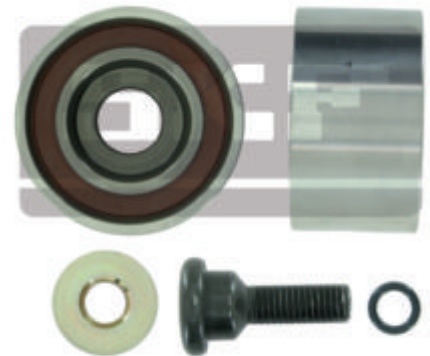

D=58 W=32

**VKM 85147**

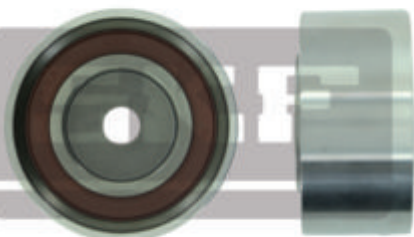

D=60 W=28,5

**VKM 85148**

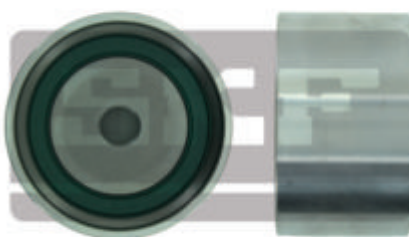

D=60 W=35

**VKM 85150**

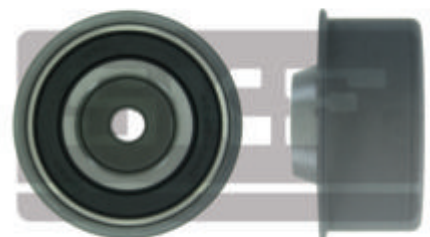

D=60 W=28



VKM 87000

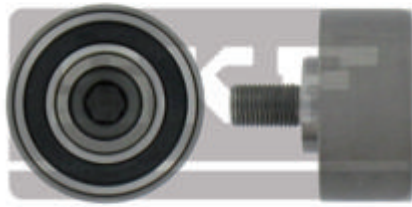

D=50 W=24

VKM 88000



D=60 W=35

VKM 88001

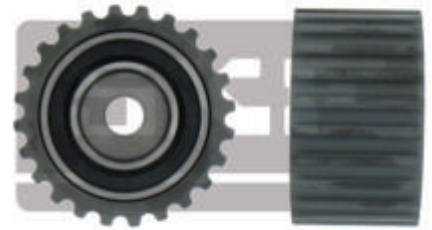

D=60 W=35

VKM 88002

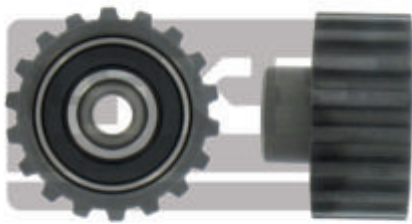

D=53 W=25

VKM 88004

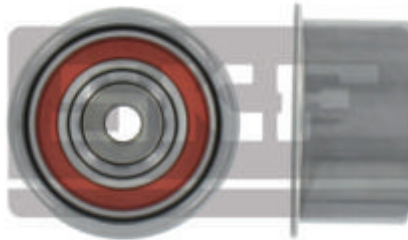

D=60 W=31

VKM 89001

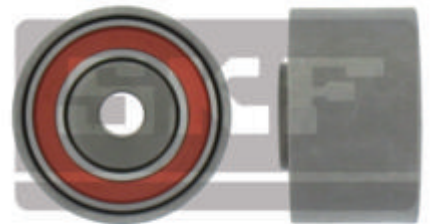

D=60 W=35

VKM 89002



D=60 W=35

VKM 89003

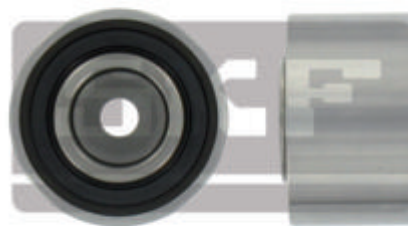

D=67 W=38

VKM 93301



VKM 93302



VKM 93305

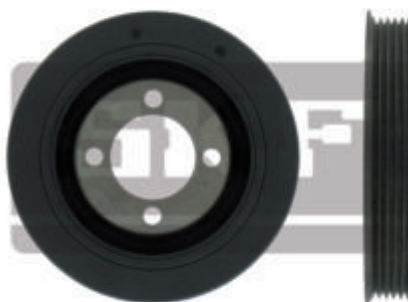

VKM 93306



VKMA 04223



VKMA 04304



VKMA 04305



VKMA 05500



VKMA 05501



VKM 05502

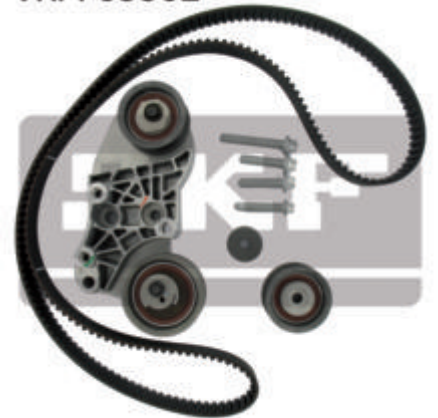

VKPA 81400



VKPA 81401



VKPA 81402

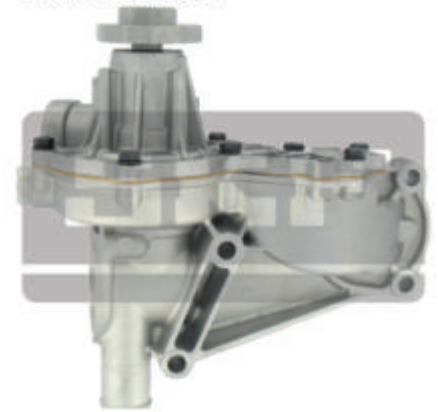

VKPA 82202



VKPA 82203



VKPA 82210





VKPA 82218

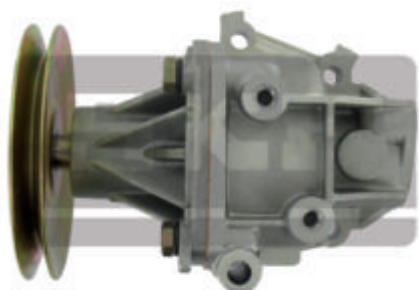

VKPA 82220

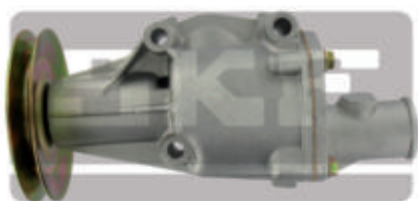

VKPA 82222

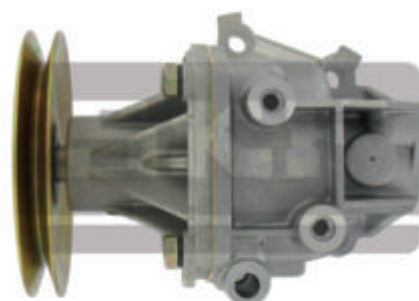

VKPA 82230



VKPA 82240



VKPA 82248



☐=5

☐=6

VKPA 82426



VKPA 82428



VKPA 82429



VKPA 82431

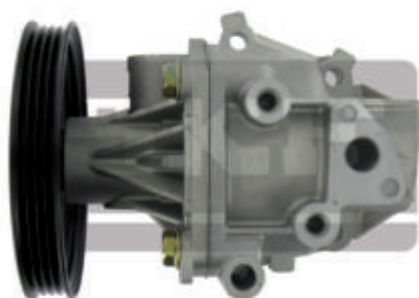

VKPA 82435



VKPA 82440



☐=4



VKPA 82441



К=4/2

VKPA 82618



К=5

VKPA 82634



VKPA 82648

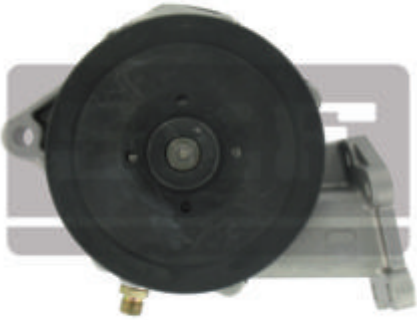

VKPA 82653



VKPA 82666



VKPA 82670



VKPA 82671



VKPA 83200

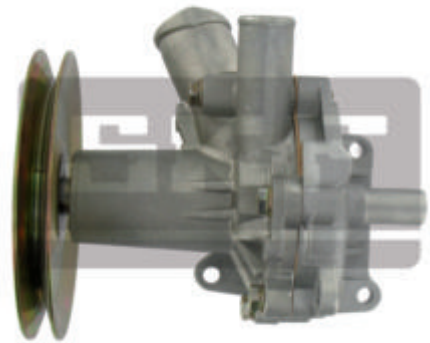

VKPA 83431

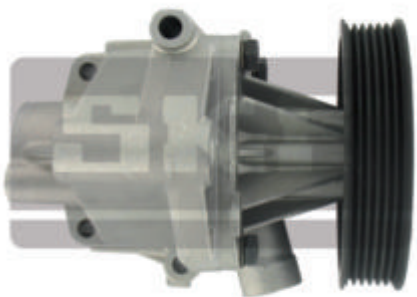

К=6

VKPA 83432



К=6

VKPA 84621





VKPA 84623



VKPA 85605

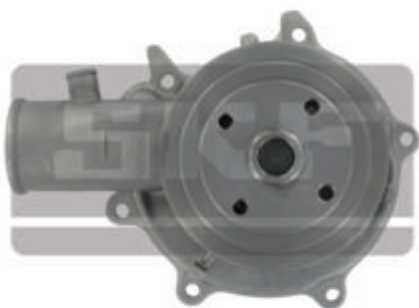

VKPA 85608

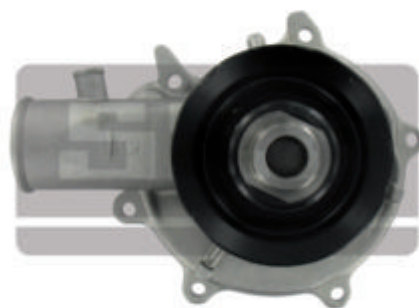

VKPA 86200



VKPA 86206



VKPA 86212



VKPA 86217



VKPA 91409



VKPA 91417

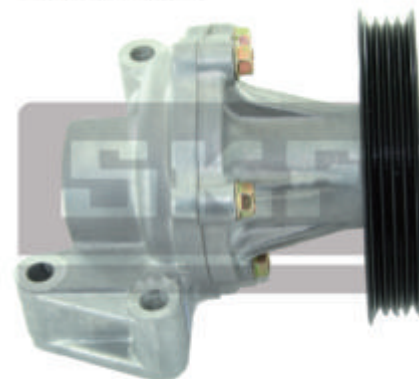

К=3

VKPA 91441

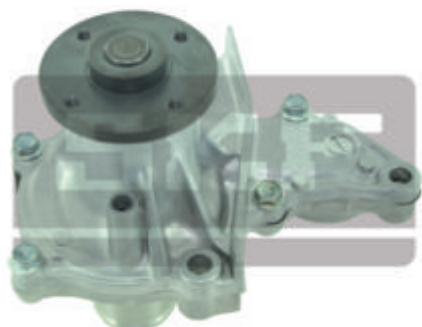

VKPA 91615



VKPA 95003

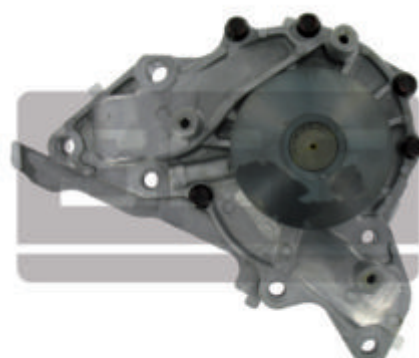

К=3

VKPA 95851



VKPC 81200



λ=26

VKPC 81204



λ=30

VKPC 81206



λ=18

VKPC 81210



VKPC 81215



VKPC 81220



λ=23

VKPC 81301



VKPC 81302



VKPC 81303



λ=19

VKPC 83425



λ=20

VKPC 81401





VKPC 81402

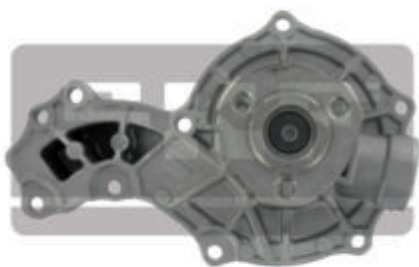

VKPC 81405



κ=1

VKPC 81406



κ=4

VKPC 81407



VKPC 81408



VKPC 81409



κ=4

VKPC 81411



VKPC 81412

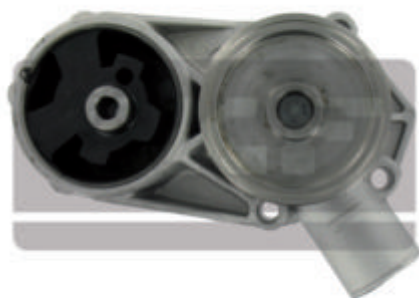

VKPC 81416



VKPC 81417



VKPC 81418



VKPC 81419



λ=27



VKPC 81501



VKPC 81601

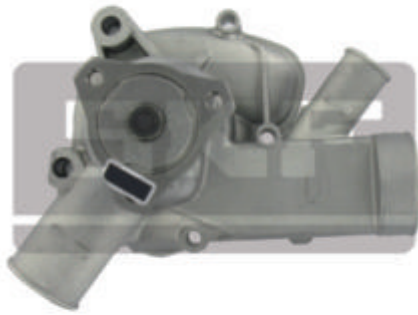

VKPC 81602



$\lambda=20$



VKPC 81603



$\lambda=20$

VKPC 81605



$\lambda=26$

VKPC 81606



$\lambda=29$

VKPC 81607

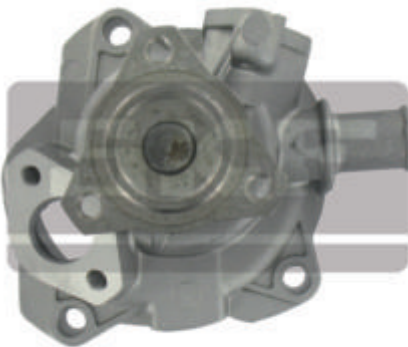

VKPC 81609



VKPC 81611



VKPC 81612



$\lambda=29$

VKPC 81615



VKPC 81620





VKPC 81622



VKPC 81623



λ=19

VKPC 81624

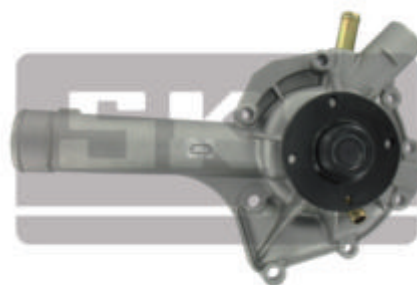

VKPC 81625

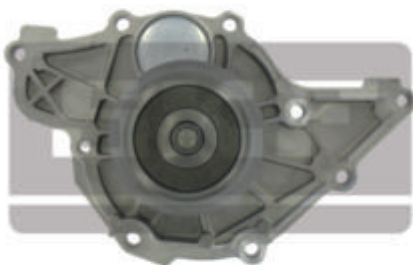

VKPC 81626



λ=19

VKPC 81627



VKPC 81800



VKPC 81802

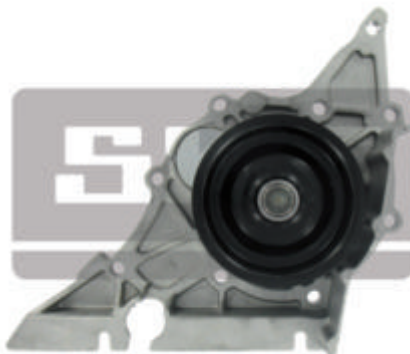

VKPC 81803

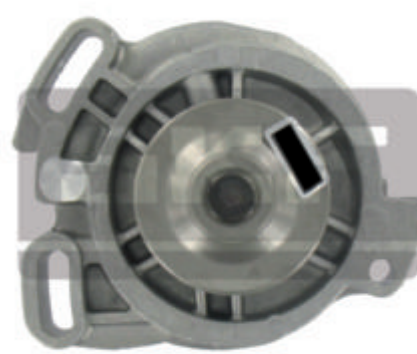

λ=18

VKPC 81805

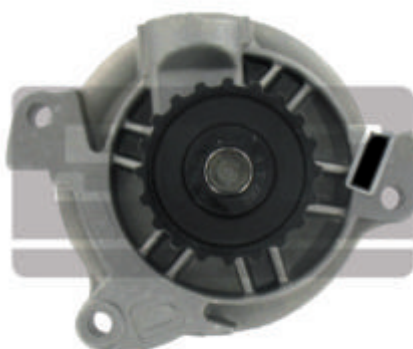

VKPC 81806

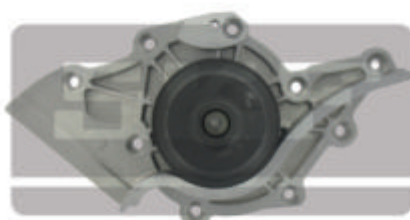

VKPC 81807



λ=20





VKPC 81811



VKPC 82201



VKPC 82205

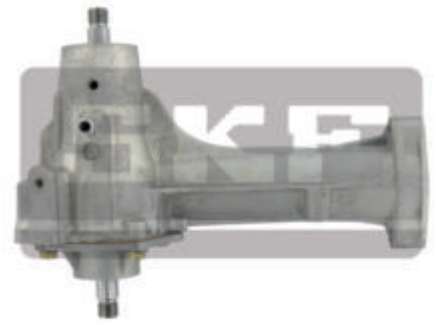

VKPC 82206

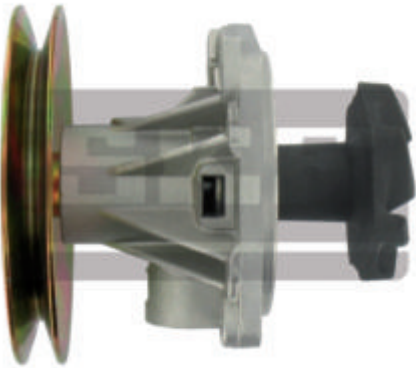

VKPC 82208



VKPC 82210



VKPC 82214



λ=20

VKPC 82216



VKPC 82218

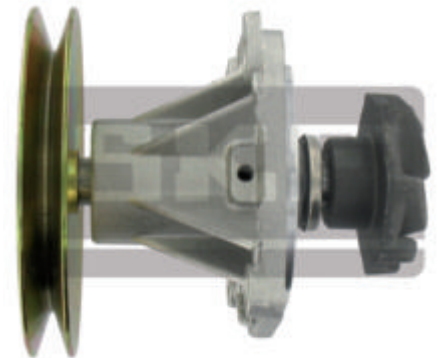

VKPC 82224



VKPC 82230



λ=5

VKPC 82245

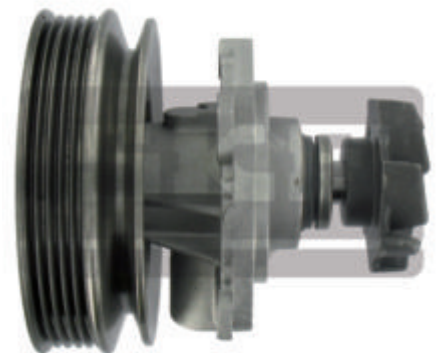

λ=5

VKPC 82246



ε=4

VKPC 82247



VKPC 82249



λ=23

VKPC 82250



VKPC 82251



λ=23

VKPC 82404

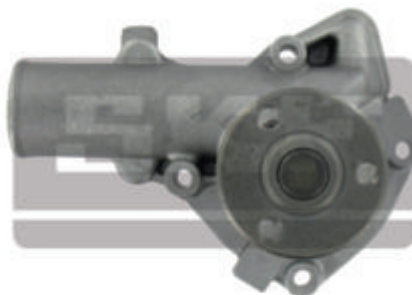

VKPC 82410



VKPC 82412

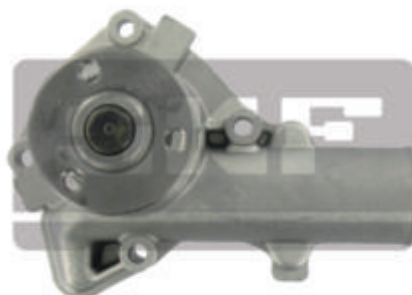

VKPC 82419

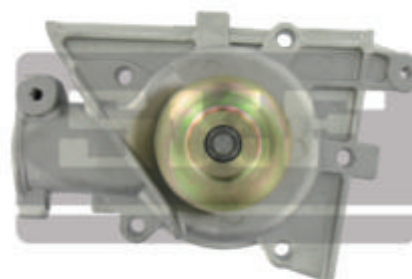

VKPC 82424



VKPC 82426

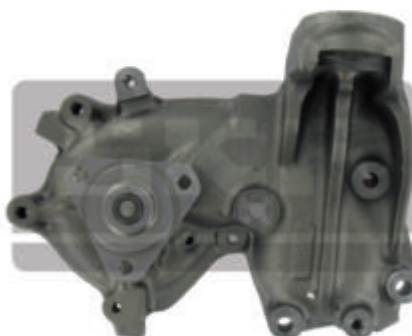

VKPC 82428





VKPC 82429



VKPC 82431

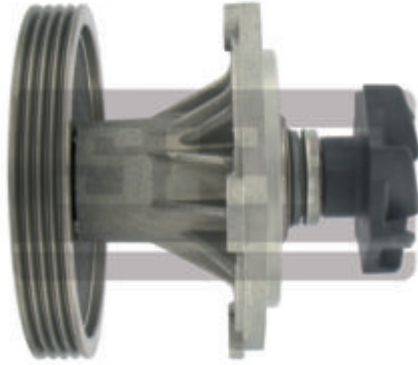

☒=4

VKPC 82432



VKPC 82437



VKPC 82441



☒=4/2

VKPC 82450



☒=4

VKPC 82451



VKPC 82600

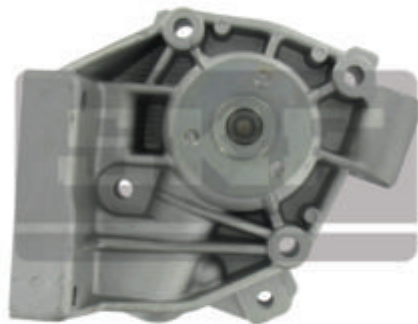

VKPC 82606

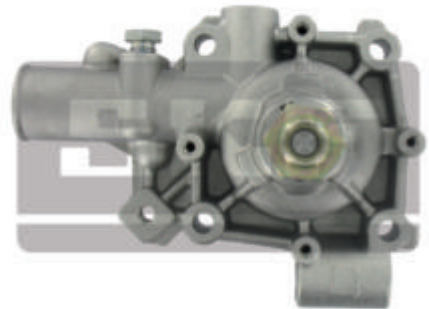

VKPC 82614



VKPC 82616



VKPC 82618



☒=5

VKPC 82620



VKPC 82621



VKPC 82622



☒=4

VKPC 82629



VKPC 82630

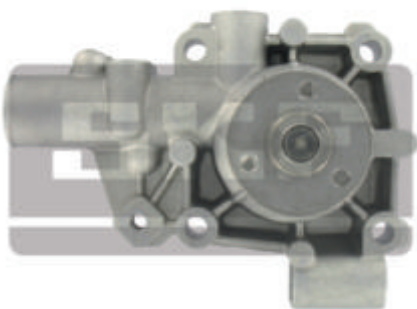

VKPC 82631

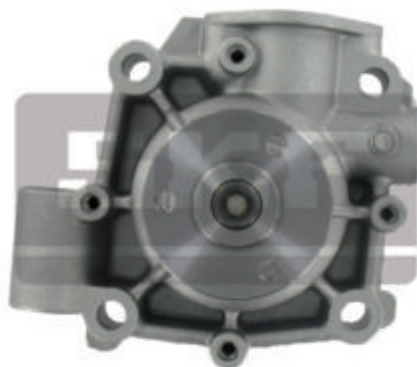

VKPC 82638



VKPC 82642



VKPC 82643



VKPC 82645



VKPC 82646



VKPC 82647





VKPC 82650

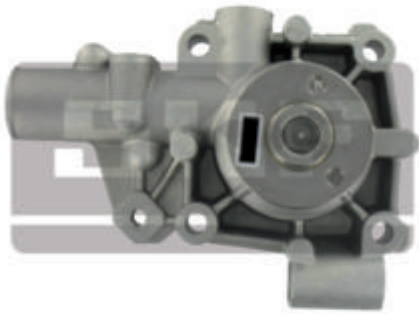

VKPC 82651



VKPC 82652

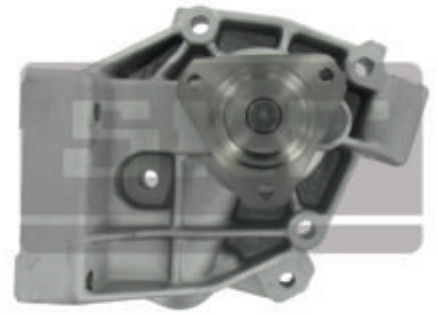

VKPC 82660



VKPC 82665

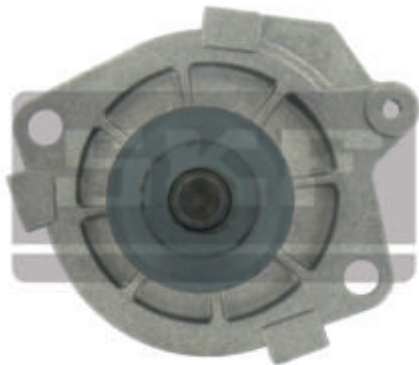

VKPC 82667



VKPC 82800



VKPC 82810



VKPC 83140

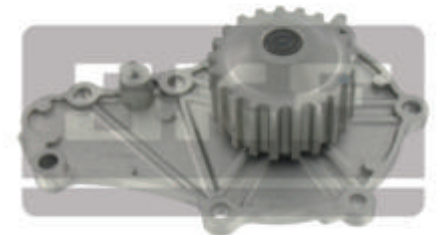

λ=31

VKPC 83200

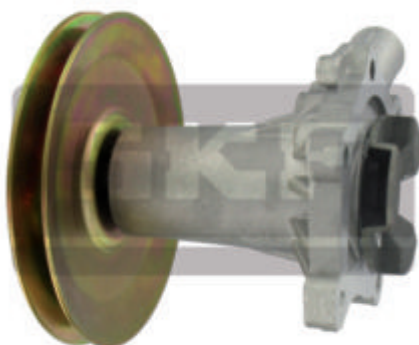

VKPC 83203



VKPC 83205

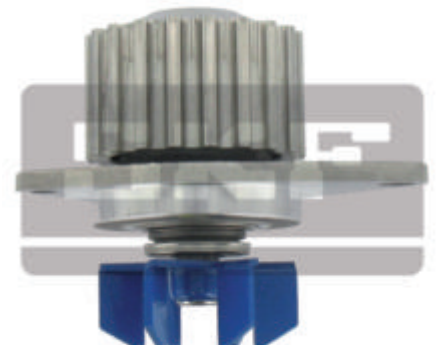

λ=20

VKPC 83206

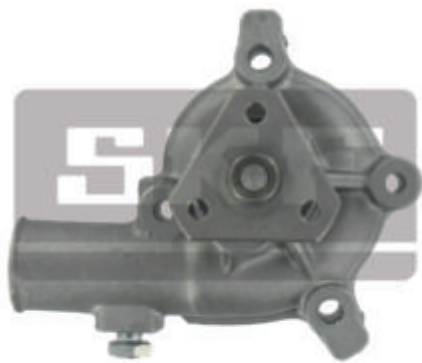

VKPC 83258

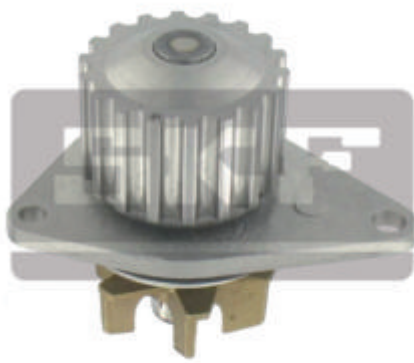

λ=18

VKPC 83259



λ=19

VKPC 83401

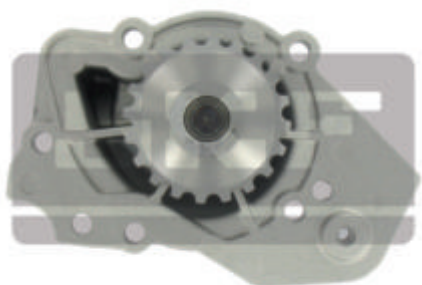

λ=20

VKPC 83403

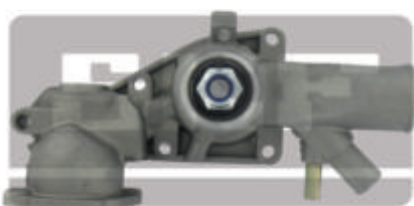

VKPC 83420



λ=20

VKPC 83423

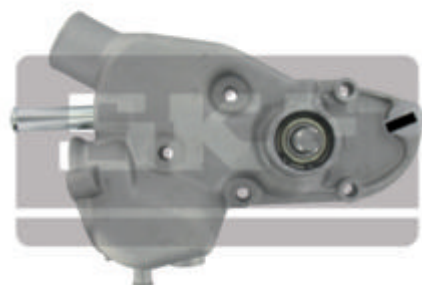

VKPC 83424

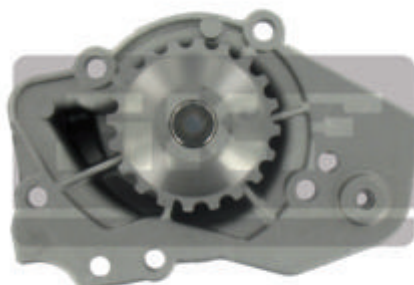

λ=20

VKPC 83425



λ=20

VKPC 83428



VKPC 83430



λ=19

VKPC 83603

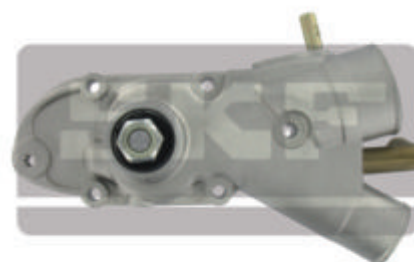



VKPC 83604



VKPC 83605

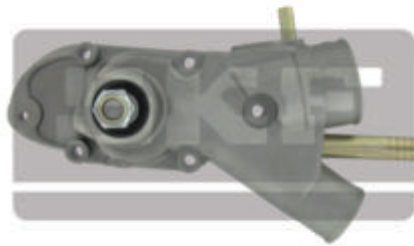

VKPC 83607



VKPC 83612



VKPC 83615



VKPC 83616

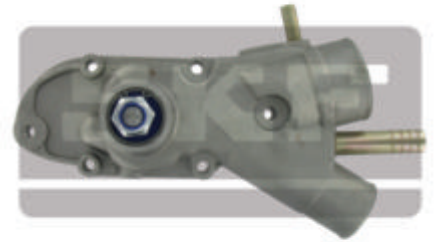

VKPC 83617

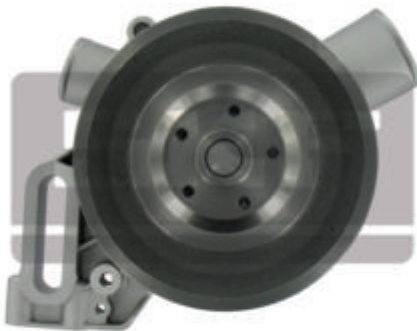

VKPC 83618



VKPC 83622



VKPC 83624



VKPC 83625



VKPC 83626

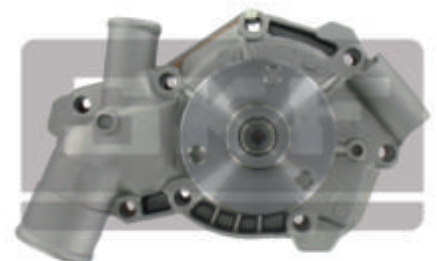

VKPC 83628

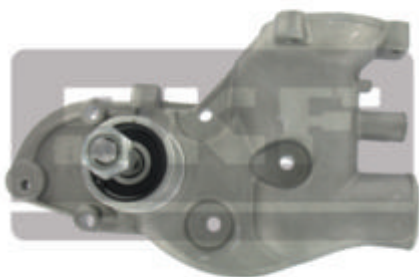

VKPC 83630

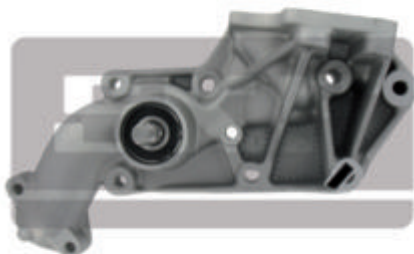

VKPC 83635



λ=20

VKPC 83636



λ=20

VKPC 83637



λ=27

VKPC 83639



λ=20

VKPC 83640



VKPC 83643



λ=19

VKPC 83644



λ=18

VKPC 83650



VKPC 83810

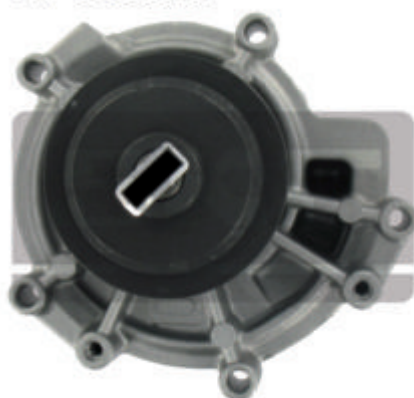

κ=4

VKPC 83811



κ=3



VKPC 84201



VKPC 84205



VKPC 84207

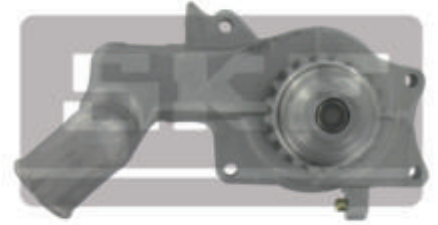

λ=20

VKPC 84208



VKPC 84209



VKPC 84210

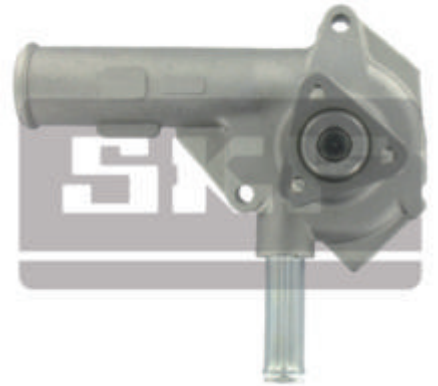

λ=20

VKPC 84215

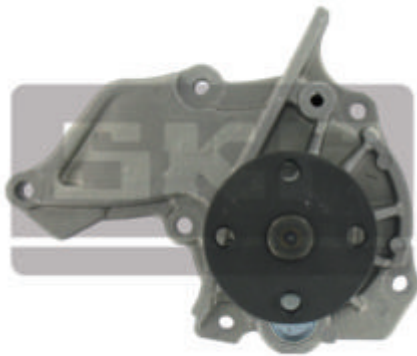

VKPC 84216



VKPC 84400



VKPC 84403

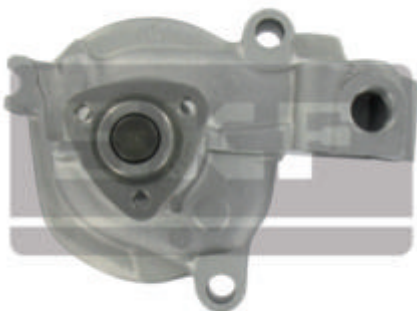

VKPC 84405

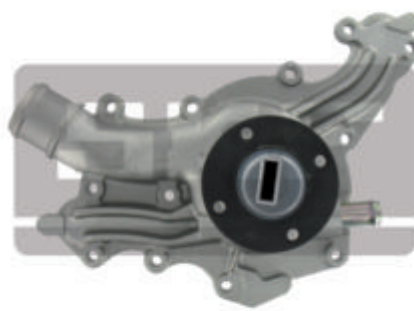

VKPC 84406





**VKPC 84407**



**VKPC 84408**



**VKPC 84409**



**VKPC 84410**



**VKPC 84411**

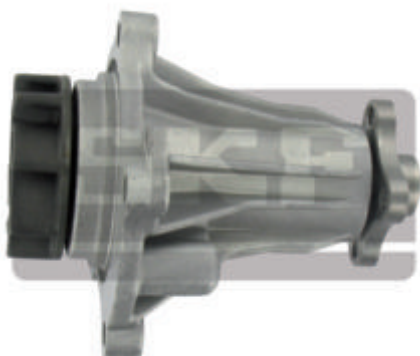

**VKPC 84412**



**VKPC 84415**



**VKPC 84416**



**VKPC 84600**



**VKPC 84601**



**VKPC 84603**



**VKPC 84607**

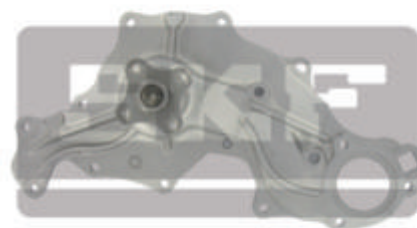

VKPC 84608

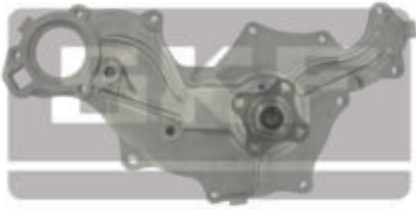

VKPC 84609

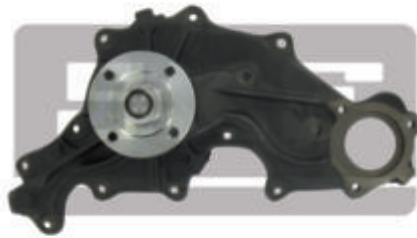

VKPC 84610



λ=20

VKPC 84611



VKPC 84612

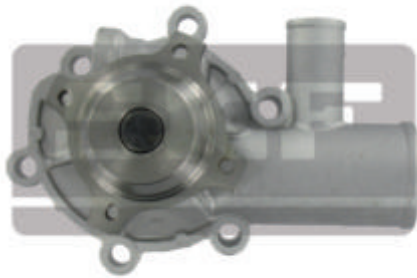

VKPC 84613



VKPC 84616

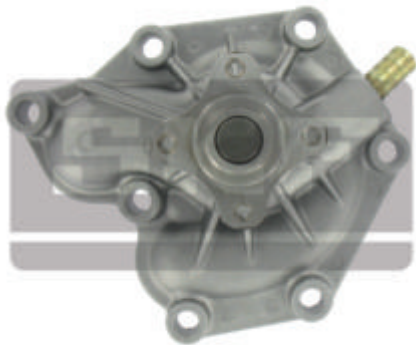

VKPC 84617



VKPC 84618



VKPC 84620



VKPC 84622



VKPC 84629





VKPC 85201

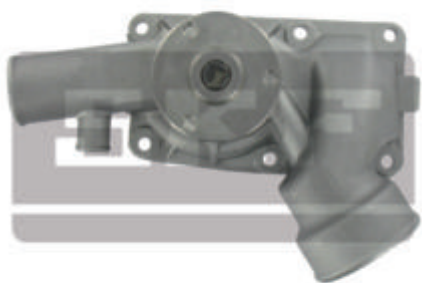

VKPC 85202



⌘=19



VKPC 85203

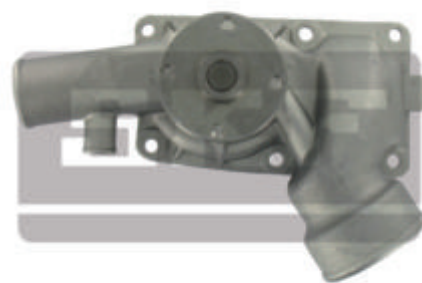

VKPC 85206



⌘=19



VKPC 85211



VKPC 85212



VKPC 85220



VKPC 85300



VKPC 85302

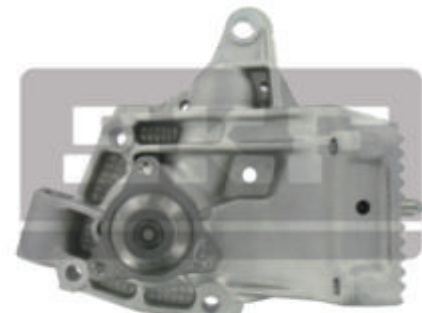

VKPC 85303

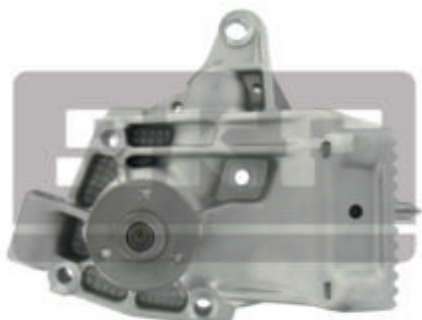

VKPC 85304



VKPC 85308





VKPC 85310



VKPC 85400



$\lambda=21$

VKPC 85401



$\lambda=19$

VKPC 85403



VKPC 85404



VKPC 85406



$\lambda=21$

VKPC 85407



$\lambda=21$

VKPC 85408



$\lambda=21$

VKPC 85409



$\lambda=25$

VKPC 85410



VKPC 85460



VKPC 85600



VKPC 85603



VKPC 85610



λ=21

VKPC 85611



λ=25

VKPC 85613



VKPC 85620



VKPC 85621

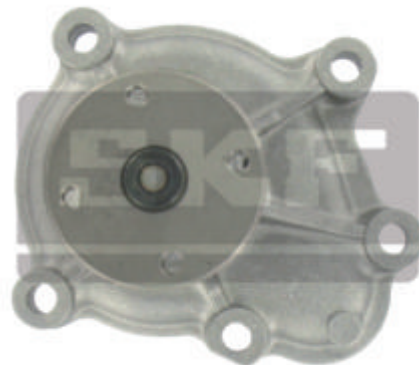

VKPC 85622



VKPC 85623



VKPC 85624



λ=23

VKPC 85700



λ=6

VKPC 86129



VKPC 86200





VKPC 86201

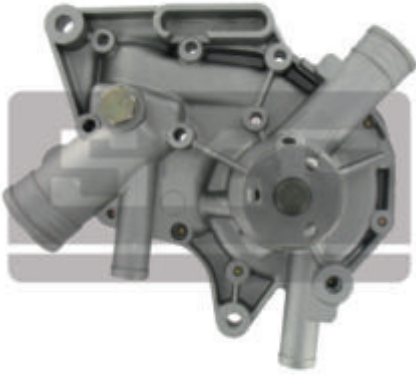

VKPC 86203



VKPC 86205



VKPC 86206



VKPC 86208



VKPC 86209



VKPC 86212



VKPC 86215

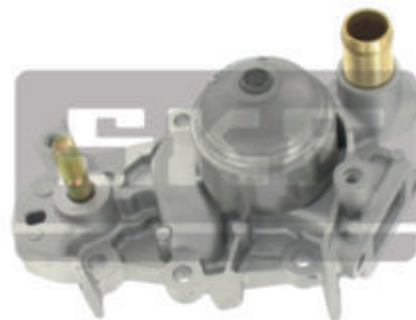

VKPC 86216



$\lambda=20$

VKPC 86217



VKPC 86305



VKPC 86401

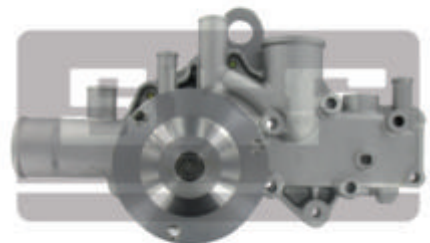

$\lambda=3$

VKPC 86402

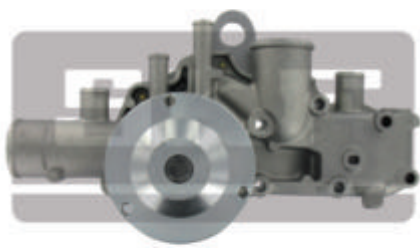

VKPC 86403



VKPC 86405



VKPC 86407

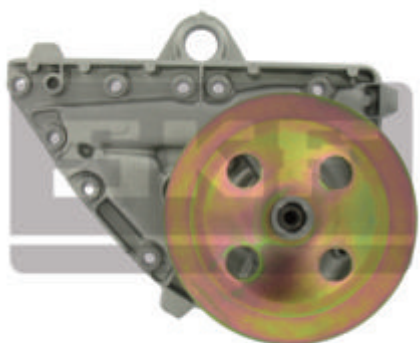

VKPC 86408

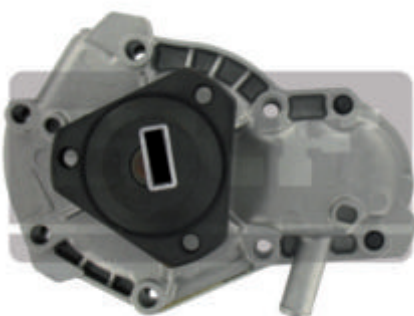

VKPC 86409



$\lambda=20$

VKPC 86413

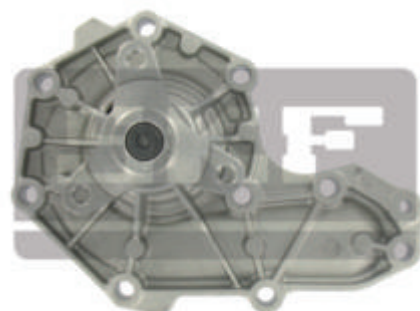

VKPC 86415

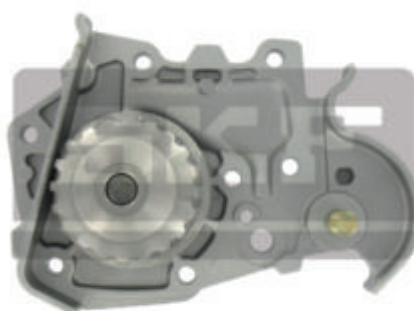

$\lambda=20$

VKPC 86416

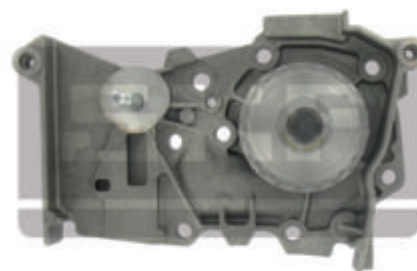

$\lambda=20$

VKPC 86417



VKPC 86500



VKPC 86520

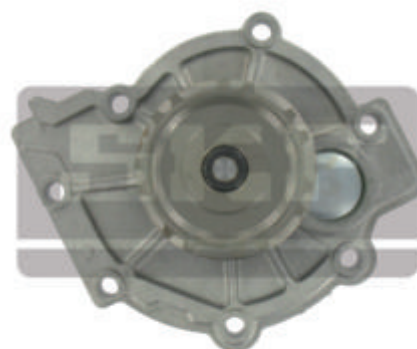



VKPC 86601



VKPC 86602



VKPC 86603

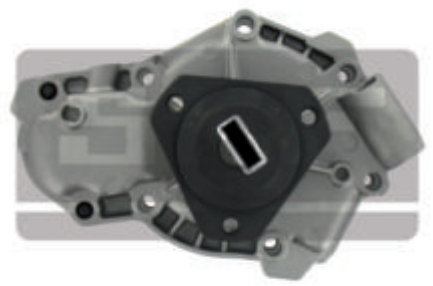

VKPC 86604



VKPC 86605



VKPC 86606



VKPC 86607



VKPC 86609



VKPC 86610



VKPC 86614

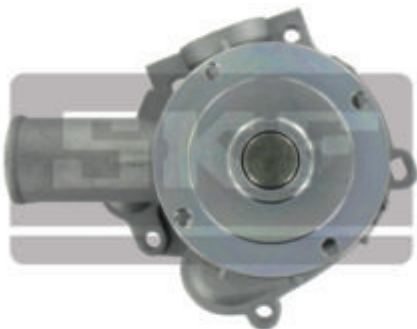

VKPC 86616



VKPC 86618



λ=19

VKPC 86619



λ=20

VKPC 86620



λ=18

VKPC 86621



VKPC 86622



VKPC 86623

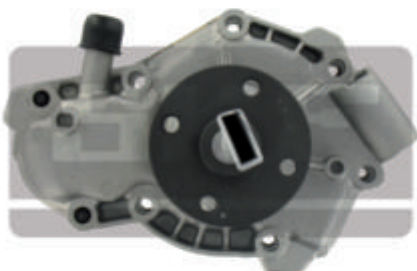

VKPC 86630



VKPC 86631



VKPC 86633

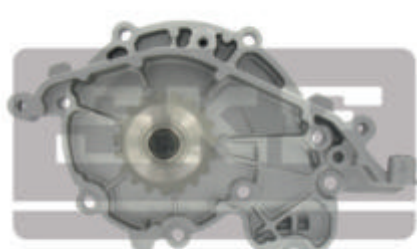

λ=19

VKPC 86635



λ=19

VKPC 86810

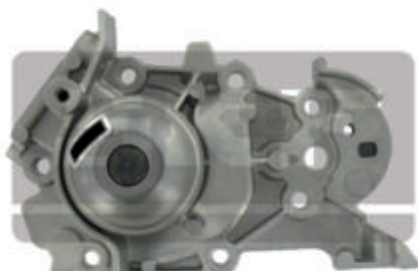

VKPC 87200



VKPC 87203

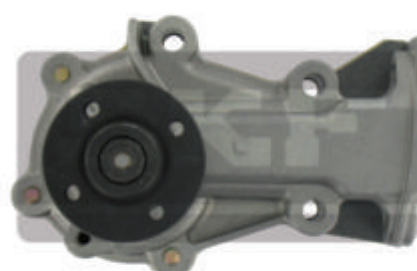



VKPC 87205

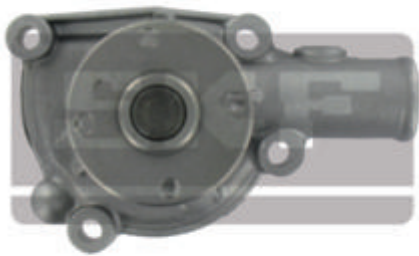

VKPC 87400



$\lambda=24$

VKPC 87401



$\lambda=24$

VKPC 87403

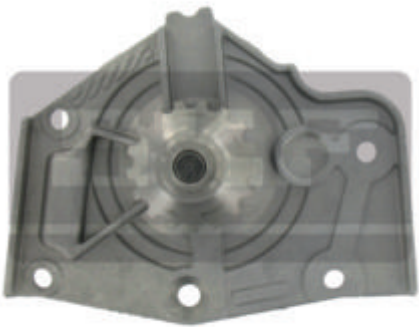

$\lambda=17$

VKPC 87404



$\lambda=19$

VKPC 87410



VKPC 87420

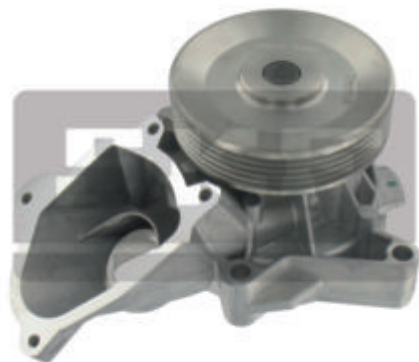

$\lambda=5$

VKPC 87607

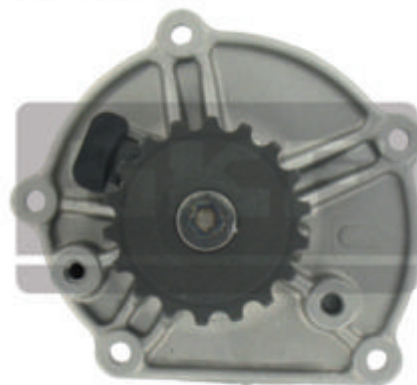

$\lambda=18$

VKPC 87609

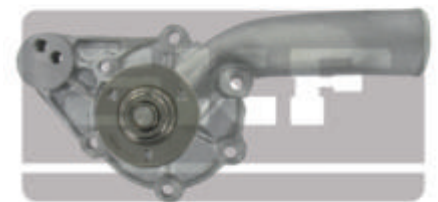

VKPC 87610



VKPC 87813



VKPC 87835

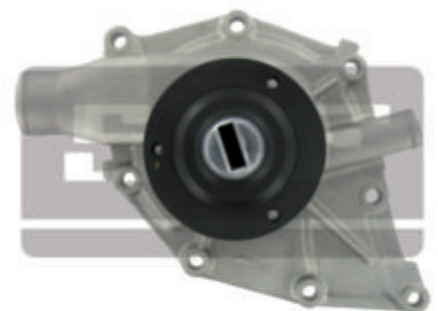

VKPC 88200



VKPC 88203



X=21

VKPC 88206



VKPC 88430



VKPC 88604



VKPC 88605



VKPC 88607

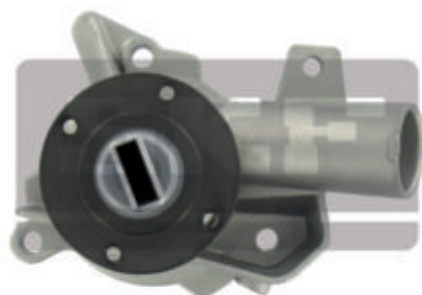

VKPC 88608



VKPC 88609

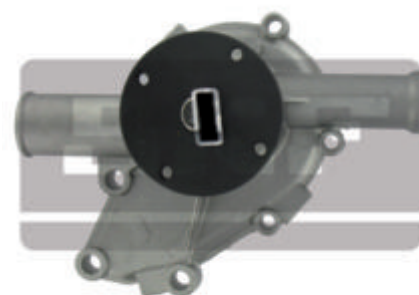

VKPC 88610

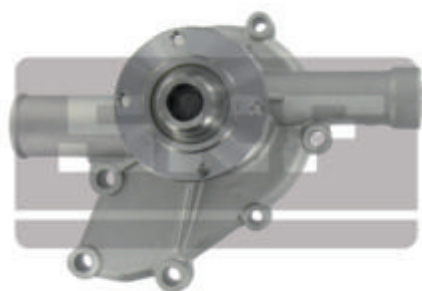

VKPC 88611



VKPC 88612





VKPC 88613

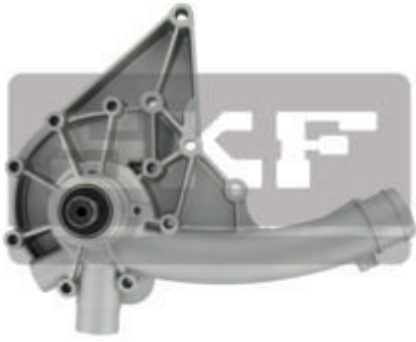

VKPC 88614



VKPC 88615



VKPC 88616



VKPC 88617



VKPC 88619

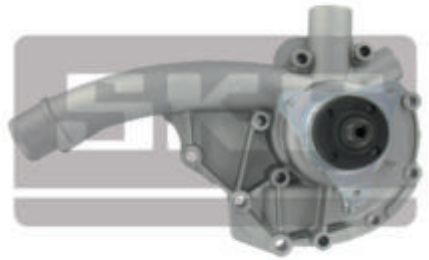

VKPC 88620



VKPC 88622

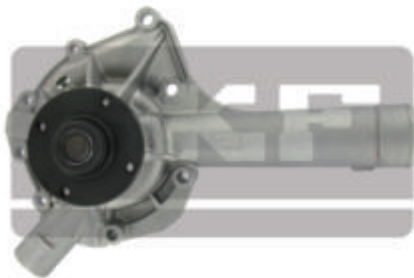

VKPC 88625

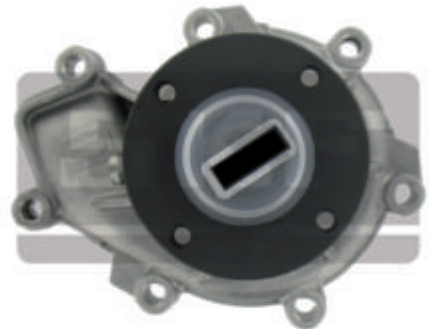

VKPC 88631

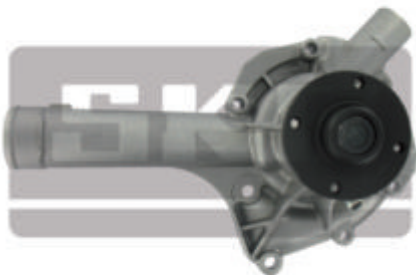

VKPC 88632



VKPC 88635

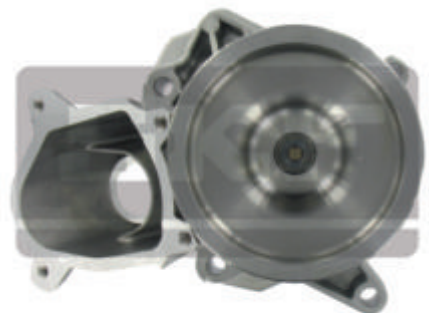

☐=5

VKPC 88636

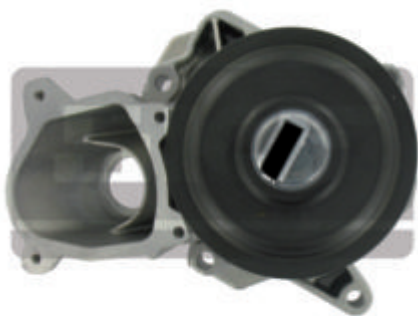

VKPC 88637



VKPC 88645



VKPC 88802

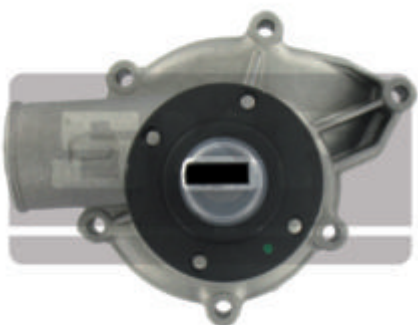

VKPC 88803



VKPC 88804



VKPC 88807



VKPC 88808



VKPC 88809



VKPC 88810



VKPC 88813



VKPC 88816





VKPC 88818

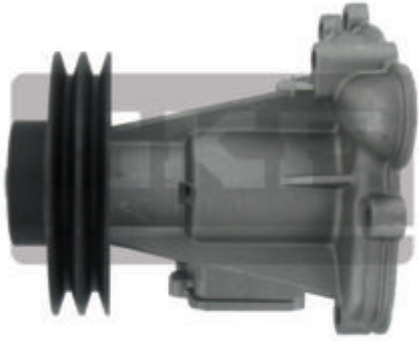

VKPC 88821



VKPC 88824



VKPC 88825



VKPC 88826



VKPC 88827



VKPC 88828



VKPC 88829

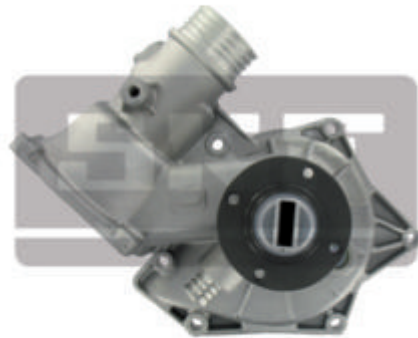

VKPC 88830



VKPC 88831



VKPC 88836



VKPC 88842



VKPC 88843

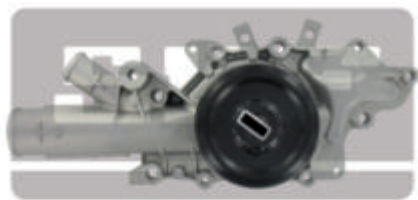

VKPC 88844

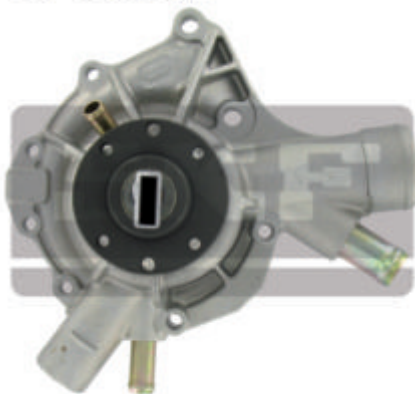

VKPC 88845

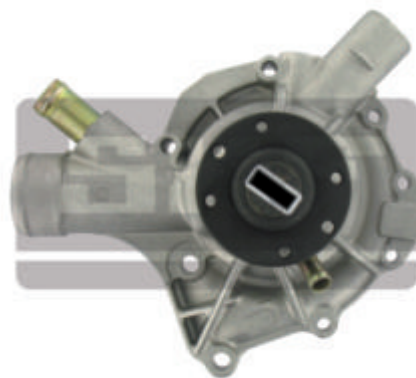

VKPC 88846



VKPC 88848

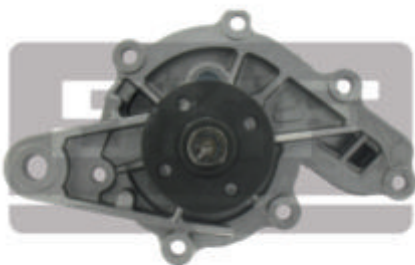

VKPC 88850



VKPC 88851



VKPC 88853



VKPC 88854

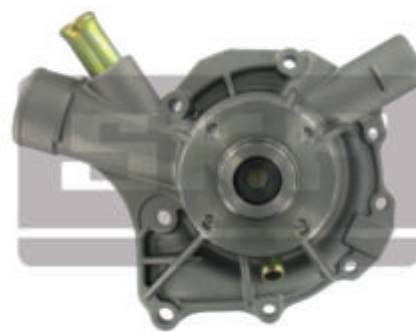

VKPC 88855



VKPC 90200



λ=19

VKPC 90202



λ=19





VKPC 90402



$\lambda=19$

VKPC 90450

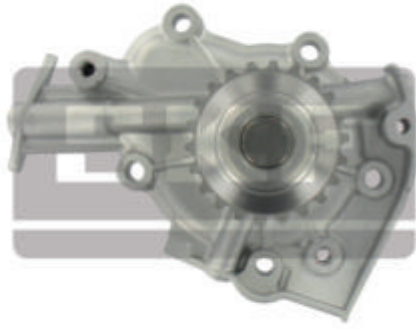

$\lambda=22$

VKPC 91402



VKPC 91404

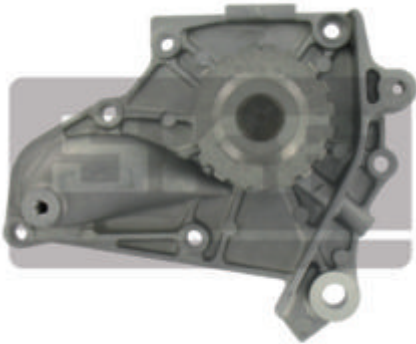

$\lambda=19$

VKPC 91405

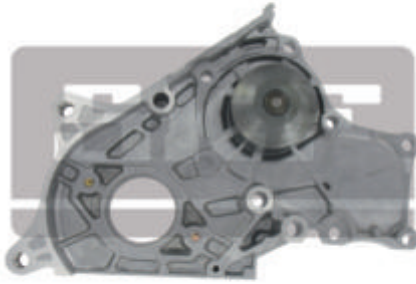

VKPC 91409

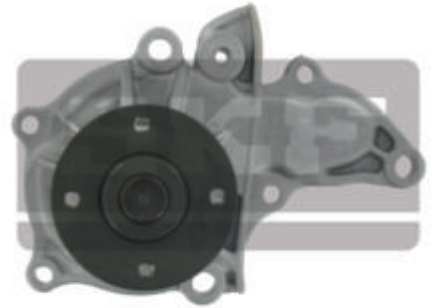

VKPC 91413



VKPC 91414



VKPC 91415

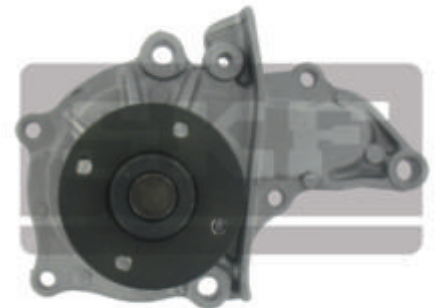

VKPC 91416



VKPC 91417



VKPC 91427

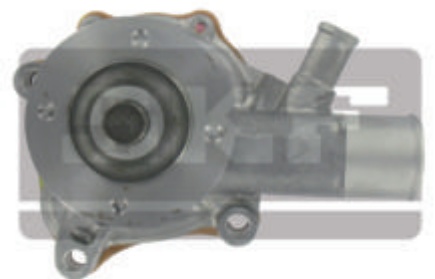

VKPC 91428



VKPC 91431



VKPC 91442

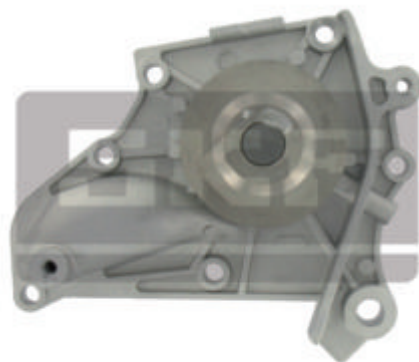

VKPC 91604



VKPC 91606



VKPC 91607



λ=22

VKPC 91613

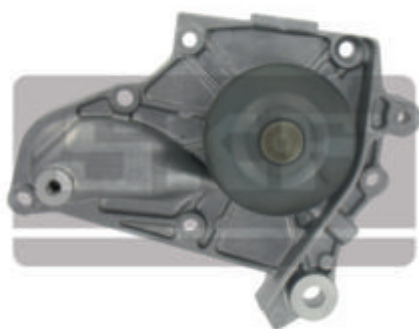

VKPC 91804

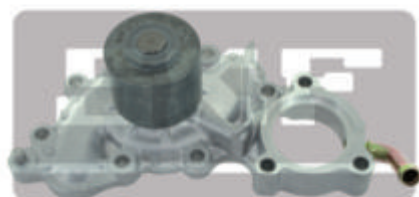

VKPC 91805



λ=23

VKPC 91806



VKPC 91807



VKPC 91808





VKPC 91813



VKPC 91814

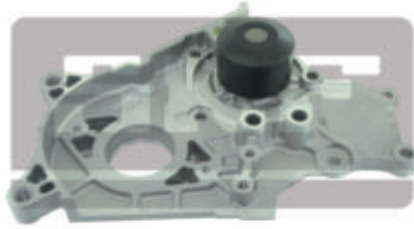

VKPC 92000

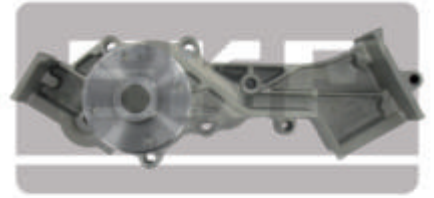

VKPC 92001

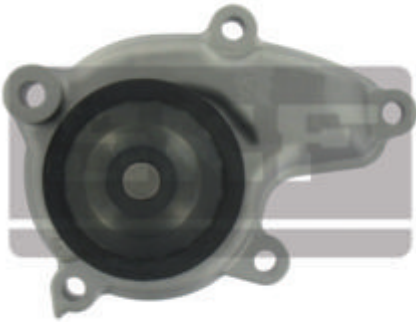

$\lambda=20$

VKPC 92203



VKPC 92204

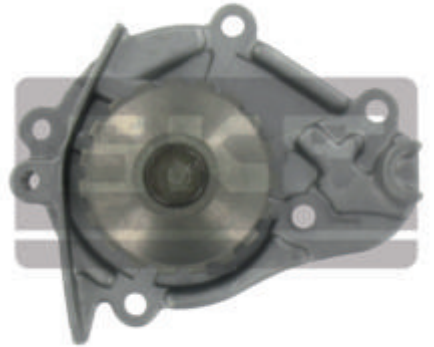

$\lambda=19$

VKPC 92205



VKPC 92208



VKPC 92209

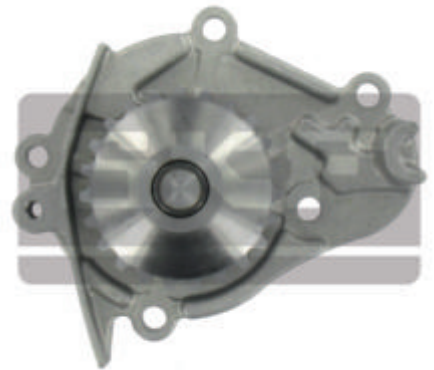

$\lambda=23$

VKPC 92401



VKPC 92404

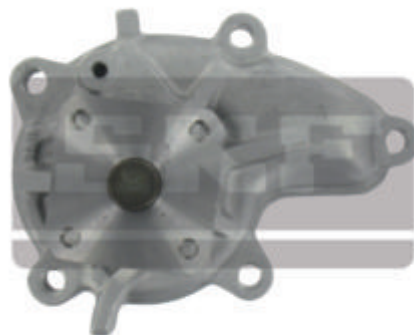

VKPC 92406



VKPC 92408

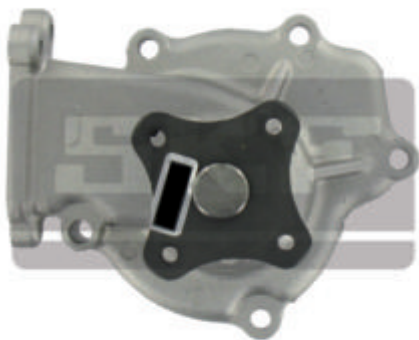

VKPC 92412

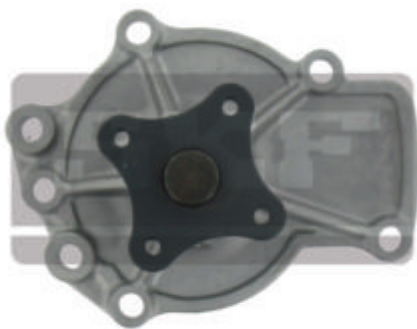

VKPC 92422



VKPC 92600

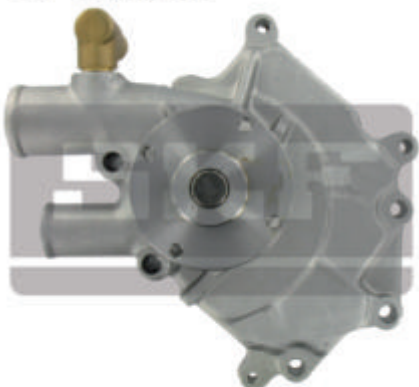

VKPC 92601

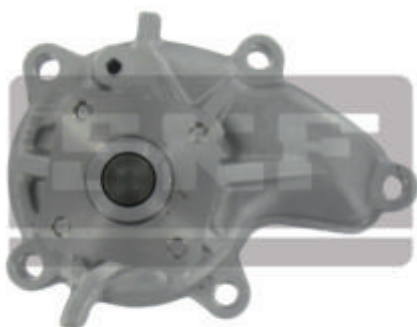

VKPC 92610

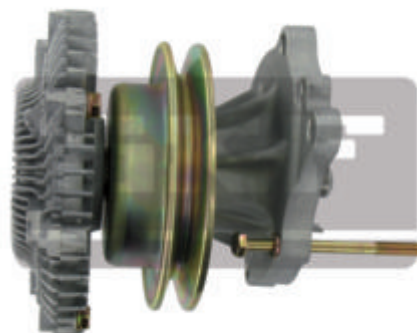

VKPC 92615

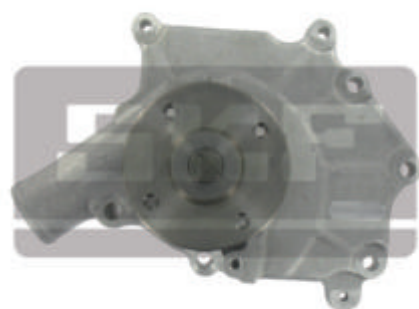

VKPC 92630

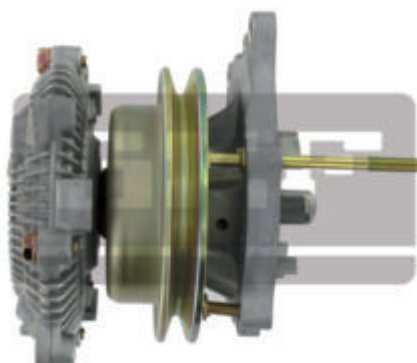

VKPC 92634



VKPC 92645



VKPC 92649



VKPC 92650





VKPC 92651



VKPC 92800



VKPC 92802



VKPC 92810



VKPC 92820



VKPC 92822



λ=23

VKPC 92823

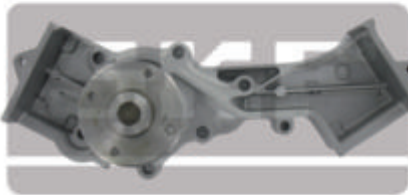

VKPC 92926



VKPC 92928

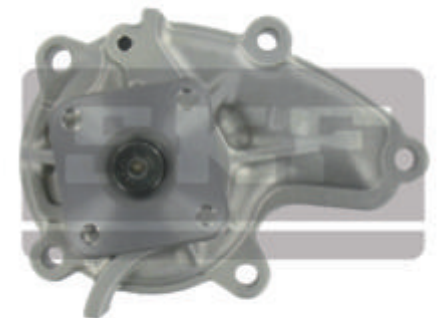

VKPC 92929



VKPC 93000



VKPC 93001



λ=20

VKPC 93205



λ=20

VKPC 93213



VKPC 93405



VKPC 93410

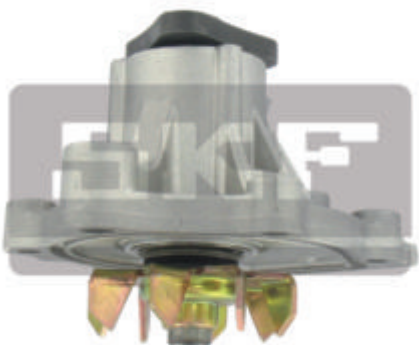

VKPC 93411



λ=19

VKPC 93415



VKPC 93600

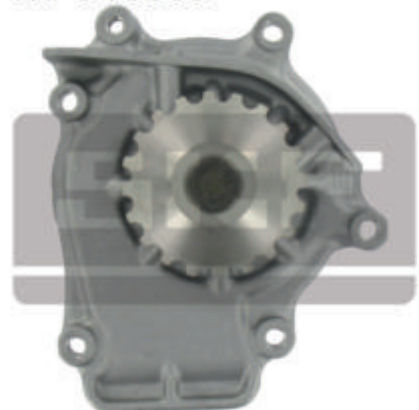

λ=20

VKPC 93601



λ=20

VKPC 93603



VKPC 93604

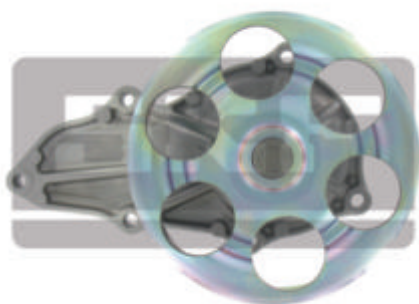

VKPC 94002



VKPC 94202





VKPC 94423



λ=20

VKPC 94424

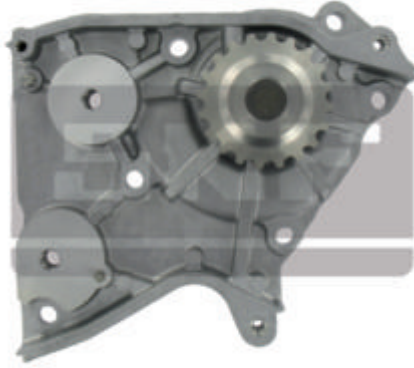

λ=20

VKPC 94425



λ=25

VKPC 94434

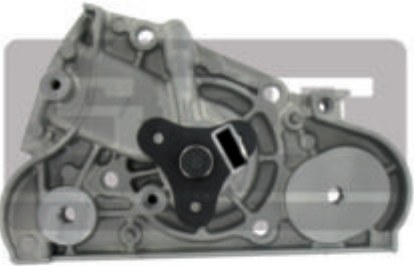

VKPC 94452



λ=22

VKPC 94602

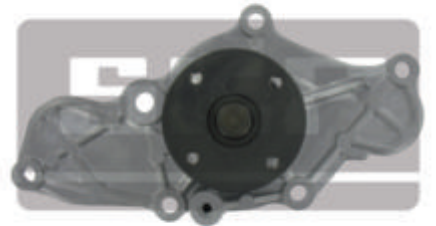

VKPC 94603



VKPC 94612



VKPC 94613

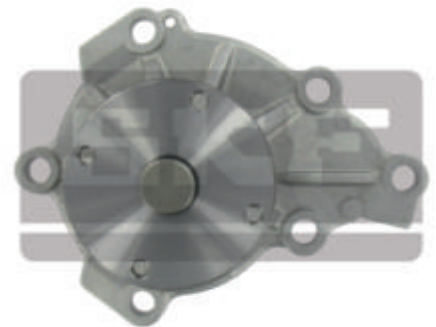

VKPC 94614

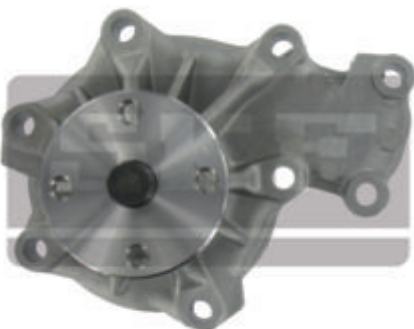

VKPC 94617



VKPC 95003



VKPC 95004



VKPC 95005



VKPC 95007

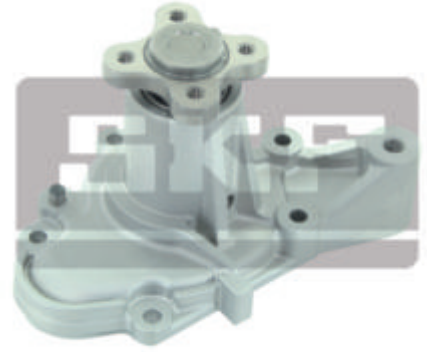

VKPC 95008



VKPC 95010

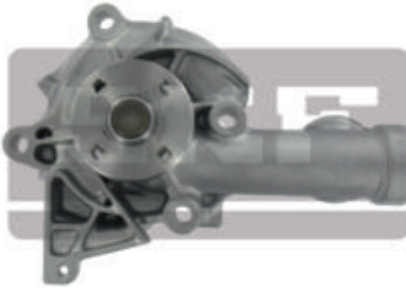

VKPC 95402

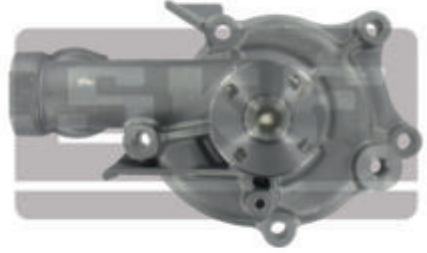

VKPC 95404

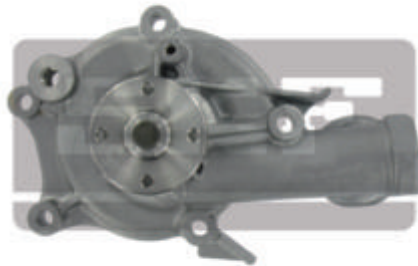

VKPC 95405



VKPC 95422

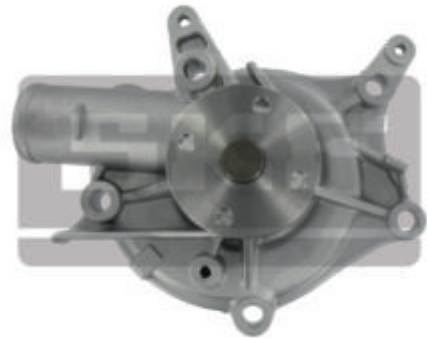

VKPC 95423



VKPC 95424



VKPC 95426

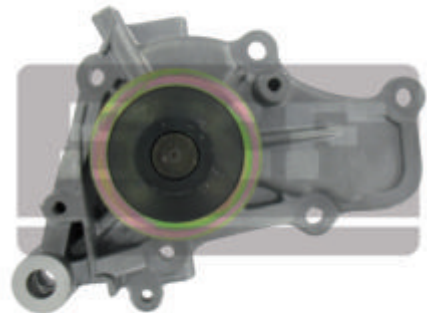

λ=24





**VKPC 95427**



**VKPC 95602**



**VKPC 95611**

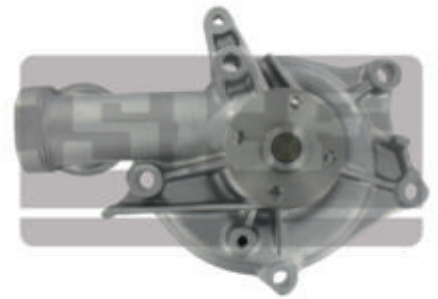

**VKPC 95612**



**VKPC 95614**



**VKPC 95800**



**VKPC 95850**

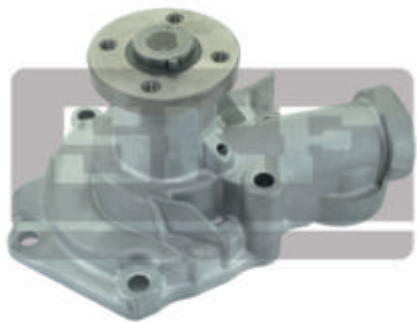

**VKPC 95852**



**VKPC 95853**

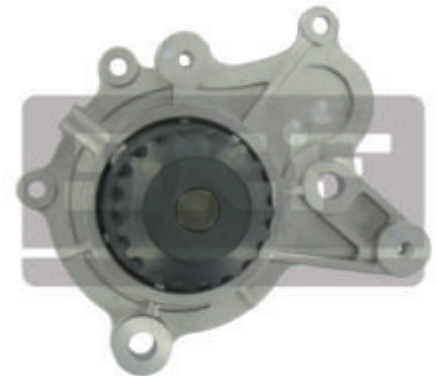

**VKPC 95854**



**VKPC 95856**

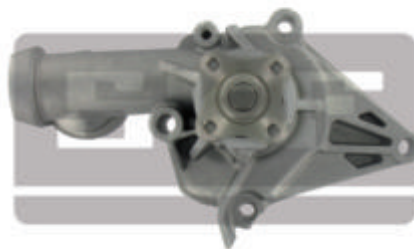

**VKPC 95857**



VKPC 95858



$\lambda=20$

VKPC 95859



VKPC 95863

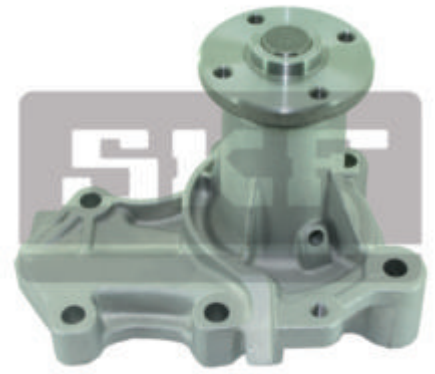

VKPC 95864



VKPC 96000

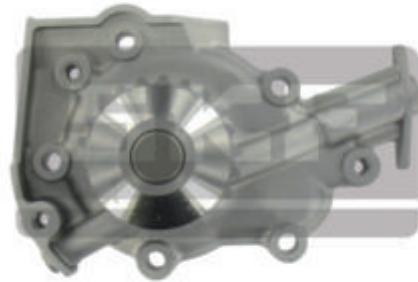

VKPC 96001

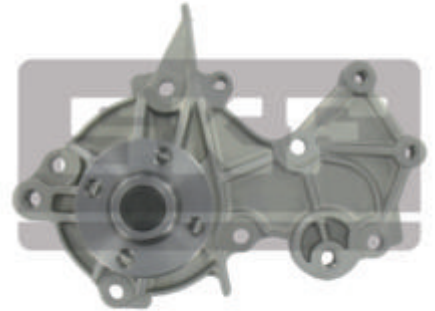

$\lambda=22$

VKPC 96204

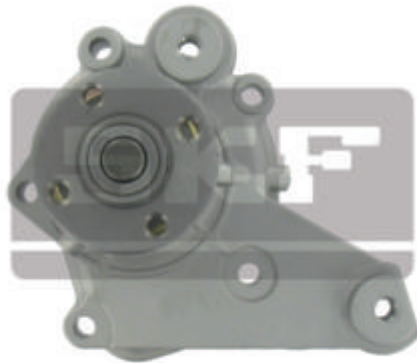

VKPC 96210



VKPC 96212

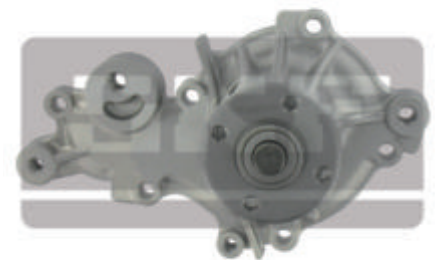

VKPC 96402



VKPC 96403



VKPC 97000

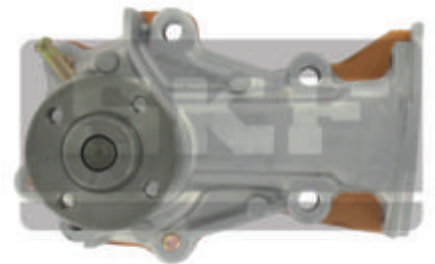

**VKPC 97001**

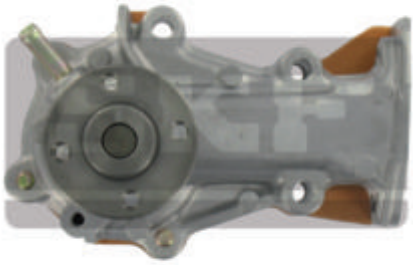

**VKPC 97002**

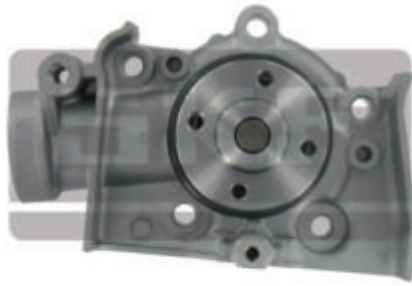

**VKPC 97200**



**VKPC 97201**



**VKPC 98000**

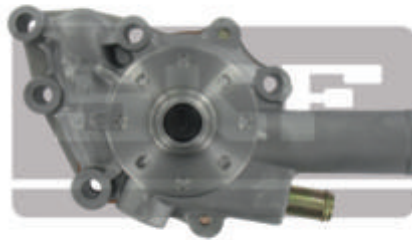

**VKPC 99404**



**VKPC 99406**



**VKPC 99407**



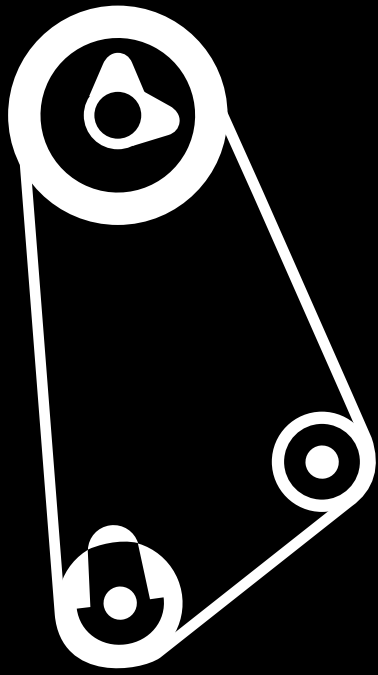



T0001



T0002



T0003



T0004

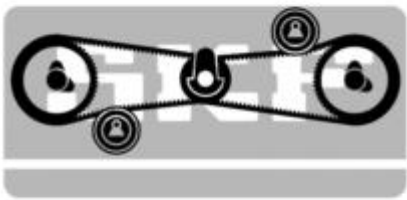

T0005



T0006

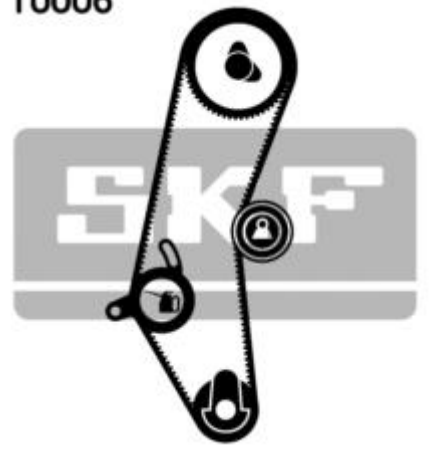

T0007



T0008



T0009

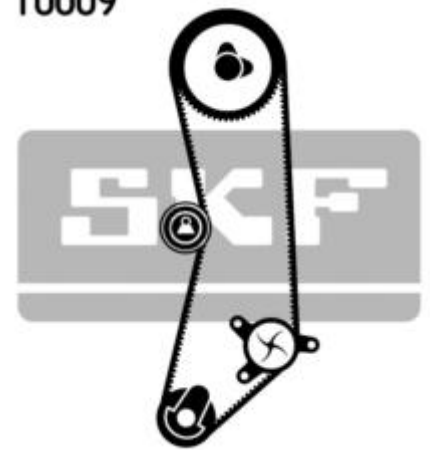

T0010



T0011



T0012



T0013



T0014



T0015



T0016



T0017



T0018



T0019



T0020



T0021



T0022



T0023



T0024



T0026



T0027



T0028



T0029

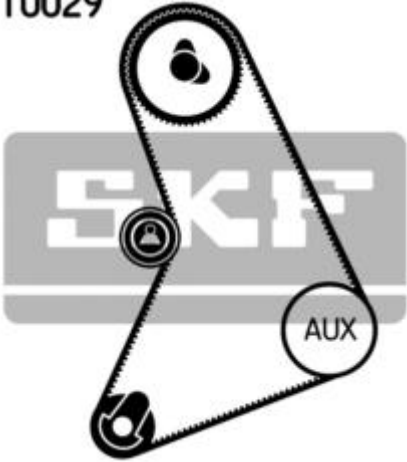

T0030



T0031



T0032



T0033



T0034

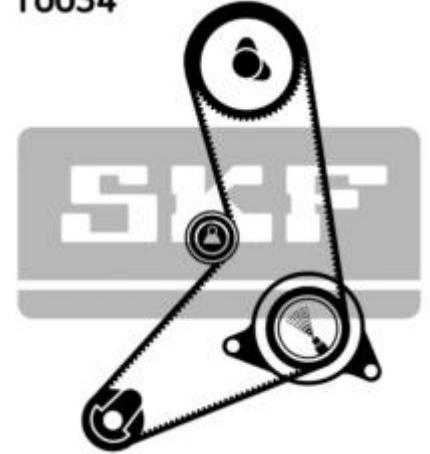

T0035



T0037



T0038



T0039



T0040

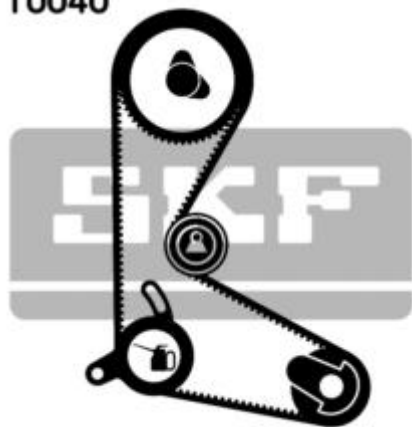

T0041



T0042



T0043



T0044



T0045



T0046



T0047



T0048



T0049

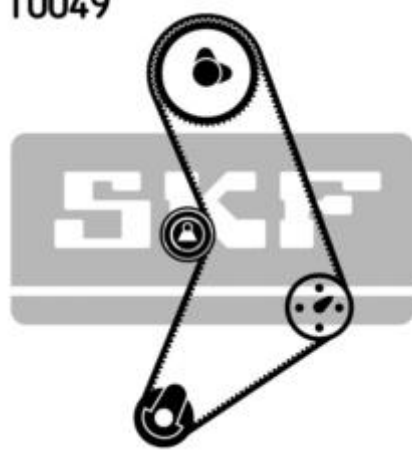

T0051



T0052



T0053



T0054



T0055



T0057



T0058

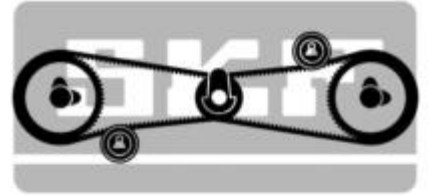

T0059



T0061



T0062

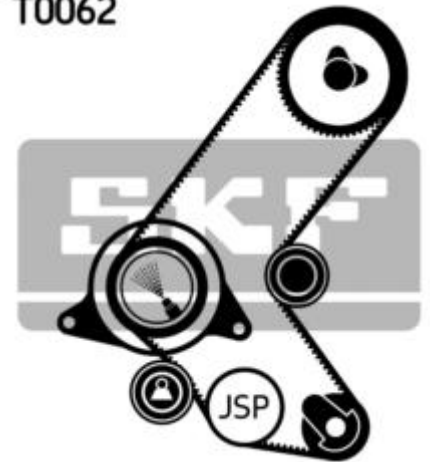

T0063



T0064



T0066



T0068



T0069



T0070



T0072

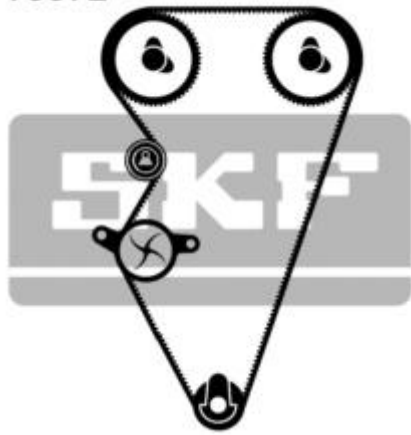

T0074

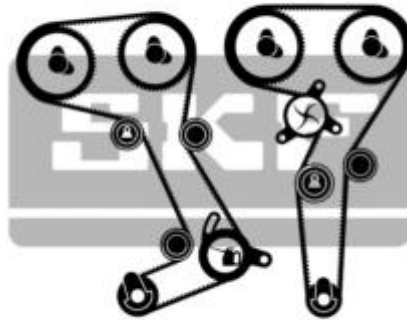

T0075

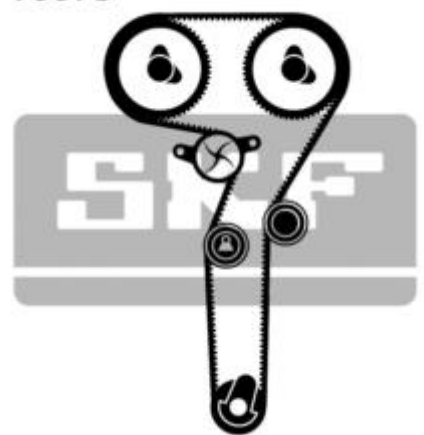

T0076

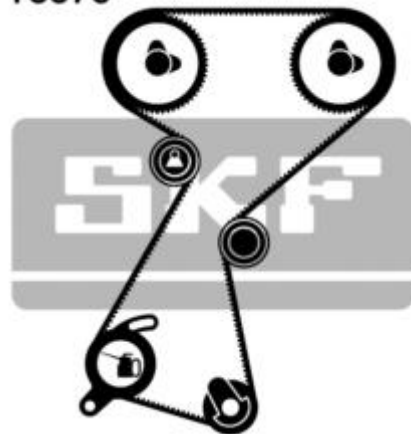

T0077



T0078

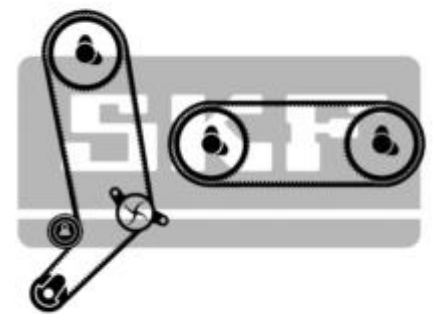

T0079



T0080



T0081





T0082

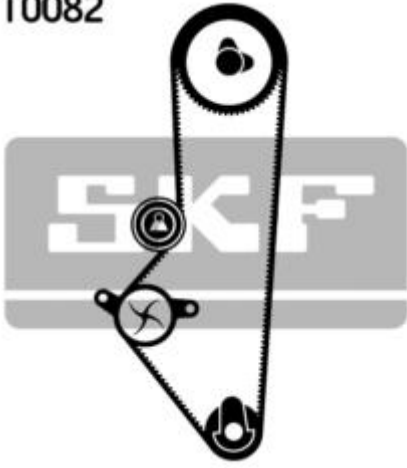

T0083

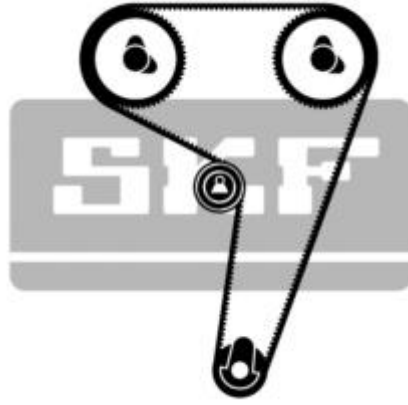

T0084



T0085

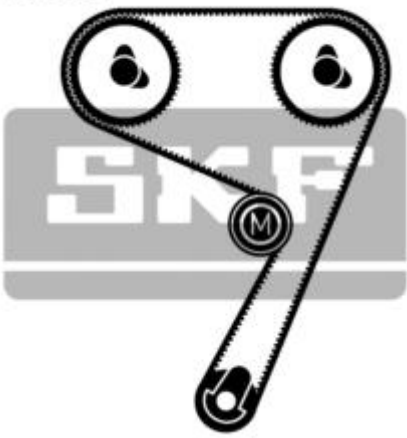

T0086



T0087



T0088

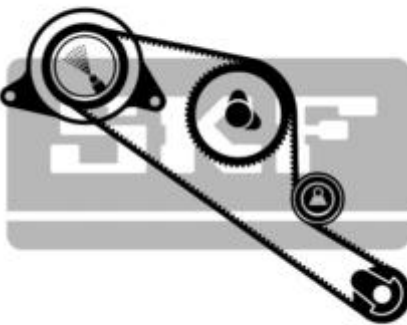

T0089



T0090



T0091



T0092



T0093

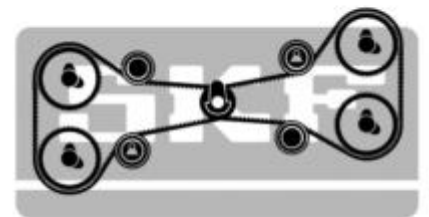

T0094



T0095



T0096



T0097



T0098



T0099



T0100



T0101



T0104



T0105



T0106



T0107



T0108



T0109



T0111



T0112



T0113



T0114



T0115



T0116



T0117



T0118



T0119



T0120



T0121



T0124



T0125



T0126



T0127



T0128



T0129



T0130



T0131



T0133

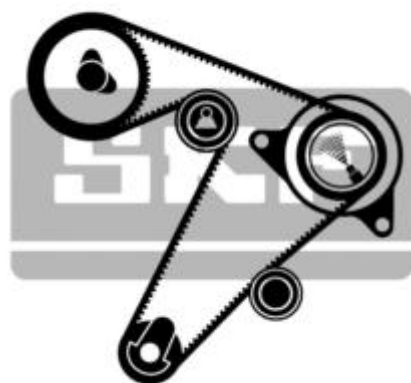

T0135

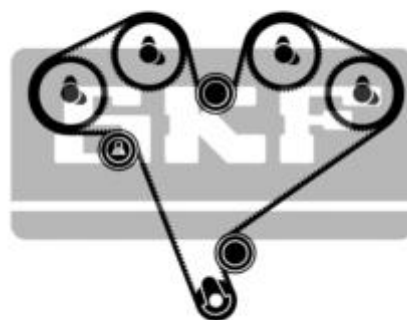

T0136

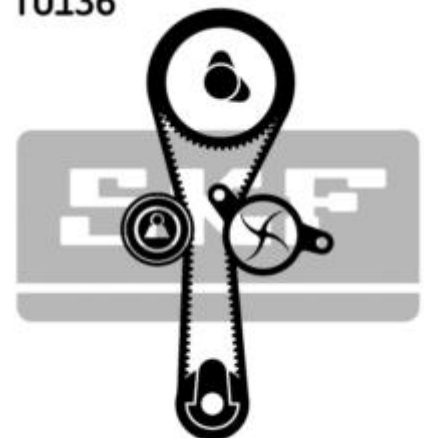

T0137



T0138

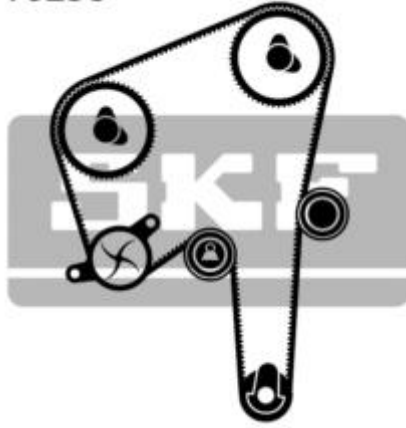

T0139



T0140

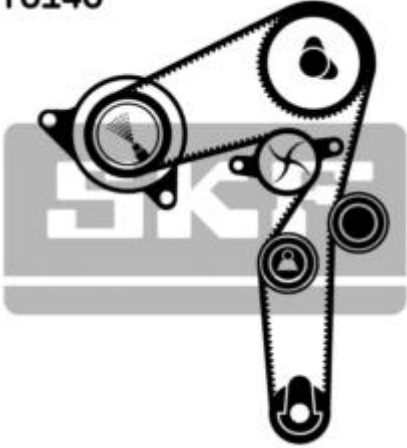

T0141

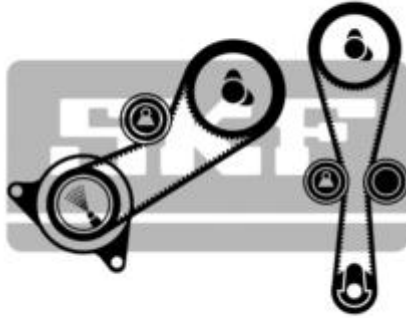

T0142



T0143



T0144



T0145



T0147



T0148



T0149



T0150

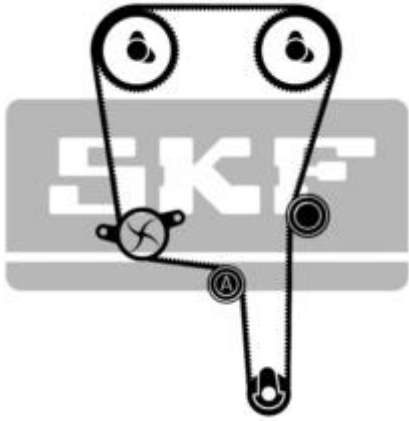

T0151



T0152



T0153



T0155



T0157



T0158

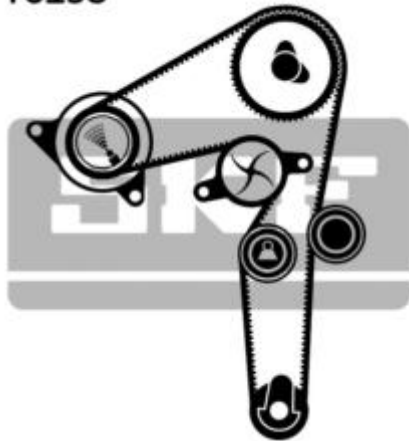

T0159



T0160



T0161



T0162



T0163





T0165

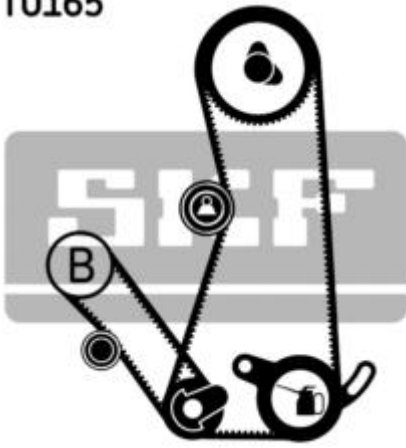

T0166



T0167



T0168



T0169



T0170



T0171



T0172



T0173



T0174



T0175



T0176

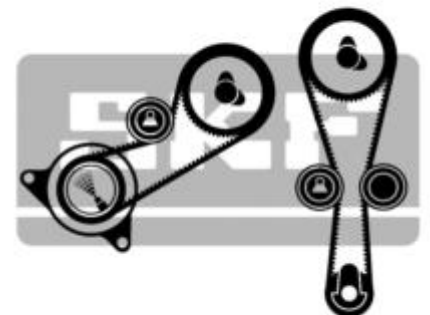

T0177



T0178



T0179



T0181



T0182



T0183



T0184



T0185



T0186



T0187

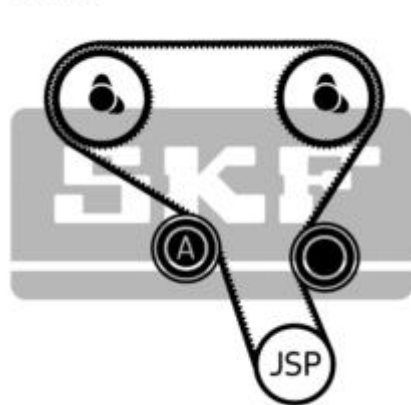

T0188



T0189



T0190



T0191



T0192



T0193



T0194



T0195



T0196



T0197



T0198



T0199



T0200

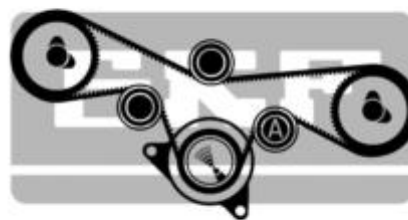

T0201



T0203

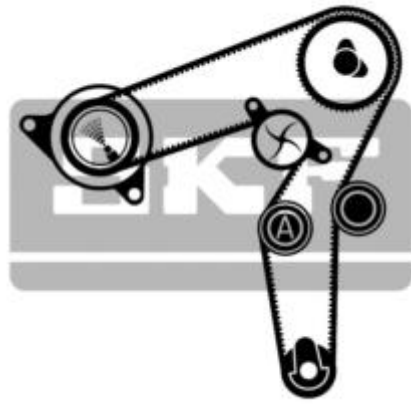

T0204

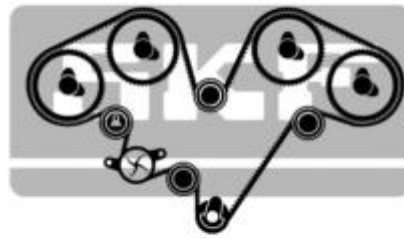

T0205



T0208



T0209



T0220



T0221

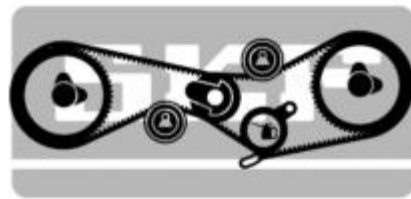

T0222



T0223

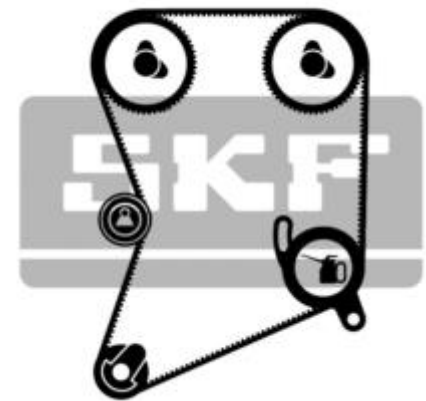

T0224



T0225



T0226

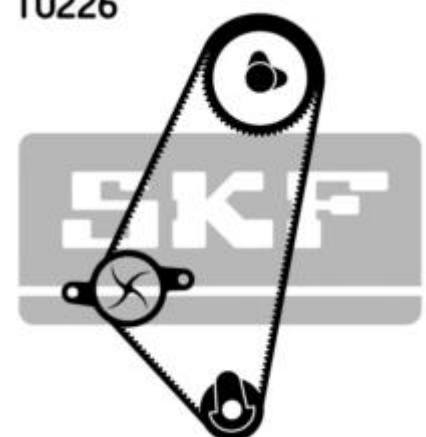

T0227



T0228



T0229



T0230



T0231



T0232

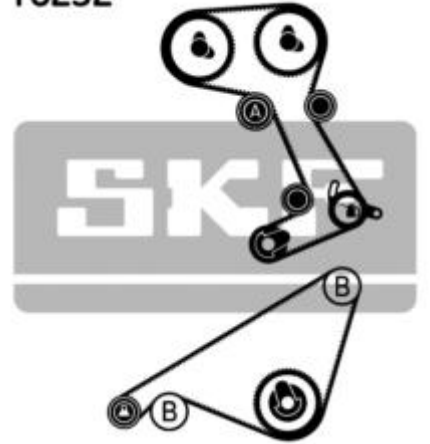

T0233



T0234

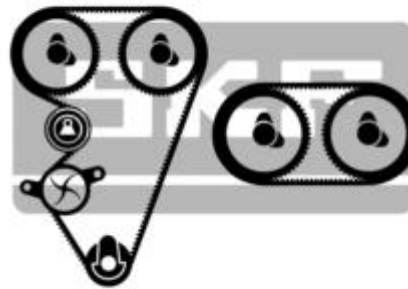

T0235



T0236



T0237

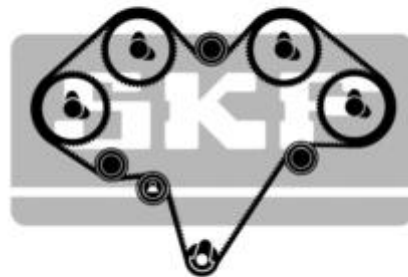

T0238

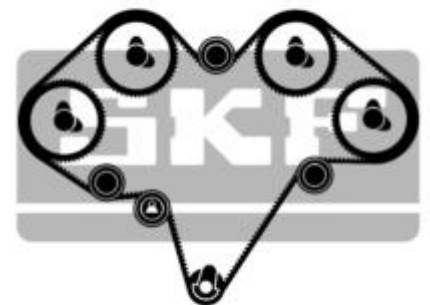

T0239



T0240



T0241

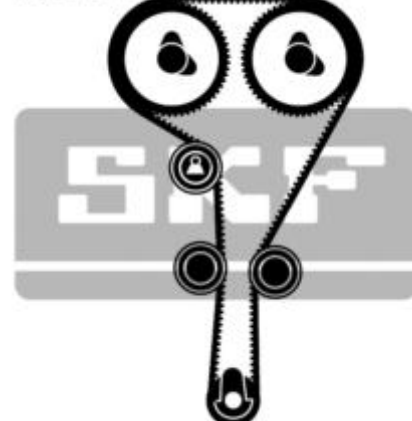

T0242



T0243



T0244



T0246

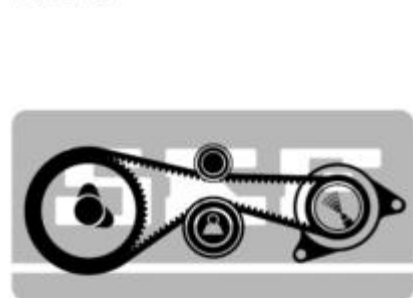

T0247



T0248



T0249

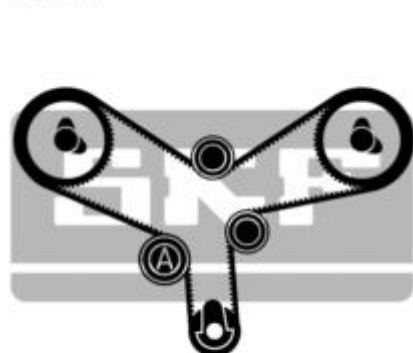

T0250



T0251





T0297



T0299



T0301

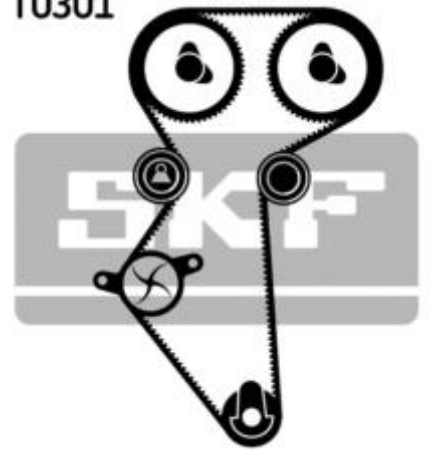

T0302



T0303



T0322

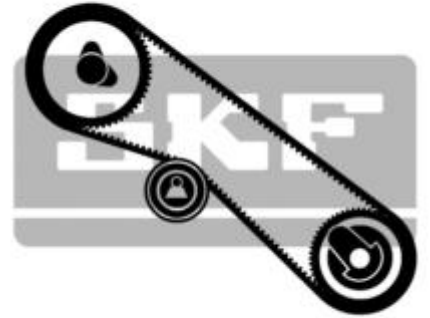

T0329



T0330



T0342



T0346



T0347

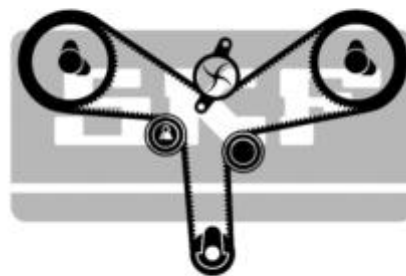

T0353



T0354



T0359

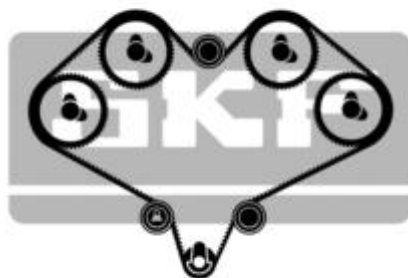

T0372



T0374



T0376



T0387



T0397

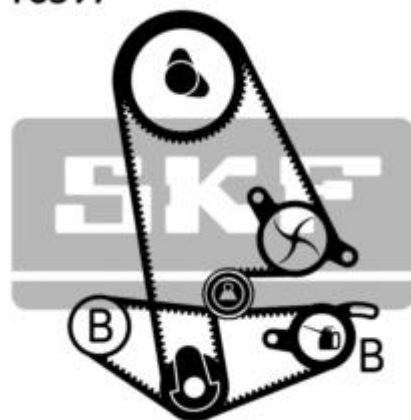

T0400

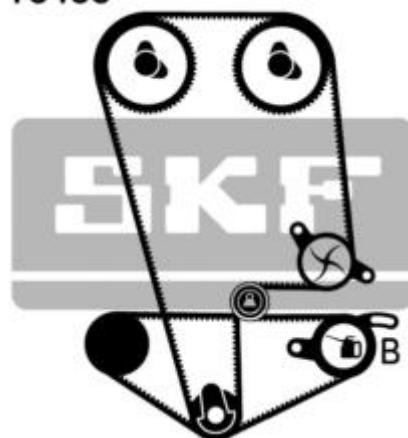

T0413

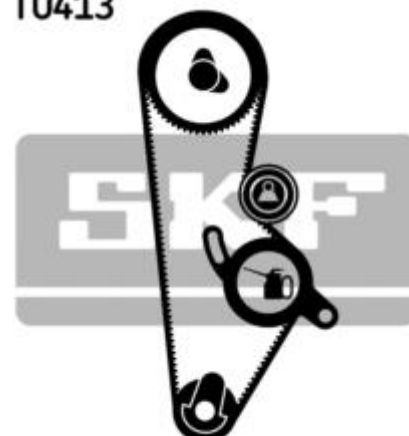

T0416



T0425



T0432



T0437



T0440



T0447

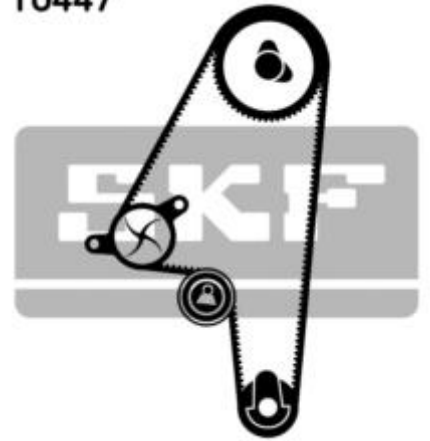

T0449



T0455

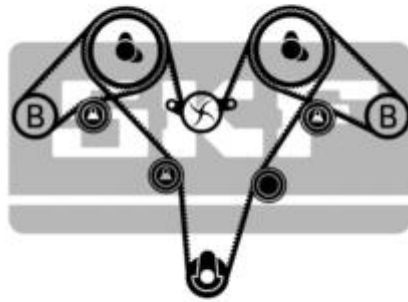

T0456



T0457



T0462



T046 4



T0479

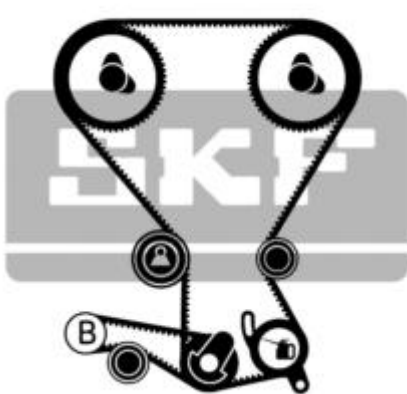

T0494



T0495



T0497

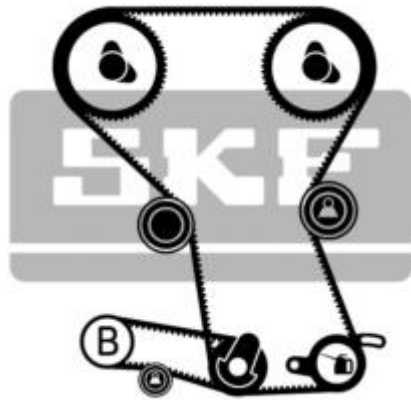

T0540



T0544

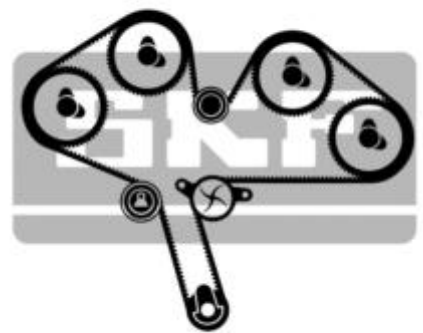

T0557



T0575



T0582



T0613



T0616



T0621



T0625



T0627



T0628



T0630

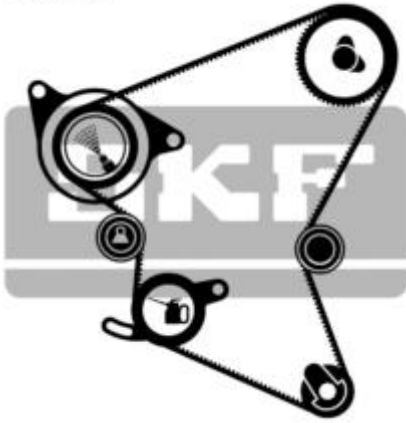

T0640



T0641



T0642

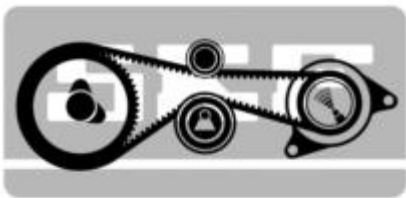

T0643

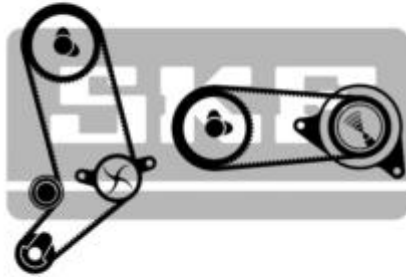

T0644

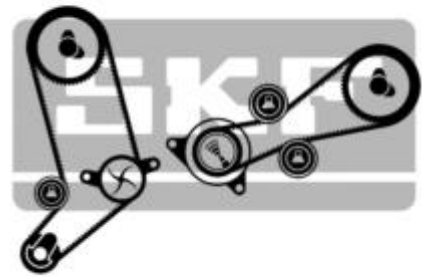

T0646

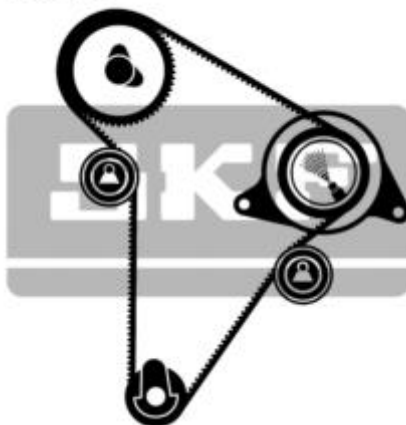

T0647



T0648



T0649



T0650

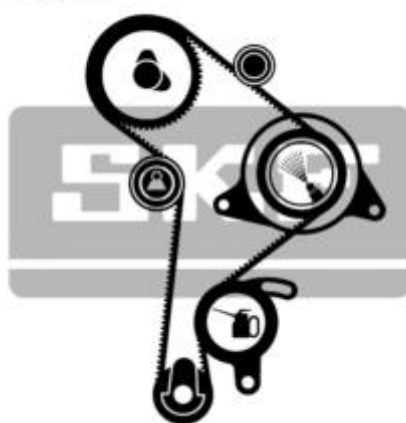

T0651

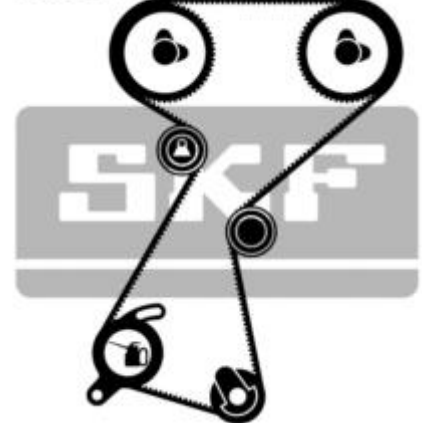

T0652



T0653



T0654



T0655



T0656



T0657

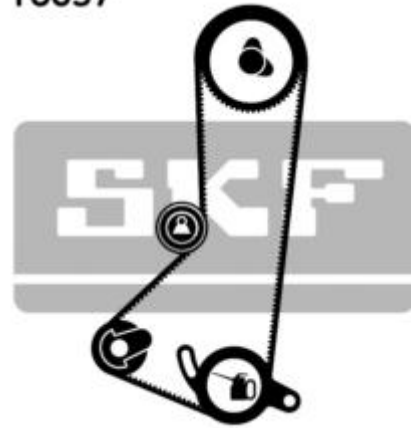

T0658



T0659



T0660



T0661

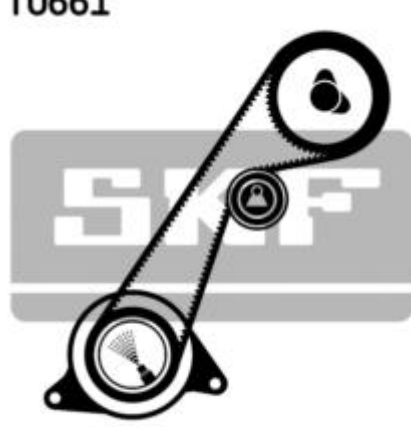

T0662



T0663





T0664



T0665



T0666



T0667

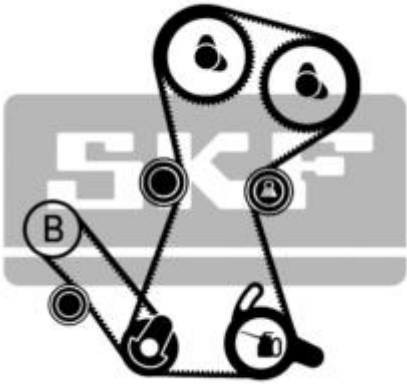

T0668



T0669

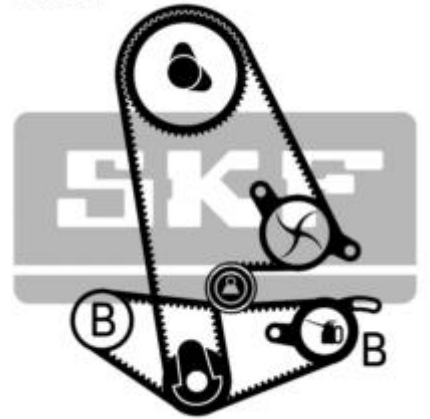

T0670

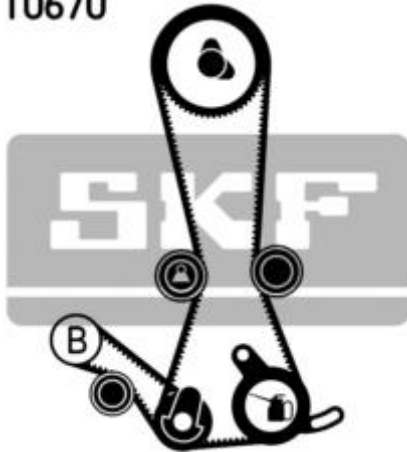

T0671



T0672

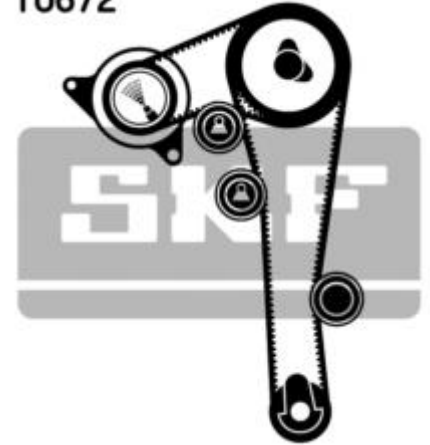

T0673

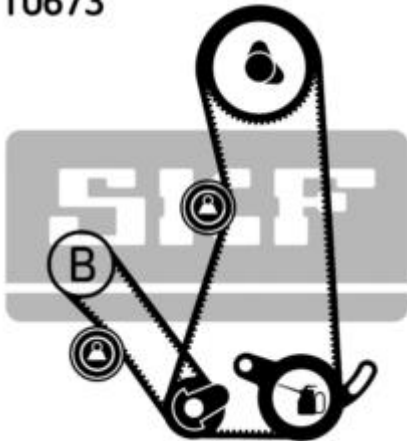

T0674



T0675



T0676



T0677



T0678



T0679



T0680

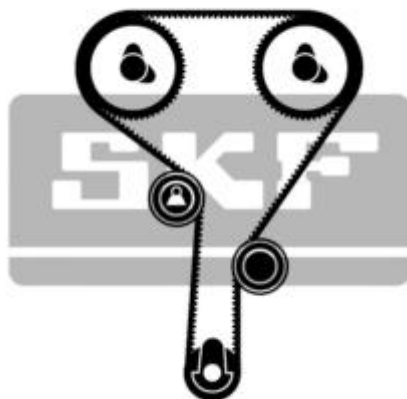

T0681

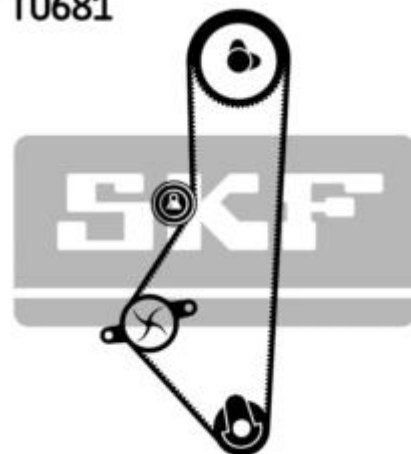

T0682



T0683



T0684



T0685



T0686

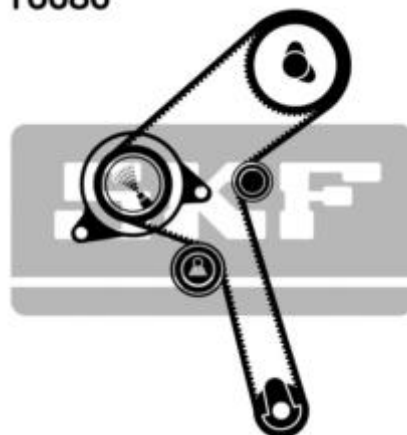

T0687



T0688

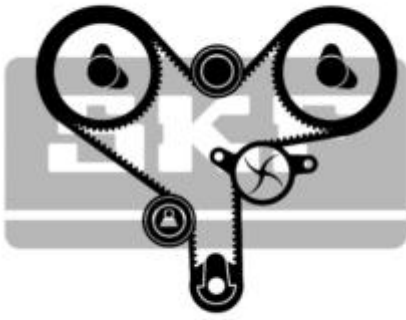

T0689

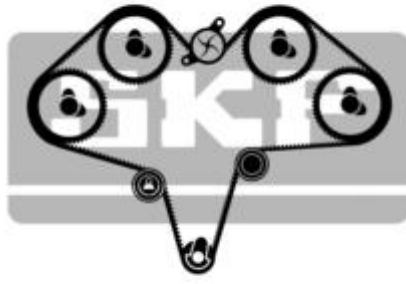

T0690



T0691



T0692



T0693



T0694



T0695

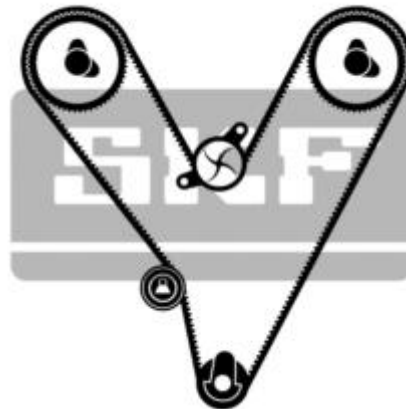

T0696









T0697

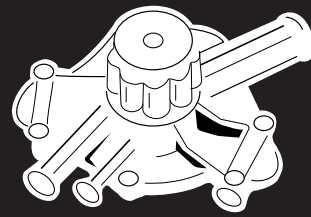
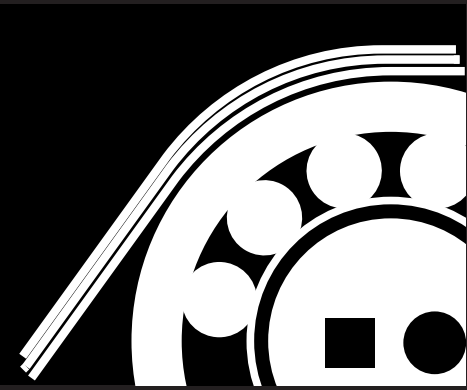







T0698





|  |   |  |    |  |   |
|--|--|---|---|---|--|
| <b>VKM 11000</b>   | <p><b>AUDI</b><br/>100 (43, C2) / 100 Avant (43, C2) / 100 (44,44Q,C3)/100 Avant (44,44Q,C3) / 100 (4A, C4) / 100 Avant (4A, C4) / 80 (80, 82, B1) / 80 (81, 85, B2) / 80 (89, 89Q, 8A, B3) / 80 (8C, B4) / 80 Avant (8C, B4) / COUPE (81, 85) / COUPE (89, 8B)</p> <p><b>PORSCHE</b><br/>924</p> <p><b>SEAT</b><br/>ALHAMBRA / CORDOBA (6K2) / CORDOBA (6K2/C2) / CORDOBA Vario (6K5) / IBIZA II (6K1) / INCA / TOLEDO I (1L)</p> <p><b>VW</b><br/>CADDY I (14) / CADDY II(9K9A)/Estate(9K9B)/Pickup(9U7) / CORRADO (53I) / GOLF I (17) / GOLF I Cabriolet (155) / GOLF II (19E, 1G1) / GOLF III (1H1) / GOLF III Variant (1H5) / GOLF III Cabriolet (1E7) / GOLF IV Cabriolet (1E7) / ILTIS (183) / JETTA I (16) / JETTA II (19E, 1G2) / LT I / PASSAT (32) / Variant (33) / PASSAT (32B) / PASSAT (3A2, 35I) / Variant (3A5, 35I) / POLO CLASSIC (6KV2) / Variant (6KV5) / SANTANA / SANTANA (32B) / SCIROCCO (53) / SCIROCCO (53B) / SHARAN (7M8, 7M9, 7M6) / TRANSPORTER IV / VENTO (1H2)</p> | <b>VKM 11010</b>  | <p><b>VW</b><br/>PASSAT (3B2) / Variant (3B5)</p> <p><b>AUDI</b><br/>80 (81, 85, B2) / 80 (89, 89Q, 8A, B3) / 80 (8C, B4) / 80 Avant (8C, B4) / 90 (81, 85, B2) / 90 (89, 89Q, 8A, B3)</p> <p><b>SEAT</b><br/>CORDOBA (6K2) / CORDOBA (6K2/C2) / IBIZA II (6K1) / TOLEDO I (1L)</p> <p><b>VW</b><br/>CADDY I (14) / GOLF I (17) / GOLF II (19E, 1G1) / GOLF III (1H1) / GOLF III Variant (1H5) / ILTIS (183) / JETTA I (16) / JETTA II (19E, 1G2) / PASSAT (32) / Variant (33) / PASSAT (32B) / PASSAT (3A2, 35I) / Variant (3A5, 35I) / SANTANA (32B) / TRANSPORTER III / TRANSPORTER IV / VENTO (1H2)</p> <p><b>AUDI</b><br/>80 (8C, B4) / 80 Avant (8C, B4)</p> <p><b>SEAT</b><br/>TOLEDO I (1L)</p> <p><b>VW</b><br/>GOLF III (1H1) / GOLF III Variant (1H5) / PASSAT (3A2, 35I) / Variant (3A5, 35I) / VENTO (1H2)</p> | <b>VKM 11018</b>  | <p><b>SKODA</b><br/>FELICIA I (6U1)/Estate (6U5)/Fun (797) / FELICIA II (6U1)/FELICIA II Estate (6U5)</p> <p><b>VW</b><br/>CADDY II(9K9A)/Estate(9K9B)/Pickup(9U7) / LUPO (6X1, 6E1) / POLO (6N1) / POLO Box (6NF) / POLO (6N2)</p> <p><b>AUDI</b><br/>A4 (8D2, B5) / A4 Avant (8D5, B5) / A4 (8E2, B6) / A4 Avant (8E5, B6) / A4 (8EC) / A4 Avant (8ED) / A4 Convertible (8H7) / A6 (4B, C5) / A6 Avant (4B, C5)</p> <p><b>SKODA</b><br/>SUPERB</p> <p><b>VW</b><br/>PASSAT (3B3) / Variant (3B6)</p> |
| <b>VKM 11001</b>   | <p><b>AUDI</b><br/>100 (4A, C4) / 100 Avant (4A, C4) / 80 (89, 89Q, 8A, B3) / 80 (8C, B4) / 80 Avant (8C, B4) / A6 (4A, C4) / A6 Avant (4A, C4) / CABRIOLET (8G7, B4)</p>  | <b>VKM 11012</b>  | <p><b>AUDI</b><br/>80 (8C, B4) / 80 Avant (8C, B4) / A4 (8D2, B5) / A4 Avant (8D5, B5) / A6 (4A, C4) / A6 Avant (4A, C4) / A6 (4B, C5) / A6 Avant (4B, C5) / CABRIOLET (8G7, B4)</p> <p><b>FORD</b><br/>GALAXY I</p> <p><b>SEAT</b><br/>ALHAMBRA / CORDOBA (6K2) / CORDOBA (6K2/C2) / CORDOBA Vario (6K5) / IBIZA II (6K1) / INCA / TOLEDO I (1L)</p> <p><b>VW</b><br/>CADDY II(9K9A)/Estate(9K9B)/Pickup(9U7) / GOLF III (1H1) / GOLF III Variant (1H5) / GOLF III Cabriolet (1E7) / GOLF IV Cabriolet (1E7) / PARATI / PASSAT (3A2, 35I) / Variant (3A5, 35I) / PASSAT (3B2) / Variant (3B5) / POLO CLASSIC (6KV2) / Variant (6KV5) / SHARAN (7M8, 7M9, 7M6) / TRANSPORTER IV / VENTO (1H2)</p>   | <b>VKM 11020</b>  | <p><b>AUDI</b><br/>100 (4A, C4) / 100 Avant (4A, C4) / 80 (89, 89Q, 8A, B3) / 80 (8C, B4) / 80 Avant (8C, B4) / A6 (4A, C4) / A6 Avant (4A, C4) / COUPE (89, 8B)</p> <p><b>SEAT</b><br/>TOLEDO I (1L)</p> <p><b>VW</b><br/>CORRADO (53I) / GOLF II (19E, 1G1) / GOLF III (1H1) / GOLF III Variant (1H5) / JETTA II (19E, 1G2) / PASSAT (3A2, 35I) / Variant (3A5, 35I) / SCIROCCO (53B)</p>  |
| <b>VKM 11003</b>   | <p><b>AUDI</b><br/>80 (8C, B4) / 80 Avant (8C, B4) / A4 (8D2, B5) / A4 Avant (8D5, B5) / A6 (4A, C4) / A6 Avant (4A, C4) / CABRIOLET (8G7, B4)</p> <p><b>VW</b><br/>GOLF IV Cabriolet (1E7)</p>  | <b>VKM 11014</b>  | <p><b>AUDI</b><br/>100 (4A, C4) / 100 Avant (4A, C4) / 80 (89, 89Q, 8A, B3) / 80 (8C, B4) / 80 Avant (8C, B4) / A6 (4A, C4) / A6 Avant (4A, C4) / CABRIOLET (8G7, B4)</p>   | <b>VKM 11021</b>  | <p><b>AUDI</b><br/>100 (4A, C4) / 100 Avant (4A, C4) / 80 (8C, B4) / 80 Avant (8C, B4) / A6 (4A, C4) / A6 Avant (4A, C4) / CABRIOLET (8G7, B4) / COUPE (89, 8B)</p> <p><b>SEAT</b><br/>CORDOBA (6K2) / CORDOBA (6K2/C2) / IBIZA II (6K1) / TOLEDO I (1L)</p> <p><b>VW</b><br/>CORRADO (53I) / GOLF III (1H1) / GOLF III Variant (1H5) / PASSAT (3A2, 35I) / Variant (3A5, 35I)</p>   |
| <b>VKM 11007</b>   | <p><b>AUDI</b><br/>A4 (8D2, B5) / A4 Avant (8D5, B5)</p>   | <b>VKM 11015</b>  | <p><b>SEAT</b><br/>AROSA</p>  | <b>VKM 11043</b>  | <p><b>AUDI</b><br/>100 (4A, C4) / 100 Avant (4A, C4)</p>   |
| <b>VKM 11008</b>   | <p><b>AUDI</b><br/>A4 (8D2, B5) / A4 Avant (8D5, B5) / A6 (4A, C4) / A6 Avant (4A, C4) / A6 (4B, C5) / A6 Avant (4B, C5) / CABRIOLET (8G7, B4)</p> <p><b>VW</b><br/>PASSAT (3B2) / Variant (3B5)</p>   |   |   | <b>VKM 11045</b>  | <p><b>VOLVO</b><br/>940 / 960</p> <p><b>VW</b><br/>LT I</p>  |
| <b>VKM 11009</b>   | <p><b>AUDI</b><br/>A4 (8D2, B5) / A4 Avant (8D5, B5) / A6 (4A, C4) / A6 Avant (4A, C4) / A6 (4B, C5) / A6 Avant (4B, C5) / CABRIOLET (8G7, B4)</p>   |   |   |   |  |







|  |    |  |    |  |   |
|---|---|---|--|---|--|
| <b>VKM 11050</b>  | <b>AUDI</b><br>100 (4A, C4) / 100 Avant (4A, C4) / 80 (8C, B4) / 80 Avant (8C, B4) / A6 (4A, C4) / A6 Avant (4A, C4) / CABRIOLET (8G7, B4) / COUPE (89, 8B)   | <b>VKM 11113</b>  | <b>AUDI</b><br>A3 (8L1) / A3 (8P1) / A3 Sportback (8PA) / A4 (8D2, B5) / A4 Avant (8D5, B5) / A4 (8E2, B6) / A4 Avant (8E5, B6) / A4 (8EC) / A4 Avant (8ED)  |   | <b>SEAT</b><br>ALHAMBRA / CORDOBA (6K2) / CORDOBA (6K2/C2) / IBIZA III (6K1) / LEON I (1M1) / TOLEDO II (1M2)  |
| <b>VKM 11054</b>  | <b>VW</b><br>TRANSPORTER IV   |   | <b>SEAT</b><br>ALHAMBRA / ALTEA / ALTEA XL / CORDOBA (6K2) / CORDOBA (6K2/C2) / CORDOBA (6L2) / CORDOBA Vario (6K5) / IBIZA III (6K1) / IBIZA IV (6L1) / LEON I (1M1) / LEON II (1P1) / TOLEDO II (1M2) / TOLEDO III (5P2)   |   | <b>SKODA</b><br>OCTAVIA I (1U2) / OCTAVIA Combi (1U5)  |
| <b>VKM 11060</b>  | <b>AUDI</b><br>100 (4A, C4) / 100 Avant (4A, C4) / 80 (8C, B4) / 80 Avant (8C, B4) / A6 (4A, C4) / A6 Avant (4A, C4) / CABRIOLET (8G7, B4) / COUPE (89, 8B)   |   | <b>SKODA</b><br>FABIA / OCTAVIA I (1U2) / OCTAVIA Combi (1U5) / OCTAVIA II (1Z3)/OCTAVIA II Combi (1Z5) / SUPERB   | <b>VKM 11117</b>  | <b>AUDI</b><br>A4 (8D2, B5) / A4 Avant (8D5, B5) / A4 (8E2, B6) / A4 Avant (8E5, B6) / A4 (8EC) / A4 Avant (8ED) / A4 Convertible (8H7) / A6 (4B, C5) / A6 Avant (4B, C5)  |
| <b>VKM 11072</b>  | <b>AUDI</b><br>100 (4A, C4) / 100 Avant (4A, C4) / A6 (4A, C4) / A6 Avant (4A, C4)  |   | <b>VW</b><br>BORA (1J2) / BORA Estate (1J6) / CADDY III (2KA) / CADDY III Estate (2KB) / GOLF IV (1J1) / GOLF IV Variant (1J5) / GOLF V (1K1) / GOLF V VARIANT (1K1) / GOLF V PLUS (5M1) / JETTA III (1KM) / MULTIVAN V (7HM) / NEW BEETLE (9C1, 1C1)/Convertible (1Y7) / PASSAT (3B2) / Variant (3B5) / PASSAT (3B3) / Variant (3B6) / PASSAT (3C2) / Variant (3C5) / POLO CLASSIC (6KV2) / Variant (6KV5) / SHARAN (7M8, 7M9, 7M6) / TOU-RAN / TRANSPORTER V |   | <b>SKODA</b><br>SUPERB   |
| <b>VKM 11073</b>  | <b>VW</b><br>LT II / TRANSPORTER IV   |   | <b>VW</b><br>PASSAT (3B3) / Variant (3B6)  | <b>VKM 11120</b>  | <b>AUDI</b><br>A2 (8Z0)  |
| <b>VKM 11073</b>  | <b>VOLVO</b><br>850 / C70 - S70 / S80 / V70 I / V70 II  |   | <b>VW</b><br>POLO (6N1) / POLO Box (6NF)   |   | <b>SEAT</b><br>AROSA / CORDOBA (6K2) / CORDOBA (6K2/C2) / CORDOBA (6L2) / CORDOBA Vario (6K5) / IBIZA II (6K1) / IBIZA III (6K1) / INCA  |
| <b>VKM 11105</b>  | <b>VW</b><br>LT II / TRANSPORTER IV   |   | <b>VW</b><br>POLO (6N1) / POLO Box (6NF)   |   | <b>SKODA</b><br>FABIA / OCTAVIA I (1U2) / OCTAVIA Combi (1U5) / OCTAVIA II (1Z3)/OCTAVIA II Combi (1Z5)  |
| <b>VKM 11105</b>  | <b>VW</b><br>POLO (6N1) / POLO Box (6NF)  | <b>VKM 11114</b>  | <b>SEAT</b><br>CORDOBA (6K2) / CORDOBA (6K2/C2) / IBIZA II (6K1) / IBIZA III (6K1)   |   | <b>VW</b><br>BORA (1J2) / BORA Estate (1J6) / CADDY II(9K9A)/Estate(9K9B)/ Pickup(9U7) / CADDY III (2KA) / CADDY III Estate (2KB) / GOLF IV (1J1) / GOLF IV Variant (1J5) / GOLF V (1K1) / GOLF V PLUS (5M1) / LUPO (6X1, 6E1) / NEW BEETLE (9C1, 1C1)/Convertible (1Y7) / POLO (6N1) / POLO Box (6NF) / POLO (6N2) / POLO CLASSIC (6KV2) / Variant (6KV5) / VENTO (1H2) |
| <b>VKM 11106</b>  | <b>SEAT</b><br>AROSA / CORDOBA (6K2) / CORDOBA (6K2/C2) / CORDOBA Vario (6K5) / IBIZA II (6K1) / IBIZA III (6K1) / INCA   | <b>VKM 11115</b>  | <b>AUDI</b><br>A3 (8L1) / A6 (4B, C5) / A6 Avant (4B, C5) / TT (8N3) / TT Roadster (8N9)   |   | <b>SEAT</b><br>ALHAMBRA / LEON I (1M1) / TOLEDO II (1M2)   |
|   | <b>SKODA</b><br>FELICIA I (6U1)/Estate (6U5)/ Fun (797) / FELICIA II (6U1)/ FELICIA II Estate (6U5) / OCTAVIA I (1U2) / OCTAVIA Combi (1U5)   |   | <b>SEAT</b><br>ALHAMBRA / LEON I (1M1) / TOLEDO II (1M2)   |   | <b>SKODA</b><br>OCTAVIA I (1U2) / OCTAVIA Combi (1U5)  |
|   | <b>VW</b><br>CADDY II(9K9A)/Estate(9K9B)/ Pickup(9U7) / GOLF III (1H1) / GOLF III Variant (1H5) / LUPO (6X1, 6E1) / POLO (6N1) / POLO Box (6NF) / POLO (6N2) / POLO CLASSIC (6KV2) / Variant (6KV5) / VENTO (1H2) | <b>VKM 11116</b>  | <b>AUDI</b><br>A3 (8L1) / A4 (8D2, B5) / A4 Avant (8D5, B5) / TT (8N3) / TT Roadster (8N9)   |   | <b>VW</b><br>BORA (1J2) / BORA Estate (1J6) / GOLF IV (1J1) / GOLF IV Variant (1J5) / NEW BEETLE (9C1, 1C1)/Convertible (1Y7) / SHARAN (7M8, 7M9, 7M6)   |
| <b>VKM 11107</b>  | <b>SEAT</b><br>AROSA / CORDOBA (6K2) / CORDOBA (6K2/C2) / CORDOBA (6L2) / CORDOBA Vario (6K5) / IBIZA III (6K1) / IBIZA IV (6L1) / INCA   |   | <b>VW</b><br>PASSAT (3B3) / Variant (3B6)  | <b>VKM 11121</b>  | <b>SEAT</b><br>LEON I (1M1) / TOLEDO II (1M2)  |
|   | <b>VW</b><br>CADDY II(9K9A)/Estate(9K9B)/ Pickup(9U7) / FOX (5Z1) / LUPO (6X1, 6E1) / POLO (6N2) / POLO CLASSIC (6KV2) / Variant (6KV5)   |   | <b>VW</b><br>PASSAT (3B3) / Variant (3B6)  |   | <b>VW</b><br>BORA (1J2) / BORA Estate (1J6) / GOLF IV (1J1) / GOLF IV Variant (1J5) / LUPO (6X1, 6E1) / POLO (6N1) / POLO Box (6NF)  |



















|           |  |           |  |           |   |
|-----------|--|-----------|--|-----------|---|
| VKM 11130 | <p><b>SEAT</b><br/>AROSA / CORDOBA (6K2) / CORDOBA (6K2/C2) / CORDOBA (6L2) / CORDOBA Vario (6K5) / IBIZA III (6K1) / IBIZA IV (6L1) / INCA / LEON I (1M1) / LEON II (1P1) / TOLEDO II (1M2)</p> <p><b>SKODA</b><br/>FABIA / OCTAVIA I (1U2) / OCTAVIA Combi (1U5) / OCTAVIA II (1Z3)/OCTAVIA II Combi (1Z5) / ROOMSTER</p> <p><b>VW</b><br/>BORA (1J2) / BORA Estate (1J6) / CADDY II(9K9A)/Estate(9K9B)/ Pickup(9U7) / CADDY III (2KA) / CADDY III Estate (2KB) / GOLF IV (1J1) / GOLF IV Variant (1J5) / GOLF V (1K1) / GOLF V VARIANT (1K1) / GOLF V PLUS (5M1) / LUPO (6X1, 6E1) / NEW BEETLE (9C1, 1C1)/Convertible (1Y7) / POLO (6N1) / POLO Box (6NF) / POLO (6N2) / POLO (9N_) / POLO CLASSIC (6KV2) / Variant (6KV5) / POLO Saloon</p> | VKM 11143 | <p><b>FORD</b><br/>GALAXY I</p> <p><b>SEAT</b><br/>ALHAMBRA / AROSA / LEON I (1M1) / TOLEDO II (1M2)</p> <p><b>SKODA</b><br/>FABIA / OCTAVIA I (1U2) / OCTAVIA Combi (1U5) / SUPERB</p> <p><b>VW</b><br/>BORA (1J2) / BORA Estate (1J6) / GOLF IV (1J1) / GOLF IV Variant (1J5) / LUPO (6X1, 6E1) / NEW BEETLE (9C1, 1C1)/Convertible (1Y7) / PASSAT (3B2) / Variant (3B5) / PASSAT (3B3) / Variant (3B6) / POLO (6N2) / POLO (9N_) / SHARAN (7M8, 7M9, 7M6)</p> | VKM 11150 | <p><b>AUDI</b><br/>A4 (8D2, B5) / A4 Avant (8D5, B5) / A4 (8E2, B6) / A4 Avant (8E5, B6) / A4 (8EC) / A4 Avant (8ED) / A4 Convertible (8H7) / A6 (4B, C5) / A6 Avant (4B, C5) / A8 (4D2, 4D8) / ALLROAD (4BH)</p> <p><b>SKODA</b><br/>SUPERB</p> <p><b>VW</b><br/>PASSAT (3B2) / Variant (3B5) / PASSAT (3B3) / Variant (3B6)</p>                                       |
|           | <p><b>AUDI</b><br/>A3 (8L1)</p> <p><b>SEAT</b><br/>CORDOBA (6K2) / CORDOBA (6K2/C2) / CORDOBA (6L2) / CORDOBA Vario (6K5) / IBIZA III (6K1) / IBIZA IV (6L1) / INCA / LEON I (1M1) / TOLEDO II (1M2)</p> <p><b>SKODA</b><br/>FABIA / OCTAVIA I (1U2) / OCTAVIA Combi (1U5)</p> <p><b>VW</b><br/>BORA (1J2) / BORA Estate (1J6) / CADDY II(9K9A)/Estate(9K9B)/ Pickup(9U7) / GOLF IV (1J1) / GOLF IV Variant (1J5) / NEW BEETLE (9C1, 1C1)/Convertible (1Y7) / POLO (9N_) / POLO CLASSIC (6KV2) / Variant (6KV5) / POLO Saloon</p>  |           | <p><b>FORD</b><br/>GALAXY I</p> <p><b>SEAT</b><br/>AROSA</p> <p><b>VW</b><br/>BORA (1J2) / BORA Estate (1J6) / GOLF IV (1J1) / GOLF IV Variant (1J5) / LUPO (6X1, 6E1) / PASSAT (3B2) / Variant (3B5) / POLO (6N2) / SHARAN (7M8, 7M9, 7M6)</p>  |           | <p><b>AUDI</b><br/>A4 (8D2, B5) / A4 Avant (8D5, B5) / A4 (8E2, B6) / A4 Avant (8E5, B6) / A4 (8EC) / A4 Avant (8ED) / A4 Convertible (8H7) / A6 (4B, C5) / A6 Avant (4B, C5) / A8 (4D2, 4D8) / ALLROAD (4BH)</p> <p><b>SKODA</b><br/>SUPERB</p> <p><b>VW</b><br/>PASSAT (3B2) / Variant (3B5) / PASSAT (3B3) / Variant (3B6)</p>                                       |
| VKM 11141 | <p><b>AUDI</b><br/>A6 (4B, C5) / A6 Avant (4B, C5)</p> <p><b>SEAT</b><br/>AROSA</p> <p><b>VW</b><br/>BORA (1J2) / BORA Estate (1J6) / GOLF IV (1J1) / GOLF IV Variant (1J5) / LUPO (6X1, 6E1) / PASSAT (3B2) / Variant (3B5) / POLO (6N2)</p>  | VKM 11144 | <p><b>FORD</b><br/>GALAXY I</p> <p><b>SEAT</b><br/>ALHAMBRA / AROSA / LEON I (1M1) / TOLEDO II (1M2)</p> <p><b>SKODA</b><br/>FABIA / OCTAVIA I (1U2) / OCTAVIA Combi (1U5) / SUPERB</p> <p><b>VW</b><br/>BORA (1J2) / BORA Estate (1J6) / GOLF IV (1J1) / GOLF IV Variant (1J5) / LUPO (6X1, 6E1) / PASSAT (3B2) / Variant (3B5) / PASSAT (3B3) / Variant (3B6) / POLO (6N2) / POLO (9N_) / SHARAN (7M8, 7M9, 7M6)</p>   | VKM 11151 | <p><b>AUDI</b><br/>A4 (8D2, B5) / A4 Avant (8D5, B5) / A4 (8E2, B6) / A4 Avant (8E5, B6) / A4 (8EC) / A4 Avant (8ED) / A4 Convertible (8H7) / A6 (4B, C5) / A6 Avant (4B, C5) / A8 (4D2, 4D8) / ALLROAD (4BH)</p> <p><b>SKODA</b><br/>SUPERB</p> <p><b>VW</b><br/>PASSAT (3B2) / Variant (3B5) / PASSAT (3B3) / Variant (3B6)</p>                                       |
|           | <p><b>AUDI</b><br/>A2 (8Z0) / A3 (8L1) / A4 (8D2, B5) / A4 Avant (8D5, B5) / A4 (8E2, B6) / A4 Avant (8E5, B6) / A6 (4B, C5) / A6 Avant (4B, C5)</p>   |           | <p><b>FORD</b><br/>GALAXY I</p> <p><b>SEAT</b><br/>ALHAMBRA / AROSA / LEON I (1M1) / TOLEDO II (1M2)</p> <p><b>SKODA</b><br/>FABIA / OCTAVIA I (1U2) / OCTAVIA Combi (1U5) / SUPERB</p> <p><b>VW</b><br/>BORA (1J2) / BORA Estate (1J6) / GOLF IV (1J1) / GOLF IV Variant (1J5) / LUPO (6X1, 6E1) / NEW BEETLE (9C1, 1C1)/Convertible (1Y7) / PASSAT (3B2) / Variant (3B5) / PASSAT (3B3) / Variant (3B6) / POLO (6N2) / POLO (9N_) / SHARAN (7M8, 7M9, 7M6)</p> |           | <p><b>AUDI</b><br/>A4 (8D2, B5) / A4 Avant (8D5, B5) / A4 (8E2, B6) / A4 Avant (8E5, B6) / A4 (8EC) / A4 Avant (8ED) / A4 Convertible (8H7) / A6 (4A, C4) / A6 Avant (4A, C4) / A6 (4B, C5) / A6 Avant (4B, C5) / A6 (4F2) / A6 Avant (4F5) / A8 (4D2, 4D8) / ALLROAD (4BH)</p>   |
| VKM 11142 | <p><b>AUDI</b><br/>A6 (4B, C5) / A6 Avant (4B, C5)</p> <p><b>SEAT</b><br/>AROSA</p> <p><b>VW</b><br/>BORA (1J2) / BORA Estate (1J6) / GOLF IV (1J1) / GOLF IV Variant (1J5) / LUPO (6X1, 6E1) / PASSAT (3B2) / Variant (3B5) / POLO (6N2)</p>  | VKM 11145 | <p><b>FORD</b><br/>GALAXY I</p> <p><b>SEAT</b><br/>ALHAMBRA / AROSA / LEON I (1M1) / TOLEDO II (1M2)</p> <p><b>SKODA</b><br/>FABIA / OCTAVIA I (1U2) / OCTAVIA Combi (1U5) / SUPERB</p> <p><b>VW</b><br/>BORA (1J2) / BORA Estate (1J6) / GOLF IV (1J1) / GOLF IV Variant (1J5) / LUPO (6X1, 6E1) / PASSAT (3B2) / Variant (3B5) / PASSAT (3B3) / Variant (3B6) / POLO (6N2) / POLO (9N_) / SHARAN (7M8, 7M9, 7M6)</p>   | VKM 11154 | <p><b>AUDI</b><br/>A4 (8D2, B5) / A4 Avant (8D5, B5) / A4 (8E2, B6) / A4 Avant (8E5, B6) / A4 (8EC) / A4 Avant (8ED) / A4 Convertible (8H7) / A6 (4B, C5) / A6 Avant (4B, C5) / A8 (4D2, 4D8) / ALLROAD (4BH)</p> <p><b>SKODA</b><br/>SUPERB</p> <p><b>VW</b><br/>PASSAT (3B2) / Variant (3B5) / PASSAT (3B3) / Variant (3B6)</p>                                       |
|           | <p><b>AUDI</b><br/>A2 (8Z0) / A3 (8L1) / A4 (8D2, B5) / A4 Avant (8D5, B5) / A4 (8E2, B6) / A4 Avant (8E5, B6) / A6 (4B, C5) / A6 Avant (4B, C5)</p>   |           | <p><b>FORD</b><br/>GALAXY I</p> <p><b>SEAT</b><br/>ALHAMBRA / AROSA / LEON I (1M1) / TOLEDO II (1M2)</p> <p><b>SKODA</b><br/>FABIA / OCTAVIA I (1U2) / OCTAVIA Combi (1U5) / SUPERB</p> <p><b>VW</b><br/>BORA (1J2) / BORA Estate (1J6) / GOLF IV (1J1) / GOLF IV Variant (1J5) / LUPO (6X1, 6E1) / PASSAT (3B2) / Variant (3B5) / PASSAT (3B3) / Variant (3B6) / POLO (6N2) / POLO (9N_) / SHARAN (7M8, 7M9, 7M6)</p>   |           | <p><b>AUDI</b><br/>100 (4A, C4) / 100 Avant (4A, C4) / 80 (8C, B4) / 80 Avant (8C, B4) / A6 (4A, C4) / A6 Avant (4A, C4) / A8 (4D2, 4D8) / CABRIOLET (8G7, B4) / COUPE (89, 8B)</p> <p><b>SKODA</b><br/>SUPERB</p> <p><b>VW</b><br/>PASSAT (3B2) / Variant (3B5) / PASSAT (3B3) / Variant (3B6)</p>   |
| VKM 11142 | <p><b>AUDI</b><br/>A2 (8Z0) / A3 (8L1) / A4 (8D2, B5) / A4 Avant (8D5, B5) / A4 (8E2, B6) / A4 Avant (8E5, B6) / A6 (4B, C5) / A6 Avant (4B, C5)</p>   | VKM 11145 | <p><b>FORD</b><br/>GALAXY I</p> <p><b>SEAT</b><br/>ALHAMBRA / AROSA / LEON I (1M1) / TOLEDO II (1M2)</p> <p><b>SKODA</b><br/>FABIA / OCTAVIA I (1U2) / OCTAVIA Combi (1U5) / SUPERB</p> <p><b>VW</b><br/>BORA (1J2) / BORA Estate (1J6) / GOLF IV (1J1) / GOLF IV Variant (1J5) / LUPO (6X1, 6E1) / PASSAT (3B2) / Variant (3B5) / PASSAT (3B3) / Variant (3B6) / POLO (6N2) / POLO (9N_) / SHARAN (7M8, 7M9, 7M6)</p>   | VKM 11200 | <p><b>AUDI</b><br/>80 (8C, B4) / 80 Avant (8C, B4) / A4 (8D2, B5) / A4 Avant (8D5, B5) / A6 (4A, C4) / A6 Avant (4A, C4) / A8 (4D2, 4D8) / CABRIOLET (8G7, B4) / COUPE (89, 8B)</p> <p><b>AUDI</b><br/>80 (8C, B4) / 80 Avant (8C, B4) / A4 (8D2, B5) / A4 Avant (8D5, B5) / A6 (4A, C4) / A6 Avant (4A, C4) / A8 (4D2, 4D8) / CABRIOLET (8G7, B4) / COUPE (89, 8B)</p> |
|           | <p><b>AUDI</b><br/>A2 (8Z0) / A3 (8L1) / A4 (8D2, B5) / A4 Avant (8D5, B5) / A4 (8E2, B6) / A4 Avant (8E5, B6) / A6 (4B, C5) / A6 Avant (4B, C5)</p>   |           | <p><b>FORD</b><br/>GALAXY I</p> <p><b>SEAT</b><br/>ALHAMBRA / AROSA / LEON I (1M1) / TOLEDO II (1M2)</p> <p><b>SKODA</b><br/>FABIA / OCTAVIA I (1U2) / OCTAVIA Combi (1U5) / SUPERB</p> <p><b>VW</b><br/>BORA (1J2) / BORA Estate (1J6) / GOLF IV (1J1) / GOLF IV Variant (1J5) / LUPO (6X1, 6E1) / PASSAT (3B2) / Variant (3B5) / PASSAT (3B3) / Variant (3B6) / POLO (6N2) / POLO (9N_) / SHARAN (7M8, 7M9, 7M6)</p>   |           | <p><b>AUDI</b><br/>A4 (8D2, B5) / A4 Avant (8D5, B5) / A4 (8E2, B6) / A4 Avant (8E5, B6) / A4 (8EC) / A4 Avant (8ED) / A4 Convertible (8H7) / A6 (4A, C4) / A6 Avant (4A, C4) / A6 (4B, C5) / A6 Avant (4B, C5) / A6 (4F2) / A6 Avant (4F5) / A8 (4D2, 4D8) / ALLROAD (4BH)</p>   |







|    |   |   |   |     |  |  |  |
|---|--|--|---|--|---|--|--|
| VKM 11204   | <b>SKODA</b><br>SUPERB   | VKM 11250  | <b>AUDI</b><br>A2 (8Z0) / A3 (8L1) / A3 (8P1) / A3 Sportback (8PA) / A4 (8E2, B6) / A4 Avant (8E5, B6) / A4 (8EC) / A4 Avant (8ED) / A4 Convertible (8H7) / A6 (4B, C5) / A6 Avant (4B, C5) | VKM 11257  | <b>VOLVO</b><br>850 / C70 - S70 / S80 / V70 I / V70 II                              |  |  |
|   | <b>VW</b><br>PASSAT (3B2) / Variant (3B5) / PASSAT (3B3) / Variant (3B6)   |  | <b>FORD</b><br>GALAXY I   |  | VKM 11258   | <b>VW</b><br>CRAFTER 30-35 / 30-50 (2E) / LT II / TRANSPORTER IV   |  |
|   | <b>AUDI</b><br>A6 (4B, C5) / A6 Avant (4B, C5) / A8 (4D2, 4D8) / A8 (4E_)  |  | <b>SEAT</b><br>ALHAMBRA / ALTEA / ALTEA XL / AROSA / CORDOBA (6L2) / IBIZA IV (6L1) / LEON I (1M1) / LEON II (1P1) / TOLEDO II (1M2) / TOLEDO III (5P2)                                     |  |   | VKM 11265  | <b>VOLVO</b><br>850 / C70 - S70 / S80 / V70 I / V70 II |
|   | <b>VW</b><br>PHAETON (3D2) / TOUAREG (7LA)   |  | <b>SKODA</b><br>FABIA / OCTAVIA I (1U2) / OCTAVIA Combi (1U5) / OCTAVIA II (1Z3) / OCTAVIA II Combi (1Z5) / ROOMSTER / SUPERB   |  |   |  | VKM 11266  |
| VKM 11207   | <b>AUDI</b><br>A6 (4B, C5) / A6 Avant (4B, C5) / A8 (4D2, 4D8)   | <b>VW</b><br>BORA (1J2) / BORA Estate (1J6) / CADDY III (2KA) / CADDY III Estate (2KB) / EOS / FOX (5Z1) / GOLF IV (1J1) / GOLF IV Variant (1J5) / GOLF V (1K1) / GOLF V VARIANT (1K1) / GOLF V PLUS (5M1) / JETTA III (1KM) / LUPO (6X1, 6E1) / MULTIVAN V (7HM) / NEW BEETLE (9C1, 1C1) / Convertible (1Y7) / PASSAT (3B3) / Variant (3B6) / PASSAT (3C2) / Variant (3C5) / POLO (9N_) / POLO Saloon / SHARAN (7M8, 7M9, 7M6) / TOURAN / TRANSPORTER V | VKM 11300   | <b>AUDI</b><br>100 (44,44Q,C3)/100 Avant (44,44Q,C3) / A6 (4A, C4) / A6 Avant (4A, C4) |   |  |  |
|   | VKM 11208  | <b>AUDI</b><br>A4 (8D2, B5) / A4 Avant (8D5, B5) / A6 (4A, C4) / A6 Avant (4A, C4) / A8 (4D2, 4D8)   |   | <b>VW</b><br>TRANSPORTER IV  | VKM 11330   |  |  |
| VKM 11209   |  | <b>AUDI</b><br>A4 (8D2, B5) / A4 Avant (8D5, B5) / A4 (8E2, B6) / A4 Avant (8E5, B6) / A4 Convertible (8H7) / A6 (4B, C5) / A6 Avant (4B, C5) / A6 (4F2) / A6 Avant (4F5) / A8 (4D2, 4D8) / ALL-ROAD (4BH)   | <b>VW</b><br>TRANSPORTER V  | VKM 11331  |   | <b>AUDI</b><br>A4 (8E2, B6) / A4 Avant (8E5, B6) / A4 (8EC) / A4 Avant (8ED) / A4 Convertible (8H7) / A6 (4B, C5) / A6 Avant (4B, C5) / A6 (4F2) / A6 Avant (4F5) / A8 (4E_) |  |
|   | VKM 11220  | <b>SKODA</b><br>SUPERB   | <b>VW</b><br>GOLF V (1K1) / GOLF V VARIANT (1K1) / TOURAN   |  | VKM 11332   | <b>AUDI</b><br>A8 (4D2, 4D8)   |  |
| VKM 11222   |  | <b>VW</b><br>PASSAT (3B2) / Variant (3B5) / PASSAT (3B3) / Variant (3B6)   | <b>AUDI</b><br>A3 (8P1) / A3 Sportback (8PA) / A4 (8E2, B6) / A4 Avant (8E5, B6)  | VKM 11333  |   | <b>AUDI</b><br>A8 (4D2, 4D8)   |  |
|   | VKM 11222  | <b>AUDI</b><br>A3 (8P1) / A3 Sportback (8PA) / A4 (8EC) / A4 Avant (8ED) / A4 Convertible (8H7) / A6 (4F2) / A6 Avant (4F5) / TT (8J3) / TT Roadster (8J9)   | <b>VW</b><br>GOLF V (1K1) / GOLF V VARIANT (1K1) / TOURAN   |  | VKM 12001   | <b>AUDI</b><br>A4 (8EC) / A4 Avant (8ED) / A4 (8K) / A4 Convertible (8H7) / A5 / A6 (4F2) / A6 Avant (4F5) / A6 Allroad (4FH) / A8 (4E_) / Q7                                |  |
| VKM 11222   |  | <b>SEAT</b><br>ALTEA / ALTEA XL / LEON II (1P1) / TOLEDO III (5P2)   | <b>AUDI</b><br>A3 (8P1) / A3 Sportback (8PA) / A4 (8EC) / A4 Avant (8ED) / A6 (4F2) / A6 Avant (4F5)  | VKM 12003  |   | <b>VW</b><br>PHAETON (3D2) / TOUAREG (7LA)   |  |
|   | <b>SEAT</b><br>ALTEA / ALTEA XL / LEON II (1P1) / TOLEDO III (5P2)   | <b>SEAT</b><br>ALTEA / ALTEA XL / LEON II (1P1) / TOLEDO III (5P2)   | VKM 12004   |  | <b>FIAT</b><br>ARGENTA / REGATA / RITMO   |  |  |
| <b>SKODA</b><br>OCTAVIA II (1Z3) / OCTAVIA II Combi (1Z5)   | <b>SKODA</b><br>OCTAVIA II (1Z3) / OCTAVIA II Combi (1Z5)  | VKM 12005  |   | <b>LANCIA</b><br>DELTA I / PRISMA  |   |  |  |
| <b>VW</b><br>EOS / GOLF V (1K1) / GOLF V VARIANT (1K1) / GOLF V PLUS (5M1) / JETTA III (1KM) / PASSAT (3C2) / Variant (3C5) | <b>VW</b><br>GOLF V (1K1) / GOLF V VARIANT (1K1) / GOLF V PLUS (5M1) / JETTA III (1KM) / PASSAT (3C2) / Variant (3C5) / TOURAN |  | VKM 12004   | <b>SEAT</b><br>131 / RONDA   |   |  |  |
| VKM 11256   | <b>AUDI</b><br>A4 (8D2, B5) / A4 Avant (8D5, B5)   | VKM 12005  |   | <b>FIAT</b><br>ARGENTA / REGATA / RITMO / UNO  |   |  |  |
|   | <b>VW</b><br>PASSAT (3B2) / Variant (3B5)  |  | <b>LANCIA</b><br>DELTA I / PRISMA   |  |   |  |  |
| VKM 11256   | <b>AUDI</b><br>A4 (8D2, B5) / A4 Avant (8D5, B5)   | VKM 12005  | <b>FIAT</b><br>RITMO  |  |   |  |  |
|   | <b>VW</b><br>PASSAT (3B2) / Variant (3B5)  |  | <b>LANCIA</b><br>BETA   |  |   |  |  |
| VKM 11256   | <b>AUDI</b><br>A4 (8D2, B5) / A4 Avant (8D5, B5)   | VKM 12005  | <b>ALFA ROMEO</b><br>164  |  |   |  |  |
|   | <b>VW</b><br>PASSAT (3B2) / Variant (3B5)  |  | <b>FIAT</b><br>CROMA (154) / REGATA / RITMO / TEMPRA / TIPO   |  |   |  |  |









|  |            |  |    |  |  |
|--|---|---|---|---|---|
| VKM 12010  | LANCIA<br>DELTA I / PRISMA / THEMA  | VKM 12174   | LANCIA<br>DEDRA / DELTA II  | VKM 12206   | FIAT<br>500 / DOBLO / GRANDE PUNTO / PANDA (169) / PUNTO (188) / STRADA             |
| VKM 12012  | AUTOBIANCHI<br>Y10  |   | ALFA ROMEO<br>145/146 / 147 / 156 / 159 / 166 / BRERA / GT  | VKM 12215   | LANCIA<br>MUSA / YPSILON  |
| VKM 12100  | LANCIA<br>Y10   |   | FIAT<br>BRAVA/BRAVO (182) / BRAVO / CROMA (194) / DOBLO / GRANDE PUNTO / IDEA / MAREA / MULTIPLA / PALIO / SIENA / PUNTO (188) / SEDICI / STILO / STRADA  | VKM 12227   | FIAT<br>CROMA (154) / TEMPRA / TIPO   |
| VKM 12101  | FIAT<br>ARGENTA   |   | LANCIA<br>KAPPA / LYBRA / MUSA / THESIS   | VKM 12242   | LANCIA<br>DEDRA / DELTA I / DELTA II / PRISMA / THEMA                               |
| VKM 12150  | LANCIA<br>BETA  | VKM 12182   | OPEL<br>ASTRA H / SIGNUM / VECTRA C / ZAFIRA B  | VKM 12277   | FIAT<br>BRAVA/BRAVO (182) / DOBLO / MAREA / MULTIPLA / PALIO / SIENA / STILO        |
| VKM 12151  | SEAT<br>131 / RONDA   |   | SAAB<br>9-3 II  | VKM 12390   | LANCIA<br>DEDRA / DELTA II / LYBRA  |
| VKM 12153  | FIAT<br>RITMO   | VKM 12200   | VAUXHALL<br>ASTRA Mk V / SIGNUM / VECTRA Mk II / ZAFIRA Mk II   | VKM 12400   | ALFA ROMEO<br>145/146 / 147 / 155 / 156 / 166 / GT / GTV / SPIDER                   |
| VKM 12160  | LANCIA<br>DELTA I   |   | ALFA ROMEO<br>145/146 / 147 / 155 / 156 / GT / GTV / SPIDER   | VKM 12500   | LANCIA<br>DEDRA / DELTA II / LYBRA  |
| VKM 12172  | ALFA ROMEO<br>155   | VKM 12201   | FIAT<br>BARCHETTA / BRAVA/BRAVO (182) / COUPE / MAREA / PUNTO (188) / STILO   | VKM 12501   | FIAT<br>DUCATO (244)  |
| VKM 12173  | FIAT<br>COUPE / CROMA (154) / ELBA / FIORINO / REGATA / RITMO / TIPO / UNO                  |   | LANCIA<br>DELTA II / LYBRA  | VKM 12630   | IVECO<br>DAILY II   |
|  | LANCIA<br>DEDRA / DELTA I / DELTA II / KAPPA / PRISMA / THEMA                               |   | AUTOBIANCHI<br>Y10  | VKM 12700   | FIAT<br>CROMA (154)   |
|  | FIAT<br>CROMA (154) / REGATA / RITMO  |   | CITROËN<br>AMI / AXEL / C25 / CX / GS / JUMPY I   | VKM 13050   | LANCIA<br>THEMA   |
|  | LANCIA<br>DELTA I / PRISMA  |   | FIAT<br>CINQUECENTO / DOBLO / DUCATO (280/290) / ELBA / FIORINO / PALIO/SIENA / PANDA (141A_) / PANDA (169) / PUNTO (176) / PUNTO (188) / SCUDO (220) / SEICENTO / STRADA / TEMPRA / TIPO / UNO |   | RENAULT<br>SAFRANE I  |
|  | FIAT<br>DUNA / ELBA / FIORINO / PALIO/SIENA / PUNTO (176) / STRADA / UNO                    |   | LANCIA<br>DEDRA / DELTA II / Y / Y10 / YPSILON  |   | ALFA ROMEO<br>145/146 / 33 / ALFASUD / ARNA   |
|  | ALFA ROMEO<br>145/146 / 155   |   | PEUGEOT<br>EXPERT I / J5  |   | ALFA ROMEO<br>145/146 / 33 / ALFASUD / ARNA   |
|  | CITROËN<br>C25  |   | FIAT<br>500 / BRAVA/BRAVO (182) / BRAVO / IDEA / MAREA / PALIO / SIENA / PUNTO (176) / PUNTO (188) / STILO  |   | FIAT<br>FIORINO / PANDA (141A_) / UNO   |
|  | FIAT<br>BRAVA/BRAVO (182) / DUCATO (230) / DUCATO (280/290) / TALENTO (290) / TEMPRA / TIPO |   | LANCIA<br>MUSA / Y / YPSILON  |   | SEAT<br>IBIZA I (021A) / MALAGA / RONDA   |
|  | LANCIA<br>DEDRA / DELTA II  |   |   |   | CITROËN<br>C25 / CX   |
|  | FIAT<br>REGATA / RITMO  |   |   |   | FIAT<br>DUCATO (280/290)  |
|  | FIAT<br>BRAVA/BRAVO (182) / COUPE / MAREA / STILO   |   |   |   | PEUGEOT<br>J5   |
|  | LANCIA<br>KAPPA / LYBRA / THESIS  |   |   |   |   |
|  | ALFA ROMEO<br>145/146 / 147 / 155 / 156 / 166 / GTV / SPIDER                                |   |   |   |   |
|  | FIAT<br>BARCHETTA / COUPE   |   |   |   |   |

|  |    |  |    |  |   |
|---|---|---|--|---|--|
| VKM 13100   | <b>CITROËN</b><br>AX / BERLINGO / BX / C15 / EVASION / SAXO / XANTIA I / XANTIA II / XM I / XM II / XSARA / XSARA PICASSO / ZX<br><hr/> <b>FIAT</b><br>ULYSSE (220)<br><hr/> <b>LANCIA</b><br>ZETA<br><hr/> <b>PEUGEOT</b><br>106 I / 106 II / 205 / 206 / 306 / 307 / 309 / 405 I / 405 II / 406 / 605 / 806 / EXPERT I / PARTNER                                  | VKM 13210   | <b>LANCIA</b><br>ZETA<br><hr/> <b>PEUGEOT</b><br>306 / 406 / 605 / 806 / BOXER I / BOXER II<br><hr/> <b>CITROËN</b><br>BX / XANTIA I / ZX<br><hr/> <b>PEUGEOT</b><br>306 / 309 / 405 I / 405 II<br><hr/> <b>CITROËN</b><br>XANTIA I / ZX<br><hr/> <b>PEUGEOT</b><br>306 / 405 II | VKM 13241   | <b>TALBOT</b><br>HORIZON<br><hr/> <b>CITROËN</b><br>BERLINGO / C15 / EVASION / JUMPER (230) / JUMPY I / JUMPY II / XANTIA I / XANTIA II / XSARA / ZX<br><hr/> <b>FIAT</b><br>DUCATO (230) / SCUDO (220) / ULYSSE (220)<br><hr/> <b>HYUNDAI</b><br>LANTRA<br><hr/> <b>LADA</b><br>NIVA<br><hr/> <b>PEUGEOT</b><br>205 / 306 / 405 II / 406 / 806 / BOXER I / EXPERT I / PARTNER<br><hr/> <b>ROVER</b><br>200 (XW) / 400 (XW)<br><hr/> <b>SUZUKI</b><br>SAMURAI / VITARA |
| VKM 13120   | <b>CITROËN</b><br>AX / SAXO / XSARA<br><hr/> <b>NISSAN</b><br>MICRA<br><hr/> <b>PEUGEOT</b><br>106 I / 106 II<br><hr/> <b>ROVER</b><br>100  | VKM 13214   | <b>CITROËN</b><br>XANTIA I / XANTIA II / XSARA / ZX<br><hr/> <b>PEUGEOT</b><br>306 / 406<br><hr/> <b>CITROËN</b><br>XANTIA II<br><hr/> <b>PEUGEOT</b><br>306 / 406   | VKM 13244   | <b>CITROËN</b><br>BERLINGO / C15 / C5 I / EVASION / JUMPY I / JUMPY II / XSARA / XSARA PICASSO<br><hr/> <b>FIAT</b><br>SCUDO (220) / ULYSSE (220)<br><hr/> <b>LANCIA</b><br>ZETA<br><hr/> <b>PEUGEOT</b><br>206 / 306 / 307 / 406 / 607 / 806 / EXPERT I / PARTNER   |
| VKM 13130   | <b>CITROËN</b><br>SAXO<br><hr/> <b>PEUGEOT</b><br>106 II  | VKM 13216   | <b>CITROËN</b><br>XANTIA I / XANTIA II / XSARA / ZX<br><hr/> <b>PEUGEOT</b><br>306 / 406   | VKM 13244   | <b>CITROËN</b><br>BERLINGO / C15 / C5 I / EVASION / JUMPY I / JUMPY II / XSARA / XSARA PICASSO<br><hr/> <b>FIAT</b><br>SCUDO (220) / ULYSSE (220)<br><hr/> <b>LANCIA</b><br>ZETA<br><hr/> <b>PEUGEOT</b><br>206 / 306 / 307 / 406 / 607 / 806 / EXPERT I / PARTNER   |
| VKM 13132   | <b>CITROËN</b><br>BERLINGO / C3 / C3 Pluriel / XSARA<br><hr/> <b>PEUGEOT</b><br>206 / 307 / PARTNER   | VKM 13218   | <b>CITROËN</b><br>XANTIA I / XANTIA II / XSARA / ZX<br><hr/> <b>PEUGEOT</b><br>306 / 406   | VKM 13244   | <b>CITROËN</b><br>BERLINGO / C15 / C5 I / EVASION / JUMPY I / JUMPY II / XSARA / XSARA PICASSO<br><hr/> <b>FIAT</b><br>SCUDO (220) / ULYSSE (220)<br><hr/> <b>LANCIA</b><br>ZETA<br><hr/> <b>PEUGEOT</b><br>206 / 306 / 307 / 406 / 607 / 806 / EXPERT I / PARTNER   |
| VKM 13140   | <b>CITROËN</b><br>BERLINGO / C1 / C2 / C3 / C3 Pluriel / C4 / C4 Picasso / C5 II / XSARA / XSARA PICASSO<br><hr/> <b>FORD</b><br>FIESTA V / FOCUS C-MAX I / FOCUS C-MAX II / FOCUS II / FUSION<br><hr/> <b>MAZDA</b><br>2 / 3<br><hr/> <b>PEUGEOT</b><br>1007 / 107 / 206 / 207 / 207 CC / 207 SW / 307 / 308 / 407 / PARTNER<br><hr/> <b>VOLVO</b><br>S40 II - V50 | VKM 13220   | <b>CITROËN</b><br>XANTIA I / XANTIA II / XSARA / ZX<br><hr/> <b>PEUGEOT</b><br>306 / 406   | VKM 13244   | <b>CITROËN</b><br>BERLINGO / C5 I / C8 / EVASION / JUMPER (230) / JUMPER (244) / JUMPY I / JUMPY II / XANTIA II / XSARA / XSARA PICASSO<br><hr/> <b>FIAT</b><br>DUCATO (230) / DUCATO (244) / SCUDO (220) / ULYSSE (179AX) / ULYSSE (220)<br><hr/> <b>LANCIA</b><br>PHEDRA / ZETA<br><hr/> <b>PEUGEOT</b><br>206 / 306 / 406 / 607 / 806 / 807 / BOXER I / BOXER II / EXPERT I / PARTNER   |
| VKM 13200   | <b>CITROËN</b><br>BX / VISA / ZX<br><hr/> <b>PEUGEOT</b><br>205 / 305 / 309 / 405 I   | VKM 13231   | <b>CITROËN</b><br>C5 I<br><hr/> <b>PEUGEOT</b><br>605  | VKM 13244   | <b>CITROËN</b><br>BERLINGO / C5 I / C8 / EVASION / JUMPER (230) / JUMPER (244) / JUMPY I / JUMPY II / XANTIA II / XSARA / XSARA PICASSO<br><hr/> <b>FIAT</b><br>DUCATO (230) / DUCATO (244) / SCUDO (220) / ULYSSE (179AX) / ULYSSE (220)<br><hr/> <b>LANCIA</b><br>PHEDRA / ZETA<br><hr/> <b>PEUGEOT</b><br>206 / 306 / 406 / 607 / 806 / 807 / BOXER I / BOXER II / EXPERT I / PARTNER   |
| VKM 13202   | <b>CITROËN</b><br>EVASION / JUMPER (230) / JUMPER (244) / XANTIA I / XANTIA II / XM II / XSARA / ZX<br><hr/> <b>FIAT</b><br>DUCATO (230) / DUCATO (244) / ULYSSE (220)  | VKM 13234   | <b>CITROËN</b><br>C4 / C5 I / C5 II / C8 / EVASION / JUMPY I / XSARA / XSARA PICASSO<br><hr/> <b>FIAT</b><br>SCUDO (220) / ULYSSE (179AX) / ULYSSE (220)<br><hr/> <b>LANCIA</b><br>PHEDRA / ZETA<br><hr/> <b>PEUGEOT</b><br>206 / 307 / 406 / 407 / 607 / 806 / 807 / EXPERT I   | VKM 13244   | <b>CITROËN</b><br>BERLINGO / C5 I / C8 / EVASION / JUMPER (230) / JUMPER (244) / JUMPY I / JUMPY II / XANTIA II / XSARA / XSARA PICASSO<br><hr/> <b>FIAT</b><br>DUCATO (230) / DUCATO (244) / SCUDO (220) / ULYSSE (179AX) / ULYSSE (220)<br><hr/> <b>LANCIA</b><br>PHEDRA / ZETA<br><hr/> <b>PEUGEOT</b><br>206 / 306 / 406 / 607 / 806 / 807 / BOXER I / BOXER II / EXPERT I / PARTNER   |
|   |   | VKM 13240   | <b>CITROËN</b><br>BX / C15 / C25 / VISA / ZX<br><hr/> <b>LADA</b><br>NIVA<br><hr/> <b>PEUGEOT</b><br>205 / 305 / 306 / 309 / 405 I / 405 II / J5<br><hr/> <b>ROVER</b><br>200 (XW) / 400 (XW)  | VKM 13250   | <b>CITROËN</b><br>EVASION / XANTIA I / XANTIA II / XM I / XM II<br><hr/> <b>FIAT</b><br>ULYSSE (220)<br><hr/> <b>LANCIA</b><br>ZETA<br><hr/> <b>PEUGEOT</b><br>406 / 605 / 806   |















|  |  |   |   |   |   |
|--|--|---|---|---|---|
|  |         |  |    |  |    |
| <b>VKM 13253</b>   | <b>CITROËN</b><br>BERLINGO / C2 / C3 / C3 Pluriel / SAXO / XSARA                         | <b>VKM 13301</b>  | <b>CITROËN</b><br>XM II   | <b>VKM 14108</b>  | <b>FORD</b><br>FIESTA BOX / COURRIER / FIESTA IV / FOCUS C-MAX I / FOCUS I / FOCUS II / GALAXY II / MONDEO IV / S-MAX / TRANSIT CONNECT / TOURNEO CONNECT   |
| <b>VKM 13256</b>   | <b>CITROËN</b><br>BERLINGO / C2 / C3 / C3 Pluriel / C4 / XSARA / XSARA PICASSO           | <b>VKM 13304</b>  | <b>PEUGEOT</b><br>605   | <b>VKM 14200</b>  | <b>FORD</b><br>ESCORT BOX 81 / ESCORT BOX 86 / ESCORT II / ESCORT III / ESCORT IV / FIESTA BOX / COURRIER / FIESTA I / FIESTA II / ORION I  |
| <b>VKM 13257</b>   | <b>PEUGEOT</b><br>1007 / 106 II / 206 / 207 / 207 CC / 207 SW / 306 / 307 / PARTNER      | <b>VKM 13902</b>  | <b>CITROËN</b><br>JUMPER (230)  | <b>VKM 14201</b>  | <b>FORD</b><br>ESCORT BOX 81 / ESCORT BOX 86 / ESCORT BOX 91 / ESCORT BOX 95 / ESCORT III / ESCORT IV / ESCORT V / ESCORT VI / ESCORT VII / FIESTA BOX / COURRIER / FIESTA I / FIESTA II / FIESTA III / ORION I / ORION II / ORION III / SIERRA |
| <b>VKM 13258</b>   | <b>CITROËN</b><br>C4 / C4 Picasso / C5 II / C6 / C8 / JUMPY III                          | <b>VKM 14000</b>  | <b>PEUGEOT</b><br>406 / 407 / 605 / 607 / 807   | <b>VKM 14204</b>  | <b>FORD</b><br>SIERRA   |
| <b>VKM 13259</b>   | <b>FORD</b><br>FOCUS C-MAX I / FOCUS C-MAX II / FOCUS II / GALAXY II / MONDEO IV / S-MAX | <b>VKM 14100</b>  | <b>RENAULT</b><br>AVANTIME / CLIO II / ESPACE III / LAGUNA I / LAGUNA II / SAFRANE II   | <b>VKM 14210</b>  | <b>FORD</b><br>ESCORT V / ESCORT VI / ESCORT VII / FIESTA III / MONDEO I / MONDEO II / ORION III  |
| <b>VKM 13260</b>   | <b>LANCIA</b><br>PHEDRA  | <b>VKM 14101</b>  | <b>FORD</b><br>CAPRI / ESCORT II / GRANADA / P 100 I / P 100 II / SCORPIO / SIERRA / TRANSIT  | <b>VKM 14211</b>  | <b>FORD</b><br>COUGAR / FOCUS I / MONDEO II / TRANSIT CONNECT / TOURNEO CONNECT   |
| <b>VKM 13261</b>   | <b>PEUGEOT</b><br>307 / 308 / 407 / 607 / 807 / EXPERT II / EXPERT Tepee                 | <b>VKM 14103</b>  | <b>FORD</b><br>ESCORT BOX 86 / ESCORT BOX 91 / ESCORT BOX 95 / ESCORT IV / ESCORT V / ESCORT VI / ESCORT VII / FIESTA BOX / COURRIER / FIESTA III / FIESTA IV / MONDEO I / ORION II / ORION III / P 100 II / SIERRA | <b>VKM 14216</b>  | <b>FORD</b><br>MAVERICK   |
| <b>VKM 13262</b>   | <b>VOLVO</b><br>S40 II - V50   | <b>VKM 14105</b>  | <b>FORD</b><br>ESCORT BOX 81 / ESCORT BOX 86 / ESCORT III / ESCORT IV / FIESTA II / ORION I / ORION II  | <b>VKM 14220</b>  | <b>FORD</b><br>FIESTA IV  |
| <b>VKM 13263</b>   | <b>CITROËN</b><br>C2 / C3 / C4   | <b>VKM 14107</b>  | <b>FORD</b><br>ESCORT BOX 95 / ESCORT VII / ESCORT VIII / FIESTA BOX / COURRIER / FIESTA III / FIESTA IV / MONDEO I / MONDEO II / ORION II / ORION III / P 100 II / SIERRA  | <b>VKM 14222</b>  | <b>FORD</b><br>FIESTA IV / FIESTA V / FOCUS C-MAX I / FOCUS I / FOCUS II / FUSION / PUMA  |
| <b>VKM 13264</b>   | <b>PEUGEOT</b><br>1007 / 206 / 207 / 207 CC / 207 SW / 307                               | <b>VKM 14300</b>  | <b>FORD</b><br>ESCORT BOX 95 / ESCORT VII / FIESTA BOX / COURRIER / FIESTA III / FIESTA IV / MONDEO I / MONDEO II   | <b>VKM 14224</b>  | <b>FORD</b><br>FIESTA V / FOCUS C-MAX I / FOCUS C-MAX II / FOCUS II / FUSION / MONDEO IV  |
| <b>VKM 13265</b>   | <b>CITROËN</b><br>C6   | <b>VKM 14301</b>  | <b>FORD</b><br>ESCORT BOX 95 / ESCORT VII / FIESTA BOX / COURRIER / FIESTA III / FIESTA IV / MONDEO I / MONDEO II   | <b>VKM 14300</b>  | <b>FORD</b><br>TRANSIT  |
| <b>VKM 13266</b>   | <b>LAND ROVER</b><br>DISCOVERY III / RANGE ROVER SPORT                                   | <b>VKM 14301</b>  | <b>FORD</b><br>ESCORT BOX 95 / ESCORT VII / FIESTA BOX / COURRIER / FIESTA III / FIESTA IV / MONDEO I / MONDEO II   | <b>VKM 14301</b>  | <b>FORD</b><br>TRANSIT  |
| <b>VKM 13267</b>   | <b>PEUGEOT</b><br>407 / 607  | <b>VKM 15121</b>  | <b>FORD</b><br>ESCORT BOX 95 / ESCORT VII / FIESTA BOX / COURRIER / FIESTA III / FIESTA IV / MONDEO I / MONDEO II   | <b>VKM 15121</b>  | <b>CHEVROLET</b><br>AVEO  |
| <b>VKM 13268</b>   | <b>CITROËN</b><br>C4 / C4 Picasso / C5 II / C8   | <b>VKM 14400</b>  | <b>FORD</b><br>ESCORT BOX 95 / ESCORT VII / FIESTA BOX / COURRIER / FIESTA III / FIESTA IV / MONDEO I / MONDEO II   | <b>VKM 15121</b>  | <b>DAEWOO</b><br>CIELO / ESPERO / KALOS / LANOS / NEXIA / NUBIRA  |
| <b>VKM 13269</b>   | <b>PEUGEOT</b><br>307 / 407 / 807  | <b>VKM 14401</b>  | <b>FORD</b><br>ESCORT BOX 95 / ESCORT VII / FIESTA BOX / COURRIER / FIESTA III / FIESTA IV / MONDEO I / MONDEO II   | <b>VKM 15121</b>  | <b>OPEL</b><br>ASTRA F / ASTRA F CLASSIC / ASTRA G / COMBO A / COMBO B / CORSA A / CORSA B / KADETT E / MERIVA / VECTRA A / VECTRA B  |
| <b>VKM 13270</b>   | <b>CITROËN</b><br>C5 I / C5 II / C8 / JUMPER (244)                                       | <b>VKM 14402</b>  | <b>FORD</b><br>ESCORT BOX 95 / ESCORT VII / FIESTA BOX / COURRIER / FIESTA III / FIESTA IV / MONDEO I / MONDEO II   |   |   |
| <b>VKM 13271</b>   | <b>FIAT</b><br>SCUDO (220)   |   |   |   |   |
| <b>VKM 13272</b>   | <b>PEUGEOT</b><br>406 / 607 / 807 / BOXER II / EXPERT I                                  |   |   |   |   |
| <b>VKM 13273</b>   | <b>SUZUKI</b><br>GRAND VITARA  |   |   |   |   |
| <b>VKM 13300</b>   | <b>CITROËN</b><br>JUMPER (230) / XM II   |   |   |   |   |
|  | <b>PEUGEOT</b><br>605 / BOXER I  |   |   |   |   |

|  |    |  |   |  |    |
|---|---|---|---|---|---|
| VKM 15140   | <b>VAUXHALL</b><br>ASTRA Mk II / ASTRA Mk III /<br>ASTRA Mk IV / CAVALIER Mk III /<br>COMBO I / COMBO II / CORSA<br>Mk I / MERIVA / NOVA / VECTRA<br>Mk I | VKM 15216   | <b>OPEL</b><br>ASTRA F / ASTRA F CLASSIC /<br>ASTRA G / ASTRA H / COMBO A<br>/ COMBO B / CORSA B / CORSA<br>C / MERIVA / SIGNUM / TIGRA /<br>TIGRA Twin Top / VECTRA B /<br>VECTRA C / ZAFIRA A | VKM 16000   | <b>NISSAN</b><br>KUBISTAR   |
|   | <b>OPEL</b><br>ASTRA G / ASTRA H /<br>SPEEDSTER / ZAFIRA A /<br>ZAFIRA B  |   | <b>SAAB</b><br>9-3 II   |   | <b>RENAULT</b><br>CLIO I / CLIO II / EXPRESS/<br>EXTRA/RAPID / KANGOO /<br>MEGANE I / R19 / SCENIC I /<br>TWINGO  |
| VKM 15202   | <b>VAUXHALL</b><br>ASTRA Mk IV / ASTRA Mk V / VX<br>220 / ZAFIRA Mk I   | VKM 15218   | <b>VAUXHALL</b><br>ASTRA Mk III / ASTRA Mk IV /<br>ASTRA Mk V / CORSA Mk I /<br>CORSA Mk II / MERIVA / TIGRA<br>Mk I / TIGRA Mk II / VECTRA Mk<br>I / VECTRA Mk II / ZAFIRA Mk I                | VKM 16002   | <b>RENAULT</b><br>CLIO II / CLIO III / KANGOO /<br>MODUS / THALIA / TWINGO /<br>TWINGO II   |
|   | <b>CHEVROLET</b><br>EPICA   |   | <b>OPEL</b><br>ASTRA G / ASTRA H / COMBO B<br>/ CORSA B / CORSA C / CORSA<br>D / MERIVA   |   | <b>DACIA</b><br>LOGAN   |
| VKM 15210   | <b>DAEWOO</b><br>EVANDA / LACETTI / LEGANZA<br>/ MAGNUS / NUBIRA / REZZO /<br>TACUMA  | VKM 15220   | <b>VAUXHALL</b><br>ASTRA Mk IV / ASTRA Mk V /<br>COMBO II / CORSA Mk II /<br>CORSA Mk III / MERIVA  | VKM 16020   | <b>DACIA</b><br>LOGAN   |
|   | <b>LADA</b><br>110  |   | <b>OPEL</b><br>SIGNUM / VECTRA C  |   | <b>NISSAN</b><br>KUBISTAR   |
| VKM 15211   | <b>OPEL</b><br>ASTRA F / ASTRA G / CALIBRA /<br>FRONTERA A / KADETT E /<br>OMEGA B / VECTRA A / VECTRA<br>B   | VKM 15230   | <b>RENAULT</b><br>ESPACE IV / VEL SATIS   | VKM 16021   | <b>RENAULT</b><br>CLIO II / CLIO III / KANGOO /<br>LAGUNA I / LAGUNA II / MEG-<br>ANE I / MEGANE II / MODUS /<br>SCENIC I / SCENIC II / GRAND<br>SCENIC / THALIA        |
|   | <b>SUZUKI</b><br>VERONA   |   | <b>SAAB</b><br>9-5  |   | <b>RENAULT</b><br>CLIO III / LAGUNA II / MEGANE II<br>/ MODUS / SCENIC II / GRAND<br>SCENIC   |
| VKM 15213   | <b>VAUXHALL</b><br>ASTRA Mk II / ASTRA Mk III /<br>ASTRA Mk IV / CALIBRA /<br>CAVALIER Mk III / FRONTERA<br>Mk I / OMEGA / VECTRA Mk I                    | VKM 15260   | <b>VAUXHALL</b><br>SIGNUM / VECTRA Mk II  | VKM 16040   | <b>FORD</b><br>FOCUS II / MONDEO IV / S-MAX   |
|   | <b>OPEL</b><br>CORSA A / CORSA B / KADETT<br>E  |   | <b>OPEL</b><br>ANTARA / FRONTERA A /<br>FRONTERA B / OMEGA B /<br>SINTRA / VECTRA B   |   | <b>VOLVO</b><br>S40 II - V50 / S60 / S80 / V70 II<br>/ XC70 I / XC90  |
| VKM 15215   | <b>VAUXHALL</b><br>ASTRA Mk II / CORSA Mk I /<br>NOVA / NOVAVAN   | VKM 15402   | <b>VAUXHALL</b><br>FRONTERA Mk I / FRONTERA<br>Mk II / OMEGA / SINTRA /<br>VECTRA Mk I  | VKM 16100   | <b>RENAULT</b><br>R11 / R21 / R9 / SUPER 5 /<br>TRAFIC I  |
|   | <b>OPEL</b><br>ASTRA F / CALIBRA / KADETT E<br>/ VECTRA A   |   | <b>OPEL</b><br>ASTRA G / ASTRA H / CORSA D<br>/ MERIVA / VECTRA C / ZAFIRA<br>B   |   | <b>VOLVO</b><br>340-360 / 480   |
| VKM 15215   | <b>VAUXHALL</b><br>ASTRA Mk II / ASTRA Mk III /<br>CALIBRA / CAVALIER Mk III  | VKM 16101   | <b>VAUXHALL</b><br>ASTRA Mk V / ASTRA TwinTop /<br>CORSA Mk III / MERIVA /<br>VECTRA Mk II / ZAFIRA Mk II   | VKM 16102   | <b>OPEL</b><br>ARENA  |
|   | <b>OPEL</b><br>ASTRA F / COMBO A / VECTRA<br>A  |   | <b>DAEWOO</b><br>LEGANZA / NUBIRA   |   | <b>RENAULT</b><br>CLIO I / CLIO II / ESPACE III /<br>EXPRESS/EXTRA/RAPID /<br>KANGOO / LAGUNA I / MEGANE<br>I / R11 / R19 / R21 / R9 /<br>SCENIC I / SUPER 5 / TRAFIC I |
| VKM 15215   | <b>VAUXHALL</b><br>ASTRA Mk III / CAVALIER Mk III /<br>COMBO I / CORSA Mk I   | VKM 16102   | <b>OPEL</b><br>ASTRA F / CALIBRA /<br>FRONTERA A / KADETT E /<br>OMEGA A / OMEGA B / VECTRA<br>A / VECTRA B   | VKM 16102   | <b>VAUXHALL</b><br>ARENA  |
|   | <b>OPEL</b><br>ASTRA F / ASTRA G / COMBO A<br>/ COMBO B / CORSA B / CORSA<br>C / VECTRA A / VECTRA B  |   | <b>VAUXHALL</b><br>ASTRA Mk II / ASTRA Mk III /<br>CALIBRA / CARLTON Mk III /<br>CAVALIER Mk III / FRONTERA<br>Mk I / OMEGA   |   | <b>VOLVO</b><br>340-360 / 440-460 / 480 /<br>S40 I - V40  |
|   | <b>VAUXHALL</b><br>ASTRA Mk III / ASTRA Mk IV /<br>CAVALIER Mk III / COMBO I /<br>COMBO II / CORSA Mk I / CORSA<br>Mk II / VECTRA Mk I                    |   |   |   | <b>DACIA</b><br>LOGAN   |
|   |   |   |   |   | <b>NISSAN</b><br>ALMERA / KUBISTAR / MICRA  |











|  |                                     |  |    |  |   |
|--|--|---|---|---|--|
| VKM 16110  | RENAULT<br>CLIO II / CLIO III / KANGOO /<br>LAGUNA III / MEGANE II /<br>MODUS / SCENIC II / GRAND<br>SCENIC / THALIA | VKM 16501   | RENAULT<br>ESPACE III / LAGUNA I /<br>SAFRANE II  | VKM 17300   | ROVER<br>200 (XH) / MAESTRO  |
| VKM 16112  | RENAULT<br>R11 / R9 / SUPER 5  | VKM 16503   | NISSAN<br>INTERSTAR / PRIMASTAR   | VKM 17301   | ROVER<br>100 / 200 (RF) / 200 (XW) / 200<br>cabriolet (XW)   |
| VKM 16113  | VOLVO<br>340-360   |   | OPEL<br>MOVANO / VIVARO   |   | LAND ROVER<br>FREELANDER I   |
|  | RENAULT<br>CLIO I / MEGANE I / R19 /<br>SPORT SPIDER   |   | RENAULT<br>AVANTIME / ESPACE III /<br>ESPACE IV / LAGUNA II /<br>MASTER II / TRAFIC II / VEL<br>SATIS   |   | MG<br>MG ZR / MG ZS / MG ZT / MGF /<br>MGTF  |
|  | NISSAN<br>INTERSTAR / PRIMASTAR  |   | VAUXHALL<br>MOVANO / VIVARO   |   | ROVER<br>200 (RF) / 200 coupe (RF) / 25 /<br>400 (RT) / 45 / 75 /<br>STREETWISE  |
|  | OPEL<br>MOVANO / VIVARO  | VKM 16550   | RENAULT<br>AVANTIME / CLIO II / CLIO III /<br>ESPACE III / ESPACE IV /<br>LAGUNA I / LAGUNA II /<br>LAGUNA III / MEGANE I /<br>MEGANE II / SCENIC I / SCENIC<br>II / GRAND SCENIC / VEL SATIS | VKM 17302   | HONDA<br>ACCORD / CIVIC  |
|  | RENAULT<br>ESPACE IV / LAGUNA I /<br>LAGUNA II / MASTER II / TRAFIC<br>II  |   | OPEL<br>MOVANO  | VKM 17303   | ROVER<br>200 (RF) / 400 (RT) / 600   |
|  | VAUXHALL<br>MOVANO / VIVARO  | VKM 16551   | RENAULT<br>CLIO II / ESPACE III / KANGOO /<br>LAGUNA I / MASTER II /<br>MEGANE I / SCENIC I   |   | LAND ROVER<br>FREELANDER I   |
| VKM 16129  | VOLVO<br>S40 I - V40   |   | VAUXHALL<br>MOVANO  |   | MG<br>MG ZR / MG ZS  |
|  | NISSAN<br>PRIMERA  |   | RENAULT<br>CLIO II / ESPACE III / KANGOO /<br>LAGUNA I / MASTER II /<br>MEGANE I / SCENIC I   | VKM 17304   | ROVER<br>25 / 45 / STREETWISE  |
|  | RENAULT<br>LAGUNA II / MEGANE II /<br>SCENIC II / GRAND SCENIC   | VKM 16560   | VAUXHALL<br>MOVANO  |   | HONDA<br>ACCORD / CIVIC  |
| VKM 16200  | CITROËN<br>CX  | VKM 16600   | VOLVO<br>S80  |   | LAND ROVER<br>FREELANDER I   |
|  | PEUGEOT<br>505   | VKM 16602   | VOLVO<br>850 / 960  |   | MG<br>MG ZR / MG ZS  |
|  | RENAULT<br>ESPACE I / MASTER I / R18 /<br>R20 / R21 / R25 / TRAFIC I   |   | RENAULT<br>LAGUNA I / SAFRANE II  | VKM 17305   | ROVER<br>200 (RF) / 25 / 400 (RT) / 45 /<br>600 / STREETWISE   |
| VKM 16204  | RENAULT<br>ESPACE II / MASTER I / R21 /<br>R25 / SAFRANE I / TRAFIC I  | VKM 16604   | VOLVO<br>850 / 960 / C70 - S70 / S40 I -<br>V40 / V70 I   |   | MG<br>MG ZR / MG ZS  |
| VKM 16212  | JEEP<br>CHEROKEE   |   | RENAULT<br>LAGUNA I / SAFRANE II  | VKM 17310   | ROVER<br>25 / 45 / STREETWISE  |
|  | RENAULT<br>ESPACE I / ESPACE II / MASTER<br>I / R18 / R20 / R21 / R25 / R30<br>/ SAFRANE I / TRAFIC I                | VKM 16612   | VOLVO<br>C70 - S70 / S40 I - V40 / S60 /<br>S80 / V70 I / V70 II / XC70 I /<br>XC90   |   | LAND ROVER<br>FREELANDER I   |
| VKM 16220  | VOLVO<br>C30 / S60 / S80 / V70 II / XC70<br>I / XC90   | VKM 16800   | VOLVO<br>960 / S90 - V90  |   | MG<br>MG ZR / MGF / MGTF   |
| VKM 16300  | VOLVO<br>240 / 340-360 / 740 / 760 /<br>940  | VKM 17000   | AUSTIN<br>MAESTRO / MONTEGO   | VKM 17400   | ROVER<br>100 / 200 (RF) / 200 (XW) / 200<br>cabriolet (XW) / 200 coupe (RF)<br>/ 25 / 400 (RT) / 400 (XW) / 45 /<br>STREETWISE |
| VKM 16400  | VOLVO<br>740   |   | ROVER<br>200 (XW)   | VKM 18000   | LAND ROVER<br>90/110   |
| VKM 16402  | VOLVO<br>740 / 940 / 960   | VKM 17110   | ROVER<br>MAESTRO / MONTEGO  |   | BMW<br>3 (E30) / 3 Convertible (E30) / 3<br>Touring (E30) / 5 (E34)  |
| VKM 16410  | VOLVO<br>740 / 940 / 960   | VKM 17200   | AUSTIN<br>MAESTRO / MONTEGO   | VKM 18001   | BMW<br>3 (E36) / 5 (E34) / 5 Touring<br>(E34)  |







|  |    |  |    |  |   |
|---|---|---|--|---|--|
| VKM 18100   | <b>BMW</b><br>3 (E21) / 3 (E30) / 3 Convertible (E30) / 3 Touring (E30) / 5 (E12) / 5 (E28) / 5 (E34) / Z1  | VKM 21031   | <b>AUDI</b><br>100 (43, C2) / 100 Avant (43, C2) / 100 (44,44Q,C3)/100 Avant (44,44Q,C3) / 100 (4A, C4) / 100 Avant (4A, C4) / 200 (44, 44Q) / 200 Avant (44, 44Q) / 80 (81, 85, B2) / 90 (81, 85, B2) / 90 (89, 89Q, 8A, B3) / COUPE (81, 85) / COUPE (89, 8B) / QUATTRO (85) |   | <b>SEAT</b><br>AROSA / CORDOBA (6K2) / CORDOBA (6K2/C2) / CORDOBA (6L2) / CORDOBA Vario (6K5) / IBIZA III (6K1) / IBIZA IV (6L1) / INCA / LEON I (1M1) / LEON II (1P1) / TOLEDO II (1M2) |
| VKM 18120   | <b>BMW</b><br>3 (E30) / 3 Touring (E30) / 5 (E28) / 5 (E34)   |   | <b>VOLVO</b><br>240 / 740 / 760 / 940  |   | <b>SKODA</b><br>FABIA / OCTAVIA I (1U2) / OCTAVIA Combi (1U5) / OCTAVIA II (1Z3)/OCTAVIA II Combi (1Z5) / ROOMSTER   |
| VKM 18200   | <b>LADA</b><br>FORMA / SAMARA   |   | <b>VW</b><br>LT I / PASSAT (32B) / SANTANA (32B) / TRANSPORTER IV  |   |  |
| VKM 21004   | <b>AUDI</b><br>A3 (8L1) / A4 (8D2, B5) / A4 Avant (8D5, B5) / A6 (4A, C4) / A6 Avant (4A, C4) / A6 (4B, C5) / A6 Avant (4B, C5) / CABRIOLET (8G7, B4)   | VKM 21032   | <b>AUDI</b><br>100 (44,44Q,C3)/100 Avant (44,44Q,C3) / 200 (44, 44Q) / 200 Avant (44, 44Q) / 90 (81, 85, B2) / 90 (89, 89Q, 8A, B3) / COUPE (81, 85) / COUPE (89, 8B) / QUATTRO (85)   |   |  |
|   | <b>SEAT</b><br>CORDOBA (6K2) / CORDOBA (6K2/C2) / CORDOBA (6L2) / CORDOBA Vario (6K5) / IBIZA III (6K1) / IBIZA IV (6L1) / INCA / LEON I (1M1) / TOLEDO II (1M2)  |   | <b>VW</b><br>LT I  |   |  |
|   | <b>SKODA</b><br>FABIA / OCTAVIA I (1U2) / OCTAVIA Combi (1U5)   | VKM 21041   | <b>AUDI</b><br>100 (44,44Q,C3)/100 Avant (44,44Q,C3) / 100 (4A, C4) / 100 Avant (4A, C4)   | VKM 21121   | <b>AUDI</b><br>A2 (8Z0)  |
|   | <b>VW</b><br>BORA (1J2) / BORA Estate (1J6) / CADDY II(9K9A)/Estate(9K9B)/ Pickup(9U7) / CRAFTER 30-35 / 30-50 (2E) / GOLF IV (1J1) / GOLF IV Variant (1J5) / NEW BEETLE (9C1, 1C1)/Convertible (1Y7) / PASSAT (3B2) / Variant (3B5) / POLO (9N_) / POLO CLASSIC (6KV2) / Variant (6KV5) / POLO Saloon  | VKM 21045   | <b>VOLVO</b><br>940 / 960  |   | <b>SEAT</b><br>AROSA / CORDOBA (6K2) / CORDOBA (6K2/C2) / CORDOBA (6L2) / CORDOBA Vario (6K5) / IBIZA III (6K1) / IBIZA IV (6L1) / INCA / LEON I (1M1) / LEON II (1P1) / TOLEDO II (1M2) |
|   | <b>VW</b><br>BORA (1J2) / BORA Estate (1J6) / CADDY II(9K9A)/Estate(9K9B)/ Pickup(9U7) / CRAFTER 30-35 / 30-50 (2E) / GOLF IV (1J1) / GOLF IV Variant (1J5) / NEW BEETLE (9C1, 1C1)/Convertible (1Y7) / PASSAT (3B2) / Variant (3B5) / POLO (9N_) / POLO CLASSIC (6KV2) / Variant (6KV5) / POLO Saloon  | VKM 21052   | <b>VW</b><br>LT I  |   |  |
|   | <b>VW</b><br>BORA (1J2) / BORA Estate (1J6) / CADDY II(9K9A)/Estate(9K9B)/ Pickup(9U7) / CRAFTER 30-35 / 30-50 (2E) / GOLF IV (1J1) / GOLF IV Variant (1J5) / NEW BEETLE (9C1, 1C1)/Convertible (1Y7) / PASSAT (3B2) / Variant (3B5) / POLO (9N_) / POLO CLASSIC (6KV2) / Variant (6KV5) / POLO Saloon  | VKM 21115   | <b>AUDI</b><br>100 (4A, C4) / 100 Avant (4A, C4) / 80 (8C, B4) / 80 Avant (8C, B4) / A6 (4A, C4) / A6 Avant (4A, C4) / A8 (4D2, 4D8) / CABRIOLET (8G7, B4) / COUPE (89, 8B)  |   | <b>SKODA</b><br>FABIA / OCTAVIA I (1U2) / OCTAVIA Combi (1U5) / OCTAVIA II (1Z3)/OCTAVIA II Combi (1Z5) / ROOMSTER   |
| VKM 21012   | <b>AUDI</b><br>80 (8C, B4) / 80 Avant (8C, B4) / A4 (8D2, B5) / A4 Avant (8D5, B5) / A6 (4A, C4) / A6 Avant (4A, C4) / A6 (4B, C5) / A6 Avant (4B, C5) / CABRIOLET (8G7, B4)  |   | <b>SEAT</b><br>ALHAMBRA / CORDOBA (6K2) / CORDOBA (6K2/C2) / IBIZA III (6K1) / LEON I (1M1) / TOLEDO II (1M2)  |   |  |
|   | <b>FORD</b><br>GALAXY I   |   | <b>SKODA</b><br>OCTAVIA I (1U2) / OCTAVIA Combi (1U5)  |   |  |
|   | <b>SEAT</b><br>ALHAMBRA / AROSA / CORDOBA (6K2) / CORDOBA (6K2/C2) / CORDOBA Vario (6K5) / IBIZA II (6K1) / INCA / TOLEDO I (1L)  |   | <b>VW</b><br>BORA (1J2) / BORA Estate (1J6) / GOLF IV (1J1) / GOLF IV Variant (1J5) / NEW BEETLE (9C1, 1C1)/Convertible (1Y7) / SHARAN (7M8, 7M9, 7M6)   | VKM 21122   | <b>SEAT</b><br>CORDOBA (6K2) / CORDOBA (6K2/C2) / IBIZA II (6K1) / IBIZA III (6K1)   |
|   | <b>VW</b><br>CADDY II(9K9A)/Estate(9K9B)/ Pickup(9U7) / GOLF III (1H1) / GOLF III Variant (1H5) / GOLF III Cabriolet (1E7) / GOLF IV Cabriolet (1E7) / LUPO (6X1, 6E1) / PASSAT (3A2, 35I) / Variant (3A5, 35I) / PASSAT (3B2) / Variant (3B5) / POLO (6N1) / POLO Box (6NF) / POLO (6N2) / POLO CLASSIC (6KV2) / Variant (6KV5) / SHARAN (7M8, 7M9, 7M6) / VENTO (1H2) | VKM 21120   | <b>AUDI</b><br>A2 (8Z0)  |   | <b>VW</b><br>POLO (6N1) / POLO Box (6NF)   |
|   |   |   |  | VKM 21130   | <b>AUDI</b><br>A3 (8L1)  |



|           |  |           |   |           |  |
|-----------|--|-----------|---|-----------|--|
| VKM 21131 | <p><b>SEAT</b><br/>CORDOBA (6K2) / CORDOBA (6K2/C2) / CORDOBA (6L2) / CORDOBA Vario (6K5) / IBIZA III (6K1) / IBIZA IV (6L1) / INCA / LEON I (1M1) / TOLEDO II (1M2)</p> <p><b>SKODA</b><br/>FABIA / OCTAVIA I (1U2) / OCTAVIA Combi (1U5)</p> <p><b>VW</b><br/>BORA (1J2) / BORA Estate (1J6) / CADDY II(9K9A)/Estate(9K9B)/ Pickup(9U7) / CRAFTER 30-35 / 30-50 (2E) / GOLF IV (1J1) / GOLF IV Variant (1J5) / NEW BEETLE (9C1, 1C1)/Convertible (1Y7) / POLO (9N_) / POLO CLASSIC (6KV2) / Variant (6KV5) / POLO Saloon</p> | VKM 21147 | <p><b>VW</b><br/>BORA (1J2) / BORA Estate (1J6) / GOLF IV (1J1) / GOLF IV Variant (1J5) / LUPO (6X1, 6E1) / NEW BEETLE (9C1, 1C1)/ Convertible (1Y7) / PASSAT (3B2) / Variant (3B5) / PASSAT (3B3) / Variant (3B6) / POLO (6N2) / POLO (9N_) / SHARAN (7M8, 7M9, 7M6) / TIGUAN (5N)</p> <p><b>AUDI</b><br/>A2 (8Z0) / A3 (8L1) / A3 (8P1) / A3 Sportback (8PA) / A4 (8E2, B6) / A4 Avant (8E5, B6) / A4 (8EC) / A4 Avant (8ED) / A4 (8K) / A4 Convertible (8H7) / A6 (4B, C5) / A6 Avant (4B, C5) / A6 (4F2) / A6 Avant (4F5)</p> <p><b>FORD</b><br/>GALAXY I</p> <p><b>SEAT</b><br/>ALHAMBRA / ALTEA / ALTEA XL / AROSA / CORDOBA (6L2) / IBIZA IV (6L1) / LEON I (1M1) / LEON II (1P1) / TOLEDO II (1M2) / TOLEDO III (5P2)</p> <p><b>SKODA</b><br/>FABIA / OCTAVIA I (1U2) / OCTAVIA Combi (1U5) / OCTAVIA II (1Z3)/OCTAVIA II Combi (1Z5) / ROOMSTER / SUPERB</p> <p><b>VW</b><br/>BORA (1J2) / BORA Estate (1J6) / CADDY III (2KA) / CADDY III Estate (2KB) / EOS / FOX (5Z1) / GOLF IV (1J1) / GOLF IV Variant (1J5) / GOLF V (1K1) / GOLF V VARIANT (1K1) / GOLF V PLUS (5M1) / JETTA III (1KM) / LUPO (6X1, 6E1) / MULTIVAN V (7HM) / NEW BEETLE (9C1, 1C1)/ Convertible (1Y7) / PASSAT (3B3) / Variant (3B6) / PASSAT (3C2) / Variant (3C5) / POLO (9N_) / POLO Saloon / SHARAN (7M8, 7M9, 7M6) / TIGUAN (5N) / TOURAN / TRANSPORTER V</p> <p><b>AUDI</b><br/>A4 (8D2, B5) / A4 Avant (8D5, B5) / A4 (8E2, B6) / A4 Avant (8E5, B6) / A4 (8EC) / A4 Avant (8ED) / A4 Convertible (8H7) / A6 (4B, C5) / A6 Avant (4B, C5) / A8 (4D2, 4D8) / ALLROAD (4BH)</p> <p><b>SKODA</b><br/>SUPERB</p> <p><b>VW</b><br/>PASSAT (3B2) / Variant (3B5) / PASSAT (3B3) / Variant (3B6)</p> | VKM 21201 | <p><b>AUDI</b><br/>80 (8C, B4) / 80 Avant (8C, B4) / A4 (8D2, B5) / A4 Avant (8D5, B5) / A6 (4A, C4) / A6 Avant (4A, C4) / A8 (4D2, 4D8) / CABRIOLET (8G7, B4) / COUPE (89, 8B)</p>  |
| VKM 21142 | <p><b>AUDI</b><br/>A3 (8L1)</p> <p><b>SEAT</b><br/>CORDOBA (6K2) / CORDOBA (6K2/C2) / CORDOBA Vario (6K5) / IBIZA III (6K1) / INCA / LEON I (1M1) / TOLEDO II (1M2)</p> <p><b>SKODA</b><br/>OCTAVIA I (1U2) / OCTAVIA Combi (1U5)</p> <p><b>VW</b><br/>BORA (1J2) / BORA Estate (1J6) / CADDY II(9K9A)/Estate(9K9B)/ Pickup(9U7) / GOLF IV (1J1) / GOLF IV Variant (1J5) / NEW BEETLE (9C1, 1C1)/Convertible (1Y7) / POLO CLASSIC (6KV2) / Variant (6KV5)</p>  | VKM 21151 | <p><b>AUDI</b><br/>A2 (8Z0) / A3 (8L1) / A4 (8D2, B5) / A4 Avant (8D5, B5) / A4 (8E2, B6) / A4 Avant (8E5, B6) / A4 (8K) / A6 (4B, C5) / A6 Avant (4B, C5) / A8 (4E_)</p> <p><b>FORD</b><br/>GALAXY I</p> <p><b>SEAT</b><br/>ALHAMBRA / AROSA / LEON I (1M1) / TOLEDO II (1M2)</p> <p><b>SKODA</b><br/>FABIA / OCTAVIA I (1U2) / OCTAVIA Combi (1U5) / SUPERB</p>   | VKM 21202 | <p><b>AUDI</b><br/>A4 (8D2, B5) / A4 Avant (8D5, B5) / A4 (8E2, B6) / A4 Avant (8E5, B6) / A4 Convertible (8H7) / A6 (4A, C4) / A6 Avant (4A, C4) / A6 (4B, C5) / A6 Avant (4B, C5) / A6 (4F2) / A6 Avant (4F5) / A8 (4D2, 4D8) / ALLROAD (4BH)</p> <p><b>SKODA</b><br/>SUPERB</p> <p><b>VW</b><br/>PASSAT (3B2) / Variant (3B5) / PASSAT (3B3) / Variant (3B6)</p> <p><b>VW</b><br/>PHAETON (3D2) / TOUAREG (7LA)</p>   |
| VKM 21142 | <p><b>AUDI</b><br/>A2 (8Z0) / A3 (8L1) / A4 (8D2, B5) / A4 Avant (8D5, B5) / A4 (8E2, B6) / A4 Avant (8E5, B6) / A4 (8K) / A6 (4B, C5) / A6 Avant (4B, C5) / A8 (4E_)</p> <p><b>FORD</b><br/>GALAXY I</p> <p><b>SEAT</b><br/>ALHAMBRA / AROSA / LEON I (1M1) / TOLEDO II (1M2)</p> <p><b>SKODA</b><br/>FABIA / OCTAVIA I (1U2) / OCTAVIA Combi (1U5) / SUPERB</p>  | VKM 21151 | <p><b>VW</b><br/>BORA (1J2) / BORA Estate (1J6) / CADDY III (2KA) / CADDY III Estate (2KB) / EOS / FOX (5Z1) / GOLF IV (1J1) / GOLF IV Variant (1J5) / GOLF V (1K1) / GOLF V VARIANT (1K1) / GOLF V PLUS (5M1) / JETTA III (1KM) / LUPO (6X1, 6E1) / MULTIVAN V (7HM) / NEW BEETLE (9C1, 1C1)/ Convertible (1Y7) / PASSAT (3B3) / Variant (3B6) / PASSAT (3C2) / Variant (3C5) / POLO (9N_) / POLO Saloon / SHARAN (7M8, 7M9, 7M6) / TIGUAN (5N) / TOURAN / TRANSPORTER V</p> <p><b>AUDI</b><br/>A4 (8D2, B5) / A4 Avant (8D5, B5) / A4 (8E2, B6) / A4 Avant (8E5, B6) / A4 (8EC) / A4 Avant (8ED) / A4 Convertible (8H7) / A6 (4B, C5) / A6 Avant (4B, C5) / A8 (4D2, 4D8) / ALLROAD (4BH)</p> <p><b>SKODA</b><br/>SUPERB</p> <p><b>VW</b><br/>PASSAT (3B2) / Variant (3B5) / PASSAT (3B3) / Variant (3B6)</p>   | VKM 21203 | <p><b>AUDI</b><br/>A6 (4B, C5) / A6 Avant (4B, C5) / A8 (4D2, 4D8) / A8 (4E_)</p> <p><b>VW</b><br/>PHAETON (3D2) / TOUAREG (7LA)</p> <p><b>AUDI</b><br/>A6 (4B, C5) / A6 Avant (4B, C5) / A8 (4D2, 4D8) / A8 (4E_)</p> <p><b>VW</b><br/>PHAETON (3D2) / TOUAREG (7LA)</p> <p><b>AUDI</b><br/>A3 (8P1) / A3 Sportback (8PA) / A4 (8D2, B5) / A4 Avant (8D5, B5) / A4 (8E2, B6) / A4 Avant (8E5, B6) / A4 (8EC) / A4 Avant (8ED) / A4 Convertible (8H7) / A6 (4B, C5) / A6 Avant (4B, C5) / A6 (4F2) / A6 Avant (4F5) / TT (8J3) / TT Roadster (8J9)</p> <p><b>SEAT</b><br/>ALTEA / ALTEA XL / LEON II (1P1) / TOLEDO III (5P2)</p> <p><b>SKODA</b><br/>OCTAVIA II (1Z3)/OCTAVIA II Combi (1Z5) / SUPERB</p> <p><b>VW</b><br/>EOS / GOLF V (1K1) / GOLF V VARIANT (1K1) / GOLF V PLUS (5M1) / JETTA III (1KM) / PASSAT (3B3) / Variant (3B6) / PASSAT (3C2) / Variant (3C5) / TOURAN</p> |
| VKM 21142 | <p><b>AUDI</b><br/>A2 (8Z0) / A3 (8L1) / A4 (8D2, B5) / A4 Avant (8D5, B5) / A4 (8E2, B6) / A4 Avant (8E5, B6) / A4 (8K) / A6 (4B, C5) / A6 Avant (4B, C5) / A8 (4E_)</p> <p><b>FORD</b><br/>GALAXY I</p> <p><b>SEAT</b><br/>ALHAMBRA / AROSA / LEON I (1M1) / TOLEDO II (1M2)</p> <p><b>SKODA</b><br/>FABIA / OCTAVIA I (1U2) / OCTAVIA Combi (1U5) / SUPERB</p>  | VKM 21151 | <p><b>VW</b><br/>BORA (1J2) / BORA Estate (1J6) / CADDY III (2KA) / CADDY III Estate (2KB) / EOS / FOX (5Z1) / GOLF IV (1J1) / GOLF IV Variant (1J5) / GOLF V (1K1) / GOLF V VARIANT (1K1) / GOLF V PLUS (5M1) / JETTA III (1KM) / LUPO (6X1, 6E1) / MULTIVAN V (7HM) / NEW BEETLE (9C1, 1C1)/ Convertible (1Y7) / PASSAT (3B3) / Variant (3B6) / PASSAT (3C2) / Variant (3C5) / POLO (9N_) / POLO Saloon / SHARAN (7M8, 7M9, 7M6) / TIGUAN (5N) / TOURAN / TRANSPORTER V</p> <p><b>AUDI</b><br/>A4 (8D2, B5) / A4 Avant (8D5, B5) / A4 (8E2, B6) / A4 Avant (8E5, B6) / A4 (8EC) / A4 Avant (8ED) / A4 Convertible (8H7) / A6 (4B, C5) / A6 Avant (4B, C5) / A8 (4D2, 4D8) / ALLROAD (4BH)</p> <p><b>SKODA</b><br/>SUPERB</p> <p><b>VW</b><br/>PASSAT (3B2) / Variant (3B5) / PASSAT (3B3) / Variant (3B6)</p>   | VKM 21204 | <p><b>AUDI</b><br/>A6 (4B, C5) / A6 Avant (4B, C5) / A8 (4D2, 4D8) / A8 (4E_)</p> <p><b>VW</b><br/>PHAETON (3D2) / TOUAREG (7LA)</p> <p><b>AUDI</b><br/>A6 (4B, C5) / A6 Avant (4B, C5) / A8 (4D2, 4D8) / A8 (4E_)</p> <p><b>VW</b><br/>PHAETON (3D2) / TOUAREG (7LA)</p> <p><b>AUDI</b><br/>A3 (8P1) / A3 Sportback (8PA) / A4 (8D2, B5) / A4 Avant (8D5, B5) / A4 (8E2, B6) / A4 Avant (8E5, B6) / A4 (8EC) / A4 Avant (8ED) / A4 Convertible (8H7) / A6 (4B, C5) / A6 Avant (4B, C5) / A6 (4F2) / A6 Avant (4F5) / TT (8J3) / TT Roadster (8J9)</p> <p><b>SEAT</b><br/>ALTEA / ALTEA XL / LEON II (1P1) / TOLEDO III (5P2)</p> <p><b>SKODA</b><br/>OCTAVIA II (1Z3)/OCTAVIA II Combi (1Z5) / SUPERB</p> <p><b>VW</b><br/>EOS / GOLF V (1K1) / GOLF V VARIANT (1K1) / GOLF V PLUS (5M1) / JETTA III (1KM) / PASSAT (3B3) / Variant (3B6) / PASSAT (3C2) / Variant (3C5) / TOURAN</p> |
| VKM 21142 | <p><b>AUDI</b><br/>A2 (8Z0) / A3 (8L1) / A4 (8D2, B5) / A4 Avant (8D5, B5) / A4 (8E2, B6) / A4 Avant (8E5, B6) / A4 (8K) / A6 (4B, C5) / A6 Avant (4B, C5) / A8 (4E_)</p> <p><b>FORD</b><br/>GALAXY I</p> <p><b>SEAT</b><br/>ALHAMBRA / AROSA / LEON I (1M1) / TOLEDO II (1M2)</p> <p><b>SKODA</b><br/>FABIA / OCTAVIA I (1U2) / OCTAVIA Combi (1U5) / SUPERB</p>  | VKM 21151 | <p><b>VW</b><br/>BORA (1J2) / BORA Estate (1J6) / CADDY III (2KA) / CADDY III Estate (2KB) / EOS / FOX (5Z1) / GOLF IV (1J1) / GOLF IV Variant (1J5) / GOLF V (1K1) / GOLF V VARIANT (1K1) / GOLF V PLUS (5M1) / JETTA III (1KM) / LUPO (6X1, 6E1) / MULTIVAN V (7HM) / NEW BEETLE (9C1, 1C1)/ Convertible (1Y7) / PASSAT (3B3) / Variant (3B6) / PASSAT (3C2) / Variant (3C5) / POLO (9N_) / POLO Saloon / SHARAN (7M8, 7M9, 7M6) / TIGUAN (5N) / TOURAN / TRANSPORTER V</p> <p><b>AUDI</b><br/>A4 (8D2, B5) / A4 Avant (8D5, B5) / A4 (8E2, B6) / A4 Avant (8E5, B6) / A4 (8EC) / A4 Avant (8ED) / A4 Convertible (8H7) / A6 (4B, C5) / A6 Avant (4B, C5) / A8 (4D2, 4D8) / ALLROAD (4BH)</p> <p><b>SKODA</b><br/>SUPERB</p> <p><b>VW</b><br/>PASSAT (3B2) / Variant (3B5) / PASSAT (3B3) / Variant (3B6)</p>   | VKM 21205 | <p><b>AUDI</b><br/>A3 (8P1) / A3 Sportback (8PA) / A4 (8E2, B6) / A4 Avant (8ED) / A4 (8K) / A6 (4F2) / A6 Avant (4F5)</p>   |

|  |   |  |                               |  |             |
|---|--|---|---|---|--|
| VKM 21302   | <b>SEAT</b><br>ALTEA / ALTEA XL / TOLEDO III (5P2)   | VKM 22179   | <b>FIAT</b><br>BARCHETTA / BRAVA/BRAVO (182) / COUPE / MAREA / PUNTO (188) / STILO                              | VKM 22385   | <b>VAUXHALL</b><br>ARENA / MOVANO  |
|   | <b>SKODA</b><br>OCTAVIA II (1Z3)/OCTAVIA II Combi (1Z5)  |   | <b>LANCIA</b><br>DEDRA / DELTA II / LYBRA   |   | <b>ALFA ROMEO</b><br>AR 6 / AR 8   |
|   | <b>VW</b><br>GOLF V (1K1) / GOLF V VARIANT (1K1) / GOLF V PLUS (5M1) / JETTA III (1KM) / PASSAT (3C2) / Variant (3C5) / TIGUAN (5N) / TOURAN                                 |   | <b>ALFA ROMEO</b><br>145/146 / 147 / 156 / GT   |   | <b>CITROËN</b><br>JUMPER (230) / JUMPER (244)  |
|   | <b>AUDI</b><br>A4 (8E2, B6) / A4 Avant (8E5, B6) / A4 (8EC) / A4 Avant (8ED) / A4 Convertible (8H7) / A6 (4B, C5) / A6 Avant (4B, C5) / A6 (4F2) / A6 Avant (4F5) / A8 (4E_) |   | <b>FIAT</b><br>BRAVA/BRAVO (182) / DOBLO / IDEA / MAREA / MULTIPLA / PALIO/SIENA / PUNTO (188) / STILO / STRADA |   | <b>FIAT</b><br>ARGENTA / CAMPAGNOLA / DUCATO (230) / DUCATO (244) / DUCATO (280/290)           |
|   | <b>VW</b><br>GOLF V (1K1) / GOLF V VARIANT (1K1) / GOLF V PLUS (5M1) / JETTA III (1KM) / PASSAT (3C2) / Variant (3C5) / TIGUAN (5N) / TOURAN                                 |   | <b>LANCIA</b><br>LYBRA  |   | <b>IVECO</b><br>DAILY / TURBO DAILY / TURBO DAILY (96) / DAILY II / NEW DAILY / NEW DAILY (96) |
|   | <b>VW</b><br>GOLF V (1K1) / GOLF V VARIANT (1K1) / GOLF V PLUS (5M1) / JETTA III (1KM) / PASSAT (3C2) / Variant (3C5) / TIGUAN (5N) / TOURAN                                 |   | <b>ALFA ROMEO</b><br>147 / 156 / 159 / BRERA / GT   |   | <b>OPEL</b><br>ARENA / MOVANO  |
|   | <b>VW</b><br>GOLF V (1K1) / GOLF V VARIANT (1K1) / GOLF V PLUS (5M1) / JETTA III (1KM) / PASSAT (3C2) / Variant (3C5) / TIGUAN (5N) / TOURAN                                 |   | <b>FIAT</b><br>CROMA (194) / DOBLO / GRANDE PUNTO / MULTIPLA / PUNTO (188) / SEDICI / STILO / STRADA            |   | <b>PEUGEOT</b><br>BOXER I / BOXER II   |
|   | <b>VW</b><br>GOLF V (1K1) / GOLF V VARIANT (1K1) / GOLF V PLUS (5M1) / JETTA III (1KM) / PASSAT (3C2) / Variant (3C5) / TIGUAN (5N) / TOURAN                                 |   | <b>LANCIA</b><br>LYBRA / MUSA   |   | <b>RENAULT</b><br>MASTER I / MASTER II / TRAFIC I  |
|   | <b>VW</b><br>GOLF V (1K1) / GOLF V VARIANT (1K1) / GOLF V PLUS (5M1) / JETTA III (1KM) / PASSAT (3C2) / Variant (3C5) / TIGUAN (5N) / TOURAN                                 |   | <b>OPEL</b><br>ASTRA H / SIGNUM / VECTRA C / ZAFIRA B   |   | <b>SEAT</b><br>131   |
|   | <b>VW</b><br>GOLF V (1K1) / GOLF V VARIANT (1K1) / GOLF V PLUS (5M1) / JETTA III (1KM) / PASSAT (3C2) / Variant (3C5) / TIGUAN (5N) / TOURAN                                 |   | <b>SAAB</b><br>9-3 II   |   | <b>VAUXHALL</b><br>ARENA / MOVANO  |
| VKM 21330   | <b>AUDI</b><br>A8 (4D2, 4D8)   | VKM 22180   | <b>VAUXHALL</b><br>ARENA / MOVANO   | VKM 22390   | <b>FIAT</b><br>DUCATO (244)  |
| VKM 22150   | <b>FIAT</b><br>REGATA / RITMO  | VKM 22242   | <b>FIAT</b><br>BRAVA/BRAVO (182) / DOBLO / MAREA / MULTIPLA / PALIO/SIENA / STILO                               | VKM 22510   | <b>IVECO</b><br>DAILY II   |
| VKM 22151   | <b>FIAT</b><br>DUNA / ELBA / FIORINO / PALIO/SIENA / PUNTO (176) / STRADA / UNO  | VKM 22380   | <b>LANCIA</b><br>DEDRA / DELTA II / LYBRA   | VKM 22540   | <b>ALFA ROMEO</b><br>145/146 / 33  |
| VKM 22153   | <b>ALFA ROMEO</b><br>145/146 / 155   | VKM 22380   | <b>ALFA ROMEO</b><br>AR 6 / AR 8  | VKM 22541   | <b>ALFA ROMEO</b><br>164   |
| VKM 22153   | <b>CITROËN</b><br>C25  | VKM 22380   | <b>CITROËN</b><br>JUMPER (230) / JUMPER (244)   | VKM 22630   | <b>LANCIA</b><br>KAPPA   |
| VKM 22153   | <b>FIAT</b><br>BRAVA/BRAVO (182) / DUCATO (230) / DUCATO (280/290) / TALENTO (290) / TEMPRA / TIPO   | VKM 22380   | <b>FIAT</b><br>ARGENTA / CAMPAGNOLA / DUCATO (230) / DUCATO (244) / DUCATO (280/290)                            | VKM 23120   | <b>FIAT</b><br>FIORINO / PANDA (141A_) / UNO   |
| VKM 22155   | <b>LANCIA</b><br>DEDRA / DELTA II  | VKM 22380   | <b>IVECO</b><br>DAILY II / NEW DAILY / NEW DAILY (96)   | VKM 23120   | <b>CITROËN</b><br>AX / SAXO / XM I / XM II / XSARA   |
| VKM 22155   | <b>FIAT</b><br>CROMA (154)   | VKM 22380   | <b>OPEL</b><br>ARENA / MOVANO   | VKM 23120   | <b>PEUGEOT</b><br>106 I / 106 II / 605   |
| VKM 22160   | <b>FIAT</b><br>REGATA / RITMO  | VKM 22380   | <b>PEUGEOT</b><br>BOXER I / BOXER II  | VKM 23120   | <b>ROVER</b><br>100  |
| VKM 22174   | <b>SEAT</b><br>IBIZA I (021A) / MALAGA / RITMO / RONDA   | VKM 22380   | <b>RENAULT</b><br>MASTER I / MASTER II / TRAFIC I   | VKM 23120   | <b>CITROËN</b><br>SAXO   |
| VKM 22174   | <b>ALFA ROMEO</b><br>156 / 159 / 166   | VKM 22380   | <b>SEAT</b><br>131  | VKM 23120   | <b>NISSAN</b><br>MICRA   |
| VKM 22174   | <b>FIAT</b><br>BRAVA/BRAVO (182) / BRAVO / COUPE / CROMA (194) / MAREA / STILO   | VKM 22380   |   | VKM 23120   | <b>PEUGEOT</b><br>106 II   |
| VKM 22177   | <b>LANCIA</b><br>KAPPA / LYBRA / THESIS  | VKM 22380   |   | VKM 23120   |  |
| VKM 22177   | <b>ALFA ROMEO</b><br>145/146 / 147 / 155 / 156 / 166 / GT / GTV / SPIDER   | VKM 22380   |   | VKM 23120   |  |









|  |                         |    |                                   |  |    |
|--|--|---|--|---|---|
| VKM 23130  | <b>CITROËN</b><br>BERLINGO / C3 / C3 Pluriel / SAXO / XSARA  | VKM 23241   | <b>PEUGEOT</b><br>205 / 305 / 306 / 309 / 405 I / 405 II / J5  | VKM 23258   | <b>PEUGEOT</b><br>307 / 308 / 407 / 607 / 807 / EXPERT II / EXPERT Tepee              |
| VKM 23140  | <b>PEUGEOT</b><br>106 II / 206 / 307 / PARTNER   |   | <b>ROVER</b><br>200 (XW) / 400 (XW)  |   | <b>VOLVO</b><br>S40 II - V50  |
|  | <b>CITROËN</b><br>BERLINGO / C1 / C2 / C3 / C3 Pluriel / C4 / C4 Picasso / C5 II / XSARA / XSARA PICASSO |   | <b>TALBOT</b><br>HORIZON   |   | <b>CITROËN</b><br>C2 / C3 / C4  |
|  | <b>FORD</b><br>FIESTA V / FOCUS C-MAX I / FOCUS C-MAX II / FOCUS II / FUSION                             |   | <b>CITROËN</b><br>BERLINGO / C15 / EVASION / JUMPER (230) / JUMPY I / JUMPY II / XANTIA I / XANTIA II / XSARA / ZX |   | <b>PEUGEOT</b><br>1007 / 206 / 207 / 207 CC / 207 SW / 307                            |
|  | <b>MAZDA</b><br>2 / 3  |   | <b>FIAT</b><br>DUCATO (230) / SCUDO (220) / ULYSSE (220)   |   | <b>CITROËN</b><br>C6  |
|  | <b>PEUGEOT</b><br>1007 / 107 / 206 / 207 / 207 CC / 207 SW / 307 / 308 / 407 / PARTNER                   | <b>HYUNDAI</b><br>LANTRA  | <b>LAND ROVER</b><br>DISCOVERY III / RANGE ROVER SPORT   |   |   |
| VKM 23213  | <b>VOLVO</b><br>S40 II - V50   | <b>LADA</b><br>NIVA   | <b>PEUGEOT</b><br>407 / 607  | VKM 23264   | <b>CITROËN</b><br>C5 I / C5 II / C8 / JUMPER (244)                                    |
|  | <b>CITROËN</b><br>EVASION / XANTIA I / XANTIA II / XM I / XM II / XSARA / ZX                             | <b>PEUGEOT</b><br>205 / 306 / 405 II / 406 / 806 / BOXER I / EXPERT I / PARTNER   | <b>FIAT</b><br>SCUDO (220)   |   | <b>FIAT</b><br>SCUDO (220)  |
|  | <b>FIAT</b><br>ULYSSE (220)  | <b>ROVER</b><br>200 (XW) / 400 (XW)   | <b>PEUGEOT</b><br>406 / 607 / 807 / BOXER II / EXPERT I  | VKM 23300   | <b>PEUGEOT</b><br>406 / 607 / 807 / BOXER II / EXPERT I                               |
|  | <b>LANCIA</b><br>ZETA  | <b>SUZUKI</b><br>SAMURAI / VITARA   | <b>SUZUKI</b><br>GRAND VITARA  |   | <b>SUZUKI</b><br>GRAND VITARA   |
|  | <b>PEUGEOT</b><br>306 / 406 / 605 / 806  | <b>CITROËN</b><br>BERLINGO / C15 / C5 I / C8 / EVASION / JUMPER (230) / JUMPER (244) / JUMPY I / JUMPY II / XANTIA II / XSARA / XSARA PICASSO | <b>CITROËN</b><br>JUMPER (230) / XM II   | VKM 23304   | <b>CITROËN</b><br>JUMPER (230) / XM II  |
| VKM 23214  | <b>CITROËN</b><br>XANTIA I / XANTIA II / XSARA / ZX  | <b>FIAT</b><br>DUCATO (230) / DUCATO (244) / SCUDO (220) / ULYSSE (179AX) / ULYSSE (220)  | <b>PEUGEOT</b><br>605 / BOXER I  |   | <b>PEUGEOT</b><br>605 / BOXER I   |
|  | <b>PEUGEOT</b><br>306 / 406  | <b>LANCIA</b><br>PHEDRA / ZETA  | <b>CITROËN</b><br>JUMPER (230)   | VKM 23304   | <b>CITROËN</b><br>JUMPER (230)  |
| VKM 23218  | <b>CITROËN</b><br>XSARA  | <b>PEUGEOT</b><br>206 / 306 / 307 / 406 / 607 / 806 / 807 / BOXER I / BOXER II / EXPERT I / PARTNER   | <b>PEUGEOT</b><br>BOXER I  | VKM 23900   | <b>PEUGEOT</b><br>BOXER I   |
|  | <b>PEUGEOT</b><br>306  | <b>CITROËN</b><br>BERLINGO / C2 / C3 / C3 Pluriel / C4 / XSARA / XSARA PICASSO  | <b>CITROËN</b><br>C5 I / C5 II / C6 / C8 / XANTIA I / XANTIA II / XM II  |   | <b>CITROËN</b><br>C5 I / C5 II / C6 / C8 / XANTIA I / XANTIA II / XM II               |
| VKM 23230  | <b>CITROËN</b><br>C4 / C4 Picasso / C5 I / C5 II / C8 / EVASION / JUMPY I / XSARA / XSARA PICASSO        | <b>PEUGEOT</b><br>1007 / 206 / 207 / 207 CC / 207 SW / 307 / PARTNER  | <b>FIAT</b><br>ULYSSE (179AX)  |   | <b>FIAT</b><br>ULYSSE (179AX)   |
|  | <b>FIAT</b><br>SCUDO (220) / ULYSSE (179AX) / ULYSSE (220)   | <b>CITROËN</b><br>C4 / C4 Picasso / C5 II / C6 / C8 / JUMPY III   | <b>LANCIA</b><br>PHEDRA  | VKM 23901   | <b>LANCIA</b><br>PHEDRA   |
|  | <b>LANCIA</b><br>PHEDRA / ZETA   | <b>FORD</b><br>FOCUS C-MAX I / FOCUS C-MAX II / FOCUS II / GALAXY II / MONDEO IV / S-MAX  | <b>PEUGEOT</b><br>406 / 407 / 605 / 607 / 807  |   | <b>PEUGEOT</b><br>406 / 407 / 605 / 607 / 807   |
|  | <b>PEUGEOT</b><br>206 / 307 / 406 / 407 / 607 / 806 / 807 / EXPERT I                                     | <b>LANCIA</b><br>PHEDRA   | <b>RENAULT</b><br>AVANTIME / CLIO II / ESPACE III / LAGUNA I / LAGUNA II / SAFRANE II                              |   | <b>RENAULT</b><br>AVANTIME / CLIO II / ESPACE III / LAGUNA I / LAGUNA II / SAFRANE II |
| VKM 23240  | <b>CITROËN</b><br>BX / C15 / C25 / VISA / ZX   |   | <b>CITROËN</b><br>C5 I / C5 II / C6 / C8 / XANTIA I / XANTIA II / XM II  |   | <b>CITROËN</b><br>C5 I / C5 II / C6 / C8 / XANTIA I / XANTIA II / XM II               |
|  | <b>LADA</b><br>NIVA  |   | <b>FIAT</b><br>ULYSSE (179AX)  |   | <b>FIAT</b><br>ULYSSE (179AX)   |
|  |  |   | <b>LANCIA</b><br>PHEDRA  |   | <b>LANCIA</b><br>PHEDRA   |
|  |  |   | <b>PEUGEOT</b><br>406 / 407 / 605 / 607 / 807  |   | <b>PEUGEOT</b><br>406 / 407 / 605 / 607 / 807   |



|           |  |           |   |           |   |           |  |           |  |           |  |           |  |           |   |           |  |           |   |           |   |           |   |           |   |           |   |
|-----------|--|-----------|---|-----------|---|-----------|--|-----------|--|-----------|--|-----------|--|-----------|---|-----------|--|-----------|---|-----------|---|-----------|---|-----------|---|-----------|---|
| VKM 24100 | <p><b>RENAULT</b><br/>AVANTIME / CLIO II / ESPACE III / LAGUNA I / LAGUNA II / SAFRANE II</p> <hr/> <p><b>FORD</b><br/>ESCORT BOX 86 / ESCORT BOX 91 / ESCORT BOX 95 / ESCORT IV / ESCORT V / ESCORT VI / ESCORT VII / FIESTA BOX / COURRIER / FIESTA III / FIESTA IV / MONDEO I / MONDEO II / ORION II / ORION III / P 100 II / SIERRA</p> <hr/> <p><b>FORD</b><br/>SIERRA</p> <hr/> <p><b>FORD</b><br/>ESCORT BOX 95 / ESCORT VII / FIESTA BOX / COURRIER / FIESTA IV / MONDEO II</p> <hr/> <p><b>FORD</b><br/>ESCORT V / ESCORT VI / ESCORT VII / FIESTA III / MONDEO I / MONDEO II / ORION III</p> <hr/> <p><b>FORD</b><br/>ESCORT V / ESCORT VI / ESCORT VII / FIESTA III / MONDEO I / MONDEO II / ORION III</p> <hr/> <p><b>FORD</b><br/>COUGAR / FOCUS I / MONDEO II</p> <hr/> <p><b>FORD</b><br/>COUGAR / FOCUS I / MAVERICK / MONDEO II / TRANSIT CONNECT / TOURNEO CONNECT</p> <hr/> <p><b>FORD</b><br/>COUGAR / FOCUS I / MONDEO III</p> <hr/> <p><b>OPEL</b><br/>ASTRA F / ASTRA F CLASSIC / ASTRA G / COMBO A / CORSA B / TIGRA / VECTRA B / ZAFIRA A</p> <hr/> <p><b>VAUXHALL</b><br/>ASTRA Mk III / ASTRA Mk IV / CORSA Mk I / TIGRA Mk I / VECTRA Mk I / ZAFIRA Mk I</p> <hr/> <p><b>OPEL</b><br/>ASTRA F / ASTRA F CLASSIC / ASTRA G / ASTRA H / COMBO A / CORSA B / CORSA C / MERIVA / SIGNUM / TIGRA / TIGRA Twin Top / VECTRA B / VECTRA C / ZAFIRA A</p> <hr/> <p><b>SAAB</b><br/>9-3 II</p> <hr/> <p><b>VAUXHALL</b><br/>ASTRA Mk III / ASTRA Mk IV / ASTRA Mk V / CORSA Mk I / CORSA Mk II / MERIVA / TIGRA Mk I / TIGRA Mk II / VECTRA Mk I / VECTRA Mk II / ZAFIRA Mk I</p> | VKM 25158 | <p><b>OPEL</b><br/>ASTRA G / ASTRA H / COMBO B / CORSA C / MERIVA / SIGNUM / TIGRA Twin Top / VECTRA C / ZAFIRA A</p> <hr/> <p><b>VAUXHALL</b><br/>ASTRA Mk IV / ASTRA Mk V / CORSA Mk II / MERIVA / TIGRA Mk II / VECTRA Mk II / ZAFIRA Mk I</p> <hr/> <p><b>OPEL</b><br/>ASCONA C / KADETT D / KADETT E</p> <hr/> <p><b>VAUXHALL</b><br/>ASTRA Mk II / CAVALIER Mk II</p> | VKM 25200 | <p><b>OPEL</b><br/>ASCONA C / ASTRA F / KADETT E / VECTRA A</p> <hr/> <p><b>VAUXHALL</b><br/>ASTRA Mk II / ASTRA Mk III / CAVALIER Mk II / CAVALIER Mk III</p> <hr/> <p><b>OPEL</b><br/>ASTRA F / ASTRA G / KADETT E / VECTRA A</p> <hr/> <p><b>VAUXHALL</b><br/>ASTRA Mk II / ASTRA Mk III / ASTRA Mk IV / CAVALIER Mk III</p> | VKM 25201 | <p><b>OPEL</b><br/>ASTRA F / ASTRA G / KADETT E / VECTRA A</p> <hr/> <p><b>VAUXHALL</b><br/>ASTRA Mk II / ASTRA Mk III / ASTRA Mk IV / CAVALIER Mk III</p> | VKM 25202 | <p><b>OPEL</b><br/>ASTRA F / ASTRA G / COMBO A / COMBO B / CORSA A / CORSA B / CORSA C / KADETT E / MERIVA / VECTRA A / VECTRA B</p> <hr/> <p><b>VAUXHALL</b><br/>ASTRA Mk II / ASTRA Mk III / ASTRA Mk IV / CAVALIER Mk III</p> | VKM 25208 | <p><b>OPEL</b><br/>ASTRA G / ASTRA H</p> <hr/> <p><b>VAUXHALL</b><br/>ASTRA Mk IV / ASTRA Mk V</p> | VKM 25209 | <p><b>OPEL</b><br/>ASTRA F / CALIBRA / KADETT E / VECTRA A</p> <hr/> <p><b>VAUXHALL</b><br/>ASTRA Mk II / ASTRA Mk III / CALIBRA / CAVALIER Mk III</p> <hr/> <p><b>CHEVROLET</b><br/>EPICA</p> <hr/> <p><b>DAEWOO</b><br/>EVANDA / LACETTI / LEGANZA / MAGNUS / NUBIRA / REZZO / TACUMA</p> <hr/> <p><b>LADA</b><br/>110</p> | VKM 25212 | <p><b>OPEL</b><br/>ANTARA / ASTRA F / CALIBRA / FRONTERA A / FRONTERA B / KADETT E / OMEGA B / SINTRA / VECTRA A / VECTRA B</p> <hr/> <p><b>SUZUKI</b><br/>VERONA</p> <hr/> <p><b>VAUXHALL</b><br/>ASTRA Mk II / ASTRA Mk III / CALIBRA / CAVALIER Mk III / FRONTERA Mk I / FRONTERA Mk II / OMEGA / SINTRA / VECTRA Mk I</p> <hr/> <p><b>LADA</b><br/>110</p> <hr/> <p><b>OPEL</b><br/>ASTRA F / CALIBRA / KADETT E / VECTRA A</p> <hr/> <p><b>VAUXHALL</b><br/>SIGNUM / VECTRA C</p> <hr/> <p><b>RENAULT</b><br/>ESPACE IV / VEL SATIS</p> <hr/> <p><b>SAAB</b><br/>9-5</p> <hr/> <p><b>VAUXHALL</b><br/>SIGNUM / VECTRA Mk II</p> <hr/> <p><b>OPEL</b><br/>ASTRA G / ASTRA H / SPEEDSTER / ZAFIRA A / ZAFIRA B</p> <hr/> <p><b>VAUXHALL</b><br/>ASTRA Mk IV / ASTRA Mk V / VX 220 / ZAFIRA Mk I</p> <hr/> <p><b>OPEL</b><br/>SIGNUM / VECTRA C</p> <hr/> <p><b>RENAULT</b><br/>ESPACE IV / VEL SATIS</p> <hr/> <p><b>SAAB</b><br/>9-5</p> <hr/> <p><b>VAUXHALL</b><br/>SIGNUM / VECTRA Mk II</p> <hr/> <p><b>OPEL</b><br/>ASTRA G / ASTRA H / CORSA C / MERIVA / SIGNUM / TIGRA Twin Top / VECTRA C / ZAFIRA A</p> <hr/> <p><b>SAAB</b><br/>9-3 II</p> <hr/> <p><b>VAUXHALL</b><br/>ASTRA Mk IV / ASTRA Mk V / CORSA Mk II / MERIVA / TIGRA Mk II / VECTRA Mk II / ZAFIRA Mk I</p> <hr/> <p><b>DACIA</b><br/>LOGAN</p> | VKM 25213 | <p><b>OPEL</b><br/>ASTRA F / ASTRA G / KADETT E / VECTRA A</p> <hr/> <p><b>VAUXHALL</b><br/>ASTRA Mk II / ASTRA Mk III / ASTRA Mk IV / CAVALIER Mk III</p> | VKM 25222 | <p><b>OPEL</b><br/>ASTRA G / ASTRA H / CORSA C / MERIVA / SIGNUM / TIGRA Twin Top / VECTRA C / ZAFIRA A</p> <hr/> <p><b>SAAB</b><br/>9-3 II</p> <hr/> <p><b>VAUXHALL</b><br/>ASTRA Mk IV / ASTRA Mk V / CORSA Mk II / MERIVA / TIGRA Mk II / VECTRA Mk II / ZAFIRA Mk I</p> <hr/> <p><b>DACIA</b><br/>LOGAN</p> | VKM 25224 | <p><b>OPEL</b><br/>ASTRA G / ASTRA H / CORSA C / MERIVA / SIGNUM / TIGRA Twin Top / VECTRA C / ZAFIRA A</p> <hr/> <p><b>SAAB</b><br/>9-3 II</p> <hr/> <p><b>VAUXHALL</b><br/>ASTRA Mk IV / ASTRA Mk V / CORSA Mk II / MERIVA / TIGRA Mk II / VECTRA Mk II / ZAFIRA Mk I</p> <hr/> <p><b>DACIA</b><br/>LOGAN</p> | VKM 25226 | <p><b>OPEL</b><br/>ASTRA G / ASTRA H / CORSA C / MERIVA / SIGNUM / TIGRA Twin Top / VECTRA C / ZAFIRA A</p> <hr/> <p><b>SAAB</b><br/>9-3 II</p> <hr/> <p><b>VAUXHALL</b><br/>ASTRA Mk IV / ASTRA Mk V / CORSA Mk II / MERIVA / TIGRA Mk II / VECTRA Mk II / ZAFIRA Mk I</p> <hr/> <p><b>DACIA</b><br/>LOGAN</p> | VKM 25312 | <p><b>OPEL</b><br/>ASTRA G / ASTRA H / CORSA C / MERIVA / SIGNUM / TIGRA Twin Top / VECTRA C / ZAFIRA A</p> <hr/> <p><b>SAAB</b><br/>9-3 II</p> <hr/> <p><b>VAUXHALL</b><br/>ASTRA Mk IV / ASTRA Mk V / CORSA Mk II / MERIVA / TIGRA Mk II / VECTRA Mk II / ZAFIRA Mk I</p> <hr/> <p><b>DACIA</b><br/>LOGAN</p> | VKM 26020 | <p><b>OPEL</b><br/>ASTRA G / ASTRA H / CORSA C / MERIVA / SIGNUM / TIGRA Twin Top / VECTRA C / ZAFIRA A</p> <hr/> <p><b>SAAB</b><br/>9-3 II</p> <hr/> <p><b>VAUXHALL</b><br/>ASTRA Mk IV / ASTRA Mk V / CORSA Mk II / MERIVA / TIGRA Mk II / VECTRA Mk II / ZAFIRA Mk I</p> <hr/> <p><b>DACIA</b><br/>LOGAN</p> |
|-----------|--|-----------|---|-----------|---|-----------|--|-----------|--|-----------|--|-----------|--|-----------|---|-----------|--|-----------|---|-----------|---|-----------|---|-----------|---|-----------|---|





|  |    |  |    |  |    |
|--|---|---|---|---|---|
|  | <b>NISSAN</b><br>KUBISTAR   | <b>VKM 26125</b>  | <b>RENAULT</b><br>CLIO II / ESPACE III / EXPRESS/<br>EXTRA/RAPID / KANGOO /<br>LAGUNA I / MASTER II / MEG-<br>ANE I / SCENIC I / SPORT SPI-<br>DER / TRAFIC I | <b>VKM 26610</b>  | <b>VOLVO</b><br>850 / C70 - S70 / S40 I - V40 /<br>S40 II - V50 / S60 / S80 / V70 I<br>/ V70 II / XC70 I / XC90   |
| <b>VKM 26100</b>   | <b>RENAULT</b><br>CLIO II / CLIO III / ESPACE III /<br>KANGOO / LAGUNA I / LAGUNA<br>II / MEGANE I / MEGANE II /<br>MODUS / SCENIC I / SCENIC II /<br>GRAND SCENIC / THALIA /<br>TRAFIC II            | <b>VKM 26128</b>  | <b>OPEL</b><br>MOVANO   | <b>VKM 26612</b>  | <b>VOLVO</b><br>960   |
|  | <b>RENAULT</b><br>R11 / R21 / R9 / SUPER 5 /<br>TRAFIC I  |   | <b>RENAULT</b><br>CLIO II / ESPACE III / KANGOO /<br>LAGUNA I / MASTER II /<br>MEGANE I / SCENIC I  | <b>VKM 27110</b>  | <b>ROVER</b><br>MAESTRO / MONTEGO   |
| <b>VKM 26101</b>   | <b>VOLVO</b><br>340-360 / 480   | <b>VKM 26211</b>  | <b>VAUXHALL</b><br>MOVANO   | <b>VKM 27302</b>  | <b>HONDA</b><br>ACCORD / CIVIC  |
|  | <b>OPEL</b><br>ARENA  |   | <b>JEEP</b><br>CHEROKEE   | <b>VKM 27303</b>  | <b>ROVER</b><br>200 (RF) / 400 (RT) / 600   |
|  | <b>RENAULT</b><br>CLIO I / ESPACE III / EXPRESS/<br>EXTRA/RAPID / LAGUNA I /<br>MEGANE I / R11 / R19 / R21 /<br>R9 / SCENIC I / SUPER 5 /<br>TRAFIC I   | <b>VKM 26212</b>  | <b>RENAULT</b><br>ESPACE I / ESPACE II / MASTER<br>I / R18 / R20 / R21 / R25 / R30<br>/ TRAFIC I  |   | <b>LAND ROVER</b><br>FREELANDER I   |
|  | <b>VAUXHALL</b><br>ARENA  | <b>VKM 26220</b>  | <b>RENAULT</b><br>SAFRANE I   | <b>VKM 27307</b>  | <b>MG</b><br>MG ZR / MG ZS  |
|  | <b>VOLVO</b><br>340-360 / 440-460 / 480 /<br>S40 I - V40  | <b>VKM 26310</b>  | <b>VOLVO</b><br>C30 / S60 / S80 / V70 II / XC70<br>I / XC90   |   | <b>ROVER</b><br>25 / 45 / STREETWISE  |
| <b>VKM 26102</b>   | <b>RENAULT</b><br>CLIO I / CLIO II / EXPRESS/<br>EXTRA/RAPID / KANGOO /<br>MEGANE I / R19 / SPORT SPI-<br>DER   | <b>VKM 26400</b>  | <b>RENAULT</b><br>CLIO II / ESPACE III / LAGUNA I /<br>MEGANE I / SCENIC I  | <b>VKM 27404</b>  | <b>LAND ROVER</b><br>FREELANDER I   |
|  | <b>OPEL</b><br>VIVARO   | <b>VKM 26402</b>  | <b>VOLVO</b><br>740 / 940 / 960   |   | <b>MG</b><br>MG ZS / MG ZT  |
|  | <b>RENAULT</b><br>AVANTIME / CLIO II / CLIO III /<br>ESPACE III / ESPACE IV /<br>LAGUNA II / LAGUNA III /<br>MEGANE I / MEGANE II /<br>SCENIC I / SCENIC II / GRAND<br>SCENIC / TRAFIC II / VEL SATIS | <b>VKM 26500</b>  | <b>RENAULT</b><br>LAGUNA I  | <b>VKM 28000</b>  | <b>ROVER</b><br>45 / 75 / 800   |
| <b>VKM 26105</b>   | <b>RENAULT</b><br>CLIO I / CLIO II / EXPRESS/<br>EXTRA/RAPID / KANGOO /<br>MEGANE I / R19 / SPORT SPI-<br>DER   | <b>VKM 26501</b>  | <b>RENAULT</b><br>ESPACE III / LAGUNA I /<br>SAFRANE II   |   | <b>LAND ROVER</b><br>DEFENDER I / DISCOVERY I /<br>DISCOVERY II / RANGE ROVER I<br>/ RANGE ROVER II   |
|  | <b>VAUXHALL</b><br>VIVARO   | <b>VKM 26502</b>  | <b>RENAULT</b><br>LAGUNA I  | <b>VKM 28001</b>  | <b>BMW</b><br>3 (E30) / 3 (E36) / 3 Convertible<br>(E30) / 3 Touring (E30) / 5 (E34)<br>/ 5 Touring (E34)   |
| <b>VKM 26115</b>   | <b>RENAULT</b><br>ESPACE III / KANGOO / LAGUNA<br>I / MEGANE I / SCENIC I   | <b>VKM 26503</b>  | <b>NISSAN</b><br>INTERSTAR / PRIMASTAR  |   | <b>BMW</b><br>3 (E30) / 3 (E36) / 3 Convertible<br>(E30) / 3 Touring (E30) / 5 (E34)<br>/ 5 Touring (E34)   |
|  | <b>VOLVO</b><br>S40 I - V40   |   | <b>OPEL</b><br>MOVANO / VIVARO  | <b>VKM 31002</b>  | <b>AUDI</b><br>A3 (8L1)   |
| <b>VKM 26117</b>   | <b>OPEL</b><br>MOVANO   |   | <b>RENAULT</b><br>AVANTIME / ESPACE III /<br>ESPACE IV / LAGUNA II /<br>MASTER II / TRAFIC II / VEL<br>SATIS  |   | <b>SEAT</b><br>CORDOBA (6K2) / CORDOBA<br>(6K2/C2) / CORDOBA Vario<br>(6K5) / IBIZA III (6K1) / INCA /<br>LEON I (1M1) / TOLEDO II (1M2)  |
|  | <b>RENAULT</b><br>CLIO II / ESPACE III / KANGOO /<br>LAGUNA I / MASTER II /<br>MEGANE I / SCENIC I  | <b>VKM 26600</b>  | <b>VAUXHALL</b><br>MOVANO / VIVARO  |   | <b>SKODA</b><br>OCTAVIA I (1U2) / OCTAVIA<br>Combi (1U5)  |
|  | <b>VAUXHALL</b><br>MOVANO   | <b>VKM 26602</b>  | <b>VOLVO</b><br>850 / 960   |   | <b>VW</b><br>BORA (1J2) / BORA Estate (1J6)<br>/ CADDY II(9K9A)/Estate(9K9B)/<br>Pickup(9U7) / GOLF IV (1J1) /<br>GOLF IV Variant (1J5) / NEW<br>BEETLE (9C1, 1C1)/Convertible<br>(1Y7) / POLO CLASSIC (6KV2) /<br>Variant (6KV5) |
| <b>VKM 26123</b>   | <b>RENAULT</b><br>ESPACE III / LAGUNA I /<br>MEGANE I / SCENIC I  |   | <b>FORD</b><br>FOCUS II / MONDEO IV / S-MAX   |   |   |
|  |   |   | <b>RENAULT</b><br>LAGUNA I / SAFRANE II   |   |   |









|                         |  |                         |   |                         |  |
|-------------------------|--|-------------------------|---|-------------------------|--|
| <p><b>VKM 31004</b></p> | <p><b>AUDI</b><br/>80 (8C, B4) / 80 Avant (8C, B4) / A6 (4A, C4) / A6 Avant (4A, C4) / CABRIOLET (8G7, B4)</p> <hr/> <p><b>FORD</b><br/>GALAXY I</p> <hr/> <p><b>SEAT</b><br/>ALHAMBRA / CORDOBA (6K2) / CORDOBA (6K2/C2) / CORDOBA Vario (6K5) / IBIZA II (6K1) / INCA / TOLEDO I (1L)</p> <hr/> <p><b>VW</b><br/>CADDY II(9K9A)/Estate(9K9B)/ Pickup(9U7) / CORRADO (53I) / GOLF III (1H1) / GOLF III Variant (1H5) / GOLF III Cabriolet (1E7) / GOLF IV Cabriolet (1E7) / PASSAT (3A2, 35I) / Variant (3A5, 35I) / POLO CLASSIC (6KV2) / Variant (6KV5) / SANTANA / SHARAN (7M8, 7M9, 7M6) / TRANSPORTER IV / VENTO (1H2)</p> | <p><b>VKM 31012</b></p> | <p><b>SKODA</b><br/>FABIA / OCTAVIA I (1U2) / OCTAVIA Combi (1U5) / OCTAVIA II (1Z3)/OCTAVIA II Combi (1Z5)</p> <hr/> <p><b>VW</b><br/>BORA (1J2) / BORA Estate (1J6) / CADDY III (2KA) / CADDY III Estate (2KB) / EOS / GOLF IV (1J1) / GOLF IV Variant (1J5) / GOLF V (1K1) / GOLF V VARIANT (1K1) / GOLF V PLUS (5M1) / JETTA III (1KM) / LUPO (6X1, 6E1) / MULTIVAN V (7HM) / NEW BEETLE (9C1, 1C1)/ Convertible (1Y7) / PASSAT (3C2) / Variant (3C5) / POLO (6N2) / POLO CLASSIC (6KV2) / Variant (6KV5) / SHARAN (7M8, 7M9, 7M6) / TOURAN / TRANSPORTER V</p> <hr/> <p><b>AUDI</b><br/>A3 (8L1)</p> | <p><b>VKM 31016</b></p> | <p><b>SKODA</b><br/>FABIA / FELICIA I (6U1)/Estate (6U5)/Fun (797) / FELICIA II (6U1)/FELICIA II Estate (6U5) / OCTAVIA I (1U2) / OCTAVIA Combi (1U5) / OCTAVIA II (1Z3)/ OCTAVIA II Combi (1Z5) / ROOMSTER</p> <hr/> <p><b>VW</b><br/>BORA (1J2) / BORA Estate (1J6) / CADDY II(9K9A)/Estate(9K9B)/ Pickup(9U7) / CADDY III (2KA) / CADDY III Estate (2KB) / FOX (5Z1) / GOLF III (1H1) / GOLF III Variant (1H5) / GOLF IV (1J1) / GOLF IV Variant (1J5) / GOLF V (1K1) / GOLF V VARIANT (1K1) / GOLF V PLUS (5M1) / LUPO (6X1, 6E1) / NEW BEETLE (9C1, 1C1)/Convertible (1Y7) / POLO (6N1) / POLO Box (6NF) / POLO (6N2) / POLO (9N_) / POLO CLASSIC (6KV2) / Variant (6KV5) / POLO Saloon / VENTO (1H2)</p> <hr/> <p><b>SEAT</b><br/>LEON I (1M1) / TOLEDO II (1M2)</p> <hr/> <p><b>SKODA</b><br/>OCTAVIA I (1U2) / OCTAVIA Combi (1U5)</p> <hr/> <p><b>VW</b><br/>BORA (1J2) / BORA Estate (1J6) / GOLF IV (1J1) / GOLF IV Variant (1J5)</p> |
| <p><b>VKM 31006</b></p> | <p><b>AUDI</b><br/>A4 (8E2, B6) / A4 Avant (8E5, B6) / A4 (8EC) / A4 Avant (8ED) / A4 Convertible (8H7) / A6 (4B, C5) / A6 Avant (4B, C5) / A6 (4F2) / A6 Avant (4F5)</p>  | <p><b>VKM 31013</b></p> | <p><b>SEAT</b><br/>CORDOBA (6K2) / CORDOBA (6K2/C2) / CORDOBA Vario (6K5) / IBIZA III (6K1) / LEON I (1M1) / TOLEDO II (1M2)</p> <hr/> <p><b>SKODA</b><br/>OCTAVIA I (1U2) / OCTAVIA Combi (1U5)</p>  | <p><b>VKM 31018</b></p> | <p><b>AUDI</b><br/>A3 (8L1)</p> <hr/> <p><b>SEAT</b><br/>CORDOBA (6K2) / CORDOBA (6K2/C2) / CORDOBA Vario (6K5) / IBIZA III (6K1) / INCA / LEON I (1M1) / TOLEDO II (1M2)</p> <hr/> <p><b>SKODA</b><br/>OCTAVIA I (1U2) / OCTAVIA Combi (1U5)</p>  |
| <p><b>VKM 31007</b></p> | <p><b>VW</b><br/>CORRADO (53I) / GOLF II (19E, 1G1) / LT II / PASSAT (3A2, 35I) / Variant (3A5, 35I) / TRANSPORTER IV</p>  | <p><b>VKM 31015</b></p> | <p><b>VW</b><br/>BORA (1J2) / BORA Estate (1J6) / CADDY II(9K9A)/Estate(9K9B)/ Pickup(9U7) / GOLF IV (1J1) / GOLF IV Variant (1J5) / NEW BEETLE (9C1, 1C1)/Convertible (1Y7) / POLO CLASSIC (6KV2) / Variant (6KV5)</p>   | <p><b>VKM 31019</b></p> | <p><b>AUDI</b><br/>A3 (8L1)</p> <hr/> <p><b>SEAT</b><br/>CORDOBA (6K2) / CORDOBA (6K2/C2) / CORDOBA Vario (6K5) / IBIZA III (6K1) / INCA / LEON I (1M1) / TOLEDO II (1M2)</p> <hr/> <p><b>SKODA</b><br/>OCTAVIA I (1U2) / OCTAVIA Combi (1U5)</p>  |
| <p><b>VKM 31009</b></p> | <p><b>AUDI</b><br/>80 (89, 89Q, 8A, B3) / 90 (89, 89Q, 8A, B3)</p> <hr/> <p><b>VW</b><br/>GOLF II (19E, 1G1) / JETTA II (19E, 1G2)</p>   | <p><b>VKM 31015</b></p> | <p><b>AUDI</b><br/>A4 (8D2, B5) / A4 Avant (8D5, B5) / A4 (8E2, B6) / A4 Avant (8E5, B6) / A6 (4B, C5) / A6 Avant (4B, C5)</p> <hr/> <p><b>SKODA</b><br/>SUPERB</p>   | <p><b>VKM 31019</b></p> | <p><b>VW</b><br/>BORA (1J2) / BORA Estate (1J6) / CADDY II(9K9A)/Estate(9K9B)/ Pickup(9U7) / GOLF IV (1J1) / GOLF IV Variant (1J5) / POLO CLASSIC (6KV2) / Variant (6KV5)</p>  |
| <p><b>VKM 31010</b></p> | <p><b>AUDI</b><br/>100 (4A, C4) / 100 Avant (4A, C4) / 80 (8C, B4) / 80 Avant (8C, B4) / CABRIOLET (8G7, B4) / COUPE (89, 8B)</p>  | <p><b>VKM 31015</b></p> | <p><b>VW</b><br/>PASSAT (3B2) / Variant (3B5) / PASSAT (3B3) / Variant (3B6)</p>  | <p><b>VKM 31019</b></p> | <p><b>AUDI</b><br/>A3 (8L1)</p> <hr/> <p><b>FORD</b><br/>GALAXY I</p>  |
| <p><b>VKM 31011</b></p> | <p><b>AUDI</b><br/>A3 (8L1) / A3 (8P1) / A3 Sportback (8PA) / TT (8N3) / TT Roadster (8N9)</p> <hr/> <p><b>SEAT</b><br/>ALHAMBRA / ALTEA / ALTEA XL / AROSA / CORDOBA (6K2) / CORDOBA (6K2/C2) / CORDOBA (6L2) / CORDOBA Vario (6K5) / IBIZA III (6K1) / IBIZA IV (6L1) / LEON I (1M1) / LEON II (1P1) / TOLEDO II (1M2) / TOLEDO III (5P2)</p>  | <p><b>VKM 31015</b></p> | <p><b>AUDI</b><br/>A2 (8Z0)</p> <hr/> <p><b>SEAT</b><br/>AROSA / CORDOBA (6K2) / CORDOBA (6K2/C2) / CORDOBA (6L2) / CORDOBA Vario (6K5) / IBIZA II (6K1) / IBIZA III (6K1) / IBIZA IV (6L1) / INCA / LEON I (1M1) / LEON II (1P1) / TOLEDO II (1M2)</p>   | <p><b>VKM 31019</b></p> | <p><b>SEAT</b><br/>ALHAMBRA / LEON I (1M1) / TOLEDO II (1M2)</p> <hr/> <p><b>SKODA</b><br/>OCTAVIA I (1U2) / OCTAVIA Combi (1U5)</p>   |

















|           |   |           |   |           |  |
|-----------|---|-----------|---|-----------|--|
|           | <p><b>VW</b><br/>BORA (1J2) / BORA Estate (1J6) / GOLF IV (1J1) / GOLF IV Variant (1J5) / MULTIVAN V (7HM) / NEW BEETLE (9C1, 1C1)/Convertible (1Y7) / SHARAN (7M8, 7M9, 7M6) / TRANSPORTER V</p>   |           | <p><b>VW</b><br/>CADDY II(9K9A)/Estate(9K9B)/ Pickup(9U7) / GOLF III (1H1) / GOLF III Variant (1H5) / GOLF III Cabriolet (1E7) / GOLF IV Cabriolet (1E7) / PASSAT (3A2, 35I) / Variant (3A5, 35I) / POLO CLASSIC (6KV2) / Variant (6KV5) / SHARAN (7M8, 7M9, 7M6) / TRANSPORTER IV / VENTO (1H2)</p>                              |           | <p><b>VW</b><br/>PASSAT (3B2) / Variant (3B5) / PASSAT (3B3) / Variant (3B6)</p>   |
| VKM 31022 | <p><b>AUDI</b><br/>A3 (8P1) / A3 Sportback (8PA)</p> <p><b>SEAT</b><br/>ALTEA / ALTEA XL / LEON II (1P1) / TOLEDO III (5P2)</p> <p><b>SKODA</b><br/>OCTAVIA II (1Z3)/OCTAVIA II Combi (1Z5)</p>   | VKM 31033 | <p><b>AUDI</b><br/>A4 (8D2, B5) / A4 Avant (8D5, B5) / A6 (4A, C4) / A6 Avant (4A, C4) / A6 (4B, C5) / A6 Avant (4B, C5) / CABRIOLET (8G7, B4)</p> <p><b>SKODA</b><br/>SUPERB</p>   | VKM 31040 | <p><b>AUDI</b><br/>A4 (8D2, B5) / A4 Avant (8D5, B5) / A4 (8E2, B6) / A4 Avant (8E5, B6) / A4 (8EC) / A4 Avant (8ED) / A4 Convertible (8H7) / A6 (4B, C5) / A6 Avant (4B, C5) / A8 (4D2, 4D8) / ALLROAD (4BH)</p> <p><b>SKODA</b><br/>SUPERB</p> <p><b>VW</b><br/>PASSAT (3B2) / Variant (3B5) / PASSAT (3B3) / Variant (3B6)</p>  |
|           | <p><b>VW</b><br/>CADDY III (2KA) / CADDY III Estate (2KB) / GOLF V (1K1) / GOLF V VARIANT (1K1) / GOLF V PLUS (5M1) / JETTA III (1KM) / PASSAT (3C2) / Variant (3C5) / TOURAN</p>   | VKM 31034 | <p><b>SKODA</b><br/>SUPERB</p> <p><b>VW</b><br/>PASSAT (3B2) / Variant (3B5) / PASSAT (3B3) / Variant (3B6)</p>   | VKM 31041 | <p><b>AUDI</b><br/>A4 (8D2, B5) / A4 Avant (8D5, B5) / A4 (8E2, B6) / A4 Avant (8E5, B6) / A4 (8EC) / A4 Avant (8ED) / A4 Convertible (8H7) / A6 (4B, C5) / A6 Avant (4B, C5) / A8 (4D2, 4D8) / ALLROAD (4BH)</p>  |
| VKM 31023 | <p><b>SEAT</b><br/>CORDOBA (6K2) / CORDOBA (6K2/C2) / CORDOBA Vario (6K5) / IBIZA II (6K1) / IBIZA III (6K1) / INCA</p>   | VKM 31035 | <p><b>AUDI</b><br/>A4 (8D2, B5) / A4 Avant (8D5, B5) / A6 (4B, C5) / A6 Avant (4B, C5)</p> <p><b>VW</b><br/>PASSAT (3B2) / Variant (3B5)</p>  |           | <p><b>MERCEDES-BENZ</b><br/>C-class (W202) / C-class (W203) / C-class (W204) / CLK (W208) / CLK (W209) / E-class (W210) / E-class (W211) / G-class (W463) / M-class (W163) / M-CLASS (W164) / R-class (W251) / S-class (W215) / S-class (W220) / S-class (W221) / SL (W129) / SL (W230) / SLK (R170) / SLK (R171) / SPRINTER 2-t (W901 / W902) / SPRINTER 3-t (W903) / SPRINTER 4-t (W904) / V-class (W638) / VIANO (W639) / VITO (W638) / VITO (W639)</p> |
| VKM 31025 | <p><b>VW</b><br/>CADDY II(9K9A)/Estate(9K9B)/ Pickup(9U7) / GOLF III (1H1) / GOLF III Variant (1H5) / POLO CLASSIC (6KV2) / Variant (6KV5) / VENTO (1H2)</p>  | VKM 31038 | <p><b>AUDI</b><br/>A2 (8Z0)</p> <p><b>SEAT</b><br/>CORDOBA (6L2) / IBIZA IV (6L1)</p> <p><b>SKODA</b><br/>FABIA / ROOMSTER</p> <p><b>VW</b><br/>FOX (5Z1) / LUPO (6X1, 6E1) / POLO (9N_) / POLO Saloon</p>  |           | <p><b>SKODA</b><br/>SUPERB</p> <p><b>VW</b><br/>PASSAT (3B2) / Variant (3B5) / PASSAT (3B3) / Variant (3B6)</p>  |
| VKM 31025 | <p><b>SEAT</b><br/>AROSA</p> <p><b>SKODA</b><br/>FABIA / FELICIA I (6U1)/Estate (6U5)/Fun (797) / FELICIA II (6U1)/FELICIA II Estate (6U5) / OCTAVIA I (1U2) / OCTAVIA Combi (1U5)</p>  | VKM 31039 | <p><b>AUDI</b><br/>A4 (8D2, B5) / A4 Avant (8D5, B5) / A4 (8E2, B6) / A4 Avant (8E5, B6) / A4 (8EC) / A4 Avant (8ED) / A4 Convertible (8H7) / A6 (4B, C5) / A6 Avant (4B, C5) / A8 (4D2, 4D8) / ALLROAD (4BH)</p> <p><b>SKODA</b><br/>SUPERB</p> <p><b>VW</b><br/>PASSAT (3B2) / Variant (3B5) / PASSAT (3B3) / Variant (3B6)</p> | VKM 31043 | <p><b>SKODA</b><br/>SUPERB</p> <p><b>VW</b><br/>PASSAT (3B2) / Variant (3B5) / PASSAT (3B3) / Variant (3B6)</p>  |
| VKM 31030 | <p><b>VW</b><br/>CADDY II(9K9A)/Estate(9K9B)/ Pickup(9U7) / LUPO (6X1, 6E1) / POLO (6N1) / POLO Box (6NF) / POLO (6N2)</p>  |           | <p><b>AUDI</b><br/>80 (8C, B4) / 80 Avant (8C, B4) / A6 (4A, C4) / A6 Avant (4A, C4) / CABRIOLET (8G7, B4)</p>  | VKM 31044 | <p><b>VW</b><br/>TRANSPORTER IV</p>  |
| VKM 31030 | <p><b>AUDI</b><br/>80 (8C, B4) / 80 Avant (8C, B4) / A6 (4A, C4) / A6 Avant (4A, C4) / CABRIOLET (8G7, B4)</p> <p><b>FORD</b><br/>GALAXY I</p> <p><b>SEAT</b><br/>ALHAMBRA / CORDOBA (6K2) / CORDOBA (6K2/C2) / CORDOBA Vario (6K5) / IBIZA II (6K1) / INCA / TOLEDO I (1L)</p> | VKM 31039 | <p><b>AUDI</b><br/>A4 (8D2, B5) / A4 Avant (8D5, B5) / A4 (8E2, B6) / A4 Avant (8E5, B6) / A4 (8EC) / A4 Avant (8ED) / A4 Convertible (8H7) / A6 (4B, C5) / A6 Avant (4B, C5) / A8 (4D2, 4D8) / ALLROAD (4BH)</p> <p><b>SKODA</b><br/>SUPERB</p>  | VKM 31047 | <p><b>AUDI</b><br/>A3 (8P1) / A3 Sportback (8PA)</p> <p><b>SKODA</b><br/>OCTAVIA II (1Z3)/OCTAVIA II Combi (1Z5) / ROOMSTER</p> <p><b>VW</b><br/>EOS / GOLF V (1K1) / GOLF V VARIANT (1K1) / GOLF V PLUS (5M1) / JETTA III (1KM) / PASSAT (3C2) / Variant (3C5) / POLO (9N_) / TOURAN</p>  |

|  |   |  |    |  |               |
|---|--|---|--|---|--|
| VKM 31054   | <b>SKODA</b><br>OCTAVIA II (1Z3)/OCTAVIA II Combi (1Z5) / ROOMSTER   | VKM 31061   | <b>VW</b><br>CORRADO (53I) / GOLF III (1H1) / GOLF III Variant (1H5) / PASSAT (3A2, 35I) / Variant (3A5, 35I) / SHARAN (7M8, 7M9, 7M6) / VENTO (1H2)   | VKM 32004   | <b>ALFA ROMEO</b><br>166   |
|   | <b>VW</b><br>EOS / GOLF V (1K1) / GOLF V VARIANT (1K1) / GOLF V PLUS (5M1) / JETTA III (1KM) / PASSAT (3C2) / Variant (3C5) / POLO (9N_) / TOURAN                                |   | <b>AUDI</b><br>A4 (8D2, B5) / A4 Avant (8D5, B5) / A4 (8E2, B6) / A4 Avant (8E5, B6) / A4 Convertible (8H7) / A6 (4A, C4) / A6 Avant (4A, C4) / A6 (4B, C5) / A6 Avant (4B, C5) / A6 (4F2) / A6 Avant (4F5) / A8 (4D2, 4D8) / ALL-ROAD (4BH)   | VKM 32005   | <b>FIAT</b><br>MAREA   |
|   | <b>AUDI</b><br>A3 (8P1) / A3 Sportback (8PA)   |   | <b>SKODA</b><br>SUPERB   | VKM 32006   | <b>LANCIA</b><br>KAPPA / THESIS  |
| VKM 31057   | <b>SEAT</b><br>ALHAMBRA / ALTEA / ALTEA XL / LEON II (1P1) / TOLEDO III (5P2)  | VKM 31063   | <b>VW</b><br>PASSAT (3B2) / Variant (3B5) / PASSAT (3B3) / Variant (3B6)   | VKM 32007   | <b>FIAT</b><br>BRAVA/BRAVO (182) / COUPE / MAREA / PALIO/SIENA / STRADA                          |
|   | <b>SKODA</b><br>OCTAVIA II (1Z3)/OCTAVIA II Combi (1Z5)  |   | <b>VW</b><br>LT II / TRANSPORTER IV  |   | <b>ALFA ROMEO</b><br>145/146 / 147 / 156 / GT  |
|   | <b>VW</b><br>CADDY III (2KA) / CADDY III Estate (2KB) / EOS / GOLF V (1K1) / GOLF V VARIANT (1K1) / GOLF V PLUS (5M1) / JETTA III (1KM) / SHARAN (7M8, 7M9, 7M6) / TRANSPORTER V |   | <b>SEAT</b><br>LEON I (1M1) / TOLEDO II (1M2)  |   | <b>FIAT</b><br>BRAVA/BRAVO (182) / BRAVO / DOBLO / IDEA / MAREA / MULTIPLA / PUNTO (188) / STILO |
| VKM 31058   | <b>SEAT</b><br>CORDOBA (6L2) / IBIZA IV (6L1)  | VKM 31207   | <b>SKODA</b><br>OCTAVIA I (1U2) / OCTAVIA Combi (1U5)  | VKM 32008   | <b>LANCIA</b><br>LYBRA / MUSA  |
|   | <b>SKODA</b><br>FABIA / ROOMSTER   |   | <b>VW</b><br>BORA (1J2) / BORA Estate (1J6) / GOLF IV (1J1) / GOLF IV Variant (1J5)  |   | <b>ALFA ROMEO</b><br>145/146 / 147 / 155 / 156 / 166 / GT / GTV / SPIDER                         |
|   | <b>VW</b><br>POLO (9N_) / POLO Saloon  |   | <b>SEAT</b><br>ALHAMBRA / CORDOBA (6K2) / CORDOBA (6K2/C2) / CORDOBA Vario (6K5) / IBIZA II (6K1) / INCA / TOLEDO I (1L)   |   | <b>LANCIA</b><br>DELTA I / PRISMA  |
| VKM 31059   | <b>AUDI</b><br>A4 (8E2, B6) / A4 Avant (8E5, B6) / A4 (8EC) / A4 Avant (8ED) / A4 (8K) / A4 Convertible (8H7) / A6 (4F2) / A6 Avant (4F5)  | VKM 31210   | <b>VW</b><br>CADDY II(9K9A)/Estate(9K9B)/ Pickup(9U7) / CORRADO (53I) / GOLF III (1H1) / GOLF III Variant (1H5) / GOLF III Cabriolet (1E7) / GOLF IV Cabriolet (1E7) / PASSAT (3A2, 35I) / Variant (3A5, 35I) / POLO CLASSIC (6KV2) / Variant (6KV5) / SANTANA / SHARAN (7M8, 7M9, 7M6) / TRANSPORTER IV / VENTO (1H2) | VKM 32009   | <b>ALFA ROMEO</b><br>164   |
|   | <b>SEAT</b><br>CORDOBA (6L2) / IBIZA IV (6L1)  |   | <b>SEAT</b><br>CORDOBA (6K2) / IBIZA IV (6L1)  |   | <b>FIAT</b><br>FIORINO / PUNTO (176) / TIPO / UNO  |
|   | <b>SKODA</b><br>FABIA / ROOMSTER   |   | <b>VW</b><br>CADDY II(9K9A)/Estate(9K9B)/ Pickup(9U7) / CORRADO (53I) / GOLF III (1H1) / GOLF III Variant (1H5) / GOLF III Cabriolet (1E7) / GOLF IV Cabriolet (1E7) / PASSAT (3A2, 35I) / Variant (3A5, 35I) / POLO CLASSIC (6KV2) / Variant (6KV5) / SANTANA / SHARAN (7M8, 7M9, 7M6) / TRANSPORTER IV / VENTO (1H2) |   | <b>LANCIA</b><br>DEDRA   |
| VKM 31060   | <b>VW</b><br>POLO (9N_) / POLO Saloon / TIGUAN (5N)  | VKM 32001   | <b>ALFA ROMEO</b><br>145/146 / 147 / 155 / 156 / GT / GTV / SPIDER   | VKM 32010   | <b>ALFA ROMEO</b><br>164   |
|   | <b>AUDI</b><br>A4 (8D2, B5) / A4 Avant (8D5, B5) / A4 (8E2, B6) / A4 Avant (8E5, B6) / A6 (4B, C5) / A6 Avant (4B, C5)   |   | <b>FIAT</b><br>BARCETTA / BRAVA/BRAVO (182) / COUPE / MAREA / PUNTO (188)  |   | <b>LANCIA</b><br>KAPPA   |
|   | <b>SKODA</b><br>SUPERB   |   | <b>LANCIA</b><br>Y   |   | <b>FIAT</b><br>PUNTO (176)   |
| VKM 31060   | <b>VW</b><br>PASSAT (3B2) / Variant (3B5) / PASSAT (3B3) / Variant (3B6)   | VKM 32002   | <b>FIAT</b><br>BRAVA/BRAVO (182) / COUPE / MAREA / PUNTO (188) / STILO   | VKM 32012   | <b>LANCIA</b><br>KAPPA   |
|   | <b>FORD</b><br>GALAXY I  |   | <b>ALFA ROMEO</b><br>145 / 164   |   | <b>FIAT</b><br>BRAVA/BRAVO (182) / COUPE / MAREA   |
|   | <b>MERCEDES-BENZ</b><br>V-class (W638)   |   | <b>ALFA ROMEO</b><br>155 / 164   |   | <b>LANCIA</b><br>LYBRA   |
|   |  |   |  | VKM 32016   | <b>FIAT</b><br>CROMA (154) / REGATA / TIPO   |
|   |  |   |  | VKM 32017   | <b>LANCIA</b><br>DEDRA / PRISMA  |
|   |  |   |  | VKM 32018   | <b>ALFA ROMEO</b><br>156   |















|  |                                    |  |  |  |   |
|--|---|---|---|---|--|
| VKM 32022  | <b>FIAT</b><br>MAREA  | VKM 32031   | <b>FIAT</b><br>PALIO/SIENA / STRADA   | VKM 32243   | <b>FIAT</b><br>BRAVA/BRAVO (182) / CROMA (154) / MAREA / MULTIPLA / PALIO/SIENA / PUNTO (176) / TIPO / UNO                       |
|  | <b>LANCIA</b><br>LYBRA  | VKM 32033   | <b>FIAT</b><br>BRAVA/BRAVO (182)  |   | <b>LANCIA</b><br>DEDRA / DELTA II / LYBRA  |
|  | <b>ALFA ROMEO</b><br>145/146 / 147 / 155 / 156 / GTV / SPIDER   | VKM 32034   | <b>FIAT</b><br>BRAVA/BRAVO (182)  |   | <b>FIAT</b><br>BRAVA/BRAVO (182) / DOBLO / MAREA / MULTIPLA / PALIO/SIENA / STILO  |
| VKM 32023  | <b>FIAT</b><br>BARCHETTA / BRAVA/BRAVO (182) / COUPE / MAREA / PUNTO (188)  | VKM 32035   | <b>LANCIA</b><br>Y  | VKM 33001   | <b>LANCIA</b><br>LYBRA   |
|  | <b>LANCIA</b><br>DEDRA / DELTA II / Y   | VKM 32036   | <b>FIAT</b><br>BRAVA/BRAVO (182) / COUPE / MAREA                                  |   | <b>CITROËN</b><br>BX   |
|  | <b>FIAT</b><br>500 / BRAVO / DOBLO / GRANDE PUNTO / IDEA / PALIO/SIENA / PANDA (169) / PUNTO (188) / STILO / STRADA | VKM 32046   | <b>LANCIA</b><br>LYBRA  |   | <b>PEUGEOT</b><br>405 I  |
| VKM 32024  | <b>LANCIA</b><br>MUSA / YPSILON   | VKM 32080   | <b>ALFA ROMEO</b><br>159  | VKM 33002   | <b>CITROËN</b><br>BERLINGO / BX / EVASION / JUMPER (230) / JUMPY I / JUMPY II / XANTIA I / XANTIA II / XM I / XM II / XSARA / ZX |
|  | <b>ALFA ROMEO</b><br>156 / 166  |   | <b>FIAT</b><br>CROMA (194) / GRANDE PUNTO / STILO                                 |   | <b>FIAT</b><br>DUCATO (230) / SCUDO (220) / ULYSSE (220)   |
|  | <b>FIAT</b><br>MAREA  |   | <b>OPEL</b><br>ASTRA H / SIGNUM / VECTRA C / ZAFIRA B                             |   | <b>LANCIA</b><br>ZETA  |
| VKM 32025  | <b>LANCIA</b><br>KAPPA / LYBRA / THESIS   | VKM 32082   | <b>VAUXHALL</b><br>ASTRA Mk V / SIGNUM / VECTRA Mk II / ZAFIRA Mk II              | VKM 33003   | <b>PEUGEOT</b><br>306 / 405 I / 405 II / 406 / 605 / 806 / BOXER I / EXPERT I / PARTNER  |
|  | <b>ALFA ROMEO</b><br>156 / 166  |   | <b>FIAT</b><br>500 / DOBLO / IDEA / PALIO/SIENA / PANDA (169) / PUNTO (188)       |   | <b>CITROËN</b><br>BERLINGO / EVASION / JUMPER (230) / JUMPER (244) / XANTIA I / XANTIA II / XM II / XSARA / ZX                   |
|  | <b>FIAT</b><br>MAREA  |   | <b>LANCIA</b><br>MUSA / YPSILON   |   | <b>FIAT</b><br>DUCATO (230) / DUCATO (244) / ULYSSE (220)  |
| VKM 32026  | <b>LANCIA</b><br>KAPPA / LYBRA / THESIS   | VKM 32083   | <b>ALFA ROMEO</b><br>147 / 156 / 166 / GT / GTV / SPIDER                          | VKM 33004   | <b>LANCIA</b><br>ZETA  |
|  | <b>ALFA ROMEO</b><br>147 / 156 / 166 / GT / GTV / SPIDER  |   | <b>ALFA ROMEO</b><br>147 / 156 / 166 / GT / GTV / SPIDER                          |   | <b>PEUGEOT</b><br>306 / 405 II / 406 / 605 / 806 / BOXER I / BOXER II / EXPERT I   |
|  | <b>FIAT</b><br>PUNTO (188) / STILO  |   | <b>LANCIA</b><br>KAPPA / THESIS   |   | <b>CITROËN</b><br>BERLINGO / JUMPY I / XSARA   |
| VKM 32027  | <b>LANCIA</b><br>LYBRA  | VKM 32154   | <b>ALFA ROMEO</b><br>147 / 156 / 166 / GT / GTV / SPIDER                          | VKM 33006   | <b>FIAT</b><br>SCUDO (220)   |
|  | <b>ALFA ROMEO</b><br>145/146 / 147 / 156 / GT   |   | <b>FIAT</b><br>BRAVA/BRAVO (182) / SCUDO (220)                                    |   | <b>PEUGEOT</b><br>206 / 306 / EXPERT I / PARTNER   |
|  | <b>FIAT</b><br>BRAVA/BRAVO (182) / BRAVO / DOBLO / IDEA / MAREA / MULTIPLA / PUNTO (188) / STILO / STRADA           |   | <b>LANCIA</b><br>KAPPA / THESIS   |   | <b>CITROËN</b><br>BX   |
| VKM 32030  | <b>LANCIA</b><br>LYBRA / MUSA   | VKM 32184   | <b>FIAT</b><br>BRAVA/BRAVO (182) / SCUDO (220)                                    | VKM 33007   | <b>PEUGEOT</b><br>205 / 309 / 405 I  |
|  | <b>ALFA ROMEO</b><br>147 / 156 / 166 / GT / GTV / SPIDER  |   | <b>FIAT</b><br>STILO  |   | <b>CITROËN</b><br>XM I / XM II   |
|  | <b>FIAT</b><br>BRAVO / IDEA / PUNTO (188) / STILO   |   | <b>ALFA ROMEO</b><br>145/146 / 155  |   |  |
| VKM 32033  | <b>LANCIA</b><br>KAPPA / MUSA / THESIS  | VKM 32242   |   |   |  |

|  |    |  |    |  |                          |
|---|---|---|--|---|---|
| VKM 33008   | PEUGEOT<br>605  | VKM 33018   | CITROËN<br>BERLINGO / XSARA / XSARA<br>PICASSO   | VKM 33025   | LANCIA<br>ZETA  |
|   | CITROËN<br>XANTIA II  |   | PEUGEOT<br>206 / PARTNER   |   | PEUGEOT<br>206 / 306 / 406 / 806 / BOXER<br>I / BOXER II / EXPERT I /<br>PARTNER                            |
| VKM 33009   | PEUGEOT<br>405 II   | VKM 33019   | CITROËN<br>C4 / C5 I / C5 II / C8 / EVASION /<br>JUMPY I / XSARA / XSARA<br>PICASSO  |   | CITROËN<br>BERLINGO / EVASION / XANTIA<br>I / XANTIA II / XM II / XSARA / ZX                                |
|   | CITROËN<br>AX / SAXO  |   | FIAT<br>SCUDO (220) / ULYSSE (179AX)<br>/ ULYSSE (220)   |   | FIAT<br>ULYSSE (220)  |
|   | PEUGEOT<br>106 I / 106 II   |   | LANCIA<br>PHEDRA / ZETA  |   | LANCIA<br>ZETA  |
| VKM 33010   | ROVER<br>100  |   | PEUGEOT<br>206 / 307 / 406 / 407 / 607 /<br>806 / 807 / EXPERT I   | VKM 33026   | PEUGEOT<br>306 / 406 / 605 / 806  |
|   | CITROËN<br>ZX   | VKM 33020   | CITROËN<br>C4 / C5 I / C5 II / C8 / EVASION /<br>JUMPY I / XSARA / XSARA<br>PICASSO  |   | CITROËN<br>BERLINGO / XANTIA I / XANTIA<br>II / XSARA / ZX  |
|   | PEUGEOT<br>205 / 309 / 405 I / 405 II   |   | FIAT<br>SCUDO (220) / ULYSSE (179AX)<br>/ ULYSSE (220)   | VKM 33027   | PEUGEOT<br>306 / 406 / PARTNER  |
| VKM 33012   | CITROËN<br>AX / BERLINGO / SAXO / XSARA<br>/ ZX   |   | LANCIA<br>PHEDRA / ZETA  |   | CITROËN<br>BERLINGO / XANTIA I / XANTIA<br>II / ZX  |
|   | PEUGEOT<br>106 I / 106 II / 205 / 306 / 309<br>/ PARTNER  | VKM 33021   | PEUGEOT<br>206 / 307 / 406 / 407 / 607 /<br>806 / 807 / EXPERT I   | VKM 33028   | PEUGEOT<br>406 / PARTNER  |
| VKM 33013   | CITROËN<br>BERLINGO / C5 I / C8 /<br>EVASION / JUMPY I / JUMPY II /<br>XANTIA I / XANTIA II / XM I / XM<br>II / XSARA / XSARA PICASSO /<br>ZX |   | CITROËN<br>EVASION / XANTIA II / XSARA   |   | CITROËN<br>BERLINGO / EVASION / XANTIA<br>I / XANTIA II / XM II / XSARA / ZX                                |
|   | FIAT<br>SCUDO (220) / ULYSSE (179AX)<br>/ ULYSSE (220)  |   | FIAT<br>ULYSSE (220)   |   | FIAT<br>ULYSSE (220)  |
|   | LANCIA<br>PHEDRA / ZETA   | VKM 33022   | PEUGEOT<br>306 / 406 / 806   |   | LANCIA<br>ZETA  |
|   | PEUGEOT<br>206 / 306 / 406 / 605 / 607 /<br>806 / 807 / EXPERT I /<br>PARTNER   |   | CITROËN<br>EVASION / XANTIA I / XANTIA II<br>/ XM II / XSARA / ZX  | VKM 33029   | PEUGEOT<br>306 / 405 II / 406 / 605 / 806 /<br>PARTNER  |
| VKM 33014   | CITROËN<br>JUMPER (230) / XM II   |   | FIAT<br>ULYSSE (220)   |   | CITROËN<br>BERLINGO / EVASION / JUMPY I<br>/ JUMPY II / XANTIA I / XANTIA<br>II / XM I / XM II / XSARA / ZX |
|   | PEUGEOT<br>605 / BOXER I  |   | LANCIA<br>ZETA   |   | FIAT<br>SCUDO (220) / ULYSSE (220)  |
| VKM 33015   | CITROËN<br>JUMPER (230)   | VKM 33023   | PEUGEOT<br>306 / 406 / 605 / 806   |   | LANCIA<br>ZETA  |
|   | PEUGEOT<br>BOXER I  |   | CITROËN<br>XSARA / XSARA PICASSO   |   | PEUGEOT<br>206 / 306 / 406 / 605 / 806 /<br>EXPERT I / PARTNER  |
| VKM 33016   | CITROËN<br>JUMPER (230)   |   | PEUGEOT<br>206   | VKM 33031   | CITROËN<br>BERLINGO / JUMPY I / XSARA   |
|   | PEUGEOT<br>BOXER I  | VKM 33024   | CITROËN<br>BERLINGO / C5 I / EVASION /<br>JUMPER (230) / JUMPER (244)<br>/ JUMPY I / JUMPY II / XANTIA II<br>/ XSARA / XSARA PICASSO |   | FIAT<br>SCUDO (220)   |
| VKM 33017   | CITROËN<br>BERLINGO / JUMPY I / XSARA   |   | FIAT<br>DUCATO (230) / SCUDO (220) /<br>ULYSSE (220)   | VKM 33032   | PEUGEOT<br>206 / 306 / EXPERT I / PART-<br>NER  |
|   | FIAT<br>SCUDO (220)   |   |  |   | CITROËN<br>BERLINGO / JUMPER (230) /<br>JUMPER (244) / JUMPY I /<br>XSARA                                   |
|   | PEUGEOT<br>206 / 306 / EXPERT I /<br>PARTNER  |   |  |   |   |











|  |    |  |                  |  |                         |
|--|---|---|---|---|--|
| VKM 33033  | <b>FIAT</b><br>DUCATO (230) / SCUDO (220)   | VKM 33041   | <b>CITROËN</b><br>JUMPER (230)  | VKM 33061   | <b>PEUGEOT</b><br>206 / PARTNER  |
|  | <b>PEUGEOT</b><br>206 / 306 / 307 / BOXER I /<br>BOXER II / EXPERT I / PARTNER  | VKM 33042   | <b>PEUGEOT</b><br>BOXER I   |   | <b>CITROËN</b><br>BERLINGO / C3 / C5 II / XSARA /<br>XSARA PICASSO   |
|  | <b>CITROËN</b><br>BERLINGO / C5 I / C5 II / C8 /<br>EVASION / JUMPER (230) /<br>JUMPER (244) / JUMPY I /<br>JUMPY II / XANTIA II / XSARA /<br>XSARA PICASSO | VKM 33043   | <b>CITROËN</b><br>BERLINGO / C2 / C3 / C3 Pluriel<br>/ JUMPY I / XSARA                            |   | <b>FORD</b><br>FIESTA V / FUSION   |
| VKM 33034  | <b>FIAT</b><br>DUCATO (230) / SCUDO (220) /<br>ULYSSE (179AX) / ULYSSE<br>(220)   | VKM 33043   | <b>FIAT</b><br>SCUDO (220)  | VKM 33063   | <b>MAZDA</b><br>2  |
|  | <b>LANCIA</b><br>PHEDRA / ZETA  |   | <b>PEUGEOT</b><br>206 / 306 / 307 / EXPERT I /<br>PARTNER   | <b>CITROËN</b><br>C4  |  |
|  | <b>PEUGEOT</b><br>206 / 306 / 406 / 607 / 806 /<br>807 / BOXER I / BOXER II /<br>EXPERT I / PARTNER   |   | <b>CITROËN</b><br>C1 / C2 / C3 / C3 Pluriel / C4  | VKM 33064   | <b>PEUGEOT</b><br>206 / 307  |
| VKM 33035  | <b>CITROËN</b><br>EVASION / XANTIA I / XANTIA II<br>/ XM II / XSARA / ZX  | VKM 33044   | <b>FORD</b><br>FIESTA V / FOCUS C-MAX I /<br>FOCUS C-MAX II / FOCUS II /<br>FUSION                | VKM 33065   | <b>CITROËN</b><br>C4   |
|  | <b>FIAT</b><br>ULYSSE (220)   |   | <b>MAZDA</b><br>3   |   | <b>PEUGEOT</b><br>307 / 407  |
|  | <b>LANCIA</b><br>ZETA   |   | <b>PEUGEOT</b><br>1007 / 107 / 206 / 307  |   | <b>CITROËN</b><br>C4   |
| VKM 33037  | <b>PEUGEOT</b><br>306 / 405 II / 406 / 605 / 806  | VKM 33045   | <b>TOYOTA</b><br>AYGO   | VKM 33069   | <b>PEUGEOT</b><br>307  |
|  | <b>CITROËN</b><br>EVASION / XANTIA I / XANTIA II<br>/ XM II / XSARA / ZX  |   | <b>VOLVO</b><br>S40 II - V50  |   | <b>CITROËN</b><br>BERLINGO / C5 I / EVASION /<br>JUMPY I / JUMPY II / XANTIA II /<br>XSARA / XSARA PICASSO |
|  | <b>FIAT</b><br>ULYSSE (220)   |   | <b>CITROËN</b><br>BERLINGO / C1 / C2 / C3 / C3<br>Pluriel / C4 / C5 II / XSARA /<br>XSARA PICASSO |   | <b>FIAT</b><br>SCUDO (220) / ULYSSE (220)  |
| VKM 33038  | <b>LANCIA</b><br>ZETA   | VKM 33045   | <b>FORD</b><br>FIESTA V / FOCUS C-MAX I /<br>FOCUS C-MAX II / FOCUS II /<br>FUSION                | VKM 33073   | <b>LANCIA</b><br>ZETA  |
|  | <b>PEUGEOT</b><br>306 / 406 / 605 / 806   |   | <b>MAZDA</b><br>2 / 3   |   | <b>PEUGEOT</b><br>206 / 306 / 307 / 406 / 806 /<br>EXPERT I / PARTNER                                      |
|  | <b>CITROËN</b><br>XSARA / XSARA PICASSO   |   | <b>PEUGEOT</b><br>1007 / 107 / 206 / 307 / 407 /<br>PARTNER                                       |   | <b>CITROËN</b><br>C15  |
| VKM 33039  | <b>PEUGEOT</b><br>206   | VKM 33045   | <b>TOYOTA</b><br>AYGO   | VKM 33074   | <b>CITROËN</b><br>C2 / C3 / C3 Pluriel / C4  |
|  | <b>CITROËN</b><br>SAXO  |   | <b>VOLVO</b><br>S40 II - V50  |   | <b>PEUGEOT</b><br>1007 / 207 / 207 CC / 207 SW /<br>307  |
|  | <b>PEUGEOT</b><br>106 II  |   | <b>CITROËN</b><br>C5 I / C5 II / C8   |   | <b>CITROËN</b><br>C5 I / C5 II / C8  |
| VKM 33040  | <b>CITROËN</b><br>AX / SAXO / XSARA   | VKM 33045   | <b>FIAT</b><br>ULYSSE (179AX)   | VKM 33075   | <b>FIAT</b><br>ULYSSE (179AX)  |
|  | <b>NISSAN</b><br>MICRA  |   | <b>LANCIA</b><br>PHEDRA   |   | <b>LANCIA</b><br>PHEDRA  |
|  | <b>PEUGEOT</b><br>106 I / 106 II  |   | <b>PEUGEOT</b><br>406 / 607 / 807   |   | <b>PEUGEOT</b><br>406 / 407 / 607 / 807  |
| VKM 33040  | <b>CITROËN</b><br>XANTIA I / ZX   | VKM 33060   | <b>CITROËN</b><br>BERLINGO / C3 / XSARA /<br>XSARA PICASSO  | VKM 33082   | <b>RENAULT</b><br>AVANTIME / CLIO II / LAGUNA I /<br>LAGUNA II   |
|  | <b>PEUGEOT</b><br>306 / 405 II  |   | <b>FORD</b><br>FIESTA V / FUSION  |   | <b>PEUGEOT</b><br>205  |
|  |   |   |   |   | <b>CITROËN</b><br>XM II  |

|  |                |  |    |  |                                  |
|---|---|---|--|---|---|
| VKM 33086   | <b>PEUGEOT</b><br>605   | VKM 34004   | <b>FORD</b><br>ESCORT BOX 95 / ESCORT V /<br>ESCORT VI / ESCORT VII /<br>FIESTA BOX / COURRIER /<br>FIESTA III / FIESTA IV | VKM 34030   | <b>VAUXHALL</b><br>ASTRA Mk IV / SIGNUM /<br>VECTRA Mk I / VECTRA Mk II /<br>VX 220 / ZAFIRA Mk I / ZAFIRA<br>Mk II |
| VKM 33090   | <b>CITROËN</b><br>XM II   | VKM 34005   | <b>FORD</b><br>ESCORT BOX 95 / ESCORT VII /<br>FIESTA IV   | VKM 34031   | <b>CITROËN</b><br>JUMPER  |
| VKM 33091   | <b>PEUGEOT</b><br>605   | VKM 34007   | <b>MAZDA</b><br>121 (JASM, JBSM)   | VKM 34032   | <b>FIAT</b><br>DUCATO   |
| VKM 33100   | <b>CITROËN</b><br>BX  | VKM 34008   | <b>FORD</b><br>FIESTA BOX / COURRIER /<br>FIESTA IV / PUMA   | VKM 34033   | <b>FORD</b><br>MONDEO III / TRANSIT /<br>TRANSIT TOURNEO  |
| VKM 33101   | <b>PEUGEOT</b><br>205 / 309 / 405 I   | VKM 34009   | <b>MAZDA</b><br>121 (JASM, JBSM)   | VKM 34034   | <b>PEUGEOT</b><br>BOXER III   |
| VKM 33125   | <b>CITROËN</b><br>BERLINGO / XSARA / XSARA<br>PICASSO   | VKM 34010   | <b>FORD</b><br>FIESTA BOX / COURRIER /<br>FIESTA IV / PUMA   | VKM 34040   | <b>FORD</b><br>MONDEO III / TRANSIT   |
| VKM 33311   | <b>PEUGEOT</b><br>206 / PARTNER   | VKM 34012   | <b>MAZDA</b><br>121 (JASM, JBSM)   | VKM 34042   | <b>FORD</b><br>MONDEO III / TRANSIT   |
| VKM 33314   | <b>CITROËN</b><br>JUMPER (230)  | VKM 34013   | <b>FORD</b><br>PUMA  | VKM 34043   | <b>FORD</b><br>FIESTA IV / FIESTA V / KA  |
| VKM 33320   | <b>FIAT</b><br>SCUDO (220)  | VKM 34014   | <b>FORD</b><br>COUGAR / FOCUS I / MAVERICK<br>/ MONDEO II / TRANSIT<br>CONNECT / TOURNEO<br>CONNECT                        | VKM 34046   | <b>MAZDA</b><br>121 (JASM, JBSM)  |
| VKM 34002   | <b>PEUGEOT</b><br>206 / 306 / 406 / 605 / 806 /<br>EXPERT I / PARTNER                           | VKM 34018   | <b>FORD</b><br>GALAXY I  | VKM 34047   | <b>FORD</b><br>MONDEO I / MONDEO II   |
| VKM 34003   | <b>CITROËN</b><br>JUMPER (230) / JUMPER (244)   | VKM 34023   | <b>FORD</b><br>ESCORT BOX 91 / ESCORT BOX<br>95 / ESCORT V / ESCORT VI /<br>ESCORT VII / ORION III                         | VKM 34048   | <b>FORD</b><br>MONDEO I / MONDEO II   |
|   | <b>FIAT</b><br>DUCATO (230)   | VKM 34025   | <b>FORD</b><br>FOCUS C-MAX I / FOCUS C-<br>MAX II / FOCUS II   | VKM 34051   | <b>FORD</b><br>MONDEO I / MONDEO II   |
|   | <b>PEUGEOT</b><br>BOXER I / BOXER II  | VKM 34027   | <b>VOLVO</b><br>S40 II - V50   | VKM 34052   | <b>FORD</b><br>SCORPIO / TRANSIT  |
|   | <b>CITROËN</b><br>C4 / C5 II / C8   | VKM 34028   | <b>FORD</b><br>FOCUS I   | VKM 34056   | <b>FORD</b><br>MONDEO I / MONDEO II   |
|   | <b>FORD</b><br>FOCUS C-MAX I / FOCUS C-<br>MAX II / FOCUS II / GALAXY II /<br>MONDEO IV / S-MAX | VKM 34029   | <b>SAAB</b><br>9-3 I / 9-5   | VKM 34061   | <b>FORD</b><br>FIESTA V / MONDEO III /<br>TRANSIT   |
|   | <b>LANCIA</b><br>PHEDRA   | VKM 34030   | <b>FORD</b><br>MONDEO III / TRANSIT  | VKM 34071   | <b>FORD</b><br>GALAXY II / MONDEO III /<br>MONDEO IV / S-MAX /<br>TRANSIT   |
|   | <b>PEUGEOT</b><br>307 / 407 / 607 / 807 /<br>EXPERT II / EXPERT Tepee                           | VKM 34031   | <b>ALFA ROMEO</b><br>159 / BRERA / SPIDER  |   | <b>FORD</b><br>ESCORT V / ESCORT VI /<br>ESCORT VII / ORION III   |
|   | <b>VOLVO</b><br>S40 II - V50  | VKM 34032   | <b>FIAT</b><br>CROMA (194)   |   | <b>FORD</b><br>ESCORT V / ESCORT VI /<br>ESCORT VII / FIESTA III / ORION<br>III                                     |
|   | <b>FORD</b><br>FIESTA III / P 100 II / SIERRA   | VKM 34033   | <b>OPEL</b><br>ASTRA G / SIGNUM /<br>SPEEDSTER / VECTRA B /<br>VECTRA C / ZAFIRA A / ZAFIRA<br>B                           |   | <b>FORD</b><br>TRANSIT  |
|   | <b>FORD</b><br>FIESTA III / P 100 II / SIERRA   | VKM 34034   | <b>SAAB</b><br>9-3 II  |   |   |









|           |   |           |   |           |   |
|-----------|---|-----------|---|-----------|---|
| VKM 34072 | <b>FORD</b><br>TRANSIT  | VKM 35009 | <b>OPEL</b><br>ASTRA F / ASTRA F CLASSIC /<br>ASTRA G / ASTRA H / CALIBRA /<br>COMBO A / CORSA B /<br>FRONTERA A / FRONTERA B /<br>OMEGA B / SINTRA / SPEED-<br>STER / TIGRA / VECTRA A /<br>VECTRA B / ZAFIRA A / ZAFIRA<br>B      | VKM 35025 | <b>OPEL</b><br>AGILA B / ASTRA H / COMBO B<br>/ CORSA C / CORSA D / MERIVA<br>/ TIGRA Twin Top            |
| VKM 34102 | <b>FORD</b><br>TRANSIT CONNECT / TOURNEO<br>CONNECT   |           | <b>VAUXHALL</b><br>ASTRA Mk III / ASTRA Mk IV /<br>ASTRA Mk V / CALIBRA /<br>CAVALIER Mk III / COMBO I /<br>CORSA Mk I / FRONTERA Mk I /<br>FRONTERA Mk II / OMEGA /<br>SINTRA / TIGRA Mk I / VECTRA<br>Mk I / VX 220 / ZAFIRA Mk I |           | <b>VAUXHALL</b><br>ASTRA Mk V / CORSA Mk II /<br>CORSA Mk III / TIGRA Mk II                               |
| VKM 34107 | <b>FORD</b><br>FIESTA BOX / COURRIER /<br>FIESTA IV / FOCUS I / TRANSIT<br>CONNECT / TOURNEO CON-<br>NECT                     |           | <b>OPEL</b><br>ASTRA F / COMBO A / CORSA B<br>/ TIGRA   |           | <b>OPEL</b><br>ASTRA G / ASTRA H / COMBO B<br>/ CORSA B / CORSA C / MERIVA                                |
| VKM 34108 | <b>FORD</b><br>FOCUS I / TRANSIT CONNECT /<br>TOURNEO CONNECT   | VKM 35011 | <b>OPEL</b><br>ASTRA G / ASTRA H / COMBO B<br>/ CORSA C / MERIVA / SIGNUM /<br>TIGRA Twin Top / VECTRA C /<br>ZAFIRA A  | VKM 35212 | <b>VAUXHALL</b><br>ASTRA Mk IV / ASTRA Mk V /<br>COMBO II / CORSA Mk II /<br>MERIVA                       |
| VKM 34110 | <b>FORD</b><br>FOCUS C-MAX I / FOCUS II   | VKM 35012 | <b>OPEL</b><br>ASTRA G / ASTRA H / COMBO B<br>/ CORSA C / MERIVA / SIGNUM /<br>TIGRA Twin Top / VECTRA C /<br>ZAFIRA A  |           | <b>OPEL</b><br>SIGNUM / VECTRA C  |
| VKM 34111 | <b>FORD</b><br>FIESTA BOX / COURRIER /<br>FIESTA IV / FOCUS C-MAX I /<br>FOCUS II / GALAXY II / MONDEO<br>IV / S-MAX          |           | <b>SAAB</b><br>9-3 II   | VKM 35214 | <b>RENAULT</b><br>ESPACE IV / VEL SATIS   |
| VKM 34500 | <b>SAAB</b><br>9000   |           | <b>VAUXHALL</b><br>ASTRA Mk IV / ASTRA Mk V /<br>COMBO II / CORSA Mk II /<br>MERIVA / TIGRA Mk II / VECTRA<br>Mk II / ZAFIRA Mk I   |           | <b>VAUXHALL</b><br>SIGNUM / VECTRA Mk II  |
| VKM 34501 | <b>SAAB</b><br>900 II / 9-3 I / 9-5   | VKM 35013 | <b>OPEL</b><br>AGILA B / ASTRA G / ASTRA H /<br>COMBO B / CORSA B / CORSA C<br>/ CORSA D / MERIVA / TIGRA<br>Twin Top   |           | <b>OPEL</b><br>SIGNUM / VECTRA C  |
| VKM 34502 | <b>SAAB</b><br>900 II / 9000 / 9-5  |           | <b>VAUXHALL</b><br>AGILA / ASTRA Mk IV / ASTRA<br>Mk V / COMBO II / CORSA Mk I /<br>CORSA Mk II / CORSA Mk III /<br>MERIVA / TIGRA Mk II  | VKM 35216 | <b>RENAULT</b><br>ESPACE IV / VEL SATIS   |
| VKM 34510 | <b>SAAB</b><br>9-3 I / 9-5  |           | <b>VAUXHALL</b><br>AGILA / ASTRA Mk IV / ASTRA<br>Mk V / COMBO II / CORSA Mk I /<br>CORSA Mk II / CORSA Mk III /<br>MERIVA / TIGRA Mk II  |           | <b>VAUXHALL</b><br>SIGNUM / VECTRA Mk II  |
| VKM 35002 | <b>OPEL</b><br>ASTRA F / COMBO A / CORSA B<br>/ TIGRA   | VKM 35015 | <b>OPEL</b><br>ASTRA G / ASTRA H / COMBO B<br>/ CORSA B / CORSA C / MERIVA  | VKM 35260 | <b>OPEL</b><br>ASTRA G / ASTRA H / CORSA D<br>/ MERIVA / SIGNUM / VECTRA C<br>/ ZAFIRA B                  |
| VKM 35007 | <b>VAUXHALL</b><br>ASTRA Mk III / CORSA Mk I  |           | <b>VAUXHALL</b><br>ASTRA Mk IV / ASTRA Mk V /<br>COMBO II / CORSA Mk II /<br>MERIVA   |           | <b>VAUXHALL</b><br>ASTRA Mk V / ASTRA TwinTop /<br>CORSA Mk III / MERIVA /<br>VECTRA Mk II / ZAFIRA Mk II |
| VKM 35007 | <b>OPEL</b><br>ASTRA G / FRONTERA B /<br>OMEGA B / SIGNUM / SINTRA /<br>VECTRA B / VECTRA C / ZAFIRA<br>A                     | VKM 35016 | <b>OPEL</b><br>ASTRA G / SIGNUM / SPEED-<br>STER / VECTRA C / ZAFIRA A  | VKM 35500 | <b>OPEL</b><br>CALIBRA / OMEGA B / SIGNUM<br>/ SINTRA / VECTRA A / VECTRA<br>B / VECTRA C                 |
| VKM 35007 | <b>SAAB</b><br>9-3 I / 9-3 II / 9-5   |           | <b>VAUXHALL</b><br>ASTRA Mk IV / SIGNUM /<br>VECTRA Mk II / VX 220 / ZAFIRA<br>Mk I   |           | <b>SAAB</b><br>9-5  |
| VKM 35007 | <b>VAUXHALL</b><br>ASTRA Mk IV / FRONTERA Mk II<br>/ OMEGA / SIGNUM / SINTRA /<br>VECTRA Mk I / VECTRA Mk II /<br>ZAFIRA Mk I | VKM 35023 | <b>FIAT</b><br>GRANDE PUNTO   | VKM 36001 | <b>RENAULT</b><br>SAFRANE I   |
| VKM 35008 | <b>OPEL</b><br>ASTRA F / ASTRA F CLASSIC /<br>COMBO A / CORSA B / VECTRA<br>A / VECTRA B                                      |           |   | VKM 36002 | <b>RENAULT</b><br>CLIO I / EXPRESS/EXTRA/<br>RAPID  |
| VKM 35008 | <b>VAUXHALL</b><br>ASTRA Mk III / CAVALIER Mk III /<br>COMBO I / CORSA Mk I /<br>VECTRA Mk I                                  |           |   |           |   |







|   |   |   |  |   |   |
|---|---|---|--|---|---|
|  |  |  |    |  |                          |
| VKM 36003   | <b>RENAULT</b><br>LAGUNA I / SAFRANE II   | VKM 36025   | <b>RENAULT</b><br>CLIO II / KANGOO / THALIA  | VKM 36050   | <b>VAUXHALL</b><br>VIVARO   |
| VKM 36004   | <b>VOLVO</b><br>850 / 960 / C70 - S70 / V70 I                                     | VKM 36026   | <b>RENAULT</b><br>ESPACE III / LAGUNA I /<br>SAFRANE II  | VKM 36052   | <b>NISSAN</b><br>ALMERA / MICRA   |
| VKM 36005   | <b>RENAULT</b><br>TWINGO  | VKM 36030   | <b>NISSAN</b><br>INTERSTAR / PRIMASTAR   | VKM 36053   | <b>RENAULT</b><br>CLIO II / MEGANE II / MODUS /<br>SCENIC II / GRAND SCENIC /<br>THALIA                     |
| VKM 36006   | <b>RENAULT</b><br>MEGANE I / SCENIC I   | VKM 36031   | <b>OPEL</b><br>VIVARO  | VKM 36070   | <b>NISSAN</b><br>ALMERA / MICRA   |
| VKM 36007   | <b>RENAULT</b><br>CLIO I / ESPACE III / LAGUNA I /<br>MEGANE I / SCENIC I         | VKM 36032   | <b>RENAULT</b><br>AVANTIME / ESPACE IV /<br>LAGUNA I / LAGUNA II /<br>MASTER II / TRAFIC II / VEL<br>SATIS   | VKM 36072   | <b>RENAULT</b><br>CLIO II / CLIO III / KANGOO /<br>MEGANE II / MODUS / SCENIC II<br>/ GRAND SCENIC / THALIA |
| VKM 36008   | <b>RENAULT</b><br>TWINGO  | VKM 36033   | <b>VAUXHALL</b><br>VIVARO  | VKM 36075   | <b>NISSAN</b><br>ALMERA / MICRA   |
| VKM 36009   | <b>RENAULT</b><br>LAGUNA I  | VKM 36034   | <b>VOLVO</b><br>S40 I - V40  | VKM 36080   | <b>RENAULT</b><br>CLIO II / CLIO III / KANGOO /<br>MEGANE II / MODUS / SCENIC II<br>/ GRAND SCENIC / THALIA |
| VKM 36010   | <b>RENAULT</b><br>TWINGO  | VKM 36035   | <b>DACIA</b><br>LOGAN  | VKM 36082   | <b>RENAULT</b><br>MASTER II   |
| VKM 36011   | <b>RENAULT</b><br>LAGUNA I  | VKM 36038   | <b>NISSAN</b><br>INTERSTAR / PRIMASTAR   | VKM 36091   | <b>RENAULT</b><br>CLIO II   |
| VKM 36012   | <b>RENAULT</b><br>R19   | VKM 36040   | <b>OPEL</b><br>VIVARO  | VKM 36120   | <b>RENAULT</b><br>CLIO III / MEGANE II / SCENIC II<br>/ GRAND SCENIC  |
| VKM 36013   | <b>RENAULT</b><br>CLIO I / R19 / SUPER 5  | VKM 36042   | <b>RENAULT</b><br>AVANTIME / CLIO II / ESPACE III<br>/ KANGOO / LAGUNA I /<br>LAGUNA II / MASTER II /<br>MEGANE I / SCENIC I / THALIA /<br>TRAFIC II | VKM 36122   | <b>RENAULT</b><br>MEGANE I  |
| VKM 36014   | <b>RENAULT</b><br>R19   | VKM 36044   | <b>VAUXHALL</b><br>VIVARO  | VKM 36124   | <b>RENAULT</b><br>CLIO II / KANGOO  |
| VKM 36016   | <b>RENAULT</b><br>CLIO II / ESPACE III / LAGUNA I /<br>MEGANE I / SCENIC I        | VKM 36046   | <b>VOLVO</b><br>S40 I - V40  | VKM 36126   | <b>RENAULT</b><br>CLIO II / KANGOO  |
| VKM 36017   | <b>VOLVO</b><br>S40 I - V40   | VKM 36048   | <b>VOLVO</b><br>S40 I - V40  | VKM 36128   | <b>RENAULT</b><br>CLIO II / KANGOO  |
| VKM 36018   | <b>OPEL</b><br>MOVANO   | VKM 36050   | <b>RENAULT</b><br>ESPACE III / LAGUNA I /<br>MEGANE I / SCENIC I   | VKM 36130   | <b>RENAULT</b><br>CLIO II / KANGOO  |
| VKM 36019   | <b>RENAULT</b><br>MASTER II   | VKM 36052   | <b>VOLVO</b><br>S40 I - V40  | VKM 36132   | <b>DACIA</b><br>LOGAN   |
| VKM 36020   | <b>VAUXHALL</b><br>MOVANO   | VKM 36054   | <b>RENAULT</b><br>ESPACE III / LAGUNA I /<br>MEGANE I / SCENIC I   | VKM 36134   | <b>RENAULT</b><br>CLIO II / KANGOO / LAGUNA I /<br>LAGUNA II / MEGANE I / SCENIC<br>I / THALIA              |
| VKM 36021   | <b>RENAULT</b><br>MEGANE I  | VKM 36056   | <b>VOLVO</b><br>S40 I - V40  | VKM 36136   | <b>RENAULT</b><br>CLIO II / KANGOO / LAGUNA I /<br>LAGUNA II / MEGANE I / SCENIC<br>I / THALIA              |
| VKM 36022   | <b>VOLVO</b><br>S40 I - V40   | VKM 36058   | <b>RENAULT</b><br>ESPACE III / MEGANE I / SCENIC<br>I  | VKM 36138   | <b>RENAULT</b><br>LAGUNA I / SAFRANE II   |
| VKM 36023   | <b>RENAULT</b><br>ESPACE III / LAGUNA I /<br>SAFRANE II                           | VKM 36060   | <b>OPEL</b><br>VIVARO  | VKM 36140   | <b>VOLVO</b><br>850 / 960 / C70 - S70 / V70 I   |
| VKM 36024   | <b>NISSAN</b><br>KUBISTAR   | VKM 36062   | <b>RENAULT</b><br>ESPACE IV / LAGUNA II /<br>MASTER II / TRAFIC II / VEL<br>SATIS  | VKM 36142   | <b>VOLVO</b><br>S40 I - V40   |
| VKM 36025   | <b>RENAULT</b><br>CLIO I / CLIO II / KANGOO /<br>THALIA / TWINGO                  | VKM 36064   | <b>VAUXHALL</b><br>VIVARO  | VKM 36144   | <b>VOLVO</b><br>S40 I - V40   |
| VKM 36026   | <b>RENAULT</b><br>ESPACE III / LAGUNA I /<br>SAFRANE II                           | VKM 36066   | <b>OPEL</b><br>VIVARO  | VKM 36146   | <b>VOLVO</b><br>S60 / S80 / V70 II / XC70 I /<br>XC90   |
| VKM 36027   | <b>NISSAN</b><br>KUBISTAR   | VKM 36068   | <b>RENAULT</b><br>AVANTIME / ESPACE III /<br>ESPACE IV / LAGUNA II /<br>MASTER II / TRAFIC II / VEL<br>SATIS   | VKM 36148   | <b>VOLVO</b><br>S60 / S80 / V70 II / XC70 I /<br>XC90   |
| VKM 36028   | <b>RENAULT</b><br>CLIO I / CLIO II / KANGOO /<br>THALIA / TWINGO                  | VKM 36070   | <b>RENAULT</b><br>AVANTIME / ESPACE III /<br>ESPACE IV / LAGUNA II /<br>MASTER II / TRAFIC II / VEL<br>SATIS   | VKM 36150   | <b>FORD</b><br>FOCUS II   |















|           |   |           |  |           |  |
|-----------|---|-----------|--|-----------|--|
| VKM 36238 | <b>VOLVO</b><br>C30 / C70 - S70 / S40 II - V50<br><hr/> <b>FORD</b><br>FOCUS II<br><hr/> <b>VOLVO</b><br>C30 / C70 - S70 / S40 II - V50   | VKM 38001 | <b>MERCEDES-BENZ</b><br>(W 124) / 190 (W201) / C-class (W202) / E-class (W124) / E-class (W210) / G-class (W460) / G-class (W461) / G-class (W463) / S-class (W140) / V-class (W638) / VITO (W638)<br><hr/> <b>VW</b><br>LT II                                       | VKM 38020 | <b>MERCEDES-BENZ</b><br>C-class (W202) / C-class (W203) / C-class (W204) / CLK (W209) / E-class (W210) / E-class (W211) / M-class (W163) / S-class (W220) / SPRINTER 2-t (W901 / W902) / SPRINTER 3-t (W903) / SPRINTER 4-t (W904) / V-class (W638) / VIANO (W639) / VITO (W638)                         |
| VKM 36240 | <b>VOLVO</b><br>C70 - S70 / S40 I - V40 / S60 / S80 / V70 I / V70 II / XC70 I   | VKM 38002 | <b>MERCEDES-BENZ</b><br>G-class (W461)   | VKM 38022 | <b>MERCEDES-BENZ</b><br>(W 124) / C-class (W202) / C-class (W203) / CLK (W208) / E-class (W124) / E-class (W210) / M-class (W163) / SLK (R170) / SPRINTER 2-t (W901 / W902) / SPRINTER 3-t (W903) / SPRINTER 4-t (W904) / V-class (W638) / VITO (W638)   |
| VKM 36250 | <b>VOLVO</b><br>C70 - S70 / S40 I - V40 / S60 / S80 / V70 I / V70 II / XC70 I   | VKM 38003 | <b>BMW</b><br>3 (E36) / 3 (E46) / 3 Compact (E36) / 3 Compact (E46) / 3 Convertible (E36) / 3 Convertible (E46) / 3 Coupe (E36) / 3 Coupe (E46) / 3 Touring (E36) / 3 Touring (E46) / 5 (E34) / 5 (E39) / 5 Touring (E34) / 5 Touring (E39) / 7 (E38) / X5 / Z3      | VKM 38023 | <b>MERCEDES-BENZ</b><br>E-class (W211)   |
| VKM 36530 | <b>VOLVO</b><br>850 / C70 - S70 / S80 / V70 I / V70 II  | VKM 38004 | <b>BMW</b><br>3 (E36) / 3 (E46) / 3 Compact (E36) / 3 Compact (E46) / 3 Convertible (E36) / 3 Convertible (E46) / 3 Coupe (E36) / 3 Coupe (E46) / 3 Touring (E36) / 3 Touring (E46) / 5 (E34) / 5 (E39) / 5 Touring (E34) / 5 Touring (E39) / 7 (E38) / X3 / X5 / Z3 | VKM 38026 | <b>MERCEDES-BENZ</b><br>C-class (W202) / C-class (W203) / CLK (W208) / CLK (W209) / E-class (W210) / E-class (W211) / G-class (W463) / M-class (W163) / M-CLASS (W164) / R-class (W251) / S-class (W215) / S-class (W220) / SL (W129) / SL (W230) / SLK (R170) / SLK (R171) / VIANO (W639) / VITO (W639) |
| VKM 37002 | <b>ROVER</b><br>800   | VKM 38007 | <b>BMW</b><br>3 (E36) / 3 (E46) / 3 Compact (E36) / 3 Compact (E46) / 3 Convertible (E36) / 3 Convertible (E46) / 3 Coupe (E36) / 3 Coupe (E46) / 3 Touring (E36) / 3 Touring (E46) / 5 (E34) / 5 (E39) / 5 Touring (E34) / 5 Touring (E39) / 7 (E38) / X3 / X5 / Z3 | VKM 38027 | <b>MERCEDES-BENZ</b><br>(W 124) / C-class (W202) / C-class (W203) / CLK (W208) / E-class (W124) / E-class (W210) / M-class (W163) / SLK (R170) / SPRINTER 2-t (W901 / W902) / SPRINTER 3-t (W903) / SPRINTER 4-t (W904) / V-class (W638) / VITO (W638)   |
| VKM 37005 | <b>HONDA</b><br>ACCORD<br><hr/> <b>LAND ROVER</b><br>FREELANDER I<br><hr/> <b>MG</b><br>MG ZR / MG ZS<br><hr/> <b>ROVER</b><br>200 (RF) / 25 / 400 (RT) / 45 / 600 / STREETWISE | VKM 38008 | <b>BMW</b><br>3 (E36) / 3 (E46) / 3 Compact (E36) / 3 Compact (E46) / 3 Convertible (E36) / 3 Convertible (E46) / 3 Coupe (E36) / 5 (E34) / 5 (E39) / 5 Touring (E34) / 5 Touring (E39) / 7 (E38)  | VKM 38100 | <b>MERCEDES-BENZ</b><br>(W 124) / C-class (W202) / E-class (W124) / E-class (W210) / G-class (W463) / S-class (W140) / SL (W129)   |
| VKM 37010 | <b>LAND ROVER</b><br>FREELANDER I<br><hr/> <b>MG</b><br>MG ZR / MG ZS / MG ZT<br><hr/> <b>ROVER</b><br>200 (RF) / 200 coupe (RF) / 25 / 400 (RT) / 45 / 75 / STREETWISE         | VKM 38009 | <b>BMW</b><br>5 (E34)  | VKM 38202 | <b>BMW</b><br>3 (E36) / 3 (E46) / 3 Compact (E36) / 3 Compact (E46) / 3 Convertible (E36) / 3 Convertible (E46) / 3 Coupe (E36) / 3 Coupe (E46) / 3 Touring (E36) / 3 Touring (E46) / 5 (E34) / 5 (E39) / 5 (E60) / 5 Touring (E34) / 5 Touring (E39) / 7 (E38) / X3 / X5 / Z3                           |
| VKM 37011 | <b>LAND ROVER</b><br>FREELANDER I<br><hr/> <b>MG</b><br>MG ZT<br><hr/> <b>ROVER</b><br>75   | VKM 38011 | <b>BMW</b><br>3 (E36) / 3 (E46) / 3 Compact (E36) / 3 Compact (E46) / 3 Convertible (E36) / 3 Coupe (E36) / 3 Touring (E36) / 5 (E34) / 5 (E39) / 5 Touring (E34) / 5 Touring (E39) / 7 (E38)  |           |  |
| VKM 37014 | <b>MG</b><br>MG ZR<br><hr/> <b>ROVER</b><br>200 (RF) / 200 (XW) / 200 coupe (RF) / 25 / 400 (XW) / 45 / STREETWISE  | VKM 38012 | <b>MERCEDES-BENZ</b><br>(W 124) / 190 (W201) / E-class (W210) / G-class (W461) / S-class (W126)  |           |  |
| VKM 37015 | <b>MG</b><br>MG ZR / MGF / MGTF<br><hr/> <b>ROVER</b><br>200 (RF) / 200 coupe (RF) / 25 / STREETWISE  |           |  |           |  |







|  |   |  |                           |  |                               |
|---|--|---|---|---|--|
| VKM 38220   | <b>BMW</b><br>3 (E36) / 3 (E46) / 3 Compact (E36) / 3 Touring (E36) / 3 Touring (E46) / 5 (E34) / 5 (E39) / 5 Touring (E34) / 5 Touring (E39)    | VKM 61016   | <b>TOYOTA</b><br>AVENSIS / COROLLA VERSO  | VKM 71013   | <b>TOYOTA</b><br>CARINA / CELICA   |
| VKM 38221   | <b>BMW</b><br>3 (E36) / 3 (E46) / 3 Compact (E36) / 3 Convertible (E36) / 3 Coupe (E36) / 3 Coupe (E46) / 3 Touring (E36) / 3 Touring (E46) / Z3 | VKM 63000   | <b>HONDA</b><br>CIVIC   | VKM 71014   | <b>TOYOTA</b><br>4 RUNNER / HIACE / HILUX / LAND CRUISER / LAND CRUISER 90                                       |
| VKM 38225   | <b>BMW</b><br>3 (E36) / 3 Compact (E36) / 3 Touring (E36) / 5 (E34) / 5 (E39) / 5 Touring (E34) / 5 Touring (E39)                                | VKM 63001   | <b>HONDA</b><br>CIVIC / HR-V / LOGO   | VKM 71100   | <b>TOYOTA</b><br>AVENSIS / CAMRY / CARINA / COROLLA / CORONA / LITEACE / MASTERACE / PICNIC / SPRINTER / TOWNACE |
| VKM 38226   | <b>BMW</b><br>3 (E46) / 3 Coupe (E46) / 3 Touring (E46)  | VKM 63004   | <b>HONDA</b><br>ACCORD / CR-V / FR-V  | VKM 71101   | <b>TOYOTA</b><br>CAMRY / CARINA / CELICA / CORONA  |
| VKM 38230   | <b>BMW</b><br>3 (E36) / 3 Compact (E36) / 3 Convertible (E36) / 3 Coupe (E36) / 3 Touring (E36) / 5 (E34) / 5 Touring (E34) / Z3                 | VKM 64000   | <b>MAZDA</b><br>323 (BA) / 323 (BG)   | VKM 71103   | <b>TOYOTA</b><br>CRESSIDA  |
| VKM 38231   | <b>BMW</b><br>3 (E46) / 3 Compact (E46) / 3 Convertible (E46) / 3 Coupe (E46) / 3 Touring (E46) / 5 (E39) / 5 Touring (E39) / 7 (E38) / X5 / Z3  | VKM 65004   | <b>MITSUBISHI</b><br>LANCER   | VKM 71200   | <b>TOYOTA</b><br>COROLLA / STARLET   |
| VKM 38240   | <b>BMW</b><br>3 (E46) / 3 Touring (E46) / 5 (E39) / 5 Touring (E39) / X5   | VKM 65005   | <b>MITSUBISHI</b><br>LANCER   | VKM 71201   | <b>TOYOTA</b><br>COROLLA / CORONA / SPRINTER / STARLET / TERCEL  |
| VKM 38700   | <b>LAND ROVER</b><br>FREELANDER I / RANGE ROVER III  | VKM 67000   | <b>DAIHATSU</b><br>SIRION / TERIOS  | VKM 71202   | <b>DAIHATSU</b><br>CHARMANT  |
| VKM 61000   | <b>MG</b><br>MG ZT   | VKM 70000   | <b>CHEVROLET</b><br>AVEO  | VKM 71302   | <b>TOYOTA</b><br>CAMRY / CELICA / CORONA   |
| VKM 61002   | <b>ROVER</b><br>75   | VKM 70001   | <b>DAEWOO</b><br>AVEO / CIELO / ESPERO / KALOS / LACETTI / LANOS / LEMANS / NEXIA / NUBIRA / REZZO / TACUMA | VKM 71303   | <b>TOYOTA</b><br>AVENSIS / AVENSIS VERSO / COROLLA / COROLLA VERSO / PICNIC / PREVIA / RAV 4                     |
| VKM 61003   | <b>MINI</b><br>MINI  | VKM 70004   | <b>DAEWOO</b><br>REZZO / TACUMA   | VKM 71304   | <b>TOYOTA</b><br>CAMRY   |
| VKM 61009   | <b>TOYOTA</b><br>COROLLA   | VKM 71000   | <b>TOYOTA</b><br>STARLET  | VKM 71400   | <b>TOYOTA</b><br>CARINA / COROLLA / PASEO / SPRINTER / STARLET / TERCEL  |
| VKM 61011   | <b>TOYOTA</b><br>STARLET   | VKM 71001   | <b>TOYOTA</b><br>4 RUNNER / CRESSIDA / CROWN / DYNA / HIACE / HILUX / LAND CRUISER                          | VKM 71401   | <b>TOYOTA</b><br>CELICA / COROLLA / MR 2 / SPRINTER  |
|   |  | VKM 71002   | <b>TOYOTA</b><br>4 RUNNER / CRESSIDA / CROWN / DYNA / HIACE / HILUX / LAND CRUISER / MARK II                | VKM 71700   | <b>TOYOTA</b><br>CRESSIDA / CROWN / SUPRA  |
|   |  | VKM 71003   | <b>VW</b><br>TARO   | VKM 71701   | <b>TOYOTA</b><br>4 RUNNER / LAND CRUISER 90  |
|   |  | VKM 71004   | <b>TOYOTA</b><br>AVENSIS / CAMRY / CARINA / CELICA / CORONA / MARK II / MR 2 / PICNIC / RAV 4               | VKM 71704   | <b>TOYOTA</b><br>LAND CRUISER 100  |
|   |  | VKM 71006   | <b>TOYOTA</b><br>AVALON / CAMRY / LEXUS / PRONARD / WINDOM  | VKM 71705   | <b>TOYOTA</b><br>CRESTA / CROWN ESTATE / MARK II / SC400 / SOARER  |
|   |  | VKM 71007   | <b>TOYOTA</b><br>CARINA / CELICA / CORONA / MR 2  | VKM 72000   | <b>MAZDA</b><br>626 (GC)   |
|   |  | VKM 71010   | <b>TOYOTA</b><br>AVENSIS / CARINA / CELICA / COROLLA / CORONA / SPRINTER                                    |   | <b>NISSAN</b><br>CHERRY / EXA / LAUREL SPIRIT / MULTI / PRAIRIE / PULSAR / SENTRA / STANZA / SUNNY               |
|   |  | VKM 71012   | <b>TOYOTA</b><br>CROWN / MARK II / SUPRA  |   |  |
|   |  |   | <b>TOYOTA</b><br>COASTER / LAND CRUISER   |   |  |









|  |   |   |  |   |  |
|--|---|---|--|---|--|
|  |    |  |                                     |  |   |
| VKM 72004  | <b>NISSAN</b><br>300 ZX / CARAVAN / CEDRIC / CEFIRO / HOMOY VAN / LAUREL / LAUREL ALTIMA / MAXIMA / PATHFINDER / PATROL / PICKUP / QUEST / SAFARI / SKYLINE / TERRANO / URVAN | VKM 73005   | <b>HONDA</b><br>ACCORD / CIVIC / CIVIC CRX / CIVIC DEL SOL / CRX / HR-V / LOGO                                       | VKM 74006   | <b>MAZDA</b><br>929 (HC) / 929 (HD)  |
| VKM 72100  | <b>NISSAN</b><br>200 SX / BLUEBIRD / EXA / PULSAR / STANZA / SUNNY  | VKM 73006   | <b>HONDA</b><br>ACCORD / PRELUDE   | VKM 74007   | <b>MAZDA</b><br>323 (BJ) / 626 (GE) / 626 (GF) / 626 (GW) / PREMACY  |
| VKM 72200  | <b>NISSAN</b><br>BLUEBIRD / CEDRIC / PRAIRIE / PRAIRIE PRO / STANZA   | VKM 73007   | <b>HONDA</b><br>ACCORD / PRELUDE   | VKM 74008   | <b>MAZDA</b><br>929 (HC) / 929 (LV) / MPV  |
| VKM 72300  | <b>NISSAN</b><br>AD MAX VAN / CHERRY / PULSAR / SENTRA / STANZA / SUNNY   | VKM 73011   | <b>HONDA</b><br>ACCORD / ODYSSEY / PRELUDE / SHUTTLE   | VKM 74200   | <b>KIA</b><br>AVELLA / CAPITAL / PRIDE / RIO / SEPHIA  |
| VKM 72303  | <b>NISSAN</b><br>AD MAX VAN / AD WAGON / ALMERA / AVENIR / PRIMERA / PULSAR / SENTRA / SUNNY  | VKM 73101   | <b>ROVER</b><br>600  | VKM 74201   | <b>MAZDA</b><br>121 (DA) / 121 (DB) / 121 (JASM, JBSM) / 323 (BA) / 323 (BF) / 323 (BG) / 323 (BJ) / 323 (BW) / DEMIO (DW)   |
| VKM 72310  | <b>NISSAN</b><br>AD WAGON / ALMERA / AVENIR / PRIMERA / PULSAR / SENTRA / SUNNY / VANETTE CARGO   | VKM 73200   | <b>HONDA</b><br>BALLADE / BALLADE SPORTS / CIVIC / CIVIC PRO / CIVIC SHUTTLE / CRX / INTEGRA                         | VKM 74300   | <b>KIA</b><br>CAPITAL / SEPHIA   |
| VKM 72320  | <b>NISSAN</b><br>BLUEBIRD / CARAVAN / CHERRY VANETTE / HOMOY VAN / SERENA / STANZA / URVAN / VANETTE / VANETTE SERENA   | VKM 73201   | <b>ROVER</b><br>200 (XH)   | VKM 74310   | <b>MAZDA</b><br>323 (BA) / 323 (BG) / 323 (BJ) / EUNOS 500 / EUNOS ROADSTER (NA) / MIATA (NA) / MIATA (NB) / MX-3 (EC) / MX-5 (NA) / MX-5 (NB) / PROTÉGÉ / XEDOS 6 |
| VKM 72400  | <b>NISSAN</b><br>MARCH / MICRA  | VKM 73201   | <b>HONDA</b><br>ACCORD / PRELUDE   | VKM 74501   | <b>MAZDA</b><br>626 (GC)   |
| VKM 72500  | <b>NISSAN</b><br>LAUREL / PATROL / PATROL GR / SAFARI   | VKM 73605   | <b>HONDA</b><br>ACCORD / PRELUDE   | VKM 74502   | <b>MAZDA</b><br>626 (GD) / 626 (GE) / 626 (GV)   |
| VKM 72501  | <b>NISSAN</b><br>VANETTE CARGO  | VKM 73607   | <b>HONDA</b><br>ACCORD   | VKM 74503   | <b>MAZDA</b><br>929 (HB) / COSMO   |
| VKM 73000  | <b>HONDA</b><br>CIVIC / CIVIC DEL SOL / CIVIC PRO / CIVIC SHUTTLE / CONCERTO / CRX / INTEGRA  | VKM 74000   | <b>HONDA</b><br>CIVIC  | VKM 74504   | <b>KIA</b><br>CARENS   |
| VKM 73001  | <b>ROVER</b><br>200 (XW) / 200 cabriolet (XW) / 400 (XW)  | VKM 74001   | <b>MAZDA</b><br>323 (BA) / 626 (GE) / 929 (TA12) / EUNOS 500 / EUNOS 800 / MX-3 (EC) / MX-6 (GE) / XEDOS 6 / XEDOS 9 | VKM 74506   | <b>KIA</b><br>CARNIVAL / SEDONA  |
| VKM 73002  | <b>HONDA</b><br>LEGEND  | VKM 74002   | <b>KIA</b><br>CAPITAL / CONCORD  | VKM 74600   | <b>KIA</b><br>CARNIVAL / SEDONA  |
| VKM 73003  | <b>ROVER</b><br>800   | VKM 74004   | <b>MAZDA</b><br>626 (GC) / B-SERIE (UF) / E 1800 (SDX) / E 1800 (SRX) / E 2000, E 2200                               | VKM 74601   | <b>KIA</b><br>CONCORD / POTENTIA / SPORTAGE  |
| VKM 73004  | <b>HONDA</b><br>ACCORD / PRELUDE  | VKM 74005   | <b>MAZDA</b><br>323 (BJ) / 626 (GE) / 626 (GF) / 626 (GW) / MX-6 (GE) / PREMACY                                      | VKM 74602   | <b>MAZDA</b><br>626 (GD) / 626 (GV) / 929 (HC) / B-SERIE (UF) / B-SERIE (UN) / E 1800 (SDX) / E 1800 (SRW) / E 2000, E 2200 / MX-6 (GD)                            |
|  | <b>DAEWOO</b><br>ARCADIA  |   | <b>KIA</b><br>SPORTAGE   | VKM 74604   | <b>MAZDA</b><br>323 (BA) / 323 (BJ)  |
|  | <b>HONDA</b><br>LEGEND  |   | <b>MAZDA</b><br>B-SERIE (UF) / E 2000, E 2200  |   | <b>MAZDA</b><br>323 (BJ) / 626 (GF) / 626 (GW) / PREMACY   |
|  |   |   | <b>SUZUKI</b><br>ESCUDO / GRAND VITARA   |   | <b>FORD</b><br>RANGER  |
|  |   |   | <b>KIA</b><br>POTENTIA   |   | <b>MAZDA</b><br>B-SERIE (UN)   |

|  |                                  |  |   |  |   |
|---|---|---|---|---|--|
| VKM 74606   | <b>MAZDA</b><br>B-SERIE (UF)  |   | <b>MITSUBISHI</b><br>COLT / ECLIPSE / EXPO / EXPO-LRV / GALANT / L 200 / L 300 / LANCER / PAJERO / SANTAMO / SPACE RUNNER / SPACE WAGON                                 | VKM 75144   | <b>HYUNDAI</b><br>ELANTRA / LANTRA / SANTAMO / SONATA  |
| VKM 74607   | <b>MAZDA</b><br>6 (GG) / 6 (GY)   |   | <b>PROTON</b><br>PERDANA  | VKM 75601   | <b>MITSUBISHI</b><br>COLT / ECLIPSE / GALANT / LANCER / MIRAGE / SANTAMO   |
| VKM 74608   | <b>KIA</b><br>CARNIVAL / SEDONA   |   | <b>MITSUBISHI</b><br>COLT / GALANT / LANCER / SPACE RUNNER / SPACE WAGON  | VKM 75612   | <b>HYUNDAI</b><br>GALLOPER / GRACE / H-1 / H100 / PORTER / STAREX  |
| VKM 74609   | <b>KIA</b><br>CARNIVAL / SEDONA   | VKM 75054   | <b>MITSUBISHI</b><br>EXPO / EXPO-LRV / GALANT / L 200 / L 300 / OUTLANDER / SPACE WAGON   | VKM 75613   | <b>HYUNDAI</b><br>GALLOPER / GRACE / H-1 / H100 / PORTER / STAREX  |
| VKM 75000   | <b>MITSUBISHI</b><br>3000 GT / CHALLENGER / GALANT / MAGNA / MONTERO / PAJERO / PAJERO SPORT / SHOGUN / SIGMA     | VKM 75064   | <b>PROTON</b><br>PERDANA  | VKM 75614   | <b>MITSUBISHI</b><br>CHALLENGER / DELICA / GALANT / L 200 / L 300 / MONTERO / MONTERO SPORT / PAJERO / PAJERO CLASSIC / PAJERO SPORT |
| VKM 75001   | <b>MITSUBISHI</b><br>COLT / LANCER / MIRAGE   | VKM 75100   | <b>HYUNDAI</b><br>ELANTRA / EXCEL / LANTRA / PONY / S COUPE   | VKM 75615   | <b>MITSUBISHI</b><br>GALANT / OUTLANDER / SPACE WAGON  |
| VKM 75002   | <b>PROTON</b><br>SAGA / SATRIA / WIRA   | VKM 75101   | <b>MITSUBISHI</b><br>COLT / LANCER / MIRAGE / TREDIA  | VKM 75616   | <b>HYUNDAI</b><br>SANTA FE / SONATA / TRAJET   |
| VKM 75004   | <b>MITSUBISHI</b><br>COLT / EXPO-LRV / GALANT / LANCER / MIRAGE / SPACE RUNNER / SPACE WAGON                      | VKM 75108   | <b>PROTON</b><br>SAGA   | VKM 75621   | <b>KIA</b><br>SORENTO  |
| VKM 75006   | <b>PROTON</b><br>PERSONA / SATRIA / WIRA  | VKM 75113   | <b>MITSUBISHI</b><br>CHARIOT / COLT / CORDIA / DELICA / GALANT / L 200 / L 300 / LANCER / MIRAGE / SAPPORO / SPACE WAGON / TREDIA / TREDIA (NON-EUR/SIN) / TREDIA (SIN) | VKM 75624   | <b>MITSUBISHI</b><br>GALANT  |
| VKM 75008   | <b>HYUNDAI</b><br>SONATA  | VKM 75119   | <b>MITSUBISHI</b><br>COLT / CORDIA / DELICA / ECLIPSE / GALANT / L 200 / L 300 / LANCER / MIRAGE / SPACE WAGON / TREDIA / TREDIA (EUR) / TREDIA (NON-EUR/SIN)           | VKM 75625   | <b>MITSUBISHI</b><br>GALANT  |
| VKM 75009   | <b>MITSUBISHI</b><br>DIAMANTE / GALANT / L 200 / MONTERO / PAJERO / SIGMA   | VKM 75130   | <b>HYUNDAI</b><br>GRACE   | VKM 75629   | <b>HYUNDAI</b><br>AMICA / ATOS / ATOS PRIME / GETZ   |
| VKM 75033   | <b>HYUNDAI</b><br>ACCENT / COUPE / ELANTRA / EXCEL / GETZ / LANTRA / MATRIX / PONY / S COUPE / VERNA              | VKM 75140   | <b>MITSUBISHI</b><br>COLT / GALANT / LANCER / PAJERO / SANTAMO / SPACE WAGON / STARION  | VKM 75630   | <b>KIA</b><br>PICANTO / VISTO  |
| VKM 75044   | <b>HYUNDAI</b><br>H-1 / H100 / SANTAMO / SONATA   |   | <b>PROTON</b><br>WIRA   | VKM 75633   | <b>MITSUBISHI</b><br>GALANT  |
|   | <b>MITSUBISHI</b><br>GALANT / L 200 / L 300 / PAJERO / SANTAMO / SPACE WAGON / STARION                            |   | <b>VOLVO</b><br>S40 I - V40   |   | <b>MITSUBISHI</b><br>GALANT  |
|   | <b>HYUNDAI</b><br>GRACE / H-1 / H100 / SONATA   |   | <b>HYUNDAI</b><br>ELANTRA / GETZ / LANTRA / MATRIX / SANTA FE / TRAJET  |   | <b>MITSUBISHI</b><br>COLT / LANCER   |
|   | <b>MITSUBISHI</b><br>CORDIA / GALANT / L 200 / L 300 / LANCER / PAJERO / SAPPORO / SPACE WAGON / STARION / TREDIA |   | <b>HYUNDAI</b><br>ELANTRA / GETZ / LANTRA / MATRIX  |   | <b>MITSUBISHI</b><br>CARISMA / COLT / GALANT / LANCER  |
|   | <b>HYUNDAI</b><br>ELANTRA / LANTRA / SANTAMO / SONATA   |   | <b>HYUNDAI</b><br>COUPE / ELANTRA / LANTRA / TRAJET   |   | <b>HYUNDAI</b><br>SANTA FE / SONATA / TRAJET   |







|  |                                   |  |                                     |  |   |
|--|--|---|--|---|--|
|  | <b>KIA</b><br>SORENTO  | <b>VKM 78105</b>  | <b>SUBARU</b><br>JUSTY   | <b>VKM 81005</b>  | <b>TOYOTA</b><br>CELSIOR / CROWN / LAND<br>CRUISER / LAND CRUISER 100<br>/ LEXUS   |
| <b>VKM 75634</b>   | <b>MITSUBISHI</b><br>COLT  | <b>VKM 79000</b>  | <b>HONDA</b><br>PASSPORT   | <b>VKM 81100</b>  | <b>TOYOTA</b><br>AVENSIS / CAMRY / CARINA /<br>COROLLA / CORONA / LITEACE<br>/ MASTERACE / PICNIC /<br>SPRINTER / TOWNACE      |
| <b>VKM 76001</b>   | <b>SUZUKI</b><br>ALTO / BALENO / CARRY /<br>ESCUDO / GRAND VITARA /<br>SE416 / SWIFT / VITARA /<br>WAGON R+ / X-90 | <b>VKM 79001</b>  | <b>ISUZU</b><br>AMIGO / FASTER / PICKUP /<br>RODEO / TROOPER   | <b>VKM 81201</b>  | <b>TOYOTA</b><br>COROLLA / SPRINTER /<br>STARLET / TERCEL  |
| <b>VKM 76102</b>   | <b>CHEVROLET</b><br>MATIZ / SPARK  |   | <b>ISUZU</b><br>AMIGO / FARGO / FASTER /<br>IMPULSE / PICKUP / RODEO /<br>TROOPER                                    | <b>VKM 81203</b>  | <b>TOYOTA</b><br>COROLLA / STARLET   |
|  | <b>DAEWOO</b><br>DAMAS / FINO / LABO / MATIZ /<br>MICA / TICO  | <b>VKM 79002</b>  | <b>OPEL</b><br>CAMPO   | <b>VKM 81204</b>  | <b>TOYOTA</b><br>AVENSIS / AVENSIS VERSO /<br>COROLLA / COROLLA VERSO /<br>PICNIC / PREVIA / RAV 4                             |
| <b>VKM 76103</b>   | <b>SUZUKI</b><br>CAPPUCINO / CARRY / EVERY   |   | <b>VAUXHALL</b><br>BRAVA   | <b>VKM 81400</b>  | <b>TOYOTA</b><br>CARINA / COROLLA / PASEO /<br>SPRINTER / STARLET / TERCEL   |
| <b>VKM 76200</b>   | <b>SUZUKI</b><br>ALTO / CARRY / CERVO /<br>FRONTE / JIMNY / SB308  |   | <b>ISUZU</b><br>FASTER / TROOPER   | <b>VKM 81401</b>  | <b>TOYOTA</b><br>4 RUNNER / LAND CRUISER 90  |
| <b>VKM 76202</b>   | <b>SUZUKI</b><br>CULTUS / SWIFT  | <b>VKM 79003</b>  | <b>OPEL</b><br>CAMPO / FRONTERA A /<br>MONTEREY B  | <b>VKM 82000</b>  | <b>NISSAN</b><br>300 ZX  |
| <b>VKM 76203</b>   | <b>SUZUKI</b><br>FORSA / SAMURAI / SE416 /<br>SIDEKICK / SPRINT / SWIFT /<br>VITARA                                |   | <b>VAUXHALL</b><br>BRAVA / FRONTERA Mk I /<br>MONTEREY   | <b>VKM 82101</b>  | <b>NISSAN</b><br>200 SX / BLUEBIRD / EXA /<br>LAUREL SPIRIT / PULSAR /<br>STANZA / SUNNY                                       |
| <b>VKM 76203</b>   | <b>SUZUKI</b><br>CULTUS / FORSA / SF310 /<br>SWIFT   |   | <b>ISUZU</b><br>FASTER / KB / PICKUP / RODEO<br>/ TROOPER  | <b>VKM 82300</b>  | <b>NISSAN</b><br>CHERRY / PULSAR / SENTRA /<br>STANZA / SUNNY  |
| <b>VKM 77100</b>   | <b>DAIHATSU</b><br>CHARADE / HIJET   |   | <b>OPEL</b><br>CAMPO   | <b>VKM 82302</b>  | <b>NISSAN</b><br>AD MAX VAN / AD WAGON /<br>ALMERA / AVENIR / PRIMERA /<br>PULSAR / SENTRA / SUNNY                             |
| <b>VKM 77300</b>   | <b>DAIHATSU</b><br>CHARADE / HIJET   | <b>VKM 80000</b>  | <b>VAUXHALL</b><br>BRAVA   | <b>VKM 82320</b>  | <b>NISSAN</b><br>BLUEBIRD / CARAVAN /<br>CHERRY VANETTE / HOMOY VAN<br>/ SERENA / STANZA / URVAN /<br>VANETTE / VANETTE SERENA |
| <b>VKM 77401</b>   | <b>DAIHATSU</b><br>CUORE / DOMINO / HANDI /<br>HIJET / MIRA / MOVE   |   | <b>CHEVROLET</b><br>AVEO   | <b>VKM 82500</b>  | <b>NISSAN</b><br>LAUREL / PATROL / PATROL GR<br>/ SAFARI   |
| <b>VKM 77500</b>   | <b>DAIHATSU</b><br>APPLAUSE / CHARADE /<br>FEROZA / GRAN MOVE / ROCKY<br>/ TERIOS                                  | <b>VKM 80002</b>  | <b>DAEWOO</b><br>AVEO / CIELO / ESPERO /<br>KALOS / LACETTI / LANOS /<br>LEMANS / NEXIA / NUBIRA /<br>REZZO / TACUMA | <b>VKM 82502</b>  | <b>NISSAN</b><br>ALMERA / PULSAR / SENTRA /<br>SUNNY / VANETTE CARGO   |
| <b>VKM 77501</b>   | <b>DAIHATSU</b><br>CUORE / DOMINO / HANDI /<br>HIJET / MIRA  | <b>VKM 81000</b>  | <b>DAEWOO</b><br>REZZO / TACUMA  | <b>VKM 82503</b>  | <b>NISSAN</b><br>VANETTE CARGO   |
| <b>VKM 77503</b>   | <b>DAIHATSU</b><br>CHARADE / CUORE / MOVE /<br>SIRION / TREVIS / YRV   | <b>VKM 81001</b>  | <b>TOYOTA</b><br>AVALON / CAMRY / LEXUS /<br>PRONARD / WINDOM  | <b>VKM 83003</b>  | <b>HONDA</b><br>ACCORD   |
| <b>VKM 78000</b>   | <b>SUBARU</b><br>IMPREZA / LEGACY  | <b>VKM 81002</b>  | <b>TOYOTA</b><br>4 RUNNER / CRESSIDA /<br>CROWN / DYNA / HIACE / HILUX<br>/ LAND CRUISER                             | <b>VKM 84000</b>  | <b>MAZDA</b><br>323 (BJ) / 626 (GE) / 626 (GF) /<br>626 (GW) / MX-6 (GE) /<br>PREMACY  |
| <b>VKM 78001</b>   | <b>SUBARU</b><br>LEONE   |   | <b>TOYOTA</b><br>4 RUNNER / CRESSIDA /<br>CROWN / DYNA / HIACE / HILUX<br>/ LAND CRUISER / MARK II                   |   |  |
| <b>VKM 78002</b>   | <b>SUBARU</b><br>LEONE   |   | <b>VW</b><br>TARO  |   |  |
| <b>VKM 78005</b>   | <b>SUBARU</b><br>FORESTER / IMPREZA / LEG-<br>ACY / OUTBACK  | <b>VKM 81004</b>  | <b>TOYOTA</b><br>AVENSIS / CAMRY / CARINA /<br>CELICA / CORONA / CRESSIDA /<br>MARK II / MR 2 / PICNIC / RAV 4       |   |  |
| <b>VKM 78103</b>   | <b>SUBARU</b><br>JUSTY   |   |  |   |  |

|  |   |  |   |  |    |
|---|--|---|---|---|---|
| VKM 84001   | <b>MAZDA</b><br>323 (BA) / 626 (GE) / 929 (TA12) / EUNOS 500 / EUNOS 800 / MX-3 (EC) / MX-6 (GE) / XEDOS 6 / XEDOS 9   |   | <b>MITSUBISHI</b><br>CARISMA / COLT / ECLIPSE / EXPO / EXPO-LRV / GALANT / L 200 / L 300 / LANCER / MIRAGE / OUTLANDER / PAJERO PININ / SANTAMO / SPACE WAGON |   | <b>OPEL</b><br>CAMPO / FRONTERA A / MONTEREY B  |
| VKM 84002   | <b>MAZDA</b><br>323 (BA) / 626 (GE) / 929 (TA12) / EUNOS 500 / EUNOS 800 / MX-3 (EC) / MX-6 (GE) / XEDOS 6 / XEDOS 9   |   | <b>PROTON</b><br>PERDANA / WIRA   | VKM 93301   | <b>VAUXHALL</b><br>BRAVA / FRONTERA Mk I / MONTEREY   |
| VKM 84007   | <b>MAZDA</b><br>929 (HC) / 929 (LV) / MPV  | VKM 85002   | <b>VOLVO</b><br>S40 I - V40   |   | <b>CITROËN</b><br>BERLINGO / C5 I / C5 II / C8 / EVASION / JUMPER (230) / JUMPER (244) / JUMPY I / JUMPY II / XANTIA II / XSARA / XSARA PICASSO |
| VKM 84201   | <b>KIA</b><br>CAPITAL / CARENS / SEPHIA  |   | <b>MITSUBISHI</b><br>3000 GT / CHALLENGER / GALANT / MAGNA / MONTERO / PAJERO / PAJERO SPORT / SHOGUN / SIGMA   |   | <b>PEUGEOT</b><br>206 / 306 / 307 / 406 / 806 / BOXER I / BOXER II / EXPERT I / PARTNER   |
|   | <b>MAZDA</b><br>323 (BA) / 323 (BG) / 323 (BJ) / EUNOS 500 / EUNOS ROADSTER (NA) / MIATA (NA) / MIATA (NB) / MX-3 (EC) / MX-5 (NA) / MX-5 (NB) / PROTÉGÉ / XEDOS 6 | VKM 85140   | <b>MITSUBISHI</b><br>COLT / GALANT / LANCER / SPACE RUNNER / SPACE WAGON  | VKM 93302   | <b>CITROËN</b><br>BERLINGO / BX / EVASION / JUMPER (230) / JUMPY I / JUMPY II / XANTIA I / XANTIA II / XSARA / ZX                               |
| VKM 84310   | <b>MAZDA</b><br>626 (GD) / 626 (GE) / 626 (GV)   | VKM 85141   | <b>MITSUBISHI</b><br>GALANT   |   | <b>PEUGEOT</b><br>306 / 405 I / 405 II / 406 / 806 / BOXER I / EXPERT I / PARTNER   |
| VKM 84502   | <b>KIA</b><br>CARNIVAL / SEDONA  | VKM 85145   | <b>HYUNDAI</b><br>ACCENT / COUPE / ELANTRA / EXCEL / GETZ / LANTRA / MATRIX / VERNA   | VKM 93305   | <b>CITROËN</b><br>AX / SAXO / XSARA   |
| VKM 84503   | <b>KIA</b><br>CARNIVAL / SEDONA  | VKM 85146   | <b>HYUNDAI</b><br>ELANTRA / GETZ / LANTRA / MATRIX / SANTA FE / TRAJET  |   | <b>PEUGEOT</b><br>106 I / 106 II  |
| VKM 84504   | <b>KIA</b><br>CARNIVAL / SEDONA  | VKM 85147   | <b>HYUNDAI</b><br>COUPE / ELANTRA / LANTRA / MATRIX   | VKM 93306   | <b>CITROËN</b><br>EVASION / XANTIA I / XANTIA II / XM II  |
| VKM 84506   | <b>KIA</b><br>CARNIVAL / SEDONA  | VKM 85148   | <b>HYUNDAI</b><br>COUPE / SANTA FE / SONATA / TRAJET  |   | <b>PEUGEOT</b><br>406 / 605 / 806   |
| VKM 84600   | <b>MAZDA</b><br>626 (GD) / 626 (GV) / 929 (HC) / B-SERIE (UF) / B-SERIE (UN) / E 1800 (SDX) / E 1800 (SRW) / E 2000, E 2200 / MX-6 (GD)                            | VKM 85150   | <b>MITSUBISHI</b><br>COLT   |   |   |
| VKM 84601   | <b>KIA</b><br>CONCORD / POTENTIA / SPORTAGE  | VKM 87000   | <b>DAIHATSU</b><br>CHARADE  |   |   |
|   | <b>MAZDA</b><br>626 (GD) / 626 (GV)  | VKM 88000   | <b>SUBARU</b><br>FORESTER / IMPREZA / LEGACY / OUTBACK  |   |   |
| VKM 84602   | <b>MAZDA</b><br>323 (BA) / 323 (BJ)  | VKM 88001   | <b>SUBARU</b><br>FORESTER / IMPREZA / LEGACY / OUTBACK  |   |   |
| VKM 84603   | <b>MAZDA</b><br>323 (BJ) / 626 (GF) / 626 (GW) / PREMACY   | VKM 88002   | <b>SUBARU</b><br>LEONE  |   |   |
| VKM 84604   | <b>MAZDA</b><br>323 (BA)   | VKM 88004   | <b>SUBARU</b><br>FORESTER / IMPREZA / LEGACY / OUTBACK  |   |   |
| VKM 84608   | <b>MAZDA</b><br>6 (GG) / 6 (GY)  | VKM 89001   | <b>ISUZU</b><br>FARGO   |   |   |
| VKM 85000   | <b>HYUNDAI</b><br>ELANTRA / LANTRA / SANTA FE / SANTAMO / SONATA / TRAJET  | VKM 89002   | <b>ISUZU</b><br>FARGO   |   |   |
|   | <b>KIA</b><br>SORENTO  | VKM 89003   | <b>ISUZU</b><br>FASTER / TROOPER  |   |   |









|  |   |    |    |  |    |   |  |
|---|--|---|---|---|---|---|--|
| <b>VKMA 01000</b>   | <p><b>AUDI</b><br/>100 (43, C2) / 100 Avant (43, C2) / 100 (44,44Q,C3)/100 Avant (44,44Q,C3) / 100 (4A, C4) / 100 Avant (4A, C4) / 80 (80, 82, B1) / 80 (81, 85, B2) / 80 (89, 89Q, 8A, B3) / 80 (8C, B4) / 80 Avant (8C, B4) / COUPE (81, 85) / COUPE (89, 8B)</p> <p><b>PORSCHE</b><br/>924</p> <p><b>SEAT</b><br/>CORDOBA (6K2) / CORDOBA (6K2/C2) / CORDOBA Vario (6K5) / IBIZA II (6K1) / INCA / TOLEDO I (1L)</p> <p><b>VW</b><br/>CADDY I (14) / CADDY II(9K9A)/Estate(9K9B)/Pickup(9U7) / CORRADO (53I) / GOLF I (17) / GOLF I Cabriolet (155) / GOLF II (19E, 1G1) / GOLF III (1H1) / GOLF III Variant (1H5) / GOLF III Cabriolet (1E7) / GOLF IV Cabriolet (1E7) / ILTIS (183) / JETTA I (16) / JETTA II (19E, 1G2) / LT I / PASSAT (32) / Variant (33) / PASSAT (32B) / PASSAT (3A2, 35I) / Variant (3A5, 35I) / POLO CLASSIC (6KV2) / Variant (6KV5) / SANTANA / SANTANA (32B) / SCIROCCO (53) / SCIROCCO (53B) / TRANSPORTER IV / VENTO (1H2)</p> | <p><b>VKMA 01007</b></p>  | <p><b>AUDI</b><br/>A4 (8D2, B5) / A4 Avant (8D5, B5)</p>  | <p><b>VKMA 01008</b></p>  | <p><b>AUDI</b><br/>A4 (8D2, B5) / A4 Avant (8D5, B5) / A6 (4A, C4) / A6 Avant (4A, C4) / A6 (4B, C5) / A6 Avant (4B, C5) / CABRIOLET (8G7, B4)</p>  | <p><b>VKMA 01014</b></p>  | <p><b>VW</b><br/>CADDY II(9K9A)/Estate(9K9B)/Pickup(9U7) / GOLF III (1H1) / GOLF III Variant (1H5) / PARATI / PASSAT (3A2, 35I) / Variant (3A5, 35I) / POLO CLASSIC (6KV2) / Variant (6KV5) / TRANSPORTER IV / VENTO (1H2)</p> |
|   | <p><b>VKMA 01009</b></p>   | <p><b>SEAT</b><br/>CORDOBA (6K2) / CORDOBA (6K2/C2) / CORDOBA Vario (6K5) / IBIZA II (6K1) / TOLEDO I (1L)</p>  | <p><b>VW</b><br/>PASSAT (3B2) / Variant (3B5)</p>   |   | <p><b>AUDI</b><br/>80 (8C, B4) / 80 Avant (8C, B4) / A4 (8D2, B5) / A4 Avant (8D5, B5) / A6 (4A, C4) / A6 Avant (4A, C4) / A6 (4B, C5) / A6 Avant (4B, C5) / CABRIOLET (8G7, B4)</p>  |   |  |
|   | <p><b>VKMA 01010</b></p>   | <p><b>VW</b><br/>GOLF III (1H1) / GOLF III Variant (1H5) / GOLF III Cabriolet (1E7) / POLO CLASSIC (6KV2) / Variant (6KV5) / VENTO (1H2)</p>  |   |   | <p><b>SEAT</b><br/>CORDOBA (6K2) / CORDOBA (6K2/C2) / CORDOBA Vario (6K5) / IBIZA II (6K1) / TOLEDO I (1L)</p>  |   |  |
|   | <p><b>VKMA 01011</b></p>   | <p><b>AUDI</b><br/>80 (81, 85, B2) / 80 (89, 89Q, 8A, B3) / 90 (81, 85, B2) / 90 (89, 89Q, 8A, B3)</p>  |   |   | <p><b>VW</b><br/>CADDY II(9K9A)/Estate(9K9B)/Pickup(9U7) / GOLF III (1H1) / GOLF III Variant (1H5) / GOLF III Cabriolet (1E7) / GOLF IV Cabriolet (1E7) / PASSAT (3A2, 35I) / Variant (3A5, 35I) / POLO CLASSIC (6KV2) / Variant (6KV5) / VENTO (1H2)</p> |   |  |
| <b>VKMA 01001</b>   | <p><b>AUDI</b><br/>100 (4A, C4) / 100 Avant (4A, C4) / 80 (89, 89Q, 8A, B3) / 80 (8C, B4) / 80 Avant (8C, B4) / A6 (4A, C4) / A6 Avant (4A, C4) / CABRIOLET (8G7, B4)</p>  | <p><b>VKMA 01012</b></p>  | <p><b>VW</b><br/>CADDY I (14) / GOLF I (17) / GOLF II (19E, 1G1) / ILTIS (183) / JETTA I (16) / JETTA II (19E, 1G2) / PASSAT (32) / Variant (33) / PASSAT (32B) / PASSAT (3A2, 35I) / Variant (3A5, 35I) / SANTANA (32B) / SCIROCCO (53) / SCIROCCO (53B) / TRANSPORTER III</p> |   | <p><b>VKMA 01015</b></p>  | <p><b>SKODA</b><br/>FELICIA I (6U1)/Estate (6U5)/Fun (797) / FELICIA II (6U1)/FELICIA II Estate (6U5)</p>   |  |
|   | <p><b>VKMA 01002</b></p>   | <p><b>SEAT</b><br/>ALHAMBRA / CORDOBA (6K2) / CORDOBA (6K2/C2) / IBIZA II (6K1) / TOLEDO I (1L)</p>   |   |   | <p><b>VW</b><br/>CADDY II(9K9A)/Estate(9K9B)/Pickup(9U7) / POLO (6N1) / POLO Box (6NF) / POLO (6N2)</p>   |   |  |
|   | <p><b>VKMA 01003</b></p>   | <p><b>VW</b><br/>CORRADO (53I) / GOLF III (1H1) / GOLF III Variant (1H5) / GOLF III Cabriolet (1E7) / GOLF IV Cabriolet (1E7) / PASSAT (3A2, 35I) / Variant (3A5, 35I) / POLO CLASSIC (6KV2) / Variant (6KV5) / SHARAN (7M8, 7M9, 7M6) / TRANSPORTER IV / VENTO (1H2)</p> |   |   | <p><b>SEAT</b><br/>AROSA</p>  |   |  |
|   | <p><b>VKMA 01004</b></p>   | <p><b>AUDI</b><br/>80 (8C, B4) / 80 Avant (8C, B4) / A6 (4A, C4) / A6 Avant (4A, C4) / CABRIOLET (8G7, B4)</p>  | <p><b>VKMA 01013</b></p>  | <p><b>AUDI</b><br/>80 (8C, B4) / 80 Avant (8C, B4)</p>                              |   | <p><b>VW</b><br/>LUPU (6X1, 6E1) / POLO (6N1) / POLO Box (6NF) / POLO (6N2)</p>   |  |
|   | <p><b>VKMA 01005</b></p>   | <p><b>VW</b><br/>GOLF IV Cabriolet (1E7)</p>  |   |   | <p><b>VKMA 01018</b></p>  | <p><b>AUDI</b><br/>A4 (8D2, B5) / A4 Avant (8D5, B5) / A4 (8E2, B6) / A4 Avant (8E5, B6) / A4 (8EC) / A4 Avant (8ED) / A4 Convertible (8H7) / A6 (4B, C5) / A6 Avant (4B, C5)</p> |  |
|   | <p><b>VKMA 01006</b></p>   | <p><b>AUDI</b><br/>A4 (8D2, B5) / A4 Avant (8D5, B5)</p>  |   |   | <p><b>SKODA</b><br/>SUPERB</p>  |   |  |
|   |  |   | <p><b>VW</b><br/>PASSAT (3B3) / Variant (3B6)</p>   |   | <p><b>VKMA 01019</b></p>  | <p><b>FORD</b><br/>GALAXY I</p>   |  |
|   |  |   | <p><b>SEAT</b><br/>ALHAMBRA / CORDOBA (6K2) / CORDOBA (6K2/C2) / CORDOBA Vario (6K5) / IBIZA II (6K1) / INCA</p>  |   |   | <p><b>SEAT</b><br/>ALHAMBRA / CORDOBA (6K2) / CORDOBA (6K2/C2) / CORDOBA Vario (6K5) / IBIZA II (6K1) / INCA</p>  |  |















|  |   |  |   |    |    |
|---|--|---|---|---|---|
| VKMA 01020  | <b>VW</b><br>CADDY II(9K9A)/Estate(9K9B)/<br>Pickup(9U7) / POLO CLASSIC<br>(6KV2) / Variant (6KV5) / SHA-<br>RAN (7M8, 7M9, 7M6)   | VKMA 01034  | <b>AUDI</b><br>90 (89, 89Q, 8A, B3) / COUPE<br>(81, 85)   | VKMA 01110  | <b>SEAT</b><br>CORDOBA (6K2) / CORDOBA<br>(6K2/C2) / CORDOBA Vario<br>(6K5) / IBIZA II (6K1) / IBIZA III<br>(6K1) / INCA  |
|   | <b>AUDI</b><br>100 (4A, C4) / 100 Avant (4A,<br>C4) / 80 (89, 89Q, 8A, B3) / 80<br>(8C, B4) / 80 Avant (8C, B4) /<br>A6 (4A, C4) / A6 Avant (4A, C4) /<br>COUPE (89, 8B)                             | VKMA 01040  | <b>AUDI</b><br>100 (43, C2) / 100 Avant (43,<br>C2) / 100 (44,44Q,C3)/100<br>Avant (44,44Q,C3)  | <b>VOLVO</b><br>240 / 740 / 760 / 940   | <b>SKODA</b><br>FELICIA I (6U1)/Estate (6U5)/<br>Fun (797) / FELICIA II (6U1)/<br>FELICIA II Estate (6U5) / OCTA-<br>VIA I (1U2) / OCTAVIA Combi<br>(1U5)   |
|   | <b>SEAT</b><br>TOLEDO I (1L)   | VKMA 01042  | <b>VW</b><br>LT I   | <b>VW</b><br>TRANSPORTER IV   | <b>VW</b><br>CADDY II(9K9A)/Estate(9K9B)/<br>Pickup(9U7) / GOLF III (1H1) /<br>GOLF III Variant (1H5) / POLO<br>(6N1) / POLO Box (6NF) / POLO<br>CLASSIC (6KV2) / Variant<br>(6KV5) / VENTO (1H2) |
| VKMA 01021  | <b>VW</b><br>CORRADO (53I) / GOLF II (19E,<br>1G1) / JETTA II (19E, 1G2) /<br>PASSAT (3A2, 35I) / Variant<br>(3A5, 35I) / SCIROCCO (53B)   | VKMA 01044  | <b>AUDI</b><br>100 (4A, C4) / 100 Avant (4A,<br>C4)   | VKMA 01113  | <b>AUDI</b><br>A3 (8L1) / A3 (8P1) / A3<br>Sportback (8PA) / A4 (8D2, B5)<br>/ A4 Avant (8D5, B5) / A4 (8E2,<br>B6) / A4 Avant (8E5, B6) / A4<br>(8EC) / A4 Avant (8ED)                           |
|   | <b>VW</b><br>GOLF III (1H1) / GOLF III Variant<br>(1H5) / PASSAT (3A2, 35I) /<br>Variant (3A5, 35I)  | VKMA 01046  | <b>VOLVO</b><br>940 / 960   |   | <b>VW</b><br>LT I   |
| VKMA 01023  | <b>AUDI</b><br>100 (4A, C4) / 100 Avant (4A,<br>C4) / 80 (8C, B4) / 80 Avant (8C,<br>B4) / A6 (4A, C4) / A6 Avant (4A,<br>C4) / CABRIOLET (8G7, B4) /<br>COUPE (89, 8B)                              | VKMA 01050  | <b>AUDI</b><br>100 (4A, C4) / 100 Avant (4A,<br>C4) / 80 (8C, B4) / 80 Avant (8C,<br>B4) / A6 (4A, C4) / A6 Avant (4A,<br>C4) / CABRIOLET (8G7, B4) /<br>COUPE (89, 8B)   | <b>SEAT</b><br>ALHAMBRA / ALTEA / ALTEA XL<br>/ CORDOBA (6K2) / CORDOBA<br>(6K2/C2) / CORDOBA (6L2) /<br>CORDOBA Vario (6K5) / IBIZA III<br>(6K1) / IBIZA IV (6L1) / LEON I<br>(1M1) / LEON II (1P1) / TOLEDO<br>II (1M2) / TOLEDO III (5P2)  |   |
| VKMA 01024  | <b>SEAT</b><br>CORDOBA (6K2) / CORDOBA<br>(6K2/C2) / IBIZA II (6K1) /<br>TOLEDO I (1L)   | VKMA 01105  | <b>VW</b><br>POLO (6N1) / POLO Box (6NF)  | <b>SKODA</b><br>FABIA / OCTAVIA I (1U2) /<br>OCTAVIA Combi (1U5) /<br>OCTAVIA II (1Z3)/OCTAVIA II<br>Combi (1Z5) / SUPERB   |   |
|   | <b>VW</b><br>CORRADO (53I)   | VKMA 01106  | <b>SEAT</b><br>AROSA / CORDOBA (6K2) /<br>CORDOBA (6K2/C2) / CORDOBA<br>Vario (6K5) / IBIZA II (6K1) /<br>IBIZA III (6K1) / INCA  | <b>VW</b><br>BORA (1J2) / BORA Estate (1J6)<br>/ CADDY III (2KA) / CADDY III<br>Estate (2KB) / GOLF IV (1J1) /<br>GOLF IV Variant (1J5) / GOLF V<br>(1K1) / GOLF V VARIANT (1K1) /<br>GOLF V PLUS (5M1) / JETTA III<br>(1KM) / MULTIVAN V (7HM) /<br>NEW BEETLE (9C1, 1C1)/Con-<br>vertible (1Y7) / PASSAT (3B2) /<br>Variant (3B5) / PASSAT (3B3) /<br>Variant (3B6) / PASSAT (3C2) /<br>Variant (3C5) / POLO CLASSIC<br>(6KV2) / Variant (6KV5) / SHA-<br>RAN (7M8, 7M9, 7M6) / TOU-<br>RAN / TRANSPORTER V |   |
| VKMA 01025  | <b>VW</b><br>GOLF III (1H1) / GOLF III Variant<br>(1H5) / PASSAT (3A2, 35I) /<br>Variant (3A5, 35I)  | VKMA 01106  | <b>VW</b><br>CADDY II(9K9A)/Estate(9K9B)/<br>Pickup(9U7) / GOLF III (1H1) /<br>GOLF III Variant (1H5) / LUPO<br>(6X1, 6E1) / POLO (6N1) / POLO<br>Box (6NF) / POLO (6N2) / POLO<br>CLASSIC (6KV2) / Variant<br>(6KV5) / VENTO (1H2) | VKMA 01114  | <b>SEAT</b><br>CORDOBA (6K2) / CORDOBA<br>(6K2/C2) / CORDOBA<br>(6L2) / CORDOBA Vario (6K5) /<br>IBIZA III (6K1) / IBIZA IV (6L1) /<br>INCA   |
|   | <b>AUDI</b><br>100 (4A, C4) / 100 Avant (4A,<br>C4)  | VKMA 01107  | <b>VW</b><br>CADDY II(9K9A)/Estate(9K9B)/<br>Pickup(9U7) / FOX (5Z1) / LUPO<br>(6X1, 6E1) / POLO (6N2) / POLO<br>CLASSIC (6KV2) / Variant<br>(6KV5)   |   | <b>SEAT</b><br>CORDOBA (6K2) / CORDOBA<br>(6K2/C2) / IBIZA II (6K1) / IBIZA<br>III (6K1)  |
| VKMA 01031  | <b>AUDI</b><br>100 (44,44Q,C3)/100 Avant<br>(44,44Q,C3) / 200 (44, 44Q) /<br>200 Avant (44, 44Q) / 80 (81,<br>85, B2) / 90 (81, 85, B2) / 90<br>(89, 89Q, 8A, B3) / COUPE (81,<br>85) / QUATTRO (85) | VKMA 01107  | <b>VW</b><br>CADDY II(9K9A)/Estate(9K9B)/<br>Pickup(9U7) / FOX (5Z1) / LUPO<br>(6X1, 6E1) / POLO (6N2) / POLO<br>CLASSIC (6KV2) / Variant<br>(6KV5)   | <b>VW</b><br>POLO (6N1) / POLO Box (6NF)  |   |
| VKMA 01032  | <b>VW</b><br>PASSAT (32B) / SANTANA<br>(32B)   |   |   | VKMA 01115  | <b>AUDI</b><br>A3 (8L1) / A6 (4B, C5) / A6<br>Avant (4B, C5) / TT (8N3) / TT<br>Roadster (8N9)  |
|   | <b>AUDI</b><br>100 (44,44Q,C3)/100 Avant<br>(44,44Q,C3) / 200 (44, 44Q) /<br>200 Avant (44, 44Q) / 90 (81,<br>85, B2) / 90 (89, 89Q, 8A, B3) /<br>COUPE (81, 85) / COUPE (89,<br>8B) / QUATTRO (85)  |   |   |   |   |









| VKMA 01116 | <b>SEAT</b><br>ALHAMBRA / LEON I (1M1) / TOLEDO II (1M2)   | VKMA 01130 | <b>VW</b><br>BORA (1J2) / BORA Estate (1J6) / CADDY II(9K9A)/Estate(9K9B)/ Pickup(9U7) / CADDY III (2KA) / CADDY III Estate (2KB) / GOLF IV (1J1) / GOLF IV Variant (1J5) / GOLF V (1K1) / GOLF V VARIANT (1K1) / GOLF V PLUS (5M1) / LUPO (6X1, 6E1) / NEW BEETLE (9C1, 1C1)/Convertible (1Y7) / POLO (6N1) / POLO Box (6NF) / POLO (6N2) / POLO (9N_) / POLO CLASSIC (6KV2) / Variant (6KV5) / POLO Saloon | VKMA 01142 | <b>AUDI</b><br>A2 (8Z0) / A3 (8L1) / A4 (8D2, B5) / A4 Avant (8D5, B5) / A4 (8E2, B6) / A4 Avant (8E5, B6) / A6 (4B, C5) / A6 Avant (4B, C5)                                |
|------------|--|------------|--|------------|---|
|            | <b>SKODA</b><br>OCTAVIA I (1U2) / OCTAVIA Combi (1U5)  |            | <b>AUDI</b><br>A3 (8L1)  |            | <b>FORD</b><br>GALAXY I   |
|            | <b>VW</b><br>BORA (1J2) / BORA Estate (1J6) / GOLF IV (1J1) / GOLF IV Variant (1J5) / NEW BEETLE (9C1, 1C1)/Convertible (1Y7) / SHARAN (7M8, 7M9, 7M6)                                   |            | <b>SEAT</b><br>CORDOBA (6K2) / CORDOBA (6K2/C2) / CORDOBA Vario (6K5) / IBIZA III (6K1) / LEON I (1M1) / TOLEDO II (1M2)   |            | <b>SEAT</b><br>ALHAMBRA / AROSA / LEON I (1M1) / TOLEDO II (1M2)  |
| VKMA 01120 | <b>AUDI</b><br>A3 (8L1) / A4 (8D2, B5) / A4 Avant (8D5, B5) / TT (8N3) / TT Roadster (8N9)   | VKMA 01131 | <b>SEAT</b><br>CORDOBA (6K2) / CORDOBA (6K2/C2) / CORDOBA Vario (6K5) / IBIZA III (6K1) / LEON I (1M1) / TOLEDO II (1M2)   | VKMA 01143 | <b>SKODA</b><br>FABIA / OCTAVIA I (1U2) / OCTAVIA Combi (1U5)   |
|            | <b>SEAT</b><br>ALHAMBRA / CORDOBA (6K2) / CORDOBA (6K2/C2) / IBIZA III (6K1) / LEON I (1M1) / TOLEDO II (1M2)  |            | <b>VW</b><br>GOLF IV (1J1) / GOLF IV Variant (1J5) / POLO CLASSIC (6KV2) / Variant (6KV5)  |            | <b>VW</b><br>BORA (1J2) / BORA Estate (1J6) / GOLF IV (1J1) / GOLF IV Variant (1J5) / LUPO (6X1, 6E1) / NEW BEETLE (9C1, 1C1)/Convertible (1Y7) / SHARAN (7M8, 7M9, 7M6)    |
|            | <b>SKODA</b><br>OCTAVIA I (1U2) / OCTAVIA Combi (1U5)  |            | <b>AUDI</b><br>A3 (8L1)  |            | <b>FORD</b><br>GALAXY I   |
| VKMA 01121 | <b>VW</b><br>BORA (1J2) / BORA Estate (1J6) / GOLF IV (1J1) / GOLF IV Variant (1J5) / NEW BEETLE (9C1, 1C1)/Convertible (1Y7) / SHARAN (7M8, 7M9, 7M6)                                   | VKMA 01140 | <b>SEAT</b><br>CORDOBA (6K2) / CORDOBA (6K2/C2) / CORDOBA Vario (6K5) / IBIZA III (6K1) / INCA / LEON I (1M1) / TOLEDO II (1M2)  | VKMA 01151 | <b>VW</b><br>PASSAT (3B2) / Variant (3B5) / PASSAT (3B3) / Variant (3B6)  |
|            | <b>SEAT</b><br>LEON I (1M1) / TOLEDO II (1M2)  |            | <b>SKODA</b><br>OCTAVIA I (1U2) / OCTAVIA Combi (1U5)  |            | <b>AUDI</b><br>A4 (8D2, B5) / A4 Avant (8D5, B5) / A6 (4B, C5) / A6 Avant (4B, C5) / A8 (4D2, 4D8)  |
|            | <b>VW</b><br>BORA (1J2) / BORA Estate (1J6) / GOLF IV (1J1) / GOLF IV Variant (1J5) / LUPO (6X1, 6E1) / POLO (6N1) / POLO Box (6NF)  |            | <b>VW</b><br>BORA (1J2) / BORA Estate (1J6) / CADDY II(9K9A)/Estate(9K9B)/ Pickup(9U7) / GOLF IV (1J1) / GOLF IV Variant (1J5) / NEW BEETLE (9C1, 1C1)/Convertible (1Y7) / POLO CLASSIC (6KV2) / Variant (6KV5)  |            | <b>VW</b><br>PASSAT (3B2) / Variant (3B5) / PASSAT (3B3) / Variant (3B6)  |
| VKMA 01141 | <b>AUDI</b><br>A2 (8Z0)  | VKMA 01141 | <b>VW</b><br>BORA (1J2) / BORA Estate (1J6) / CADDY II(9K9A)/Estate(9K9B)/ Pickup(9U7) / GOLF IV (1J1) / GOLF IV Variant (1J5) / NEW BEETLE (9C1, 1C1)/Convertible (1Y7) / POLO CLASSIC (6KV2) / Variant (6KV5)  | VKMA 01152 | <b>AUDI</b><br>A4 (8E2, B6) / A4 Avant (8E5, B6) / A4 (8EC) / A4 Avant (8ED) / A4 Convertible (8H7) / A6 (4B, C5) / A6 Avant (4B, C5) / A8 (4D2, 4D8) / ALLROAD (4BH)       |
|            | <b>SEAT</b><br>AROSA / CORDOBA (6K2) / CORDOBA (6K2/C2) / CORDOBA (6L2) / CORDOBA Vario (6K5) / IBIZA III (6K1) / IBIZA IV (6L1) / INCA / LEON I (1M1) / LEON II (1P1) / TOLEDO II (1M2) |            | <b>AUDI</b><br>A2 (8Z0)  |            | <b>SKODA</b><br>SUPERB  |
|            | <b>SKODA</b><br>FABIA / OCTAVIA I (1U2) / OCTAVIA Combi (1U5) / OCTAVIA II (1Z3)/OCTAVIA II Combi (1Z5)  |            | <b>VW</b><br>LUPO (6X1, 6E1)   |            | <b>VW</b><br>PASSAT (3B3) / Variant (3B6)   |
| VKMA 01142 | <b>VW</b><br>BORA (1J2) / BORA Estate (1J6) / GOLF IV (1J1) / GOLF IV Variant (1J5) / LUPO (6X1, 6E1) / PASSAT (3B2) / Variant (3B5) / POLO (6N2)  | VKMA 01142 | <b>AUDI</b><br>A6 (4B, C5) / A6 Avant (4B, C5)   | VKMA 01200 | <b>AUDI</b><br>100 (4A, C4) / 100 Avant (4A, C4) / 80 (8C, B4) / 80 Avant (8C, B4) / A6 (4A, C4) / A6 Avant (4A, C4) / A8 (4D2, 4D8) / CABRIOLET (8G7, B4) / COUPE (89, 8B) |
|            | <b>SEAT</b><br>AROSA   |            | <b>VW</b><br>BORA (1J2) / BORA Estate (1J6) / GOLF IV (1J1) / GOLF IV Variant (1J5) / LUPO (6X1, 6E1) / PASSAT (3B2) / Variant (3B5) / POLO (6N2)  |            | <b>AUDI</b><br>80 (8C, B4) / 80 Avant (8C, B4) / A4 (8D2, B5) / A4 Avant (8D5, B5) / A6 (4A, C4) / A6 Avant (4A, C4) / A8 (4D2, 4D8) / CABRIOLET (8G7, B4) / COUPE (89, 8B) |
|            | <b>VW</b><br>BORA (1J2) / BORA Estate (1J6) / GOLF IV (1J1) / GOLF IV Variant (1J5) / LUPO (6X1, 6E1) / PASSAT (3B2) / Variant (3B5) / POLO (6N2)  |            | <b>SEAT</b><br>AROSA   |            | <b>VW</b><br>PASSAT (3B3) / Variant (3B6)   |

|  |    |  |    |  |    |
|---|---|---|--|---|---|
| VKMA 01202  | <b>AUDI</b><br>A4 (8D2, B5) / A4 Avant (8D5, B5) / A4 (8E2, B6) / A4 Avant (8E5, B6) / A4 Convertible (8H7) / A6 (4A, C4) / A6 Avant (4A, C4) / A6 (4B, C5) / A6 Avant (4B, C5) / A8 (4D2, 4D8) / ALLROAD (4BH) |   | <b>VW</b><br>BORA (1J2) / BORA Estate (1J6) / CADDY III (2KA) / CADDY III Estate (2KB) / EOS / FOX (5Z1) / GOLF IV (1J1) / GOLF IV Variant (1J5) / GOLF V (1K1) / GOLF V VARIANT (1K1) / GOLF V PLUS (5M1) / JETTA III (1KM) / LUPO (6X1, 6E1) / MULTIVAN V (7HM) / NEW BEETLE (9C1, 1C1) / Convertible (1Y7) / PASSAT (3B3) / Variant (3B6) / PASSAT (3C2) / Variant (3C5) / POLO (9N_) / POLO Saloon / SHARAN (7M8, 7M9, 7M6) / TOURAN / TRANSPORTER V |   | <b>VW</b><br>LT II / TRANSPORTER IV   |
| VKMA 01220  | <b>AUDI</b><br>A3 (8P1) / A3 Sportback (8PA) / A4 (8E2, B6) / A4 Avant (8E5, B6)  | VKMA 01251  | <b>AUDI</b><br>A3 (8L1)  | VKMA 01262  | <b>VW</b><br>TRANSPORTER IV   |
| VKMA 01222  | <b>VW</b><br>GOLF V (1K1) / GOLF V VARIANT (1K1) / TOURAN   |   | <b>SEAT</b><br>CORDOBA (6K2) / CORDOBA (6K2/C2) / CORDOBA Vario (6K5) / IBIZA III (6K1) / INCA / LEON I (1M1) / TOLEDO II (1M2)  | VKMA 01265  | <b>AUDI</b><br>A6 (4A, C4) / A6 Avant (4A, C4)  |
|   | <b>AUDI</b><br>A3 (8P1) / A3 Sportback (8PA) / A4 (8EC) / A4 Avant (8ED) / A4 Convertible (8H7) / A6 (4F2) / A6 Avant (4F5) / TT (8J3) / TT Roadster (8J9)  |   | <b>SKODA</b><br>OCTAVIA I (1U2) / OCTAVIA Combi (1U5)  | VKMA 01266  | <b>VW</b><br>TRANSPORTER IV   |
|   | <b>SEAT</b><br>ALTEA / ALTEA XL / LEON II (1P1) / TOLEDO III (5P2)  |   | <b>VW</b><br>BORA (1J2) / BORA Estate (1J6) / CADDY II(9K9A)/Estate(9K9B)/ Pickup(9U7) / GOLF IV (1J1) / GOLF IV Variant (1J5) / NEW BEETLE (9C1, 1C1)/Convertible (1Y7) / POLO CLASSIC (6KV2) / Variant (6KV5)  | VKMA 01270  | <b>VW</b><br>LT II / TRANSPORTER IV   |
|   | <b>SKODA</b><br>OCTAVIA II (1Z3)/OCTAVIA II Combi (1Z5)   | VKMA 01253  | <b>VW</b><br>TRANSPORTER IV  | VKMA 01271  | <b>VW</b><br>TRANSPORTER IV   |
|   | <b>VW</b><br>EOS / GOLF V (1K1) / GOLF V VARIANT (1K1) / GOLF V PLUS (5M1) / JETTA III (1KM) / PASSAT (3C2) / Variant (3C5)   | VKMA 01255  | <b>AUDI</b><br>A3 (8P1) / A3 Sportback (8PA) / A4 (8EC) / A4 Avant (8ED) / A6 (4F2) / A6 Avant (4F5)   | VKMA 01275  | <b>SEAT</b><br>CORDOBA (6L2) / IBIZA IV (6L1)   |
| VKMA 01224  | <b>AUDI</b><br>A4 (8E2, B6) / A4 Avant (8E5, B6)  |   | <b>SKODA</b><br>OCTAVIA II (1Z3)/OCTAVIA II Combi (1Z5)  | VKMA 01301  | <b>AUDI</b><br>A4 (8E2, B6) / A4 Avant (8E5, B6) / A4 (8EC) / A4 Avant (8ED) / A4 Convertible (8H7) / A6 (4B, C5) / A6 Avant (4B, C5) / A6 (4F2) / A6 Avant (4F5) / A8 (4E_)                              |
| VKMA 01250  | <b>AUDI</b><br>A2 (8Z0) / A3 (8L1) / A3 (8P1) / A3 Sportback (8PA) / A4 (8E2, B6) / A4 Avant (8E5, B6) / A4 (8EC) / A4 Avant (8ED) / A4 Convertible (8H7) / A6 (4B, C5) / A6 Avant (4B, C5)                     |   | <b>VW</b><br>TRANSPORTER IV  | VKMA 01332  | <b>AUDI</b><br>A4 (8EC) / A4 Avant (8ED) / A4 Convertible (8H7) / A6 (4F2) / A6 Avant (4F5) / A6 Allroad (4FH) / A8 (4E_) / Q7  |
|   | <b>FORD</b><br>GALAXY I   |   | <b>VW</b><br>GOLF V (1K1) / GOLF V VARIANT (1K1) / GOLF V PLUS (5M1) / JETTA III (1KM) / PASSAT (3C2) / Variant (3C5) / TOURAN   | VKMA 01902  | <b>AUDI</b><br>A4 (8D2, B5) / A4 Avant (8D5, B5) / A6 (4A, C4) / A6 Avant (4A, C4) / A8 (4D2, 4D8)  |
|   | <b>SEAT</b><br>ALHAMBRA / ALTEA / ALTEA XL / AROSA / CORDOBA (6L2) / IBIZA IV (6L1) / LEON I (1M1) / LEON II (1P1) / TOLEDO II (1M2) / TOLEDO III (5P2)   | VKMA 01256  | <b>SKODA</b><br>OCTAVIA II (1Z3)/OCTAVIA II Combi (1Z5)  | VKMA 01903  | <b>AUDI</b><br>A4 (8D2, B5) / A4 Avant (8D5, B5) / A4 (8E2, B6) / A4 Avant (8E5, B6) / A4 Convertible (8H7) / A6 (4B, C5) / A6 Avant (4B, C5) / A6 (4F2) / A6 Avant (4F5) / A8 (4D2, 4D8) / ALLROAD (4BH) |
|   | <b>SKODA</b><br>FABIA / OCTAVIA I (1U2) / OCTAVIA Combi (1U5) / OCTAVIA II (1Z3)/OCTAVIA II Combi (1Z5) / ROOMSTER / SUPERB   | VKMA 01258  | <b>VW</b><br>PASSAT (3B2) / Variant (3B5)  | VKMA 01904  | <b>AUDI</b><br>A6 (4B, C5) / A6 Avant (4B, C5) / A8 (4D2, 4D8)  |
|   |   |   | <b>VOLVO</b><br>850 / C70 - S70 / S80 / V70 I / V70 II   | VKMA 01905  | <b>AUDI</b><br>A6 (4B, C5) / A6 Avant (4B, C5) / A8 (4D2, 4D8)  |
|   |   |   |  | VKMA 01907  | <b>AUDI</b><br>A4 (8D2, B5) / A4 Avant (8D5, B5)  |

|  |    |  |   |  |  |
|---|---|---|--|---|---|
| <b>VKMA 01908</b>   | <b>AUDI</b><br>A4 (8D2, B5) / A4 Avant (8D5, B5) / A6 (4A, C4) / A6 Avant (4A, C4) / A6 (4B, C5) / A6 Avant (4B, C5) / CABRIOLET (8G7, B4)                                |   | <b>VW</b><br>BORA (1J2) / BORA Estate (1J6) / GOLF IV (1J1) / GOLF IV Variant (1J5) / LUPU (6X1, 6E1) / NEW BEETLE (9C1, 1C1) / Convertible (1Y7) / PASSAT (3B2) / Variant (3B5) / PASSAT (3B3) / Variant (3B6) / POLO (6N2) / POLO (9N_) / SHARAN (7M8, 7M9, 7M6) | <b>VKMA 02152</b>   | <b>FIAT</b><br>DUNA / ELBA / FIORINO / PALIO/SIENA / PUNTO (176) / STRADA / UNO     |
| <b>VKMA 01918</b>   | <b>AUDI</b><br>A4 (8D2, B5) / A4 Avant (8D5, B5) / A4 (8E2, B6) / A4 Avant (8E5, B6) / A4 (8EC) / A4 Avant (8ED) / A4 Convertible (8H7) / A6 (4B, C5) / A6 Avant (4B, C5) | <b>VKMA 01943</b>   | <b>FORD</b><br>GALAXY I  | <b>VKMA 02153</b>   | <b>FIAT</b><br>TIPO   |
|   | <b>SKODA</b><br>SUPERB  | <b>VKMA 01951</b>   | <b>VW</b><br>SHARAN (7M8, 7M9, 7M6)  | <b>VKMA 02154</b>   | <b>ALFA ROMEO</b><br>145/146 / 155  |
|   | <b>VW</b><br>PASSAT (3B3) / Variant (3B6)   |   | <b>AUDI</b><br>A4 (8D2, B5) / A4 Avant (8D5, B5) / A6 (4B, C5) / A6 Avant (4B, C5) / A8 (4D2, 4D8)   | <b>VKMA 02155</b>   | <b>FIAT</b><br>BRAVA/BRAVO (182) / TEMPRA / TIPO                                    |
| <b>VKMA 01927</b>   | <b>AUDI</b><br>A6 (4B, C5) / A6 Avant (4B, C5) / A8 (4D2, 4D8) / A8 (4E_)   | <b>VKMA 01952</b>   | <b>VW</b><br>PASSAT (3B2) / Variant (3B5) / PASSAT (3B3) / Variant (3B6)   | <b>VKMA 02161</b>   | <b>FIAT</b><br>RITMO  |
|   | <b>VW</b><br>PHAETON (3D2) / TOUAREG (7LA)  |   | <b>AUDI</b><br>A4 (8E2, B6) / A4 Avant (8E5, B6) / A4 (8EC) / A4 Avant (8ED) / A4 Convertible (8H7) / A6 (4B, C5) / A6 Avant (4B, C5) / A8 (4D2, 4D8) / ALLROAD (4BH)  | <b>VKMA 02168</b>   | <b>SEAT</b><br>IBIZA I (021A) / MALAGA / RITMO / RONDA                              |
| <b>VKMA 01940</b>   | <b>AUDI</b><br>A2 (8Z0)   |   | <b>SKODA</b><br>SUPERB   | <b>VKMA 02169</b>   | <b>FIAT</b><br>DUCATO (280/290) / TALENTO (290)                                     |
|   | <b>VW</b><br>LUPU (6X1, 6E1)  | <b>VKMA 02005</b>   | <b>VW</b><br>PASSAT (3B3) / Variant (3B6)  |   | <b>CITROËN</b><br>C25   |
| <b>VKMA 01941</b>   | <b>AUDI</b><br>A6 (4B, C5) / A6 Avant (4B, C5)  |   | <b>FIAT</b><br>REGATA / RITMO  | <b>VKMA 02171</b>   | <b>FIAT</b><br>DUCATO (230) / DUCATO (280/290)                                      |
|   | <b>SEAT</b><br>AROSA  | <b>VKMA 02021</b>   | <b>LANCIA</b><br>DELTA I / PRISMA  |   | <b>FIAT</b><br>MAREA  |
|   | <b>VW</b><br>BORA (1J2) / BORA Estate (1J6) / GOLF IV (1J1) / GOLF IV Variant (1J5) / LUPU (6X1, 6E1) / PASSAT (3B2) / Variant (3B5) / POLO (6N2)                         | <b>VKMA 02101</b>   | <b>FIAT</b><br>UNO   | <b>VKMA 02172</b>   | <b>LANCIA</b><br>KAPPA  |
| <b>VKMA 01942</b>   | <b>AUDI</b><br>A2 (8Z0) / A3 (8L1) / A4 (8D2, B5) / A4 Avant (8D5, B5) / A4 (8E2, B6) / A4 Avant (8E5, B6) / A6 (4B, C5) / A6 Avant (4B, C5)                              | <b>VKMA 02110</b>   | <b>FIAT</b><br>REGATA / RITMO / UNO  |   | <b>FIAT</b><br>BRAVA/BRAVO (182) / COUPE / MAREA                                    |
|   | <b>FORD</b><br>GALAXY I   | <b>VKMA 02111</b>   | <b>LANCIA</b><br>DELTA I / PRISMA  | <b>VKMA 02174</b>   | <b>LANCIA</b><br>KAPPA / LYBRA  |
|   | <b>SEAT</b><br>ALHAMBRA / AROSA / LEON I (1M1) / TOLEDO II (1M2)  |   | <b>FIAT</b><br>REGATA / RITMO / UNO  | <b>VKMA 02175</b>   | <b>FIAT</b><br>REGATA   |
|   | <b>SKODA</b><br>FABIA / OCTAVIA I (1U2) / OCTAVIA Combi (1U5) / SUPERB  | <b>VKMA 02140</b>   | <b>LANCIA</b><br>DELTA I / PRISMA  | <b>VKMA 02176</b>   | <b>ALFA ROMEO</b><br>156 / 166  |
|   |   | <b>VKMA 02151</b>   | <b>FIAT</b><br>ELBA / FIORINO / REGATA / RITMO / UNO   |   | <b>FIAT</b><br>BRAVO / MAREA  |
|   |   |   | <b>LANCIA</b><br>DELTA I / PRISMA  | <b>VKMA 02177</b>   | <b>ALFA ROMEO</b><br>145/146 / 147 / 155 / 156 / 166 / GTV / SPIDER                 |
|   |   |   | <b>FIAT</b><br>REGATA / RITMO / UNO  |   | <b>FIAT</b><br>BARCETTA / COUPE   |
|   |   |   | <b>LANCIA</b><br>DELTA I / PRISMA  |   | <b>LANCIA</b><br>DEDRA / DELTA II   |







|  |                 |  |                                  |  |  |
|---|--|---|--|---|---|
| VKMA 02178  | FIAT<br>STILO  |   | FIAT<br>CROMA (194) / STILO  | VKMA 02215  | FIAT<br>BRAVA/BRAVO (182) / MAREA   |
|   | LANCIA<br>KAPPA / THESIS   |   | OPEL<br>ASTRA H / SIGNUM / VECTRA C<br>/ ZAFIRA B  | VKMA 02216  | LANCIA<br>Y   |
| VKMA 02179  | ALFA ROMEO<br>145/146 / 147 / 156  |   | SAAB<br>9-3 II   | VKMA 02222  | FIAT<br>FIORINO   |
|   | FIAT<br>BRAVA/BRAVO (182) / DOBLO /<br>IDEA / MAREA / MULTIPLA /<br>PUNTO (188) / STILO / STRADA |   | VAUXHALL<br>ASTRA Mk V / SIGNUM /<br>VECTRA Mk II  | VKMA 02224  | FIAT<br>TEMPRA / TIPO   |
|   | LANCIA<br>LYBRA  | VKMA 02195  | ALFA ROMEO<br>159  |   | ALFA ROMEO<br>155   |
| VKMA 02181  | ALFA ROMEO<br>145/146 / 147 / 156  |   | FIAT<br>CROMA (194)  |   | FIAT<br>COUPE / CROMA (154) / TIPO  |
| VKMA 02183  | ALFA ROMEO<br>156 / GT / GTV / SPIDER  |   | LANCIA<br>THESIS   | VKMA 02227  | LANCIA<br>DEDRA / DELTA I / DELTA II /<br>KAPPA / THEMA                             |
|   | FIAT<br>BARCETTA / BRAVA/BRAVO<br>(182) / COUPE / MAREA /<br>PUNTO (188)                         | VKMA 02197  | ALFA ROMEO<br>147 / 156  |   | FIAT<br>CROMA (154) / TEMPRA / TIPO   |
|   | LANCIA<br>DELTA II / LYBRA   | VKMA 02198  | FIAT<br>STILO  |   | LANCIA<br>DEDRA / DELTA I / DELTA II /<br>PRISMA / THEMA                            |
| VKMA 02184  | ALFA ROMEO<br>145/146 / 155 / 156 / GT   | VKMA 02200  | FIAT<br>DOBLO  | VKMA 02242  | FIAT<br>BRAVA/BRAVO (182) / DOBLO /<br>MAREA / MULTIPLA / PALIO/<br>SIENA / STILO   |
|   | FIAT<br>BARCETTA / PUNTO (188) /<br>STILO  |   | AUTOBIANCHI<br>Y10   |   | LANCIA<br>DEDRA / DELTA II / LYBRA  |
| VKMA 02185  | FIAT<br>MAREA  |   | FIAT<br>PANDA (141A_) / PUNTO (176)<br>/ TIPO / UNO  | VKMA 02277  | ALFA ROMEO<br>145/146 / 147 / 155 / 156 /<br>166 / GTV / SPIDER                     |
|   | LANCIA<br>LYBRA / THESIS   | VKMA 02201  | LANCIA<br>Y / Y10  |   | LANCIA<br>DEDRA / DELTA II  |
| VKMA 02186  | ALFA ROMEO<br>156  |   | FIAT<br>PALIO/SIENA / PUNTO (176) /<br>STRADA  | VKMA 02283  | ALFA ROMEO<br>156 / GT / GTV / SPIDER   |
|   | FIAT<br>BARCETTA   | VKMA 02202  | LANCIA<br>Y  |   | LANCIA<br>DELTA II / LYBRA  |
| VKMA 02190  | ALFA ROMEO<br>147 / 156 / GT   | VKMA 02203  | FIAT<br>CINQUECENTO / PALIO/SIENA /<br>PUNTO (176) / SEICENTO  | VKMA 02381  | ALFA ROMEO<br>AR 6 / AR 8   |
| VKMA 02191  | ALFA ROMEO<br>156 / 166  |   | FIAT<br>DOBLO / PALIO/SIENA / PANDA<br>(169) / PUNTO (176) / PUNTO<br>(188) / STRADA                               |   | FIAT<br>ARGENTA / CAMPAGNOLA /<br>DUCATO (280/290)                                  |
|   | LANCIA<br>THESIS   |   | LANCIA<br>Y / YPSILON  |   | IVECO<br>NEW DAILY  |
| VKMA 02192  | ALFA ROMEO<br>147  | VKMA 02204  | FIAT<br>500 / BRAVA/BRAVO (182) /<br>BRAVO / IDEA / MAREA / PALIO/<br>SIENA / PUNTO (176) / PUNTO<br>(188) / STILO |   | RENAULT<br>MASTER I / TRAFIC I  |
|   | FIAT<br>DOBLO / MULTIPLA / PUNTO<br>(188) / STILO / STRADA                                       |   | LANCIA<br>MUSA / Y / YPSILON   | VKMA 02382  | SEAT<br>131   |
|   | LANCIA<br>LYBRA / MUSA   | VKMA 02210  | FIAT<br>PALIO/SIENA / PANDA (141A_) /<br>PANDA (169) / PUNTO (176) /<br>SEICENTO / UNO                             |   | ALFA ROMEO<br>AR 8  |
|   | OPEL<br>ASTRA H / SIGNUM / VECTRA C<br>/ ZAFIRA B  |   | LANCIA<br>Y  | VKMA 02383  | FIAT<br>DUCATO (280/290)  |
|   | VAUXHALL<br>ASTRA Mk V / SIGNUM /<br>VECTRA Mk II / ZAFIRA Mk II                                 |   |  |   | IVECO<br>NEW DAILY  |
| VKMA 02193  | ALFA ROMEO<br>147 / 159 / BRERA / GT   |   |  |   | RENAULT<br>MASTER I   |
|   |  |   |  |   | CITROËN<br>JUMPER (230) / JUMPER (244)  |

|  |                     |  |  |  |  |
|---|--|---|---|---|---|
| VKMA 02384  | <b>FIAT</b><br>DUCATO (230) / DUCATO (244)<br>/ DUCATO (280/290)                                     | VKMA 02500  | <b>FIAT</b><br>CROMA (154)  | VKMA 03110  | <b>PEUGEOT</b><br>106 I / 106 II / 205 / 206 / 306<br>/ 309 / PARTNER               |
|   | <b>IVECO</b><br>DAILY II / NEW DAILY (96)  |   | <b>LANCIA</b><br>THEMA  |   | <b>CITROËN</b><br>AX / BERLINGO / BX / C15 /<br>SAXO / XSARA / ZX                   |
|   | <b>OPEL</b><br>ARENA / MOVANO  |   | <b>ALFA ROMEO</b><br>33 / ALFASUD / ARNA  |   | <b>PEUGEOT</b><br>106 I / 106 II / 205 / 206 / 306<br>/ 307 / 309 / 405 I / PARTNER |
|   | <b>PEUGEOT</b><br>BOXER I / BOXER II   |   | <b>ALFA ROMEO</b><br>145/146 / 33 / ALFASUD                                       |   | <b>CITROËN</b><br>AX / BX / C15 / SAXO / XSARA /<br>XSARA PICASSO / ZX              |
| VKMA 02386  | <b>RENAULT</b><br>MASTER I / MASTER II / TRAFIC<br>I   | VKMA 02630  | <b>ALFA ROMEO</b><br>145/146 / 33   | VKMA 03120  | <b>PEUGEOT</b><br>106 I / 106 II / 205 / 206 / 306<br>/ 309 / 405 I / 405 II        |
|   | <b>VAUXHALL</b><br>ARENA / MOVANO  |   | <b>FIAT</b><br>FIORINO / PANDA (141A_) /<br>UNO                                   |   | <b>CITROËN</b><br>AX  |
|   | <b>FIAT</b><br>DUCATO (230) / DUCATO (280/<br>290)   |   | <b>SEAT</b><br>IBIZA I (021A) / MALAGA /<br>RONDA                                 |   | <b>PEUGEOT</b><br>106 I   |
|   | <b>IVECO</b><br>DAILY / TURBO DAILY / TURBO<br>DAILY (96) / DAILY II / NEW<br>DAILY / NEW DAILY (96) |   | <b>CITROËN</b><br>JUMPER (230) / JUMPER (244)                                     |   | <b>ROVER</b><br>100   |
| VKMA 02390  | <b>RENAULT</b><br>MASTER I   | VKMA 02983  | <b>FIAT</b><br>DUCATO (230) / DUCATO (244)<br>/ DUCATO (280/290)                  | VKMA 03121  | <b>CITROËN</b><br>AX / SAXO / XSARA   |
|   | <b>FIAT</b><br>DUCATO (230)  |   | <b>OPEL</b><br>ARENA / MOVANO   |   | <b>PEUGEOT</b><br>106 I / 106 II  |
|   | <b>IVECO</b><br>DAILY / TURBO DAILY (96) /<br>DAILY II   |   | <b>PEUGEOT</b><br>BOXER I / BOXER II  |   | <b>ROVER</b><br>100   |
|   | <b>OPEL</b><br>MOVANO  |   | <b>RENAULT</b><br>MASTER I / MASTER II / TRAFIC<br>I                              |   | <b>CITROËN</b><br>SAXO  |
| VKMA 02410  | <b>RENAULT</b><br>MASTER II  | VKMA 02984  | <b>VAUXHALL</b><br>ARENA / MOVANO   | VKMA 03130  | <b>NISSAN</b><br>MICRA  |
|   | <b>VAUXHALL</b><br>MOVANO  |   | <b>FIAT</b><br>DUCATO (230) / DUCATO (280/<br>290)                                |   | <b>PEUGEOT</b><br>106 II  |
|   | <b>FIAT</b><br>DUCATO (244)  |   | <b>RENAULT</b><br>MASTER I  |   | <b>CITROËN</b><br>SAXO  |
|   | <b>IVECO</b><br>DAILY II   |   | <b>FIAT</b><br>DUCATO (230)   |   | <b>PEUGEOT</b><br>106 II  |
| VKMA 02422  | <b>CITROËN</b><br>JUMPY I  | VKMA 02986  | <b>OPEL</b><br>MOVANO   | VKMA 03132  | <b>CITROËN</b><br>BERLINGO / C3 / C3 Pluriel /<br>XSARA                             |
|   | <b>FIAT</b><br>ELBA / FIORINO / PUNTO (176)<br>/ SCUDO (220) / TEMPRA /<br>TIPO / UNO                |   | <b>RENAULT</b><br>MASTER II   |   | <b>PEUGEOT</b><br>206 / 307 / PARTNER   |
|   | <b>LANCIA</b><br>DEDRA / DELTA II  |   | <b>VAUXHALL</b><br>MOVANO   |   | <b>CITROËN</b><br>C1 / C2 / C3 / C3 Pluriel /<br>XSARA                              |
|   | <b>PEUGEOT</b><br>EXPERT I   |   | <b>CITROËN</b><br>AMI / GS  |   | <b>FORD</b><br>FIESTA V / FUSION  |
| VKMA 02450  | <b>FIAT</b><br>CROMA (154)   | VKMA 03000  | <b>FIAT</b><br>DUCATO (280/290)   | VKMA 03140  | <b>MAZDA</b><br>2   |
|   | <b>LANCIA</b><br>THEMA   |   | <b>CITROËN</b><br>AXEL / GS   |   | <b>PEUGEOT</b><br>1007 / 107 / 206 / 207 / 207<br>CC / 207 SW / 307                 |
|   | <b>RENAULT</b><br>SAFRANE I  |   | <b>CITROËN</b><br>C25 / CX  |   | <b>CITROËN</b><br>C3  |
|   | <b>ALFA ROMEO</b><br>164   |   | <b>FIAT</b><br>DUCATO (280/290)   |   | <b>CITROËN</b><br>BX / VISA / ZX  |









|            |  |            |  |            |   |
|------------|--|------------|--|------------|---|
| VKMA 03201 | <b>PEUGEOT</b><br>205 / 305 / 309 / 405 I<br><b>CITROËN</b><br>BERLINGO / BX / EVASION / XANTIA I / XANTIA II / XM I / XM II / XSARA / ZX<br><b>FIAT</b><br>ULYSSE (220)<br><b>LANCIA</b><br>ZETA<br><b>PEUGEOT</b><br>205 / 306 / 309 / 405 I / 405 II / 406 / 605 / 806 / EXPERT I / PARTNER | VKMA 03235 | <b>PEUGEOT</b><br>406<br><b>CITROËN</b><br>C4 / C5 I / C5 II / C8 / EVASION / JUMPY I / XSARA / XSARA PICASSO<br><b>FIAT</b><br>SCUDO (220) / ULYSSE (179AX) / ULYSSE (220)<br><b>LANCIA</b><br>PHEDRA / ZETA<br><b>PEUGEOT</b><br>206 / 307 / 406 / 407 / 607 / 806 / 807 / EXPERT I  | VKMA 03247 | <b>FIAT</b><br>DUCATO (230) / DUCATO (244) / SCUDO (220) / ULYSSE (220)<br><b>LANCIA</b><br>ZETA<br><b>PEUGEOT</b><br>206 / 306 / 406 / 806 / BOXER I / BOXER II / EXPERT I / PARTNER<br><b>CITROËN</b><br>BERLINGO / C5 I / EVASION / JUMPY I / JUMPY II / XSARA / XSARA PICASSO<br><b>FIAT</b><br>SCUDO (220) / ULYSSE (220)<br><b>LANCIA</b><br>ZETA<br><b>PEUGEOT</b><br>206 / 306 / 307 / 406 / 607 / 806 / EXPERT I / PARTNER |
| VKMA 03202 | <b>CITROËN</b><br>JUMPER (230) / JUMPER (244)<br><b>FIAT</b><br>DUCATO (230) / DUCATO (244)<br><b>PEUGEOT</b><br>BOXER I / BOXER II  | VKMA 03240 | <b>CITROËN</b><br>BX / C15 / C25 / VISA / ZX<br><b>LADA</b><br>NIVA<br><b>PEUGEOT</b><br>205 / 305 / 306 / 309 / 405 I / 405 II / J5<br><b>ROVER</b><br>200 (XW) / 400 (XW)  | VKMA 03248 | <b>CITROËN</b><br>C8 / EVASION<br><b>FIAT</b><br>SCUDO (220) / ULYSSE (179AX) / ULYSSE (220)<br><b>LANCIA</b><br>PHEDRA / ZETA<br><b>PEUGEOT</b><br>806 / 807 / EXPERT I  |
| VKMA 03210 | <b>CITROËN</b><br>BX<br><b>PEUGEOT</b><br>309 / 405 I  | VKMA 03241 | <b>CITROËN</b><br>BERLINGO / C15 / EVASION / JUMPER (230) / JUMPY I / JUMPY II / XANTIA I / XANTIA II / XSARA / ZX<br><b>FIAT</b><br>DUCATO (230) / SCUDO (220) / ULYSSE (220)<br><b>HYUNDAI</b><br>LANTRA<br><b>LADA</b><br>NIVA<br><b>PEUGEOT</b><br>205 / 306 / 405 II / 406 / 806 / BOXER I / EXPERT I / PARTNER<br><b>ROVER</b><br>200 (XW) / 400 (XW)<br><b>SUZUKI</b><br>SAMURAI / VITARA | VKMA 03250 | <b>CITROËN</b><br>XM I / XM II<br><b>PEUGEOT</b><br>605<br><b>CITROËN</b><br>EVASION / XANTIA I / XANTIA II / XM I / XM II<br><b>FIAT</b><br>ULYSSE (220)<br><b>LANCIA</b><br>ZETA<br><b>PEUGEOT</b><br>406 / 605 / 806   |
| VKMA 03211 | <b>CITROËN</b><br>XANTIA I / ZX<br><b>PEUGEOT</b><br>306 / 405 II  | VKMA 03244 | <b>CITROËN</b><br>BERLINGO / C15 / JUMPY I / XSARA<br><b>FIAT</b><br>SCUDO (220)<br><b>PEUGEOT</b><br>206 / 306 / EXPERT I / PARTNER<br><b>CITROËN</b><br>BERLINGO / EVASION / JUMPER (230) / JUMPER (244) / JUMPY I / JUMPY II / XANTIA II / XSARA / XSARA PICASSO  | VKMA 03251 | <b>CITROËN</b><br>XM I / XM II<br><b>PEUGEOT</b><br>605<br><b>CITROËN</b><br>EVASION / XANTIA I / XANTIA II / XM I / XM II<br><b>FIAT</b><br>ULYSSE (220)<br><b>LANCIA</b><br>ZETA<br><b>PEUGEOT</b><br>406 / 605 / 806   |
| VKMA 03213 | <b>CITROËN</b><br>EVASION / XANTIA I / XANTIA II / XM II / XSARA / ZX<br><b>FIAT</b><br>ULYSSE (220)<br><b>LANCIA</b><br>ZETA<br><b>PEUGEOT</b><br>306 / 406 / 605 / 806   | VKMA 03246 | <b>CITROËN</b><br>BERLINGO / C15 / JUMPY I / XSARA<br><b>FIAT</b><br>SCUDO (220)<br><b>PEUGEOT</b><br>206 / 306 / EXPERT I / PARTNER<br><b>CITROËN</b><br>BERLINGO / EVASION / JUMPER (230) / JUMPER (244) / JUMPY I / JUMPY II / XANTIA II / XSARA / XSARA PICASSO  | VKMA 03252 | <b>CITROËN</b><br>C5 I / C8<br><b>FIAT</b><br>ULYSSE (179AX)<br><b>LANCIA</b><br>PHEDRA<br><b>PEUGEOT</b><br>406 / 607 / 807  |
| VKMA 03214 | <b>CITROËN</b><br>XANTIA I / XANTIA II / XSARA / ZX<br><b>PEUGEOT</b><br>306 / 406   | VKMA 03246 | <b>CITROËN</b><br>BERLINGO / C15 / JUMPY I / XSARA<br><b>FIAT</b><br>SCUDO (220)<br><b>PEUGEOT</b><br>206 / 306 / EXPERT I / PARTNER<br><b>CITROËN</b><br>BERLINGO / EVASION / JUMPER (230) / JUMPER (244) / JUMPY I / JUMPY II / XANTIA II / XSARA / XSARA PICASSO  | VKMA 03253 | <b>CITROËN</b><br>BERLINGO / C2 / C3 / SAXO<br><b>PEUGEOT</b><br>106 II / 206 / PARTNER   |
| VKMA 03216 | <b>CITROËN</b><br>XANTIA II<br><b>PEUGEOT</b><br>306 / 406   | VKMA 03246 | <b>CITROËN</b><br>BERLINGO / EVASION / JUMPER (230) / JUMPER (244) / JUMPY I / JUMPY II / XANTIA II / XSARA / XSARA PICASSO  |            |   |
| VKMA 03218 | <b>CITROËN</b><br>XSARA<br><b>PEUGEOT</b><br>306   |            |  |            |   |
| VKMA 03220 | <b>CITROËN</b><br>XM I<br><b>PEUGEOT</b><br>605  | VKMA 03246 | <b>CITROËN</b><br>BERLINGO / EVASION / JUMPER (230) / JUMPER (244) / JUMPY I / JUMPY II / XANTIA II / XSARA / XSARA PICASSO  |            |   |
| VKMA 03231 | <b>CITROËN</b><br>C5 I   |            |  |            |   |















|  |         |  |      |  |    |
|---|--|---|---|---|---|
| VKMA 03254  | <b>CITROËN</b><br>BERLINGO / C2 / C3 / C3 Pluriel / SAXO / XSARA                         |   | <b>LAND ROVER</b><br>DISCOVERY III / RANGE ROVER SPORT                                | VKMA 04101  | <b>FORD</b><br>ESCORT BOX 81 / ESCORT BOX 86 / ESCORT III / ESCORT IV / FIESTA II / ORION I / ORION II  |
|   | <b>PEUGEOT</b><br>1007 / 106 II / 206 / 207 / 207 CC / 207 SW / 306 / 307 / PARTNER      | VKMA 03263  | <b>PEUGEOT</b><br>407 / 607   | VKMA 04103  | <b>FORD</b><br>ESCORT BOX 86 / ESCORT BOX 91 / ESCORT BOX 95 / ESCORT IV / ESCORT V / ESCORT VI / ESCORT VII / FIESTA BOX / COURRIER / FIESTA III / FIESTA IV / MONDEO I / ORION II / ORION III / P 100 II / SIERRA |
| VKMA 03255  | <b>CITROËN</b><br>JUMPER (244)   |   | <b>CITROËN</b><br>C4 / C4 Picasso / C5 II / C8  |   |   |
|   | <b>PEUGEOT</b><br>BOXER II   | VKMA 03264  | <b>PEUGEOT</b><br>307 / 407 / 807   | VKMA 04106  | <b>FORD</b><br>ESCORT BOX 95 / ESCORT VII / FIESTA BOX / COURRIER / FIESTA III / FIESTA IV / MONDEO I / MONDEO II   |
| VKMA 03256  | <b>CITROËN</b><br>BERLINGO / C2 / C3 / C3 Pluriel / C4 / XSARA / XSARA PICASSO           |   | <b>CITROËN</b><br>C5 I / C5 II / C8   |   |   |
|   | <b>PEUGEOT</b><br>1007 / 206 / 207 / 207 CC / 207 SW / 307 / PARTNER                     | VKMA 03265  | <b>PEUGEOT</b><br>406 / 607 / 807   | VKMA 04107  | <b>FORD</b><br>ESCORT BOX 95 / ESCORT VII / FIESTA BOX / COURRIER / FIESTA III / FIESTA IV / MONDEO I / MONDEO II   |
| VKMA 03257  | <b>CITROËN</b><br>C4 / C4 Picasso / C5 II / C8 / JUMPY III                               |   | <b>FIAT</b><br>SCUDO (220)  |   |   |
|   | <b>FORD</b><br>FOCUS C-MAX I / FOCUS C-MAX II / FOCUS II / GALAXY II / MONDEO IV / S-MAX | VKMA 03266  | <b>PEUGEOT</b><br>EXPERT I  | VKMA 04107  | <b>FORD</b><br>ESCORT BOX 95 / ESCORT VII / FIESTA BOX / COURRIER / FIESTA IV / MONDEO II   |
|   | <b>LANCIA</b><br>PHEDRA  |   | <b>SUZUKI</b><br>GRAND VITARA   | VKMA 04108  | <b>FORD</b><br>FIESTA BOX / COURRIER / FIESTA IV / FOCUS C-MAX I / FOCUS I / FOCUS II / GALAXY II / MONDEO IV / S-MAX / TRANSIT CONNECT / TOURNEO CONNECT   |
|   | <b>PEUGEOT</b><br>307 / 308 / 407 / 607 / 807 / EXPERT II / EXPERT Tepee                 | VKMA 03300  | <b>CITROËN</b><br>JUMPER (244)  |   |   |
|   | <b>VOLVO</b><br>S40 II - V50   |   | <b>PEUGEOT</b><br>BOXER II  | VKMA 04200  | <b>FORD</b><br>ESCORT BOX 81 / ESCORT BOX 86 / ESCORT II / ESCORT III / ESCORT IV / FIESTA BOX / COURRIER / FIESTA I / FIESTA II / ORION I  |
| VKMA 03258  | <b>CITROËN</b><br>C2 / C3 / C4   | VKMA 03301  | <b>CITROËN</b><br>JUMPER (230) / XM II  |   |   |
|   | <b>PEUGEOT</b><br>1007 / 206 / 207 / 207 CC / 207 SW / 307                               |   | <b>PEUGEOT</b><br>605 / BOXER I   | VKMA 04201  | <b>FORD</b><br>ESCORT BOX 81 / ESCORT BOX 86 / ESCORT BOX 91 / ESCORT III / ESCORT IV / ESCORT V / FIESTA I / FIESTA II / FIESTA III / ORION I / ORION II / ORION III / SIERRA                                      |
| VKMA 03259  | <b>CITROËN</b><br>BERLINGO / C3 / C4 / C4 Picasso / C5 II / XSARA PICASSO                | VKMA 03304  | <b>CITROËN</b><br>JUMPER (230)  |   |   |
|   | <b>FORD</b><br>FIESTA V / FOCUS C-MAX I / FOCUS C-MAX II / FOCUS II / FUSION             |   | <b>PEUGEOT</b><br>BOXER I   | VKMA 04202  | <b>FORD</b><br>ESCORT BOX 91 / ESCORT BOX 95 / ESCORT V / ESCORT VI / ESCORT VII / FIESTA BOX / COURRIER / FIESTA III / ORION III / SIERRA  |
|   | <b>MAZDA</b><br>3  | VKMA 03902  | <b>CITROËN</b><br>C5 I / C5 II / C6 / C8 / XANTIA II / XM II                          |   |   |
|   | <b>PEUGEOT</b><br>1007 / 206 / 207 / 207 CC / 207 SW / 307 / 308 / 407 / PARTNER         |   | <b>FIAT</b><br>ULYSSE (179AX)   | VKMA 04204  | <b>FORD</b><br>SIERRA   |
|   | <b>VOLVO</b><br>S40 II - V50   | VKMA 04000  | <b>LANCIA</b><br>PHEDRA   | VKMA 04212  | <b>FORD</b><br>ESCORT V / ESCORT VI / ESCORT VII / FIESTA III / MONDEO I / MONDEO II / ORION III  |
| VKMA 03260  | <b>CITROËN</b><br>C4   |   | <b>PEUGEOT</b><br>406 / 407 / 605 / 607 / 807   | VKMA 04213  | <b>FORD</b><br>COUGAR / FOCUS I / MONDEO II   |
|   | <b>PEUGEOT</b><br>206 / 307  | VKMA 04001  | <b>RENAULT</b><br>AVANTIME / CLIO II / ESPACE III / LAGUNA I / LAGUNA II / SAFRANE II | VKMA 04214  | <b>FORD</b><br>COUGAR / FOCUS I / MONDEO II / TRANSIT CONNECT / TOURNEO CONNECT   |
| VKMA 03261  | <b>CITROËN</b><br>C6   |   | <b>FORD</b><br>CAPRI / GRANADA / P 100 I / SIERRA / TRANSIT                           | VKMA 04220  | <b>FORD</b><br>FIESTA IV  |
|   |  |   | <b>FORD</b><br>CAPRI / ESCORT II / GRANADA / P 100 II / SCORPIO / SIERRA / TRANSIT    |   |   |









|            |   |            |   |            |   |
|------------|---|------------|---|------------|---|
| VKMA 04222 | <b>FORD</b><br>FIESTA IV / FIESTA V / FOCUS C-MAX I / FOCUS I / FOCUS II / FUSION / PUMA  |            | <b>VAUXHALL</b><br>ASTRA Mk IV / ASTRA Mk V / CORSA Mk II / MERIVA / TIGRA Mk II / VECTRA Mk II / ZAFIRA Mk I | VKMA 05220 | <b>LADA</b><br>110  |
| VKMA 04223 | <b>FORD</b><br>PUMA   | VKMA 05156 | <b>OPEL</b><br>ASTRA G / ASTRA H / COMBO B / CORSA C / MERIVA / SIGNUM / TIGRA Twin Top / VECTRA C / ZAFIRA A |            | <b>OPEL</b><br>ASTRA F / CALIBRA / KADETT E / VECTRA A                            |
| VKMA 04224 | <b>FORD</b><br>FIESTA V / FOCUS C-MAX I / FOCUS C-MAX II / FOCUS II / FUSION / MONDEO IV  |            | <b>VAUXHALL</b><br>ASTRA Mk IV / ASTRA Mk V / CORSA Mk II / MERIVA / TIGRA Mk II / VECTRA Mk II / ZAFIRA Mk I | VKMA 05222 | <b>VAUXHALL</b><br>ASTRA Mk II / ASTRA Mk III / CALIBRA / CAVALIER Mk III         |
| VKMA 04300 | <b>FORD</b><br>TRANSIT  |            | <b>OPEL</b><br>ASCONA C / KADETT D / KADETT E   |            | <b>CHEVROLET</b><br>EPICA   |
| VKMA 04301 | <b>FORD</b><br>TRANSIT  | VKMA 05200 | <b>VAUXHALL</b><br>ASTRA Mk II / CAVALIER Mk II   |            | <b>DAEWOO</b><br>EVANDA / LACETTI / LEGANZA / MAGNUM / NUBIRA / REZZO / TACUMA    |
| VKMA 04304 | <b>FORD</b><br>TRANSIT  |            | <b>OPEL</b><br>ASCONA C / ASTRA F / KADETT E / VECTRA A   |            | <b>OPEL</b><br>ASTRA F / CALIBRA / OMEGA B / VECTRA A / VECTRA B                  |
| VKMA 04305 | <b>FORD</b><br>TRANSIT  | VKMA 05201 | <b>VAUXHALL</b><br>ASTRA Mk II / ASTRA Mk III / CAVALIER Mk II / CAVALIER Mk III                              |            | <b>SUZUKI</b><br>VERONA   |
| VKMA 05121 | <b>CHEVROLET</b><br>AVEO  |            | <b>OPEL</b><br>ASTRA F / ASTRA G / KADETT E / VECTRA A  | VKMA 05223 | <b>VAUXHALL</b><br>ASTRA Mk III / CALIBRA / CAVALIER Mk III / OMEGA / VECTRA Mk I |
|            | <b>DAEWOO</b><br>CIELO / ESPERO / KALOS / LANOS / NEXIA / NUBIRA  | VKMA 05202 | <b>VAUXHALL</b><br>ASTRA Mk II / CORSA Mk I / NOVA / NOVAVAN  |            | <b>DAEWOO</b><br>LEGANZA  |
|            | <b>OPEL</b><br>ASTRA F / ASTRA F CLASSIC / ASTRA G / COMBO A / COMBO B / CORSA A / CORSA B / KADETT E / MERIVA / VECTRA A / VECTRA B          |            | <b>OPEL</b><br>ASTRA F / CALIBRA / KADETT E / VECTRA A  | VKMA 05224 | <b>OPEL</b><br>FRONTERA A   |
|            | <b>VAUXHALL</b><br>ASTRA Mk II / ASTRA Mk III / ASTRA Mk IV / CAVALIER Mk III / COMBO I / COMBO II / CORSA Mk I / MERIVA / NOVA / VECTRA Mk I | VKMA 05208 | <b>VAUXHALL</b><br>ASTRA Mk II / CORSA Mk I / NOVA / NOVAVAN  |            | <b>VAUXHALL</b><br>FRONTERA Mk I  |
| VKMA 05140 | <b>OPEL</b><br>ASTRA G / SPEEDSTER / ZAFIRA A   |            | <b>OPEL</b><br>CORSA A / CORSA B / KADETT E   | VKMA 05228 | <b>OPEL</b><br>ASTRA G  |
|            | <b>VAUXHALL</b><br>ASTRA Mk IV / VX 220 / ZAFIRA Mk I   | VKMA 05211 | <b>VAUXHALL</b><br>ASTRA Mk II / ASTRA Mk III / CALIBRA / CAVALIER Mk III                                     |            | <b>VAUXHALL</b><br>ASTRA Mk IV  |
| VKMA 05150 | <b>OPEL</b><br>ASTRA F / ASTRA F CLASSIC / COMBO A / CORSA B / TIGRA / VECTRA B   |            | <b>OPEL</b><br>ASTRA F / COMBO A / VECTRA A   | VKMA 05230 | <b>OPEL</b><br>ANTARA / FRONTERA A / FRONTERA B / OMEGA B / SINTRA / VECTRA B     |
|            | <b>VAUXHALL</b><br>ASTRA Mk III / CORSA Mk I / TIGRA Mk I / VECTRA Mk I   | VKMA 05213 | <b>VAUXHALL</b><br>ASTRA F / COMBO A / CORSA B / VECTRA A   |            | <b>VAUXHALL</b><br>FRONTERA Mk I / FRONTERA Mk II / OMEGA / SINTRA / VECTRA Mk I  |
| VKMA 05152 | <b>OPEL</b><br>ASTRA G / ZAFIRA A   |            | <b>VAUXHALL</b><br>ASTRA Mk III / CAVALIER Mk III / COMBO I / CORSA Mk I                                      | VKMA 05230 | <b>OPEL</b><br>SIGNUM / VECTRA C  |
|            | <b>VAUXHALL</b><br>ASTRA Mk IV / ZAFIRA Mk I  | VKMA 05214 | <b>OPEL</b><br>ASTRA F / COMBO A / CORSA B / VECTRA A / VECTRA B  |            | <b>RENAULT</b><br>ESPACE IV / VEL SATIS   |
| VKMA 05154 | <b>OPEL</b><br>ASTRA G / ASTRA H / CORSA C / MERIVA / SIGNUM / TIGRA Twin Top / VECTRA C / ZAFIRA A   |            | <b>VAUXHALL</b><br>ASTRA Mk III / CAVALIER Mk III / COMBO I / CORSA Mk I / VECTRA Mk I                        | VKMA 05402 | <b>SAAB</b><br>9-5  |
|            | <b>SAAB</b><br>9-3 II   |            | <b>OPEL</b><br>ASTRA F / COMBO A / CORSA B / VECTRA A / VECTRA B  |            | <b>VAUXHALL</b><br>SIGNUM / VECTRA Mk II  |







|  |                                   |  |   |  |           |   |
|---|--|---|--|---|--|---|
| VKMA 05500  | <b>VAUXHALL</b><br>ASTRA Mk II / ASTRA Mk III / CALIBRA / CARLTON Mk III / CAVALIER Mk III / FRONTERA Mk I / OMEGA | VKMA 06010  | <b>NISSAN</b><br>KUBISTAR  | VKMA 06111  | <b>VOLVO</b><br>340-360  |   |
|   | <b>OPEL</b><br>CALIBRA / OMEGA B / SINTRA / VECTRA A / VECTRA B  | VKMA 06020  | <b>RENAULT</b><br>CLIO I / CLIO II / KANGOO / TWINGO   |   | <b>RENAULT</b><br>EXPRESS/EXTRA/RAPID / MEGANE I / R11 / R19 / R21 / SUPER 5                 |   |
|   | <b>SAAB</b><br>900 II / 9000   |   | <b>DACIA</b><br>LOGAN  |   | <b>VOLVO</b><br>340-360 / 440-460 / S40 I - V40  |   |
| VKMA 05501  | <b>VAUXHALL</b><br>CALIBRA / CAVALIER Mk III / OMEGA / SINTRA / VECTRA Mk I  | VKMA 06021  | <b>NISSAN</b><br>KUBISTAR  | VKMA 06112  | <b>RENAULT</b><br>CLIO I / MEGANE I / R19 / SPORT SPIDER                                     |   |
|   | <b>OPEL</b><br>OMEGA B / VECTRA B  |   | <b>RENAULT</b><br>CLIO II / CLIO III / KANGOO / LAGUNA I / LAGUNA II / MEGANE I / MEGANE II / MODUS / SCENIC I / SCENIC II / GRAND SCENIC / THALIA |   | VKMA 06113   | <b>RENAULT</b><br>CLIO I / EXPRESS/EXTRA/ RAPID |
|   | <b>SAAB</b><br>9-5   |   | <b>RENAULT</b><br>CLIO III / LAGUNA II / MEGANE II / MODUS / SCENIC II / GRAND SCENIC  |   |  | VKMA 06114                                      |
| VKMA 05502  | <b>VAUXHALL</b><br>OMEGA / VECTRA Mk I   | VKMA 06040  | <b>FORD</b><br>FOCUS II / MONDEO IV / S-MAX  | VKMA 06115  |  |   |
|   | <b>OPEL</b><br>OMEGA B / SIGNUM / VECTRA B / VECTRA C  |   | <b>VOLVO</b><br>S40 II - V50 / S60 / S80 / V70 II / XC70 I / XC90  |   | <b>VAUXHALL</b><br>ARENA   |   |
|   | <b>SAAB</b><br>9-5   |   | <b>RENAULT</b><br>R11 / R21 / R9 / SUPER 5 / TRAFIC I  |   | <b>VOLVO</b><br>S40 I - V40  |   |
| VKMA 05606  | <b>VAUXHALL</b><br>OMEGA / SIGNUM / VECTRA Mk I / VECTRA Mk II   | VKMA 06100  | <b>VOLVO</b><br>340-360 / 480  | VKMA 06116  | <b>RENAULT</b><br>ESPACE III / KANGOO / LAGUNA I / MEGANE I / SCENIC I                       |   |
|   | <b>OPEL</b><br>ASTRA G / COMBO B / CORSA B / CORSA C   |   | <b>RENAULT</b><br>CLIO I / LAGUNA I / R11 / R19 / R21 / R9 / SUPER 5 / TRAFIC I  |   | <b>VOLVO</b><br>S40 I - V40  |   |
|   | <b>VAUXHALL</b><br>ASTRA Mk IV / COMBO II / CORSA Mk II  |   | <b>VOLVO</b><br>440-460 / 480  |   | <b>RENAULT</b><br>CLIO I / CLIO II / EXPRESS/ EXTRA/RAPID / KANGOO                           |   |
| VKMA 05608  | <b>OPEL</b><br>ASTRA G / COMBO B / CORSA B / CORSA C / MERIVA  | VKMA 06101  | <b>RENAULT</b><br>CLIO I / CLIO II / EXPRESS/ EXTRA/RAPID / KANGOO   | VKMA 06117  | <b>OPEL</b><br>MOVANO  |   |
|   | <b>VAUXHALL</b><br>ASTRA Mk IV / COMBO II / CORSA Mk II / MERIVA   |   | <b>RENAULT</b><br>CLIO II / ESPACE III / KANGOO / LAGUNA I / MASTER II / MEGANE I / SCENIC I   |   | <b>RENAULT</b><br>CLIO II / ESPACE III / KANGOO / LAGUNA I / MASTER II / MEGANE I / SCENIC I |   |
|   | <b>OPEL</b><br>ASTRA G / ASTRA H   |   | <b>VOLVO</b><br>440-460 / 480  |   | <b>VAUXHALL</b><br>MOVANO  |   |
| VKMA 05700  | <b>VAUXHALL</b><br>ASTRA Mk IV / COMBO II / CORSA Mk II / MERIVA   | VKMA 06102  | <b>RENAULT</b><br>ESPACE III / LAGUNA I / MEGANE I / SCENIC I  | VKMA 06122  | <b>RENAULT</b><br>MEGANE I / SPORT SPIDER  |   |
|   | <b>OPEL</b><br>ASTRA G / ASTRA H   |   | <b>RENAULT</b><br>LAGUNA II  |   | <b>RENAULT</b><br>MEGANE I / SCENIC I  |   |
|   | <b>VAUXHALL</b><br>ASTRA Mk IV / ASTRA Mk V  |   | <b>VOLVO</b><br>440-460 / 480  |   | <b>VAUXHALL</b><br>MOVANO  |   |
| VKMA 06000  | <b>OPEL</b><br>ASTRA G / ASTRA H   | VKMA 06103  | <b>RENAULT</b><br>ESPACE III / LAGUNA I / MEGANE I / SCENIC I  | VKMA 06123  | <b>RENAULT</b><br>ESPACE III / LAGUNA I / MEGANE I / SCENIC I                                |   |
|   | <b>VAUXHALL</b><br>ASTRA Mk IV / ASTRA Mk V  |   | <b>RENAULT</b><br>AVANTIME / CLIO III / ESPACE IV / LAGUNA II / LAGUNA III / MEGANE II / SCENIC II / GRAND SCENIC / VEL SATIS                      |   | <b>RENAULT</b><br>ESPACE III / LAGUNA I / MEGANE I / SCENIC I                                |   |
|   | <b>RENAULT</b><br>CLIO I / EXPRESS/EXTRA/ RAPID / MEGANE I / R19 / SCENIC I  |   | <b>VOLVO</b><br>440-460 / 480  |   | <b>VAUXHALL</b><br>MOVANO  |   |
| VKMA 06002  | <b>RENAULT</b><br>CLIO II / CLIO III / KANGOO / MODUS / THALIA / TWINGO / TWINGO II                                | VKMA 06104  | <b>RENAULT</b><br>CLIO I / LAGUNA I / R11 / R19 / R21 / R9 / SUPER 5 / TRAFIC I  | VKMA 06124  | <b>RENAULT</b><br>MEGANE I / SCENIC I / TRAFIC I   |   |
|   | <b>RENAULT</b><br>CLIO II / ESPACE III / KANGOO / LAGUNA I / MEGANE I / SCENIC I                                   |   | <b>RENAULT</b><br>CLIO II / ESPACE III / LAGUNA I / MEGANE I / SCENIC I  |   | <b>RENAULT</b><br>MEGANE I / SCENIC I  |   |
|   | <b>RENAULT</b><br>CLIO II / CLIO III / KANGOO / MODUS / THALIA / TWINGO / TWINGO II                                |   | <b>VOLVO</b><br>340-360 / 440-460 / 480  |   | <b>RENAULT</b><br>ESPACE III / KANGOO / LAGUNA I / MEGANE I / SCENIC I                       |   |
| VKMA 06003  | <b>DACIA</b><br>LOGAN  | VKMA 06105  | <b>RENAULT</b><br>CLIO II / ESPACE III / LAGUNA I / MEGANE I / SCENIC I  | VKMA 06125  | <b>RENAULT</b><br>ESPACE III / KANGOO / LAGUNA I / MEGANE I / SCENIC I                       |   |
|   | <b>RENAULT</b><br>CLIO II / KANGOO / MEGANE I / SCENIC I / THALIA  |   | <b>RENAULT</b><br>CLIO II / ESPACE III / LAGUNA I / MEGANE I / SCENIC I  |   | <b>RENAULT</b><br>ESPACE III / KANGOO / LAGUNA I / MEGANE I / SCENIC I                       |   |
|   | <b>RENAULT</b><br>CLIO II / KANGOO / MEGANE I / SCENIC I / THALIA  |   | <b>VOLVO</b><br>340-360 / 440-460 / 480  |   | <b>RENAULT</b><br>ESPACE III / KANGOO / LAGUNA I / MEGANE I / SCENIC I                       |   |







|  |    |  |                            |  |         |
|---|---|---|--|---|--|
|   | <b>RENAULT</b><br>ESPACE IV / LAGUNA I /<br>LAGUNA II / MASTER II / TRAFIC<br>II  | <b>VKMA 06205</b>   | <b>RENAULT</b><br>ESPACE II / MASTER I / R21 /<br>R25 / SAFRANE I / TRAFIC I                                 | <b>VKMA 06603</b>   | <b>VOLVO</b><br>850 / C70 - S70 / V70 I  |
|   | <b>VAUXHALL</b><br>MOVANO / VIVARO  | <b>VKMA 06206</b>   | <b>RENAULT</b><br>R21  | <b>VKMA 06604</b>   | <b>RENAULT</b><br>LAGUNA I / SAFRANE II  |
|   | <b>VOLVO</b><br>S40 I - V40   | <b>VKMA 06207</b>   | <b>RENAULT</b><br>R21  |   | <b>VOLVO</b><br>C70 - S70 / S40 I - V40 / S60 /<br>S80 / V70 I / V70 II / XC70 I /<br>XC90 |
| <b>VKMA 06128</b>   | <b>RENAULT</b><br>ESPACE III / SCENIC I   | <b>VKMA 06212</b>   | <b>RENAULT</b><br>SAFRANE I  | <b>VKMA 06605</b>   | <b>VOLVO</b><br>C70 - S70 / V70 I  |
| <b>VKMA 06129</b>   | <b>NISSAN</b><br>PRIMERA  | <b>VKMA 06213</b>   | <b>JEEP</b><br>CHEROKEE  | <b>VKMA 06608</b>   | <b>VOLVO</b><br>960  |
|   | <b>RENAULT</b><br>LAGUNA II / MEGANE II /<br>SCENIC II / GRAND SCENIC   |   | <b>RENAULT</b><br>ESPACE I / ESPACE II / MASTER<br>I / R18 / R20 / R21 / R25 / R30<br>/ TRAFIC I             | <b>VKMA 06610</b>   | <b>VOLVO</b><br>960 / S90 - V90  |
| <b>VKMA 06130</b>   | <b>NISSAN</b><br>ALMERA / MICRA   | <b>VKMA 06220</b>   | <b>VOLVO</b><br>C30 / S60 / S80 / V70 II / XC70<br>I / XC90  | <b>VKMA 06800</b>   | <b>VOLVO</b><br>S80 / XC90   |
|   | <b>RENAULT</b><br>CLIO II / KANGOO / MEGANE II /<br>SCENIC II / GRAND SCENIC /<br>THALIA                                    | <b>VKMA 06300</b>   | <b>VOLVO</b><br>240 / 340-360 / 740 / 760 /<br>940   | <b>VKMA 07100</b>   | <b>AUSTIN</b><br>MAESTRO / MONTEGO   |
| <b>VKMA 06132</b>   | <b>DACIA</b><br>LOGAN   | <b>VKMA 06301</b>   | <b>VOLVO</b><br>240 / 940  | <b>VKMA 07110</b>   | <b>ROVER</b><br>200 (XW)   |
|   | <b>NISSAN</b><br>ALMERA / KUBISTAR / MICRA  | <b>VKMA 06406</b>   | <b>VOLVO</b><br>740  | <b>VKMA 07200</b>   | <b>AUSTIN</b><br>MAESTRO / MONTEGO   |
|   | <b>RENAULT</b><br>CLIO II / CLIO III / KANGOO /<br>LAGUNA III / MEGANE II /<br>MODUS / SCENIC II / GRAND<br>SCENIC / THALIA | <b>VKMA 06408</b>   | <b>VOLVO</b><br>740 / 940 / 960  | <b>VKMA 07300</b>   | <b>ROVER</b><br>200 (XH) / MAESTRO   |
| <b>VKMA 06137</b>   | <b>RENAULT</b><br>CLIO II / ESPACE III / KANGOO /<br>LAGUNA I / MASTER II / MEG-<br>ANE I / SCENIC I                        | <b>VKMA 06500</b>   | <b>RENAULT</b><br>LAGUNA I   | <b>VKMA 07301</b>   | <b>ROVER</b><br>100 / 200 (RF) / 200 (XW) / 200<br>cabriolet (XW)                          |
| <b>VKMA 06200</b>   | <b>CITROËN</b><br>CX  | <b>VKMA 06501</b>   | <b>RENAULT</b><br>ESPACE III / LAGUNA I /<br>SAFRANE II  |   | <b>LAND ROVER</b><br>FREELANDER I  |
|   | <b>PEUGEOT</b><br>505   | <b>VKMA 06502</b>   | <b>RENAULT</b><br>LAGUNA I   |   | <b>MG</b><br>MG ZR / MG ZS / MG ZT / MGF /<br>MGTF   |
|   | <b>RENAULT</b><br>MASTER I / R18 / R20  | <b>VKMA 06503</b>   | <b>NISSAN</b><br>INTERSTAR / PRIMASTAR   |   | <b>ROVER</b><br>200 (RF) / 200 coupe (RF) / 25 /<br>400 (RT) / 45 / 75 /<br>STREETWISE     |
| <b>VKMA 06201</b>   | <b>CITROËN</b><br>CX  |   | <b>OPEL</b><br>MOVANO / VIVARO   | <b>VKMA 07302</b>   | <b>HONDA</b><br>ACCORD / CIVIC   |
|   | <b>PEUGEOT</b><br>505   |   | <b>RENAULT</b><br>AVANTIME / ESPACE III /<br>ESPACE IV / LAGUNA II /<br>MASTER II / TRAFIC II / VEL<br>SATIS | <b>VKMA 07303</b>   | <b>ROVER</b><br>200 (RF) / 400 (RT) / 600  |
|   | <b>RENAULT</b><br>ESPACE I / MASTER I / R18 /<br>R21 / R25 / TRAFIC I   | <b>VKMA 06560</b>   | <b>VAUXHALL</b><br>MOVANO / VIVARO   |   | <b>MG</b><br>MG ZR / MG ZS   |
| <b>VKMA 06203</b>   | <b>CITROËN</b><br>CX  | <b>VKMA 06600</b>   | <b>VOLVO</b><br>S80  | <b>VKMA 07304</b>   | <b>ROVER</b><br>25 / 45 / STREETWISE   |
|   | <b>PEUGEOT</b><br>505   | <b>VKMA 06601</b>   | <b>VOLVO</b><br>850 / 960  |   | <b>LAND ROVER</b><br>FREELANDER I  |
|   | <b>RENAULT</b><br>ESPACE I / MASTER I / R21 /<br>R25 / TRAFIC I   | <b>VKMA 06602</b>   | <b>VOLVO</b><br>850  | <b>VKMA 07310</b>   | <b>MG</b><br>MG ZR / MG ZS   |
| <b>VKMA 06204</b>   | <b>RENAULT</b><br>ESPACE II / MASTER I / R21 /<br>R25 / SAFRANE I / TRAFIC I  |   | <b>RENAULT</b><br>LAGUNA I / SAFRANE II  |   | <b>ROVER</b><br>25 / 45 / STREETWISE   |
|   |   |   | <b>VOLVO</b><br>850 / C70 - S70 / S40 I - V40 /<br>V70 I   |   | <b>MG</b><br>MG ZR / MGF / MGTF  |







|  |    |  |    |  |    |
|---|---|---|---|---|---|
| VKMA 07400  | <b>ROVER</b><br>100 / 200 (RF) / 200 (XW) / 200 cabriolet (XW) / 200 coupe (RF) / 25 / 400 (RT) / 400 (XW) / 45 / STREETWISE  |   | <b>SKODA</b><br>OCTAVIA I (1U2) / OCTAVIA Combi (1U5)   |   | <b>VW</b><br>CADDY II(9K9A)/Estate(9K9B)/ Pickup(9U7) / GOLF III (1H1) / GOLF III Variant (1H5) / GOLF III Cabriolet (1E7) / GOLF IV Cabriolet (1E7) / PASSAT (3A2, 351) / Variant (3A5, 351) / POLO CLASSIC (6KV2) / Variant (6KV5) / SHARAN (7M8, 7M9, 7M6) / VENTO (1H2) |
| VKMA 08000  | <b>LAND ROVER</b><br>90/110   |   | <b>VW</b><br>BORA (1J2) / BORA Estate (1J6) / CADDY II(9K9A)/Estate(9K9B)/ Pickup(9U7) / GOLF IV (1J1) / GOLF IV Variant (1J5) / POLO CLASSIC (6KV2) / Variant (6KV5)   |   | <b>FORD</b><br>GALAXY I   |
| VKMA 08001  | <b>BMW</b><br>3 (E30) / 3 Convertible (E30) / 3 Touring (E30) / 5 (E34)   | VKMA 31014  | <b>AUDI</b><br>A3 (8L1)   | VKMA 31030  | <b>SEAT</b><br>ALHAMBRA / CORDOBA (6K2) / CORDOBA (6K2/C2) / CORDOBA Vario (6K5) / IBIZA II (6K1) / INCA / TOLEDO I (1L)  |
| VKMA 08100  | <b>BMW</b><br>3 (E36) / 5 (E34) / 5 Touring (E34)   |   | <b>SEAT</b><br>CORDOBA (6K2) / CORDOBA (6K2/C2) / CORDOBA Vario (6K5) / IBIZA III (6K1) / LEON I (1M1) / TOLEDO II (1M2)  |   | <b>VW</b><br>CADDY II(9K9A)/Estate(9K9B)/ Pickup(9U7) / GOLF III (1H1) / GOLF III Variant (1H5) / GOLF IV Cabriolet (1E7) / PASSAT (3A2, 351) / Variant (3A5, 351) / POLO CLASSIC (6KV2) / Variant (6KV5) / SHARAN (7M8, 7M9, 7M6) / VENTO (1H2)                            |
| VKMA 08110  | <b>BMW</b><br>3 (E21) / 5 (E12) / 5 (E28)   |   | <b>SKODA</b><br>OCTAVIA I (1U2) / OCTAVIA Combi (1U5)   |   | <b>FORD</b><br>GALAXY I   |
| VKMA 08120  | <b>BMW</b><br>3 (E21) / 3 (E30) / 3 Convertible (E30) / 3 Touring (E30) / 5 (E12) / 5 (E28) / 5 (E34) / Z1  |   | <b>VW</b><br>BORA (1J2) / BORA Estate (1J6) / CADDY II(9K9A)/Estate(9K9B)/ Pickup(9U7) / GOLF IV (1J1) / GOLF IV Variant (1J5) / NEW BEETLE (9C1, 1C1)/Convertible (1Y7) / POLO CLASSIC (6KV2) / Variant (6KV5) |   | <b>SEAT</b><br>ALHAMBRA / CORDOBA (6K2) / CORDOBA (6K2/C2) / CORDOBA Vario (6K5) / IBIZA II (6K1) / IBIZA III (6K1) / INCA  |
| VKMA 08201  | <b>BMW</b><br>3 (E30) / 3 Touring (E30) / 5 (E28) / 5 (E34)   |   | <b>SEAT</b><br>AROSA  | VKMA 31060  | <b>FORD</b><br>GALAXY I   |
| VKMA 08201  | <b>LADA</b><br>FORMA / SAMARA   |   | <b>SKODA</b><br>FELICIA I (6U1)/Estate (6U5)/ Fun (797) / FELICIA II (6U1)/ FELICIA II Estate (6U5)   |   | <b>MERCEDES-BENZ</b><br>V-class (W638)  |
| VKMA 31000  | <b>AUDI</b><br>A4 (8D2, B5) / A4 Avant (8D5, B5) / A4 (8E2, B6) / A4 Avant (8E5, B6) / A6 (4B, C5) / A6 Avant (4B, C5)  | VKMA 31017  | <b>VW</b><br>CADDY II(9K9A)/Estate(9K9B)/ Pickup(9U7) / LUPO (6X1, 6E1) / POLO (6N1) / POLO Box (6NF) / POLO (6N2)  |   | <b>VW</b><br>CORRADO (531) / GOLF III (1H1) / GOLF III Variant (1H5) / PASSAT (3A2, 351) / Variant (3A5, 351) / SHARAN (7M8, 7M9, 7M6) / VENTO (1H2)  |
|   | <b>SKODA</b><br>SUPERB  |   | <b>AUDI</b><br>A4 (8D2, B5) / A4 Avant (8D5, B5) / A6 (4B, C5) / A6 Avant (4B, C5)  | VKMA 31202  | <b>SEAT</b><br>AROSA / CORDOBA (6K2) / CORDOBA (6K2/C2) / CORDOBA Vario (6K5) / IBIZA II (6K1) / IBIZA III (6K1) / INCA   |
|   | <b>VW</b><br>PASSAT (3B2) / Variant (3B5) / PASSAT (3B3) / Variant (3B6)  |   | <b>SKODA</b><br>SUPERB  |   | <b>VW</b><br>CADDY II(9K9A)/Estate(9K9B)/ Pickup(9U7) / CADDY III (2KA) / CADDY III Estate (2KB) / GOLF III (1H1) / GOLF III Variant (1H5) / LUPO (6X1, 6E1) / POLO (6N1) / POLO Box (6NF) / POLO (6N2) / POLO CLASSIC (6KV2) / Variant (6KV5) / VENTO (1H2)                |
| VKMA 31001  | <b>AUDI</b><br>A3 (8L1)   | VKMA 31020  | <b>VW</b><br>PASSAT (3B2) / Variant (3B5) / PASSAT (3B3) / Variant (3B6)  |   | <b>AUDI</b><br>A3 (8L1) / TT (8N3) / TT Roadster (8N9)  |
|   | <b>FORD</b><br>GALAXY I   |   | <b>FORD</b><br>GALAXY I   | VKMA 31203  | <b>SEAT</b><br>ALHAMBRA / AROSA / CORDOBA (6K2) / CORDOBA (6K2/C2) / CORDOBA Vario (6K5) / IBIZA III (6K1) / LEON I (1M1) / TOLEDO II (1M2)   |
|   | <b>SEAT</b><br>ALHAMBRA / LEON I (1M1) / TOLEDO II (1M2)  |   | <b>SEAT</b><br>ALHAMBRA / CORDOBA (6K2) / CORDOBA (6K2/C2) / CORDOBA Vario (6K5) / IBIZA II (6K1) / INCA / TOLEDO I (1L)  |   |   |
|   | <b>SKODA</b><br>OCTAVIA I (1U2) / OCTAVIA Combi (1U5)   |   |   |   |   |
|   | <b>VW</b><br>BORA (1J2) / BORA Estate (1J6) / GOLF IV (1J1) / GOLF IV Variant (1J5) / MULTIVAN V (7HM) / NEW BEETLE (9C1, 1C1)/Convertible (1Y7) / SHARAN (7M8, 7M9, 7M6) / TRANSPORTER V | VKMA 31028  |   |   |   |
| VKMA 31005  | <b>AUDI</b><br>A3 (8L1)   |   |   |   |   |
|   | <b>SEAT</b><br>CORDOBA (6K2) / CORDOBA (6K2/C2) / CORDOBA Vario (6K5) / IBIZA III (6K1) / INCA / LEON I (1M1) / TOLEDO II (1M2)   |   |   |   |   |







|  |    |  |  |  |  |
|---|---|---|--|---|---|
| VKMA 31204  | <b>SKODA</b><br>OCTAVIA I (1U2) / OCTAVIA Combi (1U5)   | VKMA 31216  | <b>SEAT</b><br>IBIZA IV (6L1)  | VKMA 32025  | <b>ALFA ROMEO</b><br>156  |
|   | <b>VW</b><br>BORA (1J2) / BORA Estate (1J6) / GOLF IV (1J1) / GOLF IV Variant (1J5) / LUPO (6X1, 6E1) / MULTIVAN V (7HM) / NEW BEETLE (9C1, 1C1)/Convertible (1Y7) / POLO (6N2) / POLO CLASSIC (6KV2) / Variant (6KV5) / SHARAN (7M8, 7M9, 7M6) / TRANSPORTER V |   | <b>SKODA</b><br>FABIA  |   | <b>FIAT</b><br>MAREA  |
|   | <b>AUDI</b><br>A3 (8L1) / TT (8N3) / TT Roadster (8N9)  |   | <b>VW</b><br>LUPO (6X1, 6E1)   |   | <b>LANCIA</b><br>KAPPA  |
|   | <b>SEAT</b><br>ALHAMBRA / CORDOBA (6K2) / CORDOBA (6K2/C2) / CORDOBA Vario (6K5) / IBIZA III (6K1) / LEON I (1M1) / TOLEDO II (1M2)   |   | <b>AUDI</b><br>A2 (8Z0)  |   | <b>ALFA ROMEO</b><br>145/146 / 147 / 156  |
| VKMA 31206  | <b>SKODA</b><br>OCTAVIA I (1U2) / OCTAVIA Combi (1U5)   | VKMA 31219  | <b>SEAT</b><br>CORDOBA (6L2) / IBIZA IV (6L1)                                      | VKMA 32027  | <b>FIAT</b><br>BRAVA/BRAVO (182) / MAREA / MULTIPLA                                 |
|   | <b>VW</b><br>BORA (1J2) / BORA Estate (1J6) / GOLF IV (1J1) / GOLF IV Variant (1J5) / MULTIVAN V (7HM) / NEW BEETLE (9C1, 1C1)/Convertible (1Y7) / POLO CLASSIC (6KV2) / Variant (6KV5) / SHARAN (7M8, 7M9, 7M6) / TRANSPORTER V                                |   | <b>SKODA</b><br>FABIA / ROOMSTER   |   | <b>LANCIA</b><br>LYBRA  |
|   | <b>SEAT</b><br>LEON I (1M1) / TOLEDO II (1M2)   |   | <b>VW</b><br>FOX (5Z1) / POLO (9N_) / POLO Saloon                                  |   | <b>ALFA ROMEO</b><br>145/146  |
|   | <b>SKODA</b><br>FELICIA I (6U1)/Estate (6U5)/ Fun (797) / FELICIA II (6U1)/ FELICIA II Estate (6U5)   |   | <b>SEAT</b><br>AROSA   |   | <b>FIAT</b><br>BRAVA/BRAVO (182)  |
| VKMA 31207  | <b>VW</b><br>BORA (1J2) / BORA Estate (1J6) / GOLF IV (1J1) / GOLF IV Variant (1J5) / NEW BEETLE (9C1, 1C1)/Convertible (1Y7)   | VKMA 32004  | <b>ALFA ROMEO</b><br>166   | VKMA 32028  | <b>ALFA ROMEO</b><br>145/146  |
|   | <b>SEAT</b><br>LEON I (1M1) / TOLEDO II (1M2)   |   | <b>FIAT</b><br>MAREA   |   | <b>FIAT</b><br>BRAVA/BRAVO (182)  |
|   | <b>SKODA</b><br>FELICIA I (6U1)/Estate (6U5)/ Fun (797) / FELICIA II (6U1)/ FELICIA II Estate (6U5) / OCTAVIA I (1U2) / OCTAVIA Combi (1U5)   |   | <b>LANCIA</b><br>KAPPA / THESIS  |   | <b>ALFA ROMEO</b><br>145/146  |
|   | <b>VW</b><br>BORA (1J2) / BORA Estate (1J6) / GOLF IV (1J1) / GOLF IV Variant (1J5) / NEW BEETLE (9C1, 1C1)/Convertible (1Y7)   |   | <b>LANCIA</b><br>KAPPA   |   | <b>FIAT</b><br>BRAVA/BRAVO (182)  |
| VKMA 31208  | <b>SEAT</b><br>LEON I (1M1) / TOLEDO II (1M2)   | VKMA 32012  | <b>ALFA ROMEO</b><br>145/146 / 147 / 155 / 156                                     | VKMA 32030  | <b>FIAT</b><br>PUNTO (188)  |
|   | <b>SKODA</b><br>OCTAVIA I (1U2) / OCTAVIA Combi (1U5)   |   | <b>LANCIA</b><br>KAPPA   |   | <b>ALFA ROMEO</b><br>145/146 / 147 / 156 / 156 / GTV / SPIDER                       |
|   | <b>VW</b><br>BORA (1J2) / BORA Estate (1J6) / GOLF IV (1J1) / GOLF IV Variant (1J5)   |   | <b>LANCIA</b><br>KAPPA   |   | <b>FIAT</b><br>BARCETTA / BRAVA/BRAVO (182) / COUPE / MAREA                         |
|   | <b>VW</b><br>BORA (1J2) / BORA Estate (1J6) / GOLF IV (1J1) / GOLF IV Variant (1J5)   |   | <b>LANCIA</b><br>Y   |   | <b>LANCIA</b><br>Y  |
| VKMA 31215  | <b>AUDI</b><br>A2 (8Z0)   | VKMA 32022  | <b>ALFA ROMEO</b><br>145/146 / 147 / 155 / 156 / GTV / SPIDER                      | VKMA 32039  | <b>ALFA ROMEO</b><br>147 / 156 / GT   |
|   |   |   | <b>ALFA ROMEO</b><br>145/146 / 147 / 155 / 156                                     |   | <b>FIAT</b><br>BRAVA/BRAVO (182) / MAREA / MULTIPLA                                 |
|   |   |   | <b>FIAT</b><br>BARCETTA / BRAVA/BRAVO (182) / COUPE / MAREA                        |   | <b>LANCIA</b><br>LYBRA  |
|   |   |   | <b>LANCIA</b><br>Y   |   | <b>ALFA ROMEO</b><br>500 / BRAVO / DOBLO / IDEA / PANDA (169) / PUNTO (188) / STILO |
| VKMA 32004  | <b>SEAT</b><br>LEON I (1M1) / TOLEDO II (1M2)   | VKMA 32020  | <b>ALFA ROMEO</b><br>145/146 / 147 / 155 / 156                                     | VKMA 32040  | <b>LANCIA</b><br>LYBRA  |
|   | <b>SKODA</b><br>OCTAVIA I (1U2) / OCTAVIA Combi (1U5)   |   | <b>ALFA ROMEO</b><br>145/146 / 147 / 155 / 156                                     |   | <b>FIAT</b><br>500 / BRAVO / DOBLO / IDEA / PANDA (169) / PUNTO (188) / STILO       |
|   | <b>VW</b><br>BORA (1J2) / BORA Estate (1J6) / GOLF IV (1J1) / GOLF IV Variant (1J5)   |   | <b>FIAT</b><br>BARCETTA / BRAVA/BRAVO (182) / COUPE / MAREA                        |   | <b>LANCIA</b><br>MUSA / YPSILON   |
|   | <b>VW</b><br>BORA (1J2) / BORA Estate (1J6) / GOLF IV (1J1) / GOLF IV Variant (1J5)   |   | <b>LANCIA</b><br>Y   |   | <b>FIAT</b><br>BRAVA/BRAVO (182) / MAREA  |
| VKMA 32028  | <b>AUDI</b><br>A2 (8Z0)   | VKMA 32024  | <b>ALFA ROMEO</b><br>156   | VKMA 32050  | <b>FIAT</b><br>BRAVA/BRAVO (182) / MAREA  |
|   |   |   | <b>FIAT</b><br>PUNTO (188)   |   | <b>LANCIA</b><br>KAPPA  |
|   |   |   | <b>ALFA ROMEO</b><br>156   |   | <b>CITROËN</b><br>JUMPER (230)  |
|   |   |   | <b>FIAT</b><br>MAREA   |   | <b>PEUGEOT</b><br>BOXER I   |
| VKMA 32039  | <b>SEAT</b><br>CORDOBA (6L2) / IBIZA IV (6L1)   | VKMA 32039  | <b>ALFA ROMEO</b><br>145/146 / 147 / 155 / 156 / GTV / SPIDER                      | VKMA 32212  | <b>CITROËN</b><br>BERLINGO / EVASION / XANTIA I / XANTIA II / XM II / XSARA / ZX    |
|   | <b>SKODA</b><br>FABIA / ROOMSTER  |   | <b>ALFA ROMEO</b><br>145/146 / 147 / 155 / 156                                     |   | <b>LANCIA</b><br>KAPPA  |
|   | <b>VW</b><br>FOX (5Z1) / POLO (9N_) / POLO Saloon   |   | <b>FIAT</b><br>BARCETTA / BRAVA/BRAVO (182) / COUPE / MAREA                        |   | <b>FIAT</b><br>ULYSSE (220)   |
|   | <b>SEAT</b><br>AROSA  |   | <b>LANCIA</b><br>Y   |   | <b>LANCIA</b><br>ZETA   |









|  |                            |  |                |  |                        |
|---|---|---|---|---|---|
| VKMA 33010  | PEUGEOT<br>306 / 405 II / 406 / 605 / 806<br>CITROËN<br>ZX  | VKMA 33031  | PEUGEOT<br>306 / 405 II / 406 / 806<br>CITROËN<br>EVASION / XANTIA II / XSARA                   | VKMA 33044  | FORD<br>FIESTA V / FOCUS C-MAX I /<br>FOCUS C-MAX II / FOCUS II /<br>FUSION                               |
| VKMA 33012  | PEUGEOT<br>205 / 309 / 405 I / 405 II<br>CITROËN<br>AX / SAXO   | VKMA 33032  | FIAT<br>ULYSSE (220)<br>PEUGEOT<br>306 / 406 / 806  | VKMA 33045  | MAZDA<br>3<br>PEUGEOT<br>1007 / 206 / 307   |
| VKMA 33019  | PEUGEOT<br>106 I / 106 II<br>CITROËN<br>XSARA / XSARA PICASSO   | VKMA 33033  | CITROËN<br>BERLINGO / XANTIA I / XANTIA<br>II / XSARA / ZX<br>PEUGEOT<br>306 / 406 / PARTNER    | VKMA 33046  | VOLVO<br>S40 II - V50<br>CITROËN<br>BERLINGO / EVASION / JUMPY I<br>/ JUMPY II / XSARA / XSARA<br>PICASSO |
| VKMA 33020  | PEUGEOT<br>206 / 406<br>CITROËN<br>XSARA / XSARA PICASSO  | VKMA 33034  | CITROËN<br>BERLINGO / XANTIA I / XANTIA<br>II / ZX<br>PEUGEOT<br>406 / PARTNER                  | VKMA 33047  | FIAT<br>SCUDO (220) / ULYSSE (220)<br>LANCIA<br>ZETA  |
| VKMA 33021  | PEUGEOT<br>206 / 406<br>CITROËN<br>BERLINGO / JUMPY I / XSARA   | VKMA 33035  | PEUGEOT<br>406 / PARTNER<br>CITROËN<br>EVASION / XSARA / ZX                                     | VKMA 33048  | PEUGEOT<br>206 / 306 / 406 / 806 /<br>EXPERT I / PARTNER  |
| VKMA 33023  | FIAT<br>SCUDO (220)<br>PEUGEOT<br>206 / 306 / EXPERT I / PART-<br>NER                                       | VKMA 33036  | FIAT<br>ULYSSE (220)<br>LANCIA<br>ZETA  | VKMA 33049  | PEUGEOT<br>106 I / 106 II<br>ROVER<br>100   |
| VKMA 33024  | CITROËN<br>SAXO<br>PEUGEOT<br>106 II  | VKMA 33037  | PEUGEOT<br>306 / 406 / 605 / 806<br>CITROËN<br>EVASION / XANTIA I / XANTIA II<br>/ XM I / XM II | VKMA 33051  | CITROËN<br>AX / SAXO<br>PEUGEOT<br>106 I / 106 II   |
| VKMA 33025  | CITROËN<br>BERLINGO / XSARA / XSARA<br>PICASSO<br>PEUGEOT<br>206 / PARTNER                                  | VKMA 33038  | FIAT<br>ULYSSE (220)<br>LANCIA<br>ZETA  | VKMA 33052  | NISSAN<br>MICRA<br>PEUGEOT<br>106 I / 106 II  |
| VKMA 33026  | PEUGEOT<br>206<br>CITROËN<br>XSARA / XSARA PICASSO  | VKMA 33039  | PEUGEOT<br>306 / 406 / 605 / 806<br>CITROËN<br>EVASION / C5 I / EVASION /<br>XANTIA II / XSARA  | VKMA 33053  | CITROËN<br>XANTIA I / XANTIA II / XM II   |
| VKMA 33027  | PEUGEOT<br>206<br>CITROËN<br>BERLINGO / JUMPY I / XSARA   | VKMA 33040  | FIAT<br>ULYSSE (220)<br>LANCIA<br>ZETA  | VKMA 33054  | CITROËN<br>ZX<br>PEUGEOT<br>306   |
| VKMA 33030  | FIAT<br>SCUDO (220)<br>PEUGEOT<br>206 / 306 / EXPERT I / PART-<br>NER                                       | VKMA 33041  | PEUGEOT<br>306 / 406 / 806<br>CITROËN<br>BERLINGO / JUMPY I / JUMPY II                          | VKMA 33055  | CITROËN<br>XANTIA II<br>CITROËN<br>C5 I / XANTIA II   |
| VKMA 33031  | CITROËN<br>EVASION / XANTIA I / XANTIA II<br>/ XM II / XSARA / ZX<br>FIAT<br>ULYSSE (220)<br>LANCIA<br>ZETA | VKMA 33042  | FIAT<br>DUCATO (230) / SCUDO (220)<br>PEUGEOT<br>EXPERT I / PARTNER                             | VKMA 33056  | CITROËN<br>C5 I / EVASION<br>FIAT<br>SCUDO (220) / ULYSSE (179AX)<br>/ ULYSSE (220)                       |
| VKMA 33032  | LANCIA<br>ZETA  | VKMA 33043  | PEUGEOT<br>EXPERT I / PARTNER<br>CITROËN<br>C2 / C3 / C3 Pluriel / C4                           |   | LANCIA<br>PHEDRA / ZETA<br>PEUGEOT<br>607 / 806<br>CITROËN<br>C5 I / EVASION / JUMPY I                    |

|  |  |  |                 |                                 |                            |  |
|---|---|---|---|--|---|--|
| VKMA 33058  | <b>FIAT</b><br>SCUDO (220) / ULYSSE (179AX) / ULYSSE (220)                        | VKMA 33093  | <b>CITROËN</b><br>BERLINGO / JUMPY I / XSARA  | VKMA 34103   | <b>FORD</b><br>FOCUS I  |  |
|   | <b>LANCIA</b><br>PHEDRA / ZETA  |   | <b>PEUGEOT</b><br>306 / 406 / EXPERT I / PARTNER  |  | <b>VKMA 34104</b>   | <b>FORD</b><br>FOCUS I   |
|   | <b>PEUGEOT</b><br>806 / EXPERT I  |   | <b>VKMA 33102</b>   |  | <b>VKMA 34107</b>   | <b>FORD</b><br>FOCUS I / TRANSIT CONNECT / TOURNEO CONNECT           |
|   | <b>CITROËN</b><br>C1 / C2 / C3 / C3 Pluriel / C4                                  |   | <b>VKMA 33112</b>   |  | <b>VKMA 34123</b>   | <b>SAAB</b><br>9-3 I   |
|   | <b>FORD</b><br>FIESTA V / FOCUS C-MAX I / FOCUS C-MAX II / FOCUS II / FUSION      |   | <b>VKMA 33122</b>   |  | <b>VKMA 34502</b>   | <b>SAAB</b><br>9-5   |
|   | <b>MAZDA</b><br>3   |   | <b>VKMA 33202</b>   |  | <b>VKMA 34511</b>   | <b>SAAB</b><br>9-3 I   |
|   | <b>PEUGEOT</b><br>1007 / 107 / 206 / 307  |   | <b>VKMA 33212</b>   |  | <b>VKMA 34522</b>   | <b>SAAB</b><br>9-5   |
|   | <b>TOYOTA</b><br>AYGO   |   | <b>VKMA 33312</b>   |  | <b>VKMA 35006</b>   | <b>OPEL</b><br>ASTRA G / SIGNUM / VECTRA C / ZAFIRA A                |
|   | <b>VOLVO</b><br>S40 II - V50  |   | <b>VKMA 33322</b>   |  | <b>VKMA 35007</b>   | <b>VAUXHALL</b><br>ASTRA Mk IV / SIGNUM / VECTRA Mk II / ZAFIRA Mk I |
|   | <b>CITROËN</b><br>C2 / C3 / C3 Pluriel  |   | <b>VKMA 33332</b>   |  | <b>VKMA 35008</b>   | <b>OPEL</b><br>FRONTERA B / OMEGA B / SINTRA / VECTRA B              |
| VKMA 33059  | <b>PEUGEOT</b><br>307   | <b>VKMA 33320</b>   | <b>CITROËN</b><br>BERLINGO / XSARA / ZX   | <b>SAAB</b><br>9-3 I   |   |  |
|   | <b>CITROËN</b><br>BERLINGO / C3 / XSARA / XSARA PICASSO                           | <b>VKMA 33320</b>   | <b>PEUGEOT</b><br>306 / PARTNER   | <b>VAUXHALL</b><br>FRONTERA Mk II / OMEGA / SINTRA / VECTRA Mk I   |   |  |
| VKMA 33060  | <b>FORD</b><br>FIESTA V / FUSION  | <b>VKMA 33320</b>   | <b>CITROËN</b><br>C4 / C5 II / C8   | <b>OPEL</b><br>ASTRA F / ASTRA F CLASSIC / COMBO A / CORSA B / VECTRA A / VECTRA B                                 |   |  |
|   | <b>PEUGEOT</b><br>206 / PARTNER   | <b>VKMA 33320</b>   | <b>FORD</b><br>FOCUS C-MAX I / FOCUS C-MAX II / FOCUS II / MONDEO IV                              | <b>VAUXHALL</b><br>ASTRA Mk III / CAVALIER Mk III / COMBO I / CORSA Mk I / VECTRA Mk I                             |   |  |
| VKMA 33061  | <b>CITROËN</b><br>BERLINGO / C3 / C5 II / XSARA / XSARA PICASSO                   | <b>VKMA 34027</b>   | <b>LANCIA</b><br>PHEDRA   | <b>VKMA 35009</b>  | <b>OPEL</b><br>ASTRA F / CALIBRA / FRONTERA A / FRONTERA B / OMEGA B / SINTRA / VECTRA A / VECTRA B           |  |
|   | <b>FORD</b><br>FIESTA V / FUSION  | <b>VKMA 34027</b>   | <b>PEUGEOT</b><br>307 / 407 / 607 / 807 / EXPERT II / EXPERT Tepee                                | <b>VAUXHALL</b><br>ASTRA Mk III / CALIBRA / CAVALIER Mk III / FRONTERA Mk I / FRONTERA Mk II / OMEGA / VECTRA Mk I |   |  |
| VKMA 33065  | <b>MAZDA</b><br>2   | <b>VKMA 34027</b>   | <b>VOLVO</b><br>S40 II - V50  | <b>VKMA 35010</b>  | <b>OPEL</b><br>ZAFIRA A   |  |
|   | <b>PEUGEOT</b><br>206 / 407 / PARTNER   | <b>VKMA 34027</b>   | <b>FIAT</b><br>CROMA (194)  | <b>VKMA 35012</b>  | <b>OPEL</b><br>ASTRA G / ASTRA H / COMBO B / CORSA C / MERIVA / SIGNUM / TIGRA Twin Top / VECTRA C / ZAFIRA A |  |
| VKMA 33066  | <b>PEUGEOT</b><br>307   | <b>VKMA 34030</b>   | <b>OPEL</b><br>ASTRA G / SIGNUM / VECTRA B / VECTRA C / ZAFIRA A / ZAFIRA B                       |  |   |  |
|   | <b>CITROËN</b><br>C4  | <b>VKMA 34030</b>   | <b>SAAB</b><br>9-3 II   |  |   |  |
| VKMA 33067  | <b>PEUGEOT</b><br>307   | <b>VKMA 34031</b>   | <b>VAUXHALL</b><br>ASTRA Mk IV / SIGNUM / VECTRA Mk I / VECTRA Mk II / ZAFIRA Mk I / ZAFIRA Mk II |  |   |  |
|   | <b>PEUGEOT</b><br>307   | <b>VKMA 34031</b>   | <b>FORD</b><br>MONDEO III   |  |   |  |
| VKMA 33068  | <b>CITROËN</b><br>JUMPER (244)  | <b>VKMA 34031</b>   | <b>FORD</b><br>TRANSIT  |  |   |  |
|   | <b>PEUGEOT</b><br>307 / BOXER II  |   |   |  |   |  |
| VKMA 33069  | <b>PEUGEOT</b><br>307   |   |   |  |   |  |
|   |   |   |   |  |   |  |

|  |   |  |    |  |                    |
|---|--|---|---|---|---|
| VKMA 35013  | <b>VAUXHALL</b><br>ASTRA Mk IV / ASTRA Mk V / COMBO II / CORSA Mk II / MERIVA / TIGRA Mk II / VECTRA Mk II / ZAFIRA Mk I | VKMA 35112  | <b>OPEL</b><br>SIGNUM / VECTRA C  | VKMA 36008  | <b>RENAULT</b><br>LAGUNA I  |
|   | <b>OPEL</b><br>AGILA B / ASTRA G / ASTRA H / CORSA B / CORSA C / CORSA D / MERIVA  |   | <b>SAAB</b><br>9-3 II   |   | <b>RENAULT</b><br>MEGANE I  |
| VKMA 35015  | <b>VAUXHALL</b><br>AGILA / ASTRA Mk IV / ASTRA Mk V / CORSA Mk I / CORSA Mk II / CORSA Mk III / MERIVA                   | VKMA 35113  | <b>VAUXHALL</b><br>VECTRA Mk II   | VKMA 36012  | <b>RENAULT</b><br>R19   |
|   | <b>OPEL</b><br>ASTRA G / ASTRA H / COMBO B / CORSA C / MERIVA  |   | <b>OPEL</b><br>AGILA B / ASTRA G / ASTRA H / COMBO B / CORSA B / CORSA C / CORSA D / MERIVA / TIGRA Twin Top                    |   | <b>RENAULT</b><br>CLIO I / SUPER 5  |
| VKMA 35016  | <b>VAUXHALL</b><br>ASTRA Mk IV / ASTRA Mk V / CORSA Mk II / MERIVA   | VKMA 35119  | <b>OPEL</b><br>ASTRA G / ASTRA H / ZAFIRA A / ZAFIRA B  | VKMA 36016  | <b>RENAULT</b><br>MEGANE I  |
|   | <b>OPEL</b><br>SIGNUM / VECTRA C   |   | <b>VAUXHALL</b><br>AGILA / ASTRA Mk IV / ASTRA Mk V / COMBO II / CORSA Mk I / CORSA Mk II / CORSA Mk III / MERIVA / TIGRA Mk II |   | <b>VOLVO</b><br>S40 I - V40   |
| VKMA 35022  | <b>VAUXHALL</b><br>SIGNUM / VECTRA Mk II   | VKMA 35125  | <b>OPEL</b><br>ASTRA F / COMBO A / CORSA B / TIGRA / VECTRA B   | VKMA 36020  | <b>OPEL</b><br>MOVANO   |
|   | <b>OPEL</b><br>ASTRA G / ASTRA H / COMBO B / CORSA C / MERIVA / TIGRA Twin Top / ZAFIRA A                                |   | <b>VAUXHALL</b><br>ASTRA Mk IV / ASTRA Mk V / ZAFIRA Mk I   |   | <b>RENAULT</b><br>MASTER II   |
| VKMA 35025  | <b>VAUXHALL</b><br>ASTRA Mk IV / ASTRA Mk V / COMBO II / CORSA Mk II / MERIVA / TIGRA Mk II / ZAFIRA Mk I                | VKMA 35215  | <b>OPEL</b><br>ASTRA G / COMBO B / CORSA B / CORSA C / MERIVA   | VKMA 36026  | <b>VAUXHALL</b><br>MOVANO   |
|   | <b>OPEL</b><br>ASTRA F / ASTRA F CLASSIC / COMBO A / CORSA B / TIGRA / VECTRA B  |   | <b>VAUXHALL</b><br>ASTRA Mk III / COMBO I / CORSA Mk I / TIGRA Mk I / VECTRA Mk I   |   | <b>DACIA</b><br>LOGAN   |
| VKMA 35030  | <b>VAUXHALL</b><br>CORSA Mk I / TIGRA Mk I / VECTRA Mk I   | VKMA 35315  | <b>OPEL</b><br>ASTRA G / COMBO B / CORSA B / CORSA C / MERIVA   | VKMA 36032  | <b>RENAULT</b><br>CLIO II / KANGOO  |
|   | <b>OPEL</b><br>ASTRA G / ZAFIRA A  |   | <b>VAUXHALL</b><br>ASTRA Mk IV / COMBO II / CORSA Mk II   |   | <b>RENAULT</b><br>CLIO II / ESPACE III / KANGOO / LAGUNA I / LAGUNA II / MEGANE I / SCENIC I / THALIA |
| VKMA 35107  | <b>VAUXHALL</b><br>ASTRA Mk IV / ZAFIRA Mk I   | VKMA 35500  | <b>OPEL</b><br>CALIBRA / OMEGA B / SINTRA / VECTRA A / VECTRA B   | VKMA 36033  | <b>RENAULT</b><br>ESPACE III / LAGUNA I / SAFRANE II  |
|   | <b>OPEL</b><br>FRONTERA B / OMEGA B / SINTRA / VECTRA B  |   | <b>OPEL</b><br>ASTRA G / COMBO B / CORSA B / CORSA C / MERIVA   |   | <b>RENAULT</b><br>CLIO II / KANGOO  |
| VKMA 35109  | <b>SAAB</b><br>9-3 I / 9-3 II / 9-5  | VKMA 36002  | <b>VAUXHALL</b><br>CALIBRA / CAVALIER Mk III / OMEGA / SINTRA / VECTRA Mk I   | VKMA 36034  | <b>RENAULT</b><br>ESPACE III / LAGUNA I / SAFRANE II  |
|   | <b>VAUXHALL</b><br>FRONTERA Mk II / OMEGA / SINTRA / VECTRA Mk I   |   | <b>RENAULT</b><br>CLIO I / EXPRESS/EXTRA / RAPID  |   | <b>RENAULT</b><br>ESPACE III / LAGUNA I / MEGANE I / SCENIC I   |
| VKMA 35109  | <b>OPEL</b><br>ASTRA F / CALIBRA / OMEGA B / SINTRA / VECTRA A / VECTRA B  | VKMA 36005  | <b>RENAULT</b><br>MEGANE I / SCENIC I   | VKMA 36035  | <b>NISSAN</b><br>INTERSTAR / PRIMASTAR  |
|   | <b>VAUXHALL</b><br>ASTRA Mk III / CALIBRA / CAVALIER Mk III / OMEGA / SINTRA / VECTRA Mk I                               |   | <b>RENAULT</b><br>ESPACE III / LAGUNA I / MEGANE I / SCENIC I   |   | <b>OPEL</b><br>VIVARO   |
|   |  |   |   |   | <b>RENAULT</b><br>AVANTIME / LAGUNA I / LAGUNA II / MASTER II / TRAFIC II                             |
|   |  |   |   |   | <b>VAUXHALL</b><br>VIVARO   |
|   |  |   |   |   | <b>VOLVO</b><br>S40 I - V40   |
|   |  |   |   |   | <b>RENAULT</b><br>MEGANE I / SCENIC I   |
|   |  |   |   |   | <b>RENAULT</b><br>ESPACE III / MEGANE I / SCENIC I  |

|  |                            |  |    |  |   |
|---|---|---|--|---|--|
| VKMA 36038  | <b>OPEL</b><br>VIVARO   | VKMA 38001  | <b>MERCEDES-BENZ</b><br>(W 124) / 190 (W201)   | VKMA 38265  | <b>BMW</b><br>3 (E36) / 3 Compact (E36) / 3<br>Convertible (E36) / 3 Coupe<br>(E36) / 3 Touring (E36) / 5 (E34)<br>/ 5 Touring (E34) |
|   | <b>RENAULT</b><br>LAGUNA II / MASTER II / TRAFIC<br>II / VEL SATIS  | VKMA 38002  | <b>MERCEDES-BENZ</b><br>(W 124) / 190 (W201) / C-class<br>(W202) / E-class (W124) / E-<br>class (W210) / G-class (W460) /<br>G-class (W463)  | VKMA 38266  | <b>BMW</b><br>3 (E36) / 3 Convertible (E36) / 3<br>Coupe (E36)   |
|   | <b>VAUXHALL</b><br>VIVARO   | VKMA 38003  | <b>MERCEDES-BENZ</b><br>(W 124) / 190 (W201) / C-class<br>(W202) / E-class (W124) / E-<br>class (W210)   | VKMA 63000  | <b>HONDA</b><br>CIVIC  |
| VKMA 36040  | <b>RENAULT</b><br>AVANTIME / ESPACE III /<br>LAGUNA II / VEL SATIS  | VKMA 38004  | <b>MERCEDES-BENZ</b><br>(W 124) / 190 (W201) / E-class<br>(W124)   | VKMA 63001  | <b>HONDA</b><br>CIVIC  |
| VKMA 36041  | <b>RENAULT</b><br>ESPACE IV   | VKMA 38005  | <b>MERCEDES-BENZ</b><br>(W 124) / 190 (W201) / E-class<br>(W124)   | VKMA 90000  | <b>CHEVROLET</b><br>AVEO   |
| VKMA 36050  | <b>NISSAN</b><br>ALMERA / MICRA   | VKMA 38006  | <b>MERCEDES-BENZ</b><br>(W 124) / 190 (W201) / E-class<br>(W124) / V-class (W638) / VITO<br>(W638)   | VKMA 90001  | <b>CHEVROLET</b><br>MATIZ / SPARK  |
|   | <b>RENAULT</b><br>CLIO II / MEGANE II / MODUS /<br>SCENIC II / GRAND SCENIC /<br>THALIA                     | VKMA 38007  | <b>MERCEDES-BENZ</b><br>(W 124) / C-class (W202) / E-<br>class (W124) / E-class (W210) /<br>VITO (W638)  | VKMA 90002  | <b>DAEWOO</b><br>ESPERO  |
| VKMA 36052  | <b>NISSAN</b><br>ALMERA / MICRA   | VKMA 38020  | <b>MERCEDES-BENZ</b><br>C-class (W202) / E-class<br>(W210) / M-class (W163) /<br>SPRINTER 2-t (W901 / W902) /<br>SPRINTER 3-t (W903) /<br>SPRINTER 4-t (W904)                      | VKMA 90007  | <b>DAEWOO</b><br>REZZO / TACUMA  |
|   | <b>RENAULT</b><br>CLIO II / CLIO III / KANGOO /<br>MEGANE II / MODUS / SCENIC II<br>/ GRAND SCENIC / THALIA | VKMA 38021  | <b>MERCEDES-BENZ</b><br>C-class (W203) / C-class<br>(W204) / CLK (W209) / E-class<br>(W211) / S-class (W220)   | VKMA 90008  | <b>CHEVROLET</b><br>MATIZ / SPARK  |
| VKMA 36070  | <b>RENAULT</b><br>CLIO II   | VKMA 38202  | <b>BMW</b><br>3 (E36) / 3 Compact (E36) / 3<br>Convertible (E36) / 3 Coupe<br>(E36) / 5 (E34) / 5<br>Touring (E34)   | VKMA 91000  | <b>TOYOTA</b><br>STARLET   |
| VKMA 36072  | <b>RENAULT</b><br>MEGANE II / SCENIC II / GRAND<br>SCENIC   | VKMA 38241  | <b>BMW</b><br>3 (E36) / 3 Compact (E36) / 3<br>Convertible (E36) / 3 Coupe<br>(E36) / 3 Touring (E36) / 5 (E34)<br>/ 5 (E39) / 5 Touring (E34) / 5<br>Touring (E39) / 7 (E38) / Z3 | VKMA 91001  | <b>TOYOTA</b><br>CAMRY / LEXUS / WINDOM  |
| VKMA 36091  | <b>DACIA</b><br>LOGAN   | VKMA 38242  | <b>BMW</b><br>3 (E36) / 3 Compact (E36) / 3<br>Convertible (E36) / 3 Coupe<br>(E36) / 3 Touring (E36) / 5 (E34)<br>/ 5 (E39) / 5 Touring (E34) / 5<br>Touring (E39) / 7 (E38) / Z3 | VKMA 91002  | <b>TOYOTA</b><br>CARINA / CELICA / COROLLA   |
|   | <b>RENAULT</b><br>CLIO II / KANGOO / LAGUNA I /<br>LAGUNA II / MEGANE I / SCENIC<br>I / THALIA              | VKMA 38250  | <b>BMW</b><br>3 (E36) / 3 Compact (E36) / 3<br>Convertible (E36) / 3 Coupe<br>(E36) / 3 Touring (E36) / 5 (E34)<br>/ 5 (E39) / 5 Touring (E34) / 5<br>Touring (E39) / 7 (E38) / Z3 | VKMA 91003  | <b>TOYOTA</b><br>AVENSIS / CAMRY / CARINA /<br>CELICA / CORONA / MARK II /<br>MR 2 / PICNIC / RAV 4                                  |
| VKMA 36117  | <b>OPEL</b><br>MOVANO   | VKMA 38260  | <b>BMW</b><br>3 (E36) / 3 Compact (E36) / 3<br>Convertible (E36) / 3 Coupe<br>(E36) / 3 Touring (E36) / 5 (E34)<br>/ 5 (E39) / 5 Touring (E34) / 5<br>Touring (E39) / 7 (E38) / Z3 | VKMA 91005  | <b>TOYOTA</b><br>AVENSIS / CARINA / COROLLA /<br>CORONA / SPRINTER   |
|   | <b>RENAULT</b><br>MASTER II   | VKMA 38264  | <b>BMW</b><br>3 (E36) / 3 Compact (E36) / 3<br>Convertible (E36) / 3 Coupe<br>(E36) / 3 Touring (E36) / 5 (E34)<br>/ 5 (E39) / 5 Touring (E34) / 5<br>Touring (E39) / 7 (E38) / Z3 | VKMA 91006  | <b>TOYOTA</b><br>AVENSIS / CARINA / CELICA /<br>COROLLA  |
|   | <b>VAUXHALL</b><br>MOVANO   | VKMA 38264  | <b>BMW</b><br>3 (E36) / 3 Compact (E36) / 3<br>Convertible (E36) / 3 Coupe<br>(E36) / 3 Touring (E36) / 5 (E34)<br>/ 5 (E39) / 5 Touring (E34) / 5<br>Touring (E39) / 7 (E38) / Z3 | VKMA 91011  | <b>TOYOTA</b><br>AVALON / CAMRY / PRONARD  |
| VKMA 36121  | <b>VOLVO</b><br>S40 I - V40   | VKMA 38264  | <b>BMW</b><br>3 (E36) / 3 Compact (E36) / 3<br>Convertible (E36) / 3 Coupe<br>(E36) / 3 Touring (E36) / 5 (E34)<br>/ 5 (E39) / 5 Touring (E34) / 5<br>Touring (E39) / 7 (E38) / Z3 | VKMA 91013  | <b>TOYOTA</b><br>CARINA / CELICA / CORONA /<br>MR 2  |
| VKMA 36122  | <b>VOLVO</b><br>S40 I - V40   | VKMA 38264  | <b>BMW</b><br>3 (E36) / 3 Compact (E36) / 3<br>Convertible (E36) / 3 Coupe<br>(E36) / 3 Touring (E36) / 5 (E34)<br>/ 5 (E39) / 5 Touring (E34) / 5<br>Touring (E39) / 7 (E38) / Z3 | VKMA 91015  | <b>TOYOTA</b><br>CARINA / PASEO / TERCEL   |
| VKMA 36123  | <b>VOLVO</b><br>S40 I - V40   | VKMA 38264  | <b>BMW</b><br>3 (E36) / 3 Compact (E36) / 3<br>Convertible (E36) / 3 Coupe<br>(E36) / 3 Touring (E36) / 5 (E34)<br>/ 5 (E39) / 5 Touring (E34) / 5<br>Touring (E39) / 7 (E38) / Z3 | VKMA 91017  | <b>TOYOTA</b><br>CROWN / MARK II / SUPRA   |
| VKMA 36124  | <b>VOLVO</b><br>S40 I - V40   |   |  |   |  |
| VKMA 36220  | <b>VOLVO</b><br>S60 / S80 / V70 II / XC70 I   |   |  |   |  |
| VKMA 36230  | <b>VOLVO</b><br>C70 - S70 / S40 I - V40 / S60 /<br>S80 / V70 I / V70 II / XC70 I                            |   |  |   |  |
| VKMA 36520  | <b>VOLVO</b><br>850 / C70 - S70 / S80 / V70 I /<br>V70 II   |   |  |   |  |







|   |   |   |   |   |   |
|---|---|---|---|---|---|
|  |    |  |                                |  |  |
| VKMA 91020  | <b>TOYOTA</b><br>COASTER / LAND CRUISER   | VKMA 91702  | <b>TOYOTA</b><br>CARINA / CELICA / COROLLA /<br>CORONA / SPRINTER   | VKMA 92411  | <b>NISSAN</b><br>MARCH / MICRA  |
| VKMA 91021  | <b>TOYOTA</b><br>CARINA / CELICA  | VKMA 91704  | <b>TOYOTA</b><br>4 RUNNER / LAND CRUISER 90   | VKMA 92500  | <b>NISSAN</b><br>LAUREL / PATROL / PATROL GR<br>/ SAFARI                            |
| VKMA 91022  | <b>TOYOTA</b><br>4 RUNNER / HIACE / HILUX /<br>LAND CRUISER 90  | VKMA 91707  | <b>TOYOTA</b><br>LAND CRUISER / LAND<br>CRUISER 100   | VKMA 92501  | <b>NISSAN</b><br>MAXIMA / QUEST   |
| VKMA 91100  | <b>TOYOTA</b><br>AVENSIS / CAMRY / CARINA /<br>COROLLA / CORONA / LITEACE<br>/ MASTERACE / PICNIC /<br>SPRINTER / TOWNACE | VKMA 91708  | <b>TOYOTA</b><br>LAND CRUISER 100   | VKMA 92513  | <b>NISSAN</b><br>AD WAGON / ALMERA / AVENIR<br>/ PRIMERA / PULSAR / SUNNY           |
| VKMA 91101  | <b>TOYOTA</b><br>CAMRY / CARINA / CELICA /<br>CORONA  | VKMA 91710  | <b>TOYOTA</b><br>CRESTA / CROWN ESTATE /<br>MARK II / SC400 / SOARER  | VKMA 92514  | <b>NISSAN</b><br>AD MAX VAN / PULSAR /<br>SENTRA / SUNNY                            |
| VKMA 91122  | <b>TOYOTA</b><br>4 RUNNER / CRESSIDA /<br>CROWN / DYNA / HIACE / HILUX<br>/ LAND CRUISER                                  | VKMA 91711  | <b>TOYOTA</b><br>HIACE / HILUX / LAND CRUISER<br>/ LAND CRUISER 90  | VKMA 92515  | <b>NISSAN</b><br>AD MAX VAN / SUNNY   |
| VKMA 91124  | <b>TOYOTA</b><br>4 RUNNER / CRESSIDA /<br>CROWN / DYNA / HIACE / HILUX<br>/ LAND CRUISER / MARK II                        | VKMA 91713  | <b>TOYOTA</b><br>LAND CRUISER 90  | VKMA 92516  | <b>NISSAN</b><br>ALMERA / PULSAR / SUNNY  |
|   | <b>VW</b><br>TARO   | VKMA 92000  | <b>NISSAN</b><br>CHERRY / PULSAR / SENTRA /<br>SUNNY  | VKMA 92517  | <b>NISSAN</b><br>VANETTE CARGO  |
| VKMA 91200  | <b>TOYOTA</b><br>STARLET  | VKMA 92001  | <b>NISSAN</b><br>CHERRY / EXA / MULTI /<br>PRAIRIE / PULSAR / SENTRA /<br>STANZA / SUNNY                        | VKMA 92518  | <b>NISSAN</b><br>PATROL GR  |
| VKMA 91201  | <b>TOYOTA</b><br>COROLLA / SPRINTER /<br>STARLET / TERCEL   | VKMA 92004  | <b>NISSAN</b><br>300 ZX / CARAVAN / CEDRIC /<br>HOMY VAN / MAXIMA /<br>PATHFINDER / PICKUP /<br>TERRANO / URVAN | VKMA 93001  | <b>HONDA</b><br>CIVIC / CIVIC SHUTTLE /<br>CONCERTO / CRX / INTEGRA                 |
| VKMA 91202  | <b>DAIHATSU</b><br>CHARMANT   | VKMA 92006  | <b>NISSAN</b><br>MAXIMA / PATHFINDER /<br>PICKUP / TERRANO  | VKMA 93002  | <b>HONDA</b><br>CIVIC / CONCERTO / CRX  |
|   | <b>TOYOTA</b><br>CARINA / CELICA / COROLLA /<br>CORONA / TERCEL   | VKMA 92008  | <b>NISSAN</b><br>300 ZX   | VKMA 93005  | <b>HONDA</b><br>CIVIC   |
| VKMA 91203  | <b>TOYOTA</b><br>COROLLA / STARLET  | VKMA 92012  | <b>NISSAN</b><br>CARAVAN / CHERRY VANETTE /<br>HOMY VAN / SERENA / URVAN /<br>VANETTE / VANETTE SERENA          | VKMA 93006  | <b>HONDA</b><br>ACCORD / CIVIC / CIVIC CRX /<br>CIVIC DEL SOL / CRX / HR-V          |
| VKMA 91205  | <b>TOYOTA</b><br>STARLET  | VKMA 92101  | <b>NISSAN</b><br>200 SX / BLUEBIRD / EXA /<br>PULSAR / STANZA / SUNNY   | VKMA 93007  | <b>HONDA</b><br>ACCORD / PRELUDE / QUINTET  |
| VKMA 91302  | <b>TOYOTA</b><br>CAMRY / CELICA / CORONA  | VKMA 92200  | <b>NISSAN</b><br>BLUEBIRD / PRAIRIE / STANZA  | VKMA 93009  | <b>HONDA</b><br>PRELUDE   |
| VKMA 91303  | <b>TOYOTA</b><br>AVENSIS / AVENSIS VERSO /<br>COROLLA / COROLLA VERSO /<br>PICNIC / PREVIA / RAV 4                        | VKMA 92210  | <b>NISSAN</b><br>BLUEBIRD / CEDRIC / PRAIRIE /<br>PRAIRIE PRO / STANZA  | VKMA 93011  | <b>HONDA</b><br>ACCORD / SHUTTLE  |
| VKMA 91304  | <b>TOYOTA</b><br>CAMRY  | VKMA 92300  | <b>NISSAN</b><br>CHERRY / PULSAR / SENTRA /<br>STANZA / SUNNY   | VKMA 93012  | <b>DAEWOO</b><br>ARCADIA  |
| VKMA 91400  | <b>TOYOTA</b><br>COROLLA / SPRINTER /<br>STARLET  | VKMA 92320  | <b>NISSAN</b><br>BLUEBIRD / STANZA  | VKMA 93013  | <b>HONDA</b><br>LEGEND  |
| VKMA 91401  | <b>TOYOTA</b><br>CELICA / COROLLA / MR 2 /<br>SPRINTER  | VKMA 92400  | <b>NISSAN</b><br>MARCH / MICRA  | VKMA 93014  | <b>HONDA</b><br>ACCORD / PRELUDE  |
| VKMA 91700  | <b>TOYOTA</b><br>CRESSIDA / CROWN / SUPRA   | VKMA 92401  | <b>NISSAN</b><br>MARCH / MICRA  | VKMA 93019  | <b>HONDA</b><br>LOGO  |
| VKMA 91701  | <b>TOYOTA</b><br>CELICA   | VKMA 92410  | <b>NISSAN</b><br>MARCH / MICRA  | VKMA 93100  | <b>HONDA</b><br>ACCORD / PRELUDE  |















|            |  |            |   |            |  |
|------------|--|------------|---|------------|--|
| VKMA 93101 | <b>HONDA</b><br>BALLADE / BALLADE SPORTS / CIVIC / CIVIC PRO / CIVIC SHUTTLE / CRX / INTEGRA                         | VKMA 94100 | <b>MAZDA</b><br>323 (BF)  | VKMA 94612 | <b>MAZDA</b><br>323 (BJ) / 626 (GF) / 626 (GW) / PREMACY                             |
|            | <b>ROVER</b><br>200 (XH)   | VKMA 94101 | <b>MAZDA</b><br>121 (DA) / 323 (BF) / 323 (BW)  | VKMA 94614 | <b>MAZDA</b><br>B-SERIE (UF)   |
| VKMA 93200 | <b>HONDA</b><br>ACCORD / PRELUDE   | VKMA 94102 | <b>KIA</b><br>AVELLA / CAPITAL / PRIDE / RIO / SEPHIA   | VKMA 94616 | <b>FORD</b><br>RANGER  |
| VKMA 93201 | <b>HONDA</b><br>CIVIC / CIVIC CRX / CIVIC DEL SOL / CRX  |            | <b>MAZDA</b><br>121 (DA) / 121 (DB) / 121 (JASM, JBSM) / 323 (BA) / 323 (BG) / 323 (BJ) / 323 (BW) / DEMIO (DW)   | VKMA 94619 | <b>MAZDA</b><br>B-SERIE (UN)   |
| VKMA 93210 | <b>HONDA</b><br>CR-V / STEP WAGON  | VKMA 94201 | <b>KIA</b><br>CAPITAL / SEPHIA  | VKMA 95000 | <b>MAZDA</b><br>6 (GG) / 6 (GY)  |
| VKMA 93302 | <b>HONDA</b><br>LEGEND   |            | <b>MAZDA</b><br>323 (BA) / 323 (BG) / EUNOS 500 / EUNOS ROADSTER (NA) / MIATA (NA) / MIATA (NB) / MX-3 (EC) / MX-5 (NA) / MX-5 (NB) / PROTÉGÉ / XEDOS 6 | VKMA 95003 | <b>MAZDA</b><br>3000 GT / GALANT / SIGMA   |
|            | <b>ROVER</b><br>800  | VKMA 94222 | <b>MAZDA</b><br>626 (GD) / 626 (GV) / 929 (HC) / B-SERIE (UF) / B-SERIE (UN) / MX-6 (GD)  | VKMA 95003 | <b>HYUNDAI</b><br>SONATA   |
| VKMA 93500 | <b>HONDA</b><br>CIVIC / CIVIC DEL SOL / CIVIC PRO / CIVIC SHUTTLE / CONCERTO / CRX                                   |            | <b>MAZDA</b><br>626 (GD) / 626 (GV) / 929 (HC) / E 2000, E 2200   | VKMA 95005 | <b>HYUNDAI</b><br>DIAMANTE / GALANT / L 200 / MONTERO / PAJERO / SIGMA               |
| VKMA 93600 | <b>HONDA</b><br>ACCORD / ODYSSEY / PRELUDE / SHUTTLE   | VKMA 94230 | <b>MAZDA</b><br>626 (GC)  | VKMA 95006 | <b>HYUNDAI</b><br>ELANTRA / LANTRA / SANTAMO / SONATA                                |
|            | <b>ROVER</b><br>600  | VKMA 94300 | <b>MAZDA</b><br>626 (GD) / 626 (GE) / 626 (GV)  | VKMA 95006 | <b>MITSUBISHI</b><br>COLT / ECLIPSE / GALANT / LANCER / SANTAMO                      |
| VKMA 93612 | <b>HONDA</b><br>ACCORD   | VKMA 94310 | <b>MAZDA</b><br>929 (HB)  | VKMA 95008 | <b>MITSUBISHI</b><br>COLT / GALANT / LANCER / SPACE WAGON                            |
| VKMA 93615 | <b>HONDA</b><br>CIVIC  | VKMA 94501 | <b>MAZDA</b><br>929 (HB) / COSMO  | VKMA 95008 | <b>MITSUBISHI</b><br>CORDIA / ECLIPSE / GALANT / SPACE WAGON / TREDIA / TREDIA (EUR) |
| VKMA 93616 | <b>HONDA</b><br>CIVIC  | VKMA 94504 | <b>KIA</b><br>CARENS  | VKMA 95009 | <b>MITSUBISHI</b><br>GALANT  |
| VKMA 94000 | <b>MAZDA</b><br>323 (BA) / 626 (GE) / 929 (TA12) / EUNOS 500 / EUNOS 800 / MX-3 (EC) / MX-6 (GE) / XEDOS 6 / XEDOS 9 | VKMA 94507 | <b>KIA</b><br>CARNIVAL / SEDONA   | VKMA 95009 | <b>MITSUBISHI</b><br>GALANT  |
| VKMA 94007 | <b>MAZDA</b><br>626 (GC) / B-SERIE (UF) / E 2000, E 2200   | VKMA 94508 | <b>KIA</b><br>CARNIVAL / SEDONA   | VKMA 95010 | <b>HYUNDAI</b><br>GRACE / H100 / PORTER  |
| VKMA 94009 | <b>KIA</b><br>SPORTAGE   | VKMA 94509 | <b>KIA</b><br>CARNIVAL / SEDONA   | VKMA 95010 | <b>HYUNDAI</b><br>GRACE / H100 / PORTER  |
|            | <b>MAZDA</b><br>B-SERIE (UF) / E 2000, E 2200  | VKMA 94600 | <b>MAZDA</b><br>626 (GD) / 626 (GV) / E 1800 (SDX) / E 1800 (SRW)   | VKMA 95012 | <b>MITSUBISHI</b><br>DELICA / GALANT / L 200 / L 300 / MONTERO / PAJERO              |
| VKMA 94010 | <b>MAZDA</b><br>323 (BJ) / 626 (GE) / 626 (GF) / 626 (GW) / MX-6 (GE) / PREMACY                                      | VKMA 94601 | <b>KIA</b><br>CONCORD / POTENTIA / SPORTAGE   | VKMA 95012 | <b>MITSUBISHI</b><br>COLT / LANCER / MIRAGE  |
| VKMA 94012 | <b>MAZDA</b><br>323 (BJ) / 626 (GE) / 626 (GF) / 626 (GW) / PREMACY  |            | <b>MAZDA</b><br>626 (GD) / 626 (GV)   | VKMA 95013 | <b>PROTON</b><br>SAGA / SATRIA / WIRA  |
| VKMA 94014 | <b>MAZDA</b><br>323 (BF) / 323 (BG) / 323 (BW)   | VKMA 94609 | <b>MAZDA</b><br>323 (BA)  | VKMA 95013 | <b>HYUNDAI</b><br>ELANTRA / LANTRA   |
| VKMA 94016 | <b>KIA</b><br>CONCORD / SPORTAGE   | VKMA 94610 | <b>MAZDA</b><br>323 (BA) / 323 (BJ)   | VKMA 95014 | <b>HYUNDAI</b><br>GALLOPER / H-1 / H100 / STAREX                                     |
| VKMA 94017 | <b>MAZDA</b><br>929 (HC) / 929 (LV) / MPV  | VKMA 94611 | <b>MAZDA</b><br>323 (BA) / 323 (BJ)   | VKMA 95015 | <b>HYUNDAI</b><br>H-1 / H100 / SONATA  |
|            |  |            |   |            | <b>MITSUBISHI</b><br>L 200 / L 300 / PAJERO  |

















|  |                                  |  |                           |  |    |
|---|---|---|--|---|---|
| VKMA 95016  | <b>MITSUBISHI</b><br>L 300  | VKMA 95105  | <b>MITSUBISHI</b><br>COLT / CORDIA / L 200 / L 300 /<br>LANCER / MIRAGE / TREDIA /<br>TREDIA (NON-EUR/SIN) | VKMA 95642  | <b>KIA</b><br>PICANTO / VISTO   |
| VKMA 95019  | <b>MITSUBISHI</b><br>GALANT / L 200 / L 300 /<br>SPACE WAGON  | VKMA 95206  | <b>HYUNDAI</b><br>PONY   | VKMA 95645  | <b>HYUNDAI</b><br>SANTAMO / SONATA  |
| VKMA 95020  | <b>PROTON</b><br>PERDANA  | VKMA 95207  | <b>MITSUBISHI</b><br>COLT / LANCER / MIRAGE /<br>TREDIA  | VKMA 95648  | <b>MITSUBISHI</b><br>SANTAMO  |
| VKMA 95021  | <b>MITSUBISHI</b><br>COLT / LANCER  | VKMA 95613  | <b>PROTON</b><br>SAGA  | VKMA 95651  | <b>MITSUBISHI</b><br>PAJERO PININ   |
| VKMA 95022  | <b>PROTON</b><br>PERSONA / SATRIA / WIRA  | VKMA 95617  | <b>MITSUBISHI</b><br>COLT / LANCER / MIRAGE  | VKMA 95652  | <b>HYUNDAI</b><br>ACCENT / GETZ   |
| VKMA 95023  | <b>MITSUBISHI</b><br>COLT / LANCER  | VKMA 95619  | <b>PROTON</b><br>SAGA  | VKMA 95655  | <b>MITSUBISHI</b><br>GALANT   |
| VKMA 95025  | <b>PROTON</b><br>WIRA   | VKMA 95620  | <b>MITSUBISHI</b><br>CHALLENGER / MONTERO /<br>PAJERO SPORT / SIGMA  | VKMA 95657  | <b>MITSUBISHI</b><br>COLT / LANCER  |
| VKMA 95027  | <b>MITSUBISHI</b><br>COLT / GALANT / LANCER /<br>SPACE RUNNER / SPACE<br>WAGON                                    | VKMA 95621  | <b>MITSUBISHI</b><br>GALANT  | VKMA 95658  | <b>MITSUBISHI</b><br>COLT / SPACE STAR  |
| VKMA 95030  | <b>MITSUBISHI</b><br>COLT / EXPO-LRV / GALANT /<br>LANCER / MIRAGE / SPACE<br>RUNNER / SPACE WAGON                | VKMA 95622  | <b>HYUNDAI</b><br>ELANTRA / EXCEL / LANTRA /<br>PONY / S COUPE   | VKMA 95659  | <b>HYUNDAI</b><br>COUPE / ELANTRA / LANTRA /<br>MATRIX                                |
| VKMA 95031  | <b>PROTON</b><br>WIRA   | VKMA 95623  | <b>MITSUBISHI</b><br>GALANT / SPACE WAGON  | VKMA 95660  | <b>HYUNDAI</b><br>COUPE / ELANTRA / LANTRA  |
| VKMA 95033  | <b>MITSUBISHI</b><br>L 200 / L 300 / PAJERO   | VKMA 95624  | <b>MITSUBISHI</b><br>COLT / LANCER   | VKMA 95663  | <b>HYUNDAI</b><br>COUPE / SANTA FE / SONATA /<br>TRAJET                               |
| VKMA 95036  | <b>HYUNDAI</b><br>ACCENT / LANTRA / PONY / S<br>COUPE   | VKMA 95625  | <b>MITSUBISHI</b><br>COLT / LANCER   | VKMA 95666  | <b>HYUNDAI</b><br>SANTA FE / SONATA / TRAJET  |
| VKMA 95039  | <b>MITSUBISHI</b><br>COLT / DELICA / GALANT / L<br>200 / L 300 / LANCER /<br>MIRAGE / TREDIA (NON-EUR/<br>SIN)    | VKMA 95626  | <b>MITSUBISHI</b><br>CARISMA / COLT / LANCER /<br>PAJERO PININ   | VKMA 95669  | <b>HYUNDAI</b><br>SANTA FE / SONATA   |
| VKMA 95040  | <b>MITSUBISHI</b><br>GALANT / L 200 / L 300 /<br>SPACE WAGON / STARION  | VKMA 95627  | <b>VOLVO</b><br>S40 I - V40  | VKMA 95670  | <b>KIA</b><br>SORENTO   |
| VKMA 95102  | <b>MITSUBISHI</b><br>MAGNA / MONTERO / PAJERO /<br>SHOGUN   | VKMA 95628  | <b>MITSUBISHI</b><br>COLT / LANCER   | VKMA 95671  | <b>HYUNDAI</b><br>ELANTRA / GETZ / LANTRA /<br>MATRIX / SANTA FE / TRAJET             |
| VKMA 95103  | <b>MITSUBISHI</b><br>CHARIOT / CORDIA / GALANT /<br>LANCER / SAPPORO / SPACE<br>WAGON / TREDIA / TREDIA<br>(SIN)  | VKMA 95629  | <b>MITSUBISHI</b><br>CARISMA / GALANT  | VKMA 95672  | <b>MITSUBISHI</b><br>COLT   |
| VKMA 95104  | <b>MITSUBISHI</b><br>CORDIA / GALANT / L 200 / L<br>300 / LANCER / SAPPORO /<br>SPACE WAGON / STARION /<br>TREDIA | VKMA 95630  | <b>MITSUBISHI</b><br>GALANT  | VKMA 95673  | <b>MITSUBISHI</b><br>OUTLANDER  |
|   |   | VKMA 95631  | <b>HYUNDAI</b><br>ACCENT / COUPE / ELANTRA /<br>EXCEL / GETZ / LANTRA /<br>MATRIX / VERNA                  | VKMA 95674  | <b>SUZUKI</b><br>ALTO / FRONTE / SB308  |
|   |   | VKMA 95632  | <b>HYUNDAI</b><br>ATOS   | VKMA 95675  | <b>SUZUKI</b><br>BALENO / ESCUDO / GRAND<br>VITARA / SE416 / SWIFT /<br>VITARA / X-90 |
|   |   | VKMA 95633  | <b>HYUNDAI</b><br>SANTAMO / SONATA   | VKMA 95676  | <b>SUZUKI</b><br>ESCUDO / GRAND VITARA  |
|   |   | VKMA 95634  | <b>HYUNDAI</b><br>AMICA / ATOS / ATOS PRIME /<br>GETZ  | VKMA 95677  | <b>SUZUKI</b><br>CULTUS / SWIFT   |
|   |   | VKMA 95635  |  | VKMA 95678  | <b>SUZUKI</b><br>FORSA / SWIFT  |
|   |   | VKMA 95636  |  | VKMA 95679  | <b>SUZUKI</b><br>FORSA / SAMURAI / SPRINT /<br>SWIFT                                  |
|   |   | VKMA 95637  |  | VKMA 95680  | <b>SUZUKI</b><br>CULTUS / SWIFT   |

|  |  |  |   |  |   |
|---|---|---|---|---|--|
| VKMA 96204  | <b>SUZUKI</b><br>SE416 / SIDEKICK / VITARA  | VKMA 99003  | <b>HONDA</b><br>PASSPORT  |   | <b>VW</b><br>GOLF II (19E, 1G1) / GOLF III (1H1) / GOLF III Variant (1H5) / JETTA II (19E, 1G2) / POLO (86C, 80) / POLO Box (86CF) / VENTO (1H2) |
| VKMA 96206  | <b>SUZUKI</b><br>CAPPUCINO / CARRY / EVERY  |   | <b>ISUZU</b><br>AMIGO / FASTER / PICKUP / RODEO / TROOPER   |   |  |
| VKMA 96207  | <b>SUZUKI</b><br>CARRY / EVERY  | VKMA 99004  | <b>ISUZU</b><br>FASTER / TROOPER  | VKMC 01104  | <b>SEAT</b><br>CORDOBA (6K2) / CORDOBA (6K2/C2) / IBIZA II (6K1)   |
| VKMA 96208  | <b>SUZUKI</b><br>SAMURAI / SWIFT  |   | <b>OPEL</b><br>CAMPO / FRONTERA A / MONTEREY B  |   | <b>VW</b><br>GOLF III (1H1) / GOLF III Variant (1H5) / VENTO (1H2)   |
| VKMA 96213  | <b>SUZUKI</b><br>CULTUS / SF310 / SWIFT   |   | <b>VAUXHALL</b><br>BRAVA / FRONTERA Mk I / MONTEREY   | VKMC 01105  | <b>VW</b><br>POLO (6N1) / POLO Box (6NF)   |
| VKMA 96214  | <b>SUZUKI</b><br>ALTO / CARRY / SWIFT / WAGON R+                                  | VKMA 99006  | <b>ISUZU</b><br>FARGO   | VKMC 01107  | <b>SEAT</b><br>AROSA / CORDOBA (6K2) / CORDOBA (6K2/C2) / CORDOBA Vario (6K5) / IBIZA III (6K1) / INCA   |
| VKMA 96218  | <b>SUZUKI</b><br>ALTO / SWIFT   | VKMC 01031  | <b>AUDI</b><br>100 (44,44Q,C3)/100 Avant (44,44Q,C3) / 200 (44, 44Q) / 200 Avant (44, 44Q) / 80 (81, 85, B2) / 90 (81, 85, B2) / 90 (89, 89Q, 8A, B3) / COUPE (81, 85) / QUATTRO (85)   |   | <b>VW</b><br>CADDY II(9K9A)/Estate(9K9B)/ Pickup(9U7) / LUPO (6X1, 6E1) / POLO (6N2) / POLO CLASSIC (6KV2) / Variant (6KV5)                      |
| VKMA 97005  | <b>DAIHATSU</b><br>CHARADE  |   | <b>VW</b><br>PASSAT (32B) / SANTANA (32B)   | VKMC 01114  | <b>SEAT</b><br>CORDOBA (6K2) / CORDOBA (6K2/C2) / IBIZA II (6K1) / IBIZA III (6K1)   |
| VKMA 97007  | <b>DAIHATSU</b><br>CUORE / DOMINO / HANDI / MIRA                                  | VKMC 01032  | <b>AUDI</b><br>100 (44,44Q,C3)/100 Avant (44,44Q,C3) / 200 (44, 44Q) / 200 Avant (44, 44Q) / 90 (81, 85, B2) / 90 (89, 89Q, 8A, B3) / COUPE (81, 85) / COUPE (89, 8B) / QUATTRO (85)  |   | <b>VW</b><br>POLO (6N1) / POLO Box (6NF)   |
| VKMA 97009  | <b>DAIHATSU</b><br>CHARADE / HIJET  |   | <b>AUDI</b><br>100 (43, C2) / 100 Avant (43, C2) / 100 (44,44Q,C3)/100 Avant (44,44Q,C3)  | VKMC 02174  | <b>FIAT</b><br>BRAVA/BRAVO (182) / DOBLO / MAREA / PUNTO (188) / STRADA  |
| VKMA 97300  | <b>DAIHATSU</b><br>CHARADE / HIJET  | VKMC 01040  | <b>VOLVO</b><br>240 / 740 / 760 / 940   | VKMC 02176  | <b>ALFA ROMEO</b><br>156 / 166   |
| VKMA 97501  | <b>DAIHATSU</b><br>APPLAUSE / CHARADE / FEROZA / GRAN MOVE / ROCKY                |   | <b>VW</b><br>LT I   |   | <b>FIAT</b><br>BRAVO / MAREA   |
| VKMA 97503  | <b>DAIHATSU</b><br>CHARADE / TERIOS   | VKMC 01100  | <b>AUDI</b><br>50 (86) / 80 (81, 85, B2)  | VKMC 02177  | <b>LANCIA</b><br>KAPPA / LYBRA / THESIS  |
| VKMA 97504  | <b>DAIHATSU</b><br>CUORE / DOMINO / MIRA / MOVE                                   |   | <b>VW</b><br>DERBY (86) / DERBY (86C, 80) / GOLF I (17) / GOLF II (19E, 1G1) / JETTA I (16) / JETTA II (19E, 1G2) / PASSAT (32) / Variant (33) / PASSAT (32B) / POLO (86) / POLO (86C, 80) / POLO Box (86CF) / SANTANA (32B) / SCIROCCO (53) / SCIROCCO (53B) |   | <b>ALFA ROMEO</b><br>145/146 / 147 / 155 / 156 / 166 / GTV / SPIDER  |
| VKMA 97505  | <b>DAIHATSU</b><br>CHARADE / CUORE / MOVE / SIRION / TREVIS / YRV                 |   | <b>SEAT</b><br>TERRA  | VKMC 02179  | <b>FIAT</b><br>BARCETTA / COUPE  |
| VKMA 98000  | <b>SUBARU</b><br>IMPREZA / LEGACY   | VKMC 01101  | <b>VW</b><br>POLO (86C, 80) / POLO Box (86CF)   |   | <b>LANCIA</b><br>DEDRA / DELTA II  |
| VKMA 98001  | <b>SUBARU</b><br>LEONE  |   | <b>SEAT</b><br>CORDOBA (6K2) / CORDOBA (6K2/C2) / IBIZA II (6K1)  |   | <b>ALFA ROMEO</b><br>145/146 / 147 / 156   |
| VKMA 98105  | <b>SUBARU</b><br>JUSTY  |   |   | VKMC 02181  | <b>FIAT</b><br>BRAVA/BRAVO (182) / DOBLO / MAREA / MULTIPLA / PUNTO (188) / STILO / STRADA   |
| VKMA 98109  | <b>SUBARU</b><br>FORESTER / IMPREZA / LEGACY / OUTBACK                            |   |   |   | <b>LANCIA</b><br>LYBRA   |
| VKMA 98110  | <b>SUBARU</b><br>FORESTER / IMPREZA   |   |   |   | <b>ALFA ROMEO</b><br>145/146 / 147 / 156   |
| VKMA 98112  | <b>SUBARU</b><br>IMPREZA  |   |   |   |  |
| VKMA 99001  | <b>ISUZU</b><br>AMIGO / FASTER / IMPULSE / PICKUP / RODEO / TROOPER               |   |   |   |  |
|   | <b>OPEL</b><br>CAMPO  |   |   |   |  |
|   | <b>VAUXHALL</b><br>BRAVA  |   |   |   |  |

|  |    |  |    |  |   |
|---|---|---|---|---|--|
| VKMC 02183  | ALFA ROMEO<br>156 / GT / GTV / SPIDER<br><hr/> FIAT<br>BARCHETTA / BRAVA/BRAVO<br>(182) / COUPE / MAREA /<br>PUNTO (188) <hr/> LANCIA<br>DELTA II / LYBRA | VKMC 03244  | FIAT<br>DUCATO (230) / SCUDO (220) /<br>ULYSSE (220) <hr/> PEUGEOT<br>205 / 306 / 405 II / 406 / 806 /<br>BOXER I / EXPERT I / PARTNER  | VKMC 04212  | FORD<br>ESCORT V / ESCORT VI /<br>ESCORT VII / FIESTA III / ORION<br>III   |
| VKMC 02200  | AUTOBIANCHI<br>Y10<br><hr/> FIAT<br>PANDA (141A_) / UNO<br><hr/> LANCIA<br>Y / Y10  | VKMC 03246  | CITROËN<br>BERLINGO / C15 / JUMPY I /<br>XSARA<br><hr/> FIAT<br>SCUDO (220)<br><hr/> PEUGEOT<br>206 / 306 / EXPERT I /<br>PARTNER   | VKMC 05100  | OPEL<br>CORSA A / KADETT D / KADETT<br>E<br><hr/> VAUXHALL<br>ASTRA Mk I / ASTRA Mk II /<br>NOVA / NOVAVAN   |
| VKMC 02201  | FIAT<br>PALIO/SIENA / PUNTO (176) /<br>STRADA<br><hr/> LANCIA<br>Y  | VKMC 03246  | CITROËN<br>BERLINGO / EVASION /<br>JUMPER (230) / JUMPER (244)<br>/ JUMPY I / JUMPY II / XANTIA II<br>/ XSARA / XSARA PICASSO   | VKMC 05103  | OPEL<br>ASCONA C / CORSA A / KADETT<br>D / KADETT E / MANTA B<br><hr/> VAUXHALL<br>ASTRA Mk I / ASTRA Mk II /<br>CAVALIER Mk I / CAVALIER Mk II<br>/ NOVA  |
| VKMC 02202  | FIAT<br>CINQUECENTO / PALIO/SIENA /<br>PUNTO (176) / SEICENTO   | VKMC 03247  | FIAT<br>DUCATO (230) / DUCATO (244)<br>/ SCUDO (220) / ULYSSE (220)<br><hr/> LANCIA<br>ZETA<br><hr/> PEUGEOT<br>206 / 306 / 406 / 806 / BOXER<br>I / BOXER II / EXPERT I /<br>PARTNER   | VKMC 05120  | DAEWOO<br>ESPERO<br><hr/> OPEL<br>ASCONA C / CORSA A / KADETT<br>E / VECTRA A<br><hr/> VAUXHALL<br>ASTRA Mk II / CAVALIER Mk II /<br>CAVALIER Mk III / NOVA  |
| VKMC 02203  | FIAT<br>DOBLO / PALIO/SIENA / PANDA<br>(169) / PUNTO (176) / PUNTO<br>(188) / STRADA<br><hr/> LANCIA<br>Y / YPSILON                                       | VKMC 03247  | CITROËN<br>BERLINGO / C5 I / EVASION /<br>JUMPY I / JUMPY II / XSARA /<br>XSARA PICASSO<br><hr/> FIAT<br>SCUDO (220) / ULYSSE (220)<br><hr/> LANCIA<br>ZETA<br><hr/> PEUGEOT<br>206 / 306 / 307 / 406 / 607 /<br>806 / EXPERT I / PARTNER       | VKMC 05121  | DAEWOO<br>ESPERO<br><hr/> OPEL<br>ASTRA F / ASTRA F CLASSIC /<br>ASTRA G / COMBO A / CORSA A<br>/ CORSA B / KADETT E /<br>VECTRA A / VECTRA B<br><hr/> VAUXHALL<br>ASTRA Mk II / ASTRA Mk III /<br>ASTRA Mk IV / CAVALIER Mk III /<br>COMBO I / CORSA Mk I / NOVA /<br>VECTRA Mk I |
| VKMC 02210  | FIAT<br>PALIO/SIENA / PANDA (141A_) /<br>PANDA (169) / PUNTO (176) /<br>SEICENTO / UNO<br><hr/> LANCIA<br>Y   | VKMC 03248  | PEUGEOT<br>206 / 306 / 307 / 406 / 607 /<br>806 / EXPERT I / PARTNER<br><hr/> CITROËN<br>C8 / EVASION<br><hr/> FIAT<br>SCUDO (220) / ULYSSE (179AX)<br>/ ULYSSE (220)<br><hr/> LANCIA<br>PHEDRA / ZETA<br><hr/> PEUGEOT<br>806 / 807 / EXPERT I | VKMC 05150  | OPEL<br>VECTRA B<br><hr/> VAUXHALL<br>VECTRA Mk I<br><hr/> OPEL<br>ASCONA C / ASTRA F / KADETT<br>E / VECTRA A<br><hr/> VAUXHALL<br>ASTRA Mk II / ASTRA Mk III /<br>CAVALIER Mk II / CAVALIER Mk<br>III  |
| VKMC 03100  | CITROËN<br>AX / BERLINGO / BX / C15 /<br>SAXO / ZX<br><hr/> PEUGEOT<br>106 I / 106 II / 205 / 206 / 306<br>/ 309 / PARTNER                                | VKMC 03251  | CITROËN<br>EVASION / XANTIA I / XANTIA II<br>/ XM I / XM II<br><hr/> FIAT<br>ULYSSE (220)<br><hr/> LANCIA<br>ZETA<br><hr/> PEUGEOT<br>406 / 605 / 806   | VKMC 05201  | OPEL<br>VECTRA A<br><hr/> VAUXHALL<br>VECTRA Mk I<br><hr/> OPEL<br>ASCONA C / ASTRA F / KADETT<br>E / VECTRA A<br><hr/> VAUXHALL<br>ASTRA Mk II / ASTRA Mk III /<br>CAVALIER Mk II / CAVALIER Mk<br>III  |
| VKMC 03121  | CITROËN<br>AX / SAXO / XSARA<br><hr/> PEUGEOT<br>106 I / 106 II<br><hr/> ROVER<br>100   | VKMC 03251  | FIAT<br>ULYSSE (220)<br><hr/> LANCIA<br>ZETA<br><hr/> PEUGEOT<br>406 / 605 / 806  | VKMC 05400  | OPEL<br>ASCONA C / KADETT D /<br>KADETT E / MANTA B /<br>REKORD E<br><hr/> VAUXHALL<br>ASTRA Mk I / ASTRA Mk II /<br>CARLTON Mk II / CAVALIER Mk II  |
| VKMC 03240  | CITROËN<br>BX / C15 / C25 / VISA / ZX<br><hr/> PEUGEOT<br>205 / 305 / 306 / 309 / 405 I /<br>405 II / J5  | VKMC 03251  | FIAT<br>ULYSSE (220)<br><hr/> LANCIA<br>ZETA<br><hr/> PEUGEOT<br>406 / 605 / 806  | VKMC 05401  | OPEL<br>ASCONA C / ASTRA F / CALIBRA<br>/ FRONTERA A / KADETT E /<br>OMEGA A / VECTRA A  |
| VKMC 03241  | CITROËN<br>BERLINGO / C15 / EVASION /<br>JUMPER (230) / JUMPY I /<br>JUMPY II / XANTIA I / XANTIA II<br>/ XSARA / ZX                                      |   |   |   |  |

|  |    |  |   |  |                                 |
|---|---|---|---|---|--|
| VKMC 06000  | <b>VAUXHALL</b><br>ASTRA Mk II / ASTRA Mk III / CALIBRA / CARLTON Mk III / CAVALIER Mk II / CAVALIER Mk III / FRONTERA Mk I   |   | <b>VW</b><br>CADDY I (14) / CADDY II(9K9A)/ Estate(9K9B)/Pickup(9U7) / CORRADO (53I) / GOLF I (17) / GOLF I Cabriolet (155) / GOLF II (19E, 1G1) / GOLF III (1H1) / GOLF III Variant (1H5) / GOLF III Cabriolet (1E7) / GOLF IV Cabriolet (1E7) / ILTIS (183) / JETTA I (16) / JETTA II (19E, 1G2) / PASSAT (32) / Variant (33) / PASSAT (32B) / PASSAT (3A2, 35I) / Variant (3A5, 35I) / POLO CLASSIC (6KV2) / Variant (6KV5) / SANTANA / SANTANA (32B) / SCIROCCO (53) / SCIROCCO (53B) / VENTO (1H2) | VKMS 03100-1  | <b>PEUGEOT</b><br>106 I / 106 II / 205 / 206 / 306 / 309 / PARTNER   |
| VKMC 06002  | <b>RENAULT</b><br>CLIO I / EXPRESS/EXTRA/ RAPID / R19   |   |   | VKMS 03100-2  | <b>CITROËN</b><br>AX / BERLINGO / BX / C15 / SAXO / ZX   |
| VKMC 06003  | <b>RENAULT</b><br>CLIO II / KANGOO / MEGANE I / SCENIC I / THALIA   |   |   | VKMS 03110-1  | <b>PEUGEOT</b><br>106 I / 106 II / 205 / 206 / 306 / 307 / 309 / 405 I / PARTNER                                   |
| VKMC 06005  | <b>RENAULT</b><br>CLIO II / KANGOO / MEGANE I   |   |   | VKMS 03110-2  | <b>CITROËN</b><br>AX / BERLINGO / BX / C15 / SAXO / XSARA / ZX   |
| VKMC 06010  | <b>RENAULT</b><br>CLIO I / CLIO II / KANGOO / TWINGO  | VKMS 01010  | <b>AUDI</b><br>80 (81, 85, B2) / 80 (89, 89Q, 8A, B3) / 90 (81, 85, B2) / 90 (89, 89Q, 8A, B3)  | VKMS 03121  | <b>CITROËN</b><br>AX / SAXO / XSARA  |
| VKMC 06020  | <b>RENAULT</b><br>CLIO II / KANGOO / LAGUNA I / LAGUNA II / MEGANE I / MEGANE II / MODUS / SCENIC I / SCENIC II / GRAND SCENIC / THALIA   |   | <b>VW</b><br>CADDY I (14) / GOLF II (19E, 1G1) / ILTIS (183) / JETTA I (16) / JETTA II (19E, 1G2) / PASSAT (32) / Variant (33) / PASSAT (32B) / PASSAT (3A2, 35I) / Variant (3A5, 35I) / TRANSPORTER III  | VKMS 03240  | <b>PEUGEOT</b><br>106 I / 106 II   |
| VKMC 06106  | <b>RENAULT</b><br>AVANTIME / CLIO III / ESPACE IV / LAGUNA II / LAGUNA III / MEGANE II / SCENIC II / GRAND SCENIC / VEL SATIS   |   |   |   | <b>ROVER</b><br>100  |
| VKMC 06127  | <b>NISSAN</b><br>INTERSTAR / PRIMASTAR  | VKMS 02200-1  | <b>AUTOBIANCHI</b><br>Y10   | VKMS 03241  | <b>CITROËN</b><br>BERLINGO / C15 / EVASION / JUMPER (230) / JUMPY I / JUMPY II / XANTIA I / XANTIA II / XSARA / ZX |
|   | <b>OPEL</b><br>MOVANO / VIVARO  |   | <b>FIAT</b><br>PANDA (141A_) / PUNTO (176) / TIPO / UNO   |   | <b>FIAT</b><br>DUCATO (230) / SCUDDO (220) / ULYSSE (220)  |
|   | <b>RENAULT</b><br>ESPACE IV / LAGUNA I / LAGUNA II / MASTER II / TRAFIC II  | VKMS 02200-2  | <b>LANCIA</b><br>Y10  |   | <b>PEUGEOT</b><br>205 / 306 / 405 II / 406 / 806 / BOXER I / EXPERT I / PARTNER                                    |
|   | <b>VAUXHALL</b><br>MOVANO / VIVARO  |   | <b>AUTOBIANCHI</b><br>Y10   | VKMS 03246  | <b>SUZUKI</b><br>SAMURAI / VITARA  |
|   | <b>VOLVO</b><br>S40 I - V40   |   | <b>FIAT</b><br>PANDA (141A_) / PUNTO (176) / UNO  |   | <b>CITROËN</b><br>BERLINGO / EVASION / JUMPER (230) / JUMPER (244) / XANTIA II / XSARA / XSARA PICASSO             |
| VKMC 06415  | <b>RENAULT</b><br>MEGANE I / SCENIC I   | VKMS 02215  | <b>LANCIA</b><br>Y10  |   | <b>PEUGEOT</b><br>206 / 306 / 406 / 806 / BOXER I / BOXER II / PARTNER   |
| VKMC 06501  | <b>RENAULT</b><br>ESPACE III / LAGUNA I / SAFRANE II  |   | <b>FIAT</b><br>BRAVA/BRAVO (182) / MAREA  | VKMS 03251  | <b>CITROËN</b><br>EVASION / XANTIA I / XANTIA II / XM I / XM II  |
| VKMS 01000  | <b>AUDI</b><br>100 (43, C2) / 100 Avant (43, C2) / 100 (44,44Q,C3)/100 Avant (44,44Q,C3) / 100 (4A, C4) / 100 Avant (4A, C4) / 80 (80, 82, B1) / 80 (81, 85, B2) / 80 (89, 89Q, 8A, B3) / 80 (8C, B4) / 80 Avant (8C, B4) / COUPE (81, 85) / COUPE (89, 8B) | VKMS 02242-1  | <b>LANCIA</b><br>Y  |   | <b>FIAT</b><br>ULYSSE (220)  |
|   | <b>SEAT</b><br>CORDOBA (6K2) / CORDOBA (6K2/C2) / CORDOBA Varío (6K5) / IBIZA II (6K1) / INCA / TOLEDO I (1L)   | VKMS 02242-2  | <b>FIAT</b><br>BRAVA/BRAVO (182) / DOBLO / MAREA / MULTIPLA / PALIO/ SIENA / STILO  | VKMS 03300  | <b>LANCIA</b><br>ZETA  |
|   |   |   | <b>LANCIA</b><br>LYBRA  |   | <b>PEUGEOT</b><br>406 / 605 / 806  |

|  |    |  |                |  |           |
|---|---|---|---|---|--|
| VKMS 04103  | <b>FORD</b><br>ESCORT BOX 86 / ESCORT BOX 91 / ESCORT BOX 95 / ESCORT IV / ESCORT V / ESCORT VI / ESCORT VII / FIESTA BOX / COURRIER / FIESTA III / FIESTA IV / MONDEO I / ORION II / ORION III / P 100 II / SIERRA |   | <b>SAAB</b><br>9-3 II   |   | <b>RENAULT</b><br>ESPACE I / ESPACE II / MASTER I / R21 / R25 / TRAFIC I                     |
| VKMS 04106  | <b>FORD</b><br>ESCORT BOX 95 / ESCORT VII / FIESTA BOX / COURRIER / FIESTA III / FIESTA IV / MONDEO I / MONDEO II   | VKMS 05208  | <b>VAUXHALL</b><br>ASTRA Mk IV / ASTRA Mk V / MERIVA / TIGRA Mk II / VECTRA Mk II / ZAFIRA Mk I | VKMS 06501  | <b>RENAULT</b><br>ESPACE III / LAGUNA I / SAFRANE II   |
| VKMS 05121  | <b>OPEL</b><br>ASTRA F / ASTRA F CLASSIC / ASTRA G / COMBO A / COMBO B / CORSA A / CORSA B / KADETT E / MERIVA / VECTRA A / VECTRA B  | VKMS 05222  | <b>OPEL</b><br>CORSA A / CORSA B / KADETT E   | VKMS 90000  | <b>DAEWOO</b><br>CIELO / ESPERO / LACETTI / LANOS / LEMANS / NEXIA / NUBIRA / REZZO / TACUMA |
| VKMS 05150  | <b>VAUXHALL</b><br>ASTRA Mk II / ASTRA Mk IV / COMBO II / MERIVA  | VKMS 06000  | <b>VAUXHALL</b><br>ASTRA Mk II / CORSA Mk I / NOVA / NOVAVAN                                    | VKMS 90002  | <b>DAEWOO</b><br>ESPERO  |
| VKMS 05152-1  | <b>OPEL</b><br>ASTRA F / ASTRA F CLASSIC / COMBO A / CORSA B / TIGRA / VECTRA B   | VKMS 06010-1  | <b>OPEL</b><br>ASTRA F / CALIBRA / OMEGA B / VECTRA A / VECTRA B                                | VKMS 91001  | <b>TOYOTA</b><br>CAMRY   |
| VKMS 05152-2  | <b>VAUXHALL</b><br>ASTRA Mk III / CORSA Mk I / TIGRA Mk I   | VKMS 06010-2  | <b>VAUXHALL</b><br>ASTRA Mk III / CALIBRA / CAVALIER Mk III / OMEGA / VECTRA Mk I               | VKMS 91002  | <b>TOYOTA</b><br>CARINA / CELICA / COROLLA   |
| VKMS 05152-3  | <b>OPEL</b><br>ASTRA G / ZAFIRA A   | VKMS 06101  | <b>RENAULT</b><br>CLIO I / EXPRESS/EXTRA/ RAPID / MEGANE I / R19 / SCENIC I                     | VKMS 91003  | <b>TOYOTA</b><br>AVENSIS / CAMRY / CARINA / CELICA / CORONA / MARK II / PICNIC               |
| VKMS 05154-1  | <b>VAUXHALL</b><br>ASTRA Mk IV / ZAFIRA Mk I  | VKMS 06111-1  | <b>RENAULT</b><br>CLIO I / CLIO II / KANGOO / TWINGO  | VKMS 91005  | <b>TOYOTA</b><br>AVENSIS / CARINA / COROLLA / SPRINTER                                       |
| VKMS 05154-2  | <b>OPEL</b><br>ASTRA G / ZAFIRA A   | VKMS 06111-2  | <b>RENAULT</b><br>CLIO II / KANGOO / TWINGO   | VKMS 91006  | <b>TOYOTA</b><br>AVENSIS / CARINA / COROLLA / SPRINTER                                       |
| VKMS 05154-3  | <b>VAUXHALL</b><br>ASTRA Mk IV / ZAFIRA Mk I  | VKMS 06113  | <b>RENAULT</b><br>CLIO I / LAGUNA I / R19 / R21 / SUPER 5 / TRAFIC I                            | VKMS 91013  | <b>TOYOTA</b><br>CARINA  |
| VKMS 06115  | <b>OPEL</b><br>ASTRA G / CORSA C / MERIVA / VECTRA C / ZAFIRA A   | VKMS 06114-1  | <b>RENAULT</b><br>CLIO I / EXPRESS/EXTRA/ RAPID   | VKMS 91100  | <b>TOYOTA</b><br>AVENSIS / CAMRY / CARINA / COROLLA / PICNIC                                 |
| VKMS 06116  | <b>VAUXHALL</b><br>ASTRA Mk IV / CORSA Mk II / MERIVA / VECTRA Mk II / ZAFIRA Mk I  | VKMS 06114-2  | <b>RENAULT</b><br>EXPRESS/EXTRA/RAPID / MEGANE I / R19 / R21 / SUPER 5                          | VKMS 91101  | <b>TOYOTA</b><br>CAMRY / CARINA / CELICA / CORONA  |
| VKMS 06213  | <b>OPEL</b><br>ASTRA G / ASTRA H / CORSA C / MERIVA / SIGNUM / TIGRA Twin Top / VECTRA C / ZAFIRA A   | VKMS 06115  | <b>VOLVO</b><br>340-360 / 440-460 / S40 I - V40   | VKMS 91122  | <b>TOYOTA</b><br>4 RUNNER / CRESSIDA / CROWN / DYNA / HIACE / HILUX                          |
|   |   | VKMS 06116  | <b>RENAULT</b><br>CLIO I / EXPRESS/EXTRA/ RAPID   | VKMS 91124  | <b>TOYOTA</b><br>4 RUNNER / CRESSIDA / CROWN / DYNA / HIACE / HILUX / LAND CRUISER           |
|   |   | VKMS 06213  | <b>RENAULT</b><br>CLIO II / EXPRESS/EXTRA/ RAPID / KANGOO                                       | VKMS 91125  | <b>TOYOTA</b><br>4 RUNNER / DYNA / HIACE / HILUX / LAND CRUISER                              |
|   |   |   | <b>JEEP</b><br>CHEROKEE   | VKMS 91201  | <b>TOYOTA</b><br>4 RUNNER / DYNA / HIACE / HILUX / LAND CRUISER                              |
|   |   |   |   | VKMS 91202  | <b>VW</b><br>TARO  |
|   |   |   |   | VKMS 91203  | <b>TOYOTA</b><br>STARLET   |
|   |   |   |   |   | <b>DAIHATSU</b><br>CHARMANT  |
|   |   |   |   |   | <b>TOYOTA</b><br>CARINA / CELICA / COROLLA / TERCEL  |
|   |   |   |   |   | <b>TOYOTA</b><br>COROLLA / STARLET   |





|            |  |            |  |            |  |
|------------|--|------------|--|------------|--|
| VKMS 91303 | <b>TOYOTA</b><br>AVENSIS / AVENSIS VERSO /<br>COROLLA / COROLLA VERSO /<br>PICNIC / PREVIA / RAV 4 | VKMS 93006 | <b>HONDA</b><br>CIVIC / CIVIC CRX / CIVIC DEL<br>SOL / CRX / HR-V  | VKMS 94201 | <b>KIA</b><br>SEPHIA   |
| VKMS 91304 | <b>TOYOTA</b><br>CAMRY   | VKMS 93011 | <b>HONDA</b><br>ACCORD / SHUTTLE   |            | <b>MAZDA</b><br>323 (BA) / 323 (BG) / MIATA<br>(NB) / MX-3 (EC) / MX-5 (NA) /<br>MX-5 (NB)     |
| VKMS 91400 | <b>TOYOTA</b><br>COROLLA / STARLET   | VKMS 93019 | <b>HONDA</b><br>LOGO   | VKMS 94222 | <b>MAZDA</b><br>626 (GD) / 626 (GV) / 929 (HC) /<br>B-SERIE (UF) / B-SERIE (UN) /<br>MX-6 (GD) |
| VKMS 91401 | <b>TOYOTA</b><br>CELICA / COROLLA / MR 2 /<br>SPRINTER   | VKMS 93101 | <b>HONDA</b><br>CIVIC / CRX  | VKMS 94230 | <b>MAZDA</b><br>626 (GD) / 626 (GV) / 929 (HC) /<br>E 2000, E 2200                             |
| VKMS 91700 | <b>TOYOTA</b><br>CRESSIDA / CROWN / SUPRA  | VKMS 93200 | <b>HONDA</b><br>ACCORD / PRELUDE   | VKMS 94310 | <b>MAZDA</b><br>626 (GD) / 626 (GE) / 626 (GV)   |
| VKMS 91702 | <b>TOYOTA</b><br>CARINA / CELICA / COROLLA /<br>CORONA / SPRINTER                                  | VKMS 93201 | <b>HONDA</b><br>CIVIC / CIVIC CRX / CIVIC DEL<br>SOL / CRX   | VKMS 94601 | <b>KIA</b><br>CONCORD / POTENTIA /<br>SPORTAGE   |
| VKMS 91704 | <b>TOYOTA</b><br>4 RUNNER / LAND CRUISER 90  | VKMS 93210 | <b>HONDA</b><br>CR-V   |            | <b>MAZDA</b><br>626 (GD) / 626 (GV)  |
| VKMS 91710 | <b>TOYOTA</b><br>CRESTA / CROWN ESTATE /<br>MARK II / SC400 / SOARER                               | VKMS 93302 | <b>HONDA</b><br>LEGEND   | VKMS 94609 | <b>MAZDA</b><br>323 (BA)   |
| VKMS 92001 | <b>NISSAN</b><br>CHERRY / EXA / MULTI / PRAI-<br>RIE / PULSAR / SENTRA /<br>STANZA / SUNNY         | VKMS 93500 | <b>HONDA</b><br>CIVIC / CIVIC DEL SOL / CIVIC<br>SHUTTLE / CONCERTO  | VKMS 94610 | <b>MAZDA</b><br>323 (BA) / 323 (BJ)  |
| VKMS 92012 | <b>NISSAN</b><br>SERENA / VANETTE  | VKMS 93601 | <b>HONDA</b><br>HR-V   | VKMS 94611 | <b>MAZDA</b><br>323 (BA) / 323 (BJ)  |
| VKMS 92101 | <b>NISSAN</b><br>200 SX / BLUEBIRD / EXA /<br>PULSAR / STANZA / SUNNY                              | VKMS 93615 | <b>HONDA</b><br>CIVIC  | VKMS 94612 | <b>MAZDA</b><br>626 (GF) / 626 (GW) /<br>PREMACY   |
| VKMS 92210 | <b>NISSAN</b><br>BLUEBIRD / CEDRIC / PRAIRIE /<br>PRAIRIE PRO / STANZA                             | VKMS 93616 | <b>HONDA</b><br>CIVIC  | VKMS 94614 | <b>MAZDA</b><br>B-SERIE (UF)   |
| VKMS 92400 | <b>NISSAN</b><br>MARCH / MICRA   | VKMS 94000 | <b>MAZDA</b><br>323 (BA) / 626 (GE) / 929<br>(TA12) / MX-3 (EC) / MX-6 (GE)  | VKMS 94616 | <b>MAZDA</b><br>B-SERIE (UN)   |
| VKMS 92411 | <b>NISSAN</b><br>MARCH / MICRA   | VKMS 94007 | <b>MAZDA</b><br>626 (GC) / B-SERIE (UF) / E<br>2000, E 2200  | VKMS 94619 | <b>MAZDA</b><br>6 (GG) / 6 (GY)  |
| VKMS 92500 | <b>NISSAN</b><br>LAUREL / PATROL / PATROL GR<br>/ SAFARI   | VKMS 94009 | <b>KIA</b><br>SPORTAGE   | VKMS 95003 | <b>HYUNDAI</b><br>SONATA   |
| VKMS 92513 | <b>NISSAN</b><br>AD WAGON / ALMERA / AVENIR<br>/ PRIMERA / PULSAR / SUNNY                          |            | <b>MAZDA</b><br>B-SERIE (UF) / E 2000, E 2200  |            | <b>MITSUBISHI</b><br>DIAMANTE / GALANT / L 200 /<br>MONTERO / PAJERO / SIGMA                   |
| VKMS 92514 | <b>NISSAN</b><br>AD MAX VAN / PULSAR /<br>SENTRA / SUNNY   | VKMS 94010 | <b>MAZDA</b><br>323 (BJ) / 626 (GE) / 626 (GF) /<br>626 (GW) / MX-6 (GE)   | VKMS 95005 | <b>HYUNDAI</b><br>ELANTRA / LANTRA /<br>SANTAMO / SONATA                                       |
| VKMS 92517 | <b>NISSAN</b><br>VANETTE CARGO   | VKMS 94012 | <b>MAZDA</b><br>323 (BJ) / 626 (GE) / 626 (GF) /<br>626 (GW)   |            | <b>MITSUBISHI</b><br>COLT / ECLIPSE / GALANT /<br>LANCER                                       |
| VKMS 92518 | <b>NISSAN</b><br>PATROL GR   | VKMS 94014 | <b>MAZDA</b><br>323 (BF) / 323 (BG) / 323 (BW)   | VKMS 95009 | <b>MITSUBISHI</b><br>GALANT  |
| VKMS 93001 | <b>HONDA</b><br>CIVIC / CIVIC SHUTTLE /<br>CONCERTO / CRX  | VKMS 94101 | <b>MAZDA</b><br>121 (DA) / 323 (BF) / 323 (BW)   | VKMS 95010 | <b>MITSUBISHI</b><br>L 200 / L 300 / MONTERO /<br>PAJERO                                       |
| VKMS 93002 | <b>HONDA</b><br>CIVIC / CONCERTO   | VKMS 94102 | <b>KIA</b><br>AVELLA / CAPITAL / RIO /<br>SEPHIA   | VKMS 95012 | <b>MITSUBISHI</b><br>COLT / LANCER / MIRAGE  |
| VKMS 93005 | <b>HONDA</b><br>CIVIC  |            | <b>MAZDA</b><br>121 (DA) / 121 (DB) / 121<br>(JASM, JBSM) / 323 (BA) / 323<br>(BG) / 323 (BJ) / 323 (BW) /<br>DEMIO (DW) | VKMS 95014 | <b>MITSUBISHI</b><br>L 200 / L 300 / PAJERO<br>CLASSIC   |







|              |  |            |   |
|--------------|--|------------|---|
| VKMS 95019   | <b>MITSUBISHI</b><br>GALANT / L 300  | VKMS 96203 | <b>SUZUKI</b><br>CULTUS / SWIFT                                 |
| VKMS 95020   | <b>MITSUBISHI</b><br>COLT / LANCER   | VKMS 96204 | <b>SUZUKI</b><br>SE416 / SIDEKICK / VITARA                      |
| VKMS 95023   | <b>MITSUBISHI</b><br>COLT / GALANT / LANCER /<br>SPACE RUNNER / SPACE<br>WAGON                     | VKMS 97005 | <b>DAIHATSU</b><br>CHARADE                                      |
| VKMS 95025   | <b>MITSUBISHI</b><br>COLT / EXPO-LRV / GALANT /<br>LANCER / MIRAGE / SPACE<br>RUNNER / SPACE WAGON | VKMS 97009 | <b>DAIHATSU</b><br>CHARADE                                      |
| VKMS 95030   | <b>HYUNDAI</b><br>ACCENT / LANTRA / S COUPE  | VKMS 97501 | <b>DAIHATSU</b><br>APPLAUSE / CHARADE / FER-<br>OZA / GRAN MOVE |
| VKMS 95036   | <b>MITSUBISHI</b><br>GALANT / L 200 / L 300 /<br>SPACE WAGON / STARION                             | VKMS 97503 | <b>DAIHATSU</b><br>CHARADE / TERIOS                             |
| VKMS 95039   | <b>MITSUBISHI</b><br>MAGNA / MONTERO / PAJERO /<br>SHOGUN  | VKMS 97505 | <b>DAIHATSU</b><br>CUORE / MOVE                                 |
| VKMS 95040   | <b>MITSUBISHI</b><br>MAGNA / MONTERO / PAJERO /<br>SHOGUN  | VKMS 97507 | <b>DAIHATSU</b><br>CUORE  |
| VKMS 95207   | <b>MITSUBISHI</b><br>COLT / LANCER / MIRAGE  | VKMS 98000 | <b>SUBARU</b><br>IMPREZA / LEGACY                               |
| VKMS 95619   | <b>HYUNDAI</b><br>ELANTRA / EXCEL / LANTRA /<br>PONY / S COUPE                                     | VKMS 98001 | <b>SUBARU</b><br>LEONE  |
| VKMS 95623   | <b>MITSUBISHI</b><br>LANCER  | VKMS 98105 | <b>SUBARU</b><br>JUSTY  |
| VKMS 95632   | <b>HYUNDAI</b><br>ACCENT / COUPE / ELANTRA /<br>EXCEL / GETZ / LANTRA /<br>MATRIX / VERNA          | VKMS 98109 | <b>SUBARU</b><br>FORESTER / IMPREZA /<br>LEGACY / OUTBACK       |
| VKMS 95650   | <b>MITSUBISHI</b><br>LANCER  | VKMS 98110 | <b>SUBARU</b><br>FORESTER / IMPREZA                             |
| VKMS 95651-1 | <b>MITSUBISHI</b><br>SPACE STAR  |            |   |
| VKMS 95651-2 | <b>MITSUBISHI</b><br>SPACE STAR  |            |   |
| VKMS 95655   | <b>HYUNDAI</b><br>COUPE / ELANTRA / LANTRA /<br>MATRIX   |            |   |
| VKMS 95656   | <b>HYUNDAI</b><br>COUPE / ELANTRA / LANTRA   |            |   |
| VKMS 95663   | <b>MITSUBISHI</b><br>COLT  |            |   |
| VKMS 95666   | <b>MITSUBISHI</b><br>OUTLANDER   |            |   |
| VKMS 96002   | <b>SUZUKI</b><br>BALENO / ESCUDO / SE416 /<br>SWIFT / VITARA                                       |            |   |
| VKMS 96010   | <b>SUZUKI</b><br>ESCUDO / GRAND VITARA   |            |   |
| VKMS 96202   | <b>SUZUKI</b><br>SAMURAI / SWIFT   |            |   |



**VKPC 81200**  
**AUDI**  
50 (86) / 80 (81, 85, B2)

**VW**  
DERBY (86) / DERBY (86C, 80) / GOLF I (17) / GOLF II (19E, 1G1) / JETTA I (16) / JETTA II (19E, 1G2) / PASSAT (32) / Variant (33) / PASSAT (32B) / POLO (6N1) / POLO Box (6NF) / POLO (86) / POLO (86C, 80) / POLO Box (86CF) / SANTANA (32B) / SCIROCCO (53) / SCIROCCO (53B)

**VKPC 81204**  
**SEAT**  
CORDOBA (6K2) / CORDOBA (6K2/C2) / IBIZA II (6K1)

**VW**  
GOLF II (19E, 1G1) / GOLF III (1H1) / GOLF III Variant (1H5) / JETTA II (19E, 1G2) / POLO (6N1) / POLO Box (6NF) / POLO (86C, 80) / POLO Box (86CF) / VENTO (1H2)

**VKPC 81206**  
**SEAT**  
TERRA

**VW**  
POLO (86C, 80) / POLO Box (86CF)

**VKPC 81210**  
**SEAT**  
AROSA / CORDOBA (6K2) / CORDOBA (6K2/C2) / CORDOBA (6L2) / CORDOBA Vario (6K5) / IBIZA II (6K1) / IBIZA III (6K1) / IBIZA IV (6L1) / INCA

**SKODA**  
FELICIA I (6U1)/Estate (6U5)/ Fun (797) / FELICIA II (6U1)/ FELICIA II Estate (6U5) / OCTAVIA I (1U2) / OCTAVIA Combi (1U5)

**VW**  
CADDY II(9K9A)/Estate(9K9B)/ Pickup(9U7) / FOX (5Z1) / GOLF III (1H1) / GOLF III Variant (1H5) / POLO (6N1) / POLO Box (6NF) / POLO CLASSIC (6KV2) / Variant (6KV5) / VENTO (1H2)

**VKPC 81215**  
**SEAT**  
AROSA / CORDOBA (6K2) / CORDOBA (6K2/C2) / CORDOBA Vario (6K5) / IBIZA II (6K1) / IBIZA III (6K1) / INCA

**VW**  
CADDY II(9K9A)/Estate(9K9B)/ Pickup(9U7) / LUPO (6X1, 6E1) / POLO (6N1) / POLO Box (6NF) / POLO (6N2) / POLO CLASSIC (6KV2) / Variant (6KV5)

**VKPC 81220**  
**AUDI**  
A3 (8P1) / A3 Sportback (8PA) / A4 (8E2, B6) / A4 Avant (8E5, B6)

**VKPC 81301**  
**SEAT**  
CORDOBA (6L2) / IBIZA IV (6L1)

**SKODA**  
FABIA / ROOMSTER

**VW**  
FOX (5Z1) / POLO (9N\_)

**VKPC 81302**  
**SEAT**  
CORDOBA (6L2) / IBIZA IV (6L1)

**SKODA**  
FABIA

**VW**  
POLO (9N\_) / POLO Saloon

**VKPC 81303**  
**AUDI**  
A3 (8L1) / A3 (8P1) / A3 Sportback (8PA) / A4 (8D2, B5) / A4 Avant (8D5, B5) / A4 (8E2, B6) / A4 Avant (8E5, B6) / A4 (8EC) / A4 Avant (8ED) / A4 Convertible (8H7) / A6 (4B, C5) / A6 Avant (4B, C5)

**FORD**  
GALAXY I

**SEAT**  
ALTEA / ALTEA XL / LEON II (1P1) / TOLEDO III (5P2)

**SKODA**  
OCTAVIA I (1U2) / OCTAVIA Combi (1U5) / OCTAVIA II (1Z3) / OCTAVIA II Combi (1Z5) / SUPERB

**VW**  
BORA (1J2) / BORA Estate (1J6) / GOLF IV (1J1) / GOLF IV Variant (1J5) / GOLF V (1K1) / GOLF V VARIANT (1K1) / GOLF V PLUS (5M1) / JETTA III (1KM) / NEW BEETLE (9C1, 1C1)/ Convertible (1Y7) / PASSAT (3B3) / Variant (3B6) / PASSAT (3C2) / Variant (3C5) / SHARAN (7M8, 7M9, 7M6)

**VKPA 81400**  
**AUDI**  
80 (80, 82, B1)

**SEAT**  
ALTEA / ALTEA XL / LEON II (1P1) / TOLEDO III (5P2)

**SKODA**  
OCTAVIA II (1Z3)/OCTAVIA II Combi (1Z5)

**VW**  
EOS / GOLF V (1K1) / GOLF V VARIANT (1K1) / GOLF V PLUS (5M1) / JETTA III (1KM) / PASSAT (3C2) / Variant (3C5) / TOURAN

**VKPC 81400**  
**AUDI**  
80 (80, 82, B1)

**VW**  
GOLF I (17) / GOLF I Cabriolet (155) / ILTIS (183) / JETTA I (16) / PASSAT (32) / Variant (33) / PASSAT (32B) / SANTANA (32B) / SCIROCCO (53) / SCIROCCO (53B)







**VKPA 81401**  
**AUDI**  
100 (43, C2) / 100 Avant (43, C2) / 100 (44,44Q,C3)/100 Avant (44,44Q,C3) / 100 (4A, C4) / 100 Avant (4A, C4) / 80 (81, 85, B2) / 80 (89, 89Q, 8A, B3) / 80 (8C, B4) / 80 Avant (8C, B4) / 90 (81, 85, B2) / 90 (89, 89Q, 8A, B3) / A6 (4A, C4) / A6 Avant (4A, C4) / CABRIOLET (8G7, B4) / COUPE (81, 85) / COUPE (89, 8B)

**FORD**  
GALAXY I

**SEAT**  
ALHAMBRA / CORDOBA (6K2) / CORDOBA (6K2/C2) / CORDOBA Vario (6K5) / IBIZA II (6K1) / INCA / TOLEDO I (1L)

**VW**  
CADDY I (14) / CADDY II(9K9A)/ Estate(9K9B)/Pickup(9U7) / CORRADO (531) / GOLF I (17) / GOLF I Cabriolet (155) / GOLF II (19E, 1G1) / GOLF III (1H1) / GOLF III Variant (1H5) / GOLF III Cabriolet (1E7) / GOLF IV Cabriolet (1E7) / JETTA I (16) / JETTA II (19E, 1G2) / PASSAT (32) / Variant (33) / PASSAT (32B) / PASSAT (3A2, 35I) / Variant (3A5, 35I) / PASSAT (3B2) / Variant (3B5) / POLO CLASSIC (6KV2) / Variant (6KV5) / SANTANA / SANTANA (32B) / SCIROCCO (53) / SCIROCCO (53B) / SHARAN (7M8, 7M9, 7M6) / TRANSPORTER III / TRANSPORTER IV / VENTO (1H2)









|  |    |  |   |  |    |
|---|---|---|--|---|---|
| <b>VKPC 81401</b>   | <p><b>AUDI</b><br/>100 (43, C2) / 100 Avant (43, C2) / 100 (44,44Q,C3)/100 Avant (44,44Q,C3) / 100 (4A, C4) / 100 Avant (4A, C4) / 80 (81, 85, B2) / 80 (89, 89Q, 8A, B3) / 80 (8C, B4) / 80 Avant (8C, B4) / 90 (81, 85, B2) / 90 (89, 89Q, 8A, B3) / A6 (4A, C4) / A6 Avant (4A, C4) / CABRIOLET (8G7, B4) / COUPE (81, 85) / COUPE (89, 8B)</p> <p><b>FORD</b><br/>GALAXY I</p> <p><b>SEAT</b><br/>ALHAMBRA / CORDOBA (6K2) / CORDOBA (6K2/C2) / CORDOBA Vario (6K5) / IBIZA II (6K1) / INCA / TOLEDO I (1L)</p> <p><b>VW</b><br/>CADDY I (14) / CADDY II(9K9A)/Estate(9K9B)/Pickup(9U7) / CORRADO (53I) / GOLF I (17) / GOLF I Cabriolet (155) / GOLF II (19E, 1G1) / GOLF III (1H1) / GOLF III Variant (1H5) / GOLF III Cabriolet (1E7) / GOLF IV Cabriolet (1E7) / ILTIS (183) / JETTA I (16) / JETTA II (19E, 1G2) / PASSAT (32) / Variant (33) / PASSAT (32B) / PASSAT (3A2, 35I) / Variant (3A5, 35I) / PASSAT (3B2) / Variant (3B5) / POLO CLASSIC (6KV2) / Variant (6KV5) / SANTANA / SANTANA (32B) / SCIROCCO (53) / SCIROCCO (53B) / SHARAN (7M8, 7M9, 7M6) / TRANSPORTER III / TRANSPORTER IV / VENTO (1H2)</p> | <b>VKPC 81407</b>   | <p><b>AUDI</b><br/>A2 (8Z0)</p> <p><b>SEAT</b><br/>AROSA / CORDOBA (6K2) / CORDOBA (6K2/C2) / CORDOBA (6L2) / CORDOBA Vario (6K5) / IBIZA III (6K1) / IBIZA IV (6L1) / INCA / LEON I (1M1) / LEON II (1P1) / TOLEDO II (1M2)</p> <p><b>SKODA</b><br/>FABIA / OCTAVIA I (1U2) / OCTAVIA Combi (1U5) / OCTAVIA II (1Z3)/OCTAVIA II Combi (1Z5) / ROOMSTER</p> <p><b>VW</b><br/>BORA (1J2) / BORA Estate (1J6) / CADDY II(9K9A)/Estate(9K9B)/Pickup(9U7) / CADDY III (2KA) / CADDY III Estate (2KB) / GOLF IV (1J1) / GOLF IV Variant (1J5) / GOLF V (1K1) / GOLF V VARIANT (1K1) / GOLF V PLUS (5M1) / LUPO (6X1, 6E1) / NEW BEETLE (9C1, 1C1)/Convertible (1Y7) / POLO (6N2) / POLO (9N_) / POLO CLASSIC (6KV2) / Variant (6KV5) / POLO Saloon</p>  | <b>VKPC 81411</b>   | <p><b>SEAT</b><br/>CORDOBA (6K2) / CORDOBA (6K2/C2) / IBIZA II (6K1) / IBIZA III (6K1)</p> <p><b>VW</b><br/>POLO (6N1) / POLO Box (6NF)</p>   |
|   |   | <b>VKPC 81408</b>   | <p><b>AUDI</b><br/>A3 (8L1) / A3 (8P1) / A3 Sport-back (8PA) / A4 (8D2, B5) / A4 Avant (8D5, B5) / A4 (8E2, B6) / A4 Avant (8E5, B6) / A4 (8EC) / A4 Avant (8ED) / A4 Convertible (8H7) / A6 (4B, C5) / A6 Avant (4B, C5)</p> <p><b>SEAT</b><br/>ALTEA / ALTEA XL / CORDOBA (6K2) / CORDOBA (6K2/C2) / CORDOBA Vario (6K5) / IBIZA III (6K1) / LEON I (1M1) / LEON II (1P1) / TOLEDO II (1M2) / TOLEDO III (5P2)</p> <p><b>SKODA</b><br/>OCTAVIA I (1U2) / OCTAVIA Combi (1U5) / OCTAVIA II (1Z3) / OCTAVIA II Combi (1Z5)</p> <p><b>VW</b><br/>BORA (1J2) / BORA Estate (1J6) / CADDY III (2KA) / CADDY III Estate (2KB) / GOLF IV (1J1) / GOLF IV Variant (1J5) / GOLF V (1K1) / GOLF V VARIANT (1K1) / GOLF V PLUS (5M1) / JETTA III (1KM) / NEW BEETLE (9C1, 1C1)/Convertible (1Y7) / PASSAT (3B2) / Variant (3B5) / PASSAT (3B3) / Variant (3B6) / PASSAT (3C2) / Variant (3C5) / POLO CLASSIC (6KV2) / Variant (6KV5) / TOURAN</p> | <b>VKPC 81412</b>   | <p><b>SKODA</b><br/>FELICIA I (6U1)/Estate (6U5)/Fun (797)</p>  |
| <b>VKPA 81402</b>   | <p><b>AUDI</b><br/>A4 (8D2, B5) / A4 Avant (8D5, B5) / A6 (4A, C4) / A6 Avant (4A, C4) / A6 (4B, C5) / A6 Avant (4B, C5) / CABRIOLET (8G7, B4)</p> <p><b>VW</b><br/>PASSAT (3B2) / Variant (3B5)</p>  |   |  | <b>VKPC 81416</b>   | <p><b>SEAT</b><br/>IBIZA IV (6L1)</p> <p><b>SKODA</b><br/>FABIA</p> <p><b>VW</b><br/>POLO (9N_) / POLO Saloon</p>   |
| <b>VKPC 81402</b>   | <p><b>AUDI</b><br/>A4 (8D2, B5) / A4 Avant (8D5, B5) / A6 (4A, C4) / A6 Avant (4A, C4) / A6 (4B, C5) / A6 Avant (4B, C5) / CABRIOLET (8G7, B4)</p> <p><b>VW</b><br/>PASSAT (3B2) / Variant (3B5)</p>  |   |  | <b>VKPC 81417</b>   | <p><b>AUDI</b><br/>A2 (8Z0)</p> <p><b>SEAT</b><br/>AROSA / IBIZA IV (6L1)</p> <p><b>SKODA</b><br/>FABIA</p> <p><b>VW</b><br/>LUPO (6X1, 6E1) / POLO (6N2) / POLO (9N_) / POLO Saloon</p>  |
| <b>VKPC 81405</b>   | <p><b>SKODA</b><br/>FAVORIT</p>   |   |  | <b>VKPC 81418</b>   | <p><b>AUDI</b><br/>A2 (8Z0) / A3 (8P1) / A3 Sport-back (8PA)</p> <p><b>FORD</b><br/>GALAXY I</p> <p><b>SEAT</b><br/>ALHAMBRA / ALTEA / ALTEA XL / AROSA / CORDOBA (6L2) / IBIZA IV (6L1) / LEON II (1P1) / TOLEDO III (5P2)</p> <p><b>SKODA</b><br/>FABIA / OCTAVIA II (1Z3) / OCTAVIA II Combi (1Z5) / ROOMSTER</p> <p><b>VW</b><br/>CADDY III (2KA) / CADDY III Estate (2KB) / FOX (5Z1) / GOLF V (1K1) / GOLF V VARIANT (1K1) / GOLF V PLUS (5M1) / JETTA III (1KM) / LUPO (6X1, 6E1) / MULTIVAN V (7HM) / PASSAT (3C2) / Variant (3C5) / POLO (9N_) / POLO Saloon / SHARAN (7M8, 7M9, 7M6) / TOURAN / TRANSPORTER V</p> |
| <b>VKPC 81406</b>   | <p><b>SKODA</b><br/>FAVORIT / FELICIA I (6U1)/Estate (6U5)/Fun (797) / FELICIA II (6U1)/FELICIA II Estate (6U5)</p>   | <b>VKPC 81409</b>   | <p><b>SKODA</b><br/>FAVORIT</p>  | <b>VKPC 81419</b>   | <p><b>AUDI</b><br/>A2 (8Z0)</p> <p><b>SEAT</b><br/>LEON I (1M1) / TOLEDO II (1M2)</p> <p><b>VW</b><br/>BORA (1J2) / BORA Estate (1J6) / GOLF IV (1J1) / GOLF IV Variant (1J5) / LUPO (6X1, 6E1) / POLO (6N1) / POLO Box (6NF) / POLO (6N2)</p>  |



|            |  |            |   |            |   |
|------------|--|------------|---|------------|---|
| VKPC 81501 | <p><b>AUDI</b><br/>A3 (8P1) / A3 Sportback (8PA)</p> <p><b>SKODA</b><br/>OCTAVIA II (1Z3)/OCTAVIA II Combi (1Z5)</p> <p><b>VW</b><br/>EOS / GOLF V (1K1) / GOLF V VARIANT (1K1) / GOLF V PLUS (5M1) / JETTA III (1KM) / PASSAT (3C2) / Variant (3C5) / POLO (9N_) / TOURAN</p>                 |            | <p><b>SEAT</b><br/>ALHAMBRA / LEON I (1M1)</p> <p><b>VW</b><br/>BORA (1J2) / BORA Estate (1J6) / CORRADO (53I) / GOLF III (1H1) / GOLF III Variant (1H5) / GOLF IV (1J1) / GOLF IV Variant (1J5) / PASSAT (3A2, 35I) / Variant (3A5, 35I) / SHARAN (7M8, 7M9, 7M6) / TRANSPORTER IV / VENTO (1H2)</p>   |            | <p><b>VW</b><br/>BORA (1J2) / BORA Estate (1J6) / GOLF IV (1J1) / GOLF IV Variant (1J5) / MULTIVAN V (7HM) / NEW BEETLE (9C1, 1C1)/Convertible (1Y7) / PASSAT (3B2) / Variant (3B5) / PASSAT (3B3) / Variant (3B6) / POLO (9N_) / SHARAN (7M8, 7M9, 7M6) / TRANSPORTER V</p>  |
| VKPC 81601 | <p><b>AUDI</b><br/>100 (43, C2) / 100 Avant (43, C2)</p> <p><b>PORSCHE</b><br/>924</p> <p><b>VW</b><br/>LT I</p>   | VKPC 81612 | <p><b>AUDI</b><br/>100 (44,44Q,C3)/100 Avant (44,44Q,C3) / 100 (4A, C4) / 100 Avant (4A, C4) / 80 (8C, B4) / 80 Avant (8C, B4) / A6 (4A, C4) / A6 Avant (4A, C4) / CABRIOLET (8G7, B4) / COUPE (81, 85) / COUPE (89, 8B)</p>  | VKPC 81622 | <p><b>SEAT</b><br/>TOLEDO II (1M2)</p> <p><b>VW</b><br/>BORA (1J2) / BORA Estate (1J6) / GOLF IV (1J1) / GOLF IV Variant (1J5) / NEW BEETLE (9C1, 1C1)/Convertible (1Y7) / PASSAT (3B2) / Variant (3B5) / PASSAT (3B3) / Variant (3B6)</p>  |
| VKPC 81602 | <p><b>AUDI</b><br/>100 (43, C2) / 100 Avant (43, C2) / 100 (44,44Q,C3)/100 Avant (44,44Q,C3)</p> <p><b>VOLVO</b><br/>240 / 740 / 760 / 940 / 960</p> <p><b>VW</b><br/>LT I</p>   | VKPC 81615 | <p><b>AUDI</b><br/>A4 (8D2, B5) / A4 Avant (8D5, B5) / A6 (4B, C5) / A6 Avant (4B, C5)</p> <p><b>SEAT</b><br/>AROSA</p> <p><b>SKODA</b><br/>FELICIA I (6U1)/Estate (6U5)/ Fun (797) / FELICIA II (6U1)/ FELICIA II Estate (6U5)</p>   | VKPC 81623 | <p><b>AUDI</b><br/>A3 (8L1)</p> <p><b>SEAT</b><br/>CORDOBA (6K2) / CORDOBA (6K2/C2) / CORDOBA Vario (6K5) / IBIZA III (6K1) / INCA / LEON I (1M1) / TOLEDO II (1M2)</p> <p><b>SKODA</b><br/>OCTAVIA I (1U2) / OCTAVIA Combi (1U5)</p> <p><b>VW</b><br/>BORA (1J2) / BORA Estate (1J6) / CADDY II(9K9A)/Estate(9K9B)/ Pickup(9U7) / GOLF IV (1J1) / GOLF IV Variant (1J5) / NEW BEETLE (9C1, 1C1)/Convertible (1Y7) / POLO CLASSIC (6KV2) / Variant (6KV5)</p> |
| VKPC 81603 | <p><b>AUDI</b><br/>100 (44,44Q,C3)/100 Avant (44,44Q,C3)</p>   |            | <p><b>VW</b><br/>CADDY II(9K9A)/Estate(9K9B)/ Pickup(9U7) / LUPO (6X1, 6E1) / PASSAT (3A2, 35I) / Variant (3A5, 35I) / PASSAT (3B2) / Variant (3B5) / POLO (6N1) / POLO Box (6NF) / POLO (6N2)</p>  | VKPC 81624 | <p><b>MERCEDES-BENZ</b><br/>SPRINTER 2-t (W901 / W902) / SPRINTER 3-t (W903)</p> <p><b>VW</b><br/>LT II</p>   |
| VKPC 81605 | <p><b>AUDI</b><br/>100 (43, C2) / 100 Avant (43, C2) / 100 (44,44Q,C3)/100 Avant (44,44Q,C3) / 200 (43) / 200 (44, 44Q) / 200 Avant (44, 44Q) / 80 (81, 85, B2) / 90 (81, 85, B2) / 90 (89, 89Q, 8A, B3) / COUPE (81, 85) / QUATTRO (85)</p> <p><b>VW</b><br/>PASSAT (32B) / SANTANA (32B)</p> | VKPC 81620 | <p><b>AUDI</b><br/>A3 (8L1) / A4 (8D2, B5) / A4 Avant (8D5, B5) / A4 (8E2, B6) / A4 Avant (8E5, B6) / A4 (8EC) / A4 Avant (8ED) / A4 Convertible (8H7) / A6 (4B, C5) / A6 Avant (4B, C5) / TT (8N3) / TT Roadster (8N9)</p> <p><b>SEAT</b><br/>ALHAMBRA / CORDOBA (6K2) / CORDOBA (6K2/C2) / CORDOBA (6L2) / IBIZA III (6K1) / IBIZA IV (6L1) / LEON I (1M1) / TOLEDO II (1M2)</p> <p><b>SKODA</b><br/>FABIA / OCTAVIA I (1U2) / OCTAVIA Combi (1U5) / SUPERB</p> | VKPC 81625 | <p><b>AUDI</b><br/>A4 (8D2, B5) / A4 Avant (8D5, B5) / A4 (8E2, B6) / A4 Avant (8E5, B6) / A4 (8EC) / A4 Avant (8ED) / A4 Convertible (8H7) / A6 (4B, C5) / A6 Avant (4B, C5) / A8 (4D2, 4D8) / ALLROAD (4BH)</p> <p><b>SKODA</b><br/>SUPERB</p> <p><b>VW</b><br/>PASSAT (3B2) / Variant (3B5) / PASSAT (3B3) / Variant (3B6)</p>   |
| VKPC 81606 | <p><b>AUDI</b><br/>100 (43, C2) / 100 Avant (43, C2) / 100 (44,44Q,C3)/100 Avant (44,44Q,C3) / 200 (44, 44Q) / 200 Avant (44, 44Q) / 80 (8C, B4) / 80 Avant (8C, B4) / 90 (81, 85, B2) / 90 (89, 89Q, 8A, B3) / COUPE (81, 85) / COUPE (89, 8B) / QUATTRO (85)</p>                             |            |   | VKPC 81626 | <p><b>AUDI</b><br/>A3 (8L1) / A4 (8D2, B5) / A4 Avant (8D5, B5) / A4 (8E2, B6) / A4 Avant (8E5, B6) / A6 (4B, C5) / A6 Avant (4B, C5) / A8 (4D2, 4D8) / ALLROAD (4BH)</p>   |
| VKPC 81607 | <p><b>VW</b><br/>TRANSPORTER III</p>   |            |   |            |   |
| VKPC 81609 | <p><b>VW</b><br/>TRANSPORTER III</p>   |            |   |            |   |
| VKPC 81611 | <p><b>FORD</b><br/>GALAXY I</p> <p><b>MERCEDES-BENZ</b><br/>V-class (W638)</p>   |            |   |            |   |









|  |   |                        |                   |                                     |  |
|---|--|---|--|--|---|
| VKPC 81627  | <b>FORD</b><br>GALAXY I  | VKPC 81806  | <b>AUDI</b><br>100 (4A, C4) / 100 Avant (4A, C4) / V8 (D1)   | VKPC 82216   | <b>FIAT</b><br>REGATA / RITMO   |
|   | <b>SEAT</b><br>ALHAMBRA / LEON I (1M1) / TOLEDO II (1M2)   | VKPC 81807  | <b>AUDI</b><br>A6 (4A, C4) / A6 Avant (4A, C4) / A8 (4D2, 4D8)                                     | VKPA 82218   | <b>FIAT</b><br>ELBA / FIORINO / RITMO / UNO   |
|   | <b>VW</b><br>BORA (1J2) / BORA Estate (1J6) / EOS / GOLF IV (1J1) / GOLF IV Variant (1J5) / NEW BEETLE (9C1, 1C1) / Convertible (1Y7) / PASSAT (3B2) / Variant (3B5) / PASSAT (3B3) / Variant (3B6) / SHARAN (7M8, 7M9, 7M6)           | VKPC 81810  | <b>VW</b><br>TRANSPORTER IV  | VKPC 82218   | <b>FIAT</b><br>ELBA / FIORINO / RITMO / UNO   |
|   | <b>AUDI</b><br>A3 (8P1) / A3 Sportback (8PA) / A4 (8EC) / A4 Avant (8ED) / A6 (4F2) / A6 Avant (4F5)   | VKPC 81811  | <b>AUDI</b><br>A4 (8D2, B5) / A4 Avant (8D5, B5) / A6 (4B, C5) / A6 Avant (4B, C5) / ALLROAD (4BH) | VKPA 82220   | <b>LANCIA</b><br>DELTA I  |
|   | <b>SEAT</b><br>ALTEA / ALTEA XL / IBIZA IV (6L1) / LEON I (1M1) / LEON II (1P1) / TOLEDO II (1M2) / TOLEDO III (5P2)   | VKPC 82201  | <b>ALFA ROMEO</b><br>145/146 / 33 / ALFASUD / ARNA   | VKPC 82222   | <b>FIAT</b><br>PANDA (141A_)  |
|   | <b>SKODA</b><br>OCTAVIA II (1Z3) / OCTAVIA II Combi (1Z5)  | VKPC 82202  | <b>NISSAN</b><br>CHERRY / PULSAR   | VKPA 82222   | <b>SEAT</b><br>PANDA  |
|   | <b>VW</b><br>BORA (1J2) / BORA Estate (1J6) / GOLF IV (1J1) / GOLF IV Variant (1J5) / GOLF V (1K1) / GOLF V VARIANT (1K1) / GOLF V PLUS (5M1) / JETTA III (1KM) / PASSAT (3B3) / Variant (3B6) / PASSAT (3C2) / Variant (3C5) / TOURAN | VKPA 82202  | <b>FIAT</b><br>FIORINO / PANDA (141A_) / UNO   | VKPC 82224   | <b>LANCIA</b><br>DELTA I  |
|   | <b>VW</b><br>BORA (1J2) / BORA Estate (1J6) / GOLF IV (1J1) / GOLF IV Variant (1J5) / GOLF V (1K1) / GOLF V VARIANT (1K1) / GOLF V PLUS (5M1) / JETTA III (1KM) / PASSAT (3B3) / Variant (3B6) / PASSAT (3C2) / Variant (3C5) / TOURAN | VKPC 82203  | <b>LANCIA</b><br>A 112   | VKPC 82230   | <b>FIAT</b><br>TEMPRA / TIPO / UNO  |
|   | <b>AUDI</b><br>100 (4A, C4) / 100 Avant (4A, C4) / 80 (8C, B4) / 80 Avant (8C, B4) / A6 (4A, C4) / A6 Avant (4A, C4) / A8 (4D2, 4D8) / CABRIOLET (8G7, B4) / COUPE (89, 8B)  | VKPA 82203  | <b>SEAT</b><br>127 / FURA / IBIZA I (021A) / MARBELLA / TERRA                                      | VKPC 82230   | <b>FIAT</b><br>PALIO/SIENA / PUNTO (176) / TEMPRA / TIPO                            |
|   | <b>VKPC 81800</b>  | VKPC 82205  | <b>FIAT</b><br>CINQUECENTO / PANDA (141A_) / SEICENTO  | VKPC 82230   | <b>LANCIA</b><br>DEDRA / DELTA II   |
| <b>VKPC 81802</b>   | VKPC 82206   | <b>SEAT</b><br>600 D  | VKPC 82230   | <b>FIAT</b><br>PALIO/SIENA / PUNTO (176) / TEMPRA / TIPO   |   |
| <b>VKPC 81803</b>   | VKPC 82208   | <b>LANCIA</b><br>DELTA I  | VKPA 82240   | <b>LANCIA</b><br>DEDRA / DELTA II  |   |
| <b>VKPC 81805</b>   | VKPC 82210   | <b>SEAT</b><br>128  | VKPC 82245   | <b>FIAT</b><br>BRAVA/BRAVO (182)   |   |
|   | VKPC 82210   | <b>AUTOBIANCHI</b><br>Y10   | VKPC 82245   | <b>FIAT</b><br>TEMPRA / TIPO   |   |
|   | VKPC 82214   | <b>FIAT</b><br>DUNA / ELBA / FIORINO / PANDA (141A_) / UNO  | VKPC 82246   | <b>LANCIA</b><br>DEDRA / DELTA II  |   |
|   |  | <b>LANCIA</b><br>Y10  | VKPC 82247   | <b>FIAT</b><br>FIORINO / PALIO/SIENA / TEMPRA / TIPO   |   |
|   |  | <b>SEAT</b><br>127  | VKPC 82247   | <b>FIAT</b><br>BRAVA/BRAVO (182) / MAREA   |   |
|   |  | <b>FIAT</b><br>DUNA / ELBA / FIORINO  | VKPA 82248   | <b>FIAT</b><br>CINQUECENTO   |   |
|   |  | <b>FIAT</b><br>DUNA / ELBA / FIORINO  | VKPC 82249   | <b>FIAT</b><br>BRAVA/BRAVO (182) / MAREA / PUNTO (176)   |   |
|   |  | <b>AUTOBIANCHI</b><br>Y10   | VKPC 82250   | <b>LANCIA</b><br>Y   |   |
|   |  | <b>FIAT</b><br>CINQUECENTO / PALIO/SIENA / PANDA (141A_) / PUNTO (176) / SEICENTO / STRADA / TIPO / UNO |  | <b>FIAT</b><br>DOBLO / PALIO/SIENA / PANDA (141A_) / PANDA (169) / PUNTO (176) / PUNTO (188) / SEICENTO / STRADA / UNO |   |
|   |  | <b>LANCIA</b><br>Y / Y10  |  | <b>LANCIA</b><br>Y / YPSILON   |   |









|            |  |            |  |            |  |
|------------|--|------------|--|------------|--|
| VKPC 82251 | <b>FIAT</b><br>500 / BRAVA/BRAVO (182) / BRAVO / DOBLO / GRANDE PUNTO / IDEA / MAREA / PALIO/SIENA / PANDA (169) / PUNTO (176) / PUNTO (188) / STILO / STRADA<br><hr/> <b>LANCIA</b><br>MUSA / Y / YPSILON | VKPA 82440 | <b>FIAT</b><br>UNO   | VKPC 82622 | <b>FIAT</b><br>CROMA (154) / TEMPRA / TIPO   |
|            |  | VKPA 82441 | <b>FIAT</b><br>BRAVA/BRAVO (182) / DOBLO / MAREA / MULTIPLA / PALIO / SIENA / STILO<br><hr/> <b>LANCIA</b><br>DEDRA / DELTA II / LYBRA | VKPC 82629 | <b>LANCIA</b><br>DEDRA / THEMA<br><hr/> <b>FIAT</b><br>CROMA (154) / TIPO<br><hr/> <b>LANCIA</b><br>KAPPA / THEMA  |
| VKPC 82404 | <b>SEAT</b><br>124 / 131   | VKPC 82441 | <b>FIAT</b><br>BRAVA/BRAVO (182) / DOBLO / MAREA / MULTIPLA / PALIO / SIENA / STILO<br><hr/> <b>LANCIA</b><br>DEDRA / DELTA II / LYBRA | VKPC 82630 | <b>IVECO</b><br>NEW DAILY<br><hr/> <b>OPEL</b><br>ARENA<br><hr/> <b>RENAULT</b><br>MASTER I / TRAFIC I<br><hr/> <b>VAUXHALL</b><br>ARENA                     |
| VKPC 82410 | <b>FIAT</b><br>RITMO<br><hr/> <b>SEAT</b><br>IBIZA I (021A) / MALAGA / RITMO / RONDA   | VKPC 82450 | <b>FIAT</b><br>TEMPRA / TIPO<br><hr/> <b>LANCIA</b><br>KAPPA   | VKPC 82631 | <b>IVECO</b><br>NEW DAILY  |
| VKPC 82412 | <b>FIAT</b><br>ARGENTA<br><hr/> <b>SEAT</b><br>131 / 132   | VKPC 82451 | <b>ALFA ROMEO</b><br>145/146 / 155 / 156 / GT<br><hr/> <b>FIAT</b><br>BARCHETTA / PUNTO (188) / STILO                                  | VKPA 82634 | <b>FIAT</b><br>DUCATO (280/290) / TALENTO (290)  |
| VKPC 82419 | <b>SEAT</b><br>IBIZA I (021A) / MALAGA / RONDA   | VKPC 82600 | <b>ALFA ROMEO</b><br>AR 6<br><hr/> <b>FIAT</b><br>DUCATO (280/290)   | VKPC 82638 | <b>FIAT</b><br>CROMA (154)<br><hr/> <b>LANCIA</b><br>THEMA<br><hr/> <b>RENAULT</b><br>SAFRANE I  |
| VKPC 82424 | <b>FIAT</b><br>REGATA / RITMO<br><hr/> <b>LANCIA</b><br>DELTA I / PRISMA   | VKPC 82606 | <b>FIAT</b><br>ARGENTA<br><hr/> <b>IVECO</b><br>NEW DAILY<br><hr/> <b>SEAT</b><br>131 / 132  | VKPC 82642 | <b>ALFA ROMEO</b><br>155 / 164 / 33<br><hr/> <b>FORD</b><br>SCORPIO<br><hr/> <b>ROVER</b><br>800   |
| VKPA 82426 | <b>FIAT</b><br>UNO   | VKPC 82608 | <b>FIAT</b><br>REGATA / RITMO  | VKPC 82643 | <b>FIAT</b><br>DUCATO (280/290)  |
| VKPC 82426 | <b>FIAT</b><br>UNO   | VKPC 82614 | <b>ALFA ROMEO</b><br>164<br><hr/> <b>FIAT</b><br>CROMA (154)   | VKPC 82645 | <b>ALFA ROMEO</b><br>145/146 / 147 / 155 / 156 / 166 / GT / GTV / SPIDER<br><hr/> <b>FIAT</b><br>BARCHETTA / BRAVA/BRAVO (182) / COUPE / MAREA / PUNTO (188) |
| VKPA 82428 | <b>FIAT</b><br>UNO   | VKPC 82616 | <b>FIAT</b><br>CROMA (154)<br><hr/> <b>LANCIA</b><br>THEMA   | VKPC 82646 | <b>LANCIA</b><br>DEDRA / DELTA II / LYBRA<br><hr/> <b>FIAT</b><br>BRAVA/BRAVO (182) / COUPE / MAREA / STILO<br><hr/> <b>LANCIA</b><br>KAPPA / LYBRA / THESIS |
| VKPC 82428 | <b>FIAT</b><br>UNO   | VKPC 82618 | <b>ALFA ROMEO</b><br>145/146<br><hr/> <b>FIAT</b><br>TEMPRA / TIPO   | VKPC 82647 | <b>FIAT</b><br>TEMPRA / TIPO<br><hr/> <b>LANCIA</b><br>DEDRA / DELTA II  |
| VKPA 82429 | <b>FIAT</b><br>TEMPRA / TIPO   | VKPC 82620 | <b>FIAT</b><br>CROMA (154)   | VKPA 82648 | <b>FIAT</b><br>CROMA (154)   |
| VKPC 82429 | <b>FIAT</b><br>TEMPRA / TIPO   | VKPC 82621 | <b>ALFA ROMEO</b><br>75  |            |  |
| VKPA 82431 | <b>FIAT</b><br>FIORINO / TEMPRA / TIPO / UNO   |            |  |            |  |
| VKPC 82431 | <b>FIAT</b><br>FIORINO / TEMPRA / TIPO / UNO   |            |  |            |  |
| VKPC 82432 | <b>FIAT</b><br>TEMPRA / TIPO   |            |  |            |  |
| VKPA 82435 | <b>SEAT</b><br>IBIZA I (021A) / MALAGA   |            |  |            |  |
| VKPC 82436 | <b>ALFA ROMEO</b><br>155 / 164   |            |  |            |  |
| VKPC 82437 | <b>FIAT</b><br>BRAVA/BRAVO (182) / MAREA<br><hr/> <b>LANCIA</b><br>Y   |            |  |            |  |











|  |   |  |  |  |    |
|---|--|---|---|---|---|
| VKPC 82650  | LANCIA<br>THEMA  | VKPA 82670  | VAUXHALL<br>ASTRA Mk V / SIGNUM /<br>VECTRA Mk II                                 | VKPC 83258  | PEUGEOT<br>205 / 309  |
| VKPC 82651  | IVECO<br>NEW DAILY   | VKPA 82671  | FIAT<br>DUCATO (230)  | VKPC 83259  | TALBOT<br>1307-1510 / HORIZON /<br>RANCHO / SOLARA  |
| VKPC 82652  | IVECO<br>NEW DAILY   | VKPC 82800  | FIAT<br>DUCATO (230)  |   | CITROËN<br>C2 / C3 / C4   |
|   | CITROËN<br>JUMPER (230) / JUMPER (244)   |   | ALFA ROMEO<br>164 / 75  |   | PEUGEOT<br>1007 / 206 / 207 / 207 CC /<br>207 SW / 307  |
|   | FIAT<br>DUCATO (230) / DUCATO (244)  |   | FIAT<br>CROMA (154)   |   | CITROËN<br>BERLINGO / C3 / C4 / C4<br>Picasso / C5 II / JUMPY III /<br>XSARA PICASSO  |
| VKPA 82653  | PEUGEOT<br>BOXER I / BOXER II  | VKPC 82810  | ALFA ROMEO<br>164   |   | FORD<br>FIESTA V / FOCUS C-MAX I /<br>FOCUS C-MAX II / FOCUS II /<br>FUSION   |
| VKPC 82660  | FIAT<br>PUNTO (176)  |   | FORD<br>SCORPIO   |   | MAZDA<br>3  |
|   | ALFA ROMEO<br>155  |   | OPEL<br>FRONTERA A  |   | PEUGEOT<br>1007 / 206 / 207 / 207 CC /<br>207 SW / 307 / 308 / 407 /<br>EXPERT II / EXPERT Teepee /<br>PARTNER  |
|   | FIAT<br>COUPE / TIPO   |   | VAUXHALL<br>FRONTERA Mk I   |   | VOLVO<br>S40 II - V50   |
| VKPC 82665  | LANCIA<br>DEDRA / DELTA II   | VKPC 83140  | CITROËN<br>C1 / C2 / C3 / C3 Pluriel /<br>XSARA                                   | VKPC 83401  | CITROËN<br>BX / C15 / VISA / ZX   |
|   | ALFA ROMEO<br>145/146 / 147 / 156 / 159 /<br>166   |   | FORD<br>FIESTA V / FUSION   |   | PEUGEOT<br>205 / 305 / 309 / 405 I  |
|   | FIAT<br>BRAVA/BRAVO (182) / BRAVO /<br>CROMA (194) / DOBLO /<br>GRANDE PUNTO / IDEA /<br>MAREA / MULTIPLA / PALIO/<br>SIENA / PUNTO (188) / SEDICI /<br>STILO / STRADA |   | PEUGEOT<br>1007 / 107 / 206 / 207 / 207<br>CC / 207 SW / 307                      |   | TALBOT<br>HORIZON   |
|   | LANCIA<br>KAPPA / LYBRA / MUSA /<br>THESIS   | VKPA 83200  | TOYOTA<br>AYGO  | VKPC 83403  | PEUGEOT<br>504 / 505  |
|   | OPEL<br>ASTRA H / SIGNUM / VECTRA C<br>/ ZAFIRA B  |   | CITROËN<br>BX / C15 / LNA / VISA  | VKPC 83420  | CITROËN<br>BERLINGO / C15 / EVASION /<br>JUMPER (230) / JUMPER (244)<br>/ JUMPY I / JUMPY II / XANTIA I<br>/ XANTIA II / XM I / XM II /<br>XSARA / ZX |
|   | SAAB<br>9-3 II   | VKPC 83200  | PEUGEOT<br>104 / 205  |   | FIAT<br>DUCATO (230) / DUCATO (244)<br>/ SCUDO (220) / ULYSSE (220)   |
|   | VAUXHALL<br>ASTRA Mk V / SIGNUM / VEC-<br>TRA Mk II / ZAFIRA Mk II   |   | TALBOT<br>SAMBA   |   | HONDA<br>CONCERTO   |
| VKPA 82666  | ALFA ROMEO<br>145/146 / 155  |   | CITROËN<br>BX / C15 / LNA / VISA  |   | HYUNDAI<br>LANTRA   |
|   | LANCIA<br>DEDRA / DELTA II   | VKPC 83203  | PEUGEOT<br>104 / 205  |   | LANCIA<br>ZETA  |
| VKPC 82667  | ALFA ROMEO<br>147 / 156 / 159 / 166 / BRERA<br>/ GT  | VKPC 83205  | RENAULT<br>R14  |   | PEUGEOT<br>205 / 306 / 405 II / 406 / 605 /<br>806 / BOXER I / BOXER II /<br>EXPERT I / PARTNER   |
|   | FIAT<br>CROMA (194) / STILO  |   | TALBOT<br>SAMBA   |   | ROVER<br>200 (XW) / 400 (XW)  |
|   | LANCIA<br>THESIS   | VKPC 83206  | PEUGEOT<br>204 / 304 / 305  |   | FORD<br>GRANADA / SCORPIO / SIERRA  |
|   | OPEL<br>ASTRA H / SIGNUM / VECTRA C<br>/ ZAFIRA B  |   | CITROËN<br>AX / BERLINGO / BX / C15 /<br>SAXO / XSARA / ZX                        |   |   |
|   | SAAB<br>9-3 II   |   | PEUGEOT<br>106 I / 106 II / 205 / 206 / 306<br>/ 307 / 309 / 405 I / PARTNER      |   |   |
|   |  |   | ROVER<br>100  |   |   |
|   |  |   | CITROËN<br>C15  | VKPC 83423  |   |

|  |   |  |    |  |   |
|---|--|---|--|---|--|
| VKPC 83424  | <b>PEUGEOT</b><br>505<br><b>CITROËN</b><br>BX / C15 / C25 / VISA / ZX<br><b>LADA</b><br>NIVA<br><b>PEUGEOT</b><br>205 / 305 / 306 / 309 / 405 I / 405 II / J5<br><b>ROVER</b><br>200 (XW) / 400 (XW) | VKPC 83605  | <b>PEUGEOT</b><br>504 / 505<br><b>PEUGEOT</b><br>404 / 504<br><b>CITROËN</b><br>BERLINGO / BX / EVASION / XANTIA I / XANTIA II / XSARA / ZX<br><b>FIAT</b><br>ULYSSE (220)                 | VKPC 83637  | <b>PEUGEOT</b><br>306 / 406 / 605 / 806<br><b>CITROËN</b><br>XANTIA I / XANTIA II / XM II<br><b>PEUGEOT</b><br>406 / 605<br><b>RENAULT</b><br>ESPACE III / LAGUNA I / SAFRANE II   |
| VKPC 83425  | <b>CITROËN</b><br>EVASION / XANTIA I / XANTIA II / XM I / XM II<br><b>FIAT</b><br>ULYSSE (220)<br><b>LANCIA</b><br>ZETA<br><b>PEUGEOT</b><br>406 / 605 / 806   | VKPC 83616  | <b>FORD</b><br>GRANADA<br><b>PEUGEOT</b><br>504<br><b>CITROËN</b><br>C25 / CX<br><b>FIAT</b><br>DUCATO (280/290)   | VKPC 83639  | <b>CITROËN</b><br>BERLINGO / C15 / C5 I / C8 / EVASION / JUMPER (230) / JUMPER (244) / JUMPY I / JUMPY II / XANTIA II / XSARA / XSARA PICASSO<br><b>FIAT</b><br>DUCATO (230) / DUCATO (244) / SCUDO (220) / ULYSSE (179AX) / ULYSSE (220)<br><b>LANCIA</b><br>PHEDRA / ZETA<br><b>PEUGEOT</b><br>206 / 306 / 307 / 406 / 607 / 806 / 807 / BOXER I / BOXER II / EXPERT I / PARTNER           |
| VKPC 83428  | <b>CITROËN</b><br>AX / BX / SAXO / XSARA / XSARA PICASSO<br><b>NISSAN</b><br>MICRA<br><b>PEUGEOT</b><br>106 I / 106 II / 205 / 206 / 306 / 309 / 405 I / 405 II<br><b>ROVER</b><br>100               | VKPC 83617  | <b>PEUGEOT</b><br>504 / 505<br><b>PEUGEOT</b><br>J7 / J9<br><b>PEUGEOT</b><br>505  | VKPC 83643  | <b>CITROËN</b><br>C4 / C4 Picasso / C5 I / C5 II / C8 / JUMPER (244) / JUMPY III<br><b>FIAT</b><br>ULYSSE (179AX)<br><b>FORD</b><br>FOCUS C-MAX I / FOCUS C-MAX II / FOCUS II / GALAXY II / MONDEO IV / S-MAX<br><b>LANCIA</b><br>PHEDRA<br><b>PEUGEOT</b><br>307 / 308 / 406 / 407 / 607 / 807 / BOXER II / EXPERT II / EXPERT Tepee  |
| VKPC 83430  | <b>CITROËN</b><br>BERLINGO / C2 / C3 / C3 Pluriel / C4 / SAXO / XSARA / XSARA PICASSO<br><b>PEUGEOT</b><br>1007 / 106 II / 206 / 207 / 207 CC / 207 SW / 307 / PARTNER                               | VKPC 83622  | <b>PEUGEOT</b><br>505<br><b>PEUGEOT</b><br>J9<br><b>CITROËN</b><br>C25<br><b>FIAT</b><br>DUCATO (280/290) / TALENTO (290)  | VKPC 83644  | <b>VOLVO</b><br>S40 II - V50<br><b>CITROËN</b><br>BERLINGO / C2 / C3 / C3 Pluriel / SAXO / XSARA<br><b>PEUGEOT</b><br>1007 / 106 II / 206 / 207 / 207 CC / 207 SW / 306 / 307 / PARTNER<br><b>CITROËN</b><br>C4 / C4 Picasso / C5 I / C5 II / C8 / EVASION / JUMPY I / XSARA / XSARA PICASSO<br><b>FIAT</b><br>SCUDO (220) / ULYSSE (179AX) / ULYSSE (220)<br><b>LANCIA</b><br>PHEDRA / ZETA |
| VKPA 83431  | <b>CITROËN</b><br>JUMPY I<br><b>FIAT</b><br>SCUDO (220)<br><b>PEUGEOT</b><br>EXPERT I  | VKPC 83624  | <b>PEUGEOT</b><br>505<br><b>PEUGEOT</b><br>J5<br><b>CITROËN</b><br>XANTIA I / XANTIA II / XSARA / ZX<br><b>PEUGEOT</b><br>306 / 406  | VKPC 83645  | <b>PEUGEOT</b><br>1007 / 106 II / 206 / 207 / 207 CC / 207 SW / 306 / 307 / PARTNER<br><b>CITROËN</b><br>C4 / C4 Picasso / C5 I / C5 II / C8 / EVASION / JUMPY I / XSARA / XSARA PICASSO<br><b>FIAT</b><br>SCUDO (220) / ULYSSE (179AX) / ULYSSE (220)<br><b>LANCIA</b><br>PHEDRA / ZETA   |
| VKPA 83432  | <b>CITROËN</b><br>JUMPY I<br><b>FIAT</b><br>SCUDO (220)<br><b>PEUGEOT</b><br>EXPERT I  | VKPC 83625  | <b>CITROËN</b><br>XANTIA I / XANTIA II / XSARA / ZX<br><b>PEUGEOT</b><br>306 / 406<br><b>CITROËN</b><br>EVASION / XANTIA I / XANTIA II / XM II / XSARA / ZX<br><b>FIAT</b><br>ULYSSE (220) | VKPC 83646  | <b>PEUGEOT</b><br>1007 / 106 II / 206 / 207 / 207 CC / 207 SW / 306 / 307 / PARTNER<br><b>CITROËN</b><br>C4 / C4 Picasso / C5 I / C5 II / C8 / EVASION / JUMPY I / XSARA / XSARA PICASSO<br><b>FIAT</b><br>SCUDO (220) / ULYSSE (179AX) / ULYSSE (220)<br><b>LANCIA</b><br>PHEDRA / ZETA   |
| VKPC 83603  | <b>PEUGEOT</b><br>505<br><b>FORD</b><br>SCORPIO<br><b>PEUGEOT</b><br>505 / 604   | VKPC 83626  | <b>PEUGEOT</b><br>505<br><b>CITROËN</b><br>CX<br><b>PEUGEOT</b><br>J9<br><b>CITROËN</b><br>C25<br><b>FIAT</b><br>DUCATO (280/290) / TALENTO (290)  | VKPC 83647  | <b>PEUGEOT</b><br>1007 / 106 II / 206 / 207 / 207 CC / 207 SW / 306 / 307 / PARTNER<br><b>CITROËN</b><br>C4 / C4 Picasso / C5 I / C5 II / C8 / EVASION / JUMPY I / XSARA / XSARA PICASSO<br><b>FIAT</b><br>SCUDO (220) / ULYSSE (179AX) / ULYSSE (220)<br><b>LANCIA</b><br>PHEDRA / ZETA   |
| VKPC 83604  | <b>PEUGEOT</b><br>505 / 604  | VKPC 83628  | <b>PEUGEOT</b><br>505<br><b>PEUGEOT</b><br>J9<br><b>CITROËN</b><br>C25<br><b>FIAT</b><br>DUCATO (280/290) / TALENTO (290)  | VKPC 83648  | <b>PEUGEOT</b><br>1007 / 106 II / 206 / 207 / 207 CC / 207 SW / 306 / 307 / PARTNER<br><b>CITROËN</b><br>C4 / C4 Picasso / C5 I / C5 II / C8 / EVASION / JUMPY I / XSARA / XSARA PICASSO<br><b>FIAT</b><br>SCUDO (220) / ULYSSE (179AX) / ULYSSE (220)<br><b>LANCIA</b><br>PHEDRA / ZETA   |
| VKPC 83605  | <b>PEUGEOT</b><br>505 / 604  | VKPC 83629  | <b>PEUGEOT</b><br>505<br><b>PEUGEOT</b><br>J9<br><b>CITROËN</b><br>C25<br><b>FIAT</b><br>DUCATO (280/290) / TALENTO (290)  | VKPC 83649  | <b>PEUGEOT</b><br>1007 / 106 II / 206 / 207 / 207 CC / 207 SW / 306 / 307 / PARTNER<br><b>CITROËN</b><br>C4 / C4 Picasso / C5 I / C5 II / C8 / EVASION / JUMPY I / XSARA / XSARA PICASSO<br><b>FIAT</b><br>SCUDO (220) / ULYSSE (179AX) / ULYSSE (220)<br><b>LANCIA</b><br>PHEDRA / ZETA   |









|  |   |  |    |  |   |
|---|--|---|---|---|--|
| VKPC 83810  | <b>PEUGEOT</b><br>206 / 307 / 406 / 407 / 607 / 806 / 807 / EXPERT I   | VKPC 84406  | <b>FORD</b><br>ESCORT V / ESCORT VI / ESCORT VII / FIESTA III / ORION III   | VKPC 84617  | <b>FORD</b><br>TRANSIT   |
| VKPC 83811  | <b>CITROËN</b><br>JUMPER (230) / XM II   | VKPC 84407  | <b>FORD</b><br>MONDEO I / MONDEO II   | VKPC 84618  | <b>FORD</b><br>TRANSIT   |
| VKPC 84201  | <b>PEUGEOT</b><br>605 / BOXER I  | VKPC 84408  | <b>FORD</b><br>MONDEO I / MONDEO II   | VKPC 84620  | <b>FORD</b><br>ESCORT BOX 86 / ESCORT BOX 91 / ESCORT BOX 95 / ESCORT IV / ESCORT V / ESCORT VI / ESCORT VII / FIESTA BOX / COURRIER / FIESTA III / FIESTA IV / ORION II / ORION III |
| VKPC 84205  | <b>CITROËN</b><br>JUMPER (230) / XM II   | VKPC 84409  | <b>FORD</b><br>ESCORT BOX 95 / ESCORT VI / ESCORT VII / ORION III   | VKPA 84621  | <b>MAZDA</b><br>121 (JASM, JBSM)   |
| VKPC 84207  | <b>PEUGEOT</b><br>605 / BOXER I  | VKPC 84410  | <b>FORD</b><br>ESCORT VI / FIESTA III / ORION III / P 100 II / SIERRA   | VKPC 84622  | <b>FORD</b><br>MONDEO III / TRANSIT  |
| VKPC 84208  | <b>FORD</b><br>ESCORT I / ESCORT II  | VKPC 84411  | <b>FORD</b><br>SCORPIO / SIERRA / TRANSIT   | VKPA 84623  | <b>FORD</b><br>FIESTA V / FOCUS C-MAX I / FOCUS C-MAX II / FOCUS II / GALAXY II / MAVERICK / MONDEO III / MONDEO IV / S-MAX  |
| VKPC 84209  | <b>FORD</b><br>ESCORT BOX 81 / ESCORT BOX 86 / ESCORT BOX 91 / ESCORT BOX 95 / ESCORT IV / ESCORT V / ESCORT VI / ESCORT VII / FIESTA II / FIESTA III / ORION I / ORION II / ORION III | VKPC 84412  | <b>FORD</b><br>ESCORT V / ESCORT VI / ESCORT VII / GALAXY I / SIERRA  | VKPC 84629  | <b>FORD</b><br>TRANSIT   |
| VKPC 84210  | <b>FORD</b><br>ESCORT BOX 81 / ESCORT BOX 86 / ESCORT BOX 91 / ESCORT BOX 95 / ESCORT IV / ESCORT V / ESCORT VI / ESCORT VII / FIESTA II / FIESTA III / ORION I / ORION II / ORION III | VKPC 84415  | <b>FORD</b><br>COUGAR / ESCORT VII / FOCUS I / MONDEO II / TRANSIT CONNECT / TOURNEO CONNECT  | VKPC 85201  | <b>FORD</b><br>FIESTA V / KA / STREET KA   |
| VKPC 84211  | <b>FORD</b><br>ESCORT BOX 81 / ESCORT BOX 86 / ESCORT BOX 91 / ESCORT BOX 95 / ESCORT IV / ESCORT V / ESCORT VI / ESCORT VII / FIESTA II / FIESTA III / ORION I / ORION II / ORION III | VKPC 84416  | <b>FORD</b><br>FIESTA BOX / COURRIER / FIESTA IV / FOCUS C-MAX I / FOCUS I / FOCUS II / GALAXY II / MONDEO IV / S-MAX / TRANSIT CONNECT / TOURNEO CONNECT | VKPC 85202  | <b>OPEL</b><br>CORSA A / KADETT C / KADETT D / KADETT E  |
| VKPC 84215  | <b>FORD</b><br>ESCORT BOX 86 / ESCORT BOX 91 / ESCORT IV / ESCORT V / FIESTA III / ORION II / ORION III  | VKPC 84600  | <b>FORD</b><br>CAPRI / ESCORT II / GRANADA / P 100 I / SIERRA / TAUNUS  | VKPC 85203  | <b>OPEL</b><br>ASCONA B / ASCONA C / CORSA A / KADETT D / KADETT E / MANTA B   |
| VKPC 84216  | <b>FORD</b><br>ESCORT BOX 91 / ESCORT V / ESCORT VI / ESCORT VII / FIESTA BOX / COURRIER / FIESTA III / ORION III  | VKPC 84601  | <b>FORD</b><br>CAPRI / GRANADA / SCORPIO / SIERRA / TRANSIT   | VKPC 85206  | <b>VAUXHALL</b><br>ASTRA Mk I / ASTRA Mk II / CAVALIER Mk I / CAVALIER Mk II / NOVA  |
| VKPC 84400  | <b>FORD</b><br>FIESTA BOX / COURRIER / FIESTA IV / FIESTA V / FOCUS C-MAX I / FOCUS I / FOCUS II / FUSION / PUMA   | VKPC 84603  | <b>FORD</b><br>TRANSIT  | VKPC 85211  | <b>OPEL</b><br>ASCONA B / KADETT C / MANTA B   |
| VKPC 84403  | <b>FORD</b><br>FIESTA BOX / COURRIER / FIESTA IV / KA  | VKPC 84607  | <b>FORD</b><br>SIERRA   |   | <b>DAEWOO</b><br>ESPERO / NEXIA  |
| VKPC 84405  | <b>MAZDA</b><br>121 (JASM, JBSM)   | VKPC 84608  | <b>FORD</b><br>CAPRI / GRANADA / SIERRA   |   | <b>OPEL</b><br>ASTRA F / ASTRA F CLASSIC / ASTRA G / COMBO A / CORSA A / CORSA B / KADETT D / KADETT E / VECTRA A / VECTRA B   |
|   | <b>FORD</b><br>CAPRI / CONSUL / CORSAIR / GRANADA / TRANSIT  | VKPC 84609  | <b>FORD</b><br>CAPRI / GRANADA / SCORPIO / SIERRA   |   | <b>VAUXHALL</b><br>ASTRA Mk II / ASTRA Mk III / ASTRA Mk IV / CAVALIER Mk III / COMBO I / CORSA Mk I / NOVA / VECTRA Mk I  |
|   | <b>SAAB</b><br>95 / 96   | VKPC 84610  | <b>FORD</b><br>SIERRA   |   | <b>OPEL</b><br>ASTRA F CLASSIC / ASTRA G / COMBO B / CORSA C / MERIVA / VECTRA B / VECTRA C / ZAFIRA A   |
|   | <b>FORD</b><br>ESCORT BOX 81 / ESCORT BOX 86 / ESCORT III / ESCORT IV / FIESTA II / ORION I / ORION II   | VKPC 84611  | <b>SAAB</b><br>90 / 900 I / 99  |   |  |
|   | <b>FORD</b><br>ESCORT BOX 81 / ESCORT BOX 86 / ESCORT III / ESCORT IV / FIESTA II / ORION I / ORION II   | VKPC 84612  | <b>SAAB</b><br>9000   |   |  |
|   | <b>FORD</b><br>SCORPIO / SIERRA / TRANSIT  | VKPC 84613  | <b>SAAB</b><br>9000   |   |  |
|   |  | VKPC 84616  | <b>FORD</b><br>TRANSIT  |   |  |



|            |   |            |  |            |  |
|------------|---|------------|--|------------|--|
| VKPC 85212 | <p><b>VAUXHALL</b><br/>ASTRA Mk IV / CORSA Mk II / MERIVA / VECTRA Mk I / VECTRA Mk II / ZAFIRA Mk I</p> <p><b>OPEL</b><br/>ASTRA F / ASTRA F CLASSIC / ASTRA G / COMBO A / CORSA B / CORSA C / TIGRA / VECTRA B / ZAFIRA A</p> <p><b>VAUXHALL</b><br/>ASTRA Mk III / ASTRA Mk IV / CORSA Mk I / CORSA Mk II / TIGRA Mk I / VECTRA Mk I / ZAFIRA Mk I</p> | VKPC 85310 | <p><b>OPEL</b><br/>ASTRA G / SIGNUM / SPEEDSTER / VECTRA B / VECTRA C / ZAFIRA A</p> <p><b>SAAB</b><br/>9-3 II</p> <p><b>VAUXHALL</b><br/>ASTRA Mk IV / SIGNUM / VECTRA Mk I / VECTRA Mk II / VX 220 / ZAFIRA Mk I</p> <p><b>OPEL</b><br/>AGILA B / ASTRA H / COMBO B / CORSA C / CORSA D / MERIVA / TIGRA Twin Top</p> <p><b>VAUXHALL</b><br/>ASTRA Mk V / COMBO II / CORSA Mk III / MERIVA / TIGRA Mk II</p> | VKPC 85408 | <p><b>VAUXHALL</b><br/>ASTRA Mk II / ASTRA Mk III / CALIBRA / CARLTON Mk II / CARLTON Mk III / CAVALIER Mk II / CAVALIER Mk III / FRONTERA Mk I</p> <p><b>OPEL</b><br/>ASCONA C / ASTRA F / KADETT E / VECTRA A</p> <p><b>VAUXHALL</b><br/>ASTRA Mk II / ASTRA Mk III / CAVALIER Mk II / CAVALIER Mk III</p> |
| VKPC 85220 | <p><b>OPEL</b><br/>AGILA B / ASTRA G / CORSA B / CORSA C</p> <p><b>VAUXHALL</b><br/>AGILA / ASTRA Mk IV / CORSA Mk I / CORSA Mk II</p>  | VKPC 85400 | <p><b>DAEWOO</b><br/>ESPERO</p> <p><b>OPEL</b><br/>ASCONA C / KADETT D / KADETT E / MANTA B / REKORD E</p> <p><b>VAUXHALL</b><br/>ASTRA Mk I / ASTRA Mk II / CARLTON Mk II / CAVALIER Mk II</p>  | VKPC 85409 | <p><b>OPEL</b><br/>ASTRA F / CALIBRA / FRONTERA A / KADETT E / OMEGA A / OMEGA B / VECTRA A / VECTRA B</p> <p><b>VAUXHALL</b><br/>ASTRA Mk II / ASTRA Mk III / CALIBRA / CARLTON Mk III / CAVALIER Mk III / FRONTERA Mk I / OMEGA</p>  |
| VKPC 85300 | <p><b>OPEL</b><br/>ASTRA G / ASTRA H / COMBO B / CORSA B / CORSA C / CORSA D / MERIVA</p> <p><b>VAUXHALL</b><br/>ASTRA Mk IV / ASTRA Mk V / COMBO II / CORSA Mk II / CORSA Mk III / MERIVA</p>  | VKPC 85401 | <p><b>DAEWOO</b><br/>ESPERO</p> <p><b>OPEL</b><br/>ASCONA C / CORSA A / KADETT E / VECTRA A</p> <p><b>VAUXHALL</b><br/>ASTRA Mk II / CAVALIER Mk II / CAVALIER Mk III / NOVA</p>   | VKPC 85410 | <p><b>OPEL</b><br/>CORSA A / CORSA B / KADETT E</p> <p><b>VAUXHALL</b><br/>ASTRA Mk II / CORSA Mk I / NOVA / NOVAVAN</p>   |
| VKPC 85302 | <p><b>OPEL</b><br/>MOVANO</p> <p><b>RENAULT</b><br/>MASTER II</p> <p><b>VAUXHALL</b><br/>MOVANO</p>   | VKPC 85403 | <p><b>OPEL</b><br/>CORSA A / KADETT E</p> <p><b>VAUXHALL</b><br/>ASTRA Mk II / NOVA / NOVAVAN</p>  | VKPC 85460 | <p><b>OPEL</b><br/>ASTRA G / COMBO B / MERIVA</p> <p><b>VAUXHALL</b><br/>ASTRA Mk IV / COMBO II / MERIVA</p>   |
| VKPC 85303 | <p><b>OPEL</b><br/>MOVANO</p> <p><b>RENAULT</b><br/>MASTER II</p> <p><b>VAUXHALL</b><br/>MOVANO</p>   | VKPC 85404 | <p><b>OPEL</b><br/>ASTRA F / COMBO A / CORSA A / CORSA B / VECTRA A</p> <p><b>VAUXHALL</b><br/>ASTRA Mk III / CAVALIER Mk III / COMBO I / CORSA Mk I / NOVA / NOVAVAN</p>  | VKPC 85600 | <p><b>OPEL</b><br/>ADMIRAL A / ADMIRAL B / ASCONA A / ASCONA B / COMMODORE B / COMMODORE C / DIPLOMAT B / GT / KADETT B / MANTA A / MANTA B / MONZA A / REKORD D / REKORD E / SENATOR A</p> <p><b>VAUXHALL</b><br/>CALIBRA / CARLTON Mk II / CAVALIER Mk I / ROYALE / SENATOR Mk I / VICEROY</p>             |
| VKPC 85304 | <p><b>NISSAN</b><br/>INTERSTAR / PRIMASTAR</p> <p><b>OPEL</b><br/>MOVANO / VIVARO</p> <p><b>RENAULT</b><br/>AVANTIME / CLIO III / ESPACE IV / LAGUNA I / LAGUNA II / LAGUNA III / MASTER II / MEGANE II / SCENIC II / GRAND SCENIC / TRAFIC II / VEL SATIS</p> <p><b>VAUXHALL</b><br/>MOVANO / VIVARO</p>   | VKPC 85406 | <p><b>OPEL</b><br/>ASCONA C / KADETT D / KADETT E</p> <p><b>VAUXHALL</b><br/>ASTRA Mk I / ASTRA Mk II / CAVALIER Mk II</p> <p><b>DAEWOO</b><br/>ESPERO</p>   | VKPC 85603 | <p><b>OPEL</b><br/>FRONTERA A / OMEGA A / SENATOR B</p> <p><b>VAUXHALL</b><br/>CARLTON Mk III / FRONTERA Mk I / SENATOR Mk II</p>  |
| VKPC 85308 | <p><b>VOLVO</b><br/>S40 I - V40</p> <p><b>ALFA ROMEO</b><br/>159 / BRERA / SPIDER</p> <p><b>FIAT</b><br/>CROMA (194)</p>  | VKPC 85407 | <p><b>OPEL</b><br/>ASCONA C / ASTRA F / CALIBRA / FRONTERA A / KADETT E / OMEGA A / VECTRA A</p>   | VKPA 85605 | <p><b>OPEL</b><br/>ASCONA B / CAMPO / MONTEREY B / REKORD D / REKORD E</p>   |
|            |   |            |  | VKPA 85608 | <p><b>OPEL</b><br/>ASCONA B / MANTA B / MONZA A / REKORD E / SENATOR A</p>   |









|  |    |  |    |  |   |
|---|---|---|---|---|--|
| VKPC 85610  | <b>VAUXHALL</b><br>CARLTON Mk II / ROYALE   |   | <b>VAUXHALL</b><br>ASTRA Mk IV / FRONTERA Mk II / OMEGA / SIGNUM / SINTRA / VECTRA Mk I / VECTRA Mk II / ZAFIRA Mk I        | VKPC 86212  | <b>RENAULT</b><br>CLIO I / EXPRESS/EXTRA/ RAPID / TWINGO   |
|   | <b>OPEL</b><br>ASTRA F / CALIBRA / KADETT E / VECTRA A  | VKPC 85624  | <b>OPEL</b><br>ASTRA G / ASTRA H / CORSA C / MERIVA / SIGNUM / TIGRA Twin Top / VECTRA B / VECTRA C / ZAFIRA A              | VKPC 86215  | <b>NISSAN</b><br>KUBISTAR  |
| VKPC 85611  | <b>VAUXHALL</b><br>ASTRA Mk II / ASTRA Mk III / CALIBRA / CAVALIER Mk III   |   | <b>SAAB</b><br>9-3 II   | VKPC 86216  | <b>RENAULT</b><br>CLIO I / CLIO II / KANGOO / TWINGO   |
|   | <b>DAEWOO</b><br>EVANDA / LACETTI / LEGANZA / MAGNUS / NUBIRA   | VKPC 85700  | <b>VAUXHALL</b><br>ASTRA Mk IV / ASTRA Mk V / CORSA Mk II / MERIVA / TIGRA Mk II / VECTRA Mk I / VECTRA Mk II / ZAFIRA Mk I | VKPC 86217  | <b>RENAULT</b><br>CLIO II / EXPRESS/EXTRA/ RAPID / KANGOO / MEGANE I / SCENIC I  |
|   | <b>OPEL</b><br>ANTARA / ASTRA F / ASTRA G / ASTRA H / CALIBRA / FRONTERA A / FRONTERA B / KADETT E / OMEGA B / SINTRA / SPEEDSTER / VECTRA A / VECTRA B / ZAFIRA A / ZAFIRA B               |   | <b>FIAT</b><br>500 / DOBLO / GRANDE PUNTO / IDEA / PANDA (169) / PUNTO (188)  | VKPC 86217  | <b>RENAULT</b><br>TWINGO   |
|   | <b>VAUXHALL</b><br>ASTRA Mk II / ASTRA Mk III / ASTRA Mk IV / ASTRA Mk V / CALIBRA / CAVALIER Mk III / FRONTERA Mk I / FRONTERA Mk II / OMEGA / SINTRA / VECTRA Mk I / VX 220 / ZAFIRA Mk I | VKPC 85700  | <b>LANCIA</b><br>MUSA / YPSILON   | VKPC 86217  | <b>RENAULT</b><br>TWINGO   |
| VKPC 85613  | <b>OPEL</b><br>CALIBRA / OMEGA B / SIGNUM / SINTRA / VECTRA A / VECTRA B / VECTRA C   |   | <b>OPEL</b><br>AGILA B / ASTRA H / COMBO B / CORSA C / CORSA D / MERIVA / TIGRA Twin Top                                    | VKPC 86305  | <b>NISSAN</b><br>INTERSTAR / PRIMASTAR   |
|   | <b>SAAB</b><br>900 II / 9000 / 9-5  | VKPC 86129  | <b>VAUXHALL</b><br>ASTRA Mk V / CORSA Mk II / CORSA Mk III / TIGRA Mk II  |   | <b>OPEL</b><br>MOVANO / VIVARO   |
|   | <b>VAUXHALL</b><br>CAVALIER Mk III / OMEGA / SIGNUM / SINTRA / VECTRA Mk I / VECTRA Mk II   |   | <b>NISSAN</b><br>PRIMERA  | VKPC 86401  | <b>RENAULT</b><br>AVANTIME / ESPACE III / ESPACE IV / LAGUNA II / MASTER II / TRAFIC II / VEL SATIS  |
| VKPC 85620  | <b>OPEL</b><br>ASTRA F / ASTRA G / COMBO A / CORSA B / VECTRA A / VECTRA B  | VKPC 86129  | <b>NISSAN</b><br>PRIMERA  | VKPC 86402  | <b>VAUXHALL</b><br>MOVANO / VIVARO   |
|   | <b>VAUXHALL</b><br>ASTRA Mk III / ASTRA Mk IV / COMBO I / CORSA Mk I / VECTRA Mk I  | VKPC 86200  | <b>RENAULT</b><br>LAGUNA II / MEGANE II / SCENIC II / GRAND SCENIC  | VKPC 86402  | <b>RENAULT</b><br>FUEGO / R18  |
| VKPC 85621  | <b>OPEL</b><br>CORSA B  | VKPC 86200  | <b>RENAULT</b><br>R4 / R6   | VKPC 86403  | <b>RENAULT</b><br>FUEGO / R18 / TRAFIC I   |
|   | <b>VAUXHALL</b><br>CORSA Mk I   | VKPC 86201  | <b>RENAULT</b><br>R4 / R6   | VKPC 86403  | <b>VOLVO</b><br>340-360  |
| VKPC 85622  | <b>OPEL</b><br>CORSA B  | VKPC 86201  | <b>RENAULT</b><br>R4 / R5 / R6  | VKPC 86405  | <b>RENAULT</b><br>R12 / R15  |
|   | <b>VAUXHALL</b><br>CORSA Mk I   | VKPC 86203  | <b>RENAULT</b><br>R4 / R5 / R6  | VKPC 86405  | <b>VOLVO</b><br>340-360 / 66   |
| VKPC 85623  | <b>OPEL</b><br>ASTRA G / FRONTERA B / OMEGA B / SIGNUM / SINTRA / VECTRA B / VECTRA C / ZAFIRA A  | VKPC 86205  | <b>RENAULT</b><br>R10 / R8  | VKPC 86407  | <b>RENAULT</b><br>MASTER I / R20 / R25 / TRAFIC I  |
|   | <b>SAAB</b><br>9-3 I / 9-3 II / 9-5   | VKPC 86205  | <b>RENAULT</b><br>R4 / R5   | VKPC 86407  | <b>RENAULT</b><br>FUEGO / R18 / TRAFIC I   |
|   |   | VKPA 86206  | <b>RENAULT</b><br>EXPRESS/EXTRA/RAPID / R11 / R19 / R21 / R9 / SUPER 5  | VKPC 86408  | <b>RENAULT</b><br>MASTER I / R21 / R25   |
|   |   | VKPC 86206  | <b>RENAULT</b><br>CLIO I / EXPRESS/EXTRA/ RAPID / R11 / R19 / R21 / R5 / R9 / SUPER 5                                       | VKPC 86409  | <b>RENAULT</b><br>CLIO I / EXPRESS/EXTRA/ RAPID / R19  |
|   |   | VKPC 86208  | <b>RENAULT</b><br>ESTAFETTE   | VKPC 86413  | <b>NISSAN</b><br>CARISMA   |
|   |   | VKPC 86209  | <b>RENAULT</b><br>R21 / SUPER 5   |   | <b>OPEL</b><br>ARENA / MOVANO  |
|   |   | VKPA 86212  | <b>RENAULT</b><br>CLIO I / TWINGO   |   | <b>RENAULT</b><br>CLIO I / CLIO II / ESPACE III / EXPRESS/EXTRA/RAPID / KANGOO / LAGUNA I / MASTER II / MEGANE I / R11 / R19 / R21 / R9 / SCENIC I / SPORT SPIDER / SUPER 5 / TRAFIC I |



|            |  |            |   |            |  |
|------------|--|------------|---|------------|--|
| VKPC 86415 | <b>VAUXHALL</b><br>ARENA / MOVANO  | VKPC 86619 | <b>VOLVO</b><br>850 / 960 / C70 - S70 / S40 I - V40 / S40 II - V50 / S60 / S80 / V70 I / V70 II / XC70 I / XC90                   | VKPC 87403 | <b>AUSTIN</b><br>MAESTRO / MONTEGO   |
| VKPC 86416 | <b>VOLVO</b><br>340-360 / 440-460 / 480 / S40 I - V40  | VKPC 86620 | <b>AUDI</b><br>100 (4A, C4) / 100 Avant (4A, C4) / A6 (4A, C4) / A6 Avant (4A, C4)  | VKPC 87404 | <b>ROVER</b><br>200 (XH) / MAESTRO   |
| VKPC 86417 | <b>DACIA</b><br>LOGAN  | VKPC 86621 | <b>VW</b><br>LT I / LT II / TRANSPORTER IV  | VKPC 87410 | <b>HONDA</b><br>CIVIC / CIVIC SHUTTLE / CONCERTO / CRX / INTEGRA                             |
| VKPC 86500 | <b>RENAULT</b><br>CLIO II / KANGOO / MEGANE I / SCENIC I / THALIA  | VKPC 86622 | <b>VOLVO</b><br>850 / 940 / 960 / C70 - S70 / S80 / V70 I / V70 II  | VKPC 87420 | <b>ROVER</b><br>200 (XW) / 200 cabriolet (XW) / 400 (XW)                                     |
| VKPC 86520 | <b>DACIA</b><br>LOGAN  | VKPC 86623 | <b>RENAULT</b><br>ESPACE II   | VKPC 87607 | <b>LAND ROVER</b><br>FREELANDER I  |
| VKPC 86601 | <b>NISSAN</b><br>KUBISTAR  | VKPC 86630 | <b>RENAULT</b><br>R25   | VKPC 87609 | <b>MG</b><br>MG ZS / MG ZT   |
| VKPC 86602 | <b>RENAULT</b><br>CLIO II / CLIO III / KANGOO / LAGUNA I / LAGUNA II / MEGANE I / MEGANE II / MODUS / SCENIC I / SCENIC II / GRAND SCENIC / THALIA | VKPC 86631 | <b>RENAULT</b><br>R20 / R25 / R30 / TRAFIC I  | VKPC 87610 | <b>ROVER</b><br>45 / 75  |
| VKPC 86603 | <b>NISSAN</b><br>ALMERA / KUBISTAR / MICRA   | VKPC 86633 | <b>SAAB</b><br>900 II / 9-3 I / 9-5   | VKPC 87813 | <b>LAND ROVER</b><br>FREELANDER I  |
| VKPC 86604 | <b>RENAULT</b><br>CLIO II / KANGOO / MEGANE II / SCENIC II / GRAND SCENIC / THALIA   | VKPC 87200 | <b>RENAULT</b><br>LAGUNA I  | VKPC 88200 | <b>MG</b><br>MG ZT   |
| VKPC 86605 | <b>VOLVO</b><br>S40 I - V40  | VKPC 87205 | <b>RENAULT</b><br>ESPACE III / LAGUNA I / SAFRANE II  | VKPC 88203 | <b>ROVER</b><br>75   |
| VKPC 86606 | <b>VOLVO</b><br>S80  | VKPC 87400 | <b>VOLVO</b><br>S60 / S80 / V70 II / XC70 I / XC90  | VKPC 88206 | <b>ROVER</b><br>800  |
| VKPC 86614 | <b>RENAULT</b><br>R20 / R25  | VKPC 87401 | <b>RENAULT</b><br>CLIO II / KANGOO / THALIA   |            | <b>AUSTIN</b><br>MAESTRO / MONTEGO   |
| VKPC 86616 | <b>RENAULT</b><br>ESPACE I / FUEGO / MASTER I / R18  |            | <b>AUSTIN</b><br>METRO / MINI   |            | <b>ROVER</b><br>MONTEGO  |
| VKPC 86618 | <b>RENAULT</b><br>R21 / TRAFIC I   |            | <b>MG</b><br>MIDGET   |            | <b>HONDA</b><br>LEGEND   |
|            | <b>VKPC 86603</b>  |            | <b>ROVER</b><br>MINI  |            | <b>ROVER</b><br>800  |
|            | <b>VKPC 86604</b>  |            | <b>DAIHATSU</b><br>CHARADE  |            | <b>HONDA</b><br>ACCORD / CIVIC   |
|            | <b>VKPC 86605</b>  |            | <b>AUSTIN</b><br>MAESTRO / MONTEGO  |            | <b>LAND ROVER</b><br>DISCOVERY I / DISCOVERY II / FREELANDER I                               |
|            | <b>VKPC 86606</b>  |            | <b>ROVER</b><br>MAESTRO / MONTEGO   |            | <b>MG</b><br>MG ZR   |
|            | <b>VKPC 86607</b>  |            | <b>ROVER</b><br>100 (RF) / 200 (XW) / 25 / 400 (RT) / 400 (XW) / STREETWISE   |            | <b>ROVER</b><br>200 (RF) / 200 (XW) / 25 / 400 (RT) / 400 (XW) / 45 / 600 / 800 / STREETWISE |
|            | <b>VKPC 86609</b>  |            | <b>LAND ROVER</b><br>FREELANDER I   |            | <b>LAND ROVER</b><br>DISCOVERY I / DISCOVERY II / RANGE ROVER I / RANGE ROVER II             |
|            | <b>VKPC 86610</b>  |            | <b>MG</b><br>MG ZR / MG ZS / MGF / MGTF   |            | <b>MG</b><br>MG ZR   |
|            | <b>VKPC 86614</b>  |            | <b>ROVER</b><br>100 / 200 (RF) / 200 (XW) / 200 cabriolet (XW) / 200 coupe (RF) / 25 / 400 (RT) / 400 (XW) / 45 / 75 / STREETWISE |            | <b>ROVER</b><br>200 (RF) / 200 (XW) / 25 / 400 (RT) / 400 (XW) / 45 / 600 / 800 / STREETWISE |
|            | <b>VKPC 86616</b>  |            |   |            | <b>LAND ROVER</b><br>DISCOVERY I / DISCOVERY II / RANGE ROVER I / RANGE ROVER II             |
|            | <b>VKPC 86618</b>  |            |   |            | <b>LADA</b><br>NIVA  |
|            |  |            |   |            | <b>LADA</b><br>FORMA / SAMARA  |
|            |  |            |   |            | <b>MERCEDES-BENZ</b><br>A-class (W168)   |











|  |    |  |   |  |    |
|---|---|---|--|---|---|
| VKPC 88430  | <b>BMW</b><br>3 (E46) / 3 Touring (E46) / 5 (E39) / 5 Touring (E39) / 7 (E38) / X5  | VKPC 88620  | <b>MERCEDES-BENZ</b><br>(W 124) / 190 (W201) / C-class (W202) / E-class (W124) / E-class (W210) / G-class (W460) / G-class (W461) / G-class (W463) / S-class (W140) / SPRINTER 2-t (W901 / W902) / SPRINTER 3-t (W903) / SPRINTER 4-t (W904) / T1 (W601 / W602) / V-class (W638) / VITO (W638) | VKPC 88810  | <b>MERCEDES-BENZ</b><br>(W 124) / 190 (W201) / E-class (W124) / G-class (W463) / S-class (W126) / SL (W107) / SL (W129)     |
|   | <b>LAND ROVER</b><br>RANGE ROVER III  |   |  | VKPC 88813  | <b>MERCEDES-BENZ</b><br>(W 123) / S-class (W126)  |
|   | <b>OPEL</b><br>OMEGA B  |   |  | VKPC 88816  | <b>MERCEDES-BENZ</b><br>(W 124) / E-class (W124) / SL (W129)  |
|   | <b>VAUXHALL</b><br>OMEGA  | VKPC 88622  | <b>MERCEDES-BENZ</b><br>(W 124) / C-class (W202) / CLK (W208) / E-class (W124) / E-class (W210) / M-class (W163) / SLK (R170)  | VKPC 88818  | <b>MERCEDES-BENZ</b><br>S-class (W126) / SL (W107)  |
| VKPC 88604  | <b>MERCEDES-BENZ</b><br>(W 123) / 190 (W201)  |   |  | VKPC 88821  | <b>MERCEDES-BENZ</b><br>S-class (W140)  |
| VKPC 88605  | <b>BMW</b><br>3 (E21) / 3 (E30) / 3 Convertible (E30) / 5 (E28)   | VKPC 88625  | <b>MERCEDES-BENZ</b><br>C-class (W202) / E-class (W210)  | VKPC 88824  | <b>MERCEDES-BENZ</b><br>(W 124) / C-class (W202) / E-class (W124) / E-class (W210) / SL (W129)                              |
| VKPC 88607  | <b>BMW</b><br>3 (E30) / 3 Convertible (E30) / 3 Touring (E30) / 5 (E12) / 5 (E28) / 5 (E34) / Z1  | VKPC 88631  | <b>MERCEDES-BENZ</b><br>C-class (W202) / CLK (W208) / E-class (W210) / SLK (R170)  | VKPC 88825  | <b>MERCEDES-BENZ</b><br>(W 124) / E-class (W124)  |
| VKPC 88608  | <b>MERCEDES-BENZ</b><br>(W 124) / 190 (W201) / E-class (W124)   | VKPC 88632  | <b>BMW</b><br>3 (E46) / 3 Touring (E46)  | VKPC 88826  | <b>BMW</b><br>3 (E36) / 3 Compact (E36) / 3 Touring (E36) / 5 (E34) / 5 (E39) / 5 Touring (E34) / 5 Touring (E39) / 7 (E38) |
| VKPC 88609  | <b>BMW</b><br>3 (E21) / 5 (E12) / 5 (E28)   | VKPC 88635  | <b>BMW</b><br>1 (E87) / 3 (E46) / 3 (E90) / 3 Compact (E46) / 3 Convertible (E46) / 3 Coupe (E46) / 3 Touring (E46) / 3 Touring (E91) / X3   |   | <b>LAND ROVER</b><br>RANGE ROVER II   |
| VKPC 88610  | <b>BMW</b><br>3 (E30) / 5 (E28)   |   |  |   | <b>OPEL</b><br>OMEGA B  |
| VKPC 88611  | <b>BMW</b><br>3 (E30) / 3 Convertible (E30) / 3 Touring (E30) / 5 (E34)   | VKPC 88636  | <b>BMW</b><br>3 (E46) / 3 Compact (E46) / 3 Convertible (E46) / 3 Coupe (E46) / 3 Touring (E46) / 7 (E65 / E66) / X5   |   | <b>VAUXHALL</b><br>OMEGA  |
| VKPC 88612  | <b>BMW</b><br>5 (E34)   | VKPC 88637  | <b>BMW</b><br>3 (E46) / 3 Touring (E46) / 5 (E39) / 5 Touring (E39)  | VKPC 88827  | <b>MERCEDES-BENZ</b><br>G-class (W463) / S-class (W126) / SL (W107)   |
| VKPC 88613  | <b>MERCEDES-BENZ</b><br>T1 (W601 / W602)  | VKPC 88645  | <b>BMW</b><br>1 (E87) / 3 (E90) / 3 Convertible (E93) / 3 Coupe (E92) / 3 Touring (E91) / 5 (E60) / 5 Touring (E61) / X3   | VKPC 88828  | <b>MERCEDES-BENZ</b><br>G-class (W463) / S-class (W140)   |
| VKPC 88614  | <b>BMW</b><br>3 (E30) / 3 Touring (E30) / 5 (E28)   |   |  | VKPC 88829  | <b>BMW</b><br>5 (E39) / 5 Touring (E39) / 7 (E38) / 8 (E31)   |
| VKPC 88615  | <b>BMW</b><br>3 (E30) / 3 (E36) / 3 (E46) / 3 Compact (E36) / 3 Convertible (E36) / 3 Coupe (E36) / 3 Coupe (E46) / 3 Touring (E36) / 3 Touring (E46) / 5 (E34) / 5 Touring (E34) / Z3  | VKPC 88802  | <b>BMW</b><br>5 (E12) / 5 (E28) / 5 (E34) / 6 (E24) / 7 (E23) / 7 (E32)  | VKPC 88830  | <b>BMW</b><br>7 (E38) / 8 (E31)   |
| VKPC 88616  | <b>BMW</b><br>3 (E36) / 5 (E34) / 5 Touring (E34)   | VKPC 88803  | <b>MERCEDES-BENZ</b><br>W110 / W111 / W114 / W115  | VKPC 88831  | <b>BMW</b><br>5 (E34) / 5 Touring (E34) / 7 (E32)   |
| VKPC 88617  | <b>BMW</b><br>3 (E36) / 3 (E46) / 3 Compact (E36) / 3 Compact (E46) / 3 Convertible (E36) / 3 Convertible (E46) / 3 Coupe (E36) / 3 Coupe (E46) / 3 Touring (E36) / 3 Touring (E46) / 5 (E34) / 5 (E39) / 5 (E60) / 5 Touring (E34) / 5 Touring (E39) / 5 Touring (E61) / 7 (E38) / 7 (E65 / E66) / X3 / X5 / Z3 / Z4 | VKPC 88804  | <b>MERCEDES-BENZ</b><br>190 (W201) / S-class (W126) / SL (W107)  | VKPC 88836  | <b>MERCEDES-BENZ</b><br>(W 124) / E-class (W124)  |
| VKPC 88619  | <b>MERCEDES-BENZ</b><br>(W 124) / 190 (W201)  | VKPC 88807  | <b>MERCEDES-BENZ</b><br>(W 123) / G-class (W460) / S-class (W108 / W109) / S-class (W116) / SL (W107) / T1 (W601 / W602) / W110 / W111 / W113 / W114 / W115  | VKPC 88842  | <b>MERCEDES-BENZ</b><br>(W 124) / C-class (W202) / E-class (W124) / E-class (W210) / G-class (W463) / S-class (W140)        |
|   |   | VKPC 88808  | <b>MERCEDES-BENZ</b><br>T1 (W601 / W602)   | VKPC 88843  | <b>MERCEDES-BENZ</b><br>C-class (W202) / C-class (W203) / CLK (W209) / E-class (W210) / M-class (W163)                      |
|   |   | VKPC 88809  | <b>MERCEDES-BENZ</b><br>100 (W631) / T1 (W601 / W602)  | VKPC 88844  | <b>MERCEDES-BENZ</b><br>V-class (W638) / VITO (W638)  |



|            |  |            |   |            |  |
|------------|--|------------|---|------------|--|
| VKPC 88845 | <b>MERCEDES-BENZ</b><br>V-class (W638) / VITO (W638)   | VKPA 91409 | <b>TOYOTA</b><br>CARINA / CELICA / COROLLA / CORONA   | VKPC 91613 | <b>TOYOTA</b><br>CAMRY / CARINA / CELICA / CORONA / CRESSIDA / MR 2 / PICNIC / RAV 4       |
| VKPC 88846 | <b>MERCEDES-BENZ</b><br>C-class (W202) / C-class (W203) / CLK (W208) / CLK (W209) / E-class (W210) / E-class (W211) / G-class (W463) / M-class (W163) / M-CLASS (W164) / S-class (W215) / S-class (W220) / SL (W129) / SL (W230) / SLK (R170) / VIANO (W639) / VITO (W639) | VKPC 91409 | <b>TOYOTA</b><br>CARINA / CELICA / COROLLA / CORONA / MR 2  | VKPC 91615 | <b>TOYOTA</b><br>PREVIA  |
| VKPC 88848 | <b>SMART</b><br>CABRIO / CITY-COUPE / CROSSBLADE / FORTWO / ROADSTER   | VKPC 91413 | <b>TOYOTA</b><br>CARINA / COROLLA / CORONA / STARLET / TERCEL   | VKPC 91804 | <b>TOYOTA</b><br>HILUX   |
| VKPC 88850 | <b>MERCEDES-BENZ</b><br>G-class (W463) / SPRINTER 2-t (W901 / W902) / SPRINTER 3-t (W903) / SPRINTER 4-t (W904)  | VKPC 91414 | <b>TOYOTA</b><br>CARINA / CELICA / COROLLA / CORONA / MR 2  | VKPC 91805 | <b>TOYOTA</b><br>YARIS   |
| VKPC 88851 | <b>MERCEDES-BENZ</b><br>A-class (W168) / Vaneo (W414)  | VKPC 91415 | <b>TOYOTA</b><br>CARINA / CELICA / COROLLA / CORONA   | VKPC 91806 | <b>TOYOTA</b><br>COROLLA / PRIUS / YARIS   |
| VKPC 88853 | <b>MERCEDES-BENZ</b><br>C-class (W203) / C-class (W204) / CLK (W209) / E-class (W211)  | VKPC 91416 | <b>TOYOTA</b><br>CARINA / CELICA / COROLLA / CORONA   | VKPC 91807 | <b>TOYOTA</b><br>YARIS   |
| VKPC 88854 | <b>MERCEDES-BENZ</b><br>C-class (W202) / C-class (W203) / CLK (W208) / E-class (W210) / SLK (R170)   | VKPC 91416 | <b>TOYOTA</b><br>AVENSIS / CARINA / COROLLA   | VKPC 91808 | <b>TOYOTA</b><br>AVENSIS / CELICA / COROLLA / COROLLA VERSO / MR 2 / RAV 4                 |
| VKPC 88855 | <b>MERCEDES-BENZ</b><br>C-class (W203) / C-class (W204) / CLK (W209) / E-class (W211)  | VKPC 91417 | <b>TOYOTA</b><br>COROLLA / PASEO / STARLET / TERCEL   | VKPC 91813 | <b>TOYOTA</b><br>AVENSIS / AVENSIS VERSO / CAMRY / PICNIC / PREVIA / PREVIA/TARAGO / RAV 4 |
| VKPC 90200 | <b>DAEWOO</b><br>ESPERO / LANOS / NEXIA  | VKPC 91417 | <b>TOYOTA</b><br>COROLLA / PASEO / STARLET / TERCEL   | VKPC 91814 | <b>TOYOTA</b><br>AVENSIS VERSO / COROLLA / COROLLA VERSO / PICNIC / PREVIA / RAV 4         |
| VKPC 90202 | <b>DAEWOO</b><br>LANOS   | VKPC 91427 | <b>TOYOTA</b><br>LITEACE / MASTERACE / PUBLICA / SPACE CRUISER / TOWNACE  | VKPC 92000 | <b>NISSAN</b><br>TERRANO   |
| VKPC 90402 | <b>DAEWOO</b><br>KALOS / LACETTI / NUBIRA  | VKPC 91428 | <b>TOYOTA</b><br>CORONA / CRESSIDA / CROWN / DYNA / HIACE / HILUX / LITEACE / MASTERACE / MODEL-F / SPACE CRUISER / TOWNACE / TOYOACE | VKPC 92001 | <b>NISSAN</b><br>SUNNY   |
| VKPC 90450 | <b>CHEVROLET</b><br>MATIZ / SPARK  | VKPC 91431 | <b>TOYOTA</b><br>COROLLA / TERCEL   | VKPC 92203 | <b>NISSAN</b><br>CARGO / CHERRY / PULSAR / SUNNY / VANETTE / VIOLET                        |
| VKPC 91402 | <b>DAEWOO</b><br>MATIZ / TICO  | VKPC 91441 | <b>TOYOTA</b><br>COROLLA / TERCEL   | VKPC 92204 | <b>NISSAN</b><br>MARCH / MICRA   |
| VKPC 91402 | <b>DAIHATSU</b><br>CHARMANT  | VKPC 91442 | <b>TOYOTA</b><br>AVENSIS / CARINA / CELICA / COROLLA  | VKPC 92205 | <b>NISSAN</b><br>CHERRY / PRAIRIE / PULSAR / SUNNY   |
| VKPC 91404 | <b>TOYOTA</b><br>STARLET   | VKPC 91604 | <b>TOYOTA</b><br>AVENSIS / CARINA / CELICA / COROLLA  | VKPC 92208 | <b>NISSAN</b><br>MARCH / MICRA   |
| VKPC 91404 | <b>TOYOTA</b><br>CAMRY / CARINA / CELICA / CORONA / CRESSIDA   | VKPC 91606 | <b>TOYOTA</b><br>CAMRY / CARINA / CELICA / CORONA / MR 2  | VKPC 92209 | <b>NISSAN</b><br>MARCH / MICRA   |
| VKPC 91405 | <b>TOYOTA</b><br>AVENSIS / CAMRY / CARINA / COROLLA / CORONA / LITEACE / MASTERACE / MODEL-F / PICNIC / SPACE CRUISER / TOWNACE  | VKPC 91607 | <b>TOYOTA</b><br>BLIZZARD / CRESSIDA / CROWN / DYNA / HIACE / HILUX / LAND CRUISER / TOYOACE  | VKPC 92401 | <b>NISSAN</b><br>BLUEBIRD / PRAIRIE / STANZA   |
|            |  |            | <b>VW</b><br>TARO   | VKPC 92404 | <b>NISSAN</b><br>BLUEBIRD / PRAIRIE / PRAIRIE PRO / STANZA / SUNNY                         |
|            |  |            | <b>TOYOTA</b><br>COROLLA / TERCEL   | VKPC 92406 | <b>NISSAN</b><br>SUNNY   |
|            |  |            | <b>TOYOTA</b><br>AVENSIS / CARINA / CELICA / COROLLA  | VKPC 92408 | <b>NISSAN</b><br>100 NX / ALMERA / PRAIRIE / PRIMERA / SERENA / SUNNY                      |
|            |  |            | <b>TOYOTA</b><br>CELICA   | VKPC 92412 | <b>NISSAN</b><br>100 NX / ALMERA / PRAIRIE PRO / PRIMERA / SERENA / SUNNY                  |
|            |  |            | <b>TOYOTA</b><br>CAMRY / CARINA / CELICA / CORONA / MR 2  |            |  |
|            |  |            | <b>TOYOTA</b><br>BLIZZARD / CRESSIDA / CROWN / DYNA / HIACE / HILUX / LAND CRUISER / TOYOACE  |            |  |
|            |  |            | <b>TOYOTA</b><br>CRESSIDA / CROWN / DYNA / HIACE / HILUX / LAND CRUISER / TOYOACE   |            |  |
|            |  |            | <b>VW</b><br>TARO   |            |  |















|   |   |   |  |   |  |
|---|---|---|--|---|--|
|  |  |  |                                   |  |   |
| VKPC 92422  | NISSAN<br>STANZA / SUNNY  | VKPC 93405  | HONDA<br>ACCORD / INTEGRA / PRELUDE<br>/ QUINTET   | VKPC 94613  | MAZDA<br>B-SERIE (UN)  |
| VKPC 92600  | NISSAN<br>CARGO / SERENA / TRADE /<br>VANETTE                                     | VKPC 93410  | HONDA<br>ACCORD / PRELUDE  | VKPC 94614  | MAZDA<br>B-SERIE (UN)  |
| VKPC 92601  | NISSAN<br>200 SX / BLUEBIRD / CEDRIC /<br>LAUREL / SILVIA / VIOLET                | VKPC 93411  | HONDA<br>CIVIC / CRX   | VKPC 94617  | MAZDA<br>323 (BJ)  |
| VKPC 92610  | NISSAN<br>BLUEBIRD / CARGO / VANETTE  | VKPC 93415  | HONDA<br>CIVIC / INTEGRA   | VKPA 95003  | HYUNDAI<br>TERRACAN  |
| VKPC 92615  | NISSAN<br>BLUEBIRD / STANZA   | VKPC 93600  | HONDA<br>ACCORD / PRELUDE  | VKPC 95003  | MITSUBISHI<br>GALANT   |
| VKPC 92630  | NISSAN<br>BLUEBIRD / PICK UP /<br>TERRANO / VIOLET                                | VKPC 93601  | HONDA<br>ACCORD / CIVIC / CRX /<br>ODYSSEY / PRELUDE /<br>SHUTTLE  | VKPC 95004  | MITSUBISHI<br>CELESTE / FIORE / FORTE /<br>GALANT / L 200 / L 300 /<br>LANCER / PICK UP / SAPPORO /<br>SIGMA               |
| VKPC 92634  | NISSAN<br>CARGO / URVAN / VANETTE   |   | ROVER<br>600   | VKPC 95005  | MITSUBISHI<br>LANCER / MIRAGE  |
| VKPC 92645  | NISSAN<br>PICK UP / TERRANO   | VKPC 93603  | HONDA<br>JAZZ  | VKPC 95007  | HYUNDAI<br>ATOS / ATOS PRIME / GETZ  |
| VKPC 92649  | NISSAN<br>PICK UP   | VKPC 93604  | HONDA<br>CR-V / FR-V / STREAM  | VKPC 95008  | HYUNDAI<br>ACCENT / EXCEL / LANTRA /<br>PONY / S COUPE   |
| VKPC 92650  | NISSAN<br>PICK UP   | VKPC 94002  | KIA<br>MENTOR / PRIDE / SEPHIA   |   | MITSUBISHI<br>COLT / FIORE / LANCER /<br>MIRAGE  |
| VKPC 92651  | NISSAN<br>PICK UP   |   | MAZDA<br>121 (DA) / 121 (DB) / 121<br>(JASM, JBSM) / 323 (BG) / 323<br>(BJ) / 323 (BW) / DEMIO (DW) /<br>MX-3 (EC) |   | PROTON<br>PERSONA 300 / PERSONA 400  |
| VKPC 92800  | NISSAN<br>PATROL  |   | KIA<br>PRIDE   | VKPC 95010  | MITSUBISHI<br>CHARIOT / COLT / CORDIA /<br>FIORE / GALANT / LANCER /<br>MIRAGE / SAPPORO / SIGMA /<br>SPACE WAGON / TREDIA |
| VKPC 92802  | NISSAN<br>280 ZX,ZXT / CARGO / LAUREL<br>/ PATROL / URVAN / VANETTE               | VKPC 94202  | MAZDA<br>323 (BD) / 323 (BF)   |   | MITSUBISHI<br>CHARIOT / COLT / FIORE /<br>GALANT / LANCER / MIRAGE /<br>SAPPORO / SIGMA / SPACE<br>WAGON                   |
| VKPC 92810  | NISSAN<br>PATROL / PATROL GR  | VKPC 94423  | MAZDA<br>626 (GC) / 929 (HB) / BONGO /<br>B-SERIE (UF)   | VKPC 95402  | MITSUBISHI<br>COLT / FIORE / GALANT /<br>LANCER / MIRAGE   |
| VKPC 92820  | NISSAN<br>PATROL  | VKPC 94424  | KIA<br>SPORTAGE  | VKPC 95404  | MITSUBISHI<br>COLT / FIORE / GALANT /<br>LANCER / MIRAGE   |
| VKPC 92822  | NISSAN<br>MAXIMA QX   |   | MAZDA<br>626 (GD) / 626 (GV) / 929 (HC) /<br>BONGO / B-SERIE (UF) / E<br>2000, E 2200                              | VKPC 95405  | MITSUBISHI<br>L 200 / L 300 / PAJERO /<br>SHOGUN   |
| VKPC 92823  | NISSAN<br>TERRANO   | VKPC 94425  | KIA<br>SPORTAGE  | VKPC 95422  | MITSUBISHI<br>FORTE / GALANT / L 300 /<br>PAJERO / SAPPORO / SHOGUN<br>/ SIGMA   |
| VKPC 92926  | NISSAN<br>CARGO / SERENA / TRADE /<br>VANETTE / VANETTE CARGO                     |   | MAZDA<br>626 (GD) / 626 (GV) / B-SERIE<br>(UF)   | VKPC 95423  | MITSUBISHI<br>CHARIOT / GALANT   |
| VKPC 92928  | NISSAN<br>SUNNY / VANETTE CARGO   | VKPC 94434  | MAZDA<br>323 (BG) / MX-5 (NA) / MX-5<br>(NB)   | VKPC 95424  | HYUNDAI<br>LANTRA / SONATA   |
| VKPC 92929  | NISSAN<br>TERRANO   | VKPC 94452  | MAZDA<br>626 (GC)  |   | MITSUBISHI<br>COLT / ECLIPSE / FIORE /<br>GALANT / LANCER  |
| VKPC 93000  | HONDA<br>CIVIC / HR-V   | VKPC 94602  | MAZDA<br>626 (GE) / MX-3 (EC) / MX-6<br>(GE) / XEDOS 6   | VKPC 95426  | MITSUBISHI<br>CHARIOT / FIORE / LANCER /<br>SPACE WAGON  |
| VKPC 93001  | HONDA<br>CR-V / S-MX  |   | MAZDA<br>626 (GE) / MX-3 (EC) / MX-6<br>(GE) / XEDOS 6 / XEDOS 9   |   |  |
| VKPC 93205  | HONDA<br>CIVIC / CRX / INTEGRA  |   |  |   |  |
| VKPC 93213  | ROVER<br>200 (XH)   |   |  |   |  |









|            |  |            |   |
|------------|--|------------|---|
| VKPC 95427 | <b>PROTON</b><br>PERSONA 300 / PERSONA 400                       | VKPC 96204 | <b>SUZUKI</b><br>ALTO / JIMNY / MIGHTY - BOY /<br>SAMURAI / SJ 410 / SUPER<br>CARRY           |
|            | <b>HYUNDAI</b><br>LANTRA   | VKPC 96210 | <b>SUBARU</b><br>JUSTY  |
| VKPC 95602 | <b>mitsubishi</b><br>COLT / FIORE / LANCER /<br>MIRAGE           |            | <b>SUZUKI</b><br>ALTO / CARRY / JUSTY / SWIFT /<br>WAGON R+                                   |
| VKPC 95611 | <b>HYUNDAI</b><br>SONATA   | VKPC 96212 | <b>SUZUKI</b><br>SAMURAI / SJ 413 / SWIFT   |
|            | <b>mitsubishi</b><br>CHARIOT / SPACE WAGON                       | VKPC 96402 | <b>SUZUKI</b><br>BALENO / SWIFT / VITARA / X-<br>90   |
| VKPC 95612 | <b>mitsubishi</b><br>CHARIOT / ECLIPSE / SPACE<br>WAGON          | VKPC 96403 | <b>SUZUKI</b><br>GRAND VITARA   |
| VKPC 95614 | <b>mitsubishi</b><br>CHARIOT / FIORE / LANCER /<br>SPACE WAGON   | VKPC 97000 | <b>DAIHATSU</b><br>CHARADE  |
|            | <b>PROTON</b><br>PERSONA 400                                     | VKPC 97001 | <b>DAIHATSU</b><br>CHARADE  |
| VKPC 95800 | <b>mitsubishi</b><br>PAJERO / PAJERO CLASSIC /<br>SHOGUN         | VKPC 97002 | <b>DAIHATSU</b><br>CUORE / L200 / L201 / MOVE   |
| VKPC 95850 | <b>HYUNDAI</b><br>SANTA FE / SONATA / TRAJET                     | VKPC 97200 | <b>DAIHATSU</b><br>APPLAUSE / CHARADE / GRAN<br>MOVE  |
| VKPA 95851 | <b>HYUNDAI</b><br>XG 30  | VKPC 97201 | <b>DAIHATSU</b><br>FEROZA / SPORTRAK / TERIOS   |
| VKPC 95852 | <b>HYUNDAI</b><br>COUPE / MATRIX                                 | VKPC 98000 | <b>ISUZU</b><br>117 COUPE / ASKA / BIGHORN<br>/ ELF 350 / FASTER RODEO /<br>FLORIAN / TROOPER |
| VKPC 95853 | <b>HYUNDAI</b><br>ACCENT / ELANTRA / GETZ /<br>MATRIX / SANTA FE | VKPC 99404 | <b>SUBARU</b><br>LEONE  |
| VKPC 95854 | <b>HYUNDAI</b><br>H-1  | VKPC 99406 | <b>SUBARU</b><br>L SERIES / LEONE   |
|            | <b>KIA</b><br>SORENTO  | VKPC 99407 | <b>SUBARU</b><br>FORESTER / IMPREZA /<br>LEGACY / OUTBACK                                     |
| VKPC 95856 | <b>HYUNDAI</b><br>ACCENT / GETZ                                  |            |   |
| VKPC 95857 | <b>HYUNDAI</b><br>ACCENT / COUPE / ELANTRA /<br>GETZ / MATRIX    |            |   |
| VKPC 95858 | <b>HYUNDAI</b><br>ACCENT / GETZ                                  |            |   |
| VKPC 95859 | <b>HYUNDAI</b><br>COUPE  |            |   |
| VKPC 95863 | <b>mitsubishi</b><br>LANCER                                      |            |   |
| VKPC 95864 | <b>mitsubishi</b><br>LANCER / OUTLANDER                          |            |   |
| VKPC 96000 | <b>SUZUKI</b><br>CARRY / EVERY                                   |            |   |
| VKPC 96001 | <b>SUZUKI</b><br>CULTUS / GRAND VITARA                           |            |   |















|  |                        |  |   |  |       |
|---|---|---|--|---|--|
| VKMM 3PK648   | <b>FORD</b><br>ESCORT BOX 86 / ESCORT IV /<br>ESCORT V / FIESTA BOX /<br>COURRIER / ORION II            | VKMM 3PK1006  | <b>FIAT</b><br>PUNTO (176)   | VKMM 4PK775   | <b>RENAULT</b><br>ESPACE IV / VEL SATIS  |
| VKMM 3PK649   | <b>FORD</b><br>MONDEO III   | VKMM 3PK1023  | <b>FORD</b><br>FIESTA III / P 100 II / SIERRA  | VKMM 4PK780   | <b>BMW</b><br>5 (E39) / 5 Touring (E39) / 7<br>(E38)                                     |
| VKMM 3PK668   | <b>FIAT</b><br>BRAVA/BRAVO (182) / MAREA /<br>MULTIPLA / PALIO/SIENA                                    | VKMM 3PK1040  | <b>RENAULT</b><br>CLIO II / KANGOO   |   | <b>DAIHATSU</b><br>TERIOS  |
|   | <b>LANCIA</b><br>DELTA II / LYBRA   | VKMM 4PK545   | <b>FIAT</b><br>CINQUECENTO   |   | <b>ROVER</b><br>100  |
| VKMM 3PK675   | <b>FORD</b><br>ESCORT V / ESCORT VI / FIESTA<br>BOX / COURRIER / FIESTA III /<br>FIESTA IV              | VKMM 4PK560   | <b>RENAULT</b><br>SAFRANE I  |   | <b>VOLVO</b><br>S40 I - V40  |
| VKMM 3PK712   | <b>RENAULT</b><br>CLIO I / MEGANE I / SCENIC I  | VKMM 4PK654   | <b>FORD</b><br>ESCORT BOX 95 / ESCORT V /<br>ESCORT VI / ESCORT VII /<br>FIESTA BOX / COURRIER /<br>FIESTA III / FIESTA IV   | VKMM 4PK781   | <b>BMW</b><br>3 (E36) / 3 Touring (E36) / 5<br>(E34) / 5 Touring (E34)                   |
| VKMM 3PK719   | <b>FIAT</b><br>PUNTO (176)  | VKMM 4PK668   | <b>FIAT</b><br>500 / BRAVO / DOBLO /<br>GRANDE PUNTO / PALIO/SIENA<br>/ PANDA (169) / PUNTO (188) /<br>SEICENTO / STRADA   |   | <b>OPEL</b><br>OMEGA B   |
| VKMM 3PK738   | <b>MG</b><br>MG ZT  | VKMM 4PK675   | <b>FIAT</b><br>BRAVA/BRAVO (182) /<br>CINQUECENTO / DOBLO / IDEA<br>/ MAREA / PALIO/SIENA /<br>PANDA (141A_) / PUNTO (176)<br>/ PUNTO (188) / SEICENTO /<br>STILO / STRADA | VKMM 4PK795   | <b>CITROËN</b><br>C25  |
|   | <b>ROVER</b><br>75  |   | <b>KIA</b><br>PICANTO  |   | <b>HONDA</b><br>CIVIC  |
| VKMM 3PK740   | <b>NISSAN</b><br>KUBISTAR   |   | <b>LANCIA</b><br>Y / Y10   | VKMM 4PK810   | <b>NISSAN</b><br>100 NX / ALMERA / SUNNY   |
|   | <b>RENAULT</b><br>CLIO II / KANGOO / THALIA /<br>TWINGO   |   | <b>CITROËN</b><br>BX / C15 / VISA / ZX   |   | <b>PEUGEOT</b><br>205 / 309  |
| VKMM 3PK753   | <b>LAND ROVER</b><br>FREELANDER I   | VKMM 4PK698   | <b>FIAT</b><br>BRAVA/BRAVO (182) / DOBLO /<br>MAREA / PALIO/SIENA /<br>STRADA  | VKMM 4PK820   | <b>DAIHATSU</b><br>CHARADE / GRAN MOVE   |
|   | <b>MG</b><br>MG ZR / MG ZS  |   | <b>PEUGEOT</b><br>205 / 309 / 405 I / 405 II   |   | <b>HONDA</b><br>CR-V   |
|   | <b>ROVER</b><br>200 (RF) / 200 (XW) / 200<br>coupe (RF) / 25 / 400 (RT) / 400<br>(XW) / 45 / STREETWISE |   | <b>PEUGEOT</b><br>205  | VKMM 4PK825   | <b>NISSAN</b><br>ALMERA  |
| VKMM 3PK814   | <b>FORD</b><br>P 100 II / SIERRA  | VKMM 4PK720   | <b>RENAULT</b><br>CLIO II / KANGOO / TWINGO  |   | <b>ROVER</b><br>400 (RT)   |
| VKMM 3PK828   | <b>FORD</b><br>FIESTA III / P 100 II / SIERRA   | VKMM 4PK730   | <b>FORD</b><br>MONDEO III / TRANSIT  |   | <b>FORD</b><br>FIESTA III  |
| VKMM 3PK835   | <b>RENAULT</b><br>MEGANE I / SCENIC I   | VKMM 4PK735   | <b>RENAULT</b><br>CLIO I / CLIO II / KANGOO /<br>TWINGO  | VKMM 4PK836   | <b>NISSAN</b><br>ALMERA / ALMERA TINO /<br>PRIMERA                                       |
| VKMM 3PK863   | <b>MINI</b><br>MINI   |   | <b>ROVER</b><br>100 / 200 (XW) / 400 (XW)  |   | <b>BMW</b><br>3 (E36) / 3 Compact (E36) / 3<br>Touring (E36)                             |
| VKMM 3PK866   | <b>CITROËN</b><br>JUMPER (230)  | VKMM 4PK736   | <b>ROVER</b><br>100 / 200 (XW) / 400 (XW)  | VKMM 4PK841   | <b>AUDI</b><br>A4 (8E2, B6) / A4 Avant (8E5,<br>B6) / A6 (4B, C5) / A6 Avant<br>(4B, C5) |
|   | <b>PEUGEOT</b><br>BOXER I   | VKMM 4PK755   | <b>CITROËN</b><br>JUMPER (230) / JUMPER (244)  |   | <b>CITROËN</b><br>ZX   |
| VKMM 3PK915   | <b>FIAT</b><br>BRAVA/BRAVO (182) / DOBLO /<br>MAREA / PALIO/SIENA / PUNTO<br>(176) / STRADA             |   | <b>FIAT</b><br>BRAVA/BRAVO (182) / DUCATO<br>(230)   |   | <b>FIAT</b><br>BRAVA/BRAVO (182) / DOBLO /<br>MAREA / PALIO/SIENA /<br>STRADA            |
|   | <b>CITROËN</b><br>JUMPER (230) / XM II  |   | <b>PEUGEOT</b><br>BOXER I / BOXER II   | VKMM 4PK843   | <b>PEUGEOT</b><br>205 / 309 / 405 I / 405 II   |
| VKMM 3PK946   | <b>PEUGEOT</b><br>605 / BOXER I   |   |  |   | <b>BMW</b><br>5 (E60)  |







|   |   |   |   |   |  |
|---|---|---|---|---|--|
|  |    |  |   |  |                                 |
| VKMV 4PK854   | <b>FIAT</b><br>PALIO/SIENA / PUNTO (176)  |   | <b>RENAULT</b><br>CLIO II / KANGOO / THALIA   | VKMV 4PK1230  | <b>PEUGEOT</b><br>205 / 309  |
| VKMV 4PK855   | <b>AUDI</b><br>100 (4A, C4) / 100 Avant (4A, C4) / 80 (8C, B4) / 80 Avant (8C, B4) / A4 (8D2, B5) / A4 Avant (8D5, B5) / A6 (4A, C4) / A6 Avant (4A, C4) / A6 (4B, C5) / A6 Avant (4B, C5) / CABRIOLET (8G7, B4) / COUPE (89, 8B) | VKMV 4PK928   | <b>NISSAN</b><br>KUBISTAR   | VKMV 4PK1237  | <b>AUDI</b><br>A4 (8D2, B5) / A4 Avant (8D5, B5) / A6 (4B, C5) / A6 Avant (4B, C5) / A8 (4D2, 4D8) / ALLROAD (4BH) |
|   | <b>NISSAN</b><br>200 SX   | VKMV 4PK946   | <b>RENAULT</b><br>CLIO II / KANGOO / THALIA / TWINGO  |   | <b>SKODA</b><br>SUPERB   |
|   | <b>PEUGEOT</b><br>205 / 306   |   | <b>CITROËN</b><br>JUMPER (230) / XM II  |   | <b>VW</b><br>PASSAT (3B2) / Variant (3B5) / PASSAT (3B3) / Variant (3B6)   |
|   | <b>SKODA</b><br>SUPERB  | VKMV 4PK950   | <b>FIAT</b><br>PUNTO (176)  | VKMV 4PK1238  | <b>RENAULT</b><br>CLIO II / KANGOO   |
|   | <b>VW</b><br>PASSAT (3B2) / Variant (3B5) / PASSAT (3B3) / Variant (3B6)  |   | <b>PEUGEOT</b><br>605 / BOXER I   | VKMV 4PK1272  | <b>RENAULT</b><br>MEGANE I / SCENIC I  |
| VKMV 4PK860   | <b>CITROËN</b><br>BERLINGO / XSARA / ZX   | VKMV 4PK954   | <b>SKODA</b><br>FAVORIT / FELICIA I (6U1) / Estate (6U5) / Fun (797) / FELICIA II (6U1) / FELICIA II Estate (6U5)                                     | VKMV 4PK1538  | <b>RENAULT</b><br>CLIO II / KANGOO / THALIA  |
|   | <b>FORD</b><br>FIESTA III   |   | <b>CITROËN</b><br>BX / ZX   | VKMV 5PK628   | <b>FORD</b><br>MONDEO IV / S-MAX   |
| VKMV 4PK863   | <b>BMW</b><br>3 (E46) / 3 Compact (E46) / 3 Convertible (E46) / 3 Coupe (E46) / 3 Touring (E46) / 5 (E60) / 5 Touring (E61) / X3 / X5 / Z4  | VKMV 4PK962   | <b>PEUGEOT</b><br>205 / 309 / 405 I / 405 II  |   | <b>VOLVO</b><br>S80  |
|   |   |   | <b>ALFA ROMEO</b><br>155  | VKMV 5PK672   | <b>FORD</b><br>FIESTA BOX / COURRIER / FIESTA IV   |
| VKMV 4PK866   | <b>CITROËN</b><br>JUMPER (230)  |   | <b>FIAT</b><br>BRAVA/BRAVO (182) / MAREA / MULTIPLA / UNO   | VKMV 5PK690   | <b>CITROËN</b><br>AX / XM I  |
|   | <b>PEUGEOT</b><br>BOXER I   | VKMV 4PK968   | <b>LANCIA</b><br>DEDRA / DELTA II / LYBRA   |   | <b>PEUGEOT</b><br>106 I / 605  |
| VKMV 4PK878   | <b>RENAULT</b><br>ESPACE II / R21 / R25   |   | <b>BMW</b><br>3 (E46) / 3 Compact (E46) / 3 Coupe (E46) / 3 Touring (E46)   | VKMV 5PK698   | <b>CITROËN</b><br>BX   |
| VKMV 4PK882   | <b>AUDI</b><br>100 (4A, C4) / 100 Avant (4A, C4) / 80 (8C, B4) / 80 Avant (8C, B4) / A6 (4A, C4) / A6 Avant (4A, C4) / CABRIOLET (8G7, B4) / COUPE (89, 8B)   | VKMV 4PK980   | <b>FIAT</b><br>PUNTO (176)  | VKMV 5PK705   | <b>FORD</b><br>ESCORT BOX 95 / ESCORT VI / ESCORT VII  |
|   | <b>BMW</b><br>X3  |   | <b>RENAULT</b><br>CLIO II / KANGOO  | VKMV 5PK710   | <b>CITROËN</b><br>XM I / XM II   |
|   | <b>OPEL</b><br>ASTRA G  | VKMV 4PK1006  | <b>FIAT</b><br>PUNTO (176)  |   | <b>PEUGEOT</b><br>605  |
|   | <b>VAUXHALL</b><br>ASTRA Mk IV  | VKMV 4PK1020  | <b>CITROËN</b><br>AX  | VKMV 5PK715   | <b>CITROËN</b><br>BX / XM I  |
| VKMV 4PK889   | <b>BMW</b><br>3 (E36) / 3 Compact (E36) / 3 Convertible (E36) / 3 Coupe (E36) / 3 Touring (E36) / 5 (E34) / 5 Touring (E34) / Z3  | VKMV 4PK1045  | <b>LANCIA</b><br>DEDRA  |   | <b>PEUGEOT</b><br>605  |
|   |   | VKMV 4PK1072  | <b>RENAULT</b><br>CLIO I  | VKMV 5PK738   | <b>LAND ROVER</b><br>FREELANDER I  |
| VKMV 4PK903   | <b>FIAT</b><br>SCUDO (220) / UNO  | VKMV 4PK1165  | <b>RENAULT</b><br>TWINGO  |   | <b>MG</b><br>MG ZR / MG ZT   |
|   | <b>PEUGEOT</b><br>EXPERT I  | VKMV 4PK1205  | <b>RENAULT</b><br>SAFRANE I   |   | <b>ROVER</b><br>200 (RF) / 200 coupe (RF) / 25 / 45 / 75 / STREETWISE  |
| VKMV 4PK908   | <b>NISSAN</b><br>KUBISTAR   | VKMV 4PK1217  | <b>AUDI</b><br>A4 (8E2, B6) / A4 Avant (8E5, B6) / A4 (8EC) / A4 Avant (8ED) / A4 Convertible (8H7) / A6 (4B, C5) / A6 Avant (4B, C5) / ALLROAD (4BH) | VKMV 5PK740   | <b>PEUGEOT</b><br>605  |
|   |   | VKMV 4PK1218  | <b>RENAULT</b><br>CLIO I / EXPRESS/EXTRA / RAPID  | VKMV 5PK770   | <b>CITROËN</b><br>XM I / XM II   |
|   |   |   |   | VKMV 5PK775   | <b>CITROËN</b><br>AX / SAXO  |









|   |  |   |   |   |   |
|---|--|---|---|---|---|
|  |   |  |    |  |    |
| VKMMV 5PK780  | <b>PEUGEOT</b><br>106 I / 106 II<br><b>ROVER</b><br>100<br><b>CITROËN</b><br>SAXO<br><b>PEUGEOT</b><br>106 II                              | VKMMV 5PK881  | <b>RENAULT</b><br>CLIO I / CLIO II / KANGOO<br><b>VAUXHALL</b><br>ASTRA Mk IV / SIGNUM / VECTRA Mk I / VECTRA Mk II / VX 220 / ZAFIRA Mk I / ZAFIRA Mk II<br><b>CITROËN</b><br>BERLINGO / XSARA / ZX<br><b>PEUGEOT</b><br>306 / PARTNER | VKMMV 5PK938  | <b>FIAT</b><br>BRAVA/BRAVO (182) / DOBLO / MAREA / MULTIPLA / PALIO / SIENA / PUNTO (176) / STILO<br><b>LANCIA</b><br>DEDRA / DELTA II / LYBRA<br><b>OPEL</b><br>ASTRA G / ASTRA H / COMBO B / CORSA C / MERIVA / SIGNUM / TIGRA Twin Top / VECTRA C / ZAFIRA A<br><b>VAUXHALL</b><br>ASTRA Mk IV / ASTRA Mk V / COMBO II / CORSA Mk II / MERIVA / TIGRA Mk II / VECTRA Mk II / ZAFIRA Mk I |
| VKMMV 5PK785  | <b>BMW</b><br>3 (E36) / 3 Convertible (E36) / 3 Coupe (E36) / Z3   | VKMMV 5PK882  | <b>FORD</b><br>MONDEO I / MONDEO II   | VKMMV 5PK950  | <b>BMW</b><br>3 (E46) / 3 Coupe (E46) / 3 Touring (E46)   |
| VKMMV 5PK810  | <b>BMW</b><br>3 (E46) / 3 Touring (E46) / 5 (E39) / 5 Touring (E39) / X5   | VKMMV 5PK884  | <b>LAND ROVER</b><br>FREELANDER I   | VKMMV 5PK960  | <b>CITROËN</b><br>AX / SAXO / XSARA   |
| VKMMV 5PK820  | <b>RENAULT</b><br>SAFRANE I  | VKMMV 5PK886  | <b>SUBARU</b><br>FORESTER / IMPREZA / LEGACY  | VKMMV 5PK962  | <b>NISSAN</b><br>MICRA  |
| VKMMV 5PK829  | <b>BMW</b><br>3 Convertible (E46) / 3 Coupe (E46) / Z3   | VKMMV 5PK890  | <b>RENAULT</b><br>EXPRESS/EXTRA/RAPID / R11 / SUPER 5   | VKMMV 5PK967  | <b>PEUGEOT</b><br>106 I / 106 II  |
| VKMMV 5PK836  | <b>CITROËN</b><br>XSARA  | VKMMV 5PK891  | <b>FORD</b><br>FIESTA BOX / COURRIER / FIESTA IV  | VKMMV 5PK970  | <b>FIAT</b><br>TIPO   |
| VKMMV 5PK847  | <b>BMW</b><br>3 (E46) / 3 Touring (E46) / 5 (E39) / 5 Touring (E39)  | VKMMV 5PK905  | <b>BMW</b><br>3 (E36) / 3 Convertible (E36) / 3 Coupe (E36)   | VKMMV 5PK967  | <b>LANCIA</b><br>DEDRA / DELTA II   |
| VKMMV 5PK850  | <b>FORD</b><br>FOCUS II  | VKMMV 5PK906  | <b>FORD</b><br>FOCUS II   | VKMMV 5PK980  | <b>FIAT</b><br>SCUDO (220)  |
| VKMMV 5PK850  | <b>RENAULT</b><br>CLIO I / R11 / R19 / R21 / SUPER 5 / TRAFIC I  | VKMMV 5PK907  | <b>VOLVO</b><br>C30 / C70 - S70 / S40 II - V50  | VKMMV 5PK970  | <b>ALFA ROMEO</b><br>145/146 / 155  |
| VKMMV 5PK850  | <b>VOLVO</b><br>C30 / C70 - S70 / S40 II - V50   | VKMMV 5PK910  | <b>RENAULT</b><br>TWINGO  | VKMMV 5PK986  | <b>FIAT</b><br>CROMA (154) / TIPO   |
| VKMMV 5PK850  | <b>CITROËN</b><br>XM I / XM II   | VKMMV 5PK915  | <b>BMW</b><br>3 (E36) / 3 Compact (E36) / 3 Convertible (E36) / 3 Coupe (E36) / 3 Touring (E36) / 5 (E34) / 5 (E39) / 5 Touring (E34) / 5 Touring (E39) / 7 (E38)   | VKMMV 5PK986  | <b>LANCIA</b><br>DEDRA / DELTA II   |
| VKMMV 5PK850  | <b>HONDA</b><br>JAZZ   | VKMMV 5PK915  | <b>ALFA ROMEO</b><br>145/146  | VKMMV 5PK1004   | <b>BMW</b><br>5 (E34) / 7 (E32) / 7 (E38) / 8 (E31) / Z8  |
| VKMMV 5PK863  | <b>RENAULT</b><br>SAFRANE I  | VKMMV 5PK915  | <b>FIAT</b><br>CROMA (154)  | VKMMV 5PK1010   | <b>ALFA ROMEO</b><br>145/146 / 155  |
| VKMMV 5PK863  | <b>BMW</b><br>3 (E46) / 3 Compact (E46) / 3 Convertible (E46) / 3 Coupe (E46) / 3 Touring (E46) / 5 (E39) / 5 Touring (E39) / 7 (E38) / X5 | VKMMV 5PK915  | <b>LANCIA</b><br>DEDRA / DELTA II   | VKMMV 5PK1020   | <b>FIAT</b><br>CROMA (154) / TIPO   |
| VKMMV 5PK864  | <b>ALFA ROMEO</b><br>145/146   | VKMMV 5PK915  | <b>LANCIA</b><br>DEDRA / DELTA II   | VKMMV 5PK1020   | <b>LANCIA</b><br>DEDRA / DELTA II   |
| VKMMV 5PK869  | <b>LAND ROVER</b><br>FREELANDER I  | VKMMV 5PK915  | <b>RENAULT</b><br>CLIO I / CLIO II / KANGOO / TWINGO  | VKMMV 5PK1020   | <b>BMW</b><br>5 (E39) / 5 Touring (E39) / 8 (E31)   |
| VKMMV 5PK869  | <b>MG</b><br>MG ZT   | VKMMV 5PK915  | <b>ALFA ROMEO</b><br>145/146  | VKMMV 5PK1020   | <b>PEUGEOT</b><br>405 I   |
| VKMMV 5PK870  | <b>ROVER</b><br>75   | VKMMV 5PK915  | <b>LANCIA</b><br>DEDRA / DELTA II   | VKMMV 5PK1020   | <b>CITROËN</b><br>AX / SAXO   |
| VKMMV 5PK870  | <b>FORD</b><br>MONDEO I / MONDEO II  | VKMMV 5PK915  | <b>FIAT</b><br>PUNTO (176)  | VKMMV 5PK1020   | <b>FIAT</b><br>CROMA (154)  |
| VKMMV 5PK880  | <b>OPEL</b><br>ASTRA G / SIGNUM / SPEEDSTER / VECTRA B / VECTRA C / ZAFIRA A / ZAFIRA B  | VKMMV 5PK935  |   | VKMMV 5PK1020   | <b>PEUGEOT</b><br>106 I / 106 II  |







|   |   |   |  |   |   |
|---|---|---|--|---|---|
|  |                    |  |                    |  |    |
| VKMM 5PK1025  | FORD<br>ESCORT VI   |   | NISSAN<br>INTERSTAR / PRIMASTAR  | VKMM 5PK1195  | CITROËN<br>XM I / XM II   |
| VKMM 5PK1028  | FIAT<br>CROMA (194)   |   | OPEL<br>MOVANO / VIVARO  |   | PEUGEOT<br>605  |
|   | OPEL<br>ASTRA G / SIGNUM / VECTRA B<br>/ VECTRA C / ZAFIRA A / ZAFIRA<br>B                          |   | PEUGEOT<br>605   | VKMM 5PK1199  | NISSAN<br>ALMERA / MICRA  |
|   | SAAB<br>9-3 II  |   | RENAULT<br>ESPACE III / LAGUNA I /<br>LAGUNA II / MASTER II / TRAFIC<br>II                           |   | RENAULT<br>CLIO II / KANGOO / MEGANE II /<br>MODUS / SCENIC II / GRAND<br>SCENIC / THALIA   |
|   | VAUXHALL<br>ASTRA Mk IV / SIGNUM /<br>VECTRA Mk I / VECTRA Mk II /<br>ZAFIRA Mk I / ZAFIRA Mk II    | VKMM 5PK1135  | VAUXHALL<br>VIVARO   | VKMM 5PK1200  | LAND ROVER<br>FREELANDER I  |
| VKMM 5PK1030  | CITROËN<br>SAXO   |   | NISSAN<br>ALMERA / MICRA   |   | MG<br>MG ZT / MGF / MGTF  |
|   | PEUGEOT<br>106 II   |   | RENAULT<br>CLIO II / CLIO III / KANGOO /<br>MEGANE II / MODUS / SCENIC II<br>/ GRAND SCENIC / THALIA |   | RENAULT<br>MASTER II  |
| VKMM 5PK1042  | LANCIA<br>DEDRA / DELTA II  | VKMM 5PK1140  | CITROËN<br>XM I  | VKMM 5PK1212  | OPEL<br>ASTRA G / ASTRA H / COMBO B<br>/ CORSA C / MERIVA / TIGRA<br>Twin Top / ZAFIRA A  |
| VKMM 5PK1050  | ALFA ROMEO<br>155   |   | PEUGEOT<br>605   |   | VAUXHALL<br>ASTRA Mk IV / ASTRA Mk V /<br>COMBO II / CORSA Mk II /<br>MERIVA / TIGRA Mk II / ZAFIRA<br>Mk I                       |
|   | CITROËN<br>SAXO   | VKMM 5PK1144  | FORD<br>ESCORT BOX 95 / ESCORT VII /<br>FIESTA IV  | VKMM 5PK1218  | CITROËN<br>BERLINGO   |
|   | FIAT<br>DUCATO (230)  |   | MAZDA<br>121 (JASM, JBSM)  | VKMM 5PK1219  | SEAT<br>AROSA   |
|   | LANCIA<br>DEDRA / DELTA II  | VKMM 5PK1145  | FIAT<br>500 / BRAVO / DOBLO / IDEA /<br>PANDA (169) / PUNTO (188) /<br>STILO                         |   | SKODA<br>FABIA / FELICIA I (6U1)/Estate<br>(6U5)/Fun (797) / FELICIA II<br>(6U1)/FELICIA II Estate (6U5)                          |
|   | PEUGEOT<br>106 II   |   | LANCIA<br>MUSA / YPSILON   |   | VW<br>CADDY II(9K9A)/Estate(9K9B)/<br>Pickup(9U7) / LUPO (6X1, 6E1)<br>/ POLO (6N1) / POLO Box (6NF)<br>/ POLO (6N2)              |
| VKMM 5PK1065  | FIAT<br>CROMA (154)   | VKMM 5PK1148  | ROVER<br>200 (RF) / 200 (XW) / 200<br>coupe (RF) / 400 (XW)  | VKMM 5PK1230  | CITROËN<br>BX   |
| VKMM 5PK1090  | VOLVO<br>S40 I - V40  |   | CITROËN<br>XM I / XM II  |   | OPEL<br>AGILA B / ASTRA G / ASTRA H /<br>COMBO B / CORSA B / CORSA C<br>/ CORSA D / MERIVA / TIGRA<br>Twin Top                    |
| VKMM 5PK1094  | FORD<br>MONDEO IV / S-MAX   | VKMM 5PK1151  | PEUGEOT<br>605   |   | PEUGEOT<br>405 I  |
|   | VOLVO<br>S80  | VKMM 5PK1160  | CITROËN<br>XM I  |   | VAUXHALL<br>AGILA / ASTRA Mk IV / ASTRA<br>Mk V / COMBO II / CORSA Mk I /<br>CORSA Mk II / CORSA Mk III /<br>MERIVA / TIGRA Mk II |
| VKMM 5PK1100  | FIAT<br>CROMA (154)   |   | PEUGEOT<br>605   | VKMM 5PK1175  | MG<br>MG ZR   |
|   | LANCIA<br>THEMA   | VKMM 5PK1163  | ROVER<br>200 (XW) / 25 / 400 (XW) / 600<br>/ STREETWISE  |   | FIAT<br>PUNTO (188)   |
|   | PEUGEOT<br>BOXER II   | VKMM 5PK1175  | FIAT<br>PUNTO (188)  | VKMM 5PK1190  | LAND ROVER<br>FREELANDER I  |
| VKMM 5PK1110  | DACIA<br>LOGAN  |   | LAND ROVER<br>FREELANDER I   |   | TOYOTA<br>YARIS   |
|   | RENAULT<br>CLIO II / KANGOO / LAGUNA I /<br>LAGUNA II / MEGANE I /<br>SAFRANE I / SCENIC I / THALIA |   |  | VKMM 5PK1240  | OPEL<br>SIGNUM / VECTRA C   |
| VKMM 5PK1125  | BMW<br>3 (E36) / 3 Convertible (E36) / 3<br>Coupe (E36) / Z3  |   |  |   | SAAB<br>9-3 II  |
|   | CITROËN<br>XM I   |   |  |   |   |

|  |    |  |                            |  |                    |
|---|---|---|---|---|---|
| VKMV 5PK1255  | <b>TOYOTA</b><br>AVENSIS VERSO  | VKMV 5PK1450  | <b>VW</b><br>PASSAT (3B2) / Variant (3B5) /<br>PASSAT (3B3) / Variant (3B6)                                 | VKMV 5PK1815  | <b>BMW</b><br>3 (E36) / 3 Touring (E36) / 5<br>(E34) / 5 (E39) / 5 Touring (E34)<br>/ 5 Touring (E39) |
|   | <b>VAUXHALL</b><br>VECTRA Mk II   |   | <b>OPEL</b><br>ASTRA G / ASTRA H / CORSA D<br>/ MERIVA / SIGNUM / VECTRA C<br>/ ZAFIRA B                    |   | <b>OPEL</b><br>OMEGA B  |
| VKMV 5PK1260  | <b>OPEL</b><br>SIGNUM / VECTRA C / ZAFIRA A   | VKMV 5PK1515  | <b>OPEL</b><br>ASTRA G / ASTRA H / CORSA D<br>/ MERIVA / SIGNUM / VECTRA C<br>/ ZAFIRA B                    | VKMV 5PK1885  | <b>BMW</b><br>3 (E36) / 3 Compact (E36) / 3<br>Touring (E36)  |
|   | <b>VAUXHALL</b><br>VECTRA Mk II / ZAFIRA Mk I   |   | <b>VAUXHALL</b><br>ASTRA Mk V / ASTRA TwinTop /<br>CORSA Mk III / MERIVA / VEC-<br>TRA Mk II / ZAFIRA Mk II |   | <b>BMW</b><br>X5  |
| VKMV 5PK1263  | <b>RENAULT</b><br>MEGANE I  | VKMV 5PK1546  | <b>RENAULT</b><br>CLIO II / KANGOO  | VKMV 5PK2020  | <b>BMW</b><br>X5  |
|   | <b>MERCEDES-BENZ</b><br>A-class (W168) / Vaneo<br>(W414)  |   | <b>OPEL</b><br>ASTRA G / ASTRA H / CORSA D<br>/ MERIVA / SIGNUM / VECTRA C<br>/ ZAFIRA B                    |   | <b>LAND ROVER</b><br>RANGE ROVER III  |
| VKMV 5PK1270  | <b>CITROËN</b><br>BX  | VKMV 5PK1570  | <b>LANCIA</b><br>Y  | VKMV 5PK2030  | <b>BMW</b><br>3 (E46) / 3 Touring (E46) / 5<br>(E39) / 5 Touring (E39)                                |
|   | <b>MERCEDES-BENZ</b><br>A-class (W168)  |   | <b>OPEL</b><br>SIGNUM / VECTRA C  |   | <b>LAND ROVER</b><br>FREELANDER I   |
| VKMV 5PK1290  | <b>PEUGEOT</b><br>405 I   | VKMV 5PK1585  | <b>LANCIA</b><br>Y  | VKMV 5PK2063  | <b>MG</b><br>MG ZT  |
|   | <b>MERCEDES-BENZ</b><br>A-class (W168) / Vaneo<br>(W414)  |   | <b>FIAT</b><br>BRAVA/BRAVO (182)  |   | <b>ROVER</b><br>75  |
| VKMV 5PK1300  | <b>AUDI</b><br>A4 (8D2, B5) / A4 Avant (8D5,<br>B5) / A6 (4A, C4) / A6 Avant (4A,<br>C4) / A6 (4B, C5) / A6 Avant<br>(4B, C5) / CABRIOLET (8G7, B4) | VKMV 5PK1592  | <b>AUDI</b><br>A4 (8D2, B5) / A4 Avant (8D5,<br>B5) / A6 (4B, C5) / A6 Avant<br>(4B, C5)                    | VKMV 6PK698   | <b>CITROËN</b><br>JUMPER (230) / JUMPER (244)<br>/ ZX   |
|   | <b>MERCEDES-BENZ</b><br>A-class (W169) / B-class<br>(W245)  |   | <b>VW</b><br>PASSAT (3B2) / Variant (3B5) /<br>PASSAT (3B3) / Variant (3B6)                                 |   | <b>FIAT</b><br>DUCATO (244)   |
| VKMV 5PK1345  | <b>SKODA</b><br>SUPERB  | VKMV 5PK1680  | <b>OPEL</b><br>ASTRA G / ASTRA H /<br>SPEEDSTER / ZAFIRA A /<br>ZAFIRA B                                    | VKMV 6PK703   | <b>FIAT</b><br>BRAVA/BRAVO (182) / COUPE /<br>MAREA   |
|   | <b>VW</b><br>PASSAT (3B2) / Variant (3B5) /<br>PASSAT (3B3) / Variant (3B6)   |   | <b>VW</b><br>PASSAT (3B2) / Variant (3B5)   |   | <b>CITROËN</b><br>C2 / C3 / C3 Pluriel / C4   |
| VKMV 5PK1355  | <b>LANCIA</b><br>DELTA I / PRISMA   | VKMV 5PK1715  | <b>MERCEDES-BENZ</b><br>A-class (W168) / Vaneo<br>(W414)  | VKMV 6PK728   | <b>CITROËN</b><br>C2 / C3 / C3 Pluriel / C4   |
|   | <b>OPEL</b><br>AGILA B / ASTRA G / ASTRA H /<br>CORSA B / CORSA C / CORSA D<br>/ MERIVA   |   | <b>MERCEDES-BENZ</b><br>A-class (W169) / B-class<br>(W245)  |   | <b>PEUGEOT</b><br>1007 / 207 / 207 CC / 207 SW /<br>307   |
| VKMV 5PK1368  | <b>VAUXHALL</b><br>AGILA / ASTRA Mk IV / ASTRA<br>Mk V / CORSA Mk I / CORSA Mk<br>II / CORSA Mk III / MERIVA  | VKMV 5PK1745  | <b>MERCEDES-BENZ</b><br>A-class (W168) / Vaneo<br>(W414)  | VKMV 6PK730   | <b>CITROËN</b><br>BERLINGO / JUMPER (230) /<br>JUMPY I / JUMPY II / XSARA /<br>ZX                     |
|   | <b>OPEL</b><br>COMBO B / CORSA C / MERIVA /<br>TIGRA Twin Top   |   | <b>MERCEDES-BENZ</b><br>A-class (W168) / Vaneo<br>(W414)  |   | <b>FIAT</b><br>DUCATO (230)   |
| VKMV 5PK1432  | <b>VAUXHALL</b><br>COMBO II / CORSA Mk II /<br>MERIVA / TIGRA Mk II   | VKMV 5PK1750  | <b>MERCEDES-BENZ</b><br>A-class (W168) / Vaneo<br>(W414)  | VKMV 6PK733   | <b>PEUGEOT</b><br>306 / 307 / 405 II / BOXER I /<br>EXPERT I  |
|   | <b>AUDI</b><br>A4 (8D2, B5) / A4 Avant (8D5,<br>B5) / A4 (8E2, B6) / A4 Avant<br>(8E5, B6) / A6 (4B, C5) / A6<br>Avant (4B, C5)                     |   | <b>MERCEDES-BENZ</b><br>A-class (W168) / Vaneo<br>(W414)  |   | <b>PEUGEOT</b><br>206   |
|   | <b>SKODA</b><br>SUPERB  | VKMV 5PK1790  | <b>ROVER</b><br>800   | VKMV 6PK736   | <b>AUDI</b><br>A2 (8Z0)   |
|   |   |   |   |   | <b>SEAT</b><br>CORDOBA (6L2) / IBIZA IV (6L1)<br>/ LEON II (1P1)                                      |







|  |    |  |  |  |   |
|---|---|---|--|---|--|
| VKMV 6PK737   | <b>SKODA</b><br>FABIA / OCTAVIA II (1Z3)/OCTAVIA II Combi (1Z5) / ROOMSTER  | VKMV 6PK815   | <b>VOLVO</b><br>S40 II - V50   | VKMV 6PK895   | <b>SEAT</b><br>ALHAMBRA / CORDOBA (6K2) / CORDOBA (6K2/C2) / CORDOBA Vario (6K5) / IBIZA II (6K1) / INCA / TOLEDO I (1L)   |
|   | <b>VW</b><br>CADDY III (2KA) / CADDY III Estate (2KB) / GOLF V (1K1) / GOLF V VARIANT (1K1) / GOLF V PLUS (5M1) / POLO (9N_) / POLO Saloon  |   | <b>CITROËN</b><br>C3   |   | <b>VW</b><br>CADDY II(9K9A)/Estate(9K9B)/ Pickup(9U7) / CORRADO (53I) / GOLF III (1H1) / GOLF III Variant (1H5) / GOLF III Cabriolet (1E7) / GOLF IV Cabriolet (1E7) / PAS-SAT (3A2, 35I) / Variant (3A5, 35I) / POLO CLASSIC (6KV2) / Variant (6KV5) / SHARAN (7M8, 7M9, 7M6) / VENTO (1H2) |
| VKMV 6PK745   | <b>SEAT</b><br>CORDOBA (6K2) / CORDOBA (6K2/C2) / IBIZA II (6K1)  | VKMV 6PK850   | <b>FIAT</b><br>PUNTO (188) / STILO   | VKMV 6PK900   | <b>OPEL</b><br>ASTRA F / COMBO A / CORSA B / TIGRA   |
|   | <b>VW</b><br>GOLF III (1H1) / GOLF III Variant (1H5) / VENTO (1H2)  |   | <b>OPEL</b><br>MOVANO  |   | <b>SEAT</b><br>ALTEA / ALTEA XL / LEON II (1P1) / TOLEDO III (5P2)   |
| VKMV 6PK747   | <b>AUDI</b><br>A2 (8Z0)   | VKMV 6PK858   | <b>RENAULT</b><br>MASTER II  | VKMV 6PK903   | <b>SKODA</b><br>OCTAVIA II (1Z3)/OCTAVIA II Combi (1Z5)  |
|   | <b>SEAT</b><br>IBIZA IV (6L1)   |   | <b>VAUXHALL</b><br>MOVANO  |   | <b>VW</b><br>CADDY III (2KA) / CADDY III Estate (2KB) / EOS / GOLF V (1K1) / GOLF V VARIANT (1K1) / GOLF V PLUS (5M1) / TOURAN   |
| VKMV 6PK751   | <b>SKODA</b><br>FABIA   | VKMV 6PK860   | <b>CITROËN</b><br>C1   | VKMV 6PK906   | <b>SEAT</b><br>CORDOBA (6K2) / CORDOBA (6K2/C2) / CORDOBA Vario (6K5) / IBIZA II (6K1) / IBIZA III (6K1) / IBIZA IV (6L1) / INCA   |
|   | <b>VW</b><br>LUPO (6X1, 6E1)  |   | <b>RENAULT</b><br>CLIO I / TRAFIC I  |   | <b>RENAULT</b><br>CLIO I / EXPRESS/EXTRA/ RAPID  |
| VKMV 6PK780   | <b>CITROËN</b><br>C15   | VKMV 6PK866   | <b>TOYOTA</b><br>AYGO  | VKMV 6PK915   | <b>AUDI</b><br>A3 (8P1) / A3 Sportback (8PA)   |
|   | <b>SEAT</b><br>AROSA / CORDOBA (6K2) / CORDOBA (6K2/C2) / CORDOBA (6L2) / CORDOBA Vario (6K5) / IBIZA II (6K1) / IBIZA III (6K1) / IBIZA IV (6L1) / INCA  |   | <b>AUDI</b><br>A2 (8Z0)  |   | <b>SEAT</b><br>CORDOBA (6K2) / CORDOBA (6K2/C2) / CORDOBA Vario (6K5) / IBIZA III (6K1) / IBIZA IV (6L1) / INCA  |
| VKMV 6PK802   | <b>VW</b><br>CADDY II(9K9A)/Estate(9K9B)/ Pickup(9U7) / GOLF III (1H1) / GOLF III Variant (1H5) / LUPO (6X1, 6E1) / POLO (6N1) / POLO Box (6NF) / POLO (6N2) / POLO CLASSIC (6KV2) / Variant (6KV5) / VENTO (1H2) | VKMV 6PK870   | <b>SEAT</b><br>CORDOBA (6L2) / IBIZA IV (6L1)                                      | VKMV 6PK872   | <b>RENAULT</b><br>MASTER II  |
|   | <b>SKODA</b><br>FABIA / ROOMSTER  |   | <b>OPEL</b><br>MOVANO  |   | <b>VAUXHALL</b><br>MOVANO  |
| VKMV 6PK871   | <b>VW</b><br>POLO (9N_) / POLO Saloon   | VKMV 6PK872   | <b>RENAULT</b><br>R19 / R21  | VKMV 6PK890   | <b>SEAT</b><br>CORDOBA (6K2) / CORDOBA (6K2/C2) / CORDOBA Vario (6K5) / IBIZA III (6K1) / INCA / LEON I (1M1) / TOLEDO II (1M2)  |
|   | <b>CITROËN</b><br>C1 / C2 / C3 / C3 Pluriel / C4 / JUMPER (230)   |   | <b>CITROËN</b><br>BERLINGO / JUMPY I / XSARA                                       |   | <b>FIAT</b><br>SCUDO (220)   |
| VKMV 6PK872   | <b>FORD</b><br>FIESTA V / FOCUS C-MAX I / FOCUS C-MAX II / FOCUS II / FUSION  | VKMV 6PK894   | <b>PEUGEOT</b><br>206 / 306 / EXPERT I / PARTNER                                   | VKMV 6PK915   | <b>VW</b><br>BORA (1J2) / BORA Estate (1J6) / CADDY II(9K9A)/Estate(9K9B)/ Pickup(9U7) / GOLF IV (1J1) / GOLF IV Variant (1J5) / NEW BEETLE (9C1, 1C1)/Convertible (1Y7) / POLO CLASSIC (6KV2) / Variant (6KV5)  |
|   | <b>MAZDA</b><br>3   |   | <b>RENAULT</b><br>MASTER II  |   | <b>PEUGEOT</b><br>307 / BOXER II / EXPERT I  |
| VKMV 6PK894   | <b>PEUGEOT</b><br>1007 / 107 / 206 / 307 / BOXER I  | VKMV 6PK894   | <b>RENAULT</b><br>CLIO I / CLIO II / EXPRESS/ EXTRA/RAPID / KANGOO                 | VKMV 6PK915   | <b>FORD</b><br>ESCORT V / ESCORT VI / ESCORT VII / FIESTA III  |
|   | <b>TOYOTA</b><br>AYGO   |   | <b>RENAULT</b><br>MASTER II  |   | <b>PEUGEOT</b><br>BOXER I  |









|  |    |  |    |  |   |
|---|---|---|---|---|--|
| VKMV 6PK923   | <b>SEAT</b><br>IBIZA II (6K1) / INCA / TOLEDO I (1L)<br><hr/> <b>VW</b><br>GOLF III (1H1) / GOLF III Variant (1H5) / POLO CLASSIC (6KV2) / Variant (6KV5) / SHARAN (7M8, 7M9, 7M6) / TRANSPORTER IV / VENTO (1H2) |   | <b>VOLVO</b><br>S40 II - V50<br><hr/> <b>VW</b><br>CORRADO (53I) / GOLF III (1H1) / GOLF III Variant (1H5) / GOLF III Cabriolet (1E7) / PASSAT (3A2, 35I) / Variant (3A5, 35I) / SHARAN (7M8, 7M9, 7M6) / VENTO (1H2) |   | <b>SEAT</b><br>ALHAMBRA / CORDOBA (6K2) / CORDOBA (6K2/C2) / IBIZA II (6K1) / TOLEDO I (1L)<br><hr/> <b>VW</b><br>GOLF III (1H1) / GOLF III Variant (1H5) / GOLF III Cabriolet (1E7) / GOLF IV Cabriolet (1E7) / PASSAT (3A2, 35I) / Variant (3A5, 35I) / SHARAN (7M8, 7M9, 7M6) / VENTO (1H2) |
| VKMV 6PK926   | <b>SEAT</b><br>CORDOBA (6L2) / IBIZA IV (6L1)   | VKMV 6PK986   | <b>FIAT</b><br>BRAVA/BRAVO (182) / PUNTO (176)  | VKMV 6PK1036  | <b>ALFA ROMEO</b><br>145/146 / 147 / 156   |
| VKMV 6PK935   | <b>SKODA</b><br>FABIA   | VKMV 6PK996   | <b>AUDI</b><br>A2 (8Z0)   |   | <b>FIAT</b><br>BRAVA/BRAVO (182) / MAREA / MULTIPLA  |
| VKMV 6PK950   | <b>FIAT</b><br>PUNTO (176)  |   | <b>SEAT</b><br>CORDOBA (6L2) / IBIZA IV (6L1)   |   | <b>LANCIA</b><br>KAPPA / LYBRA   |
|   | <b>AUDI</b><br>A3 (8P1) / A3 Sportback (8PA)  |   | <b>SKODA</b><br>FABIA / ROOMSTER  |   |  |
|   | <b>HONDA</b><br>PRELUDE   |   | <b>VW</b><br>FOX (5Z1) / LUPO (6X1, 6E1) / POLO (9N_) / POLO Saloon   | VKMV 6PK1042  | <b>AUDI</b><br>A3 (8P1) / A3 Sportback (8PA)   |
|   | <b>PEUGEOT</b><br>BOXER II  | VKMV 6PK998   | <b>CITROËN</b><br>C4 / C4 Picasso / C5 II / C8 / JUMPY III  |   | <b>CITROËN</b><br>BERLINGO / JUMPY I / XSARA   |
|   | <b>SEAT</b><br>ALTEA / ALTEA XL / LEON II (1P1) / TOLEDO III (5P2)  |   | <b>PEUGEOT</b><br>307 / 407 / 607 / 807 / EXPERT II / EXPERT Tepee  |   | <b>FIAT</b><br>SCUDO (220)   |
|   | <b>VW</b><br>CADDY III (2KA) / CADDY III Estate (2KB) / GOLF V (1K1) / GOLF V VARIANT (1K1) / GOLF V PLUS (5M1) / TOURAN  | VKMV 6PK1007  | <b>RENAULT</b><br>CLIO I  |   | <b>FORD</b><br>FOCUS I   |
|   | <b>VW</b><br>CADDY III (2KA) / CADDY III Estate (2KB) / EOS / GOLF V (1K1) / GOLF V VARIANT (1K1) / GOLF V PLUS (5M1) / JETTA III (1KM) / PASSAT (3C2) / Variant (3C5) / TOURAN                                   | VKMV 6PK1010  | <b>PEUGEOT</b><br>206   |   | <b>PEUGEOT</b><br>306 / EXPERT I / PARTNER   |
| VKMV 6PK953   | <b>AUDI</b><br>A3 (8P1) / A3 Sportback (8PA) / TT (8J3) / TT Roadster (8J9)   | VKMV 6PK1012  | <b>RENAULT</b><br>ESPACE III / LAGUNA I / SAFRANE II  |   | <b>SEAT</b><br>ALTEA / ALTEA XL / LEON II (1P1) / TOLEDO III (5P2)   |
|   | <b>SEAT</b><br>ALTEA / ALTEA XL / LEON II (1P1)   |   | <b>CITROËN</b><br>JUMPER (230)  |   | <b>SKODA</b><br>OCTAVIA II (1Z3)/OCTAVIA II Combi (1Z5)  |
|   | <b>SKODA</b><br>OCTAVIA II (1Z3)/OCTAVIA II Combi (1Z5)   | VKMV 6PK1015  | <b>PEUGEOT</b><br>BOXER I   |   | <b>VW</b><br>CADDY III (2KA) / CADDY III Estate (2KB) / EOS / GOLF V (1K1) / GOLF V VARIANT (1K1) / GOLF V PLUS (5M1) / JETTA III (1KM) / PASSAT (3C2) / Variant (3C5) / TOURAN  |
|   | <b>VW</b><br>GOLF V (1K1) / GOLF V VARIANT (1K1)  | VKMV 6PK1020  | <b>MERCEDES-BENZ</b><br>190 (W201)  |   | <b>VW</b><br>CADDY III (2KA) / CADDY III Estate (2KB) / EOS / GOLF V (1K1) / GOLF V VARIANT (1K1) / GOLF V PLUS (5M1) / JETTA III (1KM) / PASSAT (3C2) / Variant (3C5) / TOURAN  |
| VKMV 6PK966   | <b>CITROËN</b><br>C1  | VKMV 6PK1030  | <b>CITROËN</b><br>C2 / C3   | VKMV 6PK1045  | <b>ALFA ROMEO</b><br>145/146 / 147 / 155 / 156 / GTV / SPIDER  |
|   | <b>PEUGEOT</b><br>107   |   | <b>NISSAN</b><br>ALMERA   |   | <b>FIAT</b><br>BARCETTA / BRAVA/BRAVO (182) / COUPE / MAREA  |
|   | <b>TOYOTA</b><br>AYGO   | VKMV 6PK1032  | <b>PEUGEOT</b><br>206   |   | <b>FORD</b><br>GALAXY I  |
| VKMV 6PK976   | <b>CITROËN</b><br>C2 / C3 / C3 Pluriel / C4   |   | <b>SEAT</b><br>CORDOBA (6L2) / IBIZA IV (6L1)   |   | <b>LANCIA</b><br>Y   |
|   | <b>FORD</b><br>FIESTA V / FOCUS C-MAX I / FOCUS C-MAX II / FOCUS II / FUSION  | VKMV 6PK1033  | <b>SKODA</b><br>FABIA   |   | <b>SEAT</b><br>ALHAMBRA / CORDOBA (6K2) / CORDOBA (6K2/C2) / CORDOBA Vario (6K5) / IBIZA II (6K1) / INCA / TOLEDO I (1L)   |
|   | <b>MAZDA</b><br>3   |   | <b>MINI</b><br>MINI   |   |  |
|   | <b>PEUGEOT</b><br>1007 / 206 / 307  |   |   |   |  |







|  |    |  |   |  |    |
|---|---|---|---|---|---|
| VKMV 6PK1049  | <b>VW</b><br>CADDY II(9K9A)/Estate(9K9B)/<br>Pickup(9U7) / GOLF III (1H1) /<br>GOLF III Variant (1H5) / GOLF III<br>Cabriolet (1E7) / GOLF IV Cabri-<br>olet (1E7) / PASSAT (3A2, 35I) /<br>Variant (3A5, 35I) / POLO<br>CLASSIC (6KV2) / Variant<br>(6KV5) / SHARAN (7M8, 7M9,<br>7M6) / TRANSPORTER IV /<br>VENTO (1H2) | VKMV 6PK1068  | <b>FIAT</b><br>ULYSSE (220)   | VKMV 6PK1080  | <b>ALFA ROMEO</b><br>145/146 / 147 / 156 / GTV /<br>SPIDER                            |
|   | <b>CITROËN</b><br>C2 / C3 / C3 Pluriel / C4   |   | <b>LANCIA</b><br>ZETA   |   | <b>AUDI</b><br>A4 (8EC) / A4 Avant (8ED) / A4<br>Convertible (8H7)                    |
| VKMV 6PK1050  | <b>PEUGEOT</b><br>1007 / 207 / 207 CC / 207 SW /<br>307   | VKMV 6PK1069  | <b>PEUGEOT</b><br>306 / 405 II / 406 / 806 /<br>EXPERT I  | VKMV 6PK1084  | <b>FIAT</b><br>STRADA   |
|   | <b>AUDI</b><br>A3 (8P1) / A3 Sportback (8PA)  |   | <b>SEAT</b><br>AROSA / CORDOBA (6K2) /<br>CORDOBA (6K2/C2) / CORDOBA<br>Vario (6K5) / IBIZA II (6K1) /<br>IBIZA III (6K1) / INCA  |   | <b>LANCIA</b><br>DELTA II / LYBRA   |
| VKMV 6PK1054  | <b>FIAT</b><br>DOBLO / STRADA   | VKMV 6PK1072  | <b>VW</b><br>CADDY II(9K9A)/Estate(9K9B)/<br>Pickup(9U7) / CADDY III (2KA) /<br>CADDY III Estate (2KB) / GOLF III<br>(1H1) / GOLF III Variant (1H5) /<br>LUPO (6X1, 6E1) / POLO (6N1) /<br>POLO Box (6NF) / POLO (6N2) /<br>POLO CLASSIC (6KV2) / Variant<br>(6KV5) / TRANSPORTER IV /<br>VENTO (1H2) | VKMV 6PK1087  | <b>AUDI</b><br>A2 (8Z0)   |
|   | <b>OPEL</b><br>ASTRA H / SIGNUM / VECTRA C<br>/ ZAFIRA B  |   | <b>CITROËN</b><br>C4  |   | <b>SEAT</b><br>IBIZA IV (6L1)   |
| VKMV 6PK1054  | <b>SEAT</b><br>ALTEA / ALTEA XL / LEON II<br>(1P1) / TOLEDO III (5P2)   | VKMV 6PK1076  | <b>LANCIA</b><br>KAPPA  | VKMV 6PK1094  | <b>SKODA</b><br>FABIA   |
|   | <b>SKODA</b><br>OCTAVIA II (1Z3)/OCTAVIA II<br>Combi (1Z5)  |   | <b>AUDI</b><br>A2 (8Z0)   |   | <b>VW</b><br>LUPO (6X1, 6E1)  |
| VKMV 6PK1054  | <b>VAUXHALL</b><br>ASTRA Mk V / SIGNUM /<br>VECTRA Mk II / ZAFIRA Mk II   | VKMV 6PK1076  | <b>CITROËN</b><br>BERLINGO / EVASION / XANTIA<br>I / XANTIA II / XM II / XSARA / ZX   | VKMV 6PK1095  | <b>AUDI</b><br>A3 (8P1) / A3 Sportback (8PA)<br>/ JUMPER (230) / JUMPER (244)<br>/ ZX |
|   | <b>VW</b><br>CADDY III (2KA) / CADDY III<br>Estate (2KB) / EOS / GOLF V<br>(1K1) / GOLF V VARIANT (1K1) /<br>GOLF V PLUS (5M1) / JETTA III<br>(1KM) / PASSAT (3C2) / Variant<br>(3C5) / TOURAN  |   | <b>FIAT</b><br>ULYSSE (220)   |   | <b>FIAT</b><br>DUCATO (230) / DUCATO (244)  |
| VKMV 6PK1062  | <b>AUDI</b><br>A3 (8P1) / A3 Sportback (8PA) /<br>TT (8J3) / TT Roadster (8J9)  | VKMV 6PK1078  | <b>LANCIA</b><br>ZETA   | VKMV 6PK1100  | <b>PEUGEOT</b><br>306 / 405 II / BOXER I / BOXER<br>II                                |
|   | <b>SEAT</b><br>ALTEA / ALTEA XL / LEON II<br>(1P1)  |   | <b>SEAT</b><br>CORDOBA (6L2) / IBIZA IV (6L1)   |   | <b>RENAULT</b><br>CLIO I / ESPACE IV / SUPER 5 /<br>VEL SATIS                         |
| VKMV 6PK1067  | <b>SKODA</b><br>OCTAVIA II (1Z3)/OCTAVIA II<br>Combi (1Z5)  | VKMV 6PK1078  | <b>PEUGEOT</b><br>306 / 405 II / 406 / 605 / 806  | VKMV 6PK1100  | <b>SEAT</b><br>CORDOBA (6L2) / IBIZA IV (6L1)   |
|   | <b>VW</b><br>EOS / GOLF V (1K1) / GOLF V<br>VARIANT (1K1) / JETTA III<br>(1KM)  |   | <b>SKODA</b><br>FABIA / ROOMSTER  |   | <b>SKODA</b><br>FABIA   |
| VKMV 6PK1067  | <b>ALFA ROMEO</b><br>147 / 156 / GT / GTV / SPIDER  | VKMV 6PK1078  | <b>VW</b><br>FOX (5Z1) / POLO (9N_) / POLO<br>Saloon  | VKMV 6PK1100  | <b>VW</b><br>POLO (9N_) / POLO Saloon   |
|   | <b>LANCIA</b><br>LYBRA  |   | <b>SEAT</b><br>LEON I (1M1) / TOLEDO II (1M2)   |   | <b>NISSAN</b><br>ALMERA / ALMERA TINO /<br>PRIMERA                                    |
| VKMV 6PK1067  | <b>CITROËN</b><br>EVASION / XSARA / ZX  | VKMV 6PK1078  | <b>SKODA</b><br>FELICIA I (6U1)/Estate (6U5)/<br>Fun (797) / FELICIA II (6U1)/<br>FELICIA II Estate (6U5) /<br>OCTAVIA I (1U2) / OCTAVIA<br>Combi (1U5)   | VKMV 6PK1100  | <b>SEAT</b><br>CORDOBA (6K2) / CORDOBA<br>(6K2/C2) / LEON II (1P1)                    |
|   |   |   | <b>VW</b><br>BORA (1J2) / BORA Estate (1J6)<br>/ GOLF IV (1J1) / GOLF IV Vari-<br>ant (1J5) / NEW BEETLE (9C1,<br>1C1)/Convertible (1Y7)  |   | <b>SKODA</b><br>OCTAVIA II (1Z3)/OCTAVIA II<br>Combi (1Z5)                            |









|  |    |  |    |  |    |
|---|---|---|---|---|---|
| VKMM 6PK1102  | <b>CITROËN</b><br>EVASION / XANTIA I / XANTIA II / XM I / XM II   |   | <b>SKODA</b><br>FELICIA I (6U1)/Estate (6U5)/ Fun (797) / FELICIA II (6U1)/ FELICIA II Estate (6U5)   | VKMM 6PK1148  | <b>OPEL</b><br>VIVARO   |
|   | <b>FIAT</b><br>ULYSSE (220)   |   | <b>VW</b><br>LUPO (6X1, 6E1) / POLO (6N1) / POLO Box (6NF) / POLO (6N2)   |   | <b>RENAULT</b><br>MASTER II / TRAFIC II   |
|   | <b>LANCIA</b><br>ZETA   | VKMM 6PK1125  | <b>CITROËN</b><br>C2 / C3 / C3 Pluriel  | VKMM 6PK1151  | <b>VAUXHALL</b><br>VIVARO   |
| VKMM 6PK1105  | <b>PEUGEOT</b><br>306 / 406 / 605 / 806   |   | <b>PEUGEOT</b><br>307   |   | <b>CITROËN</b><br>JUMPER (230)  |
|   | <b>ALFA ROMEO</b><br>156  |   | <b>RENAULT</b><br>ESPACE III / LAGUNA I / MEGANE I / SCENIC I   | VKMM 6PK1153  | <b>PEUGEOT</b><br>BOXER I   |
|   | <b>FIAT</b><br>MAREA / PALIO/SIENA  | VKMM 6PK1127  | <b>RENAULT</b><br>CLIO II / KANGOO / MASTER II  |   | <b>SEAT</b><br>ALHAMBRA / CORDOBA (6K2) / CORDOBA (6K2/C2) / CORDOBA Vario (6K5) / IBIZA II (6K1) / INCA / TOLEDO I (1L)  |
|   | <b>HONDA</b><br>ACCORD  | VKMM 6PK1130  | <b>CITROËN</b><br>BX / XANTIA I / XSARA / ZX  |   | <b>VW</b><br>CADDY II(9K9A)/Estate(9K9B)/ Pickup(9U7) / CORRADO (53I) / GOLF III (1H1) / GOLF III Variant (1H5) / GOLF III Cabriolet (1E7) / GOLF IV Cabriolet (1E7) / PASSAT (3A2, 35I) / Variant (3A5, 35I) / POLO CLASSIC (6KV2) / Variant (6KV5) / SANTANA / SHARAN (7M8, 7M9, 7M6) / VENTO (1H2) |
|   | <b>LANCIA</b><br>KAPPA  | VKMM 6PK1135  | <b>PEUGEOT</b><br>306 / 405 I / 405 II  |   | <b>CITROËN</b><br>JUMPER (230)  |
| VKMM 6PK1110  | <b>RENAULT</b><br>VEL SATIS   |   | <b>RENAULT</b><br>ESPACE III / LAGUNA I / MEGANE I / SCENIC I / TRAFIC I  | VKMM 6PK1155  | <b>FIAT</b><br>DUCATO (230)   |
|   | <b>CITROËN</b><br>BERLINGO / EVASION / JUMPY I / JUMPY II   | VKMM 6PK1139  | <b>VW</b><br>CADDY III (2KA) / CADDY III Estate (2KB)   |   | <b>PEUGEOT</b><br>BOXER I   |
|   | <b>FIAT</b><br>SCUDO (220) / ULYSSE (220)   |   | <b>FIAT</b><br>BRAVA/BRAVO (182) / COUPE / MAREA  | VKMM 6PK1156  | <b>PEUGEOT</b><br>307   |
|   | <b>NISSAN</b><br>ALMERA / ALMERA TINO   | VKMM 6PK1145  | <b>LANCIA</b><br>LYBRA  | VKMM 6PK1160  | <b>CITROËN</b><br>BERLINGO / EVASION / JUMPY I / JUMPY II / XSARA / ZX  |
|   | <b>PEUGEOT</b><br>406 / EXPERT I / PARTNER  |   | <b>FORD</b><br>GALAXY I   |   | <b>FIAT</b><br>DUCATO (230) / SCUDO (220) / ULYSSE (220)  |
| VKMM 6PK1120  | <b>AUDI</b><br>A3 (8L1) / TT (8N3) / TT Roadster (8N9)  |   | <b>RENAULT</b><br>R19   |   | <b>LANCIA</b><br>ZETA   |
|   | <b>SEAT</b><br>ALHAMBRA / AROSA / CORDOBA (6K2) / CORDOBA (6K2/C2) / CORDOBA Vario (6K5) / IBIZA III (6K1) / LEON I (1M1) / TOLEDO II (1M2)   | VKMM 6PK1146  | <b>SEAT</b><br>ALHAMBRA / CORDOBA (6K2) / CORDOBA (6K2/C2) / CORDOBA Vario (6K5) / IBIZA II (6K1) / INCA / TOLEDO I (1L)  |   | <b>PEUGEOT</b><br>306 / 406 / 605 / 806 / EXPERT I / PARTNER  |
|   | <b>SKODA</b><br>OCTAVIA I (1U2) / OCTAVIA Combi (1U5)   |   | <b>VW</b><br>CADDY II(9K9A)/Estate(9K9B)/ Pickup(9U7) / GOLF III (1H1) / GOLF III Variant (1H5) / GOLF III Cabriolet (1E7) / GOLF IV Cabriolet (1E7) / PASSAT (3A2, 35I) / Variant (3A5, 35I) / POLO CLASSIC (6KV2) / Variant (6KV5) / SHARAN (7M8, 7M9, 7M6) / VENTO (1H2) | VKMM 6PK1165  | <b>RENAULT</b><br>CLIO I  |
|   | <b>VW</b><br>BORA (1J2) / BORA Estate (1J6) / GOLF IV (1J1) / GOLF IV Variant (1J5) / LUPO (6X1, 6E1) / MULTIVAN V (7HM) / NEW BEETLE (9C1, 1C1)/Convertible (1Y7) / POLO (6N2) / POLO CLASSIC (6KV2) / Variant (6KV5) / SHARAN (7M8, 7M9, 7M6) / TRANSPORTER V | VKMM 6PK1170  | <b>CITROËN</b><br>ZX  |   | <b>CITROËN</b><br>ZX  |
| VKMM 6PK1123  | <b>AUDI</b><br>A4 (8E2, B6) / A4 Avant (8E5, B6)  |   | <b>PEUGEOT</b><br>306 / 405 II  | VKMM 6PK1173  | <b>PEUGEOT</b><br>306 / 405 II  |
|   | <b>SEAT</b><br>AROSA  | VKMM 6PK1147  | <b>FIAT</b><br>STILO  |   | <b>RENAULT</b><br>R19   |
|   |   |   | <b>PEUGEOT</b><br>307   | VKMM 6PK1175  | <b>AUDI</b><br>80 (8C, B4) / 80 Avant (8C, B4) / A6 (4A, C4) / A6 Avant (4A, C4) / CABRIOLET (8G7, B4)  |







|   |   |   |  |   |  |
|---|---|---|--|---|--|
|  |                                |  |    |  |   |
| <b>VKMMV 6PK1180</b>  | <b>FIAT</b><br>500 / DOBLO / IDEA / PALIO / SIENA / PANDA (169) / PUNTO (188)                                   | <b>VKMMV 6PK1190</b>  | <b>PEUGEOT</b><br>307 / 806 / EXPERT I   | <b>VKMMV 6PK1217</b>  | <b>VW</b><br>SHARAN (7M8, 7M9, 7M6) / TRANSPORTER V  |
|   | <b>LANCIA</b><br>MUSA / YPSILON   | <b>VKMMV 6PK1193</b>  | <b>RENAULT</b><br>CLIO I   |   | <b>CITROËN</b><br>C4 / C4 Picasso / C5 II / C8 / JUMPY III   |
|   | <b>SEAT</b><br>CORDOBA (6L2) / IBIZA IV (6L1)   | <b>VKMMV 6DK1195</b>  | <b>RENAULT</b><br>CLIO II / KANGOO   |   | <b>FORD</b><br>FOCUS C-MAX I / FOCUS C-MAX II / FOCUS II / MONDEO IV   |
|   | <b>SKODA</b><br>FABIA / ROOMSTER  |   | <b>AUDI</b><br>A3 (8L1) / TT (8N3) / TT Roadster (8N9)   |   | <b>LANCIA</b><br>PHEDRA  |
| <b>VKMMV 6PK1181</b>  | <b>VW</b><br>POLO (9N_)   |   | <b>FORD</b><br>GALAXY I  |   | <b>PEUGEOT</b><br>307 / 308 / 407 / 607 / 807 / EXPERT II / EXPERT Tepee   |
|   | <b>FORD</b><br>FIESTA BOX / COURRIER / FIESTA IV / PUMA   |   | <b>SEAT</b><br>ALHAMBRA / CORDOBA (6K2) / CORDOBA (6K2/C2) / CORDOBA Vario (6K5) / IBIZA III (6K1) / LEON I (1M1) / TOLEDO II (1M2)  |   | <b>VOLVO</b><br>S40 II - V50   |
|   | <b>MAZDA</b><br>121 (JASM, JBSM)  |   | <b>SKODA</b><br>OCTAVIA I (1U2) / OCTAVIA Combi (1U5)  | <b>VKMMV 6PK1230</b>  | <b>FIAT</b><br>PUNTO (188)   |
| <b>VKMMV 6PK1182</b>  | <b>CITROËN</b><br>JUMPER (230) / JUMPER (244)   |   | <b>VW</b><br>BORA (1J2) / BORA Estate (1J6) / GOLF IV (1J1) / GOLF IV Variant (1J5) / MULTIVAN V (7HM) / NEW BEETLE (9C1, 1C1)/Convertible (1Y7) / POLO CLASSIC (6KV2) / Variant (6KV5) / SHARAN (7M8, 7M9, 7M6) / TRANSPORTER V | <b>VKMMV 6PK1235</b>  | <b>RENAULT</b><br>LAGUNA I / SAFRANE II  |
|   | <b>FIAT</b><br>DUCATO (230) / GRANDE PUNTO  | <b>VKMMV 6PK1195</b>  | <b>BMW</b><br>7 (E38)  | <b>VKMMV 6PK1240</b>  | <b>AUDI</b><br>A3 (8P1) / A3 Sportback (8PA)   |
|   | <b>OPEL</b><br>AGILA B / ASTRA H / COMBO B / CORSA C / CORSA D / MERIVA / TIGRA Twin Top                        |   | <b>FIAT</b><br>IDEA / PUNTO (188)  |   | <b>VW</b><br>GOLF V (1K1) / GOLF V VARIANT (1K1)   |
|   | <b>PEUGEOT</b><br>BOXER I / BOXER II  |   | <b>LANCIA</b><br>MUSA  | <b>VKMMV 6PK1250</b>  | <b>OPEL</b><br>ASTRA G / ASTRA H / COMBO B / CORSA B / CORSA C / CORSA D / MERIVA  |
|   | <b>VAUXHALL</b><br>ASTRA Mk V / CORSA Mk II / CORSA Mk III / TIGRA Mk II  | <b>VKMMV 6PK1198</b>  | <b>PEUGEOT</b><br>605  | <b>VKMMV 6PK1253</b>  | <b>VAUXHALL</b><br>ASTRA Mk IV / COMBO II / CORSA Mk II / CORSA Mk III   |
| <b>VKMMV 6PK1183</b>  | <b>LAND ROVER</b><br>FREELANDER I   | <b>VKMMV 6PK1199</b>  | <b>DACIA</b><br>LOGAN  | <b>VKMMV 6PK1255</b>  | <b>VOLVO</b><br>C70 - S70 / S90 - V90 / V70 I  |
|   | <b>MG</b><br>MG ZS  |   | <b>RENAULT</b><br>CLIO II / CLIO III / KANGOO / MEGANE II / MODUS / SCENIC II / GRAND SCENIC / THALIA  | <b>VKMMV 6PK1264</b>  | <b>FIAT</b><br>BRAVO / STILO   |
|   | <b>ROVER</b><br>400 (RT) / 45 / STREETWISE  | <b>VKMMV 6PK1200</b>  | <b>CITROËN</b><br>XANTIA I / XANTIA II / XM II   |   | <b>SEAT</b><br>LEON I (1M1) / TOLEDO II (1M2)  |
| <b>VKMMV 6PK1185</b>  | <b>SEAT</b><br>CORDOBA (6K2) / CORDOBA (6K2/C2) / CORDOBA Vario (6K5) / IBIZA II (6K1) / IBIZA III (6K1) / INCA | <b>VKMMV 6PK1205</b>  | <b>CITROËN</b><br>C5 II / C6 / XSARA / XSARA PICASSO   | <b>VKMMV 6PK1267</b>  | <b>VW</b><br>BORA (1J2) / BORA Estate (1J6) / GOLF IV (1J1) / GOLF IV Variant (1J5) / MULTIVAN V (7HM) / NEW BEETLE (9C1, 1C1)/Convertible (1Y7) |
|   | <b>VW</b><br>CADDY II(9K9A)/Estate(9K9B)/ Pickup(9U7) / POLO CLASSIC (6KV2) / Variant (6KV5)                    | <b>VKMMV 6PK1209</b>  | <b>PEUGEOT</b><br>206 / 406 / 407 / 607  |   | <b>FIAT</b><br>STILO   |
| <b>VKMMV 6DK1188</b>  | <b>SEAT</b><br>AROSA  |   | <b>RENAULT</b><br>CLIO II / KANGOO   | <b>VKMMV 6PK1270</b>  | <b>VOLVO</b><br>850 / C70 - S70 / S90 - V90 / V70 I  |
|   | <b>VW</b><br>LUPO (6X1, 6E1) / POLO (6N2)   | <b>VKMMV 6PK1210</b>  | <b>CITROËN</b><br>C1   |   | <b>FIAT</b><br>STILO   |
| <b>VKMMV 6PK1188</b>  | <b>CITROËN</b><br>C5 I / EVASION / JUMPY I / XM II  | <b>VKMMV 6PK1215</b>  | <b>TOYOTA</b><br>AYGO  | <b>VKMMV 6PK1275</b>  | <b>OPEL</b><br>ASTRA G / ASTRA H / COMBO B / CORSA C / MERIVA  |
|   | <b>FIAT</b><br>SCUDO (220) / ULYSSE (179AX) / ULYSSE (220)  |   | <b>SEAT</b><br>ALHAMBRA  |   | <b>VAUXHALL</b><br>ASTRA Mk IV / ASTRA Mk V / CORSA Mk II / MERIVA   |
|   | <b>LANCIA</b><br>PHEDRA / ZETA  |   |  |   |  |









|   |  |   |   |   |  |
|---|--|---|---|---|--|
|  |   |  |    |  |   |
| VKMMV 6PK1285   | <b>FIAT</b><br>STILO<br><hr/> <b>MG</b><br>MG ZS / MG ZT<br><hr/> <b>ROVER</b><br>45 / 75<br><hr/> <b>SEAT</b><br>TOLEDO II (1M2)<br><hr/> <b>VW</b><br>BORA (1J2) / BORA Estate (1J6) / GOLF IV (1J1) / GOLF IV Variant (1J5) | VKMMV 6PK1400   | <b>RENAULT</b><br>CLIO II / KANGOO<br><hr/> <b>TOYOTA</b><br>MR 2<br><hr/> <b>VKMMV 6PK1410</b>   | VKMMV 6PK1468   | <b>MG</b><br>MG ZR / MG ZS<br><hr/> <b>RENAULT</b><br>R19<br><hr/> <b>ROVER</b><br>200 (RF) / 25 / 400 (RT) / 45 / 600 / STREETWISE<br><hr/> <b>CITROËN</b><br>BERLINGO / EVASION / JUMPER (230) / JUMPER (244) / JUMPY I / JUMPY II / XSARA / XSARA PICASSO<br><hr/> <b>FIAT</b><br>DUCATO (230) / SCUDO (220) / ULYSSE (220)<br><hr/> <b>LANCIA</b><br>ZETA<br><hr/> <b>PEUGEOT</b><br>206 / 306 / 406 / 806 / BOXER I / BOXER II / EXPERT I / PARTNER |
| VKMMV 6PK1290   | <b>ROVER</b><br>800  | VKMMV 6PK1418   | <b>FORD</b><br>FOCUS I / TRANSIT CONNECT / TOURNEO CONNECT  | VKMMV 6PK1480   | <b>VW</b><br>LUPO (6X1, 6E1)   |
| VKMMV 6PK1306   | <b>FORD</b><br>FOCUS C-MAX I / FOCUS C-MAX II / FOCUS II<br><hr/> <b>VOLVO</b><br>S40 II - V50   | VKMMV 6PK1425   | <b>RENAULT</b><br>LAGUNA I  | VKMMV 6PK1515   | <b>BMW</b><br>3 (E36) / 3 Convertible (E36) / 3 Coupe (E36) / Z3   |
| VKMMV 6PK1310   | <b>FIAT</b><br>500 / DOBLO / IDEA / PALIO / SIENA / PANDA (169) / PUNTO (188)<br><hr/> <b>LANCIA</b><br>MUSA / YPSILON   | VKMMV 6PK1430   | <b>FORD</b><br>GALAXY I / TRANSIT   | VKMMV 6PK1520   | <b>FORD</b><br>FOCUS C-MAX I / FOCUS II<br><hr/> <b>SKODA</b><br>OCTAVIA I (1U2) / OCTAVIA Combi (1U5)<br><hr/> <b>VW</b><br>LUPO (6X1, 6E1)   |
| VKMMV 6PK1330   | <b>MERCEDES-BENZ</b><br>C-class (W202) / CLK (W208) / E-class (W210) / SLK (R170)  | VKMMV 6PK1437   | <b>CITROËN</b><br>BERLINGO / JUMPY I / XSARA<br><hr/> <b>FIAT</b><br>SCUDO (220)<br><hr/> <b>PEUGEOT</b><br>206 / 306 / EXPERT I / PARTNER  | VKMMV 6PK1530   | <b>OPEL</b><br>ASTRA F / ASTRA F CLASSIC / COMBO A / CORSA B / TIGRA / VECTRA B<br><hr/> <b>VAUXHALL</b><br>CORSA Mk I / TIGRA Mk I / VECTRA Mk I  |
| VKMMV 6PK1341   | <b>AUDI</b><br>A6 (4A, C4) / A6 Avant (4A, C4)<br><hr/> <b>CITROËN</b><br>BERLINGO / C3 / XSARA / XSARA PICASSO<br><hr/> <b>FORD</b><br>FIESTA V / FUSION<br><hr/> <b>PEUGEOT</b><br>206 / PARTNER                             | VKMMV 6PK1445   | <b>ROVER</b><br>200 (XW) / 400 (XW) / 600   | VKMMV 6PK1538   | <b>BMW</b><br>3 (E46) / 3 Compact (E46) / 3 Convertible (E46) / 3 Coupe (E46) / 3 Touring (E46) / 5 (E39) / 5 (E60) / 5 Touring (E39) / 7 (E38) / X3 / X5  |
| VKMMV 6PK1343   | <b>VW</b><br>TRANSPORTER IV  | VKMMV 6PK1451   | <b>CITROËN</b><br>BERLINGO / C5 I / XANTIA II / XSARA / XSARA PICASSO<br><hr/> <b>PEUGEOT</b><br>206 / PARTNER  | VKMMV 6PK1540   | <b>VW</b><br>BORA (1J2) / BORA Estate (1J6) / GOLF IV (1J1) / GOLF IV Variant (1J5)  |
| VKMMV 6PK1355   | <b>MERCEDES-BENZ</b><br>C-class (W202) / C-class (W203) / CLK (W208) / E-class (W210) / SLK (R170)<br><hr/> <b>VW</b><br>TRANSPORTER IV  | VKMMV 6PK1454   | <b>SEAT</b><br>CORDOBA (6L2) / IBIZA IV (6L1)<br><hr/> <b>SKODA</b><br>FABIA / ROOMSTER<br><hr/> <b>VW</b><br>FOX (5Z1) / POLO (9N_)  | VKMMV 6PK1545   | <b>RENAULT</b><br>R19  |
| VKMMV 6PK1360   | <b>FIAT</b><br>STILO   | VKMMV 6PK1460   | <b>BMW</b><br>Z3<br><hr/> <b>LAND ROVER</b><br>FREELANDER I<br><hr/> <b>OPEL</b><br>ASTRA F / ASTRA F CLASSIC / COMBO A / CORSA B / VECTRA A / VECTRA B<br><hr/> <b>VAUXHALL</b><br>ASTRA Mk III / CAVALIER Mk III / COMBO I / CORSA Mk I / VECTRA Mk I | VKMMV 6PK1548   | <b>SEAT</b><br>LEON I (1M1) / TOLEDO II (1M2)<br><hr/> <b>SKODA</b><br>OCTAVIA I (1U2) / OCTAVIA Combi (1U5)   |
| VKMMV 6PK1388   | <b>CITROËN</b><br>BERLINGO / JUMPY I / XSARA<br><hr/> <b>FIAT</b><br>SCUDO (220)<br><hr/> <b>PEUGEOT</b><br>206 / 306 / EXPERT I / PARTNER   | VKMMV 6PK1462   | <b>HONDA</b><br>ACCORD  |   |  |
| VKMMV 6PK1390   | <b>FIAT</b><br>GRANDE PUNTO  |   |   |   |  |

|  |   |  |   |  |    |
|---|--|---|---|---|---|
|   | <b>VW</b><br>BORA (1J2) / BORA Estate (1J6) / GOLF IV (1J1) / GOLF IV Variant (1J5) / NEW BEETLE (9C1, 1C1)/Convertible (1Y7)  |   | <b>VAUXHALL</b><br>ASTRA Mk IV / COMBO II / CORSA Mk II   | <b>VKMOV 6PK1621</b>  | <b>VOLVO</b><br>S40 I - V40   |
| <b>VKMOV 6PK1555</b>  | <b>BMW</b><br>3 (E36) / 3 Compact (E36) / 3 Convertible (E36) / 3 Coupe (E36) / 3 Touring (E36) / 5 (E34) / 5 (E39) / 5 Touring (E34) / 5 Touring (E39) / 7 (E38) / Z3 | <b>VKMOV 6PK1600</b>  | <b>VW</b><br>TRANSPORTER IV   | <b>VKMOV 6PK1623</b>  | <b>VOLVO</b><br>960   |
|   | <b>MG</b><br>MG ZS / MG ZT   |   | <b>OPEL</b><br>COMBO B / CORSA C / MERIVA   | <b>VKMOV 6PK1636</b>  | <b>FORD</b><br>TRANSIT  |
|   | <b>ROVER</b><br>45 / 75 / 800  | <b>VKMOV 6PK1600</b>  | <b>VAUXHALL</b><br>CORSA Mk II / MERIVA   | <b>VKMOV 6PK1637</b>  | <b>BMW</b><br>1 (E87) / 3 (E46) / 3 Compact (E46) / 3 Convertible (E46) / 3 Coupe (E46) / 3 Touring (E46) / Z4                  |
| <b>VKMOV 6PK1560</b>  | <b>CITROËN</b><br>BERLINGO / XSARA / XSARA PICASSO   | <b>VKMOV 6PK1603</b>  | <b>CITROËN</b><br>EVASION / XSARA / ZX  |   | <b>RENAULT</b><br>MEGANE I  |
|   | <b>PEUGEOT</b><br>206 / PARTNER  |   | <b>FIAT</b><br>ULYSSE (220)   | <b>VKMOV 6PK1640</b>  | <b>RENAULT</b><br>ESPACE III / LAGUNA I / MEGANE I / SCENIC I   |
|   | <b>TOYOTA</b><br>COROLLA VERSO   | <b>VKMOV 6PK1605</b>  | <b>LANCIA</b><br>ZETA   |   | <b>SUBARU</b><br>LEGACY / OUTBACK   |
| <b>VKMOV 6PK1564</b>  | <b>CITROËN</b><br>BERLINGO / XSARA / XSARA PICASSO   | <b>VKMOV 6PK1605</b>  | <b>PEUGEOT</b><br>306 / 406 / 605 / 806   | <b>VKMOV 6PK1642</b>  | <b>VOLVO</b><br>S40 I - V40   |
|   | <b>PEUGEOT</b><br>206 / PARTNER  | <b>VKMOV 6PK1605</b>  | <b>OPEL</b><br>ASTRA G  |   | <b>FORD</b><br>MONDEO III   |
| <b>VKMOV 6PK1572</b>  | <b>AUDI</b><br>A4 (8E2, B6) / A4 Avant (8E5, B6) / A4 (8EC) / A4 Avant (8ED) / A4 Convertible (8H7) / A6 (4F2) / A6 Avant (4F5)  | <b>VKMOV 6PK1605</b>  | <b>RENAULT</b><br>LAGUNA I  | <b>VKMOV 6PK1650</b>  | <b>VW</b><br>LT II  |
|   | <b>FORD</b><br>GALAXY I  | <b>VKMOV 6PK1605</b>  | <b>RENAULT</b><br>SAFRANE II  |   | <b>FORD</b><br>ESCORT VI / ESCORT VII   |
| <b>VKMOV 6PK1580</b>  | <b>ALFA ROMEO</b><br>159 / BRERA   | <b>VKMOV 6PK1606</b>  | <b>VAUXHALL</b><br>ASTRA Mk IV  | <b>VKMOV 6PK1658</b>  | <b>CITROËN</b><br>XANTIA I / XANTIA II / XM II  |
| <b>VKMOV 6PK1585</b>  | <b>CITROËN</b><br>C5 I / C5 II / C8  | <b>VKMOV 6PK1606</b>  | <b>RENAULT</b><br>ESPACE III  |   | <b>RENAULT</b><br>CLIO II / ESPACE III / LAGUNA I / MEGANE I / SCENIC I   |
|   | <b>FIAT</b><br>ULYSSE (179AX)  | <b>VKMOV 6PK1606</b>  | <b>RENAULT</b><br>MEGANE I  | <b>VKMOV 6PK1660</b>  | <b>AUDI</b><br>A3 (8L1)   |
|   | <b>LANCIA</b><br>PHEDRA  | <b>VKMOV 6PK1610</b>  | <b>RENAULT</b><br>SCENIC I  |   | <b>BMW</b><br>3 (E36) / 3 Compact (E36) / 3 Convertible (E36) / 3 Coupe (E36) / 5 (E34) / 5 Touring (E34)                       |
|   | <b>PEUGEOT</b><br>406 / 407 / 607 / 807  | <b>VKMOV 6PK1615</b>  | <b>FORD</b><br>FIESTA BOX / COURRIER / FIESTA IV  |   | <b>CITROËN</b><br>BERLINGO / EVASION / XANTIA I / XANTIA II / XM II / XSARA / ZX  |
| <b>VKMOV 6PK1589</b>  | <b>RENAULT</b><br>AVANTIME / CLIO II / LAGUNA II   |   | <b>FORD</b><br>FIESTA BOX / COURRIER / FIESTA IV  |   | <b>FIAT</b><br>ULYSSE (220)   |
|   | <b>AUDI</b><br>A4 (8E2, B6) / A4 Avant (8E5, B6) / A4 (8EC) / A4 Avant (8ED) / A4 Convertible (8H7) / A6 (4B, C5) / A6 Avant (4B, C5)                                  | <b>VKMOV 6PK1615</b>  | <b>FORD</b><br>FIESTA BOX / COURRIER / FIESTA IV  |   | <b>LANCIA</b><br>ZETA   |
| <b>VKMOV 6PK1590</b>  | <b>CITROËN</b><br>C6   | <b>VKMOV 6PK1615</b>  | <b>FORD</b><br>FIESTA BOX / COURRIER / FIESTA IV  |   | <b>PEUGEOT</b><br>306 / 405 II / 406 / 605 / 806 / PARTNER  |
|   | <b>OPEL</b><br>ASTRA G / COMBO B / CORSA B / CORSA C / MERIVA  | <b>VKMOV 6PK1620</b>  | <b>AUDI</b><br>A4 (8E2, B6) / A4 Avant (8E5, B6) / A4 (8EC) / A4 Avant (8ED) / A4 Convertible (8H7) / A6 (4F2) / A6 Avant (4F5) |   | <b>SEAT</b><br>CORDOBA (6K2) / CORDOBA (6K2/C2) / CORDOBA Vario (6K5) / IBIZA III (6K1) / INCA / LEON I (1M1) / TOLEDO II (1M2) |
|   | <b>PEUGEOT</b><br>407  |   | <b>VOLVO</b><br>S40 I - V40   |   | <b>SKODA</b><br>OCTAVIA I (1U2) / OCTAVIA Combi (1U5)   |
|   |  |   | <b>OPEL</b><br>ASTRA H / CORSA D / MERIVA   |   |   |
|   |  |   | <b>VAUXHALL</b><br>CORSA Mk III   |   |   |
|   |  |   | <b>OPEL</b><br>ASTRA H  |   |   |
|   |  |   | <b>VAUXHALL</b><br>ASTRA Mk V   |   |   |
|   |  |   | <b>VW</b><br>EOS / GOLF V (1K1) / GOLF V VARIANT (1K1) / PASSAT (3C2) / Variant (3C5)   |   |   |















|  |   |  |                                   |  |    |
|---|--|---|--|---|---|
| VKMV 6PK1670  | <b>VW</b><br>BORA (1J2) / BORA Estate (1J6) / CADDY II(9K9A)/Estate(9K9B)/ Pickup(9U7) / CORRADO (53I) / GOLF II (19E, 1G1) / GOLF IV (1J1) / GOLF IV Variant (1J5) / NEW BEETLE (9C1, 1C1)/ Convertible (1Y7) / PASSAT (3A2, 35I) / Variant (3A5, 35I) / PASSAT (3B2) / Variant (3B5) / PASSAT (3B3) / Variant (3B6) / POLO CLASSIC (6KV2) / Variant (6KV5) | VKMV 6PK1695  | <b>CITROËN</b><br>BERLINGO   | VKMV 6PK1726  | <b>CITROËN</b><br>XANTIA I / XANTIA II / XM I / XM II / XSARA / XSARA PICASSO   |
| VKMV 6PK1674  | <b>CITROËN</b><br>JUMPER   | VKMV 6PK1700  | <b>PEUGEOT</b><br>PARTNER  | VKMV 6PK1733  | <b>PEUGEOT</b><br>206 / 406 / 605   |
| VKMV 6PK1675  | <b>FIAT</b><br>DUCATO  | VKMV 6PK1705  | <b>CITROËN</b><br>XANTIA I / ZX  | VKMV 6PK1735  | <b>BMW</b><br>3 (E36) / 3 (E46) / 3 Compact (E36) / 3 Convertible (E36) / 3 Coupe (E36) / 3 Coupe (E46) / 3 Touring (E36) / 3 Touring (E46) / Z3  |
| VKMV 6PK1680  | <b>FORD</b><br>TRANSIT / TRANSIT TOURNEO   | VKMV 6PK1706  | <b>PEUGEOT</b><br>306 / 405 II   | VKMV 6PK1736  | <b>ALFA ROMEO</b><br>159  |
| VKMV 6PK1682  | <b>PEUGEOT</b><br>BOXER III  | VKMV 6PK1710  | <b>AUDI</b><br>100 (4A, C4) / 100 Avant (4A, C4)   | VKMV 6PK1737  | <b>AUDI</b><br>A4 (8D2, B5) / A4 Avant (8D5, B5) / ALLROAD (4BH)  |
| VKMV 6PK1683  | <b>FORD</b><br>ESCORT VII  | VKMV 6PK1715  | <b>CITROËN</b><br>BERLINGO / C3 / C5 II / XSARA / XSARA PICASSO  | VKMV 6PK1740  | <b>AUDI</b><br>A3 (8P1) / A3 Sportback (8PA)  |
| VKMV 6PK1687  | <b>AUDI</b><br>100 (4A, C4) / 100 Avant (4A, C4) / 80 (8C, B4) / 80 Avant (8C, B4) / CABRIOLET (8G7, B4) / COUPE (89, 8B)  | VKMV 6PK1719  | <b>FORD</b><br>FIESTA V / FUSION   |   | <b>CITROËN</b><br>C5 I / JUMPY I / XANTIA I / XANTIA II / XSARA   |
| VKMV 6PK1688  | <b>CITROËN</b><br>BERLINGO / JUMPY I / XSARA   | VKMV 6PK1725  | <b>MAZDA</b><br>2  |   | <b>FIAT</b><br>SCUDO (220)  |
| VKMV 6PK1690  | <b>FIAT</b><br>SCUDO (220)   |   | <b>PEUGEOT</b><br>206 / 407 / PARTNER  |   | <b>PEUGEOT</b><br>206 / EXPERT I / PARTNER  |
| VKMV 6PK1692  | <b>PEUGEOT</b><br>PARTNER  |   | <b>CITROËN</b><br>C5 I / EVASION   |   | <b>SKODA</b><br>OCTAVIA II (1Z3)/OCTAVIA II Combi (1Z5) / ROOMSTER  |
| VKMV 6PK1694  | <b>RENAULT</b><br>LAGUNA I   |   | <b>FIAT</b><br>SCUDO (220) / ULYSSE (179AX) / ULYSSE (220)   |   | <b>VW</b><br>EOS / GOLF V (1K1) / GOLF V VARIANT (1K1) / GOLF V PLUS (5M1) / JETTA III (1KM) / PASSAT (3C2) / Variant (3C5) / POLO (9N_) / TOURAN |
|   | <b>BMW</b><br>1 (E87)  |   | <b>LANCIA</b><br>PHEDRA / ZETA   |   | <b>CITROËN</b><br>EVASION / JUMPY I / JUMPY II / XSARA / ZX   |
|   | <b>VOLVO</b><br>850 / C70 - S70 / S80 / V70 I / V70 II   |   | <b>PEUGEOT</b><br>307 / 607 / 806  |   | <b>FIAT</b><br>SCUDO (220) / ULYSSE (220)   |
|   | <b>VW</b><br>LT II   |   | <b>CITROËN</b><br>BERLINGO / C4 / C5 I / C5 II / C8 / JUMPY I / XANTIA I / XSARA PICASSO                           |   | <b>LANCIA</b><br>ZETA   |
|   | <b>FORD</b><br>FIESTA BOX / COURRIER / FIESTA IV   |   | <b>PEUGEOT</b><br>307 / 407 / 607 / 807 / EXPERT I / PARTNER   |   | <b>PEUGEOT</b><br>306 / 406 / 806 / EXPERT I  |
|   | <b>FORD</b><br>FIESTA V / GALAXY II / MONDEO IV / S-MAX  |   | <b>RENAULT</b><br>SUPER 5  |   | <b>ALFA ROMEO</b><br>166  |
|   | <b>RENAULT</b><br>R19 / R21  |   | <b>FORD</b><br>FOCUS I / TRANSIT CONNECT / TOURNEO CONNECT   |   | <b>CITROËN</b><br>BERLINGO / C5 I / C5 II / C8 / EVASION / JUMPY I / JUMPY II / XSARA / XSARA PICASSO / ZX  |
|   | <b>TOYOTA</b><br>MR 2  |   | <b>VW</b><br>LT II   |   | <b>FIAT</b><br>MAREA / SCUDO (220) / ULYSSE (179AX) / ULYSSE (220)  |
|   | <b>LANCIA</b><br>KAPPA / THESIS  |   | <b>FORD</b><br>MONDEO I / MONDEO II  |   | <b>LANCIA</b><br>KAPPA / PHEDRA / THESIS  |
|   | <b>VW</b><br>TRANSPORTER IV  |   | <b>OPEL</b><br>ASTRA F / CALIBRA / FRONTERA A / FRONTERA B / OMEGA B / SINTRA / VECTRA A / VECTRA B                |   | <b>PEUGEOT</b><br>206 / 306 / 406 / 607 / 806 / 807 / EXPERT I / PARTNER  |
|   |  |   | <b>VAUXHALL</b><br>ASTRA Mk III / CALIBRA / CAVALIER Mk III / FRONTERA Mk I / FRONTERA Mk II / OMEGA / VECTRA Mk I |   |   |

|  |   |  |                |  |                                   |
|---|--|---|--|---|--|
| VKMMV 6PK1743   | <b>RENAULT</b><br>SAFRANE I  | VKMMV 6PK1762   | <b>VOLVO</b><br>S40 I - V40  | VKMMV 6PK1810   | <b>VAUXHALL</b><br>ASTRA Mk IV / FRONTERA Mk II / OMEGA / SIGNUM / SINTRA / VECTRA Mk I / VECTRA Mk II / ZAFIRA Mk I |
| VKMMV 6PK1744   | <b>VOLVO</b><br>850 / C70 - S70 / V70 I  | VKMMV 6PK1767   | <b>FORD</b><br>FIESTA BOX / COURRIER / FIESTA IV / PUMA  | VKMMV 6PK1815   | <b>FORD</b><br>ESCORT V / ESCORT VI / ORION III  |
| VKMMV 6PK1747   | <b>CITROËN</b><br>C5 I   | VKMMV 6PK1775   | <b>VW</b><br>TRANSPORTER IV  | VKMMV 6DK1825   | <b>DACIA</b><br>LOGAN  |
| VKMMV 6PK1748   | <b>PEUGEOT</b><br>206 / 406 / 607  | VKMMV 6PK1778   | <b>ALFA ROMEO</b><br>145/146   | VKMMV 6PK1830   | <b>FIAT</b><br>DOBLO   |
| VKMMV 6PK1750   | <b>CITROËN</b><br>XANTIA II  | VKMMV 6PK1780   | <b>FIAT</b><br>BRAVA/BRAVO (182)   | VKMMV 6DK1836   | <b>RENAULT</b><br>LAGUNA II  |
| VKMMV 6PK1751   | <b>SKODA</b><br>FABIA  | VKMMV 6PK1792   | <b>MERCEDES-BENZ</b><br>C-class (W202) / E-class (W210) / SLK (R170)                             | VKMMV 6PK1836   | <b>VOLVO</b><br>C70 - S70 / S80 / V70 I / XC90   |
| VKMMV 6PK1752   | <b>CITROËN</b><br>BERLINGO / C5 I / EVASION / JUMPY I / XANTIA II / XSARA  | VKMMV 6PK1795   | <b>RENAULT</b><br>AVANTIME / ESPACE III / LAGUNA II / VEL SATIS                                  | VKMMV 6PK1842   | <b>ALFA ROMEO</b><br>145/146   |
| VKMMV 6PK1755   | <b>FIAT</b><br>ULYSSE (220)  | VKMMV 6PK1800   | <b>FORD</b><br>FIESTA BOX / COURRIER / FIESTA IV / TRANSIT                                       | VKMMV 6PK1844   | <b>FIAT</b><br>BRAVA/BRAVO (182) / MAREA   |
| VKMMV 6PK1756   | <b>FORD</b><br>FIESTA BOX / COURRIER / FIESTA IV   | VKMMV 6PK1805   | <b>MAZDA</b><br>121 (JASM, JBSM)   | VKMMV 6DK1853   | <b>VOLVO</b><br>C70 - S70 / V70 I  |
| VKMMV 6PK1760   | <b>LANCIA</b><br>ZETA  |   | <b>NISSAN</b><br>INTERSTAR / PRIMASTAR   | VKMMV 6PK1855   | <b>ALFA ROMEO</b><br>145/146 / 147 / 155 / 156 / GT  |
|   | <b>MAZDA</b><br>121 (JASM, JBSM)   |   | <b>OPEL</b><br>VIVARO  |   | <b>BMW</b><br>1 (E87) / 3 (E90) / 3 Touring (E91)  |
|   | <b>PEUGEOT</b><br>306 / 406 / 806 / EXPERT I / PARTNER   |   | <b>RENAULT</b><br>AVANTIME / LAGUNA I / LAGUNA II / MASTER II / TRAFIC II / VEL SATIS            |   | <b>FIAT</b><br>BRAVA/BRAVO (182) / MAREA / MULTIPLA  |
|   | <b>RENAULT</b><br>CLIO II / KANGOO / LAGUNA I / LAGUNA II / MEGANE I / SCENIC I / THALIA   |   | <b>VAUXHALL</b><br>VIVARO  |   | <b>LANCIA</b><br>LYBRA   |
|   | <b>VW</b><br>LT II / TRANSPORTER IV  |   | <b>VOLVO</b><br>S40 I - V40  |   | <b>VOLVO</b><br>C70 - S70 / S40 I - V40 / S60 / S80 / V70 I / V70 II / XC70 I  |
|   | <b>VOLVO</b><br>S40 I - V40 / S90 - V90  |   | <b>ALFA ROMEO</b><br>145/146   |   | <b>ALFA ROMEO</b><br>145/146 / 147 / 155 / 156 / GT  |
|   | <b>FORD</b><br>SCORPIO   |   | <b>FIAT</b><br>BARCETTA / BRAVA/BRAVO (182)  |   | <b>FIAT</b><br>BARCETTA / BRAVA/BRAVO (182) / COUPE / MAREA / PUNTO (188)  |
|   | <b>ALFA ROMEO</b><br>156   |   | <b>OPEL</b><br>ASTRA F / COMBO A / CORSA B / TIGRA / VECTRA B                                    |   | <b>LANCIA</b><br>Y   |
|   | <b>AUDI</b><br>A4 (8D2, B5) / A4 Avant (8D5, B5) / A6 (4A, C4) / A6 Avant (4A, C4) / A8 (4D2, 4D8)   |   | <b>RENAULT</b><br>MASTER II / TRAFIC II  |   | <b>FIAT</b><br>STRADA  |
|   | <b>FIAT</b><br>MAREA   |   | <b>VAUXHALL</b><br>ASTRA Mk III / COMBO I / CORSA Mk I / TIGRA Mk I / VECTRA Mk I                |   | <b>MERCEDES-BENZ</b><br>190 (W201)   |
|   | <b>FORD</b><br>FIESTA IV / KA  |   | <b>FORD</b><br>TRANSIT   |   | <b>OPEL</b><br>FRONTERA B  |
|   | <b>LANCIA</b><br>LYBRA   |   | <b>OPEL</b><br>ASTRA G / FRONTERA B / OMEGA B / SIGNUM / SINTRA / VECTRA B / VECTRA C / ZAFIRA A |   | <b>VAUXHALL</b><br>FRONTERA Mk II  |
|   | <b>MERCEDES-BENZ</b><br>C-class (W202)   |   | <b>SAAB</b><br>9-3 I   |   | <b>VOLVO</b><br>C70 - S70 / V70 I  |
|   | <b>VW</b><br>CORRADO (53I) / GOLF II (19E, 1G1) / PASSAT (3A2, 35I) / Variant (3A5, 35I) / PASSAT (3B2) / Variant (3B5) / PASSAT (3B3) / Variant (3B6) |   |  |   | <b>ALFA ROMEO</b><br>145/146 / 147 / 156 / GTV / SPIDER  |

















|  |    |  |   |  |   |
|---|---|---|--|---|--|
| VKMOV 6PK1856   | <b>FIAT</b><br>BRAVA/BRAVO (182) / COUPE<br><b>AUDI</b><br>A4 (8D2, B5) / A4 Avant (8D5, B5) / A4 (8E2, B6) / A4 Avant (8E5, B6) / A4 Convertible (8H7) / A6 (4B, C5) / A6 Avant (4B, C5) / A6 (4F2) / A6 Avant (4F5) / ALLROAD (4BH)             | VKMOV 6PK1882   | <b>AUDI</b><br>A4 (8D2, B5) / A4 Avant (8D5, B5) / A6 (4A, C4) / A6 Avant (4A, C4) / A6 (4B, C5) / A6 Avant (4B, C5) / A8 (4D2, 4D8)<br><b>SKODA</b><br>SUPERB<br><b>VW</b><br>PASSAT (3B2) / Variant (3B5) / PASSAT (3B3) / Variant (3B6) | VKMOV 6PK1962   | <b>ALFA ROMEO</b><br>147 / 156 / 166 / GT / GTV / SPIDER<br><b>LANCIA</b><br>LYBRA   |
| VKMOV 6PK1860   | <b>MERCEDES-BENZ</b><br>C-class (W202) / CLK (W208)   | VKMOV 6PK1885   | <b>MERCEDES-BENZ</b><br>(W 124) / 190 (W201)   | VKMOV 6PK1973   | <b>FORD</b><br>COUGAR / FOCUS I / MONDEO II / TRANSIT CONNECT / TOURNEO CONNECT  |
| VKMOV 6PK1862   | <b>CITROËN</b><br>XM II<br><b>PEUGEOT</b><br>605  | VKMOV 6PK1887   | <b>CITROËN</b><br>C6<br><b>PEUGEOT</b><br>407 / 607  | VKMOV 6PK1975   | <b>ALFA ROMEO</b><br>145/146 / 147 / 156 / 166 / GTV / SPIDER<br><b>LANCIA</b><br>DELTA II / LYBRA   |
| VKMOV 6PK1863   | <b>AUDI</b><br>A6 (4A, C4) / A6 Avant (4A, C4)<br><b>OPEL</b><br>ZAFIRA A<br><b>VAUXHALL</b><br>ZAFIRA Mk I   | VKMOV 6PK1893   | <b>FORD</b><br>FOCUS I   | VKMOV 6PK1980   | <b>MERCEDES-BENZ</b><br>(W 124) / 190 (W201)<br><b>SAAB</b><br>9-5   |
| VKMOV 6PK1870   | <b>BMW</b><br>1 (E87) / 3 (E46) / 3 (E90) / 3 Compact (E46) / 3 Convertible (E46) / 3 Coupe (E46) / 3 Touring (E46) / X3 / Z4<br><b>MERCEDES-BENZ</b><br>C-class (W203) / CLK (W208) / E-class (W210) / SLK (R170)<br><b>VW</b><br>TRANSPORTER IV | VKMOV 6PK1900   | <b>OPEL</b><br>ASTRA F / CALIBRA / OMEGA B / SINTRA / VECTRA A / VECTRA B<br><b>VAUXHALL</b><br>ASTRA Mk III / CALIBRA / CAVALIER Mk III / OMEGA / SINTRA / VECTRA Mk I  | VKMOV 6PK1983   | <b>ALFA ROMEO</b><br>147 / 156 / 166 / GT / GTV / SPIDER<br><b>LANCIA</b><br>KAPPA / THESIS  |
| VKMOV 6PK1873   | <b>OPEL</b><br>ASTRA G / ZAFIRA A<br><b>SEAT</b><br>CORDOBA (6L2) / IBIZA IV (6L1)<br><b>SKODA</b><br>ROOMSTER<br><b>VAUXHALL</b><br>ASTRA Mk IV / ZAFIRA Mk I<br><b>VW</b><br>FOX (5Z1) / POLO (9N_)   | VKMOV 6PK1902   | <b>OPEL</b><br>FRONTERA B / OMEGA B / SINTRA / VECTRA B<br><b>SAAB</b><br>9-3 I / 9-3 II / 9-5<br><b>VAUXHALL</b><br>FRONTERA Mk II / OMEGA / SINTRA / VECTRA Mk I   | VKMOV 6PK1990   | <b>BMW</b><br>1 (E87) / 3 (E90) / 3 Touring (E91) / 5 (E60) / 5 Touring (E61)  |
| VKMOV 6PK1875   | <b>MERCEDES-BENZ</b><br>C-class (W202) / CLK (W208) / E-class (W210) / SLK (R170)   | VKMOV 6PK1905   | <b>VW</b><br>TRANSPORTER IV  | VKMOV 6PK1992   | <b>OPEL</b><br>SIGNUM / VECTRA C<br><b>VAUXHALL</b><br>SIGNUM / VECTRA Mk II   |
| VKMOV 6PK1880   | <b>OPEL</b><br>SIGNUM / VECTRA C<br><b>SEAT</b><br>CORDOBA (6L2) / IBIZA IV (6L1)<br><b>SKODA</b><br>FABIA<br><b>VAUXHALL</b><br>SIGNUM / VECTRA Mk II<br><b>VW</b><br>LUPO (6X1, 6E1) / POLO (9N_)   | VKMOV 6PK1915   | <b>FORD</b><br>FOCUS I   | VKMOV 6PK2000   | <b>MERCEDES-BENZ</b><br>VITO (W638)<br><b>VW</b><br>CRAFTER 30-35 / 30-50 (2E) / LT II   |
|   |   | VKMOV 6PK1920   | <b>FORD</b><br>ESCORT VI / ESCORT VII  | VKMOV 6PK2020   | <b>MERCEDES-BENZ</b><br>V-class (W638) / VITO (W638)<br><b>OPEL</b><br>CALIBRA / OMEGA B / SINTRA / VECTRA A / VECTRA B<br><b>SAAB</b><br>9-5<br><b>VAUXHALL</b><br>CALIBRA / CAVALIER Mk III / OMEGA / SINTRA / VECTRA Mk I |
|   |   | VKMOV 6PK1930   | <b>FORD</b><br>FIESTA BOX / COURRIER / FIESTA IV / PUMA<br><b>MAZDA</b><br>121 (JASM, JBMS)  | VKMOV 6PK2030   | <b>MERCEDES-BENZ</b><br>(W 124) / 190 (W201) / E-class (W124)  |
|   |   | VKMOV 6PK1936   | <b>FORD</b><br>FIESTA IV / KA<br><b>MAZDA</b><br>121 (JASM, JBMS)  | VKMOV 6PK2035   | <b>MERCEDES-BENZ</b><br>C-class (W203)   |
|   |   | VKMOV 6PK1949   | <b>RENAULT</b><br>ESPACE III / LAGUNA I / SAFRANE II   | VKMOV 6PK2040   | <b>FORD</b><br>SCORPIO<br><b>MERCEDES-BENZ</b><br>(W 124) / C-class (W202) / CLK (W208) / E-class (W124)   |
|   |   | VKMOV 6PK1950   | <b>MERCEDES-BENZ</b><br>190 (W201)   |   |  |
|   |   | VKMOV 6PK1954   | <b>FORD</b><br>TRANSIT   |   |  |







|   |  |   |  |   |  |
|---|--|---|--|---|--|
|  |   |  |    |  |   |
| VKVMV 6PK2050   | <b>MERCEDES-BENZ</b><br>(W 124) / 190 (W201) / C-class (W202) / E-class (W124) / E-class (W210) / G-class (W460) / G-class (W463)                          | VKVMV 6PK2125   | <b>MERCEDES-BENZ</b><br>C-class (W202)   | VKVMV 6PK2225   | <b>MERCEDES-BENZ</b><br>S-class (W140) / SL (W129)   |
| VKVMV 6PK2055   | <b>OPEL</b><br>FRONTERA A  | VKVMV 6PK2130   | <b>MERCEDES-BENZ</b><br>E-class (W210)   | VKVMV 6PK2227   | <b>FORD</b><br>MONDEO III  |
| VKVMV 6PK2060   | <b>VAUXHALL</b><br>FRONTERA Mk I   | VKVMV 6PK2135   | <b>VW</b><br>TRANSPORTER IV  | VKVMV 6PK2236   | <b>VW</b><br>TRANSPORTER IV  |
| VKVMV 6PK2063   | <b>MERCEDES-BENZ</b><br>C-class (W202) / CLK (W208) / E-class (W210) / M-class (W163) / SLK (R170)   | VKVMV 6PK2140   | <b>MERCEDES-BENZ</b><br>C-class (W202) / C-class (W203)  | VKVMV 6PK2241   | <b>MERCEDES-BENZ</b><br>C-class (W202) / E-class (W211)  |
| VKVMV 6PK2065   | <b>VW</b><br>TRANSPORTER IV  | VKVMV 6PK2145   | <b>MERCEDES-BENZ</b><br>(W 124) / C-class (W202) / CLK (W208) / E-class (W124) / E-class (W210) / G-class (W463) / S-class (W140)                          | VKVMV 6PK2245   | <b>MERCEDES-BENZ</b><br>C-class (W202) / E-class (W210) / G-class (W461)   |
| VKVMV 6PK2065   | <b>BMW</b><br>X3   | VKVMV 6PK2155   | <b>MERCEDES-BENZ</b><br>S-class (W140)   | VKVMV 6PK2255   | <b>MERCEDES-BENZ</b><br>C-class (W203)   |
| VKVMV 6PK2077   | <b>MERCEDES-BENZ</b><br>E-class (W210)   | VKVMV 6PK2160   | <b>MERCEDES-BENZ</b><br>(W 124) / C-class (W202) / CLK (W208) / E-class (W124) / E-class (W210) / G-class (W461) / M-class (W163) / SLK (R170)             | VKVMV 6PK2257   | <b>MERCEDES-BENZ</b><br>(W 124) / 190 (W201) / E-class (W124) / S-class (W126)   |
| VKVMV 6PK2080   | <b>MERCEDES-BENZ</b><br>V-class (W638) / VITO (W638)   | VKVMV 6PK2170   | <b>VW</b><br>LT II   | VKVMV 6PK2260   | <b>AUDI</b><br>100 (4A, C4) / 100 Avant (4A, C4) / 80 (8C, B4) / 80 Avant (8C, B4) / CABRIOLET (867, B4) / COUPE (89, 8B)  |
| VKVMV 6PK2100   | <b>BMW</b><br>3 (E46) / 3 Compact (E46) / 3 Convertible (E46) / 3 Coupe (E46) / 3 Touring (E46) / 5 (E60) / 5 Touring (E61) / X3                           | VKVMV 6PK2176   | <b>MERCEDES-BENZ</b><br>C-class (W202) / V-class (W638) / VITO (W638)  | VKVMV 6PK2270   | <b>MERCEDES-BENZ</b><br>C-class (W203) / C-class (W204) / CLK (W209) / E-class (W211) / S-class (W220) / VIANO (W639)  |
| VKVMV 6PK2103   | <b>FORD</b><br>MONDEO I / MONDEO II / MONDEO III   | VKVMV 6PK2190   | <b>MERCEDES-BENZ</b><br>C-class (W202) / V-class (W638) / VITO (W638)  | VKVMV 6PK2285   | <b>MERCEDES-BENZ</b><br>C-class (W202) / E-class (W210) / M-class (W163) / SPRINTER 2-t (W901 / W902) / SPRINTER 3-t (W903) / SPRINTER 4-t (W904)  |
| VKVMV 6PK2115   | <b>MERCEDES-BENZ</b><br>(W 124) / C-class (W202) / E-class (W124) / E-class (W210) / G-class (W461) / S-class (W140) / VITO (W638)                         | VKVMV 6PK2196   | <b>MERCEDES-BENZ</b><br>C-class (W202) / V-class (W638) / VITO (W638)  | VKVMV 6PK2315   | <b>MERCEDES-BENZ</b><br>C-class (W202) / E-class (W210) / M-class (W163) / SPRINTER 2-t (W901 / W902) / SPRINTER 3-t (W903) / SPRINTER 4-t (W904)  |
| VKVMV 6PK2120   | <b>FORD</b><br>COUGAR / FOCUS I / MAVERICK / MONDEO II / TRANSIT CONNECT / TOURNEO CONNECT   | VKVMV 6PK2205   | <b>MERCEDES-BENZ</b><br>(W 124) / 190 (W201) / E-class (W124) / E-class (W210) / G-class (W461) / S-class (W140) / VITO (W638)                             | VKVMV 6PK2330   | <b>MERCEDES-BENZ</b><br>C-class (W202) / G-class (W463) / VIANO (W639) / VITO (W639)   |
| VKVMV 6PK2125   | <b>MERCEDES-BENZ</b><br>(W 124) / 190 (W201) / E-class (W124) / E-class (W210) / G-class (W461) / S-class (W140) / VITO (W638)                             | VKVMV 6PK2215   | <b>MERCEDES-BENZ</b><br>C-class (W202) / V-class (W638) / VITO (W638)  | VKVMV 6PK2345   | <b>MERCEDES-BENZ</b><br>S-class (W140) / SL (W129)   |
| VKVMV 6PK2130   | <b>MERCEDES-BENZ</b><br>C-class (W202) / CLK (W208) / E-class (W210) / M-class (W163) / SLK (R170)   | VKVMV 6PK2222   | <b>FORD</b><br>MONDEO III  | VKVMV 6PK2373   | <b>SAAB</b><br>9-3 I   |
| VKVMV 6PK2135   | <b>VW</b><br>TRANSPORTER IV  | VKVMV 6PK2225   | <b>MERCEDES-BENZ</b><br>S-class (W140) / SL (W129) / SPRINTER 2-t (W901 / W902) / SPRINTER 3-t (W903) / SPRINTER 4-t (W904) / V-class (W638) / VITO (W638) | VKVMV 6PK2390   | <b>VW</b><br>PASSAT (3B2) / Variant (3B5) / PASSAT (3B3) / Variant (3B6)   |
| VKVMV 6PK2140   | <b>MERCEDES-BENZ</b><br>C-class (W202) / C-class (W203)  | VKVMV 6PK2227   | <b>MERCEDES-BENZ</b><br>C-class (W202) / E-class (W210) / G-class (W461) / S-class (W140) / VITO (W638)  | VKVMV 6PK2390   | <b>MERCEDES-BENZ</b><br>C-class (W202) / C-class (W203) / CLK (W208) / CLK (W209) / E-class (W210) / E-class (W211) / G-class (W463) / M-class (W163) / S-class (W215) / S-class (W220) / SL (W129) / SL (W230) / SLK (R170) |
| VKVMV 6PK2145   | <b>MERCEDES-BENZ</b><br>(W 124) / C-class (W202) / CLK (W208) / E-class (W124) / E-class (W210) / G-class (W463) / S-class (W140)                          | VKVMV 6PK2236   | <b>VW</b><br>TRANSPORTER IV  | VKVMV 6PK2390   | <b>MERCEDES-BENZ</b><br>C-class (W202) / C-class (W203) / CLK (W208) / CLK (W209) / E-class (W210) / E-class (W211) / G-class (W463) / M-class (W163) / S-class (W215) / S-class (W220) / SL (W129) / SL (W230) / SLK (R170) |
| VKVMV 6PK2155   | <b>MERCEDES-BENZ</b><br>C-class (W202) / C-class (W203)  | VKVMV 6PK2241   | <b>MERCEDES-BENZ</b><br>C-class (W202) / E-class (W211)  | VKVMV 6PK2390   | <b>MERCEDES-BENZ</b><br>C-class (W202) / C-class (W203) / CLK (W208) / CLK (W209) / E-class (W210) / E-class (W211) / G-class (W463) / M-class (W163) / S-class (W215) / S-class (W220) / SL (W129) / SL (W230) / SLK (R170) |
| VKVMV 6PK2160   | <b>BMW</b><br>5 (E60) / 5 Touring (E61)  | VKVMV 6PK2245   | <b>MERCEDES-BENZ</b><br>C-class (W202) / E-class (W210) / G-class (W461)   | VKVMV 6PK2390   | <b>MERCEDES-BENZ</b><br>C-class (W202) / C-class (W203) / CLK (W208) / CLK (W209) / E-class (W210) / E-class (W211) / G-class (W463) / M-class (W163) / S-class (W215) / S-class (W220) / SL (W129) / SL (W230) / SLK (R170) |
| VKVMV 6PK2170   | <b>MERCEDES-BENZ</b><br>(W 124) / 190 (W201) / E-class (W124) / S-class (W126)   | VKVMV 6PK2255   | <b>MERCEDES-BENZ</b><br>C-class (W203)   | VKVMV 6PK2390   | <b>MERCEDES-BENZ</b><br>C-class (W202) / C-class (W203) / CLK (W208) / CLK (W209) / E-class (W210) / E-class (W211) / G-class (W463) / M-class (W163) / S-class (W215) / S-class (W220) / SL (W129) / SL (W230) / SLK (R170) |
| VKVMV 6PK2176   | <b>MERCEDES-BENZ</b><br>C-class (W202)   | VKVMV 6PK2257   | <b>MERCEDES-BENZ</b><br>(W 124) / 190 (W201) / E-class (W124) / S-class (W126)   | VKVMV 6PK2390   | <b>MERCEDES-BENZ</b><br>C-class (W202) / C-class (W203) / CLK (W208) / CLK (W209) / E-class (W210) / E-class (W211) / G-class (W463) / M-class (W163) / S-class (W215) / S-class (W220) / SL (W129) / SL (W230) / SLK (R170) |
| VKVMV 6PK2190   | <b>MERCEDES-BENZ</b><br>C-class (W202)   | VKVMV 6PK2260   | <b>AUDI</b><br>100 (4A, C4) / 100 Avant (4A, C4) / 80 (8C, B4) / 80 Avant (8C, B4) / CABRIOLET (867, B4) / COUPE (89, 8B)                                  | VKVMV 6PK2390   | <b>MERCEDES-BENZ</b><br>C-class (W202) / C-class (W203) / CLK (W208) / CLK (W209) / E-class (W210) / E-class (W211) / G-class (W463) / M-class (W163) / S-class (W215) / S-class (W220) / SL (W129) / SL (W230) / SLK (R170) |
| VKVMV 6PK2196   | <b>FORD</b><br>KA / STREET KA  | VKVMV 6PK2270   | <b>MERCEDES-BENZ</b><br>C-class (W202) / E-class (W210) / M-class (W163) / SPRINTER 2-t (W901 / W902) / SPRINTER 3-t (W903) / SPRINTER 4-t (W904)          | VKVMV 6PK2390   | <b>MERCEDES-BENZ</b><br>C-class (W202) / C-class (W203) / CLK (W208) / CLK (W209) / E-class (W210) / E-class (W211) / G-class (W463) / M-class (W163) / S-class (W215) / S-class (W220) / SL (W129) / SL (W230) / SLK (R170) |
| VKVMV 6PK2198   | <b>MERCEDES-BENZ</b><br>C-class (W202) / E-class (W210)  | VKVMV 6PK2285   | <b>MERCEDES-BENZ</b><br>C-class (W202) / E-class (W210) / M-class (W163) / SPRINTER 2-t (W901 / W902) / SPRINTER 3-t (W903) / SPRINTER 4-t (W904)          | VKVMV 6PK2390   | <b>MERCEDES-BENZ</b><br>C-class (W202) / C-class (W203) / CLK (W208) / CLK (W209) / E-class (W210) / E-class (W211) / G-class (W463) / M-class (W163) / S-class (W215) / S-class (W220) / SL (W129) / SL (W230) / SLK (R170) |
| VKVMV 6PK2205   | <b>FORD</b><br>GALAXY II / MONDEO IV / S-MAX   | VKVMV 6PK2315   | <b>MERCEDES-BENZ</b><br>C-class (W202) / G-class (W463) / VIANO (W639) / VITO (W639)   | VKVMV 6PK2390   | <b>MERCEDES-BENZ</b><br>C-class (W202) / C-class (W203) / CLK (W208) / CLK (W209) / E-class (W210) / E-class (W211) / G-class (W463) / M-class (W163) / S-class (W215) / S-class (W220) / SL (W129) / SL (W230) / SLK (R170) |
| VKVMV 6PK2215   | <b>MERCEDES-BENZ</b><br>S-class (W140) / SL (W129) / SPRINTER 2-t (W901 / W902) / SPRINTER 3-t (W903) / SPRINTER 4-t (W904) / V-class (W638) / VITO (W638) | VKVMV 6PK2330   | <b>MERCEDES-BENZ</b><br>C-class (W202) / E-class (W210) / M-class (W163) / SPRINTER 2-t (W901 / W902) / SPRINTER 3-t (W903) / SPRINTER 4-t (W904)          | VKVMV 6PK2390   | <b>MERCEDES-BENZ</b><br>C-class (W202) / C-class (W203) / CLK (W208) / CLK (W209) / E-class (W210) / E-class (W211) / G-class (W463) / M-class (W163) / S-class (W215) / S-class (W220) / SL (W129) / SL (W230) / SLK (R170) |
| VKVMV 6PK2222   | <b>FORD</b><br>MONDEO III  | VKVMV 6PK2345   | <b>SAAB</b><br>9-3 I   | VKVMV 6PK2390   | <b>MERCEDES-BENZ</b><br>C-class (W202) / C-class (W203) / CLK (W208) / CLK (W209) / E-class (W210) / E-class (W211) / G-class (W463) / M-class (W163) / S-class (W215) / S-class (W220) / SL (W129) / SL (W230) / SLK (R170) |









|   |   |   |  |   |  |
|---|---|---|--|---|--|
|  |    |  |   |  |                   |
| VKMM 6PK2404  | <p><b>AUDI</b><br/>A4 (8D2, B5) / A4 Avant (8D5, B5) / A4 (8E2, B6) / A4 Avant (8E5, B6) / A4 (8EC) / A4 Avant (8ED) / A4 Convertible (8H7) / A6 (4B, C5) / A6 Avant (4B, C5) / A8 (4D2, 4D8) / ALLROAD (4BH)</p> <p><b>MERCEDES-BENZ</b><br/>C-class (W203) / C-class (W204) / CLK (W209) / E-class (W211) / M-CLASS (W164) / R-class (W251) / S-class (W221) / SLK (R171)</p> <p><b>SKODA</b><br/>SUPERB</p> <p><b>VW</b><br/>PASSAT (3B2) / Variant (3B5) / PASSAT (3B3) / Variant (3B6)</p> | VKMM 7DK1360  | <p><b>VW</b><br/>CORRADO (53I) / GOLF III (1H1) / GOLF III Variant (1H5) / PASSAT (3A2, 35I) / Variant (3A5, 35I) / SHARAN (7M8, 7M9, 7M6) / VENTO (1H2)</p> <p><b>FORD</b><br/>GALAXY I</p> <p><b>MERCEDES-BENZ</b><br/>V-class (W638)</p> <p><b>VW</b><br/>CORRADO (53I) / GOLF III (1H1) / GOLF III Variant (1H5) / PASSAT (3A2, 35I) / Variant (3A5, 35I) / SHARAN (7M8, 7M9, 7M6) / VENTO (1H2)</p> | VKMM 7PK1970  | <b>VAUXHALL</b><br>MOVANO  |
| VKMM 6PK2445  | <b>MERCEDES-BENZ</b><br>S-class (W140)  | VKMM 7PK1440  | <b>BMW</b><br>Z8   | VKMM 7PK1975  | <b>RENAULT</b><br>ESPACE IV / LAGUNA II / VEL SATIS  |
| VKMM 6PK2462  | <b>MERCEDES-BENZ</b><br>S-class (W215) / S-class (W220) / SL (W230)   | VKMM 7PK1580  | <b>BMW</b><br>5 (E34) / 5 Touring (E34) / 7 (E32) / 7 (E38) / 8 (E31)  | VKMM 7PK2035  | <b>ALFA ROMEO</b><br>145/146 / 156 / 166 / GTV / SPIDER  |
| VKMM 6PK2475  | <b>MERCEDES-BENZ</b><br>(W 124) / E-class (W124)  | VKMM 7PK1595  | <b>LAND ROVER</b><br>DEFENDER I / DISCOVERY II   | VKMM 7PK2271  | <b>LANCIA</b><br>DELTA II  |
| VKMM 6PK2480  | <b>VW</b><br>PHAETON (3D2)  | VKMM 7PK1605  | <b>LAND ROVER</b><br>DEFENDER I / DISCOVERY II / RANGE ROVER I / RANGE ROVER II  | VKMM 7PK2335  | <b>MERCEDES-BENZ</b><br>C-class (W203) / C-class (W204) / CLK (W209) / E-class (W211) / VIANO (W639) |
| VKMM 6PK2510  | <b>MERCEDES-BENZ</b><br>E-class (W210)  | VKMM 7PK1629  | <b>BMW</b><br>5 (E34) / 5 Touring (E34) / 7 (E32) / 7 (E38) / 8 (E31)  | VKMM 7PK2345  | <b>MERCEDES-BENZ</b><br>S-class (W215) / S-class (W220)  |
| VKMM 6PK2622  | <b>SAAB</b><br>900 II   | VKMM 7PK1635  | <b>BMW</b><br>5 (E39) / 5 Touring (E39) / 7 (E38) / 8 (E31)  | VKMM 7PK2420  | <b>MERCEDES-BENZ</b><br>S-class (W215) / S-class (W220)  |
| VKMM 7PK880   | <b>RENAULT</b><br>CLIO III / MODUS  | VKMM 7PK1705  | <b>BMW</b><br>5 (E39) / 5 Touring (E39) / 7 (E38)  | VKMM 7PK2569  | <b>MERCEDES-BENZ</b><br>C-class (W203) / C-class (W204) / CLK (W209) / E-class (W211) / SLK (R171)   |
| VKMM 7PK935   | <b>MINI</b><br>MINI   | VKMM 7PK1716  | <b>RENAULT</b><br>MEGANE II / SCENIC II / GRAND SCENIC   | VKMM 7DK2842  | <b>VW</b><br>PASSAT (3B3) / Variant (3B6)  |
| VKMM 7PK1035  | <b>BMW</b><br>7 (E38)   | VKMM 7PK1770  | <b>LAND ROVER</b><br>DEFENDER I / DISCOVERY II   | VKMM 7PK2842  | <b>FORD</b><br>TRANSIT   |
| VKMM 7PK1080  | <b>RENAULT</b><br>CLIO III / MODUS  | VKMM 7PK1784  | <b>RENAULT</b><br>ESPACE IV  | VKMM 8PK2035  | <b>MERCEDES-BENZ</b><br>M-CLASS (W164) / R-class (W251) / S-class (W221)                             |
| VKMM 7PK1127  | <b>ALFA ROMEO</b><br>145/146 / 155 / 156 / GTV / SPIDER   | VKMM 7PK1792  | <b>RENAULT</b><br>ESPACE IV  | VKMM 10AVx550   | <b>PEUGEOT</b><br>205 / 309 / 405 I  |
| VKMM 7PK1135  | <b>LANCIA</b><br>DEDRA / DELTA II   | VKMM 7PK1801  | <b>RENAULT</b><br>LAGUNA II / VEL SATIS  | VKMM 10AVx600   | <b>AUDI</b><br>100 (43, C2) / 100 Avant (43, C2) / 80 (81, 85, B2)                                   |
| VKMM 7PK1175  | <b>RENAULT</b><br>MEGANE II / SCENIC II / GRAND SCENIC  | VKMM 7PK1820  | <b>LAND ROVER</b><br>DEFENDER I / DISCOVERY II   |   | <b>CITROËN</b><br>C25  |
| VKMM 7PK1290  | <b>RENAULT</b><br>CLIO III  | VKMM 7PK1855  | <b>RENAULT</b><br>DISCOVERY II   |   | <b>PEUGEOT</b><br>309 / J5   |
|   | <b>MINI</b><br>MINI   | VKMM 7PK1867  | <b>BMW</b><br>3 Coupe (E92)  |   | <b>RENAULT</b><br>R5   |
|   | <b>MERCEDES-BENZ</b><br>V-class (W638)  | VKMM 7PK1922  | <b>LAND ROVER</b><br>DISCOVERY II  |   | <b>VW</b><br>TRANSPORTER III   |
|   |   |   | <b>OPEL</b><br>MOVANO  |   | <b>LAND ROVER</b><br>DISCOVERY I / RANGE ROVER II  |
|   |   |   |  |   | <b>PEUGEOT</b><br>205 / 309  |
|   |   |   |  |   | <b>CITROËN</b><br>BX / C25   |
|   |   |   |  |   | <b>RENAULT</b><br>R4   |
|   |   |   |  |   | <b>VW</b><br>TRANSPORTER III   |

|   |   |   |   |   |   |
|---|---|---|---|---|---|
|  |    |  |   |  |    |
| <b>VKMV 10AVx630</b>  | <b>SEAT</b><br>TOLEDO I (1L)<br><hr/> <b>VW</b><br>CORRADO (53I) / GOLF I Cabriolet (155) / GOLF II (19E, 1G1) / JETTA II (19E, 1G2) / PASSAT (3A2, 35I) / Variant (3A5, 35I) / TRANSPORTER III   |   | <b>VW</b><br>DERBY (86) / DERBY (86C, 80) / GOLF I (17) / JETTA I (16) / JETTA II (19E, 1G2) / PASSAT (32) / Variant (33) / PASSAT (32B) / PASSAT (3A2, 35I) / Variant (3A5, 35I) / POLO (86) / POLO (86C, 80) / POLO Box (86CF) / SANTANA (32B) / SCIROCCO (53) / SCIROCCO (53B) / TRANSPORTER III   |   | <b>LANCIA</b><br>DEDRA / DELTA I<br><hr/> <b>VW</b><br>CORRADO (53I) / PASSAT (32B) / SANTANA (32B)   |
| <b>VKMV 10AVx650</b>  | <b>CITROËN</b><br>BX / XM I<br><hr/> <b>FIAT</b><br>BRAVA/BRAVO (182)<br><hr/> <b>PEUGEOT</b><br>309 / 405 I / J9<br><hr/> <b>VW</b><br>GOLF I (17) / TRANSPORTER III / TRANSPORTER IV  | <b>VKMV 10AVx700</b>  | <b>CITROËN</b><br>AX / C25<br><hr/> <b>PEUGEOT</b><br>106 I / J5<br><hr/> <b>RENAULT</b><br>R5  | <b>VKMV 10AVx740</b>  | <b>VW</b><br>GOLF II (19E, 1G1) / JETTA II (19E, 1G2) / PASSAT (3A2, 35I) / Variant (3A5, 35I)  |
| <b>VKMV 10AVx660</b>  | <b>VW</b><br>CORRADO (53I) / GOLF II (19E, 1G1)   | <b>VKMV 10AVx710</b>  | <b>AUDI</b><br>80 (89, 89Q, 8A, B3) / 90 (89, 89Q, 8A, B3)<br><hr/> <b>CITROËN</b><br>AX / BERLINGO / BX / C15 / SAXO / XSARA / ZX<br><hr/> <b>FIAT</b><br>CROMA (154)<br><hr/> <b>PEUGEOT</b><br>106 I / 106 II / 205 / 206 / 306 / 309 / 405 I / 405 II / BOXER I   | <b>VKMV 10AVx750</b>  | <b>SEAT</b><br>IBIZA I (021A) / MALAGA<br><hr/> <b>TALBOT</b><br>TAGORA   |
| <b>VKMV 10AVx666</b>  | <b>RENAULT</b><br>R5  |   |   | <b>VKMV 10AVx763</b>  | <b>AUDI</b><br>80 (81, 85, B2) / COUPE (81, 85)<br><hr/> <b>VW</b><br>PASSAT (32B) / SANTANA (32B) / TRANSPORTER III  |
| <b>VKMV 10AVx675</b>  | <b>AUDI</b><br>50 (86) / 80 (81, 85, B2)<br><hr/> <b>AUTOBIANCHI</b><br>Y10<br><hr/> <b>FIAT</b><br>PANDA (141A_) / TIPO / UNO<br><hr/> <b>LANCIA</b><br>Y10<br><hr/> <b>SEAT</b><br>TERRA<br><hr/> <b>VW</b><br>DERBY (86) / DERBY (86C, 80) / GOLF II (19E, 1G1) / JETTA I (16) / JETTA II (19E, 1G2) / PASSAT (32) / Variant (33) / PASSAT (32B) / POLO (86) / POLO (86C, 80) / POLO Box (86CF) / SANTANA (32B) / SCIROCCO (53) / SCIROCCO (53B) | <b>VKMV 10AVx725</b>  | <b>LANCIA</b><br>DEDRA / DELTA II   | <b>VKMV 10AVx775</b>  | <b>AUDI</b><br>80 (81, 85, B2) / 80 (89, 89Q, 8A, B3)   |
| <b>VKMV 10AVx690</b>  | <b>FIAT</b><br>PUNTO (176) / SCUDO (220)<br><hr/> <b>LANCIA</b><br>DEDRA / DELTA II<br><hr/> <b>PEUGEOT</b><br>EXPERT I<br><hr/> <b>RENAULT</b><br>CLIO I / EXPRESS/EXTRA/ RAPID / R19 / R4   | <b>VKMV 10AVx730</b>  | <b>AUDI</b><br>100 (44,44Q,C3)/100 Avant (44,44Q,C3)<br><hr/> <b>FORD</b><br>GALAXY I<br><hr/> <b>SEAT</b><br>ALHAMBRA / CORDOBA (6K2) / CORDOBA (6K2/C2) / CORDOBA Vario (6K5) / IBIZA II (6K1) / INCA / TOLEDO I (1L)   | <b>VKMV 10AVx785</b>  | <b>AUDI</b><br>200 (44, 44Q) / 200 Avant (44, 44Q) / 80 (89, 89Q, 8A, B3) / 90 (89, 89Q, 8A, B3) / QUATTRO (85)   |
| <b>VKMV 10AVx695</b>  | <b>AUDI</b><br>50 (86) / 80 (81, 85, B2)  | <b>VKMV 10AVx735</b>  | <b>VW</b><br>CADDY II(9K9A)/Estate(9K9B)/ Pickup(9U7) / CORRADO (53I) / GOLF I Cabriolet (155) / GOLF II (19E, 1G1) / GOLF III (1H1) / GOLF III Variant (1H5) / GOLF III Cabriolet (1E7) / GOLF IV Cabriolet (1E7) / JETTA II (19E, 1G2) / PASSAT (3A2, 35I) / Variant (3A5, 35I) / POLO CLASSIC (6KV2) / Variant (6KV5) / SHARAN (7M8, 7M9, 7M6) / VENTO (1H2) | <b>VKMV 10AVx800</b>  | <b>BMW</b><br>3 Convertible (E30) / 3 Touring (E30) / 5 (E12) / 5 (E28) / 5 (E34) / 5 Touring (E34) / 7 (E23)   |
|   |   |   |   |   | <b>CITROËN</b><br>BX / C25<br><hr/> <b>FIAT</b><br>CINQUECENTO / PANDA (141A_) / SEICENTO<br><hr/> <b>FORD</b><br>ESCORT BOX 81 / ESCORT III / ESCORT V / ESCORT VI / ESCORT VII / FIESTA III / FIESTA IV / ORION I / ORION III<br><hr/> <b>OPEL</b><br>OMEGA A<br><hr/> <b>PEUGEOT</b><br>J5<br><hr/> <b>RENAULT</b><br>R9<br><hr/> <b>SEAT</b><br>FURA / IBIZA I (021A) / MAR-BELLA / PANDA / TERRA |
|   |   |   | <b>AUDI</b><br>80 (81, 85, B2) / 80 (89, 89Q, 8A, B3) / 90 (81, 85, B2) / 90 (89, 89Q, 8A, B3)  | <b>VKMV 10AVx813</b>  | <b>AUDI</b><br>100 (43, C2) / 100 Avant (43, C2) / 100 (44,44Q,C3)/100 Avant (44,44Q,C3)  |









|  |    |  |   |  |  |  |
|---|---|---|--|---|---|--|
| VKMV 10AVx825   | <b>BMW</b><br>3 (E30) / 3 Convertible (E30) / 5 (E28)   | VKMV 10AVx865   | <b>AUDI</b><br>80 (8C, B4) / 80 Avant (8C, B4) / 90 (89, 89Q, 8A, B3) / CABRIOLET (8G7, B4) / COUPE (89, 8B)   | VKMV 10AVx913   | <b>CITROËN</b><br>BX / C15 / LNA / VISA   |  |
|   | <b>FORD</b><br>ESCORT BOX 86 / ESCORT IV / ORION II   |   | <b>BMW</b><br>3 (E21) / 3 (E30) / 3 Convertible (E30) / 3 Touring (E30) / 5 (E28) / 7 (E32)  |   | <b>VW</b><br>TRANSPORTER III  |  |
|   | <b>OPEL</b><br>ASTRA F  |   | <b>SEAT</b><br>TOLEDO I (1L)   |   | <b>BMW</b><br>7 (E23)   |  |
| VKMV 10AVx838   | <b>VW</b><br>LT I   | VKMV 10AVx875   | <b>BMW</b><br>3 (E21) / 5 (E12) / 5 (E28)  | VKMV 10AVx925   | <b>OPEL</b><br>ASCONA C / CORSA A / CORSA B   |  |
|   | <b>ALFA ROMEO</b><br>145/146 / 33   |   | <b>VW</b><br>GOLF I Cabriolet (155) / GOLF II (19E, 1G1) / PASSAT (3A2, 35I) / Variant (3A5, 35I)  |   | <b>PEUGEOT</b><br>104 / 205   |  |
|   | <b>BMW</b><br>3 (E21) / 3 (E30) / 3 Convertible (E30) / 3 Touring (E30) / 5 (E28)   |   | <b>OPEL</b><br>ASCONA C / ASTRA F / FRONTERA A / KADETT E  |   | <b>TALBOT</b><br>SAMBA / TAGORA   |  |
| VKMV 10AVx850   | <b>FORD</b><br>ESCORT BOX 81 / ESCORT BOX 86 / ESCORT III / ESCORT IV / ORION II  | VKMV 10AVx888   | <b>VAUXHALL</b><br>CAVALIER Mk II  | VKMV 10AVx935   | <b>VAUXHALL</b><br>CAVALIER Mk II   |  |
|   | <b>LANCIA</b><br>DELTA I  |   | <b>BMW</b><br>5 (E28) / 6 (E24)  |   | VKMV 10AVx940   | <b>CITROËN</b><br>C25  |
|   | <b>RENAULT</b><br>R5  |   | <b>OPEL</b><br>FRONTERA A / SENATOR B  |   |   | VKMV 10AVx950  |
| <b>SEAT</b><br>RITMO  | VKMV 10AVx900   | <b>VAUXHALL</b><br>CAVALIER Mk II   | <b>VAUXHALL</b><br>ASTRA Mk III / CAVALIER Mk II   |   |   |  |
| <b>AUDI</b><br>100 (44,44Q,C3)/100 Avant (44,44Q,C3)                              |   | <b>BMW</b><br>5 (E12) / 5 (E28) / 6 (E24) / 7 (E23) / Z1                          | <b>VW</b><br>CADDY I (14) / GOLF I (17) / TRANSPORTER III  | <b>VW</b><br>K 70 (48)  |   |  |
| <b>FORD</b><br>ESCORT BOX 86 / ESCORT IV / ORION II                               |   | <b>OPEL</b><br>FRONTERA A / SENATOR B   | <b>PEUGEOT</b><br>J9   | <b>MERCEDES-BENZ</b><br>SL (W107)   |   |  |
| VKMV 10AVx850   | <b>LANCIA</b><br>DELTA I  | VKMV 10AVx905   | <b>PEUGEOT</b><br>104  | VKMV 10AVx950   | <b>BMW</b><br>5 (E28)   |  |
|   | <b>SEAT</b><br>IBIZA I (021A) / MALAGA  |   | <b>RENAULT</b><br>R14  |   | VKMV 10AVx910   | <b>AUDI</b><br>100 (43, C2) / 100 Avant (43, C2) / 100 (4A, C4) / 100 Avant (4A, C4) / 100 Avant (4A, C4) / 80 (80, 82, B1) / 80 (81, 85, B2) / 80 (89, 89Q, 8A, B3) / 80 (8C, B4) / 80 Avant (8C, B4) / COUPE (81, 85) / COUPE (89, 8B) |
|   | <b>VW</b><br>TRANSPORTER III  |   | <b>VW</b><br>181 / KAEFER / BEETLE / COCCINELLE / FUSCA / TRANSPORTER II   |   |   | <b>BMW</b><br>3 (E21) / 3 (E30) / 5 (E12)  |
| <b>ALFA ROMEO</b><br>33   | <b>AUDI</b><br>100 (43, C2) / 100 Avant (43, C2) / 100 (4A, C4) / 100 Avant (4A, C4) / 80 (89, 89Q, 8A, B3) / 80 (8C, B4) / 80 Avant (8C, B4) / COUPE (81, 85) / QUATTRO (85) | <b>SEAT</b><br>TOLEDO I (1L)  | <b>SKODA</b><br>FAVORIT / FELICIA I (6U1) / Estate (6U5) / Fun (797) / FELICIA II (6U1) / FELICIA II Estate (6U5)  |   |   |  |
| VKMV 10AVx850   | <b>BMW</b><br>3 (E21) / 3 Touring (E30)   | VKMV 10AVx910   | <b>AUDI</b><br>100 (43, C2) / 100 Avant (43, C2) / 100 (4A, C4) / 100 Avant (4A, C4) / 80 (89, 89Q, 8A, B3) / 80 (8C, B4) / 80 Avant (8C, B4) / A6 (4A, C4) / A6 Avant (4A, C4) / CABRIOLET (8G7, B4) / COUPE (89, 8B) |   |   |  |
|   | <b>OPEL</b><br>ASCONA C   |   |  |   |   |  |
|   | <b>SEAT</b><br>RITMO  |   |  |   |   |  |
| VKMV 10AVx850   | <b>VAUXHALL</b><br>CAVALIER Mk II   |   |  |   |   |  |
|   | <b>VW</b><br>GOLF I (17) / GOLF II (19E, 1G1) / PASSAT (32B) / SCIROCCO (53B)   |   |  |   |   |  |



|  |   |  |  |  |    |
|---|--|---|--|---|---|
| VKMV 10AVx965   | <b>VW</b><br>CADDY I (14) / CORRADO (53I) / GOLF I (17) / GOLF I Cabriolet (155) / GOLF II (19E, 1G1) / ILTIS (183) / JETTA I (16) / JETTA II (19E, 1G2) / PASSAT (32) / Variant (33) / PASSAT (32B) / PASSAT (3A2, 35I) / Variant (3A5, 35I) / SANTANA (32B) / SCIROCCO (53) / SCIROCCO (53B) | VKMV 10AVx1090  | <b>CITROËN</b><br>XM I   | VKMV 11.5x790   | <b>VW</b><br>CADDY II(9K9A)/Estate(9K9B)/ Pickup(9U7) / CORRADO (53I) / GOLF III (1H1) / GOLF III Variant (1H5) / GOLF III Cabriolet (1E7) / GOLF IV Cabriolet (1E7) / PASSAT (3A2, 35I) / Variant (3A5, 35I) / POLO CLASSIC (6KV2) / Variant (6KV5) / SANTANA / VENTO (1H2)                                      |
|   | <b>BMW</b><br>3 (E30) / 3 Convertible (E30) / 3 Touring (E30) / Z1   |   | <b>CITROËN</b><br>XM I   |   | <b>AUDI</b><br>100 (43, C2) / 100 Avant (43, C2) / 100 (44, 44Q, C3) / 100 Avant (44, 44Q, C3) / 200 (43) / 80 (81, 85, B2) / 90 (81, 85, B2) / COUPE (81, 85)  |
|   | <b>VW</b><br>411,412 / GOLF II (19E, 1G1) / ILTIS (183) / JETTA II (19E, 1G2) / TRANSPORTER IV   |   | <b>TALBOT</b><br>TAGORA  |   | <b>FORD</b><br>GALAXY I   |
|   | <b>BMW</b><br>3 (E21) / 5 (E28)  |   | <b>VW</b><br>TRANSPORTER III   |   | <b>SEAT</b><br>ALHAMBRA / CORDOBA (6K2) / CORDOBA (6K2/C2) / CORDOBA Vario (6K5) / IBIZA II (6K1) / INCA / TOLEDO I (1L)  |
|   | <b>NISSAN</b><br>MICRA   |   | <b>TALBOT</b><br>TAGORA  |   | <b>VW</b><br>CADDY II(9K9A)/Estate(9K9B)/ Pickup(9U7) / GOLF III (1H1) / GOLF III Variant (1H5) / GOLF III Cabriolet (1E7) / GOLF IV Cabriolet (1E7) / LT I / PASSAT (32B) / PASSAT (3A2, 35I) / Variant (3A5, 35I) / POLO CLASSIC (6KV2) / Variant (6KV5) / SANTANA (32B) / SHARAN (7M8, 7M9, 7M6) / VENTO (1H2) |
|   | <b>BMW</b><br>3 (E30) / 3 Touring (E30) / 5 (E28)  |   | <b>NISSAN</b><br>PATROL GR   |   | <b>RENAULT</b><br>ESPACE II   |
|   | <b>OPEL</b><br>FRONTERA A / OMEGA A  |   | <b>RENAULT</b><br>CLIO I / EXPRESS/EXTRA/ RAPID / R11 / R19 / R21 / R9 / SUPER 5   |   | <b>SEAT</b><br>CORDOBA (6K2) / CORDOBA Vario (6K5) / IBIZA II (6K1) / INCA / TOLEDO I (1L)  |
|   | <b>PEUGEOT</b><br>605  |   | <b>RENAULT</b><br>SUPER 5 / TWINGO   |   | <b>VW</b><br>PASSAT (32B)   |
|   | <b>RENAULT</b><br>ESPACE I / ESPACE II   |   | <b>RENAULT</b><br>SAFRANE I  |   | <b>SEAT</b><br>CORDOBA (6K2) / CORDOBA Vario (6K5) / IBIZA II (6K1) / INCA / TOLEDO I (1L)  |
|   | <b>RENAULT</b><br>ESPACE II  |   | <b>VW</b><br>PASSAT (32B)  |   | <b>VW</b><br>GOLF II (19E, 1G1) / JETTA II (19E, 1G2) / POLO (86C, 80) / POLO Box (86CF)  |
| <b>RENAULT</b><br>MASTER I / R18 / R20 / R21 / TRAFIC I                           | <b>VW</b><br>181 / KAEFER / BEETLE / COCCINELLE / FUSCA / TRANSPORTER II   | <b>FORD</b><br>ESCORT BOX 86 / ESCORT IV / ORION II                               |  |   |   |
| <b>MERCEDES-BENZ</b><br>190 (W201)  | <b>VW</b><br>181 / KAEFER / BEETLE / COCCINELLE / FUSCA / TRANSPORTER II   | <b>RENAULT</b><br>ESPACE II / MASTER I / R21 / R25                                |  |   |   |
| <b>RENAULT</b><br>ESPACE II   | <b>VW</b><br>CADDY II(9K9A)/Estate(9K9B)/ Pickup(9U7) / CORRADO (53I) / GOLF III (1H1) / GOLF III Variant (1H5) / GOLF III Cabriolet (1E7) / GOLF IV Cabriolet (1E7) / PASSAT (3A2, 35I) / Variant (3A5, 35I) / POLO CLASSIC (6KV2) / Variant (6KV5) / SHARAN (7M8, 7M9, 7M6) / VENTO (1H2)    | <b>RENAULT</b><br>ESPACE II / ESPACE II / MASTER I / R20 / R21 / R25 / TRAFIC I   |  |   |   |
| <b>RENAULT</b><br>ESPACE II   | <b>VW</b><br>CADDY II(9K9A)/Estate(9K9B)/ Pickup(9U7) / CORRADO (53I) / GOLF III (1H1) / GOLF III Variant (1H5) / GOLF III Cabriolet (1E7) / GOLF IV Cabriolet (1E7) / PASSAT (3A2, 35I) / Variant (3A5, 35I) / POLO CLASSIC (6KV2) / Variant (6KV5) / SHARAN (7M8, 7M9, 7M6) / VENTO (1H2)    |   |  |   |   |
| <b>BMW</b><br>3 Convertible (E30) / 3 Touring (E30) / 5 (E34)                     | <b>VW</b><br>CADDY II(9K9A)/Estate(9K9B)/ Pickup(9U7) / CORRADO (53I) / GOLF III (1H1) / GOLF III Variant (1H5) / GOLF III Cabriolet (1E7) / GOLF IV Cabriolet (1E7) / PASSAT (3A2, 35I) / Variant (3A5, 35I) / POLO CLASSIC (6KV2) / Variant (6KV5) / SHARAN (7M8, 7M9, 7M6) / VENTO (1H2)    |   |  |   |   |
| <b>AUDI</b><br>COUPE (89, 8B)   | <b>VW</b><br>181 / KAEFER / BEETLE / COCCINELLE / FUSCA / TRANSPORTER II   |   |  |   |   |
| <b>BMW</b><br>5 (E34) / 5 Touring (E34)   | <b>VW</b><br>181 / KAEFER / BEETLE / COCCINELLE / FUSCA / TRANSPORTER II   |   |  |   |   |
| <b>CITROËN</b><br>XM I / XM II  | <b>VW</b><br>181 / KAEFER / BEETLE / COCCINELLE / FUSCA / TRANSPORTER II   |   |  |   |   |
| <b>MERCEDES-BENZ</b><br>(W 123)   | <b>VW</b><br>181 / KAEFER / BEETLE / COCCINELLE / FUSCA / TRANSPORTER II   |   |  |   |   |
| <b>OPEL</b><br>FRONTERA A / OMEGA A   | <b>VW</b><br>181 / KAEFER / BEETLE / COCCINELLE / FUSCA / TRANSPORTER II   |   |  |   |   |
| <b>PEUGEOT</b><br>J9  | <b>VW</b><br>181 / KAEFER / BEETLE / COCCINELLE / FUSCA / TRANSPORTER II   |   |  |   |   |





|  |    |  |   |  |  |
|---|---|---|--|---|---|
| VKMM 13AVx715   | FIAT<br>TIPO  |   | VW<br>LT I / TARO  |   | LAND ROVER<br>DEFENDER I  |
| VKMM 13AVx750   | ALFA ROMEO<br>155   | VKMM 13AVx875   | ALFA ROMEO<br>155  |   | MERCEDES-BENZ<br>100 (W631)   |
|   | FIAT<br>CROMA (154)   |   | FIAT<br>CROMA (154)  | VKMM 13AVx1050  | BMW<br>3 Touring (E30) / 5 (E12) / 5 (E28) / 6 (E24) / 7 (E23) / 7 (E32)            |
|   | LANCIA<br>DEDRA / DELTA II / THEMA  |   | LANCIA<br>DEDRA / DELTA II / THEMA   |   | LANCIA<br>DEDRA / DELTA II  |
|   | MERCEDES-BENZ<br>(W 123)  |   | MERCEDES-BENZ<br>190 (W201)  |   | NISSAN<br>PATROL GR / VANETTE   |
|   | NISSAN<br>VANETTE   | VKMM 13AVx900   | OPEL<br>CORSA A  | VKMM 13AVx1150  | MERCEDES-BENZ<br>(W 123)  |
| VKMM 13AVx800   | AUDI<br>100 (44,44Q,C3)/100 Avant (44,44Q,C3) / 100 (4A, C4) / 100 Avant (4A, C4) / 80 (89, 89Q, 8A, B3) / 80 (8C, B4) / 80 Avant (8C, B4) / A6 (4A, C4) / A6 Avant (4A, C4) / CABRIOLET (8G7, B4) / COUPE (89, 8B) |   | BMW<br>3 (E30)   | VKMM 13AVx1250  | VW<br>TRANSPORTER III   |
|   | BMW<br>3 (E30) / 3 Convertible (E30) / 3 Touring (E30) / 5 (E28) / 7 (E23)  | VKMM 13AVx915   | NISSAN<br>PATROL GR  |   | VW<br>PASSAT (32B) / SANTANA (32B)  |
|   | NISSAN<br>ALMERA / PRIMERA / SUNNY  |   | AUDI<br>100 (44,44Q,C3)/100 Avant (44,44Q,C3) / 200 (43) / 80 (8C, B4) / 80 Avant (8C, B4) / 90 (89, 89Q, 8A, B3) / CABRIOLET (8G7, B4) / COUPE (89, 8B)   |   |   |
|   | VW<br>LT I  |   | OPEL<br>ASTRA F / COMBO A / CORSA B / VECTRA A / VECTRA B  |   |   |
| VKMM 13AVx825   | AUDI<br>80 (81, 85, B2) / 90 (81, 85, B2)   | VKMM 13AVx925   | VAUXHALL<br>ASTRA Mk III   |   |   |
|   | BMW<br>3 (E21) / 3 Touring (E30) / 5 (E34)  |   | LAND ROVER<br>DEFENDER I   |   |   |
|   | LANCIA<br>DEDRA   |   | RENAULT<br>ESPACE II   |   |   |
|   | NISSAN<br>MICRA   | VKMM 13AVx950   | ALFA ROMEO<br>145/146  |   |   |
|   | VW<br>PASSAT (32B) / SANTANA (32B) / TARO   |   | AUDI<br>100 (44,44Q,C3)/100 Avant (44,44Q,C3) / QUATTRO (85)   |   |   |
| VKMM 13AVx850   | ALFA ROMEO<br>155   |   | SEAT<br>TOLEDO I (1L)  |   |   |
|   | BMW<br>3 Convertible (E30) / 3 Touring (E30) / 5 (E34)  |   | VW<br>CORRADO (53I) / GOLF I (17) / GOLF II (19E, 1G1) / JETTA II (19E, 1G2) / PASSAT (3A2, 35I) / Variant (3A5, 35I)  |   |   |
|   | FIAT<br>CINQUECENTO / CROMA (154) / TIPO  | VKMM 13AVx990   | AUDI<br>100 (43, C2) / 100 Avant (43, C2) / 100 (44,44Q,C3)/100 Avant (44,44Q,C3) / 200 (43) / 80 (81, 85, B2) / 90 (81, 85, B2) / 90 (89, 89Q, 8A, B3) / COUPE (81, 85) / COUPE (89, 8B) / QUATTRO (85) |   |   |
|   | LANCIA<br>DEDRA / DELTA II / THEMA  |   | VW<br>CORRADO (53I) / GOLF I (17) / GOLF II (19E, 1G1) / JETTA II (19E, 1G2) / PASSAT (3A2, 35I) / Variant (3A5, 35I)  |   |   |
|   | LAND ROVER<br>DEFENDER I  | VKMM 13AVx1000  | AUDI<br>200 (43) / 80 (8C, B4) / 80 Avant (8C, B4) / CABRIOLET (8G7, B4) / COUPE (89, 8B) / QUATTRO (85)   |   |   |
|   | NISSAN<br>ALMERA / PRIMERA / SUNNY  |   | FORD<br>RANGER   |   |   |
| VKMM 13AVx865   | AUDI<br>80 (89, 89Q, 8A, B3)  |   |  |   |   |

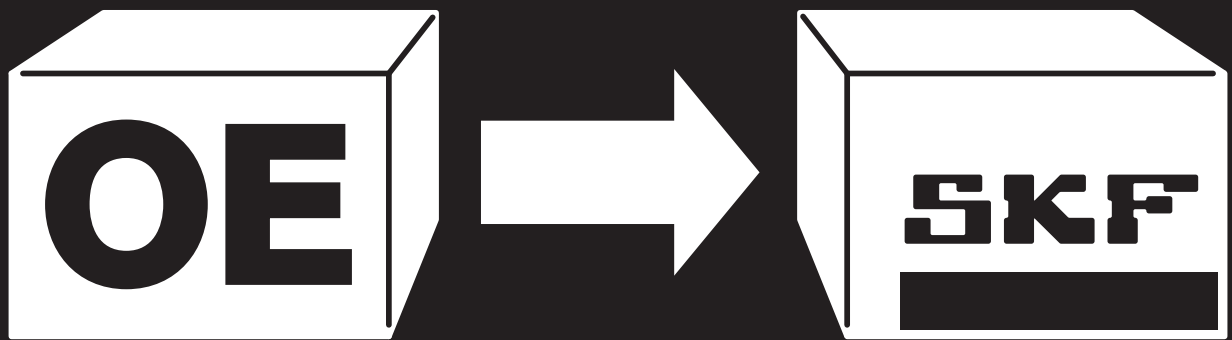

|                         |      |
|-------------------------|------|
| ALFA ROMEO . . . . .    | 1034 |
| AUDI . . . . .          | 1035 |
| BMW . . . . .           | 1038 |
| CHRYSLER . . . . .      | 1039 |
| CITROËN . . . . .       | 1039 |
| DAEWOO . . . . .        | 1041 |
| DAIHATSU . . . . .      | 1041 |
| FIAT . . . . .          | 1042 |
| FORD . . . . .          | 1045 |
| HONDA . . . . .         | 1049 |
| HYUNDAI . . . . .       | 1050 |
| ISUZU . . . . .         | 1051 |
| IVECO . . . . .         | 1051 |
| KIA . . . . .           | 1051 |
| LADA . . . . .          | 1051 |
| LANCIA . . . . .        | 1051 |
| LAND ROVER . . . . .    | 1053 |
| MAZDA . . . . .         | 1053 |
| MERCEDES-BENZ . . . . . | 1054 |
| MG . . . . .            | 1055 |

|                      |      |
|----------------------|------|
| MINI . . . . .       | 1055 |
| MITSUBISHI . . . . . | 1055 |
| NISSAN . . . . .     | 1056 |
| OPEL . . . . .       | 1057 |
| PEUGEOT . . . . .    | 1061 |
| PORSCHE . . . . .    | 1064 |
| PROTON . . . . .     | 1064 |
| RENAULT . . . . .    | 1064 |
| ROVER . . . . .      | 1066 |
| SAAB . . . . .       | 1067 |
| SEAT . . . . .       | 1067 |
| SKODA . . . . .      | 1070 |
| SMART . . . . .      | 1072 |
| SUBARU . . . . .     | 1070 |
| SUZUKI . . . . .     | 1072 |
| TALBOT . . . . .     | 1072 |
| TOYOTA . . . . .     | 1073 |
| VAUXHALL . . . . .   | 1074 |
| VOLVO . . . . .      | 1077 |
| VW . . . . .         | 1078 |

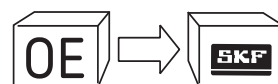
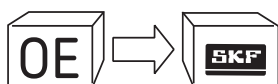
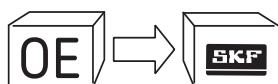

**ALFA ROMEO**

|              |              |          |               |          |              |
|--------------|--------------|----------|---------------|----------|--------------|
| 113050702400 | VKPC 82621   | 60504224 | VKM 12500     | 60811328 | VKPC 82645   |
| 113050702401 | VKPC 82621   | 60504225 | VKM 12501     | 60811332 | VKM 32022    |
| 117010702400 | VKPC 82621   | 60504226 | VKM 22510     | 60811487 | VKM 22153    |
| 195320702402 | VKPC 82800   | 60504407 | VKPC 82201    | 60811488 | VKM 12153    |
| 195360702400 | VKPC 82621   | 60504835 | VKMV 10AVx850 | 60811823 | VKM 32242    |
| 46424716     | VKM 32242    | 60513151 | VKPC 82800    | 60812262 | VKPA 82618   |
| 46429443     | VKMV 4PK675  | 60518083 | VKPC 82621    | 60812262 | VKPC 82618   |
| 46432248     | VKPC 82665   | 60523035 | VKPC 82621    | 60812263 | VKPA 82666   |
| 46435858     | VKPA 82666   | 60536055 | VKPC 82201    | 60812430 | VKMV 5PK986  |
| 46439000     | VKMV 6PK1105 | 60548814 | VKMV 13AVx950 | 60812515 | VKM 32001    |
| 46442999     | VKM 32022    | 60555347 | VKPC 82800    | 60812622 | VKM 12173    |
| 46462949     | VKMV 6PK935  | 60555348 | VKPC 82800    | 60812645 | VKM 32242    |
| 46469587     | VKM 32018    | 60561614 | VKM 32010     | 60813221 | VKM 32030    |
| 46515970     | VKPC 82665   | 60561649 | VKM 22541     | 60813311 | VKM 22540    |
| 46515972     | VKPC 82665   | 60561800 | VKPC 82800    | 60813569 | VKM 32025    |
| 46524692     | VKM 32022    | 60562567 | VKPC 82642    | 60813590 | VKM 22174    |
| 46540546     | VKMV 6PK1036 | 60564004 | VKPC 82642    | 60813592 | VKM 12174    |
| 46542303     | VKMV 4PK854  | 60564048 | VKPC 82800    | 60813757 | VKMV 6PK1842 |
| 46546374     | VKM 32027    | 60565727 | VKPC 82201    | 60813774 | VKM 32018    |
| 46547566     | VKM 32024    | 60585358 | VKPC 82436    | 60814033 | VKM 32006    |
| 46550322     | VKMV 5PK1585 | 60585362 | VKPC 82436    | 60814110 | VKM 32022    |
| 46554826     | VKM 22242    | 60586222 | VKPC 82645    | 60814395 | VKMV 6PK1855 |
| 46736814     | VKMV 4PK668  | 60586467 | VKPC 82201    | 60814609 | VKPC 82665   |
| 46747484     | VKMV 6PK1230 | 60595630 | VKM 32017     | 60814616 | VKMV 6PK1760 |
| 46787905     | VKMV 3PK915  | 60596372 | VKM 12173     | 60814917 | VKM 32024    |
| 46787907     | VKMV 6PK1760 | 60597487 | VKPC 82436    | 60815559 | VKPC 82665   |
| 46794035     | VKM 32006    | 60602136 | VKM 32007     | 60815666 | VKMV 6PK1775 |
| 46804051     | VKPC 82667   | 60603056 | VKM 22540     | 60815805 | VKMV 6PK1795 |
| 4714636      | VKPC 82630   | 60606518 | VKMV 5PK864   | 60815887 | VKMV 6PK1842 |
| 4740847      | VKM 22380    | 60608898 | VKPC 82451    | 60816054 | VKMV 6PK1836 |
| 4754850      | VKPC 82630   | 60611459 | VKPC 82201    | 60816055 | VKMV 6PK1795 |
| 4764761      | VKPC 82630   | 60614390 | VKPC 82201    | 60816115 | VKMV 6PK1775 |
| 504010846    | VKM 12390    | 60617858 | VKMV 7PK1080  | 71713045 | VKPC 82800   |
| 504183759    | VKM 12390    | 60620443 | VKM 12277     | 71718718 | VKMV 4PK675  |
| 51758124     | VKMV 6PK1390 | 60622295 | VKPC 82201    | 71719007 | VKMV 5PK986  |
| 51758365     | VKMV 6PK1410 | 60624147 | VKM 32082     | 71719394 | VKMV 6PK1836 |
| 51773551     | VKM 32046    | 60624553 | VKPC 82201    | 71719398 | VKMV 3PK915  |
| 532912       | VKPC 82201   | 60624747 | VKM 32083     | 71719399 | VKMV 3PK719  |
| 534134       | VKM 12500    | 60626658 | VKMV 6PK1983  | 71719401 | VKMV 6PK1775 |
| 534135       | VKM 12501    | 60630741 | VKMV 6PK1975  | 71719407 | VKMV 5PK970  |
| 55180011     | VKM 32027    | 60630747 | VKMV 6PK1855  | 71719680 | VKPC 82660   |
| 55183527     | VKM 12174    | 60652358 | VKMV 7PK1975  | 71719738 | VKMV 4PK668  |
| 55184055     | VKM 32026    | 60652477 | VKM 12182     | 71732350 | VKMV 5PK1145 |
| 55187100     | VKM 22179    | 60653029 | VKMV 6PK1062  | 71732372 | VKMV 6PK1962 |
| 55187100     | VKM 22180    | 60653030 | VKMV 6PK1962  | 71732386 | VKMV 6PK1062 |
| 55189677     | VKMV 6PK1836 | 60662969 | VKMV 6PK1080  | 71734476 | VKMV 6PK1836 |
| 55190052     | VKM 32030    | 60662991 | VKMV 6PK1855  | 71734715 | VKMV 6PK1760 |
| 55190053     | VKM 32082    | 60664403 | VKM 22177     | 71734716 | VKMV 6PK1740 |
| 55190054     | VKM 32083    | 60666950 | VKMV 6PK1842  | 71736493 | VKM 22174    |
| 55190813     | VKM 32046    | 60667050 | VKMV 6PK1285  | 71736724 | VKMA 02183   |
| 55191970     | VKMV 5PK1145 | 60667496 | VKM 12277     | 71736725 | VKMA 02184   |
| 55192239     | VKM 12173    | 60671573 | VKM 22177     | 71736726 | VKMA 02179   |
| 55192240     | VKM 12182    | 60676135 | VKMV 6PK1962  | 71736726 | VKMA 02192   |
| 55192323     | VKM 12174    | 60676136 | VKMV 6PK1062  | 71736727 | VKMA 02177   |
| 55193330     | VKM 32033    | 60733346 | VKPC 82621    | 71736728 | VKMA 02186   |
| 55193360     | VKMV 6PK1580 | 60778983 | VKPC 82810    | 71736729 | VKMA 02181   |
| 55200253     | VKMV 6PK1410 | 60800148 | VKM 12005     | 71736795 | VKMA 02176   |
| 55201362     | VKMV 6PK1735 | 60800169 | VKPC 82614    | 71737965 | VKPC 82660   |
| 5956109      | VKM 12005    | 60808692 | VKM 22153     | 71737985 | VKPC 82436   |
| 5973319      | VKPC 82614   | 60808693 | VKM 12153     | 71737986 | VKPC 82201   |
|              |              | 60808793 | VKMV 5PK970   | 71739304 | VKM 34027    |
|              |              | 60809209 | VKPC 82660    | 71739401 | VKPC 85308   |
|              |              | 60810426 | VKPC 82660    | 71739618 | VKMV 5PK884  |



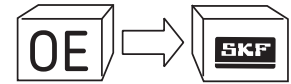
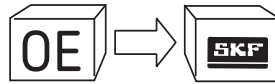
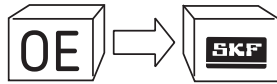

|                |                |                |                |                |                |
|----------------|----------------|----------------|----------------|----------------|----------------|
| 036 109 243 L  | VKM 11120      | 038 121 011 J  | VKPC 81303     | 045 109 243 F  | VKM 11250      |
| 036 109 243 R  | VKM 11120      | 038 121 011 K  | VKPC 81627     | 045 109 244 A  | VKM 21142      |
| 036 109 243 S  | VKM 11124      | 038 145 276    | VKM 31002      | 045 109 479 B  | VKM 11145      |
| 036 109 244 C  | VKM 21120      | 038 145 278    | VKM 31013      | 045 109 479 C  | VKM 11144      |
| 036 109 244 D  | VKM 21120      | 038 145 283 A  | VKM 31013      | 045 121 011 B  | VKPC 81417     |
| 036 109 244 J  | VKM 21120      | 038 145 299 A  | VKM 31013      | 045 121 011 C  | VKPC 81416     |
| 036 109 244    | VKM 21122      | 038 198 119 A  | VKMA 01250     | 045 121 011 F  | VKPC 81418     |
| 036 121 005 B  | VKPC 81407     | 038 198 119 B  | VKMA 01141     | 045 121 011 G  | VKPC 81302     |
| 036 121 005 D  | VKPC 81411     | 038 198 119 C  | VKMA 01250     | 045 121 011 H  | VKPC 81418     |
| 036 121 005 E  | VKPC 81407     | 038 198 119 D  | VKMA 01131     | 045 121 011 J  | VKPC 81302     |
| 036 121 005 F  | VKPC 81419     | 038 198 119 E  | VKMA 01251     | 045 260 849    | VKMV 6DK1188   |
| 036 121 005 J  | VKPC 81419     | 038 198 119 F  | VKMA 01130     | 045 903 137 D  | VKMV 6PK996    |
| 036 121 005 M  | VKPC 81411     | 038 198 119    | VKMA 01142     | 045 903 137 E  | VKMV 6PK858    |
| 036 121 005 P  | VKPC 81419     | 038 260 849 A  | VKMOV 4PK841   | 045 903 315 A  | VKM 31035      |
| 036 121 005 Q  | VKPC 81407     | 038 903 137 AA | VKMOV 6PK1180  | 046 121 004 D  | VKPC 81805     |
| 036 121 005 QV | VKPC 81407     | 038 903 137 G  | VKMOV 6PK906   | 046 121 004    | VKPC 81603     |
| 036 121 005 R  | VKPC 81407     | 038 903 137 H  | VKMOV 5PK1432  | 046 130 195 B  | VKM 11265      |
| 036 121 005 S  | VKPC 81407     | 038 903 137 J  | VKMOV 6PK1660  | 046 130 195 D  | VKM 11266      |
| 036 121 008 G  | VKPC 81419     | 038 903 137 L  | VKMOV 6PK1180  | 046 903 137 N  | VKMOV 6PK1341  |
| 036 121 008 L  | VKPC 81407     | 038 903 137 M  | VKMOV 6PK780   | 047 121 011 B  | VKPC 81412     |
| 036 145 933 AC | VKMOV 6PK1151  | 038 903 137 N  | VKMOV 6PK1095  | 047 145 933 E  | VKMOV 6PK1680  |
| 036 145 933 AG | VKMOV 6PK736   | 038 903 137 R  | VKMOV 6PK1135  | 047 903 137 AB | VKMOV 6PK1748  |
| 036 145 933 AJ | VKMOV 6PK1076  | 038 903 137 S  | VKMOV 6DK1215  | 047 903 137 E  | VKMOV 6PK1880  |
| 036 145 933 F  | VKMOV 6PK1084  | 038 903 137 T  | VKMOV 5PK1432  | 047 903 137 F  | VKMOV 6PK1480  |
| 036 145 933 H  | VKMOV 6PK1548  | 038 903 315 A  | VKM 31018      | 047 903 137 G  | VKMOV 6PK1520  |
| 036 145 933 M  | VKMOV 6PK745   | 038 903 315 AB | VKM 31057      | 047 903 137 L  | VKMOV 4PK950   |
| 036 145 933 Q  | VKMOV 6PK1123  | 038 903 315 AD | VKM 31058      | 047 903 137 R  | VKMOV 5PK1219  |
| 036 198 119 E  | VKMA 01121     | 038 903 315 AE | VKM 31019      | 048 109 243 A  | VKM 11001      |
| 037 121 005 B  | VKPC 81401     | 038 903 315 AG | VKM 31058      | 048 121 011    | VKPC 81601     |
| 037 121 005 C  | VKPC 81401     | 038 903 315 AH | VKM 31058      | 048 198 119    | VKMA 01024     |
| 037 121 010 A  | VKPA 81401     | 038 903 315 C  | VKM 31012      | 049 260 849 A  | VKMOV 13AVx825 |
| 037 121 010 B  | VKPA 81401     | 038 903 315 D  | VKM 31013      | 050 121 010 A  | VKPA 81402     |
| 037 121 010 C  | VKPA 81401     | 038 903 315 E  | VKM 31018      | 050 121 010 C  | VKPA 81402     |
| 037 121 010    | VKPA 81401     | 038 903 315 F  | VKM 31019      | 050 121 010    | VKPA 81402     |
| 037 145 271 E  | VKMOV 11.5x685 | 038 903 315 K  | VKM 31018      | 050 121 039 A  | VKMOV 10AVx910 |
| 037 145 271 F  | VKMOV 11.5x755 | 038 903 315 P  | VKM 31018      | 050 260 849    | VKMOV 13AVx800 |
| 037 145 271    | VKMOV 10AVx660 | 038 903 315 T  | VKM 31013      | 050 903 137 C  | VKMOV 4PK855   |
| 037 145 276 A  | VKM 31007      | 03C 121 005 D  | VKM 31058      | 050 903 137    | VKMOV 10AVx950 |
| 037 145 276    | VKM 31007      | 03C 145 299 C  | VKPC 81501     | 051 109 243 A  | VKM 11021      |
| 037 145 933 C  | VKMOV 6PK1760  | 03D 121 005    | VKM 31047      | 051 109 243    | VKM 11020      |
| 037 198 119    | VKMA 01002     | 03D 121 013 B  | VKPC 81301     | 051 198 119    | VKMA 01009     |
| 037 260 849 C  | VKMOV 6PK1153  | 03D 145 933 AD | VKPC 81301     | 052 121 004    | VKPC 81200     |
| 037 903 137 G  | VKMOV 6PK976   | 03D 145 933 AG | VKMOV 6PK1880  | 052 121 005 A  | VKPC 81200     |
| 037 903 137 H  | VKMOV 6PK1033  | 03D 145 933 S  | VKMOV 6PK1453  | 052 121 005    | VKPC 81200     |
| 037 903 315 B  | VKM 31210      | 03E 260 849 A  | VKMOV 6PK1873  | 052 121 019    | VKPC 81200     |
| 037 903 315 C  | VKM 31210      | 03E 260 849 B  | VKMOV 6PK1873  | 052 903 137 F  | VKMOV 10AVx675 |
| 038 109 243 D  | VKM 11130      | 03G 109 243    | VKM 11255      | 054 109 479    | VKM 11050      |
| 038 109 243 F  | VKM 11130      | 03G 109 244    | VKM 121256     | 054 109 479    | VKM 11060      |
| 038 109 243 G  | VKM 11130      | 03G 198 119    | VKMA 01255     | 054 121 004 A  | VKPC 81612     |
| 038 109 243 H  | VKM 11130      | 03G 903 137 A  | VKMOV 6PK950   | 054 121 004    | VKPC 81612     |
| 038 109 243 M  | VKM 11250      | 03G 903 137 B  | VKMOV 6PK1050  | 054 903 137 D  | VKMOV 10AVx875 |
| 038 109 243 N  | VKM 11130      | 03G 903 137 E  | VKMOV 6PK1613  | 054 903 137    | VKMOV 10AVx865 |
| 038 109 243    | VKM 11130      | 03G 903 315 A  | VKM 31022      | 055 121 010    | VKPA 81400     |
| 038 109 244 B  | VKM 21130      | 03G 903 315 C  | VKM 31054      | 055 903 137 G  | VKMOV 10AVx850 |
| 038 109 244 E  | VKM 21131      | 044 145 271 K  | VKMOV 10AVx650 | 056 121 005 A  | VKPC 81400     |
| 038 109 244 H  | VKM 21130      | 044 145 278 A  | VKM 31043      | 056 121 011    | VKPA 81400     |
| 038 109 244 J  | VKM 21147      | 044 260 849 B  | VKMOV 6PK1590  | 056 121 013 A  | VKPA 81400     |
| 038 109 244 M  | VKM 21130      | 044 260 849 E  | VKMOV 6PK1905  | 056 198 119    | VKMA 01000     |
| 038 121 011 A  | VKPC 81623     | 044 903 137 R  | VKMOV 6PK1870  | 057 109 243 A  | VKM 11330      |
| 038 121 011 C  | VKPC 81626     | 045 109 243 A  | VKM 11142      | 057 109 244    | VKM 21330      |
| 038 121 011 D  | VKPC 81626     | 045 109 243 B  | VKM 11141      | 057 109 487    | VKM 11331      |
| 038 121 011 G  | VKPC 81303     | 045 109 243 C  | VKM 11142      | 058 109 243 C  | VKM 11008      |
| 038 121 011 H  | VKPC 81627     | 045 109 243 D  | VKM 11143      | 058 109 243 D  | VKM 11007      |



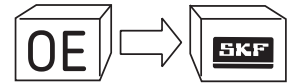
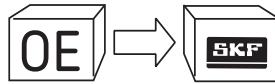
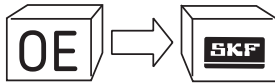

058 109 243 E  
058 109 244  
058 109 479 A  
058 109 479 B  
058 198 119 A  
058 198 119  
058 260 511  
058 260 849 A  
058 903 133 C  
058 903 133 D  
059 109 243 D  
059 109 243 F  
059 109 243 G  
059 109 243 J  
059 109 243 L  
059 109 243 P  
059 109 244 A  
059 109 244 B  
059 109 479 B  
059 121 004 B  
059 121 004 C  
059 121 004 D  
059 121 004 E  
059 145 276  
059 198 119 A  
059 198 119  
059 260 523 A  
059 260 523 B  
059 260 523  
059 260 849 B  
059 260 849 D  
059 903 137 AC  
059 903 137 H  
059 903 341 A  
059 903 341  
060 121 011  
062 145 933 A  
062 260 849 B  
062 903 137  
066 121 011 C  
066 145 933 K  
068 109 243 F  
068 121 005 A  
068 121 005 B  
068 121 005 C  
068 121 005  
068 121 010 A  
068 121 010  
068 121 039 B  
068 121 039 L  
068 145 271 B  
068 145 271 C  
068 145 271 E  
068 260 849 D  
068 260 849 G  
068 260 849  
068 260 940  
068 903 137 AF  
068 903 137 AJ  
068 903 137 AP  
068 903 137 AQ  
068 903 137 AR  
068 903 137 B

**VKM 11008**  
**VKM 21004**  
**VKM 11009**  
**VKM 11009**  
**VKMA 01007**  
**VKMA 01008**  
**VKM 31059**  
**VKMV 4PK855**  
**VKM 31033**  
**VKM 31033**  
**VKM 11150**  
**VKM 11151**  
**VKM 11151**  
**VKM 11150**  
**VKM 11151**  
**VKM 11332**  
**VKM 21151**  
**VKM 21151**  
**VKM 11154**  
**VKPC 81625**  
**VKPC 81625**  
**VKPC 81625**  
**VKPC 81625**  
**VKPC 81625**  
**VKM 31039**  
**VKMA 01152**  
**VKMA 01152**  
**VKM 31040**  
**VKM 31040**  
**VKM 31040**  
**VKMV 4PK1237**  
**VKMV 4PK1217**  
**VKMV 6PK2480**  
**VKMV 6PK2404**  
**VKM 31041**  
**VKM 31038**  
**VKPC 81601**  
**VKMV 6PK1683**  
**VKMV 6PK2155**  
**VKMV 6PK2000**  
**VKPC 81622**  
**VKMV 6PK1264**  
**VKM 11010**  
**VKPC 81401**  
**VKPC 81400**  
**VKPC 81400**  
**VKPC 81400**  
**VKPA 81401**  
**VKPA 81400**  
**VKMV 10AVx650**  
**VKMV 10AVx838**  
**VKMV 10AVx740**  
**VKMV 10AVx763**  
**VKMV 11.9x650**  
**VKMV 13AVx1250**  
**VKMV 13AVx950**  
**VKMV 13AVx950**  
**VKM 31009**  
**VKMV 10AVx600**  
**VKMV 10AVx625**  
**VKMV 10AVx710**  
**VKMV 10AVx695**  
**VKMV 11.9x950**  
**VKMV 10AVx875**

068 903 137 D  
068 903 137 Q  
068 903 137 S  
069 109 243 B  
069 121 005 D  
069 903 137 C  
06A 109 479 A  
06A 109 479 C  
06A 109 479  
06A 121 011 E  
06A 121 011 F  
06A 121 011 G  
06A 121 011 L  
06A 121 011 T  
06A 121 012  
06A 145 933 D  
06A 145 933 F  
06A 198 119  
06A 260 849 C  
06A 260 849 E  
06A 260 849 G  
06A 260 849 K  
06A 903 315 E  
06B 109 243 A  
06B 109 243 B  
06B 109 243 D  
06B 109 243 E  
06B 109 243 F  
06B 109 243  
06B 109 244  
06B 109 477 A  
06B 109 477  
06B 121 011 B  
06B 121 011 C  
06B 121 011 E  
06B 121 011 H  
06B 121 011 L  
06B 121 011 M  
06B 145 933  
06B 198 119 A  
06B 260 849 A  
06B 260 849 B  
06B 903 133  
06B 903 137 D  
06B 903 137 E  
06B 903 137 J  
06B 903 137  
06C 109 244 D  
06C 109 244  
06C 109 485 A  
06D 109 243 B  
06D 109 243  
06D 903 137 C  
06F 198 119 A  
06F 198 119  
06F 260 849 E  
06F 260 849 L  
06F 903 137 E  
06F 903 137 L  
071 121 005  
071 145 933 F  
071 145 933 H  
071 145 933 M

**VKMV 10AVx965**  
**VKMV 10AVx735**  
**VKMV 10AVx775**  
**VKM 21031**  
**VKPC 81602**  
**VKMV 11.5x790**  
**VKM 11113**  
**VKM 11113**  
**VKM 11113**  
**VKPC 81620**  
**VKPC 81620**  
**VKPC 81620**  
**VKPC 81620**  
**VKPC 81620**  
**VKPC 81620**  
**VKPC 81620**  
**VKMV 6PK1120**  
**VKMV 6PK926**  
**VKMA 01113**  
**VKMV 6DK1195**  
**VKMV 6DK1195**  
**VKMV 6PK1032**  
**VKMV 6PK1032**  
**VKM 31011**  
**VKM 11116**  
**VKM 11018**  
**VKM 11116**  
**VKM 11018**  
**VKM 11116**  
**VKM 11115**  
**VKM 21220**  
**VKM 11117**  
**VKM 21115**  
**VKPC 81408**  
**VKPC 81408**  
**VKPC 81408**  
**VKPC 81220**  
**VKPC 81408**  
**VKPC 81220**  
**VKMV 6PK1080**  
**VKMA 01018**  
**VKMV 4PK855**  
**VKMV 4PK855**  
**VKM 31006**  
**VKMV 6PK1589**  
**VKMV 5PK1300**  
**VKMV 6PK1572**  
**VKMV 5PK1300**  
**VKM 21302**  
**VKM 21302**  
**VKM 11300**  
**VKM 11222**  
**VKM 11220**  
**VKMV 6PK1572**  
**VKMA 01222**  
**VKMA 01220**  
**VKMV 6PK1042**  
**VKMV 6PK1054**  
**VKMV 6PK900**  
**VKMV 6PK953**  
**VKPC 81622**  
**VKMV 6PK1285**  
**VKMV 6PK2373**  
**VKMV 6PK2373**

074 109 243 A  
074 109 243 B  
074 109 243 C  
074 109 243 D  
074 109 243 E  
074 109 243 F  
074 109 243 G  
074 109 243 H  
074 109 243 J  
074 109 243 M  
074 109 243 R  
074 109 243  
074 121 004  
074 121 005 N  
074 130 195 B  
074 130 245  
074 145 278 B  
074 145 278 E  
074 145 278 F  
074 145 299 A  
074 145 933 AK  
074 145 933 AL  
074 145 933 AR  
074 145 933 G  
074 145 933 N  
074 145 933 P  
074 198 119 A  
074 198 119 B  
074 198 119 C  
074 198 119 E  
074 198 119 F  
074 198 119 G  
074 198 119 H  
074 198 119  
074 260 849 AB  
074 260 849 J  
074 903 137  
075 109 243 B  
075 109 243 D  
076 903 137  
077 109 244 C  
077 109 244 E  
077 109 485 C  
077 109 485 E  
077 121 004 A  
077 121 004 F  
077 121 004 G  
077 121 004 GX  
077 121 004 H  
078 109 243 C  
078 109 243 C  
078 109 243 K  
078 109 243 Q  
078 109 243 R  
078 109 243  
078 109 243  
078 109 244 C  
078 109 244 F  
078 109 244 G  
078 109 244 H  
078 109 244  
078 109 479 B  
078 109 479 E

**VKM 21041**  
**VKM 11043**  
**VKM 11054**  
**VKM 11045**  
**VKM 11257**  
**VKM 11072**  
**VKM 11072**  
**VKM 11054**  
**VKM 11072**  
**VKM 11257**  
**VKM 11072**  
**VKM 21032**  
**VKPC 86619**  
**VKPC 86619**  
**VKM 11073**  
**VKM 11258**  
**VKM 31007**  
**VKM 31007**  
**VKM 31043**  
**VKM 31063**  
**VKMV 6PK1767**  
**VKMV 6PK1355**  
**VKMV 6PK1751**  
**VKMV 6PK2060**  
**VKMV 6PK1343**  
**VKMV 6PK1715**  
**VKMA 01271**  
**VKMA 01258**  
**VKMA 01253**  
**VKMA 01253**  
**VKMA 01271**  
**VKMA 01258**  
**VKMA 01270**  
**VKMV 6PK2236**  
**VKMV 6PK2130**  
**VKMV 10AVx838**  
**VKM 21045**  
**VKM 21045**  
**VKMV 10AVx813**  
**VKM 21203**  
**VKM 21204**  
**VKM 11207**  
**VKM 11204**  
**VKPC 81806**  
**VKPC 81807**  
**VKPC 81806**  
**VKPC 81806**  
**VKPC 81807**  
**VKM 11200**  
**VKM 14101**  
**VKM 11201**  
**VKM 11202**  
**VKM 11202**  
**VKM 11200**  
**VKM 14101**  
**VKM 21052**  
**VKM 21052**  
**VKM 21201**  
**VKM 21202**  
**VKM 21052**  
**VKM 11208**  
**VKM 11209**





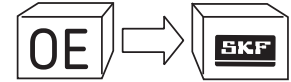
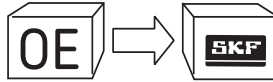
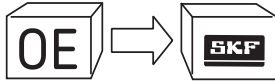

|                |               |                 |              |                 |               |
|----------------|---------------|-----------------|--------------|-----------------|---------------|
| 078 121 004 B  | VKPC 81800    | 11 28 1 437 368 | VKMV 6PK1555 | 11 31 1 709 646 | VKM 28001     |
| 078 121 004 C  | VKPC 81800    | 11 28 1 437 369 | VKMV 6PK1733 | 11 31 1 711 153 | VKM 18100     |
| 078 121 004 H  | VKPC 81802    | 11 28 1 437 449 | VKMV 5PK906  | 11 31 1 721 245 | VKM 18000     |
| 078 121 004 J  | VKPC 81802    | 11 28 1 437 450 | VKMV 5PK863  | 11 31 1 721 264 | VKM 28000     |
| 078 121 004 L  | VKPC 81811    | 11 28 1 437 873 | VKMV 5PK906  | 11 31 1 727 141 | VKM 28000     |
| 078 121 004 Q  | VKPC 81802    | 11 28 1 437 874 | VKMV 5PK950  | 11 31 1 727 611 | VKM 18001     |
| 078 121 004 R  | VKPC 81811    | 11 28 1 437 875 | VKMV 4PK889  | 11 31 2 241 090 | VKM 18120     |
| 078 121 006 A  | VKPC 81811    | 11 28 1 437 880 | VKMV 6PK1733 | 11 51 0 007 043 | VKPC 88830    |
| 078 121 006    | VKPC 81802    | 11 28 1 437 929 | VKMV 6PK1555 | 11 51 0 032 679 | VKPC 88826    |
| 078 198 119 A  | VKMA 01201    | 11 28 1 702 898 | VKMV 7PK1580 | 11 51 0 393 338 | VKPC 88615    |
| 078 198 119    | VKMA 01202    | 11 28 1 703 943 | VKMV 5PK890  | 11 51 0 393 730 | VKPC 88637    |
| 078 903 133 AB | VKM 31061     | 11 28 1 704 719 | VKMV 7PK1035 | 11 51 0 393 731 | VKPC 88632    |
| 078 903 137 AP | VKMV 6PK1760  | 11 28 1 706 545 | VKMV 6PK1538 | 11 51 1 258 933 | VKPC 88609    |
| 078 903 137 AQ | VKMV 6PK1863  | 11 28 1 717 188 | VKM 38007    | 11 51 1 259 660 | VKPC 88609    |
| 078 903 137 BC | VKMV 6PK1882  | 11 28 1 717 210 | VKM 38011    | 11 51 1 271 435 | VKPC 88605    |
| 078 903 137 BL | VKMV 6PK1856  | 11 28 1 735 899 | VKM 38202    | 11 51 1 284 247 | VKPC 88614    |
| 078 903 137 BM | VKMV 6PK1735  | 11 28 1 736 986 | VKMV 7PK1605 | 11 51 1 286 355 | VKPC 88610    |
| 078 903 137 P  | VKMV 6PK2260  | 11 28 1 738 061 | VKM 38003    | 11 51 1 286 358 | VKPC 88610    |
| 078 903 137    | VKMV 6PK1675  | 11 28 1 738 605 | VKM 38003    | 11 51 1 286 417 | VKPC 88802    |
| 078 903 341 J  | VKM 31010     | 11 28 1 739 816 | VKMV 6PK1733 | 11 51 1 312 539 | VKPC 88802    |
| 07D 145 933 E  | VKMV 7DK2569  | 11 28 1 741 427 | VKMV 6PK1195 | 11 51 1 433 712 | VKPC 88617    |
| 111 903 137 D  | VKMV 10AVx905 | 11 28 1 742 012 | VKMV 7PK1605 | 11 51 1 433 828 | VKPC 88617    |
| 111 903 137 E  | VKMV 11.3x912 | 11 28 1 743 193 | VKMV 4PK889  | 11 51 1 706 564 | VKPC 88605    |
| 1J0 145 276    | VKM 31044     | 11 28 1 748 130 | VKM 38003    | 11 51 1 706 588 | VKPC 88605    |
| 1J0 145 299    | VKM 31047     | 11 28 1 748 131 | VKM 38004    | 11 51 1 706 710 | VKMV 10AVx965 |
| 1K0 260 849 A  | VKMV 6PK1100  | 11 28 1 748 832 | VKM 38202    | 11 51 1 707 190 | VKPC 88802    |
| 1K0 260 849 B  | VKMV 6PK1100  | 11 28 2 243 592 | VKM 38220    | 11 51 1 707 191 | VKPC 88802    |
| 1L0 198 002 A  | VKMA 01014    | 11 28 2 243 702 | VKM 38225    | 11 51 1 707 192 | VKPC 88802    |
| 6K0 145 299    | VKM 31023     | 11 28 2 244 179 | VKMV 5PK1815 | 11 51 1 711 492 | VKPC 88605    |
| 6K0 198 001 A  | VKMA 01106    | 11 28 2 244 754 | VKM 38220    | 11 51 1 715 292 | VKPC 88611    |
| 6K0 198 002    | VKMA 01000    | 11 28 2 245 087 | VKM 38230    | 11 51 1 719 836 | VKPC 88607    |
| 6K0 198 004    | VKMA 01002    | 11 28 2 245 166 | VKM 38225    | 11 51 1 720 609 | VKPC 88607    |
| 6K0 198 005    | VKMA 01011    | 11 28 2 245 848 | VKMV 5PK1815 | 11 51 1 720 881 | VKPC 88802    |
| 6Q0 260 849 A  | VKMV 6PK1736  | 11 28 2 245 849 | VKMV 5PK1885 | 11 51 1 720 883 | VKPC 88802    |
| 6Q0 903 137 A  | VKMV 6PK1087  | 11 28 2 245 850 | VKMV 4PK836  | 11 51 1 720 892 | VKPC 88802    |
| 6U0 903 137    | VKMV 4PK950   | 11 28 2 247 435 | VKM 38240    | 11 51 1 720 893 | VKPC 88802    |
| 7M0 145 271 A  | VKMV 11.5x745 | 11 28 7 511 476 | VKMV 6PK1870 | 11 51 1 721 337 | VKPC 88611    |
| 7M0 145 271    | VKMV 11.5x685 | 11 28 7 512 563 | VKMV 4PK843  | 11 51 1 721 477 | VKPC 88610    |
| 943 095 009    | VKMV 10AVx950 | 11 28 7 512 762 | VKMV 4PK863  | 11 51 1 721 872 | VKPC 88615    |
|                |               | 11 28 7 515 316 | VKMV 6PK1637 | 11 51 1 722 536 | VKPC 88617    |
|                |               | 11 28 7 520 199 | VKMV 6PK1388 | 11 51 1 727 123 | VKPC 88616    |
|                |               | 11 28 7 527 564 | VKMV 6PK1990 | 11 51 1 730 414 | VKPC 88617    |
|                |               | 11 28 7 532 145 | VKMV 6PK1870 | 11 51 1 731 680 | VKPC 88831    |
|                |               | 11 28 7 532 146 | VKMV 6PK1637 | 11 51 1 734 269 | VKPC 88616    |
|                |               | 11 28 7 549 150 | VKMV 6PK1990 | 11 51 1 734 595 | VKPC 88615    |
|                |               | 11 28 7 552 233 | VKMV 6PK1870 | 11 51 1 734 602 | VKPC 88615    |
|                |               | 11 28 7 552 236 | VKMV 6PK1637 | 11 51 1 736 146 | VKPC 88831    |
|                |               | 11 28 7 559 454 | VKMV 4PK843  | 11 51 1 736 203 | VKPC 88830    |
|                |               | 11 28 7 568 247 | VKMV 7PK1855 | 11 51 1 740 241 | VKPC 88617    |
|                |               | 11 28 7 786 075 | VKMV 6PK2080 | 11 51 1 741 001 | VKPC 88831    |
|                |               | 11 28 7 787 369 | VKMV 5PK2063 | 11 51 1 741 002 | VKPC 88830    |
|                |               | 11 28 7 787 516 | VKMV 5PK2020 | 11 51 1 742 498 | VKPC 88831    |
|                |               | 11 28 7 789 985 | VKMV 6PK2160 | 11 51 1 742 517 | VKPC 88830    |
|                |               | 11 28 7 790 450 | VKMV 6PK1836 | 11 51 1 742 647 | VKPC 88829    |
|                |               | 11 28 7 792 059 | VKMV 6PK2063 | 11 51 1 744 243 | VKPC 88617    |
|                |               | 11 28 7 795 601 | VKMV 6PK1683 | 11 51 2 241 641 | VKPC 88614    |
|                |               | 11 28 7 830 946 | VKMV 5PK829  | 11 51 2 242 176 | VKPC 88612    |
|                |               | 11 28 7 832 327 | VKMV 6PK1460 | 11 51 2 242 675 | VKPC 88614    |
|                |               | 11 28 7 833 264 | VKMV 7PK1629 | 11 51 2 242 677 | VKPC 88612    |
|                |               | 11 28 7 833 265 | VKMV 7PK1440 | 11 51 2 243 003 | VKPC 88826    |
|                |               | 11 28 7 833 266 | VKMV 5PK980  | 11 51 2 244 333 | VKPC 88826    |
|                |               | 11 28 7 837 898 | VKMV 6PK1460 | 11 51 2 245 687 | VKPC 88826    |
|                |               | 11 31 1 708 806 | VKM 28001    | 11 51 2 247 552 | VKPC 88632    |

## BMW

11 23 1 266 125  
11 23 1 706 668  
11 23 1 709 636  
11 23 1 717 952  
11 23 1 721 408  
  
11 23 2 241 172  
11 23 2 243 046  
11 28 1 247 051  
11 28 1 247 647  
11 28 1 247 986  
  
11 28 1 401 159  
11 28 1 401 162  
11 28 1 404 018  
11 28 1 427 252  
11 28 1 432 104  
  
11 28 1 432 724  
11 28 1 433 571  
11 28 1 433 948  
11 28 1 435 280  
11 28 1 435 594

VKMV 10AVx950  
VKMV 13AVx1050  
VKMV 10AVx865  
VKMV 10AVx1013  
VKMV 10AVx1025  
  
VKMV 10AVx1000  
VKMV 10AVx1000  
VKM 38008  
VKM 38221  
VKMV 6PK1660  
  
VKMV 5PK1125  
VKMV 5PK785  
VKMV 6PK1515  
VKM 38202  
VKM 38221  
  
VKMV 7PK1635  
VKM 38231  
VKMV 5PK950  
VKMV 5PK1004  
VKM 38226

11 28 7 532 146  
11 28 7 549 150  
  
11 28 7 552 233  
11 28 7 552 236  
11 28 7 559 454  
11 28 7 568 247  
11 28 7 786 075  
11 28 7 787 369  
11 28 7 787 516  
11 28 7 789 985  
11 28 7 790 450  
11 28 7 792 059  
  
11 28 7 795 601  
11 28 7 830 946  
11 28 7 832 327  
11 28 7 833 264  
11 28 7 833 265  
  
11 28 7 833 266  
11 28 7 837 898  
11 31 1 708 806

VKMV 6PK1388  
VKMV 6PK1990  
VKMV 6PK1870  
VKMV 6PK1637  
VKMV 6PK1990  
  
VKMV 6PK1870  
VKMV 6PK1637  
VKMV 4PK843  
VKMV 7PK1855  
VKMV 6PK2080  
  
VKMV 5PK2063  
VKMV 5PK2020  
VKMV 6PK2160  
VKMV 6PK1836  
VKMV 6PK2063  
  
VKMV 6PK1683  
VKMV 5PK829  
VKMV 6PK1460  
VKMV 7PK1629  
VKMV 7PK1440  
  
VKMV 5PK980  
VKMV 6PK1460  
VKM 28001

11 51 1 731 680  
11 51 1 734 269  
11 51 1 734 595  
11 51 1 734 602  
11 51 1 736 146  
  
11 51 1 736 203  
11 51 1 740 241  
11 51 1 741 001  
11 51 1 741 002  
11 51 1 742 498  
  
11 51 1 742 517  
11 51 1 742 647  
11 51 1 744 243  
11 51 2 241 641  
11 51 2 242 176  
  
11 51 2 242 675  
11 51 2 242 677  
11 51 2 243 003  
11 51 2 244 333  
11 51 2 245 687  
11 51 2 247 552

VKPC 88831  
VKPC 88616  
VKPC 88615  
VKPC 88615  
VKPC 88831  
  
VKPC 88830  
VKPC 88617  
VKPC 88831  
VKPC 88830  
VKPC 88831  
  
VKPC 88830  
VKPC 88829  
VKPC 88617  
VKPC 88614  
VKPC 88612  
  
VKPC 88614  
VKPC 88612  
VKPC 88826  
VKPC 88826  
VKPC 88826  
VKPC 88632

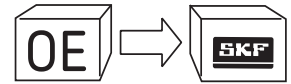
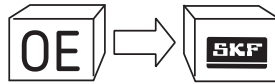
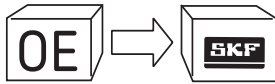

11 51 7 503 884  
 11 51 7 504 040  
 11 51 7 527 799  
 11 51 7 527 910  
 11 51 7 786 192  
 11 51 7 788 305  
 11 51 7 788 306  
 11 51 7 790 322  
 11 51 7 791 833  
 11 51 7 791 834  
 11 51 7 794 247  
 11 51 7 801 609  
 11 51 7 805 808  
 11 51 7 805 810  
 11 51 7 806 349  
 11 51 9 058 996  
 11 51 9 061 160  
 11 51 9 068 606  
 11 51 9 069 529  
 11 51 9 070 752  
 11 51 9 070 759  
 11 51 9 070 763  
 12 31 1 268 675  
 12 31 1 268 678  
 12 31 1 268 697  
 12 31 1 278 250  
 12 31 1 284 317  
 12 31 1 284 740  
 32 41 1 711 144  
 32 42 1 316 785  
 32 42 1 706 750  
 32 42 1 706 825  
 32 42 1 711 065  
 32 42 1 717 953  
 32 42 1 720 644  
 64 52 1 706 826  
 64 52 1 711 056  
 64 55 1 717 954  
 64 55 1 721 423  
 64 55 1 722 990  
 64 55 1 726 699  
 64 55 1 734 669  
 64 55 2 242 867  
 64 55 2 245 179  
 64 55 2 246 732  
 64 55 7 785 212  
 64 55 7 786 170  
 64 55 7 786 171  
 66 55 7 786 705

VKPC 88617  
 VKPC 88617  
 VKPC 88617  
 VKPC 88617  
 VKPC 88430  
 VKPC 88635  
 VKPC 88636  
 VKPC 88635  
 VKPC 88635  
 VKPC 88645  
 VKPC 88636  
 VKPC 88645  
 VKPC 88635  
 VKPC 88645  
 VKPC 88636  
 VKPC 88605  
 VKPC 88802  
 VKPC 88826  
 VKPC 88826  
 VKPC 88609  
 VKPC 88607  
 VKPC 88611  
 VKMV 10AVx875  
 VKMV 10AVx850  
 VKMV 10AVx975  
 VKMV 10AVx940  
 VKMV 10AVx950  
 VKMV 10AVx940  
 VKMV 10AVx913  
 VKMV 10AVx813  
 VKMV 10AVx888  
 VKMV 10AVx825  
 VKMV 10AVx900  
 VKMV 10AVx800  
 VKMV 10AVx850  
 VKMV 13AVx800  
 VKMV 10AVx800  
 VKMV 13AVx850  
 VKMV 13AVx900  
 VKMV 13AVx825  
 VKM 38230  
 VKMV 13AVx900  
 VKM 38009  
 VKMV 4PK781  
 VKMV 4PK781  
 VKMV 4PK968  
 VKMV 5PK810  
 VKMV 5PK836  
 VKMV 4PK882

0807.12  
 0807.13  
 0818.19  
 0818.20  
 0818.21  
 0818.22  
 0818.32  
 0823.08  
 0823.09  
 0823.10  
 0829.10  
 0829.11  
 0829.12  
 0829.17  
 0829.19  
 0829.20  
 0829.22  
 0829.29  
 0829.30  
 0829.32  
 0829.33  
 0829.35  
 0829.46  
 0829.49  
 0829.52  
 0829.54  
 0829.59  
 0829.62  
 0829.66  
 0829.69  
 0829.77  
 0829.79  
 0829.80  
 0829.82  
 0829.84  
 0829.88  
 0829.90  
 0829.92  
 0829.96  
 0829.98  
 0829.A0  
 0829.A1  
 0829.A4  
 0829.A5  
 0829.A7  
 0829.A9  
 0829.C3  
 0829.C4  
 0829.C5  
 0829.C6  
 0829.C7  
 0829.C8  
 0829.C9  
 0830.02  
 0830.11  
 0830.11  
 0830.12  
 0830.13  
 0830.14  
 0830.14  
 0830.20  
 0830.20  
 0830.23  
 0830.24

VKM 12153  
 VKM 22153  
 VKM 13250  
 VKM 13300  
 VKM 12200  
 VKM 13050  
 VKM 22385  
 VKM 13902  
 VKM 13902  
 VKM 13902  
 VKM 16200  
 VKM 13240  
 VKM 13200  
 VKM 12200  
 VKM 13100  
 VKM 13210  
 VKM 13220  
 VKM 13100  
 VKM 13120  
 VKM 13202  
 VKM 13241  
 VKM 13202  
 VKM 13211  
 VKM 13130  
 VKM 13304  
 VKM 13100  
 VKM 13244  
 VKM 13246  
 VKM 13211  
 VKM 13214  
 VKM 13234  
 VKM 13216  
 VKM 13231  
 VKM 13132  
 VKM 13218  
 VKM 13140  
 VKM 13253  
 VKM 13234  
 VKM 13234  
 VKM 13231  
 VKM 13256  
 VKM 23256  
 VKM 13257  
 VKM 13258  
 VKM 13234  
 VKM 13263  
 VKM 13264  
 VKM 23264  
 VKM 13902  
 VKM 13258  
 VKM 13132  
 VKM 13256  
 VKM 13130  
 VKM 23240  
 VKM 23214  
 VKM 23218  
 VKM 23300  
 VKM 23241  
 VKM 23214  
 VKM 23218  
 VKM 23130  
 VKM 23304  
 VKM 23900

0830.25  
 0830.26  
 0830.27  
 0830.28  
 0830.31  
 0830.32  
 0830.37  
 0830.37  
 0830.40  
 0830.42  
 0830.46  
 0830.48  
 0830.51  
 0830.52  
 0830.53  
 0830.54  
 0830.55  
 0830.58  
 0830.59  
 0830.60  
 0830.61  
 0830.62  
 0830.63  
 0831.07  
 0831.12  
 0831.13  
 0831.14  
 0831.16  
 0831.17  
 0831.19  
 0831.20  
 0831.28  
 0831.29  
 0831.31  
 0831.32  
 0831.35  
 0831.37  
 0831.41  
 0831.43  
 0831.45  
 0831.47  
 0831.49  
 0831.51  
 0831.53  
 0831.56  
 0831.59  
 0831.61  
 0831.64  
 0831.66  
 0831.68  
 0831.70  
 0831.72  
 0831.74  
 0831.77  
 0831.79  
 0831.81  
 0831.83  
 0831.85  
 0831.87  
 0831.89  
 0831.91  
 0831.K0  
 0831.K1

VKM 23901  
 VKM 23900  
 VKM 23901  
 VKM 23246  
 VKM 23246  
 VKM 22380  
 VKM 23214  
 VKM 23218  
 VKM 22385  
 VKM 23230  
 VKM 23122  
 VKM 23140  
 VKM 23257  
 VKM 23258  
 VKM 23900  
 VKM 23901  
 VKM 23261  
 VKM 23900  
 VKM 23901  
 VKM 23258  
 VKM 23130  
 VKM 23256  
 VKM 23246  
 VKMA 03210  
 VKMA 03050  
 VKMA 03100  
 VKMA 03110  
 VKMA 03200  
 VKMA 03201  
 VKMA 03220  
 VKMA 03240  
 VKMA 03111  
 VKMA 03211  
 VKMA 03241  
 VKMA 03213  
 VKMA 03202  
 VKMA 03300  
 VKMA 03246  
 VKMA 03213  
 VKMA 03120  
 VKMA 03121  
 VKMA 03213  
 VKMA 03250  
 VKMA 03251  
 VKMA 03214  
 VKMA 03244  
 VKMA 03252  
 VKMA 03304  
 VKMA 03235  
 VKMA 03216  
 VKMA 03231  
 VKMA 03218  
 VKMA 03248  
 VKMA 03122  
 VKMA 03247  
 VKMA 03140  
 VKMA 03246  
 VKMA 03253  
 VKMA 03254  
 VKMA 03235  
 VKMA 03255  
 VKMA 03257  
 VKMA 03263

**CHRYSLER**

4720429

VKPC 82642

**CITROËN**

0513.61  
 0515.G3  
 0515.J9  
 0515.L6  
 0515.P2  
 0515.V5

VKM 13301  
 VKM 93302  
 VKM 93306  
 VKM 93305  
 VKM 93301  
 VKM 93301



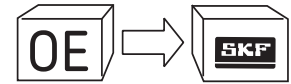
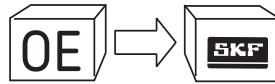
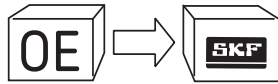

|         |                |         |                 |         |               |
|---------|----------------|---------|-----------------|---------|---------------|
| 0831.K2 | VKMA 03260     | 5200.O7 | VKMOV 10AVx1025 | 5750.P2 | VKMOV 6PK1710 |
| 0831.K5 | VKMA 03265     | 5750.D1 | VKMOV 5PK1195   | 5750.PC | VKMOV 6PK1147 |
| 0831.K7 | VKMA 03264     | 5750.D8 | VKMOV 5PK690    | 5750.PF | VKMOV 6PK998  |
| 0831.K9 | VKMA 03266     | 5750.EK | VKMOV 6PK1706   | 5750.PG | VKMOV 6PK1217 |
| 0831.L1 | VKMA 03130     | 5750.EM | VKMOV 6PK1468   | 5750.PN | VKMOV 6PK1049 |
| 0831.L3 | VKMA 03256     | 5750.EW | VKMOV 6PK1585   | 5750.PQ | VKMOV 6PK1069 |
| 0831.L5 | VKMA 03258     | 5750.EY | VKMOV 6PK1437   | 5750.PT | VKMOV 6PK1887 |
| 0831.L7 | VKMA 03132     | 5750.F5 | VKMOV 10AVx700  | 5750.PW | VKMOV 6PK1030 |
| 0831.L9 | VKMA 03902     | 5750.F6 | VKMOV 10AVx710  | 5750.PY | VKMOV 6PK1682 |
| 0831.N3 | VKMA 03244     | 5750.F9 | VKMOV 10AVx800  | 5750.Q2 | VKMOV 5PK1050 |
| 0831.N5 | VKMA 03247     | 5750.FC | VKMOV 6PK1726   | 5750.Q7 | VKMOV 5PK881  |
| 1201.55 | VKPC 83425     | 5750.FF | VKMOV 6PK747    | 5750.QH | VKMOV 6PK966  |
| 1201.58 | VKPC 83428     | 5750.FG | VKMOV 6PK1188   | 5750.QK | VKMOV 6PK850  |
| 1201.61 | VKPC 83615     | 5750.FJ | VKMOV 6PK1205   | 5750.QN | VKMOV 6PK1210 |
| 1201.70 | VKPC 83810     | 5750.FR | VKMOV 5PK1218   | 5750.QR | VKMOV 6PK872  |
| 1201.91 | VKPC 83420     | 5750.FT | VKMOV 6PK802    | 5750.QT | VKMOV 6PK1182 |
| 1201.93 | VKPC 83636     | 5750.FW | VKMOV 6PK976    | 5750.QV | VKMOV 6PK1590 |
| 1201.95 | VKPA 83431     | 5750.G2 | VKMOV 10AVx910  | 5750.R2 | VKMOV 6PK1603 |
| 1201.96 | VKPA 83432     | 5750.G3 | VKMOV 10AVx925  | 5750.R9 | VKMOV 6PK1739 |
| 1201.98 | VKPC 83635     | 5750.G5 | VKMOV 10AVx1090 | 5750.RE | VKMOV 6PK1217 |
| 1201.A1 | VKPC 83636     | 5750.G8 | VKMOV 4PK698    | 5750.RF | VKMOV 6PK1564 |
| 1201.A2 | VKPC 83430     | 5750.GC | VKMOV 6PK728    | 5750.RP | VKMOV 6PK1030 |
| 1201.A3 | VKPC 83810     | 5750.GE | VKMOV 6PK1125   | 5750.RR | VKMOV 6PK1710 |
| 1201.A4 | VKPC 83420     | 5750.GF | VKMOV 6PK1747   | 5750.RZ | VKMOV 6PK1205 |
| 1201.A5 | VKPC 83811     | 5750.GH | VKMOV 6PK1182   | 5750.T4 | VKMOV 5PK829  |
| 1201.A6 | VKPC 83637     | 5750.GJ | VKMOV 6PK1388   | 5750.T6 | VKMOV 6PK1451 |
| 1201.A8 | VKPC 83420     | 5750.GK | VKMOV 6PK1740   | 5750.V0 | VKMOV 4PK860  |
| 1201.C1 | VKPC 83425     | 5750.GZ | VKMOV 6PK1560   | 5750.VF | VKMOV 6PK1437 |
| 1201.C4 | VKPC 83639     | 5750.H1 | VKMOV 4PK954    | 5750.VJ | VKMOV 6PK1188 |
| 1201.C5 | VKPC 83425     | 5750.H3 | VKMOV 5PK698    | 5750.VP | VKMOV 6PK1341 |
| 1201.C6 | VKPC 83425     | 5750.H4 | VKMOV 5PK715    | 5750.VQ | VKMOV 6PK1705 |
| 1201.C7 | VKPC 83637     | 5750.H5 | VKMOV 5PK850    | 5750.W2 | VKMOV 6PK1042 |
| 1201.C9 | VKPC 82652     | 5750.H7 | VKMOV 5PK1160   | 5750.W9 | VKMOV 5PK780  |
| 1201.E0 | VKPC 83425     | 5750.H8 | VKMOV 6PK698    | 5750.WN | VKMOV 6PK728  |
| 1201.E3 | VKPC 83205     | 5750.H9 | VKMOV 6PK730    | 5750.WP | VKMOV 6PK1710 |
| 1201.E4 | VKPC 83428     | 5750.HE | VKMOV 6PK1680   | 5750.WY | VKMOV 6PK1049 |
| 1201.E5 | VKPC 83430     | 5750.HH | VKMOV 6PK1744   | 5750.X4 | VKMOV 6PK866  |
| 1201.E6 | VKPC 83428     | 5750.J0 | VKMOV 6PK802    | 5750.X6 | VKMOV 6PK1388 |
| 1201.E8 | VKPC 83643     | 5750.J1 | VKMOV 6PK915    | 5750.X7 | VKMOV 6PK1736 |
| 1201.F5 | VKPC 83650     | 5750.J2 | VKMOV 6PK1012   | 5750.XA | VKMOV 6PK1564 |
| 1201.F9 | VKPC 83140     | 5750.J3 | VKMOV 6PK1076   | 5750.XE | VKMOV 5PK1050 |
| 1201.G0 | VKPC 83644     | 5750.J4 | VKMOV 6PK1094   | 5750.XG | VKMOV 6PK998  |
| 1201.G1 | VKPC 83259     | 5750.J5 | VKMOV 6PK1130   | 5750.XN | VKMOV 6PK1217 |
| 1201.G2 | VKPC 83258     | 5750.J6 | VKMOV 6PK1151   | 5750.XR | VKMOV 6PK1710 |
| 1201.G5 | VKPC 83650     | 5750.J7 | VKMOV 6PK1660   | 5750.XT | VKMOV 6PK1468 |
| 1201.G8 | VKPC 83140     | 5750.J8 | VKMOV 6PK1700   | 5750.Y2 | VKMOV 6PK1205 |
| 1201.G9 | VKPC 83259     | 5750.K1 | VKMOV 6PK1146   | 5750.Y3 | VKMOV 6PK1726 |
| 1201.H5 | VKPC 82652     | 5750.K3 | VKMOV 5PK775    | 5750.YH | VKMOV 6PK1670 |
| 1201.J2 | VKPC 83650     | 5750.K5 | VKMOV 5PK960    | 5750.Z1 | VKMOV 6PK1451 |
| 1207.23 | VKPC 83205     | 5750.K6 | VKMOV 6PK1862   | 5750.Z3 | VKMOV 6PK1564 |
| 1207.25 | VKPC 83428     | 5750.K8 | VKMOV 6PK1067   | 5750.Z5 | VKMOV 6PK1736 |
| 1280.27 | VKMOV 4PK866   | 5750.KT | VKMOV 6PK1705   | 5750.Z7 | VKMOV 6PK1750 |
| 1280.28 | VKMOV 4PK946   | 5750.KV | VKMOV 6PK1341   | 5751.14 | VKM 33006     |
| 1280.39 | VKMOV 3PK866   | 5750.L0 | VKMOV 6PK1110   | 5751.18 | VKM 33003     |
| 1280.41 | VKMOV 3PK946   | 5750.L4 | VKMOV 6PK1155   | 5751.20 | VKM 33034     |
| 1280.62 | VKMOV 3PK866   | 5750.LA | VKMOV 6PK1468   | 5751.21 | VKM 33007     |
| 1281.34 | VKM 33016      | 5750.LH | VKMOV 6PK1710   | 5751.23 | VKM 33040     |
| 1281.35 | VKM 33086      | 5750.M0 | VKMOV 6PK1200   | 5751.24 | VKM 33008     |
| 1281.38 | VKM 33125      | 5750.M3 | VKMOV 6PK1188   | 5751.26 | VKM 33009     |
| 1628.WA | VKM 33065      | 5750.M5 | VKMOV 6PK1102   | 5751.27 | VKM 33039     |
| 1926.67 | VKM 13262      | 5750.M7 | VKMOV 6PK1726   | 5751.29 | VKM 33013     |
| 4007.E4 | VKM 33015      | 5750.M9 | VKMOV 6PK1160   | 5751.30 | VKM 33029     |
| 5200.04 | VKMOV 10AVx600 | 5750.P1 | VKMOV 4PK755    | 5751.31 | VKM 33311     |

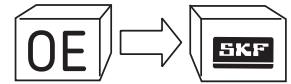
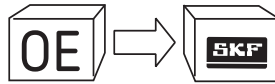
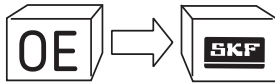

5751.32  
5751.33  
5751.34  
5751.35  
  
5751.36  
5751.37  
5751.38  
5751.43  
5751.44  
  
5751.45  
5751.46  
5751.50  
5751.51  
5751.52  
  
5751.53  
5751.54  
5751.55  
5751.56  
5751.57  
  
5751.58  
5751.59  
5751.60  
5751.61  
5751.62  
  
5751.63  
5751.67  
5751.72  
5751.73  
5751.74  
  
5751.75  
5751.76  
5751.81  
5751.85  
5751.86  
  
5751.87  
5751.89  
5751.90  
5751.91  
5751.92  
  
5751.95  
5751.96  
5751.97  
5751.98  
5751.A0  
  
5751.A1  
5751.A2  
5751.A7  
5751.C3  
5751.C9  
  
5751.F1  
6453.76  
6453.AE  
6453.AN  
6453.C6  
  
6453.CE  
6453.CY  
6453.E5  
6453.E0  
6453.R8  
  
6453.S4  
6453.S5  
6453.Y1  
6453.Y3

VKM 33022  
VKM 33025  
VKM 33035  
VKM 33028  
  
VKM 33026  
VKM 33027  
VKM 33002  
VKM 33311  
VKM 33311  
  
VKM 33004  
VKM 33017  
VKM 33018  
VKM 33023  
VKM 33037  
  
VKM 33021  
VKM 33311  
VKM 33033  
VKM 33024  
VKM 33069  
  
VKM 33008  
VKM 33017  
VKM 33020  
VKM 33019  
VKM 33017  
  
VKM 33017  
VKM 33017  
VKM 33017  
VKM 33031  
VKM 33032  
  
VKM 33075  
VKM 33045  
VKM 33311  
VKM 33073  
VKM 33043  
  
VKM 33044  
VKM 33061  
VKM 33060  
VKM 33042  
VKM 33314  
  
VKM 33314  
VKM 33069  
VKM 33101  
VKM 33100  
VKM 33063  
  
VKM 33064  
VKM 33101  
VKM 33320  
VKM 33074  
VKM 33100  
  
VKM 34030  
VKM 33010  
VKMV 5PK1020  
VKM 33041  
VKM 33090  
  
VKM 36001  
VKMV 5PK1030  
VKMV 4PK810  
VKM 33001  
VKM 33014  
  
VKM 33012  
VKM 33012  
VKM 33038  
VKM 33083

75530147  
7701556717  
7901120258  
7946002102  
91 536 224  
91 536 298  
  
91508298  
91536227  
91538722  
91541177  
91541178  
  
91541179  
93501404  
93501405  
93510847  
9401201480  
  
9431142021  
9451001263  
95006268  
95495830  
95548541  
  
95619217  
95619748  
95625017  
95640195  
95641148  
  
95643824  
95655207  
95655208  
95655210  
95656566  
  
95656567  
95656568  
95656569  
95666768  
96010219  
  
96010220  
96010657  
96014241  
96031955  
96035624  
  
96047088  
96056183  
9608564280  
96094102  
96097691  
  
96098278  
96099089  
96099089  
96099089  
  
96137001  
96144511  
96152090  
96173680  
9617376980  
  
9618888580  
96201309  
96201309  
96201309  
  
96216260  
9635336880

VKPC 83617  
VKPC 83626  
VKPC 83200  
VKPC 83626  
VKMV 4PK841  
VKMV 10AVx625  
  
VKM 13200  
VKMV 4PK1020  
VKM 13210  
VKMV 4PK795  
VKMV 4PK1230  
  
VKMV 5PK1230  
VKM 13240  
VKM 23240  
VKM 33090  
VKPC 83424  
  
VKPC 83636  
VKPC 83205  
VKMV 5PK1125  
VKM 13050  
VKPC 83617  
  
VKM 12200  
VKPC 83617  
VKPC 83615  
VKM 13120  
VKPC 83401  
  
VKPC 83424  
VKPC 83401  
VKPC 83615  
VKPC 83424  
VKPC 83401  
  
VKPC 83615  
VKPC 83424  
VKPC 83424  
VKPC 83420  
VKMV 5PK1140  
  
VKMV 5PK710  
VKM 13220  
VKMV 5PK1270  
VKMV 10AVx1100  
VKMV 10AVx650  
  
VKPC 83425  
VKM 13250  
VKPC 83428  
VKM 23300  
VKM 13301  
  
VKM 13300  
VKM 23120  
VKM 23213  
VKM 23214  
VKM 23218  
  
VKM 13211  
VKMV 6PK1170  
VKMV 5PK1151  
VKMV 5PK770  
VKPC 83205  
  
VKM 33013  
VKM 23120  
VKM 23213  
VKM 23214  
VKM 23218  
  
VKM 33023  
VKM 13214

9635438080  
9636640580  
9637058080  
  
9637877180  
9638380780  
9638976580  
96399167  
9640828480  
  
9642929880  
9643329680  
9645209880  
9645925180  
9646247380  
  
9647834880  
9649675880  
9652073680  
9660098680  
96650955  
  
97521368  
97535002

**DAEWOO**

12810A81400-000  
17400A60D01-00  
17400A60D02-00  
5094008601  
5094013802  
  
90220568  
90284802  
90325660-A  
90411782  
90466343  
  
90499401  
90530124  
9158004  
92064250  
92065969  
  
93202400  
94580139  
94599007  
94599008  
96103222  
  
96182871  
96230607  
96230608  
96350526  
96350550  
  
96350799  
96351284  
96351969  
96351971  
96352648  
  
96352650  
96518977  
96563958  
96666219

**DAIHATSU**

13504-87701  
13505-87102

VKM 13231  
VKM 33020  
VKM 13216  
  
VKM 13218  
VKM 33061  
VKM 33101  
VKM 33073  
VKM 13257  
  
VKM 13253  
VKM 13234  
VKM 13258  
VKM 13231  
VKM 13244  
  
VKM 33063  
VKM 33101  
VKM 33074  
VKM 23230  
VKPC 83420  
  
VKPC 83206  
VKM 13100  
  
VKM 76102  
VKPC 90450  
VKPC 90450  
VKM 70000  
VKPC 90200  
  
VKPC 85407  
VKPC 85400  
VKPC 85206  
VKM 25212  
VKPC 85611  
  
VKM 15121  
VKM 15402  
VKM 15202  
VKPC 85611  
VKPC 85611  
  
VKM 70001  
VKM 76102  
VKPC 90450  
VKPC 90450  
VKM 80000  
  
VKPC 90402  
VKM 70004  
VKM 80002  
VKM 80000  
VKM 70000  
  
VKPC 90202  
VKPC 90200  
VKPC 85206  
VKPC 90200  
VKPC 90202  
  
VKPC 90402  
VKPC 90450  
VKPC 90450  
VKPC 90450  
  
VKM 87000  
VKM 77500





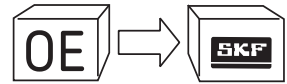
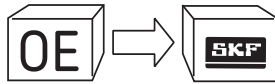
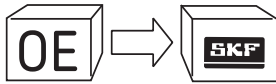

13505-87201  
 13505-87203  
 13505-87206  
  
 13505-87701  
 13505-87702  
 13505-97201  
 16100-19015  
 16100-87182  
  
 16100-87183  
 16100-87184  
 16100-87185  
 16100-87248  
 16100-87287-000  
  
 16100-87786  
 16100-87787  
 16100-87790  
 16100-87795  
 16100-87796  
  
 16100-87797  
 16100-B9210  
 16100-B9250  
 16603-97401

**VKM 77501**  
**VKM 77401**  
**VKM 77401**  
  
**VKM 77100**  
**VKM 77300**  
**VKM 77503**  
**VKPC 91402**  
**VKPC 97200**  
  
**VKPC 97201**  
**VKPC 97200**  
**VKPC 97201**  
**VKPC 97002**  
**VKPC 97002**  
  
**VKPC 97000**  
 VKPC 87203  
**VKPC 97001**  
**VKPC 97001**  
**VKPC 97000**  
 VKPC 87203  
  
**VKPC 97001**  
**VKPC 97002**  
**VKPC 97201**  
**VKM 67000**

46414859  
 46416489  
 46422512  
  
 46423351  
 46424623  
 46424716  
 46428896  
 46429443  
  
 46437912  
 46437913  
 46437914  
 46437916  
 46439000  
  
 46439471  
 46439824  
 46440604  
 46441096  
 46442999  
  
 46444355  
 46444537  
 46446963  
 46454225  
 46454419

46460702  
 46462949  
 46469587  
 46474060  
 46474062  
  
 46514222  
 46515970  
 46515971  
 46515972  
 46520401  
  
 46524692  
 46526243  
 46531183  
 46537101  
 46540546  
  
 46541092  
 46542302  
 46542303  
 46546374  
 46547564  
  
 46547566  
 46548452  
 46548454  
 46550322  
 46554826  
  
 46556131  
 46736814  
 46738445  
 46742168  
 46742968  
  
 46747484  
 46749664  
 46751071  
 46751834  
 46754624  
  
 46756937  
 46759720  
 46787905  
 46792898  
 46794035

**VKMV 6PK1072**  
**VKM 12242**  
**VKPC 82249**  
  
**VKPC 82214**  
**VKMV 3PK1006**  
**VKM 32242**  
**VKMV 4PK980**  
**VKMV 4PK675**  
  
 VKPA 82230  
 VKPA 83432  
 VKPA 83431  
 VKPA 82230  
**VKMV 6PK1105**  
  
**VKM 32154**  
**VKMV 6PK935**  
**VKM 32005**  
**VKM 32015**  
**VKM 32022**  
  
 VKPA 82441  
**VKMV 6PK1740**  
**VKMV 4PK903**  
**VKMV 5PK1020**  
**VKM 32006**  
  
**VKM 32025**  
**VKMV 6PK935**  
**VKM 32018**  
**VKMV 4PK755**  
**VKMV 6PK1842**  
  
**VKM 32006**  
**VKPC 82665**  
**VKPC 82247**  
**VKPC 82665**  
**VKPC 82251**  
  
**VKM 32022**  
**VKPC 82250**  
**VKPC 82214**  
**VKM 32243**  
**VKMV 6PK1036**  
  
 VKPA 82441  
**VKMV 4PK962**  
**VKMV 4PK854**  
**VKM 32027**  
**VKM 32036**  
  
**VKM 32024**  
**VKM 32023**  
**VKMV 5PK1175**  
**VKMV 5PK1585**  
**VKM 22242**  
  
**VKMV 6PK1795**  
**VKMV 4PK668**  
**VKMV 3PK668**  
**VKPA 82203**  
**VKM 32034**  
  
**VKMV 6PK1230**  
**VKMV 6PK1830**  
**VKMV 6PK1139**  
**VKMV 6PK986**  
**VKM 32033**  
  
**VKM 32031**  
**VKMV 6PK1836**  
**VKMV 3PK915**  
**VKM 12242**  
**VKM 32006**

46798891  
 46801955  
 46804051  
 46805736  
 46819138  
  
 46819146  
 46820062  
 46820063  
 4720031  
 4740846  
  
 4740847  
 4755003  
 4764782  
 4822231  
 4823810  
  
 4829216  
 4852375  
 500344281  
 500388688  
 504010846  
  
 504083122  
 504183759  
 51758124  
 51758365  
 51773551  
  
 55180010  
 55180011  
 55183497  
 55183527  
 55184055  
  
 55184080  
 55184081  
 55184761  
 55185074  
 55185077  
  
 55187100  
 55187100  
 55189677  
 55189680  
 55190052  
  
 55190813  
 55191006  
 55191969  
 55191970  
 55192239  
  
 55192240  
 55192323  
 55192773  
 55192802  
 55193330  
  
 55193360  
 55193679  
 55195023  
 55196971  
 55200253  
  
 5548541  
 5882684  
 5882689  
 5882695  
 5883960  
  
 5890406  
 5893336  
 5893336

**VKMV 6PK1147**  
**VKMV 6PK1050**  
**VKPC 82667**  
**VKPC 82250**  
**VKPC 85700**  
  
**VKM 32080**  
**VKMV 6PK1180**  
**VKMV 6PK1310**  
**VKPC 82606**  
**VKM 22385**  
  
**VKM 22380**  
**VKPC 82606**  
**VKPC 82606**  
**VKPC 82616**  
**VKPC 82643**  
  
**VKPC 82616**  
**VKM 12400**  
**VKMV 5PK1100**  
**VKM 22390**  
**VKM 12390**  
  
**VKPC 82652**  
**VKM 12390**  
**VKMV 6PK1390**  
**VKMV 6PK1410**  
**VKM 32046**  
  
**VKMV 6PK1270**  
**VKM 32027**  
**VKM 12206**  
**VKM 12174**  
**VKM 32026**  
  
**VKPC 82250**  
**VKPC 82251**  
**VKM 32025**  
**VKM 35023**  
**VKMV 6PK1182**  
  
**VKM 22179**  
**VKM 22180**  
**VKMV 6PK1836**  
**VKMV 6PK1815**  
**VKM 32030**  
  
**VKM 32046**  
**VKMV 6PK1195**  
**VKM 32023**  
**VKMV 5PK1145**  
**VKM 12173**  
  
**VKM 12182**  
**VKM 12174**  
**VKM 12172**  
**VKMV 3PK668**  
**VKM 32033**  
  
**VKMV 6PK1580**  
**VKMV 6PK815**  
**VKM 32023**  
**VKM 12215**  
**VKMV 6PK1410**  
  
**VKPC 83617**  
**VKPC 82404**  
**VKPC 82412**  
**VKPC 82206**  
**VKPC 82206**  
  
**VKPC 82208**  
**VKPA 82222**  
**VKPC 82206**

**FIAT**

1304596080  
 1313021080  
 1317462080  
 1317466080  
 4065269  
  
 4129810  
 4297101  
 4320086  
 4331825  
 4336009  
  
 4336188  
 4364117  
 4384128  
 4385583  
 4386575  
  
 4408285  
 4427068  
 4429224  
 4438894  
 4443446  
  
 4443703  
 4458134  
 46139910  
 46400054  
 46400058  
  
 46403679  
 46407766  
 46408312  
 46409134  
 46409136  
  
 46409136  
 46409200  
 46409201  
 46410549  
 46410551  
  
 46411595  
 46412338

**VKPA 82670**  
**VKPA 82671**  
**VKPA 82670**  
**VKPA 82671**  
**VKPC 82205**  
  
**VKPC 82404**  
**VKPC 82206**  
**VKPC 82404**  
**VKPC 82412**  
**VKPC 82208**  
  
**VKPC 82404**  
**VKPC 82410**  
**VKPC 82206**  
**VKM 12100**  
**VKM 12003**  
  
**VKPC 82216**  
 VKM 12010  
**VKPC 82216**  
**VKM 12630**  
**VKM 12012**  
  
**VKM 12001**  
**VKPC 82424**  
**VKPC 82629**  
**VKM 22242**  
 VKPA 82441  
  
**VKM 12201**  
**VKPC 82429**  
**VKPA 82634**  
 VKPA 82428  
**VKPA 82210**  
  
**VKPC 82210**  
 VKPA 83432  
 VKPA 83431  
 VKPA 82230  
**VKPA 82240**  
  
**VKMV 4PK962**  
**VKPA 82440**

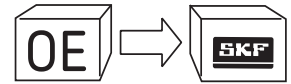
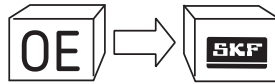
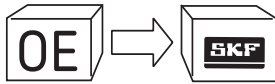

|          |               |          |                |          |                |
|----------|---------------|----------|----------------|----------|----------------|
| 5893338  | VKPC 82218    | 71713728 | VKPC 82249     | 71739615 | VKVM 6PK1036   |
| 5893339  | VKPC 82206    | 71716878 | VKPC 82441     | 71739618 | VKVM 5PK884    |
| 5893340  | VKPC 82224    | 71716879 | VKPC 82246     | 71739620 | VKVM 6PK935    |
| 5894047  | VKPC 82410    | 71716884 | VKPC 82218     | 71739621 | VKVM 4PK946    |
| 5894129  | VKPA 82222    | 71716893 | VKPC 82230     | 71739622 | VKVM 5PK1100   |
| 5894129  | VKPC 82206    | 71718718 | VKVM 4PK675    | 71739904 | VKVM 10AVx800  |
| 5894394  | VKPC 82622    | 71718838 | VKVM 4PK841    | 71739905 | VKVM 5PK938    |
| 5894582  | VKPA 82218    | 71719039 | VKVM 4PK698    | 71739908 | VKVM 10AVx650  |
| 5894583  | VKPC 82224    | 71719396 | VKVM 6PK986    | 71739912 | VKVM 10AVx825  |
| 5896813  | VKPC 82620    | 71719398 | VKVM 3PK915    | 71739915 | VKVM 6PK1842   |
| 5896820  | VKPC 82618    | 71719399 | VKVM 3PK719    | 71739916 | VKVM 6PK1795   |
| 5896821  | VKPC 82618    | 71719400 | VKVM 6PK1139   | 71739921 | VKVM 6PK1660   |
| 5896822  | VKPC 82618    | 71719401 | VKVM 6PK1775   | 71739924 | VKVM 6PK1739   |
| 5924366  | VKPC 82216    | 71719407 | VKVM 5PK970    | 71740977 | VKM 12200      |
| 5939200  | VKPA 82202    | 71719640 | VKVM 13AVx1050 | 71744462 | VKVM 6PK1255   |
| 5952181  | VKM 22630     | 71719644 | VKVM 6PK1050   | 71745026 | VKPC 85700     |
| 5956109  | VKM 12005     | 71719668 | VKPC 82208     | 71746480 | VKVM 6PK815    |
| 5966001  | VKM 12160     | 71719678 | VKPC 82647     | 71747799 | VKM 12174      |
| 5972277  | VKM 12200     | 71719695 | VKPA 82431     | 7301300  | VKPC 82600     |
| 5973319  | VKPC 82614    | 71719697 | VKPA 82431     | 7301593  | VKPC 82600     |
| 5973713  | VKPC 82214    | 71719738 | VKVM 4PK668    | 7302443  | VKPC 82600     |
| 5983960  | VKPC 82206    | 71719745 | VKVM 5PK907    | 7302554  | VKPC 82616     |
| 5984047  | VKPC 82410    | 71728659 | VKVM 6PK1080   | 7303030  | VKPC 82600     |
| 5985019  | VKM 12150     | 71728660 | VKVM 6PK1844   | 7303050  | VKPC 82606     |
| 5990701  | VKPC 82216    | 71732350 | VKVM 5PK1145   | 73501649 | VKVM 6PK1195   |
| 5990928  | VKM 22150     | 71732394 | VKVM 6PK1795   | 73501924 | VKM 32001      |
| 5993339  | VKPC 82206    | 71734476 | VKVM 6PK1836   | 73502730 | VKM 32033      |
| 5996594  | VKPC 82218    | 71734715 | VKVM 6PK1760   | 73503128 | VKM 12201      |
| 5997325  | VKM 12101     | 71734716 | VKVM 6PK1740   | 7392549  | VKPC 82429     |
| 5999790  | VKPC 82622    | 71734717 | VKVM 6PK1815   | 7533502  | VKPC 82218     |
| 60504835 | VKVM 10AVx850 | 71734799 | VKM 12242      | 7540301  | VKM 22160      |
| 60596372 | VKM 12173     | 71736242 | VKVM 6PK1265   | 7541718  | VKM 12227      |
| 60606518 | VKVM 5PK864   | 71736257 | VKVM 6PK1360   | 7547752  | VKVM 5PK1345   |
| 60608898 | VKPC 82451    | 71736493 | VKM 22174      | 7553396  | VKPC 82426     |
| 60610908 | VKM 32001     | 71736714 | VKMA 02174     | 7553564  | VKM 12151      |
| 60620443 | VKM 12277     | 71736715 | VKMA 02242     | 7553565  | VKM 22151      |
| 60626658 | VKVM 6PK1983  | 71736716 | VKMA 02390     | 7553760  | VKM 12150      |
| 60652477 | VKM 12182     | 71736717 | VKMA 02204     | 7553760  | VKM 32016      |
| 60654130 | VKM 32030     | 71736718 | VKMA 02203     | 7554724  | VKPC 82218     |
| 60662991 | VKVM 6PK1855  | 71736719 | VKMA 02210     | 7565764  | VKPC 82424     |
| 60664403 | VKM 22177     | 71736720 | VKMA 02383     | 7574887  | VKPA 82428     |
| 60666950 | VKVM 6PK1842  | 71736722 | VKMA 02185     | 7575827  | VKPC 82428     |
| 60667050 | VKVM 6PK1285  | 71736723 | VKMA 02178     | 7575827  | VKM 12160      |
| 60667496 | VKM 12277     | 71736724 | VKMA 02183     | 7580613  | VKPA 82218     |
| 60671573 | VKM 22177     | 71736725 | VKMA 02184     | 7580754  | VKPC 82218     |
| 60671789 | VKM 32184     | 71736726 | VKMA 02192     | 7580755  | VKPC 82218     |
| 60674147 | VKVM 6PK1795  | 71736727 | VKMA 02177     | 7581316  | VKVM 10AVx825  |
| 60805460 | VKM 32009     | 71736795 | VKPC 82208     | 7581805  | VKVM 13AVx715  |
| 60808116 | VKPC 82800    | 71737960 | VKPC 82208     | 7589065  | VKPC 82432     |
| 60809160 | VKVM 5PK938   | 71737961 | VKPA 82202     | 7589248  | VKVM 13AVx825  |
| 60809209 | VKPC 82660    | 71737965 | VKPC 82660     | 7596727  | VKM 22153      |
| 60810426 | VKPC 82660    | 71737966 | VKPA 82248     | 7596728  | VKM 12153      |
| 60810641 | VKM 32010     | 71737972 | VKPA 82431     | 7596876  | VKM 22153      |
| 60811328 | VKPC 82645    | 71737976 | VKPA 82634     | 7596877  | VKM 12153      |
| 60811332 | VKM 32022     | 71737979 | VKPA 82230     | 7597569  | VKPC 82620     |
| 60813774 | VKM 32018     | 71737991 | VKPA 82670     | 7598226  | VKM 22155      |
| 60814032 | VKVM 6PK1830  | 71737993 | VKPC 83630     | 7608844  | VKPA 82210     |
| 60814110 | VKM 32022     | 71739304 | VKM 34027      | 7608844  | VKPC 82210     |
| 60814462 | VKM 12182     | 71739401 | VKPC 85308     | 7609204  | VKPC 82629     |
| 60814609 | VKPC 82665    | 71739512 | VKVM 6PK1270   | 7610476  | VKVM 10AVx710  |
| 60814917 | VKM 32024     | 71739605 | VKVM 13AVx750  | 7611334  | VKVM 10AVx650  |
| 71712149 | VKVM 5PK1050  | 71739606 | VKVM 4PK545    | 7617168  | VKPA 82431     |
| 71713727 | VKPC 82214    | 71739613 | VKVM 4PK980    | 7617214  | VKVM 13AVx1050 |





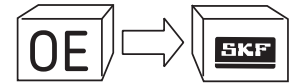
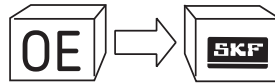
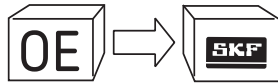

|         |               |            |                |            |              |
|---------|---------------|------------|----------------|------------|--------------|
| 7617278 | VKMM 13AVx850 | 7719919    | VKPC 82206     | 9400829599 | VKM 13244    |
| 7617364 | VKPA 82220    | 7719921    | VKPA 82218     | 9400829629 | VKM 13246    |
| 7618521 | VKMM 10AVx838 | 7720922    | VKMM 13AVx1050 | 9400829929 | VKM 13234    |
| 7621046 | VKMM 5PK1065  | 7720987    | VKPC 82245     | 9400830149 | VKM 23214    |
| 7621256 | VKMM 13AVx875 | 7721293    | VKMM 5PK935    | 9400830149 | VKM 23218    |
| 7627908 | VKMM 13AVx850 | 7723345    | VKPA 82431     | 9400830289 | VKM 23246    |
| 7628880 | VKPC 82208    | 7723347    | VKPA 82431     | 9400830319 | VKM 23246    |
| 7629228 | VKPC 82429    | 7723828    | VKMM 10AVx690  | 9400830379 | VKM 23120    |
| 7630343 | VKPC 82224    | 7724414    | VKPA 82203     | 9400830379 | VKM 23213    |
| 7631494 | VKPC 82620    | 7737200    | VKPC 82245     | 9400830379 | VKM 23214    |
| 7633335 | VKMM 10AVx735 | 7738267    | VKPA 82431     | 9400830379 | VKM 23218    |
| 7633470 | VKPA 82440    | 7740252    | VKM 32002      | 9400830429 | VKM 23230    |
| 7633560 | VKPC 82216    | 7743134    | VKMM 10AVx690  | 9400831069 | VKMA 03201   |
| 7635180 | VKPC 82622    | 7747382    | VKPC 82660     | 9400831279 | VKMA 03241   |
| 7636057 | VKMM 4PK1045  | 7747386    | VKPC 82629     | 9400831349 | VKMA 03202   |
| 7640163 | VKPC 82214    | 7747388    | VKPC 82660     | 9400831489 | VKMA 03213   |
| 7640257 | VKMM 5PK986   | 7748000    | VKPA 82222     | 9400831529 | VKMA 03251   |
| 7644928 | VKMM 10AVx800 | 7748002    | VKPA 82431     | 9400831589 | VKMA 03244   |
| 7646849 | VKMM 5PK1050  | 7749452    | VKM 32011      | 9400831609 | VKMA 03252   |
| 7648451 | VKPC 82429    | 7750698    | VKPA 82230     | 9400831629 | VKMA 03246   |
| 7649219 | VKMM 13AVx850 | 7752928    | VKPC 82246     | 9400831739 | VKMA 03248   |
| 7650925 | VKM 32242     | 7762924    | VKPC 82437     | 9400831789 | VKMA 03247   |
| 7651586 | VKPA 82431    | 7762925    | VKPC 82665     | 9400831829 | VKMA 03246   |
| 7655543 | VKMM 13AVx850 | 7762926    | VKPC 82646     | 9400831889 | VKMA 03235   |
| 7655544 | VKMM 13AVx750 | 7762986    | VKPA 82248     | 9401201340 | VKPC 83630   |
| 7658062 | VKPA 82608    | 7762990    | VKMM 13AVx850  | 9401201400 | VKPC 83630   |
| 7658606 | VKPC 82620    | 7763644    | VKM 22174      | 9405751679 | VKM 33017    |
| 7658607 | VKPC 82620    | 7764585    | VKMM 10AVx675  | 9405751819 | VKM 33311    |
| 7659699 | VKMM 10AVx675 | 7765720    | VKMM 10AVx690  | 9463623088 | VKPC 83643   |
| 7661811 | VKPC 82629    | 7766487    | VKM 32012      | 9464867280 | VKMM 6PK1680 |
| 7661813 | VKPC 82622    | 7766585    | VKMM 10AVx735  | 9467521280 | VKMA 03265   |
| 7671810 | VKPC 82216    | 7768335    | VKPC 82245     | 95495830   | VKM 13050    |
| 7671811 | VKPC 82216    | 7770034    | VKPA 82431     | 9565095580 | VKPC 83420   |
| 7675213 | VKMM 4PK545   | 7770038    | VKPA 82431     | 9565656788 | VKPC 83615   |
| 7691044 | VKPC 82218    | 7770042    | VKPA 82431     | 9566945680 | VKPC 83420   |
| 7691046 | VKPA 82431    | 7771529    | VKMM 4PK1006   | 9566945688 | VKPC 83420   |
| 7691047 | VKPA 82431    | 7771530    | VKMM 10AVx690  | 9566950080 | VKPC 83636   |
| 7691820 | VKPC 82214    | 7771742    | VKMM 10AVx838  | 9567521488 | VKPC 83420   |
| 7692278 | VKPC 82429    | 7771811    | VKPC 82245     | 9569147388 | VKPC 83639   |
| 7692285 | VKPC 82620    | 7772961    | VKM 12172      | 9569623880 | VKPC 83425   |
| 7692294 | VKPC 82618    | 7776570    | VKMM 10AVx650  | 9604708880 | VKPC 83425   |
| 7692551 | VKPA 82634    | 7778565    | VKM 12174      | 9608859180 | VKM 33003    |
| 7692554 | VKPC 82428    | 7781232    | VKPA 82653     | 9608989980 | VKM 33034    |
| 7693569 | VKPC 82620    | 7782192    | VKM 12215      | 9609016880 | VKM 33028    |
| 7693966 | VKPA 82210    | 7783006    | VKPC 82647     | 9614284080 | VKMM 6PK698  |
| 7693966 | VKPC 82210    | 7783009    | VKPC 82622     | 9615207880 | VKMM 6PK1660 |
| 7694229 | VKPC 82622    | 7784613    | VKM 32011      | 9615208280 | VKMM 6PK1067 |
| 7694408 | VKPC 82618    | 7784976    | VKPC 82431     | 9615208480 | VKMM 6PK1076 |
| 7694426 | VKPC 82618    | 7784977    | VKPC 82245     | 9615208980 | VKMM 6PK1094 |
| 7695557 | VKPC 82622    | 7784978    | VKPA 82222     | 9615923380 | VKM 23241    |
| 7695559 | VKPC 82629    | 7784978    | VKPC 82206     | 9616660580 | VKM 23900    |
| 7695968 | VKMM 5PK1042  | 7784979    | VKPA 82431     | 9616660780 | VKM 23901    |
| 7696083 | VKPA 82440    | 7784982    | VKPA 82431     | 9617188680 | VKM 13241    |
| 7701137 | VKPC 82647    | 7784987    | VKPC 82450     | 9618888580 | VKM 33013    |
| 7702173 | VKM 32009     | 7784988    | VKPC 82245     | 9620550980 | VKMM 6PK1603 |
| 7704978 | VKMM 4PK675   | 7788010    | VKM 32004      | 9620903880 | VKMM 6PK730  |
| 7706132 | VKMM 5PK970   | 7789752    | VKM 32005      | 9622234180 | VKM 33035    |
| 7708187 | VKPC 82660    | 7797142    | VKM 32242      | 9622521280 | VKMM 6PK1110 |
| 7715051 | VKPC 82429    | 7798722    | VKMM 6PK703    | 9622574480 | VKM 13202    |
| 7715242 | VKPC 82214    | 7893966    | VKPC 82210     | 9623001280 | VKM 33029    |
| 7718418 | VKMM 5PK1100  | 82360789   | VKM 12004      | 9623436980 | VKMM 6PK1155 |
| 7719917 | VKPA 82431    | 9153623080 | VKMM 5PK967    | 9623659880 | VKM 33311    |
| 7719919 | VKPA 82222    | 9400818199 | VKM 13250      | 9623684780 | VKMM 6PK1160 |

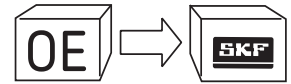
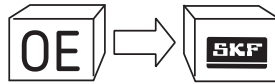
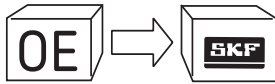

|            |              |         |               |         |              |
|------------|--------------|---------|---------------|---------|--------------|
| 9624233680 | VKMV 4PK755  | 1004484 | VKMV 6PK1181  | 1058458 | VKM 11014    |
| 9624233880 | VKMV 6PK1102 | 1004485 | VKMV 6PK1750  | 1058743 | VKPC 84415   |
| 9625621780 | VKM 33022    | 1004486 | VKMV 6PK1930  | 1059843 | VKPC 81611   |
| 9625621880 | VKM 33025    | 1004487 | VKMV 6PK1780  | 1061459 | VKM 34010    |
| 9626365280 | VKM 33028    | 1004549 | VKM 34033     | 1067944 | VKM 34018    |
| 9627667988 | VKPC 83420   | 1004961 | VKM 34005     | 1069144 | VKM 34047    |
| 9627860780 | VKM 33002    | 1004989 | VKMV 5PK886   | 1069359 | VKM 34108    |
| 9629110980 | VKPC 83425   | 1005120 | VKM 21012     | 1070102 | VKMV 6PK1767 |
| 9629471780 | VKM 33004    | 1005130 | VKMV 5PK1144  | 1072031 | VKM 14211    |
| 9631847480 | VKM 33045    | 1005516 | VKM 14105     | 1072131 | VKM 14222    |
| 9631962880 | VKM 33017    | 1005822 | VKM 14103     | 1072317 | VKMV 6PK1893 |
| 9633010080 | VKMV 6PK866  | 1005823 | VKM 24100     | 1072321 | VKM 34034    |
| 9633010480 | VKMV 6PK1042 | 1007714 | VKPC 84215    | 1073096 | VKM 34010    |
| 9633315180 | VKM 33024    | 1011688 | VKMV 6PK1810  | 1073485 | VKM 34108    |
| 9633315280 | VKM 33069    | 1011697 | VKMV 6PK915   | 1075546 | VKM 34018    |
| 9633478180 | VKMV 6PK1468 | 1013197 | VKMV 6PK2120  | 1077539 | VKPC 84215   |
| 9633802580 | VKM 33021    | 1013202 | VKMV 6PK2080  | 1077687 | VKM 34009    |
| 9634465780 | VKM 33033    | 1014374 | VKMV 6PK1719  | 1077689 | VKM 34008    |
| 9636207480 | VKM 33019    | 1015694 | VKMV 6PK1425  | 1079085 | VKPC 84416   |
| 9636640580 | VKM 33020    | 1017591 | VKMV 5PK886   | 1079155 | VKM 34108    |
| 9636782780 | VKM 33032    | 1017592 | VKMV 5PK1144  | 1079173 | VKM 14108    |
| 9637024080 | VKM 33031    | 1017593 | VKMV 5PK672   | 1079383 | VKMV 6PK1414 |
| 9638027080 | VKMV 6PK1585 | 1020538 | VKPC 84215    | 1079384 | VKMV 6PK1715 |
| 9638464180 | VKMV 6PK1736 | 1020567 | VKPC 84216    | 1079393 | VKM 34107    |
| 9638464380 | VKMV 6PK1750 | 1020988 | VKPC 84620    | 1084993 | VKMV 6PK1674 |
| 9641069580 | VKMV 6PK1188 | 1021706 | VKM 14107     | 1084994 | VKMV 6PK1920 |
| 9641198680 | VKMV 6PK1437 | 1023645 | VKPC 84620    | 1087286 | VKMV 5PK886  |
| 9641705880 | VKMV 6PK1706 | 1025656 | VKPC 84405    | 1088100 | VKM 34004    |
| 9642006780 | VKM 33042    | 1027404 | VKM 34046     | 1089679 | VKM 34005    |
| 9642184080 | VKM 13902    | 1028280 | VKMV 5PK705   | 1089795 | VKPC 84629   |
| 9642965780 | VKM 33069    | 1029417 | VKMV 11.5x790 | 1093816 | VKMV 5PK1144 |
| 9644759580 | VKM 33314    | 1031279 | VKPC 84409    | 1094596 | VKPC 84415   |
| 9644788580 | VKM 33314    | 1031369 | VKPC 81401    | 1094675 | VKMV 6PK1936 |
| 9644846680 | VKMV 6PK1740 | 1031879 | VKPC 81401    | 1095025 | VKM 24213    |
| 9647463180 | VKMV 6PK1468 | 1032940 | VKPC 82810    | 1096484 | VKM 34071    |
| 9652746580 | VKMV 6PK1468 | 1033499 | VKMV 6PK2040  | 1096556 | VKPA 84623   |
| 9653522380 | VKM 33033    | 1036188 | VKPA 81401    | 1097574 | VKM 34072    |
| 9653522780 | VKM 33032    | 1036916 | VKMV 6PK1936  | 1099552 | VKM 24107    |
| 9662806680 | VKMV 6PK1670 | 1036917 | VKMV 6PK1760  | 1099553 | VKM 14107    |
| 9664471589 | VKMV 6PK1388 | 1038384 | VKM 24212     | 1099922 | VKM 34071    |
| 98430541   | VKPA 82648   | 1039422 | VKM 14222     | 1099957 | VKM 34047    |
| 98435125   | VKPC 82638   | 1039797 | VKMV 10AVx730 | 1100566 | VKM 11144    |
| 98435994   | VKPC 82606   | 1039799 | VKMV 5PK1144  | 1100583 | VKM 11143    |
| 98455448   | VKMV 5PK890  | 1039800 | VKMV 6PK923   | 1100585 | VKM 21142    |
| 98459757   | VKPC 82606   | 1039808 | VKM 31030     | 1100635 | VKPC 81626   |
| 98459763   | VKPC 82600   | 1040677 | VKM 24107     | 1100693 | VKM 34018    |
| 98473452   | VKPC 82652   | 1040678 | VKM 14107     | 1102826 | VKMV 6PK1610 |
| 99432547   | VKM 22385    | 1040754 | VKMV 6PK1430  | 1102827 | VKMV 6PK1642 |
| 99440717   | VKPC 82652   | 1040760 | VKMV 6PK1575  | 1103598 | VKM 24100    |
| 99440930   | VKPC 82638   | 1041193 | VKMV 6PK1750  | 1104003 | VKM 14216    |
| 99459759   | VKPC 82643   | 1041194 | VKMV 6PK1930  | 1104087 | VKM 14222    |
|            |              | 1044510 | VKMV 5PK1144  | 1104115 | VKPC 84416   |
|            |              | 1044515 | VKM 34009     | 1106830 | VKM 31060    |
|            |              | 1049578 | VKMV 6PK1973  | 1107573 | VKM 14211    |
|            |              | 1049613 | VKMV 6PK2103  | 1108752 | VKMA 04103   |
|            |              | 1050417 | VKMV 6PK2120  | 1108756 | VKMA 04107   |
|            |              | 1051901 | VKM 31004     | 1108758 | VKMA 04107   |
|            |              | 1053054 | VKPC 84410    | 1108759 | VKMA 04212   |
|            |              | 1053055 | VKPC 84208    | 1110999 | VKMA 04106   |
|            |              | 1053684 | VKM 34005     | 1111911 | VKM 14222    |
|            |              | 1053879 | VKPC 84415    | 1111928 | VKMV 6DK1195 |
|            |              | 1053942 | VKM 24214     | 1112530 | VKMA 04212   |
|            |              | 1056697 | VKM 24107     | 1112807 | VKM 34034    |

## FORD

1 135 358  
1000159  
1001510  
1001889  
1002789  
1004409  
1004475  
1004481

VKMA 04304  
VKM 14211  
VKMV 3PK648  
VKPC 81611  
VKPC 81401  
VKM 14220  
VKM 34008  
VKM 34007

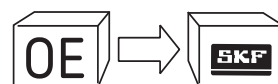
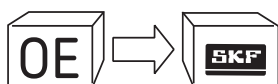
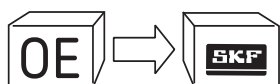

|         |              |         |              |         |              |
|---------|--------------|---------|--------------|---------|--------------|
| 1112954 | VKMV 6PK1936 | 1143871 | VKPC 82642   | 1310015 | VKPC 81303   |
| 1113174 | VKM 14108    | 1145493 | VKM 34107    | 1313167 | VKPC 84622   |
| 1113355 | VKM 14222    | 1145947 | VKM 13140    | 1313842 | VKPC 83259   |
| 1113611 | VKM 34108    | 1145955 | VKM 23140    | 1315781 | VKM 34014    |
| 1114044 | VKM 34018    | 1146965 | VKPA 84623   | 1316336 | VKMV 6PK1520 |
| 1116379 | VKM 34071    | 1147585 | VKPC 83140   | 1317021 | VKPC 84406   |
| 1116996 | VKPA 84621   | 1148358 | VKM 34012    | 1317038 | VKPC 84415   |
| 1117008 | VKM 34030    | 1148908 | VKMV 6PK1042 | 1317913 | VKPC 84620   |
| 1117009 | VKM 34031    | 1149503 | VKM 34111    | 1318336 | VKM 33320    |
| 1118677 | VKM 34107    | 1152359 | VKM 33044    | 1318354 | VKPC 84408   |
| 1119021 | VKM 11142    | 1152360 | VKM 33060    | 1320085 | VKPC 84411   |
| 1119023 | VKM 11145    | 1152890 | VKM 34018    | 1320086 | VKPC 84412   |
| 1119938 | VKM 34051    | 1198047 | VKPC 84416   | 1320286 | VKMV 6PK1674 |
| 1119954 | VKM 34071    | 1201178 | VKM 34030    | 1320289 | VKMV 6PK1920 |
| 1120198 | VKMV 6PK2227 | 1201181 | VKM 34032    | 1320446 | VKPC 84416   |
| 1120199 | VKMV 4PK735  | 1201255 | VKMA 04108   | 1326374 | VKPC 84215   |
| 1120687 | VKM 34025    | 1203767 | VKMA 04223   | 1328472 | VKM 14211    |
| 1122523 | VKM 31019    | 1206466 | VKMV 6PK1636 | 1329630 | VKM 33061    |
| 1124040 | VKMA 04108   | 1211185 | VKMA 03140   | 1333203 | VKM 34071    |
| 1124360 | VKPC 84608   | 1212732 | VKPA 81401   | 1336008 | VKPC 84622   |
| 1124362 | VKPC 84609   | 1213357 | VKPC 81611   | 1341835 | VKPA 84621   |
| 1124693 | VKPA 81401   | 1213852 | VKM 24213    | 1347102 | VKPA 84621   |
| 1125415 | VKMV 6PK1636 | 1214747 | VKM 33061    | 1348621 | VKPC 83140   |
| 1125419 | VKM 34032    | 1215978 | VKM 14108    | 1348648 | VKMA 03140   |
| 1126030 | VKPC 84600   | 1221490 | VKM 11250    | 1350461 | VKPC 84215   |
| 1126032 | VKPC 84601   | 1221491 | VKM 21147    | 1351130 | VKPC 83259   |
| 1126033 | VKPC 84601   | 1222855 | VKM 33060    | 1351134 | VKM 34108    |
| 1126035 | VKPC 84405   | 1222856 | VKM 33044    | 1352451 | VKM 34110    |
| 1126041 | VKPC 84208   | 1225896 | VKPC 81626   | 1355389 | VKM 33043    |
| 1126044 | VKPC 84403   | 1227543 | VKMV 6PK1045 | 1357587 | VKM 33061    |
| 1126046 | VKPC 84618   | 1227545 | VKMV 6PK1145 | 1359027 | VKPC 84622   |
| 1126048 | VKPC 84209   | 1227902 | VKPC 84415   | 1359934 | VKM 13140    |
| 1126049 | VKPC 84400   | 1229540 | VKM 33043    | 1359942 | VKPC 83140   |
| 1127103 | VKM 34052    | 1229548 | VKMV 6PK802  | 1361486 | VKPC 84622   |
| 1127235 | VKMV 6PK1687 | 1229549 | VKMV 6PK976  | 1361545 | VKM 34102    |
| 1127408 | VKMV 6PK1780 | 1229571 | VKPC 84629   | 1361840 | VKM 14222    |
| 1128896 | VKM 34031    | 1229768 | VKMA 03259   | 1361983 | VKM 14224    |
| 1129745 | VKMV 6PK1954 | 1231960 | VKMV 6PK1217 | 1364152 | VKPC 84622   |
| 1131255 | VKM 34025    | 1231975 | VKM 13257    | 1364681 | VKPC 83259   |
| 1131878 | VKPC 84416   | 1231978 | VKM 23257    | 1365338 | VKMV 6PK1042 |
| 1132355 | VKPC 84416   | 1231979 | VKMA 03257   | 1366614 | VKPC 83140   |
| 1132644 | VKM 34025    | 1232179 | VKPC 83259   | 1367254 | VKM 34110    |
| 1133958 | VKMV 6PK1418 | 1232499 | VKPC 83643   | 1370971 | VKMV 5PK847  |
| 1133960 | VKMV 6PK1715 | 1232500 | VKMV 6PK1306 | 1370974 | VKMV 5PK891  |
| 1133988 | VKM 34108    | 1233202 | VKPC 84410   | 1371224 | VKM 34052    |
| 1135627 | VKM 34051    | 1233204 | VKPC 84201   | 1371715 | VKM 16040    |
| 1135719 | VKMV 6PK1145 | 1233208 | VKPC 84403   | 1371753 | VKM 26602    |
| 1136183 | VKM 34111    | 1233209 | VKPC 84209   | 1372015 | VKMA 06040   |
| 1136393 | VKPA 84623   | 1233216 | VKPC 84601   | 1373306 | VKMA 03259   |
| 1136426 | VKMA 04305   | 1233217 | VKPC 84405   | 1374385 | VKM 34051    |
| 1137008 | VKMV 6PK1915 | 1233218 | VKPC 84618   | 1374425 | VKM 36236    |
| 1138318 | VKPC 84415   | 1233219 | VKPC 84617   | 1374427 | VKM 36238    |
| 1139951 | VKM 34034    | 1250685 | VKPC 81418   | 1376164 | VKM 14224    |
| 1141314 | VKMV 6PK1341 | 1251661 | VKM 34014    | 1376631 | VKM 31019    |
| 1141315 | VKMV 6PK1705 | 1253584 | VKMV 6PK1042 | 1376752 | VKMV 7PK2842 |
| 1141483 | VKPC 84416   | 1253937 | VKMV 6PK1217 | 1381645 | VKMV 6PK1688 |
| 1141999 | VKM 33060    | 1301973 | VKM 14222    | 1383663 | VKMV 6PK1670 |
| 1142000 | VKM 33044    | 1303612 | VKMV 3PK675  | 1385827 | VKPA 84623   |
| 1142005 | VKPC 84622   | 1303613 | VKMV 5PK1025 | 1387692 | VKMV 6PK2222 |
| 1142427 | VKPC 84622   | 1303929 | VKMV 6PK2196 | 1388493 | VKM 16040    |
| 1142688 | VKMV 6PK1042 | 1306666 | VKM 34052    | 1416245 | VKMV 6PK2198 |
| 1143406 | VKM 33061    | 1308227 | VKM 34102    | 1417825 | VKPA 84621   |
| 1143851 | VKPA 84621   | 1308453 | VKPA 84623   | 1418182 | VKMV 6PK1688 |

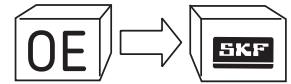
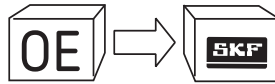
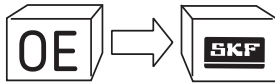

|                |               |                |                |               |               |
|----------------|---------------|----------------|----------------|---------------|---------------|
| 1421340        | VKVM 5PK1094  | 2S61 6A228 AE  | VKM 33061      | 4M5Q 6A228 BB | VKM 33043     |
| 1421435        | VKVM 5PK628   | 2S61 6A228 AF  | VKM 33061      | 4M5Q 6A228 ED | VKM 34110     |
| 1432630        | VKPC 83643    | 2S61 6C301 CA  | VKVM 6PK1341   | 4M5Q 6A228 FD | VKM 33320     |
| 1434283        | VKVM 6PK1670  | 2S61 6C301 DA  | VKVM 6PK1705   | 4M5Q 6C301 CA | VKVM 6PK802   |
| 1434347        | VKPC 84622    | 2S6G 6C301 JA  | VKVM 6PK1688   | 4M5Q 6C301 DA | VKVM 6PK976   |
| 1438244        | VKVM 6PK1217  | 2S6G 8591 AA   | VKPC 84629     | 4M5Q 6C301 EA | VKVM 6PK1217  |
| 1440434        | VKVM 7PK2842  | 2S6G 6B217 AA  | VKM 13140      | 4M5Q 6C301 EB | VKVM 6PK1217  |
| 1446648        | VKMA 03259    | 2S6Q 6B217 AB  | VKM 13140      | 4M5Q 6C301 EC | VKVM 6PK1217  |
| 1453619        | VKVM 5PK1094  | 2S6Q 6B217 AC  | VKM 13140      | 4M5Q 6C301 GB | VKVM 6PK1520  |
| 1473365        | VKM 13140     | 2S6Q 6B217 AD  | VKM 13140      | 5004972       | VKPC 84600    |
| 1473383        | VKM 34102     | 2S6Q 6M250 AA  | VKM 23140      | 5004976       | VKPC 83616    |
| 1473384        | VKM 34108     | 2S6Q 8591 AA   | VKPC 83140     | 5004977       | VKPC 83616    |
| 1477444        | VKPA 84621    | 2S6Q 8591 AB   | VKPC 83140     | 5004978       | VKPC 84600    |
| 1479084        | VKM 14108     | 2S6Q 8591 AC   | VKPC 83140     | 5004988       | VKPC 84603    |
| 1481774        | VKM 13140     | 2S6Q 8591 BA   | VKPC 83140     | 5004997       | VKPC 84601    |
| 1496915        | VKM 14000     | 2S6Q 8A615 AA  | VKMA 03140     | 5005036       | VKPC 84400    |
| 1500004        | VKM 14300     | 2S6Q 8A615 AB  | VKMA 03140     | 5005054       | VKPC 84201    |
| 1564718        | VKPC 84201    | 2S7E 6A228 AA  | VKM 34025      | 5005058       | VKPC 84600    |
| 1629019        | VKVM 10AVx838 | 2S7E 8620 AA   | VKVM 6PK2080   | 5005197       | VKPC 84205    |
| 1649176        | VKM 14204     | 2T1Q 19A216 AA | VKM 34102      | 5005916       | VKPC 84616    |
| 1649177        | VKPC 84610    | 2T1Q 19A216 BA | VKM 34102      | 5006043       | VKPC 84601    |
| 1650770        | VKVM 6PK1810  | 2T1Q 19A216 BB | VKM 34102      | 5007851       | VKPC 84608    |
| 1651816        | VKPC 84411    | 2T1Q 6K254 AA  | VKM 14108      | 5007852       | VKPC 84607    |
| 1657600        | VKPC 84610    | 2T1Q 6K254 AB  | VKM 14108      | 5008470       | VKPC 84207    |
| 1669904        | VKM 11014     | 2T1Q 6M260 AA  | VKMA 04108     | 5009286       | VKPC 84601    |
| 1669984        | VKM 31060     | 2U1Q 8K500 AA  | VKPA 84623     | 5009287       | VKPC 84601    |
| 1C1Q 6C301 BA  | VKVM 6PK1780  | 2U1Q 8K500 AB  | VKPA 84623     | 5009823       | VKPC 83423    |
| 1C1Q 6C301 DA  | VKVM 6PK1636  | 3023801        | VKVM 6PK2080   | 5010794       | VKPC 84403    |
| 1C1Q 6M260 AA  | VKMA 04305    | 3382081        | VKPC 94603     | 5010875       | VKPC 84600    |
| 1M21 8501 BA   | VKPA 81401    | 3395997        | VKM 74000      | 5010876       | VKPC 84600    |
| 1N3J 6268 AA   | VKMA 04223    | 3396015        | VKM 84001      | 5010877       | VKPC 84601    |
| 1S4Q 6A228 AD  | VKM 34108     | 3396016        | VKM 84002      | 5010878       | VKPC 84601    |
| 1S4Q 6A228 AE  | VKM 34108     | 3396916        | VKPC 94603     | 5010879       | VKPC 84600    |
| 1S4Q 6A228 AF  | VKM 34108     | 3590347        | VKM 74604      | 5010880       | VKPC 84600    |
| 1S4Q 6C301 AA  | VKVM 6PK1418  | 3601380        | VKVM 13AVx1000 | 5011012       | VKPC 84617    |
| 1S4Q 6C301 BA  | VKVM 6PK1715  | 3815689        | VKVM 13AVx1000 | 5011013       | VKPC 84403    |
| 1S7G 8501 AL   | VKPC 84622    | 3864995        | VKM 84001      | 5011846       | VKPC 84609    |
| 1S7G 8501 AM   | VKPC 84622    | 3894197        | VKM 74000      | 5011863       | VKPC 84601    |
| 1S7G 8501 AN   | VKPC 84622    | 3935008        | VKVM 6PK2080   | 5011864       | VKPC 84600    |
| 1S7G 8501 AP   | VKPC 84622    | 3973814        | VKVM 5PK1010   | 5012322       | VKPC 84403    |
| 1S7G 8501 AR   | VKPC 84622    | 3994039        | VKM 74000      | 5012359       | VKPC 84601    |
| 1S7G 8501 BA   | VKPC 84622    | 3M21 6C301 AA  | VKVM 6PK1045   | 5012434       | VKPC 84405    |
| 1S7G 8501 BB   | VKPC 84622    | 3M21 8501 AA   | VKPC 81418     | 5012773       | VKPC 84618    |
| 1S7G 8591 AA   | VKPC 84622    | 3M5Q 6A228 AD  | VKM 34014      | 5013267       | VKPC 84600    |
| 1S7Q 19A216 AB | VKM 34051     | 3M5Q 6B217 AA  | VKM 13257      | 5013268       | VKPC 84601    |
| 1S7Q 19A216 AC | VKM 34051     | 3M5Q 6C301 AA  | VKVM 6PK1306   | 5013274       | VKPC 84601    |
| 1S7Q 19A216 AD | VKM 34051     | 3M5Q 6M250 AA  | VKM 23257      | 5013320       | VKPC 84208    |
| 1S7Q 6A228 AC  | VKM 34052     | 3M5Q 8591 AA   | VKPC 83643     | 5013520       | VKVM 10AVx813 |
| 1S7Q 6A228 AD  | VKM 34052     | 3M5Q 8591 BB   | VKPC 83259     | 5014269       | VKPC 84601    |
| 1S7Q 6A228 AE  | VKM 34052     | 3M5Q 8591 BC   | VKPC 83259     | 5014270       | VKPC 84600    |
| 1S7Q 6C301 AA  | VKVM 6PK2227  | 3M5Q 8591 CA   | VKPC 83259     | 5017721       | VKVM 5PK870   |
| 1S7Q 6C301 AB  | VKVM 6PK2222  | 3M5Q 8591 DA   | VKPC 83643     | 5018437       | VKPC 84207    |
| 1S7Q 6C301 CA  | VKVM 6PK1642  | 3M5Q 8A615 AA  | VKMA 03259     | 5018852       | VKPC 84207    |
| 2C1Q 6C301 AA  | VKVM 6PK1636  | 3M5Q 8A615 AB  | VKMA 03259     | 5019394       | VKPC 83604    |
| 2M21 6K254 AA  | VKM 11250     | 3M5Q 8A615 BA  | VKMA 03257     | 5020121       | VKPC 84610    |
| 2M21 6K297 AA  | VKM 21147     | 3M5Q 8A615 CA  | VKMA 03259     | 5020242       | VKPC 84620    |
| 2M2E 6A228 AA  | VKM 34012     | 4335876        | VKMA 03257     | 5020424       | VKPC 84603    |
| 2S61 19A216 AB | VKM 33060     | 4370488        | VKVM 6PK2080   | 5020437       | VKPC 84209    |
| 2S61 19A216 BB | VKM 33044     | 4513849        | VKPC 94603     | 5020651       | VKPC 84208    |
| 2S61 19A216 CA | VKM 33044     | 4600280        | VKVM 3PK649    | 5020713       | VKPC 84410    |
| 2S61 19A216 DA | VKM 33060     | 4M5G 6K254 DA  | VKVM 6PK2080   | 5020717       | VKPC 84201    |
| 2S61 6A228 AC  | VKM 33061     | 4M5G 6K254 DB  | VKM 14222      | 5020823       | VKPC 84616    |
| 2S61 6A228 AD  | VKM 33061     | 4M5Q 6A228 BA  | VKM 33043      | 5020880       | VKPC 84601    |





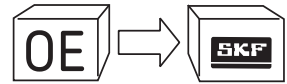
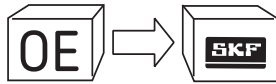
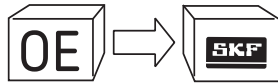

|               |               |                |               |                |               |
|---------------|---------------|----------------|---------------|----------------|---------------|
| 5023817       | VKPC 84403    | 6744307        | VKM 24211     | 88FX 8591 B2B  | VKPC 84410    |
| 5024297       | VKPC 84409    | 6776020        | VKMV 5PK882   | 88FX 8591 BA   | VKPC 84410    |
| 5024545       | VKPC 84618    | 6788620        | VKMV 6PK1800  | 88GX 8591 AA   | VKPC 83604    |
| 5024546       | VKPC 84617    | 6789631        | VKM 34040     | 88SX 8591 A1B  | VKPC 84208    |
| 5024603       | VKPC 84205    | 6792801        | VKMV 10AVx800 | 88SX 8591 AA   | VKPC 84208    |
| 5024638       | VKPC 83423    | 6811351        | VKMV 6PK2080  | 88WF 6A228 AC  | VKM 34040     |
| 5024901       | VKPC 84405    | 6842244        | VKMV 5PK870   | 88WF 6C301 B2A | VKMV 6PK1810  |
| 5024972       | VKPC 84601    | 6844096        | VKMV 6PK1650  | 88WF 6C301 G2A | VKMV 6PK1800  |
| 5025607       | VKPC 84406    | 6878045        | VKPC 84407    | 88YX 8591 AA   | VKPC 84610    |
| 5025832       | VKPC 84608    | 6911750        | VKM 34047     | 89EX 8591 AA   | VKPC 83423    |
| 5025908       | VKPC 84209    | 6935235        | VKM 34042     | 89FF 6C301 E2B | VKMV 3PK814   |
| 5026076       | VKPC 84609    | 6935236        | VKM 34043     | 89FF 6K254 AC  | VKM 14100     |
| 5026492       | VKPC 84400    | 6961947        | VKMV 6PK1650  | 89FF 6K254 AD  | VKM 14100     |
| 5026783       | VKPC 84209    | 6977403        | VKM 34047     | 89FF 6K254 CB  | VKM 24104     |
| 5028472       | VKPC 84408    | 6988203        | VKM 14103     | 89FX 8591 A1B  | VKPC 84403    |
| 5L8 8K543 AA  | VKMV 3PK649   | 6C1Q 6C301 CB  | VKMV 6PK1670  | 8AK2 15 010    | VKPC 94603    |
| 5M5G 6K254 AB | VKM 14224     | 6C1Q 6C301 CC  | VKMV 6PK1670  | 914FX 8591 A2B | VKPC 84618    |
| 6050034       | VKPC 84205    | 6C1Q 6C301-HB  | VKMV 7PK2842  | 914FX 8591 AA  | VKPC 84618    |
| 6050907       | VKPC 84205    | 6C1Q 6C301-HC  | VKMV 7PK2842  | 914FX 8591 B2B | VKPC 84617    |
| 6077865       | VKMV 10AVx813 | 6G9N 10C318 BA | VKMV 5PK1094  | 914FX 8591 BA  | VKPC 84617    |
| 6089286       | VKM 14200     | 6G9N 10C318 BB | VKMV 5PK628   | 91FX 8591 AA   | VKPC 84409    |
| 6104232       | VKMV 10AVx825 | 6G9N 19D621 AA | VKM 16040     | 91SF 19A216 AA | VKM 34013     |
| 6121753       | VKM 14301     | 6G9N 6K254 BA  | VKMV 6PK2198  | 91SF 19A216 AB | VKM 34013     |
| 6121754       | VKM 14301     | 6G9Q 6C301 CA  | VKMV 6PK1688  | 91SF 6C301 B2C | VKMV 6PK1425  |
| 6121780       | VKM 11200     | 6G9Q 6C301 DB  | VKM 16040     | 91WM 8501 AB   | VKPC 84411    |
| 6121780       | VKM 14101     | 6M5G 6K254 AA  | VKM 26602     | 91WM 8591 AA   | VKPC 84411    |
| 6129349       | VKPC 84205    | 6M5G 6M250 AA  | VKM 36236     | 91XM 8501 AA   | VKPC 84412    |
| 6131141       | VKM 14201     | 6M5Q 6A228 AA  | VKM 36238     | 928F 19A216 AA | VKM 34061     |
| 6135823       | VKPC 84601    | 6M5Q 6A228 BA  | VKMV 5PK847   | 928F 6A228 AB  | VKM 34056     |
| 6135824       | VKPC 84600    | 6M5Q 6C301 AA  | VKMV 5PK891   | 928M6K254 AC   | VKM 14210     |
| 6145027       | VKM 14200     | 6M5Q 6C301 BA  | VKMV 4PK860   | 928M6M250 BC   | VKM 24210     |
| 6145028       | VKM 14201     | 7007791        | VKMV 4PK825   | 928M6M250 DC   | VKM 24211     |
| 6158518       | VKMV 11.9x758 | 7040340        | VKM 34004     | 928X 8591 AA   | VKPC 84406    |
| 6158874       | VKPC 84601    | 7044044        | VKM 34013     | 92BX 8591 AA   | VKPC 84210    |
| 6158875       | VKPC 84600    | 7053546        | VKM 24100     | 92BX 8591 C1B  | VKPC 84209    |
| 6168156       | VKM 34040     | 7053802        | VKM 34046     | 92BX 8591 C2B  | VKPC 84209    |
| 6168158       | VKMV 6PK1810  | 7064724        | VKPC 82642    | 92FB 6C301 AA  | VKMV 10AVx800 |
| 6170166       | VKMV 3PK828   | 7072641        | VKM 32017     | 92FJ 6C301 A2A | VKMV 3PK675   |
| 6174657       | VKPC 84405    | 7072698        | VKPC 84411    | 92TX 8591 B2B  | VKPC 84608    |
| 6177882       | VKM 14103     | 7087382        | VKPC 84412    | 92TX 8591 D2B  | VKPC 84609    |
| 6177883       | VKM 24104     | 7087383        | VKM 34034     | 938M 8501 AJ   | VKPC 84407    |
| 6182891       | VKM 14201     | 7109163        | VKMV 6PK1430  | 938M 8591 AA   | VKPC 84407    |
| 6185100       | VKMV 3PK1023  | 7120854        | VKM 34048     | 93BB 19A216 AD | VKM 34048     |
| 6189520       | VKPC 84412    | 7158445        | VKMV 4PK654   | 93BB 19A216 BF | VKM 34042     |
| 6196578       | VKMV 10AVx813 | 7158659        | VKMV 6PK1145  | 93BB 19A216 CE | VKM 34043     |
| 6200285       | VKM 34061     | 7198530        | VKMV 6PK1045  | 93BB 6A228 AE  | VKM 34047     |
| 6457409       | VKPC 84411    | 7198532        | VKMV 7DK1360  | 93BB 6A228 AF  | VKM 34047     |
| 6482249       | VKM 34013     | 7198536        | VKM 34012     | 93BB 6A228 AG  | VKM 34047     |
| 6497120       | VKM 14100     | 7239509        | VKMV 6PK1575  | 93BB 6C301 AB  | VKMV 6PK1719  |
| 6501088       | VKM 34040     | 7239510        | VKMV 6PK1920  | 93BB 6C301 BE  | VKMV 6PK2080  |
| 6577227       | VKM 34056     | 7287675        | VKMV 6PK1755  | 93BB 6C301 CD  | VKMV 5PK870   |
| 6616951       | VKM 34002     | 7310608        | VKM 14100     | 93BB 6C301 EC  | VKMV 5PK882   |
| 6616952       | VKM 34003     | 7330712        | VKM 34012     | 93FF 6K254 BA  | VKM 14103     |
| 6635941       | VKM 14210     | 7392480        | VKM 21012     | 93FX 8591 A1B  | VKPC 84408    |
| 6635942       | VKM 24210     | 7400530        | VKM 11200     | 93FX 8591 AA   | VKPC 84408    |
| 6680459       | VKMV 3PK648   | 84FM 6K254 AB  | VKM 14101     | 94FF 19A216 AB | VKM 34004     |
| 6680460       | VKMV 3PK814   | 84FM 6K254 AB  | VKM 14200     | 94FF 19A216 AC | VKM 34004     |
| 6683522       | VKPC 84210    | 84SM 6K254 AA  | VKM 14201     | 94FF 6C301 AC  | VKMV 4PK654   |
| 6710259       | VKM 34056     | 84SM 6K254 CA  | VKPC 84207    | 95BB 6C301 AA  | VKMV 6PK2120  |
| 6727879       | VKMV 6PK1719  | 870X 8591 AA   | VKPC 84620    | 95VW 10145 DA  | VKM 31030     |
| 6727880       | VKMV 6PK2080  | 88FX 8591 A1C  | VKPC 84620    | 95VW 3F572 CA  | VKMV 10AVx730 |
| 6727881       | VKMV 5PK870   | 88FX 8591 AB   | VKPC 84410    | 95VW 3F572 EA  | VKMV 11.5x790 |
| 6727884       | VKM 34048     | 88FX 8591 B1A  |               | 95VW 6A228 AB  | VKM 31060     |

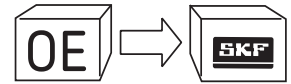
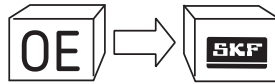
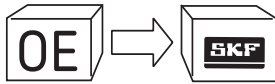

95VW 6A228 EA  
 95VW 6C301 AA  
 95VW 6C301 AC  
 95VW 6C301 CA  
 95VW 6C301 KA  
 95VW 6K254 CA  
 95VW 6K254 DA  
 95VW 8503 AA  
 95VW 8591 AA  
 95WF 19A216 AC  
 95WF 19A216 AD  
 95WF 6A228 AB  
 95WF 6A228 BB  
 95WF 6C301 CB  
 95WF 6C301 EB  
 95WF 6C301 GA  
 95XM 8501 AA  
 95XM 8591 AA  
 96BF 6A228 AB  
 96BX 8591 AA  
 96FF 19A216 AE  
 96FF 19A216 AF  
 96FF 6C301 AE  
 96FF 6C301 AF  
 96FF 6C301 CD  
 96FF 6C301 GA  
 96FF 6K254 AA  
 96FF 6K254 BA  
 96FF6K254 DA  
 96FF6K254 DB  
 96FX 8591 AA  
 96FX 8591 EA  
 96MF 6C301 AC  
 96MF 6C301 BC  
 96MF 6C301 CC  
 96MF 6C301 DB  
 96MF6A228 AD  
 96MF6A228 BD  
 96MX 8591 AA  
 96WF 6A228 AA  
 96WF 6C301 AB  
 978M 6K254 AD  
 978M 6M250 AA  
 978M 6M250 BB  
 97BB 6A228 AG  
 97FF 6C301 AC  
 97FF 6C301 AD  
 97FF 6K254 CB  
 97FF 6K254 CC  
 97FF 6K254 DA  
 97FF 6K254 DB  
 97FF 6K254 DC  
 97FF 6K254 DD  
 97FJ 6C301 AD  
 97KB 6C301 DA  
 97WF 6C301 AA  
 97WF 6C301 BA  
 988M 6K254 AB  
 988M 6K254 AC  
 988M 6K254 AD  
 988M 6K254 AE  
 988X 8591 F1B  
 988X 8591 F1D

**VKM 31060**  
**VKMV 6PK1145**  
**VKMV 6PK1145**  
**VKMV 6PK1045**  
**VKMV 7DK1360**  
**VKM 11014**  
**VKM 11014**  
**VKPC 81401**  
**VKPC 81611**  
**VKM 34034**  
**VKM 34034**  
**VKM 34046**  
**VKM 34012**  
**VKMV 6PK1430**  
**VKMV 6PK1575**  
**VKMV 6PK1755**  
**VKPC 84412**  
**VKPC 84412**  
**VKM 34033**  
**VKPC 84216**  
**VKM 34005**  
**VKM 34005**  
**VKMV 5PK886**  
**VKMV 5PK886**  
**VKMV 5PK672**  
**VKMV 5PK705**  
**VKM 14105**  
**VKM 14103**  
**VKM 24100**  
**VKM 24100**  
**VKPC 84620**  
**VKPC 84409**  
**VKMV 6PK1181**  
**VKMV 6PK1750**  
**VKMV 6PK1930**  
**VKMV 6PK1780**  
**VKM 34008**  
**VKM 34007**  
**VKPC 84215**  
**VKM 34046**  
**VKMV 6PK2040**  
**VKM 14216**  
**VKM 24212**  
**VKM 24214**  
**VKM 34010**  
**VKMV 5PK1144**  
**VKMV 5PK1144**  
**VKM 14107**  
**VKM 14107**  
**VKM 24107**  
**VKM 24107**  
**VKM 24107**  
**VKM 24107**  
**VKMV 5PK1025**  
**VKMV 6PK1936**  
**VKMV 6PK1430**  
**VKMV 6PK1575**  
**VKM 14211**  
**VKM 14211**  
**VKM 14211**  
**VKM 14211**  
**VKPC 84415**  
**VKPC 84415**

988X 8591 FA  
 988X 8591 FC  
 98BB 6C301 AA  
 98BB 6C301 BA  
 98BB 6C301 CA  
 98FF 19A216 BB  
 98FF 19A216 BC  
 98FF 19A216 BD  
 98FF 3K738 BG  
 98FF 3K738 BH  
 98FF 6C301 CD  
 98FF 6C301 DD  
 98MF 3C631 CD  
 98MF 3C631 CE  
 98MF 3C631 CF  
 98MF 6C301 CC  
 98MF 6C301 DA  
 98MM 6K254 AC  
 98MM 6K254 AD  
 98MM 6K254 BC  
 98MM 6K254 BD  
 98MM 8501 BC  
 98VW 6A359 CA  
 A790X 8591 HA  
 A790X 8591 KA  
 A830X 8591 CUA  
 A830X 8591 DAA  
 A840X 8591 AUA  
 A840X 8591 B1BB  
 A840X 8591 K1B  
 A840X 8591 K2B  
 A840X 8591 KA  
 A840X 8591 M1A  
 A840X 8591 M1B  
 A840X 8591 M2B  
 F32Z-8501A  
 F7PE 8620 BB  
 KL01 12 730A  
 KL01 12 740  
 KL02 12 750  
 KL47 15 010C  
 KLY2 12 SJ0  
 RM3M21 8501 BA  
 RM95VW 8591 AA  
 RMXM21 8501 AA  
 V94BF 6C301 AB  
 V94BF 6C301 BA  
 V94DD 8501 AA  
 V97MF 6C301 AA  
 V97MF 6C301 BA  
 V97MF6A228 AB  
 VX028 109244 VX  
 VX028 145278 EVX  
 VX028 903 137 AMVX  
 XM21 6B260 AA  
 XM21 6K254 AA  
 XM21 6K297 AA  
 XM21 8501 AA  
 XM34 19D621 AB  
 XM34 6K254 AA  
 XS4J 8591 AC  
 XS4J 8591 DB

**VKPC 84415**  
**VKPC 84415**  
**VKMV 6PK1973**  
**VKMV 6PK2103**  
**VKMV 6PK2120**  
**VKM 34107**  
**VKM 34107**  
**VKM 34107**  
**VKM 34108**  
**VKM 34108**  
**VKMV 6PK1414**  
**VKMV 6PK1715**  
**VKM 34018**  
**VKM 34018**  
**VKM 34018**  
**VKM 34018**  
**VKMV 6PK1893**  
**VKMV 6PK1915**  
**VKM 14222**  
**VKM 14222**  
**VKM 14222**  
**VKM 14222**  
**VKPC 84215**  
**VKMV 6DK1195**  
**VKPC 83616**  
**VKPC 83616**  
**VKPC 84601**  
**VKPC 84600**  
**VKPC 84600**  
**VKPC 84601**  
**VKPC 84601**  
**VKPC 84601**  
**VKPC 84601**  
**VKPC 84405**  
**VKPC 84405**  
**VKPC 84405**  
**VKPC 84405**  
**VKPC 94602**  
**VKMV 6PK2080**  
**VKM 84001**  
**VKM 84002**  
**VKM 74000**  
**VKPC 94603**  
**VKM 74000**  
**VKPC 81303**  
**VKPC 81611**  
**VKPC 81626**  
**VKMV 4PK825**  
**VKMV 4PK860**  
**VKPC 82642**  
**VKMV 6PK1750**  
**VKMV 6PK1930**  
**VKM 34009**  
**VKM 21012**  
**VKM 31004**  
**VKMV 6PK923**  
**VKM 11144**  
**VKM 11143**  
**VKM 21142**  
**VKPC 81626**  
**VKMV 13AVx1000**  
**VKM 74604**  
**VKPC 84416**  
**VKPC 84416**

XS4Q 6B217 AD  
 XS6E 6C301 JA  
 XS6E 6C301 JB  
 XS6E 8501 AD  
 XS7E 19A216 AC  
 XS7E 19A216 AD  
 XS7E 19A216 BC  
 XS7E 6A228 BC  
 XS7E 6A228 CB  
 XS7E 6A228 CC  
 XS7E 6C301 CC  
 XS7G 6M250 AA  
 XS7G 6M250 BA  
 XS7Q 8K500 AE  
 XS7Q 8K500 AH  
 XS7Q 8K500 AJ  
 XS7Q 8K500 AK  
 YC1E 6A228 AF  
 YC1E 6A228 AG  
 YC1E 9444 AD  
 YC1Q 8K500 AD  
 YC1Q 8K500 AF  
 YM21 6B260 AA  
 YM21 6K254 AA  
 YM21 6K254 CA  
 YM21 6K254 EA  
 YS4E 19A216 AA  
 YS4J 6K288 AA  
 YS4J 6K288 BA  
 YS4J 6K288 CA  
 YS4J 6K288 DA  
 YS4Q 6M260 AA  
 YS6E 19A216 AA  
 YS6E 19A216 AB  
 YS6E 6C301 AB  
 YS6E 6C301 BB  
 YS6G 8591 A1C  
 YS6G 8591 A2C  
 YS7J 6268 AB

**VKM 14108**  
**VKMV 6PK1936**  
**VKMV 6PK1936**  
**VKPC 84629**  
**VKM 34030**  
**VKM 34030**  
**VKM 34031**  
**VKM 34025**  
**VKM 34032**  
**VKM 34032**  
**VKMV 4PK735**  
**VKM 24213**  
**VKM 24213**  
**VKPA 84621**  
**VKPA 84621**  
**VKPA 84621**  
**VKPA 84621**  
**VKM 34071**  
**VKM 34071**  
**VKM 34072**  
**VKPA 84623**  
**VKPA 84623**  
**VKM 11145**  
**VKM 31019**  
**VKM 11142**  
**VKM 31019**  
**VKM 34034**  
**VKMA 04103**  
**VKMA 04106**  
**VKMA 04107**  
**VKMA 04107**  
**VKMA 04108**  
**VKM 34111**  
**VKM 34111**  
**VKMV 6PK1610**  
**VKMV 6PK1687**  
**VKPC 84215**  
**VKPC 84215**  
**VKMA 04212**

**HONDA**

13404-P13-003  
 13404-PT0-003  
 13404-PT0-004  
 14325-P5T-G00  
 14510-P08-003  
 14510-P08-004  
 14510-P13-003  
 14510-P2A-004  
 14510-P2A-J01  
 14510-P30-003  
 14510-P5T-G00  
 14510-P8A-A01  
 14510-PC6-013  
 14510-PD2-003  
 14510-PD2-004  
 14510-PE0-003  
 14510-PE0-005  
 14510-PG6-013  
 14510-PGE-A01  
 14510-PH1-003

**VKM 73007**  
**VKM 73011**  
**VKM 73011**  
**VKM 17304**  
**VKM 73005**  
**VKM 73005**  
**VKM 73006**  
**VKM 73005**  
**VKM 73005**  
**VKM 73005**  
**VKM 73201**  
**VKM 17302**  
**VKM 73605**  
**VKM 73200**  
**VKM 73200**  
**VKM 73200**  
**VKM 73101**  
**VKM 73101**  
**VKM 73003**  
**VKM 73605**  
**VKM 73200**





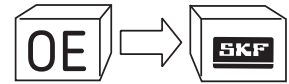
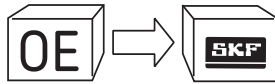
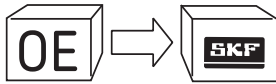

|                |            |               |              |             |            |
|----------------|------------|---------------|--------------|-------------|------------|
| 14510-PH1-004  | VKM 73200  | 19200-PR3-003 | VKPC 93601   | 24450-33020 | VKM 75144  |
| 14510-PH3-003  | VKM 73002  | 19200-PT2-003 | VKPC 93601   | 24450-37100 | VKM 85148  |
| 14510-PH3-004  | VKM 73002  | 19200-PTO-003 | VKPC 93601   | 24450-37120 | VKM 85148  |
| 14510-PH7-003  | VKM 73001  | 19200-PTO-013 | VKPC 93601   | 24450-38010 | VKM 75633  |
| 14510-PH7-004  | VKM 73001  | 19200-PWA-003 | VKPC 93603   | 24450-38011 | VKM 75633  |
| 14510-PK1-004  | VKM 73002  | 19210-PH3-305 | VKPC 93600   | 24810-23011 | VKM 85147  |
| 14510-PK1-014  | VKM 73002  | 31110-P3F-004 | VKMV 4PK820  | 24810-23400 | VKM 85147  |
| 14510-PM7-003  | VKM 73000  | 31110-P5K-003 | VKMV 6PK950  | 24810-23500 | VKM 85147  |
| 14510-PM7-004  | VKM 73000  | 31110-P5K-004 | VKMV 6PK950  | 24810-26010 | VKM 85145  |
| 14510-PR3-003  | VKM 73201  | 31110-PWA-G01 | VKMV 5PK850  | 24810-26020 | VKM 85145  |
| 14510-PR3-004  | VKM 73201  | 31170-PNA-013 | VKM 63004    | 24810-27000 | VKM 85146  |
| 14510-PT0-003  | VKM 73600  | 31170-PNA-023 | VKM 63004    | 24810-27250 | VKM 85146  |
| 14510-PT0-004  | VKM 73600  | 38920-P2A-003 | VKMV 4PK820  | 24810-2X700 | VKM 84201  |
| 14510-PY3-003  | VKM 73004  | 38920-PDA-E03 | VKMV 6PK1105 | 24810-33021 | VKM 85000  |
| 14510-PY3-0031 | VKM 73004  | 38942-P01-003 | VKM 63001    | 24810-33024 | VKM 85000  |
| 14510-PY3-004  | VKM 73004  | 38942-PM3-000 | VKM 63000    | 24810-37100 | VKM 75630  |
| 14510-PY3-0041 | VKM 73004  | 38950-P2K-305 | VKM 63001    | 24810-37120 | VKM 75630  |
| 14520-P2A-305  | VKM 73005  | 56900-P5T-G05 | VKM 37005    | 24810-38001 | VKM 85000  |
| 14520-P2A-306  | VKM 73005  | 56992-P5T-G20 | VKMV 6PK1462 | 25100-02502 | VKPC 95007 |
| 14520-P5T-G00  | VKM 27302  | GWP 344       | VKPC 83420   | 25100-21000 | VKPC 95008 |
| 14520-PLC-305  | VKM 73607  |               |              | 25100-22010 | VKPC 95008 |
| 14520-PLC-325  | VKM 73607  |               |              | 25100-22012 | VKPC 95008 |
| 14520-PLC-335  | VKM 73607  |               |              | 25100-22650 | VKPC 95856 |
| 14550-P8A-A01  | VKM 83003  |               |              | 25100-23001 | VKPC 95859 |
| 14550-PGE-A01  | VKM 83003  |               |              | 25100-23002 | VKPC 95859 |
| 19200-P08-003  | VKPC 93411 | 23357-32000   | VKM 75008    | 25100-23003 | VKPC 95852 |
| 19200-P08-004  | VKPC 93411 | 23357-32020   | VKM 75008    | 25100-23010 | VKPC 95852 |
| 19200-P08-A01  | VKPC 93411 | 23357-32030   | VKM 75008    | 25100-23011 | VKPC 95852 |
| 19200-P0A-003  | VKPC 93601 | 23357-32040   | VKM 75008    | 25100-23510 | VKPC 95852 |
| 19200-P1G-E02  | VKPC 93213 | 23357-32050   | VKM 75008    | 25100-23511 | VKPC 95852 |
| 19200-P1J-E02  | VKPC 87404 | 23357-32120   | VKM 75044    | 25100-23513 | VKPC 95852 |
| 19200-P2A-004  | VKPC 93000 | 23357-33120   | VKM 75044    | 25100-23530 | VKPC 95852 |
| 19200-P2A-A01  | VKPC 93000 | 23357-33130   | VKM 75044    | 25100-24030 | VKPC 95008 |
| 19200-P2A-A02  | VKPC 93000 | 23357-33350   | VKM 75613    | 25100-24040 | VKPC 95008 |
| 19200-P30-003  | VKPC 93601 | 23357-38001   | VKM 75613    | 25100-24060 | VKPC 95008 |
| 19200-P5T-G00  | VKPC 87813 | 23357-42000   | VKM 75612    | 25100-24060 | VKPC 95857 |
| 19200-P72-013  | VKPC 93415 | 23357-42010   | VKM 75612    | 25100-26901 | VKPC 95857 |
| 19200-PA6-030  | VKPC 93405 | 23357-42020   | VKM 75612    | 25100-26902 | VKPC 95857 |
| 19200-PC1-000  | VKPC 93405 | 23357-42030   | VKM 75612    | 25100-27000 | VKPC 95853 |
| 19200-PC1-010  | VKPC 93405 | 24317-42000   | VKM 75601    | 25100-27900 | VKPC 95858 |
| 19200-PC1-030  | VKPC 93405 | 24317-42010   | VKM 75601    | 25100-32500 | VKPC 95611 |
| 19200-PC1-080  | VKPC 93405 | 24317-42020   | VKM 75601    | 25100-32501 | VKPC 95611 |
| 19200-PC1-405  | VKPC 93405 | 24410-02510   | VKM 75621    | 25100-32502 | VKPC 95611 |
| 19200-PE0-010  | VKPC 93205 | 24410-02550   | VKM 75621    | 25100-32510 | VKPC 95611 |
| 19200-PE0-415  | VKPC 93205 | 24410-21010   | VKM 75100    | 25100-32512 | VKPC 95611 |
| 19200-PE0-515  | VKPC 93205 | 24410-22000   | VKM 75006    | 25100-32515 | VKPC 95611 |
| 19200-PE0-660  | VKPC 93205 | 24410-22020   | VKM 75006    | 25100-32556 | VKPC 95423 |
| 19200-PH1-000  | VKPC 93410 | 24410-23011   | VKM 75629    | 25100-32566 | VKPC 95423 |
| 19200-PH1-505  | VKPC 93410 | 24410-23400   | VKM 75629    | 25100-32568 | VKPC 95423 |
| 19200-PH3-000  | VKPC 93600 | 24410-23500   | VKM 75629    | 25100-32569 | VKPC 95423 |
| 19200-PH3-505  | VKPC 93600 | 24410-26000   | VKM 75006    | 25100-32573 | VKPC 95423 |
| 19200-PH7-003  | VKPC 87610 | 24410-27000   | VKM 75628    | 25100-32590 | VKPC 95423 |
| 19200-PM3-003  | VKPC 87404 | 24410-2X000   | VKM 74200    | 25100-33001 | VKPC 95427 |
| 19200-PM3-004  | VKPC 87404 | 24410-32000   | VKM 75033    | 25100-33011 | VKPC 95427 |
| 19200-PM3-013  | VKPC 87404 | 24410-32010   | VKM 75033    | 25100-33012 | VKPC 95427 |
| 19200-PM3-014  | VKPC 87404 | 24410-32020   | VKM 75033    | 25100-33111 | VKPC 95424 |
| 19200-PNA-003  | VKPC 93604 | 24410-32553   | VKM 75130    | 25100-33112 | VKPC 95424 |
| 19200-P01-003  | VKPC 87404 | 24410-32554   | VKM 75130    | 25100-33120 | VKPC 95424 |
| 19200-P01-004  | VKPC 87404 | 24410-32555   | VKM 75130    | 25100-33122 | VKPC 95424 |
| 19200-P08-003  | VKPC 93411 | 24410-32560   | VKM 75130    | 25100-33130 | VKPC 95424 |
| 19200-P08-004  | VKPC 93411 | 24410-35010   | VKM 75004    | 25100-33132 | VKPC 95424 |
| 19200-P0B-A01  | VKPC 93601 | 24410-35020   | VKM 75004    | 25100-38002 | VKPC 95850 |
| 19200-P0G-A01  | VKPC 87610 | 24450-2Y000   | VKM 74502    | 25100-39010 | VKPA 95851 |
|                |            | 24450-33010   | VKM 75144    | 25100-39800 | VKPA 95003 |

### HYUNDAI

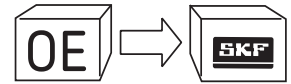
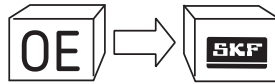
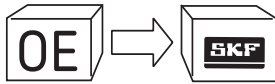

25100-4A000  
25100-4A100  
25111-29000

VKPC 95854  
VKPC 95854  
VKPC 83420

MD 030863  
MD 972052  
MD 997076  
MD 997417  
MD 997418

VKPC 95008  
VKPC 95424  
VKPC 95008  
VKPC 95424  
VKPC 95427

MD 997609  
MD 997615  
MD 997620  
MD 997621

VKPC 95008  
VKPC 95422  
VKPC 95427  
VKPC 95424

### ISUZU

5-12539-013-2  
8-94215-197-0  
8-94215-197-1  
8-94376-837-0  
8-94382-214-0

VKM 79003  
VKM 79001  
VKM 79001  
VKPC 98000  
VKM 79002

8-94382-214-1  
8-94382-215-0  
8-94382-215-1  
8-94433-820-0  
8-94433-821-0

VKM 79002  
VKM 89003  
VKM 89003  
VKM 89003  
VKM 79002

8-94472-349-0  
8-94472-349-1

VKM 79000  
VKM 79000

### IVECO

4714636  
4740847  
4754850  
4764761  
7303009  
7303050

VKPC 82630  
VKM 22380  
VKPC 82630  
VKPC 82630  
VKPC 82630  
VKPC 82606

### KIA

0FE1H-15-010H  
0FE3N-15-010E  
OK247-12-700  
OK551-12-700B  
OK551-12-730A  
OK551-12-740A  
OK88R-12-700  
OK88R-12-740  
OK88R-12-750  
OK930-15-010A

VKPC 94424  
VKPC 94425  
VKM 74502  
VKM 74608  
VKM 84504  
VKM 84503  
VKM 74609  
VKM 84503  
VKM 84506  
VKPC 94002

OK95K-12-750  
OK9BV-12-730  
OK9BV-12-780  
OK9BV-12-790  
24317-4X-001

VKM 74506  
VKM 84502  
VKM 74504  
VKM 74503  
VKM 84504

24322-4X-000  
24450-3Y100  
24450-3Y200  
25100-4A000  
97713-02000

VKM 74609  
VKM 74504  
VKM 74503  
VKPC 95854  
VKMV 4PK675

KK150-12-700A  
KK150-12-700B

VKM 74200  
VKM 74200

MB660-12-730C  
OK016-12-700  
OK937-12-700A

VKM 84201  
VKM 74004  
VKM 74201

OK937-12-730  
OK938-12-730  
OK954-12-730  
OK972-12-700  
OK972-12-700A  
OK972-12-730

VKM 84201  
VKM 84201  
VKM 84601  
VKM 74600  
VKM 74600  
VKM 84601

### LADA

2101-1307010  
2101-4197598  
2105-1006124  
2108.1307.010.00  
2109.0130.70.10

VKPC 88200  
VKPC 88200  
VKM 18200  
VKPC 88203  
VKPC 88203

4197598  
-984905  
-984923

VKPC 88200  
VKM 13240  
VKM 23240

### LANCIA

4336009  
4385583  
4386575  
4443446  
4443703

VKPC 82208  
VKM 12100  
VKM 12003  
VKM 12012  
VKM 12001

4458134  
46139910  
46400054  
46403679  
46416489

VKPC 82424  
VKPC 82629  
VKM 22242  
VKM 12201  
VKM 12242

46422512  
46424716  
46429443  
46435858  
46439000

VKPC 82249  
VKM 32242  
VKMV 4PK675  
VKPA 82666  
VKMV 6PK1105

46442999  
46444355  
46460702  
46462949  
46469587

VKM 32022  
VKPA 82441  
VKM 32025  
VKMV 6PK935  
VKM 32018

46474062  
46515970  
46520401  
46524692  
46526243

VKMV 6PK1842  
VKPC 82665  
VKPC 82251  
VKM 32022  
VKPC 82250

46531183  
46540146  
46540546  
46542302  
46542303

VKPC 82214  
VKMV 6PK1692  
VKMV 6PK1036  
VKMV 4PK962  
VKMV 4PK854

46546374  
46547566  
46550322  
46554826  
46736814

VKM 32027  
VKM 32024  
VKMV 5PK1585  
VKM 22242  
VKMV 4PK668

46742968  
46747484  
46751071  
46754624

VKM 32034  
VKMV 6PK1230  
VKMV 6PK1139  
VKM 32033

46756937  
46787905  
46792898  
46804051  
46805736  
46819138

VKM 32031  
VKMV 3PK915  
VKM 12242  
VKPC 82667  
VKPC 82250  
VKPC 85700

46819146  
46820062  
46820063  
4740847  
4822231

VKM 32080  
VKMV 6PK1180  
VKMV 6PK1310  
VKM 22380  
VKPC 82616

4829216  
4852375  
504010846  
504183759  
51758124

VKPC 82616  
VKM 12400  
VKM 12390  
VKM 12390  
VKMV 6PK1390

51758365  
51773551  
55180011  
55183497  
55183527

VKMV 6PK1410  
VKM 32046  
VKM 32027  
VKM 12206  
VKM 12174

55184055  
55184080  
55184081  
55190052  
55190053

VKM 32026  
VKPC 82250  
VKPC 82251  
VKM 32030  
VKM 32082

55190054  
55190813  
55191006  
55191969  
55191970

VKM 32083  
VKM 32046  
VKMV 6PK1195  
VKM 32023  
VKMV 5PK1145

55192239  
55192240  
55192323  
55192773  
55193330

VKM 12173  
VKM 12182  
VKM 12174  
VKM 12172  
VKM 32033

55193360  
55195023  
55196971  
55200253  
5580613

VKMV 6PK1580  
VKM 32023  
VKM 12215  
VKMV 6PK1410  
VKPC 82218

5890406  
5939200  
5955242  
5955242  
5956109

VKPC 82208  
VKPA 82202  
VKPA 82218  
VKPC 82218  
VKM 12005

5972277  
5973319  
5973713  
5985019  
5996594

VKM 12200  
VKPC 82614  
VKPC 82214  
VKM 12150  
VKPC 82218

5997325  
5999790  
60504835  
60586222  
60596372

VKM 12101  
VKPC 82622  
VKMV 10AVx850  
VKPC 82645  
VKM 12173

60602136  
60603056  
60606518  
60610908  
60617858

VKM 32007  
VKM 22540  
VKMV 5PK864  
VKM 32001  
VKMV 7PK1080

60620443  
60624147

VKM 12277  
VKM 32082



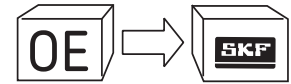
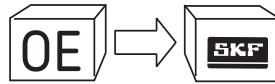
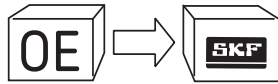

|          |                 |          |                |            |                 |
|----------|-----------------|----------|----------------|------------|-----------------|
| 60624747 | VKM 32083       | 71736795 | VKMA 02176     | 7695559    | VKPC 82629      |
| 60626658 | VKMMV 6PK1983   | 71737960 | VKPC 82208     | 7695968    | VKMMV 5PK1042   |
| 60630741 | VKMMV 6PK1975   | 71737961 | VKPA 82202     | 7701137    | VKPC 82647      |
| 60652358 | VKMMV 7PK1975   | 71737964 | VKPC 82629     | 7702173    | VKM 32009       |
| 60652477 | VKM 12182       | 71737965 | VKPC 82660     | 7704978    | VKMMV 4PK675    |
| 60653029 | VKMMV 6PK1062   | 71739605 | VKMMV 13AVx750 | 7708187    | VKPC 82660      |
| 60653030 | VKMMV 6PK1962   | 71739610 | VKMMV 5PK962   | 7710471    | VKPA 82666      |
| 60654130 | VKM 32030       | 71739618 | VKMMV 5PK884   | 7715242    | VKPC 82214      |
| 60662969 | VKMMV 6PK1080   | 71739620 | VKMMV 6PK935   | 7718418    | VKMMV 5PK1100   |
| 60664403 | VKM 22177       | 71739621 | VKMMV 4PK946   | 7720987    | VKPC 82245      |
| 60667050 | VKMMV 6PK1285   | 71739622 | VKMMV 5PK1100  | 7723828    | VKMMV 10AVx690  |
| 60667496 | VKM 12277       | 71739904 | VKMMV 10AVx800 | 7737200    | VKPC 82245      |
| 60671573 | VKM 22177       | 71739905 | VKMMV 5PK938   | 7740252    | VKM 32002       |
| 60676135 | VKMMV 6PK1962   | 71739908 | VKMMV 10AVx650 | 7743134    | VKMMV 10AVx690  |
| 60676136 | VKMMV 6PK1062   | 71739912 | VKMMV 10AVx825 | 7747382    | VKPC 82660      |
| 60809160 | VKMMV 5PK938    | 71739915 | VKMMV 6PK1842  | 7747386    | VKPC 82629      |
| 60809209 | VKPC 82660      | 71740977 | VKM 12200      | 7747388    | VKPC 82660      |
| 60810426 | VKPC 82660      | 71745026 | VKPC 85700     | 7762924    | VKPC 82437      |
| 60810644 | VKM 22541       | 71747799 | VKM 12174      | 7762925    | VKPC 82665      |
| 60811328 | VKPC 82645      | 7302554  | VKPC 82616     | 7762926    | VKPC 82646      |
| 60811332 | VKM 32022       | 73501649 | VKMMV 6PK1195  | 7762990    | VKMMV 13AVx850  |
| 60812263 | VKPA 82666      | 73501924 | VKM 32001      | 7763320    | VKMMV 13AVx1050 |
| 60812329 | VKMMV 7PK1080   | 73502729 | VKM 32035      | 7763644    | VKM 22174       |
| 60813311 | VKM 22540       | 73502730 | VKM 32033      | 7764585    | VKMMV 10AVx675  |
| 60813774 | VKM 32018       | 73503128 | VKM 12201      | 7765717    | VKMMV 5PK962    |
| 60814110 | VKM 32022       | 7533502  | VKPC 82218     | 7765720    | VKMMV 10AVx690  |
| 60814609 | VKPC 82665      | 7541718  | VKM 12227      | 7770034    | VKPC 82245      |
| 60814917 | VKM 32024       | 7547752  | VKMMV 5PK1345  | 7771530    | VKMMV 10AVx690  |
| 60815412 | VKMMV 6PK1080   | 7553760  | VKM 12150      | 7771742    | VKMMV 10AVx838  |
| 60815414 | VKMMV 6PK1975   | 7554724  | VKM 32016      | 7771811    | VKPC 82245      |
| 71713727 | VKPC 82214      | 7565764  | VKPC 82218     | 7772961    | VKM 12172       |
| 71713728 | VKPC 82249      | 7574887  | VKPC 82424     | 7776570    | VKMMV 10AVx650  |
| 71718718 | VKMMV 4PK675    | 7580442  | VKM 32008      | 7776571    | VKMMV 10AVx725  |
| 71718838 | VKMMV 4PK841    | 7580754  | VKPC 82218     | 7778565    | VKM 12174       |
| 71719039 | VKMMV 4PK698    | 7580755  | VKPC 82218     | 7782192    | VKM 12215       |
| 71719394 | VKMMV 6PK1836   | 7581316  | VKMMV 10AVx825 | 7783006    | VKPC 82647      |
| 71719398 | VKMMV 3PK915    | 7589248  | VKMMV 13AVx825 | 7784977    | VKPC 82245      |
| 71719399 | VKMMV 3PK719    | 7596876  | VKM 22153      | 7784981    | VKPA 82218      |
| 71719400 | VKMMV 6PK1139   | 7596877  | VKM 12153      | 7784988    | VKPC 82245      |
| 71719559 | VKMMV 5PK1570   | 7609204  | VKPC 82629     | 7788010    | VKM 32004       |
| 71719640 | VKMMV 13AVx1050 | 7611334  | VKMMV 10AVx650 | 82360789   | VKM 12004       |
| 71719668 | VKPC 82208      | 7615058  | VKMMV 5PK986   | 91107589   | VKPC 82629      |
| 71719675 | VKPC 82629      | 7617278  | VKMMV 13AVx850 | 9400818199 | VKM 13250       |
| 71719678 | VKPC 82647      | 7618521  | VKMMV 10AVx838 | 9400830149 | VKM 23214       |
| 71719738 | VKMMV 4PK668    | 7621256  | VKMMV 13AVx875 | 9400830149 | VKM 23218       |
| 71719745 | VKMMV 5PK907    | 7627908  | VKMMV 13AVx850 | 9400830289 | VKM 23246       |
| 71732350 | VKMMV 5PK1145   | 7633335  | VKMMV 10AVx735 | 9400830379 | VKM 23120       |
| 71732372 | VKMMV 6PK1962   | 7635180  | VKPC 82622     | 9400830379 | VKM 23213       |
| 71732386 | VKMMV 6PK1062   | 7636057  | VKMMV 4PK1045  | 9400830379 | VKM 23214       |
| 71734476 | VKMMV 6PK1836   | 7640163  | VKPC 82214     | 9400830379 | VKM 23218       |
| 71734715 | VKMMV 6PK1760   | 7644467  | VKMMV 5PK962   | 9400830509 | VKM 23257       |
| 71734716 | VKMMV 6PK1740   | 7646849  | VKMMV 5PK1050  | 9400831929 | VKMA 03257      |
| 71734799 | VKM 12242       | 7649219  | VKMMV 13AVx850 | 9463623088 | VKPC 83643      |
| 71736493 | VKM 22174       | 7650925  | VKM 32242      | 9464640480 | VKM 13257       |
| 71736715 | VKMA 02242      | 7655543  | VKMMV 13AVx850 | 9565095580 | VKPC 83420      |
| 71736717 | VKMA 02204      | 7655544  | VKMMV 13AVx750 | 9566945688 | VKPC 83420      |
| 71736718 | VKMA 02203      | 7659699  | VKMMV 10AVx675 | 9566950080 | VKPC 83636      |
| 71736719 | VKMA 02210      | 7661813  | VKPC 82622     | 9569147388 | VKPC 83639      |
| 71736722 | VKMA 02185      | 7671810  | VKPC 82216     | 9569623880 | VKPC 83425      |
| 71736723 | VKMA 02178      | 7691044  | VKPC 82218     | 9604708880 | VKPC 83425      |
| 71736724 | VKMA 02183      | 7691811  | VKPC 82629     | 9608859180 | VKM 33003       |
| 71736726 | VKMA 02192      | 7694229  | VKPC 82622     | 9608989980 | VKM 33034       |
| 71736727 | VKMA 02177      | 7695557  | VKPC 82622     | 9609016880 | VKM 33028       |

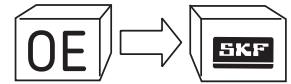
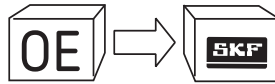
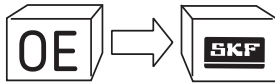

9614284080  
9615207880  
9615208280  
9615208480  
  
9616660580  
9616660780  
9618888580  
9620550980  
9622234180  
  
9623684780  
9624233880  
9625621780  
9625621880  
9626365280  
  
9627667988  
9629110980  
9631847480  
9633315180  
9633315280

VKMV 6PK698  
VKMV 6PK1660  
VKMV 6PK1067  
VKMV 6PK1076  
  
VKM 23900  
VKM 23901  
VKM 33013  
VKMV 6PK1603  
VKM 33035  
  
VKMV 6PK1160  
VKMV 6PK1102  
VKM 33022  
VKM 33025  
VKM 33028  
  
VKPC 83420  
VKPC 83425  
VKM 33045  
VKM 33024  
VKM 33069

9634465780  
9635638380  
9636207480  
9638027080  
9638464380  
  
9641705880  
9642184080  
9642965780  
9644846680  
9650542480  
  
9653522380  
9655945780  
9695557  
98430541  
98455448  
99440930

VKM 33033  
VKM 33075  
VKM 33019  
VKMV 6PK1585  
VKMV 6PK1750  
  
VKMV 6PK1706  
VKM 13902  
VKM 33069  
VKMV 6PK1740  
VKM 33320  
  
VKM 33033  
VKMV 6PK1217  
VKPC 82622  
VKPA 82648  
VKMV 5PK890  
VKPC 82638

PQS 100851  
PQS 101030  
PQS 101130  
PQS 101180  
PQS 101300L  
PQS 101310L  
  
PQS 101490  
PQS 101500  
PQS 101510  
PQS 101520  
PRF 100060L  
  
STC 2128  
STC 2131  
STC 2132  
STC 3342  
STC 3397  
  
STC 4378  
STC 4455

VKMV 6PK1460  
VKMV 6PK1183  
VKMV 5PK1190  
VKMV 5PK1200  
VKMV 5PK2030  
VKMV 5PK869  
  
VKMV 7PK1716  
VKMV 7PK1801  
VKMV 7PK1867  
VKMV 7PK1820  
VKM 38240  
  
VKM 38220  
VKM 38230  
VKM 38225  
VKPC 88826  
VKMV 4PK836  
  
VKPC 87835  
VKMV 5PK1815

B630-12-700B  
B630-12-700C  
B630-12-700D  
B630-12-700E  
  
B630-15-010  
B631-12-700C  
B660-12-700A  
B660-12-700B  
B660-12-700C  
  
B660-12-700D  
B660-12-700E  
B660-12-700F  
B660-12-730  
B660-12-730A  
  
B660-12-730B  
B660-12-730C  
E301-15-010  
E301-15-010A  
E301-15-010B

VKM 74200  
VKM 74200  
VKM 74200  
VKM 74200  
  
VKPC 94002  
VKM 74200  
VKM 74201  
VKM 74201  
VKM 74201  
  
VKM 74201  
VKM 74201  
VKM 74201  
VKM 74201  
VKM 84201  
VKM 84201  
  
VKM 84201  
VKM 84201  
VKPC 94202  
VKPC 94202  
VKPC 94202

**MAZDA**

1E03-15-909B  
1E03-15-909D  
1E03-15-930A  
1E03-15-980  
1E04-15-010  
  
1E05-15-010  
1E05-15-907  
1E05-15-908  
1E05-15-909  
1E05-15-980A  
  
1E05-18-381  
1E06-15-010  
1E06-15-980  
1E07-15-010  
1E07-15-907B  
  
1E07-15-930B  
1E07-18-381A  
8AB1-15-010  
8AB2-15-010  
8AB3-15-010  
  
8AB4-15-010  
8AB5-15-010  
8AB7-15-010  
8AB8-15-010  
8AD2-15-010A  
  
8AE2-15-010  
8AG1-15-010B  
8AG2-15-010  
8AG2-15-010B  
8AG2-15-010C  
  
8AG6-15-010A  
8AH2-15-010  
8AH2-15-010A  
8AH2-15-010B  
8AK1-15-010  
  
8AK2-15-010  
8AL1-15-010C  
8BU1-15-010  
B366-15-940  
B3C7-15-010  
B3C7-15-010A

VKMV 6PK1905  
VKMV 6PK1936  
VKM 34034  
VKM 34033  
VKPC 84216  
  
VKPC 84215  
VKMV 6PK1750  
VKMV 6PK1780  
VKMV 6PK1930  
VKM 34008  
  
VKMV 6PK1181  
VKPC 84215  
VKM 34007  
VKPC 84620  
VKMV 5PK1144  
  
VKM 34005  
VKMV 5PK886  
VKPC 94202  
VKPC 94202  
VKPC 94002  
  
VKPC 94002  
VKPC 94434  
VKPC 94002  
VKPC 94434  
VKPC 94002  
  
VKPC 94602  
VKPC 94423  
VKPC 94425  
VKPC 94425  
VKPC 94425  
  
VKPC 94452  
VKPC 94424  
VKPC 94424  
VKPC 94424  
VKPC 94603  
VKPC 94613  
VKPC 95602  
VKM 64000  
VKPC 94002  
VKPC 94002

E301-15-010C  
E301-15-010D  
E301-15-010F  
E5B6-15-010  
F801-12-700  
  
F801-12-700B  
F801-12-700C  
F805-12-700  
F805-12-700A  
F805-12-700C  
  
F806-12-700  
FE1H-12-700A  
FE1H-12-730  
FE1H-12-730A  
FE3N-12-730  
  
FE79-15-010B  
FE79-15-010C  
FP01-12-700  
FP01-12-700A  
FP05-12-700A  
  
FS01-12-700A  
FS01-12-700B  
FS01-12-730A  
FS05-12-700A  
G601-15-010C  
  
G601-15-010D  
JE15-12-730  
JE15-12-730A  
JE15-12-730C  
JE15-12-750  
  
JE15-12-750A  
JE26-12-750  
JF01-12-730  
JF01-12-730A  
JF01-12-730B  
  
JF01-12-750  
JF01-12-750E  
JF01-12-750F  
KL01-12-730  
KL01-12-730A  
  
KL01-12-740  
KL02-12-750  
KL02-12-750A  
KLY2-12-SJO

VKPC 94202  
VKPC 94202  
VKPC 94202  
VKPC 94202  
VKM 74501  
  
VKM 74501  
VKM 74501  
VKM 74001  
VKM 74001  
VKM 74001  
  
VKM 74001  
VKM 74600  
VKM 84600  
VKM 84600  
VKM 84601  
  
VKPC 94423  
VKPC 94423  
VKM 74006  
VKM 74006  
VKM 74006  
  
VKM 74002  
VKM 74002  
VKM 84000  
VKM 74002  
VKPC 94613  
  
VKPC 94613  
VKM 84007  
VKM 84007  
VKM 84007  
VKM 74007  
  
VKM 74007  
VKM 74005  
VKM 84007  
VKM 84007  
VKM 84007  
  
VKM 74007  
VKM 74007  
VKM 74007  
VKM 84001  
VKM 84001  
  
VKM 84002  
VKM 74000  
VKM 74000  
VKM 74000

**LAND ROVER**

1311306  
1324388  
1324390  
457Q 6K254 CB  
603713  
  
614670  
CDU 2160  
ERC 675  
ERR 3287  
ERR 5911  
  
ETC 7469  
ETC 7939  
ETC 8560  
LHP 100550L  
LHP 100840  
  
LHP10015L  
LHV 100110L  
PEB 000050  
PQG 100180  
PQG 100190L  
  
PQG 100230L  
PQS 000180  
PQS 000200  
PQS 100840

VKM 23261  
VKMA 03261  
VKMA 03261  
VKM 13262  
VKMV 13AVx850  
  
VKMV 13AVx1000  
VKMV 3PK753  
VKMV 13AVx925  
VKMV 7PK1595  
VKMV 7PK1580  
  
VKMV 10AVx613  
VKMV 10AVx1025  
VKM 27404  
VKM 17304  
VKM 17303  
  
VKM 17310  
VKM 27307  
VKPC 88430  
VKM 37010  
VKM 37011  
  
VKM 37005  
VKMV 5PK882  
VKMV 5PK2020  
VKMV 5PK738





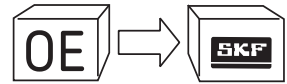
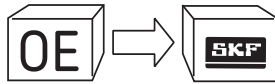
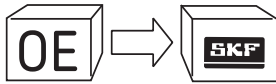

|              |              |               |                 |               |               |
|--------------|--------------|---------------|-----------------|---------------|---------------|
| OJE26-12-750 | VKM 74005    | 008 997 09 92 | VKMOV 6PK2100   | 011 997 96 92 | VKMOV 6PK2315 |
| PN11-12-700  | VKM 74008    | 008 997 17 92 | VKMOV 6PK2170   | 011 997 97 92 | VKMOV 6PK2390 |
| R201-12-700A | VKM 74004    | 008 997 21 92 | VKMOV 6PK2080   | 012 997 05 92 | VKMOV 6PK2196 |
| R201-15-010A | VKPC 94452   | 008 997 32 92 | VKMOV 6PK1015   | 012 997 06 92 | VKMOV 6PK2160 |
| R201-15-010B | VKPC 94452   | 008 997 33 92 | VKMOV 6PK2050   | 012 997 07 92 | VKMOV 6PK2270 |
| RF01-99-154  | VKPC 94452   | 008 997 34 92 | VKMOV 6PK2120   | 012 997 08 92 | VKMOV 6PK2241 |
| RF03-12-700A | VKM 74300    | 008 997 35 92 | VKMOV 6PK2030   | 012 997 15 92 | VKMOV 6PK2055 |
| RF03-12-720  | VKM 72303    | 008 997 36 92 | VKMOV 6PK2100   | 012 997 35 92 | VKMOV 6PK2315 |
| RF03-15-010B | VKPC 94452   | 008 997 37 92 | VKMOV 6PK2080   | 012 997 36 92 | VKMOV 6PK2390 |
| RF1G-12-700A | VKM 74601    | 008 997 38 92 | VKMOV 6PK2145   | 012 997 42 92 | VKMOV 6PK2077 |
| RF1G-12-730  | VKM 84602    | 008 997 63 92 | VKMOV 6PK2020   | 012 997 43 92 | VKMOV 6PK2160 |
| RF2A-12-700  | VKM 74602    | 008 997 69 92 | VKMOV 6PK2170   | 012 997 54 92 | VKMOV 6PK1355 |
| RF2A-12-730  | VKM 84603    | 008 997 70 92 | VKMOV 6PK2257   | 012 997 58 92 | VKMOV 6PK2035 |
| RF2A-12-730A | VKM 84603    | 008 997 71 92 | VKMOV 6PK1020   | 012 997 59 92 | VKMOV 6PK1775 |
| RF5C-12-700  | VKM 74607    | 008 997 72 92 | VKMOV 6PK1885   | 012 997 74 92 | VKMOV 5PK1270 |
| RF5C-12-730  | VKM 84608    | 008 997 73 92 | VKMOV 6PK1980   | 012 997 75 92 | VKMOV 5PK1720 |
| RF71-12-700C | VKM 74310    | 008 997 88 92 | VKMOV 6PK2285   | 013 997 14 92 | VKMOV 5PK1290 |
| RF71-12-730A | VKM 84310    | 008 997 90 92 | VKMOV 6PK2000   | 013 997 15 92 | VKMOV 5PK1750 |
| RF95-15-010  | VKPC 94452   | 008 997 91 92 | VKMOV 6PK1885   | 013 997 22 92 | VKMOV 6PK2190 |
| RFC6-12-700  | VKM 74310    | 008 997 92 92 | VKMOV 6PK2050   | 013 997 23 92 | VKMOV 6PK2260 |
| WL01-12-700  | VKM 74606    | 009 997 03 92 | VKMOV 10AVx1005 | 013 997 25 92 | VKMOV 6PK2077 |
| WL81-12-700  | VKM 74604    | 009 997 13 92 | VKMOV 6PK1850   | 013 997 26 92 | VKMOV 6PK2160 |
| WL81-15-100C | VKPC 94614   | 009 997 53 92 | VKMOV 10AVx1005 | 013 997 41 92 | VKMOV 6PK2125 |
| WL81-15-100D | VKPC 94614   | 009 997 54 92 | VKMOV 6PK2176   | 013 997 45 92 | VKMOV 6PK2135 |
| Y401-12-730  | VKM 23140    | 009 997 91 92 | VKMOV 6PK2155   | 013 997 46 92 | VKMOV 6PK1870 |
| Y401-12-770  | VKM 13140    | 009 997 94 92 | VKMOV 6PK1950   | 013 997 47 92 | VKMOV 6PK1870 |
| Y401-15-930  | VKM 33060    | 010 997 05 92 | VKMOV 6PK2040   | 013 997 50 92 | VKMOV 7PK2271 |
| Y401-15-980C | VKM 33061    | 010 997 06 92 | VKMOV 6PK2140   | 013 997 71 92 | VKMOV 7PK2345 |
| Y601-15-010B | VKPC 83259   | 010 997 57 92 | VKMOV 6PK2330   | 013 997 74 92 | VKMOV 7PK2420 |
| Y601-15-909  | VKMOV 6PK976 | 010 997 70 92 | VKMOV 6PK2050   | 014 997 04 92 | VKMOV 6PK2270 |
| Y601-15-980  | VKM 33043    | 010 997 71 92 | VKMOV 6PK2040   | 014 997 06 92 | VKMOV 6PK2260 |
| Y602-15-909  | VKMOV 6PK802 | 010 997 79 92 | VKMOV 6PK2140   | 014 997 08 92 | VKMOV 6PK2077 |
| Y602-15-940  | VKM 33044    | 010 997 86 92 | VKMOV 6PK2140   | 014 997 09 92 | VKMOV 6PK2196 |
| Z501-12-730  | VKM 84604    | 010 997 88 92 | VKMOV 6PK2225   | 014 997 10 92 | VKMOV 6PK2241 |
| Z501-12-730A | VKM 84604    | 010 997 89 92 | VKMOV 6PK2475   | 014 997 11 92 | VKMOV 6PK2160 |
| ZL01-15-010A | VKPC 94617   | 010 997 91 92 | VKMOV 6PK2190   | 014 997 12 92 | VKMOV 6PK2160 |
|              |              | 011 997 01 92 | VKMOV 6PK1775   | 014 997 13 92 | VKMOV 5PK1263 |
|              |              | 011 997 02 92 | VKMOV 6PK1875   | 014 997 14 92 | VKMOV 5PK1715 |
|              |              | 011 997 04 92 | VKMOV 6PK2330   | 014 997 15 92 | VKMOV 7PK2271 |
|              |              | 011 997 06 92 | VKMOV 6PK2445   | 014 997 32 92 | VKMOV 5PK1290 |
|              |              | 011 997 09 92 | VKMOV 6PK2510   | 014 997 33 92 | VKMOV 5PK1750 |
|              |              | 011 997 18 92 | VKMOV 6PK2055   | 014 997 37 92 | VKMOV 7PK2335 |
|              |              | 011 997 19 92 | VKMOV 6PK2155   | 014 997 79 92 | VKMOV 6PK2140 |
|              |              | 011 997 20 92 | VKMOV 6PK2100   | 015 997 03 92 | VKMOV 7PK2271 |
|              |              | 011 997 21 92 | VKMOV 6PK2205   | 015 997 25 92 | VKMOV 6PK2404 |
|              |              | 011 997 33 92 | VKMOV 6PK1330   | 015 997 47 92 | VKMOV 5PK1300 |
|              |              | 011 997 36 92 | VKMOV 6PK1760   | 102 200 01 20 | VKPC 88604    |
|              |              | 011 997 37 92 | VKMOV 6PK1860   | 102 200 02 01 | VKPC 88604    |
|              |              | 011 997 42 92 | VKMOV 6PK2040   | 102 200 03 01 | VKPC 88613    |
|              |              | 011 997 45 92 | VKMOV 6PK2510   | 102 200 03 20 | VKPC 88613    |
|              |              | 011 997 48 92 | VKMOV 6PK2115   | 102 200 04 01 | VKPC 88613    |
|              |              | 011 997 49 92 | VKMOV 6PK2215   | 102 200 04 20 | VKPC 88613    |
|              |              | 011 997 52 92 | VKMOV 6PK2155   | 102 200 05 20 | VKPC 88619    |
|              |              | 011 997 53 92 | VKMOV 6PK2000   | 102 200 06 20 | VKPC 88619    |
|              |              | 011 997 55 92 | VKMOV 6PK2205   | 102 200 08 01 | VKPC 88604    |
|              |              | 011 997 58 92 | VKMOV 6PK1330   | 102 200 09 01 | VKPC 88604    |
|              |              | 011 997 69 92 | VKMOV 7PK1290   | 102 200 09 20 | VKPC 88619    |
|              |              | 011 997 71 92 | VKMOV 7DK1360   | 102 200 10 01 | VKPC 88604    |
|              |              | 011 997 80 92 | VKMOV 6PK2120   | 102 200 11 01 | VKPC 88613    |
|              |              | 011 997 84 92 | VKMOV 6PK2065   | 102 200 15 01 | VKPC 88613    |
|              |              | 011 997 85 92 | VKMOV 6PK2130   | 102 200 31 01 | VKPC 88613    |
|              |              | 011 997 87 92 | VKMOV 6PK2390   | 102 200 39 01 | VKPC 88619    |
|              |              | 011 997 92 92 | VKMOV 5PK1750   | 102 200 40 01 | VKPC 88613    |

## MERCEDES-BENZ

|               |                 |  |  |  |  |
|---------------|-----------------|--|--|--|--|
| 000 200 07 01 | VKPC 81611      |  |  |  |  |
| 000 202 00 19 | VKM 31041       |  |  |  |  |
| 000 993 20 96 | VKMOV 5PK1745   |  |  |  |  |
| 000 993 28 96 | VKMOV 8PK2035   |  |  |  |  |
| 001 993 30 96 | VKMOV 5PK1745   |  |  |  |  |
| 001 997 64 92 | VKMOV 13AVx750  |  |  |  |  |
| 004 997 39 92 | VKMOV 10AVx1025 |  |  |  |  |
| 004 997 94 92 | VKMOV 13AVx875  |  |  |  |  |
| 004 997 95 92 | VKMOV 13AVx750  |  |  |  |  |
| 004 997 99 92 | VKMOV 13AVx1150 |  |  |  |  |
| 005 997 01 92 | VKMOV 13AVx875  |  |  |  |  |
| 005 997 66 92 | VKMOV 10AVx1005 |  |  |  |  |
| 005 997 67 92 | VKMOV 10AVx1005 |  |  |  |  |
| 005 997 68 92 | VKMOV 13AVx1000 |  |  |  |  |
| 006 997 07 92 | VKMOV 10AVx1005 |  |  |  |  |
| 006 997 09 92 | VKMOV 13AVx750  |  |  |  |  |
| 006 997 12 92 | VKMOV 13AVx875  |  |  |  |  |
| 006 997 32 92 | VKMOV 10AVx935  |  |  |  |  |
| 007 997 80 92 | VKMOV 6PK1980   |  |  |  |  |
| 007 997 82 92 | VKMOV 6PK2245   |  |  |  |  |
| 007 997 84 92 | VKMOV 6PK2120   |  |  |  |  |
| 007 997 90 92 | VKMOV 6PK1015   |  |  |  |  |
| 007 997 94 92 | VKMOV 6PK1020   |  |  |  |  |





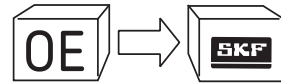
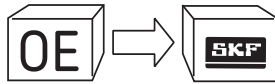
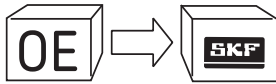

MD 302010  
MD 306414  
MD 309756

VKPC 95003  
VKPC 95426  
VKPC 95005

MD 315265  
MD 316826  
MD 319022  
MD 320174  
MD 325568

VKM 75002  
VKM 75614  
VKM 85002  
VKM 75616  
VKM 75624

MD 327654  
MD 329976  
MD 345611  
MD 352473  
MD 356509

VKM 65005  
VKM 75615  
VKPC 86413  
VKM 75613  
VKM 75625

MD 971538  
MD 971539  
MD 972001  
MD 972002  
MD 972006

VKPC 95612  
VKPC 95614  
VKPC 95405  
VKPC 95800  
VKPC 95614

MD 972050  
MD 972052  
MD 972053  
MD 972054  
MD 974649

VKPC 95612  
VKPC 95424  
VKPC 95423  
VKPC 95614  
VKPC 95008

MD 997052  
MD 997053  
MD 997076  
MD 997077  
MD 997078

VKPC 95424  
VKPC 95424  
VKPC 95008  
VKPC 95004  
VKPC 95010

MD 997079  
MD 997080  
MD 997081  
MD 997082  
MD 997084

VKPC 95422  
VKPC 95422  
VKPC 95611  
VKPC 95602  
VKPC 95405

MD 997128  
MD 997150  
MD 997157  
MD 997158  
MD 997160

VKPC 95402  
VKPC 95405  
VKPC 95602  
VKPC 95602  
VKPC 95405

MD 997173  
MD 997177  
MD 997178  
MD 997417  
MD 997421

VKPC 95004  
VKPC 95404  
VKPC 95602  
VKPC 95424  
VKPC 95010

MD 997430  
MD 997485  
MD 997609  
MD 997610  
MD 997611

VKPC 95423  
VKPC 95010  
VKPC 95008  
VKPC 95004  
VKPC 95010

MD 997612  
MD 997613  
MD 997614  
MD 997615  
MD 997616

VKPC 95422  
VKPC 95422  
VKPC 95611  
VKPC 95422  
VKPC 95602

MD 997619  
MD 997621  
MD 997622  
MD 997686  
MD 997692

VKPC 95010  
VKPC 95424  
VKPC 95423  
VKPC 95800  
VKPC 95404

MD 997699  
MD308882  
MD323372  
MD365087  
MD975913

VKPC 95010  
VKM 65004  
VKPC 95863  
VKPC 95863  
VKPC 95864

MD977311  
MD978552  
MN119741  
MR984714

**NISSAN**

02117-04523  
02117-75523  
02117-76023  
02117-80523  
02117-86523

02117-90523  
02117-91023  
11720-00QA2  
11720-00QAB  
11720-00QAJ

11720-00QAS  
11720-00QAT  
11720-00QAV  
11720-03J00  
11720-0E400

11720-0E401  
11720-0M000  
11720-2F200  
11720-2F205  
11720-2F610

11720-59M00  
11720-59Y00  
11720-6F900  
11720-70J00  
11720-70J01

11720-70J05  
11720-77702  
11720-AW300  
11720-BN700  
11720-BN701

11720-D4007  
11720-D4008  
11720-G8000  
11720-V7301  
11720-V7302

11750-00QAB  
11750-00QAC  
11750-00QAD  
11750-00QAF  
11750-00QAH

11750-00QAP  
11750-00QAS  
11920-00QAB  
11920-0E001  
11920-21B01

11920-21M00  
11920-2Y501  
11920-6J900  
11920-9F605  
11920-9F610

11920-9F615  
11923-BN700  
11925-00QAB  
11925-00QAF  
11925-00QAP

VKPC 95864  
VKPC 95864  
VKM 85150  
VKM 75634

VKMOV 13AVx1050  
VKMOV 13AVx750  
VKMOV 13AVx750  
VKMOV 13AVx800  
VKMOV 13AVx850

VKMOV 13AVx900  
VKMOV 13AVx900  
VKMOV 6PK1199  
VKMV 5PK1125  
VKMV 5PK1125

VKMOV 4PK928  
VKMV 4PK908  
VKMOV 3PK740  
VKMOV 10AVx1140  
VKMOV 13AVx850

VKMOV 13AVx850  
VKMOV 4PK820  
VKMV 4PK825  
VKMOV 4PK825  
VKMOV 13AVx850

VKMOV 13AVx850  
VKMOV 5PK960  
VKMV 4PK825  
VKMV 4PK825

VKMOV 4PK825  
VKMOV 10AVx975  
VKMV 7PK1192  
VKMV 5PK1135  
VKMV 5PK1199

VKMOV 4PK810  
VKMV 4PK810  
VKMOV 13AVx1050  
VKMV 4PK855  
VKMV 4PK855

VKM 36030  
VKM 36030  
VKM 36030  
VKM 36025  
VKM 36023

VKM 36052  
VKM 36023  
VKMV 5PK1110  
VKMV 6PK1030  
VKMV 4PK825

VKMOV 13AVx825  
VKMV 6PK1105  
VKMV 6PK1110  
VKMV 6PK1100  
VKMV 6PK1100

VKMOV 6PK1100  
VKM 36053  
VKM 36091  
VKM 36031  
VKM 36040

11925-AW300  
11944-6F901  
11955-BN701  
11955-BN702  
13028-BN700

13070-00QAC  
13070-00QAE  
13070-01B00  
13070-01B01  
13070-01M00

13070-05E00  
13070-05E10  
13070-16A00  
13070-16A02  
13070-16A03

13070-16A10  
13070-24B00  
13070-2J600  
13070-3C900  
13070-42L00

13070-57J00  
13070-57J01  
13070-57J10  
13070-6F901  
13070-AW300

13070-BN700  
13070-D0100  
13070-D4200  
13070-V5001  
13070-V7201

13074-05E00  
13074-16A01  
13077-00QAA  
13077-00QAD  
13077-35F00

13077-3C900  
13077-45V00  
13077-54A00  
13077-54A02  
13077-D4200

13077-F6200  
13077-F6512  
13077-V7200  
13077-V7202  
16806-00QAB

16806-00QAF  
16806-00QAG  
16806-00QAJ  
17400-1120  
17400-1121

17400-1122  
17400-1123  
17400-1124  
21010-00QAA  
21010-00QAC

21010-00QAH  
21010-00QAK  
21010-00QAL  
21010-00QAR  
21010-00QAS

21010-00QAT  
21010-01B25  
21010-01B26

VKM 36040  
VKM 33039  
VKM 36050  
VKM 36052  
VKMA 06130

VKM 16113  
VKM 16503  
VKM 72400  
VKM 72400  
VKM 72000

VKM 72320  
VKM 72320  
VKM 72300  
VKM 72300  
VKM 72300

VKM 72303  
VKM 72400  
VKM 72310  
VKM 72501  
VKM 72004

VKM 72310  
VKM 72310  
VKM 13120  
VKM 16129

VKMA 06130  
VKM 72200  
VKM 72100  
VKM 72004  
VKM 72500

VKM 82320  
VKM 82300  
VKM 26503  
VKM 16000  
VKM 82101

VKM 82503  
VKM 82000  
VKM 82302  
VKM 82502  
VKM 82101

VKM 82000  
VKM 82000  
VKM 82500  
VKM 82500  
VKMA 06020

VKMA 06127  
VKMA 06503  
VKMA 06127  
VKPC 92800  
VKPC 92800

VKPC 92800  
VKPC 92800  
VKPC 92800  
VKPC 86416  
VKPC 85304

VKPC 86810  
VKPC 86810  
VKPC 86810  
VKPC 86810  
VKPC 86417

VKPC 86417  
VKPC 92204  
VKPC 92204

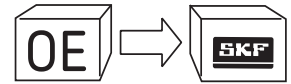
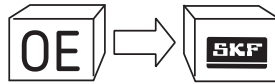
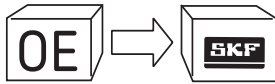

|             |            |             |            |             |            |
|-------------|------------|-------------|------------|-------------|------------|
| 21010-01B27 | VKPC 92204 | 21010-61527 | VKPC 92820 | 21010-V0726 | VKPC 92802 |
| 21010-01B28 | VKPC 92204 | 21010-61528 | VKPC 92820 | 21010-V4425 | VKPC 92601 |
| 21010-01M00 | VKPC 92205 | 21010-61529 | VKPC 92820 | 21010-V4426 | VKPC 92601 |
| 21010-01M01 | VKPC 92205 | 21010-61585 | VKPC 92820 | 21010-V5500 | VKPC 92601 |
| 21010-01M25 | VKPC 92205 | 21010-61594 | VKPC 92820 | 21010-V5510 | VKPC 92601 |
| 21010-05E25 | VKPC 92615 | 21010-70J00 | VKPC 92412 | 21010-V5525 | VKPC 92601 |
| 21010-05E26 | VKPC 92615 | 21010-71J00 | VKPC 92408 | 21010-V5526 | VKPC 92601 |
| 21010-05E27 | VKPC 92615 | 21010-77A00 | VKPC 92406 | 21010-V5527 | VKPC 92601 |
| 21010-06E25 | VKPC 92404 | 21010-7F400 | VKPC 92929 | 21010-V5528 | VKPC 92601 |
| 21010-06E26 | VKPC 92404 | 21010-80W25 | VKPC 92630 | 21010-V5529 | VKPC 92601 |
| 21010-09W25 | VKPC 92649 | 21010-80W26 | VKPC 92630 | 21010-V5585 | VKPC 92601 |
| 21010-09W26 | VKPC 92649 | 21010-80W27 | VKPC 92630 | 21010-V5594 | VKPC 92601 |
| 21010-09W94 | VKPC 92649 | 21010-80W94 | VKPC 92630 | 21010-V7025 | VKPC 92802 |
| 21010-0M300 | VKPC 92408 | 21010-81T25 | VKPC 92810 | 21010-V7225 | VKPC 92810 |
| 21010-0M301 | VKPC 92408 | 21010-81T26 | VKPC 92810 | 21010-V7226 | VKPC 92810 |
| 21010-10G25 | VKPC 92650 | 21010-86G00 | VKPC 92645 | 21010-V7228 | VKPC 92810 |
| 21010-10G26 | VKPC 92650 | 21010-99B00 | VKPC 92208 | 21010-V9400 | VKPC 92601 |
| 21010-12G25 | VKPC 92823 | 21010-9C600 | VKPC 92926 | 21010-W1727 | VKPC 92610 |
| 21010-12G26 | VKPC 92823 | 21010-AW300 | VKPC 86129 | 21010-W1786 | VKPC 92610 |
| 21010-12G27 | VKPC 92823 | 21010-BA010 | VKPC 92401 | 21010-W3626 | VKPC 92802 |
| 21010-17C25 | VKPC 92634 | 21010-D0104 | VKPC 92401 | 21010-W3627 | VKPC 92802 |
| 21010-17C26 | VKPC 92634 | 21010-D0125 | VKPC 92401 | 21010-W3628 | VKPC 92802 |
| 21010-17C27 | VKPC 92634 | 21010-D0126 | VKPC 92401 | 21010-W3685 | VKPC 92802 |
| 21010-17S25 | VKPC 92802 | 21010-D2825 | VKPC 92422 | 21010-W3686 | VKPC 92802 |
| 21010-17S26 | VKPC 92802 | 21010-E3000 | VKPC 92802 | 21010-W3694 | VKPC 92802 |
| 21010-17S27 | VKPC 92802 | 21010-E3001 | VKPC 92802 | 21010-W4425 | VKPC 92601 |
| 21010-19B25 | VKPC 92209 | 21010-E3003 | VKPC 92802 | 21010-W4426 | VKPC 92601 |
| 21010-22J00 | VKPC 92810 | 21010-E3004 | VKPC 92802 | 21010-Y7025 | VKPC 92802 |
| 21010-22J25 | VKPC 92810 | 21010-E3025 | VKPC 92802 | BA010-06E26 | VKPC 92404 |
| 21010-22J26 | VKPC 92810 | 21010-E3026 | VKPC 92802 | BA010-22J25 | VKPC 92810 |
| 21010-24B25 | VKPC 92209 | 21010-E3027 | VKPC 92802 | BA010-54A26 | VKPC 92422 |
| 21010-28J25 | VKPC 92810 | 21010-E3028 | VKPC 92802 | BA010-80W94 | VKPC 92630 |
| 21010-28J26 | VKPC 92810 | 21010-E3075 | VKPC 92802 | BA010-D0194 | VKPC 92401 |
| 21010-31U25 | VKPC 92822 | 21010-E3087 | VKPC 92802 | BA010-E3027 | VKPC 92802 |
| 21010-31U26 | VKPC 92822 | 21010-G3625 | VKPC 92610 | BA010-G3626 | VKPC 92610 |
| 21010-31U27 | VKPC 92822 | 21010-G3626 | VKPC 92610 | BA010-G5586 | VKPC 92600 |
| 21010-31W25 | VKPC 92649 | 21010-G3925 | VKPC 92630 | BA010-G8125 | VKPC 92600 |
| 21010-31W26 | VKPC 92649 | 21010-G3926 | VKPC 92630 | BA010-H7227 | VKPC 92203 |
| 21010-40F25 | VKPC 92645 | 21010-G3927 | VKPC 92630 | BA010-V5594 | VKPC 92601 |
| 21010-40F26 | VKPC 92645 | 21010-G5510 | VKPC 92600 | BA010-W3694 | VKPC 92802 |
| 21010-41B00 | VKPC 92208 | 21010-G5585 | VKPC 92600 |             |            |
| 21010-41B01 | VKPC 92208 | 21010-G5586 | VKPC 92600 |             |            |
| 21010-41B02 | VKPC 92208 | 21010-G5594 | VKPC 92600 |             |            |
| 21010-41B03 | VKPC 92208 | 21010-G8125 | VKPC 92600 |             |            |
| 21010-43G27 | VKPC 92651 | 21010-G81Y5 | VKPC 92600 |             |            |
| 21010-43G29 | VKPC 92651 | 21010-H7225 | VKPC 92203 |             |            |
| 21010-43G87 | VKPC 92651 | 21010-H7226 | VKPC 92203 |             |            |
| 21010-43G88 | VKPC 92651 | 21010-H7227 | VKPC 92203 |             |            |
| 21010-50A25 | VKPC 92205 | 21010-N5826 | VKPC 92630 |             |            |
| 21010-50A26 | VKPC 92205 | 21010-N5827 | VKPC 92630 |             |            |
| 21010-50A27 | VKPC 92205 | 21010-N5828 | VKPC 92630 |             |            |
| 21010-50A94 | VKPC 92205 | 21010-N5829 | VKPC 92630 |             |            |
| 21010-50V25 | VKPC 92601 | 21010-P7503 | VKPC 92802 |             |            |
| 21010-53J00 | VKPC 92412 | 21010-P7525 | VKPC 92802 |             |            |
| 21010-53Y00 | VKPC 92408 | 21010-P7526 | VKPC 92802 |             |            |
| 21010-53Y01 | VKPC 92408 | 21010-P7527 | VKPC 92802 |             |            |
| 21010-54A25 | VKPC 92422 | 21010-P7528 | VKPC 92802 |             |            |
| 21010-54A26 | VKPC 92422 | 21010-P7585 | VKPC 92802 |             |            |
| 21010-57J25 | VKPC 92928 | 21010-P7586 | VKPC 92802 |             |            |
| 21010-57J26 | VKPC 92928 | 21010-P7587 | VKPC 92802 |             |            |
| 21010-57J27 | VKPC 92928 | 21010-P7588 | VKPC 92802 |             |            |
| 21010-57J28 | VKPC 92928 | 21010-R7400 | VKPC 82201 |             |            |
| 21010-59Y25 | VKPC 92001 | 21010-V0725 | VKPC 92802 |             |            |
|             |            |             |            | <b>OPEL</b> |            |
|             |            |             |            | 02898355    | VKPC 85600 |
|             |            |             |            | 09292375    | VKPC 85203 |
|             |            |             |            | 12 04 641   | VKM 35015  |
|             |            |             |            | 12 06 990   | VKM 35011  |
|             |            |             |            | 13 34 004   | VKPC 85202 |
|             |            |             |            | 13 34 008   | VKPC 85407 |
|             |            |             |            | 13 34 009   | VKPC 85603 |
|             |            |             |            | 13 34 010   | VKPC 85206 |
|             |            |             |            | 13 34 011   | VKPC 85401 |
|             |            |             |            | 13 34 012   | VKPC 85406 |
|             |            |             |            | 13 34 013   | VKPC 85400 |
|             |            |             |            | 13 34 014   | VKPC 85408 |
|             |            |             |            | 13 34 015   | VKPC 85406 |
|             |            |             |            | 13 34 016   | VKPC 85403 |
|             |            |             |            | 13 34 017   | VKPC 85610 |
|             |            |             |            | 13 34 021   | VKPC 85603 |
|             |            |             |            | 13 34 023   | VKPC 85202 |
|             |            |             |            | 13 34 024   | VKPC 85401 |
|             |            |             |            | 13 34 025   | VKPC 85206 |



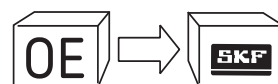
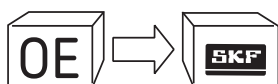
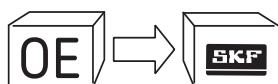

|           |            |           |                |           |               |
|-----------|------------|-----------|----------------|-----------|---------------|
| 13 34 027 | VKPC 85201 | 13 40 540 | VKM 38225      | 16 06 191 | VKMA 05222    |
| 13 34 031 | VKPC 85404 | 13 40 541 | VKM 35009      | 16 06 192 | VKMA 05222    |
| 13 34 032 | VKPC 85600 | 13 40 543 | VKM 38220      | 16 06 193 | VKMA 05220    |
| 13 34 034 | VKPC 85410 | 13 40 544 | VKM 35009      | 16 06 194 | VKMA 05224    |
| 13 34 035 | VKPC 85600 | 13 40 545 | VKM 35007      | 16 06 195 | VKMA 05223    |
| 13 34 038 | VKPC 85610 | 13 40 547 | VKM 35500      | 16 06 196 | VKMA 05140    |
| 13 34 041 | VKPC 85611 | 13 40 550 | VKM 35013      | 16 06 197 | VKMA 05211    |
| 13 34 045 | VKPA 85605 | 13 40 551 | VKM 35013      | 16 06 198 | VKMA 05228    |
| 13 34 046 | VKPC 85212 | 13 40 555 | VKM 35012      | 16 06 199 | VKMA 05228    |
| 13 34 050 | VKPC 85611 | 13 40 600 | VKMV 6PK1250   | 16 06 262 | VKMA 05154    |
| 13 34 052 | VKPC 85404 | 13 40 611 | VKMV 5PK1815   | 16 06 274 | VKMA 05150    |
| 13 34 053 | VKPC 85611 | 13 40 612 | VKMV 10AVx913  | 16 06 281 | VKMA 05152    |
| 13 34 054 | VKPC 85409 | 13 40 613 | VKMV 6PK1725   | 16 06 306 | VKMA 05156    |
| 13 34 058 | VKPC 85203 | 13 40 615 | VKMV 6PK2020   | 18 54 421 | VKM 35025     |
| 13 34 059 | VKPC 85613 | 13 40 617 | VKMV 6PK1460   | 18 54 711 | VKMV 10AVx888 |
| 13 34 065 | VKPC 85206 | 13 40 618 | VKMV 6PK1530   | 18 54 712 | VKMV 10AVx875 |
| 13 34 066 | VKPC 85212 | 13 40 619 | VKMV 6PK895    | 18 54 714 | VKMV 6PK2020  |
| 13 34 067 | VKPC 85308 | 13 40 622 | VKMV 10AVx925  | 18 54 725 | VKMV 4PK781   |
| 13 34 069 | VKPC 85620 | 13 40 625 | VKMV 6PK1902   | 18 54 728 | VKMV 6PK2020  |
| 13 34 070 | VKPC 85202 | 13 40 626 | VKMV 6PK1805   | 18 55 750 | VKMV 6PK2050  |
| 13 34 071 | VKPC 85201 | 13 40 629 | VKMV 5PK1230   | 24409355  | VKPC 85611    |
| 13 34 072 | VKPC 85600 | 13 40 635 | VKMV 5PK1212   | 24412292  | VKM 35009     |
| 13 34 073 | VKPC 85300 | 13 40 636 | VKMV 5PK1680   | 24413292  | VKMV 6PK1902  |
| 13 34 075 | VKPC 85308 | 13 40 637 | VKMV 5PK938    | 24413293  | VKMV 6PK1805  |
| 13 34 077 | VKPC 85211 | 13 40 638 | VKMV 6PK1850   | 24413294  | VKMV 6PK1873  |
| 13 34 078 | VKPC 85460 | 13 40 640 | VKMV 4PK882    | 24426500  | VKM 15216     |
| 13 34 079 | VKPC 85220 | 13 40 642 | VKMV 5PK1230   | 24430296  | VKM 34027     |
| 13 34 081 | VKPC 85600 | 13 40 643 | VKMV 6PK1530   | 24435940  | VKMV 5PK1028  |
| 13 34 082 | VKPC 88430 | 13 40 644 | VKMV 6PK895    | 24435953  | VKMV 5PK880   |
| 13 34 083 | VKPC 85308 | 13 40 645 | VKMV 6PK1460   | 24447794  | VKM 15260     |
| 13 34 084 | VKPC 85400 | 13 40 646 | VKMV 6PK1795   | 24466972  | VKMV 5PK1028  |
| 13 34 087 | VKPA 85605 | 13 40 647 | VKMV 6PK1900   | 24466976  | VKMV 5PK880   |
| 13 34 097 | VKPA 85608 | 13 40 648 | VKMV 6PK1725   | 24466979  | VKMV 5PK880   |
| 13 34 099 | VKPC 85406 | 13 40 649 | VKMV 6PK2020   | 24469102  | VKPC 85310    |
| 13 34 101 | VKPC 88826 | 13 40 652 | VKMV 5PK1680   | 30 09 003 | VKMV 10AVx875 |
| 13 34 102 | VKPC 85410 | 13 40 657 | VKMV 5PK1255   | 30 13 021 | VKMV 10AVx925 |
| 13 34 104 | VKPA 85605 | 13 40 658 | VKMV 5PK1212   | 44 00 204 | VKM 22380     |
| 13 34 105 | VKPC 85404 | 13 40 660 | VKMV 5PK1028   | 44 01 416 | VKM 16551     |
| 13 34 107 | VKPC 85410 | 13 40 662 | VKMV 6PK1590   | 44 01 428 | VKMA 06503    |
| 13 34 112 | VKPC 88826 | 13 40 663 | VKMV 6PK1902   | 44 01 430 | VKM 16503     |
| 13 34 113 | VKPA 85605 | 13 40 664 | VKMV 6PK1805   | 44 01 595 | VKPC 86305    |
| 13 34 114 | VKPC 85621 | 13 40 665 | VKMV 6PK1873   | 44 01 609 | VKM 16101     |
| 13 34 115 | VKPC 85620 | 13 40 666 | VKMV 6PK1863   | 44 02 631 | VKM 16551     |
| 13 34 117 | VKPC 85623 | 13 40 667 | VKMV 5PK1028   | 44 03 144 | VKM 22385     |
| 13 34 121 | VKPC 85622 | 13 40 671 | VKMV 5PK1355   | 44 03 270 | VKM 26101     |
| 13 34 123 | VKPC 82810 | 13 40 672 | VKMV 5PK1355   | 44 04 088 | VKPC 82630    |
| 13 34 124 | VKPC 88826 | 13 40 674 | VKMV 5PK1028   | 44 04 098 | VKPC 86413    |
| 13 34 130 | VKPC 85220 | 13 40 675 | VKMV 5PK880    | 44 04 308 | VKPC 82630    |
| 13 34 131 | VKPC 85613 | 13 40 677 | VKMV 5PK1028   | 44 08 028 | VKPC 85304    |
| 13 34 135 | VKPC 85624 | 13 40 678 | VKMV 5PK880    | 44 08 922 | VKM 16113     |
| 13 34 137 | VKPC 85611 | 13 40 681 | VKMV 13AVx915  | 44 09 162 | VKPC 86413    |
| 13 34 139 | VKPC 85611 | 13 40 683 | VKMV 6PK1600   | 44 09 485 | VKMA 06127    |
| 13 34 140 | VKPC 85613 | 13 40 714 | VKMV 10AVx913  | 44 10 172 | VKMV 6PK1792  |
| 13 34 143 | VKPC 85300 | 13 40 720 | VKMV 10AVx1000 | 44 10 513 | VKM 16113     |
| 13 34 145 | VKPC 85310 | 13 40 727 | VKMV 13AVx915  | 44 10 548 | VKM 26105     |
| 13 34 147 | VKPC 82667 | 13 40 728 | VKMV 6PK1460   | 44 10 595 | VKM 36031     |
| 13 34 646 | VKPC 85611 | 13 40 729 | VKMV 10AVx925  | 44 11 707 | VKM 36030     |
| 13 40 530 | VKM 35007  | 13 40 732 | VKMV 10AVx1000 | 44 11 717 | VKMV 5PK1125  |
| 13 40 533 | VKM 35008  | 13 40 737 | VKMV 10AVx1025 | 44 13 791 | VKM 36038     |
| 13 40 534 | VKM 35009  | 13 40 739 | VKMV 10AVx900  | 44 14 654 | VKM 36040     |
| 13 40 535 | VKM 35002  | 13 40 743 | VKMV 6PK1725   | 44 30 891 | VKMA 06127    |
| 13 40 536 | VKM 35500  | 13 40 747 | VKMV 6PK895    | 45 00 034 | VKMV 6PK860   |
| 13 40 539 | VKM 38220  | 13 40 827 | VKM 35016      | 45 00 056 | VKMV 6PK841   |

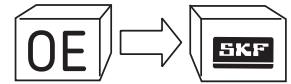
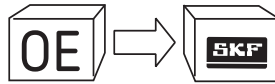
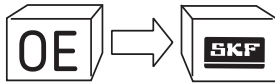

|           |              |           |              |           |                |
|-----------|--------------|-----------|--------------|-----------|----------------|
| 45 00 955 | VKM 36017    | 56 36 746 | VKM 15140    | 63 40 602 | VKMV 6PK1992   |
| 45 01 293 | VKPC 85302   | 56 36 755 | VKM 25226    | 63 40 605 | VKMV 5PK1450   |
| 45 01 294 | VKPC 85303   | 56 36 756 | VKM 25222    | 63 40 606 | VKMV 5PK1546   |
| 45 06 045 | VKPC 86305   | 6 14 533  | VKM 34027    | 63 40 609 | VKMV 5PK1028   |
| 45 06 090 | VKM 16503    | 6 36 383  | VKM 79002    | 63 40 610 | VKMV 5PK880    |
| 45 06 092 | VKM 26503    | 6 36 415  | VKM 25212    | 63 40 613 | VKMV 5PK1368   |
| 45 06 181 | VKMV 6PK1795 | 6 36 416  | VKM 25213    | 63 40 615 | VKMV 6PK1182   |
| 45 06 189 | VKMV 6PK1148 | 6 36 418  | VKM 25202    | 63 40 617 | VKMV 6PK1275   |
| 45 06 194 | VKM 36040    | 6 36 420  | VKM 25312    | 63 40 618 | VKMV 6PK1605   |
| 55185074  | VKM 35023    | 6 36 421  | VKM 25200    | 63 40 619 | VKMV 6PK1050   |
| 55185077  | VKMV 6PK1182 | 6 36 422  | VKM 25201    | 63 40 620 | VKMV 6PK1410   |
| 55190813  | VKM 32046    | 6 36 423  | VKM 25211    | 63 40 621 | VKMV 6PK1902   |
| 55350420  | VKMV 5PK1450 | 6 36 429  | VKM 15402    | 63 40 622 | VKMV 6PK1880   |
| 55350421  | VKMV 5PK1546 | 6 36 671  | VKMA 05500   | 63 40 623 | VKMV 6PK1805   |
| 55350422  | VKM 35260    | 6 36 723  | VKM 15230    | 63 40 624 | VKMV 7PK1922   |
| 55350580  | VKM 25158    | 6 36 726  | VKM 15202    | 63 40 625 | VKMV 6PK1620   |
| 55350960  | VKM 35016    | 6 36 727  | VKM 15402    | 63 40 626 | VKMV 5PK1212   |
| 55351458  | VKMV 5PK1028 | 6 36 728  | VKMA 05500   | 63 40 627 | VKMV 5PK1212   |
| 55351459  | VKMV 5PK880  | 6 36 729  | VKM 15230    | 63 40 628 | VKMV 13AVx915  |
| 55352021  | VKM 35013    | 6 36 730  | VKM 25208    | 63 40 632 | VKMV 10AVx913  |
| 55353810  | VKM 15140    | 6 36 730  | VKM 25209    | 63 40 639 | VKMV 5PK1230   |
| 55354680  | VKMV 6PK1902 | 6 36 731  | VKM 15210    | 63 40 640 | VKMV 5PK1355   |
| 55354681  | VKMV 6PK1880 | 6 36 732  | VKM 15211    | 63 40 646 | VKMV 5PK1028   |
| 55354682  | VKMV 6PK1805 | 6 36 734  | VKM 15121    | 63 40 648 | VKMV 10AVx950  |
| 55555653  | VKM 15260    | 6 36 735  | VKM 15213    | 63 40 656 | VKMV 5PK938    |
| 55556090  | VKM 35260    | 6 36 737  | VKM 15202    | 63 40 660 | VKMV 5PK1680   |
| 55560052  | VKMV 5PK1570 | 6 36 740  | VKM 15121    | 63 40 663 | VKMV 6PK1050   |
| 56 36 384 | VKM 15140    | 6 36 741  | VKM 15215    | 63 40 667 | VKMV 5PK1255   |
| 56 36 385 | VKMA 05501   | 6 36 742  | VKM 15210    | 63 40 668 | VKMV 6PK1600   |
| 56 36 393 | VKMA 05502   | 6 36 745  | VKM 15215    | 63 40 669 | VKMV 6PK1620   |
| 56 36 395 | VKM 25208    | 6 36 746  | VKM 15402    | 63 40 671 | VKMV 6PK1250   |
| 56 36 395 | VKM 25209    | 6 36 747  | VKM 25208    | 63 40 672 | VKMV 6PK1615   |
| 56 36 403 | VKM 15218    | 6 36 747  | VKM 25209    | 63 40 677 | VKMV 5PK1570   |
| 56 36 404 | VKM 15220    | 6 36 748  | VKM 15121    | 8 15 971  | VKM 89003      |
| 56 36 412 | VKM 35214    | 6 36 749  | VKM 15121    | 9 50 358  | VKMV 10AVx875  |
| 56 36 415 | VKM 25150    | 62 04 661 | VKM 35015    | 9 50 361  | VKMV 10AVx850  |
| 56 36 416 | VKM 25152    | 63 34 000 | VKPC 85611   | 9 50 365  | VKMV 10AVx800  |
| 56 36 419 | VKM 25150    | 63 34 001 | VKPC 85700   | 9 50 371  | VKMV 10AVx813  |
| 56 36 423 | VKM 25224    | 63 34 002 | VKPC 85308   | 9 50 376  | VKMV 10AVx875  |
| 56 36 424 | VKM 25202    | 63 34 003 | VKPC 82665   | 9 50 380  | VKMV 10AVx950  |
| 56 36 425 | VKM 25212    | 63 34 004 | VKPC 85410   | 90006259  | VKMV 10AVx875  |
| 56 36 426 | VKM 25152    | 63 34 005 | VKPC 85621   | 90006267  | VKMV 10AVx913  |
| 56 36 427 | VKM 25150    | 63 34 008 | VKPC 85620   | 90007451  | VKPA 85608     |
| 56 36 429 | VKM 15402    | 63 34 011 | VKPC 85403   | 90076952  | VKPC 85202     |
| 56 36 434 | VKM 25226    | 63 34 015 | VKPA 85605   | 90091035  | VKPC 85201     |
| 56 36 435 | VKM 25222    | 63 34 019 | VKPC 85300   | 90124093  | VKPC 85403     |
| 56 36 437 | VKM 35212    | 63 34 022 | VKPC 85220   | 90136224  | VKPC 85600     |
| 56 36 451 | VKM 15260    | 63 34 024 | VKPC 85300   | 90169081  | VKMV 10AVx875  |
| 56 36 455 | VKM 25158    | 63 34 025 | VKPC 85220   | 90169084  | VKMV 10AVx850  |
| 56 36 456 | VKM 12174    | 63 34 035 | VKPC 85211   | 90180131  | VKM 25200      |
| 56 36 475 | VKM 12174    | 63 34 038 | VKPC 85620   | 90183273  | VKPC 85202     |
| 56 36 722 | VKM 15121    | 63 34 039 | VKPC 85460   | 90220568  | VKPC 85407     |
| 56 36 724 | VKM 15215    | 63 34 040 | VKPC 85623   | 90231797  | VKMV 10AVx1000 |
| 56 36 725 | VKM 15260    | 63 34 048 | VKPC 85300   | 90234200  | VKPC 85401     |
| 56 36 732 | VKM 15216    | 63 40 532 | VKM 35009    | 90264022  | VKM 25201      |
| 56 36 733 | VKM 15216    | 63 40 538 | VKM 35500    | 90272361  | VKPC 85407     |
| 56 36 738 | VKM 15202    | 63 40 551 | VKM 35016    | 90273924  | VKPC 85400     |
| 56 36 739 | VKM 15218    | 63 40 552 | VKM 35260    | 90280872  | VKMV 10AVx800  |
| 56 36 740 | VKM 15216    | 63 40 553 | VKM 35013    | 90281612  | VKPC 85610     |
| 56 36 741 | VKM 35216    | 63 40 554 | VKM 35023    | 9028200   | VKM 15402      |
| 56 36 743 | VKM 22179    | 63 40 557 | VKM 32046    | 90284802  | VKPC 85400     |
| 56 36 743 | VKM 22180    | 63 40 558 | VKM 35260    | 90284813  | VKPC 85408     |
| 56 36 745 | VKM 12174    | 63 40 600 | VKMV 5PK1240 | 90284913  | VKPC 85408     |





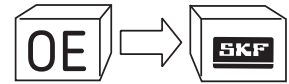
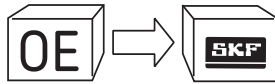
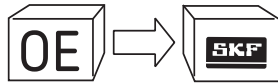

|          |                |          |               |          |              |
|----------|----------------|----------|---------------|----------|--------------|
| 90285418 | VKPC 85406     | 90530124 | VKM 15402     | 9192568  | VKMV 5PK1255 |
| 90285679 | VKMV 6PK1460   | 90530125 | VKM 15202     | 9192793  | VKPC 85206   |
| 90295077 | VKPC 85406     | 90530126 | VKM 15230     | 9192797  | VKPC 85212   |
| 90295078 | VKPC 85408     | 90531965 | VKM 35013     | 9194660  | VKMV 5PK1212 |
| 90323501 | VKM 15211      | 90531986 | VKM 35013     | 9194661  | VKMV 5PK1212 |
| 90323503 | VKM 25211      | 90540478 | VKPC 85623    | 9194747  | VKPC 85308   |
| 90324217 | VKPC 85603     | 90541671 | VKPC 88826    | 9195191  | VKMV 5PK1028 |
| 90325659 | VKPC 85202     | 90542606 | VKPC 85220    | 9196547  | VKMV 6PK1863 |
| 90325661 | VKPC 85401     | 90542748 | VKMV 5PK1230  | 9198522  | VKMV 6PK1148 |
| 90341998 | VKPC 85404     | 90543277 | VKPC 85613    | 9198527  | VKM 36040    |
| 90348231 | VKPC 85603     | 90543935 | VKPC 85624    | 9198828  | VKMV 5PK1355 |
| 90349239 | VKPC 85206     | 90570525 | VKM 15121     | 9198829  | VKMV 5PK1355 |
| 90349240 | VKPC 85401     | 90570913 | VKM 25150     | 9199592  | VKPC 85211   |
| 90349241 | VKPC 85202     | 90571757 | VKMV 4PK882   | 9199595  | VKPC 85460   |
| 90353137 | VKMV 10AVx925  | 90571758 | VKM 35012     | 9201450  | VKPC 86305   |
| 90353176 | VKM 15121      | 9108204  | VKM 22380     | 9201537  | VKM 16503    |
| 90397190 | VKMV 10AVx925  | 9109416  | VKM 16551     | 9201540  | VKM 26503    |
| 90409238 | VKM 35002      | 9109428  | VKMA 06503    | 9201679  | VKMV 5PK1028 |
| 90409783 | VKM 35500      | 9109430  | VKM 16503     | 9201887  | VKMA 05501   |
| 90409912 | VKPC 85201     | 9109595  | VKPC 86305    | 9202478  | VKM 15121    |
| 90410386 | VKMV 10AVx888  | 9109609  | VKM 16101     | 9202550  | VKM 35500    |
| 90411009 | VKMV 10AVx1025 | 9110631  | VKM 16551     | 92061745 | VKMV 6PK2050 |
| 90411025 | VKM 35008      | 9111144  | VKM 22385     | 92063403 | VKMV 6PK1850 |
| 90411773 | VKM 25213      | 9111270  | VKM 26101     | 92064250 | VKPC 85611   |
| 90411774 | VKM 15202      | 9112088  | VKPC 82630    | 92065368 | VKM 15140    |
| 90411782 | VKM 25212      | 9112098  | VKPC 86413    | 92065969 | VKPC 85611   |
| 90411787 | VKM 25202      | 9112308  | VKPC 82630    | 9240033  | VKM 25312    |
| 90412730 | VKM 25152      | 91142246 | VKMV 10AVx875 | 93160191 | VKMV 6PK1792 |
| 90412731 | VKM 25150      | 91151669 | VKPC 82810    | 93160237 | VKM 16113    |
| 90412884 | VKM 35011      | 91158706 | VKMA 06127    | 93160244 | VKM 26105    |
| 90442207 | VKPC 85610     | 91159773 | VKPC 85304    | 93160256 | VKM 36031    |
| 90443549 | VKPC 85611     | 91160164 | VKM 16113     | 93160750 | VKMV 5PK1125 |
| 90444079 | VKPC 85212     | 91160212 | VKPC 86413    | 93160779 | VKM 36040    |
| 90444123 | VKPC 85409     | 9117585  | VKMV 5PK1212  | 93161273 | VKM 36038    |
| 90444311 | VKPC 85611     | 9117587  | VKMV 5PK1680  | 93161478 | VKMA 06127   |
| 90444486 | VKMV 10AVx813  | 9117588  | VKMV 5PK1680  | 93170142 | VKPC 85220   |
| 90444649 | VKPC 85613     | 9117589  | VKMV 5PK938   | 93170401 | VKPC 85308   |
| 90448002 | VKMV 6PK2020   | 9117695  | VKM 15121     | 93170697 | VKPC 85613   |
| 90448698 | VKMV 10AVx900  | 9118612  | VKMV 5PK1230  | 93171540 | VKPC 88430   |
| 90486316 | VKMV 6PK895    | 9118613  | VKMV 6PK1530  | 93172354 | VKMA 05502   |
| 90499401 | VKM 15121      | 9118614  | VKMV 6PK895   | 93172363 | VKMV 5PK1240 |
| 90500229 | VKM 35009      | 9118616  | VKMV 6PK1460  | 93172395 | VKMV 6PK1992 |
| 90500354 | VKMV 6PK2020   | 9118617  | VKMV 6PK1795  | 93172718 | VKPC 85308   |
| 90501384 | VKMV 6PK1460   | 9118618  | VKMV 6PK1900  | 93174260 | VKMA 05222   |
| 90502129 | VKM 35009      | 9118619  | VKMV 6PK1725  | 93174261 | VKMA 05222   |
| 90502286 | VKMV 10AVx925  | 9118620  | VKMV 6PK2020  | 93174262 | VKMA 05220   |
| 90502421 | VKM 35007      | 9120501  | VKMA 05500    | 93174263 | VKMA 05224   |
| 90502734 | VKMV 6PK1902   | 9128516  | VKM 15216     | 93174264 | VKMA 05223   |
| 90502735 | VKMV 6PK1805   | 9128656  | VKM 15216     | 93174265 | VKMA 05140   |
| 90509273 | VKM 38220      | 9128738  | VKM 25212     | 93174266 | VKMA 05211   |
| 90509282 | VKM 38225      | 9128739  | VKM 25152     | 93174267 | VKMA 05228   |
| 90509315 | VKMV 5PK1815   | 9128740  | VKM 25150     | 93174268 | VKMA 05228   |
| 90510025 | VKMV 10AVx913  | 9128741  | VKM 25202     | 93175325 | VKMV 6PK1880 |
| 90510610 | VKMV 6PK1530   | 9158003  | VKM 15402     | 93177340 | VKPC 85700   |
| 90510611 | VKMV 6PK895    | 9158004  | VKM 15202     | 93177561 | VKMV 5PK1368 |
| 90511627 | VKM 38220      | 9160334  | VKMV 6PK860   | 93178602 | VKPC 85308   |
| 90512535 | VKPC 88826     | 9160356  | VKMV 6PK841   | 93178713 | VKPC 82665   |
| 90512538 | VKMV 4PK781    | 9161255  | VKM 36017     | 93178807 | VKM 22179    |
| 90528200 | VKM 15402      | 9161593  | VKPC 85302    | 93178807 | VKM 22180    |
| 90528603 | VKM 15230      | 9161594  | VKPC 85303    | 93178816 | VKM 12174    |
| 90528760 | VKM 35500      | 9162107  | VKMA 02386    | 93179102 | VKMV 6PK1050 |
| 90528761 | VKMV 6PK2020   | 9180809  | VKM 35007     | 93179109 | VKMV 6PK1410 |
| 90529810 | VKM 25224      | 9192370  | VKPC 85611    | 93179114 | VKPC 82667   |





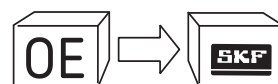
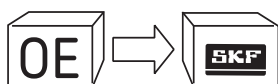
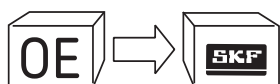

|         |            |         |            |         |                |
|---------|------------|---------|------------|---------|----------------|
| 0830.60 | VKM 23258  | 1201.33 | VKPC 83603 | 1201.69 | VKPC 83259     |
| 0830.61 | VKM 23130  | 1201.35 | VKPC 83423 | 1201.H5 | VKPC 82652     |
| 0830.62 | VKM 23256  | 1201.36 | VKPC 83617 | 1201.J2 | VKPC 83650     |
| 0830.63 | VKM 23246  | 1201.37 | VKPC 83617 | 1202.19 | VKPC 83203     |
| 0831.01 | VKMA 03050 | 1201.38 | VKPC 83628 | 1202.29 | VKPC 83203     |
| 0831.02 | VKMA 03100 | 1201.39 | VKPC 83401 | 1202.40 | VKPC 83203     |
| 0831.03 | VKMA 03110 | 1201.40 | VKPC 83630 | 1202.42 | VKPC 83604     |
| 0831.04 | VKMA 03120 | 1201.42 | VKPC 83604 | 1202.50 | VKPC 83203     |
| 0831.05 | VKMA 03200 | 1201.45 | VKPC 83206 | 1202.55 | VKPC 83203     |
| 0831.06 | VKMA 03201 | 1201.48 | VKPC 83424 | 1202.58 | VKPC 83200     |
| 0831.07 | VKMA 03210 | 1201.50 | VKPC 83615 | 1202.60 | VKPC 83424     |
| 0831.08 | VKMA 03220 | 1201.51 | VKPC 83424 | 1202.61 | VKPC 83612     |
| 0831.09 | VKMA 03240 | 1201.52 | VKPC 83420 | 1202.67 | VKPC 83203     |
| 0831.10 | VKMA 03250 | 1201.54 | VKPC 83425 | 1202.70 | VKPC 83612     |
| 0831.11 | VKMA 03251 | 1201.55 | VKPC 83425 | 1202.71 | VKPC 83612     |
| 0831.24 | VKMA 03111 | 1201.58 | VKPC 83428 | 1202.73 | VKPC 83616     |
| 0831.25 | VKMA 03211 | 1201.59 | VKPC 83401 | 1202.74 | VKPC 83616     |
| 0831.26 | VKMA 03121 | 1201.60 | VKPC 83424 | 1202.82 | VKPC 83618     |
| 0831.27 | VKMA 03241 | 1201.61 | VKPC 83615 | 1202.85 | VKPC 83616     |
| 0831.32 | VKMA 03213 | 1201.62 | VKPC 83424 | 1202.86 | VKPC 83616     |
| 0831.34 | VKMA 03202 | 1201.63 | VKPC 83401 | 1202.88 | VKPC 83622     |
| 0831.36 | VKMA 03300 | 1201.65 | VKPC 83420 | 1202.91 | VKPC 83622     |
| 0831.40 | VKMA 03246 | 1201.67 | VKPC 83420 | 1202.93 | VKPC 83625     |
| 0831.43 | VKMA 03213 | 1201.69 | VKPC 83200 | 1202.94 | VKPC 83624     |
| 0831.44 | VKMA 03120 | 1201.70 | VKPC 83810 | 1202.95 | VKPC 83622     |
| 0831.46 | VKMA 03121 | 1201.73 | VKPC 83200 | 1202.97 | VKPC 83618     |
| 0831.48 | VKMA 03213 | 1201.74 | VKPC 83423 | 1202.98 | VKPC 83403     |
| 0831.50 | VKMA 03250 | 1201.76 | VKPC 83604 | 1202.99 | VKPC 83622     |
| 0831.52 | VKMA 03251 | 1201.79 | VKPC 83612 | 1204.34 | VKPC 83205     |
| 0831.57 | VKMA 03214 | 1201.85 | VKPC 83625 | 1207.18 | VKPC 83205     |
| 0831.58 | VKMA 03244 | 1201.87 | VKPC 83622 | 1207.23 | VKPC 83205     |
| 0831.60 | VKMA 03252 | 1201.91 | VKPC 83420 | 1207.25 | VKPC 83428     |
| 0831.62 | VKMA 03246 | 1201.93 | VKPC 83636 | 1280.01 | VKMV 10AVx888  |
| 0831.63 | VKMA 03304 | 1201.95 | VKPA 83431 | 1280.14 | VKMV 10AVx1000 |
| 0831.65 | VKMA 03235 | 1201.96 | VKPA 83432 | 1280.15 | VKMV 10AVx775  |
| 0831.67 | VKMA 03216 | 1201.97 | VKPC 83428 | 1280.25 | VKMV 4PK866    |
| 0831.69 | VKMA 03231 | 1201.98 | VKPC 83635 | 1280.26 | VKMV 4PK946    |
| 0831.71 | VKMA 03218 | 1201.A1 | VKPC 83636 | 1280.38 | VKMV 3PK866    |
| 0831.73 | VKMA 03248 | 1201.A2 | VKPC 83430 | 1280.40 | VKMV 3PK946    |
| 0831.76 | VKMA 03122 | 1201.A3 | VKPC 83810 | 1280.43 | VKMV 6PK895    |
| 0831.78 | VKMA 03247 | 1201.A4 | VKPC 83420 | 1280.50 | VKMV 6PK950    |
| 0831.80 | VKMA 03140 | 1201.A5 | VKPC 83811 | 1281.34 | VKM 33016      |
| 0831.82 | VKMA 03246 | 1201.A6 | VKPC 83637 | 1281.35 | VKM 33086      |
| 0831.84 | VKMA 03253 | 1201.A7 | VKPC 83425 | 1281.38 | VKM 33125      |
| 0831.86 | VKMA 03254 | 1201.A8 | VKPC 83420 | 1628.WA | VKM 33065      |
| 0831.88 | VKMA 03235 | 1201.C1 | VKPC 83425 | 1926.67 | VKM 13262      |
| 0831.90 | VKMA 03255 | 1201.C4 | VKPC 83639 | 4003.25 | VKMV 10AVx913  |
| 0831.92 | VKMA 03257 | 1201.C6 | VKPC 83425 | 4003.66 | VKMV 10AVx800  |
| 0831.93 | VKMA 03260 | 1201.C7 | VKPC 83637 | 4007.99 | VKMV 5PK881    |
| 0831.K3 | VKMA 03263 | 1201.C9 | VKPC 82652 | 4007.E4 | VKM 33015      |
| 0831.K4 | VKMA 03265 | 1201.E0 | VKPC 83425 | 4007.E7 | VKMV 6PK1198   |
| 0831.K6 | VKMA 03264 | 1201.E3 | VKPC 83205 | 4007.J3 | VKMV 10AVx690  |
| 0831.K8 | VKMA 03266 | 1201.E4 | VKPC 83428 | 4009.06 | VKMV 10AVx1025 |
| 0831.L0 | VKMA 03130 | 1201.E5 | VKPC 83430 | 4009.22 | VKMV 10AVx650  |
| 0831.L2 | VKMA 03256 | 1201.E6 | VKPC 83428 | 4025.09 | VKMV 4PK908    |
| 0831.L4 | VKMA 03258 | 1201.E8 | VKPC 83643 | 4025.10 | VKMV 4PK1538   |
| 0831.L6 | VKMA 03132 | 1201.F5 | VKPC 83650 | 4569.04 | VKMV 10AVx650  |
| 0831.L8 | VKMA 03902 | 1201.F9 | VKPC 83140 | 4569.12 | VKMV 10AVx550  |
| 0831.N2 | VKMA 03244 | 1201.G0 | VKPC 83644 | 4569.15 | VKMV 10AVx613  |
| 0831.N4 | VKMA 03247 | 1201.G1 | VKPC 83259 | 4569.17 | VKMV 10AVx600  |
| 0831.P1 | VKMA 03259 | 1201.G2 | VKPC 83258 | 5750.37 | VKMV 10AVx775  |
| 1201.29 | VKPC 83203 | 1201.G5 | VKPC 83650 | 5750.53 | VKMV 10AVx700  |
| 1201.32 | VKPC 83624 | 1201.G8 | VKPC 83140 | 5750.55 | VKMV 4PK698    |

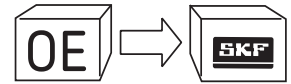
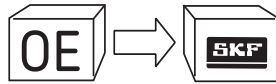
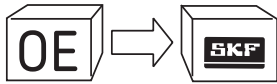

|         |               |         |              |         |              |
|---------|---------------|---------|--------------|---------|--------------|
| 5750.63 | VKMM 10AVx925 | 5750.KZ | VKMM 6PK1468 | 5751.29 | VKM 33013    |
| 5750.70 | VKMM 4PK954   | 5750.L3 | VKMM 6PK1155 | 5751.30 | VKM 33029    |
| 5750.73 | VKMM 10AVx710 | 5750.L9 | VKMM 6PK1160 | 5751.31 | VKM 33311    |
| 5750.75 | VKMM 5PK1010  | 5750.LC | VKMM 6PK728  | 5751.32 | VKM 33022    |
| 5750.76 | VKMM 4PK795   | 5750.LE | VKMM 6PK1217 | 5751.33 | VKM 33025    |
| 5750.78 | VKMM 4PK1230  | 5750.LG | VKMM 6PK1710 | 5751.34 | VKM 33035    |
| 5750.79 | VKMM 5PK967   | 5750.M1 | VKMM 6PK1603 | 5751.35 | VKM 33028    |
| 5750.80 | VKMM 4PK855   | 5750.M4 | VKMM 6PK1102 | 5751.36 | VKM 33026    |
| 5750.81 | VKMM 5PK1230  | 5750.M6 | VKMM 6PK1726 | 5751.37 | VKM 33027    |
| 5750.83 | VKMM 5PK698   | 5750.PO | VKMM 4PK755  | 5751.38 | VKM 33002    |
| 5750.84 | VKMM 5PK1270  | 5750.PL | VKMM 6PK1049 | 5751.43 | VKM 33311    |
| 5750.87 | VKMM 5PK1140  | 5750.PP | VKMM 6PK1069 | 5751.44 | VKM 33311    |
| 5750.88 | VKMM 5PK710   | 5750.PR | VKMM 6PK1564 | 5751.45 | VKM 33004    |
| 5750.89 | VKMM 5PK1125  | 5750.PS | VKMM 6PK1887 | 5751.46 | VKM 33017    |
| 5750.92 | VKMM 5PK740   | 5750.PV | VKMM 6PK733  | 5751.50 | VKM 33018    |
| 5750.94 | VKMM 4PK720   | 5750.Q1 | VKMM 5PK1050 | 5751.51 | VKM 33023    |
| 5750.98 | VKMM 6PK1067  | 5750.QE | VKMM 6PK872  | 5751.52 | VKM 33037    |
| 5750.A0 | VKMM 6PK1094  | 5750.QG | VKMM 6PK966  | 5751.53 | VKM 33021    |
| 5750.A1 | VKMM 6PK1660  | 5750.QP | VKMM 6PK998  | 5751.54 | VKM 33311    |
| 5750.A2 | VKMM 6PK1076  | 5750.QQ | VKMM 6PK872  | 5751.55 | VKM 33033    |
| 5750.A5 | VKMM 6PK698   | 5750.QS | VKMM 6PK1182 | 5751.56 | VKM 33024    |
| 5750.A6 | VKMM 6PK1130  | 5750.QW | VKMM 6PK1590 | 5751.57 | VKM 33069    |
| 5750.C0 | VKMM 5PK1151  | 5750.RC | VKMM 6PK1217 | 5751.59 | VKM 33017    |
| 5750.C1 | VKMM 6PK1170  | 5750.RS | VKMM 6PK1160 | 5751.60 | VKM 33020    |
| 5750.C3 | VKMM 6PK730   | 5750.RZ | VKMM 6PK1205 | 5751.61 | VKM 33019    |
| 5750.C4 | VKMM 5PK850   | 5750.S0 | VKMM 6PK1739 | 5751.62 | VKM 33017    |
| 5750.C5 | VKMM 5PK770   | 5750.T1 | VKMM 6PK1451 | 5751.63 | VKM 33017    |
| 5750.D0 | VKMM 5PK1195  | 5750.T3 | VKMM 6PK1564 | 5751.67 | VKM 33017    |
| 5750.D2 | VKMM 5PK715   | 5750.T5 | VKMM 6PK1468 | 5751.72 | VKM 33017    |
| 5750.D4 | VKMM 5PK1160  | 5750.T7 | VKMM 6PK1740 | 5751.73 | VKM 33031    |
| 5750.D7 | VKMM 5PK690   | 5750.VJ | VKMM 6PK1188 | 5751.74 | VKM 33032    |
| 5750.E6 | VKMM 6PK915   | 5750.VL | VKMM 6PK802  | 5751.75 | VKM 33075    |
| 5750.E7 | VKMM 6PK802   | 5750.VN | VKMM 6PK976  | 5751.76 | VKM 33045    |
| 5750.E8 | VKMM 6PK1012  | 5750.VP | VKMM 6PK1341 | 5751.81 | VKM 33311    |
| 5750.E9 | VKMM 6PK1151  | 5750.W1 | VKMM 6PK1042 | 5751.86 | VKM 33043    |
| 5750.EJ | VKMM 6PK1585  | 5750.W6 | VKMM 6PK1726 | 5751.87 | VKM 33044    |
| 5750.EX | VKMM 6PK1437  | 5750.W8 | VKMM 5PK780  | 5751.89 | VKM 33061    |
| 5750.FA | VKMM 6PK1726  | 5750.WA | VKMM 5PK775  | 5751.90 | VKM 33060    |
| 5750.FH | VKMM 6PK1205  | 5750.WC | VKMM 5PK960  | 5751.91 | VKM 33042    |
| 5750.FK | VKMM 6PK1188  | 5750.WP | VKMM 6PK1710 | 5751.92 | VKM 33314    |
| 5750.FL | VKMM 3PK740   | 5750.X0 | VKMM 6PK866  | 5751.95 | VKM 33314    |
| 5750.FN | VKMM 6PK872   | 5750.X1 | VKMM 6PK1030 | 5751.96 | VKM 33069    |
| 5750.FS | VKMM 6PK802   | 5750.X3 | VKMM 6PK1736 | 5751.97 | VKM 33101    |
| 5750.FV | VKMM 6PK976   | 5750.XG | VKMM 6PK998  | 5751.98 | VKM 33100    |
| 5750.FX | VKMM 6PK1341  | 5750.XN | VKMM 6PK1217 | 5751.A0 | VKM 33063    |
| 5750.FY | VKMM 6PK1705  | 5750.Y0 | VKMM 6PK866  | 5751.A1 | VKM 33064    |
| 5750.GG | VKMM 6PK1182  | 5750.Y5 | VKMM 6PK1706 | 5751.A2 | VKM 33101    |
| 5750.GL | VKMM 6PK1740  | 5750.YH | VKMM 6PK1670 | 5751.A7 | VKM 33320    |
| 5750.GN | VKMM 6PK1125  | 5750.Z0 | VKMM 6PK1451 | 5751.C3 | VKM 33074    |
| 5750.GP | VKMM 6PK1388  | 5750.Z2 | VKMM 6PK1564 | 5751.C9 | VKM 33100    |
| 5750.GR | VKMM 6PK1695  | 5750.Z4 | VKMM 6PK1736 | 5751.F1 | VKM 34030    |
| 5750.GW | VKMM 6PK1147  | 5750.Z6 | VKMM 6PK1750 | 6453.76 | VKM 33010    |
| 5750.GX | VKMM 6PK1156  | 5750.Z8 | VKMM 6PK1437 | 6453.AF | VKMM 5PK1020 |
| 5750.GY | VKMM 6PK1560  | 5751.07 | VKM 33091    | 6453.AN | VKM 33041    |
| 5750.HG | VKMM 6PK1744  | 5751.13 | VKM 33082    | 6453.CE | VKM 36001    |
| 5750.J9 | VKMM 6PK1700  | 5751.14 | VKM 33006    | 6453.CZ | VKMM 5PK1030 |
| 5750.K0 | VKMM 6PK1146  | 5751.18 | VKM 33003    | 6453.E5 | VKMM 4PK810  |
| 5750.K2 | VKMM 5PK775   | 5751.20 | VKM 33034    | 6453.E0 | VKM 33001    |
| 5750.K4 | VKMM 5PK960   | 5751.21 | VKM 33007    | 6453.KL | VKMM 4PK928  |
| 5750.K7 | VKMM 6PK1862  | 5751.23 | VKM 33040    | 6453.L2 | VKMM 4PK841  |
| 5750.K9 | VKMM 6PK1110  | 5751.24 | VKM 33008    | 6453.NY | VKMM 5PK1100 |
| 5750.KR | VKMM 6PK1680  | 5751.26 | VKM 33009    | 6453.R8 | VKM 33014    |
| 5750.KX | VKMM 6PK1560  | 5751.27 | VKM 33039    | 6453.S4 | VKM 33012    |



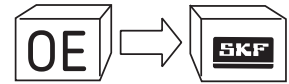
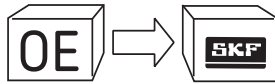
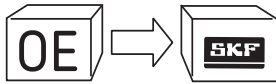

6453.S5  
6453.Y1  
6453.Y3  
9431142021  
  
96097691  
9618888580  
96216260  
9635336880  
9635438080  
  
9636640580  
9637058080  
9637877180  
9638380780  
9638976580  
  
9640828480  
9642658180  
9642929880  
9643329680  
9645209880  
  
9645925180  
9646247380  
9647834880  
9649675880  
9652073680  
  
9660098680

VKM 33012  
VKM 33038  
VKM 33083  
VKPC 83636  
  
VKM 13301  
VKM 33013  
VKM 33023  
VKM 13214  
VKM 13231  
  
VKM 33020  
VKM 13216  
VKM 13218  
VKM 33061  
VKM 33101  
  
VKM 13257  
VKM 33100  
VKM 13253  
VKM 13234  
VKM 13258  
  
VKM 13231  
VKM 13244  
VKM 33063  
VKM 33101  
VKM 33074  
  
VKM 23230

77 00 105 378  
77 00 106 101  
77 00 106 708  
77 00 107 150  
  
77 00 107 249  
77 00 107 493  
77 00 107 845  
77 00 108 589  
77 00 108 626  
  
77 00 109 477  
77 00 111 822  
77 00 111 841  
77 00 112 719  
77 00 114 352  
  
77 00 114 635  
77 00 114 730  
77 00 114 860  
77 00 115 070  
77 00 115 075  
  
77 00 115 862  
77 00 116 049  
77 00 116 050  
77 00 116 054  
77 00 116 192  
  
77 00 267 465  
77 00 267 945  
77 00 271 618  
77 00 271 648  
77 00 272 652

VKPC 86416  
VKPC 86633  
VKM 36026  
VKM 26020  
  
VKM 26125  
VKMV 5PK1110  
VKPC 86633  
VKMV 6PK1135  
VKM 26310  
  
VKMV 6PK1795  
VKM 16113  
VKPC 86633  
VKMV 6PK1209  
VKMV 6PK1400  
  
VKMV 6PK1125  
VKMV 6PK1127  
VKM 16550  
VKM 16101  
VKM 26115  
  
VKM 16551  
VKM 26101  
VKM 26102  
VKM 26128  
VKM 26115  
  
VKMV 5PK1450  
VKMV 13AVx925  
VKM 36014  
VKMV 6PK1545  
VKM 36004  
  
VKMV 4PK1165  
VKM 36005  
VKMV 4PK1272  
VKM 36053  
VKM 36081  
  
VKM 36080  
VKPC 86416  
VKMV 5PK1200  
VKMV 6PK860  
VKM 36064  
  
VKMV 6PK841  
VKMV 10AVx1000  
VKMV 10AVx625  
VKMV 10AVx600  
VKMV 10AVx1140  
  
VKM 16200  
VKMV 11.9x1010  
VKM 16110  
VKM 26100  
VKM 16100  
  
VKM 26211  
VKM 16212  
VKMV 6PK1710  
VKMV 6PK1915  
VKM 16101  
  
VKMV 4PK878  
VKMV 10AVx1150  
VKMV 5PK847  
VKM 26102  
VKMV 5PK884  
  
VKM 26101  
VKMV 6PK1690  
VKMV 6PK1462  
VKM 16000

77 00 736 091  
77 00 736 419  
77 00 738 035  
77 00 738 783  
77 00 742 336  
77 00 743 548  
77 00 743 549  
77 00 744 380  
77 00 744 961  
77 00 745 215  
77 00 745 397  
77 00 747 381  
77 00 749 104  
77 00 749 108  
77 00 749 115  
77 00 749 393  
77 00 850 113  
77 00 850 114  
77 00 850 603  
77 00 850 766  
77 00 851 321  
77 00 852 114  
77 00 852 410  
77 00 853 230  
77 00 853 550  
77 00 853 887  
77 00 853 990  
77 00 854 083  
77 00 854 373  
77 00 855 098  
77 00 856 068  
77 00 856 370  
77 00 857 065  
77 00 857 070  
77 00 857 071  
77 00 857 492  
77 00 858 358  
77 00 858 762  
77 00 859 638  
77 00 859 639  
77 00 859 931  
77 00 860 455  
77 00 860 463  
77 00 860 833  
77 00 860 884  
77 00 861 627  
77 00 861 686  
77 00 861 810  
77 00 862 108  
77 00 862 152  
77 00 862 173  
77 00 862 615  
77 00 862 743  
77 00 862 744  
77 00 862 888  
77 00 863 111  
77 00 863 112  
77 00 864 019  
77 00 864 572  
77 00 864 573  
77 00 864 596  
77 00 865 429  
77 00 865 588

VKPC 86409  
VKM 16112  
VKMV 6PK1095  
VKMV 6PK1416  
VKMV 10AVx690  
VKMV 6PK870  
VKMV 6PK1173  
VKMV 6PK1165  
VKMV 5PK850  
VKM 16204  
VKMV 6PK1007  
VKMV 6PK850  
VKMV 10AVx1005  
VKMV 10AVx1000  
VKMV 11.9x758  
VKMV 6PK903  
VKMV 3PK712  
VKMV 4PK1072  
VKM 36013  
VKMV 6PK1190  
VKM 36006  
VKM 16212  
VKM 36012  
VKMV 6PK1145  
VKM 26212  
VKMV 4PK1205  
VKMV 4PK1218  
VKMV 10AVx1250  
VKM 36002  
VKMV 6PK1740  
VKM 26212  
VKM 26212  
VKMV 6PK1165  
VKMV 6PK1658  
VKMV 6PK1425  
VKM 26500  
VKM 36007  
VKMV 10AVx1150  
VKMV 6PK1949  
VKMV 6PK1010  
VKPC 86631  
VKM 36008  
VKMV 6PK1637  
VKMV 5PK905  
VKM 36009  
VKPC 86633  
VKPC 86415  
VKM 36018  
VKM 36010  
VKM 36075  
VKMV 5PK1260  
VKM 26501  
VKM 36019  
VKM 36022  
VKM 36024  
VKM 26102  
VKM 26101  
VKMV 5PK820  
VKM 26502  
VKM 36011  
VKPC 86215  
VKMV 6PK1135  
VKMV 5PK1515

## PORSCHE

048 121 011  
060 121 011

VKPC 81601  
VKPC 81601

## PROTON

MD 300799  
MD 306414  
MD 972054  
MD 997609

VKPC 95426  
VKPC 95426  
VKPC 95614  
VKPC 95008

## RENAULT

0980695500  
50 01 001 272  
50 01 001 274  
74 30 638 277  
74 31 275 380  
  
74 38 610 006  
74 38 610 035  
74 38 610 040  
74 39 135 036  
74 39 146 139  
  
74 39 146 376  
74 39 146 899  
74 39 440 329  
77 00 100 671  
77 00 101 261  
  
77 00 101 474  
77 00 102 395  
77 00 102 931  
77 00 104 092  
77 00 105 176  
77 00 105 325

VKPC 86208  
VKM 22380  
VKPC 82630  
VKM 16604  
VKM 36120  
  
VKPC 86618  
VKPC 86618  
VKMA 06604  
VKM 16602  
VKM 36003  
  
VKM 26602  
VKMV 6PK1235  
VKM 16604  
VKM 26115  
VKMV 6PK1750  
  
VKMV 6PK1400  
VKM 36032  
VKM 36031  
VKM 36031  
VKPC 86416  
VKM 36091

77 00 274 218  
77 00 274 330  
77 00 300 347  
77 00 300 348  
77 00 300 378  
  
77 00 300 614  
77 00 349 594  
77 00 619 572  
77 00 673 236  
77 00 685 633  
  
77 00 692 315  
77 00 694 741  
77 00 696 986  
77 00 696 987  
77 00 720 366  
  
77 00 721 690  
77 00 722 452  
77 00 722 704  
77 00 725 409  
77 00 726 440  
  
77 00 729 330  
77 00 729 371  
77 00 729 540  
77 00 733 489  
77 00 733 788  
  
77 00 735 486  
77 00 735 904  
77 00 735 905  
77 00 736 085

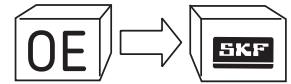
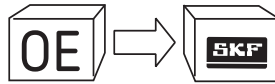
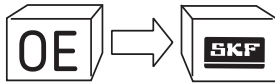

|               |                |               |            |               |              |
|---------------|----------------|---------------|------------|---------------|--------------|
| 77 00 866 437 | VKMV 3PK835    | 77 01 461 006 | VKPC 86405 | 77 01 471 426 | VKMA 06212   |
| 77 00 866 518 | VKPC 86216     | 77 01 461 173 | VKPC 86200 | 77 01 471 464 | VKMA 06502   |
| 77 00 867 939 | VKMV 5PK910    | 77 01 461 236 | VKPC 86407 | 77 01 471 519 | VKMA 06602   |
| 77 00 867 985 | VKM 36016      | 77 01 461 336 | VKPC 86623 | 77 01 471 769 | VKMA 02381   |
| 77 00 868 201 | VKM 36023      | 77 01 461 405 | VKPC 86602 | 77 01 471 771 | VKMA 02383   |
| 77 00 868 273 | VKMV 5PK880    | 77 01 462 145 | VKPC 86206 | 77 01 471 773 | VKMA 02384   |
| 77 00 869 440 | VKMV 6PK894    | 77 01 462 389 | VKPC 86402 | 77 01 471 774 | VKMA 02386   |
| 77 00 869 684 | VKM 36080      | 77 01 462 419 | VKPC 86206 | 77 01 471 864 | VKMA 06114   |
| 77 00 869 685 | VKMV 4PK995    | 77 01 462 491 | VKPA 86206 | 77 01 471 865 | VKMA 06115   |
| 77 00 869 686 | VKMV 4PK1238   | 77 01 462 808 | VKPC 82630 | 77 01 471 866 | VKMA 06116   |
| 77 00 869 687 | VKMV 3PK1040   | 77 01 462 809 | VKPC 86413 | 77 01 471 974 | VKMA 06020   |
| 77 00 870 367 | VKMV 4PK735    | 77 01 463 014 | VKPC 86205 | 77 01 472 182 | VKPC 85304   |
| 77 00 870 432 | VKM 36081      | 77 01 463 111 | VKPC 86413 | 77 01 472 292 | VKMA 06107   |
| 77 00 870 495 | VKM 36082      | 77 01 463 182 | VKPC 86602 | 77 01 472 329 | VKMA 06503   |
| 77 00 870 795 | VKM 36023      | 77 01 463 377 | VKPA 86206 | 77 01 472 625 | VKPC 86305   |
| 77 00 870 937 | VKM 36016      | 77 01 463 397 | VKPC 86413 | 77 01 472 644 | VKMA 06010   |
| 77 00 870 961 | VKMV 6PK1682   | 77 01 463 637 | VKPC 86622 | 77 01 472 675 | VKMA 06010   |
| 77 00 871 168 | VKM 16204      | 77 01 464 030 | VKPC 86603 | 77 01 472 696 | VKMA 06104   |
| 77 00 871 169 | VKM 16212      | 77 01 464 054 | VKPC 86209 | 77 01 472 726 | VKMA 06000   |
| 77 00 871 801 | VKPC 86631     | 77 01 464 736 | VKPC 86413 | 77 01 473 001 | VKMA 06002   |
| 77 00 872 531 | VKM 16501      | 77 01 465 122 | VKPC 86601 | 77 01 473 120 | VKMA 06130   |
| 77 00 872 550 | VKM 36026      | 77 01 465 513 | VKPC 86605 | 77 01 473 224 | VKMA 06117   |
| 77 00 873 731 | VKM 16501      | 77 01 465 643 | VKPC 86604 | 77 01 473 312 | VKMA 06127   |
| 77 00 874 202 | VKMV 6PK1400   | 77 01 465 816 | VKPC 86413 | 77 01 473 327 | VKPC 86417   |
| 77 01 035 651 | VKMV 4PK560    | 77 01 466 121 | VKPC 86402 | 77 01 473 365 | VKPC 86413   |
| 77 01 035 652 | VKMV 5PK820    | 77 01 466 152 | VKPC 86408 | 77 01 473 553 | VKMC 06501   |
| 77 01 035 743 | VKM 12400      | 77 01 466 410 | VKPC 86206 | 77 01 473 569 | VKMA 03902   |
| 77 01 035 966 | VKM 36001      | 77 01 466 419 | VKPA 86206 | 77 01 473 837 | VKMA 06128   |
| 77 01 040 204 | VKM 22385      | 77 01 466 420 | VKPC 86209 | 77 01 473 849 | VKMA 06503   |
| 77 01 040 944 | VKMV 4PK560    | 77 01 466 571 | VKPC 86621 | 77 01 474 013 | VKM 35216    |
| 77 01 044 676 | VKM 36017      | 77 01 466 578 | VKPC 86413 | 77 01 474 019 | VKMA 06108   |
| 77 01 050 377 | VKM 25226      | 77 01 466 693 | VKPC 86605 | 77 01 474 021 | VKMA 06106   |
| 77 01 050 387 | VKM 25222      | 77 01 466 779 | VKPC 86616 | 77 01 474 022 | VKMA 06107   |
| 77 01 052 717 | VKM 35214      | 77 01 466 788 | VKPC 86606 | 77 01 474 023 | VKMA 06106   |
| 77 01 052 775 | VKM 35212      | 77 01 467 153 | VKPA 86212 | 77 01 474 190 | VKPC 86305   |
| 77 01 053 088 | VKM 15220      | 77 01 467 153 | VKPC 86212 | 77 01 474 198 | VKMA 05230   |
| 77 01 055 084 | VKM 35216      | 77 01 467 223 | VKPC 86603 | 77 01 474 359 | VKMA 06021   |
| 77 01 057 890 | VKMV 7PK1922   | 77 01 467 278 | VKPC 82638 | 77 01 474 368 | VKMA 36041   |
| 77 01 063 970 | VKM 25226      | 77 01 467 546 | VKPC 86200 | 77 01 474 435 | VKPC 86129   |
| 77 01 063 971 | VKM 25222      | 77 01 467 549 | VKPC 86407 | 77 01 474 443 | VKMA 06129   |
| 77 01 064 339 | VKMV 6PK1740   | 77 01 467 622 | VKPC 86631 | 77 01 474 446 | VKMA 06115   |
| 77 01 064 349 | VKMV 5PK880    | 77 01 467 642 | VKPA 86217 | 77 01 474 514 | VKMV 6PK1105 |
| 77 01 064 354 | VKMV 5PK1515   | 77 01 467 915 | VKPC 86205 | 77 01 474 517 | VKMV 4PK775  |
| 77 01 108 920 | VKM 16550      | 77 01 468 163 | VKMA 06110 | 77 01 474 950 | VKMV 6PK1095 |
| 77 01 348 137 | VKMV 10AVx666  | 77 01 468 164 | VKMA 06100 | 77 01 475 115 | VKMA 06132   |
| 77 01 348 230 | VKMV 11.9x758  | 77 01 468 165 | VKMA 06201 | 77 01 475 192 | VKMA 36040   |
| 77 01 348 507 | VKMV 11.9x1010 | 77 01 468 166 | VKMA 06203 | 77 01 476 496 | VKPC 86417   |
| 77 01 348 549 | VKMV 10AVx700  | 77 01 468 167 | VKMA 06101 | 77 01 476 674 | VKMA 06107   |
| 77 01 349 028 | VKMV 10AVx825  | 77 01 468 168 | VKMA 06111 | 77 01 476 745 | VKMA 06002   |
| 77 01 349 245 | VKMV 10AVx800  | 77 01 468 342 | VKPC 82630 | 77 01 477 013 | VKMA 06010   |
| 77 01 349 425 | VKMV 10AVx900  | 77 01 468 491 | VKPC 86413 | 77 01 477 014 | VKMA 06020   |
| 77 01 349 620 | VKMV 11.9x1010 | 77 01 469 774 | VKMA 06113 | 77 01 477 023 | VKMA 06021   |
| 77 01 452 155 | VKPC 86403     | 77 01 469 775 | VKMA 06112 | 77 01 477 024 | VKMA 06003   |
| 77 01 452 158 | VKPC 86203     | 77 01 469 776 | VKMA 06103 | 77 01 477 028 | VKMA 06132   |
| 77 01 457 415 | VKPC 86403     | 77 01 469 820 | VKMA 06500 | 77 01 477 046 | VKMA 06115   |
| 77 01 457 447 | VKPC 86203     | 77 01 469 821 | VKMA 06501 | 77 01 477 047 | VKMA 06115   |
| 77 01 457 450 | VKPC 86208     | 77 01 469 822 | VKMA 06205 | 77 01 477 048 | VKMA 06127   |
| 77 01 457 453 | VKPC 86203     | 77 01 469 823 | VKMA 06204 | 77 01 477 050 | VKMA 06129   |
| 77 01 457 671 | VKPC 86201     | 77 01 469 824 | VKMA 06212 | 77 01 477 093 | VKMA 06106   |
| 77 01 459 820 | VKPC 83200     | 77 01 469 825 | VKMA 02422 | 77 01 477 184 | VKMA 06108   |
| 77 01 459 890 | VKPC 86208     | 77 01 470 879 | VKPC 85302 | 77 01 477 522 | VKMA 36091   |
| 77 01 460 697 | VKPC 86401     | 77 01 470 880 | VKPC 85303 | 77 01 478 018 | VKPC 86415   |
| 77 01 460 698 | VKPC 86407     | 77 01 471 367 | VKMA 06109 | 77 01 505 397 | VKPC 86201   |





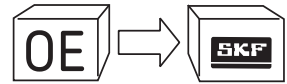
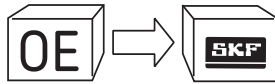
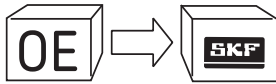

77 01 506 944  
 77 01 633 125  
 82 00 004 342  
 82 00 004 593  
 82 00 009 194  
 82 00 020 924  
 82 00 023 912  
 82 00 027 520  
 82 00 034 396  
 82 00 035 827  
 82 00 037 686  
 82 00 040 155  
 82 00 040 161  
 82 00 041 850  
 82 00 041 851  
 82 00 041 852  
 82 00 042 514  
 82 00 042 880  
 82 00 043 325  
 82 00 045 735  
 82 00 048 486  
 82 00 051 091  
 82 00 051 092  
 82 00 053 294  
 82 00 058 139  
 82 00 059 395  
 82 00 059 425  
 82 00 061 345  
 82 00 061 673  
 82 00 064 664  
 82 00 065 479  
 82 00 065 601  
 82 00 065 970  
 82 00 071 267  
 82 00 071 402  
 82 00 071 404  
 82 00 072 113  
 82 00 072 120  
 82 00 078 576  
 82 00 079 341  
 82 00 088 660  
 82 00 088 663  
 82 00 089 047  
 82 00 093 814  
 82 00 102 941  
 82 00 103 069  
 82 00 104 754  
 82 00 111 788  
 82 00 113 203  
 82 00 125 710  
 82 00 127 467  
 82 00 127 693  
 82 00 136 224  
 82 00 146 297  
 82 00 146 298  
 82 00 146 301  
 82 00 170 009  
 82 00 191 324  
 82 00 192 843  
 82 00 206 889  
 82 00 211 784  
 82 00 211 989  
 82 00 222 092

VKPC 86203  
 VKPC 86409  
 VKMV 6PK1778  
 VKM 26503  
 VKM 16503  
 VKMV 5PK1135  
 VKMV 6PK1148  
 VKMV 4PK730  
 VKMV 5PK1199  
 VKM 16002  
 VKPC 86215  
 VKM 36023  
 VKM 36025  
 VKMV 4PK928  
 VKMV 4PK908  
 VKMV 4PK1538  
 VKPC 86633  
 VKPC 86810  
 VKM 26117  
 VKM 26115  
 VKM 36050  
 VKM 26101  
 VKM 26102  
 VKM 36052  
 VKMV 6PK1640  
 VKMV 6PK1135  
 VKMV 6PK871  
 VKM 16550  
 VKMV 5PK1110  
 VKM 26105  
 VKM 36016  
 VKMV 3PK740  
 VKM 36035  
 VKM 16129  
 VKM 36030  
 VKM 36040  
 VKMV 7PK1127  
 VKM 36072  
 VKMV 6PK1606  
 VKM 16551  
 VKPC 86215  
 VKPC 86215  
 VKMV 6PK1193  
 VKMV 6PK1792  
 VKM 16102  
 VKM 16002  
 VKM 36031  
 VKMV 7PK1770  
 VKMV 6PK1792  
 VKM 26117  
 VKM 16503  
 VKMV 7PK1784  
 VKM 36023  
 VKPC 86416  
 VKPC 86415  
 VKPC 86216  
 VKM 36053  
 VKM 16021  
 VKM 36091  
 VKMV 5PK1125  
 VKM 16003  
 VKMV 7PK1792  
 VKM 16550

82 00 226 495  
 82 00 230 958  
 82 00 238 333  
 82 00 243 021  
 82 00 244 615  
 82 00 262 773  
 82 00 266 947  
 82 00 266 950  
 82 00 285 009  
 82 00 292 784  
 82 00 322 233  
 82 00 322 234  
 82 00 328 372  
 82 00 347 761  
 82 00 356 268  
 82 00 356 445  
 82 00 356 446  
 82 00 397 735  
 82 00 420 964  
 82 00 421 400  
 82 00 428 447  
 82 00 429 703  
 82 00 434 732  
 82 00 454 895  
 82 00 483 288  
 82 00 492 180  
 82 00 499 908  
 82 00 499 909  
 82 00 548 227  
 82 00 582 675  
 82 00 673 090  
 82 00 673 091  
 82 00 676 403  
 82 00 676 404  
 82 00 704 394  
 82 00 709 717  
 82 00 709 719  
 82 00 833 549  
 82 00 833 554  
 96 16 660 580  
 96 16 660 780  
 96 29 937 980  
 96 30 535 380  
 96 35 638 380  
 96 37 506 680  
 96 38 027 080  
 96 40 344 280  
 96 51 260 980  
 96 51 261 480  
 96 52 748 480

**ROVER**

26526500010  
 ADU 8335  
 AHU 2503  
 AHU 2504  
 CAM 9153  
 CDU 2005  
 CDU 2049  
 CDU 2160  
 CDU 3558

VKM 36070  
 VKM 36035  
 VKPC 86810  
 VKMV 6PK1199  
 VKM 16020  
 VKM 36052  
 VKPC 86215  
 VKPC 86810  
 VKM 36038  
 VKM 36052  
 VKMV 7PK1035  
 VKMV 7PK880  
 VKM 36052  
 VKM 16021  
 VKMV 6PK1815  
 VKMV 7PK1705  
 VKMV 7PK1970  
 VKPC 86215  
 VKM 26125  
 VKMV 7PK1135  
 VKPC 86416  
 VKM 36070  
 VKM 36023  
 VKM 16002  
 VKM 36310  
 VKM 36072  
 VKM 16550  
 VKM 16550  
 VKM 26117  
 VKPC 86416  
 VKM 36072  
 VKM 36030  
 VKM 16550  
 VKM 16002  
 VKM 16113  
 VKM 16129  
 VKMV 6PK1792  
 VKMV 7PK1784  
 VKM 23900  
 VKM 23901  
 VKPC 83637  
 VKM 13902  
 VKM 33075  
 VKPC 83637  
 VKMV 6PK1585  
 VKPC 83637  
 VKM 23901  
 VKM 23900  
 VKM 23900  
 VKM 13902  
 VKPC 87610  
 VKM 17000  
 VKM 27110  
 VKM 17110  
 VKM 17200  
 VKM 27110  
 VKM 37015  
 VKMV 3PK753  
 VKM 17310

CDU 3559  
 DBP 9291  
 ERC 8861  
 ERR 5214  
 FDU 2691  
 GFB 272  
 GWP 101  
 GWP 102  
 GWP 1143  
 GWP 117  
 GWP 132  
 GWP 134  
 GWP 151  
 GWP 157  
 GWP 158  
 GWP 160  
 GWP 164  
 GWP 168  
 GWP 171  
 GWP 173  
 GWP 176  
 GWP 179  
 GWP 181  
 GWP 183  
 GWP 185  
 GWP 186  
 GWP 188  
 GWP 193  
 GWP 195  
 GWP 2155  
 GWP 2157  
 GWP 2161  
 GWP 2162  
 GWP 2163  
 GWP 2165  
 GWP 2166  
 GWP 2513  
 GWP 2707  
 GWP 330  
 GWP 333  
 GWP 336  
 GWP 337  
 GWP 338  
 GWP 341  
 GWP 342  
 GWP 344  
 GWP 345  
 GWP 346  
 GWP 347  
 LHP 10002  
 LHP 100070  
 LHP 10009  
 LHP 10010  
 LHP 10013  
 LHP 10014  
 LHP 10015  
 LHP 100390  
 LHP 100440  
 LHP 100450  
 LHP 100480  
 LHP 100490  
 LHP 100550  
 LHP 100590

VKM 17300  
 VKM 73101  
 VKM 17400  
 VKM 37005  
 VKM 73000  
 VKMV 10AVx935  
 VKPC 87200  
 VKPC 87200  
 VKPC 93205  
 VKPC 87200  
 VKPC 87200  
 VKPC 87200  
 VKPC 87200  
 VKPC 87205  
 VKPC 87205  
 VKPC 87403  
 VKPC 87205  
 VKPC 87200  
 VKPC 87609  
 VKPC 87200  
 VKPC 87205  
 VKPC 87205  
 VKPC 87403  
 VKPC 87609  
 VKPC 87200  
 VKPC 87205  
 VKPC 87403  
 VKPC 87609  
 VKPC 87200  
 VKPC 87205  
 VKPC 87813  
 VKPC 83205  
 VKPC 87607  
 VKPC 87404  
 VKPC 87404  
 VKPC 82642  
 VKPC 87404  
 VKPC 87607  
 VKPC 87607  
 VKPC 87404  
 VKPC 87607  
 VKPC 87610  
 VKPC 87401  
 VKPC 87400  
 VKPC 83424  
 VKPC 83424  
 VKPC 83205  
 VKPC 93601  
 VKPC 83420  
 VKPC 93601  
 VKPC 83428  
 VKPC 87813  
 VKM 17110  
 VKM 23241  
 VKM 23240  
 VKM 13240  
 VKM 13120  
 VKM 17300  
 VKM 17310  
 VKM 17302  
 VKM 73600  
 VKM 73600  
 VKM 73011  
 VKM 73011  
 VKM 17304  
 VKM 13241

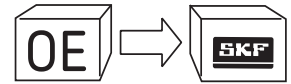
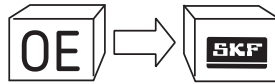
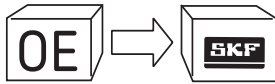

LHP 100790  
LHP 100840A  
LHP 100900  
  
LHP 100940  
LHV 10002  
LHV 10002  
LHV 100080  
LHV 100080  
  
LHV 100110  
LHV 100120  
LHV 100160  
LHV 100160A  
PEB 10031 EVA  
  
PEB 10036 EVA  
PEB 10051  
PEB 10080 EVA  
PEB 10095  
PEB 10139  
  
PEB 101780 EVA  
PEB 101930 EVA  
PEB 102240  
PEB 102420  
PEB 102470  
  
PEB 102510  
PEE 002710 EVA  
PFS 100020 EVA  
PQG 100180A  
PQG 100190  
  
PQG 100220  
PQG 100230  
PQG 100230A  
PQR 10013  
PQR 10027  
  
PQR 10028  
PQS 10013EVA  
PQS 10028EVA  
PQS 10035  
PQS 10045EVA  
  
PQS 100840  
PQS 100850  
PQS 100940  
PQS 100950EVA  
PQS 100980EVA  
  
PQS 101030  
PQS 101180  
PQS 101200EVA  
PQS 101210EVA  
PQS 101261  
  
PQS 101262  
PQS 101271  
PQS 101272  
PQS 101300  
PQS 101310  
  
PQS 101450  
PQS 101460  
PQS 101590  
PRF 100060  
RTC 6395  
  
XHM 461  
YLY 100040

VKM 73005  
VKM 17303  
VKM 17301  
  
VKM 17305  
VKM 23214  
VKM 23218  
VKM 23214  
VKM 23218  
  
VKM 27307  
VKM 27302  
VKM 27303  
VKM 27303  
VKPC 83424  
  
VKPC 87200  
VKPC 87401  
VKPC 82642  
VKPC 87813  
VKPC 87404  
  
VKPC 83420  
VKPC 93601  
VKPC 87410  
VKPC 87813  
VKPC 87420  
  
VKPC 87401  
VKPC 83428  
VKPC 83205  
VKM 37010  
VKM 37011  
  
VKM 37005  
VKM 37005  
VKM 37005  
VKM 37002  
VKM 37014  
  
VKM 37015  
VKMV 4PK736  
VKMV 4PK780  
VKMV 6PK1445  
VKMV 6PK1415  
  
VKMV 5PK738  
VKMV 6PK1462  
VKMV 5PK1148  
VKMV 5PK1790  
VKMV 5PK775  
  
VKMV 6PK1183  
VKMV 5PK1200  
VKMV 6PK1290  
VKMV 6PK1558  
VKMV 6PK1285  
  
VKMV 6PK1285  
VKMV 6PK1558  
VKMV 6PK1558  
VKMV 5PK2030  
VKMV 5PK869  
  
VKMV 3PK738  
VKMV 4PK820  
VKMV 5PK1163  
VKM 38240  
VKPC 87835  
  
VKM 73001  
VKM 33009

**SAAB**

24 426 500  
24 430 296  
24 435 940  
24 452 030  
24 467 301  
  
40 29 930  
43 56 127  
45 75 478  
47 50 220  
47 52 960  
  
47 70 970  
47 72 711  
47 73 842  
48 98 755  
48 99 555  
  
49 04 728  
49 61 058  
49 61 066  
49 65 687  
49 67 907  
  
49 68 590  
50 05 036  
53 40 526  
53 42 456  
59 54 508  
  
59 54 516  
59 54 771  
59 55 190  
59 58 061  
59 60 414  
  
60 36 362  
75 01 547  
75 07 460  
75 92 017  
88 17 900  
  
88 17 918  
88 19 948  
88 21 944  
88 22 710  
88 22 744  
  
88 22 793  
90 540 478  
90 543 935  
90 571 758  
91 21 670  
  
91 28 739  
91 48 289  
91 80 809  
92 40 033  
93 07 893  
  
93 178 602  
93 178 713  
93 179 114  
93 181 118  
93 182 043  
  
93 185 049  
93 21 670  
93 21 688  
93 21 951  
93172363

VKM 15216  
VKM 34027  
VKMV 5PK1028  
VKMV 6PK1902  
VKPC 85308  
  
VKM 34500  
VKM 34501  
VKM 35007  
VKM 35500  
VKM 34502  
  
VKPC 85613  
VKPC 85623  
VKMA 05500  
VKM 34510  
VKMV 6PK2020  
  
VKMV 6PK2622  
VKMV 6PK1805  
VKMV 6PK2345  
VKMV 6PK1980  
VKM 34023  
  
VKM 34023  
VKPC 84400  
VKMV 6PK1805  
VKM 35007  
VKM 15220  
  
VKM 25226  
VKM 35216  
VKPC 85613  
VKPC 85613  
VKPC 86630  
  
VKPC 84400  
VKPC 84611  
VKPC 84611  
VKM 34502  
VKPC 84611  
  
VKPC 84612  
VKPC 84613  
VKPC 85613  
VKPC 86630  
VKPC 86630  
  
VKPC 86630  
VKPC 85623  
VKPC 85624  
VKM 35012  
VKPC 84612  
  
VKM 25152  
VKPC 84613  
VKM 35007  
VKM 25312  
VKPC 84611  
  
VKPC 85308  
VKPC 82665  
VKPC 82667  
VKPC 85308  
VKPC 85623  
  
VKMV 6PK2622  
VKPC 84612  
VKPC 84613  
VKPC 86630  
VKMV 5PK1240

**SEAT**

00A 121 010  
021 121 004 A  
021 121 004  
021 145 933 C  
022 145 933 H  
  
022 145 933 N  
022 145 933 T  
023 121 004  
025 121 010 AV  
025 121 010 F  
  
026 109 243 E  
026 109 243 L  
026 109 243  
026 121 005 C  
026 121 005 F  
  
026 121 005 F  
026 121 005 H  
026 121 005 K  
026 121 005 L  
026 121 010 D  
  
026 121 010 D  
026 145 271  
026 198 119  
026 260 849 A  
026 903 137 C  
  
027 903 137  
028 109 243 B  
028 109 243 D  
028 109 243 E  
028 109 243 F  
  
028 109 243 G  
028 109 243  
028 109 244  
028 121 004  
028 145 271 F  
  
028 145 271 K  
028 145 271 L  
028 145 278 A  
028 145 278 E  
028 145 278 J  
  
028 145 278 M  
028 198 119 A  
028 198 119 B  
028 198 119 C  
028 198 119 D  
  
028 198 119 E  
028 198 119 F  
028 198 119 G  
028 198 119  
028 260 849 H  
  
028 260 849 L  
028 903 137 AK  
028 903 137 AM  
028 903 137 AP  
028 903 137 AR  
  
028 903 137 BB  
028 903 315 M  
028 903 315 R  
030 109 243 L  
030 109 243 M

VKPC 81624  
VKPC 81611  
VKPC 81611  
VKMV 7PK1290  
VKMV 6PK1264  
  
VKMV 6PK1240  
VKMV 6PK1620  
VKPC 81803  
VKPC 81607  
VKPC 81609  
  
VKM 11000  
VKM 11000  
VKM 11000  
VKPC 81401  
VKPC 81401  
  
VKPC 81402  
VKPC 81401  
VKPC 81402  
VKPC 81402  
VKPA 81400  
  
VKPC 81400  
VKMV 10AVx730  
VKMA 01006  
VKMV 13AVx800  
VKMV 10AVx950  
  
VKMV 10AVx630  
VKM 11012  
VKM 11015  
VKM 11014  
VKM 11014  
  
VKM 11015  
VKM 11012  
VKM 21012  
VKPC 81615  
VKMV 11.9x903  
  
VKMV 10AVx730  
VKMV 11.5x790  
VKM 31004  
VKM 31004  
VKM 31034  
  
VKM 31025  
VKMA 01013  
VKMA 01012  
VKMA 01014  
VKMA 01256  
  
VKMA 01019  
VKMA 01016  
VKMA 01015  
VKMA 01011  
VKMV 6PK1175  
  
VKMV 6PK1145  
VKMV 6PK890  
VKMV 6PK923  
VKMV 5PK1219  
VKMV 5PK1592  
  
VKMV 6PK1045  
VKM 31034  
VKM 31030  
VKM 11107  
VKM 11107





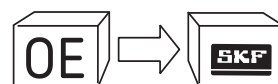
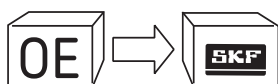
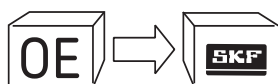

|                |                 |                |                |                |                |
|----------------|-----------------|----------------|----------------|----------------|----------------|
| 030 121 004 B  | VKPC 81204      | 036 145 933 AJ | VKMOV 6PK1076  | 038 903 137 T  | VKMOV 5PK1432  |
| 030 121 005 L  | VKPC 81204      | 036 145 933 F  | VKMOV 6PK1084  | 038 903 315 A  | VKM 31018      |
| 030 121 005 LV | VKPC 81204      | 036 145 933 H  | VKMOV 6PK1548  | 038 903 315 AB | VKM 31057      |
| 030 121 005 LX | VKPC 81204      | 036 145 933 J  | VKMOV 6PK1078  | 038 903 315 AD | VKM 31058      |
| 030 121 005 N  | VKPC 81210      | 036 145 933 M  | VKMOV 6PK745   | 038 903 315 AE | VKM 31019      |
| 030 121 005 S  | VKPC 81215      | 036 145 933 Q  | VKMOV 6PK1123  | 038 903 315 AG | VKM 31058      |
| 030 121 005 T  | VKPC 81210      | 036 198 119 E  | VKMA 01121     | 038 903 315 AH | VKM 31058      |
| 030 121 008 A  | VKPC 81215      | 037 121 005 B  | VKPC 81401     | 038 903 315 C  | VKM 31012      |
| 030 121 008 C  | VKPC 81215      | 037 121 005 C  | VKPC 81401     | 038 903 315 D  | VKM 31013      |
| 030 121 008 D  | VKPC 81210      | 037 121 010 A  | VKPA 81401     | 038 903 315 E  | VKM 31018      |
| 030 145 299 F  | VKM 31015       | 037 121 010 B  | VKPA 81401     | 038 903 315 F  | VKM 31019      |
| 030 145 933 T  | VKMOV 6PK1068   | 037 121 010 C  | VKPA 81401     | 038 903 315 K  | VKM 31018      |
| 030 145 933    | VKMOV 6PK1100   | 037 145 271 E  | VKMOV 11.5x685 | 038 903 315 P  | VKM 31013      |
| 030 198 119 A  | VKMA 01106      | 037 145 271 F  | VKMOV 11.5x755 | 038 903 315 T  | VKM 31058      |
| 030 198 119 B  | VKMA 01107      | 037 145 271    | VKMOV 10AVx660 | 03C 121 005 D  | VKPC 81501     |
| 030 903 137 AA | VKMOV 6PK737    | 037 145 276 A  | VKM 31007      | 03C 145 299 C  | VKM 31047      |
| 030 903 137 E  | VKMOV 11.9x710  | 037 145 276    | VKM 31007      | 03D 121 005    | VKPC 81301     |
| 030 903 137 T  | VKMOV 6PK751    | 037 145 276    | VKM 31007      | 03D 121 013 B  | VKPC 81301     |
| 031 121 004    | VKPC 81206      | 037 145 933 C  | VKMOV 6PK1760  | 03D 145 933 AD | VKMOV 6PK1880  |
| 031 121 005 A  | VKPC 81206      | 037 198 119    | VKMA 01002     | 03D 145 933 S  | VKMOV 6PK1453  |
| 031 121 005 C  | VKPC 81206      | 037 260 849 C  | VKMOV 6PK1153  | 03E 260 849 A  | VKMOV 6PK1453  |
| 032 145 276    | VKM 31207       | 037 903 137 G  | VKMOV 6PK976   | 03E 260 849 B  | VKMOV 6PK1873  |
| 032 145 299 A  | VKM 31016       | 037 903 137 H  | VKMOV 6PK1033  | 03G 109 243    | VKMOV 6PK1873  |
| 032 145 299 C  | VKM 31023       | 037 903 315 B  | VKM 31210      | 03G 109 244    | VKM 11255      |
| 032 145 933 AB | VKMOV 6PK1540   | 037 903 315 C  | VKM 31210      | 03G 198 119    | VKM 21256      |
| 032 145 933 T  | VKMOV 6PK1185   | 038 109 243 F  | VKM 11130      | 03G 903 137 A  | VKMA 01255     |
| 032 198 119    | VKMA 01110      | 038 109 243 G  | VKM 11130      | 03G 903 137 B  | VKMOV 6PK950   |
| 034 260 849    | VKMOV 13AVx915  | 038 109 243 H  | VKM 11130      | 03G 903 315 A  | VKMOV 6PK1050  |
| 034 903 137 A  | VKMOV 11.2x820  | 038 109 243 M  | VKM 11250      | 03G 903 315 C  | VKM 31022      |
| 034 903 137 B  | VKMOV 4PK882    | 038 109 243 N  | VKM 11130      | 044 145 271 K  | VKM 31054      |
| 035 121 004 A  | VKPC 81605      | 038 109 243    | VKM 11130      | 044 145 278 A  | VKMOV 10AVx650 |
| 035 145 271 F  | VKMOV 13AVx1000 | 038 109 244 B  | VKM 21130      | 044 260 849 B  | VKM 31043      |
| 035 260 849 C  | VKMOV 13AVx990  | 038 109 244 E  | VKM 21131      | 044 260 849 E  | VKMOV 6PK1590  |
| 035 903 137 C  | VKMOV 10AVx785  | 038 109 244 H  | VKM 21130      | 044 260 849 R  | VKMOV 6PK1905  |
| 036 109 181 A  | VKM 21121       | 038 109 244 J  | VKM 21147      | 045 109 243 A  | VKMOV 6PK1870  |
| 036 109 181 B  | VKM 21121       | 038 109 244 M  | VKM 21130      | 045 109 243 B  | VKM 11142      |
| 036 109 243 AB | VKM 11120       | 038 121 011 A  | VKPC 81623     | 045 109 243 C  | VKM 11141      |
| 036 109 243 AC | VKM 11124       | 038 121 011 C  | VKPC 81626     | 045 109 243 F  | VKM 11142      |
| 036 109 243 AD | VKM 11120       | 038 121 011 D  | VKPC 81626     | 045 109 243 F  | VKM 11250      |
| 036 109 243 AF | VKM 11120       | 038 121 011 G  | VKPC 81303     | 045 109 244 A  | VKM 21142      |
| 036 109 243 AG | VKM 11124       | 038 121 011 H  | VKPC 81627     | 045 109 479 B  | VKM 11145      |
| 036 109 243 F  | VKM 11121       | 038 121 011 J  | VKPC 81303     | 045 109 479 C  | VKM 11144      |
| 036 109 243 J  | VKM 11114       | 038 121 011 K  | VKPC 81627     | 045 121 011 B  | VKPC 81417     |
| 036 109 244 C  | VKM 21120       | 038 145 276    | VKM 31002      | 045 121 011 C  | VKPC 81416     |
| 036 109 244 D  | VKM 21120       | 038 145 278    | VKM 31013      | 045 121 011 F  | VKPC 81418     |
| 036 109 244 J  | VKM 21120       | 038 145 283 A  | VKM 31013      | 045 121 011 G  | VKPC 81302     |
| 036 109 244    | VKM 21122       | 038 145 299 A  | VKM 31013      | 045 121 011 H  | VKPC 81418     |
| 036 121 005 B  | VKPC 81407      | 038 198 119 A  | VKMA 01250     | 045 121 011 J  | VKPC 81302     |
| 036 121 005 D  | VKPC 81411      | 038 198 119 B  | VKMA 01141     | 045 260 849    | VKMOV 6DK1188  |
| 036 121 005 E  | VKPC 81407      | 038 198 119 C  | VKMA 01250     | 045 903 137 D  | VKMOV 6PK996   |
| 036 121 005 F  | VKPC 81419      | 038 198 119 D  | VKMA 01131     | 045 903 137 E  | VKMOV 6PK858   |
| 036 121 005 J  | VKPC 81419      | 038 198 119 E  | VKMA 01251     | 045 903 315 A  | VKM 31035      |
| 036 121 005 M  | VKPC 81411      | 038 198 119 F  | VKMA 01130     | 046 121 004 D  | VKPC 81805     |
| 036 121 005 P  | VKPC 81419      | 038 198 119    | VKMA 01142     | 046 121 004    | VKPC 81603     |
| 036 121 005 Q  | VKPC 81407      | 038 260 849 A  | VKMOV 4PK841   | 047 121 011 B  | VKPC 81412     |
| 036 121 005 QV | VKPC 81407      | 038 903 137 AA | VKMOV 6PK1180  | 047 145 933 E  | VKMOV 6PK1680  |
| 036 121 005 R  | VKPC 81407      | 038 903 137 G  | VKMOV 6PK906   | 047 903 137 AB | VKMOV 6PK1748  |
| 036 121 005 S  | VKPC 81407      | 038 903 137 H  | VKMOV 5PK1432  | 047 903 137 E  | VKMOV 6PK1880  |
| 036 121 005    | VKPC 81411      | 038 903 137 J  | VKMOV 6PK1660  | 047 903 137 F  | VKMOV 6PK1480  |
| 036 121 008 G  | VKPC 81419      | 038 903 137 L  | VKMOV 6PK1180  | 047 903 137 G  | VKMOV 6PK1520  |
| 036 121 008 L  | VKPC 81407      | 038 903 137 M  | VKMOV 6PK780   | 047 903 137 L  | VKMOV 4PK950   |
| 036 145 933 AC | VKMOV 6PK1151   | 038 903 137 N  | VKMOV 6PK1095  | 047 903 137 R  | VKMOV 5PK1219  |
| 036 145 933 AG | VKMOV 6PK736    | 038 903 137 R  | VKMOV 6PK1135  | 048 198 119    | VKMA 01024     |
|                |                 | 038 903 137 S  | VKMOV 6DK1215  |                |                |

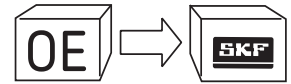
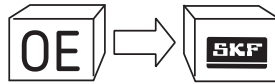
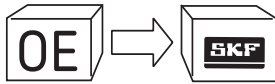

049 260 849 A  
 050 121 010 A  
 050 121 010 C  
 050 121 039 A  
 050 260 849  
 050 903 137 C  
 050 903 137  
 051 109 243 A  
 051 109 243  
 051 198 119  
 052 121 005 A  
 052 903 137 F  
 052 903 137 M  
 054 121 004 A  
 054 121 004  
 054 903 137 D  
 054 903 137  
 055 903 137 G  
 056 198 119  
 058 109 243 D  
 058 109 244  
 058 198 119 A  
 058 198 119  
 058 260 511  
 058 260 849 A  
 058 903 133 C  
 058 903 133 D  
 059 121 004 C  
 059 121 004 D  
 059 121 004 E  
 059 145 276  
 059 198 119 A  
 059 198 119  
 059 260 523 A  
 059 260 523 B  
 059 260 523  
 059 260 849 B  
 059 260 849 D  
 059 903 137 AC  
 059 903 137 H  
 059 903 341 A  
 059 903 341  
 062 145 933 A  
 062 260 849 B  
 062 903 137  
 066 121 011 C  
 066 145 933 K  
 068 109 243 F  
 068 121 010 A  
 068 121 039 B  
 068 121 039 L  
 068 145 271 B  
 068 145 271 C  
 068 145 271 E  
 068 260 849 D  
 068 260 849 G  
 068 260 849  
 068 260 940  
 068 903 137 AF  
 068 903 137 AJ  
 068 903 137 AP  
 068 903 137 AQ  
 068 903 137 AR

VKVM 13AVx825  
 VKPA 81402  
 VKPA 81402  
 VKMV 10AVx910  
 VKMV 13AVx800  
 VKMV 4PK855  
 VKMV 10AVx950  
 VKM 11021  
 VKM 11020  
 VKMA 01009  
 VKPC 81200  
 VKMV 10AVx675  
 VKMV 10AVx675  
 VKPC 81612  
 VKPC 81612  
 VKMV 10AVx875  
 VKMV 10AVx865  
 VKMV 10AVx850  
 VKMA 01000  
 VKM 11007  
 VKM 21004  
 VKMA 01007  
 VKMA 01008  
 VKM 31059  
 VKMV 4PK855  
 VKM 31033  
 VKM 31033  
 VKPC 81625  
 VKPC 81625  
 VKPC 81625  
 VKM 31039  
 VKMA 01152  
 VKMA 01152  
 VKM 31040  
 VKM 31040  
 VKM 31040  
 VKMV 4PK1237  
 VKMV 4PK1217  
 VKMV 6PK2480  
 VKMV 6PK2404  
 VKM 31041  
 VKM 31038  
 VKMV 6PK1683  
 VKMV 6PK2155  
 VKMV 6PK2000  
 VKPC 81622  
 VKMV 6PK1264  
 VKM 11010  
 VKPA 81401  
 VKMV 10AVx650  
 VKMV 10AVx838  
 VKMV 10AVx740  
 VKMV 10AVx763  
 VKMV 11.9x650  
 VKMV 13AVx1250  
 VKMV 13AVx950  
 VKMV 13AVx950  
 VKM 31009  
 VKMV 10AVx600  
 VKMV 10AVx625  
 VKMV 10AVx710  
 VKMV 10AVx695  
 VKMV 11.9x950

068 903 137 B  
 068 903 137 D  
 068 903 137 Q  
 068 903 137 S  
 069 903 137 C  
 06A 109 479 A  
 06A 109 479 C  
 06A 109 479  
 06A 121 011 E  
 06A 121 011 F  
 06A 121 011 G  
 06A 121 011 L  
 06A 121 011 T  
 06A 121 012  
 06A 145 933 D  
 06A 145 933 F  
 06A 198 119  
 06A 260 849 C  
 06A 260 849 E  
 06A 260 849 G  
 06A 260 849 K  
 06A 903 315 E  
 06B 109 243 A  
 06B 109 243 B  
 06B 109 243 D  
 06B 109 243 E  
 06B 109 243 F  
 06B 109 243  
 06B 109 244  
 06B 109 477 A  
 06B 109 477  
 06B 121 011 B  
 06B 121 011 C  
 06B 121 011 E  
 06B 121 011 H  
 06B 121 011 L  
 06B 121 011 M  
 06B 198 119 A  
 06B 260 849 A  
 06B 260 849 B  
 06B 903 137 D  
 06B 903 137 E  
 06B 903 137 J  
 06B 903 137  
 06C 109 244 D  
 06C 109 244  
 06D 109 243 B  
 06D 109 243  
 06D 903 137 C  
 06F 198 119 A  
 06F 198 119  
 06F 260 849 E  
 06F 260 849 L  
 06F 903 137 E  
 06F 903 137 L  
 071 121 005  
 071 145 933 F  
 071 145 933 H  
 071 145 933 M  
 074 145 278 B  
 074 145 278 E  
 074 145 278 F  
 074 145 299 A

VKVM 10AVx875  
 VKMV 10AVx965  
 VKMV 10AVx735  
 VKMV 10AVx775  
 VKMV 11.5x790  
 VKM 11113  
 VKM 11113  
 VKM 11113  
 VKPC 81620  
 VKPC 81620  
 VKPC 81620  
 VKPC 81620  
 VKPC 81620  
 VKPC 81620  
 VKPC 81620  
 VKMV 6PK1120  
 VKMV 6PK926  
 VKMA 01113  
 VKMV 6DK1195  
 VKMV 6DK1195  
 VKMV 6PK1032  
 VKMV 6PK1032  
 VKM 31011  
 VKM 11116  
 VKM 11018  
 VKM 11116  
 VKM 11018  
 VKM 11116  
 VKM 11115  
 VKM 21220  
 VKM 11117  
 VKM 21115  
 VKPC 81408  
 VKPC 81408  
 VKPC 81408  
 VKPC 81220  
 VKPC 81408  
 VKPC 81220  
 VKPC 81220  
 VKMA 01018  
 VKMV 4PK855  
 VKMV 4PK855  
 VKMV 6PK1589  
 VKMV 5PK1300  
 VKMV 6PK1572  
 VKMV 5PK1300  
 VKM 21302  
 VKM 21302  
 VKM 11222  
 VKM 11220  
 VKMV 6PK1572  
 VKMA 01222  
 VKMA 01220  
 VKMV 6PK1042  
 VKMV 6PK1054  
 VKMV 6PK900  
 VKMV 6PK953  
 VKPC 81622  
 VKMV 6PK1285  
 VKMV 6PK2373  
 VKMV 6PK2373  
 VKM 31007  
 VKM 31007  
 VKM 31043  
 VKM 31063

074 145 933 AL  
 074 145 933 AR  
 074 145 933 G  
 074 145 933 N  
 074 145 933 P  
 074 198 119 A  
 074 198 119 B  
 074 198 119 C  
 074 198 119 E  
 074 198 119 F  
 074 198 119 G  
 074 198 119 H  
 074 198 119  
 074 260 849 J  
 074 903 137  
 077 109 244 E  
 077 109 485 C  
 077 109 485 E  
 077 121 004 A  
 077 121 004 F  
 077 121 004 G  
 077 121 004 GX  
 077 121 004 H  
 078 109 243 K  
 078 109 243 Q  
 078 109 243 R  
 078 109 244 G  
 078 109 479 B  
 078 109 479 E  
 078 121 004 J  
 078 121 004 L  
 078 121 004 R  
 078 121 006 A  
 078 121 006  
 078 198 119 A  
 078 198 119  
 078 903 133 AB  
 078 903 137 BC  
 078 903 137 P  
 078 903 137  
 07D 145 933 E  
 111 903 137 D  
 111 903 137 E  
 1J0 145 276  
 1J0 145 299  
 1K0 260 849 A  
 1K0 260 849 B  
 1L0 198 002 A  
 3939739  
 4364117  
 4443446  
 4443703  
 4740847  
 4755003  
 4764782  
 6K0 145 299  
 6K0 198 001 A  
 6K0 198 002  
 6K0 198 004  
 6K0 198 005  
 6Q0 260 849 A  
 6Q0 903 137 A  
 6U0 903 137

VKVM 6PK1355  
 VKMV 6PK1751  
 VKMV 6PK2060  
 VKMV 6PK1343  
 VKMV 6PK1715  
 VKMA 01271  
 VKMA 01258  
 VKMA 01253  
 VKMA 01253  
 VKMA 01271  
 VKMA 01258  
 VKMA 01270  
 VKMA 01270  
 VKMV 6PK2130  
 VKMV 10AVx838  
 VKM 21204  
 VKM 11207  
 VKM 11204  
 VKPC 81806  
 VKPC 81807  
 VKM 11201  
 VKM 11202  
 VKM 11202  
 VKM 21201  
 VKM 11208  
 VKM 11209  
 VKPC 81802  
 VKPC 81811  
 VKPC 81811  
 VKPC 81811  
 VKPC 81802  
 VKMA 01201  
 VKMA 01202  
 VKM 31061  
 VKMV 6PK1882  
 VKMV 6PK2260  
 VKMV 6PK1675  
 VKMV 7DK2569  
 VKMV 10AVx905  
 VKMV 11.3x912  
 VKM 31044  
 VKM 31047  
 VKMV 6PK1100  
 VKMV 6PK1100  
 VKMA 01014  
 VKMV 10AVx800  
 VKPC 82410  
 VKM 12012  
 VKM 12001  
 VKM 22380  
 VKPC 82606  
 VKPC 82606  
 VKM 31023  
 VKMA 01106  
 VKMA 01000  
 VKMA 01002  
 VKMA 01011  
 VKMV 6PK1736  
 VKMV 6PK1087  
 VKMV 4PK950



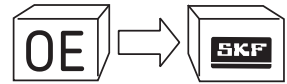
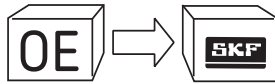
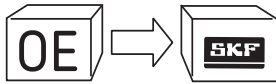

7303050  
7M0 145 271 A  
  
7M0 145 271  
943 095 009  
BA 03209901  
BD 03200102  
FA 03200003  
  
FD032310.01  
GE 03200002  
SE 020032000 A  
SE 021012060 A  
SE 021032000 A  
  
SE 021032000  
SE 700012090 A  
SE 700032000 A  
SE 700032000 C  
SE020032310A  
  
SE021040210A  
SE700032310B

**VKPC 82606**  
**VKMV 11.5x745**  
  
**VKMV 11.5x685**  
**VKMV 10AVx950**  
**VKPC 82205**  
**VKPC 82205**  
**VKPC 82404**  
  
**VKMV 10AVx850**  
**VKPC 82412**  
**VKPA 82202**  
**VKM 12700**  
**VKPC 82419**  
  
**VKPC 82419**  
**VKM 22160**  
**VKPC 82410**  
**VKPA 82435**  
**VKMV 10AVx800**  
  
**VKMV 10AVx750**  
**VKMV 10AVx838**

028 198 119  
028 260 849 H  
028 260 849 L  
028 903 137 AK  
028 903 137 AM  
  
028 903 137 AP  
028 903 137 AR  
028 903 137 BB  
028 903 315 M  
028 903 315 R  
  
030 109 243 L  
030 109 243 M  
030 121 004 B  
030 121 005 L  
030 121 005 LV  
  
030 121 005 LX  
030 121 005 N  
030 121 005 S  
030 121 005 T  
030 121 008 A

**VKMA 01011**  
**VKMV 6PK1175**  
**VKMV 6PK1145**  
**VKMV 6PK890**  
**VKMV 6PK923**  
  
**VKMV 5PK1219**  
**VKMV 5PK1592**  
**VKMV 6PK1045**  
**VKM 31034**  
**VKM 31030**  
  
**VKM 11107**  
**VKM 11107**  
**VKPC 81204**  
**VKPC 81204**  
**VKPC 81204**  
  
**VKPC 81204**  
**VKPC 81210**  
**VKPC 81215**  
**VKPC 81210**  
**VKPC 81215**

036 121 005 P  
036 121 005 Q  
  
036 121 005 QV  
036 121 005 R  
036 121 005 S  
036 121 008 G  
036 121 008 L  
  
036 145 933 AC  
036 145 933 AG  
036 145 933 AJ  
036 145 933 F  
036 145 933 H  
  
036 145 933 J  
036 145 933 M  
036 145 933 Q  
036 198 119 E  
037 121 005 C  
  
037 121 010 B  
037 121 010 C  
037 145 271 E  
037 145 271 F  
037 145 271 F  
  
037 145 276 A  
037 145 276  
037 145 933 C  
037 198 119  
037 260 849 C  
  
037 903 137 G  
037 903 137 H  
037 903 315 B  
037 903 315 C  
038 109 243 F  
  
038 109 243 G  
038 109 243 H  
038 109 243 M  
038 109 243 N  
038 109 243

**VKPC 81419**  
**VKPC 81407**  
  
**VKPC 81407**  
**VKPC 81407**  
**VKPC 81407**  
**VKPC 81419**  
**VKPC 81407**  
  
**VKMV 6PK1151**  
**VKMV 6PK736**  
**VKMV 6PK1076**  
**VKMV 6PK1084**  
**VKMV 6PK1548**  
  
**VKMV 6PK1078**  
**VKMV 6PK745**  
**VKMV 6PK1123**  
**VKMA 01121**  
**VKPC 81401**  
  
**VKPA 81401**  
**VKPA 81401**  
**VKMV 11.5x685**  
**VKMV 10AVx660**  
**VKMV 11.5x755**

**SKODA**

007 070 243  
007 070 246  
007 070 251  
00A 121 010  
021 121 004  
  
021 145 933 C  
022 145 933 H  
022 145 933 N  
022 145 933 T  
023 121 004  
  
025 121 010 AV  
025 121 010 F  
026 121 005 F  
026 121 005 F  
026 121 005 H  
  
026 121 005 K  
026 121 005 L  
026 121 010 D  
026 121 010 D  
026 145 271  
  
026 198 119  
026 260 849 A  
026 903 137 C  
027 903 137  
028 109 244  
  
028 121 004  
028 145 271 F  
028 145 271 K  
028 145 271 L  
028 145 278 A  
  
028 145 278 E  
028 145 278 J  
028 145 278 M  
028 198 119 A  
028 198 119 B  
  
028 198 119 C  
028 198 119 D  
028 198 119 E  
028 198 119 F  
028 198 119 G

**VKPC 81409**  
**VKPC 81406**  
**VKPC 81412**  
**VKPC 81624**  
**VKPC 81611**  
  
**VKMV 7PK1290**  
**VKMV 6PK1264**  
**VKMV 6PK1240**  
**VKMV 6PK1620**  
**VKPC 81803**  
  
**VKPC 81607**  
**VKPC 81609**  
**VKPC 81401**  
**VKPC 81402**  
**VKPC 81401**  
  
**VKPC 81402**  
**VKPC 81402**  
**VKPA 81400**  
**VKPC 81400**  
**VKMV 10AVx730**  
  
**VKMA 01006**  
**VKMV 13AVx800**  
**VKMV 10AVx950**  
**VKMV 10AVx630**  
**VKM 21012**  
  
**VKPC 81615**  
**VKMV 11.9x903**  
**VKMV 10AVx730**  
**VKMV 11.5x790**  
**VKM 31004**  
  
**VKM 31004**  
**VKM 31034**  
**VKM 31025**  
**VKMA 01013**  
**VKMA 01012**  
  
**VKMA 01014**  
**VKMA 01256**  
**VKMA 01019**  
**VKMA 01016**  
**VKMA 01015**

030 145 299 F  
030 145 933 T  
030 145 933  
  
030 198 119 A  
030 198 119 B  
030 903 137 AA  
030 903 137 E  
030 903 137 T  
  
031 121 004  
031 121 005 C  
032 145 276  
032 145 299 A  
032 145 299 C  
  
032 145 933 AB  
032 145 933 T  
032 198 119  
034 260 849  
034 903 137 A  
  
034 903 137 B  
035 121 004 A  
035 145 271 F  
035 260 849 C  
035 903 137 C  
  
036 109 181 A  
036 109 181 B  
036 109 243 AB  
036 109 243 AC  
036 109 243 AD  
  
036 109 243 AF  
036 109 243 AG  
036 109 243 F  
036 109 243 J  
036 109 244 C  
  
036 109 244 D  
036 109 244 J  
036 121 005 B  
036 121 005 D  
036 121 005 E  
  
036 121 005 F  
036 121 005 J  
036 121 005 M

**VKMA 01106**  
**VKMA 01107**  
**VKMV 6PK737**  
**VKMV 11.9x710**  
**VKMV 6PK751**  
  
**VKPC 81206**  
**VKPC 81206**  
**VKM 31207**  
**VKM 31016**  
**VKM 31023**  
  
**VKMV 6PK1540**  
**VKMV 6PK1185**  
**VKMA 01110**  
**VKMV 13AVx915**  
**VKMV 11.2x820**  
  
**VKMV 4PK882**  
**VKPC 81605**  
**VKMV 13AVx1000**  
**VKMV 13AVx990**  
**VKMV 10AVx785**  
  
**VKM 21121**  
**VKM 21121**  
**VKM 11120**  
**VKM 11124**  
**VKM 11120**  
  
**VKM 11120**  
**VKM 11124**  
**VKM 11121**  
**VKM 11114**  
**VKM 21120**  
  
**VKM 21120**  
**VKM 21120**  
**VKPC 81407**  
**VKPC 81411**  
**VKPC 81407**  
  
**VKPC 81419**  
**VKPC 81419**  
**VKPC 81411**

037 145 276 A  
037 145 276  
037 145 933 C  
037 198 119  
037 260 849 C  
  
037 903 137 G  
037 903 137 H  
037 903 315 B  
037 903 315 C  
038 109 243 F  
  
038 109 243 G  
038 109 243 H  
038 109 243 M  
038 109 243 N  
038 109 243  
  
038 109 244 B  
038 109 244 E  
038 109 244 H  
038 109 244 J  
038 109 244 M  
  
038 121 011 A  
038 121 011 C  
038 121 011 D  
038 121 011 G  
038 121 011 H  
  
038 121 011 J  
038 121 011 K  
038 145 276  
038 145 278  
038 145 283 A  
  
038 145 299 A  
038 198 119 A  
038 198 119 B  
038 198 119 C  
038 198 119 D  
  
038 198 119 E  
038 198 119 F  
038 198 119  
038 260 849 A  
038 903 137 AA  
  
038 903 137 G

**VKM 31007**  
**VKM 31007**  
**VKMV 6PK1760**  
**VKMA 01002**  
**VKMV 6PK1153**  
  
**VKMV 6PK976**  
**VKMV 6PK1033**  
**VKM 31210**  
**VKM 31210**  
**VKM 11130**  
  
**VKM 11130**  
**VKM 11130**  
**VKM 11250**  
**VKM 11130**  
**VKM 11130**  
  
**VKM 21130**  
**VKM 21131**  
**VKM 21130**  
**VKM 21147**  
**VKM 21130**  
  
**VKPC 81623**  
**VKPC 81626**  
**VKPC 81626**  
**VKPC 81303**  
**VKPC 81627**  
  
**VKPC 81303**  
**VKPC 81627**  
**VKM 31002**  
**VKM 31013**  
**VKM 31013**  
  
**VKM 31013**  
**VKMA 01250**  
**VKMA 01141**  
**VKMA 01250**  
**VKMA 01131**  
  
**VKMA 01251**  
**VKMA 01130**  
**VKMA 01142**  
**VKMV 4PK841**  
**VKMV 6PK1180**  
  
**VKMV 6PK906**



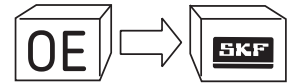
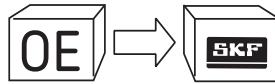
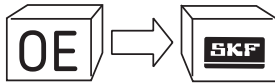

038 903 137 H  
 038 903 137 J  
 038 903 137 L  
 038 903 137 M  
 038 903 137 N  
 038 903 137 R  
 038 903 137 S  
 038 903 137 T  
 038 903 315 A  
 038 903 315 AB  
 038 903 315 AD  
 038 903 315 AE  
 038 903 315 AG  
 038 903 315 AH  
 038 903 315 C  
 038 903 315 D  
 038 903 315 E  
 038 903 315 F  
 038 903 315 K  
 038 903 315 P  
 038 903 315 T  
 03C 121 005 D  
 03C 145 299 C  
 03D 121 005  
 03D 121 013 B  
 03D 145 933 AD  
 03D 145 933 AG  
 03D 145 933 AH  
 03D 145 933 S  
 03E 260 849 A  
 03E 260 849 B  
 03G 109 243  
 03G 109 244  
 03G 198 119  
 03G 903 137 A  
 03G 903 137 B  
 03G 903 315 A  
 03G 903 315 C  
 044 145 271 K  
 044 145 278 A  
 044 260 849 B  
 044 260 849 E  
 044 903 137 R  
 045 109 243 A  
 045 109 243 B  
 045 109 243 C  
 045 109 243 F  
 045 109 244 A  
 045 109 479 B  
 045 121 011 B  
 045 121 011 C  
 045 121 011 F  
 045 121 011 G  
 045 121 011 H  
 045 121 011 J  
 045 260 849  
 045 903 137 D  
 045 903 137 E  
 045 903 315 A  
 046 121 004 D  
 046 121 004  
 047 121 011 A  
 047 121 011 B

VKMM 5PK1432  
 VKMM 6PK1660  
 VKMM 6PK1180  
 VKMM 6PK780  
 VKMM 6PK1095  
 VKMM 6PK1135  
 VKMM 6DK1215  
 VKMM 5PK1432  
 VKM 31018  
 VKM 31057  
 VKM 31058  
 VKM 31019  
 VKM 31058  
 VKM 31058  
 VKM 31012  
 VKM 31013  
 VKM 31018  
 VKM 31019  
 VKM 31018  
 VKM 31013  
 VKM 31058  
 VKPC 81501  
 VKM 31047  
 VKPC 81301  
 VKPC 81301  
 VKMM 6PK1880  
 VKMM 6PK1453  
 VKMM 6PK1880  
 VKMM 6PK1453  
 VKMM 6PK1873  
 VKMM 6PK1873  
 VKM 11255  
 VKM 21256  
 VKMA 01255  
 VKMM 6PK950  
 VKMM 6PK1050  
 VKM 31022  
 VKM 31054  
 VKMM 10AVx650  
 VKM 31043  
 VKMM 6PK1590  
 VKMM 6PK1905  
 VKMM 6PK1870  
 VKM 11142  
 VKM 11141  
 VKM 11142  
 VKM 11250  
 VKM 21142  
 VKM 11145  
 VKPC 81417  
 VKPC 81416  
 VKPC 81418  
 VKPC 81302  
 VKPC 81418  
 VKPC 81302  
 VKMM 6DK1188  
 VKMM 6PK996  
 VKMM 6PK858  
 VKM 31035  
 VKPC 81805  
 VKPC 81603  
 VKPC 81406  
 VKPC 81412

047 121 011  
 047 145 933 E  
 047 903 137 AB  
 047 903 137 E  
 047 903 137 F  
 047 903 137 G  
 047 903 137 L  
 047 903 137 R  
 048 198 119  
 049 260 849 A  
 050 121 010 A  
 050 121 010 C  
 050 121 039 A  
 050 260 849  
 050 903 137 C  
 050 903 137  
 051 198 119  
 052 121 005 A  
 052 903 137 F  
 054 121 004 A  
 054 121 004  
 054 903 137 D  
 054 903 137  
 055 903 137 G  
 056 198 119  
 058 109 243 D  
 058 109 244  
 058 198 119 A  
 058 198 119  
 058 260 511  
 058 260 849 A  
 058 903 133 C  
 058 903 133 D  
 059 121 004 C  
 059 121 004 D  
 059 121 004 E  
 059 145 276  
 059 198 119 A  
 059 198 119  
 059 260 523 A  
 059 260 523 B  
 059 260 523  
 059 260 849 B  
 059 260 849 D  
 059 903 137 AC  
 059 903 137 H  
 059 903 341 A  
 059 903 341  
 062 145 933 A  
 062 260 849 B  
 062 903 137  
 066 121 011 C  
 066 145 933 K  
 068 109 243 F  
 068 121 010 A  
 068 121 039 B  
 068 121 039 L  
 068 145 271 B  
 068 145 271 C  
 068 145 271 E  
 068 260 849 D  
 068 260 849 G  
 068 260 849

VKPC 81406  
 VKMM 6PK1680  
 VKMM 6PK1748  
 VKMM 6PK1880  
 VKMM 6PK1480  
 VKMM 6PK1520  
 VKMM 4PK950  
 VKMM 5PK1219  
 VKMA 01024  
 VKMM 13AVx825  
 VKPA 81402  
 VKPA 81402  
 VKMM 10AVx910  
 VKMM 13AVx800  
 VKMM 4PK855  
 VKMM 10AVx950  
 VKMA 01009  
 VKPC 81200  
 VKMM 10AVx675  
 VKPC 81612  
 VKPC 81612  
 VKMM 10AVx875  
 VKMM 10AVx865  
 VKMM 10AVx850  
 VKMA 01000  
 VKM 11007  
 VKM 21004  
 VKMA 01007  
 VKMA 01008  
 VKM 31059  
 VKMM 4PK855  
 VKM 31033  
 VKM 31033  
 VKPC 81625  
 VKPC 81625  
 VKPC 81625  
 VKPC 81625  
 VKM 31039  
 VKMA 01152  
 VKMA 01152  
 VKM 31040  
 VKM 31040  
 VKM 31040  
 VKMM 4PK1237  
 VKMM 4PK1217  
 VKMM 6PK2480  
 VKMM 6PK2404  
 VKM 31041  
 VKM 31038  
 VKMM 6PK1683  
 VKMM 6PK2155  
 VKMM 6PK2000  
 VKPC 81622  
 VKMM 6PK1264  
 VKM 11010  
 VKPA 81401  
 VKMM 10AVx650  
 VKMM 10AVx838  
 VKMM 10AVx740  
 VKMM 10AVx763  
 VKMM 11.9x650  
 VKMM 13AVx1250  
 VKMM 13AVx950  
 VKMM 13AVx950

068 260 940  
 068 903 137 AF  
 068 903 137 AJ  
 068 903 137 AP  
 068 903 137 AQ  
 068 903 137 AR  
 068 903 137 B  
 068 903 137 D  
 068 903 137 Q  
 068 903 137 S  
 069 903 137 C  
 06A 109 479 A  
 06A 109 479 C  
 06A 109 479  
 06A 121 011 E  
 06A 121 011 F  
 06A 121 011 G  
 06A 121 011 L  
 06A 121 011 T  
 06A 121 012  
 06A 145 933 D  
 06A 145 933 F  
 06A 198 119  
 06A 260 849 C  
 06A 260 849 E  
 06A 260 849 G  
 06A 260 849 K  
 06A 903 315 E  
 06B 109 243 A  
 06B 109 243 B  
 06B 109 243 D  
 06B 109 243 E  
 06B 109 243 F  
 06B 109 243  
 06B 109 244  
 06B 109 477 A  
 06B 109 477  
 06B 121 011 B  
 06B 121 011 C  
 06B 121 011 E  
 06B 121 011 H  
 06B 121 011 L  
 06B 121 011 M  
 06B 198 119 A  
 06B 260 849 A  
 06B 260 849 B  
 06B 903 137 D  
 06B 903 137 E  
 06B 903 137 J  
 06B 903 137  
 06C 109 244 D  
 06C 109 244  
 06D 109 243 B  
 06D 109 243  
 06D 903 137 C  
 06F 198 119 A  
 06F 198 119  
 06F 260 849 E  
 06F 260 849 L  
 06F 903 137 E  
 06F 903 137 L  
 071 121 005  
 071 145 933 F

VKM 31009  
 VKMM 10AVx600  
 VKMM 10AVx625  
 VKMM 10AVx710  
 VKMM 10AVx695  
 VKMM 11.9x950  
 VKMM 10AVx875  
 VKMM 10AVx965  
 VKMM 10AVx735  
 VKMM 10AVx775  
 VKMM 11.5x790  
 VKM 11113  
 VKM 11113  
 VKM 11113  
 VKPC 81620  
 VKPC 81620  
 VKPC 81620  
 VKPC 81620  
 VKPC 81620  
 VKPC 81620  
 VKPC 81620  
 VKPC 81620  
 VKMM 6PK1120  
 VKMM 6PK926  
 VKMA 01113  
 VKMM 6DK1195  
 VKMM 6DK1195  
 VKMM 6PK1032  
 VKMM 6PK1032  
 VKM 31011  
 VKM 11116  
 VKM 11018  
 VKM 11116  
 VKM 11018  
 VKM 11116  
 VKM 11115  
 VKM 21220  
 VKM 11117  
 VKM 21115  
 VKPC 81408  
 VKPC 81408  
 VKPC 81220  
 VKPC 81408  
 VKPC 81220  
 VKMA 01018  
 VKMM 4PK855  
 VKMM 4PK855  
 VKMM 6PK1589  
 VKMM 5PK1300  
 VKMM 6PK1572  
 VKMM 5PK1300  
 VKM 21302  
 VKM 21302  
 VKM 11222  
 VKM 11220  
 VKMM 6PK1572  
 VKMA 01222  
 VKMA 01220  
 VKMM 6PK1042  
 VKMM 6PK1054  
 VKMM 6PK900  
 VKMM 6PK953  
 VKPC 81622  
 VKMM 6PK1285





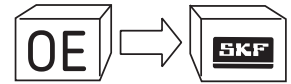
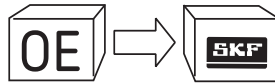
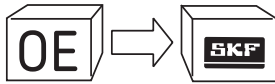

4003.25  
5749.11  
5749.21  
5750.49  
7901120258

VKMV 10AVx913  
VKMV 10AVx750  
VKMV 10AVx913  
VKMV 10AVx1100  
VKPC 83200

13505-62050  
13505-62060  
13505-62070  
13505-63010  
13505-63021  
13505-64011

VKM 71004  
VKM 71004  
VKM 71701  
VKM 71101  
VKM 71101  
VKM 71100

16100-29155  
16100-29156  
16100-29175  
16100-29415  
16100-39395  
16100-59135  
16100-59136  
16100-59137

VKPC 91806  
VKPC 91806  
VKPC 91808  
VKPC 91808  
VKPC 91806  
VKPC 91606  
VKPC 91606  
VKPC 91606

**TOYOTA**

13503-10010  
13503-10011  
13503-10021  
13503-11030  
13503-11040

VKM 81203  
VKM 81201  
VKM 81201  
VKM 81400  
VKM 81400

13505-64012  
13505-64020  
13505-64021  
13505-67040  
13505-67041

VKM 71100  
VKM 71100  
VKM 71100  
VKM 71014  
VKM 71014

16100-59138  
16100-59155  
16100-59255  
16100-59256  
16100-59257

VKPC 91606  
VKPC 91607  
VKPC 91607  
VKPC 91607  
VKPC 91607

13503-27010  
13503-50010  
13503-50011  
13503-54010  
13503-54020

VKM 81204  
VKM 81005  
VKM 81005  
VKM 81001  
VKM 81001

13505-67050  
13505-70012  
13505-70020  
13505-70021  
13505-74010

VKM 71706  
VKM 71103  
VKM 71103  
VKM 71003  
VKM 71003

16100-69075  
16100-69085  
16100-69095  
16100-69275  
16100-69295

VKPC 91404  
VKPC 91405  
VKPC 91404  
VKPC 91405  
VKPC 91405

13503-54030  
13503-62010  
13503-62030  
13503-62040  
13503-63010

VKM 81002  
VKM 81000  
VKM 81000  
VKM 81401  
VKM 81004

13505-74011  
13505-74030  
13505-88300  
13505-88301  
13505-88360

VKM 71302  
VKM 71103  
VKM 71103  
VKM 71302  
VKM 71302

16100-69296  
16100-69425  
16100-79035  
16100-79036  
16100-79045

VKPC 91405  
VKPC 91405  
VKPC 91428  
VKPC 91428  
VKPC 91604

13503-63011  
13503-63020  
13503-63021  
13503-64020  
13503-64021

VKM 81004  
VKM 81004  
VKM 81004  
VKM 81100  
VKM 81100

13505-88361  
13505-88382  
13505-88383  
13505-88480  
13570-YV010

VKM 71302  
VKM 71006  
VKM 71013  
VKM 33044  
VKPC 91409

16100-79075  
16100-79095  
16100-79165  
16110-09010  
16110-15050

VKPC 91613  
VKPC 91604  
VKPA 91615  
VKPC 91613  
VKPC 91409

13503-70040  
13503-88360  
13503-88361  
13503-88380  
13505-02020

VKM 81004  
VKM 81004  
VKM 81004  
VKM 81004  
VKM 71401

16100-09010  
16100-09051  
16100-09060  
16100-09130  
16100-09140

VKPC 91409  
VKPC 91416  
VKPA 91441  
VKPC 91808  
VKPC 91807

16110-15060  
16110-15070  
16110-15080  
16110-16020  
16110-19035

VKPC 91409  
VKPC 91415  
VKPC 91415  
VKPC 91414  
VKPC 91431

13505-02030  
13505-10010  
13505-11010  
13505-11011  
13505-11020

VKM 71007  
VKM 71200  
VKM 71201  
VKM 71201  
VKM 71201

16100-09141  
16100-09310  
16100-19015  
16100-19016  
16100-19017

VKPC 91807  
VKPC 91808  
VKPC 91402  
VKPC 91402  
VKPC 91402

16110-19036  
16110-19045  
16110-19046  
16110-19047  
16110-19055

VKPC 91431  
VKPC 91409  
VKPC 91409  
VKPC 91409  
VKPC 91413

13505-11040  
13505-11050  
13505-15041  
13505-15050  
13505-15060

VKM 71400  
VKM 71400  
VKM 71202  
VKM 71007  
VKM 71007

16100-19025  
16100-19026  
16100-19027  
16100-19028  
16100-19045

VKPC 91431  
VKPC 91431  
VKPC 91431  
VKPC 91427  
VKPC 91427

16110-19065  
16110-19075  
16110-19076  
16110-19085  
16110-19086

VKPC 91413  
VKPC 91415  
VKPC 91415  
VKPC 91409  
VKPC 91415

13505-16010  
13505-16011  
13505-16020  
13505-16021  
13505-17010

VKM 71401  
VKM 71401  
VKM 71401  
VKM 71401  
VKM 71012

16100-19046  
16100-19105  
16100-19106  
16100-19125  
16100-19126

VKPC 91427  
VKPC 91409  
VKPA 91409  
VKPA 91417  
VKPA 91417

16110-19095  
16110-19105  
16110-19106  
16110-19107  
16110-19165

VKPC 91413  
VKPC 91417  
VKPC 91417  
VKPC 91417  
VKPC 91414

13505-17011  
13505-17020  
13505-20010  
13505-20020  
13505-20030

VKM 71012  
VKM 71704  
VKM 71004  
VKM 71004  
VKM 71304

16100-19155  
16100-19156  
16100-19195  
16100-19205  
16100-19225

VKPC 91427  
VKPC 91427  
VKPC 91413  
VKPC 91415  
VKPA 91417

16110-19205  
16110-63010  
16110-69035  
16110-69036  
16110-79015

VKPC 91416  
VKPC 91404  
VKPC 91404  
VKPC 91404  
VKPC 91604

13505-27010  
13505-42010  
13505-42020  
13505-46041  
13505-54010

VKM 71303  
VKM 71700  
VKM 71700  
VKM 71010  
VKM 71001

16100-19226  
16100-19255  
16100-19295  
16100-19296  
16100-19305

VKPA 91417  
VKPA 91416  
VKPA 91416  
VKPA 91441  
VKPC 91813

16110-79025  
16110-79026  
16110-79035  
16110-79045  
16110-79095

VKPC 91613  
VKPC 91613  
VKPC 91604  
VKPC 91613  
VKPC 91604

13505-54020  
13505-54021  
13505-55020  
13505-62031

VKM 71002  
VKM 71002  
VKM 71000  
VKM 71004

16100-28040  
16100-28041  
16100-29095  
16100-29115  
16100-29116

VKPC 91813  
VKPC 91808  
VKPC 91805  
VKPC 91805  
VKPC 91807

16601-YV010  
16620-0R010  
88440-12100

VKPC 91604  
VKPC 91442  
VKM 33043  
VKM 61016  
VKM 61002

16100-29125  
16100-29135

VKPC 91814





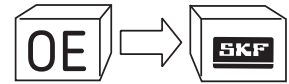
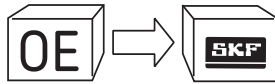
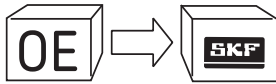

88440-12170  
88440-12190  
88440-16050  
88440-17010  
88440-20160  
  
88440-20170  
90507-27003  
90916-02533  
90916-02539  
90916-02549  
  
90916-W2002  
90916-W2003  
90916-W2005  
90916-WX001  
90916-WX002  
  
99365-A1190  
99365-C1190

VKM 61009  
VKM 61003  
VKM 61011  
VKM 61000  
VKM 61000  
  
VKM 61000  
VKM 71012  
VKMV 5PK1240  
VKMV 6PK1400  
VKMV 6PK1690  
  
VKMV 6PK1210  
VKMV 6PK850  
VKMV 6PK1560  
VKMV 6PK802  
VKMV 6PK966  
  
VKMV 5PK1190  
VKMV 5PK1190

13 34 121  
13 34 123  
13 34 124  
  
13 34 130  
13 34 131  
13 34 135  
13 34 139  
13 34 140  
  
13 34 143  
13 34 145  
13 34 147  
13 34 646  
13 40 530  
  
13 40 533  
13 40 535  
13 40 536  
13 40 539  
13 40 540

VKPC 85622  
VKPC 82810  
VKPC 88826  
  
VKPC 85220  
VKPC 85613  
VKPC 85624  
VKPC 85611  
VKPC 85613  
  
VKPC 85300  
VKPC 85310  
VKPC 82667  
VKPC 85611  
VKM 35007  
  
VKM 35008  
VKM 35002  
VKM 35500  
VKM 38220  
VKM 38225

13 40 732  
13 40 737  
13 40 739  
13 40 827  
16 06 191  
  
16 06 192  
16 06 193  
16 06 194  
16 06 195  
16 06 196  
  
16 06 197  
16 06 198  
16 06 199  
16 06 262  
16 06 274  
  
16 06 281  
16 06 306  
18 54 421  
18 54 711  
18 54 712

VKMOV 10AVx1000  
VKMV 10AVx1025  
VKMV 10AVx900  
VKM 35016  
VKMA 05222  
  
VKMA 05222  
VKMA 05220  
VKMA 05224  
VKMA 05223  
VKMA 05140  
  
VKMA 05211  
VKMA 05228  
VKMA 05228  
VKMA 05154  
VKMA 05150  
  
VKMA 05152  
VKMA 05156  
VKM 35025  
VKMV 10AVx888  
VKMV 10AVx875

**VAUXHALL**

12 04 641  
12 06 990  
13 34 008  
13 34 013  
13 34 014  
  
13 34 015  
13 34 016  
13 34 021  
13 34 023  
13 34 024  
  
13 34 025  
13 34 027  
13 34 031  
13 34 034  
13 34 038  
  
13 34 046  
13 34 050  
13 34 052  
13 34 053  
13 34 054  
  
13 34 059  
13 34 065  
13 34 066  
13 34 067  
13 34 069  
  
13 34 071  
13 34 073  
13 34 075  
13 34 077  
13 34 078  
  
13 34 079  
13 34 081  
13 34 082  
13 34 083  
13 34 087  
  
13 34 097  
13 34 102  
13 34 105  
13 34 112  
13 34 114  
  
13 34 115  
13 34 117

VKM 35015  
VKM 35011  
VKPC 85407  
VKPC 85400  
VKPC 85408  
  
VKPC 85406  
VKPC 85403  
VKPC 85603  
VKPC 85202  
VKPC 85401  
  
VKPC 85206  
VKPC 85201  
VKPC 85404  
VKPC 85410  
VKPC 85610  
  
VKPC 85212  
VKPC 85611  
VKPC 85404  
VKPC 85611  
VKPC 85409  
  
VKPC 85613  
VKPC 85206  
VKPC 85212  
VKPC 85308  
VKPC 85620  
  
VKPC 85201  
VKPC 85300  
VKPC 85308  
VKPC 85211  
VKPC 85460  
  
VKPC 85220  
VKPC 85600  
VKPC 88430  
VKPC 85308  
VKPA 85605  
  
VKPA 85608  
VKPC 85410  
VKPC 85404  
VKPC 88826  
VKPC 85621  
  
VKPC 85620  
VKPC 85623

13 40 541  
13 40 543  
13 40 545  
13 40 547  
13 40 550  
  
13 40 551  
13 40 555  
13 40 600  
13 40 611  
13 40 612  
  
13 40 617  
13 40 622  
13 40 625  
13 40 626  
13 40 629  
  
13 40 638  
13 40 640  
13 40 642  
13 40 643  
13 40 644  
  
13 40 645  
13 40 646  
13 40 648  
13 40 649  
13 40 652  
  
13 40 657  
13 40 660  
13 40 662  
13 40 663  
13 40 664  
  
13 40 665  
13 40 667  
13 40 671  
13 40 672  
13 40 674  
  
13 40 675  
13 40 677  
13 40 678  
13 40 681  
13 40 683  
  
13 40 714  
13 40 720  
13 40 727  
13 40 728  
13 40 729

VKM 35009  
VKM 38220  
VKM 35007  
VKM 35500  
VKM 35013  
  
VKM 35013  
VKM 35012  
VKMV 6PK1250  
VKMV 5PK1815  
VKMV 10AVx913  
  
VKMV 6PK1460  
VKMV 10AVx925  
VKMV 6PK1902  
VKMV 6PK1805  
VKMV 5PK1230  
  
VKMV 6PK1850  
VKMV 4PK882  
VKMV 5PK1230  
VKMV 6PK1530  
VKMV 6PK895  
  
VKMV 6PK1460  
VKMV 6PK1795  
VKMV 6PK1725  
VKMV 6PK2020  
VKMV 5PK1680  
  
VKMV 5PK1255  
VKMV 5PK1028  
VKMV 6PK1590  
VKMV 6PK1902  
VKMV 6PK1805  
  
VKMV 6PK1873  
VKMV 5PK1028  
VKMV 5PK1355  
VKMV 5PK1355  
VKMV 5PK1028  
  
VKMV 5PK880  
VKMV 5PK1028  
VKMV 5PK880  
VKMV 13AVx915  
VKMV 6PK1600  
  
VKMV 10AVx913  
VKMV 10AVx1000  
VKMV 13AVx915  
VKMV 6PK1460  
VKMV 10AVx925

18 54 725  
18 55 750  
24409355  
24412292  
24413292  
  
24413293  
24413294  
24426500  
24430296  
24435940  
  
24435953  
24447794  
24466972  
24466976  
24469102  
  
30 09 003  
30 13 021  
44 00 204  
44 01 416  
44 01 428  
  
44 01 430  
44 01 595  
44 01 609  
44 02 631  
44 03 144  
  
44 03 270  
44 04 088  
44 04 098  
44 04 308  
44 08 028  
  
44 08 922  
44 09 162  
44 09 485  
44 10 172  
44 10 513  
  
44 10 548  
44 10 595  
44 11 707  
44 11 717  
44 13 791  
  
44 14 654  
44 30 891  
45 00 034

VKMV 4PK781  
VKMV 6PK2050  
VKPC 85611  
VKM 35009  
VKMV 6PK1902  
  
VKMV 6PK1805  
VKMV 6PK1873  
VKM 15216  
VKM 34027  
VKMV 5PK1028  
  
VKMV 5PK880  
VKM 15260  
VKMV 5PK1028  
VKMV 5PK880  
VKPC 85310  
  
VKMV 10AVx875  
VKMV 10AVx925  
VKM 22380  
VKM 16551  
VKMA 06503  
  
VKM 16503  
VKPC 86305  
VKM 16101  
VKM 16551  
VKM 22385  
  
VKM 26101  
VKPC 82630  
VKPC 86413  
VKPC 82630  
VKPC 85304  
  
VKM 16113  
VKPC 86413  
VKMA 06127  
VKMV 6PK1792  
VKM 16113  
  
VKM 26105  
VKM 36031  
VKM 36030  
VKMV 5PK1125  
VKM 36038  
  
VKM 36040  
VKMA 06127  
VKMV 6PK860

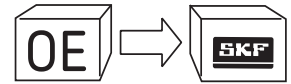
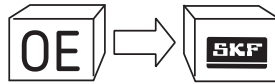
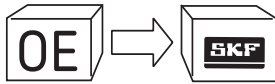

|           |              |           |            |           |                |
|-----------|--------------|-----------|------------|-----------|----------------|
| 45 00 056 | VKMV 6PK841  | 56 36 745 | VKM 12174  | 63 40 600 | VKMV 5PK1240   |
| 45 00 955 | VKM 36017    | 56 36 746 | VKM 15140  | 63 40 602 | VKMV 6PK1992   |
| 45 01 293 | VKPC 85302   | 56 36 755 | VKM 25226  | 63 40 605 | VKMV 5PK1450   |
| 45 01 294 | VKPC 85303   | 56 36 756 | VKM 25222  | 63 40 606 | VKMV 5PK1546   |
| 45 06 045 | VKPC 86305   | 6 14 533  | VKM 34027  | 63 40 609 | VKMV 5PK1028   |
| 45 06 090 | VKM 16503    | 6 36 383  | VKM 79002  | 63 40 610 | VKMV 5PK880    |
| 45 06 092 | VKM 26503    | 6 36 415  | VKM 25212  | 63 40 615 | VKMV 6PK1182   |
| 45 06 181 | VKMV 6PK1795 | 6 36 416  | VKM 25213  | 63 40 617 | VKMV 6PK1275   |
| 45 06 189 | VKMV 6PK1148 | 6 36 418  | VKM 25202  | 63 40 618 | VKMV 6PK1605   |
| 45 06 194 | VKM 36040    | 6 36 420  | VKM 25312  | 63 40 619 | VKMV 6PK1050   |
| 55185074  | VKM 35023    | 6 36 421  | VKM 25200  | 63 40 620 | VKMV 6PK1410   |
| 55185077  | VKMV 6PK1182 | 6 36 422  | VKM 25201  | 63 40 621 | VKMV 6PK1902   |
| 55190813  | VKM 32046    | 6 36 423  | VKM 25211  | 63 40 622 | VKMV 6PK1880   |
| 55350420  | VKMV 5PK1450 | 6 36 429  | VKM 15402  | 63 40 623 | VKMV 6PK1805   |
| 55350421  | VKMV 5PK1546 | 6 36 671  | VKMA 05500 | 63 40 624 | VKMV 7PK1922   |
| 55350422  | VKM 35260    | 6 36 723  | VKM 15230  | 63 40 625 | VKMV 6PK1620   |
| 55350580  | VKM 25158    | 6 36 726  | VKM 15202  | 63 40 626 | VKMV 5PK1212   |
| 55350960  | VKM 35016    | 6 36 727  | VKM 15402  | 63 40 627 | VKMV 5PK1212   |
| 55351458  | VKMV 5PK1028 | 6 36 728  | VKMA 05500 | 63 40 628 | VKMV 13AVx915  |
| 55351459  | VKMV 5PK880  | 6 36 729  | VKM 15230  | 63 40 632 | VKMV 10AVx913  |
| 55352021  | VKM 35013    | 6 36 730  | VKM 25208  | 63 40 639 | VKMV 5PK1230   |
| 55353810  | VKM 15140    | 6 36 730  | VKM 25209  | 63 40 640 | VKMV 5PK1355   |
| 55354680  | VKMV 6PK1902 | 6 36 731  | VKM 15210  | 63 40 646 | VKMV 5PK1028   |
| 55354681  | VKMV 6PK1880 | 6 36 732  | VKM 15211  | 63 40 648 | VKMV 10AVx950  |
| 55354682  | VKMV 6PK1805 | 6 36 734  | VKM 15121  | 63 40 656 | VKMV 5PK938    |
| 55555653  | VKM 15260    | 6 36 735  | VKM 15213  | 63 40 660 | VKMV 5PK1680   |
| 55556090  | VKM 35260    | 6 36 737  | VKM 15202  | 63 40 667 | VKMV 5PK1255   |
| 55560052  | VKMV 5PK1570 | 6 36 740  | VKM 15121  | 63 40 668 | VKMV 6PK1600   |
| 56 36 384 | VKM 15140    | 6 36 741  | VKM 15215  | 63 40 669 | VKMV 6PK1620   |
| 56 36 385 | VKMA 05501   | 6 36 742  | VKM 15210  | 63 40 671 | VKMV 6PK1250   |
| 56 36 393 | VKMA 05502   | 6 36 745  | VKM 15215  | 63 40 672 | VKMV 6PK1615   |
| 56 36 395 | VKM 25208    | 6 36 746  | VKM 15402  | 63 40 677 | VKMV 5PK1570   |
| 56 36 395 | VKM 25209    | 6 36 747  | VKM 25208  | 8 15 971  | VKM 89003      |
| 56 36 403 | VKM 15218    | 6 36 747  | VKM 25209  | 9 50 358  | VKMV 10AVx875  |
| 56 36 404 | VKM 15220    | 6 36 748  | VKM 15121  | 9 50 361  | VKMV 10AVx850  |
| 56 36 412 | VKM 35214    | 6 36 749  | VKM 15121  | 9 50 365  | VKMV 10AVx800  |
| 56 36 415 | VKM 25150    | 62 04 661 | VKM 35015  | 9 50 371  | VKMV 10AVx813  |
| 56 36 416 | VKM 25152    | 63 34 000 | VKPC 85611 | 9 50 376  | VKMV 10AVx875  |
| 56 36 419 | VKM 25150    | 63 34 001 | VKPC 85700 | 9 50 380  | VKMV 10AVx950  |
| 56 36 423 | VKM 25224    | 63 34 002 | VKPC 85308 | 90006259  | VKMV 10AVx875  |
| 56 36 424 | VKM 25202    | 63 34 003 | VKPC 82665 | 90006267  | VKMV 10AVx913  |
| 56 36 425 | VKM 25212    | 63 34 004 | VKPC 85410 | 90091035  | VKPC 85201     |
| 56 36 426 | VKM 25152    | 63 34 005 | VKPC 85621 | 90136224  | VKPC 85600     |
| 56 36 427 | VKM 25150    | 63 34 006 | VKPC 85622 | 90136377  | VKPC 85600     |
| 56 36 429 | VKM 15402    | 63 34 008 | VKPC 85620 | 90136382  | VKPC 85600     |
| 56 36 434 | VKM 25226    | 63 34 011 | VKPC 85403 | 90169081  | VKMV 10AVx875  |
| 56 36 435 | VKM 25222    | 63 34 019 | VKPC 85300 | 90169084  | VKMV 10AVx850  |
| 56 36 437 | VKM 35212    | 63 34 022 | VKPC 85220 | 90180131  | VKM 25200      |
| 56 36 451 | VKM 15260    | 63 34 024 | VKPC 85300 | 90220568  | VKPC 85407     |
| 56 36 455 | VKM 25158    | 63 34 025 | VKPC 85220 | 90231797  | VKMV 10AVx1000 |
| 56 36 456 | VKM 12174    | 63 34 035 | VKPC 85211 | 90264022  | VKM 25201      |
| 56 36 475 | VKM 12174    | 63 34 038 | VKPC 85620 | 90272361  | VKPC 85407     |
| 56 36 722 | VKM 15121    | 63 34 039 | VKPC 85460 | 90273924  | VKPC 85400     |
| 56 36 724 | VKM 15215    | 63 34 040 | VKPC 85623 | 90280872  | VKMV 10AVx800  |
| 56 36 725 | VKM 15260    | 63 34 048 | VKPC 85300 | 9028200   | VKM 15402      |
| 56 36 732 | VKM 15216    | 63 40 532 | VKM 35009  | 90284802  | VKPC 85400     |
| 56 36 733 | VKM 15216    | 63 40 538 | VKM 35500  | 90284913  | VKPC 85408     |
| 56 36 738 | VKM 15202    | 63 40 551 | VKM 35016  | 90285418  | VKPC 85406     |
| 56 36 739 | VKM 15218    | 63 40 552 | VKM 35260  | 90285679  | VKMV 6PK1460   |
| 56 36 740 | VKM 15216    | 63 40 553 | VKM 35013  | 90323501  | VKM 15211      |
| 56 36 741 | VKM 35216    | 63 40 554 | VKM 35023  | 90323503  | VKM 25211      |
| 56 36 743 | VKM 22179    | 63 40 557 | VKM 32046  | 90325659  | VKPC 85202     |
| 56 36 743 | VKM 22180    | 63 40 558 | VKM 35260  | 90325661  | VKPC 85401     |



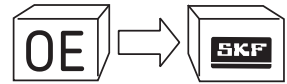
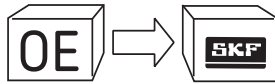
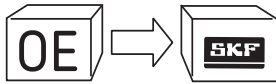

|          |                |          |                |          |                |
|----------|----------------|----------|----------------|----------|----------------|
| 90348231 | VKPC 85603     | 9110631  | VKM 16551      | 9202550  | VKM 35500      |
| 90349239 | VKPC 85206     | 9111144  | VKM 22385      | 92061745 | VKMMV 6PK2050  |
| 90349240 | VKPC 85401     | 9111270  | VKM 26101      | 92063403 | VKMMV 6PK1850  |
| 90349241 | VKPC 85202     | 9112088  | VKPC 82630     | 92064250 | VKPC 85611     |
| 90353137 | VKMMV 10AVx925 | 9112098  | VKPC 86413     | 92065368 | VKM 15140      |
| 90353176 | VKM 15121      | 9112308  | VKPC 82630     | 92065969 | VKPC 85611     |
| 90397190 | VKMMV 10AVx925 | 91126380 | VKMMV 5PK1230  | 9240033  | VKM 25312      |
| 90409238 | VKM 35002      | 91126381 | VKMMV 6PK1530  | 93160191 | VKMMV 6PK1792  |
| 90409783 | VKM 35500      | 91126382 | VKMMV 6PK895   | 93160237 | VKM 16113      |
| 90409912 | VKPC 85201     | 91126385 | VKMMV 6PK1795  | 93160244 | VKM 26105      |
| 90410386 | VKMMV 10AVx888 | 91126386 | VKMMV 6PK1900  | 93160256 | VKM 36031      |
| 90411025 | VKM 35008      | 91126387 | VKMMV 6PK1725  | 93160750 | VKMMV 5PK1125  |
| 90411773 | VKM 25213      | 91126388 | VKMMV 6PK2020  | 93160779 | VKM 36040      |
| 90411774 | VKM 15202      | 91126403 | VKMMV 5PK1680  | 93161273 | VKM 36038      |
| 90411782 | VKM 25212      | 91142246 | VKMMV 10AVx875 | 93161478 | VKMA 06127     |
| 90411787 | VKM 25202      | 91151669 | VKPC 82810     | 93170142 | VKPC 85220     |
| 90412730 | VKM 25152      | 91158706 | VKMA 06127     | 93170401 | VKPC 85308     |
| 90412731 | VKM 25150      | 91159773 | VKPC 85304     | 93170697 | VKPC 85613     |
| 90412884 | VKM 35011      | 91160164 | VKM 16113      | 93171540 | VKPC 88430     |
| 90442207 | VKPC 85610     | 91160212 | VKPC 86413     | 93172354 | VKMA 05502     |
| 90444123 | VKPC 85409     | 9117586  | VKMMV 5PK1212  | 93172363 | VKMMV 5PK1240  |
| 90444311 | VKPC 85611     | 9117588  | VKMMV 5PK1680  | 93172395 | VKMMV 6PK1992  |
| 90444486 | VKMMV 10AVx813 | 9117590  | VKMMV 5PK938   | 93172718 | VKPC 85308     |
| 90444649 | VKPC 85613     | 9117695  | VKM 15121      | 93174260 | VKMA 05222     |
| 90448698 | VKMMV 10AVx900 | 9118612  | VKMMV 5PK1230  | 93174261 | VKMA 05222     |
| 90499401 | VKM 15121      | 9118614  | VKMMV 6PK895   | 93174262 | VKMA 05220     |
| 90500229 | VKM 35009      | 9118616  | VKMMV 6PK1460  | 93174263 | VKMA 05224     |
| 90501384 | VKMMV 6PK1460  | 9118617  | VKMMV 6PK1795  | 93174264 | VKMA 05223     |
| 90502286 | VKMMV 10AVx925 | 9120501  | VKMA 05500     | 93174265 | VKMA 05140     |
| 90502421 | VKM 35007      | 9128516  | VKM 15216      | 93174266 | VKMA 05211     |
| 90502734 | VKMMV 6PK1902  | 9128656  | VKM 15216      | 93174267 | VKMA 05228     |
| 90502735 | VKMMV 6PK1805  | 9128738  | VKM 25212      | 93174268 | VKMA 05228     |
| 90509273 | VKM 38220      | 9128739  | VKM 25152      | 93175325 | VKMMV 6PK1880  |
| 90509282 | VKM 38225      | 9128740  | VKM 25150      | 93177340 | VKPC 85700     |
| 90509315 | VKMMV 5PK1815  | 9128741  | VKM 25202      | 93177562 | VKMMV 5PK1368  |
| 90510025 | VKMMV 10AVx913 | 9158003  | VKM 15402      | 93178602 | VKPC 85308     |
| 90511627 | VKM 38220      | 9158004  | VKM 15202      | 93178713 | VKPC 82665     |
| 90512535 | VKPC 88826     | 9160334  | VKMMV 6PK860   | 93178807 | VKM 22179      |
| 90512538 | VKMMV 4PK781   | 9160356  | VKMMV 6PK841   | 93178807 | VKM 22180      |
| 90528222 | VKM 15402      | 9161255  | VKM 36017      | 93178816 | VKM 12174      |
| 90528603 | VKM 15230      | 9161593  | VKPC 85302     | 93179102 | VKMMV 6PK1050  |
| 90528760 | VKM 35500      | 9161594  | VKPC 85303     | 93179109 | VKMMV 6PK1410  |
| 90529810 | VKM 25224      | 9180809  | VKM 35007      | 93179114 | VKPC 82667     |
| 90530124 | VKM 15402      | 9192370  | VKPC 85611     | 93179360 | VKPC 85410     |
| 90530125 | VKM 15202      | 9192568  | VKMMV 5PK1255  | 93179361 | VKPC 85621     |
| 90530126 | VKM 15230      | 9192793  | VKPC 85206     | 93179362 | VKPC 85622     |
| 90531965 | VKM 35013      | 9192797  | VKPC 85212     | 93179364 | VKPC 85620     |
| 90531986 | VKM 35013      | 9194660  | VKMMV 5PK1212  | 93179379 | VKPC 85403     |
| 90540478 | VKPC 85623     | 9194661  | VKMMV 5PK1212  | 93180218 | VKMA 05154     |
| 90542606 | VKPC 85220     | 9194747  | VKPC 85308     | 93180219 | VKMA 05150     |
| 90542748 | VKMMV 5PK1230  | 9195191  | VKMMV 5PK1028  | 93180563 | VKMMV 7PK1922  |
| 90543277 | VKPC 85613     | 9198522  | VKMMV 6PK1148  | 93181316 | VKMMV 5PK1212  |
| 90543935 | VKPC 85624     | 9198527  | VKM 36040      | 93181317 | VKMMV 5PK1212  |
| 90570525 | VKM 15121      | 9198828  | VKMMV 5PK1355  | 93181703 | VKMMV 13AVx915 |
| 90570913 | VKM 25150      | 9198829  | VKMMV 5PK1355  | 93181708 | VKMMV 10AVx913 |
| 90571757 | VKMMV 4PK882   | 9199592  | VKPC 85211     | 93181966 | VKM 12174      |
| 90571758 | VKM 35012      | 9199595  | VKPC 85460     | 93182026 | VKPC 85220     |
| 9108204  | VKM 22380      | 9201450  | VKPC 86305     | 93182028 | VKPC 85300     |
| 9109416  | VKM 16551      | 9201537  | VKM 16503      | 93182029 | VKPC 85220     |
| 9109428  | VKMA 06503     | 9201540  | VKM 26503      | 93182038 | VKPC 85211     |
| 9109430  | VKM 16503      | 9201679  | VKMMV 5PK1028  | 93182041 | VKPC 85620     |
| 9109595  | VKPC 86305     | 9201887  | VKMA 05501     | 93182042 | VKPC 85460     |
| 9109609  | VKM 16101      | 9202478  | VKM 15121      | 93182043 | VKPC 85623     |

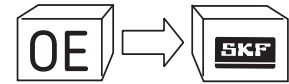
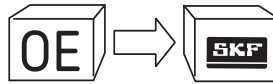
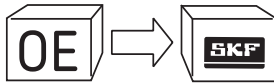

93182238  
 93182241  
 93182245  
 93182249  
 93182251  
 93182257  
 93182264  
 93182272  
 93183572  
 93185569  
 93185845  
 93186866  
 93188674  
 93284724  
 94106001  
 94106001  
 94124093  
 94149432  
 94337004  
 94341998  
 94382214  
 94382215  
 94386207  
 97010530  
 97074109  
 97101319  
 97101320  
 97110386  
 97110387  
 97112438  
 97112439  
 97114552  
 97114682  
 97114683  
 97129939  
 97129939  
 97135548  
 97184930  
 97186395  
 97210154  
 97220278  
 97222553  
 97229071  
 97229131  
 97229132  
 97229145  
 97232875  
 97232876  
 97249944  
 97249945  
 97250750  
 97251178  
 97287175  
 97307468  
 97309459  
 97309459  
 97312462  
 97312464  
 97324297  
 97355691  
 97364344  
 97381207  
 97381208

VK MV 5PK1230  
 VK MV 5PK1355  
 VK MV 10AVx875  
 VK MV 5PK1028  
 VK MV 10AVx950  
 VK MV 10AVx950  
 VK MV 5PK938  
 VK MV 5PK1680  
 VK MA 05152  
 VK MV 5PK1255  
 VK MA 05156  
 VK M 12174  
 VK MA 05500  
 VK PC 85611  
 VK M 25208  
 VK M 25209  
 VK PC 85403  
 VK M 15210  
 VK MV 13AVx915  
 VK PC 85404  
 VK M 79002  
 VK M 89003  
 VK PC 85410  
 VK M 15213  
 VK MV 13AVx915  
 VK PC 85410  
 VK PC 85404  
 VK PC 85410  
 VK PC 85404  
 VK M 15215  
 VK M 15210  
 VK M 15215  
 VK PC 85620  
 VK PC 85621  
 VK M 25208  
 VK M 25209  
 VK PC 85622  
 VK M 35025  
 VK MV 6PK1250  
 VK M 15215  
 VK PC 85620  
 VK M 35015  
 VK MV 6PK1590  
 VK M 25226  
 VK M 25222  
 VK M 15220  
 VK MV 6PK1275  
 VK MV 6PK1620  
 VK M 15218  
 VK M 15218  
 VK M 35214  
 VK PC 85300  
 VK PC 85300  
 VK PC 85300  
 VK M 25208  
 VK M 25209  
 VK M 35216  
 VK M 35212  
 VK MV 6PK1600  
 VK MV 6PK1605  
 VK M 35015  
 VK M 25226  
 VK M 25222

97385845  
 97385846  
 98003100  
 98010045  
 98010046  
 R1160008  
 R1160009  
 R1160010  
 R1160012  
 R1160013  
 R1160018  
 R1160019  
 R1160020  
 R1160025  
 R1160026  
 R1160027  
 R1160028  
 R1160030  
 R1160031  
 R1160032  
 R1160033  
 R1160034  
 R1160036  
 R1160039  
 R1160043  
 R1160044

**VOLVO**

1257118  
 1257120  
 1257185  
 1271828  
 1275380  
 1275409  
 1326284  
 1326342  
 1336029  
 1336953-3  
 1357936  
 270559-8  
 270681  
 271275  
 271602  
 271613  
 271647  
 271768  
 271830  
 271975  
 271985  
 271986  
 272136  
 272334  
 272457  
 272474  
 272476  
 274216  
 274557  
 275619  
 30616942  
 30620725

VK MV 6PK1250  
 VK MV 6PK1615  
 VK PC 85300  
 VK MV 6PK1600  
 VK MV 6PK1620  
 VK PC 85201  
 VK PC 85400  
 VK PC 85406  
 VK PC 85206  
 VK PC 85202  
 VK PC 85407  
 VK PC 85401  
 VK PC 85408  
 VK PC 85410  
 VK PC 85404  
 VK PC 85603  
 VK PC 85404  
 VK PC 85212  
 VK PC 85409  
 VK PC 85611  
 VK PA 85605  
 VK PC 85610  
 VK PC 85620  
 VK PC 85410  
 VK PC 85622  
 VK PC 85613  
 VK PC 82810  
 VK M 21031  
 VK M 21031  
 VK PC 81602  
 VK MV 6PK1613  
 VK M 36120  
 VK M 26220  
 VK M 26400  
 VK PC 86609  
 VK PC 86614  
 VK M 16400  
 VK M 16410  
 VK PC 86609  
 VK PC 86610  
 VK PC 86609  
 VK PC 86607  
 VK PC 81602  
 VK PC 86618  
 VK PC 86620  
 VK PC 86609  
 VK PC 86609  
 VK PC 86618  
 VK PC 86618  
 VK PC 86618  
 VK M 31039  
 VK PC 86520  
 VK PC 86618  
 VK PC 86618  
 VK PC 86618  
 VK PC 86635  
 VK MA 06127  
 VK PC 86610  
 VK MV 5PK1125  
 VK PC 85304

30621261  
 30621270  
 30621284  
 30621589  
 30622153  
 30637070  
 30637071  
 30637141  
 30637495  
 30637504  
 30637505  
 30637955  
 30637961  
 30637962  
 30638276  
 30638277  
 30638278  
 30638574  
 30638633  
 30650751  
 30650957  
 30677134  
 30684344  
 30684427  
 30684432  
 30711066  
 30711068  
 30711320  
 30711527  
 30729939  
 30731727  
 30731765  
 30731774  
 30731808  
 30731809  
 30731811  
 30731861  
 30751700  
 30751971  
 30757056  
 30757057  
 30757613  
 30777408  
 30777431  
 30777530  
 30777531  
 30812354  
 30813134  
 30852898  
 3085599  
 30855992  
 30855993  
 30873534  
 30873954  
 30874031  
 30874227  
 30874316  
 30883832  
 30883834  
 3100129  
 3242084  
 3267343  
 3287335

VK M 26101  
 VK M 36016  
 VK M 36030  
 VK MA 06127  
 VK M 16800  
 VK M 36220  
 VK M 36230  
 VK M 36240  
 VK MV 6PK976  
 VK MV 6PK802  
 VK M 33044  
 VK M 16040  
 VK M 36220  
 VK M 36230  
 VK M 16800  
 VK M 16604  
 VK M 16220  
 VK M 36030  
 VK M 36030  
 VK PC 86618  
 VK M 36236  
 VK M 16220  
 VK M 34014  
 VK M 33320  
 VK PC 86618  
 VK MA 03259  
 VK M 13140  
 VK M 36238  
 VK PC 83259  
 VK M 36230  
 VK MA 06040  
 VK M 33043  
 VK M 16220  
 VK MV 6DK1841  
 VK MV 6DK1853  
 VK MV 6DK1825  
 VK MV 6DK1841  
 VK PC 86618  
 VK PC 83259  
 VK M 36220  
 VK M 36240  
 VK MV 5PK628  
 VK MA 06127  
 VK MV 5PK1094  
 VK MV 5PK847  
 VK MV 5PK891  
 VK M 36018  
 VK M 36016  
 VK M 36032  
 VK PC 86413  
 VK M 26101  
 VK M 16101  
 VK MV 5PK1090  
 VK M 75009  
 VK MV 4PK780  
 VK M 85000  
 VK PC 86500  
 VK MV 6PK1792  
 VK M 36031  
 VK PC 86203  
 VK PC 86413  
 VK PC 86403  
 VK PC 86402





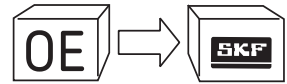
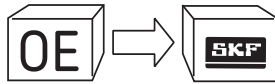
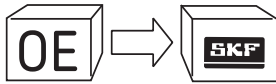

3287751  
3287773  
3287776-3  
3287778-9  
3342134  
  
3342138  
3342143  
3342860  
3343093  
3343740  
  
3343741  
3344250  
3344251  
3344252  
3344827  
  
3344831  
3345626  
3485927  
3531186  
3531279  
  
3547708  
3547715  
418327  
419689  
419691  
  
463425  
463633  
6842593  
77 00 875 305  
8627228  
  
8630590  
8642248  
8642251  
8642479  
8642562  
  
8653649  
8653651  
8653652  
8653806  
8658225  
  
8658339  
8670068  
8670156  
8670484  
8677053  
  
8692141  
8692561  
8692811  
8692839  
8692955  
  
8694627  
8694629  
8694630  
9135036  
9135555  
  
9135556  
9135937  
9135946  
9143643  
9146139  
  
9146249  
9146258  
9146376

VKPC 86413  
VKM 16100  
VKM 26100  
VKM 16110  
VKM 26100  
  
VKMV 5PK847  
VKM 16100  
VKMV 5PK884  
VKPC 86413  
VKM 26101  
  
VKM 16101  
VKPC 86402  
VKPC 86413  
VKPC 86614  
VKPC 86413  
  
VKPC 86413  
VKPC 86413  
VKMV 6PK1155  
VKM 16402  
VKM 26402  
  
VKM 26400  
VKM 26400  
VKPC 86607  
VKPC 86607  
VKPC 86607  
  
VKPC 86610  
VKM 16300  
VKM 16600  
VKM 26123  
VKMV 6DK1853  
  
VKM 26602  
VKM 26115  
VKM 16604  
VKMV 6PK1135  
VKMV 6PK1640  
  
VKMA 03257  
VKM 13257  
VKM 23257  
VKPC 83643  
VKM 16800  
  
VKM 16220  
VKMV 6PK1217  
VKMV 6PK1306  
VKM 16604  
VKM 11054  
  
VKMV 6DK1825  
VKM 26220  
VKMV 5PK891  
VKPC 86620  
VKMV 5PK847  
  
VKPC 86520  
VKPC 86635  
VKPC 86635  
VKM 16602  
VKM 16612  
  
VKM 26612  
VKM 11045  
VKM 21045  
VKM 36122  
VKM 36003  
  
VKM 36124  
VKM 26600  
VKM 26602

9146377  
9146557  
  
9146844  
9146973  
9179314  
9180594  
9180687  
  
9180701  
9180702  
9186319  
9186320  
9186352  
  
9207919  
9207920  
9207927  
9440329-2  
9440904  
  
9458376  
9458411  
9458469  
9458470  
9471799  
  
9471981  
9497331  
9640828480  
973487  
  
**VW**  
  
00A 121 010 A  
00A 121 010  
00A 903 315  
00A 903 341  
021 121 004 A  
  
021 121 004  
021 145 299 C  
021 145 933 C  
021 145 933 H  
022 145 933 H  
  
022 145 933 N  
022 145 933 T  
023 109 243  
023 121 004  
025 121 010 A  
  
025 121 010 AV  
025 121 010 C  
025 121 010 CV  
025 121 010 CX  
025 121 010 F  
  
025 121 010  
025 903 137 G  
026 109 243 A  
026 109 243 C  
026 109 243 E  
  
026 109 243 J  
026 109 243 L  
026 109 243  
026 121 004  
026 121 005 A  
  
026 121 005 C  
026 121 005 E  
026 121 005 F

VKM 26610  
VKMV 6PK1623  
  
VKMV 6PK1253  
VKMV 6PK1267  
VKM 36530  
VKM 11258  
VKM 16560  
  
VKMV 6PK1555  
VKMV 6PK1795  
VKMV 6PK1683  
VKMV 6PK1432  
VKMV 6PK1743  
  
VKMV 6PK1762  
VKMV 6PK1621  
VKM 11073  
VKM 16604  
VKM 16800  
  
VKMV 6DK1836  
VKMV 6PK1752  
VKMV 6DK1825  
VKM 36250  
VKMV 6DK1841  
  
VKMV 6DK1841  
VKM 36240  
VKM 13257  
VKMV 11.9x1010  
  
VKPC 81624  
VKPC 81624  
VKM 38022  
VKM 38027  
VKPC 81611  
  
VKPC 81611  
VKM 31060  
VKMV 7PK1290  
VKMV 7DK1360  
VKMV 6PK1264  
  
VKMV 6PK1240  
VKMV 6PK1620  
VKM 11251  
VKPC 81803  
VKPC 81607  
  
VKPC 81607  
VKPC 81609  
VKPC 81609  
VKPC 81609  
VKPC 81609  
  
VKPC 81607  
VKMV 10AVx1100  
VKM 11000  
VKM 11000  
VKM 11000  
  
VKM 11003  
VKM 11000  
VKM 11000  
VKPC 81615  
VKPC 81401  
  
VKPC 81401  
VKPC 81401  
VKPC 81401

026 121 005 F  
026 121 005 G  
  
026 121 005 H  
026 121 005 K  
026 121 005 L  
026 121 010 C  
026 121 010 D  
  
026 121 010 D  
026 121 010 F  
026 145 271  
026 198 119  
026 260 849 A  
  
026 903 137 C  
027 903 137  
028 109 243 B  
028 109 243 D  
028 109 243 E  
  
028 109 243 F  
028 109 243 G  
028 109 243 H  
028 109 243 J  
028 109 243 K  
  
028 109 243  
028 109 244  
028 121 004  
028 145 271 F  
028 145 271 K  
  
028 145 271 L  
028 145 278 A  
028 145 278 E  
028 145 278 J  
028 145 278 M  
  
028 198 119 A  
028 198 119 B  
028 198 119 C  
028 198 119 D  
028 198 119 E  
  
028 198 119 F  
028 198 119 G  
028 198 119  
028 260 849 H  
028 260 849 L  
  
028 903 137 AK  
028 903 137 AM  
028 903 137 AP  
028 903 137 AR  
028 903 137 BB  
  
028 903 315 M  
028 903 315 R  
030 109 243 C  
030 109 243 D  
030 109 243 F  
  
030 109 243 J  
030 109 243 K  
030 109 243 L  
030 109 243 M  
030 121 004 A  
  
030 121 004 B  
030 121 005 L  
030 121 005 LV  
030 121 005 LX  
030 121 005 N  
030 121 005 S

VKPC 81402  
VKPC 81401  
  
VKPC 81401  
VKPC 81402  
VKPC 81402  
VKPA 81401  
VKPA 81400  
  
VKPC 81400  
VKPA 81401  
VKMV 10AVx730  
VKMA 01006  
VKMV 13AVx800  
  
VKMV 10AVx950  
VKMV 10AVx630  
VKM 11012  
VKM 11015  
VKM 11014  
  
VKM 11014  
VKM 11015  
VKM 11256  
VKM 11256  
VKM 11256  
  
VKM 11012  
VKM 21012  
VKPC 81615  
VKMV 11.9x903  
VKMV 10AVx730  
  
VKMV 11.5x790  
VKM 31004  
VKM 31004  
VKM 31034  
VKM 31025  
  
VKMA 01013  
VKMA 01012  
VKMA 01014  
VKMA 01256  
VKMA 01019  
  
VKMA 01016  
VKMA 01015  
VKMA 01011  
VKMV 6PK1175  
VKMV 6PK1145  
  
VKMV 6PK890  
VKMV 6PK923  
VKMV 5PK1219  
VKMV 5PK1592  
VKMV 6PK1045  
  
VKM 31034  
VKM 31030  
VKM 11105  
VKM 11106  
VKM 11106  
  
VKM 11106  
VKM 11106  
VKM 11107  
VKM 11107  
VKPC 81204  
  
VKPC 81204  
VKPC 81204  
VKPC 81204  
VKPC 81204  
VKPC 81210  
  
VKPC 81215

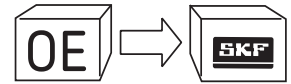
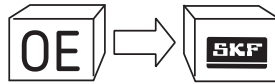
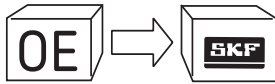

030 121 005 T  
030 121 008 A  
030 121 008 C  
030 121 008 D  
  
030 145 299 C  
030 145 299 F  
030 145 933 T  
030 145 933  
030 198 119 A  
  
030 198 119 B  
030 903 137 AA  
030 903 137 E  
030 903 137 T  
031 121 004 A  
  
031 121 004  
031 121 005 A  
031 121 005 C  
032 145 276  
032 145 299 A  
  
032 145 299 C  
032 145 933 AB  
032 145 933 T  
032 198 119  
034 121 004  
  
034 121 005 D  
034 260 849  
034 903 137 A  
034 903 137 B  
035 121 004 A  
  
035 121 005 B  
035 121 005 C  
035 121 005 E  
035 145 271 F  
035 260 849 C  
  
035 903 137 C  
036 109 181 A  
036 109 181 B  
036 109 243 AB  
036 109 243 AC  
  
036 109 243 AD  
036 109 243 AF  
036 109 243 AG  
036 109 243 D  
036 109 243 E  
  
036 109 243 F  
036 109 243 G  
036 109 243 J  
036 109 243 K  
036 109 243 L  
  
036 109 243 R  
036 109 243 S  
036 109 244 C  
036 109 244 D  
036 109 244 J  
  
036 109 244  
036 121 005 B  
036 121 005 D  
036 121 005 E  
036 121 005 F  
  
036 121 005 J  
036 121 005 M  
036 121 005 P  
036 121 005 Q

**VKPC 81210**  
**VKPC 81215**  
**VKPC 81215**  
**VKPC 81210**  
  
**VKM 31015**  
**VKM 31015**  
**VKMV 6PK1068**  
**VKMV 6PK1100**  
**VKMA 01106**  
  
**VKMA 01107**  
**VKMV 6PK737**  
**VKMV 11.9x710**  
**VKMV 6PK751**  
**VKPC 81206**  
  
**VKPC 81206**  
**VKPC 81206**  
**VKPC 81206**  
**VKM 31207**  
**VKM 31016**  
  
**VKM 31023**  
**VKMV 6PK1540**  
**VKMV 6PK1185**  
**VKMA 01110**  
**VKPC 81606**  
  
**VKPC 81606**  
**VKMV 13AVx915**  
**VKMV 11.2x820**  
**VKMV 4PK882**  
**VKPC 81605**  
  
**VKPC 81605**  
**VKPC 81605**  
**VKPC 81605**  
**VKMV 13AVx1000**  
**VKMV 13AVx990**  
  
**VKMV 10AVx785**  
**VKM 21121**  
**VKM 21121**  
**VKM 11120**  
**VKM 11124**  
  
**VKM 11120**  
**VKM 11120**  
**VKM 11124**  
**VKM 11114**  
**VKM 11120**  
  
**VKM 11120**  
**VKM 11124**  
**VKM 21120**  
**VKM 21120**  
**VKM 21120**  
**VKM 21120**  
  
**VKM 21122**  
**VKPC 81407**  
**VKPC 81411**  
**VKPC 81407**  
**VKPC 81419**  
  
**VKPC 81419**  
**VKPC 81411**  
**VKPC 81419**  
**VKPC 81407**

036 121 005 R  
  
036 121 005 S  
036 121 005  
036 121 008 G  
036 121 008 L  
036 145 933 AC  
  
036 145 933 AG  
036 145 933 AJ  
036 145 933 F  
036 145 933 H  
036 145 933 J  
  
036 145 933 M  
036 145 933 Q  
036 198 119 E  
037 121 004 A  
037 121 005 B  
  
037 121 005 C  
037 121 010 A  
037 121 010 B  
037 121 010 C  
037 121 010  
  
037 145 271 E  
037 145 271 F  
037 145 271  
037 145 276 A  
037 145 276  
  
037 145 933 C  
037 198 119  
037 260 849 C  
037 903 137 G  
037 903 137 H  
  
037 903 315 B  
037 903 315 C  
038 109 243 D  
038 109 243 F  
038 109 243 G  
  
038 109 243 H  
038 109 243 M  
038 109 243 N  
038 109 243  
038 109 244 B  
  
038 109 244 E  
038 109 244 H  
038 109 244 J  
038 109 244 M  
038 121 011 A  
  
038 121 011 C  
038 121 011 D  
038 121 011 G  
038 121 011 H  
038 121 011 J  
  
038 121 011 K  
038 145 276  
038 145 278  
038 145 283 A  
038 145 299 A  
  
038 198 119 A  
038 198 119 B  
038 198 119 C  
038 198 119 D  
038 198 119 E  
  
038 198 119 F  
038 198 119

**VKPC 81407**  
**VKPC 81407**  
**VKPC 81411**  
**VKPC 81419**  
**VKPC 81407**  
**VKMV 6PK1151**  
  
**VKMV 6PK736**  
**VKMV 6PK1076**  
**VKMV 6PK1084**  
**VKMV 6PK1548**  
**VKMV 6PK1078**  
  
**VKMV 6PK745**  
**VKMV 6PK1123**  
**VKMA 01121**  
**VKPA 81401**  
**VKPC 81401**  
  
**VKPC 81401**  
**VKPA 81401**  
**VKPA 81401**  
**VKPA 81401**  
**VKPA 81401**  
  
**VKMV 11.5x685**  
**VKMV 11.5x755**  
**VKMV 10AVx660**  
**VKM 31007**  
**VKM 31007**  
  
**VKMV 6PK1760**  
**VKMA 01002**  
**VKMV 6PK1153**  
**VKMV 6PK976**  
**VKMV 6PK1033**  
  
**VKM 31210**  
**VKM 31210**  
**VKM 11130**  
**VKM 11130**  
**VKM 11130**  
  
**VKM 11130**  
**VKM 11130**  
**VKM 11130**  
**VKM 11130**  
**VKM 21130**  
  
**VKM 21131**  
**VKM 21130**  
**VKM 21147**  
**VKM 21130**  
**VKPC 81623**  
  
**VKPC 81626**  
**VKPC 81626**  
**VKPC 81303**  
**VKPC 81627**  
**VKPC 81303**  
  
**VKPC 81627**  
**VKM 31002**  
**VKM 31013**  
**VKM 31013**  
**VKM 31013**  
  
**VKMA 01250**  
**VKMA 01141**  
**VKMA 01250**  
**VKMA 01131**  
**VKMA 01251**  
  
**VKMA 01130**  
**VKMA 01142**

038 260 849 A  
038 903 137 AA  
038 903 137 G  
  
038 903 137 H  
038 903 137 J  
038 903 137 L  
038 903 137 M  
038 903 137 N  
  
038 903 137 R  
038 903 137 S  
038 903 137 T  
038 903 315 A  
038 903 315 AB  
  
038 903 315 AD  
038 903 315 AE  
038 903 315 AG  
038 903 315 AH  
038 903 315 C  
  
038 903 315 D  
038 903 315 E  
038 903 315 F  
038 903 315 K  
038 903 315 P  
  
038 903 315 T  
03C 121 005 D  
03C 145 299 C  
03D 121 005  
03D 121 013 B  
  
03D 145 933 AD  
03D 145 933 AG  
03D 145 933 S  
03E 260 849 A  
03E 260 849 B  
  
03G 109 243  
03G 109 244  
03G 198 119  
03G 903 137 A  
03G 903 137 B  
  
03G 903 315 A  
03G 903 315 C  
044 145 271 K  
044 145 278 A  
044 260 849 B  
  
044 260 849 E  
044 903 137 R  
045 109 243 A  
045 109 243 B  
045 109 243 C  
  
045 109 243 D  
045 109 243 F  
045 109 244 A  
045 109 479 B  
045 109 479 C  
  
045 121 011 B  
045 121 011 C  
045 121 011 F  
045 121 011 G  
045 121 011 H  
  
045 121 011 J  
045 260 849  
045 903 137 D  
045 903 137 E  
045 903 315 A

**VKMV 4PK841**  
**VKMV 6PK1180**  
**VKMV 6PK906**  
  
**VKMV 5PK1432**  
**VKMV 6PK1660**  
**VKMV 6PK1180**  
**VKMV 6PK780**  
**VKMV 6PK1095**  
  
**VKMV 6PK1135**  
**VKMV 6DK1215**  
**VKMV 5PK1432**  
**VKM 31018**  
**VKM 31057**  
  
**VKM 31058**  
**VKM 31019**  
**VKM 31058**  
**VKM 31058**  
**VKM 31012**  
  
**VKM 31013**  
**VKM 31018**  
**VKM 31019**  
**VKM 31018**  
**VKM 31019**  
**VKM 31018**  
**VKM 31013**  
  
**VKM 31058**  
**VKPC 81501**  
**VKM 31047**  
**VKPC 81301**  
**VKPC 81301**  
  
**VKMV 6PK1880**  
**VKMV 6PK1453**  
**VKMV 6PK1453**  
**VKMV 6PK1873**  
**VKMV 6PK1873**  
  
**VKM 11255**  
**VKM 21256**  
**VKMA 01255**  
**VKMV 6PK950**  
**VKMV 6PK1050**  
  
**VKM 31022**  
**VKM 31054**  
**VKMV 10AVx650**  
**VKM 31043**  
**VKMV 6PK1590**  
  
**VKMV 6PK1905**  
**VKMV 6PK1870**  
**VKM 11142**  
**VKM 11141**  
**VKM 11142**  
  
**VKM 11143**  
**VKM 11250**  
**VKM 21142**  
**VKM 11145**  
**VKM 11144**  
  
**VKPC 81417**  
**VKPC 81416**  
**VKPC 81418**  
**VKPC 81302**  
**VKPC 81418**  
  
**VKPC 81302**  
**VKMV 6DK1188**  
**VKMV 6PK996**  
**VKMV 6PK858**  
**VKM 31035**





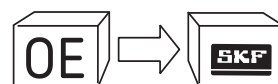
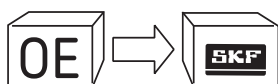
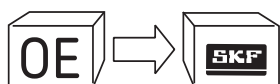

|                |                      |                |                       |                |                     |
|----------------|----------------------|----------------|-----------------------|----------------|---------------------|
| 046 121 004 D  | <b>VKPC 81805</b>    | 059 121 004 D  | <b>VKPC 81625</b>     | 06A 260 849 K  | <b>VKMV 6PK1032</b> |
| 046 121 004    | VKPC 81603           | 059 121 004 E  | <b>VKPC 81625</b>     | 06A 903 315 E  | <b>VKM 31011</b>    |
| 046 130 195 B  | <b>VKM 11265</b>     | 059 145 276    | <b>VKM 31039</b>      | 06B 109 243 A  | <b>VKM 11116</b>    |
| 046 130 195 D  | <b>VKM 11266</b>     | 059 198 119 A  | <b>VKMA 01152</b>     | 06B 109 243 B  | <b>VKM 11018</b>    |
| 047 121 011 B  | <b>VKPC 81412</b>    | 059 198 119    | <b>VKMA 01152</b>     | 06B 109 243 D  | <b>VKM 11116</b>    |
| 047 145 933 E  | <b>VKMV 6PK1680</b>  | 059 260 523 A  | <b>VKM 31040</b>      | 06B 109 243 E  | <b>VKM 11018</b>    |
| 047 903 137 AB | <b>VKMV 6PK1748</b>  | 059 260 523 B  | <b>VKM 31040</b>      | 06B 109 243 F  | <b>VKM 11116</b>    |
| 047 903 137 E  | <b>VKMV 6PK1880</b>  | 059 260 523    | <b>VKM 31040</b>      | 06B 109 243    | <b>VKM 11115</b>    |
| 047 903 137 F  | <b>VKMV 6PK1480</b>  | 059 260 849 B  | <b>VKMV 4PK1237</b>   | 06B 109 244    | <b>VKM 21220</b>    |
| 047 903 137 G  | <b>VKMV 6PK1520</b>  | 059 260 849 D  | <b>VKMV 4PK1217</b>   | 06B 109 477 A  | <b>VKM 11117</b>    |
| 047 903 137 L  | <b>VKMV 4PK950</b>   | 059 903 137 AC | <b>VKMV 6PK2480</b>   | 06B 109 477    | <b>VKM 21115</b>    |
| 047 903 137 R  | <b>VKMV 5PK1219</b>  | 059 903 137 H  | <b>VKMV 6PK2404</b>   | 06B 121 011 B  | <b>VKPC 81408</b>   |
| 048 109 243 A  | <b>VKM 11001</b>     | 059 903 341 A  | <b>VKM 31041</b>      | 06B 121 011 C  | <b>VKPC 81408</b>   |
| 048 121 011    | <b>VKPC 81601</b>    | 059 903 341    | <b>VKM 31038</b>      | 06B 121 011 E  | <b>VKPC 81408</b>   |
| 048 198 119    | <b>VKMA 01024</b>    | 060 121 011    | <b>VKPC 81601</b>     | 06B 121 011 H  | <b>VKPC 81220</b>   |
| 049 260 849 A  | <b>VKMV 13AVx825</b> | 062 145 278    | <b>VKM 38001</b>      | 06B 121 011 L  | <b>VKPC 81408</b>   |
| 050 121 010 A  | <b>VKPA 81402</b>    | 062 145 933 A  | <b>VKMV 6PK1683</b>   | 06B 121 011 M  | <b>VKPC 81220</b>   |
| 050 121 010 C  | <b>VKPA 81402</b>    | 062 260 849 B  | <b>VKMV 6PK2155</b>   | 06B 198 119 A  | <b>VKMA 01018</b>   |
| 050 121 039 A  | <b>VKMV 10AVx910</b> | 062 903 137    | <b>VKMV 6PK2000</b>   | 06B 260 849 A  | <b>VKMV 4PK855</b>  |
| 050 260 849    | <b>VKMV 13AVx800</b> | 066 121 011 C  | <b>VKPC 81622</b>     | 06B 260 849 B  | <b>VKMV 4PK855</b>  |
| 050 903 137 C  | <b>VKMV 4PK855</b>   | 066 145 933 K  | <b>VKMV 6PK1264</b>   | 06B 903 137 D  | <b>VKMV 6PK1589</b> |
| 050 903 137    | <b>VKMV 10AVx950</b> | 068 109 243 F  | <b>VKM 11010</b>      | 06B 903 137 E  | <b>VKMV 5PK1300</b> |
| 051 109 243 A  | <b>VKM 11021</b>     | 068 121 005 B  | <b>VKPC 81400</b>     | 06B 903 137 J  | <b>VKMV 6PK1572</b> |
| 051 109 243    | <b>VKM 11020</b>     | 068 121 005 C  | <b>VKPC 81400</b>     | 06B 903 137    | <b>VKMV 5PK1300</b> |
| 051 198 119    | <b>VKMA 01009</b>    | 068 121 010 A  | <b>VKPA 81401</b>     | 06C 109 244 D  | <b>VKM 21302</b>    |
| 052 121 004    | <b>VKPC 81200</b>    | 068 121 010 A  | <b>VKMV 10AVx650</b>  | 06C 109 244    | <b>VKM 21302</b>    |
| 052 121 005 A  | <b>VKPC 81200</b>    | 068 121 039 B  | <b>VKMV 10AVx838</b>  | 06D 109 243 B  | <b>VKM 11222</b>    |
| 052 903 137 F  | <b>VKMV 10AVx675</b> | 068 121 039 L  | <b>VKMV 10AVx740</b>  | 06D 109 243    | <b>VKM 11220</b>    |
| 054 109 479    | <b>VKM 11050</b>     | 068 145 271 B  | <b>VKMV 10AVx763</b>  | 06D 903 137 C  | <b>VKMV 6PK1572</b> |
| 054 109 479    | <b>VKM 11060</b>     | 068 145 271 C  | <b>VKMV 10AVx763</b>  | 06F 198 119 A  | <b>VKMA 01222</b>   |
| 054 121 004 A  | <b>VKPC 81612</b>    | 068 145 271 E  | <b>VKMV 11.9x650</b>  | 06F 198 119    | <b>VKMA 01220</b>   |
| 054 121 004    | <b>VKPC 81612</b>    | 068 260 849 D  | <b>VKMV 13AVx1250</b> | 06F 260 849 E  | <b>VKMV 6PK1042</b> |
| 054 903 137 D  | <b>VKMV 10AVx875</b> | 068 260 849 G  | <b>VKMV 13AVx950</b>  | 06F 260 849 L  | <b>VKMV 6PK1054</b> |
| 054 903 137    | <b>VKMV 10AVx865</b> | 068 260 849    | <b>VKMV 13AVx950</b>  | 06F 903 137 E  | <b>VKMV 6PK900</b>  |
| 055 121 010    | <b>VKPA 81400</b>    | 068 260 940    | <b>VKM 31009</b>      | 06F 903 137 L  | <b>VKMV 6PK953</b>  |
| 055 903 137 G  | <b>VKMV 10AVx850</b> | 068 903 137 AF | <b>VKMV 10AVx600</b>  | 071 121 005    | <b>VKPC 81622</b>   |
| 056 121 005 A  | <b>VKPC 81400</b>    | 068 903 137 AJ | <b>VKMV 10AVx625</b>  | 071 145 933 F  | <b>VKMV 6PK1285</b> |
| 056 121 011    | <b>VKPA 81400</b>    | 068 903 137 AP | <b>VKMV 10AVx710</b>  | 071 145 933 H  | <b>VKMV 6PK2373</b> |
| 056 121 013 A  | <b>VKPA 81400</b>    | 068 903 137 AQ | <b>VKMV 10AVx695</b>  | 071 145 933 M  | <b>VKMV 6PK2373</b> |
| 056 198 119    | <b>VKMA 01000</b>    | 068 903 137 AR | <b>VKMV 11.9x950</b>  | 074 109 243 A  | <b>VKM 21041</b>    |
| 058 109 243 C  | <b>VKM 11008</b>     | 068 903 137 B  | <b>VKMV 10AVx875</b>  | 074 109 243 B  | <b>VKM 11043</b>    |
| 058 109 243 D  | <b>VKM 11007</b>     | 068 903 137 D  | <b>VKMV 10AVx965</b>  | 074 109 243 C  | <b>VKM 11054</b>    |
| 058 109 243 E  | <b>VKM 11008</b>     | 068 903 137 Q  | <b>VKMV 10AVx735</b>  | 074 109 243 D  | <b>VKM 11045</b>    |
| 058 109 244    | <b>VKM 21004</b>     | 068 903 137 S  | <b>VKMV 10AVx775</b>  | 074 109 243 E  | <b>VKM 11257</b>    |
| 058 109 479 A  | <b>VKM 11009</b>     | 069 109 243 B  | <b>VKM 21031</b>      | 074 109 243 F  | <b>VKM 11072</b>    |
| 058 109 479 B  | <b>VKM 11009</b>     | 069 121 004    | <b>VKPC 81602</b>     | 074 109 243 G  | <b>VKM 11072</b>    |
| 058 198 119 A  | <b>VKMA 01007</b>    | 069 121 005 D  | <b>VKPC 81602</b>     | 074 109 243 H  | <b>VKM 11054</b>    |
| 058 198 119    | <b>VKMA 01008</b>    | 069 903 137 C  | <b>VKMV 11.5x790</b>  | 074 109 243 J  | <b>VKM 11072</b>    |
| 058 260 511    | <b>VKM 31059</b>     | 06A 109 479 A  | <b>VKM 11113</b>      | 074 109 243 M  | <b>VKM 11257</b>    |
| 058 260 849 A  | <b>VKMV 4PK855</b>   | 06A 109 479 C  | <b>VKM 11113</b>      | 074 109 243 R  | <b>VKM 11072</b>    |
| 058 903 133 C  | <b>VKM 31033</b>     | 06A 109 479    | <b>VKM 11113</b>      | 074 109 243    | <b>VKM 21032</b>    |
| 058 903 133 D  | <b>VKM 31033</b>     | 06A 121 011 E  | <b>VKPC 81620</b>     | 074 109 243    | <b>VKPC 86619</b>   |
| 059 109 243 D  | <b>VKM 11150</b>     | 06A 121 011 F  | <b>VKPC 81620</b>     | 074 121 004 A  | <b>VKPC 86619</b>   |
| 059 109 243 F  | <b>VKM 11151</b>     | 06A 121 011 G  | <b>VKPC 81620</b>     | 074 121 004    | <b>VKPC 86619</b>   |
| 059 109 243 G  | <b>VKM 11151</b>     | 06A 121 011 L  | <b>VKPC 81620</b>     | 074 121 005 N  | <b>VKPC 86619</b>   |
| 059 109 243 J  | <b>VKM 11150</b>     | 06A 121 011 T  | <b>VKPC 81620</b>     | 074 130 195 B  | <b>VKM 11073</b>    |
| 059 109 243 L  | <b>VKM 11151</b>     | 06A 121 012    | <b>VKPC 81620</b>     | 074 130 245    | <b>VKM 11258</b>    |
| 059 109 243 P  | <b>VKM 11332</b>     | 06A 145 933 D  | <b>VKPC 81620</b>     | 074 145 278 B  | <b>VKM 31007</b>    |
| 059 109 244 A  | <b>VKM 21151</b>     | 06A 145 933 F  | <b>VKMV 6PK1120</b>   | 074 145 278 E  | <b>VKM 31007</b>    |
| 059 109 244 B  | <b>VKM 21151</b>     | 06A 198 119    | <b>VKMV 6PK926</b>    | 074 145 278 F  | <b>VKM 31043</b>    |
| 059 109 479 B  | <b>VKM 11154</b>     | 06A 260 849 C  | <b>VKMA 01113</b>     | 074 145 299 A  | <b>VKM 31063</b>    |
| 059 121 004 B  | <b>VKPC 81625</b>    | 06A 260 849 E  | <b>VKMV 6DK1195</b>   | 074 145 933 AJ | <b>VKMV 6PK1694</b> |
| 059 121 004 C  | <b>VKPC 81625</b>    | 06A 260 849 G  | <b>VKMV 6DK1195</b>   | 074 145 933 AK | <b>VKMV 6PK1767</b> |
|                |                      |                | <b>VKMV 6PK1032</b>   | 074 145 933 AL | <b>VKMV 6PK1355</b> |

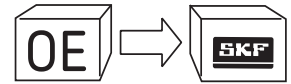
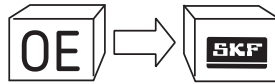
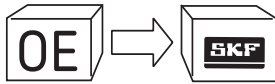







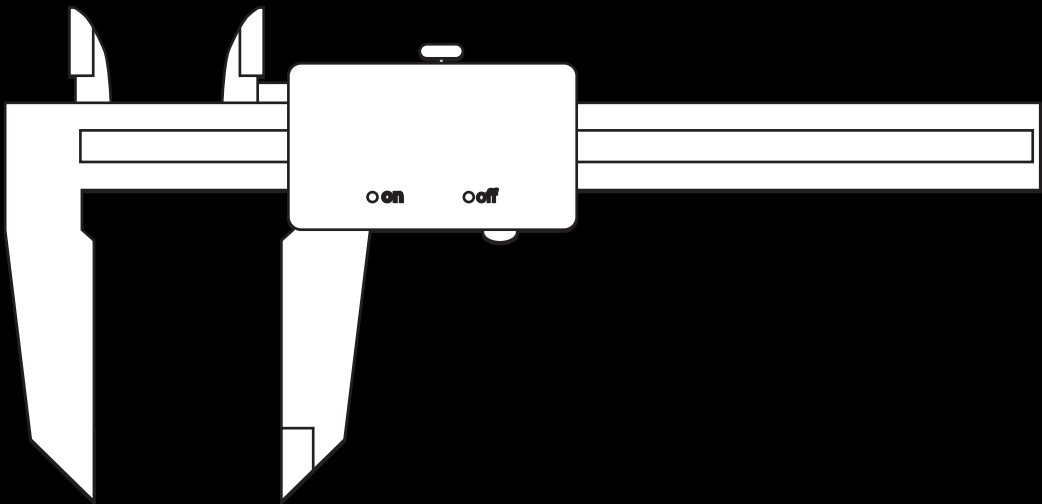



























































































|                |               |                |               |
|----------------|---------------|----------------|---------------|
| 074 145 933 AR | VKMV 6PK1751  | 111 903 137 E  | VKMV 11.3x912 |
| 074 145 933 G  | VKMV 6PK2060  | 1J0 145 276    | VKM 31044     |
| 074 145 933 N  | VKMV 6PK1343  | 1J0 145 299    | VKM 31047     |
| 074 145 933 P  | VKMV 6PK1715  | 1K0 260 849 A  | VKMV 6PK1100  |
| 074 198 119 A  | VKMA 01271    | 1K0 260 849 B  | VKMV 6PK1100  |
| 074 198 119 B  | VKMA 01258    | 1L0 198 002 A  | VKMA 01014    |
| 074 198 119 C  | VKMA 01253    | 6K0 145 299    | VKM 31023     |
| 074 198 119 E  | VKMA 01253    | 6K0 198 001 A  | VKMA 01106    |
| 074 198 119 F  | VKMA 01271    | 6K0 198 002    | VKMA 01000    |
| 074 198 119 G  | VKMA 01258    | 6K0 198 004    | VKMA 01002    |
| 074 198 119 H  | VKMA 01270    | 6K0 198 005    | VKMA 01011    |
| 074 198 119    | VKMA 01270    | 6Q0 260 849 A  | VKMV 6PK1736  |
| 074 260 849 AB | VKMV 6PK2236  | 6Q0 903 137 A  | VKMV 6PK1087  |
| 074 260 849 J  | VKMV 6PK2130  | 6U0 903 137    | VKMV 4PK950   |
| 074 903 137    | VKMV 10AVx838 | 7M0 145 271 A  | VKMV 11.5x745 |
| 075 109 243 B  | VKM 21045     | 7M0 145 271    | VKMV 11.5x685 |
| 075 109 243 D  | VKM 21045     | 943 095 009    | VKMV 10AVx950 |
| 075 145 271    | VKMV 13AVx800 | J13 503 540 30 | VKM 81002     |
| 075 260 849    | VKMV 13AVx865 | J13 505 540 21 | VKM 71002     |
| 076 145 933    | VKMV 6PK2000  | J16100-59155   | VKPC 91607    |
| 076 903 137    | VKMV 10AVx813 | J16100-59257   | VKPC 91607    |
| 077 109 244 C  | VKM 21203     | J16100-79036   | VKPC 91428    |
| 077 109 244 E  | VKM 21204     |                |               |
| 077 109 485 C  | VKM 11207     |                |               |
| 077 109 485 E  | VKM 11204     |                |               |
| 077 121 004 A  | VKPC 81806    |                |               |
| 077 121 004 F  | VKPC 81807    |                |               |
| 077 121 004 G  | VKPC 81806    |                |               |
| 077 121 004 GX | VKPC 81806    |                |               |
| 077 121 004 H  | VKPC 81807    |                |               |
| 078 109 243 C  | VKM 11200     |                |               |
| 078 109 243 C  | VKM 14101     |                |               |
| 078 109 243 K  | VKM 11201     |                |               |
| 078 109 243 Q  | VKM 11202     |                |               |
| 078 109 243 R  | VKM 11202     |                |               |
| 078 109 243    | VKM 11200     |                |               |
| 078 109 243    | VKM 14101     |                |               |
| 078 109 244 C  | VKM 21052     |                |               |
| 078 109 244 F  | VKM 21052     |                |               |
| 078 109 244 G  | VKM 21201     |                |               |
| 078 109 244 H  | VKM 21202     |                |               |
| 078 109 244    | VKM 21052     |                |               |
| 078 109 479 B  | VKM 11208     |                |               |
| 078 109 479 E  | VKM 11209     |                |               |
| 078 121 004 H  | VKPC 81802    |                |               |
| 078 121 004 J  | VKPC 81802    |                |               |
| 078 121 004 L  | VKPC 81811    |                |               |
| 078 121 004 Q  | VKPC 81802    |                |               |
| 078 121 004 R  | VKPC 81811    |                |               |
| 078 121 006 A  | VKPC 81811    |                |               |
| 078 121 006    | VKPC 81802    |                |               |
| 078 198 119 A  | VKMA 01201    |                |               |
| 078 198 119    | VKMA 01202    |                |               |
| 078 903 133 AB | VKM 31061     |                |               |
| 078 903 137 AP | VKMV 6PK1760  |                |               |
| 078 903 137 AQ | VKMV 6PK1863  |                |               |
| 078 903 137 BC | VKMV 6PK1882  |                |               |
| 078 903 137 BL | VKMV 6PK1856  |                |               |
| 078 903 137 BM | VKMV 6PK1735  |                |               |
| 078 903 137 P  | VKMV 6PK2260  |                |               |
| 078 903 137    | VKMV 6PK1675  |                |               |
| 07D 145 933 E  | VKMV 7DK2569  |                |               |
| 111 903 137 D  | VKMV 10AVx905 |                |               |









































































































|  |  | MATERIAL | PROFILE   | WIDTH (mm/V) |
|---|---|----------|---|--------------|
| VKMA 01000  | 41121x18  |          |    | 18           |
| VKMA 01001  | 96124x18 HSN  | HSN      |    | 18           |
| VKMA 01002  | 96124x18 HSN  | HSN      |    | 18           |
| VKMA 01003  | 96124x18 HSN  | HSN      |    | 18           |
| VKMA 01006  | 96121x18 HSN  | HSN      |    | 18           |
| VKMA 01007  | 90153x25  | HSN      |    | 25           |
| VKMA 01008  | 90153x25 HSN  | HSN      |    | 25           |
| VKMA 01009  | 96121x18 HSN  | HSN      |    | 18           |
| VKMA 01010  | 97135x25  |          |    | 25           |
| VKMA 01011  | 63137x25 HSN  | HSN      |    | 25           |
| VKMA 01012  | 63137x25 HSN  | HSN      |    | 25           |
| VKMA 01013  | 63137x25 HSN  | HSN      |    | 25           |
| VKMA 01014  | 63137x25 HSN  | HSN      |    | 25           |
| VKMA 01015  | 137x23  | HSN      |    | 23           |
| VKMA 01016  | 137x23  | HSN      |    | 23           |
| VKMA 01018  | 90150x23 HSN  | HSN      |    | 23           |
| VKMA 01019  | 137x25  | HSN      |    | 25           |
| VKMA 01020  | 92147x25 HSN  | HSN      |    | 25           |
| VKMA 01021  | 90151x25 HSN  | HSN      |    | 25           |
| VKMA 01023  | 92147x25 HSN  | HSN      |    | 25           |
| VKMA 01024  | 90151x25 HSN  | HSN      |   | 25           |
| VKMA 01025  | 97124x26,5  | HSN      |  | 26,5         |
| VKMA 01031  | 41120x18  |          |  | 18           |
| VKMA 01032  | 90142x19  |          |  | 19           |
| VKMA 01034  | 92147x19 HSN  | HSN      |  | 19           |
| VKMA 01035  | 41119x19  |          |  | 19           |
| VKMA 01040  | 45075x20  |          |  | 20           |
| VKMA 01040  | 45119x25  |          |  | 25           |
| VKMA 01042  | 97122x26,5 HSN  | HSN      |  | 26,5         |
| VKMA 01044  | 97124x26,5 HSN  | HSN      |  | 26,5         |
| VKMA 01045  | 97120x1" HSN  | HSN      |  | 25,4         |
| VKMA 01046  | 45075x20  |          |  | 20           |
| VKMA 01046  | 97120x1" HSN  | HSN      |  | 25,4         |
| VKMA 01050  | 92147x19 HSN  | HSN      |  | 19           |
| VKMA 01060  | 92147x19  | HSN      |  | 19           |
| VKMA 01105  | 90132x19  |          |  | 19           |
| VKMA 01106  | 90135x19 HSN  | HSN      |  | 19           |
| VKMA 01107  | 90135x19 HSN  | HSN      |  | 19           |
| VKMA 01110  | 92137x19 HSN  | HSN      |  | 19           |
| VKMA 01113  | 90138x23 HSN  | HSN      |  | 23           |
| VKMA 01114  | 90149x25 HSN  | HSN      |  | 25           |
| VKMA 01115  | 90150x23 HSN  | HSN      |  | 23           |
| VKMA 01116  | 90150x23 HSN  | HSN      |  | 23           |
| VKMA 01120  | 130x20  | HSN      |  | 20           |
| VKMA 01120  | 90058x17 HSN  | HSN      |  | 17           |
| VKMA 01121  | 130x20  | HSN      |  | 20           |
| VKMA 01121  | 90058x17 HSN  | HSN      |  | 17           |

















































|  |  | MATERIAL | PROFILE   | WIDTH (mm/V) |
|---|---|----------|---|--------------|
| VKMA 01130  | 141x25  | HSN      |    | 25           |
| VKMA 01131  | 141x25  | HSN      |    | 25           |
| VKMA 01140  | 117x30  |          |    | 30           |
| VKMA 01141  | 120x30  | HSN      |    | 30           |
| VKMA 01142  | 120x30  | HSN      |    | 30           |
| VKMA 01143  | 120x30  | HSN      |    | 30           |
| VKMA 01150  | 97087x24 HSN  | HSN      |    | 24           |
| VKMA 01150  | 97207x32 HSN  | HSN      |    | 32           |
| VKMA 01151  | 97087x24 HSN  | HSN      |    | 24           |
| VKMA 01151  | 97207x32 HSN  | HSN      |    | 32           |
| VKMA 01152  | 207x30  | HSN      |    | 30           |
| VKMA 01152  | 97087x24 HSN  | HSN      |    | 24           |
| VKMA 01200  | 90239x1"  | HSN      |    | 25,4         |
| VKMA 01201  | 90239x1"  | HSN      |    | 25,4         |
| VKMA 01202  | 90253x30 HSN  | HSN      |    | 30           |
| VKMA 01220  | 145x23  | HSN      |    | 23           |
| VKMA 01222  | 148x23  | HSN      |    | 23           |
| VKMA 01224  | 148x23  | HSN      |    | 23           |
| VKMA 01250  | 120x30  | HSN      |    | 30           |
| VKMA 01251  | 141x25  | HSN      |    | 25           |
| VKMA 01252  | 97124x26,5 HSN  | HSN      |   | 26,5         |
| VKMA 01253  | 97122x26,5 HSN  | HSN      |  | 26,5         |
| VKMA 01255  | 141x30  | HSN      |  | 30           |
| VKMA 01256  | 63137x25 HSN  | HSN      |  | 25           |
| VKMA 01257  | 97081x21 HSN  | HSN      |  | 21           |
| VKMA 01257  | 97122x26,5 HSN  | HSN      |  | 26,5         |
| VKMA 01258  | 97081x21 HSN  | HSN      |  | 21           |
| VKMA 01258  | 97122x26,5 HSN  | HSN      |  | 26,5         |
| VKMA 01260  | 97081x21 HSN  | HSN      |  | 21           |
| VKMA 01260  | 97122x26,5 HSN  | HSN      |  | 26,5         |
| VKMA 01262  | 97124x26,5  | HSN      |  | 26,5         |
| VKMA 01265  | 97080x21 HSN  | HSN      |  | 21           |
| VKMA 01265  | 97122x26,5 HSN  | HSN      |  | 26,5         |
| VKMA 01266  | 122x26,5  | HSN      |  | 26,5         |
| VKMA 01266  | 97077x21  |          |  | 21           |
| VKMA 01270  | 97081x21 HSN  | HSN      |  | 21           |
| VKMA 01270  | 97122x26,5 HSN  | HSN      |  | 26,5         |
| VKMA 01271  | 97077x21  | HSN      |  | 21           |
| VKMA 01271  | 97122x26,5 HSN  | HSN      |  | 26,5         |
| VKMA 01275  | 141x25  | HSN      |  | 25           |
| VKMA 01301  | 281x30  | HSN      |  | 30           |
| VKMA 01332  | 83x24   | HSN      |  | 24           |
| VKMA 01902  | 90253x30  | HSN      |  | 30           |
| VKMA 01903  | 90253x30  | HSN      |  | 30           |
| VKMA 01904  | 90253x30  | HSN      |  | 30           |
| VKMA 01905  | 90253x30  | HSN      |  | 30           |
| VKMA 01907  | 90153x25  | HSN      |  | 25           |

















































|  |  | MATERIAL | PROFILE   | WIDTH (mm/V) |
|---|---|----------|---|--------------|
| VKMA 01908  | 90153x25  | HSN      |    | 25           |
| VKMA 01918  | 90150x23  | HSN      |    | 23           |
| VKMA 01927  | 90253x30  | HSN      |    | 30           |
| VKMA 01940  | 117x30  |          |    | 30           |
| VKMA 01941  | 120x30  | HSN      |    | 30           |
| VKMA 01942  | 120x30  | HSN      |    | 30           |
| VKMA 01943  | 120x30  | HSN      |    | 30           |
| VKMA 01951  | 97087x24  | HSN      |    | 24           |
| VKMA 01951  | 97207x32  | HSN      |    | 32           |
| VKMA 01952  | 207x30  | HSN      |    | 30           |
| VKMA 01952  | 97087x24  | HSN      |    | 24           |
| VKMA 02005  | 41138x18  |          |    | 18           |
| VKMA 02021  | 41117x15  |          |    | 15           |
| VKMA 02101  | 41116x3/4"  |          |    | 19           |
| VKMA 02110  | 41118x3/4"  |          |    | 19           |
| VKMA 02111  | 41118x3/4"  |          |    | 19           |
| VKMA 02140  | 41116x3/4"  |          |    | 19           |
| VKMA 02151  | 99165x22  |          |    | 22           |
| VKMA 02152  | 99168x22  |          |    | 22           |
| VKMA 02153  | 99170x22  |          |    | 22           |
| VKMA 02154  | 99173x22  |          |   | 22           |
| VKMA 02155  | 99170x25  |          |  | 25           |
| VKMA 02161  | 41138x1"  |          |  | 25,4         |
| VKMA 02168  | 99170x25  |          |  | 25           |
| VKMA 02169  | 99173x25  |          |  | 25           |
| VKMA 02170  | 41126x25,4  |          |  | 25,4         |
| VKMA 02171  | 99193x24 HSN  | HSN      |  | 24           |
| VKMA 02172  | 40831x24 HSN (167)  | HSN      |  | 24           |
| VKMA 02173  | 40830x24 HSN (168)  | HSN      |  | 24           |
| VKMA 02174  | 99193x24 HSN  | HSN      |  | 24           |
| VKMA 02175  | 41143x1   |          |  | 25,4         |
| VKMA 02176  | 40847x24 HSN (190)  | HSN      |  | 24           |
| VKMA 02177  | 40830x24 HSN (168)  | HSN      |  | 24           |
| VKMA 02178  | 40830x24 HSN (168)  | HSN      |  | 24           |
| VKMA 02179  | 40847x24 HSN (190)  | HSN      |  | 24           |
| VKMA 02180  | 41110x18  |          |  | 18           |
| VKMA 02181  | 40832x24 HSN (163)  | HSN      |  | 24           |
| VKMA 02182  | 40830x24 HSN (168)  | HSN      |  | 24           |
| VKMA 02183  | 40830x24 HSN (168)  | HSN      |  | 24           |
| VKMA 02184  | 40855x24 HSN (166)  | HSN      |  | 24           |
| VKMA 02185  | 40855x24 HSN (166)  | HSN      |  | 24           |
| VKMA 02186  | 40855x24 HSN (166)  | HSN      |  | 24           |
| VKMA 02190  | 198x24  | HSN      |  | 24           |
| VKMA 02191  | 198x24  | HSN      |  | 24           |
| VKMA 02192  | 40847x24 HSN (190)  | HSN      |  | 24           |
| VKMA 02193  | 199x24  | HSN      |  | 24           |
| VKMA 02195  | 199x24  | HSN      |  | 24           |

















































|  |  | MATERIAL | PROFILE   | WIDTH (mm/V) |
|--|---|----------|---|--------------|
| VKMA 02197   | 198x24  | HSN      |    | 24           |
| VKMA 02198   | 99193x24  | HSN      |    | 24           |
| VKMA 02200   | 41104x15  |          |    | 15           |
| VKMA 02200   | 96104x15  |          |    | 15           |
| VKMA 02201   | 40824 x15 HSN (108)   | HSN      |    | 15           |
| VKMA 02202   | 96104x15 HSN  | HSN      |    | 15           |
| VKMA 02203   | 129x15  |          |    | 15           |
| VKMA 02204   | 40956x22 HSN (124)  | HSN      |    | 22           |
| VKMA 02210   | 125x15  |          |    | 15           |
| VKMA 02215   | 40836x18 HSN (134)  | HSN      |    | 18           |
| VKMA 02216   | 41118x15  |          |    | 15           |
| VKMA 02222   | 41139x18  |          |    | 18           |
| VKMA 02223   | 41145x18  |          |    | 18           |
| VKMA 02224   | 99173x18 HSN  | HSN      |    | 18           |
| VKMA 02227   | 41142x18  |          |    | 18           |
| VKMA 02242   | 40825x25 HSN (158)  | HSN      |    | 25           |
| VKMA 02277   | 130x15  | HSN      |    | 15           |
| VKMA 02277   | 40830x24  | HSN      |    | 24           |
| VKMA 02283   | 130x15  | HSN      |    | 15           |
| VKMA 02283   | 40830x24  | HSN      |    | 24           |
| VKMA 02381   | 97152x30  |          |   | 30           |
| VKMA 02382   | 97153x30  |          |  | 30           |
| VKMA 02383   | 98152x30  |          |  | 30           |
| VKMA 02384   | 98153x30 HSN  | HSN      |  | 30           |
| VKMA 02386   | 98154x30 HSN  | HSN      |  | 30           |
| VKMA 02390   | 178x30  | HSN      |  | 30           |
| VKMA 02410   | 99138x15  |          |  | 15           |
| VKMA 02422   | 97095x3/4"  |          |  | 19           |
| VKMA 02450   | 41142x18  |          |  | 18           |
| VKMA 02500   | 41098x17  |          |  | 17           |
| VKMA 02501   | 41100x17  |          |  | 17           |
| VKMA 02510   | 58121x20  |          |  | 20           |
| VKMA 02630   | 41133x22  |          |  | 22           |
| VKMA 02700   | 58112x3/4"  |          |  | 19           |
| VKMA 02983   | 98152x30  | HSN      |  | 30           |
| VKMA 02984   | 98153x30  | HSN      |  | 30           |
| VKMA 02986   | 98154x30  | HSN      |  | 30           |
| VKMA 03000   | 41091x3/4"  |          |  | 19           |
| VKMA 03010   | 41093x3/4"  |          |  | 19           |
| VKMA 03010   | 41105x3/4"  |          |  | 19           |
| VKMA 03050   | 45062x3/4"  |          |  | 19           |
| VKMA 03050   | 45118x1 1/4"  |          |  | 32           |
| VKMA 03100   | 58104x17 HSN  | HSN      |  | 17           |
| VKMA 03110   | 58108x17 HSN  | HSN      |  | 17           |
| VKMA 03111   | 58101x17 HSN  | HSN      |  | 17           |
| VKMA 03120   | 58143x1"  |          |  | 25,4         |
| VKMA 03121   | 58136x1" HSN  | HSN      |  | 25,4         |





























































|  |  | MATERIAL | PROFILE   | WIDTH (mm/V) |
|---|---|----------|---|--------------|
| VKMA 03122  | 58136x1" HSN  | HSN      |    | 25,4         |
| VKMA 03130  | 76134x1" HSN  | HSN      |    | 25,4         |
| VKMA 03132  | 134x1"  | HSN      |    | 25,4         |
| VKMA 03140  | 144x1"  | HSN      |    | 25,4         |
| VKMA 03141  | 135x1"  | HSN      |    | 25,4         |
| VKMA 03200  | 58113x17 HSN  | HSN      |    | 17           |
| VKMA 03201  | 58114x17  | HSN      |    | 17           |
| VKMA 03202  | 58114x1" HSN  | HSN      |    | 25,4         |
| VKMA 03210  | 58133x1"  |          |    | 25,4         |
| VKMA 03211  | 58134x1" HSN  | HSN      |    | 25,4         |
| VKMA 03212  | 40934x1" HSN (136)  | HSN      |    | 25,4         |
| VKMA 03213  | 40934x1" HSN (136)  | HSN      |    | 25,4         |
| VKMA 03214  | 40934x1" HSN (136)  | HSN      |    | 25,4         |
| VKMA 03216  | 40934x1" HSN (136)  | HSN      |    | 25,4         |
| VKMA 03218  | 137x25,4  | HSN      |    | 25,4         |
| VKMA 03220  | 58114x17  | HSN      |    | 17           |
| VKMA 03231  | 143x1"  | HSN      |    | 25,4         |
| VKMA 03235  | 70153x1" HSN  | HSN      |    | 25,4         |
| VKMA 03240  | 58136x1" HSN  | HSN      |    | 25,4         |
| VKMA 03241  | 58136x1" HSN  | HSN      |    | 25,4         |
| VKMA 03244  | 40966x1" HSN (140)  | HSN      |   | 25,4         |
| VKMA 03246  | 40967x1" HSN (141)  | HSN      |  | 25,4         |
| VKMA 03247  | 40967x1" HSN (141)  | HSN      |  | 25,4         |
| VKMA 03248  | 144x1"  | HSN      |  | 25,4         |
| VKMA 03250  | 58144x1" HSN  | HSN      |  | 25,4         |
| VKMA 03251  | 58149x1" HSN  | HSN      |  | 25,4         |
| VKMA 03252  | 146x1"  | HSN      |  | 25,4         |
| VKMA 03253  | 100x17  | HSN      |  | 17           |
| VKMA 03254  | 104x17  | HSN      |  | 17           |
| VKMA 03255  | 143x1"  | HSN      |  | 25,4         |
| VKMA 03256  | 134x1"  | HSN      |  | 25,4         |
| VKMA 03257  | 116x1"  | HSN      |  | 25,4         |
| VKMA 03258  | 135x1"  | HSN      |  | 25,4         |
| VKMA 03259  | 137x25  | HSN      |  | 25           |
| VKMA 03260  | 153x25  | HSN      |  | 25           |
| VKMA 03261  | 195x29  | HSN      |  | 29           |
| VKMA 03261  | 85x20   | HSN      |  | 20           |
| VKMA 03263  | 153x25  | HSN      |  | 25           |
| VKMA 03264  | 146x1   | HSN      |  | 25,4         |
| VKMA 03265  | 144x25,4  | HSN      |  | 25,4         |
| VKMA 03266  | 143x25,4  | HSN      |  | 24,4         |
| VKMA 03300  | 58141x28 HSN  | HSN      |  | 28           |
| VKMA 03301  | 106x19  | HSN      |  | 19           |
| VKMA 03301  | 58141x28  | HSN      |  | 28           |
| VKMA 03304  | 40496x32 HSN (147)  | HSN      |  | 32           |
| VKMA 03902  | 259x32  | HSN      |  | 32           |
| VKMA 04000  | 84119x3/4"  |          |  | 19           |



|  |  | MATERIAL | PROFILE   | WIDTH (mm/V) |
|---|---|----------|---|--------------|
| VKMA 04001  | 84122x3/4"  |          |    | 19           |
| VKMA 04100  | 98116x20 HSN  | HSN      |    | 20           |
| VKMA 04101  | 45098x3/4"  |          |    | 19           |
| VKMA 04103  | 98085x22 HSN  | HSN      |    | 22           |
| VKMA 04103  | 98116x20 HSN  | HSN      |    | 20           |
| VKMA 04105  | 98116x22 HSN  | HSN      |    | 22           |
| VKMA 04106  | 98085x22 HSN  | HSN      |    | 22           |
| VKMA 04106  | 98116x22 HSN  | HSN      |    | 22           |
| VKMA 04107  | 98085x22 HSN  | HSN      |    | 22           |
| VKMA 04107  | 98116x22 HSN  | HSN      |    | 22           |
| VKMA 04108  | 40971x20 HSN (91)   | HSN      |    | 20           |
| VKMA 04200  | 58092x19,75 HSN   | HSN      |    | 19,75        |
| VKMA 04201  | 58097x19,75 HSN   | HSN      |    | 19,75        |
| VKMA 04202  | 58097x21,6 HSN  | HSN      |    | 21,6         |
| VKMA 04204  | 41097x1"  |          |    | 25,4         |
| VKMA 04210  | 76131x1" HSN  | HSN      |    | 25,4         |
| VKMA 04212  | 76131x1" HSN  | HSN      |    | 25,4         |
| VKMA 04213  | 76129x1"  |          |    | 25,4         |
| VKMA 04214  | 76129x1"  |          |    | 25,4         |
| VKMA 04220  | 76117x22 HSN  | HSN      |    | 22           |
| VKMA 04222  | 76117x22 HSN  | HSN      |   | 22           |
| VKMA 04223  | 76117x22 HSN  | HSN      |  | 22           |
| VKMA 04224  | 76117x22  | HSN      |  | 22           |
| VKMA 04300  | 45123x1"  |          |  | 25,4         |
| VKMA 04301  | 45130x1"  |          |  | 25,4         |
| VKMA 04302  | 98130x1" HSN  | HSN      |  | 25,4         |
| VKMA 04303  | 40952x28 HSN  | HSN      |  | 28           |
| VKMA 04304  | 98130x25,4 T  | HSN      |  | 25,4         |
| VKMA 04305  | 98130x27,6 T  | HSN      |  | 27,6         |
| VKMA 05121  | 40433x17 HSN (111)  | HSN      |  | 17           |
| VKMA 05140  | 168x24  |          |  | 24           |
| VKMA 05150  | 40812x20 HSN (169)  | HSN      |  | 20           |
| VKMA 05152  | 40818x20 HSN (162)  | HSN      |  | 20           |
| VKMA 05154  | 40818x20 HSN (162)  | HSN      |  | 20           |
| VKMA 05156  | 40818x20 HSN (162)  | HSN      |  | 20           |
| VKMA 05200  | 40301x24 (147)  |          |  | 24           |
| VKMA 05201  | 40353x24 (146)  |          |  | 24           |
| VKMA 05202  | 40815x24 HSN (176)  | HSN      |  | 24           |
| VKMA 05208  | 45136x25 HSN  | HSN      |  | 25           |
| VKMA 05211  | 40437x24 (141)  |          |  | 24           |
| VKMA 05213  | 45136x25 HSN  | HSN      |  | 25           |
| VKMA 05214  | 45136x25 HSN  | HSN      |  | 25           |
| VKMA 05215  | 45136x25 HSN  | HSN      |  | 25           |
| VKMA 05220  | 40815x24 HSN (176)  | HSN      |  | 24           |
| VKMA 05222  | 40812x24 HSN (169)  | HSN      |  | 24           |
| VKMA 05223  | 40819x24 HSN (171)  | HSN      |  | 24           |
| VKMA 05224  | 168x24  | HSN      |  | 24           |



|  |  | MATERIAL | PROFILE   | WIDTH (mm/V) |
|---|---|----------|---|--------------|
| VKMA 05228  | 40819x24 HSN (171)  | HSN      |    | 24           |
| VKMA 05230  | 116x25  | HSN      |    | 25           |
| VKMA 05402  | 40802x20 HSN (146)  | HSN      |    | 20           |
| VKMA 05500  | 40496x30 HSN (225)  | HSN      |    | 30           |
| VKMA 05501  | 40496x30 HSN (225)  | HSN      |    | 30           |
| VKMA 05502  | 40496x30 HSN (225)  | HSN      |    | 30           |
| VKMA 05606  | 131x25  | HSN      |    | 25           |
| VKMA 05608  | 131x25  | HSN      |    | 25           |
| VKMA 05700  | 129x25  | HSN      |    | 25           |
| VKMA 06000  | 58095x17 HSN  | HSN      |    | 17           |
| VKMA 06001  | 58096x17 HSN  | HSN      |    | 17           |
| VKMA 06002  | 95x23,4   | HSN      |    | 23,4         |
| VKMA 06003  | 58096x17  | HSN      |    | 17           |
| VKMA 06010  | 58087x17  | HSN      |    | 17           |
| VKMA 06020  | 40850x27,4 HSN (132)  | HSN      |    | 27,4         |
| VKMA 06021  | 40850x27,4 HSN (132)  | HSN      |    | 27,4         |
| VKMA 06040  | 76142x23  | HSN      |    | 23           |
| VKMA 06100  | 58124x3/4"  |          |    | 19           |
| VKMA 06101  | 58125x3/4" HSN  | HSN      |    | 19           |
| VKMA 06103  | 58127x3/4" HSN  | HSN      |    | 19           |
| VKMA 06104  | 126x27  | HSN      |   | 27           |
| VKMA 06106  | 126x27  | HSN      |  | 27           |
| VKMA 06107  | 40951x27 HSN (128)  | HSN      |  | 27           |
| VKMA 06108  | 40951x27 HSN (128)  | HSN      |  | 27           |
| VKMA 06109  | 40951x27 HSN (128)  | HSN      |  | 27           |
| VKMA 06110  | 45153x1"  |          |  | 25,4         |
| VKMA 06111  | 58153x1"  |          |  | 25,4         |
| VKMA 06112  | 40451x1" HSN (148)  | HSN      |  | 25,4         |
| VKMA 06113  | 58151x1" HSN  | HSN      |  | 25,4         |
| VKMA 06114  | 76153x1" HSN  | HSN      |  | 25,4         |
| VKMA 06115  | 76153x26 HSN  | HSN      |  | 26           |
| VKMA 06116  | 76151x1" HSN  | HSN      |  | 25,4         |
| VKMA 06117  | 153x26  | HSN      |  | 26           |
| VKMA 06118  | 76153x26 HSN  | HSN      |  | 26           |
| VKMA 06122  | 40451x1" HSN (148)  | HSN      |  | 25,4         |
| VKMA 06123  | 58127x3/4" HSN  | HSN      |  | 19           |
| VKMA 06124  | 76153x1" HSN  | HSN      |  | 25,4         |
| VKMA 06125  | 76153x26 HSN  | HSN      |  | 26           |
| VKMA 06126  | 76151x1" HSN  | HSN      |  | 25,4         |
| VKMA 06127  | 132x26  | HSN      |  | 26           |
| VKMA 06128  | 153x26  | HSN      |  | 26           |
| VKMA 06129  | 133x26  | HSN      |  | 26           |
| VKMA 06130  | 123x27  | HSN      |  | 27           |
| VKMA 06132  | 123x27  | HSN      |  | 27           |
| VKMA 06137  | 153x26  | HSN      |  | 26           |
| VKMA 06138  | 76153x26 HSN  | HSN      |  | 26           |
| VKMA 06200  | 41116x3/4"  |          |  | 19           |



|  |  | MATERIAL | PROFILE   | WIDTH (mm/V) |
|--|---|----------|---|--------------|
| VKMA 06201   | 58116x3/4" HSN  | HSN      |    | 19           |
| VKMA 06203   | 58118x3/4" HSN  | HSN      |    | 19           |
| VKMA 06204   | 58118x3/4" HSN  | HSN      |    | 19           |
| VKMA 06205   | 58116x3/4" HSN  | HSN      |    | 19           |
| VKMA 06206   | 58115x3/4"  |          |    | 19           |
| VKMA 06207   | 58115x3/4"  |          |    | 19           |
| VKMA 06210   | 58148x1" HSN  | HSN      |    | 25,4         |
| VKMA 06211   | 58148x1" HSN  | HSN      |    | 25,4         |
| VKMA 06212   | 58148x1" HSN  | HSN      |    | 25,4         |
| VKMA 06213   | 58148x1" HSN  | HSN      |    | 25,4         |
| VKMA 06220   | 132x28  |          |    | 28           |
| VKMA 06300   | 41123x3/4"  |          |    | 19           |
| VKMA 06301   | 76123x3/4" HSN  | HSN      |    | 19           |
| VKMA 06400   | 40444x23 HSN (164)  | HSN      |    | 23           |
| VKMA 06402   | 40452x23 HSN (167)  | HSN      |    | 23           |
| VKMA 06406   | 40444x23 HSN (164)  | HSN      |    | 23           |
| VKMA 06406   | TP40458x14 HSN (110)  | HSN      |    | 14           |
| VKMA 06408   | 40452x23 HSN (167)  | HSN      |    | 23           |
| VKMA 06408   | TP40458x14 HSN (110)  | HSN      |    | 14           |
| VKMA 06500   | 76157x1" HSN  | HSN      |    | 25,4         |
| VKMA 06501   | 76163x1" HSN  | HSN      |   | 25,4         |
| VKMA 06502   | 76157x1" HSN  | HSN      |  | 25,4         |
| VKMA 06503   | 89x25   | HSN      |  | 25           |
| VKMA 06560   | 76152x28 HSN  | HSN      |  | 28           |
| VKMA 06600   | 76143x21 HSN  | HSN      |  | 21           |
| VKMA 06601   | 76139x21 HSN  | HSN      |  | 21           |
| VKMA 06602   | 41118x19  |          |  | 19           |
| VKMA 06602   | 76148x23 HSN  | HSN      |  | 23           |
| VKMA 06603   | 40474x23 HSN (144)  | HSN      |  | 23           |
| VKMA 06604   | 76142x23 HSN  | HSN      |  | 23           |
| VKMA 06605   | 76138x23  | HSN      |  | 23           |
| VKMA 06608   | 76148x23 HSN  | HSN      |  | 23           |
| VKMA 06610   | 76152x28 HSN  | HSN      |  | 28           |
| VKMA 06800   | 146x28  | HSN      |  | 28           |
| VKMA 07100   | 58104x17 HSN  | HSN      |  | 17           |
| VKMA 07110   | 45143x30  |          |  | 30           |
| VKMA 07200   | 58110x17  |          |  | 17           |
| VKMA 07300   | 70260x23 HSN (126)  | HSN      |  | 23           |
| VKMA 07301   | 70261x26 HSN (145)  | HSN      |  | 26           |
| VKMA 07302   | 40930x22 HSN (78)   | HSN      |  | 22           |
| VKMA 07302   | 40932x28 HSN (112)  | HSN      |  | 28           |
| VKMA 07303   | 112x30  | HSN      |  | 30           |
| VKMA 07303   | 78x24   | HSN      |  | 24           |
| VKMA 07304   | 112x30  | HSN      |  | 30           |
| VKMA 07304   | 78x24   | HSN      |  | 24           |
| VKMA 07310   | 70264x23 HSN (143)  | HSN      |  | 23           |
| VKMA 07400   | 90128x25  |          |  | 25           |







































|  |  | MATERIAL | PROFILE   | WIDTH (mm/V) |
|---|---|----------|---|--------------|
| VKMA 08000  | 58110x20,7 HSN  | HSN      |  | 20,7         |
| VKMA 08001  | 58110x20,7 HSN  | HSN      |  | 20,7         |
| VKMA 08100  | 41110x25,4  |          |  | 25,4         |
| VKMA 08110  | 40274x25 (127)  |          |  | 25           |
| VKMA 08120  | TV58138x28,5  |          |  | 28,5         |
| VKMA 08201  | 58111x3/4"  |          |  | 19           |
| VKMA 31000  | 5PK1432   |          |   | 5            |
| VKMA 31001  | 6DPK1195  |          |   | 6            |
| VKMA 31004  | 6PK1660   |          |   | 6            |
| VKMA 31004  | 6PK1663   |          |   | 6            |
| VKMA 31005  | 6PK1660   |          |   | 6            |
| VKMA 31006  | 6PK1150   |          |   | 6            |
| VKMA 31007  | 6PK923  |          |   | 6            |
| VKMA 31014  | 6PK1660   |          |   | 6            |
| VKMA 31017  | 5PK1219   |          |   | 5            |
| VKMA 31020  | 4PK855  |          |   | 4            |
| VKMA 31020  | 5PK1432   |          |   | 5            |
| VKMA 31024  | 6DPK1195  |          |   | 6            |
| VKMA 31028  | 6PK1045   |          |   | 6            |
| VKMA 31028  | AV10x730  |          |   | NA           |
| VKMA 31030  | 11,5x790  |          |   | NA           |
| VKMA 31030  | 6PK1145   |          |   | 6            |
| VKMA 31060  | 7DPK1360  |          |   | 7            |
| VKMA 31200  | 11,5x755  |          |   | NA           |
| VKMA 31200  | 6PK1153   |          |   | 6            |
| VKMA 31201  | 11,5x685  |          |   | NA           |
| VKMA 31201  | 6PK1033   |          |   | 6            |
| VKMA 31202  | 6PK1065   |          |   | 6            |
| VKMA 31203  | 6PK1120   |          |   | 6            |
| VKMA 31204  | 6DPK1195  |          |   | 6            |
| VKMA 31206  | 6PK1078   |          |   | 6            |
| VKMA 31207  | 6PK1548   |          |   | 6            |
| VKMA 31208  | 6PK1540   |          |   | 6            |
| VKMA 31215  | 6PK1084   |          |   | 6            |
| VKMA 31216  | 6PK1076   |          |   | 6            |
| VKMA 31219  | 6PK1123   |          |   | 6            |
| VKMA 32004  | 6PK1740   |          |   | 6            |
| VKMA 32012  | 6PK1036   |          |   | 6            |
| VKMA 32020  | 6PK1842   |          |   | 6            |
| VKMA 32022  | 6PK1045   |          |   | 6            |
| VKMA 32023  | 5PK1175   |          |   | 5            |
| VKMA 32024  | 6PK1760   |          |   | 6            |
| VKMA 32025  | 6PK1105   |          |   | 6            |
| VKMA 32027  | 6PK1036   |          |   | 6            |
| VKMA 32028  | 6PK1775   |          |   | 6            |
| VKMA 32029  | 6PK1795   |          |   | 6            |
| VKMA 32030  | 6PK1230   |          |   | 6            |

















































|  |  | MATERIAL | PROFILE | WIDTH (mm/V) |
|---|---|----------|---------|--------------|
| VKMA 32034  | 5PK1585   |          |         | 5            |
| VKMA 32039  | 6PK1836   |          |         | 6            |
| VKMA 32040  | 5PK1145   |          |         | 5            |
| VKMA 32050  | 6PK1830   |          |         | 6            |
| VKMA 32212  | 6PK1078   |          |         | 6            |
| VKMA 33002  | 6PK1151   |          |         | 6            |
| VKMA 33003  | 6PK1078   |          |         | 6            |
| VKMA 33010  | 4PK841  |          |         | 4            |
| VKMA 33012  | 5PK1030   |          |         | 5            |
| VKMA 33019  | 6PK1205   |          |         | 6            |
| VKMA 33020  | 6PK1726   |          |         | 6            |
| VKMA 33021  | 6PK1388   |          |         | 6            |
| VKMA 33023  | 5PK1030   |          |         | 5            |
| VKMA 33024  | 6PK1451   |          |         | 6            |
| VKMA 33025  | 6PK1010   |          |         | 6            |
| VKMA 33026  | 6PK1564   |          |         | 6            |
| VKMA 33027  | 6PK1437   |          |         | 6            |
| VKMA 33028  | 6PK1736   |          |         | 6            |
| VKMA 33029  | 6PK1468   |          |         | 6            |
| VKMA 33030  | 6PK1660   |          |         | 6            |
| VKMA 33031  | 6PK1078   |          |         | 6            |
| VKMA 33032  | 6PK1660   |          |         | 6            |
| VKMA 33033  | 6PK1660   |          |         | 6            |
| VKMA 33034  | 6PK1603   |          |         | 6            |
| VKMA 33035  | 6PK1130   |          |         | 6            |
| VKMA 33036  | 6PK1750   |          |         | 6            |
| VKMA 33037  | 6PK1750   |          |         | 6            |
| VKMA 33039  | 6PK1736   |          |         | 6            |
| VKMA 33040  | 6PK1160   |          |         | 6            |
| VKMA 33041  | 6PK1388   |          |         | 6            |
| VKMA 33043  | 6PK976  |          |         | 6            |
| VKMA 33044  | 6PK1468   |          |         | 6            |
| VKMA 33045  | 5PK775  |          |         | 5            |
| VKMA 33046  | 5PK960  |          |         | 5            |
| VKMA 33047  | 6PK1658   |          |         | 6            |
| VKMA 33048  | 6PK1706   |          |         | 6            |
| VKMA 33049  | 6PK1726   |          |         | 6            |
| VKMA 33051  | 6PK1451   |          |         | 6            |
| VKMA 33052  | 6PK1706   |          |         | 6            |
| VKMA 33053  | 6PK1740   |          |         | 6            |
| VKMA 33055  | 6PK1188   |          |         | 6            |
| VKMA 33056  | 6PK1736   |          |         | 6            |
| VKMA 33057  | 6PK975  |          |         | 6            |
| VKMA 33058  | 6PK802  |          |         | 6            |
| VKMA 33059  | 6PK1125   |          |         | 6            |
| VKMA 33060  | 6PK1341   |          |         | 6            |
| VKMA 33061  | 6PK1705   |          |         | 6            |

















































|  |  | MATERIAL | PROFILE | WIDTH (mm/V) |
|---|---|----------|---------|--------------|
| VKMA 33065  | 6PK1188   |          |         | 6            |
| VKMA 33066  | 6PK1706   |          |         | 6            |
| VKMA 33067  | 6PK1147   |          |         | 6            |
| VKMA 33068  | 6PK872  |          |         | 6            |
| VKMA 33069  | 6PK1156   |          |         | 6            |
| VKMA 33093  | 6PK1750   |          |         | 6            |
| VKMA 33102  | 6PK1110   |          |         | 6            |
| VKMA 33106  | 4PK1230   |          |         | 4            |
| VKMA 33111  | 4PK813  |          |         | 4            |
| VKMA 33112  | 4PK810  |          |         | 4            |
| VKMA 33202  | 6PK1130   |          |         | 6            |
| VKMA 33212  | 5PK881  |          |         | 5            |
| VKMA 33312  | 5PK1253   |          |         | 5            |
| VKMA 33320  | 6PK1217   |          |         | 6            |
| VKMA 34027  | 5PK1028   |          |         | 5            |
| VKMA 34030  | 6PK1642   |          |         | 6            |
| VKMA 34031  | 6PK1636   |          |         | 6            |
| VKMA 34103  | 6PK1414   |          |         | 6            |
| VKMA 34104  | 6PK1418   |          |         | 6            |
| VKMA 34107  | 6PK1715   |          |         | 6            |
| VKMA 34123  | 6PK2345   |          |         | 6            |
| VKMA 34502  | 6PK2415   |          |         | 6            |
| VKMA 34511  | 6PK2345   |          |         | 6            |
| VKMA 34522  | 6PK2415   |          |         | 6            |
| VKMA 35006  | 6PK1805   |          |         | 6            |
| VKMA 35007  | 6PK1803   |          |         | 6            |
| VKMA 35008  | 6PK1460   |          |         | 6            |
| VKMA 35009  | 6PK1725   |          |         | 6            |
| VKMA 35010  | 6PK1863   |          |         | 6            |
| VKMA 35012  | 5PK938  |          |         | 5            |
| VKMA 35013  | 5PK1355   |          |         | 5            |
| VKMA 35015  | 6PK1275   |          |         | 6            |
| VKMA 35016  | 6PK1880   |          |         | 6            |
| VKMA 35022  | 5PK1212   |          |         | 5            |
| VKMA 35025  | 6PK1530   |          |         | 6            |
| VKMA 35030  | 6PK1873   |          |         | 6            |
| VKMA 35107  | 6PK1903   |          |         | 6            |
| VKMA 35109  | 6PK1900   |          |         | 6            |
| VKMA 35112  | 5PK1240   |          |         | 5            |
| VKMA 35113  | 5PK1230   |          |         | 5            |
| VKMA 35119  | 5PK1680   |          |         | 5            |
| VKMA 35125  | 6PK1795   |          |         | 6            |
| VKMA 35215  | 6PK1250   |          |         | 6            |
| VKMA 35315  | 6PK1590   |          |         | 6            |
| VKMA 35500  | 6PK2020   |          |         | 6            |
| VKMA 36002  | 4PK1218   |          |         | 4            |
| VKMA 36005  | 6PK1263   |          |         | 6            |

















































|  |  | MATERIAL | PROFILE | WIDTH (mm/V) |
|--|---|----------|---------|--------------|
| VKMA 36006   | 6PK1658   |          |         | 6            |
| VKMA 36008   | 6PK1682   |          |         | 6            |
| VKMA 36010   | 5PK1260   |          |         | 5            |
| VKMA 36012   | 6PK1545   |          |         | 6            |
| VKMA 36013   | 6PK1103   |          |         | 6            |
| VKMA 36016   | 6PK1637   |          |         | 6            |
| VKMA 36017   | 6PK860  |          |         | 6            |
| VKMA 36020   | 5PK1750   |          |         | 5            |
| VKMA 36023   | 3PK740  |          |         | 3            |
| VKMA 36023   | 4PK908  |          |         | 4            |
| VKMA 36024   | 6PK1010   |          |         | 6            |
| VKMA 36025   | 3PK740  |          |         | 3            |
| VKMA 36025   | 4PK1538   |          |         | 4            |
| VKMA 36026   | 6PK1949   |          |         | 6            |
| VKMA 36030   | 6PK1795   |          |         | 6            |
| VKMA 36032   | 6PK1637   |          |         | 6            |
| VKMA 36033   | 6PK1795   |          |         | 6            |
| VKMA 36034   | 6PK1605   |          |         | 6            |
| VKMA 36035   | 6PK1605   |          |         | 6            |
| VKMA 36038   | 6PK1792   |          |         | 6            |
| VKMA 36040   | 6PK1778   |          |         | 6            |
| VKMA 36041   | 7PK1770   |          |         | 7            |
| VKMA 36050   | 5PK1199   |          |         | 5            |
| VKMA 36052   | 5PK1135   |          |         | 5            |
| VKMA 36070   | 6PK1658   |          |         | 6            |
| VKMA 36072   | 7PK1127   |          |         | 7            |
| VKMA 36091   | 5PK1110   |          |         | 5            |
| VKMA 36117   | 6PK841  |          |         | 6            |
| VKMA 36121   | 6PK1613   |          |         | 6            |
| VKMA 36122   | 6PK1621   |          |         | 6            |
| VKMA 36123   | 6PK1752   |          |         | 6            |
| VKMA 36124   | 6PK1762   |          |         | 6            |
| VKMA 36220   | 6DK1841   |          |         | 6            |
| VKMA 36230   | 6DK1841   |          |         | 6            |
| VKMA 36520   | 6PK1432   |          |         | 6            |
| VKMA 38001   | 6PK1885   |          |         | 6            |
| VKMA 38002   | 6PK2050   |          |         | 6            |
| VKMA 38003   | 6PK2120   |          |         | 6            |
| VKMA 38004   | 6PK2030   |          |         | 6            |
| VKMA 38005   | 6PK2100   |          |         | 6            |
| VKMA 38006   | 6PK1980   |          |         | 6            |
| VKMA 38007   | 6PK2080   |          |         | 6            |
| VKMA 38020   | 6PK2270   |          |         | 6            |
| VKMA 38021   | 6PK2260   |          |         | 6            |
| VKMA 38202   | 6PK1555   |          |         | 6            |
| VKMA 38241   | 6PK1555   |          |         | 6            |
| VKMA 38242   | 6PK1555   |          |         | 6            |



|  |  | MATERIAL | PROFILE   | WIDTH (mm/V) |
|---|---|----------|---|--------------|
| VKMA 38260  | 5PK890  |          |   | 5            |
| VKMA 38260  | 6PK1555   |          |   | 6            |
| VKMA 38261  | 5PK906  |          |   | 5            |
| VKMA 38261  | 6PK1555   |          |   | 6            |
| VKMA 38264  | 5PK890  |          |   | 5            |
| VKMA 38264  | 6PK1555   |          |   | 6            |
| VKMA 38265  | 5PK906  |          |   | 5            |
| VKMA 38265  | 6PK1555   |          |   | 6            |
| VKMA 38266  | 5PK890  |          |   | 5            |
| VKMA 38266  | 6PK1555   |          |   | 6            |
| VKMA 63000  | 4PK795  |          |   | 4            |
| VKMA 63001  | 4PK795  |          |   | 4            |
| VKMA 90000  | 76127x25,4 HSN  | HSN      |    | 25,4         |
| VKMA 90001  | 77107x25,4 HSN  | HSN      |    | 25,4         |
| VKMA 90002  | 30985x20 CR   |          |    | 20           |
| VKMA 90007  | 77137x19 HSN  | HSN      |    | 19           |
| VKMA 90008  | 77109x25 HSN  | HSN      |    | 25           |
| VKMA 91000  | 58127x25 CR   |          |    | 25           |
| VKMA 91001  | 92191x32 HSN  | HSN      |    | 32           |
| VKMA 91002  | 41094x19 HSN  | HSN      |   | 19           |
| VKMA 91003  | 92163x26,7 HSN  | HSN      |  | 26,7         |
| VKMA 91005  | 39117x21,1 HSN  | HSN      |  | 21,1         |
| VKMA 91006  | 39121x21,1 HSN  | HSN      |  | 21,1         |
| VKMA 91011  | 39211x32 HSN  | HSN      |  | 32           |
| VKMA 91013  | 39178x25,4 HSN  | HSN      |  | 25,4         |
| VKMA 91015  | 39128x26 HSN  | HSN      |  | 26           |
| VKMA 91017  | 39143x25,4 HSN  | HSN      |  | 25,4         |
| VKMA 91020  | 58094x25 HSN  | HSN      |  | 25           |
| VKMA 91021  | 39177x25,4 HSN  | HSN      |  | 25,4         |
| VKMA 91022  | 58102x25,4 HSN  | HSN      |  | 25,4         |
| VKMA 91100  | 58177x25,4 HSN  | HSN      |  | 25,4         |
| VKMA 91101  | 41139x25,4 CR   |          |  | 25,4         |
| VKMA 91122  | 58130x25,4 HSN  | HSN      |  | 25,4         |
| VKMA 91124  | 58129x31 HSN  | HSN      |  | 31           |
| VKMA 91200  | 39121x20 HSN  | HSN      |  | 20           |
| VKMA 91201  | 39123x24 HSN  | HSN      |  | 24           |
| VKMA 91202  | 41088x19 CR   |          |  | 19           |
| VKMA 91203  | 39123x20 HSN  | HSN      |  | 20           |
| VKMA 91205  | 39121x24 HSN  | HSN      |  | 24           |
| VKMA 91302  | 39178x25,4 HSN  | HSN      |  | 25,4         |
| VKMA 91303  | 58178x25,4 HSN  | HSN      |  | 25,4         |
| VKMA 91304  | 39211x32 HSN  | HSN      |  | 32           |
| VKMA 91400  | 39124x26 HSN  | HSN      |  | 26           |
| VKMA 91401  | 58113x19 HSN  | HSN      |  | 19           |
| VKMA 91700  | 39159x25,4 HSN  | HSN      |  | 25,4         |
| VKMA 91701  | 41111x25,4 CR   |          |  | 25,4         |
| VKMA 91702  | 41094x19 CR   |          |  | 19           |

















































|  |  | MATERIAL | PROFILE   | WIDTH (mm/V) |
|---|---|----------|---|--------------|
| VKMA 91704  | 39191x36 HSN  | HSN      |    | 36           |
| VKMA 91707  | 92211x34 HSN  | HSN      |    | 34           |
| VKMA 91708  | 58105x25 HSN  | HSN      |    | 25           |
| VKMA 91710  | 39137x25,4 HSN  | HSN      |    | 25,4         |
| VKMA 91711  | 58097x25 HSN  | HSN      |    | 25           |
| VKMA 91713  | 58102x25,4 HSN  | HSN      |    | 25,4         |
| VKMA 92000  | 41102x19 CR   |          |    | 19           |
| VKMA 92001  | 41106x19 CR   |          |    | 19           |
| VKMA 92004  | 41133x25,4 CR   |          |    | 25,4         |
| VKMA 92006  | 76133x25,4 HSN  | HSN      |    | 25,4         |
| VKMA 92008  | 77228x31,8 CR   |          |    | 31,8         |
| VKMA 92012  | 63141x30 CR   |          |    | 30           |
| VKMA 92101  | 92151x19 HSN  | HSN      |    | 19           |
| VKMA 92200  | 41095x19 CR   |          |    | 19           |
| VKMA 92210  | 41098x19 CR   |          |    | 19           |
| VKMA 92300  | 63117x25,4 CR   |          |    | 25,4         |
| VKMA 92302  | 63117x25,4 HSN  | HSN      |    | 25,4         |
| VKMA 92320  | 63143x30 HSN  | HSN      |    | 30           |
| VKMA 92400  | 41091x19 CR   |          |    | 19           |
| VKMA 92401  | 77107x19 HSN  | HSN      |    | 19           |
| VKMA 92410  | 41093x19 CR   |          |   | 19           |
| VKMA 92411  | 77110x19 CR   |          |  | 19           |
| VKMA 92500  | 63149x30 HSN  | HSN      |  | 30           |
| VKMA 92501  | 41133x25,4 HSN  | HSN      |  | 25,4         |
| VKMA 92513  | 63076x19 HSN  | HSN      |  | 19           |
| VKMA 92513  | 76111x25,4 HSN  | HSN      |  | 25,4         |
| VKMA 92514  | 63076x19 HSN  | HSN      |  | 19           |
| VKMA 92514  | 63117x25,4 HSN  | HSN      |  | 25,4         |
| VKMA 92515  | 63076x19 HSN  | HSN      |  | 19           |
| VKMA 92515  | 76117x25,4 HSN  | HSN      |  | 25,4         |
| VKMA 92516  | 76079x19 HSN  | HSN      |  | 19           |
| VKMA 92516  | 76111x25,4 HSN  | HSN      |  | 25,4         |
| VKMA 92517  | 76103x21 HSN  | HSN      |  | 21           |
| VKMA 92517  | 76111x25,4 HSN  | HSN      |  | 25,4         |
| VKMA 92518  | 76149x30 HSN  | HSN      |  | 30           |
| VKMA 93001  | 76107x24 HSN  | HSN      |  | 24           |
| VKMA 93002  | 76124x23,8 HSN  | HSN      |  | 23,8         |
| VKMA 93005  | 76103x24 HSN  | HSN      |  | 24           |
| VKMA 93006  | 76104x24 HSN  | HSN      |  | 24           |
| VKMA 93007  | 41095x19 CR   |          |  | 19           |
| VKMA 93009  | 76124x23,8 HSN  | HSN      |  | 23,8         |
| VKMA 93011  | 76070x16 HSN  | HSN      |  | 16           |
| VKMA 93011  | 76112x24 HSN  | HSN      |  | 24           |
| VKMA 93012  | 76196x28 HSN  | HSN      |  | 28           |
| VKMA 93013  | 76070x16 HSN  | HSN      |  | 16           |
| VKMA 93013  | 76127x24 HSN  | HSN      |  | 24           |
| VKMA 93014  | 76070x16 HSN  | HSN      |  | 16           |

















































|  |  | MATERIAL | PROFILE   | WIDTH (mm/V) |
|---|---|----------|---|--------------|
| VKMA 93014  | 77155x24 HSN  | HSN      |    | 24           |
| VKMA 93019  | 76103x22 HSN  | HSN      |    | 22           |
| VKMA 93100  | 58133x24 CR   |          |    | 24           |
| VKMA 93101  | 58101x24 HSN  | HSN      |    | 24           |
| VKMA 93200  | 58108x24 HSN  | HSN      |    | 24           |
| VKMA 93201  | 76124x26 HSN  | HSN      |    | 26           |
| VKMA 93210  | 76125x26 HSN  | HSN      |    | 26           |
| VKMA 93302  | 76192x28 HSN  | HSN      |    | 28           |
| VKMA 93500  | 76106x24 HSN  | HSN      |    | 24           |
| VKMA 93600  | 76070x16 HSN  | HSN      |    | 16           |
| VKMA 93600  | 76113x24 HSN  | HSN      |    | 24           |
| VKMA 93612  | 77197x26 HSN  | HSN      |    | 26           |
| VKMA 93615  | 76103x22 HSN  | HSN      |    | 22           |
| VKMA 93616  | 76104x22 HSN  | HSN      |    | 22           |
| VKMA 94000  | 92192x30 HSN  | HSN      |    | 30           |
| VKMA 94007  | 58109x22 HSN  | HSN      |    | 22           |
| VKMA 94009  | 92164x25,4 HSN  | HSN      |    | 25,4         |
| VKMA 94010  | 77135x25,4 HSN  | HSN      |   | 25,4         |
| VKMA 94012  | 77133x25,4 HSN  | HSN      |  | 25,4         |
| VKMA 94014  | 92152x25,4 CR   |          |  | 25,4         |
| VKMA 94016  | 76108x25,4 HSN  | HSN      |  | 25,4         |
| VKMA 94017  | 92173x30 HSN  | HSN      |  | 30           |
| VKMA 94100  | 39107x19 HSN  | HSN      |  | 19           |
| VKMA 94101  | 39107x21,6 HSN  | HSN      |  | 21,6         |
| VKMA 94102  | 77107x22 HSN  | HSN      |  | 22           |
| VKMA 94201  | 77145x22 HSN  | HSN      |  | 22           |
| VKMA 94222  | 76110x25,4 HSN  | HSN      |  | 25,4         |
| VKMA 94230  | 76108x25,4 HSN  | HSN      |  | 25,4         |
| VKMA 94300  | 92148x25,4 HSN  | HSN      |  | 25,4         |
| VKMA 94310  | 90162x30 HSN  | HSN      |  | 30           |
| VKMA 94501  | 58109x19 CR   |          |  | 19           |
| VKMA 94502  | 41106x19 CR   |          |  | 19           |
| VKMA 94504  | 41109x19 CR   |          |  | 19           |
| VKMA 94506  | 77154x22 HSN  | HSN      |  | 22           |
| VKMA 94507  | 76059x22 HSN  | HSN      |  | 22           |
| VKMA 94507  | 76176x28 HSN  | HSN      |  | 28           |
| VKMA 94508  | 76151x30 HSN  | HSN      |  | 30           |
| VKMA 94509  | 76152x30 HSN  | HSN      |  | 30           |
| VKMA 94600  | 76104x25,4 HSN  | HSN      |  | 25,4         |
| VKMA 94601  | 77168x25,4 HSN  | HSN      |  | 25,4         |
| VKMA 94609  | 77125x22 HSN  | HSN      |  | 22           |
| VKMA 94610  | 77123x22 HSN  | HSN      |  | 22           |
| VKMA 94611  | 76149x24 HSN  | HSN      |  | 24           |
| VKMA 94612  | 76153x27 HSN  | HSN      |  | 27           |
| VKMA 94614  | 76101x30 HSN  | HSN      |  | 30           |
| VKMA 94616  | 76101x30 HSN  | HSN      |  | 30           |
| VKMA 94619  | 76153x30 HSN  | HSN      |  | 30           |

















































|  |  | MATERIAL | PROFILE   | WIDTH (mm/V) |
|--|---|----------|---|--------------|
| VKMA 95000   | 77257x31,8 HSN  | HSN      |    | 31,8         |
| VKMA 95003   | 76149x25,4 HSN  | HSN      |    | 25,4         |
| VKMA 95005   | 76153x29 HSN  | HSN      |    | 29           |
| VKMA 95005   | 77065x12,7 HSN  | HSN      |    | 12,7         |
| VKMA 95006   | 58157x31,8 HSN  | HSN      |    | 31,8         |
| VKMA 95006   | 63055x12,7 HSN  | HSN      |    | 12,7         |
| VKMA 95008   | 63055x12,7 CR   |          |    | 12,7         |
| VKMA 95008   | 63122x19 HSN  | HSN      |    | 19           |
| VKMA 95009   | 63055x12,7 HSN  | HSN      |    | 12,7         |
| VKMA 95009   | 76122x24 HSN  | HSN      |    | 24           |
| VKMA 95010   | 63083x19 HSN  | HSN      |    | 19           |
| VKMA 95010   | 63163x25,4 HSN  | HSN      |    | 25,4         |
| VKMA 95012   | 76092x22 HSN  | HSN      |    | 22           |
| VKMA 95013   | 76151x29 HSN  | HSN      |    | 29           |
| VKMA 95013   | 77065x12,7 HSN  | HSN      |    | 12,7         |
| VKMA 95014   | 76163x25,4 HSN  | HSN      |    | 25,4         |
| VKMA 95014   | 77099x19 HSN  | HSN      |    | 19           |
| VKMA 95015   | 63055x12,7 HSN  | HSN      |   | 12,7         |
| VKMA 95015   | 63123x19 HSN  | HSN      |  | 19           |
| VKMA 95016   | 76122x19 HSN  | HSN      |  | 19           |
| VKMA 95016   | 77065x12,7 HSN  | HSN      |  | 12,7         |
| VKMA 95018   | 63055x12,7 HSN  | HSN      |  | 12,7         |
| VKMA 95018   | 76122x24 HSN  | HSN      |  | 24           |
| VKMA 95019   | 76123x29 HSN  | HSN      |  | 29           |
| VKMA 95019   | 77065x12,7 HSN  | HSN      |  | 12,7         |
| VKMA 95020   | 77117x29 HSN  | HSN      |  | 29           |
| VKMA 95021   | 76151x29 HSN  | HSN      |  | 29           |
| VKMA 95022   | 77156x29 HSN  | HSN      |  | 29           |
| VKMA 95023   | 76158x31,8 HSN  | HSN      |  | 31,8         |
| VKMA 95023   | 77065x12,7 HSN  | HSN      |  | 12,7         |
| VKMA 95025   | 77121x29 HSN  | HSN      |  | 29           |
| VKMA 95027   | 76123x19 HSN  | HSN      |  | 19           |
| VKMA 95027   | 77065x12,7 HSN  | HSN      |  | 12,7         |
| VKMA 95030   | 76092x22 HSN  | HSN      |  | 22           |
| VKMA 95031   | 63120x19 HSN  | HSN      |  | 19           |
| VKMA 95033   | 63123x19 HSN  | HSN      |  | 19           |
| VKMA 95036   | 63055x12,7 HSN  | HSN      |  | 12,7         |
| VKMA 95036   | 63122x19 HSN  | HSN      |  | 19           |
| VKMA 95039   | 77265x32 HSN  | HSN      |  | 32           |
| VKMA 95040   | 77195x32 HSN  | HSN      |  | 32           |
| VKMA 95102   | 63055x12,7 CR   |          |  | 12,7         |
| VKMA 95102   | 63122x19 HSN  | HSN      |  | 19           |
| VKMA 95103   | 63055x12,7 HSN  | HSN      |  | 12,7         |
| VKMA 95103   | 63122x19 HSN  | HSN      |  | 19           |
| VKMA 95105   | 63120x19 HSN  | HSN      |  | 19           |
| VKMA 95206   | 41092x19 CR   |          |  | 19           |
| VKMA 95207   | 63092x19 HSN  | HSN      |  | 19           |







































































































|  |  | MATERIAL | PROFILE   | WIDTH (mm/V) |
|---|---|----------|---|--------------|
| VKMA 95613  | 77187x31,8 HSN  | HSN      |    | 31,8         |
| VKMA 95617  | 77226x30 HSN  | HSN      |    | 30           |
| VKMA 95619  | 63092x19 CR   |          |    | 19           |
| VKMA 95620  | 76154x29 HSN  | HSN      |    | 29           |
| VKMA 95620  | 77065x12,7 HSN  | HSN      |    | 12,7         |
| VKMA 95621  | 77107x25,4 HSN  | HSN      |    | 25,4         |
| VKMA 95622  | 77140x25,4 HSN  | HSN      |    | 25,4         |
| VKMA 95623  | 77111x29 HSN  | HSN      |    | 29           |
| VKMA 95624  | 77154x29 HSN  | HSN      |    | 29           |
| VKMA 95625  | 77153x29 HSN  | HSN      |    | 29           |
| VKMA 95626  | 77116x29 HSN  | HSN      |    | 29           |
| VKMA 95627  | 76122x29 HSN  | HSN      |    | 29           |
| VKMA 95627  | 77065x12,7 HSN  | HSN      |    | 12,7         |
| VKMA 95628  | 77177x30 HSN  | HSN      |    | 30           |
| VKMA 95632  | 76105x22 HSN  | HSN      |    | 22           |
| VKMA 95638  | 77100x20 HSN  | HSN      |    | 20           |
| VKMA 95639  | 63055x12,7 HSN  | HSN      |    | 12,7         |
| VKMA 95639  | 76122x24 HSN  | HSN      |    | 24           |
| VKMA 95641  | 77101x20 HSN  | HSN      |    | 20           |
| VKMA 95642  | 63055x12,7 HSN  | HSN      |    | 12,7         |
| VKMA 95642  | 76122x19 HSN  | HSN      |   | 19           |
| VKMA 95645  | 77116x29 HSN  | HSN      |  | 29           |
| VKMA 95648  | 92110x22 HSN  | HSN      |  | 22           |
| VKMA 95649  | 76158x31,8 HSN  | HSN      |  | 31,8         |
| VKMA 95649  | 77065x12,7 HSN  | HSN      |  | 12,7         |
| VKMA 95650  | 77107x25,4 HSN  | HSN      |  | 25,4         |
| VKMA 95651  | 77109x25 HSN  | HSN      |  | 25           |
| VKMA 95652  | 76153x29 HSN  | HSN      |  | 29           |
| VKMA 95652  | 77065x12,7 HSN  | HSN      |  | 12,7         |
| VKMA 95654  | 92065x12,7 HSN  | HSN      |  | 12,7         |
| VKMA 95654  | 92173x29 HSN  | HSN      |  | 29           |
| VKMA 95655  | 76111x25,4 HSN  | HSN      |  | 25,4         |
| VKMA 95656  | 76113x25,4 HSN  | HSN      |  | 25,4         |
| VKMA 95657  | 77207x32 HSN  | HSN      |  | 32           |
| VKMA 95658  | 92065x12,7 HSN  | HSN      |  | 12,7         |
| VKMA 95658  | 92173x29 HSN  | HSN      |  | 29           |
| VKMA 95659  | 92065x12,7 HSN  | HSN      |  | 12,7         |
| VKMA 95659  | 92175x29 HSN  | HSN      |  | 29           |
| VKMA 95660  | 76123x28 HSN  | HSN      |  | 28           |
| VKMA 95663  | 77140x22 HSN  | HSN      |  | 22           |
| VKMA 95666  | 76153x29 HSN  | HSN      |  | 29           |
| VKMA 95666  | 77065x12,7 HSN  | HSN      |  | 12,7         |
| VKMA 96000  | 41088x19 CR   |          |  | 19           |
| VKMA 96002  | 76103x25,4 HSN  | HSN      |  | 25,4         |
| VKMA 96010  | 90162x25,4 HSN  | HSN      |  | 25,4         |
| VKMA 96200  | 76119x25,4 HSN  | HSN      |  | 25,4         |
| VKMA 96201  | 76119x19 HSN  | HSN      |  | 19           |

















































|  |  | MATERIAL | PROFILE   | WIDTH (mm/V) |
|---|---|----------|---|--------------|
| VKMA 96202  | 41089x19 CR   |          |    | 19           |
| VKMA 96203  | 41097x19 CR   |          |    | 19           |
| VKMA 96204  | 76095x19 CR   |          |    | 19           |
| VKMA 96206  | 77113x25,4 CR   |          |    | 25,4         |
| VKMA 96207  | 77106x25,4 CR   |          |    | 25,4         |
| VKMA 96208  | 76089x19 HSN  | HSN      |    | 19           |
| VKMA 96213  | 76097x19 HSN  | HSN      |    | 19           |
| VKMA 96214  | 76097x25,4 HSN  | HSN      |    | 25,4         |
| VKMA 96218  | 76089x25 HSN  | HSN      |    | 25           |
| VKMA 97005  | 76103x19 CR   |          |    | 19           |
| VKMA 97007  | 39103x19 CR   |          |    | 19           |
| VKMA 97009  | 76091x19 HSN  | HSN      |    | 19           |
| VKMA 97300  | 41091x19 CR   |          |    | 19           |
| VKMA 97501  | 76095x25,4 HSN  | HSN      |    | 25,4         |
| VKMA 97503  | 76093x25,4 HSN  | HSN      |    | 25,4         |
| VKMA 97504  | 39103x19 HSN  | HSN      |    | 19           |
| VKMA 97505  | 39111x25 HSN  | HSN      |    | 25           |
| VKMA 98000  | 77211x30 CR   |          |    | 30           |
| VKMA 98001  | 91098x19 HSN  | HSN      |    | 19           |
| VKMA 98001  | 91119x19 HSN  | HSN      |    | 19           |
| VKMA 98105  | 76089x19 HSN  | HSN      |   | 19           |
| VKMA 98109  | 77223x27 HSN  | HSN      |  | 27           |
| VKMA 98110  | 77211x30 CR   |          |  | 30           |
| VKMA 98112  | 77281x30 HSN  | HSN      |  | 30           |
| VKMA 99001  | 41115x19 CR   |          |  | 19           |
| VKMA 99003  | 92137x25,4 HSN  | HSN      |  | 25,4         |
| VKMA 99004  | 45119x32 CR   |          |  | 32           |
| VKMA 99006  | 45137x30 CR   |          |  | 30           |
| VKMC 01008  | 90153x25 HSN  | HSN      |  | 25           |
| VKMC 01018  | 90150x23 HSN  | HSN      |  | 23           |
| VKMC 01031  | 41120x18  |          |  | 18           |
| VKMC 01032  | 90142x19  |          |  | 19           |
| VKMC 01035  | 41119x3/4"  |          |  | 19           |
| VKMC 01040  | 45075x20  |          |  | 20           |
| VKMC 01040  | 45119x25  |          |  | 25           |
| VKMC 01042  | 97122x26,5 HSN  | HSN      |  | 26,5         |
| VKMC 01100  | 41108x3/4"  |          |  | 19           |
| VKMC 01101  | 58107x20  |          |  | 20           |
| VKMC 01103  | 40280x19 (128)  |          |  | 19           |
| VKMC 01104  | 90133x19  |          |  | 19           |
| VKMC 01105  | 90132x19  |          |  | 19           |
| VKMC 01107  | 90135x19 HSN  | HSN      |  | 19           |
| VKMC 01114  | 90149x25 HSN  | HSN      |  | 25           |
| VKMC 01141  | 120x30  |          |  | 30           |
| VKMC 01142  | 120x30  |          |  | 30           |
| VKMC 01143  | 120x30  |          |  | 30           |
| VKMC 01150  | 97087x24 HSN  | HSN      |  | 24           |





































|  |  | MATERIAL | PROFILE   | WIDTH (mm/V) |
|---|---|----------|---|--------------|
| VKMC 01150  | 97207x32 HSN  | HSN      |    | 32           |
| VKMC 01151  | 97087x24 HSN  | HSN      |    | 24           |
| VKMC 01151  | 97207x32 HSN  | HSN      |    | 32           |
| VKMC 01152  | 207x30  |          |    | 30           |
| VKMC 01152  | 97087x24 HSN  | HSN      |    | 24           |
| VKMC 01202  | 90253x30  | HSN      |    | 30           |
| VKMC 01203  | 90253x30  | HSN      |    | 30           |
| VKMC 01204  | 90253x30  | HSN      |    | 30           |
| VKMC 02174  | 99193x24 HSN  | HSN      |    | 24           |
| VKMC 02176  | 40847x24 HSN (190)  | HSN      |    | 24           |
| VKMC 02177  | 40830x24 HSN (168)  | HSN      |    | 24           |
| VKMC 02179  | 40847x24 HSN (190)  | HSN      |    | 24           |
| VKMC 02181  | 40832x24 HSN (163)  | HSN      |    | 24           |
| VKMC 02183  | 40830x24 HSN (168)  | HSN      |    | 24           |
| VKMC 02200  | 41104x15  |          |    | 15           |
| VKMC 02200  | 96104x15  |          |    | 15           |
| VKMC 02201  | 40824x15 HSN (108)  | HSN      |    | 15           |
| VKMC 02202  | 96104x15 HSN  | HSN      |   | 15           |
| VKMC 02203  | 129x15  |          |  | 15           |
| VKMC 02210  | 125x15  |          |  | 15           |
| VKMC 03100  | 58104x17 HSN  | HSN      |  | 17           |
| VKMC 03121  | 58136x1" HSN  | HSN      |  | 25,4         |
| VKMC 03240  | 58136x1" HSN  | HSN      |  | 25,4         |
| VKMC 03241  | 58136x1" HSN  | HSN      |  | 25,4         |
| VKMC 03244  | 40966x1" HSN (140)  | HSN      |  | 25,4         |
| VKMC 03246  | 40967x1" HSN (141)  | HSN      |  | 25,4         |
| VKMC 03247  | 40967x1" HSN (141)  | HSN      |  | 25,4         |
| VKMC 03248  | 144x1"  |          |  | 25,4         |
| VKMC 03251  | 58149x1" HSN  | HSN      |  | 25,4         |
| VKMC 04212  | 76131x1" HSN  | HSN      |  | 25,4         |
| VKMC 05100  | 40308x17 (101)  |          |  | 17           |
| VKMC 05103  | 41104x15  |          |  | 15           |
| VKMC 05120  | 40427x17 (104)  |          |  | 17           |
| VKMC 05121  | 40433x17 HSN (111)  | HSN      |  | 17           |
| VKMC 05150  | 40812x20 HSN (169)  | HSN      |  | 20           |
| VKMC 05201  | 40353x24 (146)  |          |  | 24           |
| VKMC 05400  | 40433x20 (111)  |          |  | 20           |
| VKMC 05401  | 40433x20 (111)  |          |  | 20           |
| VKMC 06000  | 58095x17 HSN  | HSN      |  | 17           |
| VKMC 06001  | 58096x17 HSN  | HSN      |  | 17           |
| VKMC 06002  | 95x23,4   |          |  | 23,4         |
| VKMC 06003  | 58096x17  | HSN      |  | 17           |
| VKMC 06005  | 58096x17  | HSN      |  | 17           |
| VKMC 06010  | 58087x17  |          |  | 17           |
| VKMC 06020  | 40850x27,4 HSN (132)  | HSN      |  | 27,4         |
| VKMC 06106  | 126x27  |          |  | 27           |
| VKMC 06127  | 132x26  |          |  | 26           |

|  |  | MATERIAL | PROFILE   | WIDTH (mm/V) |
|--|---|----------|---|--------------|
| VKMC 06216   | 58096x17 HSN  | HSN      |    | 17           |
| VKMC 06415   | 58095x17 HSN  | HSN      |    | 17           |
| VKMC 06501   | 76163x1" HSN  | HSN      |    | 25,4         |
| VKMS 01000   | 41121x18  |          |    | 18           |
| VKMS 01010   | 97135x25  |          |    | 25           |
| VKMS 02200-1   | 41104x15  |          |    | 15           |
| VKMS 02200-1   | 96104x15  |          |    | 15           |
| VKMS 02200-2   | 41104x15  |          |    | 15           |
| VKMS 02200-2   | 96104x15  |          |    | 15           |
| VKMS 02215   | 40836x18 HSN (134)  | HSN      |    | 18           |
| VKMS 02242-1   | 40825x25 HSN (158)  | HSN      |    | 25           |
| VKMS 02242-2   | 40825x25 HSN (158)  | HSN      |    | 25           |
| VKMS 03100-1   | 58104x17 HSN  | HSN      |    | 17           |
| VKMS 03100-2   | 58104x17 HSN  | HSN      |    | 17           |
| VKMS 03110-1   | 58108x17 HSN  | HSN      |    | 17           |
| VKMS 03110-2   | 58108x17 HSN  | HSN      |    | 17           |
| VKMS 03121   | 58136x1" HSN  | HSN      |    | 25,4         |
| VKMS 03240   | 58136x1" HSN  | HSN      |   | 25,4         |
| VKMS 03241   | 58136x1" HSN  | HSN      |  | 25,4         |
| VKMS 03246   | 40967x1" HSN (141)  | HSN      |  | 25,4         |
| VKMS 03251   | 58149x1" HSN  | HSN      |  | 25,4         |
| VKMS 03300   | 58141x28 HSN  | HSN      |  | 28           |
| VKMS 04103   | 98085x22 HSN  | HSN      |  | 22           |
| VKMS 04103   | 98116x20 HSN  | HSN      |  | 20           |
| VKMS 04106   | 98085x22 HSN  | HSN      |  | 22           |
| VKMS 04106   | 98116x22 HSN  | HSN      |  | 22           |
| VKMS 05121   | 40433x17 HSN (111)  | HSN      |  | 17           |
| VKMS 05150   | 40812x20 HSN (169)  | HSN      |  | 20           |
| VKMS 05152-1   | 40818x20 HSN (162)  | HSN      |  | 20           |
| VKMS 05152-2   | 40818x20 HSN (162)  | HSN      |  | 20           |
| VKMS 05152-3   | 40818x20 HSN (162)  | HSN      |  | 20           |
| VKMS 05154-1   | 40818x20 HSN (162)  | HSN      |  | 20           |
| VKMS 05154-2   | 40818x20 HSN (162)  | HSN      |  | 20           |
| VKMS 05154-3   | 40818x20 HSN (162)  | HSN      |  | 20           |
| VKMS 05208   | 45136x25 HSN  | HSN      |  | 25           |
| VKMS 05222   | 40812x24 HSN (169)  | HSN      |  | 24           |
| VKMS 06000   | 58095x17 HSN  | HSN      |  | 17           |
| VKMS 06010-1   | 58087x17  |          |  | 17           |
| VKMS 06010-2   | 58087x17  |          |  | 17           |
| VKMS 06101   | 58125x3/4" HSN  | HSN      |  | 19           |
| VKMS 06111-1   | 58153x1"  |          |  | 25,4         |
| VKMS 06111-2   | 58153x1"  |          |  | 25,4         |
| VKMS 06113   | 58151x1" HSN  | HSN      |  | 25,4         |
| VKMS 06114-1   | 76153x1" HSN  | HSN      |  | 25,4         |
| VKMS 06114-2   | 76153x1" HSN  | HSN      |  | 25,4         |
| VKMS 06115   | 76153x26 HSN  | HSN      |  | 26           |
| VKMS 06116   | 76151x1" HSN  | HSN      |  | 25,4         |



|  |  | MATERIAL | PROFILE   | WIDTH (mm/V) |
|---|---|----------|---|--------------|
| VKMS 06213  | 58148x1" HSN  | HSN      |    | 25,4         |
| VKMS 06501  | 76163x1" HSN  | HSN      |    | 25,4         |
| VKMS 90000  | 76127x25,4 HSN  | HSN      |    | 25,4         |
| VKMS 90002  | 30985x20 CR   |          |    | 20           |
| VKMS 91001  | 92191x32 HSN  | HSN      |    | 32           |
| VKMS 91002  | 41094x19 HSN  | HSN      |    | 19           |
| VKMS 91003  | 92163x26,7 HSN  | HSN      |    | 26,7         |
| VKMS 91005  | 39117x21,1 HSN  | HSN      |    | 21,1         |
| VKMS 91006  | 39121x21,1 HSN  | HSN      |    | 21,1         |
| VKMS 91013  | 39178x25,4 HSN  | HSN      |    | 25,4         |
| VKMS 91100  | 58177x25,4 HSN  | HSN      |    | 25,4         |
| VKMS 91101  | 41139x25,4 CR   |          |    | 25,4         |
| VKMS 91122  | 58130x25,4 HSN  | HSN      |    | 25,4         |
| VKMS 91124  | 58129x31 HSN  | HSN      |    | 31           |
| VKMS 91125  | 58129x31 HSN  | HSN      |    | 31           |
| VKMS 91201  | 39123x24 HSN  | HSN      |    | 24           |
| VKMS 91202  | 41088x19 CR   |          |    | 19           |
| VKMS 91203  | 39123x20 HSN  | HSN      |    | 20           |
| VKMS 91303  | 58178x25,4 HSN  | HSN      |    | 25,4         |
| VKMS 91304  | 39211x32 HSN  | HSN      |    | 32           |
| VKMS 91400  | 39124x26 HSN  | HSN      |   | 26           |
| VKMS 91401  | 58113x19 HSN  | HSN      |  | 19           |
| VKMS 91700  | 39159x25,4 HSN  | HSN      |  | 25,4         |
| VKMS 91702  | 41094x19 CR   |          |  | 19           |
| VKMS 91704  | 39191x36 HSN  | HSN      |  | 36           |
| VKMS 91710  | 39137x25,4 HSN  | HSN      |  | 25,4         |
| VKMS 92001  | 41106x19 CR   |          |  | 19           |
| VKMS 92012  | 63141x30 CR   |          |  | 30           |
| VKMS 92101  | 92151x19 HSN  | HSN      |  | 19           |
| VKMS 92210  | 41098x19 CR   |          |  | 19           |
| VKMS 92400  | 41091x19 CR   |          |  | 19           |
| VKMS 92411  | 77110x19 CR   |          |  | 19           |
| VKMS 92500  | 63149x30 HSN  | HSN      |  | 30           |
| VKMS 92513  | 63076x19 HSN  | HSN      |  | 19           |
| VKMS 92513  | 76111x25,4 HSN  | HSN      |  | 25,4         |
| VKMS 92514  | 63076x19 HSN  | HSN      |  | 19           |
| VKMS 92514  | 63117x25,4 HSN  | HSN      |  | 25,4         |
| VKMS 92517  | 76103x21 HSN  | HSN      |  | 21           |
| VKMS 92517  | 76111x25,4 HSN  | HSN      |  | 25,4         |
| VKMS 92518  | 76149x30 HSN  | HSN      |  | 30           |
| VKMS 93001  | 76107x24 HSN  | HSN      |  | 24           |
| VKMS 93002  | 76124x23,8 HSN  | HSN      |  | 23,8         |
| VKMS 93005  | 76103x24 HSN  | HSN      |  | 24           |
| VKMS 93006  | 76104x24 HSN  | HSN      |  | 24           |
| VKMS 93011  | 76070x16 HSN  | HSN      |  | 16           |
| VKMS 93011  | 76112x24 HSN  | HSN      |  | 24           |
| VKMS 93019  | 76103x22 HSN  | HSN      |  | 22           |

|  |  | MATERIAL | PROFILE   | WIDTH (mm/V) |
|---|---|----------|---|--------------|
| VKMS 93101  | 58101x24 HSN  | HSN      |    | 24           |
| VKMS 93200  | 58108x24 HSN  | HSN      |    | 24           |
| VKMS 93201  | 76124x26 HSN  | HSN      |    | 26           |
| VKMS 93210  | 76125x26 HSN  | HSN      |    | 26           |
| VKMS 93302  | 76192x28 HSN  | HSN      |    | 28           |
| VKMS 93500  | 76106x24 HSN  | HSN      |    | 24           |
| VKMS 93600  | 76070x16 HSN  | HSN      |    | 16           |
| VKMS 93600  | 76113x24 HSN  | HSN      |    | 24           |
| VKMS 93601  | 76104x24 HSN  | HSN      |    | 24           |
| VKMS 93615  | 76103x22 HSN  | HSN      |    | 22           |
| VKMS 93616  | 76104x22 HSN  | HSN      |    | 22           |
| VKMS 94000  | 92192x30 HSN  | HSN      |    | 30           |
| VKMS 94007  | 58109x22 HSN  | HSN      |    | 22           |
| VKMS 94009  | 92164x25,4 HSN  | HSN      |    | 25,4         |
| VKMS 94010  | 77135x25,4 HSN  | HSN      |    | 25,4         |
| VKMS 94012  | 77133x25,4 HSN  | HSN      |    | 25,4         |
| VKMS 94014  | 92152x25,4 CR   |          |    | 25,4         |
| VKMS 94101  | 39107x21,6 HSN  | HSN      |    | 21,6         |
| VKMS 94102  | 77107x22 HSN  | HSN      |    | 22           |
| VKMS 94201  | 77145x22 HSN  | HSN      |    | 22           |
| VKMS 94222  | 76110x25,4 HSN  | HSN      |   | 25,4         |
| VKMS 94230  | 76108x25,4 HSN  | HSN      |  | 25,4         |
| VKMS 94310  | 90162x30 HSN  | HSN      |  | 30           |
| VKMS 94601  | 77168x25,4 HSN  | HSN      |  | 25,4         |
| VKMS 94609  | 77125x22 HSN  | HSN      |  | 22           |
| VKMS 94610  | 77123x22 HSN  | HSN      |  | 22           |
| VKMS 94611  | 76149x24 HSN  | HSN      |  | 24           |
| VKMS 94612  | 76153x27 HSN  | HSN      |  | 27           |
| VKMS 94614  | 76101x30 HSN  | HSN      |  | 30           |
| VKMS 94616  | 76101x30 HSN  | HSN      |  | 30           |
| VKMS 94619  | 76153x30 HSN  | HSN      |  | 30           |
| VKMS 95003  | 76149x25,4 HSN  | HSN      |  | 25,4         |
| VKMS 95005  | 76153x29 HSN  | HSN      |  | 29           |
| VKMS 95005  | 77065x12,7 HSN  | HSN      |  | 12,7         |
| VKMS 95009  | 63055x12,7 HSN  | HSN      |  | 12,7         |
| VKMS 95009  | 76122x24 HSN  | HSN      |  | 24           |
| VKMS 95010  | 63083x19 HSN  | HSN      |  | 19           |
| VKMS 95010  | 63163x25,4 HSN  | HSN      |  | 25,4         |
| VKMS 95012  | 76092x22 HSN  | HSN      |  | 22           |
| VKMS 95014  | 76163x25,4 HSN  | HSN      |  | 25,4         |
| VKMS 95014  | 77099x19 HSN  | HSN      |  | 19           |
| VKMS 95019  | 76123x29 HSN  | HSN      |  | 29           |
| VKMS 95019  | 77065x12,7 HSN  | HSN      |  | 12,7         |
| VKMS 95020  | 77117x29 HSN  | HSN      |  | 29           |
| VKMS 95023  | 76158x31,8 HSN  | HSN      |  | 31,8         |
| VKMS 95023  | 77065x12,7 HSN  | HSN      |  | 12,7         |
| VKMS 95025  | 77121x29 HSN  | HSN      |  | 29           |



















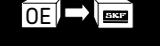



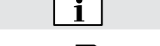







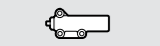

|  |  | MATERIAL | PROFILE   | WIDTH (mm/V) |
|---|---|----------|---|--------------|
| VKMS 95030  | 76092x22 HSN  | HSN      |    | 22           |
| VKMS 95036  | 63055x12,7 HSN  | HSN      |    | 12,7         |
| VKMS 95036  | 63122x19 HSN  | HSN      |    | 19           |
| VKMS 95039  | 77265x32 HSN  | HSN      |    | 32           |
| VKMS 95040  | 77195x32 HSN  | HSN      |    | 32           |
| VKMS 95207  | 63092x19 HSN  | HSN      |    | 19           |
| VKMS 95619  | 63092x19 CR   |          |    | 19           |
| VKMS 95623  | 77111x29 HSN  | HSN      |    | 29           |
| VKMS 95632  | 76105x22 HSN  | HSN      |    | 22           |
| VKMS 95650  | 77107x25,4 HSN  | HSN      |    | 25,4         |
| VKMS 95651-1  | 77109x25 HSN  | HSN      |    | 25           |
| VKMS 95651-2  | 77109x25 HSN  | HSN      |    | 25           |
| VKMS 95655  | 76111x25,4 HSN  | HSN      |    | 25,4         |
| VKMS 95656  | 76113x25,4 HSN  | HSN      |    | 25,4         |
| VKMS 95663  | 77140x22 HSN  | HSN      |    | 22           |
| VKMS 95666  | 76153x29 HSN  | HSN      |    | 29           |
| VKMS 95666  | 77065x12,7 HSN  | HSN      |    | 12,7         |
| VKMS 96002  | 76103x25,4 HSN  | HSN      |    | 25,4         |
| VKMS 96010  | 90162x25,4 HSN  | HSN      |    | 25,4         |
| VKMS 96202  | 41089x19 CR   |          |    | 19           |
| VKMS 96203  | 41097x19 CR   |          |   | 19           |
| VKMS 96204  | 76095x19 CR   |          |  | 19           |
| VKMS 97005  | 76103x19 CR   |          |  | 19           |
| VKMS 97009  | 76091x19 HSN  | HSN      |  | 19           |
| VKMS 97501  | 76095x25,4 HSN  | HSN      |  | 25,4         |
| VKMS 97503  | 76093x25,4 HSN  | HSN      |  | 25,4         |
| VKMS 97505  | 39111x25 HSN  | HSN      |  | 25           |
| VKMS 97507  | 39111x25 HSN  | HSN      |  | 25           |
| VKMS 98000  | 77211x30 CR   |          |  | 30           |
| VKMS 98001  | 91098x19 HSN  | HSN      |  | 19           |
| VKMS 98001  | 91119x19 HSN  | HSN      |  | 19           |
| VKMS 98105  | 76089x19 HSN  | HSN      |  | 19           |
| VKMS 98109  | 77223x27 HSN  | HSN      |  | 27           |
| VKMS 98110  | 77211x30 CR   |          |  | 30           |





























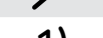



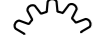

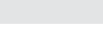



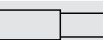

|   | English                             | Deutsch                      | Français  | Italiano                            | Español                                       |  | Nederlands                                | Polski  | Svenska                            | Norsk                           | Dansk                         | Suomi                                    |
|---|-------------------------------------|------------------------------|---|-------------------------------------|---|--|---|---|------------------------------------|---------------------------------|-------------------------------|--|
|    | New kits                            | Neuaufnahmen                 | Nouveaux kits                                     | Nuovi kit                           | Nuevos kits                                   |  | Nieuwe sets                               | Nowe zestawy i zamienniki                             | Nya satser                         | Nye satser                      | Nye sæt                       | Uudet sarjat                             |
|    | Replaced kits                       | Geänderte Sätze              | Remplacements                                     | Kit sostituiti                      | Sustituciones                                 |  | Vervangen sets                            | Zestawy zastapione                                    | Ersättningar                       | Erstatninger                    | Erstatninger                  | Korvatut sarjat                          |
|    | Deleted kits                        | Nicht mehr im Sortiment      | Kits supprimés                                    | Kit annullati                       | Kits anulados                                 |  | Geschrapte sets                           | Zestawy wycofane                                      | Annulerade satser                  | Utgåtte satser                  | Annullerede sæt               | Tuotannosta poistetut sarjat             |
|    | Vehicle applications                | Anwendung                    | Liste des marques et modèles                      | Applicazioni                        | Lista de marcas y modelos                     |  | Toepassingslijst merken en modellen       | Tabela doboru zestawów                                | Fordonsapplikationer               | Bilmerke og modeller            | Bilmærker og modeller         | Ajoneuvojen soveltavuudet                |
|    | Illustrations                       | Abbildung                    | Illustrations                                     | Illustrazioni                       | Identificación                                |  | Illustraties                              | Ilustracje  | Illustrationer                     | Illustrasjon                    | Produktillustrationer         | Tuotekuvat                               |
|    | Engine layout                       | Layout                       | Diagramme de cheminement de la courroie           | Struttura motore                    | Diagrama del motor                            |  | Motor ontwerp                             | Graficzny schemat silnika                             | Motor layout                       | Motortegning                    | Motor diagram                 | Moottorin layout                         |
|    | Simplified application list         | Vereinfachte Anwendungsliste | Liste d'applications simplifiée                   | Lista applicazioni semplificata     | Lista de aplicaciones simplificada            |  | Vereenvoudigde toepassingslijst           | Skrócona lista zastosowań                             | Förenklad applikationslista        | Forenklet applikasjonsliste     | Bilmærkeoversigt              | Pelkistetty sovellusluettelo             |
|    | Cross reference list – OE to SKF    | Vergleichsliste OE           | Liste de correspondances constructeurs – SKF      | Lista di corrispondenza da OE a SKF | Lista de correspondencias constructores – SKF |  | Crosslijst – OE naar SKF                  | Zamienniki – z oznaczeń producenta na SKF             | Översättningslista – OE till SKF   | Forenklet klassifiseringsliste  | Omsætningslister – OE til SKF | Käännösluettelo – OE:sta SKF:ään         |
|    | Dimensions                          | Abmessungen                  | Dimensions  | Dimensioni                          | Dimensiones                                   |  | Afmetingen                                | Wymiary   | Dimensioner                        | Dimensjoner                     | Dimensioner                   | Mitat                                    |
|    | Engine type                         | Motortyp                     | Type moteur                                       | Tipo di motore                      | Tipo motor                                    |  | Motor type                                | Typ silnika   | Motortyp                           | Motortyper                      | Motortype                     | Mootortyyppi                             |
|    | Model year                          | Baujahr                      | Année   | Anno                                | Año   |  | Bouwjaar                                  | Rok produkcji   | Årmodell                           | Modellår                        | Modelår                       | Vuositavuosi                             |
|    | Remarks                             | Bemerkungen                  | Remarques   | Note e Osservazioni                 | Observaciones                                 |  | Opmerkingen                               | Uwagi dodatkowe                                       | Anmärkingar                        | Bemerkninger                    | Anmærkninger                  | Huomautuksia                             |
|    | Timing system                       | Synchrone                    | Système d'entraînement de distribution            | Sistema di distribuzione            | Sistema de distribución                       |  | Distributiesysteem                        | Układ rozrządu  | Kamrem                             | Registerreim                    | Tandrem                       | Ajoitusjärjestelmä                       |
|    | Water pump                          | Wasserpumpe                  | Pompe à eau                                       | Pompa acqua                         | Bomba de agua                                 |  | Waterpomp                                 | Pompa wody  | Vattenpump                         | Vannpumpe                       | Vandpumpe                     | Vesipumppu                               |
|    | Auxiliary system                    | Nebetrieb                    | Système d'entraînement d'accessoires              | Sistema ausiliare                   | Sistema auxiliar                              |  | Hulpaandrijvingsysteem                    | Układ napędu wyposażenia dodatkowego                  | Hjälppaggregatssystem              | Hjelpereisystem                 | Hjælperesystem                | Apulaitteisto                            |
|   | Crankshaft dampener                 | Dämpfer (Kurbelwelle)        | Poulie damper                                     | Smorzatore albero a gomito          | Pistón del cigüeñal                           |  | Trillingsdemper van krukas                | Tłumik drgań wału korbowego                           | Vevaxeldämpare                     | Veivaksel demper                | Krumtap dæmper                | Nokka-akselin vaimennin                  |
|  | Includes a belt                     | Mit Riemen                   | Courroie  | Include una cinghia                 | Incluye una correa                            |  | Bevat een riem                            | Zestaw zawiera pasek                                  | Inkluderar en rem                  | Inkluderer reim                 | Rem                           | Sisältää hihnan                          |
|  | Includes a tensioner                | Mit Rolle                    | Galet tendeur                                     | Include un tenditore                | Incluye un tensor                             |  | Bevat een spanrol                         | Zestaw zawiera napinacz                               | Inkluderar en spännare             | Inkluderer spennhjul            | Strammehjul                   | Sisältää kiristimen                      |
|  | Includes an idler                   | Mit Rolle                    | Galet enrouleur                                   | Include una puleggia                | Incluye una polea                             |  | Bevat een looprol                         | Zestaw zawiera rolę prowadzącą                        | Inkluderar ett löphjul             | Inkluderer løpehjul             | Løbehjul                      | Sisältää ohjainrullan                    |
|  | Includes a dampener                 | Mit Dämpfer                  | Kit de distribution avec piston hydraulique       | Include uno smorzatore              | Incluye un pistón                             |  | Bevat een demper                          | Zestaw zawiera tłumik                                 | Inkluderar en dämpare              | Inkluderer demper               | Incl. dæmper                  | Sisältää kiristäjän                      |
|  | Includes a water pump               | Mit Wasserpumpe              | Kit de distribution avec pompe à eau              | Include pompa aqua                  | Incluye una bomba de agua                     |  | Bevat een waterpomp                       | Zestaw zawiera pompę wody                             | Inkluderar en vattenpump           | Inkluderer vannpumpe            | Incl. vandpumpe               | Sisältää vesipumpun                      |
|  | Includes a camshaft dampener        | Mit Rolle (Nockenwelle)      | Poulie damper d'arbre à cames                     | Include smorzatore albero a camme   | Incluye un pistón del árbol de levas          |  | Bevat een trillingsdemper van de nokkenas | Zestaw zawiera tłumik drgań wałka rozrządu            | Inkluderar en kamaxel-dämpare      | Inkluderer kamaksel demper      | Incl. knastakseldæmper        | Sisältää nokka-akselin vaimentimen       |
|  | Includes a seal                     | Mit Dichtung                 | Joint   | Include una guarnizione             | Incluye un retén                              |  | Bevat een afdichting                      | Zestaw zawiera uszczelniacz                           | Inkluderar en tätning              | Inkluderer tetning              | Incl. Tætning                 | Sisältää tiivisteen                      |
|  | Various                             | Verschiedenes                | Visserie  | Varie                               | Varios  |  | Divers                                    | Różne   | Diverse                            | Avvikende                       | Diverse                       | Useita                                   |
|  | Engine layout number (See page 911) | Layout (siehe Seite 911)     | Numéro de diagramme de cheminement de la courroie | Numero motore                       | Nº diagrama del motor (ver página 911)        |  | Motor ontwerp nummer (zie pag. 911)       | Graficzny schemat układu rozrządu (zobacz strona 911) | Motor layout nummer (se sidan 911) | Motortegnings nummer            | Motor layout T nr. Side 911   | Moottorin layout numero (Katso sivu 911) |
|  | Auxiliary                           | Nebetrieb                    | Arbre auxiliaire                                  | Sistema Ausiliare                   | Auxiliar                                      |  | Hulp                                      | Napęd wyposażenia dodatkowego                         | Hjälppaggregat                     | Hjelpe- og tilleggsutrustninger | Hjælperesystem                | Apulaitteisto                            |
|  | Balance shaft                       | Ausgleichswelle              | Arbre d'équilibrage                               | Albero di equilibrio                | Árbol de transmisión equilibrado              |  | Balansas                                  | Wałek wyważający                                      | Balansaxel                         | Balanse aksel                   | Balanceaksel                  | Tasapainoakseli                          |
|  | Camshaft pulley                     | Nockenwelle                  | Poulie d'arbre à cames                            | Puleggia albero a camme             | Polea del árbol de levas                      |  | Nokkenstandwiel                           | Koło wału korbowego                                   | Kamaxelhjul                        | Strammehjul for kamaksel        | Knastakselhjul                | Nokka-akselin hihnapyörä                 |
|  | Crankshaft pulley                   | Kurbelwelle                  | Poulie de vilebrequin                             | Puleggia albero a gomito            | Polea del cigüeñal                            |  | Krukaspoelie                              | Koło wałka rozrządu                                   | Vevaxelhjul                        | Strammehjul for veivaksel       | Krumtapakselhjul              | Kampiakselin hihnapyörä                  |
|  | Injection pump                      | Einspritzpumpe               | Pompe à injection                                 | Pompa ad iniezione                  | Bomba de inyección                            |  | Injectiepomp                              | Pompa wtryskowa                                       | Insprutningspump                   | Innsprøytningspumpe             | Indsprøjtningpumpe            | Ruiskutuspumppu                          |
|  | Oil pump                            | Ölpumpe                      | Pompe à huile                                     | Pompa dell'olio                     | Bomba de aceite                               |  | Oliepomp                                  | Pompa oleju   | Oljepump                           | Olje pumpe                      | Oliepumpe                     | Öljypumppu                               |
|  | Oil pump shaft                      | Ölpumpe                      | Arbre de pompe à huile                            | Albero della pompa dell'olio        | Eje de la bomba de aceite                     |  | Oliepompas                                | Wałek pompy oleju                                     | Oljepumpaxel                       | Aksel for olje pumpe            | Oliepumpe aksel               | Öljypumpun akseli                        |
|  | Vacuum pump                         | Vakuumpumpe                  | Pompe à vide                                      | Pompa da vuoto                      | Bomba de vacío                                |  | Vacuüm pump                               | Pompa podciśnieniowa                                  | Vakumpump                          | Vakuumpumpe                     | Vakuumpumpe                   | Alipainepumppu                           |

|   | English                       | Deutsch                  | Français                                       | Italiano                             | Español                            |  | Nederlands                                   | Polski                                    | Svenska                      | Norsk                          | Dansk                         | Suomi                                    |
|---|-------------------------------|--------------------------|--|--------------------------------------|------------------------------------|--|--|---|------------------------------|--------------------------------|-------------------------------|--|
|    | Passenger car                 | Limousinen               | Berlines (3 volumes)                           | Berlina                              | Turismo                            |  | Personenauto                                 | Samochód osobowy                          | Personbil                    | Personbil                      | Personvogne                   | Henkilöauto                              |
|    | Hatchback                     | Kombi Cupe               | Berlines (2 volumes)                           | Portellone posteriore                | Cinco puertas                      |  | 3-deurs of 5-deurs                           | Hatchback                                 | Halvkombi                    | Kombibil                       | Hatchback                     | Hatchback                                |
|    | Coupe                         | Coupe                    | Coupé  | Coupè                                | Cupé                               |  | Coupé  | Coupé                                     | Kupé                         | Kupé                           | Coupe                         | Coupé                                    |
|    | Estate                        | Kombi                    | Breaks   | Station wagon                        | Modelo familiar                    |  | Break  | Kombi                                     | Herrgårdsvagn                | Statsjonsvogn                  | Stationcars                   | Farmari                                  |
|    | LCV                           | Lieferwagen              | Utilitaire léger                               | Veicolo commerciale leggero          | Furgoneta                          |  | Bestelauto                                   | Samochód dostawczy                        | Van                          | Van                            | Van                           | Pakettiauto                              |
|    | European models               | Europäische Modelle      | Modèles pour l'Europe                          | Modelli Europei                      | Modelos Europeos                   |  | Europese modellen                            | Modele europejski                         | Modeller för Europa          | Europeisk modell               | Europæiske modeller           | Eurooppalaiset mallit                    |
|    | Models for Argentina          | Modelle für Argentinien  | Modèles pour l'Argentine                       | Modelli per l'Argentina              | Modelos para Argentina             |  | Modellen voor Argentinië                     | Modele na Argentynę                       | Modeller för Argentina       | Modeller for Argentina         | Modeller til Argentina        | Argentiinalaiset mallit                  |
|    | Models for Australia          | Modelle für Australien   | Modèles pour l'Australie                       | Modelli per l'Australia              | Modelos para Australia             |  | Modellen voor Australië                      | Modele na Australię                       | Modeller för Australien      | Modeller for Australia         | Modeller til Australien       | Australian mallit                        |
|    | Models for Brazil             | Modelle für Brasilien    | Modèles pour le Brésil                         | Modelli per la Brasile               | Modelos para Brasil                |  | Modellen voor Brazilië                       | Modele na Brazylię                        | Modeller för Brasilien       | Modeller for Brasil            | Modeller til Brasilien        | Brasilian mallit                         |
|    | Manufactured in Great Britain | hergestellt in UK        | Modèles fabriqués en Grande-Bretagne           | Prodotto in Gran Bretagna            | Fabricado en Gran Bretaña          |  | Geproduceerd in Groot Britannië              | Wyprodukowano w Wielkiej Brytanii         | Tillverkad i Storbritanien   | Produsert i Storbritania       | Modeller til England          | Iso-Britannialaiset mallit               |
|    | Models for Greece             | Modelle für Griechenland | Modèles pour la Grèce                          | Modelli per la Grecia                | Modelos para Grecia                |  | Modellen voor Griekenland                    | Modele na Grecję                          | Modeller för Grekland        | Modeller for Hellas            | Modeller til Grækenland       | Kreikkalaiset mallit                     |
|    | Models for Israel             | Modelle für Israel       | Modèles pour Israël                            | Modelli per Israele                  | Modelos para Israel                |  | Modellen voor Israel                         | Modele na Izrael                          | Modeller för Israel          | Modeller for Israel            | Israelin mallit               | Israelilaiset mallit                     |
|    | Models for Japan              | Modelle für Japan        | Modèles pour le Japon                          | Modelli per il Giappone              | Modelos para Japón                 |  | Modellen voor Japan                          | Modele na Japonię                         | Modeller för Japan           | Modeller for Japan             | Modeller til Japan            | Japanilaiset mallit                      |
|    | Models for Spain              | Modelle für Spanien      | Modèles pour l'Espagne                         | Modelli per la Spagna                | Modelos para España                |  | Modellen voor Spain                          | Modele na Hiszpanię                       | Modeller för Spanien         | Modeller for Spainia           | Modeller til Spanien          | Espanjalaiset mallit                     |
|    | Models for Sweden             | Modelle für Schweden     | Modèles pour la Suède                          | Modelli per la Svezia                | Modelos para Suecia                |  | Modellen voor Zweden                         | Modele na Szwecję                         | Modeller för Sverige         | Modeller for Sverige           | Modeller til Sverige          | Ruotsalaiset mallit                      |
|    | Models for Switzerland        | Modelle für die Schweiz  | Modèles pour la Suisse                         | Modelli per la Svizzera              | Modelos para Suiza                 |  | Modellen voor Zwitserland                    | Modele na Szwajcarię                      | Modeller för Schweiz         | Modeler for Sveits             | Modeller til Switzerland      | Sveitsiläiset mallit                     |
|   | Models for Turkey             | Modelle für Türkei       | Modèles pour la Turquie                        | Modelli per la Turchia               | Modelos para Turquía               |  | Modellen voor Turkije                        | Modele na Turcję                          | Modeller för Turkiet         | Modeller for Tyrkia            | Modeller til Tyrkiet          | Turkkilaiset mallit                      |
|  | From                          | Von                      | A partir de                                    | A partire da                         | Desde                              |  | Vanaf  | Od  | Från                         | Fra                            | Fra                           | Alkaen                                   |
|  | Up to                         | Bis                      | Jusqu'à  | Fino a                               | Hasta                              |  | Tot  | Aż do                                     | Till                         | Til                            | Til                           | Asti                                     |
|  | Except                        | Ausser                   | Sauf   | Escluso                              | Excepto                            |  | Behalve                                      | Z wyjątkiem                               | Utom                         | Unntatt                        | Uden                          | Ilman                                    |
|  | Remarks                       | Bemerkungen              | Remarques                                      | Osservazioni                         | Observaciones                      |  | Opmerkingen                                  | Uwagi                                     | Anmärkingar                  | Anmerkninger                   | Anmærkninger                  | Huomautuksia                             |
|  | Alternator                    | Lichtmaschine            | Alternateur                                    | Alternatore                          | Alternador                         |  | Alternator                                   | Alternator                                | Generator                    | Dynamo                         | Generator                     | Laturi                                   |
|  | Diameter                      | Durchmesser              | Diamètre                                       | Diametro                             | Diámetro                           |  | Diameter                                     | Średnica                                  | Diameter                     | Diameter                       | Diameter                      | Halkaisija                               |
|  | Chain driven timing system    | Kette                    | Système de distribution par chaîne             | Sistema distribuzione a catena       | Sistema de distribución por cadena |  | Door ketting aangedreven distributiesysteem  | łańcuchowy układ rozrządu                 | Kedjedriven kamaxel          | Kjededrevet kamaksel           | Kæde dreven knastaksel        | Ketjukäyttöinen ajoitusjärjestelmä       |
|  | Pinion driven timing system   | Zahnrad                  | Système de distribution par cascade de pignons | Sistema distribuzione ad ingranaggi  | Sistema de distribución por piñón  |  | Door tandwiel aangedreven distributiesysteem | Zębatkowy układ rozrządu                  | Kugghjulsdriven kamaxel      | Tannhjulsdrevet kamaksel       | Tandhjuls dreven knastaksel   | Hammaspyöräkäyttöinen ajoitusjärjestelmä |
|  | Number of teeth               | Anzahl der Zähne         | Nombre de dents                                | Numero di denti                      | Número de dientes                  |  | Aantal tanden                                | Dotyczy tylko pasków o >>n<< ilości zębów | Antal tänder                 | Antall tenner                  | Tandantal                     | Hammasluku                               |
|  | Tooth profile trapezoidal     | Zahnprofil trapezförmig  | Profil de dent trapézoïdal                     | Profilo denti trapeziodale           | Perfil del diente trapezoidal      |  | Trapeziumvormig tandprofiel                  | Trapezowy zarys zębów                     | Trapetsformad tandprofil     | Tannprofil trapesoide          | Trapezformet tandprofil       | Hampaan profiili puolisuunnikas          |
|  | Tooth profile rounded         | Zahnprofil bogenförmig   | Profil de dent curviligne                      | Profilo denti arrotondato            | Perfil del diente redondeado       |  | Afgerond tandprofiel                         | Zaokrągłony zarys zębów                   | Rundad tandprofil            | Tannprofil avrundet            | Afrundet tandprofil           | Hampaan profiili pyörästetty             |
|  | Double sided toothed belt     | Doppel-Profil            | Courroie à double denture                      | Cinghia con denti su entrambi i lati | Correa con dientes a ambos lados   |  | Riem met tanden aan beide kanten             | Pasek z zębami z obu stron                | Rem med tänder på båda sidor | Reim med tenner på begge sider | Rem med tænder på begge sider | Hihna molemminpuolisella hammastuksella  |
|  | With level adjustment         | Mit Niveauregulierung    | Avec correcteur d'assiette                     | Con sospensione autolivellante       | Con suspensión autonivelante       |  | Niveauregeling                               | Z regulacją poziomu                       | Med nivåjustering            | Med nivåregulering             | Med niveaustjerntger          | Korkeuden säädöllä                       |
|  | Pulley holes                  | Löcher                   | Poulie à 4 trous de fixation                   | Foro puleggia                        | Orificios de la polea              |  | Poeliegaten                                  | Otwory koła pasowego                      | Remskivehål                  | Reimskivehull                  | Remskivehål                   | Hihnapyörän reiät                        |
|  | Power steering                | Servolenkung             | Direction assistée                             | Servosterzo                          | Servodirección                     |  | Stuurbekrachting                             | Wspomaganie kierownicy                    | Servostyrning                | Servostyrning                  | Servostyrning                 | Ohjaustehostin                           |
|  | Threaded shaft                | Welle mit Gewinde        | Axe fileté                                     | Albero filettato                     | Eje roscado                        |  | As met schroefdraad                          | Wałek z gwintowaną końcówką               | Axel med gängor              | Gjenget aksel                  | Aksel med gevind              | Akseli kierteellä                        |
|  | Unthreaded shaft              | Welle ohne Gewinde       | Axe lisse                                      | Albero non filettato                 | Eje sin roscado                    |  | As zonder schroefdraad                       | Niegwintowany wał                         | Axel utan gängor             | Ikke gjenget aksel             | Aksel uden gevind             | Akseli ilman kierrettä                   |
|  | Number of doors               | Anzahl der Türen         | Nombre de portes                               | Numero di porte                      | Número de puertas                  |  | Aantal deuren                                | Liczba drzwi                              | Antal dörrar                 | Antall dører                   | Antal døre                    | Ovien lukumäärä                          |
|  | 2 wheel drive                 | 2-Rad-Antrieb            | 2 roues motrices                               | 2 ruote motrici                      | Tracción a 2 ruedas                |  | 2 wiel aandrijving                           | Napęd na dwa koła                         | 2-hjulsdrift                 | 2-hjulsdrift                   | 2-hjulstræk                   | 2-pyöräveto                              |

|                    | English                                 | Deutsch                            | Français  | Italiano                             | Español                                      |  | Nederlands                             | Polski                                   | Svenska                                   | Norsk                          | Dansk                              | Suomi                                  |
|--------------------|---|------------------------------------|---|--------------------------------------|--|--|--|--|---|--------------------------------|------------------------------------|--|
| <b>4WD</b>         | 4 wheel drive                           | 4-Rad-Antrieb                      | 4 roues motrices                                | 4 ruote motrici                      | Tracción a las 4 ruedas                      |  | 4 wiel aandrijving                     | Napęd na cztery koła                     | 4-hjulsdrift                              | 4-hjulsdrift                   | 4-hjulstræk                        | 4-pyöräveto                            |
| <b>AC</b>          | Air conditioning                        | Klimaanlage                        | Avec climatisation                              | Aria condizionata                    | Aire acondicionado                           |  | Air conditioning                       | Z klimatyzacją                           | Luftkondionering                          | Air conditioning               | Air-conditioning                   | Ilmastointi                            |
| <b>A⊙ / ⊙A</b>     | Automatic tensioner                     | Automatische Spannrolle            | Avec galet tendeur automatique                  | Tenditore automatico                 | Tensor de correa automático                  |  | Automatische spanrol                   | Napinacz automatyczny                    | Automatisk spännrulle                     | Automatisk reimstrammehjul     | Automatisk strammerulle            | Automaattikiristin                     |
| <b>Alu.</b>        | Aluminium body shell                    | Aluminium                          | Corps en Aluminium                              | Corpo in alluminio                   | Cuerpo de aluminio                           |  | Aluminium body                         | Aluminium                                | Aluminium                                 | Aluminium                      | Aluminium                          | Alumiinirunko                          |
| <b>Auto. GBX</b>   | Automatic gearbox                       | Automatikgetriebe                  | Boîte de vitesses automatique                   | Cambio automatico                    | Caja de cambios automática                   |  | Automatische versnellingsbak           | Z automatyczną skrzynią biegów           | Automatväxlad                             | Automatisk girkasse            | Automatisk gearkasse               | Automaattivaihteisto                   |
| <b>Auto. GBX 4</b> | Automatic gearbox                       | Automatikgetriebe, 4 Gänge         | Boîte de vitesses automatique 4 rapports        | Cambio automatico, 5 velocita        | Caja de cambios automática – 4 velocidades   |  | Automatische versnellingsbak, 4-speed  | Z automatyczną 4-biegową skrzynią biegów | Automatväxlad, 5-växlad                   | Automatisk girkasse            | Automatisk 5 trins gearkasse       | Automaattivaihteisto, 4-nopeuksinen    |
| <b>Auto.FAN</b>    | Automatic fan                           | Automatischer Lüfter               | Ventilateur automatique                         | Ventilatore automatico               | Ventilador automático                        |  | Automatische ventilator                | Automatyczny wiatrak                     | Automatisk fläkt                          | Automatisk kjølvifte           | Automatisk ventilator              | Automaatti puhallin                    |
| <b>B</b>           | Belt dimensions                         | Abmessungen Riemen                 | Dimension de la courroie                        | Dimensioni cinghia                   | Dimensiones para la correa                   |  | Riemaftmetingen                        | Pasek                                    | Rem                                       | Reim dimensjoner               | Rem                                | Hihna                                  |
| <b>B(AC)</b>       | Air conditioning belt                   | Riemen für Klimaanlage             | Courroie de compresseur de climatisation        | Cinghia per aria condizionata        | Correa para el aire acondicionado            |  | Riem voor het airconditioningsysteem   | Pasek do klimatyzacji                    | Rem för luftkonditioneringspump           | Reim for AC                    | Rem til luftkonditioneringspumpe   | Ilmastoinnin hihna                     |
| <b>B(Alt)</b>      | Alternator belt                         | Riemen für Lichtmaschine (AC)      | Courroie d'alternateur                          | Cinghia per l'alternatore            | Correa para el alternador                    |  | Riem voor de alternator                | Pasek do alternatora                     | Rem för växelströmsgenerator              | Reim for transmitter           | Rem til vekselstrøms-generator     | Laturin hihna                          |
| <b>B(AP)</b>       | Air pump belt                           | Riemen für Kompressor              | Courroie de pompe pneumatique                   | Cinghia per la pompa pneumatica      | Correa para la bomba de aire                 |  | Riem voor de luchtpomp                 | Pasek do pompy podciśnieniowej           | Rem för luftpump                          | Reim for luftpumpe             | Rem til luftpumpe                  | Ilmapumpun hihna                       |
| <b>B(Cam)</b>      | Camshaft belt                           | Riemen für Kurbelwelle             | Courroie de d'arbre à cames                     | Cinghia per albero a camme           | Correa para árbol de levas                   |  | Riem voor nokkenas                     | Pasek do wałka rozrządu                  | Rem för kamaxel                           | Reim for kamaxel               | Rem til knastaksel                 | Nokka-akselin hihna                    |
| <b>B(Comp)</b>     | Compressor belt                         | Riemen für Kompressor              | Courroie de compresseur moteur                  | Cinghia per compressore              | Correa para el compresor                     |  | Riem voor de compressor                | Pasek do sprężarki                       | Rem för kompressor                        | Reim for kompressor            | Rem til kompressor                 | Kompressorin hihna                     |
| <b>B(Gen)</b>      | Dynamo belt                             | Riemen für Lichtmaschine           | Courroie de dynamo                              | Cinghia per il dinamo                | Correa para la dinamo                        |  | Riem voor de dynamo                    | Pasek do prądnicy                        | Rem för likströmsgenerator                | Reim for dynamo                | Rem til dynamo                     | Laturin hihna                          |
| <b>B(Fan)</b>      | Fan belt                                | Riemen für Lüfter                  | Courroie de ventilateur                         | Cinghia per ventilatore              | Correa para ventilador                       |  | Riem voor ventilator                   | Pasek do wentylatora                     | Fläktrem                                  | Reim for vifte                 | Ventilatorrem                      | Tuulettajan hihna                      |
| <b>B(HP)</b>       | Hydraulic pump belt                     | Riemen für hydraulische Pumpe      | Courroie de pompe hydraulique                   | Cinghia per pompa idraulica          | Correa para la bomba hidráulica              |  | Riem voor hydraulische pomp            | Pasek do pompy hydraulicznej             | Rem för hydragpump                        | Reim for hydraulisk pumpe      | Rem for hydraulisk pumpe           | Hydraulpumpun hihna                    |
| <b>B(inj)</b>      | Injection pump belt                     | Riemen für Einspritzpumpe          | Courroie de pompe à injection                   | Cinghia per pompa ad iniezione       | Correa para la bomba de inyección            |  | Riem voor de injectiepomp              | Pasek do pompy wtryskowej                | Rem för insprutningspump                  | Reim for innsprøytningpumpe    | Rem til indsprøjtningpumpe         | Ruiskutusumpun hihna                   |
| <b>B(PS)</b>       | Power steering pump belt                | Riemen für Lenkhilfpumpe           | Courroie de pompe de direction assistée         | Cinghia per la pompa del servosterzo | Correa para la bomba de dirección            |  | Riem voor de stuurbekrachtigingspomp   | Pasek do pompy wspomagania kierownicy    | Rem för servostyringspump                 | Reim for servopumpe            | Rem til servo-styringspumpe        | Ohjaustehostajan hihna                 |
| <b>B(VP)</b>       | Vacuum pump belt                        | Riemen für Vakuumpumpe             | Courroie de pompe à vide                        | Chingia per pompa da vuoto           | Correa para la bomba de vacío                |  | Riem voor de vacuümpomp                | Pasek do pompy vacuum                    | Rem för vakuumpump                        | Reim for vakuumpumpe           | Rem til vakuumpumpe                | Alipainepumpun hihna                   |
| <b>B(WP)</b>       | Water pump belt                         | Riemen für Wasserpumpen            | Courroie de pompe à eau                         | Cinghia per pompa acqua              | Correa para la bomba de agua                 |  | Riem voor de waterpomp                 | Pasek do pompy wody                      | Rem för vattenpump                        | Reim for vannpumpe             | Rem til vandpumpe                  | Vesipumpun hihna                       |
| <b>c</b>           | Camshaft dampener                       | Nockenwellenrad                    | Poulie damper d'arbre à cames                   | Smorzatore albero a camme            | Pistón del árbol de levas                    |  | Camshaft damper                        | Nockenwellenrad                          | Poulie damper d'arbre à cames             | Smorzatore albero a camme      | Pistón del árbol de levas          | Camshaft damper                        |
| <b>Carbu.</b>      | Carburettor                             | Vergaser                           | Moteur à carburateur                            | Carburatore                          | Carburador                                   |  | Carburator                             | Vergaser                                 | Moteur à carburateur                      | Carburatore                    | Carburador                         | Carburator                             |
| <b>Cast.</b>       | Cast iron body shell                    | Gusseisen                          | Corps en fonte                                  | Corpo in ghisa                       | Fundición                                    |  | Cast iron                              | Gusseisen                                | Corps en fonte                            | Corpo in ghisa                 | Fundición                          | Cast iron                              |
| <b>CH</b>          | Chassis number                          | Fahrgestellnummern                 | Numéro de châssis                               | Numero di telaio                     | Referencia del chasis                        |  | Chassi reference                       | Fahrgestellnummern                       | Numéro de châssis                         | Numero di telaio               | Referencia del chasis              | Chassi reference                       |
| <b>Dep.</b>        | Depollution                             | Schadstoffemission                 | Norme de dépollution                            | Disinquinamento                      | Norma medioambiental                         |  | Depollution                            | Schadstoffemission                       | Norme de dépollution                      | Disinquinamento                | Norma medioambiental               | Depollution                            |
| <b>DOHC</b>        | Double over head camshaft               | 2 obenliegende Nockenwellen        | Double arbre à cames en tête                    | 2 alberi a camme in testa            | Doble árbol de levas en culata (DOHC)        |  | Twee bovenliggende nokkenassen         | Układ z dwoma wałkami rozrządu           | Dubbla överliggande kamaxlar              | Dobbel overliggende kamaxel    | Dobbel overliggende knastaksel     | Kahdella yläpuolisella nokka-akselilla |
| <b>EHPS</b>        | Vehicle with EHPS                       | Servolenkung (elektro-hydraulisch) | Direction assistée électro-hydraulique          | Veicolo con EHPS                     | Vehículo con dirección asistida EHPS         |  | Met EHPS                               | Pojazd z EHPS                            | Elektro- hydraulisk servostyrning         | Med EHPS                       | Elektro-hydraulisk servostyrning   | Sähköhydraulisella ohjaustehostimella  |
| <b>ESC</b>         | With Electronic Stability Control (ESC) | ESC                                | Avec correcteur électronique de trajectoire ESC | Con Sistema di controllo stabilità   | Con control electrónico de estabilidad (ESC) |  | Met elektronische stabiliteitscontrole | Z elektroniczną kontrolą trakcji         | Med elektronisk stabilitetskontroll (ESC) | Med ESC                        | ESC Elektronisk stabilitetsprogram | Elektronisella ajonvakautuksella       |
| <b>ESP</b>         | Electronic stability program            | ESP                                | Avec correcteur électronique de trajectoire ESP | Programma elettronico di stabilità   | Programa electrónico de estabilidad (ESP)    |  | Elektronisch stabiliteitsprogramma     | Z elektroniczną kontrolą trakcji         | Med elektronisk stabilitetskontroll (ESP) | Elektronisk stabilitetsprogram | ESP Elektronisk stabilitetsprogram | Elektronisella ajonvakautuksella       |
| <b>e</b>           | Mechanical tappets                      | Mechanisches Stößel                | Poussoirs mécaniques                            | Valvole a comando meccanico          | Válvulas de control mecánico                 |  | Mechanische klepstoters                | Popychacze mechaniczne                   | Mekaniska ventillyftare                   | Mekanisk ventilløfter          | Mekaniske ventilløftere            | Mekaaniset ventti-innostimet           |

|  | English                              | Deutsch  | Francais                               | Italiano                                | Español   |  | Nederlands                           | Polski                                      | Svenska                             | Norsk                                    | Dansk                           | Suomi                                 |
|--|--------------------------------------|--|--|---|---|--|--------------------------------------|---|-------------------------------------|--|---------------------------------|---------------------------------------|
| <b>f</b>                                   | Hydraulic tappets                    | Hydraulisches Stößel                           | Poussoirs hydrauliques                 | Valvole a comando idraulico             | Válvulas de control hidráulico                    |  | Hydraulische klepstoters             | Popychacze hydrauliczne                     | Hydrauliska ventillyftare           | Hydrauliske ventilløftere                | Hydrauliske ventilløftere       | Hydrauliset venttiil-innostimet       |
| <b>Fix.FAN</b>                             | Fixed fan                            | Lüfter   | Ventilateur fixe                       | Ventilatore fisso                       | Ventilador fijo                                   |  | Vaste ventilator                     | Stały napęd wentylatora                     | Fast fläkt                          | Kontinuerlig drevet kjølvifte            | Fast ventilator                 | Kiinteä puhallin                      |
| <b>HP</b>                                  | Hydraulic pump                       | Hydraulische Pumpe                             | Pompe hydraulique                      | Pompa idraulica                         | Bomba hidráulica                                  |  | Hydraulisch pomp                     | Pompa hydrauliczna                          | Hydraulisk pump                     | Hydraulisk pumpe                         | Hydraulik pumpe                 | Hydraulipumppu                        |
| <b>HT</b>                                  | Hydraulic tensioned                  | Hydraulisches Spannen                          | Tendeur hydraulique                    | Tensionamento idraulico                 | Tensión hidráulica                                |  | Hydraulisch gespannt                 | Napinacz hydrauliczny                       | Hydraulisk spänd                    | Hydraulisk strammer                      | Hydraulisk strammer             | Hydraulinen kiristin                  |
| <b>Injec.</b>                              | Injection                            | Einspritzpumpe (Satz)                          | Moteur à injection                     | Pompa iniezione                         | Kit bomba de inyección                            |  | Inspuitnig                           | Zestaw z pompą wtryskową                    | Sats för insprutningspump           | Injeksjonspumpe sett                     | Sæt for indsprøjtning-spumpe    | Ruiskutuspumppusarja                  |
| <b>j</b>                                   | Check the belt tensioner unit design | Überprüfen Sie die Abmessungen der Spannrollen | Contrôler la photo du galet            | Controllare il disegno del tendicinghia | Comprobar el diagrama de los rodillos tensores    |  | Controleer het design van de spanrol | Sprawdź konstrukcję zespołu napinacza paska | Kontrollera spännrollens utformning | Kontroller reimstrammerens typbetegnelse | Kontrollér remspænding-senheden | Tarkista hihnankiristimen numero      |
| <b>L.H.D</b>                               | Left hand drive                      | Linkslenkung                                   | Conduite à gauche                      | Guida a sinistra                        | Conducción izquierda                              |  | Linkse besturing                     | Kierownica z lewej strony                   | Vänsterstyrd                        | Ratt på venstre side                     | Venstrestyret                   | Ohjaus vasemmalla                     |
| <b>Man. GBX</b>                            | Manual gearbox                       | Schaltgetriebe                                 | Boîte de vitesses manuelle             | Cambio Manuale                          | Cambio manual                                     |  | Manuele versnellingsbak              | Z manualną skrzynią biegów                  | Manuell växellåda                   | Manuell girkasse                         | Manuel gearkasse                | Käsivalintainen vaihteisto            |
| <b>Man. GBX 5</b>                          | Manual gearbox, 5-speed              | Schaltgetriebe, 5 Gänge                        | Boîte de vitesses manuelle 5 vitesses  | Cambio manuale, 5 velocità              | Caja de cambios manual, 5 velocidades             |  | Manuele versnellingsbak, 5-speed     | Pięciobiegowa manualna skrzynia biegów      | Manuell växellåda, 5-växlad         | Manuell, 5-speed                         | Manuel 5 trins gearkasse        | Käsivalintainen vaihteisto, 5-nop     |
| <b>MO / M</b>                              | Manual tensioner                     | Mechanische Spannrolle                         | Galet tendeur manuel                   | Tensionatore manuale                    | Tensor manual                                     |  | Manuele spanrol                      | Napinacz regulowany ręcznie                 | Manuell spännrulle                  | Manuell strammer                         | Manuel strammer                 | Manuaalinen kiristin                  |
| <b>MT</b>                                  | Mechanical tensioned                 | Mechanisches Spannen                           | Tendeur mécanique                      | Tensionamento meccanico                 | Tensión mecánica                                  |  | Mechanisch gespannt                  | Napinanie mechaniczne                       | Mekaniskt spänd                     | Mechanical tensioned                     | Mekaniske strammer              | Mekaaninen kiristin                   |
| <b>Mod.</b>                                | Model reference                      | Modell Referenz                                | Modèle                                 | Versione del modello                    | Referencia del modelo                             |  | Referentie model                     | Numer modelu                                | Modellbeteckning                    | Modellreferanse                          | Model reference                 | Malli                                 |
| <b>Mot.</b>                                | Engine reference                     | Motor Referenz                                 | Numéro de moteur                       | Riferimento del motore                  | Referencia del motor                              |  | Motor referentie                     | Silnik                                      | Motorbeteckning                     | Motor referanse                          | Motor reference                 | Mootorin tyyppi                       |
| <b>p</b>                                   | Toothed pulley                       | Umlenkrolle mit Zahnprofil                     | Kit de distribution avec poulie dentée | Puleggia folle                          | Polea dentada                                     |  | Getande poelie                       | Koło pasowe zębate                          | Tandad löprulle                     | Løpehjul med tenner                      | Remskive med tænder             | Hammastettu rulla                     |
| <b>R.H.D</b>                               | Right hand drive                     | Rechtslenkung                                  | Conduite à droite                      | Guida a destra                          | Conducción derecha                                |  | Rechtse besturing                    | Kierownica z prawej strony                  | Högerstyrd                          | Ratt på høyre side                       | Højrestyret                     | Oikeanpuoleinen ohjaus                |
| <b>SOHC</b>                                | Single over head camshaft            | 1 obenliegende Nockenwelle                     | Simple arbre à cames en tête           | 1 albero a camme in testa               | Único árbol de levas en culata – monoárbol (SOHC) |  | Eén bovenliggende nokkenas           | Układ z pojedynczym wałkiem rozrządu        | Enkel överliggande kamaxel          | Singel overliggende kamaksel             | Enkel overliggende knastaksel   | Yhdellä yläpuolisella nokka-akselilla |
| <b>THT</b>                                 | Thermostat                           | Thermostat                                     | Thermostat                             | Termostato                              | Termostato  |  | Thermostaat                          | Termostat                                   | Termostat                           | Termostat                                | Termostat                       | Termostaatti                          |
| <b>VETTno</b>                              | VETT No                              | VETT Nr  | Numéro VETT                            | No di VETT.                             | No de VETT.                                       |  | VETT Nr                              | Nr VETT                                     | VETT No                             | VETT nr.                                 | VETT nr.                        | VETT numero                           |
| <b>VKM/A/C/S/V XXXXX<br/>VKP/A/C XXXXX</b> | In production                        | In Produktion                                  | Kit disponible                         | In produzione                           | En producción                                     |  | In productie                         | Oferowane                                   | I produktion                        | I produksjon                             | Producers                       | Tuotannossa                           |
| <b>VKM/A/C/S/V XXXXX<br/>VKP/A/C XXXXX</b> | No longer manufactured               | Nach Abverkauf nicht mehr im Sortiment         | N'est plus fabriqué                    | Non più in produzione                   | Finalizada su producción                          |  | Wordt niet meer gemaakt              | Wycofane z produkcji                        | Tillverkas ej längre                | Ikke lenger i produksjon                 | Producers ikke mere             | Valmistus lopetettu                   |
| <b>VKM/A/C/S/V _____<br/>VKP/A/C _____</b> | Product under development            | Produkte in Vorbereitung                       | En projet                              | Prodotti in sviluppo                    | Producto en desarrollo                            |  | Product in ontwikkeling              | Produkt opracowywany                        | Under utveckling                    | Produkter under utvikling                | Produkter under udvikling       | Tuote kehitteillä                     |
| <b>–</b>                                   | No kit available                     | Kein Reparatursatz verfügbar                   | Pas de kit disponible                  | Kit non disponible                      | Kit no disponible                                 |  | Geen set beschikbaar                 | Brak zestawu                                | Sats finns ej                       | Sett ikke tilgjengelig                   | Sæt kan ikke leveres            | Sarjaa ei saatavana                   |

# SKF – the knowledge engineering company

From the company that invented the self-aligning ball bearing more than 100 years ago, SKF has evolved into a knowledge engineering company that is able to draw on five platforms to create unique solutions for its customers. These platforms include bearings, bearing units and seals, of course, but extend to other areas including: lubricants and lubrication systems, critical for long bearing life in many applications; mechatronics that combine mechanical and electronics knowledge into systems for more effective linear motion and sensorized solutions; and a full range of services, from design and logistics support to conditioning monitoring and reliability systems.

Though the scope has broadened, SKF continues to maintain the world's leadership in the design, manufacture and marketing of rolling bearings, as well as complementary products such as radial seals. SKF also holds an increasingly important position in the market for linear motion products, high-precision aerospace bearings, machine tool spindles and plant maintenance services.

The SKF Group is globally certified to ISO 14001:2004, the international standard for environmental management, as well as OHSAS 18001, the health and safety management standard. Individual divisions have been approved for quality certification in accordance with either ISO 9001:2000 or ISO/TS 16949:2002.

With some 100 manufacturing sites world-wide and sales companies in 70 countries, SKF is a truly international corporation. In addition, our distributors and dealers in some 15 000 locations around the world, an e-business marketplace and a global distribution system put SKF close to customers for the supply of both products and services. In essence, SKF solutions are available wherever and whenever customers need them. Overall, the SKF brand and the corporation are stronger than ever. As the knowledge engineering company, we stand ready to serve you with world-class product competencies, intellectual resources, and the vision to help you succeed.

© SKF is a registered trademark of the SKF Group.

© SKF Group 2008

The contents of this publication are the copyright of the publisher and may not be reproduced (even extracts) unless permission is granted. Every care has been taken to ensure the accuracy of the information contained in this publication but no liability can be accepted for any loss or damage whether direct, indirect or consequential arising out of the use of the information contained herein.

Publication **PUB 80/P1 6587 EN E 08**

This publication supersedes publication PUB 80/P1 6203 EN E 06, PUB 80/P1 6254 EN E 07 and PUB 80/P1 6591 EN 07/08

# Engine catalogue



[www.vsm.skf.com](http://www.vsm.skf.com)

© SKF Group 2008  
PUB 80/P1 6587 EN E 08

